

# SYSTEM USER GUIDE



MiniMed™ 770G



MiniMed™ 770G  
**SYSTEM USER GUIDE**



# Copyright & trademarks

© 2020 Medtronic. All rights reserved. Medtronic, Medtronic logo and Further, Together are trademarks of Medtronic. ™\*\* Third party brands are trademarks of their respective owners. All other brands are trademarks of a Medtronic company.

Bolus Wizard™, CareLink™, Dual Wave™, Guardian™, MiniMed™, Mio™, Quick-set™, Silhouette™, SmartGuard™, Square Wave™, and Sure-T™ are trademarks of Medtronic MiniMed, Inc.

ACCU-CHEK and ACCU-CHEK GUIDE are trademarks of Roche.

Ascensia, the Ascensia Diabetes Care logo, and Contour are trademarks and/or registered trademarks of Ascensia Diabetes Care Holdings AG.

Tylenol™\*\*

Wi-Fi™\*\*

Bluetooth™\*\*

Humalog™\*\*

NovoLog™\*\*

Android™\*\*

iOS™\*\*

## Medtronic



**Medtronic MiniMed**  
18000 Devonshire Street  
Northridge, CA 91325  
USA  
1 800 646 4633  
+1 818 576 5555  
[www.medtronicdiabetes.com](http://www.medtronicdiabetes.com)

**R<sub>x</sub>** Only

## Contacts:

**Africa:** Medtronic South Africa and Southern Africa  
Office Reception Tel: +27(0) 11 260 9300  
Diabetes: 24/7 Helpline: 0800 633 7867  
Sub-Sahara 24/7 Helpline: +27(0) 11 260 9490

**Albania:** Net Electronics Albania  
Tel: +355 697070121

**Argentina:** Corpomedica SA.  
Tel: +(11) 4 814 1333  
Medtronic Directo 24/7:  
+0800 333 0752

**Armenia:** Exiol LLC  
Tel: +374 98 92 00 11  
or +374 94 38 38 52

**Australia:** Medtronic Australasia Pty. Ltd.  
Tel: 1800 668 670

**Bangladesh:** Sonargaon Healthcare Pvt Ltd.  
Mobile: (+91)-9903995417  
or (+880)-1714217131

**Belarus:** Zarga Medica  
Tel: +375 29 625 07 77  
or +375 44 733 30 99  
Helpline: +74995830400

**België/Belgique:** N.V. Medtronic Belgium SA.  
Tel: 0800-90805

**Bosnia and Herzegovina:**  
"Novopharm" d.o.o. Sarajevo  
Tel: +387 33 476 444  
Helpline: 0800 222 33  
Epsilon Research Intern. d.o.o.  
Tel: +387 51 251 037  
Helpline: 0800 222 33

**Brasil:** Medtronic Comercial Ltda.  
Tel: +(11) 2182-9200  
Medtronic Directo 24/7:  
+0800 773 9200

**Bulgaria:** RSR EOOD  
Tel: +359 888993083  
Helpline: +359 884504344

**Canada:** Medtronic Canada ULC  
Tel: 1-800-284-4416 (toll free/sans-frais)

**Chile:** Medtronic Chile  
Tel: +(9) 66 29 7126  
Medtronic Directo 24/7:  
+1 230 020 9750  
Medtronic Directo 24/7 (From Santiago):  
+(2) 595 2942

**China:** Medtronic (Shanghai) Management Co, Ltd.  
Landline: +86 800-820-1981  
Mobile Phone: +86 400-820-1981  
Calling from outside China: +86 400-820-1981

**Colombia:** Medtronic Latin America Inc. Sucursal Colombia  
Tel: +(1) 742 7300  
Medtronic Directo 24/7 (Landline):  
+01 800 710 2170  
Medtronic Directo 24/7 (Cellular):  
+1 381 4902

**Croatia:** Mediligo d.o.o.  
Tel: +385 1 6454 295  
Helpline: +385 1 4881144  
Medtronic Adriatic d.o.o.  
Helpline: +385 1 4881120

**Danmark:** Medtronic Danmark A/S  
Tel: +45 32 48 18 00

**Deutschland:** Medtronic GmbH  
Geschäftsbereich Diabetes  
Telefon: +49 2159 8149-370  
Telefax: +49 2159 8149-110  
24-Std-Hotline: 0800 6464633

**Eire:** Accu-Science LTD.  
Tel: +353 45 433000

**España:** Medtronic Ibérica SA.  
Tel: +34 91 625 05 42  
Fax: +34 91 625 03 90  
24 horas: +34 900 120 330

**Estonia:** AB Medical Group Estonia Ltd  
Tel: +372 6552310  
Helpline: +372 5140694

**Europe:** Medtronic Europe SA. Europe, Middle East and Africa HQ  
Tel: +41 (0) 21-802-7000

**France:** Medtronic France S.A.S.  
Tel: +33 (0) 1 55 38 17 00

**Hellas:** Medtronic Hellas SA.  
Tel: +30 210677-9099

**Hong Kong:** Medtronic International Ltd.  
Tel: +852 2919-1300  
To order supplies:  
+852 2919-1322  
24-hour helpline: +852 2919-6441

**India:** India Medtronic Pvt. Ltd.  
Tel: (+91)-80-22112245 / 32972359  
Mobile: (+91)-9611633007  
Patient Care Helpline:  
1800 209 6777

**Indonesia:** Medtronic International Ltd.  
Tel: +65 6436 5090  
or +65 6436 5000

**Israel:** Medtronic  
Tel. (orders):  
+9729972440, option 3 + option 1  
Tel. (product support):  
+9729972440, option 2  
Helpline (17:00 – 08:00 daily/weekends – Israel time):  
1-800-611-888

**Italia:** Medtronic Italia Sp.A.  
Tel: +39 02 24137 261  
Fax: +39 02 24138 210  
Servizio assistenza tecnica:  
Nº verde: 800 60 11 22

**Japan:** Medtronic Japan Co. Ltd.  
Tel: +81-3-6776-0019  
24 Hr. Support Line:  
0120-56-32-56

**Kazakhstan:** Medtronic BV in Kazakhstan  
Tel: +7 727 311 05 80 (Almaty)  
Tel: +7 717 224 48 11 (Astana)  
Круглосуточная линия поддержки:  
8 800 080 5001

**Kosovo:** Yess Pharma  
Tel: +377 44 999 900  
Helpline: +37745888388

**Latin America:** Medtronic, Inc.  
Tel: 1(305) 500-9328  
Fax: 1(786) 709-4244

**Latvija:** RAL SIA  
Tel: +371 67316372  
Helpline (9am to 6pm):  
+371 29611419

**Lithuania:** Monameda UAB  
Tel: +370 68405322  
Helpline: +370 68494254

**Macedonia:** Alkaloid Kons Doel  
Tel: +389 23204438

**Magyarország:** Medtronic Hungária Kft.  
Tel: +36 1 889 0688

**Malaysia:** Medtronic International Ltd.  
Tel: +603 7946 9000

**Middle East and North Africa:**  
Regional Office  
Tel: +961-1-370 670

**Montenegro:** Glosarij d.o.o.  
Tel: +382 20642495

**México:** Medtronic Servicios S. de R. L. de C.V.  
Tel (México DF): +(11) 029 058  
Tel (Interior): +01 800 000 7867  
Medtronic Directo 24/7 (from México DF):  
+(55) 36 869 787  
Medtronic Directo 24/7:  
+01 800 681 1845

**Nederland, Luxembourg:** Medtronic BV.  
Tel: +31 (0) 45-566-8291  
Gratis: 0800-3422338

**New Zealand:** Medica Pacifica  
Phone: 64 9 414 0318  
Free Phone: 0800 106 100

**Norge:** Medtronic Norge A/S  
Tel: +47 67 10 32 00  
Fax: +47 67 10 32 10

**Philippines:** Medtronic International Ltd.  
Tel: +65 6436 5090  
or +65 6436 5000

**Россия:** ООО «Медтроник»  
Tel: +7 495 580 73 77  
Круглосуточная линия поддержки:  
8 800 200 76 36

**Polska:** Medtronic Poland Sp. z o.o.  
Tel: +48 22 465 6934

**Portugal:** Medtronic Portugal Lda  
Tel: +351 21 7245100  
Fax: +351 21 7245199

**Puerto Rico:** Medtronic Puerto Rico  
Tel: 787-753-5270

**Republic of Korea:** Medtronic Korea, Co., Ltd.  
Tel: +82.2.3404.3600

**Romania:** Medtronic Romania SRL  
Tel: +40372188017  
Helpline: +40 726677171

**Schweiz:** Medtronic (Schweiz) AG  
Tel: +41 (0)31 868 0160  
24-Stunden-Hotline: 0800 633333  
Fax Allgemein: +41 (0)318680199

**Serbia:** Epsilon Research International d.o.o.  
Tel: +381 113115554  
Medtronic Serbia D.o.o  
Helpline: +381 112095900

**Singapore:** Medtronic International Ltd.  
Tel: +65 6436 5090  
or +65 6436 5000

**Slovenija:** Zaloker & Zaloker d.o.o.  
Tel: +386 1 542 51 11  
24-urna tehnična pomoč:  
+386 51316560

**Slovenská republika:** Medtronic Slovakia, s.r.o.  
Tel: +421 26820 6942  
HelpLine: +421 26820 6986

**Sri Lanka:** Swiss Biogenics Ltd.  
Mobile: (+91)-9003077499  
or (+94)-777256760

**Suomi:** Medtronic Finland Oy  
Tel: +358 20 7281 200  
Help line: +358 400 100 313

**Sverige:** Medtronic AB  
Tel: +46 8 568 585 20  
Fax: +46 8 568 585 11

**Taiwan:** Medtronic (Taiwan) Ltd.  
Tel: 02-21836000  
Toll free: +886-800-005285

**Thailand:** Medtronic (Thailand) Ltd.  
Tel: +662 232 7400

**Türkiye:** Medtronic Medikal Teknoloji Ticaret Ltd. Sirketi.  
Tel: +90 216 4694330

**USA:** Medtronic Diabetes Global Headquarters  
24-Hour Technical Support:  
+1-800-646-4633  
To order supplies:  
+1-800-843-6687

**Ukraine:** Med Ek Service TOV  
Tel: +380 50 3311898  
or +380 50 4344346  
Лінія цілодобової підтримки:  
0 800 508 300

**United Kingdom:** Medtronic Ltd.  
Tel: +44 1923-205167

**Österreich:** Medtronic Österreich GmbH  
Tel: +43 (0) 1 240 44-0  
24 – Stunden – Hotline:  
0820 820 190

**Česká republika:** Medtronic Czechia s.r.o.  
Tel: +420 233 059 111  
Non-stop helpline (24/7):  
+420 233 059 059  
Zákaznický servis (8:00 - 17:00):  
+420 233 059 950

**WARNING:**

**Do not use SmartGuard Auto Mode for people who require less than eight units or more than 250 units of total daily insulin per day. A total daily dose of at least eight units, but no more than 250 units, is required to operate in Auto Mode.**

## Warranty

The expected life of the MiniMed insulin pump is a maximum of 4 years. Medtronic Diabetes warrants the MiniMed insulin pump against defects in materials and workmanship for a period of 4 years from the date of purchase.

During the warranty period, Medtronic Diabetes will, at its discretion, replace (with a new or recertified pump, at Medtronic Diabetes' discretion) any defective pump or motor, subject to the conditions and exclusions stated herein. In the event that a pump is replaced, the warranty period will not be extended.

This warranty is valid only if the MiniMed insulin pump is used in accordance with the manufacturer's instructions. This warranty will not apply:

- If damage results from changes or modifications made to the pump by the user or third persons after the date of manufacture.
- If damage results from use of non-Medtronic reservoirs and/or infusion sets.
- If damage results from service or repairs performed by any person or entity other than the manufacturer.
- If damage results from a *Force Majeure* or other event beyond the control of the manufacturer.
- If damage results from negligence or improper use, including but not limited to improper storage; water submersion that does not meet the instructions of the manufacture; or physical abuse, such as dropping or otherwise.

This warranty shall be personal to the original user. Any sale, rental or other transfer or use of the product covered by this warranty to or by a user other than the original user shall cause this warranty to immediately terminate. This warranty does not apply to batteries, infusion sets, reservoirs, and other accessories.

**The remedies provided for in this warranty are the exclusive remedies available for any breach hereof. Neither Medtronic Diabetes nor its suppliers or distributors shall be liable for any incidental, consequential, or special damage of any nature or kind caused by or arising out of a defect in the product.**

**All other warranties, expressed or implied, are excluded, including the warranties of merchantability and fitness for a particular purpose.**



# Contents

## ■ Before you begin

3	Using this user guide
5	Acronyms and abbreviations
6	Emergency kit
7	User safety
7	Indications
8	Guardian Sensor (3)
8	One-press Serter
9	Guardian Link (3) Transmitter
9	Accu-Chek Guide Link Blood Glucose Monitoring System
10	Contraindications
10	Potential risks
13	General warnings
26	General precautions
28	Security precautions
29	Adverse reactions
29	Keeping track of your system information
30	Insulin guidelines
30	Consumables
32	Additional MiniMed 770G System devices
33	Accessories
33	Ordering supplies and accessories

## ■ **First steps**

- 37 Your pump
- 38 Using the buttons
- 39 About batteries
- 40 Inserting the battery
- 41 Removing the battery
- 42 Getting to know your pump
- 43 Entering your startup settings
- 45 Unlocking your pump
- 45 Home screen
- 46 Status icons
- 51 Using the menu
- 52 Status screens
- 54 Modes
- 55 Manual Mode
- 58 SmartGuard Auto Mode
- 59 Scroll bar
- 60 Power modes
- 60 If you remove your pump

## ■ **Basal**

- 65 Basal rate
- 66 Basal insulin settings
- 67 Max Basal rate
- 67 Example 1: Max basal rate
- 68 Example 2: Max basal rate
- 68 Basal patterns
- 69 Adding a new basal pattern
- 72 Editing, copying, or deleting a basal pattern
- 72 Changing from one basal pattern to another
- 73 Example 1: Basal patterns

73	Example 2: Basal patterns
73	Temp basal rates
74	About temp basal rates
75	Example 1: Temp basal rates
75	Starting a temp basal rate
76	Preset temp basal rates
79	Canceling a temp basal or preset temp basal rate
79	Viewing your basal information
80	Stopping and resuming your insulin delivery

## ■ Bolus

85	About bolus deliveries
85	Bolus types
86	Bolus type example
87	Bolus delivery options
89	Bolus settings
90	Max bolus
91	Example 1: Max bolus
91	Example 2: Max bolus
91	Bolus increment
92	Bolus speed
92	Bolus Wizard feature
93	Understanding your Bolus Wizard settings
94	Setting up the Bolus Wizard feature
96	Changing your Bolus Wizard settings
98	Turning off the Bolus Wizard feature
98	About active insulin
99	Bolus Wizard feature alerts
100	Normal bolus
100	Delivering a Normal bolus with the Bolus Wizard feature
103	Delivering a Normal bolus using Manual Bolus
103	Square Wave bolus

- 104 Turning on or off the Square Wave bolus feature
- 104 Delivering a Square Wave bolus with the Bolus Wizard feature
- 106 Delivering a Square Wave bolus using Manual Bolus
- 106 Dual Wave bolus
- 107 Turning on or off the Dual Wave bolus feature
- 107 Delivering a Dual Wave bolus with the Bolus Wizard feature
- 108 Delivering a Dual Wave Bolus using Manual Bolus
- 109 Easy Bolus feature
- 110 Understanding the Easy Bolus step sizes
- 110 Setting up the Easy Bolus feature
- 111 Delivering a bolus using the Easy Bolus feature
- 112 Preset bolus
- 112 Setting up and managing preset bolus deliveries
- 114 Delivering a preset bolus
- 114 Stopping a bolus delivery

## ■ Reservoir and infusion set

- 119 Setting up the reservoir and infusion set
- 132 Disconnecting your infusion set
- 132 Reconnecting your infusion set

## ■ Meter

- 135 About your Accu-Chek Guide Link meter
- 136 Pairing your pump and meter
- 138 Deleting a meter from your pump
- 138 Deleting your pump from a meter

## ■ History and events

- 141 History
- 141 Summary screen
- 142 Understanding the Summary screen
- 145 Daily History

- 145 Alarm History
- 146 Sensor Glucose Review
- 147 ISIG History
- 148 Event Markers

## ■ Reminders

- 153 Personal reminders
- 154 Bolus BG Check reminder
- 155 Missed Meal Bolus reminder
- 155 Low Reservoir reminder
- 156 Set Change reminder
- 157 Calibration reminder

## ■ General settings

- 161 Audio Options
- 161 Auto Suspend
- 162 Block Mode
- 163 Display Options
- 163 Language
- 164 Managing your pump settings
- 168 Upload to CareLink software
- 168 Self Test
- 169 Sensor Demo
- 170 Time and date

## ■ Setting up CGM

- 173 Understanding CGM
- 174 SmartGuard Technology
- 175 Home screen with CGM in Manual Mode
- 178 Understanding glucose settings
- 179 High SG settings
- 180 Low SG settings

194	Turning on the Sensor feature
194	Setting up the high SG settings
197	Setting up the low SG settings
200	Manually resuming basal insulin delivery during a SmartGuard suspend event
201	Pairing your pump and transmitter
204	Deleting the transmitter from your pump
204	Inserting the sensor
205	Connecting the transmitter to the sensor
205	Starting the sensor
206	Reconnecting the sensor
206	Calibrating your sensor
207	Where to enter your calibration BG meter reading
208	When to calibrate
209	Guidelines for calibrating
210	Disconnecting the transmitter from the sensor
210	Removing the sensor
210	Turning off Sensor Settings

## ■ Using CGM

213	The sensor graph
214	Identifying rapid changes in SG
215	Silencing glucose alerts

## ■ SmartGuard Auto Mode

221	About SmartGuard Auto Mode
222	Manual Mode
222	Before using SmartGuard Auto Mode
223	Setting up SmartGuard Auto Mode
224	Conditions to activate SmartGuard Auto Mode
225	SmartGuard suspend features and SmartGuard Auto Mode
225	SmartGuard Auto Mode Readiness

- 227 Home screen with SmartGuard Auto Mode
- 228 Using SmartGuard Auto Mode
- 228 Safe Basal
- 230 Example: Safe Basal
- 230 Block Mode when in SmartGuard Auto Mode
- 230 Setting Temp Target
- 232 SmartGuard Auto Mode sensor graph
- 233 Enter BG
- 234 SmartGuard Auto Mode Bolus
- 236 Alert Silence
- 239 Exiting SmartGuard Auto Mode
- 239 Returning to SmartGuard Auto Mode

■ **Alarms, alerts, and messages**

- 243 About alarms, alerts, and messages
- 244 Alarms
- 245 Alerts
- 246 Messages
- 246 Pump alarms, alerts, and messages
- 264 CGM (sensor) alarms, alerts, and messages
- 275 SmartGuard Auto Mode alerts and messages
- 280 CareLink software alert and message

■ **Troubleshooting**

- 285 Troubleshooting pump issues
- 286 My pump buttons are stuck
- 286 What is a Check Settings alarm?
- 286 My pump is asking me to rewind
- 287 I dropped my pump
- 287 I cannot get to the Manage Settings screen
- 287 My pump display times out too quickly
- 288 Where is my pump status screen?

- 288 My pump is asking me to enter my settings
- 290 Troubleshooting sensor issues
- 290 My pump cannot find the sensor signal
- 291 Calibration not accepted
- 291 Why does the SmartGuard suspend icon on my Home screen appear gray?

## ■ **Maintenance**

- 295 Cleaning your pump
- 296 Cleaning your transmitter
- 296 Storing your pump
- 297 Storing your transmitter
- 298 Pump disposal

## ■ **Product specifications and safety information**

- 301 Product specifications
- 301 Alarm and alert escalation
- 302 Altitude range
- 302 Audio frequency
- 303 Backlight
- 304 Basal insulin delivery
- 304 BG Target
- 304 BG meter value
- 305 Bolus delivery
- 305 Bolus Wizard feature default settings
- 305 Bolus Wizard feature specifications
- 308 Carb ratios
- 308 Delivery accuracy
- 309 Easy Bolus feature
- 310 Environmental conditions
- 310 Essential performance
- 310 Filling the infusion set and cannula



311	Infusion pressure
311	Insulin delivery default settings
312	Insulin sensitivity factor
312	Low Reservoir reminder
313	Max bolus
313	Normal bolus
313	Occlusion detection
314	Percent temp basal rate
314	Program safety checks
314	Pump dimensions
314	Pump memory
314	Pump weight
314	Sensor default settings
317	Wireless communication
317	FCC notice
318	IEC60601-1-2:4th Edition notice
318	IEC60601-1-2:4th Edition; Special EMC Precautions for Medical Electrical Equipment
318	IEC60601-1-2:4th Edition; 5.2.1.1
319	Guidance and manufacturer's declaration
322	Icon glossary

■ **MiniMed 770G System Performance Data and Technical Information**

325	I. Performance data for users 14 years old and older
325	A. Device performance for users 14 years and older
330	B. Guardian Sensor (3) Performance for 14 years old and older
346	C. Alert performance for users 14 years and older
351	II. Performance data for users ages 7 through 13
351	D. Device Performance data for users ages 7 through 13
356	E. Guardian Sensor (3) Performance in users ages 7 to 13
370	F. Alert performance for user ages 7 through 13

376	III. Performance data for users 2 through 6 years old
376	G. Device Performance data for users ages 2 through 6
380	H. Guardian Sensor (3) Performance in users ages 2 through 6
396	I. Alert performance for users ages 2 through 6

## ■ **Appendix A: Open Source Software disclosure**

405	Open Source Software disclosure
-----	---------------------------------

## ■ **Glossary**

## ■ **Index**

Before you begin



1



# 1 Before you begin

This user guide is designed to help you understand the operation of the MiniMed 770G System with smart device connectivity and SmartGuard technology, our latest advancement in diabetes management. In the MiniMed 770G System, SmartGuard technology can automatically adjust basal insulin delivery based on your sensor glucose (SG) values. The system can be used in two modes: Manual mode and SmartGuard Auto Mode. Work closely with your healthcare professional when you start insulin pump therapy.



In this user guide, the term Auto Mode refers to the automatic control of basal insulin delivery. For more information, see *About SmartGuard Auto Mode*, on page 221. When your pump is not operating in Auto Mode, the term Manual Mode is used to describe its functions.

## Using this user guide

This user guide contains valuable information about using your new insulin pump. To help you find the information you need, you can use the table of contents at the beginning of the user guide and the index at the end of the user guide. There is also a glossary of terms, which starts on page 409.

The following table describes certain terms, conventions, and concepts used in this user guide.

Convention	What it means
Select	To activate a screen item, accept a value, or initiate an action.
Select and hold	To perform an action using your pump screen, press the Select button and hold until the action is complete.

Convention	What it means
Press	To push and then release a button.
Press and hold	To push and keep pressure on a button.
Bold text	To indicate screen items and buttons. For example, "Select <b>Next</b> to continue."
X	To indicate a numeric value or name that appears differently on your pump screen.
Note	 <b>Note:</b> A note provides helpful information.
Caution	 <b>CAUTION:</b> A caution tells you of a potential hazard which, if not avoided, may result in minor or moderate injury or damage to the equipment.
WARNING	 <b>WARNING:</b> A warning tells you of a potential hazard which, if not avoided, could result in death or serious injury. It may also describe potential serious adverse reactions and safety hazards.

The MiniMed 770G System User Guide includes instructions on how to set up devices on the MiniMed 770G insulin pump. For additional instructions not included in the MiniMed 770G System User Guide, refer to the instructions for the device.

Device	For instructions see
Reservoir	Reservoir user guide
Infusion Sets	Infusion set user guide
Transmitter	Guardian Link (3) transmitter user guide
Sensor	Guardian Sensor (3) user guide

Device	For instructions see
Meter	Accu-Chek® Guide Link User's Manual

## Acronyms and abbreviations

The following table defines acronyms and abbreviations used in this guide.

Acronyms and abbreviations	Definition
BG	blood glucose
CDC	Centers for Disease Control and Prevention
CGM	continuous glucose monitoring
CT scan	computerized tomography scan
DKA	diabetic ketoacidosis
EMC	electromagnetic compatibility
ESD	electrostatic discharge
FCC	Federal Communications Commission
FDA	U.S. Food and Drug Administration
GPS	global positioning system
ISIG	input signals, which are read from the sensor and measured in nanoamperes (nA)
IV	intravenous
MRI	magnetic resonance imaging
NiMH	nickel-metal hydride
RF	radio frequency
SG	sensor glucose
SN	serial number
TDD	total daily dose

## Emergency kit

Keep an emergency kit with you at all times to make sure that you always have necessary supplies. Tell a family member, co-worker, or friend where you keep your emergency kit.

It is important that you test your blood glucose (BG) more frequently while you travel. The routine hassle of travel, including stress, changes in time zones, schedules and activity levels, meal times and types of food, can all affect your diabetes control. Be extra attentive to monitoring your BG frequently, and be prepared to respond if needed.

Your emergency kit should include these items:

- Fast-acting glucose tablets
- BG monitoring supplies
- Urine or blood ketone monitoring supplies
- Extra MiniMed infusion set and MiniMed reservoir
- Extra new AA lithium or alkaline batteries, or fully charged NiMH batteries
- Insulin syringe and rapid-acting insulin (with dosage instructions from your healthcare professional)
- Wallet card (packaged with your pump accessories)
- Adhesive dressing
- Glucagon emergency kit



**WARNING: Do not use the Bolus Wizard feature to calculate a bolus for a period of time after giving a manual injection of insulin by syringe or pen. Manual injections are not accounted for in the active insulin amount. Therefore, the Bolus Wizard feature could prompt you to deliver more insulin than needed. Too much insulin can cause hypoglycemia. Consult with your healthcare professional for how long you need to wait after a manual injection of insulin before you can rely on the active insulin calculation of the Bolus Wizard feature.**





**WARNING:** Do not use Auto Mode for a period of time after giving a manual injection of insulin by syringe or pen. Manual injections are not accounted for in Auto Mode. Therefore, Auto Mode could deliver too much insulin. Too much insulin may cause hypoglycemia. Consult with your healthcare professional for how long you need to wait after a manual injection of insulin before you resume Auto Mode.

For details on pump safety, see *User safety*, on page 7.

## User safety



**WARNING:** Do not use the MiniMed 770G system until appropriate training has been received from a healthcare professional. Training is essential to ensure the safe use of the MiniMed 770G system.

## Indications

### MiniMed 770G System

The MiniMed 770G system is intended for continuous delivery of basal insulin (at user selectable rates) and administration of insulin boluses (in user selectable amounts) for the management of type 1 diabetes mellitus in persons two years of age and older requiring insulin as well as for the continuous monitoring and trending of glucose levels in the fluid under the skin. The MiniMed 770G System includes SmartGuard technology, which can be programmed to automatically adjust delivery of basal insulin based on continuous glucose monitoring (CGM) sensor glucose values and can suspend delivery of insulin when the SG value falls below or is predicted to fall below predefined threshold values.

The Medtronic MiniMed 770G System consists of the following devices: MiniMed 770G Insulin Pump, the Guardian Link (3) Transmitter, the Guardian Sensor (3), one-press serter, the Accu-Chek Guide Link blood glucose meter, and the Accu-Chek Guide Test Strips. The system requires a prescription.

The Guardian Sensor (3) has not been evaluated and is not intended to be used directly for making therapy adjustments, but rather to provide an indication of when a fingerstick may be required. All therapy adjustments should be based on measurements obtained using a blood glucose meter and not on values provided by the Guardian Sensor (3).



**WARNING: Do not use the Suspend on low feature to prevent or treat low glucose. Always confirm your sensor glucose reading using your blood glucose meter, and follow the instructions of your healthcare professional to treat low glucose. Using Suspend on low alone to prevent or treat low glucose may result in prolonged hypoglycemia.**

### Guardian Sensor (3)

The Guardian Sensor (3) is intended for use with the MiniMed 770G system, MiniMed 670G system, MiniMed 630G system, and Guardian Connect system to continuously monitor glucose levels in persons with diabetes.

The sensor is intended for single use and requires a prescription. The Guardian Sensor (3) is indicated for seven days of continuous use.

The Guardian Sensor (3) has been studied and is approved for use in the systems, insertion sites, and ages listed in the following table:

System	Approved Age	Sensor Insertion Site
MiniMed 770G system	2-13	Abdomen and Buttocks
	14 and older	Abdomen and Arm
MiniMed 670G system	7-13	Abdomen and Buttocks
	14 and older	Abdomen and Arm
MiniMed 630G system	14 and older	Abdomen and Arm
Guardian Connect system	14 and older	Abdomen and Arm

### One-press Serter

The serter is used as an aid for inserting the sensor. It is indicated for single-patient use and is not intended for multiple patient use.

## Guardian Link (3) Transmitter

The Guardian Link (3) Transmitter is intended for use with MiniMed 770G System. The Guardian Link (3) Transmitter powers the glucose sensor, collects and calculates sensor data, and wirelessly sends the data to the MiniMed 770G insulin pump. The Transmitter is intended for single-patient multi-use.

## Accu-Chek Guide Link Blood Glucose Monitoring System

The Accu-Chek Guide Link Blood Glucose Monitoring System is comprised of the Accu-Chek Guide Link meter and the Accu-Chek Guide test strips.

The Accu-Chek Guide Link Blood Glucose Monitoring System is intended to quantitatively measure glucose in fresh capillary whole blood from the fingertip, palm, and upper arm as an aid in monitoring the effectiveness of glucose control.

The Accu-Chek Guide Link Blood Glucose Monitoring System is intended for in vitro diagnostic single-patient use by people with diabetes

The Accu-Chek Guide Link Blood Glucose Monitoring System is intended to be used by a single person and should not be shared.

This system is not for use in diagnosing or screening for diabetes mellitus and not for neonatal use.

Alternative site testing should be done only during steady-state times (when glucose is not changing rapidly).

The Accu-Chek Guide Link Blood Glucose Monitoring System is intended to be used to wirelessly transmit glucose values to the MiniMed 770G system with Bluetooth wireless technology through the use of Bluetooth low energy communication.



### **WARNING:**

- Do not use Alternative Site Testing to calibrate a continuous glucose monitoring system.
- Do not use Alternative Site Testing to make insulin dosing calculations.

## Contraindications

Pump therapy is not recommended for people whose vision or hearing does not allow recognition of pump signals and alarms.

Do not use the senter on products other than the Guardian Sensor (3). Medtronic cannot guarantee the safety or efficacy of this product if used with other products.

The reservoir is contraindicated for the infusion of blood or blood products.

Infusion sets are indicated for subcutaneous use only and not for intravenous (IV) infusion or the infusion of blood or blood products.

Insulin pump therapy is not recommended for those who are unwilling to perform at least four BG tests per day. As insulin pumps use rapid-acting insulin only, BG testing is required to help identify rapid glycemic deterioration due to insulin infusion occlusion, infusion site problems, insulin stability issues, user error, or a combination of these.



**WARNING: Do not use SmartGuard Auto Mode for people who require less than eight units or more than 250 units of total daily insulin per day. A total daily dose of at least eight units, but no more than 250 units, is required to operate in Auto Mode.**

Pump therapy is not recommended for people who are unwilling or unable to maintain contact with their healthcare professional.

## Potential risks

### Risks related to insulin pump infusion set

General risks related to insulin pump infusion set may include:

- Localized infection
- Skin irritation or redness
- Bruising
- Discomfort or pain
- Bleeding
- Irritation
- Rash

- Occlusions that can interrupt insulin delivery and lead to hyperglycemia or diabetic ketoacidosis

Patients should be instructed to follow the provided user guides for insertions and care of infusion sets. If an infusion site becomes irritated or inflamed, the infusion set should be removed and another placed in a new location.

### **Risks related to insulin administration and pump use**

Due to the use of insulin, there is risk related to the infusion of insulin and the potential interruptions of insulin delivery. These general risks may include:

- Hypoglycemia
- Hyperglycemia
- Diabetic ketoacidosis
- Seizure
- Coma
- Death

### **Risks related to sensor use**

General risks related to sensor use may include:

- Skin irritation or other reactions
- Bruising
- Discomfort
- Redness
- Bleeding
- Pain
- Rash
- Infection
- Raised bump
- Appearance of a small "freckle-like" dot where needle was inserted
- Allergic reaction
- Fainting secondary to anxiety or fear of needle insertion
- Soreness or tenderness

- Swelling at insertion site
- Sensor fracture, breakage or damage
- Minimal blood splatter associated with sensor needle removal
- Residual redness associated with adhesive, tape, or both
- Scarring

### **Specific risks related to sensor use**

Taking medications with acetaminophen, including, but not limited to Tylenol, fever reducers, or cold medicine, while wearing the sensor may falsely raise your SG readings. The level of inaccuracy depends on the amount of acetaminophen active in your body and may be different for each person. Always use BG meter readings to verify your glucose level before making therapy decisions, including when you could have acetaminophen active in your body. Avoid taking medications with acetaminophen while in Auto Mode. If acetaminophen is taken, use additional BG meter readings to verify your glucose levels, and consider exiting Auto Mode. Do not use these additional BG meter readings to calibrate the sensor. Always check the label of any medications to confirm whether acetaminophen is an active ingredient.

For persons two to thirteen years of age, sensor placement and insertion has been studied in the belly (abdomen) and buttocks only and is not approved for other sites.

For persons that are fourteen years of age and older, sensor placement and insertion has been studied in the belly (abdomen) and back of upper arm only and is not approved for other sites.

### **Specific risks related to meter use**

- For the most current warnings, see the User's Manual that came with your device.
- A list of warnings for the meter are provided in the meter section on *page 23*.

**WARNING:**

- Do not use Alternative Site Testing to calibrate a continuous glucose monitoring system.
- Do not use Alternative Site Testing to make insulin dosing calculations.

**Risks related to serter use**

General risks with serter use may include skin infection around the area where the serter is used.

**Risks related to the MiniMed 770G insulin pump system**

General risks related to the MiniMed 770G insulin pump system may include:

- Hypoglycemia
- Hyperglycemia
- Diabetic ketoacidosis
- Seizure
- Coma
- Death

**General warnings****Pump**

- Do not use the pump when a flammable anesthetic mixture with air, oxygen, or nitrous oxide is present. These environmental conditions can damage your pump and result in serious injury.
- Always use the fingertip for blood samples used for calibrating the sensor while in Auto Mode. The fingertip was the only site studied for use with Auto Mode. Do not use blood samples from the palm to calibrate the sensor as this site was not studied for use with Auto Mode and the performance of the system is not known.

- Always use the values from your BG meter for treatment decisions. The MiniMed 770G system CGM does not replace a BG meter to make treatment decisions. BG values may differ from SG values. Using the SG readings for treatment decisions could lead to high or low BG.
- For MiniMed 770G System Users Ages 2-13:  
 The low SG alert functionality is distinct from the automated insulin dosing function of the MiniMed 770G System. When used in Auto Mode, the MiniMed 770G System has been shown to be safe and effective for its intended use in this population. However, do not rely solely on the use of a low SG value for “Alert on Low” or “Alert before Low” for alerts set at 50 mg/dL and 60 mg/dL. A low SG alert may not reflect the user’s true BG at these levels, or may not alert. Do not ignore symptoms of low glucose. Always confirm your SG readings with your BG meter, and treat according to the recommendations of your healthcare professional. Solely relying on these SG alerts and readings for treatment decisions could result in missing severe hypoglycemia (low BG) events.
- Never rely on the pump beeps or vibrations alone to navigate through the pump screens or menus. Always check your pump screen as you navigate. The pump beeps and vibrations are intended to notify you of a condition that may require attention. Relying on the pump beeps or vibrations alone to navigate can result in incorrect menu selection or settings.
- Do not use your pump if the screen appears broken or unreadable. In some instances, impact to the pump can damage the screen while the buttons continue to function. If the screen is broken or unreadable, do not press any buttons. Remove the pump and begin using your backup insulin plan per the direction of your healthcare professional. If the pump is accidentally programmed while the screen is broken or unreadable, this could result in high or low BG levels. If your screen is damaged, contact 24-Hour Technical Support to arrange for shipment of a replacement pump.
- Only use rapid-acting U-100 insulin (Humalog and NovoLog) that has been prescribed by your healthcare professional for use with an infusion pump. Do not put any other drugs or medications inside your reservoir for use with this pump. Other drugs or medications are not intended for use with this pump. Use of other drugs or medications can cause serious injury.



- Always make sure the infusion set is disconnected from your body before you rewind your pump or fill the infusion set tubing. Never insert the reservoir into the pump while the tubing is connected to your body. Doing so could result in an accidental infusion of insulin.
- Do not insert the reservoir in the pump if you did not rewind your pump. Doing so could result in an accidental infusion of insulin.
- Do not use the MiniMed 770G insulin pump or additional system devices adjacent to other electrical equipment which may cause interference with the normal system operation. This includes mobile communication devices such as cell phones that are not paired with the MiniMed 770G System, GPS navigation systems, anti-theft systems, and any electrical equipment that has an output transmitter power greater than 1W. For more information about recommended separation distance guidelines between the insulin pump and common RF emitters, see *Guidance and manufacturer's declaration, on page 319*. The recommended separation distance between the insulin pump and common RF emitters is 12 inches. Other electrical equipment that may compromise normal system operation has been contraindicated. For more information, see *Exposure to magnetic fields and radiation, on page 24*.
- Do not unscrew or retighten the tubing connector on the reservoir while the infusion set is connected to your body. Doing so could result in an accidental infusion of insulin.
- Do not use standard Luer sets with the MiniMed 770G insulin pump. Standard Luer sets are not compatible with the pump. The MiniMed reservoirs and the MiniMed infusion sets are specifically designed for use with the MiniMed 770G insulin pump.
- Do not change or modify the MiniMed reservoir or the MiniMed infusion set unless expressly approved by Medtronic Diabetes. Modifying the devices can cause serious injury, interfere with your ability to operate the device, and void your warranty.
- Do not rely on preset pump alarms or reminders alone to prompt you to check your BG. This can cause you to forget to check your BG. Set additional reminders on other devices, such as your cell phone.

- Do not change or modify the internal RF transmitter or antenna unless expressly approved by Medtronic Diabetes. Doing so could interfere with your ability to operate the equipment.
- Do not attempt to use any transmitter other than the Guardian Link (3) transmitter with Bluetooth wireless technology (MMT-7911). "GL3" is marked on the transmitter. Only the "GL3" transmitter can communicate with the MiniMed 770G insulin pump with smart device connectivity.
- If other devices, outside those being used as part of the MiniMed 770G System, employ radio frequencies such as cell phones, cordless phones, walkie-talkies, and wireless networks, they may prevent communication between the transmitter and the insulin pump. This interference does not cause any incorrect data to be sent and does not cause any harm to your devices. Moving away from, or turning off, these other devices may enable communication. If you continue to experience RF interference, contact 24-Hour Technical Support.
- Special Precautions regarding Electromagnetic Compatibility (EMC): This body worn device is intended to be operated within a reasonable residential, domestic, public or work environment, where common levels of radiated "E" (V/m) or "H" fields (A/m) exist; such as cellular phones that are not paired with the MiniMed 770G System, Wi-Fi networks, Bluetooth wireless technology, electric can openers, microwave and induction ovens. This device generates, uses, and can radiate radio frequency energy and, if not installed and used in accordance with the provided instructions, may cause harmful interference to radio communications.
- Portable and mobile RF communications equipment can affect Medical Electrical Equipment as well. If you encounter RF interference from a mobile or stationary RF transmitter, move away from the RF transmitter that is causing the interference.
- This device can generate, use, and radiate radio frequency energy and, if not installed and used in accordance with the instructions, may cause harmful interference to radio communications. If the device does cause interference to radio or television reception, you are encouraged to try to correct the interference by one or more of the following measures:

- Decrease the distance between the transmitter and the insulin pump to 6 feet (1.8 meters) or less.
- Decrease the distance between the meter and the insulin pump to 6 feet (1.8 meters) or less.
- Increase the separation between the transmitter and the device that is receiving/emitting interference.



**Note:** Harmful interference is defined by the FCC as follows. Any emission, radiation or induction that endangers the functioning of a radio navigation service or of other safety services or seriously degrades, obstructs or repeatedly interrupts a radio communications service operating in accordance with FCC rules.

- The safety of the MiniMed 770G System has not been studied in people with impaired kidney function. Let your healthcare professional know if you have kidney disease so you and your healthcare professional can determine if the potential benefits of using the system outweigh the risks.
- The safety of the MiniMed 770G System has not been studied in pregnant women, people with type 2 diabetes, or in people using other anti-hyperglycemic therapies that do not include insulin. Let your healthcare professional know if any of these conditions apply to you so you and your healthcare professional can determine if the potential benefits of using the system outweigh the risks.
- The safety of using Auto Mode, Suspend before low, and Suspend on low in people who have no pump experience is not known. Auto Mode, Suspend before low, and Suspend on low should not be used if insulin pump settings have not been previously established. Insulin pump settings include basal rates, insulin to carb ratio, or insulin sensitivity factors. Always discuss with your healthcare professional before using Auto Mode, Suspend before low, or Suspend on low.

### Reservoir and infusion sets

For the most current warnings, see the user guide that came with your device.

- Only use rapid-acting U-100 insulin (Humalog and NovoLog) that has been prescribed by your healthcare professional for use with an infusion pump. Do not put any other drugs or medications inside your reservoir for use with this pump. Other drugs or medications are not intended for use with this pump, and can result in serious injury.
- If insulin, or any liquid, gets inside the tubing connector, it can temporarily block the vents that allow the pump to properly prime the infusion set. This may result in the delivery of too little or too much insulin, which can cause hyperglycemia or hypoglycemia. If this occurs, start over with a new reservoir and infusion set.
- Do not reinsert the introducer needle into the infusion set. Reinsertion may cause tearing of the soft cannula, which may result in unpredictable medication flow.
- If infusing insulin, and your BG level becomes unexplainably high, or an occlusion alarm occurs, check for clogs and leaks.
- If in doubt, change the infusion set because the soft cannula may be dislodged, crimped, or partially clogged. Should any of these problems arise, make a plan with your healthcare professional for rapidly replacing insulin. Check your BG level to make sure the problem is corrected.
- Reuse of the infusion set may cause damage to the cannula or needle and lead to infection, site irritation, and inaccurate medication delivery.
- Dispose of transfer guard safely in sharps container.
- Never prime the set or attempt to free a clogged line while the set is inserted. You may accidentally inject too much medication.
- Do not put disinfectants, perfumes, or deodorants on the infusion set as these may affect the integrity of the set.
- Dispose of the infusion set and introducer needle safely, in a sharps container, after a single use. Do not clean or re-sterilize.
- Store infusion sets in a cool, dry place. Do not leave infusion sets in direct sunlight or inside a vehicle.
- Only use reservoir and infusion sets manufactured or distributed by Medtronic Diabetes. The pump has undergone extensive testing to confirm appropriate operation when used with compatible reservoirs and infusion sets

manufactured or distributed by Medtronic Diabetes. We cannot guarantee appropriate operation if the pump is used with reservoirs or infusion sets offered by third parties. We are not responsible for any injury or malfunctioning of the pump that may occur in association with such use.

- Use aseptic techniques when temporarily disconnecting the set and consult your healthcare provider on how to compensate for missed medication when disconnected.
- If infusing insulin, carefully monitor your BG levels when disconnected and after reconnecting.
- Reservoir and transfer guard are sterile, non-pyrogenic, and for single use only.
- Do not clean or re-sterilize. Reuse of the reservoir may lead to insulin degradation, infection, inaccurate medication delivery, and leaks which may cause damage to the pump.
- Inaccurate medication delivery, infection, or site irritation may result from improper insertion and maintenance of the infusion site.
- If using this infusion set for the first time, do the first set-up in the presence of your healthcare professional.
- Do not leave air in the infusion set. Prime completely.
- Replace the infusion set every 48 to 72 hours according to Centers for Disease Control guidelines, or per your healthcare professional's instructions.
- If infusing insulin, do not change the infusion set just before bedtime unless you can check your BG 1 to 3 hours after insertion.
- Do not use if package has been opened or damaged.
- Ensure sterility by checking that the sterile paper and tamper-proof seal are not damaged.
- This device is sterile and non-pyrogenic unless the package has been opened or damaged. Do not use if the package has been opened or damaged. Do not use the infusion set if the tubing connector needle has been damaged.

- Do not use the infusion set for more than three days. Insulin is not labeled for more than three days of use when it is used in an infusion set. If insulin is used in the infusion set for more than three days, it may increase the risk of set occlusions and cause problems with insulin absorption, which may lead to severe hyperglycemia and DKA.
- Before insertion, clean the insertion site with isopropyl alcohol.
- Check frequently to make sure the soft cannula remains firmly in place as you may not feel pain if it pulls out. The soft cannula must always be completely inserted to receive the full amount of medication.
- Release the tubing with caution as a hard pull of the tubing can result in damage to the infusion set and introducer needle. Ensure that the infusion set is properly in place when the tubing is fully released.
- If the infusion site becomes inflamed, replace the set, and use a new site until the first site has healed. Replace the infusion set if the tape becomes loose, or if the soft cannula becomes fully or partially dislodged from the skin.
- Failure to remove trapped air from reservoir may result in inaccurate delivery of medication.
- Never point a loaded insertion device towards the body part where insertion is not desired.
- Remove the needle guard before inserting the infusion set.

### **Sensor andserter**

For the most current warnings, see the user guide that came with your device.

- Keep the sensor away from children. This product contains small parts and may pose a choking hazard.
- Keep theserter away from children. This product contains small parts and may pose a choking hazard.
- A retractable needle is attached to the sensor and minimal blood splatter may occur. If you are a healthcare professional or caregiver, wrap sterile gauze around the sensor to minimize contact with blood. Keep as much distance as possible between you and the patient when removing the needle.

- Do not attempt to remove the sensor yourself if you suspect that the sensor is broken. While there is no evidence of a sensor breaking in a patient's body, sensor breakage can result in serious injury. Contact your healthcare professional for assistance in removing the sensor.
- Always inspect the packaging for damage prior to use. Sensors are sterile and non-pyrogenic, unless the package has been opened or damaged. Do not use the sensor if the sterile package has been opened or damaged. Use of an unsterile sensor can cause site infection.
- If bleeding continues, causes excessive pain or discomfort, or is significantly visible in the plastic base of the sensor, do the following:
  - a. Remove the sensor and continue to apply steady pressure until the bleeding stops. Discard the sensor in a sharps container.
  - b. Check the site for redness, bleeding, irritation, pain, tenderness, or inflammation. Treat based on instructions from your healthcare professional.
  - c. Insert a new sensor in a different location.
- The one-pressserter (MMT-7512) does not work the same as other Medtronic insertion devices. Failure to follow directions or using a differentserter may result in improper insertion, pain, or injury.
- Keep the needle housing within sight at all times to avoid an accidental needlestick or puncture.
- Taking medications with acetaminophen while wearing the sensor may falsely raise your SG readings. The level of inaccuracy depends on the amount of acetaminophen active in your body and may be different for each person.
- Make sure the sensor is securely placed in theserter to avoid improper insertion, pain, or minor injury.
- Watch for bleeding at the insertion site (under, around, or on top of the sensor). If bleeding occurs, do the following:
  - a. Apply steady pressure, using sterile gauze or a clean cloth placed on top of the sensor, for up to three minutes. The use of unsterile gauze can cause site infection.

- b. If bleeding stops, connect the transmitter (or recorder) to the sensor. If bleeding does not stop, do not connect the transmitter to the sensor because blood can get into the transmitter connector, and could damage the device.
- The sensor is designed to work with Guardian Link (3) transmitter only. It is not interchangeable with transmitters and recorders that are not compatible with the sensor. Connecting your sensor to a transmitter or recorder that is not approved for use with the sensor may cause damage to the components or inaccurate sensor glucose values.
- It is not known how different conditions or medications common to the critically ill population may affect the performance of the system. Therefore, the use of this sensor in the critically ill population is not recommended.

### **Transmitter**

For the most current warnings, see the user guide that came with your device.

- Do not allow children to put small parts in their mouth. This product poses a choking hazard for young children.
- Do not use the tester if it comes in contact with blood. Touching blood can cause infection. Dispose of the tester according to the local regulations for medical waste disposal, or contact your healthcare professional for disposal information.
- Bleeding may occur after inserting the sensor. Always make sure that the site is not bleeding before connecting the transmitter to the sensor. Blood can get into the transmitter connector and damage the device. Discard the device if damaged. If bleeding occurs, apply steady pressure with a sterile gauze or clean cloth at the insertion site until bleeding stops. After bleeding stops, connect the transmitter to the sensor.
- Do not use the transmitter adjacent to other electrical equipment which may cause interference with the normal system operation. This includes mobile communication devices such as cell phones, GPS navigation systems, and other devices that have an output transmitter power greater than 1W. Other electrical equipment that may compromise normal system operation has been contraindicated.



- Do not change or modify the device unless expressly approved by Medtronic Diabetes. Modifying the device can cause serious injury, interfere with your ability to operate the device, and void your warranty.

### Meter

For the most current warnings, see the User's Manual that came with your device. Always use the fingertip for blood samples used for calibrating the sensor while in Auto Mode. The fingertip was the only site studied for use with Auto Mode. Do not use blood samples from the palm to calibrate the sensor as this site was not studied for use with Auto Mode and the performance of the system is not known.

### Limitations

- Do not use the meter at high hematocrit levels above 65% or low hematocrit levels below 10%.
- Not for use in diagnosis or screening of diabetes mellitus.
- Not for neonatal use.
- Abnormally high concentrations of ascorbic acid (vitamin C) resulting in blood concentrations in excess of 5 mg/dL may cause inaccurate test results. If you are not sure please check with your doctor.
- Do not use the meter system to measure blood glucose in people who are experiencing cardiovascular collapse (severe shock) or decreased peripheral blood flow.
- Do not use this system during xylose absorption test.
- Not for use on critically ill patients, patients in shock, dehydrated patients, or hyperosmolar patients.
- This system has not been tested at altitudes higher than 10,150 feet.



#### **WARNING:**

- Do not use Alternative Site Testing to calibrate a continuous glucose monitoring system.
- Do not use Alternative Site Testing to make insulin dosing calculations.

### Potential Biohazard

- During normal testing, any blood glucose meter or lancing device may come in contact with blood. All parts of the kit are considered biohazardous and can potentially transmit infectious diseases from bloodborne pathogens, even after you have performed cleaning and disinfecting.<sup>1, 2</sup>
- The meter and lancing device should never be used by more than one person. Do not share the meter and lancing device with anyone, including family members, due to the risk of infection from bloodborne pathogens.<sup>1, 2</sup> Do not use on multiple patients!
- Cleaning and disinfecting the meter and lancing device destroys most, but not necessarily all, bloodborne pathogens.<sup>3</sup>
- If the meter is being operated by a second person who is providing testing assistance to the user, the meter and lancing device should be cleaned and disinfected prior to use by the second person.
- Disinfect the meter and lancing device before allowing anyone else to handle them. Do not allow anyone else to test with the meter or lancing device.
- It is important to keep the meter and lancing device clean and disinfected. For instructions on how to clean and disinfect the meter and lancing device, see the chapter Meter and Lancing Device Cleaning and Disinfecting.
- Wash hands and dry thoroughly before and after handling the meter, lancing device, or test strips.

### Exposure to magnetic fields and radiation

- Do not expose your pump to MRI equipment, diathermy devices, or other devices that generate strong magnetic fields (for example, x-ray, CT scan, or other types of radiation). The strong magnetic fields can cause the system to

---

1 FDA Public Health Notification: "Use of Fingertick Devices on More than One Person Poses Risk for Transmitting Bloodborne Pathogens: Initial Communication, (2010). Update 11/29/2010." <http://wayback.archive-it.org/7993/20161022010458/> <http://www.fda.gov/MedicalDevices/Safety/AlertsandNotices/ucm224025.htm>. Accessed January 17, 2018.

2 CDC Clinical Reminder: "Use of Fingertick Devices on More than One Person Poses Risk for Transmitting Bloodborne Pathogens, (2010)." <http://www.cdc.gov/injectionsafety/Fingertick-DevicesBGM.html>. Accessed January 17, 2018.

3 Centers for Disease Control and Prevention (CDC): "Guideline for Disinfection and Sterilization in healthcare Facilities, 2008." Update: May 2019. William A. Rutala, Ph.D., M.P.H., and David J. Weber, M.D., M.P.H., and the Healthcare Infection Control Practices Advisory Committee (HICPAC). <https://www.cdc.gov/infectioncontrol/pdf/guidelines/disinfection-guidelines-H.pdf>. Accessed September 23, 2019.

malfunction, and result in serious injury. If your pump is exposed to a strong magnetic field, discontinue use and contact 24-Hour Technical Support for further assistance.

Magnetic fields, and direct contact with magnets, may affect the accurate functioning of your system, which may lead to health risks such as hypoglycemia or hyperglycemia.

- Do not expose your transmitter to MRI equipment, diathermy devices, or other devices that generate strong magnetic fields. Exposure to a strong magnetic field has not been evaluated and can cause the device to malfunction, result in serious injury, or be unsafe. If your transmitter is inadvertently exposed to a strong magnetic field, discontinue use and contact 24-Hour Technical Support for further assistance.
- Do not expose your sensor to MRI equipment, diathermy devices, or other devices that generate strong magnetic fields as the performance of the sensor has not been evaluated under those conditions and may be unsafe. If your sensor is inadvertently exposed to a strong magnetic field, discontinue use and contact 24-Hour Technical Support for further assistance.
- Always remove your pump, sensor, transmitter, and meter before entering a room that has x-ray, MRI, diathermy, or CT scan equipment. The magnetic fields and radiation in the immediate vicinity of this equipment can make your devices nonfunctional or damage the part of the pump that regulates insulin delivery, possibly resulting in over delivery and severe hypoglycemia.
- Do not expose your pump to a magnet, such as pump cases that have a magnetic clasp. Exposure to a magnet may interfere with the motor inside the pump. Damage to the motor can cause the device to malfunction, and result in serious injury.
- Always carry the Medical emergency card provided with your device when you are traveling. The Medical emergency card provides critical information about airport security systems and pump use on an airplane, which can help you and others. Not following the guidance on the Medical emergency card could result in serious injury.

## General precautions

Always check your BG levels at least four times per day. Although the pump has multiple safety alarms, it cannot notify you if the infusion set is leaking, or the insulin has lost its effectiveness. If your BG is out of range, check the pump and the infusion set to ensure that the necessary amount of insulin is being delivered.

## Waterproof capabilities

- At the time of manufacture and when the reservoir and tubing are properly inserted, your pump is waterproof. It is protected against the effects of being underwater to a depth of up to 12 feet (3.6 meters) for up to 24 hours.
- If the pump is dropped, hit against a hard object, or otherwise damaged, the waterproof characteristics of the outer casing of the pump may be compromised. If your pump has been dropped or you suspect your pump is damaged, carefully inspect your pump to ensure there are no cracks before exposing your pump to water.
- This waterproof capability rating applies only to your pump.
- If you believe that water has entered your pump or you observe any other possible pump malfunction, check your BG, and treat high BG as necessary, using an alternative source of insulin. Contact 24-Hour Technical Support for further assistance. Always contact your healthcare professional if you experience excessively high or low BG levels or if you have any questions about your care.

## Electrostatic discharge

- Although the MiniMed 770G insulin pump is designed to be unaffected by typical levels of electrostatic discharge (ESD), very high levels of ESD can result in a reset of the pump's software and a pump error alarm. After clearing the alarm, verify that your pump is set to the correct date and time, and that all other settings are programmed to the desired values. The software reset could erase your previously programmed settings. Following a pump reset, Auto Mode will be unavailable for five hours to allow active insulin to be updated.

- For more information on pump alarms, see *Pump alarms, alerts, and messages, on page 246*. For more information on re-entering your pump settings, see *My pump is asking me to enter my settings, on page 288*. If you are unable to re-enter your pump settings, or otherwise believe there is a problem with your pump, contact 24-Hour Technical Support.

### Extreme temperatures

Exposure to extreme temperatures can damage your device, which can adversely affect safety and effectiveness of your device. Avoid the following conditions:

- Avoid exposing your pump to temperatures above 104°F (40°C) or below 41°F (5°C). This may damage your device.
- Insulin solutions freeze near 32°F (0°C) and degrade at temperatures higher than 98.6°F (37°C). If you are outside in cold weather, wear your pump close to your body and cover it with warm clothing. If you are in a warm environment, take measures to keep your pump and insulin cool.
- Do not steam, heat, sterilize, or autoclave your pump. Exposure to high temperatures may damage your device.

### Lotion, sunscreen, and insect repellent

Some skin care products, such as lotion, sunscreen, and insect repellents, can cause damage to plastics, which is a material used in your pump case. After using such products, be sure to wash your hands prior to handling your pump. If you get any skin care products or insect repellents on your pump, wipe them off as soon as possible with a damp cloth and mild soap. For instructions on cleaning your pump, see *Cleaning your pump, on page 295*.

### Infusion sets and sites

Always refer to the infusion set user guide for all precautions, warnings, and instructions relating to the infusion set and your insertion sites. Not referring to the infusion set user guide can result in minor injury or damage to the infusion set.

### Sensor

Always refer to the sensor user guide for all precautions, warnings, and instructions relating to the sensor. Not referring to the sensor user guide can result in minor injury or damage to the sensor.

## Transmitter

Always refer to the transmitter user guide for all precautions, warnings, and instructions relating to the transmitter. Not referring to the transmitter user guide can result in minor injury or damage to the transmitter.

## Meter

Always refer to the Accu-Chek Guide Link User's Manual for all precautions, warnings, and instructions relating to compatible meters. Not referring to the User's Manual can result in minor injury or damage to the meter.

## Security precautions

The MiniMed 770G insulin pump system is designed with security features to help keep the system and the data secure. These security features in the insulin pump system are set in the factory and ready to use when the insulin pump is received. For example, when the pump communicates with other devices in the system, such as the BG meter, transmitter, or compatible mobile device, the data that it is sending and receiving is encrypted and protected by cyclic redundancy checks. This helps prevent other people from being able to see system data, or to interfere with insulin pump therapy.

To help keep the system secure, follow these instructions:

- Do not leave the insulin pump or the paired devices unattended.
- Do not share the pump, transmitter, or BG meter serial number.
- Do not connect the pump to any third-party devices not authorized by Medtronic.
- Do not use any software not authorized by Medtronic to control the system.
- Be attentive to pump notifications, alarms, and alerts because they may indicate that someone else is trying to connect to or interfere with the device.
- Disconnect the Blue Adapter from the computer whenever it is not being used.
- Use good cyber security practices; use anti-virus software and keep computer software up to date.
- Refer to the MiniMed Mobile App User Guide for information on how to keep the compatible mobile device safe to use with the Medtronic devices.

The pump only communicates with paired devices. The short time that it takes to pair the pump with other devices is a sensitive time for security. During this time, it is possible for an unintended device to pair with the pump. While Medtronic has designed security features into the system to prevent this, to keep the system safe during pairing always follow these instructions:

- Pair the transmitter, BG meter, or the compatible mobile device with the pump away from other people and devices.
- When the transmitter successfully pairs with the pump, the green LED on the transmitter stops blinking. If the green LED on the transmitter continues to blink for several minutes or more after it is successfully paired, it may have been paired with an unintended device. See *Deleting the transmitter from your pump, on page 204* to delete the transmitter from the pump and then follow the steps to pair it again.
- After pairing the BG meter or the compatible mobile device with the pump, make sure that the BG meter or compatible mobile device indicates that pairing was successful.

Consult a healthcare professional if there are symptoms of severe hypoglycemia or diabetic ketoacidosis, or suspect that the insulin pump settings, or insulin delivery changed unexpectedly.

If there is a concern that someone else is trying to connect to or interfere with the device, stop using it and contact 24-Hour Technical Support immediately.

### Adverse reactions

Always refer to the sensor user guide for adverse reactions related to the sensor. Not referring to the sensor user guide can result in minor injury or damage to the sensor.

### Keeping track of your system information

The serial number (SN) is located on the back of your pump. If you are using the pump clip, you need to remove the pump clip to view the serial number. It also displays in your Pump status screen. For more details on the status screens, see *Status screens, on page 52*. You will need your pump serial number if you call 24-Hour Technical Support. For future reference, enter the serial number of your pump and the purchase date in the following table:

---

## Pump serial number and purchase date

---

Serial Number:

---

Purchase Date:

---

## Insulin guidelines



**WARNING:** Never start on insulin until directed by your healthcare professional. Do not use insulin in your pump while you are practicing by either inserting an insulin filled reservoir into your pump, or connecting an insulin filled infusion set to your body. Doing so could result in an infusion of insulin, not prescribed by your healthcare professional, which may result in low or high blood glucose.

The MiniMed 770G insulin pump has been studied with, and is intended for use with, the following rapid-acting U-100 insulins:

- U-100 NovoLog
- U-100 Humalog

The use of any other insulin in the MiniMed 770G insulin pump has not been tested and may not be appropriate for use with this device.



**WARNING:** Only use rapid-acting U-100 insulin (Humalog and NovoLog) in the MiniMed 770G insulin pump. Use of the incorrect insulin, or insulin with a greater or lesser concentration, may result in over delivery or under delivery of insulin. Over delivery or under delivery of insulin may result in high or low blood glucose levels. High blood glucose levels may lead to diabetic ketoacidosis. Low blood glucose levels may lead to coma or death. If you are unsure about whether you can use a specific insulin with this pump, contact your healthcare professional.

## Consumables

The pump uses disposable, single-use, MiniMed reservoirs and infusion sets for insulin delivery.





**WARNING:** Only use reservoir and infusion sets manufactured or distributed by Medtronic Diabetes. The pump has undergone extensive testing to confirm appropriate operation when used with compatible reservoirs and infusion sets manufactured or distributed by Medtronic Diabetes. We cannot guarantee appropriate operation if the pump is used with reservoirs or infusion sets offered by third parties and therefore we are not responsible for any injury or malfunctioning of the pump that may occur in association with such use.

- **Reservoirs**—Use the MiniMed reservoir MMT-332A, 3.0 mL (300-unit).
- **Infusion sets**—Medtronic Diabetes provides a variety of infusion sets to fit your needs. Contact your healthcare professional for help in choosing an infusion set. Change your infusion set every two to three days per your infusion set manufacturer's instructions.

The following table lists the compatible infusion sets. The MMT numbers may change if other compatible infusion sets become available.

Type	MMT number
MiniMed Quick-set infusion set	MMT-386, MMT-387, MMT-394, MMT-396, MMT-397, MMT-398, MMT-399
MiniMed Silhouette infusion set	MMT-368, MMT-377, MMT-378, MMT-381, MMT-382, MMT-383, MMT-384
MiniMed Sure-T infusion set	MMT-862, MMT-864, MMT-866, MMT-874, MMT-876, MMT-884, MMT-886
MiniMed Mio infusion set	MMT-921, MMT-923, MMT-925, MMT-941, MMT-943, MMT-945, MMT-961, MMT-963, MMT-965, MMT-975
MiniMed Mio Advance infusion set	MMT-211, MMT-212, MMT-213, MMT-231, MMT-232, MMT-233, MMT-242, MMT-243, MMT-244

## Additional MiniMed 770G System devices

- **Accu-Chek Guide Link meter**—the MiniMed 770G System is compatible with an Accu-Chek Guide Link meter. The meter pairs with your pump, allowing you to send BG meter readings to your pump.
- **Guardian Link (3) transmitter (MMT-7911)**—pairs with your pump for CGM. A device that connects to a glucose sensor. The transmitter collects data measured by the sensor and wirelessly sends this data to monitoring devices.
- **Guardian Sensor (3) (MMT-7020)**—used with your pump for CGM. The sensor is a small part of the CGM system that you insert just below your skin to measure glucose levels in your interstitial fluid. The sensor is a disposable, single-use, device. Only use the Guardian Sensor (3) (MMT-7020) glucose sensor with the transmitter. Do not use any other sensor. Other sensors are not intended for use with the transmitter, and will damage the transmitter and the sensor.
- **MiniMed Mobile app (MMT-6101 for Android or MMT-6102 for iOS)**—can be downloaded onto multiple compatible mobile devices from the app store, but the pump can be paired with only one compatible mobile device at any time. Refer to the app user guide for setup and operation. This product should only be used with supported mobile devices. Refer to your local Medtronic Diabetes website for information about supported devices and operating systems.
- **CareLink Connect app (MMT-6111 for Android or MMT-6112 for iOS)**—can be downloaded onto compatible mobile devices from the app store. Refer to the app user guide for setup and operation within the app. This optional app is available to care partners to view patient therapy data and to be notified of selected patient alerts. This app does not replace the real-time display of insulin pump or CGM data on the primary display device. All therapy decisions should be based on the primary display device. Refer to your local Medtronic Diabetes website for information about supported devices and operating systems.
- **Blue Adapter**—uploads system data to CareLink software through a USB port on your computer. Refer to the CareLink software user guide for setup and operation of the Blue Adapter.

## Accessories

The following accessories may be used with the MiniMed 770G System.

- **Pump clip**—used to wear the pump on your belt. Also, you can use the tip of the pump clip to open the battery compartment on your pump. Refer to your pump clip user guide for instructions on using your pump clip.
- **Activity guard**—used if you are active in sports, or if a child is wearing the pump. Using the activity guard prevents the reservoir from being rotated or removed from the pump.
- **Skins**—personalize the look of the pump as decorative overlays and provide additional protection against surface scratches.

## Ordering supplies and accessories

To order supplies or accessories, call 800 646 4633, +1 818 362 5958 (outside U.S.), refer to the contacts list at the beginning of this user guide, or visit our website at [www.medtronicdiabetes.com](http://www.medtronicdiabetes.com).



# 2



First steps



# 2

## First steps

This chapter gives you an overview of your pump so you can become familiar with the buttons and screens. Read this entire chapter to understand the basic features before using your pump to deliver insulin.

### Your pump

The following illustration shows the different parts of your pump. The reservoir, with the tubing connector attached, is inserted into the reservoir compartment.



## Using the buttons



**CAUTION:** Do not use sharp objects to press the buttons on your pump. The use of sharp objects can damage your pump.

The following picture shows the buttons and the notification light on your pump. The notification light flashes when your pump has an alarm or alert. The notification light is not visible unless it flashes.



The following table describes how to use the buttons.

---

**To do this:**

Display the menu.

---

**Follow these steps:**

From the Home screen, press the  button.

---



To do this:	Follow these steps:
Scroll up or down a menu or list, or increase or decrease the value of a setting.	Press the $\wedge$ or $\vee$ buttons.
Select an item on a screen or menu.	Press the $\wedge$ , $\vee$ , $\langle$ , or $\rangle$ buttons to select the desired item, and then press the $\odot$ button.
Enter a value into a field.	Press the $\wedge$ , $\vee$ , $\langle$ , or $\rangle$ buttons to select the desired field, and then press the $\odot$ button. The field you select flashes. Press the $\wedge$ or $\vee$ buttons to enter the desired value, and then press the $\odot$ button.
Return to the previous screen.	Press the $\leftarrow$ button.
Display the Home screen.	Press and hold the $\leftarrow$ button to return to the Home screen.
Put the pump in sleep mode.	Press and hold the $\blacklozenge$ button for about two seconds.
Wake up the pump.	Press any button.

 **Note:**  $\text{power}$  reminds you that you can press and hold  $\blacklozenge$  to put the pump into sleep mode.

## About batteries

The pump requires one new AA (1.5 V) battery. For best results, use a new AA lithium (FR6) battery. The pump also accepts an AA alkaline (LR6) or a fully charged AA NiMH (HR6) nickel-metal hydride rechargeable battery.



**CAUTION:** Do not use a carbon zinc battery in your pump. Carbon zinc batteries are not compatible with the pump. Use of carbon zinc batteries can cause the pump to report inaccurate battery levels.

Carbon zinc batteries have a short shelf life, they deteriorate rapidly in cold weather, and oxidation of the zinc wall eventually causes the contents to leak out. They will not perform as well as other battery types to power the pump and may potentially damage your pump.



**Note:** Do not use cold batteries because the battery life may incorrectly appear as low. Allow cold batteries to reach room temperature before you insert them in your pump.

## Inserting the battery

Your pump does not ship with the battery cap on. The battery cap is located in the pump box with the accessories.

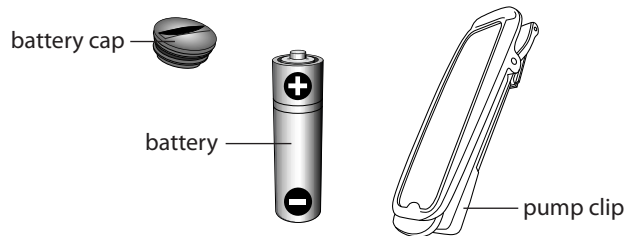

### To insert the battery:

1. Insert the new or fully charged AA battery. Be sure to insert the flat end first.

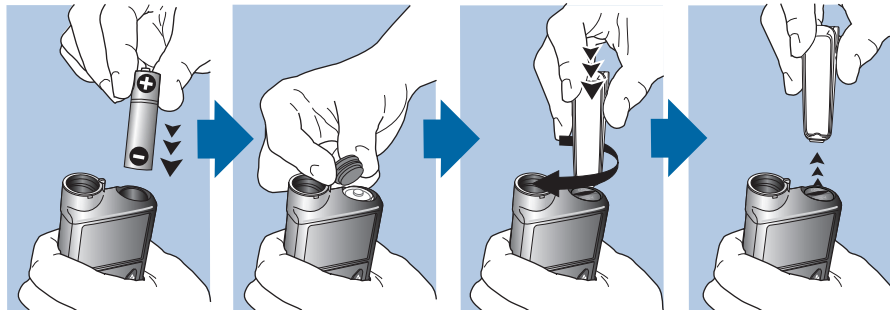

- Place the battery cap onto the pump. Use the bottom edge of the pump clip to turn the cap to the right and tighten.



**CAUTION:** Do not overtighten or undertighten the battery cap. A battery cap that is too tight can cause damage to your pump case. A battery cap that is too loose prevents detection of the new battery. Turn the battery cap clockwise until the slot in the cap is aligned horizontally with the pump case, as shown in the following example.

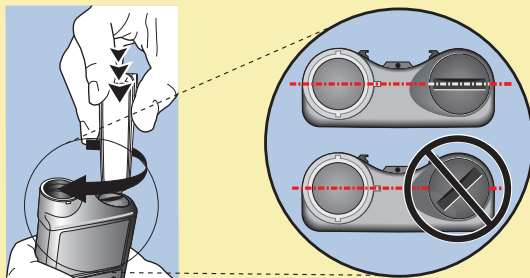

**Note:** If this is the first time you have inserted a battery in your pump, the Startup Wizard begins. For more information about the Startup Wizard, see *Entering your startup settings*, on page 43. If this is not the first time you have inserted a battery into your pump, the Home screen appears and the pump resumes your basal insulin delivery.

## Removing the battery



**CAUTION:** Do not remove the battery unless you insert a new battery or store the pump. Your pump cannot deliver insulin while the battery is removed. After you remove an old battery, be sure to replace it with a new battery within 10 minutes to clear the Insert battery alarm and avoid a Power loss alarm. If power loss occurs, you must re-enter your time and date settings.

## To remove the battery:

1. Before you remove a battery from your pump, clear any active alarms or alerts.
2. Use the pump clip to loosen and remove the battery cap.



**Note:** Use your pump clip to remove and retighten the battery cap. If the pump clip is unavailable, you may use a coin.

3. Remove the battery.

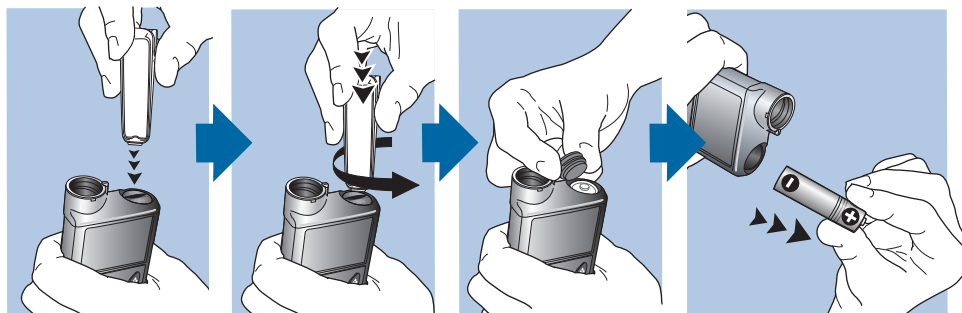

4. Dispose of old batteries according to local regulations for battery disposal (nonincineration), or contact your healthcare professional for disposal information.
5. After you remove your battery, wait until the Insert Battery screen appears before you insert a new battery.

If you remove the battery to place your pump in storage, see *Storing your pump*, on page 296 for more information.

## Getting to know your pump

The following section shows you how to navigate through the screens and menus on your pump. It also helps you learn how to enter information and view the status of your pump.

## Entering your startup settings

Your pump has a Startup Wizard that begins when you insert your battery for the first time. You set the language, time format, current time, and the current date in the Startup Wizard.



**Note:** Use this procedure when you enter your settings for the first time. If this is not the first time you enter your pump settings, and your pump is asking you to re-enter your settings, see *My pump is asking me to enter my settings*, on page 288.

### To use the Startup Wizard:

1. The Startup Wizard begins after the Welcome screen appears. When the Select Language screen appears, select your language.



2. When the Select Time Format screen appears, select a **12 Hour** or a **24 Hour** time format.

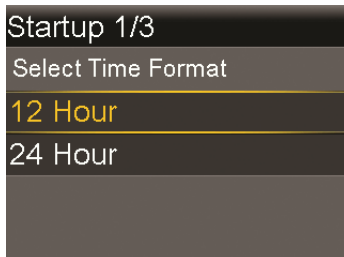

3. When the Enter Time screen appears, adjust the setting to the current time. If you use a 12-hour clock, be sure to specify AM or PM. Select **Next**.



4. When the Enter Date screen appears, adjust the **Year**, **Month**, and **Day** to the current date. Select **Next**.



5. A "Rewinding" message appears. The piston returns to its start position in the reservoir compartment. This may take several seconds.



6. When rewinding is complete, a message appears to confirm the startup is complete. Select **OK** to go to the Home screen.

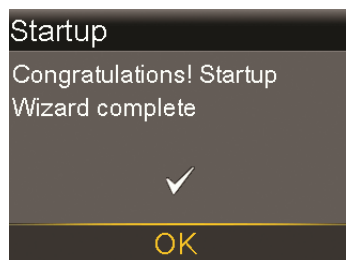

To become familiar with the buttons and screens on your pump, see the following sections in this chapter.

## Unlocking your pump

Your pump automatically locks when entering sleep mode. When you wake up your pump from sleep mode, you must unlock your pump before navigating to the menu. When you press , a screen appears and tells you to unlock your pump. Press the highlighted button to unlock your pump.



The selected screen appears after you press the correct button. If you press an incorrect button, the screen tells you to try again. If you press the  button, the Home screen appears.

After your pump is unlocked, it remains unlocked until you re-enter sleep mode. For information about the different power modes, or to put your pump to sleep, see *Power modes*, on page 60.

## Home screen

The Home screen appears by default after you change the battery, when you wake the pump from sleep mode, and when you are not actively using another screen.

To see what your Home screen looks like if you use a sensor, see *Home screen with CGM in Manual Mode*, on page 175.

To see what your Home screen looks like when you are in Auto Mode, see *Home screen with SmartGuard Auto Mode*, on page 227.

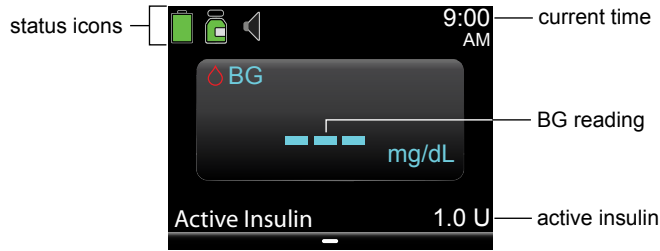





The following items appear on your Home screen:

















Item	Description
Status icons	The status icons show a quick status of your pump system. For more information, see <i>Status icons, on page 46</i> .
Current time	The current time of day is shown. For details on setting the time, see <i>Time and date, on page 170</i> .
BG meter readings	The pump shows the blood glucose (BG) meter readings from your Accu-Chek Guide Link meter or the BG meter readings you have entered manually. The pump only shows BG meter readings taken within the last 12 minutes.  You can enter your BG meter reading manually using the Enter BG feature, Event Markers feature, or when you use the Bolus Wizard feature to deliver a bolus. For details on using the Bolus Wizard feature, see <i>Bolus Wizard feature, on page 92</i> .
Active insulin	The screen shows the amount of bolus insulin the pump estimates is still working to lower your BG levels. For more details on active insulin, see <i>About active insulin, on page 98</i> .





## Status icons











The status icons appear at the top of the Home screen to provide a way for you to quickly check the status of your system. The status icons are described in the following table. For information on viewing detailed status screens, see *Status screens, on page 52*.











Icon	Icon name	What it means
	Battery	<p>The color and fill level of the battery icon indicate the charge level of your pump battery.</p> <p>When a new battery is inserted and your battery is full, the icon is solid green . This indicates that approximately 100% of your battery capacity remains. In most cases, you can expect at least seven days of use remaining.</p> <p>As the battery life is used, the icon changes from solid green in the following order . This indicates that the charge level of your battery is decreasing from 100% to 0%. The yellow icon indicates that the battery needs to be replaced soon. It is recommended that you have a new or fully charged battery available. The remaining charge level of your battery varies based on the battery type and how you use the pump.</p> <p>When your battery is low, the icon has a single red bar . This indicates that under typical use you have up to 10 hours of use remaining.</p> <p>When your battery needs to be replaced immediately, the icon is solid black with a red outline . This indicates you have less than 30 minutes of use remaining.</p>

Icon	Icon name	What it means
	Reservoir	<p>The reservoir icon shows the approximate amount of insulin left in your reservoir. The color and the fill level of the icon indicate the status. The reservoir icon is representative of the MiniMed reservoir MMT-332A, 3.0 mL (300-unit). When your reservoir is full, the icon is solid green. As your insulin is used, the icon becomes emptier, and the color of the icon changes as shown in the following example. For more information about your reservoir, see <i>Reservoir and infusion set on Setting up the reservoir and infusion set, on page 119</i>.</p> <ul style="list-style-type: none"> <li>•  Approximately 85%–100% of the reservoir remains.</li> <li>•  Approximately 71%–84% of the reservoir remains.</li> <li>•  Approximately 57%–70% of the reservoir remains.</li> <li>•  Approximately 43%–56% of the reservoir remains.</li> <li>•  Approximately 29%–42% of the reservoir remains.</li> <li>•  Approximately 15%–28% of the reservoir remains.</li> <li>•  Approximately 1%–14% of the reservoir remains.</li> <li>•  The reservoir remaining amount is unknown.</li> </ul>
	Audio	<p>The audio mode you are using: vibrate only , audio only  or vibrate and audio .</p> <p>When the Alert Silence option is turned on, the audio icons appear as follows: vibrate only , audio only  or vibrate and audio .</p>

Icon	Icon name	What it means
	Connection	<p>The connection icon appears green  when the Sensor feature is on and your transmitter is successfully communicating with your pump. The connection icon appears with a red X  when the Sensor feature is turned on, but the transmitter is not connected or communication with your pump has been lost. For more information about the Sensor feature, see <i>Understanding CGM, on page 173</i>.</p>
	Temporary network connection	<p>The temporary network connection icon replaces the connection icon while you are temporarily connected to a remote upload device.</p>

Icon	Icon name	What it means
	Calibration	<p>The calibration icon indicates the approximate time left until your next sensor calibration is due. The calibration icon appears only when the Sensor feature is turned on. The color and the circle around the icon indicate the status of calibration. When your sensor is fully calibrated, the icon has a solid green circle around it. As the time for your next sensor calibration approaches, the green circle around the icon becomes smaller, and the color of the icon changes as shown in the following example. For more information about calibrating your sensor, see <i>Calibrating your sensor</i>, on page 206.</p> <ul style="list-style-type: none"> <li data-bbox="668 631 1229 696">•  Time to your next sensor calibration is more than 10 hours.</li> <li data-bbox="668 718 1250 782">•  Time to your next sensor calibration is 8 to 10 hours.</li> <li data-bbox="668 805 1236 869">•  Time to your next sensor calibration is 6 to 8 hours.</li> <li data-bbox="668 892 1236 956">•  Time to your next sensor calibration is 4 to 6 hours.</li> <li data-bbox="668 979 1236 1043">•  Time to your next sensor calibration is 2 to 4 hours.</li> <li data-bbox="668 1065 1265 1130">•  Time to your next sensor calibration is less than 2 hours.</li> <li data-bbox="668 1152 1122 1199">•  Sensor calibration is required now.</li> <li data-bbox="668 1222 1165 1286">•  Time to your next sensor calibration is unavailable.</li> <li data-bbox="668 1308 1265 1512">•  Sensor calibration has not completed. This occurs when a new sensor is connected or when the sensor is calibrating. This also occurs within 15 minutes of a Calibration not accepted alert.</li> </ul>





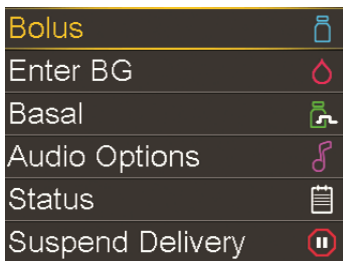

Icon	Icon name	What it means
	Sensor life	<p>The number in the center of the sensor life icon indicates the number of days that remain until the sensor expires. The icon appears only when the Sensor feature is turned on. When you insert a new sensor, the icon color is solid green. When one day remains until the sensor expires, the icon color turns red.</p> <p></p> <p>If the number of days that remain until the sensor expires is unavailable, the sensor life icon appears with three dots .</p> <p>When the system is waiting for the sensor to be started, the sensor life icon appears with a question mark .</p>
	Auto Mode Readiness	<p>The Auto Mode Readiness icon indicates whether your pump is ready to enter Auto Mode. The icon appears with a loading symbol  when the pump is updating a condition that requires you to wait. The icon appears with a question mark  when the pump requires an action from you to enter Auto Mode. For more information about Auto Mode Readiness, see <i>SmartGuard Auto Mode Readiness, on page 225</i>.</p>
	Block Mode	<p>The Block Mode icon indicates that the pump is in Block Mode, and that certain functions are restricted. Caregivers, such as parents of a young child, can use Block Mode to restrict access to critical pump settings. For more information about Block Mode, see <i>Block Mode, on page 162</i>.</p>

## Using the menu

The menu is where you access the various features and functions of your system. To display the menu, press  from the Home screen.



The following options are available from the menu:

Select this	Menu Indicators	To do this
Bolus		Set up and deliver your bolus insulin delivery.
Enter BG		Enter your BG value.
Basal		Set up your basal insulin delivery.
Audio Options		Set your audio, vibrate, and volume options for the notifications you receive.
Status		View information about your pump, any notifications you have received, your current settings, and optional sensor.
Suspend Delivery		Stop your current basal and bolus insulin delivery.
Options		Set your SmartGuard settings, reminders, delivery settings, enter event markers, view your history, and access the Utilities menu.

## Status screens

The Status screens provide information about your pump, any notifications you have received, your current settings, and optional sensor. The Status screens are described in the following table:

Status screen	Displays this information
Auto Mode Readiness	A list of conditions your pump has to meet before it can enter Auto Mode. For more information on Auto Mode, see the <i>SmartGuard Auto Mode</i> chapter.

Status screen	Displays this information
Notifications	A list of alarms, alerts, and reminders that have occurred over the past 24 hours. You can display further details about a particular alarm, alert, or reminder by selecting it from the list. For more information on alarms and alerts, see the <i>Alarms, alerts, and messages</i> chapter.
Quick Status	A summary of status information, including your last bolus, last BG meter reading, current basal rate, reservoir level, and pump battery charge level. If you are using a sensor, this screen also displays the time that your next calibration is due and the status of the SmartGuard features.
Pump	The pump screen provides a detailed view of your pump status, including whether your pump is in a specific mode, the reservoir status, battery status, pump serial number, pump name, model number, and other details about your pump.
Sensor	The Sensor screen is available only if your sensor feature is turned on. The Sensor screen indicates if any alert silence options are turned on. It also shows the status of your calibrations, your sensor life, ISIG, transmitter battery, serial number and version number of your transmitter, and the status of the SmartGuard features.
Settings Review	The Settings Review screen provides a list of all your pump settings. The settings are organized by where they appear in the menu for your pump. For example, your bolus settings appear under the Insulin Settings section, and your brightness level setting appears under the Utilities section.

## Viewing the Status screens

- From the Home screen, press  and select **Status** from the menu.

The Status screen appears.



2. Press  $\wedge$  or  $\vee$  to move up or down the screen. Select the status screen that you want to view. Refer to the table at the beginning of this section for a description of the different status screens.

## Modes

The MiniMed 770G insulin pump includes SmartGuard technology that automatically adjusts basal insulin delivery based on sensor glucose (SG) values. These glucose sensor-enabled features include SmartGuard Suspend on low, SmartGuard Suspend before low, and SmartGuard Auto Mode. The following tables show the differences between each mode and the delivery and suspend options available.

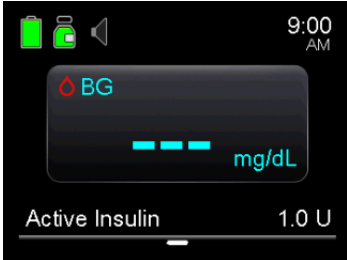

## Manual Mode

Mode CGM options	Bolus delivery options	Basal insulin delivery	Suspend options
<p>Pump without CGM</p>  <p>The screenshot shows a mobile application interface with a dark background. At the top right, the time is 9:00 AM. Below the time, there are icons for battery, signal, and a pump. A central box displays 'BG' with a red circle around the 'G' and a blue bar below it, followed by 'mg/dL'. At the bottom, it says 'Active Insulin 1.0 U' with a small bar below it.</p>	<ul style="list-style-type: none"> <li>• Bolus Wizard feature, which uses programmed carb ratio, insulin sensitivity, BG target, and active insulin time settings.</li> <li>• Normal bolus</li> <li>• Square Wave bolus</li> <li>• Dual Wave bolus</li> <li>• Preset bolus</li> <li>• Easy Bolus feature</li> </ul> <p>For more information, see the <i>Bolus</i> chapter.</p>	<ul style="list-style-type: none"> <li>• Programmed basal insulin delivery settings—For more information, see <i>Basal insulin settings</i>, on page 66.</li> <li>• Temporary basal rates—For more information, see <i>Temp basal rates</i>, on page 73.</li> <li>• Preset temporary basal rates—For more information, see <i>Preset temp basal rates</i>, on page 76.</li> </ul>	<p>Manual suspend—For more information, see <i>Stopping and resuming your insulin delivery</i>, on page 80.</p>

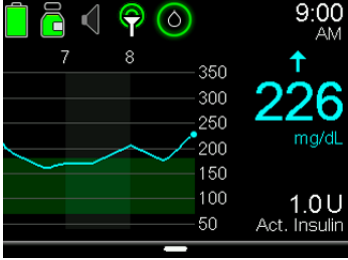
Mode CGM options	Bolus delivery options	Basal insulin delivery	Suspend options
<p>Pump with CGM</p>  <p>The screenshot shows a mobile application interface for a pump with CGM. At the top, there are icons for battery, pump, and CGM. Below these are two columns labeled '7' and '8'. A large green arrow points up to a current glucose reading of '226 mg/dL'. Below the reading is a line graph showing glucose levels over time. At the bottom right, it displays '1.0U Act. Insulin'. The time is '9:00 AM'.</p>	<ul style="list-style-type: none"> <li>• Bolus Wizard feature, which uses programmed carb ratio, insulin sensitivity, BG target, and active insulin time settings.</li> <li>• Normal bolus</li> <li>• Square Wave bolus</li> <li>• Dual Wave bolus</li> <li>• Preset bolus</li> <li>• Easy Bolus feature</li> </ul> <p>For more information, see the <i>Bolus</i> chapter.</p>	<ul style="list-style-type: none"> <li>• Programmed basal insulin delivery settings—For more information, see <i>Basal insulin settings</i>, on page 66.</li> <li>• Temporary basal rates—For more information, see <i>Temp basal rates</i>, on page 73.</li> <li>• Preset temporary basal rates—For more information, see <i>Preset temp basal rates</i>, on page 76.</li> </ul>	<p>Manual suspend—For more information, see <i>Stopping and resuming your insulin delivery</i>, on page 80.</p>

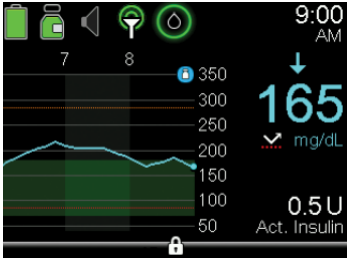
Mode CGM options	Bolus delivery options	Basal insulin delivery	Suspend options
<p>Pump with CGM and with SmartGuard features enabled: Suspend before low or Suspend on low</p> 	<ul style="list-style-type: none"> <li>• Bolus Wizard feature, which uses programmed carb ratio, insulin sensitivity, BG target, and active insulin time settings.</li> <li>• Normal bolus</li> <li>• Square Wave bolus</li> <li>• Dual Wave bolus</li> <li>• Preset bolus</li> <li>• Easy Bolus feature</li> </ul> <p>For more information, see the <i>Bolus</i> chapter.</p>	<ul style="list-style-type: none"> <li>• Programmed basal insulin delivery settings—For more information, see <i>Basal insulin settings, on page 66.</i></li> <li>• Temporary basal rates—For more information, see <i>Temp basal rates, on page 73.</i></li> <li>• Preset temporary basal rates—For more information, see <i>Preset temp basal rates, on page 76.</i></li> </ul>	<ul style="list-style-type: none"> <li>• Manual suspend—For more information, see <i>Stopping and resuming your insulin delivery, on page 80.</i></li> <li>• SmartGuard Suspend before low—For more information, see <i>SmartGuard Suspend before low, on page 181.</i></li> <li>• SmartGuard Suspend on low—For more information, see <i>SmartGuard Suspend on low, on page 185.</i></li> </ul>

## SmartGuard Auto Mode

	<b>Bolus delivery options</b>	<b>Basal insulin delivery</b>	<b>Suspend options</b>
<p>SmartGuard Auto Mode (Auto Basal delivery)</p> 	<ul style="list-style-type: none"> <li>• Auto Mode Bolus impacted by Carb Ratio and Active Insulin Time settings</li> <li>• Patient enters carb grams and BGs</li> <li>• Pump may recommend bolus when BG <math>\geq 150</math> mg/dL entered</li> <li>• Patient accepts or cancels bolus</li> </ul> <p>For more information, see the <i>SmartGuard Auto Mode</i> chapter.</p>	<ul style="list-style-type: none"> <li>• Automatic delivery of basal insulin based on recent insulin delivery needs and SG values to target of 120 mg/dL</li> <li>• May set a temporary target of 150 mg/dL for up to 12 hours</li> </ul> <p>For more information, see the <i>SmartGuard Auto Mode</i> chapter.</p>	<p>Manual suspend—</p> <p>For more information, see <i>Stopping and resuming your insulin delivery</i>, on page 80.</p>

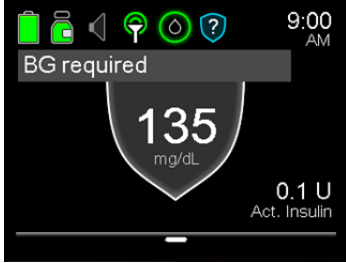
	<b>Bolus delivery options</b>	<b>Basal insulin delivery</b>	<b>Suspend options</b>
SmartGuard Auto Mode (Safe Basal delivery) 	<ul style="list-style-type: none"> <li>• Auto Mode Bolus impacted by Carb Ratio and Active Insulin Time settings</li> <li>• Patient enters carb grams and BGs</li> <li>• Pump may recommend bolus when BG <math>\geq</math>150 mg/dL entered</li> <li>• Patient accepts or cancels bolus</li> </ul> <p>For more information, see the <i>SmartGuard Auto Mode</i> chapter.</p>	<ul style="list-style-type: none"> <li>• Automatic delivery of basal insulin at a fixed rate</li> <li>• Does not use SG values to adjust rate</li> </ul> <p>For more information, see the <i>SmartGuard Auto Mode</i> chapter.</p>	Manual suspend— For more information, see <i>Stopping and resuming your insulin delivery, on page 80</i> .

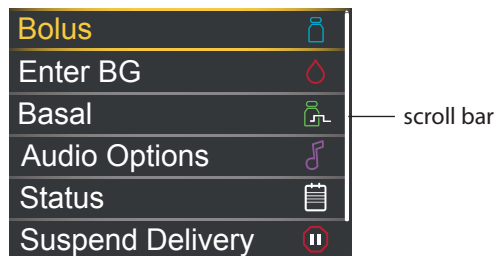

## Scroll bar

The scroll bar is located on the right side of the screen, as shown in the following example. It appears only when there is more information available to view on the screen. Press  $\wedge$  or  $\vee$  to move up or down the screen.



## Power modes

Your pump is designed to conserve battery power when you are not actively using the pump screens.

In this mode	Your pump behaves like this
Awake	<p>Your pump screen is on. Unless you are actively using another screen, your Home screen appears.</p> <p>To wake up your pump from being in power save or sleep mode, press any button. If your pump has been in sleep mode, the pump is locked. To unlock your pump, see <i>Unlocking your pump, on page 45</i>.</p>
Power save	<p>Your pump is fully functional, but the screen goes dark to save power. You can set how long it takes for your screen to enter power save mode with the Backlight setting. For more information, see <i>Display Options, on page 163</i>. If any button is pressed while the pump is in power save mode, the pump returns to the screen that was last displayed.</p>
Sleep	<p>Your pump automatically enters sleep mode when you have not pressed any buttons for about two minutes after your screen goes dark (power save mode). Your pump is still fully functional. When you press , a screen appears and tells you to unlock your pump. Press the highlighted button to unlock your pump. For details, see <i>Unlocking your pump, on page 45</i>.</p> <p>To put your pump into sleep mode, press and hold the  button for about two seconds.</p>

## If you remove your pump

You may have an occasion when you need or want to remove your pump. If you have to remove and store your pump, it is recommended that you do the following:

- Write down a record of your current basal rates and use the Save Settings feature. See *Saving your settings, on page 164* for more information.
- Remove the battery. See *Storing your pump, on page 296* for more information.

**Remember, your body still needs insulin while your pump is removed.**

Consult your healthcare professional to determine an alternate method of receiving insulin. Disconnecting from your pump for less than one hour may not require an insulin adjustment. If you remove your pump for more than one hour, you should take your insulin another way, as prescribed by your healthcare professional.





3





# 3

## Basal

Basal insulin is the "background" insulin that you need throughout the day and night to maintain your target blood glucose (BG) values when you are not eating. Your basal insulin accounts for approximately one half of your daily insulin requirements. Your pump mimics a pancreas by delivering insulin continuously over 24 hours.



**Note:** In Manual Mode, your basal insulin is delivered according to your programmed basal pattern. In SmartGuard Auto Mode, insulin is delivered based on sensor values and your recent insulin delivery needs. For more information on Manual Mode, see *Manual Mode, on page 222*. For more information on Auto Mode, see *SmartGuard Auto Mode, on page 221*.

Your basal insulin is delivered according to a basal pattern. Basal patterns and other basal settings are described in the following sections.

### Basal rate

Your basal rate is the specific amount of basal insulin that your pump continuously delivers each hour. While some people use one basal rate all day, others require different rates at different times of the day.

Your basal rates are set in one or more basal patterns. Each basal pattern covers 24 hours. For specific information about basal patterns, see *Basal patterns, on page 68*.

## Basal insulin settings

Your basal insulin delivery settings are described in the following table.

Setting	Description	Purpose
Basal Pattern	A basal pattern is a set of one or more basal rates that cover a 24-hour period.	A basal pattern lets you vary your basal rate according to your needs. You can set up to eight basal patterns. To set up basal patterns, see <i>Adding a new basal pattern</i> , on page 69. To start a basal pattern, see <i>Changing from one basal pattern to another</i> , on page 72.
Temp Basal	A temp basal rate is a basal rate that you use in place of your scheduled basal rate for short-term situations.	A temp basal rate lets you temporarily change your current basal rate for a duration of time that you specify. To start a temp basal rate, see <i>Starting a temp basal rate</i> , on page 75.
Preset Temp	A preset temp is a temporary basal rate that you can define ahead of time.	A preset temp lets you set and save temporary basal rates for known short-term situations, such as when you are sick or have times of increased or decreased activity. To set up a preset temp basal rate, see <i>Preset temp basal rates</i> , on page 76. To start a preset temp basal rate, see <i>Starting a preset temp basal rate</i> , on page 77.
Max Basal	The max basal rate is the maximum amount of basal insulin that your pump can deliver per hour.	The max basal rate is a safety feature that limits the total amount of basal insulin your pump can deliver per hour. To set your Max Basal rate, see <i>Max Basal rate</i> , on page 67.

## Max Basal rate

Max Basal rate limits the amount of basal insulin that can be delivered per hour based on the maximum rate you set. You are unable to set any basal rates, temp basal rates, or preset temp basal rates that exceed the max basal rate amount. You can set your max basal rate from 0 to 35 units per hour. Set your max basal rate as prescribed by your healthcare professional.



**Note:** If you set your max basal rate after you have set up your basal patterns or preset temp basal rates, you cannot set your max basal rate lower than any of your existing basal rates. You cannot access this feature during a normal bolus delivery.

### To set your Max Basal rate:

1. Press  and go to the Max Basal/Bolus screen.

**Options > Delivery Settings > Max Basal/Bolus**

2. Select **Max Basal** to set the maximum number of basal insulin units that can be delivered each hour.

Because the max basal rate setting determines your basal insulin limits, a Max Basal alert appears any time you enter the screen to change the value.

3. Select **Continue**.
4. In the Max Basal Rate screen, select **Max Basal** to set the maximum units per hour.
5. Select **Save**.

### Example 1: Max basal rate

Helen has a very low insulin requirement. Her highest basal rate is only 0.400 units per hour. As a safety measure, Helen's healthcare professional set her pump with a max basal rate of 1.00 units per hour.

## Example 2: Max basal rate

Rusty needs large amounts of insulin to control his BG levels. His new pump was delivered from the factory with a max basal rate of 2.00 units per hour, but he needs 2.80 units per hour in the early morning. Rusty plans to consult his healthcare professional about increasing his max basal rate to 3.00 units per hour to accommodate his needs.

## Basal patterns

Your basal pattern determines the amount of basal insulin you receive throughout the day and night. Because your basal insulin needs can vary, you can set up to eight basal patterns. For example, you might use one basal pattern during the week and a different basal pattern during the weekend.

A basal pattern is made up of one to 48 basal rates that you set up to cover a full 24-hour period. If you only need one basal rate throughout the day, you set only one rate for the 24-hour period. If you need the basal rates to change during the day or night to better match your insulin needs, you can set more than one rate, each with a separate start and end time.

The following example represents one basal pattern with three basal rates set for three different time periods.

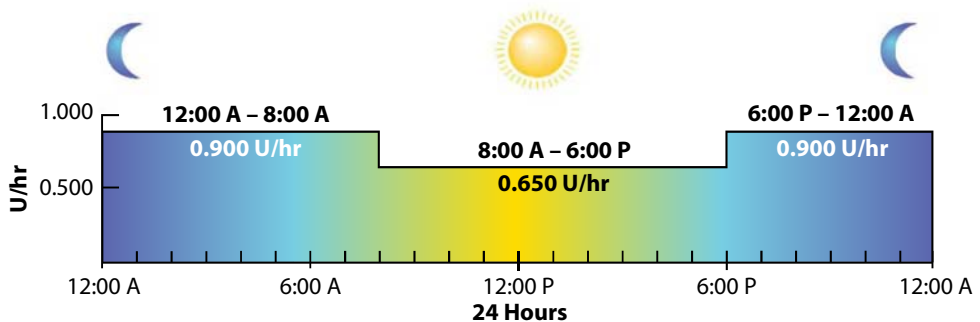

Your healthcare professional will determine what rates are right for you.



**Note:** If you have already set up basal patterns and want to switch from using one basal pattern to another, see *Changing from one basal pattern to another*, on page 72.

## Adding a new basal pattern

This procedure shows you how to add a new basal pattern.

### To add a new basal pattern:

1. Press  and go to the Basal Pattern Setup screen.

#### Options > Delivery Settings > Basal Pattern Setup

The Basal Pattern Setup screen appears. Your active basal pattern appears with a check mark and the 24-hour delivery amount, as shown in the following example.



2. If this is your first time setting up a basal pattern, the unit amount is 0.0. Select **Basal 1** and go to step 5.

If this is not your first time setting up a basal pattern, go to step 3 to add a new pattern.

3. To add a new basal pattern, select **Add New**.

The Select Name screen appears.

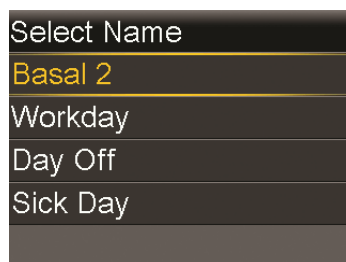

**Note:** The Workday, Day Off, and Sick Day patterns are available so that you can match a basal pattern name to your insulin needs on those particular days.

4. Select a basal pattern. An edit screen appears for the pattern you selected. The following example shows the Edit Workday screen.

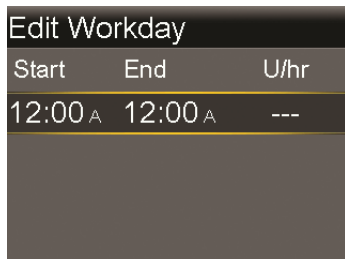

Start	End	U/hr
12:00 <sub>A</sub>	12:00 <sub>A</sub>	---

5. To create one continuous 24-hour basal rate for your basal pattern, continue with this step. To create more than one basal rate for your new basal pattern, go to step 6.
  - a. Leave End time at 12:00 AM to set a 24-hour rate. The Start time of the first time segment is always 12:00 AM.
  - b. Set your rate in units per hour.

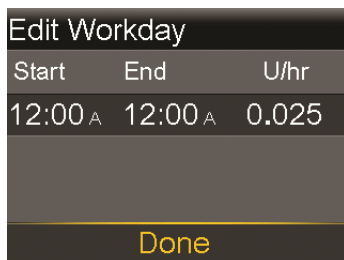

Start	End	U/hr
12:00 <sub>A</sub>	12:00 <sub>A</sub>	0.025

Done

- c. Go to Step 7.
6. To create more than one basal rate for your new basal pattern, enter one basal rate at a time, as described in the following steps:
  - a. Set the End time and the Rate for your first basal rate. You set your rates in 30-minute increments.

If you set the End time to anything other than 12:00 AM, a second basal rate setting appears.



Edit Workday		
Start	End	U/hr
12:00 <sub>A</sub>	7:30 <sub>A</sub>	0.075
7:30 <sub>A</sub>	6:00 <sub>P</sub>	---

The Start time for the next rate is always the same as the End time of the previous rate.



**Note:** If you need to make a change, press  $\wedge$  to scroll up to the rate and adjust the End time or Rate values.

Press  $\wedge$  or  $\vee$  when a field is selected to adjust the value of that field. When there is no field selected, press  $\wedge$  or  $\vee$  to scroll up or down the list of basal rates.

- b. Continue to set rates for different time periods as needed. The End time for your last rate must be 12:00 AM, as shown in the example that follows.

Edit Workday		
Start	End	U/hr
12:00 <sub>A</sub>	7:30 <sub>A</sub>	0.075
7:30 <sub>A</sub>	6:00 <sub>P</sub>	0.025
6:00 <sub>P</sub>	12:00 <sub>A</sub>	0.050

7. Select **Done**. The Done option appears only when the last End time in your basal pattern is set to 12:00 AM.

A screen appears that lets you review your basal pattern. If you need to make any changes, press  $\leftarrow$  to return to the previous screen.



**Note:** If you do not select **Done** and press  $\leftarrow$  to return to the previous screen, your changes are not saved or implemented.

8. Select **Save**.

To activate your basal pattern, see *Changing from one basal pattern to another*, on page 72.

## Editing, copying, or deleting a basal pattern

### To edit, copy, or delete a basal pattern:

1. Press  and go to the Basal Pattern Setup screen.

**Options > Delivery Settings > Basal Pattern Setup**

The Basal Pattern Setup screen shows all of your existing basal patterns.

2. Select the desired basal pattern.
3. Select **Options**.
4. Do any of the following:
  - Select **Edit** to adjust the End time or rate values for one or more of the basal rates in this basal pattern.
  - Select **Copy** to copy the basal rate information from the selected basal pattern to a new basal pattern. When the Select Name screen appears, you can select any available name from the list. Use the Edit option to adjust the new basal pattern as desired.
  - Select **Delete** to delete the selected basal pattern. You cannot delete the active basal pattern.

## Changing from one basal pattern to another

When you change to a new basal pattern, your pump delivers your basal insulin according to the basal pattern you selected.

### To change to a different basal pattern:

1. Press  and go to the Basal Patterns screen.

**Basal > Basal Patterns**

The Basal Patterns screen shows the basal patterns you have set up. The active basal pattern is indicated with a check mark.

2. Select the desired basal pattern.

The Basal screen shows the details for the selected basal pattern.

3. Select **Begin**.

### Example 1: Basal patterns

Ken has had his insulin pump for about a month. He tests his BG four to six times a day and records his results in his logbook. He is happy with his glucose control during the week but on the weekends, he noticed that he has to eat more food to prevent his BG from running too low.

Ken has realized that during the week while he is at work, he is very inactive and sits at a desk most of the time. On the weekends, though, he is busy with yard work, running errands, and playing with his kids. Ken plans to speak with his healthcare professional to see if he should add a different Basal Pattern to lower his basal settings to receive less insulin during active times, such as his weekends.

He can use the Basal Patterns feature to support his weekend change in activity. During the week, he can set his pump to deliver his Basal 1 pattern, and on Saturday morning, he can switch over to his Weekend pattern, which he can set with lower basal rates for the weekend. On Monday morning, he can return his pump to the Basal 1 pattern for his weekday insulin needs.

### Example 2: Basal patterns

Cynthia has had diabetes for about 12 years and has been on her pump for several weeks. Every Monday, Wednesday, and Friday, Cynthia goes on a two mile walk in the morning. To prevent hypoglycemia on these days, she uses a different basal pattern. For those days, she simply switches over to Basal 2, which she has programmed with a lower set of basal rates. Before she learned to use the patterns feature, she would have to eat more food throughout the day to keep her BG at a safe level. Cynthia has also noticed that a few days prior to menstruation, her BG levels seem to rise, requiring more insulin. She has programmed a Basal 3 pattern on her pump with higher basal rates for this time.

### Temp basal rates

The Temp Basal feature and Preset Temp feature allow you to set temporary basal rates to manage BG levels during short-term activities or conditions that require a basal rate different than your current one, such as an illness or a change in physical activity. You can make an immediate change to your basal insulin to a value up to your max basal rate. The period of time of your temporary basal rate can range from 30 minutes to 24 hours.



**Note:** SmartGuard Auto Mode is not available if a temp basal rate is active. To switch your pump to Auto Mode, you must first cancel the temp basal rate. For more information on canceling a temp basal rate, see *Canceling a temp basal or preset temp basal rate, on page 79*.

## About temp basal rates

A temp basal rate temporarily overrides all other basal programming. Your programmed basal pattern resumes after the temp basal rate delivery is completed or canceled.

The Temp Basal feature lets you set and start a temporary basal rate immediately. The Preset Temp feature lets you set up a temp basal rate ahead of time for known situations. You define temp basal rates and preset temp basal rates using either a percentage of your current basal pattern, or by setting a specific rate, as described in the following table.

<b>This temp basal type:</b>	<b>Works like this:</b>
Percent	<p>Percent delivers a percentage of the basal rates programmed in your active basal pattern for the duration of the temp basal rate. The temp basal amount is rounded down to the next 0.025 units if your basal rate is set at less than 1 unit per hour, or to the next 0.05 units if your basal rate is set at more than 1 unit per hour.</p> <p>Temp basal rates can be set to deliver from 0% to 200%, twice the amount, of your scheduled basal rate. The percent amount you can use is based on the largest basal rate scheduled during the temp basal duration and is limited by your max basal rate.</p>
Rate	<p>Rate delivers a fixed basal insulin rate in units per hour for the duration of your temporary basal. The amount you can set is limited by your max basal rate.</p>

To use the Temp Basal feature, see *Starting a temp basal rate, on page 75*. To use the Preset Temp Basal feature, see *Preset temp basal rates, on page 76*.

## Example 1: Temp basal rates

Jessica enjoys her exercise classes, but finds that her glucose levels drop after she attends them. Jessica works with her healthcare professional to learn how to use the Temp Basal feature so that she receives a reduced percentage of her usual basal insulin while she exercises.

### Starting a temp basal rate

When you start a temp basal rate, your basal insulin delivery changes to the temporary basal rate for the duration you set. When the duration is complete, your basal insulin delivery automatically returns to the active basal pattern.

#### To start a temp basal rate:

1. Press  and go to the Temp Basal screen.

Basal > Temp Basal

2. Set the **Duration**. The duration can be set in 15-minute increments from 30 minutes to 24 hours.

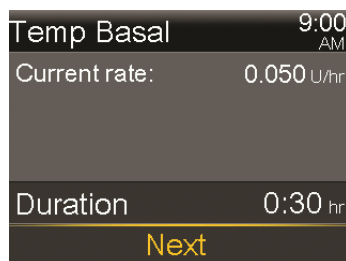

3. Select **Next**.
4. Select **Type** to select Percent or Rate.

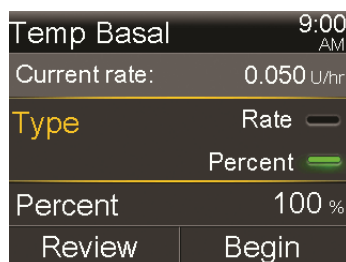

5. Depending on the Type you selected, do one of the following:
  - Enter a percentage:

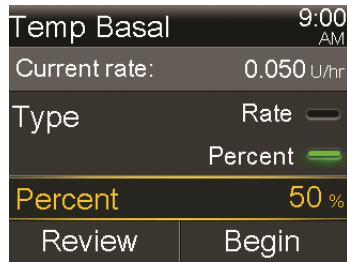

- Enter a basal rate. You cannot exceed your max basal rate.

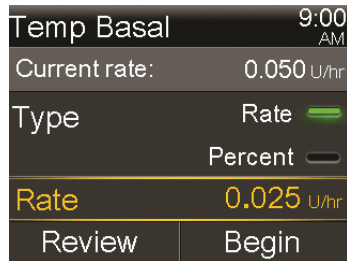

6. If desired, select **Review** to review your temp basal setting.
7. Select **Begin** to start the temp basal rate.

Your temp basal rate continues for the duration you set. A Temp Basal banner appears on the Home screen during your temp basal delivery. Your scheduled basal rate automatically starts again when your temp basal rate finishes.

## Preset temp basal rates

The Preset Temp feature lets you set up basal rates for recurring short-term situations where you need to temporarily change your basal rate.

There are four names you can use to match your preset temp basal rate to a situation: High Activity, Moderate Activity, Low Activity, and Sick. There are also four additional preset temp rates available to use for other circumstances (Temp 1 through Temp 4).

## Setting up and managing preset temp basal rates

This section describes how to set up, edit, rename, or delete a preset temp basal rate. For information on how to start using a preset temp basal rate, see *Starting a preset temp basal rate, on page 77*.

### To set up a preset temp basal rate:

1. Press  and go to the Preset Temp Setup screen.

## Options > Delivery Settings > Preset Temp Setup

2. Select **Add New**.
3. Select a name for the preset temp basal rate. For example, Temp 1, High Activity, Moderate Activity, Low Activity, or Sick.
4. Select **Type** to select Percent or Rate.
5. If you use Percent, enter a percentage. If you use Rate, enter the rate in units per hour. You cannot exceed your max basal rate.
6. Set the **Duration** for the preset temp basal rate to be active. The duration can be set in 15-minute increments from 30 minutes to 24 hours.
7. Select **Save**.

### To edit, rename, or delete a preset temp basal rate:

1. Press  and go to the Preset Temp Setup screen.

## Options > Delivery Settings > Preset Temp Setup

The Preset Temp Setup screen appears. This screen shows the settings for any existing preset temp.

2. Select the desired preset temp basal rate.



**Note:** You cannot select a preset temp basal rate that is currently in use.

3. The next screen displays the temp basal info. Do any of the following:
  - Select **Edit** to adjust the Type (Percent or Rate), the Percentage or Rate amount, and the Duration for the preset temp basal rate.
  - Select **Rename** to assign a different name to the preset temp basal rate. When the Select Name screen appears, select any available name from the list.
  - Select **Delete** to delete the preset temp basal rate.

### Starting a preset temp basal rate

You must set up preset temp basal rates before you can use the Preset Temp feature. For more information, see *Preset temp basal rates, on page 76*.

## To start a preset temp basal rate:

1. Press  and go to the Preset Temp screen. The Preset Temp feature only appears if you have set up preset temp basal rates.

### Basal > Preset Temp

The Preset Temp screen shows the preset temp basal rates you have set up, along with their percentage or rate amounts.

Preset Temp	5:08 PM
Current rate:	0.025 U/hr
Temp 1	0.100 U/hr
High Activity	25 %
Moderate...	50 %



**Note:** Depending on your active basal pattern, it is possible for a percentage preset temp basal rate to exceed your max basal limit. You cannot use a preset temp basal rate that exceeds your max basal limit. These rates appear grayed out in the list.

2. Select the preset temp basal rate you want to start.
3. Select **Begin**.

Temp 1	5:10 PM	
0.100 U/hr for 5:00 hr		
Start	End	Temp (U/hr)
5:10 P	10:10 P	0.100
<b>Begin</b>		

Your preset temp basal rate continues for the duration you set. A Temp Basal banner appears on the Home screen during your preset temp basal delivery. Your scheduled basal rate automatically starts again when your preset temp basal rate finishes.



## Canceling a temp basal or preset temp basal rate

You can cancel a temp basal or preset temp basal rate at any time. When you do so, your scheduled basal pattern automatically starts again.

### To cancel a temp basal rate:

1. From the Home screen, press  and go to the Temp Basal screen.



#### Cancel Temp Basal > Temp Basal

The Temp Basal screen shows the name (Preset Temp only), current basal rate, the set duration, and the remaining time.

2. Select **Cancel Temp Basal**.

## Viewing your basal information

The following table describes how you can view your basal rates and patterns.

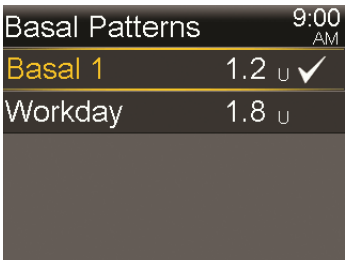
To do this:	Do this:
View your current basal rate	<p>From the Quick Status, you can view your current basal rate. Press  and go to the Quick Status screen.</p> <p><b>Status &gt; Quick Status</b></p>
View your basal patterns	<p>Press  and go to the Basal Patterns screen:</p> <p><b>Basal &gt; Basal Patterns</b></p> <p>The Basal Patterns screen shows the basal patterns you have set up, and the 24-hour insulin total for each basal pattern. A check mark appears next to the active basal pattern.</p> 

To see the individual basal rates, select the desired basal pattern.

## Stopping and resuming your insulin delivery

Use Suspend Delivery if you need to stop all active basal and bolus insulin deliveries. While your insulin delivery is suspended, your pump beeps, vibrates, or both depending on your audio settings. This reminder occurs every 15 minutes to remind you that insulin is not being delivered.



**Note:** The first reminder occurs 15 minutes after your pump display times out. If you press a button and wake up your pump, the reminder does not occur until 15 minutes after your pump display times out again. To adjust your timeout setting, see *Display Options*, on page 163.

To continue your basal insulin delivery, use the Resume Delivery feature. Your pump starts your programmed basal pattern but does not start any previously programmed bolus deliveries.



**Note:** If you want to stop a bolus delivery only, without stopping your basal insulin delivery, see *Stopping a bolus delivery*, on page 114.



**WARNING:** Always check the pump Daily History after you resume insulin delivery to determine the amount that was delivered. If needed, program a new bolus or fill the cannula. A bolus delivery or fill cannula that was suspended does not restart when you resume. Failure to resume insulin delivery can result in hyperglycemia and ketoacidosis.



**WARNING:** Do not rely solely on the audio or vibration notifications when using the Audio or Vibrate options. These notifications may not occur as expected if the speaker or vibrator in your pump malfunctions. A missed notification could result in the delivery of too much or too little insulin. This is most common when using the Easy Bolus feature, or when your pump is in Manual Suspend. Contact 24-Hour Technical Support with any concerns.

**To suspend all insulin delivery:**

1. Press  and go to the **Suspend Delivery** screen.  
A confirmation message appears.
2. Select **Yes** to suspend your pump and stop all insulin delivery.  
The Home screen indicates that your insulin delivery is suspended. Your pump functions are limited until you resume your basal insulin delivery.

**To resume basal insulin delivery:**

1. While insulin delivery is suspended, press  and go to the **Resume Delivery** screen.  
A confirmation message appears.
2. To resume your basal insulin delivery, select **Yes**. If a temp basal rate was active when you suspended your pump, it resumes if the time is still within the duration that you set.



**Note:** If you still need a bolus delivery that was in progress before you suspended your insulin delivery, check the Daily History screen for the actual bolus units delivered and the intended bolus amount. Then you can set up a new bolus amount as needed. See *Daily History*, on page 145 for details about using the Daily History screen.



4





# Bolus 4

A bolus is the amount of insulin taken to cover an expected rise in blood glucose (BG), typically when you eat a meal or snack. You can also use a bolus to correct a high BG reading.

## About bolus deliveries

There are different types of bolus deliveries you can use, depending on your insulin needs at the time. There are also different ways you can deliver a bolus. Discuss these options with your healthcare professional to determine what is best for you.

## Bolus types



**Note:** While in SmartGuard Auto Mode, you can only deliver a Normal bolus.

The following table provides general information about the available bolus types.

Bolus type	Description	Purpose
Normal	Normal bolus provides a single immediate dose of insulin.	<p>This is the typical bolus type you use to cover your food intake or to correct a high BG meter reading.</p> <p>For details about using the Normal bolus feature, see <i>Normal bolus</i>, on page 100.</p>

<b>Bolus type</b>	<b>Description</b>	<b>Purpose</b>
Square Wave bolus	Square Wave bolus delivers a single bolus evenly over an extended period of time from 30 minutes up to 8 hours.	<p>You might use a Square Wave bolus for the following reasons:</p> <ul style="list-style-type: none"> <li>• You have delayed food digestion due to gastroparesis or meals high in fat.</li> <li>• When you snack over an extended period of time.</li> <li>• A Normal bolus drops your BG too rapidly.</li> </ul> <p>For details about using the Square Wave bolus feature, see <i>Square Wave bolus, on page 103</i>.</p>
Dual Wave bolus	Dual Wave bolus delivers a combination of an immediate Normal bolus followed by a Square Wave bolus.	<p>You might use a Dual Wave bolus for the following reasons:</p> <ul style="list-style-type: none"> <li>• When you eat meals that are both high in carbs and fat which may delay digestion.</li> <li>• When your meal bolus is combined with a correction bolus for an elevated BG.</li> </ul> <p>For details about using a Dual Wave bolus, see <i>Dual Wave bolus, on page 106</i>.</p>

## Bolus type example

The following example shows how the different bolus types work.

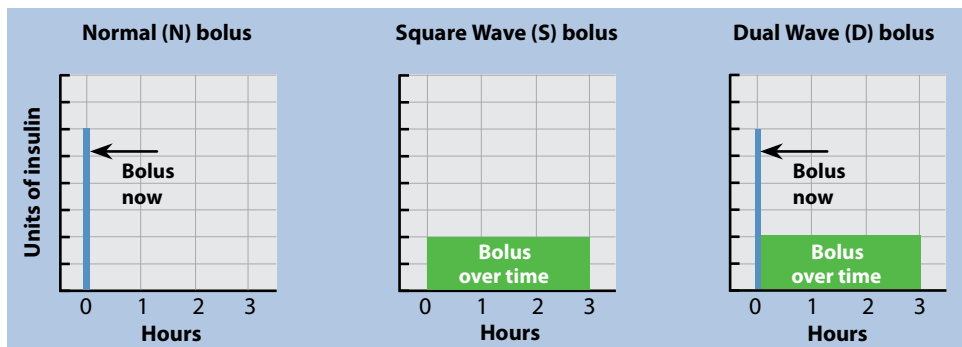



## Bolus delivery options

The following table describes the different ways you can deliver a bolus.



**Note:** Different bolus delivery options are available depending on whether the pump is in Manual Mode or Auto Mode. For a list of delivery options available for each mode, see *Modes*, on page 54.

Delivery method	Bolus types	How it works
Bolus Wizard feature	Normal bolus, Square Wave bolus, Dual Wave bolus	<p>You enter your BG meter reading or the carbs you plan to eat, or both. Then the Bolus Wizard feature calculates an estimated bolus amount based on your individual settings.</p> <p>The Bolus Wizard feature is only available in Manual Mode.</p> <p>For details about using the Bolus Wizard feature, see <i>Bolus Wizard feature</i>, on page 92.</p> <p>Refer to the corresponding section to deliver one of the following bolus types:</p> <ul style="list-style-type: none"><li>• Normal bolus using the Bolus Wizard feature, see <i>Delivering a Normal bolus with the Bolus Wizard feature</i>, on page 100.</li><li>• Square Wave bolus using the Bolus Wizard feature, see <i>Delivering a Square Wave bolus with the Bolus Wizard feature</i>, on page 104.</li><li>• Dual Wave bolus using the Bolus Wizard feature, see <i>Delivering a Dual Wave bolus with the Bolus Wizard feature</i>, on page 107.</li></ul>

<b>Delivery method</b>	<b>Bolus types</b>	<b>How it works</b>
Auto Mode Bolus	Normal bolus	<p>You enter your BG meter reading or the carbs you plan to eat, or both. Then the Auto Mode Bolus feature calculates a bolus amount to cover the meal or correction.</p> <p>The Auto Mode Bolus feature is only available in Auto Mode.</p> <p>For details about using the Auto Mode Bolus feature, see <i>SmartGuard Auto Mode Bolus</i>, on page 234.</p>
Manual	Normal bolus, Square Wave bolus, Dual Wave bolus	<p>You do your own calculation and manually enter your bolus amount.</p> <p>Refer to the corresponding section to deliver one of the following bolus types:</p> <ul style="list-style-type: none"> <li>• Normal bolus, see <i>Delivering a Normal bolus using Manual Bolus</i>, on page 103</li> <li>• Square Wave bolus, see <i>Delivering a Square Wave bolus using Manual Bolus</i>, on page 106</li> <li>• Dual Wave bolus, see <i>Delivering a Dual Wave Bolus using Manual Bolus</i>, on page 108</li> </ul>
Preset Bolus	Normal bolus, Square Wave bolus, Dual Wave bolus	<p>You select from specific bolus settings that you define ahead of time for recurring situations.</p> <p>For details about using the Preset Bolus feature, see <i>Preset bolus</i>, on page 112.</p>

Delivery method	Bolus types	How it works
Easy Bolus feature	Normal bolus	<p>After the Easy Bolus feature is set up, you can deliver a Normal bolus by using the <math>\wedge</math> button when the pump is in sleep mode.</p> <p>For details about using the Easy Bolus feature, see <i>Easy Bolus feature, on page 109</i>.</p>

## Bolus settings

The following table describes some bolus settings that you may need to change before you use your bolus options. Consult with your healthcare professional for the settings that are right for you.



**Note:** Additional settings are required to use the Bolus Wizard feature. These are described in the section, *Bolus Wizard feature, on page 92*.

Setting	What it is	What it does for you
Max bolus	Max bolus is the maximum amount of bolus insulin in units your pump can deliver in a single bolus.	<p>Max bolus provides a safety feature that limits the total amount of bolus insulin you can program for a single bolus delivery.</p> <p>To set the max bolus amount, see <i>Max bolus, on page 90</i>.</p>

Setting	What it is	What it does for you
Bolus Increment	The amount of insulin in units that is increased or decreased with each button press when adjusting your bolus amount. The Bolus Wizard feature and Auto Mode Bolus also uses the increment to display the total amount and the adjustment amount of the bolus. This setting does not apply to the Easy Bolus feature.	You can set your increment value according to your typical bolus amounts.  To set the bolus increment, see <i>Bolus increment</i> , on page 91.
Bolus Speed	The speed that your pump delivers your bolus insulin.	You can set your bolus insulin delivery speed to Standard or Quick.  To set your bolus speed, see <i>Bolus speed</i> , on page 92.

## Max bolus

The Max Bolus setting limits the amount of insulin that can be delivered in a single bolus. Your pump prevents single bolus insulin deliveries that exceed the max bolus you set. You can set your max bolus from 0 to 25 units. Set your max bolus as prescribed by your healthcare professional.

If you set your max bolus after you have set up your Preset Bolus deliveries, you cannot set your max bolus lower than any of your Preset Bolus amounts.

The max bolus setting applies to both Manual Mode and Auto Mode.

### To set your max bolus:

1. Press  and go to the Max Basal/Bolus screen.  
Options > Delivery Settings > Max Basal/Bolus
2. Select **Max Bolus**.

3. Because the max bolus setting determines your bolus insulin limit, a Max Bolus alert appears any time you go to the screen to change the value. To continue to the Max Bolus screen, select **Continue**.
4. Select **Max Bolus**, and then set the maximum number of insulin units your pump can deliver in one bolus.
5. Select **Save**.

### Example 1: Max bolus

Shelby takes very small doses of insulin for her meal boluses. As a safety limit, her healthcare professional had her reset her pump with a max bolus of 5.0 units.

### Example 2: Max bolus

David is a growing teenager. He loves to eat big meals and requires very large doses of insulin for his food. David's healthcare professional had him reset his pump with a max bolus of 20.0 units so he can take more insulin when needed.

## Bolus increment

The Bolus Increment setting determines the number of units that are increased or decreased with each button press when you adjust your bolus delivery amount in the Bolus Wizard, Manual Bolus, and Preset Bolus screens. Depending on your typical bolus amount, you can set your increment to 0.1 units, 0.05 units, or 0.025 units.



**Note:** The Easy Bolus feature uses a setting called Step Size to determine the number of insulin units for each button press. See *Setting up the Easy Bolus feature*, on page 110 for more information.

### To set your bolus increment:

1. Press  and go to the Bolus Increment screen.  
**Options > Delivery Settings > Bolus Increment**
2. Select **Increment** to set your desired increment value.
3. Select **Save**.

## Bolus speed

The Bolus Speed setting sets the rate at which your pump delivers bolus insulin. You can set a Standard rate (1.5 units per minute), or a Quick rate (15 units per minute).

### To set your bolus speed:

1. Press  and go to the Bolus Speed screen.  
Options > Delivery Settings > Bolus Speed
2. Select **Standard** or **Quick**.
3. Select **Save**.

## Bolus Wizard feature

The Bolus Wizard feature uses your individual Bolus Wizard settings to calculate an estimated bolus amount based on the BG values and carbs that you enter. Work with your healthcare professional to define your personal settings, which include your carb ratio, insulin sensitivity, BG target range, and active insulin time.



**WARNING:** Do not use Alternative Site Testing to make insulin dosing calculations.



**Note:** If you do not know how to count carbs, consult with your healthcare professional before using the Bolus Wizard feature.

After you set up the Bolus Wizard feature, you can use it to calculate and deliver a food bolus, a correction bolus, or a food plus correction bolus using a Normal bolus (see *Delivering a Normal bolus with the Bolus Wizard feature, on page 100*), Square Wave bolus (see *Delivering a Square Wave bolus with the Bolus Wizard feature, on page 104*), or Dual Wave bolus (see *Delivering a Dual Wave bolus with the Bolus Wizard feature, on page 107*).

The following sections describe how to set up the Bolus Wizard feature. Bolus delivery instructions are provided in the individual sections for each bolus type.

## Understanding your Bolus Wizard settings

Your pump tells you to enter the following settings when you first turn on the Bolus Wizard feature. Get your prescribed settings from your healthcare professional, and always consult your healthcare professional before you change your settings. The setup procedure begins on *page 94*.

Setting	Description
Carb Ratio	<p>The carb ratio setting is used for food bolus calculations.</p> <p>The number of carb grams that are covered by 1 unit of insulin.</p>
Insulin Sensitivity Factor	<p>The insulin sensitivity factor setting is used to calculate correction bolus amounts.</p> <p>Your insulin sensitivity factor is the amount that BG is reduced by one unit of insulin.</p>
BG Target	<p>The Bolus Wizard feature calculates your estimated bolus based on your BG target range. The high and low values you set are the values to which your BG is corrected. To use a single target value rather than a range, set the same value for the high and low value of your BG target.</p> <p>If your BG value is above the high target value, a correction dose is calculated. If your BG value is below the low target value, a negative correction is calculated and subtracted from your food bolus.</p>
Active Insulin Time	<p>Active insulin is the bolus insulin that has been delivered by the pump and is still working to lower your BG levels. Active insulin time is the length of time that bolus insulin is tracked as active insulin.</p> <p>Work with your healthcare professional to get the active insulin time that best represents the insulin type you use and your physiological insulin absorption rate.</p> <p>For more information about how the Bolus Wizard feature uses your active insulin amount, see <i>About active insulin</i>, on <i>page 98</i>.</p>



## Setting up the Bolus Wizard feature

Before you can use the Bolus Wizard feature to calculate a bolus, you must turn on the Bolus Wizard feature and enter your Bolus Wizard settings.

### To set up the Bolus Wizard feature:

1. Press  and go to the Bolus Estimate Setup screen.

**Options > Delivery Settings > Bolus Estimate Setup**

The Bolus Estimate Setup screen appears with the Bolus Wizard feature turned off.

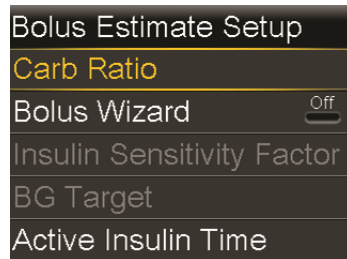

2. Select **Bolus Wizard** to turn on the feature.

If this is the first time you have turned on the Bolus Wizard feature, your pump displays information about the settings you need to enter.

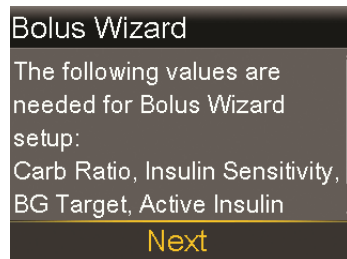

Make sure you have the values you need, and then select **Next** to continue.



**Note:** As you enter your personal settings, your pump displays information about each setting. Select **Next** to continue when you have read each explanation.



- When the Edit Carb Ratio screen appears, enter your carb ratio. You can set up to eight carb ratios using different time segments. The time segments must cover a 24-hour period.

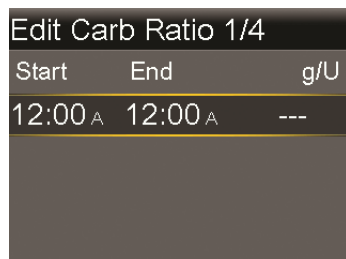

If your ratio value is outside the range of 5 to 50 grams per unit, a message appears asking you to confirm your setting.

- When the Edit Sensitivity screen appears, enter your insulin sensitivity factor. You can set up to eight different sensitivity factors using different time segments. The time segments must cover a 24-hour period.

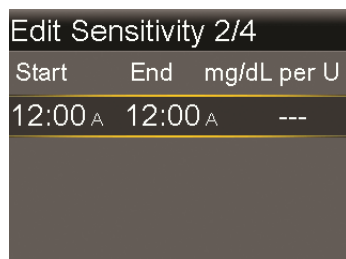

If the value you enter is outside the range of 20 to 100 mg/dL per U, a message appears asking you to confirm your setting.

- When the Edit BG Target screen appears, enter your Bolus Wizard BG target range. You can set up to eight different BG target ranges using different time segments. The time segments must cover a 24-hour period.

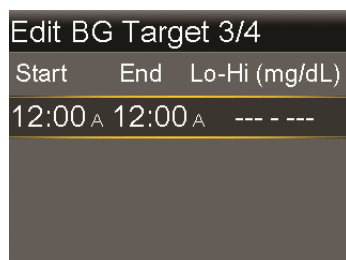

If your Bolus Wizard BG target is outside the range of 90 to 140 mg/dL, a message appears asking you to confirm your setting.

6. When the Active Insulin Time screen appears, enter your active insulin time value. The default is four hours.

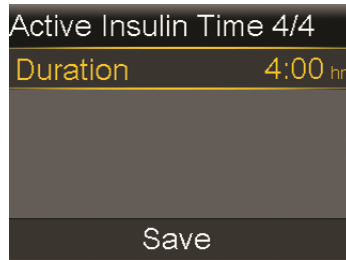

7. Select **Save**.

A message appears letting you know the Bolus Wizard setup is complete.

You can now use the Bolus Wizard feature to calculate a bolus.

## Changing your Bolus Wizard settings

This section shows you how to make changes to your personal settings after you initially set up the Bolus Wizard feature. Except for the carb ratio setting, these settings are available only if the Bolus Wizard feature is turned on. Always consult with your healthcare professional before you make changes to your personal settings.

### Changing your carb ratio

The carb ratio setting is always available whether or not you have the Bolus Wizard feature turned on.

#### To change your carb ratio:

1. Press  and go to the Carb Ratio screen.  
**Options > Delivery Settings > Bolus Estimate Setup > Carb Ratio**
2. Select **Edit**.
3. Select the carb ratio to adjust the Start time, the End time, and the ratio. You can set up to eight different carb ratios using different time segments. The time segments must cover a 24-hour period.

If you set a value outside the typical range of 5 to 50 grams per unit, a screen appears and tells you to confirm your setting.

4. Select **Save** after you make your changes.

### Changing your insulin sensitivity factor

The insulin sensitivity factor option is only available if the Bolus Wizard feature is turned on.

#### To change your insulin sensitivity factor:

1. Press  and go to the Sensitivity screen.  
**Options > Delivery Settings > Bolus Estimate Setup > Insulin Sensitivity Factor**
2. Select **Edit**.
3. Select the insulin sensitivity factor to adjust the Start time, the End time, and the Sensitivity amount. You can set up to eight different sensitivity amounts using different time segments. The time segments must cover a 24-hour period.

If you set a value that is outside the typical range of 20 to 100 mg/dL per unit, a screen appears and tells you to confirm your setting.

4. Select **Save** after you make your changes.

### Changing your Bolus Wizard BG target

Your target range can be from 60 to 250 mg/dL. The Bolus Wizard BG target option is only available if the Bolus Wizard feature is turned on.

#### To change your Bolus Wizard BG target range:

1. Press  and go to the BG Target screen.  
**Options > Delivery Settings > Bolus Estimate Setup > BG Target**
2. Select **Edit**.
3. Select the BG target to adjust the Start time, the End time, and the Lo (low) and Hi (high) BG Target values. Your high value cannot be less than your low value. You can set up to eight different values using different time segments. The time segments must cover a 24-hour period.

If your BG target is outside the typical range of 90 to 140 mg/dL, a screen appears and tells you to confirm your setting.

4. Select **Save** after you make your changes.

### Changing your active insulin time

The active insulin time setting lets the pump know which active insulin time to use in calculating the amount of active insulin to subtract before estimating a bolus. Your healthcare professional prescribes the active insulin time that is best for you.

#### To change your active insulin time:

1. Press  and go to the Active Insulin Time screen.  
**Options > Delivery Settings > Bolus Estimate Setup > Active Insulin Time**
2. Select **Duration**, and then adjust your active insulin time in hours, using 15-minute increments.
3. Select **Save**.

### Turning off the Bolus Wizard feature

You can turn off the Bolus Wizard feature at any time. Your Bolus Wizard settings remain in your pump. When the Bolus Wizard feature is turned off, the Bolus Wizard option does not appear in the Bolus menu, and you cannot edit your Insulin Sensitivity Factor or BG Target settings from the Bolus Estimate Setup screen.

#### To turn off the Bolus Wizard feature:

1. Press  and go to the Bolus Estimate Setup screen.  
**Options > Delivery Settings > Bolus Estimate Setup**
2. Select **Bolus Wizard** to turn the feature off.

### About active insulin

Active insulin is the bolus insulin that has already been delivered to your body and is still working to lower your BG levels. The pump uses your active insulin time setting to determine if any active insulin is still in your body from prior boluses. This may help prevent hypoglycemia caused by overcorrection of high BG.

Your current active insulin amount displays on the Home screen and includes only the bolus insulin you already received.

When you use the Bolus Wizard feature, the Bolus Wizard calculator uses your current active insulin value to determine if there is an active insulin adjustment needed. The active insulin adjustment calculation considers both the bolus insulin that has previously been delivered (the amount shown on the Home screen), as well as any insulin that will be delivered by an active Square Wave bolus.



**WARNING: Do not use the Bolus Wizard feature to calculate a bolus for a period of time after giving a manual injection of insulin by syringe or pen. Manual injections are not accounted for in the active insulin amount. Therefore, the Bolus Wizard feature could prompt you to deliver more insulin than needed. Too much insulin can cause hypoglycemia. Consult with your healthcare professional for how long you need to wait after a manual injection of insulin before you can rely on the active insulin calculation of the Bolus Wizard feature.**

### Bolus Wizard feature alerts

When you use the Bolus Wizard feature, there may be times when you see one of the following:

Alert:	What it means:	What to do:
High BG	Your BG meter reading is above 250 mg/dL.	<ul style="list-style-type: none"> <li>• Check infusion set.</li> <li>• Check ketones.</li> <li>• Consider an insulin injection.</li> <li>• Monitor your BG.</li> </ul>
Low BG	Your BG meter reading is below 70 mg/dL.	Treat your low BG. Do not give yourself a bolus until your BG returns to normal.

<b>Alert:</b>	<b>What it means:</b>	<b>What to do:</b>
Max Bolus exceeded	The bolus amount exceeds your Max Bolus setting.	<p>Check the bolus amount. Select <b>No</b> to cancel, or <b>Yes</b> to continue. If you select Yes, the bolus amount is reduced to your max bolus limit.</p> <p>Let your healthcare professional know if you routinely receive the Max Bolus exceeded alert so they can adjust your pump settings.</p>

## Normal bolus

A Normal bolus provides a single immediate dose of insulin. Use a Normal bolus to cover your food intake or to correct a high BG meter reading.

You cannot access the Reservoir & Tubing, Delivery Settings, or Sensor Settings menu options during a Normal bolus delivery.



**Note:** Your pump lets you deliver a Normal bolus while a Square Wave bolus or the Square portion of a Dual Wave bolus is being delivered.

## Delivering a Normal bolus with the Bolus Wizard feature

### To deliver a Normal bolus using the Bolus Wizard feature:

1. For a correction bolus or a food bolus with a correction, use your BG meter to check your BG. For a food bolus only, go to step 2.
2. Press  and go to the Bolus Wizard screen.

**Bolus > Bolus Wizard**

The Bolus Wizard screen shows your current BG meter reading, if applicable, and any insulin that is still active from previous boluses. For more information about active insulin, see *About active insulin, on page 98*. For more information about the meter, see *About your Accu-Chek Guide Link meter, on page 135*.

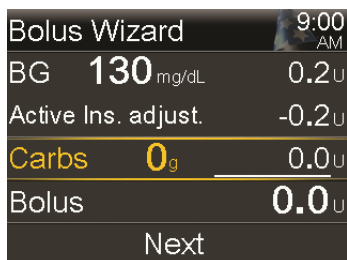

- If you are not using a paired meter, you can select **BG** to manually enter your BG meter reading.



**Note:** If you choose not to enter a BG value, three dashes appear on the screen in place of the BG value.

- For a food bolus, select **Carbs** to enter the carb count of your meal. For a correction bolus where no food was eaten, leave the Carbs value at 0.
- Your calculated bolus appears in the Bolus field.

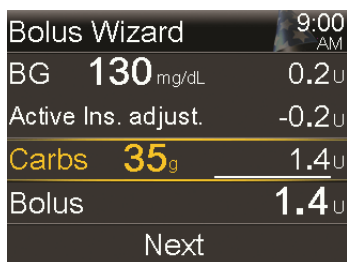

If a change to the bolus amount is needed, select **Bolus**. If you change your bolus amount, the word “Modified” appears next to the new bolus amount.

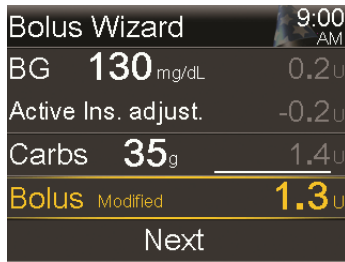

6. Select **Next** to review your bolus information.

Your bolus amount appears.



**Note:** If you modified your bolus amount in the previous step, **Bolus Calculated** shows your original bolus amount, **Modification** shows the amount you added or subtracted from your bolus, and **Bolus** shows the actual bolus amount.

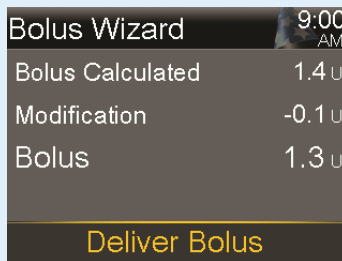

7. Select **Deliver Bolus** to start your bolus.



Your pump beeps or vibrates and a message appears when your bolus starts. The Home screen shows your bolus amount as it is being delivered. Your pump beeps or vibrates when your bolus is complete.



## Delivering a Normal bolus using Manual Bolus

The following procedure describes how to deliver a Normal bolus using the Manual Bolus feature.

### To deliver a Normal bolus using Manual Bolus:

1. Press  and go to the Manual Bolus screen.

**Bolus > Manual Bolus**



**Note:** If the Bolus Wizard feature is turned off, the Manual Bolus screen appears when you select Bolus.

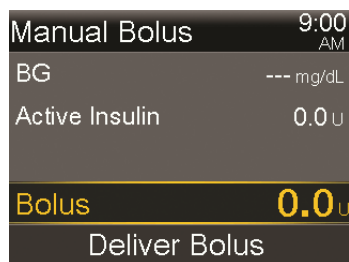

The Manual Bolus screen shows your current BG value, if applicable, and any insulin that is still active from previous boluses. For more information about active insulin, see *About active insulin, on page 98*.

2. Select **Bolus** to set your bolus delivery amount in units.
3. Select **Deliver Bolus** to start your bolus.

Your pump beeps or vibrates and a message appears when your bolus starts. The Home screen shows your bolus amount as it is being delivered. Your pump beeps or vibrates when your bolus is complete.

## Square Wave bolus

A Square Wave bolus delivers a bolus evenly over a period of time from 30 minutes up to 8 hours.

When using the Bolus Wizard feature, a Square Wave bolus is available only when giving a food bolus without a correction for an elevated BG. A Square Wave bolus is not available for a correction bolus alone or a correction bolus with food bolus.

A Square Wave bolus can be useful in the following situations:

- You have delayed food digestion due to gastroparesis or meals high in fat.
- When you snack over an extended period of time.
- A Normal bolus drops your BG too rapidly.

Since the Square Wave bolus extends delivery over a period of time, the insulin is more likely to be available as you need it.



**Note:** You cannot perform the following functions during a Square Wave bolus delivery:

- Enable Auto Mode.
- Change the Max Bolus or the Active Insulin Time settings.
- Set a second Square Wave or a Dual Wave bolus.
- Turn off the Dual Wave or Square Wave options.
- Fill the cannula.
- Rewind your pump.
- Run a self test.
- Access the Manage Settings menu.

All other functions are available during the Square Wave bolus.

## Turning on or off the Square Wave bolus feature

You can deliver a Square Wave bolus only after you turn on the Square Wave bolus feature.

### To turn on or turn off the Square Wave bolus feature:

1. Press  and go to the Dual/Square screen.

**Options > Delivery Settings > Dual/Square Wave**

2. Select **Square Wave** to turn the feature on or off.
3. Select **Save**.

## Delivering a Square Wave bolus with the Bolus Wizard feature

You can deliver a Square Wave bolus with the Bolus Wizard feature only after you turn the Square Wave option on. Also, you must have entered a value for your carbs.

## To deliver a Square Wave bolus with the Bolus Wizard feature:

1. Press  and go to the Bolus Wizard screen.

### Bolus > Bolus Wizard

The Bolus Wizard screen shows your current BG meter reading, if applicable, and any insulin that is still active from previous boluses. For more information about active insulin, see *About active insulin, on page 98*. For more information about the meter, see *About your Accu-Chek Guide Link meter, on page 135*.

2. If you are not using a paired meter, you can select **BG** to manually enter your BG meter reading.



**Note:** If you choose not to enter a BG meter reading, three dashes appear on the screen instead.

3. Select **Carbs** to enter the amount of carbs in your food.
4. Review your calculated bolus amount in the Bolus field. If you want to change the bolus amount, select **Bolus** and make your desired change. Remember, if there is a correction bolus amount calculated, you are not able to give a Square Wave bolus.



**Note:** If you change your bolus amount, the word “Modified” appears next to the new bolus amount.

5. Select **Next** to review your bolus information.
6. Select **Square**.  
The Bolus Wizard screen appears with your bolus amount.
7. Select **Duration** to adjust the time period over which you want your Square Wave bolus to be delivered. The duration can be set in 15-minute increments from 30 minutes to 8 hours.
8. Select **Deliver Bolus** to start your bolus.

During a Square Wave bolus delivery, the Square Bolus banner displays on your Home screen until bolus delivery is complete. You can press  and select **Bolus** to stop the bolus, to see details on the insulin that has been delivered, or to access the Bolus menu.

## Delivering a Square Wave bolus using Manual Bolus

The Square Wave bolus option is available in the Manual Bolus screen only after you turn on the Square Wave feature.

### To deliver a Square Wave bolus manually:

1. Press  and go to the Manual Bolus screen.  
**Bolus > Manual Bolus**
2. Set your bolus delivery amount in units, and then select **Next**.
3. Select **Square**.
4. Select **Duration** to adjust the time period over which you want your Square Wave bolus to be delivered. The duration can be set in 15-minute increments from 30 minutes to 8 hours.
5. Select **Deliver Bolus** to start your bolus.

During a Square Wave bolus delivery, the Square Bolus banner displays on your Home screen until bolus delivery is complete. You can press  and select **Bolus** to stop the bolus, to see details on the insulin that has been delivered, or to access the Bolus menu.

## Dual Wave bolus

The Dual Wave bolus feature meets both immediate and extended insulin needs by delivering a combination of an immediate Normal bolus followed by a Square Wave bolus.

A Dual Wave bolus can be useful in these situations:

- When you need to correct an elevated BG before a meal, and you also need a delayed bolus for food that is absorbed slowly.
- When you eat meals with mixed nutrients, such as carbs, fats and proteins, that are absorbed at different rates.

## Turning on or off the Dual Wave bolus feature

You can deliver a Dual Wave bolus only after you turn on the Dual Wave bolus feature.

### To turn on or turn off the Dual Wave bolus feature:

1. Press  and go to the Dual/Square screen.  
**Options > Delivery Settings > Dual/Square Wave**
2. Select **Dual Wave** to turn the feature on or off.
3. Select **Save**.

## Delivering a Dual Wave bolus with the Bolus Wizard feature

You can deliver a Dual Wave bolus with the Bolus Wizard feature only after you turn on the Dual Wave bolus feature.

### To deliver a Dual Wave bolus with the Bolus Wizard feature:

1. For a correction bolus or a food bolus with a correction, use your BG meter to check your BG. For a food bolus only, go to step 2.
2. Press  and go to the Bolus Wizard screen.

#### **Bolus > Bolus Wizard**

The Bolus Wizard screen shows your current BG meter reading, if applicable, and any insulin that is still active from previous boluses. For more information about active insulin, see *About active insulin, on page 98*. For more information about the meter, see *About your Accu-Chek Guide Link meter, on page 135*.

3. If you are not using a paired meter, you can select **BG** to manually enter your BG meter reading.



**Note:** If you choose not to enter a BG value, three dashes appear on the screen in place of the BG value.

4. For a food bolus, select **Carbs** to enter the carb count of your meal. For a correction bolus where no food was eaten, leave the Carbs value as 0.
5. Review your calculated Bolus amount. If you want to change the amount, select **Bolus** and make your desired change.



**Note:** If you change your bolus amount, the word “Modified” appears next to the new bolus amount.

6. Select **Next** to review your bolus information.
7. Select **Dual**.

The Bolus Wizard screen appears, with the food bolus amount split evenly between the Now and Square portions.

8. If you need to change the amounts, select the area of the screen with the Now value and adjust the **Now** amount.

When you adjust the Now amount, the Square amount adjusts automatically.

Bolus Wizard		9:00 AM
Bolus		1.8 U
Now	28 %	0.5 U
Square	72 %	1.3 U
Duration		3:00 hr
<b>Deliver Bolus</b>		

9. Adjust the **Duration** over which you want the Square Wave bolus portion to be delivered. The duration can be from 30 minutes to 8 hours.
10. Select **Deliver Bolus** to start your bolus.

During a Dual Wave bolus delivery, the Home screen shows the progress of the Now portion of your delivery. When the Now portion is complete, the Dual Bolus banner displays until bolus delivery is complete. You can press  and select **Bolus** to stop the bolus, to see details on the amount of bolus insulin delivered, or to access the Bolus menu.

## Delivering a Dual Wave Bolus using Manual Bolus

You can deliver a Dual Wave bolus from the Manual Bolus screen only after you turn on the Dual Wave bolus feature.

### To deliver a Dual Wave bolus using Manual Bolus:

1. Press  and go to the Manual Bolus screen.

**Bolus > Manual Bolus**

The Manual Bolus screen appears.

2. Set your bolus delivery amount in units, and then select **Next**.
3. Select **Dual**.

The Manual Bolus screen appears, with the Now and Square portions split evenly.

Manual Bolus		9:00 AM
Bolus		0.8 U
Now	50 %	0.4 U
Square	50 %	0.4 U
Duration		0:30 hr
Deliver Bolus		

4. If you need to change the amounts, select the area of the screen with the Now value and adjust the **Now** amount. When you adjust the Now amount, the Square amount adjusts automatically.
5. Adjust the **Duration** over which you want the Square Wave bolus portion to be delivered. The duration can be from 30 minutes to 8 hours.
6. Select **Deliver Bolus** to start your bolus.

During a Dual Wave bolus delivery, the Home screen shows the progress of the Now portion of your delivery. When the Now portion is complete, the Dual Bolus banner displays until bolus delivery is complete. You can press  and select **Bolus** to stop the bolus, to see details on the amount of bolus insulin delivered, or to access the Bolus menu.

## Easy Bolus feature

The Easy Bolus feature lets you quickly deliver a Normal bolus using only the  button. Your pump must be in sleep mode to use the Easy Bolus feature.

Before you use the Easy Bolus feature, you must turn on the feature and set the step size. The step size determines the number of units the bolus amount increases each time you press the  button. Your Easy Bolus delivery is limited to 20 steps or your max bolus limit, whichever comes first.

To help you count your Easy Bolus steps, each time you press the  $\wedge$  button, your pump makes a different tone. There are five different tones that repeat in a pattern for every five steps you use. If your audio options are set to Vibrate only, the pump does not beep at all, and instead it vibrates once with each key press.

## Understanding the Easy Bolus step sizes

When you set up the Easy Bolus feature, you can set the step size from 0.1 to 2.0 units. Your step size cannot be higher than your max bolus. Set the step size to a number that makes it easy for you to calculate your bolus amount.

The following example shows how your bolus amount is increased with each step or each press of the  $\wedge$  button when using the Easy Bolus feature to deliver a bolus. In this example, the step size is 0.5 units. For a delivery of 2.0 units, you need four steps. Press the  $\wedge$  button four times when using the Easy Bolus feature.

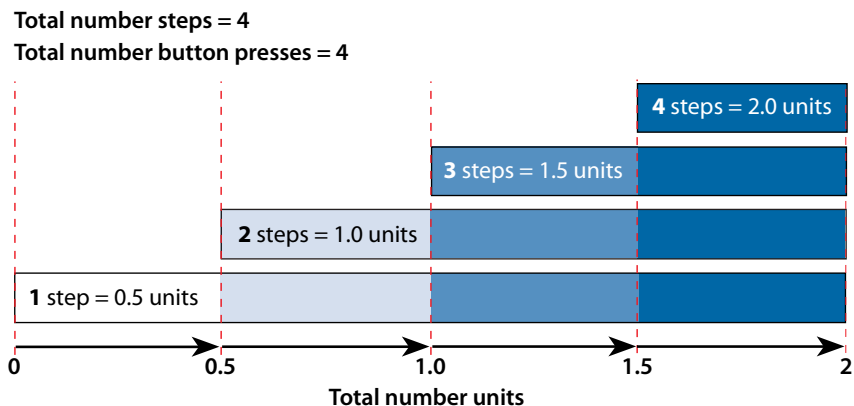

## Setting up the Easy Bolus feature

The Easy Bolus option is available only after you turn on the Easy Bolus feature.

### To set up the Easy Bolus feature:

1. Press  $\odot$  and go to the Easy Bolus screen.  
Options > Delivery Settings > Easy Bolus
2. Select **Easy Bolus** to turn on the feature.
3. Set the **Step Size** amount in units. You can set the step size from 0.1 to 2.0 units. Your step size cannot be higher than your max bolus.
4. Select **Save**.



## Delivering a bolus using the Easy Bolus feature



Initially, use the Easy Bolus feature while you look at the pump screen as you count the tones or vibrations.



**WARNING:** Never rely on beeps or vibrations alone while using the Easy Bolus feature. Always confirm your insulin delivery by looking at your pump screen. When using the Audio or Vibrate options, it is possible that an audio or vibration notification may not occur as expected if the speaker or vibrator in your pump malfunctions. Relying on beeps or vibrations while using the Easy Bolus feature could result in over delivery of insulin.



To use the Easy Bolus feature, your pump must be in sleep mode. Your pump automatically goes into sleep mode two minutes after the screen turns off. Press and hold the  button for about two seconds to manually put your pump into sleep mode.

### To deliver a bolus using the Easy Bolus feature:



1. While your pump is in sleep mode, press and hold  for about one second. After your pump beeps or vibrates, release . You can now start to program your bolus with the Easy Bolus feature.



**Note:** If your pump does not respond when you press , it may not be in sleep mode, even if the screen is dark.

2. Press  the number of times needed to set your bolus amount. Each time you press , your pump makes a tone or vibrates, and your bolus amount increases by the number of units set for the step size.



**Note:** You cannot use  to select the Easy Bolus values. Pressing  cancels the Easy Bolus delivery.

3. When you reach the desired bolus amount, press and hold  $\wedge$  to confirm the amount. Your pump beeps or vibrates for each button press. Count to ensure the amount is correct. If the amount is incorrect, press and hold  $\vee$  until you hear a tone, and then start again from step 1.
4. When the bolus amount is confirmed, press and hold  $\wedge$  for about one second to deliver your bolus. Your pump beeps or vibrates. Your bolus starts immediately after the confirmation.



**Note:** If you do not start your bolus within 10 seconds, the bolus is canceled and a message appears to notify you that your bolus was not delivered.

## Preset bolus

The Preset Bolus feature lets you set up in advance bolus deliveries you expect to use frequently. There are four preset bolus names that let you match a bolus to a meal with a known carb content: Breakfast, Lunch, Dinner, and Snack. There are four additional preset bolus names you can set for other circumstances. These are numbered from Bolus 1 to Bolus 4.



**Note:** To set up a Dual Wave bolus or Square Wave bolus, the Dual Wave bolus or Square Wave bolus feature must be turned on.

## Setting up and managing preset bolus deliveries

### To set up preset bolus amounts:

1. Press  $\odot$  and go to the Preset Bolus Setup screen.

#### Options > Delivery Settings > Preset Bolus Setup

The Preset Bolus Setup screen appears and shows any existing Preset Bolus settings.

2. Select **Add New**.

The Select Name screen appears with the available Preset Bolus names.

3. Select a preset bolus.

The Edit screen for that particular preset bolus appears.

4. Select **Bolus** to set the bolus amount.
5. Select **Type** to set this as a Normal bolus, Square Wave bolus, or Dual Wave bolus.



**Note:** The **Type** field appears only when you have the Dual Wave bolus or Square Wave bolus features turned on.

If you set the type to Square Wave or Dual Wave, do the following:

- For a Square Wave bolus, set the **Duration** of time for the bolus delivery.
- For a Dual Wave bolus, adjust the **Now/Square** percentages as needed, and then set the **Duration** of time for the Square Wave portion of the bolus.



**Note:** If you later turn off the Dual Wave bolus or Square Wave bolus feature, your existing Preset Bolus settings are still available for use.

6. Select **Save**.

### Editing, renaming, or deleting a preset bolus

You cannot delete, rename, or edit a preset bolus during preset bolus delivery.



**Note:** You can only edit a Dual Wave Preset Bolus or Square Wave Preset Bolus when the Dual Wave bolus or Square Wave bolus features are turned on.

### To edit, rename, or delete a preset bolus:

1. Press  and go to the Preset Bolus Setup screen.

#### Options > Delivery Settings > Preset Bolus Setup

The Preset Bolus Setup screen appears and shows any existing Preset Bolus settings.

2. Select the preset bolus you want to change.

3. Select **Options**.
4. Do any of the following:
  - Select **Edit** to adjust the Bolus value and Type, if applicable. If you change to a Square Wave bolus, enter the Duration. If you change to a Dual Wave bolus, enter the Now and Square amounts, and the Duration.
  - Select **Rename** to assign a different name to this preset bolus. When the Select Name screen appears, select any available name from the list.
  - Select **Delete** to delete this preset bolus.

## Delivering a preset bolus

You must set up preset bolus deliveries before you can use the Preset Bolus feature. For more information, see *Setting up and managing preset bolus deliveries*, on page 112.

### To deliver a preset bolus:

1. Press  and go to the Preset Bolus screen.

#### **Bolus > Preset Bolus**

The Preset Bolus screen shows your current BG value, if applicable, and any insulin that is still active from previous boluses. For more information about active insulin, see *About active insulin*, on page 98.

2. Select the preset bolus you want to deliver.
3. Review your bolus amounts, and then select **Deliver Bolus**.

Your pump displays a progress bar on the Home screen when your bolus starts. The pump beeps or vibrates when delivery starts and when delivery finishes.

## Stopping a bolus delivery

The following procedures describe how to stop a Normal bolus or a Dual Wave bolus during the Now portion delivery. The procedures also describe how to stop a Square Wave bolus or a Dual Wave bolus during the Square portion delivery.



**WARNING:** Always press  and select **Stop Bolus** to stop bolus insulin delivery. Do not use the **Suspend Delivery** feature to stop bolus insulin. The **Suspend Delivery** feature stops both basal insulin and bolus insulin delivery. Failure to resume basal insulin delivery could result in too little insulin, which may cause high blood glucose.



**Note:** If you need to stop all insulin delivery, use the **Suspend Delivery** feature (press  and select **Suspend Delivery**). For more information on using the **Suspend Delivery** feature, see *Stopping and resuming your insulin delivery*, on page 80.

### To stop a Normal bolus delivery or the Now portion of a Dual Wave bolus delivery:

1. While your pump is delivering your Normal bolus or the Now portion of a Dual Wave bolus, press  from the Home screen.

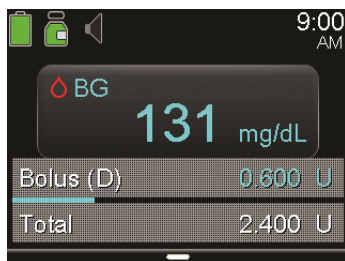

2. Select **Stop Bolus**, then select **Yes** to confirm.

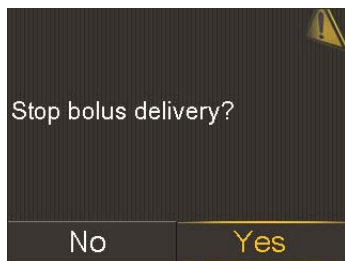



**Note:** If you are delivering a Normal bolus and a Square Wave bolus at the same time, or a Normal bolus and the Square portion of a Dual Wave bolus at the same time, both boluses are stopped.

The Bolus Stopped screen appears and shows the amount of bolus delivered, and the original bolus amount you set up.



### To stop a Square Wave bolus delivery or the Square portion of a Dual Wave bolus delivery:

1. Press  from the Home screen.
2. Select **Bolus**.
3. Select **Stop Bolus**.
4. To stop your bolus, select **Yes** to confirm.



**Note:** If you are delivering a Normal bolus and a Square Wave bolus at the same time, or a Normal bolus and the Square portion of a Dual Wave bolus at the same time, both boluses are stopped.

The Bolus Stopped screen appears and shows the amount of bolus delivered, and the original bolus amount you set up.

■ Reservoir and infusion set

5





# 5 Reservoir and infusion set

## Setting up the reservoir and infusion set

When you are ready to use your pump with insulin, make sure the time and date are correct on your pump. For details on changing the time and date on your pump, see *Time and date, on page 170*. You must also program your settings as instructed by your healthcare professional.

You need the following items:

- MiniMed 770G insulin pump
- Vial of insulin (U-100)
- MiniMed reservoir
- MiniMed-compatible infusion set and its user guide



**WARNING:** Clear the active insulin value before using your pump to deliver insulin for the first time. If you have practiced giving boluses on your pump before using insulin, the active insulin value could be inaccurate. This could result in inaccurate insulin delivery, and serious injury. For details, see *Clearing your active insulin, on page 166*.

## Removing the reservoir

If this is the first time you are inserting a reservoir into your pump and you do not currently have a reservoir loaded, go to *Rewinding your pump, on page 120*.



**WARNING:** Never insert the reservoir into the pump while the tubing is connected to your body. Doing so could result in an accidental infusion of insulin, which may cause low blood glucose.

### To remove your reservoir:

1. Wash your hands.
2. Disconnect the infusion set from the body.
3. If you have the optional activity guard attached to the reservoir compartment on your pump, remove it now.
4. Turn the tubing connector counter-clockwise until the reservoir and tubing connector can be pulled free of the pump.

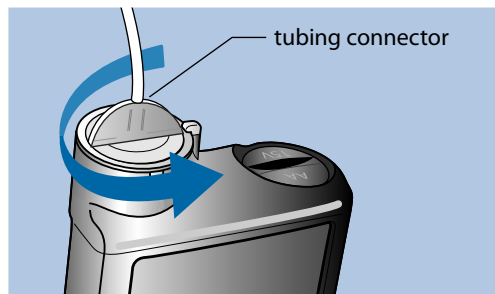

5. Dispose of the used reservoir and infusion set according to local regulations, or contact your healthcare professional for disposal information.

### Rewinding your pump



**WARNING:** Always make sure the infusion set is disconnected from your body before you rewind your pump or fill the infusion set tubing. Never insert the reservoir into the pump while the tubing is connected to your body. Doing so could result in an accidental infusion of insulin, which can cause low blood glucose.

When you rewind your pump, the piston in the reservoir compartment returns to its starting position and lets a new reservoir be placed into the pump.



**Note:** The piston is located in the reservoir compartment of your pump. It engages the reservoir and pushes insulin through the tubing.

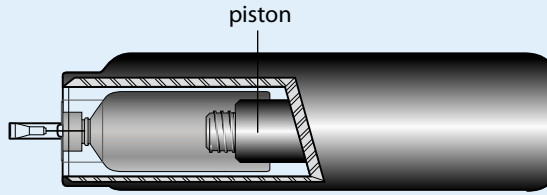

### To rewind your pump:

1. Press  and go to the New Reservoir screen.

**Options > Reservoir & Tubing > New Reservoir**

The New Reservoir screen appears.

If you have not yet removed the infusion set and reservoir, do so now.

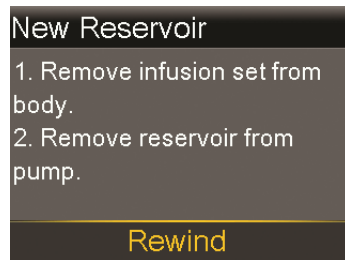

2. Select **Rewind**.

The piston in the reservoir compartment of your pump returns to its starting position. This may take several seconds. During this process, a "Rewinding" message appears.

Another message appears to notify you that your pump has finished rewinding, and then the New Reservoir screen appears.

**New Reservoir**

1. Fill reservoir.
2. Connect tubing to reservoir.

**DO NOT CONNECT TO BODY.**

**Next**

3. Follow the instructions in the next section to fill your reservoir.

### Filling the reservoir



**WARNING:** Do not use the reservoir or infusion set if any liquid gets on the top of the reservoir or inside the tubing connector (as shown in the image). Liquid can temporarily block the vents. This may result in the delivery of too little or too much insulin, which can cause hyperglycemia or hypoglycemia. If any liquid gets on the top of the reservoir or inside the tubing connector, start over with a new reservoir and infusion set.

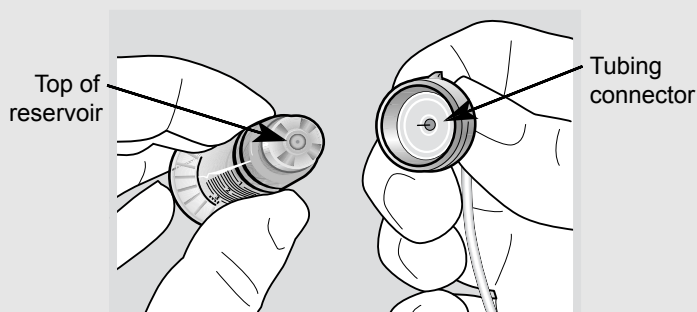

**WARNING:** Always allow your insulin to reach room temperature before use. Cold insulin can cause air bubbles in the reservoir and tubing, which may result in inaccurate insulin delivery.

**To fill the reservoir, do these steps:**

1. Remove the reservoir from the package and fully extend the plunger.

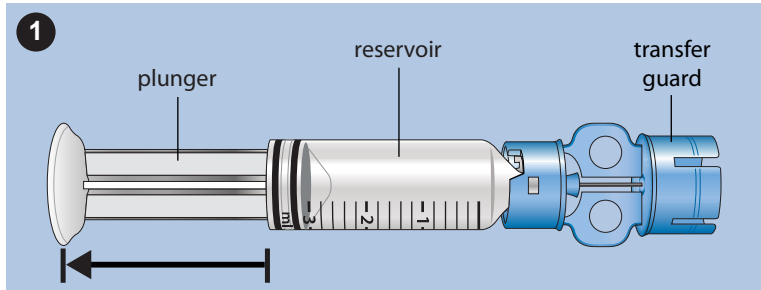

2. Swab the vial with alcohol (not shown).
3. Press the transfer guard onto the vial without pushing down on the plunger.

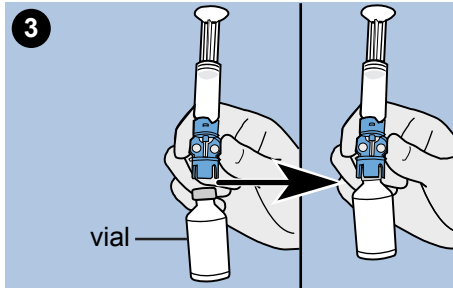

4. Push down on the plunger to pressurize the vial. Hold down the plunger rod.
5. While still holding down the plunger rod, flip the vial over so the vial is on top. Slowly pull down on the plunger to fill the reservoir.
6. Gently tap the side of the reservoir to make any air bubbles rise to the top of the reservoir.

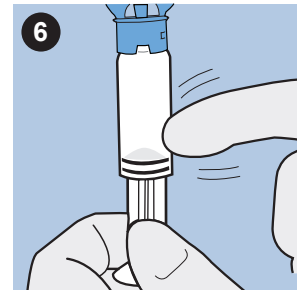
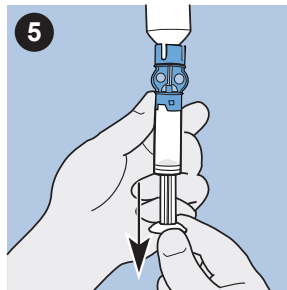
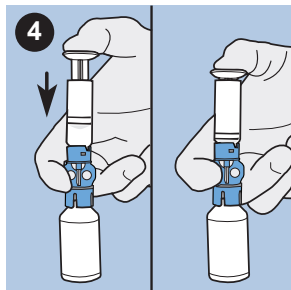

7. Slowly push up on the plunger just enough to remove any air bubbles from the reservoir.
8. Slowly pull down on the plunger to fill the reservoir to the number of units desired.
9. To avoid getting liquid on the top of the reservoir, flip the vial over so that it is upright. Turn the reservoir counter-clockwise, then pull straight up to remove the reservoir from the transfer guard.
10. Place the tubing connector onto the reservoir. Turn the connector clockwise, pressing gently against the reservoir until you feel it slide in. Push in and continue turning until the reservoir and the connector lock with a click.

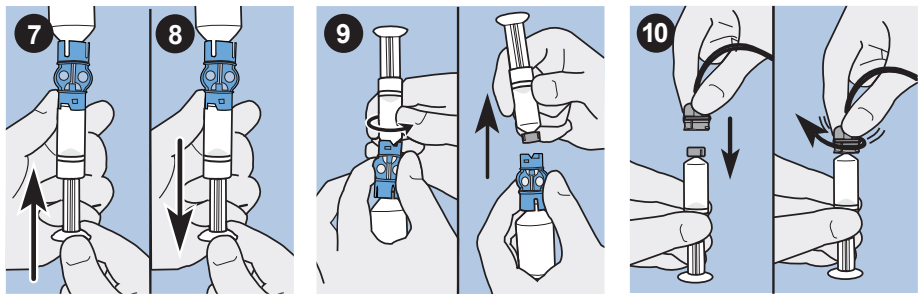

11. Tap the side of the reservoir to remove any air bubbles.
12. To purge air bubbles that have risen to the top of the reservoir, push up on the plunger until you see insulin in the tubing.
13. Without pulling, turn the plunger counter-clockwise to remove it from the reservoir.

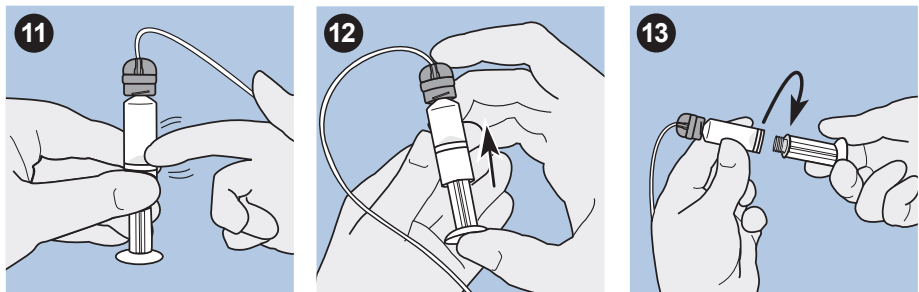

14. Select **Next** from the New Reservoir screen.



The New Reservoir screen now instructs you to place the reservoir in your pump.

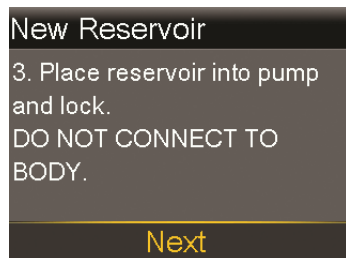

15. Follow the instructions in the next section to insert the reservoir into the reservoir compartment of your pump immediately after filling it.

### Inserting the reservoir into your pump

Be sure to perform the following steps in the order they are presented.



**Note:** Do not insert the reservoir into your pump until you receive training.



**WARNING:** Always rewind your pump before inserting a new reservoir. Failing to rewind your pump could result in an accidental infusion of insulin, which can cause hypoglycemia.

Never insert the reservoir into the pump while the tubing is connected to your body. Doing so could result in an accidental infusion of insulin, which can cause hypoglycemia.

## To insert the reservoir into your pump:

1. If you are using the pump for the first time, remove the shipping cap from the reservoir compartment.
2. Rewind your pump if you have not yet done so. See *Rewinding your pump*, on page 120 for more information.
3. Insert the reservoir into the top of the reservoir compartment.
4. Turn the tubing connector clockwise until the connector is locked into the pump. The tubing connector should be aligned horizontally with the pump case as shown in the following example.

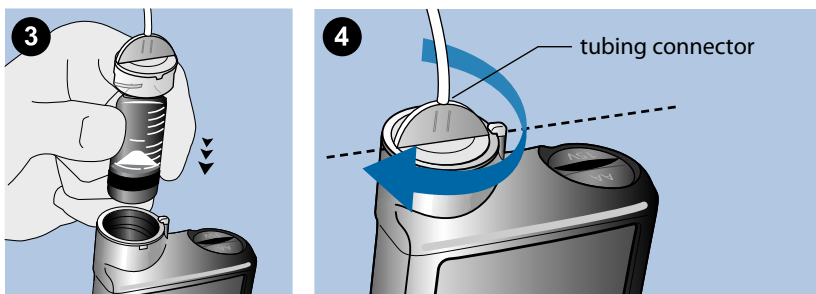

5. Your pump should be displaying the New Reservoir screen shown in the following example. Select **Next** to continue.

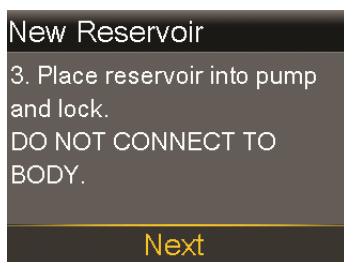

6. Select and hold **Load** until you see a checkmark on the screen and your pump beeps or vibrates. Holding **Load** moves the piston up in the reservoir compartment until it engages with the bottom of the reservoir.





**Note:** If you press the **Back** button after the loading process begins, a Loading incomplete alarm will occur.

When the loading process is completed, the following screen appears.



7. Select **Next** to continue.
8. Follow the instructions in the next section to fill the tubing with insulin.

### Filling the tubing

You need to fill the infusion set tubing with insulin before you insert the set into the body.

**WARNING:** Always make sure the infusion set is disconnected from your body before you rewind your pump or fill the infusion set tubing. Never insert the reservoir into the pump while the tubing is connected to your body. Doing so could result in an accidental infusion of insulin, which can cause low blood glucose.



**WARNING:** Always check your tubing for air bubbles. Continue to press **Fill** until the bubbles have been removed from the tubing. Air bubbles may result in inaccurate insulin delivery.

### To fill the tubing:

1. After you load your reservoir and select **Next** from the Load Reservoir screen, the Fill Tubing screen appears.

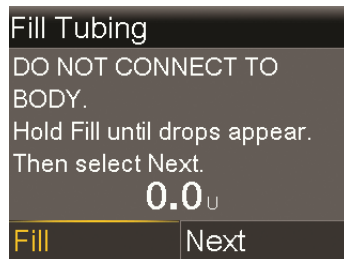

2. Select and hold **Fill**. Your pump beeps six times as it dispenses insulin into the tubing toward the infusion set needle. Continue to hold **Fill** until insulin droplets form on the tip of the infusion set needle, and then release. Your pump beeps as it fills the tubing, and the amount of insulin used appears on the screen.

If the Max Fill reached alarm occurs, it means you have used more than 30 units of insulin to fill your tubing. For details, go to *Pump alarms, alerts, and messages*, on page 246, and see the description for Max Fill reached.

3. Select **Next** to continue.
4. Follow the instructions in the next section to insert the infusion set into your body before filling the cannula.

### Inserting the infusion set



**WARNING:** Do not remove the reservoir from the pump while the infusion set is connected to your body. Doing so could result in the delivery of too little or too much insulin, which can cause high blood glucose or low blood glucose.

You must complete the following procedures, as described previously, before you insert the infusion set into your body:

- Rewind your pump.
- Fill your reservoir.
- Insert the reservoir into pump.
- Fill the tubing with insulin.

The best body areas for infusion set insertion are shaded in the following example. Avoid the 2-inch (5.0 cm) area around the navel to help ensure a comfortable infusion site and to help with adhesion.



**CAUTION:** Do not use the same infusion set insertion site for an extended period of time. This can cause the site to become overused. Rotate the infusion set insertion sites regularly.

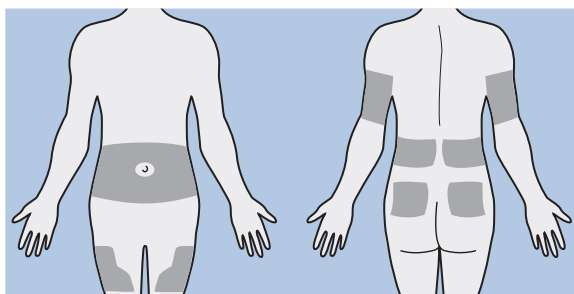

**CAUTION:** Always change your infusion set according to the product labeling. Using the same infusion set for an extended period of time can cause infusion set occlusion or site infection.

To keep sites healthy, use a visual scheme to help you rotate your insertion sites in an organized way. The following methods are commonly used. For maximum effectiveness, alternate the use of both methods.

- Visualize an imaginary clock drawn on your abdomen around your belly button. Rotate infusion set insertion sites by starting at 12 o'clock and then rotate the infusion site clockwise to 3 o'clock, 6 o'clock, and so on.

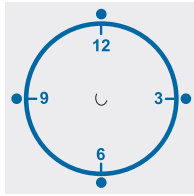

- Imagine a letter M or a letter W on either side of your belly button. Start at the end of one letter and proceed through the letter, rotating to each intersection in turn.

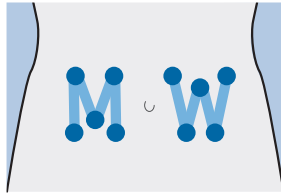

Medtronic Diabetes offers a variety of infusion sets for your pump.



**Note:** Always refer to your infusion set user guide for instructions to insert an infusion set.

After your infusion set is inserted, see *Filling the cannula*, on page 130 to fill the infusion set cannula.

### Filling the cannula

Filling the soft cannula with insulin is required after the infusion set is inserted into your body and the introducer needle is pulled out. The insulin amounts required to fill the cannula depend on the type of infusion set you use. Refer to your infusion set instructions for this information.



**Note:** If you use a steel needle infusion set, there is no cannula to fill. Select **Done** on the **Fill Cannula?** screen.



**WARNING:** Never leave your pump on the Fill Cannula? screen. Insulin delivery is suspended while on the Fill Cannula? screen. Always finish filling your cannula or return to the Home screen to avoid continued insulin delivery suspension. Failing to do this can result in hyperglycemia.

### To fill the cannula:

1. After you fill your tubing and insert your infusion set, the Fill Cannula? screen appears.

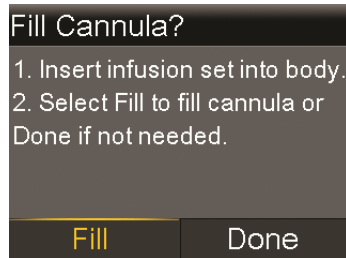

**Note:** If your screen turns off before you are ready to fill your cannula, press any button on your pump to turn it on again.

2. To fill your cannula now, select **Fill**. If you use a steel needle infusion set, there is no cannula to fill. Select **Done**.

The Fill Cannula screen appears.



3. Adjust the Fill amount for your particular infusion set, and then select **Fill Now**. If you are unsure about the fill amount, see the instructions that came with your infusion set.

4. As the cannula fills, your screen displays the amount of units being delivered. The pump beeps or vibrates when the delivery is complete.  
After the cannula is filled, the Home screen appears. Your pump is now ready to deliver insulin.

#### To stop filling the cannula:

1. Select **Stop Filling** to stop filling the cannula.



2. Select **Yes**.  
The Fill Stopped screen appears and shows amount delivered.
3. Select **Done**.

## Disconnecting your infusion set

Always refer to your infusion set user guide for instructions on how to disconnect your infusion set.

## Reconnecting your infusion set

Always refer to your infusion set user guide for instructions on how to reconnect your infusion set.

6



Meter





# Meter

The MiniMed 770G insulin pump with smart device connectivity can only pair with an Accu-Chek Guide Link meter to receive remote blood glucose (BG) readings. If you do not pair an Accu-Chek Guide Link meter with your pump, you must enter your BG readings manually. To pair your pump and meter, you need the following items:

- MiniMed 770G insulin pump with smart device connectivity
- Accu-Chek Guide Link meter

## About your Accu-Chek Guide Link meter

You can set up your pump to automatically receive BG readings from your Accu-Chek Guide Link meter. When the pump is on the Home screen, it beeps or vibrates when it receives a BG reading from the meter. After you confirm the BG value, the BG Meter screen appears. You can view your current BG reading and, if necessary, deliver a bolus. Once you have received the BG value from the meter, you must confirm the value on your pump. Your BG values appear on your pump screen for 12 minutes, as well as any insulin that is still active from any previous boluses. If your BG reading is outside the range of 70 to 250 mg/dL, an alert appears. Treat your low BG or high BG as directed by your healthcare professional.



**Note:** You can pair up to four Accu-Chek Guide Link meters to your pump. In order for your pump to use the BG reading, you must confirm the reading on your pump.

## Pairing your pump and meter

The MiniMed 770G insulin pump can be paired with the Accu-Chek Guide Link meter. The pump automatically receives BG readings from a paired Accu-Chek Guide Link meter.

### To prepare the meter to pair with the pump:

1. Press the **OK** button on the meter to turn on the meter.
2. Select **Settings**.



3. Select **Wireless**.



4. Select **Yes** if the confirmation screen appears on the meter screen. Or, select **Pairing** if the confirmation screen does not appear.

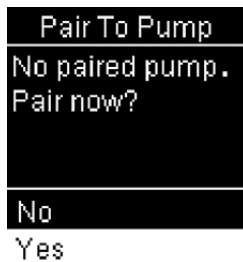

The serial number of the meter appears on the meter screen. The meter is now ready to pair with the pump.

**To prepare the pump to pair with the meter:**

1. Press  and go to the Device Options screen.  
Options > Utilities > Device Options

2. Select **Pair Device**.

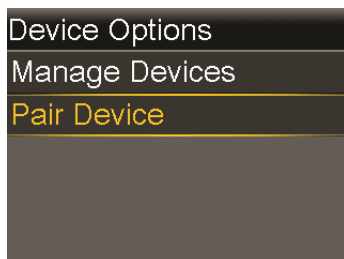

The New Device screen appears.

3. Select **Search**.

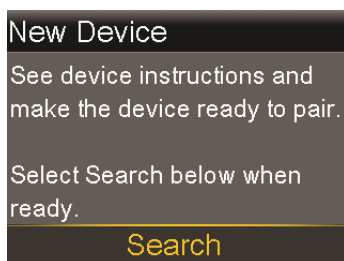

The Select Device screen appears with a list of available devices.

4. Select the meter that matches the serial number on the meter screen.



5. Ensure the serial numbers shown on the pump and meter screens match, and then select **Confirm**.



If the connection is successful, a "Pairing successful!" message appears on the pump. A "Paired with pump" message with the serial number of the pump appears on the meter screen.

## Deleting a meter from your pump

Follow this procedure to delete your Accu-Chek Guide Link meter from the pump.

### To delete the meter from the pump:

1. Press  and go to the Manage Devices screen.

**Options > Utilities > Device Options > Manage Devices**

The Manage Devices screen appears.

2. Select the serial number of the meter you want to delete. The Accu-Chek Guide Link meter serial number is located on the back of the meter.
3. Select **Delete**. A screen appears and tells you to confirm.
4. Select **Yes** to confirm or **No** to cancel.

## Deleting your pump from a meter

For steps to delete the pump from a meter, see the Accu-Chek Guide Link User's Manual.





# 7 History and events

This chapter describes the History and Event Markers features. The History screens provide details about your personal therapy with your pump, including information about your insulin deliveries, blood glucose (BG) meter readings, sensor glucose (SG) readings, and any alarms and alerts you received. You can enter and save information, such as manual BG readings, carbohydrates eaten, and exercise with the Event Markers feature.

You can view updates on the Daily History screen to learn the following information about your therapy with your pump over a period of time:

- Automatic and manual transitions into and out of SmartGuard Auto Mode
- Start time and the end time for all your Temp Target events
- Correction boluses that your pump automatically calculates for you

For more information about the Auto Mode feature on your pump, refer to *SmartGuard Auto Mode*, on page 221.

## History

The History feature includes the Summary, Daily History, and Alarm History screens. The SG Review and ISIG History screens are available if you use the Sensor feature.

### Summary screen

The Summary screen shows details about past insulin deliveries and meter readings. If you use a sensor, the Summary screen also shows information about your sensor alerts and SG readings.

You can view historical details for a single day. You can select multiple days to view an average of all the results for the number of days that you selected.

## To view your Summary screen:

1. Press  and go to the Summary screen.  
**Options > History > Summary**
2. Select the time period for the Summary screen.  
The Summary screen appears and shows the information for the number of days that you selected.
3. You can scroll down to view the entire screen. If you use the 1 Day view, you can use the < and > buttons on your pump to view the results for each day in history.

## Understanding the Summary screen

The Summary screen separates information into the following categories:

- Auto Mode
- Overview
- Bolus
- BG meter
- Sensor
- Low management mode

### Summary screen: Auto Mode

The following table describes the Auto Mode portion of the Summary screen.

Name	Description
Time in Auto Mode	number of hours / percent of time in SmartGuard Auto Mode
Time in target range	number of hours / percent of time in target range (70 to 180 mg/dL)
Time below range	number of hours / percent of time below target range (below 70 mg/dL)
Time above range	number of hours / percent of time above target range (above 180 mg/dL)

### Summary screen: overview

The following table describes the overview portion of the Summary screen.





**Note:** If you view a single day of Summary results, then the values shown are the actual results for the selected day. If you view more than one day of Summary results, then the value is an average of the days that you selected.

Name	Description
TDD	Total daily dose of insulin units.
Basal	<ul style="list-style-type: none"> <li>• Insulin units devoted to basal insulin delivery.</li> <li>• Percentage of insulin devoted to basal insulin delivery.</li> </ul>
Bolus	<ul style="list-style-type: none"> <li>• Insulin units devoted to bolus delivery.</li> <li>• Percentage of insulin devoted to bolus delivery.</li> </ul>
Total Carbs	Daily carbohydrate amount, in grams.

### Summary screen: bolus

The following table describes the bolus portion of the Summary screen:



**Note:** If you view a single day of Summary results, then the values shown are the actual results for the selected day. If you view more than one day of Summary results, then the value is an average of the days that you selected.

Name	Description
Carb bolus	<ul style="list-style-type: none"> <li>• Total insulin units delivered using the Bolus Wizard feature or Auto Mode Bolus with food or with food and correction amount.</li> <li>• Number of times the Bolus Wizard feature or Auto Mode Bolus delivered a food bolus or a food with correction bolus.</li> </ul>
BG Correction Only	<ul style="list-style-type: none"> <li>• Total insulin units delivered using the Bolus Wizard feature or Auto Mode Bolus with BG correction amount only.</li> <li>• Number of times the Bolus Wizard feature or Auto Mode Bolus delivered a BG correction bolus only.</li> </ul>

## Summary screen: BG meter

The following table describes the BG meter portion of the Summary screen:

Name	Description
BG	Total number of BG meter readings, including readings from an Accu-Chek Guide Link meter and BG meter readings entered manually.
Average BG	Average BG meter readings.
BG Std. Dev.	Standard deviation of BG meter readings.
Low BG	Lowest BG meter reading.
High BG	Highest BG meter reading.

## Summary screen: sensor

The following table describes the sensor portion of the Summary screen. If the sensor feature has never been turned on, this portion of the screen does not appear. If the sensor feature was turned on at least once, but is currently turned off, this portion of the screen appears gray.

Name	Description
SG Average	Average SG value.
SG Std. Dev.	Standard deviation of the SG readings.

## Summary screen: low management mode

The following table describes the low management mode portion of the Summary screen. This portion shows information about the SmartGuard suspend features. For details on the SmartGuard suspend features, see *SmartGuard Technology, on page 174*.

Name	Description
Suspend before low	The average number of Suspend before low events per day.
Suspend on low	The average number of Suspend on low events per day.
Time suspended by sensor	The average duration (amount of time) suspended as a result of Suspend on low or Suspend before low events per day.

## Daily History

The Daily History screen displays a list of actions you performed on your pump or event entries that you made for the selected day, such as your BG meter readings, sensor calibrations, bolus deliveries, any temp basal rates you have used, and so on. The list displays the most recent action or event first. From this list, you can display further details about any action or event.

### To view your Daily History:

1. Press  and go to the Daily History screen.

#### Options > History > Daily History

A list of dates appears.

2. Select a specific date of history to view. A list appears with any pump actions or events entered on the specified day.
3. You can select any item in the list to open the Detail screen, which displays more information about the selected action or event. For example, if you view the details of a bolus delivered using the Bolus Wizard feature, the Detail screen shows you all of the data associated with that bolus, such as the BG correction amount, active insulin adjustment, carbs entered, and calculated bolus.

## Alarm History

The Alarm History screen displays a list of alarms and alerts that occurred on the selected day. The list displays the most recent alarm or alert first. From this list, you can display further details about any alarm or alert.

### To view your Alarm History:

1. Press  and go to the Alarm History screen.

#### Options > History > Alarm History

A list of dates appears.

2. Select a specific date of alarm history to view. A list appears showing any alarms or alerts that occurred on the specified day.
3. You can select any alarm or alert in the list to open the Alarm Detail screen, which displays more information about the selected alarm or alert.

## Sensor Glucose Review

The Sensor Glucose Review feature is available if you use the Sensor feature.

The Sensor Glucose Review feature lets you view a graph of your SG history, based on high and low limits you enter. You can view information for one day, or view an average of your SG data over a number of days.



**Note:** The high and low limits that you set in the SG Review screen are only used to view your SG data. These limits are not the same as the high and low glucose limits used for your sensor alerts. Changing your limits in the SG Review screen does not affect the high and low glucose limits used for your sensor alerts.

### To review your SG history:

1. Press  and go to the SG Review screen.

#### Options > History > Sensor Glucose Review

The SG Review screen appears. The high and low limits that appear are either the values you entered for the last SG Review, or the default values of 180 mg/dL for the High Limit and 70 mg/dL for the Low Limit.

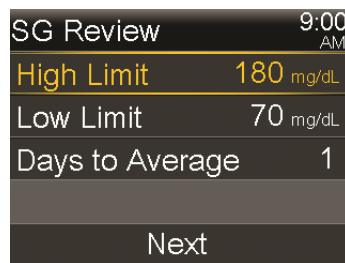

2. Enter the High Limit and Low Limit that you want to use to view your SG data.

There must be a minimum of 20 mg/dL difference between the High Limit and the Low Limit.

3. Enter the number of days of SG history to average, and select **Next**.

A graph of your SG data appears. If you specified one day of history to view, the graph shows details about when your SG was above, below, or within your specified limits. You can scroll down to view the number of hours and percentage of time you were above, within, and below your SG limits.

If you have no data saved, a message appears to notify you that there is no data available.

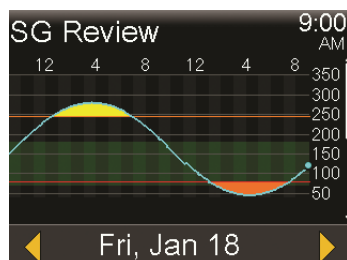

If you view information for multiple days, the graph shows the average percentage of time that your SG was above, below, or within your specific limits.

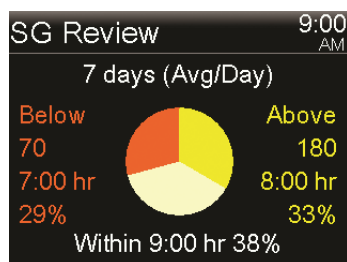

## ISIG History

ISIG is an electronic reading from your sensor that is used in conjunction with your calibration numbers to calculate the current glucose reading on your pump.

### To review your ISIG History:

1. Press and go to the ISIG History screen.

#### Options > History > ISIG History

The ISIG History screen displays an hourly sequence for one 24-hour day.

2. Scroll through the list to highlight an hour, then press to select it.  
Use the or buttons to scroll through the listing of ISIG readings, which occur every five minutes.

## Event Markers

The Event Markers feature lets you electronically save certain types of information. When using this feature, enter events when they happen because the system records the time of the entry. You cannot edit entries after you enter the information into your pump. You can view your saved events in the Daily History screen.

The information you entered can be sent to CareLink Personal software, where it can be used to generate reports you can share with your healthcare professional.

### To enter Event Markers:

1. Press  and go to the Event Markers screen.

#### Options > Event Markers

2. Select and enter event information for any of the following categories:

---

BG



If you are not recording your BG meter readings in your pump by entering them manually or by using the Bolus Wizard feature, Auto Mode Bolus, or an Accu-Chek Guide Link meter, you can enter them in this screen. If you use a sensor, you may use a BG meter reading you enter in this screen for calibration. You can also enter non-calibration BG meter readings, such as those readings taken when eating or when your BG is rising or falling rapidly.

---

Injection





Enter the number of units of any insulin you have given by injection.



**Note:** Insulin units entered using the injection event marker are not added to your Active Insulin amount tracked on the pump.

---

---

Food		<p>Enter the amount of carbohydrates that you have eaten or drunk that have not been entered in the Bolus Wizard feature or Auto Mode Bolus. For example, you might enter carbs that you ate to correct a low BG.</p> <p>Do not use this screen to enter carbs that you have already entered in the Bolus Wizard feature or Auto Mode Bolus screen.</p>
Exercise		<p>Enter the length of time you exercised. It is helpful to be consistent and enter the information either before or after each time you exercise.</p>
Other		<p>Examples of Other event markers can include when you take medications, when you feel ill, or when you are under stress.</p>

---





8



# Reminders

Reminders help you remember to do important routine activities. There are specific reminders that prompt you to check your blood glucose (BG) after a bolus, give a food bolus, check your reservoir level, and change your infusion set. There are also personal reminders you can use for any purpose. If you have the sensor feature turned on, the calibration reminder prompts you to calibrate your sensor.

## Personal reminders

The Personal reminders include six numbered reminders, along with the specific reminders for BG Check and Medication.

### To create a new Personal reminder:

1. Press  and go to the Personal screen.  
**Options > Reminders > Personal**
2. Select **Add New**.  
The Select Name screen shows the available reminders.
3. Select the reminder that you want to set.  
The Edit screen appears for the selected reminder.
4. Enter the time that you want the reminder to occur.
5. Select **Save**. The Personal reminder occurs at the specified time each day unless you change or delete it.

### To edit, rename, or delete an existing Personal reminder:

1. Press  and go to the Personal screen.

## Options > Reminders > Personal

2. Select the reminder you want to change.
3. Do any of the following:
  - Select **Reminder** to turn the reminder on or off.
  - Select **Edit** to change the time of the reminder.
  - Select **Rename** to assign a different name to the reminder. When the Select Name screen appears, select any available name from the list.
  - Select **Delete** to delete the reminder.

## Bolus BG Check reminder

The Bolus BG Check reminder tells you to check your BG after a bolus. After you start a bolus, the BG Check screen appears and lets you set a reminder to check your BG. The timer counts down from the time the bolus started.

### To turn on or turn off Bolus BG Check reminders:

1. Press  and go to the BG Check screen.

#### Options > Reminders > Bolus BG Check

2. To turn the reminder on or off, select **Reminder**.
3. Select **Save**.

### To use a Bolus BG Check reminder when delivering a bolus:

1. After you turn on the Bolus BG Check reminder, each time you start a bolus, the following screen appears:

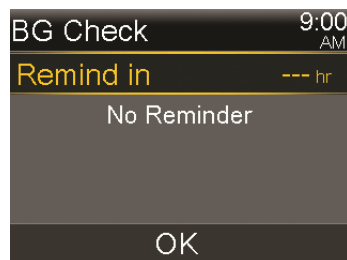

2. Enter a time from 30 minutes to 5 hours, in 30-minute increments. Select **OK**. If you do not want a reminder after the bolus delivery, select the dashes without adding a time, and then select **OK**. If needed, press  $\vee$  to return to the dashes.

## Missed Meal Bolus reminder

The Missed Meal Bolus reminder tells you if a bolus is not delivered within a time period that you set. Set time periods around your typical meal times to help ensure a meal bolus is not missed. You can set up to eight Missed Meal Bolus reminders.

### To create a new Missed Meal Bolus reminder:

1. Press  $\odot$  and go to the Missed Meal Bolus screen.  
**Options > Reminders > Missed Meal Bolus**
2. Select **Add New**.
3. Select **Start Time** and enter a time.
4. Select **End Time** and enter a time. The time range is from one minute to 24 hours.
5. Select **Save**.

### To turn on or off, edit, or delete existing Missed Meal Bolus reminders:

1. Press  $\odot$  and go to the Missed Meal Bolus screen.  
**Options > Reminders > Missed Meal Bolus**
2. Select the reminder you want to change.
3. Change any of the following:
  - Select **Reminder** to turn this reminder on or off.
  - Select **Edit** to change the time of this reminder.
  - Select **Delete** to delete this reminder.

## Low Reservoir reminder

The Low Reservoir reminder tells you when the insulin level in your reservoir is low. It tells you when your reservoir has a specified number of units remaining and again when half of the remaining units are used.



**Note:** The number of units that remain in your reservoir can be found on the Quick Status screen. For more information on accessing the Status screens, see *Status screens*, on page 52.



**WARNING:** When the pump detects a low reservoir condition during a bolus or fill cannula delivery, the Low reservoir alert displays. When delivery has finished, check the amount left in the reservoir to make sure your pump does not run out of insulin, as this could lead to an under delivery of insulin, which may cause hyperglycemia.

### Low Reservoir reminder setup:

1. Press  and go to the Low Reservoir screen.  
Options > Reminders > Low Reservoir
2. Select **Units** to enter the number of units. Set a value from 5 to 50 units.
3. Select **Save**.

## Set Change reminder

The Set Change reminder tells you when your infusion set is due to be changed. After you turn on this reminder, it automatically tracks the time between infusion set changes and reminds you to change your infusion set.

### To turn on or off, or change the Set Change reminder:

1. Press  and go to the Set Change screen.  
Options > Reminders > Set Change
2. Select **Reminder** to turn the reminder on or off. If you turn on the reminder, select **Time** and choose two or three days for the reminder.
3. Select **Save**.

## Calibration reminder

The Calibration reminder is available if you use the Sensor feature. This feature helps you remember to calibrate your sensor. For example, if you set your reminder to four hours, you receive a Calibrate by message four hours before the next BG meter reading is due.

### To turn on or off, or change the Calibration reminder:

1. Press  and go to the Calibration screen.

Options > Reminders > Calibration



2. Select **Reminder** to turn the reminder on or off.
3. If you turn on the reminder, select **Time** and enter a time between five minutes and six hours. The time can be set in five-minute increments.
4. Select **Save**.





9





# 9 General settings

This chapter provides information about common tasks for various settings.

## Audio Options

The audio and vibrate options are set in the Audio Options screen. You can also change the volume of most alerts and notifications if audio is enabled.

An audio icon appears on the Home screen. An audio icon indicates if your current settings are audio only , vibrate only , or audio and vibrate both . For more information, see *Status icons*, on page 46.

### To adjust the audio and vibrate settings:

1. Press  and select **Audio Options** to go to the Audio Options screen.
2. Select **Audio** or **Vibrate** to turn on the setting you want to use. You can use one option or both.
3. If the Audio option is enabled, the volume can be changed. Select **Volume** and press < or > to adjust to the desired level.
4. Select **Save**.

## Auto Suspend

Auto Suspend is a safety feature that stops all insulin delivery and sounds an alarm if you do not press any buttons for a specified period of time. For example, your healthcare professional may have you set the time based on the number of hours that you typically sleep at night. Discuss with your healthcare professional how to best use this feature.



**Note:** The Auto Suspend feature continues working when your pump switches to SmartGuard Auto Mode.

### To set up Auto Suspend:

1. Press  and go to the Auto Suspend screen.  
**Options > Delivery Settings > Auto Suspend**
2. Select **Alarm**.
3. Select **Time** and enter the number of hours you want to set.
4. Select **Save**.

## Block Mode

The Block Mode feature lets caregivers, such as parents of a young child, restrict access to critical pump settings.



**WARNING:** Always monitor the pump when it is used in Block Mode. You can manually suspend while in Block Mode. This could result in hyperglycemia and ketoacidosis.

When Block Mode is on, you cannot start a new bolus delivery, start a new basal pattern, or start a new temp basal delivery. Any previous bolus and basal deliveries continue normally, and the pump user can stop a bolus delivery at any time.

When your pump is in Block Mode, you can suspend insulin delivery, receive sensor glucose (SG) values, receive blood glucose (BG) values from your Accu-Chek Guide Link meter, review history, test the pump, and clear alarms and alerts. However, you cannot change any settings.



**Note:** The Block Mode feature has some differences when your pump is in Auto Mode. See *Block Mode when in SmartGuard Auto Mode*, on page 230.

### To turn Block Mode on or off:

1. Press  and go to the Block Mode screen.

### Options > Utilities > Block

2. Select **Block Mode** to turn the feature on or off.
3. Select **Save**. While Block Mode is turned on, a lock icon  appears on the Home screen.

## Display Options

In the Display Options screen, you can increase or decrease the brightness of your screen. You can also adjust the amount of time the backlight stays on after you press a button.

### To adjust the display options:

1. Press  and go to the Display Options screen.

### Options > Utilities > Display Options

2. Select **Brightness** to adjust the brightness of your screen. You can set a level from 1 to 5, or select **Auto** to have the screen automatically adjust to your current environment.



**Note:** The brightness setting you select can affect the life of your battery. Use a lower level setting to preserve battery life.

3. Select **Backlight** to adjust the timeout for the backlight on your pump screen. You can select 15 seconds, 30 seconds, 1 minute, or 3 minutes.



**Note:** The backlight can affect the life of your battery. Set the screen timeout to 15 or 30 seconds to preserve battery life.

4. Select **Save**.

## Language

You can change the language that your pump uses to display information.

### To change the Language setting:

1. Press  and go to the Language screen.

### Options > Utilities > Language

A checkmark indicates which language is active.

2. Select your desired language.
3. Select **Yes** when the confirmation message appears.

## Managing your pump settings

The Manage Settings feature lets you save, restore, or clear your settings.



The following table describes the Manage Settings options:

Option	Description
Save Settings	The Save Settings option records your current settings that you can use if a future event requires you to re-enter your settings.
Restore Settings	The Restore Settings option lets you restore your settings with the backup settings that you saved using the Save Settings feature.
Clear All Settings	The Clear All Settings option erases your settings and returns them to the factory defaults. To use your pump again after you clear all settings, you may use Restore Settings or manually re-enter your settings. This option enables you to restore a previous version of your settings or enter your settings again.
Clear Active Insulin	This option appears only if you have never cleared your active insulin. It clears both active insulin and sets your total daily dose to 0 for Auto Mode. Use this option when you are ready to use your pump with insulin for the first time or when directed by your healthcare professional. You can only clear your active insulin once.
Settings History	The Settings History option shows a history of recent activities that relate to managing your settings, such as when you saved, cleared, or restored your settings.

## Saving your settings

Save a record of your settings so they can be restored at a later date, if necessary.



### To save your current settings:

1. Press  and go to the Manage Settings screen.  
**Options > Utilities > Manage Settings**
2. Simultaneously press and hold  and  until the Manage Settings screen appears.
3. Select **Save Settings**.  
If these are the first settings you have saved, a message appears to confirm that your settings are saved.  
If you have previously saved settings, a message appears to ask if you would like to replace your previous settings with your current settings. Select **Yes** to accept. Select **No** to cancel.

### Restoring your settings

The Restore Settings option replaces your current pump settings with the last settings that you have saved. The Restore Settings menu option is available only if you have previously saved your settings.

### To restore your previous settings:

1. Press  and go to the Manage Settings screen.  
**Options > Utilities > Manage Settings**
2. Simultaneously press and hold  and  until the Manage Settings screen appears.
3. Select **Restore Settings**.
4. To replace your current settings with your previous settings, select **Yes**. To cancel, select **No**.

### Clearing your settings

The Clear All Settings option erases your current settings and returns them to the factory defaults. After you clear your settings, your pump displays the Startup Wizard, where you re-enter your pump settings. You must re-enter your settings to continue using your pump.

The Clear All Settings option does not delete paired devices, such as your transmitter or meter.





**CAUTION:** Do not clear your pump settings unless directed by your healthcare professional. If you clear your pump settings, it will be necessary to reprogram all your personal pump settings as directed by your healthcare professional.

### To clear all your settings:

1. Make sure the pump is not connected to your body.
2. Press  and go to the Manage Settings screen.

**Options > Utilities > Manage Settings**

3. Simultaneously press and hold  and  until the Manage Settings screen appears.

4. Select **Clear All Settings**.

A screen appears and tells you to confirm.

5. To continue clearing your settings, select **Yes**. If you do not want to clear your settings, select **No**.

If you clear your settings, your pump displays the Welcome screen and continues to the Startup Wizard. For more details on entering your startup settings, see *Entering your startup settings, on page 43*.

### Clearing your active insulin

Use the Clear Active Insulin option when you are ready to use your pump with insulin for the first time. This feature clears the total daily dose and any active insulin values that your pump has tracked and then sets the active insulin value to zero. If you have practiced delivering a bolus with your pump prior to using your pump with insulin, you must clear the active insulin. This ensures that the Bolus Wizard feature has an accurate active insulin amount for bolus calculations.

You can clear your active insulin only once. After you clear your active insulin, the feature is no longer available.

### To clear your active insulin:

1. Press  and go to the Manage Settings screen.

**Options > Utilities > Manage Settings**



2. Simultaneously press and hold > and ← until the Manage Settings screen appears.

The Manage Settings screen appears. If you have never cleared your active insulin, the Clear Active Insulin option appears.

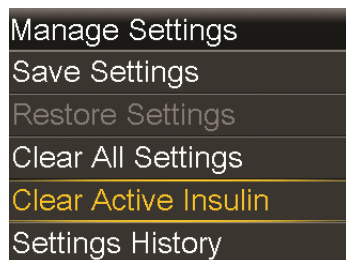

**Note:** If the Clear Active Insulin selection does not appear on the Manage Settings screen, it means that you have already cleared your active insulin on the pump.

3. Select **Clear Active Insulin**.  
A screen appears and tells you to confirm.
4. Select **Clear** to clear your active insulin value from your pump. If you do not want to clear your active insulin at this time, select **Cancel**.  
A message appears to confirm that your active insulin value is cleared.

### Viewing your pump setting history

The Settings History shows you a history of activities you have performed in the Manage Settings area, such as when you saved, restored, or cleared your settings.

1. Press Ⓞ and go to the Manage Settings screen.  
**Options > Utilities > Manage Settings**
2. Simultaneously press and hold > and ← until the Manage Settings screen appears.
3. Select **Settings History**.  
The Settings History screen appears.

## Upload to CareLink software

Upload system data to CareLink software with the MiniMed Mobile app or the Blue Adapter.

The following steps are instructions to upload system data to CareLink software with the Blue Adapter. Refer to the MiniMed Mobile app user guide for instructions to upload system data to CareLink software with the app.

### To upload to CareLink software with the Blue Adapter:

1. Press and hold  $\checkmark$ , or press  $\odot$  and go to the CareLink screen.  
**Options > Utilities > CareLink**
2. Follow the instructions on the CareLink uploader.
3. The CareLink uploader tells you to enter a pump code if the pump is new to the CareLink account. Enter the **Pump Code** from the CareLink screen on the pump.
4. Select **Next** on the CareLink uploader.
5. Select **Upload Now** on the pump screen.

## Self Test

Self Test is a safety utility that lets you check if your pump is operating properly. This self-diagnostic feature can be used for maintenance or to check that your pump is operating properly. Self Test is additional to the routine tests that run independently while the pump operates.



**Note:** Your insulin delivery suspends for up to two minutes while your pump runs a self test.

Self Test includes the following tests:

Test	Description
Display	The display turns on for up to 45 seconds.
Notification light	The notification light turns on for three seconds, and then turns it off.
Vibration	Two vibration tones are generated.

Test	Description
Tone	An alert tone, an Easy Bolus step tone, and an alarm tone are generated.

The pump performs a series of tests as listed in the previous table. Self Test requires you to observe the pump during the test.

### To run the Self Test:

1. Press  and go to the Self Test screen.

#### Options > Utilities > Self Test

A message indicates that the Self Test is in progress.

Self Test takes up to two minutes to complete. During that time, the display briefly turns white, the notification light blinks, the pump vibrates, and the pump beeps.

2. If Self Test does not detect a problem, the display returns to the Utilities screen.

If Self Test detects a problem, a message appears with more information about the problem. If Self Test displays an error message or you observe the pump not behaving as indicated during the test, contact 24-Hour Technical Support.

## Sensor Demo

Sensor Demo lets you see what the Home screen would look like if you were using the optional CGM feature. For more information about sensor graphs, see *The sensor graph, on page 213*.



**WARNING:** Do not use Sensor Demo to make any decisions related to your therapy. Information seen in the Sensor Demo is not real data. It is an example of the type of information you can access when using the sensor feature. Making treatment decisions based on data that is not real can cause hypoglycemia or hyperglycemia.

### To view the sensor graph example screens:

1. Press  and go to the Sensor Demo screen.

## Options > Utilities > Sensor Demo

The Sensor Demo screen appears as an example of what your Home screen looks like when you are using the optional CGM feature.

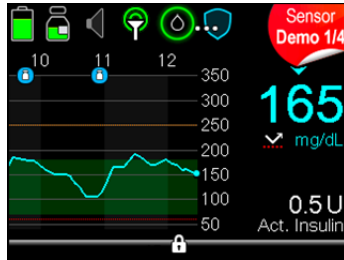

2. Press > to view the sensor graph examples.
3. Press the < or > buttons to view the different sensor screen examples.

Sensor Demo simulates an SG graph, showing an example of the general trend of glucose as it rises and falls over time. The top of the graph indicates the time of day, while the side bar shows the mg/dL scale. For details, see *The sensor graph, on page 213*.

4. To exit Sensor Demo, press ←.

## Time and date

Make sure the time and date are always set correctly on your pump. This is necessary to ensure the correct basal insulin delivery and to keep an accurate record of pump functions. You may need to change the time or the date if you travel to a different time zone or practice daylight saving time. After the time and date are changed, the pump adjusts all settings automatically.

### To change the time and the date:

1. Press Ⓞ and go to the Time & Date screen.

#### Options > Utilities > Time & Date

2. Select and change the **Time**, **Time Format**, or **Date** as necessary. If you are using a 12-hour clock, be sure to specify AM or PM.
3. Select **Save**.

# 10

Setting up CGM



# 10

## Setting up CGM

This chapter explains how to pair your pump and transmitter, enter your sensor settings, and set up CGM on your pump. You need the following:

- MiniMed 770G insulin pump
- Sensor glucose (SG) settings provided by your healthcare professional
- Guardian Sensor (3)
- Guardian Link (3) transmitter with Bluetooth wireless technology kit



**WARNING: Do not make therapy treatment decisions based on sensor glucose values. Sensor glucose (SG) and blood glucose (BG) values may differ. If your sensor glucose reading is low or high, or if you feel symptoms of low or high glucose, confirm your sensor glucose reading with your blood glucose meter prior to making therapy decisions to avoid hypoglycemia or hyperglycemia.**

### Understanding CGM

The Sensor feature on the pump lets you integrate and use CGM. CGM is an SG monitoring tool that uses a glucose sensor that is placed below your skin to continuously measure the amount of glucose in your interstitial fluid. CGM helps you better manage your diabetes in the following ways:

- It records your glucose values throughout the day and night.
- It shows the effects that your diet, exercise, and medication can have on your glucose levels.

- It gives you additional tools to help you prevent high and low glucose levels.



**Note:** If you lose sensor functionality, you will no longer have access to CGM features. For details on restoring sensor functionality, see *Troubleshooting sensor issues, on page 290*.

SG readings and BG meter readings are not the same.

## SmartGuard Technology

SmartGuard technology automatically adjusts basal insulin delivery based on your SG values. SmartGuard technology can be used in two modes: Manual Mode and Auto Mode. This chapter describes SmartGuard technology used in Manual Mode with the SmartGuard suspend (Suspend before low and Suspend on low) features. SmartGuard suspend features can automatically stop and resume insulin delivery based on your SG values and low limit. When your pump suspends insulin delivery based on your SG values and your low limit, it is called a SmartGuard suspend event. Your low limit should be set based on recommendations from your healthcare professional. When a SmartGuard suspend event occurs, basal insulin delivery automatically resumes if your SG values are rising and have met the specified criteria, or if the maximum suspend time of two hours is reached.

Auto Mode is also part of SmartGuard technology. When your pump is in Auto Mode, your basal insulin delivery is automatically controlled. For details, see *About SmartGuard Auto Mode, on page 221*.

The following table lists SmartGuard features and where to find them.

<b>To learn more about:</b>	<b>Go to this section:</b>
How to use SmartGuard technology to automatically suspend your insulin delivery before you reach your low limit.	<i>SmartGuard Suspend before low, on page 181.</i>
How to use SmartGuard technology to automatically suspend your insulin delivery when you reach your low limit.	<i>SmartGuard Suspend on low, on page 185.</i>
How SmartGuard technology automatically resumes your basal insulin delivery after a SmartGuard suspend event.	<i>Automatically resuming basal insulin delivery after a SmartGuard suspend event, on page 188.</i>



---

**To learn more about:**

How SmartGuard Auto Mode works.

**Go to this section:**

*About SmartGuard Auto Mode, on page 221.*

---

To set up the SmartGuard suspend features, see *Setting up the low SG settings, on page 197.*

## Home screen with CGM in Manual Mode







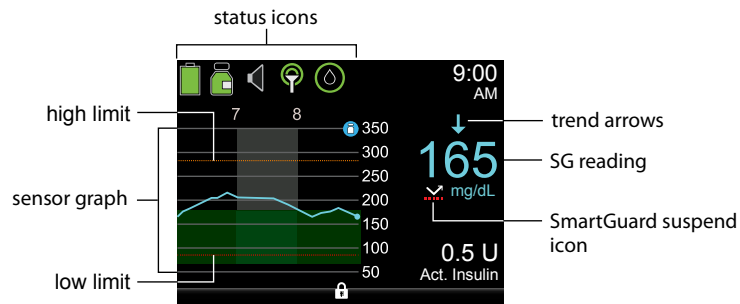



When you turn on the Sensor feature, the Home screen on your pump changes to display a real-time graph that shows your SG information. For more information, see *Turning on the Sensor feature, on page 194.*



















**Note:** To see the Home screen in Auto Mode, see *Home screen with SmartGuard Auto Mode, on page 227.*



The following items appear on your Home screen with CGM in Manual Mode:

Item	Description
Calibration icon	<p>The calibration icon indicates the approximate time left until your next sensor calibration is due. The calibration icon appears only when the Sensor feature is turned on. The color and the circle around the icon indicate the status of calibration. When your sensor is fully calibrated, the icon has a solid green circle around it. As the time for your next sensor calibration approaches, the green circle around the icon becomes smaller, and the color of the icon changes as shown in the following example. For more information about calibrating your sensor, see <i>Calibrating your sensor</i>, on page 206.</p> <ul style="list-style-type: none"> <li>•  Time to your next sensor calibration is more than 10 hours.</li> <li>•  Time to your next sensor calibration is 8 to 10 hours.</li> <li>•  Time to your next sensor calibration is 6 to 8 hours.</li> <li>•  Time to your next sensor calibration is 4 to 6 hours.</li> <li>•  Time to your next sensor calibration is 2 to 4 hours.</li> <li>•  Time to your next sensor calibration is less than 2 hours.</li> <li>•  Sensor calibration is required now.</li> <li>•  Time to your next sensor calibration is unavailable.</li> <li>•  Sensor calibration has not completed. This occurs when a new sensor is connected or when the sensor is calibrating. This also occurs within 15 minutes of a Calibration not accepted alert.</li> </ul>
Connection icon	<p>The connection icon appears green  when the Sensor feature is on and your transmitter is successfully communicating with your pump. The connection icon appears with a red X  when the Sensor feature is turned on, but the transmitter is not connected or communication with your pump has been lost. For more information about the Sensor feature, see <i>Understanding CGM</i>, on page 173.</p>

Item	Description
<p>Auto Mode Readiness icon</p>	<p>The Auto Mode Readiness icon indicates whether your pump is ready to enter Auto Mode. The icon appears with a loading symbol  when the pump is updating a condition that requires you to wait. The icon appears with a question mark  when the pump requires an action from you to enter Auto Mode. For more information about Auto Mode Readiness, see <i>SmartGuard Auto Mode Readiness</i>, on page 225.</p> <p>When your pump is in Auto Mode, the SmartGuard Auto Mode shield  appears in the center of your Home screen. For more information, see <i>Home screen with SmartGuard Auto Mode</i>, on page 227.</p>
<p>Sensor graph</p>	<p>The sensor graph shows your SG readings over a period of three hours. The orange line represents your high SG limit, and the red line represents your low SG limit. The blue line represents your SG trends during the specified period. For more information, see <i>The sensor graph</i>, on page 213.</p>
<p>Sensor life icon</p>	<p>The number in the center of the sensor life icon indicates the number of days that remain until the sensor expires. The icon appears only when the Sensor feature is turned on. When you insert a new sensor, the icon is solid green. When one day remains until the sensor expires, the icon color turns red.</p> <div data-bbox="499 1024 828 1085" style="text-align: center;">        </div> <p>If the number of days that remain until the sensor expires is unavailable, the sensor life icon appears with three dots .</p> <p>When the system is waiting for the sensor to be started, the sensor life icon appears with a question mark .</p>
<p>SG reading</p>	<p>The pump shows your current SG reading, which is sent wirelessly to your pump by the transmitter.</p>

Item	Description
SmartGuard suspend icon	<p>The SmartGuard suspend icon appears only when either the Suspend before low or Suspend on low feature is set to on. For details on SmartGuard technology, see <i>SmartGuard Technology, on page 174</i>.</p> <p>The SmartGuard suspend icon indicates the current status of the suspend features, as follows:</p> <ul style="list-style-type: none"> <li>• The icon is a white arrow with a dotted red line  when either the Suspend on low or Suspend before low is turned on and ready.</li> <li>• The arrow icon flashes if your insulin delivery is currently suspended due to a Suspend on low or Suspend before low event.</li> <li>• The icon appears as a gray cross with a dotted line under it  when neither suspend feature is available. The suspend features might be unavailable due to a recent suspend or because there are no SG values available. It might also be unavailable because the pump is not currently delivering insulin.</li> </ul>
Trend arrows	<p>The trend arrows indicate the rate at which the most recent SG level is rising or falling.</p> <ul style="list-style-type: none"> <li>•  - Rising trend arrows</li> <li>•  - Falling trend arrows</li> </ul> <p>For more information about trend arrows, see <i>Identifying rapid changes in SG, on page 214</i>.</p>

## Understanding glucose settings

There are several types of glucose alerts you can set to tell you when your glucose values change at a particular rate, or when they approach or reach a specified low or high limit. You can also set your pump to automatically suspend insulin delivery before or when you reach your low limit.

The following graph shows the different high and low glucose alerts you can use.

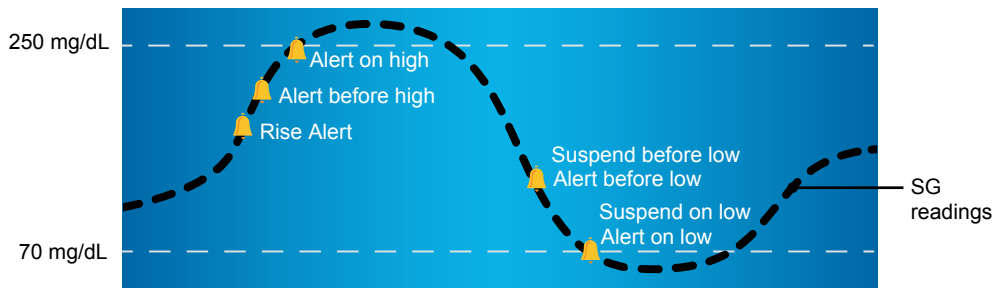

🔔 SG alert and suspend settings

The high alerts are described in the *High SG settings* section on page 179. For details on low alerts and suspend options, see *Low SG settings*, on page 180.

### High SG settings

These settings alert you:

- When your SG is rising rapidly (Rise Alert)
- When your SG is approaching your high limit (Alert before high)
- When your SG has reached your high limit (Alert on high)



The following graph shows the different high SG settings you can use:



🔔 High SG alert settings

The following table describes the high SG settings.

High glucose setting	Description
High limit	Your high limit is the value your other high SG settings are based on. Your high limit can be set from 100 to 400 mg/dL. You can set a different high limit for up to eight time segments throughout the day or night.

<b>High glucose setting</b>	<b>Description</b>
Alert before high	When Alert before high is on, the pump alert tells you any time the SG is predicted to reach the high limit. This makes you aware of potential highs before they occur.
Time before high	Time before high is only available when using Alert before high. Time before high determines when you will receive an Alert before high. You can set a time between 5 and 30 minutes.
Alert on high	When Alert on high is on, your system tells you when your SG reading reaches or exceeds your High Limit.
Rise Alert	<p>The Rise Alert tells you when your glucose is rising rapidly. This alert helps you understand how much your glucose levels are affected by meals or, for example, when forgetting to give a bolus. You can set the rise rate to match the arrows that display on the Home screen during a glucose rise, or to a custom rise rate.</p> <ul style="list-style-type: none"> <li>•  - SG is rising at a rate of 1 mg/dL per minute or more.</li> <li>•  - SG is rising at a rate of 2 mg/dL per minute or more.</li> <li>•  - SG is rising at a rate of 3 mg/dL per minute or more.</li> <li>• <b>Custom</b> - SG is rising at the rate that you set which can be set from 1.0 to 5.0 mg/dL per minute.</li> </ul>
Rise Limit	The Rise Limit determines when you will receive a Rise Alert. Rise Limit is only available when using Rise Alert.

To set up your high SG settings, see *Setting up the high SG settings, on page 194*.

## Low SG settings

The low SG settings alert or suspend insulin delivery when you either approach or reach your low limit. For more information, see *SmartGuard Technology, on page 174*.

The following graph shows the different low SG settings you can use:

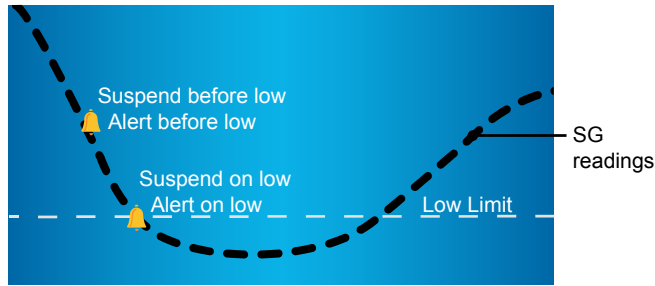

🔔 Low SG alert and suspend settings



**WARNING:** Suspend before low and Suspend on low are not intended to be a treatment for low blood glucose. Having insulin suspended when glucose is low may not bring your blood glucose back to your target range for several hours. In that case, you run the risk of hypoglycemia. Always confirm your blood glucose readings with your blood glucose meter and treat according to the recommendations of your healthcare professional.

The following sections describe how to set up your low SG settings in Manual Mode. For details on setting up your low SG settings in Manual Mode, see *Setting up the low SG settings, on page 197*.

### Low limit

The low limit is the value on which the other low SG settings are based. The low limit can be set from 50 to 90 mg/dL. You can set a different low limit for up to eight time segments throughout the day or night.

### SmartGuard Suspend before low

The SmartGuard Suspend before low feature stops insulin delivery when your SG values are approaching your low limit. This feature is intended to suspend insulin delivery to minimize the amount of time spent with low BG values.

The default setting for the Suspend before low feature is off. Consult your healthcare professional for the Suspend before low setting that is best for you.

If you turn on Suspend before low, then Alert on low is automatically turned on. You also have the option to turn on Alert before low.

- If Alert before low is on, your pump tells you when insulin delivery is suspended. For details, see *Alert before low, on page 184*.
- If Alert before low is off, then Suspend before low appears on the screen, but the pump will not beep or vibrate when insulin delivery is suspended.
- The user can enable Alert before low, Alert on low, Suspend before low, and Suspend on low. There is an additional fixed low alert at 50 mg/dL that cannot be turned off.
- Suspend before low and Suspend on low cannot be enabled at the same time. When either is enabled, the user can enable the Resume basal alert.
- The Low SG alarm appears when your SG values reach or fall below 50 mg/dL. This alarm cannot be turned off. When the alarm appears on your screen, it shows your SG value next to your Low SG alarm. In this user guide, the SG value will be represented as "Low SG XX" for this alarm.

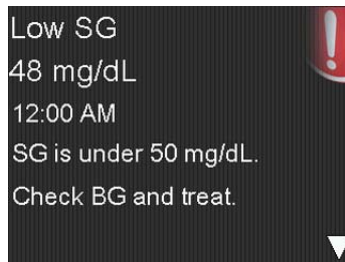

**WARNING:** Always confirm your sensor glucose readings with your blood glucose meter and treat according to the recommendations of your healthcare professional. The Suspend before low feature uses the sensor glucose value, not your blood glucose value, to automatically suspend insulin delivery. Your pump automatically suspends insulin delivery when your sensor glucose is approaching the low limit. However your blood glucose reading may be higher or lower than the sensor glucose value. Assuming that your sensor glucose value is accurate may result in the delivery of too little or too much insulin, which can cause hyperglycemia or hypoglycemia.



## Suspend before low conditions

When a Suspend before low event occurs, all insulin delivery is suspended. A Suspend before low event occurs in the following situations:

- Your SG value is at or within 70 mg/dL above your low limit.
- Your SG is predicted to reach or fall below a level that is 20 mg/dL above your low limit within approximately 30 minutes.

## Responding to a Suspend before low event

When you clear the Suspend before low alert, the SmartGuard suspend icon  flashes and "Suspended before low" appears on your Home screen. If your SG reaches your low limit, an Alert on low occurs.

When a Suspend before low event occurs, insulin delivery will remain suspended for at least 30 minutes. Insulin delivery will be suspended for a maximum of two hours. You can manually resume basal insulin delivery at any time. For details, see *Manually resuming basal insulin delivery during a SmartGuard suspend event, on page 200*. After the minimum 30-minute suspend time, basal insulin delivery will automatically resume if the following conditions are met:

- Your SG is at least 20 mg/dL above your low limit.
- Your SG is estimated to be more than 40 mg/dL above your low limit within 30 minutes.

If you do not respond to the Suspend before low alert, your pump resumes basal insulin delivery after two hours and displays a Basal delivery resumed alert.

## When Suspend before low is unavailable

After a Suspend before low event occurs, there is a period of time when the Suspend before low functionality is unavailable. This is to prevent prolonged suspended basal delivery. The length of time it is unavailable will vary. You can manually suspend insulin delivery at any time. For details, see *Stopping and resuming your insulin delivery, on page 80*.



**Note:** The maximum amount of time the Suspend before low feature will be unavailable is four hours.

When the SmartGuard suspend features are unavailable, the SmartGuard suspend icon on the Home screen appears as a gray cross .

**When a Suspend before low event occurs and you respond within two hours and:**

- Stay suspended for the two-hour maximum suspend time, the SmartGuard suspend features will be unavailable for 30 minutes after your basal insulin delivery resumes.
- Your basal insulin delivery automatically resumes due to your rising SG levels, the SmartGuard suspend features will be unavailable for 30 minutes after your basal insulin delivery resumes.
- Manually resume your basal insulin delivery, the SmartGuard suspend features will be unavailable for 30 minutes after your basal insulin delivery resumes.

**If your pump has been suspended for two hours and you have not responded,** basal insulin delivery automatically resumes.

**If you respond within 30 minutes of basal insulin delivery being resumed,** the SmartGuard suspend features will be unavailable for a total of 30 minutes. For example:

- If you respond 10 minutes after your basal insulin delivery resumes, the SmartGuard suspend features will be unavailable for an additional 20 minutes.
- If you respond 20 minutes after your basal insulin delivery resumes, the SmartGuard suspend features will be unavailable for an additional 10 minutes.

**If you respond 30 minutes to four hours after** your basal insulin delivery resumes, the SmartGuard suspend features will be available immediately.

**If you do not respond,** the SmartGuard suspend features will be unavailable for four hours after basal insulin delivery resumes.

### **Alert before low**

When Alert before low is on, you will receive an alert when you are approaching your low limit. This makes you aware of potential lows before they occur.

The Alert before low feature can be used with the Suspend before low and Suspend on low features. The Alert before low feature works as follows:

- If Alert before low is on, and both SmartGuard suspend features are off, you receive the Alert before low 30 minutes before you reach your low limit.

- If Suspend on low is on, and Alert before low is on, you receive an Alert before low 30 minutes before you reach your low limit.
- If Suspend before low is on, and Alert before low is on, you receive a Suspend before low alert when insulin delivery is suspended. For details, see *SmartGuard Suspend before low*, on page 181.

You can also choose to have the Alert before low off.

### SmartGuard Suspend on low

The SmartGuard Suspend on low feature stops insulin delivery when your SG value reaches or falls below the low limit that you set. When a Suspend on low event occurs, all insulin delivery is suspended. This feature is used for situations when you cannot respond to a low glucose condition. It is intended to suspend insulin delivery and minimize the amount of time spent with low BG values.



**WARNING: Do not use the Suspend on low feature until you have read the information in this user guide and received training from your healthcare professional. The Suspend on low feature causes the pump to temporarily suspend insulin delivery for a maximum of two hours. Under some conditions of use, the pump can suspend again, resulting in limited insulin delivery. Prolonged suspension can increase the risk of serious hyperglycemia, ketosis, and ketoacidosis.**

The default setting for the Suspend on low feature is off. Consult your healthcare professional for the Suspend on low setting that is best for you.

If you turn on Suspend on low, then Alert on low is turned on automatically. For more information, see *Alert on low*, on page 187.



**WARNING:** Always confirm your sensor glucose readings with your blood glucose meter and treat according to the recommendations of your healthcare professional. The Suspend on low feature uses the sensor glucose value, not your blood glucose value, to automatically suspend your pump. Your pump may automatically suspend when your sensor glucose is at or below the low limit, while your blood glucose is above that limit. Assuming that your sensor glucose value is accurate may result in the delivery of too little or too much insulin, which can cause hyperglycemia or hypoglycemia.

### Responding to a Suspend on low event

When you clear the Suspend on low alarm, the SmartGuard suspend icon  flashes and "Suspended on low" appears on your Home screen.

When a Suspend on low event occurs, the pump tells you.

When a Suspend on low event occurs, insulin delivery will remain suspended for at least 30 minutes. Insulin delivery will be suspended for a maximum of two hours. You can manually resume basal insulin delivery at any time. For details, see *Manually resuming basal insulin delivery during a SmartGuard suspend event, on page 200*. After the minimum 30-minute suspend time, basal insulin delivery will automatically resume if the following conditions are met:

- Your SG is at least 20 mg/dL above your low limit.
- Your SG is estimated to be more than 40 mg/dL above your low limit within 30 minutes.

If you do not respond to the Suspend on low alarm, your pump resumes basal insulin delivery after two hours and continues to display an emergency message.

### When Suspend on low is unavailable

After a Suspend on low event occurs, there is a period of time when the suspend functionality is unavailable. This time will vary depending on whether or not you respond to the Suspend on low event. You can manually suspend insulin delivery at any time. For details, see *Stopping and resuming your insulin delivery, on page 80*.



**Note:** The maximum amount of time the Suspend on low feature will be unavailable is four hours. After this time period, the Suspend on low feature automatically enables.

When the SmartGuard suspend features are unavailable, the SmartGuard suspend icon on the Home screen appears gray .

**When a Suspend on low event occurs and you respond within two hours and:**

- Stay suspended for the two-hour maximum suspend time, the SmartGuard suspend features will be unavailable for 30 minutes after your basal insulin delivery resumes.
- Your basal insulin delivery automatically resumes due to your rising SG levels, the SmartGuard suspend features will be unavailable for 30 minutes after your basal insulin delivery resumes.
- Manually resume your basal insulin delivery, the SmartGuard suspend features will be unavailable for 30 minutes after your basal insulin delivery resumes.

**If your pump has been suspended for two hours and you have not responded,** basal insulin delivery automatically resumes.

**If you respond within 30 minutes of basal insulin delivery being resumed,** the SmartGuard suspend features will be unavailable for a total of 30 minutes. For example:

- If you respond 10 minutes after your basal insulin delivery resumes, the SmartGuard suspend features will be unavailable for an additional 20 minutes.
- If you respond 20 minutes after your basal insulin delivery resumes, the SmartGuard suspend features will be unavailable for an additional 10 minutes.

**If you respond 30 minutes to four hours after** your basal insulin delivery resumes, the SmartGuard suspend features will be available immediately.

**If you do not respond,** the SmartGuard suspend features will be unavailable for four hours after basal insulin delivery resumes.

### **Alert on low**

The Alert on low feature is automatically turned on when either the Suspend before low or the Suspend on low feature is turned on.

When Alert on low is set to on, you receive an alert when your SG reading reaches or falls below your low limit. If your pump is suspended and you have not responded, an emergency message appears.

### **Automatically resuming basal insulin delivery after a SmartGuard suspend event**

In addition to suspending insulin delivery, the pump can also automatically resume delivery of basal insulin. If insulin delivery has been suspended by either the Suspend before low or the Suspend on low feature, basal insulin delivery will automatically be resumed if either of the following conditions are met:

- If insulin delivery has been suspended for a minimum of 30 minutes and SG values are at least 20 mg/dL above the low limit and expected to be more than 40 mg/dL above the low limit in 30 minutes
- After a maximum of two hours

### **Resume basal alert**

When the Resume basal alert is on, you will be alerted when basal insulin delivery is automatically resumed. If the Resume basal alert is off, basal insulin delivery resumes, but you do not receive an alert. However, you will get a message indicating that the basal insulin delivery has automatically resumed.

If basal insulin delivery resumes after the maximum suspend time of two hours, you will be alerted even if the Resume basal alert is set to off. It is important that you check your BG and ensure your glucose is at a safe level.

For details on setting up the Resume basal alert, see *Setting up the low SG settings, on page 197*.

### **SmartGuard suspend examples**

The following table shows the different scenarios that occur during and after a Suspend before low or Suspend on low event. Examples of scenarios are shown after the table.

	<b>Suspend features</b>	
<b>What happens</b>	<b>Suspend on low</b>	<b>Suspend before low</b>
The pump suspends insulin delivery.	<p>Your SG value reaches or falls below the low limit that you set.</p> <p>The pump suspends insulin delivery for at least 30 minutes and up to a maximum of 2 hours. The pump automatically resumes basal insulin delivery between 30 minutes and 2 hours if your SG value is predicted to go above the low limit that you set.</p>	<p>Your SG value is approaching your low limit and is predicted to be reached within 30 minutes.</p> <p>The pump suspends insulin delivery for at least 30 minutes and up to a maximum of 2 hours. The pump automatically resumes basal insulin delivery between 30 minutes and 2 hours if your SG value is predicted to go above the low limit that you set.</p>
You manually resume basal insulin delivery.	<p>Your pump resumes basal insulin delivery at the programmed basal rate. The SmartGuard suspend features are unavailable for 30 minutes after basal insulin delivery resumes. The pump will not automatically suspend insulin delivery again until after the suspend features are available and your SG value is below the low limit that you set.</p>	<p>Your pump resumes basal insulin delivery at the programmed basal rate. The SmartGuard suspend features are unavailable for 30 minutes after basal insulin delivery resumes. The pump will not automatically suspend insulin delivery again until after the suspend features are available and your SG value is approaching the low limit that you set.</p>

	<b>Suspend features</b>	
<b>What happens</b>	<b>Suspend on low</b>	<b>Suspend before low</b>
Your SG value is predicted to go above your low limit while insulin delivery is automatically suspended.	The pump automatically resumes basal insulin delivery after 30 minutes and if your SG values are at least 20 mg/dL above your low limit and predicted to be more than 40 mg/dL above your low limit in 30 minutes.	The pump automatically resumes basal insulin delivery after 30 minutes and if your SG values are at least 20 mg/dL above your low limit and predicted to be more than 40 mg/dL above your low limit in 30 minutes.
You respond to the alert that occurs while insulin delivery is suspended. Insulin delivery is suspended for the maximum two hour suspend time.	Your pump resumes basal insulin delivery at the programmed basal rate. The SmartGuard suspend features are unavailable for 30 minutes after basal insulin delivery resumes. The pump will not automatically suspend insulin delivery again until after the suspend features are available and your SG value is below the low limit that you set.	Your pump resumes basal insulin delivery at the programmed basal rate. The SmartGuard suspend features are unavailable for 30 minutes after basal insulin delivery resumes. The pump will not automatically suspend insulin delivery again until after the suspend features are available and your SG value is approaching the low limit that you set.
The pump resumes basal insulin delivery after the maximum two hour suspend time. You respond to the alert that occurs after basal insulin delivery resumes.	Your pump resumes basal insulin delivery at the programmed basal rate. The SmartGuard suspend features are unavailable for 30 minutes. The pump will not automatically suspend insulin delivery again until after the suspend features are available and your SG value is below the low limit that you set.	Your pump resumes basal insulin delivery at the programmed basal rate. The SmartGuard suspend features are unavailable for 30 minutes. The pump will not automatically suspend insulin delivery again until after the suspend features are available and your SG value is approaching the low limit that you set.



	Suspend features	
What happens	Suspend on low	Suspend before low
You do not respond to the alerts that occur while insulin delivery is suspended. Insulin delivery is suspended for the maximum two hour suspend time.	Your pump resumes basal insulin delivery at the programmed basal rate. The SmartGuard suspend features are unavailable for 4 hours after basal insulin delivery resumes. The pump will not automatically suspend insulin delivery again until after the suspend features are available and your SG value is below the low limit that you set.	Your pump resumes basal insulin delivery at the programmed basal rate. The SmartGuard suspend features are unavailable for 4 hours after basal insulin delivery resumes. The pump will not automatically suspend insulin delivery again until after the suspend features are available and your SG value is approaching the low limit that you set.

The following examples describe several scenarios that illustrate different types of suspend events, user actions in response to these events, and what happens to insulin delivery in each case.

The examples cover the following:

- Example 1: Suspend before low, non-responsive, auto resume basal insulin delivery (trending upwards)
- Example 2: Suspend before low, responsive, manually resume basal insulin delivery
- Example 3: Suspend before low, responsive, stays suspended
- Example 4: Suspend on low, response after basal insulin delivery resumes



**Note:** During the Suspend on low siren, you can press any button to silence your pump for two minutes. The temporary silencing of the alarm does not affect the suspension or delivery of insulin.

### Example 1: Suspend before low, non-responsive, auto resume basal insulin delivery (trending upwards)

Sarah has been experiencing low SG values. Her healthcare professional has recommended she use the Suspend before low feature. While at a concert, Sarah's SG values are approaching her low limit. Her pump recognizes that her glucose will be at or within 20 mg/dL above her low limit within 30 minutes and suspends her insulin delivery. Sarah has her Alert before low set to off so that she is not alerted when this occurs.

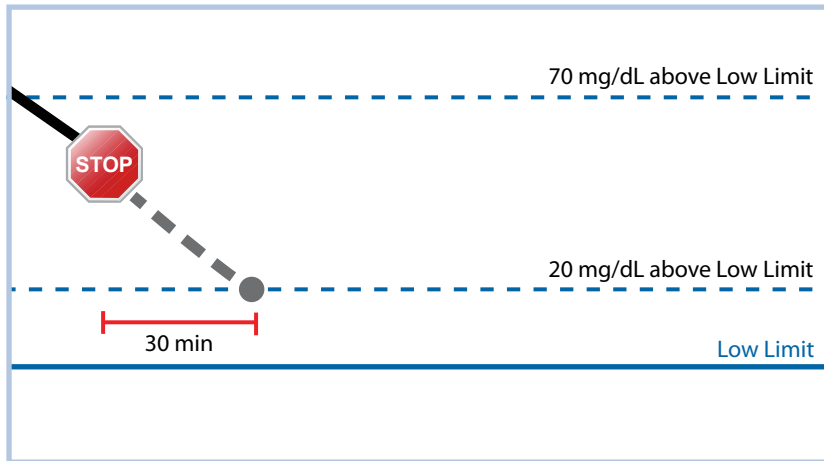

An hour later, her SG values are 21 mg/dL above her low limit. Her pump estimates her SG values will be 45 mg/dL above her low limit within 30 minutes. Her pump automatically resumes her basal insulin delivery.

When the concert ends, Sarah sees that her pump automatically suspended and resumed her insulin delivery and a potential low was avoided. She clears the messages by selecting OK.

### Example 2: Suspend before low, responsive, manually resume basal insulin delivery

Kate decides to meet her friends at the mall. While shopping, she gets a Suspend before low alert. This indicates that her SG values are approaching the low limit she has set. She clears the alert and sees that her insulin delivery has been suspended. Kate checks her BG to confirm. Based on her healthcare professional's recommendation, Kate stops for a snack to help avoid hypoglycemia. Knowing the

carbohydrate will make her glucose rise, Kate manually resumes her basal insulin delivery by selecting Suspended before low from the Home screen and choosing Resume basal.

Kate knows that after she has manually resumed her basal insulin delivery, the suspend functions will be unavailable for 30 minutes. However, she will be alerted if she reaches her low limit.

### **Example 3: Suspend before low, responsive, stays suspended**

Doug has just finished his evening jog on the beach. As he is walking home, he receives a Suspend before low alert. He sees that his pump has automatically suspended his insulin delivery. Doug clears the alert by selecting OK on his pump. He knows that his pump is now suspended and insulin delivery has been stopped. He checks his BG to confirm and keeps his insulin delivery suspended.

A while later, Doug receives another alert. He looks at his pump and sees that he has received an Alert on low. His SG has reached his low limit. He clears the alert and checks his BG to confirm. He eats carbohydrates to treat the low glucose as instructed by his healthcare professional.

Doug keeps his insulin delivery suspended as directed by his healthcare professional. He knows that once his SG is above his low limit and trending upward, or reaches the maximum suspend time of two hours, basal insulin delivery will automatically resume.

### **Example 4: Suspend on low, response after basal insulin delivery resumes**

Michael is on his college hockey team. He played in a hockey tournament all day and is so exhausted that he falls asleep watching television. His SG value begins to drop. When his SG value reaches his low limit, the pump begins to alarm. His pump automatically suspends all insulin delivery. Michael does not respond to the alarm. After ten minutes, his pump begins to siren and shows the emergency message.

About three hours later, Michael's roommate comes home. He hears the pump sirening and wakes up Michael. Michael clears any messages by selecting OK. He sees that his basal insulin was suspended for the two hour maximum and had automatically resumed delivery. He checks his blood sugar and sees that it is within the target range.

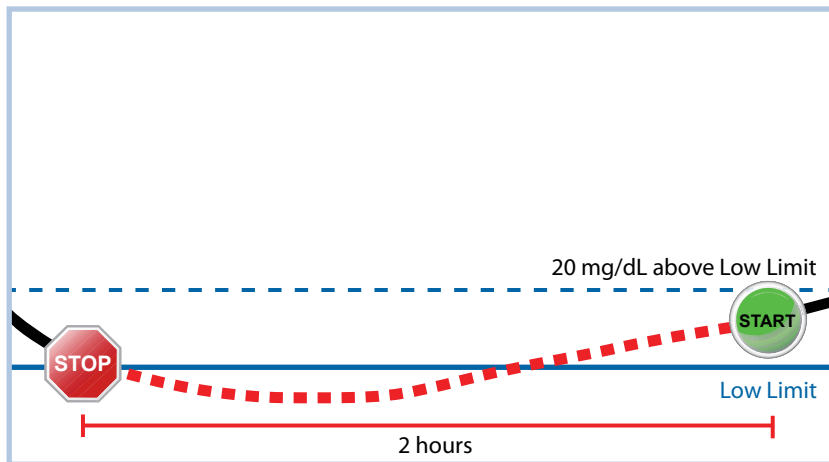

Michael has responded to his alert. The pump will suspend insulin delivery and alarm again if his sensor value reaches or falls below his low limit again.

### Turning on the Sensor feature

You must turn on the Sensor feature before you can set up your glucose alerts and start monitoring your SG levels.

#### To turn on the Sensor feature:

1. Press  and go to the Sensor Settings screen.  
**Options > Utilities > Sensor Settings**
2. Select **Sensor** to turn on the sensor feature. The sensor settings become accessible.

### Setting up the high SG settings

The steps below show you how to set up the high SG settings. For details on your high SG settings, see *High SG settings*, on page 179.



**Note:** When you enter your settings, you first define the time segment, and then select the high SG settings you want during that time segment.

#### To set up the high SG settings:

1. Press  and go to the High Setup screen.  
**Options > SmartGuard > High Setup**

The High Setup screen appears.

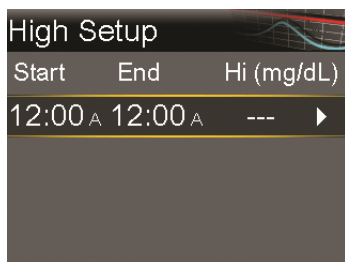

2. Select the time segment. The End time starts flashing.  
The Start time of the first time segment is always 12:00 A. You can set up to eight time segments, each with a different high limit. If you set more than one time segment, the time segments must cover a 24-hour period.
3. Set the End time.
4. Set your High limit. You can enter a value from 100 to 400 mg/dL, in increments of 5 mg/dL.
5. Select the arrow to the right of the End time to select the high alerts for this time segment.

A screen appears and shows the high alerts for the selected time segment.

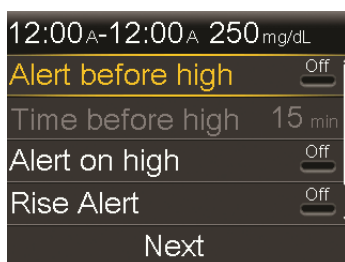

6. Set the following alerts as desired:
  - a. Select **Alert before high** to receive an alert before you reach your high limit.
  - b. Set the **Time before high** option between 5 to 30 minutes to receive an alert before you reach your high limit.
  - c. Select **Alert on high** to receive an alert when you reach your high limit.
  - d. Select **Rise Alert** to receive an alert when your SG is rising quickly.  
Go to step 11 if you do not select Rise Alert.

7. If you turned on the Rise Alert, you must set the Rise Limit. Scroll down and select **Rise Limit** to access this option.

The Rise Limit screen appears.

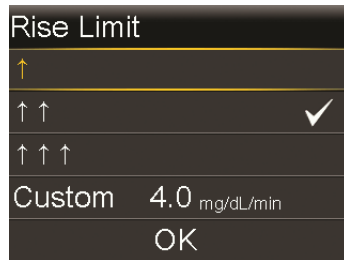

8. Select one, two, or three arrows for the rise rate. To use a custom rate, go to step 9.
  - Select **↑** for an alert when your SG has been rising at a rate of 1 mg/dL per minute or more.
  - Select **↑↑** for an alert when your SG has been rising at a rate of 2 mg/dL per minute or more.
  - Select **↑↑↑** for an alert when your SG has been rising at a rate of 3 mg/dL per minute or more.

Select **OK**, and go to step 11.



**Note:** These arrows appear on your Home screen to indicate the rate at which your SG has been rising.

9. To enter a custom rise limit, do the following:
  - a. Select **Custom**. The Custom Limit screen appears.
  - b. Select **Rise Limit** and set a rise rate in 0.1 mg/dL/min increments from 1 to 5 mg/dL/min.
  - c. Select **OK** to return to the Rise Limit screen, and then select **OK** again to confirm your settings.
10. After you set all the high SG settings for the selected time segment, select **Next** to continue.

11. If you entered an End time of anything other than 12:00 A, another time segment appears. After you enter the high SG settings, select **Done**.
12. Review your settings and select **Save**.

### To change your high SG settings:

1. Press  and go to the High Setup screen.  
**Options > SmartGuard > High Setup**  
The High Setup screen appears.
2. Select **Edit**.
3. Select and adjust the time segment you want to change.
4. Select any alert setting to turn it on or off or to adjust the setting.
5. Select **Next**.
6. Select **Done**.
7. Review your settings and select **Save**.

### High Snooze

The High Snooze option is available once you set your high SG settings. The High Snooze option lets you set the amount of time that you want to wait before you are reminded that an alert condition still exists. You are alerted again only if the high alert condition still exists after the specified snooze time.

### To set the High Snooze:

1. Press  and go to the Snooze screen.  
**Options > SmartGuard > Snooze**  
The Snooze screen appears.
2. Select **High Snooze** and enter a value in 5-minute increments from 5 minutes to 3 hours.
3. Select **Save** to save your Snooze settings.

### Setting up the low SG settings

The steps below show you how to set up the low SG settings. For details on the low SG settings, see *Low SG settings, on page 180*.



**Note:** When you enter your settings, you first define the time segment, and then select the low SG settings you want during that time segment.

### To set up the low SG settings:

1. Press  and go to the Low Setup screen.

Options > SmartGuard > Low Setup

The Low Setup screen appears.

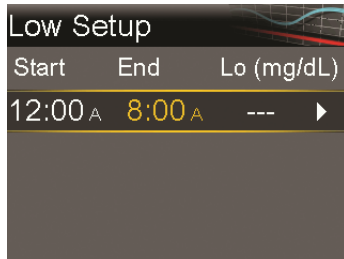

2. Select the time segment. The End time flashes.

The Start time of the first time segment is always 12:00 A. You can set up to eight time segments, each with a different low limit. If you set more than one time segment, the time segments must cover a 24-hour period.

3. Set the End time.
4. Set your low limit. Enter a value in increments of 5 mg/dL from 50 to 90 mg/dL.
5. Select the arrow to the right of the End time to select the low SG settings for this time segment.

A screen appears and shows the available settings for the selected time period.

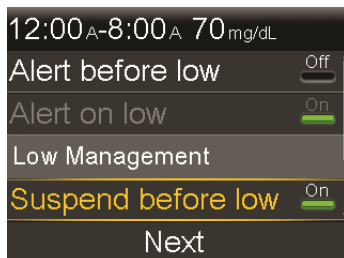

6. Set the following features as desired:



- a. Select **Suspend before low** to have insulin delivery suspended before you reach your low limit. The Alert on low alert is automatically turned on and cannot be turned off.
- b. Select **Alert before low** to receive an alert before you reach your low limit. If Suspend before low is also on, you are alerted when insulin delivery is suspended.
- c. Select **Suspend on low** to have insulin delivery suspended when you reach or fall below your low limit. The Alert on low alert is automatically turned on and cannot be turned off.
- d. Select **Alert on low** if you want to receive an alert when your SG reaches or falls below your low limit. If either suspend feature is on, this will already be on.
- e. Select **Resume basal alert** if you want an alert when basal insulin delivery resumes based on SG values during a SmartGuard suspend event. If you do not turn on the alert, the Basal delivery resumed message still appears, but you will not receive an alert.



**Note:** When you set your low alerts:

- If you turn on Suspend before low or Suspend on low, Alert on low is turned on automatically.
- Only one SmartGuard suspend feature can be used during each time segment. You cannot turn on both Suspend before low and Suspend on low in the same time segment.

7. When you have set all the low SG settings for the selected time segment, select **Next** to continue.
8. If you entered an End time of anything other than 12:00 A, another time segment appears.

When you are finished entering your low SG settings, select **Done**.

9. Review your settings, and select **Save**.

### To change your low SG settings:

1. Press  and go to the Low Setup screen.  
**Options > SmartGuard > Low Setup**  
The Low Setup screen appears.
2. Select **Edit**.
3. Select, and if needed, adjust the time segment you would like to change.
4. Select any alert setting to turn it on or off or to adjust the setting.
5. Select **Next**.
6. Select **Done**.
7. Review your settings, and select **Save**.

### Low Snooze

The Low Snooze option is available once you set your low SG settings. The Low Snooze option lets you set the amount of time that you want to wait before you are reminded that an alert condition still exists. You are alerted again only if the low alert condition still exists after the specified snooze time.

### To set the Low Snooze:

1. Press  and go to the Snooze screen.  
**Options > SmartGuard > Snooze**  
The Snooze screen appears.
2. Select **Low Snooze** and enter a time between 5 minutes and 1 hour.

### Manually resuming basal insulin delivery during a SmartGuard suspend event

When your pump suspends insulin delivery due to a Suspend before low or Suspend on low event, the bottom of your Home screen shows either Suspended before low or Suspended on low depending on which is active.

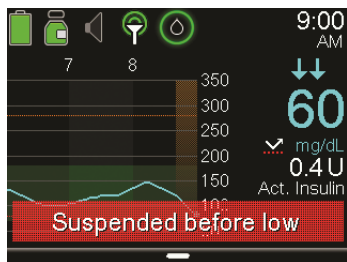

If you do not want to wait for your pump to automatically resume your basal insulin delivery, you can follow the procedure below to manually resume your basal insulin delivery.

### To manually resume basal insulin delivery:

1. Press  and select **Resume Basal**.
2. Select **Resume Basal**.
3. Select **Yes** to resume basal insulin delivery.

## Pairing your pump and transmitter

Before you can start using your sensor, you must first pair your pump with your transmitter so they can begin communicating with each other when they are wirelessly connected.

Note that you can pair only one transmitter with your pump. If you already have a transmitter paired with your pump, you must delete it before continuing. For instructions on deleting a transmitter from your pump, see *Deleting the transmitter from your pump*, on page 204.

### To pair the pump and transmitter:

1. Attach your transmitter to the charger and make sure the transmitter is fully charged. Keep your transmitter attached to the charger.

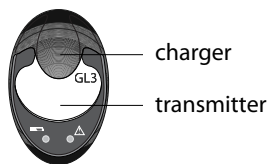



**Note:** Both lights on the charger are off when the transmitter is fully charged. For more information, see your transmitter user guide.

2. Press  and go to the Device Options screen.

**Options > Utilities > Device Options**

3. Select **Pair Device**.

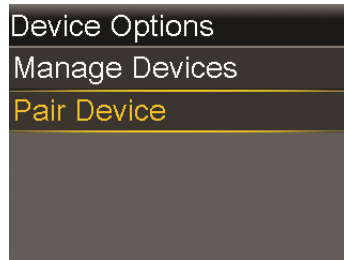

The New Device screen appears.

4. Place the transmitter (still attached to the charger) next to the pump.

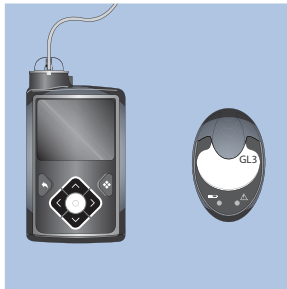

5. Select **Search** on your pump and immediately remove the transmitter from the charger.

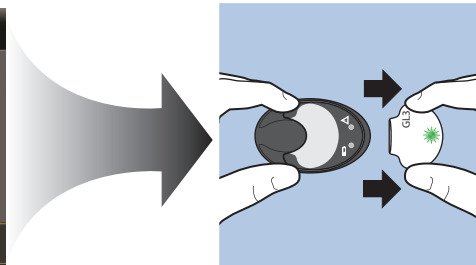

The following happens when you start the search process:

- On your pump, a message appears to let you know your pump is searching.
- On your transmitter, a green light starts to flash.



**Note:** The search process can take up to two minutes. You cannot access your pump screens or suspend your pump during the search process.

The Select Device screen appears with a list of available devices.

6. Select the CGM device that matches the serial number on the back of the transmitter.



7. Ensure the transmitter serial number on your pump screen matches the serial number on the back of your transmitter, and then select **Confirm**.

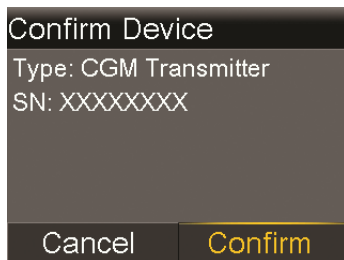

A message appears if the pump and transmitter are paired successfully. If the Sensor feature is turned on, the Connection icon  appears on the Home screen.

If your pump does not find your transmitter, the Device not found alert appears. See the following procedure, *If your pump does not find your transmitter*.

### If your pump does not find your transmitter:

1. Select **OK** on the Device not found alert. The Select Device screen appears.
2. Select CGM from the list and reconfirm to retry pairing.
3. If the pairing is unsuccessful and the Device not found alert appears a second time, select **OK**. When the Select Device screen appears, select the **Back** button to return to the New Device screen to restart the pairing process from the beginning.

## Deleting the transmitter from your pump

Follow this procedure to delete the transmitter from your pump. Use this process when you are replacing your transmitter.

### To delete your transmitter from your pump:

1. Press  and go to the Manage Devices screen.  
**Options > Utilities > Device Options > Manage Devices**
2. Select CGM.
3. Select **Delete**. A confirmation screen appears asking if you want to delete the device.
4. Select **Yes** to confirm or **No** to cancel.

## Inserting the sensor

Choose an insertion site that has an adequate amount of subcutaneous fat. The Guardian Sensor (3) has been studied and is approved for use in the following sensor insertion sites by persons of the following ages:

Approved Age	Sensor Insertion Site
2-13	Abdomen and Buttocks
14 and older	Abdomen and Arm

The following image shows the best body areas (shaded) for sensor insertion.

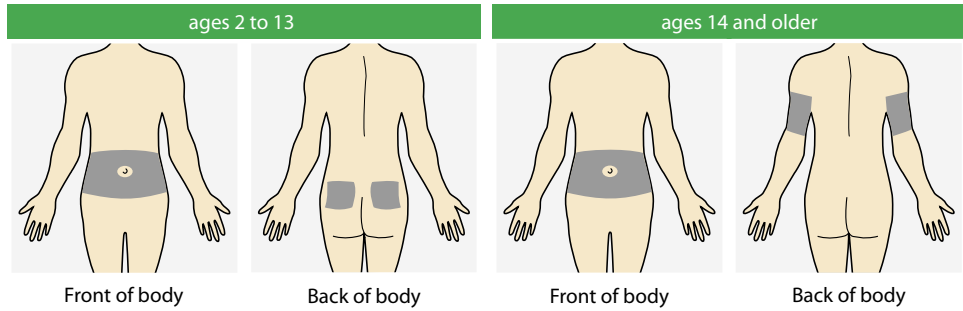

**Note:** Assistance will likely be needed for sensor insertion into the back of the upper arm and into the buttocks. Some users found it difficult to insert the sensor into their arm and buttocks by themselves.

Always refer to your sensor user guide for specific instructions on how to insert the sensor. The sensor user guide uses the abdomen insertion site as an example in the instructions.

## Connecting the transmitter to the sensor

Always refer to your transmitter user guide for instructions on how to connect the transmitter to the sensor.

## Starting the sensor

After you insert your sensor and connect your sensor and transmitter, your pump starts to communicate with the transmitter. The pump tells you when the sensor is ready to use.

### To start a new sensor:

1. Select **Start New Sensor** when it appears on the pump screen.

The "Sensor warm-up started" message appears.



**Note:** It may take up to five minutes for the "Sensor warm-up started" message to appear.

2. Select **OK**.

"Warm up..." appears on the Home screen until the sensor is ready for first calibration.

## Reconnecting the sensor

There are times when you remove the transmitter from an inserted sensor. After you reconnect the transmitter to the sensor, the pump detects the connected transmitter. A "Sensor connected" message appears.

### To reconnect a sensor:

1. Select **Reconnect Sensor**.

The "Sensor warm-up started" message appears.



**Note:** It may take up to five minutes for the "Sensor warm-up started" message to appear.

2. Select **OK**.

"Warm up..." appears on the Home screen until the sensor is ready for its first calibration.

## Calibrating your sensor

Calibration is the process of entering a BG meter reading to calculate SG values. You must calibrate your sensor regularly to ensure you continue to receive SG data. For details, see *Guidelines for calibrating*, on page 209.



**WARNING: Do not use Alternative Site Testing to calibrate a continuous glucose monitoring system.**

Within two hours after you use your pump to start the sensor, your pump displays a Calibrate now alert to let you know that a calibration is due. This BG meter reading is the first calibration for your sensor. It takes up to five minutes after calibration to see the first SG reading on your Home screen. You enter your second calibration within six hours after your first calibration.



After you have entered your first two calibrations, you must calibrate your sensor again within 12 hours. If you do not enter a BG meter reading within 12 hours, your pump displays the Calibrate now alert and stops calculating SG values until a calibration BG is successfully entered. The sensor must be calibrated at a minimum of every 12 hours throughout the life of the sensor. For better sensor performance, it is recommended that you calibrate your sensor three or four times each day at regular times throughout the day, such as before meals.

You may also receive additional Calibrate now alerts to let you know that another calibration is required to improve performance.

When the Calibrate now alert appears, the system stops calculating SG values until a calibration BG is successfully entered.



**Note:** Sensor calibration is successful only if your BG entry is in the range of 40 to 400 mg/dL. Remember to calibrate three or four times throughout the day for optimal results.

### To calibrate your sensor:

1. Take a BG meter reading.
2. Press  and go to the Calibrate Sensor screen.

**Options > Utilities > Sensor Settings > Calibrate Sensor**





3. Select **BG** and enter the value.
4. Select **Calibrate**.

### Where to enter your calibration BG meter reading

There are several screens on the pump where you can enter a BG meter reading for calibration. These screens are described in the following table. These options are available only if you are using a sensor.



**Note:** After your Accu-Chek Guide Link meter wirelessly transmits your BG reading to your pump, you will be required to confirm your BG on your pump before you can use it for calibration.

<b>Pump screen</b>	<b>How to enter your calibration BG</b>
<p>BG screen</p> <p>When you manually enter a BG, the pump will prompt if you want to calibrate your sensor with the BG reading.</p> <p>Press  then select <b>Enter BG</b>.</p>	<p>Enter a BG meter reading specifically for calibration.</p>
<p>Calibrate Sensor screen</p> <p>Press , then select:</p> <p><b>Options &gt; Utilities &gt; Sensor Settings &gt; Calibrate Sensor</b></p>	<p>Enter a BG meter reading specifically for calibration.</p>
<p>BG Meter screen</p> <p>The BG Meter screen appears after your Accu-Chek Guide Link meter sends a BG meter reading to your pump, and after you confirm the BG.</p>	<p>Select the Calibrate Sensor option to calibrate your sensor with the current BG meter reading.</p>
<p>BG screen in Event Markers</p> <p>Press , then select:</p> <p><b>Options &gt; Event Markers &gt; BG</b></p>	<p>When you enter a BG meter reading in Event Markers, the Event Markers screen has an option to use the BG value for calibration.</p>
<p>BG field in the Bolus Wizard screen</p> <p>Press , then select:</p> <p><b>Bolus &gt; Bolus Wizard</b></p> <p>The Bolus Wizard feature is only available in Manual Mode.</p>	<p>When you enter a BG meter reading to deliver a bolus using the Bolus Wizard feature, the Bolus Wizard feature gives you the option to use the BG value for calibration after the bolus is delivered.</p>
<p>BG field in the Auto Mode Bolus screen</p> <p>Press , then select <b>Bolus</b>.</p> <p>Auto Mode Bolus is only available in Auto Mode.</p>	<p>When you enter a BG meter reading to deliver a bolus using the Auto Mode Bolus feature, Auto Mode gives you the option to use the BG value for calibration after the bolus is delivered.</p>

## When to calibrate

The following table describes when to calibrate your sensor.

Calibrate	Description
After warm-up is complete.	Do your first sensor calibration. Your pump displays a Calibrate now alert within two hours after starting a new sensor. Your first SG reading appears up to five minutes after you calibrate.
Within six hours after your first calibration.	Do your second sensor calibration. Six hours after you calibrate for the first time, a Calibrate now alert appears, and your pump stops calculating your SG values. It takes up to five minutes after you calibrate to receive SG values again.
Within 12 hours after your second calibration and at least every 12 hours thereafter.	After you do your second calibration, you need to calibrate at least every 12 hours. For better sensor performance, it is recommended that you calibrate your sensor three or four times each day. If you do not calibrate for more than 12 hours, a Calibrate now alert appears. It takes up to five minutes after you calibrate to receive SG values again.
When the Calibrate now alert appears.	You may also receive additional Calibrate now alerts to let you know that another calibration is required to improve performance. It takes up to five minutes after you calibrate to receive SG values again.



**Note:** When a BG is entered for calibration, dashes appear in place of the SG reading, and "Calibrating..." appears on the sensor graph.

## Guidelines for calibrating

Follow these guidelines for best sensor calibration results:

- Calibrate three or four times spread out throughout the day to improve accuracy. For details, see *When to calibrate, on page 208*.
- You can calibrate any time. However, calibrating with two or three trend arrows may temporarily decrease accuracy until the next calibration. For an example of trend arrows on the Home screen, see *Home screen with CGM in Manual Mode, on page 175*.

- Always calibrate immediately after you check your BG. Never calibrate with a BG meter reading taken more than 12 minutes earlier as that BG value would no longer be considered valid.
- Always use clean, dry fingers when you check your BG levels.
- Use only your fingertips when obtaining blood samples for calibration.



**Note:** If your BG meter readings are significantly different than your SG readings, wash your hands and calibrate again.

## Disconnecting the transmitter from the sensor

Always refer to your transmitter user guide for instructions on disconnecting the transmitter from the sensor.

## Removing the sensor

Always refer to the sensor user guide for instructions on how to remove the sensor.

## Turning off Sensor Settings

You can turn off Sensor Settings at any time. If you disconnect the transmitter from the sensor, turn off the Sensor Settings to avoid getting a sensor alert. Your sensor settings remain in your pump. You cannot make changes to the settings until you turn on the Sensor Settings again.

### To turn off Sensor Settings:

1. Press  and go to the Sensor Settings screen.  
**Options > Utilities > Sensor Settings**
2. Select **Sensor**.
3. Select **Yes** to turn off the sensor feature.

11





# 11 Using CGM

This chapter provides information on how to use CGM on your pump and view your sensor glucose (SG) data. This information helps you identify SG trends, including being notified if your SG is falling or rising rapidly. You can also view historical SG readings in a graph format. Information is also included on how to silence your glucose alerts.

## The sensor graph

The sensor graph displays your current SG reading that is wirelessly sent to your pump by the transmitter.

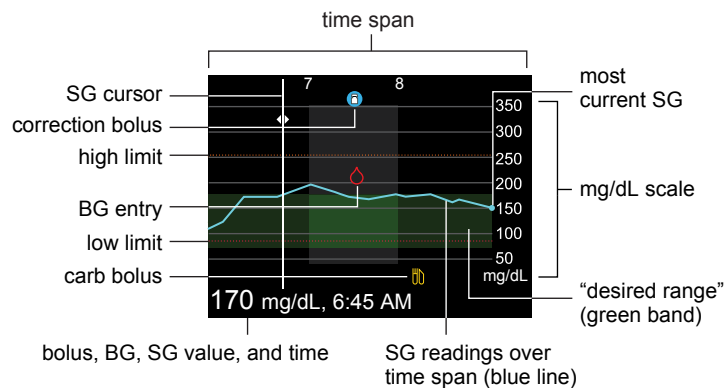

The sensor graph includes the following information:





- The most recent SG reading.
- Your historical SG readings for the last 3-hour, 6-hour, 12-hour, or 24-hour periods.

- Your high and low SG limits.
- The bolus deliveries you have given during the time period shown on the graph.
- Any suspend events that have occurred.

If an SG reading does not appear on the graph, some possible reasons for this include:

- An error condition or a sensor-related alert is occurring.
- A new sensor that you just inserted is still initializing.
- A new sensor that just initialized is still calibrating.
- An existing sensor that you have recently reconnected is not ready.
- More than six hours have passed since the initial sensor calibration.
- More than 12 hours have passed since the last sensor calibration.



### To view the sensor graph:

1. From the Home screen, press the  button.  
A full-screen view of the 3-hour graph appears.
2. Press  to navigate to the 6-hour, 12-hour, and 24-hour graphs.
3. Press  to view SG readings and event details.
4. To exit the full-screen view, press , or press the  button again.

## Identifying rapid changes in SG

When you use a sensor, trend arrows appear on the Home screen if your SG has been rising or falling faster than a certain per-minute rate. The number of arrows that appear tell you how quickly your SG is changing.

The following table shows the trend arrows and their corresponding rates.

	SG has been rising at a rate of 1 mg/dL per minute or more, but less than 2 mg/dL per minute.
	SG has been falling at a rate of 1 mg/dL per minute or more, but less than 2 mg/dL per minute.
	SG has been rising at a rate of 2 mg/dL per minute or more, but less than 3 mg/dL per minute.





SG has been falling at a rate of 2 mg/dL per minute or more, but less than 3 mg/dL per minute.





SG has been rising at a rate of 3 mg/dL per minute or more.



SG has been falling at a rate of 3 mg/dL per minute or more.

## Silencing glucose alerts

The Alert Silence option lets you make SG alerts silent for a set period of time. This is useful in situations where you do not want to disturb others, such as when you are in a business meeting or in a movie theater. When using this option, one of the following status icons appears on the Home screen, depending on your Audio Options settings: vibrate only , audio only , or vibrate and audio . Your system still records the time and glucose value for any alerts that occur. You can view this information in the Alarm History screen.



**Note:** Alert Silence does not silence the Auto Mode exit alert, the High SG alert, or the Low SG XX mg/dL (XX represents 50 mg/dL or below) alarm. These are based on set glucose thresholds and cannot be silenced.

If a glucose alert occurs when you are using the Alert Silence option, the notification light begins to flash and the Sensor alert occurred alert appears to let you know an alert was silenced, but there is no vibration or beep. If you have not cleared the alert by the end of the preset alert silence duration, your pump begins to beep or vibrate periodically until the alert is cleared.

The following table describes the glucose alerts that are silenced with each option.

Option	Silences these alerts
High Alerts Only	Alert on high, Alert before high, and Rise Alert

Option	Silences these alerts
High & Low Alerts	Alert on high, Alert before high, Rise Alert, Alert on low, Alert before low, Suspend before low, and Resume Basal Alert
<div style="background-color: #e1f5fe; padding: 10px; border: 1px solid #cfe2f3;">  <p><b>Note:</b> Alert on low cannot be silenced if the SmartGuard Suspend on low or SmartGuard Suspend before low options are turned on.</p> </div>	
All Sensor Alerts	<p>All of the alerts listed previously for High &amp; Low Alerts, plus the following:</p> <ul style="list-style-type: none"> <li>• All calibration alerts, reminders, or error messages</li> <li>• All alerts relating to sensor insertion, including alerts about sensor warm-up, changing your sensor, sensor expiration, sensor errors, connection issues, and so on</li> <li>• All alerts related to your transmitter, including all alerts about your transmitter battery and all connection issues</li> </ul>

### To silence glucose alerts:

1. Press  and go to the Alert Silence screen.

#### Audio Options > Alert Silence Options

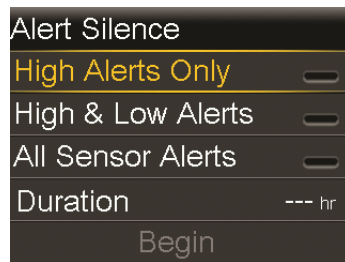

2. Select **High Alerts Only**, **High & Low Alerts**, or **All Sensor Alerts** to set the alerts you want silenced. Refer to the previous table for details about the alerts silenced with each selection.



**Note:** If you select **All Sensor Alerts**, you will not receive most alerts related to your SG readings, your sensor, calibration requirements, or your transmitter. The Low SG XX mg/dL (XX represents 50 mg/dL or

below) alarm, the Auto Mode exit alert, and the High SG alert cannot be silenced. You still receive and hear these alerts when Alert Silence is on. If a silenced glucose alert occurs, the notification light flashes and a message appears to notify you that a silenced alert occurred, but there is no vibration or beep. You can view the specific alert in Alarm History. For more information, see *Alarm History*, on page 145.

3. Set the **Duration**. The duration can be set in 30-minute increments from 30 minutes to 24 hours.
4. Select **Begin**. The Alert Silence settings immediately take effect and you are returned to the Sensor Settings screen.

**To cancel Alert Silence:**

1. Press  and go to the Alert Silence screen.

Audio Options > Alert Silence



2. Select **Cancel Alert Silence**.



# 12



# SmartGuard Auto Mode

The Auto Mode feature is part of SmartGuard technology. It automatically controls basal insulin delivery. However, the Auto Mode feature still requires your input for meals, calibrations, and times when you need the target value raised.



**Note:** A total daily dose of at least 8 units, but no more than 250 units, is required to operate in Auto Mode.

## About SmartGuard Auto Mode

SmartGuard Auto Mode is an insulin delivery feature designed to help people on intensive insulin therapy to achieve better control 24 hours a day. This is achieved by automatically controlling basal insulin delivery to regulate glucose levels to a target sensor glucose (SG) amount. The standard target SG setting is 120 mg/dL and the target can be set temporarily to 150 mg/dL for exercise and other events.

When Auto Mode is active, the SG values it receives from the transmitter are used to automatically calculate the basal insulin dose. This process of automatic delivery of insulin is called Auto Basal.

Auto Mode depends on reliable, accurate sensor measurements and your accurate entry of carbs to deliver insulin for meals. Therefore, the basic management of the therapy requires the following activities:

- Periodic blood glucose (BG) readings using a BG meter to calibrate the sensor. The minimum calibration is every 12 hours. For better sensor performance, it is recommended that you calibrate your sensor three or four times each day. You may also receive periodic requests from your pump for BG readings without the need for calibration.
- Use of the Auto Mode Bolus feature to deliver boluses to cover meals, and when your pump recommends a bolus.



**Note:** Delivering a bolus in SmartGuard Auto Mode is similar to delivering a bolus with the Bolus Wizard feature in Manual Mode.

A BG reading above 150 mg/dL causes Auto Mode to automatically calculate if a correction bolus is needed to bring BG down to the 150 mg/dL BG correction target. If needed, a correction bolus will be recommended.

## Manual Mode

In this user guide, the term Manual Mode refers to system functions other than Auto Mode. In other words, if Auto Mode is not active, the system is in Manual Mode.

## Before using SmartGuard Auto Mode

SmartGuard Auto Mode can be enabled at any time, but it does not activate until the system completes a 48-hour warm-up period while you use the pump to deliver insulin. This warm-up period begins the midnight after the pump starts delivering insulin and it does not require sensor use. During the warm-up period, your Auto Mode system collects and processes data that help enable its automatic function.





**WARNING:** Do not put your pump into Auto Mode if you have used the pump in the last 3 days to practice button pressing, or if basal insulin that was programmed into your pump was not your actual basal delivery. Doing so may result in the delivery of too little or too much insulin, which can cause hyperglycemia or hypoglycemia. Auto Mode uses the recent delivery history on your pump to determine the Auto Basal delivery amount you receive. If you have been practicing with your pump, you must clear the active insulin and the total daily doses in the pump before using Auto Mode. Use the Clear Active Insulin option in the Manage settings menu to clear both active insulin and the total daily dose.

To prepare your pump for SmartGuard Auto Mode:

1. Cancel any active Temp Basal rates. See *Canceling a temp basal or preset temp basal rate*, on page 79.
2. Ensure your delivery is not suspended. See *Stopping and resuming your insulin delivery*, on page 80.
3. Set your carb ratio. See *Changing your carb ratio*, on page 96.
4. Review your high and low limit settings. Your high and low limit settings apply to Auto Mode. See *Understanding glucose settings*, on page 178 for details.
5. Enter a BG reading if you have not entered one in the past 12 minutes. If necessary, calibrate your sensor. If you have just started a new sensor, calibrate your sensor, and then wait 30 minutes before you enter a BG for Auto Mode. For more information about calibrating your sensor, see *Calibrating your sensor*, on page 206.

## Setting up SmartGuard Auto Mode

Auto Mode can be enabled at any time but does not activate until the 48-hour warm-up period has been completed. For details about the warm-up period, see *Before using SmartGuard Auto Mode*, on page 222. Once enabled, Auto Mode begins automatically when all conditions are met and a BG is entered. For more information, see *SmartGuard Auto Mode Readiness*, on page 225.

## To set up Auto Mode:

1. Press  and go to the Auto Mode screen.  
**Options > SmartGuard > Auto Mode**
2. Select **Auto Mode** to turn the feature on or off.
3. Select **Auto Mode BG alert** to turn it on or off.



**Note:** The Auto Mode BG alert is set to On by default. When this setting is on, your pump tells you when Auto Mode requires a BG to remain active. For information about the conditions that cause Auto Mode to require a BG, see *Safe Basal*, on page 228.

4. Select **Save**.

## Conditions to activate SmartGuard Auto Mode

If you have been using Auto Mode and you turn off your pump for less than two weeks, there will only be a five-hour warm-up period once the pump is restarted. The other conditions must still be met before Auto Mode will activate.

If you have turned off your pump for more than two weeks, a new 48-hour warm-up period will be required.

If Auto Mode is enabled but not active, the Auto Mode Readiness screen indicates the reason why Auto Mode has not yet activated. See *SmartGuard Auto Mode Readiness*, on page 225.

It takes five hours for the Auto Mode Active Insulin to be updated. This update time happens under the following conditions:

- When your pump is turned on the first time
- May occur following a complete pump reset caused by a loss of power or a software error
- Following a Suspend lasting four hours or longer



Once the Active Insulin is updated, it will be valid unless one of the conditions above happens, which will restart the update period. Auto Mode will then be locked out for another five hours.

## SmartGuard suspend features and SmartGuard Auto Mode





When SmartGuard Auto Mode is active, the SmartGuard suspend features are unavailable and automatically turned off. If Suspend before low or Suspend on low are on, they are automatically turned off when Auto Mode becomes active. If your pump exits Auto Mode, the SmartGuard suspend features are not active until you turn them on after you exit Auto Mode. If you want to use the SmartGuard suspend features, you must manually turn them on after you exit Auto Mode. See *Low SG settings, on page 180*.



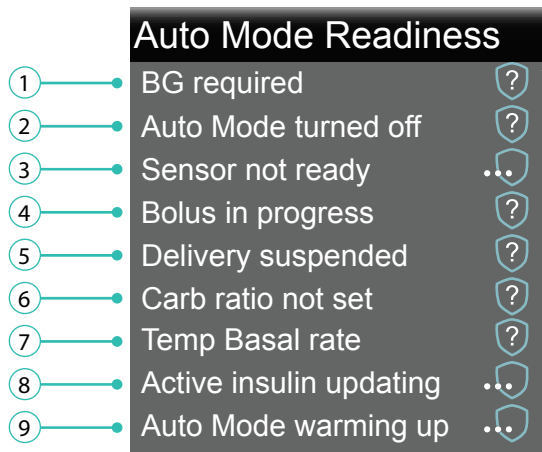



## SmartGuard Auto Mode Readiness

The Auto Mode Readiness screen indicates whether your pump is ready to enter Auto Mode, or return to Auto Basal from Safe Basal.

The following table shows what to do when the wait icon  or the question icon  appear by items on the Auto Mode Readiness status screen.



Line	Item	Instructions
1	Calibration required 	Perform a fingerstick and calibrate your sensor.
	BG required 	Perform a fingerstick and enter a new BG.
	Wait to enter BG... 	Wait until the pump prompts you to enter a BG.
	Processing BG... 	Wait until the BG has processed.

Line	Item	Instructions
2	Auto Mode turned off 	Turn on Auto Mode in the SmartGuard, Auto Mode screen.
3	Sensor not ready 	<p>Do the following:</p> <ul style="list-style-type: none"> <li>• Check to see if your pump has a transmitter ID entered in Utilities, Device Options. For example, GT6133333M.</li> </ul> <p>Make sure your pump is paired with a transmitter. For more information, see <i>Pairing your pump and transmitter, on page 201</i>.</p> <ul style="list-style-type: none"> <li>• Check your Home screen. If you see , move your pump and transmitter closer together. The pump will try to find the transmitter signal.</li> </ul> <p>If after 30 minutes the pump and transmitter are still not communicating, you will receive a Lost sensor signal alert. Check that the sensor is still inserted in the skin, and the transmitter and sensor are still connected. Move your pump closer to your transmitter.</p> <ul style="list-style-type: none"> <li>• If your SG is outside of the 40 to 400 mg/dL range, your pump will not enter Auto Mode.</li> </ul>
	Sensor off 	Turn on the sensor in the Utilities, Sensor Settings screen.
4	Bolus in progress 	Wait until the bolus is complete or stop the bolus yourself before Auto Mode can activate.
5	Delivery suspended 	If insulin delivery is suspended, Auto Mode cannot activate. Treat low BG if necessary as instructed by your healthcare professional.

Line	Item	Instructions
6	Carb ratio not set	When you turn on the Bolus Wizard feature for the first time, enter your Carb Ratio in the Edit Carb Ratio screen. You can also enter your Carb Ratio in the Bolus Estimate Setup screen, even if the Bolus Wizard feature is not turned on.
7	Temp Basal rate	If a temp basal rate is currently active, you must wait until it has completed or cancel the temp basal rate yourself before Auto Mode can activate.
8	Active insulin updating	If active insulin is currently updating, it may take up to five hours to complete. You must wait until this amount is updated before Auto Mode can activate.
9	Auto Mode warming up	Auto Mode gathers information on your insulin delivery history in order to personalize its automatic delivery of insulin. This may require up to 48 hours to complete.

### To check Auto Mode Readiness:

1. Press  and select **Status** to go to the Status screen.
2. Select **Auto Mode Readiness**.

## Home screen with SmartGuard Auto Mode

When your pump transitions into Auto Mode, the Home screen on your pump changes to display a shield that contains a real-time display of your current SG level. The Home screen also displays your current Active Insulin value.

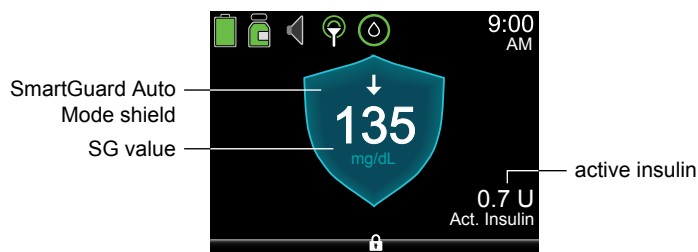

## Using SmartGuard Auto Mode

The following sections provide information on how to use SmartGuard Auto Mode and how to view your SG data. This information helps you identify SG trends, including indications that your SG is falling or rising rapidly. You can also view historical SG readings in a graph format.

### Safe Basal

Safe Basal is an automatic function within SmartGuard Auto Mode and cannot be modified. The Safe Basal rate is determined by the Auto Mode feature based on your insulin delivery history. It lets you have time to perform additional actions required to ensure Auto Mode remains active. Safe Basal delivers insulin at a constant rate to cover your basal needs. Safe Basal does not adjust insulin delivery based on your current SG values.

When the pump is in Safe Basal, the Auto Mode shield appears with a white outline.

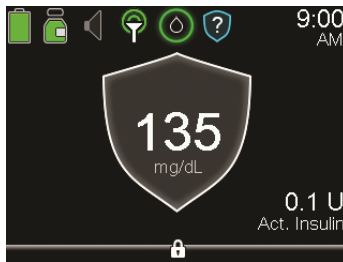

Several conditions can cause a transition into Safe Basal. The following table describes these conditions and the actions you must take to resume Auto Basal delivery. An optional setting called the Auto Mode BG alert can be set to have the pump alert you when a BG entry is required. This setting is turned on by default. For more information about the Auto Mode BG alert, see *Setting up SmartGuard Auto Mode*, on page 223.

Condition	Instructions
Auto Mode has been at the minimum delivery limit for 2 1/2 hours.	Enter a BG. An Auto Mode min delivery alert occurs if the Auto Mode BG alert is enabled.

Condition	Instructions
Auto Mode has been at the maximum delivery limit for four hours.	Enter a BG. An Auto Mode max delivery alert occurs if the Auto Mode BG alert is enabled.
Your sensor might be reading lower values than your actual glucose values.	Enter a BG. A BG required alert occurs if the Auto Mode BG alert is enabled.
An entered BG is 35% or more different than your current SG value.	Enter a BG. A BG required or Cal required for Auto Mode alert occurs if the Auto Mode BG alert is enabled.
No SG data has been received for more than five minutes.	<ul style="list-style-type: none"> <li>• If SG data is not available due to a signal interference, three dashes appear on the screen in place of the SG data. If the interference is intermittent, the Auto Mode shield appears with a white outline, and no action is required.</li> <li>• If your pump has not received SG data for 30 minutes or more, a Lost sensor signal alert occurs. For more information, see <i>CGM (sensor) alarms, alerts, and messages, on page 264.</i></li> <li>• If the SG data is not available because you need to calibrate the sensor again, calibration has expired, or when the system detects another calibration is required to improve sensor performance, you receive a Calibrate now alert. Calibrate your sensor. See <i>CGM (sensor) alarms, alerts, and messages, on page 264.</i></li> </ul> <p>The Auto Mode BG alert does not apply to this condition.</p>

After 90 minutes in Safe Basal, if the condition that caused the pump to transition into Safe Basal is not resolved, the pump enters Manual Mode.



**Note:** When you change your sensor, your pump switches to Safe Basal for up to 90 minutes. The pump tells you to calibrate and enter a BG for Auto Mode.

## Example: Safe Basal

Alex's pump is in Auto Mode. Before lunch, he checks his BG, and enters the value into his pump. Alex notices the BG he entered was much higher than his current SG reading. Alex receives a BG required alert for Auto Mode. His pump displays a gray shield, indicating that Auto Mode is now in Safe Basal delivery. He washes his hands, repeats his fingerstick, and enters the new BG into the pump.

Alex checks his user guide and realizes that his pump entered Safe Basal because the difference between his SG and BG entry was greater than 35%.

## Block Mode when in SmartGuard Auto Mode

Block Mode lets a caregiver block the patient from changing settings or delivering a bolus directly on the pump. In Block Mode, the following actions can be done while the pump is in Auto Mode:

- Auto Basal delivery
- BG correction bolus if BG was sent from your Accu-Chek Guide Link meter
- Calibration if BG was sent from your Accu-Chek Guide Link meter

The following actions cannot be done in Block Mode:

- Bolus delivery or entry unless prompted by the Bolus Recommended screen
- Changes to Auto Mode settings
- Manual BG entry

## Setting Temp Target

You can set a temporary SG target (Temp Target) of 150 mg/dL for situations in which you would like your target to be temporarily higher, such as exercise. Check with your healthcare professional regarding use of a Temp Target.

### To set a Temp Target:

1. Press  and select **Temp Target** to go to the Temp Target screen.



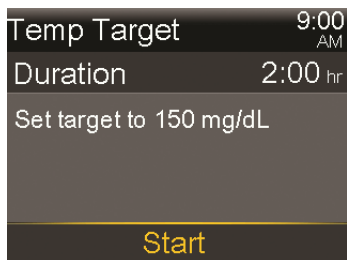

2. Set the duration. The default is two hours and the maximum duration is 12 hours. Use  $\wedge$  and  $\vee$  to set the duration in 30-minute increments.
3. Select **Start**.

The screen shows Temp Target Started, and then changes to the Home screen, where a banner shows the remaining Temp Target time.

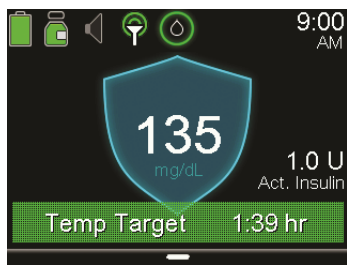

When the Temp Target time runs out, the banner disappears from the Home screen.

### To cancel Temp Target:

1. Press  $\odot$  and select **Cancel Temp Target** to go to the Temp Target screen.

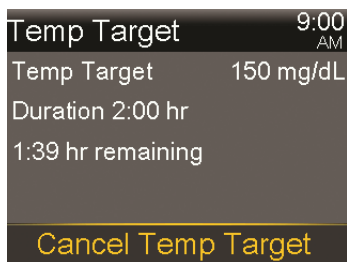

2. Select **Cancel Temp Target**.

The Temp Target will be canceled and the Home screen will appear, with no Temp Target banner.

## SmartGuard Auto Mode sensor graph

Your Auto Mode sensor graph displays your current SG reading that is wirelessly sent to your pump by your transmitter.

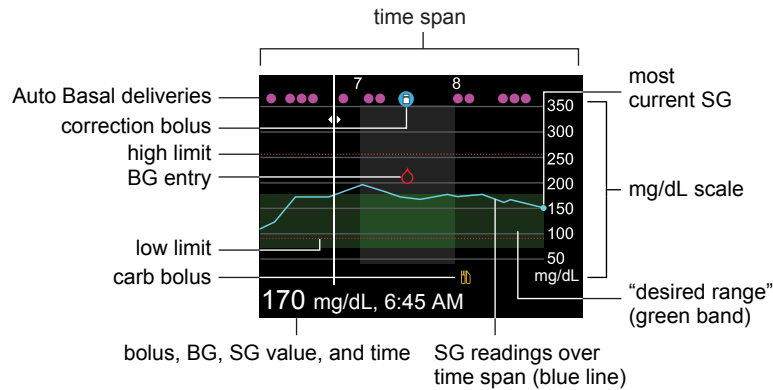

The Auto Mode sensor graph includes the following information:





- The bolus, BG, SG value, and time are displayed at the bottom of the screen. When you select a location on the graph, the specific details of the SG or event appear. Each Auto Basal delivery is displayed as a separate event rather than a delivery in units per hour. In addition, it is labeled as "Basal." For example, "Basal, 0.225 U" means 0.225 U was fully delivered at that time.
- Historical SG readings are displayed for the last 3-hour, 6-hour, 12-hour, or 24-hour periods. They appear as a blue line across the screen.
- Correction boluses are shown as white vials inside blue circles.
- Meal (carb) boluses are shown as yellow knife and fork symbols. These represent any bolus amounts that include a carb entry.
- BG entries appear as red drop symbols.
- The numerous small magenta dots along the top represent the automatically delivered basal insulin (Auto Basal or Safe Basal) delivered by SmartGuard Auto Mode.
- A time change event appears as a white clock symbol.

If an SG reading does not appear on the graph, some possible reasons for this include:

- An error condition or a sensor-related alert is occurring.

- A new sensor that you just inserted is still initializing.
- A new sensor that just initialized is still calibrating.
- An existing sensor that you have recently reconnected is not ready.
- More than six hours have passed since the initial sensor calibration.
- More than 12 hours have passed since the last sensor calibration.

### To view the sensor graph:

1. From the Home screen, press the  button to display the SG graph.  
A full-screen view of the 3-hour graph appears.
2. Press  to navigate to the 6-hour, 12-hour, and 24-hour graphs.
3. Press  to view SG readings and event details.
4. To exit the full-screen view, press  or press the  button again.

## Enter BG

The BG screen lets you manually enter a BG value. When you access the BG screen, it does not show any previously entered manual or linked meter BG values. If a BG value is received from a linked meter, that value will immediately display in a separate BG Meter screen and you will be prompted to confirm the BG value.

When you enter a BG while in Auto Mode, a correction bolus may be suggested.

### To manually enter BG readings:

1. Press  and select **Enter BG** to go to the BG screen.
2. Select **Enter BG**.
3. Enter a BG value.
4. Select **Save**.
5. A screen appears prompting you to calibrate your sensor with the BG value if you want. Select **Yes** or **No**.

## SmartGuard Auto Mode Bolus

Delivering a bolus in SmartGuard Auto Mode is similar to delivering a bolus using the Bolus Wizard feature in Manual Mode. The Bolus feature in Auto Mode requires you to enter either carbs or a BG value. You may also choose to enter both. Auto Mode then calculates the bolus amount needed to cover the meal or correction. Once you confirm this amount, Auto Mode will deliver the bolus.

The Auto Mode Bolus screen shows your current Active Insulin value.



**WARNING:** Do not use Auto Mode for a period of time after giving a manual injection of insulin by syringe or pen. Manual injections are not accounted for in Auto Mode. Therefore, Auto Mode could deliver too much insulin. Too much insulin may cause hypoglycemia. Consult with your healthcare professional for how long you need to wait after a manual injection of insulin before you resume Auto Mode.



**Note:** Auto Mode Bolus only supports Normal boluses. Square Wave, Dual Wave, Easy, Manual, and Preset bolus types cannot be delivered while in Auto Mode.

When a BG reading is over 150 mg/dL in Auto Mode, the pump may recommend a correction bolus. SmartGuard Auto Mode calculates the recommended correction bolus. SmartGuard Auto Mode takes several factors into account that include your BG reading and active insulin.

After you confirm your BG reading from an Accu-Chek Guide Link meter on the pump, Bolus recommended appears below the BG value if the pump calculates that a correction bolus is needed. Select **Bolus** to deliver the recommended bolus. If you manually enter your BG, a Bolus recommended screen appears. Select **Bolus** to deliver the recommended bolus.

If the BG is under 150 mg/dL or if the bolus is zero after the pump accounts for active insulin, no correction is recommended.

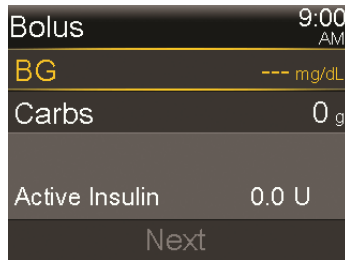

If you use an Accu-Chek Guide Link meter, you can send your BG meter readings directly to your pump. A confirmation screen appears for you to confirm the BG value on the pump. Confirmed BG values are automatically used in the BG field of the Auto Mode Bolus screen. The confirmed BG values are valid for up to 12 minutes after sending them to the pump. Confirm the BG meter reading from an Accu-Chek Guide Link meter before you use the Auto Mode Bolus feature. If you do not use an Accu-Chek Guide Link meter, you must manually enter your BG value.



**Note:** Do not use a BG meter reading in the Auto Mode Bolus screen if more than 12 minutes have passed since you have taken the BG meter reading. That BG meter reading and the corresponding bolus amount may no longer be accurate.

### To use the Auto Mode Bolus feature:

1. Press  and select Bolus to go to the Bolus screen in Auto Mode.
2. If you use an Accu-Chek Guide Link meter, go to step 3. Otherwise, enter your BG value. You can enter a value within the range of 20 to 600 mg/dL.
3. Enter your Carb amount in grams. If you choose not to enter a Carb amount, go to step 4.
4. Select **Next**.

The screen indicates the amount of the calculated bolus.

5. Select **Deliver Bolus**.

A screen appears briefly to indicate the bolus delivery has started. Then, the Home screen appears and shows the progress of the bolus delivery.

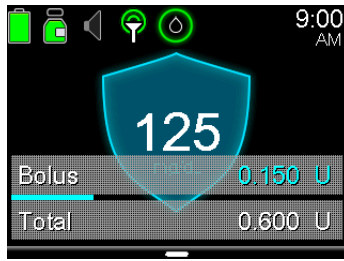

**Note:** You can stop a bolus at any point by pressing  and selecting **Stop Bolus**.

6. If a new BG value is used in the Auto Mode Bolus feature, the following screen also appears to ask you to calibrate your sensor. Select **Yes** or **No**.

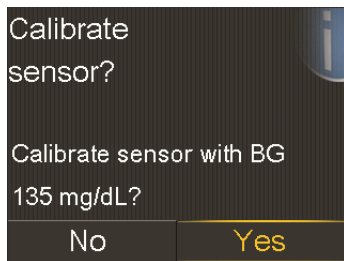

## Alert Silence

The Alert Silence option  lets you temporarily silence SG alerts. This is useful in situations where you do not want to disturb others, such as when you are in a business meeting or in a movie theater. When using this option, your system still records the time and glucose value for any alerts that occur. You can view this information in the Alarm History screen. See *Alarm History*, on page 145 for details.

If a glucose alert occurs when you are using the Alert Silence option, the notification light begins to flash and the Sensor alert occurred alert appears to let you know an alert was silenced, but there is no vibration or sound. If you have not cleared the alert by the end of the preset alert silence duration, your pump begins to beep or vibrate periodically until the alert is cleared.



**Note:** The following alarms and alerts are never silenced:

- Low SG XX mg/dL (XX represents 50 mg/dL or below) alarm

- Auto Mode exit alert
- High SG alert

For more information about the Auto Mode exit alert or the High SG alert, see *SmartGuard Auto Mode alerts and messages, on page 275*. For more information about the Low SG XX mg/dL (XX represents 50 mg/dL or below) alarm, see *CGM (sensor) alarms, alerts, and messages, on page 264*.

You can check the status of the Alert Silence option in the Sensor screen. For more information, see *Status screens, on page 52*.

The following table describes the glucose alerts that are silenced with each option.

Option	Silences these alerts
High Alerts Only	Alert on high, Alert before high, and Rise Alert
High and Low Alerts	Alert on high, Alert before high, Rise Alert, Alert on low, and Alert before low
	 <p><b>Note:</b> Alert on low cannot be silenced if the SmartGuard Suspend on low or SmartGuard Suspend before low options are turned on.</p>
All Sensor Alerts	<p>All of the alerts listed previously for High and Low Alerts, plus the following:</p> <ul style="list-style-type: none"> <li>• All calibration alerts, reminders, or error messages</li> <li>• All alerts relating to sensor insertion, including alerts about sensor warm-up, changing your sensor, sensor expiration, sensor errors, connection issues, and so on</li> <li>• All alerts related to your transmitter, including all alerts about your transmitter battery and all connection issues</li> </ul>

### To set Alert Silence in Auto Mode:

1. Press  and go to the Alert Silence screen.

Audio Options > Alert Silence Options

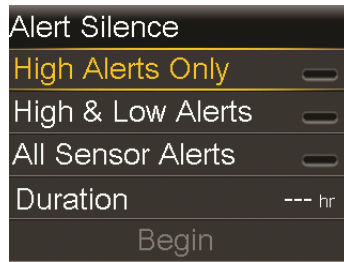

2. Select High Alerts Only, High and Low Alerts, or All Sensor Alerts to set the alerts you want silenced. Refer to the previous table for details about the alerts silenced with each selection.



**Note:** If you select **All Sensor Alerts**, you will not receive most alerts related to your SG readings, your sensor, calibration requirements, or your transmitter. The Low SG XX mg/dL (XX represents 50 mg/dL or below) alarm, the Auto Mode exit alert, and the High SG alert cannot be silenced. You still receive and hear these alerts when Alert Silence is on. If a silenced glucose alert occurs, the notification light flashes and a message appears to notify you that a silenced alert occurred, but there is no vibration or beep. You can view the specific alert in Alarm History. For more information, see *Alarm History*, on page 145.

3. Set the **Duration**. The duration can be set in 30-minute increments from 30 minutes to 24 hours.
4. Select **Begin**. The Alert Silence settings immediately take effect and you are returned to the Sensor Settings screen.

#### To cancel Alert Silence:

1. Press  and go to the Alert Silence screen.

Audio Options > Alert Silence



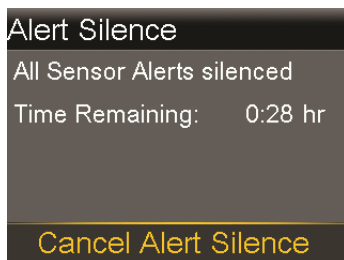

2. Select **Cancel Alert Silence**.

## Exiting SmartGuard Auto Mode

The pump will exit SmartGuard Auto Mode:

- Auto Mode has been in Safe Basal for 90 minutes. See *Safe Basal*, on page 228.
- A High SG alert has occurred.
- You have not cleared any suspend event messages within four hours.
- You manually turned off the Sensor feature or disconnected the transmitter.

Some alarms cause the pump to exit SmartGuard Auto Mode and also turn the Auto Mode feature off. Auto Mode is turned off if an alarm initiates a pump reset. If this occurs, you will no longer see the SmartGuard Auto Mode shield on your Home screen. You must turn the Auto Mode feature on again and go through a five-hour warm-up period.

You can turn off Auto Mode at any time. For more information, see *Setting up SmartGuard Auto Mode*, on page 223.

## Returning to SmartGuard Auto Mode

If you have automatically transitioned to Manual Mode, you can return to Auto Mode if all readiness conditions are satisfied and you enter a BG. For more information, see *SmartGuard Auto Mode Readiness*, on page 225.



**Note:** If you have turned Auto Mode off, you cannot return to Auto Mode until you turn Auto Mode on again.

You can return to Auto Mode if the following conditions are satisfied:

- Auto Mode is enabled on your pump.

- Your sensor is providing good SG values.
- A bolus is not in progress.
- A temp basal rate is not in progress.
- 48-hour warm-up is complete.
- Auto Mode is not in a five-hour warm-up period.
- You have entered a new BG reading.

If any of these conditions are not met, Auto Mode cannot restart.

# 13



# 13

## Alarms, alerts, and messages

This chapter describes the general behavior of the most common and the most serious notifications and how to resolve them. For information about how to set your notification preferences in the app, see the MiniMed Mobile app user guide.

### About alarms, alerts, and messages

Your pump has a sophisticated safety network. If this safety network detects anything unusual, it conveys this information in the form of notifications. Notifications include alarms, alerts, and messages.

When you receive more than one notification and there are multiple messages to view, a small white flap appears on the notification icon in the upper-right corner of the screen . When you clear the first notification, the next notification becomes visible.



**Note:** It is important that you promptly respond to all notifications and confirmations that appear on your pump. In the event that you do not respond, your pump may remain on that screen until addressed.

When you respond to a message, there may be times when another message appears. Always be sure to address all notifications you have received.

A white triangle in the lower-right corner means you must press  to continue.



**WARNING:** If you receive a Critical pump error alarm on your pump, the following screen displays and the pump sirens.



**Immediately disconnect from your insulin pump and discontinue use. Contact 24-Hour Technical Support for assistance.**

**Remember, your body still needs insulin while your pump is removed. It is important that you consult your healthcare professional to determine an alternate method of receiving insulin while your pump is removed. For more information on the Critical pump error alarm, see *Pump alarms, alerts, and messages*, on page 246.**

## Alarms

An alarm warns you of a condition that needs your immediate attention. Stopped insulin delivery and low glucose levels are the most common reasons for alarms.



**WARNING:** Always address alarms immediately when they occur. Ignoring an alarm can result in hyperglycemia or hypoglycemia.

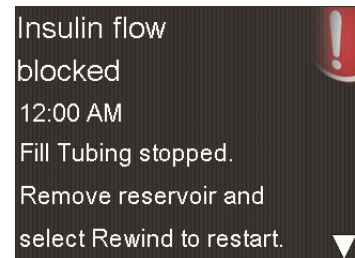

When an alarm occurs:

**Display:** The pump displays a notification with a red icon and instructions.

**Notification light:** The red notification light blinks twice, followed by a pause, in a continuous repeating pattern.

**Audio:** Depending on your Audio Options settings, the pump emits an alarm tone, a continuous three-pulse-and-pause vibration pattern, or both the alarm tone and vibration.

You must resolve the underlying problem that triggered the alarm. In most cases, you clear an alarm by pressing  $\surd$  and then you make a selection. In some cases, however, clearing the alarm does not fix the underlying problem. The alarm repeats until the underlying problem is fixed.

If you do not respond to an alarm, after ten minutes the alarm tone escalates to a loud emergency siren.

## Alerts

An alert makes you aware of a situation that may require your attention. When an alert occurs, always check your pump screen to see if any action is required.

When an alert occurs:

**Display:** The pump displays a notification with a yellow icon and instructions.

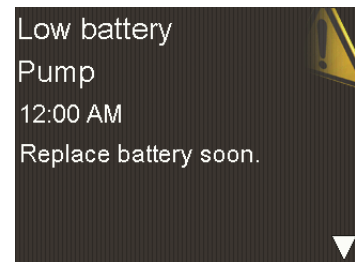

**Notification light:** The red notification light on your pump blinks once, followed by a pause, then blinks once again in a continuous repeating pattern.

**Audio:** Depending on your Audio Options settings, the pump either beeps or vibrates in a continuous three-pulse-and-pause pattern, or does both.

To clear an alert, press  $\surd$  and then make a selection. If you do not respond to an alert, the pump beeps every five minutes or every fifteen minutes, depending on the alert. Some alerts will also escalate to a loud emergency siren after ten minutes.



**Note:** If an alert occurs when you are in a screen other than the Home screen, the alert message may appear after you return to the Home screen.

## Messages

A message informs you about the status of your pump or if you need to make a decision.

When a message occurs:

**Display:** The pump displays a notification with a blue icon and instructions.

**Notification light:** Does not illuminate or blink.

**Audio:** Depending on the message, the pump emits a message tone, an alert tone, or no tone. Depending on your Audio Options settings, you may hear a tone, feel a one-pulse-only vibration, or hear a tone and feel a vibration.

You clear the message by pressing  $\vee$  and making a selection.

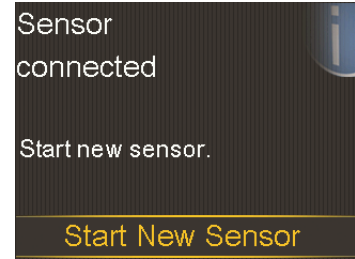

## Pump alarms, alerts, and messages

The following table lists the most common or serious alarms, alerts, and messages related to your pump. The table also explains the meaning, consequences, and the reasons why these notifications appear, and provides steps for problem resolution.



Title and text	Type	Explanation	Next steps
<p><b>Active Insulin cleared</b></p> <p>Any Active Insulin amount has been cleared.</p>	Alert	<p>Your active insulin amount is now at 0 units. This may occur because certain alarms automatically clear active insulin.</p>	<ul style="list-style-type: none"> <li>• Select <b>OK</b> to clear the alarm.</li> <li>• The active insulin tracked prior to pump restart is not included in new Bolus Wizard calculations. Consult your healthcare professional for how long you need to wait after active insulin is cleared before you can rely on the active insulin calculation of the Bolus Wizard feature.</li> <li>• You can check Daily History for the time and amount of your last bolus.</li> </ul>
<p><b>Auto Suspend</b></p> <p>Insulin delivery suspended. No buttons pressed within time set in Auto Suspend.</p>	Alarm	<p>Insulin delivery is currently suspended by Auto Suspend. Auto Suspend is a feature you enabled to automatically suspend insulin delivery and trigger an alarm after no buttons are pressed for a specified period of time. Insulin delivery is suspended until you clear the alarm and resume basal insulin delivery.</p>	<ul style="list-style-type: none"> <li>• To clear the alarm and resume basal insulin delivery, select <b>Resume Basal</b>.</li> <li>• Check your blood glucose (BG) and treat as necessary.</li> </ul>

Title and text	Type	Explanation	Next steps
<p><b>Battery failed</b></p> <p>Insert a new AA battery.</p>	Alarm	The pump battery does not have enough power.	<ul style="list-style-type: none"> <li>• Select <b>OK</b> to clear the alarm.</li> <li>• Remove the old battery and insert a new AA battery.</li> </ul>
<p><b>Battery not compatible.</b></p> <p>See User Guide.</p>	Alarm	The battery that you inserted into the pump is not compatible.	<ul style="list-style-type: none"> <li>• To clear the alarm, remove the incompatible battery.</li> <li>• Insert a new AA battery.</li> </ul>
<p><b>Bolus not delivered</b></p> <p>Bolus entry timed out before delivery. If bolus intended, enter values again.</p>	Alert	Bolus values entered, but bolus was not delivered within 30 seconds.	<ul style="list-style-type: none"> <li>• Select <b>OK</b> to clear the alert.</li> <li>• If bolus delivery was intended, check your BG, re-enter bolus values and deliver bolus.</li> </ul>
<p><b>Bolus stopped</b></p> <p>Cannot resume bolus or cannula fill. XX.XXX of YY.YYY U delivered. ZZ.ZZZ U not delivered. If needed, enter values again.</p>	Alarm	The battery power was exhausted while a bolus or Fill Cannula was in progress, or you did not respond to the Resume bolus? message after replacing the battery.	<ul style="list-style-type: none"> <li>• Note the amount of insulin not delivered.</li> <li>• Replace the AA battery.</li> <li>• Select <b>OK</b> to clear the alarm.</li> <li>• Deliver the remaining bolus amount if needed.</li> </ul>

Title and text	Type	Explanation	Next steps
<p><b>Check settings</b></p> <p>Startup Wizard settings complete. Check and set up your other settings.</p>	Alert	Some settings have been cleared or reverted to factory default values.	<ul style="list-style-type: none"> <li>• Select <b>OK</b> to clear the alert.</li> <li>• Review any settings that you have not already set in Startup Wizard and re-enter the values, if necessary.</li> </ul>
<p><b>Critical pump error</b></p> <p>Delivery stopped. Pump not working properly. Stop using pump. Remove infusion set from body. Consider other insulin treatment. See User Guide.</p>	Alarm	Your pump has encountered an error that cannot be resolved. For example, your pump may have a mechanical problem.	<p>The pump is not able to deliver insulin. Remove your infusion set and stop using your pump.</p> <ul style="list-style-type: none"> <li>• Consider another form of insulin delivery.</li> <li>• Check your BG, and treat as necessary.</li> <li>• Write down the error code that appears on the alarm screen.</li> <li>• Call 24-Hour Technical Support for assistance with your pump.</li> </ul>
<p><b>Delivery limit exceeded</b></p> <p>Delivery stopped. Check BG. See User Guide for more information.</p>	Alarm	Your pump has suspended because the hourly delivery limit was met. This limit is based on the maximum bolus and maximum basal setting. If this alarm occurs during a bolus, the bolus is canceled before it can complete.	<ul style="list-style-type: none"> <li>• Check your BG.</li> <li>• Select <b>Resume Basal</b>.</li> <li>• Check Bolus History and re-evaluate your need for insulin.</li> <li>• Continue to monitor your BG.</li> </ul>

Title and text	Type	Explanation	Next steps
<p><b>Device Limit</b></p> <p>You must delete an existing device (device type) before you can pair a new one (device type).</p>	Message	<p>The pump is already paired with the maximum number of devices for this type.</p> <p>The following list describes the maximum number of each device type to pair with the pump:</p> <ul style="list-style-type: none"> <li>• Meter—four Accu-Chek Guide Link meters</li> <li>• CGM—one Guardian Link (3) transmitter</li> <li>• Mobile Device—one compatible mobile device</li> </ul>	<ul style="list-style-type: none"> <li>• Select <b>OK</b> to clear the message.</li> <li>• Go to the Manage Devices screen and select the device you want to delete from the list of devices.</li> </ul> <p>Select <b>Delete</b>, and then select <b>Yes</b> to confirm or <b>No</b> to cancel.</p> <p>Pair the pump and the desired device.</p>
<p><b>Device not compatible</b></p> <p>Device cannot be used with this pump.</p>	Alert	The pump cannot pair with the selected device.	<ul style="list-style-type: none"> <li>• Select <b>OK</b> to clear the alert.</li> <li>• Call 24-Hour Technical Support for assistance.</li> </ul>

Title and text	Type	Explanation	Next steps
<p><b>Device not found</b></p> <p>Make sure device is in range and in pairing mode.</p>	Alert	The pump did not pair with the device.	<ul style="list-style-type: none"> <li>• Select <b>OK</b> to clear the alert.</li> <li>• Make sure the device is not already paired with a pump.</li> <li>• Make sure the device is ready to pair with the pump.</li> <li>• Make sure you are away from any electronic devices that might cause interference, such as cellular phones that are not paired with the MiniMed 770G System and other wireless devices.</li> <li>• Move the device closer to the pump.</li> <li>• Try to pair the pump with the device again.</li> </ul>
<p><b>Fill Cannula?</b></p> <p>Select Fill to fill cannula or select Done if not needed.</p>	Alarm	You had the Fill Cannula screen displayed for 15 minutes.	<ul style="list-style-type: none"> <li>• To proceed and fill the cannula, select <b>Fill</b>.</li> <li>• If you do not need to fill the cannula, select <b>Done</b> to skip this process.</li> </ul>

Title and text	Type	Explanation	Next steps
<p><b>High BG XXX mg/dL</b></p> <p>Check infusion set. Check ketones. Consider insulin injection. Monitor BG. Confirm BG?</p>	Alert	<p>Your BG meter reading is above 250 mg/dL.</p> <p>This alert applies when the Auto Mode feature is off. For High BG XXX mg/dL when the Auto Mode feature is on, see <i>SmartGuard Auto Mode alerts and messages, on page 275.</i></p>	<ul style="list-style-type: none"> <li>• Select <b>No</b> to prevent the remote BG from being used by your pump. Select <b>Yes</b> to confirm the BG reading.</li> <li>• Check your BG and treat as necessary.</li> </ul>
<p><b>Insert battery</b></p> <p>Delivery stopped. Insert a new battery now.</p>	Alarm	<p>The battery was removed from the pump.</p> <p>If a bolus was in progress when the battery was removed, a Resume bolus? message appears and a tone sounds when a new battery is inserted. The message indicates how much bolus was delivered.</p>	<ul style="list-style-type: none"> <li>• Insert a new AA battery.</li> <li>• The alarm clears when you insert a new battery.</li> <li>• The pump powers off after 10 minutes unless you insert a new battery.</li> </ul>

Title and text	Type	Explanation	Next steps
<p><b>Insulin flow blocked</b></p> <p>Check BG. Consider testing ketones. Check reservoir and infusion set.</p>	Alarm	Your pump has detected that the basal or bolus insulin flow was blocked.	<ul style="list-style-type: none"> <li>• Check your BG. Consider checking ketones and take an injection if needed.</li> <li>• Remove your infusion set and reservoir.</li> <li>• Select <b>Rewind</b> to start the new reservoir process using a new infusion set and reservoir.</li> </ul> <p>If a bolus delivery was in progress when the alarm occurred:</p> <ul style="list-style-type: none"> <li>• Check the Daily History screen for the amount of bolus already delivered before the pump alarmed.</li> <li>• Consider delivering remaining bolus, if the bolus insulin was not included in an insulin injection.</li> </ul>

 **WARNING: Do not use Auto Mode for a period of time after giving a manual injection of insulin by syringe or pen. Manual injections are not accounted for in Auto Mode. Therefore, Auto Mode could deliver too much insulin. Too much insulin may cause hypoglycemia. Consult with your healthcare professional for how long you need to wait after a manual injection of insulin before you resume Auto Mode.**

Title and text	Type	Explanation	Next steps
<p><b>Insulin flow blocked</b></p> <p>Check BG. Consider testing ketones. Estimated 0 U insulin in reservoir. Change reservoir and infusion set.</p>	Alarm	<p>Your pump has detected that the insulin flow was blocked and there is no insulin in the reservoir.</p>	<ul style="list-style-type: none"> <li>• Check your BG. Consider checking ketones and take an injection if needed.</li> <li>• Remove your infusion set and reservoir.</li> <li>• Select <b>Rewind</b> to start the new reservoir process using a new infusion set and reservoir.</li> </ul> <p>If a bolus delivery was in progress when the alarm occurred:</p> <ul style="list-style-type: none"> <li>• Check the Daily History screen for the amount of bolus already delivered before the pump alarmed.</li> <li>• Consider delivering remaining bolus, if the bolus insulin was not included in an insulin injection.</li> </ul>



Title and text	Type	Explanation	Next steps
<p><b>Insulin flow blocked</b></p> <p>Fill Cannula stopped.</p> <p>Remove infusion set from body.</p> <p>Change reservoir and infusion set.</p>	Alarm	<p>Your pump has detected the insulin flow was blocked while filling the cannula.</p>	<ul style="list-style-type: none"> <li>• Check your BG. Consider checking ketones and take an injection if needed.</li> <li>• Remove your infusion set and reservoir.</li> <li>• Select <b>Rewind</b> to start the new reservoir process using a new infusion set and reservoir.</li> </ul>
<p><b>Insulin flow blocked</b></p> <p>Fill Tubing stopped.</p> <p>Remove reservoir and select Rewind to restart.</p>	Alarm	<p>Your pump has detected the insulin flow was blocked while filling the tubing. Possible connection issue between the tubing and reservoir.</p>	<ul style="list-style-type: none"> <li>• Remove the reservoir and select <b>Rewind</b> to restart the fill tubing process.</li> <li>• Disconnect tubing from reservoir.</li> <li>• Be sure tubing is not crimped or bent.</li> <li>• Continue following the steps displayed on the pump using the same infusion set and reservoir.</li> <li>• If this alarm occurs again, use a new infusion set.</li> </ul>
<p><b>Loading incomplete</b></p> <p>Remove reservoir and select Rewind to restart loading.</p>	Alarm	<p>You pressed  after loading began.</p>	<ul style="list-style-type: none"> <li>• Remove the reservoir to start again.</li> <li>• Select <b>Rewind</b> and follow the on-screen instructions.</li> </ul>

Title and text	Type	Explanation	Next steps
<p><b>Low battery Pump</b></p> <p>Replace battery soon.</p>	Alert	<p>The battery in the pump is low on power. Remaining battery life is 10 hours or less.</p>	<ul style="list-style-type: none"> <li>• Select <b>OK</b> to clear the alert.</li> <li>• Replace the AA battery as soon as possible. Otherwise, insulin delivery stops, and the Replace Battery Now alarm occurs.</li> <li>• If the pump is delivering a bolus or filling the cannula, wait until delivery is complete to replace battery.</li> </ul>
<p><b>Low BG XX mg/dL</b></p> <p>Treat Low BG. Do not bolus until BG is normal. Monitor BG. Confirm BG?</p>	Alert	<p>Your BG meter reading is below 70 mg/dL.</p>	<ul style="list-style-type: none"> <li>• Select <b>No</b> to prevent the remote BG from being used by your pump. Select <b>Yes</b> to confirm the BG reading.</li> <li>• Check your BG and treat as necessary.</li> </ul>
<p><b>Low reservoir</b></p> <p>XX units remaining. Change reservoir.</p>	Alert	<p>Your reservoir is low on insulin, according to the number of units set in the Low Reservoir Reminder.</p>	<ul style="list-style-type: none"> <li>• Select <b>OK</b> to clear the alert.</li> <li>• Change the reservoir soon.</li> <li>• If you do not change the reservoir after you receive this alert, you will receive a second Low reservoir alert when the insulin level reaches half of your original alert amount.</li> </ul>

Title and text	Type	Explanation	Next steps
<p><b>Manage settings error</b></p> <p>Delivery stopped. Backup settings cleared from Manage Settings. Current settings are working properly. Select OK to restart. See User Guide.</p>	Alarm	<p>A pump error has occurred, and you need to restart your pump. Your backup settings have been lost, but your current settings are unchanged.</p>	<ul style="list-style-type: none"> <li>• Select <b>OK</b> to restart your pump. Your current settings are unchanged. Only your backup settings are lost.</li> <li>• When the pump restarts, follow instructions on the pump display.</li> <li>• If the pump was delivering a bolus or filling the cannula, check Daily History and evaluate your need for insulin.</li> </ul>
<p><b>Max Fill reached</b></p> <p>3X.X U. Did you see drops at the end of tubing?</p>	Alarm	<p>You have exceeded the number of units expected to fill the tubing. By now, insulin should be at the end of the tubing.</p>	<ul style="list-style-type: none"> <li>• If you see drops at the end of the tubing, select <b>Yes</b>.</li> <li>• If you do not see drops, select <b>No</b>.</li> <li>• Follow instructions displayed on the pump.</li> </ul>
<p><b>Max Fill reached</b></p> <p>4X.X U. Remove reservoir and select Rewind to restart New Reservoir procedure.</p>	Alarm	<p>You have exceeded the number of units expected to fill the tubing. By now, insulin should be at the end of the tubing.</p>	<ul style="list-style-type: none"> <li>• Remove the reservoir.</li> <li>• Check if you still have insulin in the reservoir. If you do, you can continue using the same reservoir.</li> <li>• Select <b>Rewind</b> to restart the new reservoir procedure.</li> </ul>

Title and text	Type	Explanation	Next steps
<p><b>No reservoir detected</b></p> <p>Rewind before loading reservoir.</p>	Alarm	There is no reservoir in the pump or the reservoir is not properly locked into place.	<ul style="list-style-type: none"> <li>• Select <b>Rewind</b>.</li> <li>• Ensure that your reservoir is filled with insulin.</li> <li>• When prompted, ensure that your reservoir is inserted and properly locked into place.</li> </ul>
<p><b>Power error detected</b></p> <p>Delivery stopped.</p> <p>Record your settings by uploading to CareLink or write your settings on paper. See User Guide.</p>	Alarm	The internal power source in your pump is unable to charge. Your pump is operating on the AA battery only.	<ul style="list-style-type: none"> <li>• Select <b>OK</b> to clear the alarm.</li> <li>• Check your BG and treat as necessary.</li> <li>• Record your settings as soon as possible because your AA battery may not last long.</li> <li>• Call 24-Hour Technical Support for assistance with your pump.</li> </ul>
<p><b>Power loss</b></p> <p>AA battery was removed for more than 10 min or power was lost. Select OK to re-enter time and date.</p>	Alarm	Your pump battery has been out for more than ten minutes, and your pump has lost power. You must reset your time and date.	<ul style="list-style-type: none"> <li>• Select <b>OK</b> to go to the Time &amp; Date screen.</li> <li>• Enter the current time, time format, and date.</li> </ul>

Title and text	Type	Explanation	Next steps
<p><b>Pump error</b></p> <p>Delivery stopped. Current settings cleared. Pump restart needed. Select OK to restart and then re-enter your settings. See User Guide.</p>	Alarm	<p>Your pump encountered an error and will restart. Your pump settings will return to factory default values.</p>	<ul style="list-style-type: none"> <li>• Select <b>OK</b> to restart your pump.</li> <li>• When the pump restarts, follow instructions on the pump display.</li> <li>• After restart, check settings and re-enter values as needed.</li> <li>• If you recently saved backup settings in Manage Settings, use Restore Settings.</li> <li>• If the pump was delivering a bolus or filling the cannula, check Daily History and re-evaluate your need for insulin.</li> <li>• If this alarm recurs frequently, write down the error code displayed on the alarm screen (you can also find it in your Alarm History) and call 24-Hour Technical Support.</li> </ul>

Title and text	Type	Explanation	Next steps
<p><b>Pump error</b> Delivery stopped. Settings unchanged. Pump restart needed. Select OK to restart. See User Guide.</p>	Alarm	<p>A pump error has occurred, you need to restart your pump.</p>	<ul style="list-style-type: none"> <li>• Select <b>OK</b> to restart your pump.</li> <li>• If the pump was delivering a bolus or filling the cannula, check Daily History and re-evaluate your need for insulin.</li> <li>• If this alarm recurs frequently, write down the error code displayed on the alarm screen (you can also find it in your Alarm History) and call 24-Hour Technical Support.</li> </ul>
<p><b>Pump error</b> Delivery stopped. Settings unchanged. Select OK to continue. See User Guide.</p>	Alarm	<p>Your pump encountered an error but a restart is not necessary. The issue is resolved. Your settings are not changed.</p>	<ul style="list-style-type: none"> <li>• Select <b>OK</b> to resume basal insulin delivery.</li> <li>• If the pump was delivering a bolus or filling the cannula, check Daily History and re-evaluate your need for insulin.</li> <li>• If this alarm recurs frequently, write down the error code displayed on the alarm screen (you can also find it in your Alarm History) and call 24-Hour Technical Support.</li> </ul>

Title and text	Type	Explanation	Next steps
<p><b>Pump restarted</b></p> <p>Delivery stopped. Settings unchanged. Select OK to continue. See User Guide.</p>	Alarm	<p>Your pump has encountered a problem and has restarted. Your settings have not been changed.</p>	<ul style="list-style-type: none"> <li>• Select <b>OK</b> to continue.</li> <li>• If the pump was delivering a bolus or filling the cannula, check Daily History and re-evaluate your need for insulin.</li> <li>• If this alarm recurs frequently, write down the error code displayed on the alarm screen (you can also find it in your Alarm History) and call 24-Hour Technical Support.</li> </ul>
<p><b>Replace battery</b></p> <p>Battery life less than 30 minutes. To ensure insulin delivery, replace battery now.</p>	Alert	<p>Battery life is low and will be exhausted within 30 minutes.</p>	<ul style="list-style-type: none"> <li>• Select <b>OK</b> to clear the alert.</li> <li>• Replace the AA battery.</li> </ul>
<p><b>Replace battery now</b></p> <p>Delivery stopped. Battery must be replaced to resume delivery.</p>	Alarm	<p>Insulin delivery has stopped due to low power. Battery was not replaced after the Low battery Pump alert.</p>	<p>Replace the battery immediately to resume basal insulin delivery.</p>

Title and text	Type	Explanation	Next steps
<p><b>Reservoir estimate at 0 U</b></p> <p>To ensure insulin delivery, change reservoir.</p>	Alert	Your reservoir level is estimated at 0 units.	<ul style="list-style-type: none"> <li>• Select <b>OK</b> to clear the alert.</li> <li>• Change the reservoir now.</li> </ul>
<p><b>Resume bolus?</b></p> <p>XXX of YYY U delivered.</p> <p>Resume delivery of ZZZ U?</p>	Message	A normal bolus delivery has been interrupted because the pump battery was removed. If it is within 10 minutes since this interruption, you can resume this bolus.	<ul style="list-style-type: none"> <li>• Check the message to see how much of the bolus was actually delivered.</li> <li>• To cancel remaining amount of bolus, select <b>Cancel</b>.</li> <li>• To resume remaining amount of bolus, select <b>Resume</b>.</li> </ul>
<p><b>Resume Dual bolus?</b></p> <p>XX of YY U delivered.</p> <p>Resume delivery of ZZ U for XX:XX hr?</p>	Message	The Square portion of Dual Bolus delivery has been interrupted. If it is within 10 minutes since this interruption, you can resume this bolus.	<ul style="list-style-type: none"> <li>• Check the message to see how much of the Dual Wave bolus was actually delivered.</li> <li>• To cancel remaining amount of bolus, select <b>Cancel</b>.</li> <li>• To resume remaining amount of bolus, select <b>Resume</b>.</li> </ul>



Title and text	Type	Explanation	Next steps
<p><b>Resume Dual bolus?</b></p> <p>XX of YY U delivered.</p> <p>Resume delivery of ZZ U now, and AA U Square for XX:XX hr?</p>	<p>Message</p>	<p>The Now portion of a Dual Wave bolus delivery has been interrupted because the pump battery was removed. If it is within 10 minutes since this interruption, you can resume this bolus.</p>	<ul style="list-style-type: none"> <li>• Check the message to see how much of the Dual Wave bolus was actually delivered.</li> <li>• To cancel remaining amount of bolus, select <b>Cancel</b>.</li> <li>• To resume remaining amount of bolus, select <b>Resume</b>.</li> </ul>
<p><b>Resume Square bolus?</b></p> <p>XX of YY U delivered for XX:XX hr.</p> <p>Resume delivery of ZZ U for XX:XX hr?</p>	<p>Message</p>	<p>The Square Wave bolus delivery was interrupted. If it is within 10 minutes since this interruption, you can resume this bolus.</p>	<ul style="list-style-type: none"> <li>• Check the message to see how much of the Square Wave bolus was actually delivered.</li> <li>• To cancel remaining amount of bolus, select <b>Cancel</b>.</li> <li>• To resume remaining amount of bolus, select <b>Resume</b>.</li> </ul>
<p><b>Rewind required</b></p> <p>Delivery stopped.</p> <p>Rewind was required due to pump error.</p> <p>Select OK to continue. See User Guide.</p>	<p>Alarm</p>	<p>Your pump encountered an error.</p>	<ul style="list-style-type: none"> <li>• Select <b>OK</b> to clear the alarm after the pump has completed rewinding.</li> <li>• Select <b>Reservoir &amp; Tubing</b> from the Home screen to start the new reservoir process using a new infusion set and reservoir. For details, see <i>Setting up the reservoir and infusion set, on page 119</i>.</li> </ul>

Title and text	Type	Explanation	Next steps
<b>Stuck button</b> Button pressed for more than 3 minutes.	Alarm	The pump has detected that a button has been pressed for an unusually long time.	<ul style="list-style-type: none"> <li>• Select <b>OK</b> to clear the alarm.</li> <li>• If this alarm occurs again, call 24-Hour Technical Support for assistance with your pump.</li> </ul> <p>If you are unable to clear the alarm:</p> <ul style="list-style-type: none"> <li>• See <i>Troubleshooting pump issues</i>, on page 285.</li> <li>• Consider another form of insulin, because your pump is not delivering insulin.</li> <li>• Check your BG and treat as necessary.</li> <li>• Call 24-Hour Technical Support for assistance with your pump.</li> </ul>

## CGM (sensor) alarms, alerts, and messages

The following table lists the most common or serious alarms, alerts, and messages related to your sensor glucose (SG) readings, as well as the status of your transmitter and sensor. The table also explains the meaning, consequences, and the reasons why these notifications appear, and provides steps for problem resolution.

Title and text	Type	Explanation	Next steps
<p><b>Alert before high</b></p> <p>Sensor glucose approaching High Limit. Check BG.</p>	Alert	Your SG value is approaching your specified high limit.	<ul style="list-style-type: none"> <li>• Select <b>OK</b> to clear the alert.</li> <li>• Check your BG.</li> <li>• Follow instructions from your healthcare professional and continue to monitor your BG.</li> </ul>
<p><b>Alert before low</b></p> <p>Sensor glucose approaching Low Limit. Check BG.</p>	Alert	Your SG value is approaching your specified low limit.	<ul style="list-style-type: none"> <li>• Select <b>OK</b> to clear the alert.</li> <li>• Check your BG.</li> <li>• Follow instructions from your healthcare professional and continue to monitor your BG.</li> </ul>
<p><b>Alert on high XXX mg/dL</b></p> <p>High sensor glucose. Check BG.</p>	Alert	Your SG value is at or above your specified high limit.	<ul style="list-style-type: none"> <li>• Select <b>OK</b> to clear the alert.</li> <li>• Check your BG.</li> <li>• Follow instructions from your healthcare professional and continue to monitor your BG.</li> </ul>
<p><b>Alert on low XXX mg/dL</b></p> <p>Low sensor glucose. Check BG.</p>	Alert	Your SG value is at or below your specified low limit.	<ul style="list-style-type: none"> <li>• Select <b>OK</b> to clear the alert.</li> <li>• Check your BG.</li> <li>• Follow instructions from your healthcare professional and continue to monitor your BG.</li> </ul>
<p><b>Alert on low XXX mg/dL</b></p> <p>Low sensor glucose. Insulin delivery suspended since XX:XX AM/PM. Check BG.</p>	Alarm	Your SG value is at or below your specified low limit, and the pump has suspended insulin delivery due to a Suspend on low or Suspend before low event.	<ul style="list-style-type: none"> <li>• Select <b>OK</b> to clear the alarm.</li> <li>• Check your BG.</li> <li>• Follow instructions from your healthcare professional and continue to monitor your BG.</li> </ul>

Title and text	Type	Explanation	Next steps
<p><b>Basal delivery resumed</b></p> <p>Basal delivery resumed at XX:XX AM/PM after suspend by sensor. Check BG.</p>	Message	<p>Your pump is resuming basal insulin delivery after a Suspend on low or Suspend before low event occurred.</p>	<ul style="list-style-type: none"> <li>• Select <b>OK</b> to clear the message.</li> <li>• Check your BG.</li> <li>• Follow instructions from your healthcare professional and continue to monitor your BG.</li> </ul>
<p><b>Basal delivery resumed</b></p> <p>Low settings change caused basal to be resumed at XX:XX AM/PM. Check BG.</p>	Alert	<p>Your pump is resuming basal insulin delivery after a Suspend before low or a Suspend on low event occurred, because you have turned off the Suspend before low or the Suspend on low feature.</p>	<ul style="list-style-type: none"> <li>• Select <b>OK</b> to clear the alert.</li> <li>• Check your BG.</li> <li>• Follow instructions from your healthcare professional and continue to monitor your BG.</li> </ul>
<p><b>Basal delivery resumed</b></p> <p>Maximum 2 hour suspend time reached. Check BG.</p>	Alert	<p>Your pump is resuming basal insulin delivery two hours after a Suspend before low or Suspend on low event occurred.</p>	<ul style="list-style-type: none"> <li>• Select <b>OK</b> to clear the alert.</li> <li>• Check your BG.</li> <li>• Follow instructions from your healthcare professional and continue to monitor your BG.</li> </ul>

Title and text	Type	Explanation	Next steps
<p><b>Basal delivery resumed</b></p> <p>Maximum 2 hour suspend time reached. SG is still under Low limit. Check BG.</p>	<p>Alarm</p>	<p>Your pump is resuming basal insulin delivery two hours after a Suspend before low or Suspend on low event occurred.</p>	<ul style="list-style-type: none"> <li>• Your pump has resumed basal insulin delivery; however, your SG value is still at or below your low limit.</li> <li>• Select <b>OK</b> to clear the alarm.</li> <li>• Check your BG.</li> <li>• Follow instructions from your healthcare professional and continue to monitor your BG.</li> </ul>
<p><b>BG not received</b></p> <p>Place pump close to transmitter. Select OK to resend BG to transmitter.</p>	<p>Alert</p>	<p>The transmitter was unable to receive the calibration BG meter readings from the pump.</p>	<ul style="list-style-type: none"> <li>• Move your pump and transmitter closer together.</li> <li>• Select <b>OK</b>. Your pump tries again to send your BG to your transmitter for sensor calibration.</li> </ul>
<p><b>Calibrate now</b></p> <p>Check BG and calibrate sensor.</p>	<p>Alert</p>	<p>A BG meter reading is needed immediately to calibrate your sensor so that you can continue receiving SG readings.</p>	<p>If you are unable to calibrate now, you can use the Snooze feature. Set the desired time, and select <b>Snooze</b>. If you do not calibrate before the Snooze time is up, the Calibrate now alert occurs again.</p>

Title and text	Type	Explanation	Next steps
<p><b>Calibration not accepted</b></p> <p>Wait at least 15 minutes. Wash hands, test BG again and calibrate.</p>	Alert	<p>Your system was unable to use the BG meter readings you entered to calibrate your sensor.</p>	<ul style="list-style-type: none"> <li>• Wash and dry hands thoroughly. See <i>Guidelines for calibrating</i>, on page 209.</li> <li>• Select <b>OK</b> to clear the alert.</li> <li>• After 15 minutes, enter a new BG meter reading for calibration as instructed in <i>Calibrating your sensor</i>, on page 206. If you receive a Calibration not accepted alert on your second calibration after 15 minutes, a Change sensor alert occurs.</li> <li>• Call 24-Hour Technical Support if you have questions.</li> </ul>
<p><b>Change sensor</b></p> <p>Insert new sensor and Start New Sensor.</p>	Alert	<p>You selected <b>No</b> in the Check sensor insertion message, indicating that your sensor is not fully inserted.</p>	<ul style="list-style-type: none"> <li>• Select <b>OK</b> to clear the alert.</li> <li>• Change your sensor. For details, see your sensor user guide.</li> <li>• After you change your sensor, refer to <i>Starting the sensor</i>, on page 205.</li> </ul>
<p><b>Change sensor</b></p> <p>Second calibration not accepted. Insert new sensor.</p>	Alert	<p>This alert occurs when you receive two Calibration not accepted errors in a row.</p>	<ul style="list-style-type: none"> <li>• Select <b>OK</b> to clear the alert.</li> <li>• Change your sensor. For details, see your sensor user guide.</li> </ul>

Title and text	Type	Explanation	Next steps
<p><b>Change sensor</b></p> <p>Sensor not working properly. Insert new sensor.</p>	Alert	This alert occurs when the transmitter diagnoses a problem with the sensor that cannot be resolved.	<ul style="list-style-type: none"> <li>• Select <b>OK</b> to clear the alert.</li> <li>• Change your sensor. For details, see your sensor user guide.</li> </ul>
<p><b>Check connection</b></p> <p>Ensure transmitter and sensor connection is secure, then select OK.</p>	Alert	The pump fails to detect the transmitter and is unable to receive sensor signal.	<ul style="list-style-type: none"> <li>• Select <b>OK</b> to clear the alert.</li> <li>• If your sensor is fully inserted, select <b>Yes</b>. If your sensor is not fully inserted, select <b>No</b>.</li> <li>• If your sensor was not fully inserted, insert a new sensor.</li> <li>• If you still cannot connect your sensor, see <i>My pump cannot find the sensor signal</i>, on page 290.</li> </ul>
<p><b>Lost sensor signal</b></p> <p>Move Pump closer to transmitter. May take 15 minutes to find signal.</p>	Alert	Transmitter signal has not been received for 30 minutes during or after initialization.	<ul style="list-style-type: none"> <li>• Move your pump closer to your transmitter. It can take up to 15 minutes for your pump to start communicating with your transmitter.</li> <li>• Select <b>OK</b> to clear the alert.</li> </ul>
<p><b>Low battery transmitter</b></p> <p>Recharge transmitter within 24 hours.</p>	Alert	The battery in the transmitter needs to be recharged within 24 hours.	<ul style="list-style-type: none"> <li>• Select <b>OK</b> to clear the alert.</li> <li>• Recharge your transmitter as soon as possible.</li> </ul>

Title and text	Type	Explanation	Next steps
<p>Low SG XX mg/dL</p> <p>SG is under 50 mg/dL. Check BG and treat.</p>	Alarm	<p>Your SG value has reached or fallen below 50 mg/dL. This alarm is factory set and cannot be changed or turned off.</p> <p>This alarm cannot be silenced and is always enabled, whether the pump is in Auto Mode or Manual Mode.</p>	<ul style="list-style-type: none"> <li>• Select <b>OK</b> to clear the alarm.</li> <li>• Check your BG and treat as necessary.</li> </ul>



**Note:** XX represents the SG value that appears on your pump.



**WARNING:** For MiniMed 770G Users Ages 2-13: Do not rely solely on the use of a low sensor glucose (SG) value for “Alert on Low” or “Alert before Low” for alerts set at 50 mg/dL and 60 mg/dL. A low sensor glucose alert may not reflect the user’s true blood glucose at these levels, or may not alert. Do not ignore symptoms of low glucose. Always confirm your sensor glucose readings with your blood glucose meter, and treat according to the recommendations of your healthcare professional. Solely relying on these sensor glucose alerts and readings for treatment decisions could result in missing severe hypoglycemia (low blood glucose) events.



Title and text	Type	Explanation	Next steps
<p><b>Medical device</b></p> <p>CALL FOR EMERGENCY ASSISTANCE. I have diabetes.</p>	Alarm	<p>Your pump is suspended due to low SG, and you have not responded to the alarm within 10 minutes.</p>	<ul style="list-style-type: none"> <li>• Select <b>Dismiss</b>.</li> <li>• Immediately call for emergency assistance.</li> </ul>
<p><b>No calibration occurred</b></p> <p>Confirm sensor signal. Calibrate by XX:XX AM/PM.</p>	Alert	<p>The transmitter was unable to receive the calibration BG meter readings from the pump.</p>	<ul style="list-style-type: none"> <li>• Select <b>OK</b> to clear the alert.</li> <li>• Check the status icons on your Home screen to ensure that your pump has a signal from your sensor. If there is no sensor signal, see <i>My pump cannot find the sensor signal</i>, on page 290.</li> <li>• Calibrate again by the time shown on the pump screen to ensure you continue SG monitoring.</li> </ul>
<p><b>No calibration occurred</b></p> <p>Confirm sensor signal. Check BG again to calibrate sensor.</p>	Alert	<p>The transmitter was unable to receive the required calibration BG from the pump.</p> <p>Calibration is required by the system for SG values to resume. "Calibration required" appears on your sensor graph.</p>	<ul style="list-style-type: none"> <li>• Select <b>OK</b> to clear the alert.</li> <li>• Take another BG meter reading and calibrate again.</li> </ul>

Title and text	Type	Explanation	Next steps
<p><b>Possible signal interference</b></p> <p>Move away from electronic devices. May take 15 minutes to find signal.</p>	Alert	There may be interference from another electronic device that is affecting the communication between your pump and transmitter.	<ul style="list-style-type: none"> <li>• Move away from other electronic devices. It can take up to 15 minutes for your pump to start communicating with your transmitter.</li> <li>• Select <b>OK</b> to clear the alert.</li> </ul>
<p><b>Rise Alert</b></p> <p>Sensor glucose rising rapidly.</p>	Alert	Your SG value has been rising as fast or faster than your preset Rise Alert Limit.	<ul style="list-style-type: none"> <li>• Select <b>OK</b> to clear the alert.</li> <li>• Monitor trend and glucose level.</li> <li>• Follow instructions from your healthcare professional.</li> </ul>
<p><b>Sensor alert occurred</b></p> <p>Check Alarm History for silenced alerts.</p>	Alert	Sensor alert occurred when Alert Silence is on.	<ul style="list-style-type: none"> <li>• Select <b>OK</b> to clear the alert.</li> <li>• Check the Alarm History screen to see which alerts were silenced.</li> <li>• Select the alert to open the Alarm Detail screen.</li> <li>• Take action based on the selected alert.</li> </ul>

Title and text	Type	Explanation	Next steps
<p><b>Sensor connected</b></p> <p>If new sensor, select Start New. If not, select Reconnect.</p>	<p>Message</p>	<p>The transmitter has detected that you have connected a sensor. The pump needs to know if this is a new sensor or if you have reconnected your old sensor.</p>	<ul style="list-style-type: none"> <li>• If you have connected a new sensor, select <b>Start New Sensor</b>.</li> <li>• If you have reconnected a sensor you have been using, select <b>Reconnect Sensor</b>.</li> <li>• In either case, a "Warm-up" message appears on your Home screen, and you will be prompted to enter a BG value when your sensor is ready for calibration. Your pump starts receiving your SG values again after the two-hour initialization is complete.</li> </ul>
<p><b>Sensor connected</b></p> <p>Start new sensor.</p>	<p>Message</p>	<p>The pump has detected that this is a new sensor, which needs to be started and warmed-up.</p>	<p>Select <b>Start New Sensor</b>.</p> <p>The alert will close and a "Warm-up" message appears on the sensor graph with a progress bar.</p>
<p><b>Sensor expired</b></p> <p>Insert new sensor.</p>	<p>Alert</p>	<p>The sensor has reached the end of its useful life.</p>	<ul style="list-style-type: none"> <li>• Change your sensor. For details, see your sensor user guide.</li> <li>• Select <b>OK</b> to clear the alert.</li> </ul>
<p><b>Sensor signal not found</b></p> <p>See User Guide.</p>	<p>Alert</p>	<p>After multiple attempts, the pump failed to detect the transmitter and is unable to receive sensor signal.</p>	<ul style="list-style-type: none"> <li>• Select <b>OK</b> to clear the alert.</li> <li>• If your pump still cannot find the sensor signal, call 24-Hour Technical Support for assistance.</li> </ul>

Title and text	Type	Explanation	Next steps
<p><b>Sensor warm-up started</b></p> <p>Warm-up takes up to 2 hours. You will be notified when calibration is needed.</p>	<p>Message</p>	<p>The sensor warm-up has begun.</p>	<p>Select <b>OK</b> to clear the message.</p> <p>A "Warm-up" message with a progress bar appears on the sensor graph during warm-up, which takes up to two hours.</p> <p>You will be notified when calibration is needed.</p>
<p><b>Sensor updating</b></p> <p>Do not calibrate unless notified. This could take up to 3 hours.</p>	<p>Alert</p>	<p>The SG value is unavailable due to a temporary situation.</p>	<ul style="list-style-type: none"> <li>• Select <b>OK</b> to clear the alert.</li> <li>• Follow the instructions on the pump screen. You do not need to change the sensor.</li> </ul>
<p><b>Suspend before low</b></p> <p>Delivery stopped. Sensor glucose approaching Low Limit. Check BG.</p>	<p>Alert</p>	<p>Your SG value is falling. Insulin delivery is suspended according to your Suspend before low setting and your SG is approaching your specified low limit.</p> <p>Suspend before low is not available in Auto Mode.</p>	<ul style="list-style-type: none"> <li>• Select <b>OK</b> to clear the alert.</li> <li>• Check your BG. If necessary, treat your BG as directed by your healthcare professional.</li> </ul>

Title and text	Type	Explanation	Next steps
<b>Suspend on low</b> Delivery stopped. Sensor glucose XXX mg/dL. Check BG.	Alarm	Your SG value is at or below the low limit you specified.  Suspend on low is not available in Auto Mode.	<ul style="list-style-type: none"> <li>• Select <b>OK</b> to clear the alarm.</li> <li>• Check your BG. If necessary, treat your BG as directed by your healthcare professional.</li> </ul>
<b>Transmitter battery depleted</b>  Recharge transmitter now.	Alert	The battery in the transmitter needs to be recharged. SG values are not recorded or transmitted until you recharge transmitter.	<ul style="list-style-type: none"> <li>• Select <b>OK</b> to clear the alert.</li> <li>• Recharge your transmitter.</li> </ul>

## SmartGuard Auto Mode alerts and messages

The following table lists the most common or serious alerts and messages related to Auto Mode. The table also explains the meaning, consequences, and the reasons why these notifications appear, and provides any necessary steps for problem resolution.

Title and text	Type	Explanation	Next steps
<b>Auto Mode started</b>  Current action canceled.	Alert	This alert happens when the user starts an operation that is not allowed in Auto Mode while the pump is transitioning to Auto Mode.	<ul style="list-style-type: none"> <li>• Select <b>OK</b> to clear the alert.</li> <li>• Allow your pump to complete its transition to Auto Mode.</li> </ul>

Title and text	Type	Explanation	Next steps
<p><b>Auto Mode started</b></p> <p>The following SmartGuard settings are now turned off:</p> <ul style="list-style-type: none"> <li>- Suspend before low</li> <li>- Suspend on low</li> </ul>	Alert	<p>Your pump has started Auto Mode. The Suspend before low and Suspend on low settings are now turned off.</p>	<ul style="list-style-type: none"> <li>• Select <b>OK</b> to clear the alert.</li> <li>• Allow your pump to complete the transition into Auto Mode.</li> </ul>
<p><b>Auto Mode exit</b></p> <p>X started. Would you like to review the Auto Mode Readiness screen?</p>	Alert	<p>Your pump has exited Auto Mode because you have turned off your sensor, a suspend event message has not been cleared within 4 hours, or you have been in Safe Basal the maximum of 90 minutes.</p> <p>This alert cannot be silenced, and is always enabled whenever the system is in Auto Mode.</p>	<ul style="list-style-type: none"> <li>• Select <b>No</b> to clear the alert. Select <b>Yes</b> to view the Auto Mode Readiness screen.</li> <li>• Check your BG.</li> <li>• Calibrate your sensor.</li> <li>• Follow instructions from your healthcare professional and continue to monitor your BG. For details, see <i>Exiting SmartGuard Auto Mode, on page 239</i> and <i>Returning to SmartGuard Auto Mode, on page 239</i>.</li> </ul>

Title and text	Type	Explanation	Next steps
<p><b>High SG</b></p> <p>SG has been high over 1 hour. Check infusion set. Check ketones. Monitor BG.</p> <p>Followed by</p> <p><b>Auto Mode exit</b></p> <p>Monitor BG and treat as necessary. X started. Enter BG to continue in Auto Mode.</p>	Alert	<p>Your pump has exited Auto Mode based on a set glucose threshold and length of time:</p> <ul style="list-style-type: none"> <li>• 300 mg/dL or higher for one hour</li> <li>• 250 mg/dL or higher for three hours.</li> </ul> <p>This alert cannot be silenced and is always enabled whenever the pump is in Auto Mode.</p>	<ul style="list-style-type: none"> <li>• Select <b>OK</b> to clear the alert.</li> <li>• Check your BG and treat as necessary.</li> </ul>
<p><b>Auto Mode max delivery</b></p> <p>Auto Mode has been at maximum delivery for 4 hours. Enter BG to continue in Auto Mode.</p>	Alert	<p>Auto Mode has been delivering at your maximum Auto Mode basal insulin delivery rate for four hours. This rate is determined automatically by your system.</p>	<ul style="list-style-type: none"> <li>• Select <b>OK</b> to clear the alert.</li> <li>• Check your BG and enter it into your pump to exit Safe Basal and return to Auto Basal.</li> <li>• Follow instructions from your healthcare professional and continue to monitor your BG.</li> </ul>

Title and text	Type	Explanation	Next steps
<p><b>Auto Mode max delivery</b></p> <p>Auto Mode has been unable to bring your SG down. Enter BG and resume delivery to continue in Auto Mode.</p>	Alert	Auto Mode has been unable to lower your SG value. Your pump is suspended, and your predicted SG is above target.	<ul style="list-style-type: none"> <li>• Select <b>OK</b> to clear the alert.</li> <li>• Check your BG and enter it into your pump.</li> <li>• Follow instructions from your healthcare professional and continue to monitor your BG.</li> </ul>



**Note:**

- The title of the alert appears the same as the previous Auto Mode max delivery alert in the table.
- If you have suspended your pump, you will have no delivery. However, the alert may still occur.

<p><b>Auto Mode min delivery</b></p> <p>Auto Mode has been at minimum delivery for 2:30 hr. Enter BG to continue in Auto Mode.</p>	Alert	Your pump has been delivering at your minimum Auto Mode basal insulin delivery rate for two and a half hours. This rate is determined automatically by your system.	<ul style="list-style-type: none"> <li>• Select <b>OK</b> to clear the alert.</li> <li>• Check your BG and enter it into your pump to exit Safe Basal and return to Auto Basal.</li> <li>• Follow instructions from your healthcare professional and continue to monitor your BG.</li> </ul>
--	-------	---	--



Title and text	Type	Explanation	Next steps
<p><b>Auto Mode min delivery</b></p> <p>Your SG has been below target for 2:30 hr. Enter BG and resume delivery when ready to continue in Auto Mode.</p>	Alert	Your pump is suspended, and your predicted SG has been below target for two and a half hours.	<ul style="list-style-type: none"> <li>• Select <b>OK</b> to clear the alert.</li> <li>• Check your BG and enter it into your pump.</li> <li>• Follow instructions from your healthcare professional and continue to monitor your BG.</li> </ul>



**Note:**

- The title of the alert appears the same as the previous Auto Mode min delivery alert in the table.
- If you have suspended your pump, you will have no delivery. However, the alert may still occur.

<p><b>BG required</b></p> <p>Enter a new BG for Auto Mode.</p>	Alert	Auto Mode requires a BG to check the reliability of the sensor.	<ul style="list-style-type: none"> <li>• Select <b>OK</b> to clear the alert.</li> <li>• Enter a BG to return to Auto Basal from Safe Basal, or to enter Auto Mode from Manual Mode.</li> </ul>
<p><b>Bolus recommended</b></p> <p>For XXX mg/dL entered, a correction bolus is recommended.</p> <p>Select Bolus to program a bolus.</p>	Alert	Auto Mode calculated that a bolus is recommended based on the BG value that you entered.	<ul style="list-style-type: none"> <li>• Select <b>Bolus</b> to program a correction bolus.</li> <li>• Select <b>Cancel</b> if you do not want to deliver a correction bolus.</li> </ul>

Title and text	Type	Explanation	Next steps
<p><b>Cal required for Auto Mode</b></p> <p>Enter a BG and calibrate sensor for Auto Mode.</p>	Alert	<p>Calibration may be required by Auto Mode, even when SG values are available.</p>	<ul style="list-style-type: none"> <li>• Select <b>OK</b> to clear the alert.</li> <li>• Check your BG and enter it into your pump.</li> <li>• Calibrate your sensor using the BG that you entered.</li> </ul>
<p><b>High BG XXX mg/dL</b></p> <p>Check infusion set. Check ketones. Monitor BG. Confirm BG?</p>	Alert	<p>Your BG meter reading is above 250 mg/dL.</p> <p>This alert applies only to Auto Mode. There is an equivalent alert for Manual Mode. See <i>Pump alarms, alerts, and messages</i>, on page 246.</p>	<p>Select <b>No</b> to prevent the remote BG from being used by your pump. Select <b>Yes</b> to confirm the BG reading.</p>

## CareLink software alert and message

The following table lists the most common or serious alerts and messages related to CareLink software. The table also explains the meaning, consequences, and the reasons why these notifications appear, and provides steps for problem resolution. If you get an alarm, alert, or message that is not listed, select **OK** to clear the notification and call 24-Hour Technical Support.

Title and text	Type	Explanation	Next steps
<b>CareLink uploader not found.</b> Follow instructions on the CareLink uploader.	Message	The pump cannot find the CareLink uploader because the wrong pump code was entered, or the search timed out before the pump found the uploader.	<ul style="list-style-type: none"><li>• Select <b>OK</b> to clear the message.</li><li>• Follow the instructions on the CareLink uploader. For details, see <i>Upload to CareLink software, on page 168</i>.</li></ul>



# 14

Troubleshooting



# 14

## Troubleshooting

This chapter contains procedures and information to help you understand and address conditions that might occur with your pump.

For a list of alarms, alerts, and messages that may appear on your pump, see *Pump alarms, alerts, and messages*, on page 246.

### Troubleshooting pump issues



**WARNING:** If you receive a critical error on your pump, the following screen displays and the pump sirens.



Immediately disconnect from your insulin pump and discontinue use. Contact 24-Hour Technical Support for assistance.

**Remember, your body still needs insulin while your pump is removed.** It is important that you consult your healthcare professional to determine an alternate method of receiving insulin while your pump is removed. For more information on pump alarms, see *Pump alarms, alerts, and messages*, on page 246.

## My pump buttons are stuck

During atmospheric pressure changes, your pump buttons may not work for up to 45 minutes. For example, during airplane travel your pump buttons may get stuck. This is rare. If this occurs, either wait for the problem to correct itself, or if you have a new AA battery with you:

1. Remove the battery cap.
2. Place the battery cap back onto the pump.

Your pump will check the AA battery power, and may require a new AA battery.

3. If prompted, insert a new AA battery.

If these steps do not correct the problem, contact 24-Hour Technical Support for assistance.

## What is a Check Settings alarm?

This alarm occurs when a condition causes your pump to reset to factory settings. The Check Settings alarm occurs after you re-enter the Startup Wizard settings.

The Check Settings alarm tells you that other settings may have been cleared or reverted to factory default values. Review any settings that you have not already set in Startup Wizard and re-enter the values, if necessary.

## My pump is asking me to rewind



**WARNING: Always make sure the infusion set is disconnected from your body before you rewind your pump or fill the infusion set tubing. Never insert the reservoir into the pump while the tubing is connected to your body. Doing so could result in an accidental infusion of insulin, which can cause hypoglycemia.**

You must rewind your pump when you change the reservoir. Rewinding returns the piston in the reservoir compartment to its starting position. It is normal for your pump to ask you to rewind any time you remove and replace the reservoir, such as when you resolve an Insulin Flow Blocked alarm or address a problem when you load the reservoir.



## I dropped my pump





**CAUTION:** Always inspect your pump to ensure there are no cracks before exposing your pump to water, especially if your pump has been dropped, or you suspect your pump is damaged. Water leakage can cause the pump to malfunction, and result in injury.

Do the following:

1. Check that all connections are still tightly in place.
2. Check the display, button area, and pump case for cracks or damage.
3. Check the infusion set, including the tubing connector and tubing for cracks or damage.
4. Review the status screen, basal rates, and other pump settings.
5. Perform a self test. Press  and select:  
**Options > Utilities > Self Test**
6. If the self test does not complete successfully, or if you are concerned about your pump, call 24-Hour Technical Support for assistance and check your blood glucose (BG).

## I cannot get to the Manage Settings screen

These personalized settings, under the Manage Settings screen, should be provided by your healthcare professional in your training session. If you go to **Options > Utilities > Manage Settings**, a message appears telling you that the feature is not normally accessible and to consult your user guide. To access the Manage Settings screen press  and select:

1. **Options > Utilities > Manage Settings**
2. Simultaneously press and hold  and  for about two seconds until the Manage Settings screen appears.

## My pump display times out too quickly

Your pump display times out after 15 seconds by default in order to conserve battery power. You can increase this setting up to three minutes. Press  and select **Options > Utilities > Display Options**, and then adjust the Backlight setting as desired.



**Note:** Be aware that using a longer Backlight time causes your pump to use more battery power. When your pump battery is low, the timeout for the backlight on your pump screen is automatically reduced.

## Where is my pump status screen?

1. Press  and select Status to go to the Status screen.

The Status screen appears.



2. From the Status screen, you can select the type of status information you want to view. For example, to see a quick status of your pump and recent insulin deliveries, go to Quick Status. For details, see *Status screens, on page 52*.

## My pump is asking me to enter my settings

Certain pump errors can clear your settings and return them to their factory default values. This also happens if you intentionally clear your settings. Do not clear your settings unless directed to do so by your healthcare professional.

If you have saved your settings using the Save Settings option, you can restore them using the Restore Settings option. If you restore your settings, ensure the restored settings match the settings prescribed most recently by your healthcare professional.

The Startup Wizard appears automatically when your pump restarts. The wizard tells you to enter the following information. Have the following values ready when you begin:

- Time format, time, and date
- Active insulin time
- Basal patterns

After you enter your pump settings, you have the option of entering the following Bolus Wizard settings:

- Carb ratio
- Insulin sensitivity factor
- BG target

**To enter your pump settings:**

1. Select your language, and then select **Next** to go to each new screen.
2. When the Select Time Format screen appears, select a **12 Hour** or a **24 Hour** time format.
3. When the Enter Time screen appears, adjust the setting to the current time. If you are using a 12-hour clock, be sure to specify AM or PM.
4. When the Enter Date screen appears, adjust the **Year**, **Month**, and **Day** to the current date.
5. When the Active Insulin Time screen appears, enter the **Duration**.  
For details, see *About active insulin*, on page 98.
6. Enter the End time and the rate for your first basal rate. You can enter more basal patterns after you complete the startup wizard.  
For details, see *Adding a new basal pattern*, on page 69.  
After you complete your basal pattern, a screen appears for you to review your basal information.
7. A screen appears and tells you to set up the Bolus Wizard settings. Do one of the following:
  - Select **Yes** to continue to enter your settings, and then continue to the next section.
  - Select **No** if you do not want to enter your Bolus Wizard settings. A message appears to confirm the startup is complete. Select **OK** to continue to use your pump.

**To enter your Bolus Wizard settings:**

1. When your pump shows a list of settings for the Bolus Wizard feature, make sure you have the values you need before you continue.

2. When the Carb Ratio screen appears, enter your carb ratio by entering the End time and the ratio. You can adjust your carb ratio at any time.  
For details, see *Changing your carb ratio, on page 96*.
3. When the Sensitivity screen appears, enter your insulin sensitivity factor by entering the End time and the mg/dL per unit. You can adjust your insulin sensitivity factor at any time.  
For details about entering insulin sensitivity factors, including how to set multiple time periods, see *Changing your insulin sensitivity factor, on page 97*.
4. When the BG Target screen appears, enter your BG Target range by entering the End time and your Lo (low) and Hi (high) values. You can adjust your BG Target ranges at any time.  
For details, see *Changing your Bolus Wizard BG target, on page 97*.
5. A message appears to confirm the startup is complete. Select **OK** to continue to use your pump.

## Troubleshooting sensor issues

### My pump cannot find the sensor signal

If your pump cannot find the sensor signal after 30 minutes of normal use, the Lost sensor signal alert appears. Follow the instructions on the pump screen to troubleshoot the issue, as described in the following steps:



**Note:** If the Alert Silence option is on and a glucose alert occurs, the notification light begins to flash and the Sensor alert occurred alert appears, but no explanatory text is shown. All silenced alerts are shown with explanatory text in the Alarm History screen.

1. Move your pump closer to your transmitter and select **OK**. It can take up to 15 minutes for your pump to find the sensor signal.  
If your pump still cannot find the sensor signal, the Possible signal interference alert appears.
2. Make sure you are away from any electronic devices that might cause interference, such as cellular phones that are not paired with the MiniMed 770G System and other wireless devices, and select **OK**.

If your pump does not find the sensor signal within 15 minutes after you selected OK, the Check connection alert appears.

3. Ensure the transmitter and sensor connection is secure, and then select **OK**. The "Check sensor insertion" message appears.
4. If your sensor is fully inserted, select **Yes** and skip to step 7.
5. If your sensor is not fully inserted, select **No**. A Change sensor alert appears.
6. Select **OK** and change your sensor.
7. If you selected **Yes** and your pump still cannot find the sensor signal after 15 minutes, or if your sensor graph displays "Sensor signal not found. See User Guide," call 24-Hour Technical Support for assistance.

### Calibration not accepted

Calibration not accepted alert occurs when one of the following happens:

- System was unable to use the BG meter readings you entered to calibrate your sensor.
- System rejects two calibrations in a row from the same sensor.
- The transmitter was unable to receive the calibration BG meter readings from the pump due to failed sensor signal.

For details on when and how to calibrate your sensor, see *Calibrating your sensor*, on page 206.

### Why does the SmartGuard suspend icon on my Home screen appear gray?

The SmartGuard suspend icon appears gray  on the Home screen when either the Suspend on low or Suspend before low feature is unavailable. The SmartGuard suspend features may be unavailable due to the following conditions:

- A suspend event has occurred recently.

After a Suspend before low or Suspend on low event occurs, there is a period of time when the suspend functionality is unavailable. This time will vary depending on whether or not you respond to the suspend event. Typically, the suspend features will be unavailable for 30 minutes after your basal insulin delivery is resumed. For details, see *When Suspend before low is unavailable*, on page 183 or *When Suspend on low is unavailable*, on page 186.

- No sensor glucose (SG) values are available.

SG values may be unavailable because:

- Sensor calibration is required.

For details on when and how to calibrate your sensor, see *Calibrating your sensor, on page 206*.

- Your pump has lost connection to the sensor.

Move your pump closer to the sensor. For more details, see *My pump cannot find the sensor signal, on page 290*.

- The SG value received was outside the expected range and was not displayed.

Select **OK** to clear the alert. If the issue continues, you may need to replace the sensor.

If the issue persists, call 24-Hour Technical Support for assistance.

# 15

Maintenance





# Maintenance

## Cleaning your pump



**CAUTION:** Never use organic solvents, such as lighter fluid, nail polish remover, or paint thinner to clean your pump. Never use lubricants with your pump. When you clean your pump, be sure to keep the reservoir compartment dry and away from moisture. When you clean your pump with organic solvents, it can cause the pump to malfunction and result in minor injury.

Make sure you have the following supplies ready for cleaning your pump: three or four small, clean, soft cloths, a mixture of water with a mild detergent, clean water, 70% alcohol, and a few clean cotton tips and cotton balls.

### To clean your pump:

1. Dampen a cloth with water mixed with a mild detergent.
2. Using the cloth, wipe the outside of the pump.
3. Dampen a clean cloth with water and wipe to remove any detergent residue.
4. Dry with a clean cloth.
5. Wipe your pump with a 70% alcohol wipe.
6. Using a dry clean cotton tip, remove any battery residue from the battery cap.
7. Using a dry clean cloth, remove any battery residue from the battery compartment opening.

## Cleaning your transmitter

Always refer to your transmitter user guide for instructions on cleaning the transmitter.

## Storing your pump

Storage mode lets you safely place your pump in storage while not in use.



**Note:** If you place your pump in storage mode, it is important to insert a new AA battery for 8 to 12 hours every six months to ensure that the internal battery does not discharge to a deep discharge. A battery that is deeply discharged may experience decreased performance.



**WARNING:** After placing your pump in storage mode, do not rely on active insulin tracked in the pump when making new Bolus Wizard calculations. Storage mode clears active insulin. Inaccurate Bolus Wizard calculations could result in inaccurate insulin delivery, and serious injury.

### To place your pump in storage mode:

1. Remove the AA battery from the pump. For details, see *Removing the battery*, on page 41.



**Note:** When you remove the battery, your pump issues an Insert Battery alarm for 10 minutes or until you place your pump into storage mode.

2. Press and hold  for eight seconds or more to turn the pump power off completely.



**CAUTION:** Never expose the pump to temperatures below -4°F (-20°C) or above 122°F (50°C) while it is in storage without a battery. Storing your pump in temperatures outside of this range can damage your pump.

### To wake your pump from storage mode:

1. Insert a new AA battery into your pump. For details, see *Inserting the battery, on page 40*.  
A Pump Error message appears.
2. Select **OK**.  
Your pump displays a Power Loss alarm.
3. Select **OK**.  
The Time & Date screen appears.
4. Enter the current **Time, Time Format, and Date**.
5. Select **Save**.  
Your pump displays an Active Insulin Cleared alert.
6. Select **OK**.  
Make sure that all of your settings, such as basal rate, are set as desired. If you need to, reapply your last saved settings by using the Restore Settings option as instructed in *Restoring your settings, on page 165*.
7. You must repeat the pairing process for your transmitter and meter. For transmitter details, see *Pairing your pump and transmitter, on page 201*. For meter details, see *Pairing your pump and meter, on page 136*.

## Storing your transmitter

Always refer to your transmitter user guide for instructions on storing your transmitter.

## Pump disposal

Contact 24-Hour Technical Support for information on the proper disposal of the MiniMed 770G insulin pump. Always follow local laws and regulations for the disposal of medical devices.

# 16



# 16

## Product specifications and safety information

This chapter provides detailed product specifications and safety information.

### Product specifications

This section provides detailed information on product specifications.

### Alarm and alert escalation

The following alerts may escalate to a siren if not cleared:

- Alert before high
- Alert before low
- Alert on high
- Alert on low
- Basal delivery resumed
- BG not received
- Calibration not accepted
- Calibrate now
- Change sensor
- Check connection
- Lost sensor signal
- No calibration occurred
- Possible signal interference
- High SG
- Rise Alert
- Sensor expired
- Sensor signal not found
- Low SG XX mg/dL (XX represents 50 mg/dL or below)
- Sensor updating
- Transmitter battery depleted

For alerts that escalate to a siren, the pump will begin to siren if the alert is not cleared in 10 minutes. Before the siren occurs, your pump will beep, vibrate, or both, depending on your audio settings.

Minutes	Audio	Audio and vibration	Vibration
0	Audio	Audio and vibrate	Vibrate
1	Audio	Audio and vibrate	Vibrate
2	Audio	Audio and vibrate	Vibrate
3	Audio	Audio and vibrate	Vibrate
4	Audio	Audio and vibrate	Vibrate
5	Audio	Audio and vibrate	Vibrate
6	Audio and vibrate	Audio and vibrate	Audio and vibrate
7	Audio and vibrate	Audio and vibrate	Audio and vibrate
8	Audio and vibrate	Audio and vibrate	Audio and vibrate
9	Audio and vibrate	Audio and vibrate	Audio and vibrate
10	Siren and vibrate	Siren and vibrate	Siren and vibrate



**Note:** The Medical device alarm sirens immediately when this screen appears.

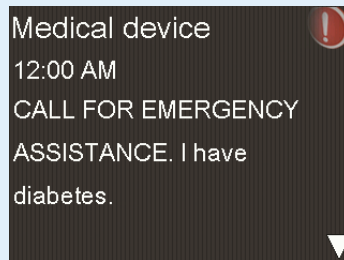

### Altitude range

- Pump operating range is from 10.2 psiA (70.33 kPa) to 15.4 psiA (106.18 kPa)
- Storage range is from 7.2 psiA (49.64 kPa) to 15.4 psiA (106.18 kPa)

### Audio frequency

The following table lists the various audible tones and their corresponding frequencies:



<b>Tone name</b>	<b>Frequency</b>
Alarm	1655 Hz followed by 3310 Hz
Alternate Alarm	1850 Hz
Siren (escalated alarm)	1655 Hz, followed by 3310 Hz
Alert	934 Hz
High Sensor Glucose	1312 Hz, followed by 1410 Hz, 1500 Hz, 1619 Hz, 1722 Hz
Low SG	1722 Hz, 1619 Hz, 1500 Hz, 1410 Hz, 1312 Hz
Lost SG	1485 Hz, followed by 1395 Hz, 1320 Hz, 1395 Hz
Message tone	1655 Hz
Reminder tone	934 Hz
Fill tubing tone	1850 Hz
Bolus delivery cancellation tone	1485 Hz, followed by 1655 Hz and 1485 Hz
Loading complete tone	934 Hz
Reservoir loading in progress tone	1850 Hz
Easy Bolus activation	1045 Hz
Easy Bolus step 1 increment	1175 Hz
Easy Bolus step 2 increment	1320 Hz
Easy Bolus step 3 increment	1395 Hz
Easy Bolus step 4 increment	1570 Hz
Easy Bolus step 5 increment	1760 Hz

## Backlight

Type	LED (Light-emitting Diode)
Time out	15 seconds (default), 30 seconds, one minute, three minutes
Time out when battery is low	15 seconds (default), 30 seconds

## Basal insulin delivery

Delivery rate range	0 to 35 units per hour or the Max Basal Rate amount, whichever is lower.
Max Basal Rate default	2 units per hour
Basal patterns	Maximum of 8 patterns. Each pattern covers a 24-hour period and can have up to 48 rates. Rates are set in 30-minute increments.
Basal pattern names	Fixed names: Basal 1, Basal 2, Basal 3, Basal 4, Basal 5, Workday, Day Off, Sick Day
Increments	<ul style="list-style-type: none"><li>• 0.025 units per hour for basal amounts in the range 0 to 0.975 units</li><li>• 0.05 units per hour for basal amounts in the range 1 to 9.95 units</li><li>• 0.1 units per hour for basal amounts of 10 to 35 units</li></ul>

## BG Target

Maximum targets	8
Range	60 to 250 mg/dL
Default value for High blood glucose (BG) targets and Low BG targets	None



**Note:** Auto Mode uses a fixed BG Target of 150 mg/dL.

## BG meter value

The most recent BG value received from the meter. If you are using an Accu-Chek Guide Link meter, this value appears on the Home screen when the Sensor feature is off. This value also appears in the Bolus Wizard screen when setting up a bolus.

Expiration	12 minutes
Range	20 to 600 mg/dL

## Bolus delivery

Bolus Speed options	<ul style="list-style-type: none"> <li>• Standard: 1.5 units/minute</li> <li>• Quick: 15 units/minute</li> </ul>
Bolus programming increments	<ul style="list-style-type: none"> <li>• 0.025 units</li> <li>• 0.05 units</li> <li>• 0.1 units</li> </ul>
Fluid delivered/stroke	<ul style="list-style-type: none"> <li>• 0.25 µL (microliter) for 0.025 unit pump stroke</li> <li>• 0.5 µL for 0.05 unit pump stroke</li> <li>• 2.0 µL for 0.2 unit pump stroke</li> </ul>

## Bolus Wizard feature default settings

Item	Default	Limits	Increments
Carb units	grams	-	-
Insulin to carb ratio	None	1–200 g/u	0.1 g/u for 1–9.9 g/u; 1 g/u for ratios of 10 g/u to 200 g/u
Insulin Sensitivity Factor	None	5–400 mg/dL	1 mg/dL
BG Target	None	60–250 mg/dL	1 mg/dL
Active Insulin Time	4 hours	2 to 8 hours	15 minutes

## Bolus Wizard feature specifications

There are four different formulas the Bolus Wizard feature uses to estimate a bolus, depending on your current BG. The following formulas apply only when the carb units are in grams.

1. If your current BG is greater than your High BG Target, the Bolus Wizard feature subtracts active insulin from the BG correction estimate, then adds this to the food estimate to get the total bolus estimate. However, if the result of subtracting active insulin from BG correction estimate is a negative number (less than zero), the total bolus estimate is based only on the food estimate.

$$\text{total bolus estimate} = \frac{\text{(food estimate)} \quad A}{B} + \frac{\text{(correction estimate)} \quad C - D}{E} - \text{active insulin}$$

where: A = food (grams)  
 B = carb ratio  
 C = current BG  
 D = High BG Target  
 E = insulin sensitivity

Food estimate:

Carb grams ÷ Carb ratio = Units of insulin

Correction estimate:

(Current BG - High BG Target) ÷ Insulin sensitivity - Active insulin = Units of insulin

Total bolus estimate:

Food estimate + Correction estimate = Units of insulin

2. If your current BG is less than your Low BG Target, the Bolus Wizard feature adds the BG correction estimate to the food estimate to get the total bolus estimate.

$$\text{total bolus estimate} = \frac{\text{(food estimate)} \quad A}{B} + \frac{\text{(correction estimate)} \quad C - D}{E}$$

where: A = food (grams)  
 B = carb ratio  
 C = current BG  
 D = Low BG Target  
 E = insulin sensitivity

Food estimate:

Carb grams ÷ Carb ratio = Units of insulin

Correction estimate:

(Current BG - Low BG Target) ÷ Insulin sensitivity = Units of insulin

Total bolus estimate:

Food estimate + Correction estimate = Units of insulin

3. If your current BG is within your High or Low BG Target, the total bolus estimate is based only on the food estimate.

$$\text{total bolus estimate} = \frac{\text{food (grams)}}{\text{carb ratio}}$$

Food estimate:

Carb grams ÷ Carb ratio = Units of insulin



**Note:** When the current BG is below the Low BG Target, an active insulin amount is not considered in the Bolus Wizard feature calculations.

Total bolus estimate = Food estimate

4. If you do not enter a BG, the total bolus estimate is based only on the food estimate.

Following are some notes about using the Bolus Wizard feature:

- If a Dual Wave bolus is less than the estimate due to the Max Bolus limit or a change that you make, the Square portion is reduced first.
- Based on the Active Insulin Time setting you choose, your pump keeps track of how much insulin is still active in your body. This is shown as Active Insulin or Act. Insulin on the Home screen, Bolus screen, Manual Bolus screen, Preset Bolus, and Daily History screens. This prevents stacking of insulin, and lowers the chances of hypoglycemia.
- The Bolus Wizard feature may utilize your current BG measurement, carbohydrate consumption, and active insulin to calculate your estimated bolus.
- The following Active Insulin Curve represents how long a bolus of insulin lowers your glucose after the bolus is given. The percentage of insulin remaining lowers at varying rates depending on how long the insulin is active in your body.

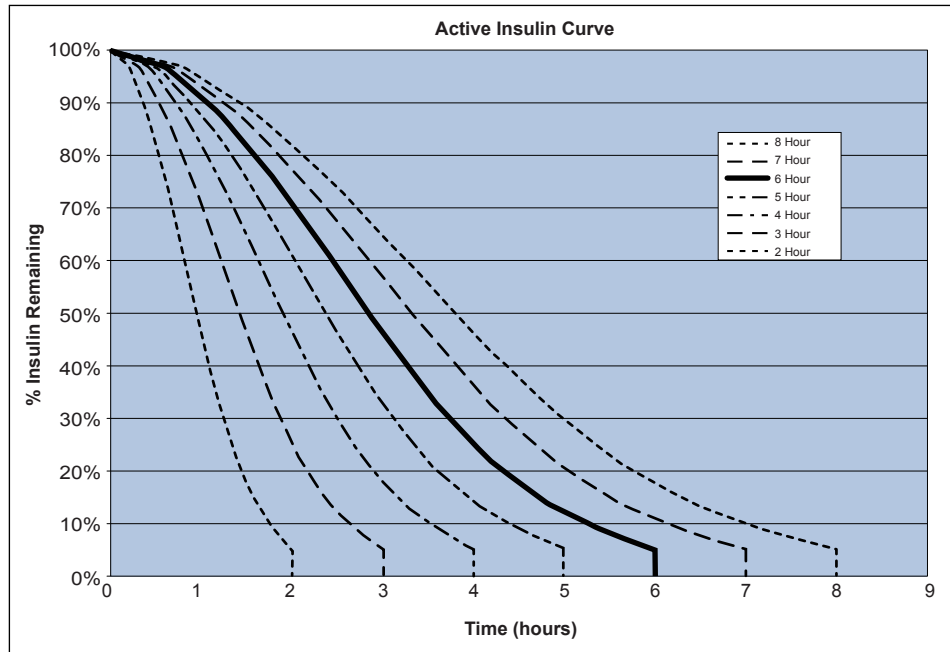

Graph adapted from Mudaliar and colleagues, Diabetes Care, Volume 22, Number 9, Sept. 1999, page 1501.

### Carb ratios

Maximum ratio settings	Range
8	1 to 200 grams/unit

### Delivery accuracy

- For a basal rate of 1.0 U/h, the delivery accuracy is  $\pm 5\%$ .  
For a basal rate of 0.025 U/h, the delivery accuracy is  $\pm 10\%$ .  
Delivery accuracy for bolus volumes  $< 0.1$  unit is  $\pm 20\%$  and delivery accuracy for bolus volumes  $\geq 0.1$  unit is  $\pm 5\%$ .
- All Normal boluses are delivered within 16 minutes, 41 seconds  $\pm 3$  seconds at Standard rate (25 units, at 1.5 units per minute), and within 1 minute, 41 seconds  $\pm 3$  seconds at Quick rate (25 units, at 15 units per minute).

- During delivery, the maximum infusion pressure generated and the occlusion threshold pressure using a 3.0-mL reservoir is 13.15 psi (90.67 kPa). The average resulting bolus volume generated upon clearing the occlusion is 0.0112 mL (equivalent to 1.12 units of U-100 insulin).
- The following image is a representative delivery accuracy curve. The Trumpet Curve represents the maximum percentage change from the expected insulin dosage for a given time interval, known as the observation window, during the infusion of insulin. The upper curve corresponds to positive changes, and the lower curve corresponds to negative changes.

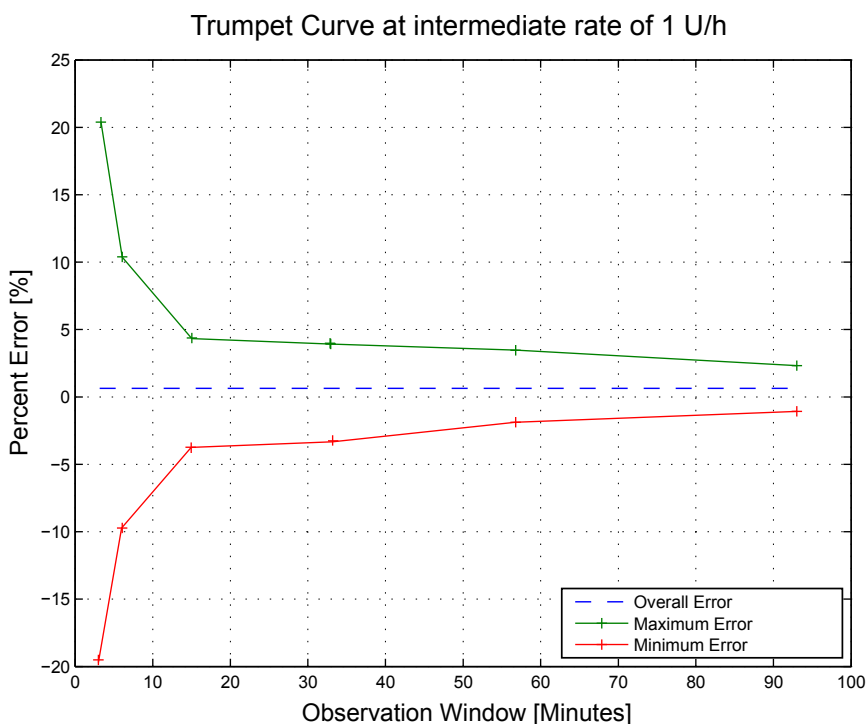

### Easy Bolus feature

The Easy Bolus feature lets the user set up and deliver a Normal Bolus when the pump is in Sleep Mode. This is done using  $\wedge$  and with the help of audio and vibration cues.

Audio mode range	0 to 20 increments or Max Bolus limit, whichever comes first
------------------	--

Vibrate mode range	0 to 20 increments or Max Bolus limit, whichever comes first
Default step size	0.1 unit
Adjustable step size	0.1 to 2 units per increment up to Max Bolus limit

## Environmental conditions

The MiniMed 770G insulin pump system is designed to withstand most conditions encountered in your daily life. For more details about environmental conditions, such as exposure to magnetic fields and radiation, waterproof capabilities, and extreme temperatures, see *User safety, on page 7*.

- Pump storage temperature range without a AA battery is from -4°F (-20°C) to 122°F (50°C).
- Pump operating temperature range is from 41°F (5°C) to 104°F (40°C).
- Operating air pressure range is from 10.2 psi (700 hPa) to 15.4 psi (1060 hPa).
- Storage air pressure range is from 7.2 psi (496.4 hPa) to 15.4 psi (1060 hPa).
- Relative humidity (RH) range during operation is from 20% to 90%.
- RH range during storage is from 5% to 95%.

## Essential performance

The pump will maintain the following functionalities to avoid under-infusion and over-infusion:

- Delivery accuracy
- Occlusion detection
- Empty reservoir detection
- Detection of power loss
- Pump therapy status–UI component: LCD
- Notification annunciation and display–UI components: piezo-electric speaker, LCD–applies to all features above

## Filling the infusion set and cannula

- The cannula can be filled from 0.025 units to 5.1 units, in increments of 0.025 units.



- The standard fill rate is 1.5 units per minute.  
The quick fill rate is 15 units per minute.
- When filling the tubing, a warning occurs at 30 units. A second warning occurs at 40 units indicating that the pump must be rewound.
- Insulin used to fill the infusion set is recorded in the Daily History.

## Infusion pressure

The maximum infusion pressure and occlusion pressure during the fill tubing process are 25 psi (172.4 kPa).

## Insulin delivery default settings

### Bolus settings

Item	Default setting	Limits	Increments
Bolus Wizard feature:	Off	-	-
Easy Bolus feature:	Off	-	-
Easy Bolus step size:	0.1 U	0.1 U to 2 U	-
Bolus increment:	0.10 U	0.025 U 0.05 U 0.10 U	-
Dual/Square bolus:	Off	-	-
Max bolus:	10 U	0 to 25 U (per single bolus)	-
Bolus BG Check Reminder:	Off	0:00 to 5:00	0:30

## Basal settings

Item	Default setting	Limits	Increments
Max Basal Rate	2 U/h	0–35 U/h	0.025 U for 0.025–0.975 U/h 0.05 U for 1.00–9.95 U/h 0.1 U for rates of 10.0 U/h or more
Basal Rate	0.000 U/h	0.000 U/h to Max Basal Rate setting	0.025 U for 0.025–0.975 U/h 0.05 U for 1.00–9.95 U/h 0.1 U for rates of 10.0 U/h or more
Temp Basal Type	Percent	Percent, Rate	N/A
Temp Basal Percent	100%	0–200%	5%
Temp Basal Rate	Current basal rate	0.0 U/hr to Max Basal Rate	0.025 U for 0.025–0.975 U/h 0.05 U for 1.00–9.95 U/h 0.1 U for rates of 10.0 U/h or more

## Insulin sensitivity factor

Maximum settings	8
Default	None. Insulin sensitivity is set during Startup of the Bolus Wizard feature.
Range	5 to 400 mg/dL/unit



**Note:** The insulin sensitivity factor only applies while the pump is in Manual Mode.

## Low Reservoir reminder

The values are based on amount shown, not actual amount.

Alert range	Increment	Default value
First reminder occurs at 5 to 50 units. Second reminder occurs at 50 percent of the remaining specified amount. The second reminder is automatic and cannot be changed by the user.	1 unit	20 units

### Max bolus

Range	0 to 25 units
Default	10 units

### Normal bolus

Range is 0.025 to 25 units of insulin, and limited by the Max Bolus setting.

### Occlusion detection

When occlusion is detected, the Insulin flow blocked alarm occurs. The occlusion alarm is triggered by an average of 2.23 units of missed insulin (standard bolus) or 1.97 units of missed insulin (quick bolus). The MiniMed 770G insulin pump is intended for use with U-100 insulin. This table shows occlusion detection for four different situations when using U-100 insulin.

Rate	Minimum time before alarm	Average time before alarm	Maximum time before alarm
bolus delivery (10 units at standard speed)	71 seconds	95 seconds	136 seconds
bolus delivery (10 units at quick speed)	9 seconds	10 seconds	14 seconds
basal delivery (1.0 u/h)	2.00 hours	2.50 hours	3.80 hours
basal delivery (0.025 u/h)	123.38 hours	142.03 hours	178.33 hours



**Note:** Certain factors, such as ambient temperature changes or the presence of air in the infusion set or the reservoir, can delay an occlusion alarm.

## Percent temp basal rate

The default value is 100 percent of basal programming. For example, if you program six units of basal per day, the default temp basal rate will be six units per day.

Range	0 to 200%
Default	100% of basal programming
Increment	5%

## Program safety checks

A single fault condition will cause the pump to suspend insulin delivery. Maximum infusion with a single fault condition is 0.2 units.

## Pump dimensions

The pump dimensions in inches are no greater than 3.78 length x 2.11 width x 0.96 depth.

The pump dimensions in centimeters are no greater than 9.60 length x 5.36 width x 2.44 depth.

## Pump memory

User settings and pump history are stored in non-volatile memory which will retain data. The memory size will hold 90 days of pump history before it becomes full and has to be written over. The viewable history on the pump is 30 days. This information can be accessed on the History screen.

## Pump weight

The mass of the insulin pump without battery and consumables is less than 106 grams.

## Sensor default settings

High sensor settings			
Item	Default setting	Limits	Increments
High SG alert limit	250 mg/dL	100 to 400 mg/dL	5 mg/dL

### High sensor settings

Item	Default setting	Limits	Increments
Alert before high	Off	-	-
Alert on high	Off	-	-
Time before high	15 minutes	5 to 30 minutes	5 minutes
Rise Alert	Off	-	-
Rise Limit	Two up arrows	<ul style="list-style-type: none"> <li>• 1 up arrow (1 mg/dL/min)</li> <li>• 2 up arrows (2 mg/dL/min)</li> <li>• 3 up arrows (3 mg/dL/min)</li> <li>• Custom limit (1.0 to 5.0 mg/dL/min)</li> </ul>	
High Snooze	1 hour	5 minutes to 3 hours	5 minutes

### Low sensor settings

Item	Default setting	Limits	Increments
Low SG alert limit	60 mg/dL	50 to 90 mg/dL	5 mg/dL
Suspend before low	Off	-	-
Suspend on low	Off	-	-
Alert before low	Off	-	-
Alert on low	Off	-	-
Low Snooze	20 minutes	5 minutes to 1 hour	5 minutes
Resume basal alert	Off	-	-

---

### Auto Mode settings

---

Item	Default setting	Limits	Increments
Auto Mode	Off	-	-
Auto Mode BG alert	On	-	-

---

## Wireless communication

The MiniMed 770G insulin pump communicates using smart device connectivity.

Operating frequency/ Modulation type(s)	2.4 GHz band, GFSK
Effective radiated power (ERP)	1.48 mW (1.69 dBm)
Effective isotropic radiated power (EIRP)	2.42 mW (3.83 dBm)

## FCC notice

This device complies with the United States Federal Communications Commission (FCC) and international standards for electromagnetic compatibility. This device complies with Part 15 of the FCC Rules. Operation is subject to the following two conditions: (1) This device may not cause harmful interference, and (2) this device must accept any interference received, including interference that may cause undesired operation. These standards are designed to provide reasonable protection against excessive radio frequency interference, and prevent undesirable operation of the devices from unwanted electromagnetic interference.

Note: This equipment has been tested and found to comply with the limits for a Class B digital device, pursuant to Part 15 of the FCC rules. These limits are designed to provide reasonable protection against harmful interference in a residential installation. This equipment generates, uses, and can radiate radio frequency energy and, if not installed and used in accordance with the instructions, may cause harmful interference to radio communications. However, there is no guarantee that interference will not occur in a particular installation. If this equipment does cause harmful interference to radio or television reception, which can be determined by turning the equipment off and on, the user is encouraged to try to correct the interference by one or more of the following measures:

- Reorient or relocate the receiving antenna.
- Increase the separation between the equipment and receiver.
- Decrease the distance between the transmitter and the insulin pump to 6 feet (1.8 meters) or less.

- Decrease the distance between the meter and the insulin pump to 6 feet (1.8 meters) or less.
- Increase the separation between the transmitter and the device that is receiving/emitting interference.

IMPORTANT: Do not change or modify the internal RF transmitter or antenna unless expressly approved by Medtronic Diabetes. Doing so could interfere with your ability to operate the equipment.

Note: Harmful interference is defined by the FCC as follows. Any emission, radiation or induction that endangers the functioning of a radio navigation service or of other safety services or seriously degrades, obstructs or repeatedly interrupts a radio communications service operating in accordance with FCC rules.

## **IEC60601-1-2:4th Edition notice**

### **IEC60601-1-2:4th Edition; Special EMC Precautions for Medical Electrical Equipment**

1. Special Precautions regarding Electromagnetic Compatibility (EMC): This body worn device is intended to be operated within a reasonable residential, domestic, public or work environment, where common levels of radiated "E" (V/m) or "H" fields (A/m) exist; such as cellular phones that are not paired with the MiniMed 770G System, Wi-Fi networks, Bluetooth wireless technology, electric can openers, microwave and induction ovens. This device generates, uses, and can radiate radio frequency energy and, if not installed and used in accordance with the provided instructions, may cause harmful interference to radio communications.
2. Portable and mobile RF communications equipment can affect Medical Electrical Equipment as well. If you encounter RF interference from a mobile or stationary RF transmitter, move away from the RF transmitter that is causing the interference.

### **IEC60601-1-2:4th Edition; 5.2.1.1**

The MiniMed 770G insulin pump should not be used adjacent to other electrical equipment. If adjacent use becomes necessary, the MiniMed 770G insulin pump should be observed to verify normal system operation.



## Guidance and manufacturer's declaration

Guidance and Manufacturer's Declaration - Electromagnetic Emissions		
<p>The MiniMed 770G insulin pump is intended for use in the electromagnetic environment specified below. The customer or the user of the MiniMed 770G insulin pump should make sure that it is used in such an environment.</p>		
Emissions Test	Compliance	Electromagnetic Environment - Guidance
<p>RF emissions</p> <p>Test: 47 CFR Part 15, Subpart C Section 15.247/FCC Part 15 Subpart B Section 15.109</p>	<ul style="list-style-type: none"> <li>• 6 dB and 99% Bandwidths: Complies</li> <li>• Maximum Output Power: Complies</li> <li>• TX Spurious Emissions: Complies</li> <li>• Power Spectral Density: Complies</li> <li>• Radiated Emission at Band Edge: Complies</li> </ul>	<p>The MiniMed 770G insulin pump must emit electromagnetic energy in order to perform its intended function. Nearby electronic equipment may be affected.</p>
<p>Harmonic emissions</p> <p>IEC 61000-3-2</p>	Not applicable	
<p>Voltage fluctuations/ flicker emissions</p> <p>IEC 61000-3-3</p>	Not applicable	
<p>RF emissions</p> <p>CISPR 11 (2009)+A1</p>	Complies Group 1 Class B	<p>The MiniMed 770G insulin pump is suitable for use in aircraft and in all establishments, including domestic and those directly connected to the public low-voltage power supply network that supplies buildings used for domestic purposes.</p>
<p>RTCA DO 160G (2010) 20.5 and 21.5</p>	Complies	

## Guidance and Manufacturer's Declaration - Electromagnetic Immunity

The MiniMed 770G insulin pump is intended for use in the electromagnetic environment specified below. The customer or the user of the MiniMed 770G insulin pump should assure that it is used in such an environment.

Immunity Test	IEC 60601-1-2 Test Level	Compliance Level	Electromagnetic Environment - Guidance
Electrostatic discharge (ESD) IEC 61000-4-2, 60601-1-2	±8 kV contact ±2, 4, 8, 15 kV air	±8 kV contact ±2, 4, 8, 15 kV air	For use in a typical domestic, commercial, or hospital environment.
Conducted disturbances induced by RF fields	3 Vrms 150 kHz to 80 MHz  6 Vrms  ISM bands between 150 kHz to 80 MHz	Not applicable	Requirement does not apply to this battery powered device.
Electrical fast transient/burst IEC 61000-4-4	±2 kV 100 kHz repetition frequency	Not applicable	Requirement does not apply to this battery powered device.
Surge IEC 61000-4-5	Line to Line: ±0.5 kV, ±1 kV  Line to Ground: ±0.5 kV, ±1 kV, ±2 kV	Not applicable	Requirement does not apply to this battery powered device.

Guidance and Manufacturer's Declaration - Electromagnetic Immunity			
Voltage dips, short interruptions, and voltage variations on power supply lines IEC 61000-4-11	0% $U_T$ ; 0.5 cycle (at 0°, 45°, 90°, 135°, 180°, 225°, 270°, and 315°) 0% $U_T$ ; 1 cycle (at 0°) 70% for 25/30 cycles (at 0°) 0% for 250/300 cycles	Not applicable	Requirement does not apply to this battery powered device.
Power frequency (50/60 Hz) electromagnetic field IEC 61000-4-8, IEC 60601-1-2	30 A/m (continuous field at 60 seconds)	30 A/m 400 A/m per IEC 60601-2-24: 1998	Power frequency magnetic fields should be at levels characteristic of a typical location in a typical commercial or hospital environment.
Proximity fields from RF wireless communications equipment IEC 61000-4-3	IEC 60601-1-2:2014, Table 9	IEC 60601-1-2:2014, Table 9	For use in a typical domestic, commercial, or hospital environment.
<b>Note:</b> $U_T$ is the a.c. mains voltage prior to application of the test level.			

## Guidance and Manufacturer's Declaration - Electromagnetic Immunity

The MiniMed 770G insulin pump is intended for use in the electromagnetic environment specified below. The customer or user of the MiniMed 770G insulin pump should assure that it is used in such an electromagnetic environment.

Immunity Test	IEC 60601-1-2 Test Level	Compliance Level	Electromagnetic Environment Guidance
Radiated RF IEC 61000-4-3 IEC 60601-1-2	10 V/m 80 MHz to 2.7 GHz 80% AM at 1 kHz	10 V/m 80 MHz to 2.7 GHz 80% AM at 1 kHz	<p>Portable and mobile RF communications equipment should be used no closer to any part of the MiniMed 770G insulin pump, including cables, than the recommended separation distance of 12 inches (30 cm).</p> <p>Field strengths from fixed RF transmitters, as determined by an electromagnetic site survey, should be less than the compliance level in each frequency range.</p> <p>Interference may occur in the vicinity of equipment marked with the following symbol:</p> 

### Icon glossary

For a definition of the symbols displayed on the device and package labels, please see <http://www.medtronicdiabetes.com/symbol-definitions>.

# 17



# 17 MiniMed 770G System Performance Data and Technical Information

## I. Performance data for users 14 years old and older

### A. Device performance for users 14 years and older

The clinical data presented in this section was obtained from studies (users ages 14 years and older) using the MiniMed 670G system. The MiniMed 770G system uses the same SmartGuard Auto Mode technology as the MiniMed 670G system. Therefore, this clinical data also applies to the MiniMed 770G system.



**CAUTION:** Since the study presented below did not include a control group, no claims regarding effectiveness can be made. However, it does support that the device is relatively safe for use.

The MiniMed 670G System can automatically increase or decrease insulin delivery when informed by continuous glucose monitoring (CGM) values; however, the user must still calculate and administer meal boluses. Previous clinical studies that did not involve the MiniMed 670G System have shown that other integrated insulin pump and CGM systems may provide better diabetes management, compared with multiple daily injections or with the pump alone. Some studies also suggest

that when you pair pump therapy with the information provided by the sensor, it may significantly improve HbA1C levels without increasing the risk of hypoglycemia.<sup>1, 2, 3</sup>

The MiniMed 670G System also features SmartGuard technology with different types of diabetes management. There are two levels of SmartGuard technology:

- The first level of SmartGuard technology automatically suspends insulin delivery when the sensor reaches a preset low limit or before the low limit is reached, referred to as Suspend on low and Suspend before low, respectively. When a Suspend on low event occurs, you can choose to continue to keep insulin delivery suspended, or you can choose to resume basal insulin delivery. When a Suspend before low occurs, basal insulin delivery will automatically resume when the sensor glucose (SG) levels recover. The Suspend on low and Suspend before low features are optional features available when the system is in Manual Mode.
- The second level of SmartGuard technology automatically calculates insulin dose using CGM data, referred to as Auto Mode. The Auto Mode feature can automatically increase or decrease the amount of insulin delivered based on sensor values. Elevated SG readings result in increased delivery rates and decreased SG values result in decreased insulin delivery rates.

During Auto Mode operation, the user must deliver meal boluses by entering the estimated amount of carbohydrates for meals at the time they are eaten. Failure to deliver meal boluses in association with meals during Auto Mode operation can result in significant post meal hyperglycemia.

Since adjustments to insulin delivery rates when the system is in Auto Mode are based on SG readings, it is critical to monitor blood glucose (BG) values using a home glucose meter regardless of whether the system is operating in the Manual Mode or the Auto Mode. If these home glucose meter measurements indicate

- 
- 1 Bergenstal RM, Tamborlane WV, Ahmann A, et al. Effectiveness of sensor-augmented insulin-pump therapy in type 1 diabetes [STAR3 Study]. *N Engl J Med.*2010;363:311–320.
  - 2 Battelino T, Conget I, Olsen B, et al. The use and efficacy of continuous glucose monitoring in type 1 diabetes treated with insulin pump therapy [SWITCH study]. *Diabetologia.* 2012 Dec;55(12):3155-62. doi: 10.1007/s00125-012-2708-9. Epub 2012 Sept 11.
  - 3 Bergenstal RM, Klonoff DC, Bode BW, et al. Threshold-based insulin-pump interruption for reduction of hypoglycemia [ASPIRE in-home study]. *N Engl J Med.* 2013;369(3):224-232.



hypoglycemia or hyperglycemia, you must follow your physician's instruction for treating these conditions and you should not rely on the MiniMed 670G System to automatically restore your glucose levels to normal.

The SmartGuard technology contains two insulin delivery suspend options: Suspend on low and Suspend before low. The Suspend on low was previously evaluated and is currently available on commercially available pumps (MiniMed 530G Pump and MiniMed 630G Pump).

The Suspend before low feature was evaluated for safety in a multi-center, single-arm, in-clinic study.<sup>4</sup> Study subjects included persons aged 14 to 75 years diagnosed with type 1 diabetes mellitus who were on pump therapy at the time of screening. A total of 71 subjects were subjected to hypoglycemic induction, followed by an observation period. For hypoglycemic induction, the target was set to 65 mg/dL, using the rate of change basal increase algorithm. Suspend before low was activated with the Low Limit setting for Suspend before low ON set to 65 mg/dL, and the subject was observed with frequent sample testing (FST) for a maximum of 19 hours. The observation period included the suspension period, the insulin resumption period, and if applicable, an insulin resuspension after basal insulin delivery resumed.

Five adverse events were reported during the study. Four adverse events were neither device nor procedure related. One adverse event was procedure related.

Data from this in-clinic study demonstrated that the Suspend before low feature is safe to use. Study success criteria, as defined in the protocol, were met (i.e. there were no device related serious adverse events, no diabetic ketoacidosis events related to the Suspend before low feature, and no unanticipated adverse device effects).

The second level of SmartGuard technology was evaluated under a pivotal, single-arm, multi-center, home and hotel study in subjects with type 1 diabetes on insulin pump therapy.<sup>5</sup> Study subjects included persons aged 14 to 75 years

---

4 Buckingham B.A., Bailey T.S., Christiansen M., Garg S., Weinzimer S., Bode B., Anderson S.M., Brazg R., Ly T.T., Kaufman F.R. Evaluation of a Predictive Low-Glucose Management System In-Clinic. *Diabetes Technology and Therapeutics* (2017) 19:5 (288-292).

5 Bergenstal RM, Garg S, Weinzimer SA, et al. Safety of a hybrid closed-loop insulin delivery system in patients with type 1 diabetes. *JAMA - Journal of the American Medical Association*. 2016;316(13): 1407-1408.

diagnosed with type 1 diabetes mellitus for two years or more that had used pump therapy for more than 6 months prior to screening. Study subjects had an HbA1C value of less than 10.0% at the time of screening.

This study consisted of a 2-week run-in phase and a 3-month study phase. A total of 124 subjects used the MiniMed 670G System in Manual Mode only first, before transitioning to Auto Mode during the study phase. In addition to system use at home, the study phase included a 6-day and 5-night hotel stay during which subjects underwent daytime and nighttime FST for a total of approximately 24 hours. Subjects were allowed to eat as they normally would, and participated in a daily exercise or activity regimen for a minimum of 4 hours per day, spread throughout the day, during the hotel stay. Two of the 124 subjects did not participate in a hotel stay. One of these two subjects withdrew from the study.

The MiniMed 670G System was used for 12,389 patient days. No serious adverse events, diabetic ketoacidosis (DKA), or severe hypoglycemia were reported during the study. Compared to Manual Mode use during the run-in phase, use of the system was associated with a higher percentage of SG values within the range of 71–180 mg/dL and lower percentage of SG values in the low and high glucose ranges. A change in mean A1C from  $7.4 \pm 0.91$  (median 7.3) at the start of the study to  $6.9 \pm 0.61$  (6.8) at the end of the study was observed. This observation was associated with a modest increase in the mean total daily dose of insulin (47.5 baseline to 50.9) and mild increase in mean weight (76.9 baseline to 77.6).

Device related adverse events reported during the different phases of the pivotal trial are listed in the following table.

<b>Event</b>	<b>Run-In Period</b>	<b>Study Period</b>
Severe hyperglycemia	5	12
Hyperglycemia	0	6
Skin irritation	3	0
Irritation on sensor site	0	1
Rash	0	1

The following table shows the time spent per day in specific glucose ranges during the run-in and study phases by all subjects.

Glucose Range (mg/dL)	Run-In Phase Time in Glucose Range Mean ±SD	Study Phase Time in Glucose Range Mean ±SD
≤50	12.8 mins ± 14.5 mins	7.7 mins ± 7.6 mins
≤60	35.2 mins ± 31.2 mins	19.9 mins ± 14.8 mins
≤70	1 hr 18.6 mins ± 55.3 mins	42.9 mins ± 25.4 mins
70–180	14 hrs 54.4 mins ± 3 hrs 1.4 min	16 hrs 2.2 mins ± 2 hrs 35.6 mins
>180	6 hrs 2.1 mins ± 2 hrs 52.7 mins	5 hrs 20.7 mins ± 1 hr 46.9 mins
>250	1 hr 30.4 mins ± 1 hr 32.3 mins	1 hr 12.1 mins ± 52.6 mins
>300	29.6 mins ± 51.7 mins	21.1 mins ± 22.2 mins
>350	8.9 mins ± 20.7 mins	6.1 mins ± 8.35 mins

The following table shows the range of changes in HbA1C observed in the study and indicates the number of subjects that demonstrated each type of change in HbA1C observed.

HbA1C Change Range	Number of Subjects (% of Subjects) with Change in A1C					
	Baseline A1C (%)	Decrease >1%	Decrease 0 to 1%	No Change	Increase 0 to 1%	Increase >1%
5% ≤ A1C < 6%		0 (0.0%)	1 (0.8%)	0 (0.0%)	3 (2.4%)	0 (0.0%)
6% ≤ A1C < 7%		1 (0.8%)	20 (16.1%)	5 (4.0%)	11 (8.9%)	0 (0.0%)
7% ≤ A1C < 8%		8 (6.5%)	34 (27.4%)	1 (0.8%)	9 (7.3%)	0 (0.0%)
8% ≤ A1C < 9%		11 (8.9%)	12 (9.7%)	1 (0.8%)	0 (0.0%)	0 (0.0%)
9% ≤ A1C < 10%		6 (4.8%)	0 (0.0%)	0 (0.0%)	0 (0.0%)	0 (0.0%)
Overall		26 (21.0%)	67 (54.0%)	7 (5.6%)	23 (18.5%)	0 (0.0%)

The following table shows the number of subjects that spent a specific range of time per day in specific glucose ranges during the study phase.

Time Range	Number of Subjects (% of Subjects) in the Glucose Range (mg/dL) Indicated							
	≤50	≤60	≤70	70 to 180	>180	>250	>300	>350
0 to 15 mins	105 (84.7%)	58 (46.8%)	12 (9.7%)	0 (0.0%)	0 (0.0%)	8 (6.5%)	66 (53.2%)	112 (90.3%)
15 to 30 mins	16 (12.9%)	43 (34.7%)	33 (26.6%)	0 (0.0%)	0 (0.0%)	16 (12.9%)	31 (25.0%)	6 (4.8%)
30 to 45 mins	3 (2.4%)	12 (9.7%)	29 (23.4%)	0 (0.0%)	0 (0.0%)	24 (19.4%)	12 (9.7%)	6 (4.8%)
45 mins to 1 hr	0 (0.0%)	10 (8.1%)	25 (20.2%)	0 (0.0%)	0 (0.0%)	17 (13.7%)	6 (4.8%)	0 (0.0%)
1 to 4 hr	0 (0.0%)	1 (0.8%)	25 (20.2%)	0 (0.0%)	34 (27.4%)	58 (46.8%)	9 (7.3%)	0 (0.0%)
4 to 8 hr	0 (0.0%)	0 (0.0%)	0 (0.0%)	0 (0.0%)	83 (66.9%)	1 (0.8%)	0 (0.0%)	0 (0.0%)
8 to 12 hr	0 (0.0%)	0 (0.0%)	0 (0.0%)	12 (9.7%)	7 (5.6%)	0 (0.0%)	0 (0.0%)	0 (0.0%)
12 to 16 hr	0 (0.0%)	0 (0.0%)	0 (0.0%)	38 (30.6%)	0 (0.0%)	0 (0.0%)	0 (0.0%)	0 (0.0%)
16 to 20 hr	0 (0.0%)	0 (0.0%)	0 (0.0%)	70 (56.5%)	0 (0.0%)	0 (0.0%)	0 (0.0%)	0 (0.0%)
20 to 24 hr	0 (0.0%)	0 (0.0%)	0 (0.0%)	4 (3.2%)	0 (0.0%)	0 (0.0%)	0 (0.0%)	0 (0.0%)

The following table shows the average amount of time spent in Auto Mode per day.

Table A-5: Time Spent in Auto Mode at Different Glucose Ranges during the Study Phase	
Glucose Range (mg/dL)	Study Phase Time in Glucose Range Mean±SD (95% CI)
≤50	4.8 mins ± 4.6 mins (4.0 mins, 5.6 mins)
≤60	13.2 mins ± 10.1 mins (11.4 mins, 15.0 mins)
≤70	29.9 mins ± 18.8 mins (26.6 mins, 33.2 mins)
70 to 180	13 hrs 50.3 mins ± 3 hrs 1.4 mins (13 hrs 18.1 min, 14 hrs 22.5 mins)
>180	4 hrs 5.2 mins ± 1 hr 5.0 mins (3 hrs 53.7 mins, 4 hrs, 16.8 mins)
>250	44.8 mins ± 24.9 mins (40.4 mins, 49.2 mins)
>300	9.3 mins ± 7.6 mins (8.0 mins, 10.7 mins)
>350	1.7 mins ± 2.0 mins (1.3 mins, 2.0 mins)
All	18 hrs 25.4 mins ± 2 hrs 44.4 mins (17 hrs 56.2 mins, 18 hrs 54.7 mins)

The pivotal clinical trial of the MiniMed 670G System suggested that the system was safe; however, this trial had a number of limitations which included the following:

- The study involved a relatively small number of patients.
- There was no control group for comparison purposes.
- The amount of time the system was used in the Manual Mode was much shorter than the time it was programmed to the Auto Mode. Additionally, for each subject, the study period lasted only three months.

Due to these limitations, the results of the clinical trial must be interpreted with caution and you should understand that your individual results when using the MiniMed 670G System may be significantly different from those of the subjects who participated in the trial.

## B. Guardian Sensor (3) Performance for 14 years old and older CGM performance

The use of the Guardian Sensor (3) with the Guardian Link (3) transmitter enables CGM technology. The transmitter transmits SG values calculated by the real-time algorithm to a primary display device, allowing you to monitor your SG values.

## Clinical study description

The performance of the Guardian Sensor (3) was evaluated in a clinical study.<sup>6</sup> This inpatient (in-clinic) and outpatient (at home) study included subjects 14 to 75 years in age. The study design was a multi-center, prospective single-sample correlational design without controls.

All subjects were assigned to treatment. Three sensors were worn at the same time by each subject.

Each subject was instructed to wear two real-time CGM systems in the abdomen area:

- One Guardian Sensor (3) connected to the Guardian Link (3) transmitter, which transmitted to the insulin pump (for display purposes only).
- One Guardian Sensor (3) connected to the Guardian Connect transmitter which transmitted to the Guardian Connect app, a standalone CGM display device.

Each subject was also instructed to wear another Guardian Sensor (3) in the arm area that was connected to a blinded glucose sensor recorder (GSR).

The SG data collected by the blinded GSRs were retrospectively processed through the real-time CGM algorithm. This is the same algorithm used in the Guardian Connect and pump CGM systems. Thus all data is representative of real-time sensor usage.

The CONTOUR NEXT LINK 2.4 Wireless Meter was the study meter used for all calibrations in this study, and was the only meter evaluated with the Guardian Sensor (3) CGM systems. The sensor has not been tested with other meters. Therefore, the performance with other BG meters may differ from the performance with the CONTOUR NEXT LINK 2.4 Wireless Meter described below.

FST was performed on days 1, 3, and 7 over the life of the sensor. Reference blood (plasma) glucose values were obtained with a Yellow Springs Instrument (YSI) Glucose Analyzer every 5 to 15 minutes. During the FSTs, the subjects were instructed to calibrate the sensors once every 12 hours, or as requested by the display device. During home use (outside the clinic), subjects were instructed to calibrate both sensors 3 or 4 times spread throughout the day.

---

<sup>6</sup> Medtronic Inc., A Performance Evaluation of the Enlite™ 3 Glucose Sensor to Support a Full 168 hours (7 Days) of Use, CER292DOC/F. Oct 2016.

A total of 93 subjects previously diagnosed with type 1 or 2 diabetes were enrolled in the study, and 88 subjects participated in at least one day of FST. The overall number of subjects that participated in FST procedures on days 1, 3, and 7 were 88, 87, and 79, respectively. During each FST period, subjects with an established insulin sensitivity ratio and insulin carbohydrate ratio underwent a hypoglycemic challenge and a hyperglycemic challenge to evaluate performance at high and low glycemic ranges.

During the study, subjects were instructed to continue with their current diabetes regimen (including glucose monitoring with their own meter when appropriate) independent of their use of the study devices. The insulin pumps were not used to infuse insulin, and neither of the two real-time CGM systems nor the blinded GSR system was used to manage diabetes during this study. The study meter was used for confirmation of alerts, treatment decisions, and sensor calibrations.

## Results

### Sensor accuracy

The following information highlights the Guardian Sensor (3) performance from 88 subjects only during FST.

### Mean absolute relative difference, by number of daily calibrations

Table B-1 shows the sensor accuracy measured by the mean absolute relative difference (MARD). MARD represents the average relative difference (regardless if positive or negative) between the SG values and the paired BG values measured by YSI.

YSI glucose ranges (mg/dL)	Abdomen Insertion Site				Arm Insertion Site			
	Calibration every 12 hours		Calibration 3 or 4 times a day		Calibration every 12 hours		Calibration 3 or 4 times a day	
	Number of paired SG-YSI	MARD (%)	Number of paired SG-YSI	MARD (%)	Number of paired SG-YSI	MARD (%)	Number of paired SG-YSI	MARD (%)
Overall	12090	10.55	11664	9.64	10526	9.09	10771	8.68
<40*	12	17.03	11	16.41	7	17.24	7	17.24
40–60*	353	7.96	324	7.53	335	6.44	349	6.42
61–80*	1445	9.44	1403	8.81	1345	7.76	1372	7.44
81–180	6505	9.94	6342	9.33	5644	8.64	5795	8.35
181–300	3277	10.00	3114	8.57	2766	8.58	2785	7.95
301–350	366	9.63	341	8.13	308	9.09	338	8.27

YSI glucose ranges (mg/dL)	Abdomen Insertion Site				Arm Insertion Site			
	Calibration every 12 hours		Calibration 3 or 4 times a day		Calibration every 12 hours		Calibration 3 or 4 times a day	
	Number of paired SG-YSI	MARD (%)	Number of paired SG-YSI	MARD (%)	Number of paired SG-YSI	MARD (%)	Number of paired SG-YSI	MARD (%)
351–400	117	9.58	114	8.56	111	8.47	115	8.23
>400	15	10.85	15	10.92	10	10.71	10	11.44

\* For YSI reference range  $\leq 80$  mg/dL, the differences in mg/dL are included instead of percent difference (%).

Note: SG Readings are within 40-400 mg/dL.

## Percent agreement, by number of daily calibrations

In Tables B-2 through B-9, the agreement of the SG values to paired YSI values was assessed by calculating the percentage of YSI values that were within 15%, 20%, 30%, 40% and greater than 40% of the paired SG values. For readings less than or equal to 80 mg/dL, the absolute difference in mg/dL between the SG and paired YSI values was calculated.

Results are shown for defined SG ranges when calibrating every 12 hours and calibrating three or four times a day for sensors.

SG ranges (mg/dL)	Number of paired SG-YSI	Percent of YSI within 15/15% of SG (%)	Percent of YSI within 20/20% of SG (%)	Percent of YSI within 30/30% of SG (%)	Percent of YSI within 40/40% of SG (%)	Percent of YSI greater than 40/40% of SG (%)
Overall	12090	76.6	85.7	94.3	97.3	2.7
$\geq 40$ –60*	781	57.7	73.2	90.7	96.9	3.1
>60–80*	1350	76.1	83.4	93.4	96.8	3.2
>80–180	6769	76.5	85.3	93.5	96.5	3.5
>180–300	2833	80.8	90	97.1	98.9	1.1
>300–350	286	86.4	95.1	99.7	100	0
>350–400	71	93	100	100	100	0

\* For reference range  $\leq 80$  mg/dL, agreement was based on 15/20/30/40 mg/dL.

Note: SG Readings are within 40–400 mg/dL.

SG ranges (mg/dL)	Number of paired SG-YSI	Percent of YSI within 15/15% of SG (%)	Percent of YSI within 20/20% of SG (%)	Percent of YSI within 30/30% of SG (%)	Percent of YSI within 40/40% of SG (%)	Percent of YSI greater than 40/40% of SG (%)
Overall	4294	65.3	76.6	89.5	94.7	5.3
$\geq 40$ –60*	278	46.8	61.9	83.5	94.2	5.8
>60–80*	474	61	71.7	88	93.5	6.5
>80–180	2443	64.9	75.4	87.6	93.2	6.8

**Table B-3: Agreement (%) of SG paired points within SG ranges on FST Day 1; Calibration every 12 hours, Abdomen.**

SG ranges (mg/dL)	Number of paired SG-YSI	Percent of YSI within 15/15% of SG (%)	Percent of YSI within 20/20% of SG (%)	Percent of YSI within 30/30% of SG (%)	Percent of YSI within 40/40% of SG (%)	Percent of YSI greater than 40/40% of SG (%)
>180-300	985	71.6	83.8	95.5	98.5	1.5
>300-350	90	82.2	95.6	100	100	0
>350-400	24	91.7	100	100	100	0

\* For reference range  $\leq 80$  mg/dL, agreement was based on 15/20/30/40 mg/dL.

**Note:** The overall number of available paired SG-YSI points on FST Day 1 was from 88 subjects. SG Readings are within 40-400 mg/dL.

**Table B-4: Overall agreement (%) of SG-YSI paired points within SG ranges on FST Days 1, 3, and 7; Calibration 3 or 4 times a day, Abdomen.**

SG ranges (mg/dL)	Number of paired SG-YSI	Percent of YSI within 15/15% of SG (%)	Percent of YSI within 20/20% of SG (%)	Percent of YSI within 30/30% of SG (%)	Percent of YSI within 40/40% of SG (%)	Percent of YSI greater than 40/40% of SG (%)
Overall	11664	80.6	88.9	95.9	98.2	1.8
$\geq 40-60^*$	686	60.2	75.1	92	98.1	1.9
$>60-80^*$	1303	78.7	85.7	93.5	96.7	3.3
$>80-180$	6549	79.9	88.5	95.7	98	2
$>180-300$	2782	86.4	93.5	98	99.4	0.6
$>300-350$	279	92.5	97.8	99.6	100	0
$>350-400$	65	95.4	100	100	100	0

\* For reference range  $\leq 80$  mg/dL, agreement was based on 15/20/30/40 mg/dL.

**Note:** SG Readings are within 40-400 mg/dL.

**Table B-5: Agreement (%) of SG paired points within SG ranges on FST Day 1; Calibration 3 or 4 times a day, Abdomen.**

SG ranges (mg/dL)	Number of paired SG-YSI	Percent of YSI within 15/15% of SG (%)	Percent of YSI within 20/20% of SG (%)	Percent of YSI within 30/30% of SG (%)	Percent of YSI within 40/40% of SG (%)	Percent of YSI greater than 40/40% of SG (%)
Overall	4136	71.4	81.9	92.3	96.3	3.7
$\geq 40-60^*$	247	50.2	64.4	84.6	95.5	4.5
$>60-80^*$	429	66.2	73.9	86.5	92.8	7.2
$>80-180$	2353	70.6	81.4	91.8	95.5	4.5
$>180-300$	988	78.6	89.1	97.2	99.5	0.5
$>300-350$	97	88.7	96.9	100	100	0
$>350-400$	22	100	100	100	100	0

\* For reference range  $\leq 80$  mg/dL, agreement was based on 15/20/30/40 mg/dL.

**Note:** The overall number of available paired SG-YSI points on FST Day 1 was from 88 subjects. SG Readings are within 40-400 mg/dL.

**Table B-6: Overall agreement (%) of SG-YSI paired points within SG ranges on FST Days 1, 3, and 7; Calibration every 12 hours, Arm.**

SG ranges (mg/dL)	Number of paired SG-YSI	Percent of YSI within 15/15% of SG (%)	Percent of YSI within 20/20% of SG (%)	Percent of YSI within 30/30% of SG (%)	Percent of YSI within 40/40% of SG (%)	Percent of YSI greater than 40/40% of SG (%)
Overall	10526	82.5	90.3	96.3	98.7	1.3
$\geq 40-60^*$	520	77.1	86.9	96	99.6	0.4



**Table B-6: Overall agreement (%) of SG-YSI paired points within SG ranges on FST Days 1, 3, and 7; Calibration every 12 hours, Arm.**

SG ranges (mg/dL)	Number of paired SG-YSI	Percent of YSI within 15/15% of SG (%)	Percent of YSI within 20/20% of SG (%)	Percent of YSI within 30/30% of SG (%)	Percent of YSI within 40/40% of SG (%)	Percent of YSI greater than 40/40% of SG (%)
>60–80*	1238	88.2	92.5	96.4	99	1
>80–180	5957	80.3	88.5	95.5	98.2	1.8
>180–300	2495	85	93.2	98	99.4	0.6
>300–350	256	90.6	96.9	100	100	0
>350–400	60	90	93.3	100	100	0

\* For reference range  $\leq 80$  mg/dL, agreement was based on 15/20/30/40 mg/dL.

Note: SG Readings are within 40–400 mg/dL.

**Table B-7: Agreement (%) of SG-YSI paired points within SG ranges on FST Day 1; Calibration every 12 hours, Arm.**

SG ranges (mg/dL)	Number of paired SG-YSI	Percent of YSI within 15/15% of SG (%)	Percent of YSI within 20/20% of SG (%)	Percent of YSI within 30/30% of SG (%)	Percent of YSI within 40/40% of SG (%)	Percent of YSI greater than 40/40% of SG (%)
Overall	3390	74.7	84.2	93.2	97.8	2.2
$\geq 40$ –60*	168	60.1	73.2	90.5	98.8	1.2
>60–80*	339	75.5	79.4	88.8	97.3	2.7
>80–180	2017	73.2	83.1	92	97	3
>180–300	760	80.5	90.8	98.2	99.6	0.4
>300–350	91	84.6	93.4	100	100	0
>350–400	15	60	73.3	100	100	0

\* For reference range  $\leq 80$  mg/dL, agreement was based on 15/20/30/40 mg/dL.

Note: The overall number of available paired SG-YSI points on FST Day 1 was from 82 subjects. SG Readings are within 40–400 mg/dL.

**Table B-8: Overall agreement (%) of SG-YSI paired points within SG ranges on FST Days 1, 3, and 7; Calibration 3 or 4 times a day, Arm.**

SG ranges (mg/dL)	Number of paired SG-YSI	Percent of YSI within 15/15% of SG (%)	Percent of YSI within 20/20% of SG (%)	Percent of YSI within 30/30% of SG (%)	Percent of YSI within 40/40% of SG (%)	Percent of YSI greater than 40/40% of SG (%)
Overall	10771	84.3	91.6	97.3	99.1	0.9
$\geq 40$ –60*	503	77.1	87.5	96.6	99.6	0.4
>60–80*	1291	89.3	93.4	97.7	99.1	0.9
>80–180	6076	82	90	96.7	98.7	1.3
>180–300	2569	87	94.4	98.3	99.7	0.3
>300–350	271	94.8	98.5	100	100	0
>350–400	61	95.1	96.7	100	100	0

\* For reference range  $\leq 80$  mg/dL, agreement was based on 15/20/30/40 mg/dL.

Note: SG Readings are within 40–400 mg/dL.

**Table B-9: Agreement (%) of SG-YSI paired points within SG ranges on FST Day 1; Calibration 3 or 4 times a day, Arm.**

SG ranges (mg/dL)	Number of paired SG-YSI	Percent of YSI within 15/15% of SG (%)	Percent of YSI within 20/20% of SG (%)	Percent of YSI within 30/30% of SG (%)	Percent of YSI within 40/40% of SG (%)	Percent of YSI greater than 40/40% of SG (%)
Overall	3591	76.8	86	95	98.5	1.5

Table B-9: Agreement (%) of SG-YSI paired points within SG ranges on FST Day 1; Calibration 3 or 4 times a day, Arm.

SG ranges (mg/dL)	Number of paired SG-YSI	Percent of YSI within 15/15% of SG (%)	Percent of YSI within 20/20% of SG (%)	Percent of YSI within 30/30% of SG (%)	Percent of YSI within 40/40% of SG (%)	Percent of YSI greater than 40/40% of SG (%)
≥40–60*	162	62.3	75.3	91.4	98.8	1.2
>60–80*	346	76.3	81.5	92.8	97.4	2.6
>80–180	2108	75.1	85	94.2	98	2
>180–300	869	81.8	91	97.7	99.9	0.1
>300–350	93	92.5	96.8	100	100	0
>350–400	13	84.6	84.6	100	100	0

\* For reference range ≤80 mg/dL, agreement was based on 15/20/30/40 mg/dL.

Note: The overall number of available paired SG-YSI points on FST Day 1 was from 83 subjects. SG Readings are within 40–400 mg/dL.

### Agreement when the CGM system reads “Below 40 mg/dL” or “Above 400 mg/dL”

The real-time CGM systems display glucose values between 40 mg/dL and 400 mg/dL. It displays “Below 40 mg/dL” when the SG value detected is below 40 mg/dL. It displays “Above 400 mg/dL” when the SG value detected is above 400 mg/dL. Tables B-10, B-11, B-12, and B-13 illustrate the number and percentage of the paired YSI values in different BG levels when the CGM system displays “Below 40 mg/dL” (LOW) or “Above 400 mg/dL” (HIGH).

Table B-10: The number and percentage of YSI values collected when CGM displays “Below 40 mg/dL” (LOW); Calibration every 12 hours.

CGM Display	Insertion Site	CGM-YSI pairs	YSI (mg/dL)					Total
			<55	<60	<70	<80	>80	
LOW	Abdomen	Cumulative, n	42	77	139	150	4	154
		Cumulative %	27%	50%	90%	97%	3%	100%
	Arm	Cumulative, n	17	35	67	74	1	75
		Cumulative %	23%	47%	89%	99%	1%	100%

Table B-11: The number and percentage of YSI values collected when CGM displays “Below 40 mg/dL” (LOW); Calibration 3 or 4 times a day.

CGM Display	Insertion Site	CGM-YSI pairs	YSI (mg/dL)					Total
			<55	<60	<70	<80	>80	
LOW	Abdomen	Cumulative, n	33	64	108	119	4	123
		Cumulative %	27%	52%	88%	97%	3%	100%
	Arm	Cumulative, n	18	35	66	72	1	73
		Cumulative %	25%	48%	90%	99%	1%	100%

**Table B-12: The number and percentage of YSI values collected when CGM displays "Above 400 mg/dL" (HIGH); Calibration every 12 hours.**

CGM Display	Insertion Site	CGM-YSI pairs	YSI (mg/dL)					Total
			<340	<320	<280	<240	>240	
HIGH	Abdomen	Cumulative, n	8	9	9	9	0	9
		Cumulative %	89%	100%	100%	100%	0%	100%
	Arm	Cumulative, n	8	8	9	9	0	9
		Cumulative %	89%	89%	100%	100%	0%	100%

**Table B-13: The number and percentage of YSI values collected when CGM displays "Above 400 mg/dL" (HIGH); Calibration 3 or 4 times a day.**

CGM Display	Insertion Site	CGM-YSI pairs	YSI (mg/dL)					Total
			<340	<320	<280	<240	>240	
HIGH	Abdomen	Cumulative, n	8	9	9	9	0	9
		Cumulative %	89%	100%	100%	100%	0%	100%
	Arm	Cumulative, n	8	8	8	8	0	8
		Cumulative %	100%	100%	100%	100%	0%	100%

### Concurrence of SG and YSI values

Tables B-14 through B-21 show, for each SG range, the percentage of concurring data points where the paired YSI values were in different BG ranges.

**Table B-14: Overall concurrence of YSI values and SG readings using SG ranges on FST Days 1, 3, and 7; Calibration every 12 hours, Abdomen**

Percent of matched pairs in each YSI glucose range for each SG range (mg/dL)												
SG ranges (mg/dL)	Number of paired SG-YSI	YSI Glucose Range (mg/dL)										
		<40	≥40-60	>60-80	>80-120	>120-160	>160-200	>200-250	>250-300	>300-350	>350-400	>400
A) <40	154	0.0% (0/154)	50.0% (77/154)	47.4% (73/154)	2.6% (4/154)	0.0% (0/154)	0.0% (0/154)	0.0% (0/154)	0.0% (0/154)	0.0% (0/154)	0.0% (0/154)	0.0% (0/154)
B) ≥40-60	781	1.2% (9/781)	30.7% (240/781)	57.2% (447/781)	10.6% (83/781)	0.3% (2/781)	0.0% (0/781)	0.0% (0/781)	0.0% (0/781)	0.0% (0/781)	0.0% (0/781)	0.0% (0/781)
C) >60-80	1350	0.2% (3/1350)	8.3% (112/1350)	60.1% (811/1350)	29.2% (394/1350)	2.1% (28/1350)	0.1% (2/1350)	0.0% (0/1350)	0.0% (0/1350)	0.0% (0/1350)	0.0% (0/1350)	0.0% (0/1350)
D) >80-120	2953	0.0% (0/2953)	0.0% (1/2953)	6.3% (185/2953)	73.0% (2157/2953)	18.2% (537/2953)	2.0% (60/2953)	0.4% (13/2953)	0.0% (0/2953)	0.0% (0/2953)	0.0% (0/2953)	0.0% (0/2953)
E) >120-160	2784	0.0% (0/2784)	0.0% (0/2784)	0.1% (2/2784)	8.8% (245/2784)	67.7% (1885/2784)	20.3% (565/2784)	2.8% (79/2784)	0.3% (8/2784)	0.0% (0/2784)	0.0% (0/2784)	0.0% (0/2784)
F) >160-200	1875	0.0% (0/1875)	0.0% (0/1875)	0.0% (0/1875)	0.1% (2/1875)	10.0% (188/1875)	60.2% (1128/1875)	28.2% (529/1875)	1.5% (28/1875)	0.0% (0/1875)	0.0% (0/1875)	0.0% (0/1875)
G) >200-250	1382	0.0% (0/1382)	0.0% (0/1382)	0.0% (0/1382)	0.0% (0/1382)	0.3% (4/1382)	8.0% (111/1382)	61.1% (844/1382)	28.1% (389/1382)	2.3% (32/1382)	0.1% (2/1382)	0.0% (0/1382)

**Table B-14: Overall concurrence of YSI values and SG readings using SG ranges on FST Days 1, 3, and 7; Calibration every 12 hours, Abdomen**

Percent of matched pairs in each YSI glucose range for each SG range (mg/dL)												
SG ranges (mg/dL)	Number of paired SG-YSI	YSI Glucose Range (mg/dL)										
		<40	≥40–60	>60–80	>80–120	>120–160	>160–200	>200–250	>250–300	>300–350	>350–400	>400
H) >250–300	608	0.0% (0/608)	0.0% (0/608)	0.0% (0/608)	0.0% (0/608)	0.0% (0/608)	0.3% (2/608)	10.9% (66/608)	61.2% (372/608)	25.5% (155/608)	2.1% (13/608)	0.0% (0/608)
I) >300–350	286	0.0% (0/286)	0.0% (0/286)	0.0% (0/286)	0.0% (0/286)	0.0% (0/286)	0.0% (0/286)	1.0% (3/286)	19.9% (57/286)	55.2% (158/286)	22.4% (64/286)	1.4% (4/286)
J) >350–400	71	0.0% (0/71)	0.0% (0/71)	0.0% (0/71)	0.0% (0/71)	0.0% (0/71)	0.0% (0/71)	0.0% (0/71)	1.4% (1/71)	29.6% (21/71)	53.5% (38/71)	15.5% (11/71)
K) >400	9	0.0% (0/9)	0.0% (0/9)	0.0% (0/9)	0.0% (0/9)	0.0% (0/9)	0.0% (0/9)	0.0% (0/9)	0.0% (0/9)	11.1% (1/9)	77.8% (7/9)	11.1% (1/9)

**Table B-15: Concurrence of YSI values and SG readings using SG ranges on FST Day 1; Calibration every 12 hours, Abdomen**

Percent of matched pairs in each YSI glucose range for each SG range (mg/dL)												
SG ranges (mg/dL)	Number of paired SG-YSI	YSI Glucose Range (mg/dL)										
		<40	≥40–60	>60–80	>80–120	>120–160	>160–200	>200–250	>250–300	>300–350	>350–400	>400
A) <40	71	0.0% (0/71)	38.0% (27/71)	57.7% (41/71)	4.2% (3/71)	0.0% (0/71)	0.0% (0/71)	0.0% (0/71)	0.0% (0/71)	0.0% (0/71)	0.0% (0/71)	0.0% (0/71)
B) ≥40–60	278	2.2% (6/278)	23.0% (64/278)	55.8% (155/278)	18.7% (52/278)	0.4% (1/278)	0.0% (0/278)	0.0% (0/278)	0.0% (0/278)	0.0% (0/278)	0.0% (0/278)	0.0% (0/278)
C) >60–80	474	0.4% (2/474)	12.0% (57/474)	47.7% (226/474)	34.8% (165/474)	4.6% (22/474)	0.4% (2/474)	0.0% (0/474)	0.0% (0/474)	0.0% (0/474)	0.0% (0/474)	0.0% (0/474)
D) >80–120	1071	0.0% (0/1071)	0.1% (1/1071)	4.6% (49/1071)	66.6% (713/1071)	23.4% (251/1071)	4.5% (48/1071)	0.8% (9/1071)	0.0% (0/1071)	0.0% (0/1071)	0.0% (0/1071)	0.0% (0/1071)
E) >120–160	978	0.0% (0/978)	0.0% (0/978)	0.1% (1/978)	8.3% (81/978)	58.4% (571/978)	26.8% (262/978)	5.9% (58/978)	0.5% (5/978)	0.0% (0/978)	0.0% (0/978)	0.0% (0/978)
F) >160–200	662	0.0% (0/662)	0.0% (0/662)	0.0% (0/662)	0.3% (2/662)	9.1% (60/662)	52.6% (348/662)	35.3% (234/662)	2.7% (18/662)	0.0% (0/662)	0.0% (0/662)	0.0% (0/662)
G) >200–250	515	0.0% (0/515)	0.0% (0/515)	0.0% (0/515)	0.0% (0/515)	0.0% (0/515)	6.2% (32/515)	56.3% (290/515)	33.8% (174/515)	3.3% (17/515)	0.4% (2/515)	0.0% (0/515)
H) >250–300	202	0.0% (0/202)	0.0% (0/202)	0.0% (0/202)	0.0% (0/202)	0.0% (0/202)	0.0% (0/202)	9.4% (19/202)	55.0% (111/202)	32.2% (65/202)	3.5% (7/202)	0.0% (0/202)
I) >300–350	90	0.0% (0/90)	0.0% (0/90)	0.0% (0/90)	0.0% (0/90)	0.0% (0/90)	0.0% (0/90)	0.0% (0/90)	20.0% (18/90)	54.4% (49/90)	23.3% (21/90)	2.2% (2/90)
J) >350–400	24	0.0% (0/24)	0.0% (0/24)	0.0% (0/24)	0.0% (0/24)	0.0% (0/24)	0.0% (0/24)	0.0% (0/24)	4.2% (1/24)	37.5% (9/24)	50.0% (12/24)	8.3% (2/24)
K) >400	1	0.0% (0/1)	0.0% (0/1)	0.0% (0/1)	0.0% (0/1)	0.0% (0/1)	0.0% (0/1)	0.0% (0/1)	0.0% (0/1)	0.0% (0/1)	0.0% (0/1)	100.0% (1/1)

Note: The overall number of available paired SG-YSI points on FST Day 1 was from 88 subjects.

**Table B-16: Overall concurrence of YSI values and SG readings using SG ranges on FST Days 1, 3, and 7; Calibration 3 or 4 times a day, Abdomen.**

Percent of matched pairs in each YSI glucose range for each SG range (mg/dL)												
SG ranges (mg/dL)	Number of paired SG-YSI	YSI Glucose Range (mg/dL)										
		<40	≥40-60	>60-80	>80-120	>120-160	>160-200	>200-250	>250-300	>300-350	>350-400	>400
A) <40	123	0.0% (0/123)	52.0% (64/123)	44.7% (55/123)	3.3% (4/123)	0.0% (0/123)	0.0% (0/123)	0.0% (0/123)	0.0% (0/123)	0.0% (0/123)	0.0% (0/123)	0.0% (0/123)
B) ≥40-60	686	1.3% (9/686)	31.6% (217/686)	57.0% (391/686)	9.9% (68/686)	0.1% (1/686)	0.0% (0/686)	0.0% (0/686)	0.0% (0/686)	0.0% (0/686)	0.0% (0/686)	0.0% (0/686)
C) >60-80	1303	0.2% (2/1303)	8.1% (106/1303)	63.4% (826/1303)	26.2% (342/1303)	1.9% (25/1303)	0.2% (2/1303)	0.0% (0/1303)	0.0% (0/1303)	0.0% (0/1303)	0.0% (0/1303)	0.0% (0/1303)
D) >80-120	2864	0.0% (0/2864)	0.0% (1/2864)	6.5% (186/2864)	74.5% (2133/2864)	17.5% (502/2864)	1.3% (36/2864)	0.2% (6/2864)	0.0% (0/2864)	0.0% (0/2864)	0.0% (0/2864)	0.0% (0/2864)
E) >120-160	2681	0.0% (0/2681)	0.0% (0/2681)	0.0% (0/2681)	9.0% (241/2681)	69.9% (1874/2681)	19.1% (512/2681)	1.8% (49/2681)	0.2% (5/2681)	0.0% (0/2681)	0.0% (0/2681)	0.0% (0/2681)
F) >160-200	1820	0.0% (0/1820)	0.0% (0/1820)	0.0% (0/1820)	0.1% (2/1820)	10.3% (188/1820)	63.6% (1157/1820)	24.9% (454/1820)	1.0% (19/1820)	0.0% (0/1820)	0.0% (0/1820)	0.0% (0/1820)
G) >200-250	1314	0.0% (0/1314)	0.0% (0/1314)	0.0% (0/1314)	0.0% (0/1314)	0.5% (7/1314)	8.5% (112/1314)	65.3% (858/1314)	24.6% (323/1314)	1.1% (14/1314)	0.0% (0/1314)	0.0% (0/1314)
H) >250-300	652	0.0% (0/652)	0.0% (0/652)	0.0% (0/652)	0.0% (0/652)	0.0% (0/652)	0.3% (2/652)	11.3% (74/652)	63.5% (414/652)	22.9% (149/652)	2.0% (13/652)	0.0% (0/652)
I) >300-350	279	0.0% (0/279)	0.0% (0/279)	0.0% (0/279)	0.0% (0/279)	0.0% (0/279)	0.0% (0/279)	0.0% (0/279)	17.9% (50/279)	59.5% (166/279)	21.1% (59/279)	1.4% (4/279)
J) >350-400	65	0.0% (0/65)	0.0% (0/65)	0.0% (0/65)	0.0% (0/65)	0.0% (0/65)	0.0% (0/65)	0.0% (0/65)	0.0% (0/65)	18.5% (12/65)	64.6% (42/65)	16.9% (11/65)
K) >400	9	0.0% (0/9)	0.0% (0/9)	0.0% (0/9)	0.0% (0/9)	0.0% (0/9)	0.0% (0/9)	0.0% (0/9)	0.0% (0/9)	11.1% (1/9)	77.8% (7/9)	11.1% (1/9)

**Table B-17: Concurrence of YSI values and SG readings using SG ranges on FST Day 1; Calibration 3 or 4 times a day, Abdomen.**

Percent of matched pairs in each YSI glucose range for each SG range (mg/dL)												
SG ranges (mg/dL)	Number of paired SG-YSI	YSI Glucose Range (mg/dL)										
		<40	≥40-60	>60-80	>80-120	>120-160	>160-200	>200-250	>250-300	>300-350	>350-400	>400
A) <40	62	0.0% (0/62)	37.1% (23/62)	58.1% (36/62)	4.8% (3/62)	0.0% (0/62)	0.0% (0/62)	0.0% (0/62)	0.0% (0/62)	0.0% (0/62)	0.0% (0/62)	0.0% (0/62)
B) ≥40-60	247	2.4% (6/247)	21.5% (53/247)	58.7% (145/247)	17.0% (42/247)	0.4% (1/247)	0.0% (0/247)	0.0% (0/247)	0.0% (0/247)	0.0% (0/247)	0.0% (0/247)	0.0% (0/247)
C) >60-80	429	0.2% (1/429)	12.6% (54/429)	52.0% (223/429)	30.3% (130/429)	4.4% (19/429)	0.5% (2/429)	0.0% (0/429)	0.0% (0/429)	0.0% (0/429)	0.0% (0/429)	0.0% (0/429)
D) >80-120	1014	0.0% (0/1014)	0.1% (1/1014)	5.3% (54/1014)	70.7% (717/1014)	20.4% (207/1014)	3.1% (31/1014)	0.4% (4/1014)	0.0% (0/1014)	0.0% (0/1014)	0.0% (0/1014)	0.0% (0/1014)

**Table B-17: Concurrence of YSI values and SG readings using SG ranges on FST Day 1; Calibration 3 or 4 times a day, Abdomen.**

Percent of matched pairs in each YSI glucose range for each SG range (mg/dL)												
SG ranges (mg/dL)	Number of paired SG-YSI	YSI Glucose Range (mg/dL)										
		<40	≥40–60	>60–80	>80–120	>120–160	>160–200	>200–250	>250–300	>300–350	>350–400	>400
E) >120–160	973	0.0% (0/973)	0.0% (0/973)	0.0% (0/973)	9.1% (89/973)	61.6% (599/973)	24.8% (241/973)	4.0% (39/973)	0.5% (5/973)	0.0% (0/973)	0.0% (0/973)	0.0% (0/973)
F) >160–200	633	0.0% (0/633)	0.0% (0/633)	0.0% (0/633)	0.3% (2/633)	10.7% (68/633)	56.7% (359/633)	30.3% (192/633)	1.9% (12/633)	0.0% (0/633)	0.0% (0/633)	0.0% (0/633)
G) >200–250	497	0.0% (0/497)	0.0% (0/497)	0.0% (0/497)	0.0% (0/497)	0.2% (1/497)	7.8% (39/497)	64.6% (321/497)	26.4% (131/497)	1.0% (5/497)	0.0% (0/497)	0.0% (0/497)
H) >250–300	224	0.0% (0/224)	0.0% (0/224)	0.0% (0/224)	0.0% (0/224)	0.0% (0/224)	0.0% (0/224)	12.9% (29/224)	58.0% (130/224)	23.7% (53/224)	5.4% (12/224)	0.0% (0/224)
I) >300–350	97	0.0% (0/97)	0.0% (0/97)	0.0% (0/97)	0.0% (0/97)	0.0% (0/97)	0.0% (0/97)	0.0% (0/97)	19.6% (19/97)	59.8% (58/97)	18.6% (18/97)	2.1% (2/97)
J) >350–400	22	0.0% (0/22)	0.0% (0/22)	0.0% (0/22)	0.0% (0/22)	0.0% (0/22)	0.0% (0/22)	0.0% (0/22)	0.0% (0/22)	27.3% (6/22)	63.6% (14/22)	9.1% (2/22)
K) >400	1	0.0% (0/1)	0.0% (0/1)	0.0% (0/1)	0.0% (0/1)	0.0% (0/1)	0.0% (0/1)	0.0% (0/1)	0.0% (0/1)	0.0% (0/1)	0.0% (0/1)	100.0% (1/1)

Note: The overall number of available SG-YSI points on FST Day 1 was from 88 subjects.

**Table B-18: Overall concurrence of YSI values and SG readings using SG ranges on FST Days 1, 3, and 7; Calibration every 12 hours, Arm.**

Percent of matched pairs in each YSI glucose range for each SG range (mg/dL)												
SG ranges (mg/dL)	Number of paired SG-YSI	YSI Glucose Range (mg/dL)										
		<40	≥40–60	>60–80	>80–120	>120–160	>160–200	>200–250	>250–300	>300–350	>350–400	>400
A) <40	75	2.7% (2/75)	44.0% (33/75)	52.0% (39/75)	1.3% (1/75)	0.0% (0/75)	0.0% (0/75)	0.0% (0/75)	0.0% (0/75)	0.0% (0/75)	0.0% (0/75)	0.0% (0/75)
B) ≥40–60	520	1.0% (5/520)	41.9% (218/520)	51.7% (269/520)	5.4% (28/520)	0.0% (0/520)	0.0% (0/520)	0.0% (0/520)	0.0% (0/520)	0.0% (0/520)	0.0% (0/520)	0.0% (0/520)
C) >60–80	1238	0.2% (2/1238)	9.2% (114/1238)	70.3% (870/1238)	20.0% (247/1238)	0.4% (5/1238)	0.0% (0/1238)	0.0% (0/1238)	0.0% (0/1238)	0.0% (0/1238)	0.0% (0/1238)	0.0% (0/1238)
D) >80–120	2722	0.0% (0/2722)	0.1% (3/2722)	7.5% (203/2722)	74.0% (2014/2722)	17.7% (481/2722)	0.8% (21/2722)	0.0% (0/2722)	0.0% (0/2722)	0.0% (0/2722)	0.0% (0/2722)	0.0% (0/2722)
E) >120–160	2348	0.0% (0/2348)	0.0% (0/2348)	0.1% (3/2348)	9.2% (215/2348)	70.4% (1652/2348)	18.0% (423/2348)	2.3% (54/2348)	0.0% (1/2348)	0.0% (0/2348)	0.0% (0/2348)	0.0% (0/2348)
F) >160–200	1614	0.0% (0/1614)	0.0% (0/1614)	0.0% (0/1614)	0.1% (2/1614)	9.4% (151/1614)	64.7% (1044/1614)	24.8% (400/1614)	0.9% (14/1614)	0.2% (3/1614)	0.0% (0/1614)	0.0% (0/1614)
G) >200–250	1212	0.0% (0/1212)	0.0% (0/1212)	0.0% (0/1212)	0.0% (0/1212)	0.6% (7/1212)	6.8% (83/1212)	63.9% (774/1212)	27.3% (331/1212)	1.4% (17/1212)	0.0% (0/1212)	0.0% (0/1212)
H) >250–300	556	0.0% (0/556)	0.0% (0/556)	0.0% (0/556)	0.0% (0/556)	0.0% (0/556)	0.2% (1/556)	9.4% (52/556)	65.1% (362/556)	23.9% (133/556)	1.4% (8/556)	0.0% (0/556)
I) >300–350	256	0.0% (0/256)	0.0% (0/256)	0.0% (0/256)	0.0% (0/256)	0.0% (0/256)	0.0% (0/256)	0.0% (0/256)	18.0% (46/256)	56.6% (145/256)	24.6% (63/256)	0.8% (2/256)

**Table B-18: Overall concurrence of YSI values and SG readings using SG ranges on FST Days 1, 3, and 7; Calibration every 12 hours, Arm.**

Percent of matched pairs in each YSI glucose range for each SG range (mg/dL)													
SG ranges (mg/dL)	Number of paired SG-YSI	YSI Glucose Range (mg/dL)											
		<40	≥40–60	>60–80	>80–120	>120–160	>160–200	>200–250	>250–300	>300–350	>350–400	>400	
J) >350–400	60	0.0% (0/60)	0.0% (0/60)	0.0% (0/60)	0.0% (0/60)	0.0% (0/60)	0.0% (0/60)	0.0% (0/60)	0.0% (0/60)	3.3% (2/60)	16.7% (10/60)	66.7% (40/60)	13.3% (8/60)
K) >400	9	0.0% (0/9)	0.0% (0/9)	0.0% (0/9)	0.0% (0/9)	0.0% (0/9)	0.0% (0/9)	0.0% (0/9)	0.0% (0/9)	0.0% (0/9)	11.1% (1/9)	55.6% (5/9)	33.3% (3/9)

**Table B-19: Concurrence of YSI values and SG readings using SG ranges on FST Day 1; Calibration every 12 hours, Arm.**

Percent of matched pairs in each YSI glucose range for each SG range (mg/dL)													
SG ranges (mg/dL)	Number of paired SG-YSI	YSI Glucose Range (mg/dL)											
		<40	≥40–60	>60–80	>80–120	>120–160	>160–200	>200–250	>250–300	>300–350	>350–400	>400	
A) <40	54	3.7% (2/54)	29.6% (16/54)	64.8% (35/54)	1.9% (1/54)	0.0% (0/54)	0.0% (0/54)	0.0% (0/54)	0.0% (0/54)	0.0% (0/54)	0.0% (0/54)	0.0% (0/54)	0.0% (0/54)
B) ≥40–60	168	1.8% (3/168)	22.0% (37/168)	64.3% (108/168)	11.9% (20/168)	0.0% (0/168)	0.0% (0/168)	0.0% (0/168)	0.0% (0/168)	0.0% (0/168)	0.0% (0/168)	0.0% (0/168)	0.0% (0/168)
C) >60–80	339	0.6% (2/339)	11.2% (38/339)	58.1% (197/339)	29.2% (99/339)	0.9% (3/339)	0.0% (0/339)	0.0% (0/339)	0.0% (0/339)	0.0% (0/339)	0.0% (0/339)	0.0% (0/339)	0.0% (0/339)
D) >80–120	895	0.0% (0/895)	0.3% (3/895)	6.6% (59/895)	69.8% (625/895)	21.6% (193/895)	1.7% (15/895)	0.0% (0/895)	0.0% (0/895)	0.0% (0/895)	0.0% (0/895)	0.0% (0/895)	0.0% (0/895)
E) >120–160	803	0.0% (0/803)	0.0% (0/803)	0.0% (0/803)	10.0% (80/803)	64.6% (519/803)	21.4% (172/803)	4.0% (32/803)	0.0% (0/803)	0.0% (0/803)	0.0% (0/803)	0.0% (0/803)	0.0% (0/803)
F) >160–200	549	0.0% (0/549)	0.0% (0/549)	0.0% (0/549)	0.2% (1/549)	8.9% (49/549)	61.4% (337/549)	28.1% (154/549)	1.5% (8/549)	0.0% (0/549)	0.0% (0/549)	0.0% (0/549)	0.0% (0/549)
G) >200–250	355	0.0% (0/355)	0.0% (0/355)	0.0% (0/355)	0.0% (0/355)	0.3% (1/355)	7.9% (28/355)	63.9% (227/355)	27.0% (96/355)	0.8% (3/355)	0.0% (0/355)	0.0% (0/355)	0.0% (0/355)
H) >250–300	175	0.0% (0/175)	0.0% (0/175)	0.0% (0/175)	0.0% (0/175)	0.0% (0/175)	0.0% (0/175)	10.9% (19/175)	65.7% (115/175)	21.1% (37/175)	2.3% (4/175)	0.0% (0/175)	0.0% (0/175)
I) >300–350	91	0.0% (0/91)	0.0% (0/91)	0.0% (0/91)	0.0% (0/91)	0.0% (0/91)	0.0% (0/91)	0.0% (0/91)	20.9% (19/91)	52.7% (48/91)	24.2% (22/91)	2.2% (2/91)	0.0% (0/91)
J) >350–400	15	0.0% (0/15)	0.0% (0/15)	0.0% (0/15)	0.0% (0/15)	0.0% (0/15)	0.0% (0/15)	0.0% (0/15)	13.3% (2/15)	33.3% (5/15)	53.3% (8/15)	0.0% (0/15)	0.0% (0/15)
K) >400	1	0.0% (0/1)	0.0% (0/1)	0.0% (0/1)	0.0% (0/1)	0.0% (0/1)	0.0% (0/1)	0.0% (0/1)	0.0% (0/1)	0.0% (0/1)	100.0% (1/1)	0.0% (0/1)	0.0% (0/1)

**Note:** The overall number of available paired SG-YSI points on FST Day 1 was from 82 subjects.

**Table B-20: Overall concurrence of YSI values and SG readings using SG ranges on FST Days 1, 3, and 7; Calibration 3 or 4 times a day, Arm.**

Percent of matched pairs in each YSI glucose range for each SG range (mg/dL)												
SG ranges (mg/dL)	Number of paired SG-YSI	YSI Glucose Range (mg/dL)										
		<40	≥40–60	>60–80	>80–120	>120–160	>160–200	>200–250	>250–300	>300–350	>350–400	>400
A) <40	73	2.7% (2/73)	45.2% (33/73)	50.7% (37/73)	1.4% (1/73)	0.0% (0/73)	0.0% (0/73)	0.0% (0/73)	0.0% (0/73)	0.0% (0/73)	0.0% (0/73)	0.0% (0/73)
B) ≥40–60	503	1.0% (5/503)	45.9% (231/503)	48.3% (243/503)	4.8% (24/503)	0.0% (0/503)	0.0% (0/503)	0.0% (0/503)	0.0% (0/503)	0.0% (0/503)	0.0% (0/503)	0.0% (0/503)
C) >60–80	1291	0.2% (2/1291)	8.9% (115/1291)	72.3% (933/1291)	18.4% (237/1291)	0.3% (4/1291)	0.0% (0/1291)	0.0% (0/1291)	0.0% (0/1291)	0.0% (0/1291)	0.0% (0/1291)	0.0% (0/1291)
D) >80–120	2756	0.0% (0/2756)	0.1% (3/2756)	7.0% (194/2756)	75.9% (2092/2756)	16.5% (456/2756)	0.4% (11/2756)	0.0% (0/2756)	0.0% (0/2756)	0.0% (0/2756)	0.0% (0/2756)	0.0% (0/2756)
E) >120–160	2442	0.0% (0/2442)	0.0% (0/2442)	0.1% (2/2442)	9.3% (228/2442)	71.4% (1743/2442)	18.0% (439/2442)	1.2% (30/2442)	0.0% (0/2442)	0.0% (0/2442)	0.0% (0/2442)	0.0% (0/2442)
F) >160–200	1588	0.0% (0/1588)	0.0% (0/1588)	0.0% (0/1588)	0.1% (2/1588)	9.4% (150/1588)	66.3% (1053/1588)	23.5% (373/1588)	0.6% (9/1588)	0.1% (1/1588)	0.0% (0/1588)	0.0% (0/1588)
G) >200–250	1246	0.0% (0/1246)	0.0% (0/1246)	0.0% (0/1246)	0.0% (0/1246)	0.5% (6/1246)	7.4% (92/1246)	65.7% (818/1246)	25.1% (313/1246)	1.4% (17/1246)	0.0% (0/1246)	0.0% (0/1246)
H) >250–300	613	0.0% (0/613)	0.0% (0/613)	0.0% (0/613)	0.0% (0/613)	0.0% (0/613)	0.2% (1/613)	8.6% (53/613)	65.1% (399/613)	24.6% (151/613)	1.5% (9/613)	0.0% (0/613)
I) >300–350	271	0.0% (0/271)	0.0% (0/271)	0.0% (0/271)	0.0% (0/271)	0.0% (0/271)	0.0% (0/271)	0.0% (0/271)	16.2% (44/271)	59.8% (162/271)	23.2% (63/271)	0.7% (2/271)
J) >350–400	61	0.0% (0/61)	0.0% (0/61)	0.0% (0/61)	0.0% (0/61)	0.0% (0/61)	0.0% (0/61)	0.0% (0/61)	4.9% (3/61)	11.5% (7/61)	70.5% (43/61)	13.1% (8/61)
K) >400	8	0.0% (0/8)	0.0% (0/8)	0.0% (0/8)	0.0% (0/8)	0.0% (0/8)	0.0% (0/8)	0.0% (0/8)	0.0% (0/8)	0.0% (0/8)	62.5% (5/8)	37.5% (3/8)

**Table B-21: Concurrence of YSI values and SG readings using SG ranges on FST Day 1; Calibration 3 or 4 times a day, Arm.**

Percent of matched pairs in each YSI glucose range for each SG range (mg/dL)												
SG ranges (mg/dL)	Number of paired SG-YSI	YSI Glucose Range (mg/dL)										
		<40	≥40–60	>60–80	>80–120	>120–160	>160–200	>200–250	>250–300	>300–350	>350–400	>400
A) <40	54	3.7% (2/54)	29.6% (16/54)	64.8% (35/54)	1.9% (1/54)	0.0% (0/54)	0.0% (0/54)	0.0% (0/54)	0.0% (0/54)	0.0% (0/54)	0.0% (0/54)	0.0% (0/54)
B) ≥40–60	162	1.9% (3/162)	25.3% (41/162)	61.7% (100/162)	11.1% (18/162)	0.0% (0/162)	0.0% (0/162)	0.0% (0/162)	0.0% (0/162)	0.0% (0/162)	0.0% (0/162)	0.0% (0/162)
C) >60–80	346	0.6% (2/346)	11.6% (40/346)	61.3% (212/346)	25.7% (89/346)	0.9% (3/346)	0.0% (0/346)	0.0% (0/346)	0.0% (0/346)	0.0% (0/346)	0.0% (0/346)	0.0% (0/346)
D) >80–120	899	0.0% (0/899)	0.3% (3/899)	6.3% (57/899)	74.0% (665/899)	18.2% (164/899)	1.1% (10/899)	0.0% (0/899)	0.0% (0/899)	0.0% (0/899)	0.0% (0/899)	0.0% (0/899)
E) >120–160	878	0.0% (0/878)	0.0% (0/878)	0.0% (0/878)	10.0% (88/878)	67.0% (588/878)	21.0% (184/878)	2.1% (18/878)	0.0% (0/878)	0.0% (0/878)	0.0% (0/878)	0.0% (0/878)



**Table B-21: Concurrence of YSI values and SG readings using SG ranges on FST) Day 1; Calibration 3 or 4 times a day, Arm.**

Percent of matched pairs in each YSI glucose range for each SG range (mg/dL)												
SG ranges (mg/dL)	Number of paired SG-YSI	YSI Glucose Range (mg/dL)										
		<40	≥40–60	>60–80	>80–120	>120–160	>160–200	>200–250	>250–300	>300–350	>350–400	>400
F) >160–200	571	0.0% (0/571)	0.0% (0/571)	0.0% (0/571)	0.2% (1/571)	9.3% (53/571)	62.3% (356/571)	27.3% (156/571)	0.9% (5/571)	0.0% (0/571)	0.0% (0/571)	0.0% (0/571)
G) >200–250	427	0.0% (0/427)	0.0% (0/427)	0.0% (0/427)	0.0% (0/427)	0.2% (1/427)	8.2% (35/427)	62.5% (267/427)	27.6% (118/427)	1.4% (6/427)	0.0% (0/427)	0.0% (0/427)
H) >250–300	202	0.0% (0/202)	0.0% (0/202)	0.0% (0/202)	0.0% (0/202)	0.0% (0/202)	0.0% (0/202)	9.9% (20/202)	59.9% (121/202)	26.7% (54/202)	3.5% (7/202)	0.0% (0/202)
I) >300–350	93	0.0% (0/93)	0.0% (0/93)	0.0% (0/93)	0.0% (0/93)	0.0% (0/93)	0.0% (0/93)	0.0% (0/93)	16.1% (15/93)	59.1% (55/93)	22.6% (21/93)	2.2% (2/93)
J) >350–400	13	0.0% (0/13)	0.0% (0/13)	0.0% (0/13)	0.0% (0/13)	0.0% (0/13)	0.0% (0/13)	0.0% (0/13)	15.4% (2/13)	7.7% (1/13)	76.9% (10/13)	0.0% (0/13)
K) >400	-	-	-	-	-	-	-	-	-	-	-	-

**Note:** The overall number of available paired SG-YSI points on FST Day 1 was from 83 subjects.

**Note:** For the blank cells (-), there are no paired points in this reference range.

## Percent agreement post calibration

The agreement of the SG values to paired YSI values was assessed for every 2-hour period post sensor calibration. For readings less than or equal to 80 mg/dL, the absolute difference in mg/dL between the SG and paired YSI values was calculated.

Tables B-22 and B-23 show the percent agreement rates post calibration for sensors inserted into the abdomen. Performance when sensors are inserted in the arm is at least comparable to results when sensors are inserted in the abdomen.

**Table B-22: Agreement rates for every 2-hour period post calibration period; Calibration every 12 hours, Abdomen.**

Time after calibration	Number of paired SG-YSI	Percent Agreement (%)				
		Percent of SG within 15/15% of YSI	Percent of SG within 20/20% of YSI	Percent of SG within 30/30% of YSI	Percent of SG within 40/40% of YSI	Percent of SG greater than 40/40% of YSI
0–2 hours	2999	85	92.6	97.8	99.6	0.4
2–4 hours	2667	75.1	85.9	95.3	98.8	1.2
4–6 hours	2138	71.4	82	92.7	97.6	2.4
6–8 hours	1521	77.6	88.4	97	99.3	0.7
8–10 hours	1523	84.2	91.1	97.6	99.3	0.7
10–12 hours	1242	79.8	89.5	96.3	98.6	1.4

\* For reference range ≤80 mg/dL, agreement was based on 15/20/30/40 mg/dL.

**Note:** SG Readings are within 40–400 mg/dL.

Table B-23: Agreement rates for every 2-hour period post calibration; Calibration 3 or 4 times a day, Abdomen.						
Time after calibration	Number of paired SG-YSI	Percent Agreement (%)				
		Percent of SG within 15/15% of YSI	Percent of SG within 20/20% of YSI	Percent of SG within 30/30% of YSI	Percent of SG within 40/40% of YSI	Percent of SG greater than 40/40% of YSI
0–2 hours	4585	87	93.5	98.1	99.7	0.3
2–4 hours	3949	80.7	89.9	96.7	99	1
4–6 hours	2856	78.7	87.6	95.5	98.5	1.5
6–8 hours	227	74.9	86.3	96.9	99.6	0.4
8–10 hours	35	82.9	85.7	91.4	94.3	5.7
10–12 hours	12	91.7	91.7	91.7	100	0

\* For reference range  $\leq 80$  mg/dL, agreement was based on 15/20/30/40 mg/dL.

Note: SG Readings are within 40–400 mg/dL.

## Trend accuracy

Tables B-24 through B-25 show, for each SG rate-of-change range (indicated on display by number of arrows), percentage of SG-YSI paired values that fell into different YSI rate-of-change ranges. The tables show the trend accuracy for sensors inserted into the abdomen. Performance when sensors are inserted in the arm is at least comparable to results when sensors are inserted into the abdomen.

Table B-24: Trend accuracy; Calibration every 12 hours, Abdomen.							
Percent of Matched Pairs-in Each YSI Rate-of-Change Range for Each SG Rate-of-Change Range							
SG Rate-of-Change Range (mg/dL/min)	Number of Paired SG-YSI	YSI Rate-of-Change Ranges (mg/dL/min)					
		<-2	[-2, -1]	[-1, 0]	[0, 1]	[1, 2]	>2
A) <-2	162	38.3% (62/162)	40.1% (65/162)	20.4% (33/162)	0.6% (1/162)	0.6% (1/162)	0.0% (0/162)
B) [-2, -1]	1001	4.8% (48/1001)	39.9% (399/1001)	51.3% (514/1001)	3.7% (37/1001)	0.3% (3/1001)	0.0% (0/1001)
C) [-1, 0]	5960	0.5% (30/5960)	3.8% (228/5960)	77.6% (4627/5960)	17.1% (1020/5960)	0.8% (49/5960)	0.1% (6/5960)
D) [0, 1]	3517	0.2% (7/3517)	0.5% (18/3517)	25.7% (903/3517)	63.4% (2231/3517)	9.3% (326/3517)	0.9% (32/3517)
E) [1, 2]	1059	0.1% (1/1059)	0.4% (4/1059)	4.5% (48/1059)	37.9% (401/1059)	48.6% (515/1059)	8.5% (90/1059)
F) >2	391	0.0% (0/391)	0.0% (0/391)	2.8% (11/391)	7.4% (29/391)	40.9% (160/391)	48.8% (191/391)

Table B-25: Trend accuracy; Calibration 3 or 4 times a day, Abdomen.							
Percent of Matched Pairs-in Each YSI Rate-of-Change Range for Each SG Rate-of-Change Range							
SG Rate-of-Change Range (mg/dL/min)	Number of Paired SG-YSI	YSI Rate-of-Change Ranges (mg/dL/min)					
		<-2	[-2, -1]	[-1, 0]	[0, 1]	[1, 2]	>2
A) <-2	159	39.0% (62/159)	39.6% (63/159)	19.5% (31/159)	0.6% (1/159)	1.3% (2/159)	0.0% (0/159)
B) [-2, -1]	967	5.1% (49/967)	38.7% (374/967)	51.9% (502/967)	4.0% (39/967)	0.3% (3/967)	0.0% (0/967)

**Table B-25: Trend accuracy; Calibration 3 or 4 times a day, Abdomen.**

Percent of Matched Pairs-in Each YSI Rate-of-Change Range for Each SG Rate-of-Change Range							
SG Rate-of-Change Range (mg/dL/min)	Number of Paired SG-YSI	YSI Rate-of-Change Ranges (mg/dL/min)					
		<-2	[-2, -1]	[-1, 0]	[0, 1]	[1, 2]	>2
C) [-1, 0]	5753	0.5% (28/5753)	4.0% (228/5753)	77.5% (4456/5753)	17.2% (990/5753)	0.8% (46/5753)	0.1% (5/5753)
D) [0, 1]	3387	0.2% (8/3387)	0.5% (18/3387)	26.5% (898/3387)	62.5% (2118/3387)	9.3% (316/3387)	0.9% (29/3387)
E) [1, 2]	1024	0.0% (0/1024)	0.2% (2/1024)	5.0% (51/1024)	38.8% (397/1024)	47.5% (486/1024)	8.6% (88/1024)
F) >2	374	0.0% (0/374)	0.0% (0/374)	2.4% (9/374)	8.0% (30/374)	42.8% (160/374)	46.8% (175/374)

### Precision

Precision of the system was evaluated by comparing the results from two separate sensors worn in the abdomen on the same subject at the same time. A total of 83 subjects provided 30,350 paired SG-YSI measurements, with a mean Percent Absolute Relative Difference (PARD) of 9.07% with a coefficient of variation (%CV) of 6.5%.

Though precision in the arm has not been specifically assessed, arm vs. arm and arm vs. abdomen is likely comparable to the abdomen precision based on internal evaluation by Medtronic.

### Sensor life

After the first successful calibration, 72.3% of sensors worn operated more than six days and up to the full seven days of wear (144 to 168 hours). The mean functional sensor life for sensors worn in the abdomen insertion site over the course of the study was 144.2 hours, with a median functional life of 167.6 hours. The mean functional sensor life for sensors worn in the arm insertion site over the course of the study was 146.1 hours, with a median functional life of 167.9 hours.

### Safety

There were no moderate or severe device-related or procedure-related adverse events, device-related or procedure-related serious adverse events, or unanticipated adverse device effects through seven days of use.

## C. Alert performance for users 14 years and older

The CGM system enables your device to display SG readings, glucose trend arrows, glucose trend graphs, and SG alerts (for example, High and Low Limit Threshold alerts, High and Low Predictive alerts, and Rise and Fall rate-of-change alerts).

The high and low limit alerts (Threshold alerts) let the user know when the SG is at or above the high limit or at or below the low limit. Using only a high or low limit alert may reduce the number of false alerts, but does not provide a warning before reaching a high or low limit.

Predictive alerts notify users that their SG level may soon reach a high or low limit setting. Users may select how early they would like to be notified before their SG level reaches a high limit setting. The earliest warning is 30 minutes before reaching a high limit setting, but users can reduce the amount of warning down to 5 minutes. Users will receive a warning approximately 30 minutes prior to when their SG level is predicted to reach their low limit setting. In general, the earlier the warning, the more time a user will have to react to a potential high or low limit setting, but this also increases the potential for false alerts.

A predictive alert is simply an estimation of a future SG level compared to the high or low limit setting. If the predicted SG value is above the high limit or below the low limit, then a predictive alert is sounded even though the current SG level has not crossed the high or low limit. The predicted SG level is calculated using the current SG level, the derivative of previous SG readings (the trend or slope of the SG readings) and the amount of early warning duration the user selects.

The device will always alert the user when the CGM system reads that the user is below 50 mg/dL, regardless of the high threshold, low threshold, or predictive alerts that the user sets.

### Glucose TRUE Alert Rate

The glucose true alert rate is the rate at which the BG confirmed that the CGM alert was triggered correctly. For example:

**True Threshold Hypoglycemic alert rate** alerted when the CGM system read that the user was below the low threshold and the user's BG was actually below that low threshold.

**True Threshold Hyperglycemic alert rate** alerted when the CGM system read that the user was above the high threshold and the user's BG was actually above that high threshold.

**True Predictive Hypoglycemic alert rate** alerted when the CGM system predicted that the user would reach below the low threshold and the user's BG was actually below that low threshold within 15 or 30 minutes.

**True Predictive Hyperglycemic alert rate** alerted when the CGM system predicted that the user would reach above the high threshold and the user's BG was actually above that high threshold within 15 or 30 minutes.

The true alert rate is important because it is necessary that users be notified when their BG is low (or high) so that they can correct the low (or high) BG. A high true alert rate indicates that when the CGM system says that their glucose values are, or will reach a specified threshold, the user's BG is likely to be at or approaching that threshold.

For example, per the following table, the low glucose alerts would have correctly indicated that the user was below (i.e. threshold only), or predicted to reach below the threshold (i.e. predictive only) or both (predictive and threshold) 66.9%, 52.7%, or 58.3% of the time within 30 minutes (or 66.9%, 47.7%, or 55.2% of the time within 15 minutes) when the user had BG values lower than 70 mg/dL for a sensor inserted in the abdomen.

mg/dL	Insertion Site	Glucose TRUE Alert Rate					
		Threshold Only		Predictive Only		Threshold & Predictive	
		30 min	15 min	30 min	15 min	30 min	15 min
50	Abdomen	25.0%	25.0%	15.2%	12.3%	18.2%	16.2%
	Arm	36.8%	36.8%	21.9%	16.7%	26.1%	22.4%
60	Abdomen	53.5%	51.9%	40.7%	37.1%	46.2%	43.4%
	Arm	69.0%	67.8%	47.5%	45.6%	55.1%	53.5%
70	Abdomen	66.9%	66.9%	52.7%	47.7%	58.3%	55.2%
	Arm	77.4%	75.3%	57.4%	54.5%	65.6%	63.0%
80	Abdomen	69.3%	69.3%	57.8%	51.1%	62.2%	58.2%
	Arm	77.5%	76.4%	59.9%	53.0%	66.5%	61.9%
90	Abdomen	75.1%	74.4%	64.0%	58.5%	67.9%	64.3%
	Arm	74.9%	74.9%	69.0%	63.2%	71.3%	68.0%
180	Abdomen	93.7%	92.8%	70.5%	66.9%	78.0%	75.4%
	Arm	92.9%	92.9%	68.0%	63.2%	76.5%	73.7%

Table C-1: Glucose TRUE Alert Performance using Calibration every 12 hours							
mg/dL	Insertion Site	Glucose TRUE Alert Rate					
		Threshold Only		Predictive Only		Threshold & Predictive	
		30 min	15 min	30 min	15 min	30 min	15 min
220	Abdomen	91.9%	91.9%	68.9%	66.3%	76.6%	74.8%
	Arm	92.2%	92.2%	65.7%	62.2%	74.5%	72.2%
250	Abdomen	90.2%	90.2%	64.0%	60.1%	72.5%	69.8%
	Arm	91.4%	91.4%	62.0%	59.8%	71.1%	69.6%
300	Abdomen	81.3%	81.3%	57.8%	54.0%	65.4%	62.7%
	Arm	81.9%	80.6%	51.7%	49.7%	61.2%	59.3%

## Glucose FALSE Alert Rate

The glucose false alert rate is the rate at which the BG did not confirm that the CGM alert was triggered correctly. For example:

**False Threshold Hypoglycemic alert rate** alerted when the CGM system read that the user was below the low threshold but the user's BG was actually above that low threshold.

**False Threshold Hyperglycemic alert rate** alerted when the CGM system read that the user was above the high threshold but the user's BG was actually below that high threshold.

**False Predictive Hypoglycemic alert rate** alerted when the CGM system predicted that the user would be below the low threshold but the user's BG was actually above that low threshold within 15 or 30 minutes.

**False Predictive Hyperglycemic alert rate** alerted when the CGM system predicted that the user would be above the high threshold but the user's BG was actually below the high threshold within 15 or 30 minutes.

The false alert rate is important because it is necessary that users be correctly notified when their BG is low (or high) so that they can correct the low (or high) BG. A low false alert rate indicates that when the CGM system says that their glucose values are, or will reach a specified threshold, the user's BG is likely to be at or approaching that threshold.

For example, per the following table, the high glucose threshold alerts would have incorrectly indicated that the user was above (i.e. threshold only), or predicted to reach above the threshold (i.e. predictive only), or both (threshold and predictive)

6.30%, 29.5%, or 22% of the time within 30 minutes (or 7.2%, 33.1%, or 24.6% of the time within 15 minutes) when the user had BG less than 180 mg/dL for a sensor inserted in the abdomen.

mg/dL	Insertion Site	Glucose FALSE Alert Rate					
		Threshold Only		Predictive Only		Threshold and Predictive	
		30 min	15 min	30 min	15 min	30 min	15 min
50	Abdomen	75.0%	75.0%	84.8%	87.7%	81.8%	83.8%
	Arm	63.2%	63.2%	78.1%	83.3%	73.9%	77.6%
60	Abdomen	46.5%	48.1%	59.3%	62.9%	53.8%	56.6%
	Arm	31.0%	32.2%	52.5%	54.4%	44.9%	46.5%
70	Abdomen	33.1%	33.1%	47.3%	52.3%	41.7%	44.8%
	Arm	22.6%	24.7%	42.6%	45.5%	34.4%	37.0%
80	Abdomen	30.7%	30.7%	42.2%	48.9%	37.8%	41.8%
	Arm	22.5%	23.6%	40.1%	47.0%	33.5%	38.1%
90	Abdomen	24.9%	25.6%	36.0%	41.5%	32.1%	35.7%
	Arm	25.1%	25.1%	31.0%	36.8%	28.7%	32.0%
180	Abdomen	6.30%	7.20%	29.5%	33.1%	22.0%	24.6%
	Arm	7.10%	7.10%	32.0%	36.8%	23.5%	26.3%
220	Abdomen	8.10%	8.10%	31.1%	33.7%	23.4%	25.2%
	Arm	7.80%	7.80%	34.3%	37.8%	25.5%	27.8%
250	Abdomen	9.80%	9.80%	36.0%	39.9%	27.5%	30.2%
	Arm	8.60%	8.60%	38.0%	40.2%	28.9%	30.4%
300	Abdomen	18.8%	18.8%	42.2%	46.0%	34.6%	37.3%
	Arm	18.1%	19.4%	48.3%	50.3%	38.8%	40.7%

## Glucose Correct Detection Rate

Glucose Correct Detection Rate is the rate that the device alerted when it should have alerted. For example, the BG was below the hypoglycemic threshold, or above the hyperglycemic threshold, and the device sounded an alert.

Glucose detection rates are important because it is necessary that users be notified when their BG is low (or high) so that they can correct the low (or high) BG. A high glucose correct detection rate indicates that users can have confidence that they will be notified by the device if their BG is low or high.

For example, per the following table, the threshold alert, the predictive alert, or both (threshold and predictive) notified the user 64%, 76%, or 76% of the time within 30 minutes (or 64%, 68%, or 68% within 15 minutes) when the user had BG less than 50 mg/dL for a sensor inserted in the abdomen.

mg/dL	Insertion Site	Glucose Correct Detection Rate					
		Threshold Only		Predictive Only		Threshold & Predictive	
		30 min	15 min	30 min	15 min	30 min	15 min
50	Abdomen	64.0%	64.0%	76.0%	68.0%	76.0%	68.0%
	Arm	66.7%	66.7%	95.2%	71.4%	95.2%	76.2%
60	Abdomen	83.3%	82.1%	94.0%	88.1%	94.0%	89.3%
	Arm	86.3%	83.6%	98.6%	94.5%	98.6%	97.3%
70	Abdomen	90.5%	90.5%	94.2%	89.8%	94.2%	92.0%
	Arm	90.2%	88.6%	92.7%	90.2%	93.5%	91.9%
80	Abdomen	87.2%	87.2%	93.6%	87.2%	93.6%	89.9%
	Arm	89.0%	88.4%	94.8%	86.6%	95.9%	92.4%
90	Abdomen	91.1%	88.7%	94.6%	89.5%	95.7%	92.2%
	Arm	91.7%	90.4%	96.9%	91.7%	97.8%	95.6%
180	Abdomen	93.1%	91.4%	96.6%	93.4%	96.9%	95.4%
	Arm	93.2%	92.2%	98.1%	94.2%	98.7%	96.4%
220	Abdomen	90.1%	89.2%	94.8%	93.5%	95.3%	94.4%
	Arm	90.1%	89.2%	96.1%	93.6%	96.1%	95.6%
250	Abdomen	81.5%	80.9%	96.5%	91.3%	96.5%	93.6%
	Arm	80.9%	79.6%	96.7%	90.8%	96.7%	91.4%
300	Abdomen	75.3%	75.3%	95.3%	92.9%	95.3%	94.1%
	Arm	74.4%	71.8%	93.6%	89.7%	93.6%	89.7%

## Glucose Missed Detection Rate

The Missed Detection Rate is the rate that the device did not alert when it should have. For example, the BG was below the hypoglycemic threshold, or above the hyperglycemic threshold, and the device did not sound a threshold or predictive alert.

Missed detection rates are important because it is necessary that users be notified when their BG is low (or high), so that they can correct the low (or high) BG. A low missed detection rate indicates that users can have confidence that they will be notified by the device if their BG is low or high.

For example, per the following table, the threshold alert, predictive alert, or both alerts (threshold and predictive) did not sound 36%, 24%, or 24% of the time within 30 minutes (or 36%, 32%, or 32% within 15 minutes) when the user had BG less than 50 mg/dL for a sensor inserted in the abdomen.



**Table C-4: Glucose Missed Detection Alert Performance using Calibration every 12 hours**

mg/dL	Insertion Site	Glucose Missed Detection Rate					
		Threshold Only		Predictive Only		Threshold & Predictive	
		30 min	15 min	30 min	15 min	30 min	15 min
50	Abdomen	36.0%	36.0%	24.0%	32.0%	24.0%	32.0%
	Arm	33.3%	33.3%	4.8%	28.6%	4.8%	23.8%
60	Abdomen	16.7%	17.9%	6.0%	11.9%	6.0%	10.7%
	Arm	13.7%	16.4%	1.4%	5.5%	1.4%	2.7%
70	Abdomen	9.5%	9.5%	5.8%	10.2%	5.8%	8.0%
	Arm	9.8%	11.4%	7.3%	9.8%	6.5%	8.1%
80	Abdomen	12.8%	12.8%	6.4%	12.8%	6.4%	10.1%
	Arm	11.0%	11.6%	5.2%	13.4%	4.1%	7.6%
90	Abdomen	8.9%	11.3%	5.4%	10.5%	4.3%	7.8%
	Arm	8.3%	9.6%	3.1%	8.3%	2.2%	4.4%
180	Abdomen	6.9%	8.6%	3.4%	6.6%	3.1%	4.6%
	Arm	6.8%	7.8%	1.9%	5.8%	1.3%	3.6%
220	Abdomen	9.9%	10.8%	5.2%	6.5%	4.7%	5.6%
	Arm	9.9%	10.8%	3.9%	6.4%	3.9%	4.4%
250	Abdomen	18.5%	19.1%	3.5%	8.7%	3.5%	6.4%
	Arm	19.1%	20.4%	3.3%	9.2%	3.3%	8.6%
300	Abdomen	24.7%	24.7%	4.7%	7.1%	4.7%	5.9%
	Arm	25.6%	28.2%	6.4%	10.3%	6.4%	10.3%

## II. Performance data for users ages 7 through 13

### D. Device Performance data for users ages 7 through 13

The clinical data presented in this section was obtained from studies (users ages 7 through 13) using the MiniMed 670G system. The MiniMed 770G system uses the same SmartGuard Auto Mode technology as the MiniMed 670G system. Therefore, this clinical data also applies to the MiniMed 770G system.



**CAUTION:** Since the study presented below did not include a control group, no claims regarding effectiveness can be made. However, it does support that the device is relatively safe for use.

The SmartGuard technology has two levels that include 1) the Suspend on low and Suspend before low features that automatically suspends insulin delivery based on the CGM system and 2) Auto Mode that automatically calculates insulin dosing using the CGM system. A study was performed to evaluate for safety in a

multi-center, single-arm, home and hotel clinical investigation.<sup>7, 8</sup> Study subjects included persons aged 7 to 13 years of age diagnosed with type 1 diabetes mellitus and who were on pump therapy for more than 6 months prior to screening. All study subjects had an HbA1C less than 10.0% at the time of screening.

The first level of SmartGuard technology included evaluation of the "Suspend before low" feature. A total of 105 subjects were asked to exercise in an in-clinic setting, in order to lower blood sugars sufficiently to trigger Suspend before low. Activation was followed by an observation period to ensure subject safety. The target for Suspend before low was set to 65 mg/dL. Subjects underwent FST for a maximum of 12 hours, which included the exercise period, insulin suspension, and approximately 4 hours after resumption of insulin delivery (which may also have included insulin resuspension).

Data from this in-clinic study demonstrated that the Suspend before low feature is safe to use. Study success criteria, as defined in the protocol, were met (i.e. there were no device related serious adverse events, no diabetic ketoacidosis events related to the Suspend before low feature, and no unanticipated adverse device effects).

The second level of SmartGuard technology was the evaluation of Auto Mode, which was accomplished during the 3-month study phase. A total of 105 subjects first used the MiniMed 670G System in Manual Mode (approximately 2 weeks during the run-in phase and 1 additional week at the start of the study phase), before transitioning to Auto Mode at specific points in time during the study phase. The timing of the transition to Auto Mode was based on the scheduling of a 6-day and 5-night hotel or house stay during the study phase. At the hotel or house, subjects underwent daytime and nighttime FST for a total of approximately 24 hours. Subjects were allowed to eat as they normally would, and participated in a daily exercise or activity regimen for a minimum of 4 hours per day, spread throughout the day. All subjects participated in a hotel or house stay and finished the study. During this study, the MiniMed 770G System was used for over 15,353 patient days (including the 2-week run-in phase and the 3-month study phase)

---

7 Forlenza G, Shulman D, Wood M, et al. Evaluation of the MiniMed 670G system predictive low glucose management feature in children. *Diabetes Technology and Therapeutics*. 2018;20:A19-A20.

8 Forlenza GP, Pinhas-Hamiel O, Liljenquist DR, et al. Safety Evaluation of the MiniMed 670G System in Children 7-13 Years of Age with Type 1 Diabetes. *Diabetes Technol Ther*. 2019;21(1):11-19.

without any reported device-related serious adverse events, such as severe hypoglycemia or diabetic ketoacidosis. Compared to Manual Mode used during the run-in phase, use of Auto Mode was associated with reduction in mean SG values, an increase within the range of 71 to 180 mg/dL, and a lower percentage of glucose values in the hyperglycemic and hypoglycemic ranges. There was a significant reduction in mean HbA1c from  $7.9\pm 0.8$  (median 7.9) at the start of study to  $7.5\pm 0.6$  (median 7.5) at the end of study. There was a small change in mean total daily dose of insulin/kg ( $0.8\pm 0.2$  baseline to  $0.9\pm 0.2$  end of study) and modest increase in weight. Weight gain would also be expected for pediatric patients 7 to 13 years of age as part of the normal growth process.

Of the 203 adverse events reported through the end of the study period, 39% (N=80) were classified as device related. Of the 80 device-related adverse events, 65 were glycemic events (hyperglycemia, severe hyperglycemia, and severe hyperglycemia with ketosis) and 14 were related to skin issues (cellulitis, skin infection at the infusion set site, infection at the sensor insertion site, pump site infection on lower abdomen, eczema, and skin irritation). Five adverse events were classified as procedure related (these included neurocardiogenic syncope, headache, and angioedema) and two of the adverse events (hyperglycemia and skin irritation) were classified as both device and procedure related.

There were 104 reports of severe hyperglycemia and there was no diabetic ketoacidosis while on the MiniMed 670G System during the study. The majority of these severe hyperglycemic events (77/104) were mild in intensity. Ketone levels were available for 102 of the 104 severe hyperglycemia episodes and the majority of ketone levels (83/104) were low (10.8–27 mg/dL).

One severe hyperglycemic event was associated with an emergency room visit, however, the ER visit was primarily due to concurrent acute gastroenteritis.

Of the 62 device related episodes of severe hyperglycemia, 51 were believed to be due to infusion set issues such as occlusion, bent cannula or cannula pull out. These issues are typically seen in relatively high rates in the pediatric population (causes provided in Table D-1 and Table D-2). Unlike insulin pump therapy which may or may not have alerts associated with infusion set failure, the MiniMed 670G System has fixed alarms (high alerts) that serve as an additional mitigation for subjects.

<b>Cause</b>	<b>Total</b>
Infusion set change	9
Occlusion Alarm	3
Infusion set fell out	2
Bent or Kinked Cannula	1
Total	15

<b>Cause</b>	<b>Total</b>
Infusion set change	28
Occlusion Alarm	12
Infusion set fell out	7
Bent or Kinked Cannula	5
Infusion set change or safe basal	3
Safe basal	2
Suspend before low suspension	1
Automatic & manual suspensions	1
Unclipped infusion set	1
Internal Battery Connector Resistance	1
Manual suspension and safe basal	1
Total	62

The following table shows the time spent per day in specific glucose ranges during the run-in and study phases by all subjects.

<b>Glucose Range (mg/dL)</b>	<b>Run-In Phase</b>	<b>Study Phase</b>
	<b>Time in Glucose Range (min) Mean±SD</b>	<b>Time in Glucose Range (min) Mean±SD</b>
≤50	12.2±16.9	7.8±7.3
≤60	32.3±32.7	20.3±14.2
≤70	68.3±55.4	43.1±23.6
70–180	808.6±163.5	936.2±110.4
>180	563.1±184.3	460.7±110.5
>250	191.0±111.5	148.4±74.1
>300	68.1±54.8	53.7±39.4
>350	23.0±24.9	17.4±17.1

The following table shows the ranges of changes in HbA1C observed in the study and indicates the number of subjects that demonstrated each type of change in HbA1C observed.

HbA1C Change Range	Number of Subjects (% of Subjects) with Change in A1C				
	Baseline A1C (%)	Decrease >1%	Decrease 0 to 1%	No Change	Increase 0 to 1%
5% ≤ A1C < 6%	0 (0.0%)	0 (0.0%)	0 (0.0%)	1 (1.0%)	0 (0.0%)
6% ≤ A1C < 7%	0 (0.0%)	1 (1.0%)	0 (0.0%)	9 (8.6%)	0 (0.0%)
7% ≤ A1C < 8%	3 (2.9%)	22 (21.0%)	6 (5.7%)	16 (15.2%)	0 (0.0%)
8% ≤ A1C < 9%	9 (8.6%)	21 (20.0%)	3 (2.9%)	4 (3.8%)	0 (0.0%)
9% ≤ A1C < 10%	4 (3.8%)	6 (5.7%)	0 (0.0%)	0 (0.0%)	0 (0.0%)
Overall	16 (15.2%)	50 (47.6%)	9 (8.6%)	30 (28.6%)	0 (0.0%)

The following table shows the number of subjects that spent a specific range of time in specific glucose ranges during the study phase.

Time Range	Number of Subjects (% of Subjects) in the Glucose Range (mg/dL) Indicated					
	≤50 mg/dL	≤60 mg/dL	≤70 mg/dL	70 to 180 mg/dL	>180 mg/dL	>250 mg/dL
0 to 15 mins	93 (88.6%)	41 (39.0%)	13 (12.4%)	0 (0.0%)	0 (0.0%)	1 (1.0%)
15 to 30 mins	10 (9.5%)	46 (43.8%)	23 (21.9%)	0 (0.0%)	0 (0.0%)	1 (1.0%)
30 to 45 mins	2 (1.9%)	12 (11.4%)	24 (22.9%)	0 (0.0%)	0 (0.0%)	4 (3.8%)
45 mins to 1 hr	0 (0.0%)	3 (2.9%)	23 (21.9%)	0 (0.0%)	0 (0.0%)	2 (1.9%)
1-4 hr	0 (0.0%)	3 (2.9%)	22 (21.0%)	0 (0.0%)	2 (1.9%)	83 (79.0%)
4-8 hr	0 (0.0%)	0 (0.0%)	0 (0.0%)	0 (0.0%)	54 (51.4%)	14 (13.3%)
8-12 hr	0 (0.0%)	0 (0.0%)	0 (0.0%)	5 (4.8%)	49 (46.7%)	0 (0.0%)
12-16 hr	0 (0.0%)	0 (0.0%)	0 (0.0%)	54 (51.4%)	0 (0.0%)	0 (0.0%)
16-20 hr	0 (0.0%)	0 (0.0%)	0 (0.0%)	45 (42.9%)	0 (0.0%)	0 (0.0%)
20-24 hr	0 (0.0%)	0 (0.0%)	0 (0.0%)	1 (1.0%)	0 (0.0%)	0 (0.0%)

The following table shows the average amount of time spent in Auto Mode per day.

Glucose Range (mg/dL)	Study Phase Time in Glucose Range (min) Mean±SD
≤50	5.0±4.0
≤60	14.0±9.0
≤70	31.2±16.8
70-180	797.0±142.2
>180	321.9±59.2
>250	84.2±32.4
All	1150.1±132.9

The pediatric pivotal clinical trial of the MiniMed 670G System suggested that the system was safe; however, this trial had a number of limitations which included the following:

- The study involved a relatively small number of patients.
- There was no control group for comparison purposes.
- The amount of time the system was used in the Manual mode was much shorter than the time it was programmed to the Auto Mode.
- Additionally, for each subject, the study period lasted only three months.

Due to these limitations, the results of the clinical trial must be interpreted with caution and you should understand that your individual results when using the MiniMed 670G System may be significantly different from those of the subjects who participated in the trial.

## **E. Guardian Sensor (3) Performance in users ages 7 to 13**

### **CGM performance**

The use of the Guardian Sensor (3) with the Guardian Link (3) transmitter enables CGM technology. The transmitter transmits SG values calculated by the real-time algorithm to a primary display device, allowing you to monitor your SG values.

### **Clinical study description**

The performance of the Guardian Sensor (3) was evaluated in a clinical study.<sup>9</sup> This in-patient (in-clinic) and outpatient (at home) study included subjects 7 to 13 years in age. The study design was a multi-center, prospective single sample correlational design without controls.

All subjects were assigned to treatment. Each subject was instructed to wear two Guardian Sensor (3) sensors in the abdomen or buttock.

- One Guardian Sensor (3) connected to the Guardian Connect Transmitter, which transmitted to the Guardian Connect app, a standalone CGM display device.
- One Guardian Sensor (3) connected to the Guardian Link (3) transmitter, which served as a glucose sensor recorder (GSR, transmitter and recorder for sensor-integrated pump systems).

---

<sup>9</sup> Medtronic Inc., A Performance Evaluation of the Enlite™ and Enlite™ 3 Glucose Sensor to Support Use in Children; CEP249 Data From Subjects 7-13 Years of Age 10703807DOC. November 2017.

The SG data collected by the blinded GSRs were retrospectively processed through the real-time CGM algorithm. This is the same algorithm used in the Guardian Connect and pump CGM systems. Thus all data is representative of real-time sensor usage.

The CONTOUR NEXT LINK 2.4 Wireless Meter was the study meter used for all calibrations in this study, and was the only meter evaluated with the Guardian Sensor (3) CGM systems. The sensor has not been tested with other meters. Therefore, the performance with other BG meters may differ from the performance with the CONTOUR NEXT LINK 2.4 Wireless Meter described below.

FST was performed on day 1, 3, or 7 for 6 hours each, over the life of the sensor. Reference blood (plasma) glucose values were obtained with a YSI Glucose Analyzer every 5 to 15 minutes. During the FSTs, the subjects were instructed to calibrate the sensors once every 12 hours, or as requested by the display device. During home use (outside the clinic), subjects were instructed to calibrate both sensors three to four times spread throughout the day. During the FST procedures, glucose challenges were limited to 30 minutes of exercise. Therefore, there were a limited number of glucose values in the high and low glucose ranges.

The overall number of subjects that participated in FST procedures on day 1, 3, or 7 were 21, 13, and 10 respectively.

During the study, the meter was used for confirmation of alarms, treatment decisions, and sensor calibrations.

## Results

### Sensor accuracy

The following information highlights the Guardian Sensor (3) performance from 50 subjects (7 to 13 years old) wearing the Guardian Link (3) Transmitter that served as a glucose sensor recorder (GSR, transmitter and recorder for sensor-integrated pump systems) and the Guardian Connect Transmitter, which transmitted to the Guardian Connect app (a standalone CGM display device) during FST.

### Mean absolute relative difference, by number of daily calibrations

Table E-1 shows the sensor accuracy measured by the MARD. MARD represents the average relative difference (regardless if positive or negative) between the SG values and the paired BG values measured by YSI.

YSI Glucose Ranges (mg/dL)	Abdomen Insertion Site				Buttock Insertion Site			
	Calibration every 12 hours		Calibration 3 or 4 times a day		Calibration every 12 hours		Calibration 3 or 4 times a day	
	Number of Paired SG-YSI	MARD (%)	Number of Paired SG-YSI	MARD (%)	Number of Paired SG-YSI	MARD (%)	Number of Paired SG-YSI	MARD (%)
Overall	733	10.46	710	9.84	710	9.14	686	8.79
40-60*	4	19.16	2	31.9	7	5.43	7	3.61
61-80*	20	10.59	18	8.54	34	10.85	28	7.86
81-180	378	11.59	367	11.04	393	9.63	374	8.99
181-300	290	8.76	282	8.4	255	7.92	253	8.56
301-350	32	7.11	32	5.63	15	4.64	18	7.67
351-400	9	8.59	9	5.57	6	5.05	6	3.01

\* For YSI reference range  $\leq 80$  mg/dL, the differences in mg/dL are included instead of percent difference (%).

Note: SG Readings are within 40-400 mg/dL.

### Percent agreement, by number of daily calibrations

In Tables E-2 through E-9, the agreement of the SG values to paired YSI values was assessed by calculating the percentage of YSI values that were within 15%, 20%, 30%, 40%, and greater than 40% of the paired SG values. For readings less than or equal to 80 mg/dL, the absolute difference in mg/dL between the SG and paired YSI values was calculated.

Results are shown for defined SG ranges when calibrating every 12 hours and calibrating three or four times a day for sensors.

YSI Glucose Ranges (mg/dL)	Number of Paired SG-YSI	Percent of SG Within 15/15% of YSI	Percent of SG Within 20/20% of YSI	Percent of SG Within 30/30% of YSI	Percent of SG Within 40/40% of YSI	Percent of SG greater than 40/40% of YSI
Overall	733	78.9	87.7	95.9	98.9	1.1
$\geq 40-60^*$	4	50	50	75	100	0
$>60-80^*$	20	70	80	90	95	5
$>80-180$	378	74.1	83.1	92.9	98.1	1.9
$>180-300$	290	83.1	93.1	100	100	0
$>300-350$	32	100	100	100	100	0
$>350-400$	9	100	100	100	100	0

\* For glucose ranges  $\leq 80$  mg/dL, agreement was based on 15/20/30/40 mg/dL.

Note: SG readings are within 40-400 mg/dL.



**Table E-3: Agreement (%) of SG-YSI paired points within YSI glucose ranges on FST Day 1; Calibration every 12 hours, Abdomen**

YSI Glucose Ranges (mg/dL)	Number of Paired SG-YSI	Percent of SG Within 15/15% of YSI	Percent of SG Within 20/20% of YSI	Percent of SG Within 30/30% of YSI	Percent of SG Within 40/40% of YSI	Percent of SG greater than 40/40% of YSI
Overall	403	81.9	90.6	96.5	99	1
≥40-60*	2	100	100	100	100	0
>60-80*	11	63.6	72.7	90.9	100	0
>80-180	196	75.5	84.2	93.4	98	2
>180-300	160	86.9	97.5	100	100	0
>300-350	27	100	100	100	100	0
>350-400	7	100	100	100	100	0

\* For glucose ranges ≤80 mg/dL, agreement was based on 15/20/30/40 mg/dL.

**Note:** The overall number of available paired SG-YSI points on FST Day 1 was from 16 subjects. SG readings are within 40-400 mg/dL.

**Table E-4: Agreement (%) of SG-YSI paired points within YSI glucose ranges on FST Days 1, 3, and 7; Calibration 3 or 4 times a day, Abdomen**

YSI Glucose Ranges (mg/dL)	Number of Paired SG-YSI	Percent of SG Within 15/15% of YSI	Percent of SG Within 20/20% of YSI	Percent of SG Within 30/30% of YSI	Percent of SG Within 40/40% of YSI	Percent of SG greater than 40/40% of YSI
Overall	710	81.7	90	97.2	99.4	0.6
≥40-60*	2	0	0	50	100	0
>60-80*	18	83.3	88.9	94.4	94.4	5.6
>80-180	367	74.9	84.5	95.1	99.2	0.8
>180-300	282	88.3	96.5	100	100	0
>300-350	32	100	100	100	100	0
>350-400	9	100	100	100	100	0

\* For glucose ranges ≤80 mg/dL, agreement was based on 15/20/30/40 mg/dL.

**Note:** SG readings are within 40-400 mg/dL.

**Table E-5: Agreement (%) of SG-YSI paired points within YSI glucose ranges on FST Day 1; Calibration 3 or 4 times a day, Abdomen**

YSI Glucose Ranges (mg/dL)	Number of Paired SG-YSI	Percent of SG Within 15/15% of YSI	Percent of SG Within 20/20% of YSI	Percent of SG Within 30/30% of YSI	Percent of SG Within 40/40% of YSI	Percent of SG greater than 40/40% of YSI
Overall	372	83.9	92.2	97.3	99.5	0.5
>60-80*	9	77.8	88.9	100	100	0
>80-180	182	76.9	86.3	94.5	98.9	1.1
>180-300	147	89.1	98	100	100	0
>300-350	27	100	100	100	100	0
>350-400	7	100	100	100	100	0

\* For glucose ranges ≤80 mg/dL, agreement was based on 15/20/30/40 mg/dL.

**Note:** The overall number of available paired SG-YSI points on FST Day 1 was from 15 subjects. SG readings are within 40-400 mg/dL.

**Table E-6: Agreement (%) of SG-YSI paired points within YSI glucose ranges on FST Days 1, 3, and 7; Calibration every 12 hours, Buttock**

YSI Glucose Ranges (mg/dL)	Number of Paired SG-YSI	Percent of SG Within 15/15% of YSI	Percent of SG Within 20/20% of YSI	Percent of SG Within 30/30% of YSI	Percent of SG Within 40/40% of YSI	Percent of SG greater than 40/40% of YSI
Overall	710	84.8	92.3	96.8	98.6	1.4
≥40-60*	7	100	100	100	100	0
>60-80*	34	70.6	79.4	94.1	100	0
>80-180	393	80.9	89.8	94.9	97.5	2.5
>180-300	255	91	96.9	99.6	100	0
>300-350	15	100	100	100	100	0
>350-400	6	100	100	100	100	0

\* For glucose ranges ≤80 mg/dL, agreement was based on 15/20/30/40 mg/dL.

Note: SG readings are within 40-400 mg/dL.

**Table E-7: Agreement (%) of SG-YSI paired points within YSI glucose ranges on FST Day 1; Calibration every 12 hours, Buttock**

YSI Glucose Ranges (mg/dL)	Number of Paired SG-YSI	Percent of SG Within 15/15% of YSI	Percent of SG Within 20/20% of YSI	Percent of SG Within 30/30% of YSI	Percent of SG Within 40/40% of YSI	Percent of SG greater than 40/40% of YSI
Overall	335	78.8	87.2	93.7	97	3
>60-80*	19	52.6	63.2	89.5	100	0
>80-180	178	71.9	82.6	89.9	94.4	5.6
>180-300	133	91	96.2	99.2	100	0
>300-350	3	100	100	100	100	0
>350-400	2	100	100	100	100	0

\* For glucose ranges ≤80 mg/dL, agreement was based on 15/20/30/40 mg/dL.

Note: The overall number of available paired SG-YSI points on FST Day 1 was from 14 subjects. SG readings are within 40-400 mg/dL.

**Table E-8: Agreement (%) of SG-YSI paired points within YSI glucose ranges on FST Days 1, 3, and 7; Calibration 3 or 4 times a day, Buttock**

YSI Glucose Ranges (mg/dL)	Number of Paired SG-YSI	Percent of SG Within 15/15% of YSI	Percent of SG Within 20/20% of YSI	Percent of SG Within 30/30% of YSI	Percent of SG Within 40/40% of YSI	Percent of SG greater than 40/40% of YSI
Overall	686	84.7	92.7	97.1	99.1	0.9
≥40-60*	7	100	100	100	100	0
>60-80*	28	85.7	89.3	100	100	0
>80-180	374	82.4	90.4	95.7	98.4	1.6
>180-300	253	87.4	96	98.4	100	0
>300-350	18	83.3	94.4	100	100	0
>350-400	6	100	100	100	100	0

\* For glucose ranges ≤80 mg/dL, agreement was based on 15/20/30/40 mg/dL.

Note: SG readings are within 40-400 mg/dL.

**Table E-9: Agreement (%) of SG-YSI paired points within YSI glucose ranges on FST Day 1; Calibration 3 or 4 times a day, Buttock**

YSI Glucose Ranges (mg/dL)	Number of Paired SG-YSI	Percent of SG Within 15/15% of YSI	Percent of SG Within 20/20% of YSI	Percent of SG Within 30/30% of YSI	Percent of SG Within 40/40% of YSI	Percent of SG greater than 40/40% of YSI
Overall	311	80.7	90.4	95.5	98.7	1.3
>60-80*	13	69.2	76.9	100	100	0
>80-180	159	77.4	86.8	92.5	97.5	2.5
>180-300	131	87	96.2	98.5	100	0
>300-350	6	50	83.3	100	100	0
>350-400	2	100	100	100	100	0

\* For glucose ranges ≤80 mg/dL, agreement was based on 15/20/30/40 mg/dL.

**Note:** The overall number of available paired SG-YSI points on FST Day 1 was from 13 subjects. SG readings are within 40-400 mg/dL.

### Agreement when CGM reads “Below 40 mg/dL” or “Above 400 mg/dL”

The real-time CGM systems display glucose values between 40 mg/dL and 400 mg/dL. It displays “Below 40 mg/dL” when the SG value detected is below 40 mg/dL. It displays “Above 400 mg/dL” when the SG value detected is above 400 mg/dL. Tables E-10 through E-13 illustrate the number and percentage of the paired YSI values in different BG levels when the CGM system displays “Below 40 mg/dL” (LOW) or “Above 400 mg/dL” (HIGH).

**Table E-10: The number and percentage of YSI values collected when CGM displays "Below 40 mg/dL" (LOW); Calibration every 12 hours**

CGM Display	Insertion Site	CGM-YSI pairs	YSI (mg/dL)					Total
			<55	<60	<70	<80	>80	
LOW	Abdomen	Cumulative, n	2	2	2	2	0	2
		Cumulative %	100%	100%	100%	100%	0%	
	Buttocks	Cumulative, n	3	4	7	7	1	8
		Cumulative %	38%	50%	88%	88%	13%	

**Table E-11: The number and percentage of YSI values collected when CGM displays "Below 40 mg/dL" (LOW); Calibration 3 or 4 times a day**

CGM Display	Insertion Site	CGM-YSI pairs	YSI (mg/dL)					Total
			<55	<60	<70	<80	>80	
LOW	Abdomen	Cumulative, n	0	0	0	0	0	0
		Cumulative %	0%	0%	0%	0%	0%	
	Buttocks	Cumulative, n	3	4	6	6	1	7
		Cumulative %	43%	57%	86%	86%	14%	

**Table E-12: The number and percentage of YSI values collected when CGM displays "Above 400 mg/dL" (HIGH); Calibration every 12 hours**

CGM Display	Insertion Site	CGM-YSI pairs	YSI (mg/dL)					Total
			>340	>320	>280	>240	<240	
HIGH	Abdomen	Cumulative, n	0	0	0	0	0	0
		Cumulative %	0%	0%	0%	0%	0%	
	Buttocks	Cumulative, n	0	0	0	0	0	0
		Cumulative %	0%	0%	0%	0%	0%	

**Table E-13: The number and percentage of YSI values collected when CGM displays "Above 400 mg/dL" (HIGH); Calibration 3 or 4 times a day.**

CGM Display	Insertion Site	CGM-YSI pairs	YSI (mg/dL)					Total
			>340	>320	>280	>240	<240	
HIGH	Abdomen	Cumulative, n	0	0	0	0	0	0
		Cumulative %	0%	0%	0%	0%	0%	
	Buttocks	Cumulative, n	0	0	0	0	0	0
		Cumulative %	0%	0%	0%	0%	0%	

### Concurrence of SG and YSI values

The following tables show the percentage of concurring SG readings with FST reference values.

**Table E-14: Overall concurrence of YSI values and SG readings using YSI ranges on FST Days 1, 3, and 7; Calibration every 12 hours, Abdomen**

Percent of Matched Pairs-in Each SG Glucose Range for Each YSI Glucose Range												
YSI Glucose Ranges (mg/dL)	Number of Paired SG-YSI	SG (mg/dL)										
		<40	≥40-60	>60-80	>80-120	>120-160	>160-200	>200-250	>250-300	>300-350	>350-400	>400
B) ≥40-60	6	33.3% (2/6)	33.3% (2/6)	0.0% (0/6)	33.3% (2/6)	0.0% (0/6)	0.0% (0/6)	0.0% (0/6)	0.0% (0/6)	0.0% (0/6)	0.0% (0/6)	0.0% (0/6)
C) >60-80	20	0.0% (0/20)	10.0% (2/20)	55.0% (11/20)	35.0% (7/20)	0.0% (0/20)	0.0% (0/20)	0.0% (0/20)	0.0% (0/20)	0.0% (0/20)	0.0% (0/20)	0.0% (0/20)
D) >80-120	124	0.0% (0/124)	4.8% (6/124)	13.7% (17/124)	66.1% (82/124)	15.3% (19/124)	0.0% (0/124)	0.0% (0/124)	0.0% (0/124)	0.0% (0/124)	0.0% (0/124)	0.0% (0/124)
E) >120-160	169	0.0% (0/169)	0.0% (0/169)	0.6% (1/169)	21.3% (36/169)	62.1% (105/169)	15.4% (26/169)	0.6% (1/169)	0.0% (0/169)	0.0% (0/169)	0.0% (0/169)	0.0% (0/169)
F) >160-200	160	0.0% (0/160)	0.0% (0/160)	0.0% (0/160)	1.9% (3/160)	25.0% (40/160)	64.4% (103/160)	8.8% (14/160)	0.0% (0/160)	0.0% (0/160)	0.0% (0/160)	0.0% (0/160)
G) >200-250	151	0.0% (0/151)	0.0% (0/151)	0.0% (0/151)	0.0% (0/151)	1.3% (2/151)	40.4% (61/151)	56.3% (85/151)	2.0% (3/151)	0.0% (0/151)	0.0% (0/151)	0.0% (0/151)
H) >250-300	64	0.0% (0/64)	0.0% (0/64)	0.0% (0/64)	0.0% (0/64)	0.0% (0/64)	0.0% (0/64)	32.8% (21/64)	64.1% (41/64)	3.1% (2/64)	0.0% (0/64)	0.0% (0/64)
I) >300-350	32	0.0% (0/32)	0.0% (0/32)	0.0% (0/32)	0.0% (0/32)	0.0% (0/32)	0.0% (0/32)	0.0% (0/32)	40.6% (13/32)	59.4% (19/32)	0.0% (0/32)	0.0% (0/32)
J) >350-400	9	0.0% (0/9)	0.0% (0/9)	0.0% (0/9)	0.0% (0/9)	0.0% (0/9)	0.0% (0/9)	0.0% (0/9)	0.0% (0/9)	88.9% (8/9)	11.1% (1/9)	0.0% (0/9)

**Table E-15: Overall concurrence of YSI values and SG readings using YSI ranges on FST Day 1; Calibration every 12 hours, Abdomen**

Percent of Matched Pairs-in Each SG Glucose Range for Each YSI Glucose Range												
YSI Glucose Ranges (mg/dL)	Number of Paired SG-YSI	SG (mg/dL)										
		<40	≥40-60	>60-80	>80-120	>120-160	>160-200	>200-250	>250-300	>300-350	>350-400	>400
B) ≥40-60	4	50.0% (2/4)	50.0% (2/4)	0.0% (0/4)	0.0% (0/4)	0.0% (0/4)	0.0% (0/4)	0.0% (0/4)	0.0% (0/4)	0.0% (0/4)	0.0% (0/4)	0.0% (0/4)
C) >60-80	11	0.0% (0/11)	18.2% (2/11)	45.5% (5/11)	36.4% (4/11)	0.0% (0/11)	0.0% (0/11)	0.0% (0/11)	0.0% (0/11)	0.0% (0/11)	0.0% (0/11)	0.0% (0/11)
D) >80-120	50	0.0% (0/50)	6.0% (3/50)	8.0% (4/50)	62.0% (31/50)	24.0% (12/50)	0.0% (0/50)	0.0% (0/50)	0.0% (0/50)	0.0% (0/50)	0.0% (0/50)	0.0% (0/50)
E) >120-160	94	0.0% (0/94)	0.0% (0/94)	1.1% (1/94)	19.1% (18/94)	58.5% (55/94)	20.2% (19/94)	1.1% (1/94)	0.0% (0/94)	0.0% (0/94)	0.0% (0/94)	0.0% (0/94)
F) >160-200	95	0.0% (0/95)	0.0% (0/95)	0.0% (0/95)	2.1% (2/95)	17.9% (17/95)	69.5% (66/95)	10.5% (10/95)	0.0% (0/95)	0.0% (0/95)	0.0% (0/95)	0.0% (0/95)
G) >200-250	83	0.0% (0/83)	0.0% (0/83)	0.0% (0/83)	0.0% (0/83)	1.2% (1/83)	27.7% (23/83)	68.7% (57/83)	2.4% (2/83)	0.0% (0/83)	0.0% (0/83)	0.0% (0/83)
H) >250-300	34	0.0% (0/34)	0.0% (0/34)	0.0% (0/34)	0.0% (0/34)	0.0% (0/34)	0.0% (0/34)	44.1% (15/34)	52.9% (18/34)	2.9% (1/34)	0.0% (0/34)	0.0% (0/34)
I) >300-350	27	0.0% (0/27)	0.0% (0/27)	0.0% (0/27)	0.0% (0/27)	0.0% (0/27)	0.0% (0/27)	0.0% (0/27)	37.0% (10/27)	63.0% (17/27)	0.0% (0/27)	0.0% (0/27)
J) >350-400	7	0.0% (0/7)	0.0% (0/7)	0.0% (0/7)	0.0% (0/7)	0.0% (0/7)	0.0% (0/7)	0.0% (0/7)	0.0% (0/7)	100.0% (7/7)	0.0% (0/7)	0.0% (0/7)

Note: The overall number of available paired SG-YSI points on FST Day 1 was from 16 subjects.

**Table E-16: Overall concurrence of YSI values and SG readings using YSI ranges on FST Days 1, 3, and 7; Calibration 3 or 4 times a day, Abdomen**

Percent of Matched Pairs-in Each SG Glucose Range for Each YSI Glucose Range												
YSI Glucose Ranges (mg/dL)	Number of Paired SG-YSI	SG (mg/dL)										
		<40	≥40-60	>60-80	>80-120	>120-160	>160-200	>200-250	>250-300	>300-350	>350-400	>400
B) ≥40-60	2	0.0% (0/2)	0.0% (0/2)	0.0% (0/2)	100.0% (2/2)	0.0% (0/2)	0.0% (0/2)	0.0% (0/2)	0.0% (0/2)	0.0% (0/2)	0.0% (0/2)	0.0% (0/2)
C) >60-80	18	0.0% (0/18)	0.0% (0/18)	61.1% (11/18)	38.9% (7/18)	0.0% (0/18)	0.0% (0/18)	0.0% (0/18)	0.0% (0/18)	0.0% (0/18)	0.0% (0/18)	0.0% (0/18)
D) >80-120	120	0.0% (0/120)	3.3% (4/120)	15.8% (19/120)	67.5% (81/120)	13.3% (16/120)	0.0% (0/120)	0.0% (0/120)	0.0% (0/120)	0.0% (0/120)	0.0% (0/120)	0.0% (0/120)
E) >120-160	162	0.0% (0/162)	0.0% (0/162)	0.0% (0/162)	17.9% (29/162)	64.8% (105/162)	16.7% (27/162)	0.6% (1/162)	0.0% (0/162)	0.0% (0/162)	0.0% (0/162)	0.0% (0/162)
F) >160-200	161	0.0% (0/161)	0.0% (0/161)	0.0% (0/161)	1.2% (2/161)	25.5% (41/161)	65.2% (105/161)	8.1% (13/161)	0.0% (0/161)	0.0% (0/161)	0.0% (0/161)	0.0% (0/161)
G) >200-250	145	0.0% (0/145)	0.0% (0/145)	0.0% (0/145)	0.0% (0/145)	1.4% (2/145)	42.8% (62/145)	53.8% (78/145)	2.1% (3/145)	0.0% (0/145)	0.0% (0/145)	0.0% (0/145)
H) >250-300	61	0.0% (0/61)	0.0% (0/61)	0.0% (0/61)	0.0% (0/61)	0.0% (0/61)	0.0% (0/61)	32.8% (20/61)	65.6% (40/61)	1.6% (1/61)	0.0% (0/61)	0.0% (0/61)
I) >300-350	32	0.0% (0/32)	0.0% (0/32)	0.0% (0/32)	0.0% (0/32)	0.0% (0/32)	0.0% (0/32)	0.0% (0/32)	37.5% (12/32)	62.5% (20/32)	0.0% (0/32)	0.0% (0/32)

**Table E-16: Overall concurrence of YSI values and SG readings using YSI ranges on FST Days 1, 3, and 7; Calibration 3 or 4 times a day, Abdomen**

Percent of Matched Pairs-in Each SG Glucose Range for Each YSI Glucose Range													
YSI Glucose Ranges (mg/dL)	Number of Paired SG-YSI	SG (mg/dL)											
		<40	≥40-60	>60-80	>80-120	>120-160	>160-200	>200-250	>250-300	>300-350	>350-400	>400	
J) >350-400	9	0.0% (0/9)	0.0% (0/9)	0.0% (0/9)	0.0% (0/9)	0.0% (0/9)	0.0% (0/9)	0.0% (0/9)	0.0% (0/9)	0.0% (0/9)	55.6% (5/9)	44.4% (4/9)	0.0% (0/9)

**Table E-17: Overall concurrence of YSI values and SG readings using YSI ranges on FST Day 1; Calibration 3 or 4 times a day, Abdomen**

Percent of Matched Pairs-in Each SG Glucose Range for Each YSI Glucose Range													
YSI Glucose Ranges (mg/dL)	Number of Paired SG-YSI	SG (mg/dL)											
		<40	≥40-60	>60-80	>80-120	>120-160	>160-200	>200-250	>250-300	>300-350	>350-400	>400	
C) >60-80	9	0.0% (0/9)	0.0% (0/9)	55.6% (5/9)	44.4% (4/9)	0.0% (0/9)	0.0% (0/9)	0.0% (0/9)	0.0% (0/9)	0.0% (0/9)	0.0% (0/9)	0.0% (0/9)	0.0% (0/9)
D) >80-120	46	0.0% (0/46)	2.2% (1/46)	10.9% (5/46)	67.4% (31/46)	19.6% (9/46)	0.0% (0/46)	0.0% (0/46)	0.0% (0/46)	0.0% (0/46)	0.0% (0/46)	0.0% (0/46)	0.0% (0/46)
E) >120-160	85	0.0% (0/85)	0.0% (0/85)	0.0% (0/85)	16.5% (14/85)	60.0% (51/85)	22.4% (19/85)	1.2% (1/85)	0.0% (0/85)	0.0% (0/85)	0.0% (0/85)	0.0% (0/85)	0.0% (0/85)
F) >160-200	91	0.0% (0/91)	0.0% (0/91)	0.0% (0/91)	2.2% (2/91)	16.5% (15/91)	70.3% (64/91)	11.0% (10/91)	0.0% (0/91)	0.0% (0/91)	0.0% (0/91)	0.0% (0/91)	0.0% (0/91)
G) >200-250	76	0.0% (0/76)	0.0% (0/76)	0.0% (0/76)	0.0% (0/76)	1.3% (1/76)	27.6% (21/76)	68.4% (52/76)	2.6% (2/76)	0.0% (0/76)	0.0% (0/76)	0.0% (0/76)	0.0% (0/76)
H) >250-300	31	0.0% (0/31)	0.0% (0/31)	0.0% (0/31)	0.0% (0/31)	0.0% (0/31)	0.0% (0/31)	38.7% (12/31)	58.1% (18/31)	3.2% (1/31)	0.0% (0/31)	0.0% (0/31)	0.0% (0/31)
I) >300-350	27	0.0% (0/27)	0.0% (0/27)	0.0% (0/27)	0.0% (0/27)	0.0% (0/27)	0.0% (0/27)	0.0% (0/27)	29.6% (8/27)	70.4% (19/27)	0.0% (0/27)	0.0% (0/27)	0.0% (0/27)
J) >350-400	7	0.0% (0/7)	0.0% (0/7)	0.0% (0/7)	0.0% (0/7)	0.0% (0/7)	0.0% (0/7)	0.0% (0/7)	0.0% (0/7)	57.1% (4/7)	42.9% (3/7)	0.0% (0/7)	0.0% (0/7)

Note: The overall number of available paired SG-YSI points on FST Day 1 was from 15 subjects.

**Table E-18: Overall concurrence of YSI values and SG readings using YSI ranges on FST Days 1, 3, and 7; Calibration every 12 hours, Buttock**

Percent of Matched Pairs-in Each SG Glucose Range for Each YSI Glucose Range													
YSI Glucose Ranges (mg/dL)	Number of Paired SG-YSI	SG (mg/dL)											
		<40	≥40-60	>60-80	>80-120	>120-160	>160-200	>200-250	>250-300	>300-350	>350-400	>400	
B) ≥40-60	11	36.4% (4/11)	63.6% (7/11)	0.0% (0/11)	0.0% (0/11)	0.0% (0/11)	0.0% (0/11)	0.0% (0/11)	0.0% (0/11)	0.0% (0/11)	0.0% (0/11)	0.0% (0/11)	0.0% (0/11)
C) >60-80	37	8.1% (3/37)	24.3% (9/37)	43.2% (16/37)	24.3% (9/37)	0.0% (0/37)	0.0% (0/37)	0.0% (0/37)	0.0% (0/37)	0.0% (0/37)	0.0% (0/37)	0.0% (0/37)	0.0% (0/37)
D) >80-120	156	0.6% (1/156)	5.1% (8/156)	9.0% (14/156)	75.6% (118/156)	9.6% (15/156)	0.0% (0/156)	0.0% (0/156)	0.0% (0/156)	0.0% (0/156)	0.0% (0/156)	0.0% (0/156)	0.0% (0/156)
E) >120-160	170	0.0% (0/170)	0.0% (0/170)	2.9% (5/170)	16.5% (28/170)	67.6% (115/170)	12.9% (22/170)	0.0% (0/170)	0.0% (0/170)	0.0% (0/170)	0.0% (0/170)	0.0% (0/170)	0.0% (0/170)

**Table E-18: Overall concurrence of YSI values and SG readings using YSI ranges on FST Days 1, 3, and 7; Calibration every 12 hours, Buttock**

Percent of Matched Pairs-in Each SG Glucose Range for Each YSI Glucose Range												
YSI Glucose Ranges (mg/dL)	Number of Paired SG-YSI	SG (mg/dL)										
		<40	≥40-60	>60-80	>80-120	>120-160	>160-200	>200-250	>250-300	>300-350	>350-400	>400
F) >160-200	144	0.0% (0/144)	0.0% (0/144)	0.0% (0/144)	0.0% (0/144)	16.0% (23/144)	75.7% (109/144)	8.3% (12/144)	0.0% (0/144)	0.0% (0/144)	0.0% (0/144)	0.0% (0/144)
G) >200-250	130	0.0% (0/130)	0.0% (0/130)	0.0% (0/130)	0.0% (0/130)	2.3% (3/130)	38.5% (50/130)	56.2% (73/130)	3.1% (4/130)	0.0% (0/130)	0.0% (0/130)	0.0% (0/130)
H) >250-300	49	0.0% (0/49)	0.0% (0/49)	0.0% (0/49)	0.0% (0/49)	0.0% (0/49)	0.0% (0/49)	40.8% (20/49)	53.1% (26/49)	6.1% (3/49)	0.0% (0/49)	0.0% (0/49)
I) >300-350	15	0.0% (0/15)	0.0% (0/15)	0.0% (0/15)	0.0% (0/15)	0.0% (0/15)	0.0% (0/15)	0.0% (0/15)	33.3% (5/15)	60.0% (9/15)	6.7% (1/15)	0.0% (0/15)
J) >350-400	6	0.0% (0/6)	0.0% (0/6)	0.0% (0/6)	0.0% (0/6)	0.0% (0/6)	0.0% (0/6)	0.0% (0/6)	0.0% (0/6)	50.0% (3/6)	50.0% (3/6)	0.0% (0/6)

**Table E-19: Overall concurrence of YSI values and SG readings using YSI ranges on FST Day 1; Calibration every 12 hours, Buttock**

Percent of Matched Pairs-in Each SG Glucose Range for Each YSI Glucose Range												
YSI Glucose Ranges (mg/dL)	Number of Paired SG-YSI	SG (mg/dL)										
		<40	≥40-60	>60-80	>80-120	>120-160	>160-200	>200-250	>250-300	>300-350	>350-400	>400
B) ≥40-60	4	100.0% (4/4)	0.0% (0/4)	0.0% (0/4)	0.0% (0/4)	0.0% (0/4)	0.0% (0/4)	0.0% (0/4)	0.0% (0/4)	0.0% (0/4)	0.0% (0/4)	0.0% (0/4)
C) >60-80	22	13.6% (3/22)	27.3% (6/22)	31.8% (7/22)	27.3% (6/22)	0.0% (0/22)	0.0% (0/22)	0.0% (0/22)	0.0% (0/22)	0.0% (0/22)	0.0% (0/22)	0.0% (0/22)
D) >80-120	68	1.5% (1/68)	11.8% (8/68)	13.2% (9/68)	58.8% (40/68)	14.7% (10/68)	0.0% (0/68)	0.0% (0/68)	0.0% (0/68)	0.0% (0/68)	0.0% (0/68)	0.0% (0/68)
E) >120-160	74	0.0% (0/74)	0.0% (0/74)	6.8% (5/74)	23.0% (17/74)	56.8% (42/74)	13.5% (10/74)	0.0% (0/74)	0.0% (0/74)	0.0% (0/74)	0.0% (0/74)	0.0% (0/74)
F) >160-200	76	0.0% (0/76)	0.0% (0/76)	0.0% (0/76)	0.0% (0/76)	18.4% (14/76)	72.4% (55/76)	9.2% (7/76)	0.0% (0/76)	0.0% (0/76)	0.0% (0/76)	0.0% (0/76)
G) >200-250	67	0.0% (0/67)	0.0% (0/67)	0.0% (0/67)	0.0% (0/67)	3.0% (2/67)	19.4% (13/67)	73.1% (49/67)	4.5% (3/67)	0.0% (0/67)	0.0% (0/67)	0.0% (0/67)
H) >250-300	27	0.0% (0/27)	0.0% (0/27)	0.0% (0/27)	0.0% (0/27)	0.0% (0/27)	0.0% (0/27)	44.4% (12/27)	48.1% (13/27)	7.4% (2/27)	0.0% (0/27)	0.0% (0/27)
I) >300-350	3	0.0% (0/3)	0.0% (0/3)	0.0% (0/3)	0.0% (0/3)	0.0% (0/3)	0.0% (0/3)	0.0% (0/3)	0.0% (0/3)	100.0% (3/3)	0.0% (0/3)	0.0% (0/3)
J) >350-400	2	0.0% (0/2)	0.0% (0/2)	0.0% (0/2)	0.0% (0/2)	0.0% (0/2)	0.0% (0/2)	0.0% (0/2)	0.0% (0/2)	50.0% (1/2)	50.0% (1/2)	0.0% (0/2)

Note: The overall number of available paired SG-YSI points on FST Day 1 was from 14 subjects.

**Table E-20: Overall concurrence of YSI values and SG readings using YSI ranges on FST Days 1, 3, and 7; Calibration 3 or 4 times a day, Buttock**

Percent of Matched Pairs-in Each SG Glucose Range for Each YSI Glucose Range												
YSI Glucose Ranges (mg/dL)	Number of Paired SG-YSI	SG (mg/dL)										
		<40	≥40-60	>60-80	>80-120	>120-160	>160-200	>200-250	>250-300	>300-350	>350-400	>400
B) ≥40-60	11	36.4% (4/11)	63.6% (7/11)	0.0% (0/11)	0.0% (0/11)	0.0% (0/11)	0.0% (0/11)	0.0% (0/11)	0.0% (0/11)	0.0% (0/11)	0.0% (0/11)	0.0% (0/11)
C) >60-80	30	6.7% (2/30)	10.0% (3/30)	50.0% (15/30)	33.3% (10/30)	0.0% (0/30)	0.0% (0/30)	0.0% (0/30)	0.0% (0/30)	0.0% (0/30)	0.0% (0/30)	0.0% (0/30)
D) >80-120	144	0.7% (1/144)	1.4% (2/144)	7.6% (11/144)	80.6% (116/144)	9.7% (14/144)	0.0% (0/144)	0.0% (0/144)	0.0% (0/144)	0.0% (0/144)	0.0% (0/144)	0.0% (0/144)
E) >120-160	164	0.0% (0/164)	0.0% (0/164)	1.8% (3/164)	16.5% (27/164)	67.1% (110/164)	14.0% (23/164)	0.6% (1/164)	0.0% (0/164)	0.0% (0/164)	0.0% (0/164)	0.0% (0/164)
F) >160-200	140	0.0% (0/140)	0.0% (0/140)	0.0% (0/140)	0.0% (0/140)	14.3% (20/140)	75.0% (105/140)	10.7% (15/140)	0.0% (0/140)	0.0% (0/140)	0.0% (0/140)	0.0% (0/140)
G) >200-250	127	0.0% (0/127)	0.0% (0/127)	0.0% (0/127)	0.0% (0/127)	1.6% (2/127)	42.5% (54/127)	51.2% (65/127)	4.7% (6/127)	0.0% (0/127)	0.0% (0/127)	0.0% (0/127)
H) >250-300	53	0.0% (0/53)	0.0% (0/53)	0.0% (0/53)	0.0% (0/53)	0.0% (0/53)	0.0% (0/53)	41.5% (22/53)	39.6% (21/53)	17.0% (9/53)	1.9% (1/53)	0.0% (0/53)
I) >300-350	18	0.0% (0/18)	0.0% (0/18)	0.0% (0/18)	0.0% (0/18)	0.0% (0/18)	0.0% (0/18)	0.0% (0/18)	38.9% (7/18)	38.9% (7/18)	22.2% (4/18)	0.0% (0/18)
J) >350-400	6	0.0% (0/6)	0.0% (0/6)	0.0% (0/6)	0.0% (0/6)	0.0% (0/6)	0.0% (0/6)	0.0% (0/6)	0.0% (0/6)	16.7% (1/6)	83.3% (5/6)	0.0% (0/6)

**Table E-21: Overall concurrence of YSI values and SG readings using YSI ranges on FST Day 1; Calibration 3 or 4 times a day, Buttock**

Percent of Matched Pairs-in Each SG Glucose Range for Each YSI Glucose Range												
YSI Glucose Ranges (mg/dL)	Number of Paired SG-YSI	SG (mg/dL)										
		<40	≥40-60	>60-80	>80-120	>120-160	>160-200	>200-250	>250-300	>300-350	>350-400	>400
B) ≥40-60	4	100.0% (4/4)	0.0% (0/4)	0.0% (0/4)	0.0% (0/4)	0.0% (0/4)	0.0% (0/4)	0.0% (0/4)	0.0% (0/4)	0.0% (0/4)	0.0% (0/4)	0.0% (0/4)
C) >60-80	15	13.3% (2/15)	0.0% (0/15)	40.0% (6/15)	46.7% (7/15)	0.0% (0/15)	0.0% (0/15)	0.0% (0/15)	0.0% (0/15)	0.0% (0/15)	0.0% (0/15)	0.0% (0/15)
D) >80-120	56	1.8% (1/56)	3.6% (2/56)	12.5% (7/56)	66.1% (37/56)	16.1% (9/56)	0.0% (0/56)	0.0% (0/56)	0.0% (0/56)	0.0% (0/56)	0.0% (0/56)	0.0% (0/56)
E) >120-160	68	0.0% (0/68)	0.0% (0/68)	4.4% (3/68)	25.0% (17/68)	57.4% (39/68)	13.2% (9/68)	0.0% (0/68)	0.0% (0/68)	0.0% (0/68)	0.0% (0/68)	0.0% (0/68)
F) >160-200	72	0.0% (0/72)	0.0% (0/72)	0.0% (0/72)	0.0% (0/72)	15.3% (11/72)	75.0% (54/72)	9.7% (7/72)	0.0% (0/72)	0.0% (0/72)	0.0% (0/72)	0.0% (0/72)
G) >200-250	64	0.0% (0/64)	0.0% (0/64)	0.0% (0/64)	0.0% (0/64)	1.6% (1/64)	29.7% (19/64)	62.5% (40/64)	6.3% (4/64)	0.0% (0/64)	0.0% (0/64)	0.0% (0/64)
H) >250-300	31	0.0% (0/31)	0.0% (0/31)	0.0% (0/31)	0.0% (0/31)	0.0% (0/31)	0.0% (0/31)	45.2% (14/31)	29.0% (9/31)	22.6% (7/31)	3.2% (1/31)	0.0% (0/31)
I) >300-350	6	0.0% (0/6)	0.0% (0/6)	0.0% (0/6)	0.0% (0/6)	0.0% (0/6)	0.0% (0/6)	0.0% (0/6)	50.0% (3/6)	50.0% (3/6)	0.0% (0/6)	0.0% (0/6)
J) >350-400	2	0.0% (0/2)	0.0% (0/2)	0.0% (0/2)	0.0% (0/2)	0.0% (0/2)	0.0% (0/2)	0.0% (0/2)	0.0% (0/2)	50.0% (1/2)	50.0% (1/2)	0.0% (0/2)



Table E-21: Overall concurrence of YSI values and SG readings using YSI ranges on FST Day 1; Calibration 3 or 4 times a day, Buttock												
Percent of Matched Pairs-in Each SG Glucose Range for Each YSI Glucose Range												
YSI Glucose Ranges (mg/dL)	Number of Paired SG-YSI	SG (mg/dL)										
		<40	≥40-60	>60-80	>80-120	>120-160	>160-200	>200-250	>250-300	>300-350	>350-400	>400
Note: The overall number of available paired SG-YSI points on FST Day 1 was from 13 subjects.												

## Percent Agreement Post Calibration

The agreement of the SG values to paired YSI values was assessed for every 2-hour period post sensor calibration. For readings less than or equal to 80 mg/dL, the absolute difference in mg/dL between the SG and paired YSI values was calculated.

Tables E-22 through E-25 show the percent agreement rates post calibration for sensors inserted into the abdomen and buttock.

Table E-22: Agreement rates for every 2-hour period post calibration period; Calibration every 12 hours, Abdomen						
Time after calibration	Number of paired YSI-sensor points	Percentage (%) Agreement				
		±15% (±15 mg/dL)	±20% (±20 mg/dL)	±30% (±30 mg/dL)	±40% (±40 mg/dL)	>±40% (±40 mg/dL)
0-2 hours	224	84.4	93.3	98.7	99.6	0.4
2-4 hours	181	77.9	85.1	94.5	98.3	1.7
4-6 hours	145	72.4	84.1	94.5	98.6	1.4
6-8 hours	77	74	83.1	97.4	100	0
8-10 hours	52	80.8	82.7	86.5	96.2	3.8
10-12 hours	54	81.5	94.4	100	100	0

Table E-23: Agreement rates for every 2-hour period post calibration; Calibration 3 or 4 times a day, Abdomen						
Time after calibration	Number of paired YSI-sensor points	Percentage (%) Agreement				
		±15% (±15 mg/dL)	±20% (±20 mg/dL)	±30% (±30 mg/dL)	±40% (±40 mg/dL)	>±40% (±40 mg/dL)
0-2 hours	360	83.3	90.8	97.8	99.4	0.6
2-4 hours	174	83.9	92.5	98.3	100	0
4-6 hours	53	75.5	90.6	98.1	100	0
6-8 hours	64	73.4	82.8	96.9	100	0
8-10 hours	36	75	77.8	83.3	94.4	5.6
10-12 hours	23	87	95.7	100	100	0

Table E-24: Agreement rates for every 2-hour period post calibration period; Calibration every 12 hours, Buttock						
Time after calibration	Number of paired YSI-sensor points	Percentage (%) Agreement				
		±15% (±15 mg/dL)	±20% (±20 mg/dL)	±30% (±30 mg/dL)	±40% (±40 mg/dL)	>±40% (±40 mg/dL)
0-2 hours	196	81.6	94.9	96.4	98.5	1.5

Time after calibration	Number of paired YSI-sensor points	Percentage (%) Agreement				
		±15% (±15 mg/dL)	±20% (±20 mg/dL)	±30% (±30 mg/dL)	±40% (±40 mg/dL)	>±40% (±40 mg/dL)
2-4 hours	195	78.5	85.1	92.8	96.9	3.1
4-6 hours	157	87.9	91.1	99.4	99.4	0.6
6-8 hours	76	96.1	100	100	100	0
8-10 hours	45	97.8	100	100	100	0
10-12 hours	41	82.9	95.1	97.6	100	0

Time after calibration	Number of paired YSI-sensor points	Percentage (%) Agreement				
		±15% (±15 mg/dL)	±20% (±20 mg/dL)	±30% (±30 mg/dL)	±40% (±40 mg/dL)	>±40% (±40 mg/dL)
0-2 hours	314	81.8	92.4	95.9	98.1	1.9
2-4 hours	195	79.5	88.2	96.4	100	0
4-6 hours	70	94.3	95.7	100	100	0
6-8 hours	52	94.2	100	100	100	0
8-10 hours	37	100	100	100	100	0
10-12 hours	18	94.4	100	100	100	0

## Trend accuracy

Tables E-26 through E-29 show, for each SG rate-of-change range (indicated on display by number of arrows), percentage of SG-YSI paired values that fell into different YSI rate-of-change ranges. The tables show the trend accuracy for sensors inserted into the abdomen or buttock.

Percent of Matched Pairs-in Each YSI Rate Range for Each SG Rate Range							
SG Rate Ranges (mg/dL/min)	Numbered of Paired SG-YSI	YSI (mg/dL/min)					
		<-2	[-2, -1]	[-1, 0]	[0, 1]	[1, 2]	>2
<-2	19	47.4% (9/19)	47.4% (9/19)	0.0% (0/19)	5.3% (1/19)	0.0% (0/19)	0.0% (0/19)
[-2, -1]	107	2.8% (3/107)	31.8% (34/107)	60.7% (65/107)	3.7% (4/107)	0.9% (1/107)	0.0% (0/107)
[-1, 0]	276	0.7% (2/276)	5.8% (16/276)	71.7% (198/276)	21.0% (58/276)	0.7% (2/276)	0.0% (0/276)
[0, 1]	209	0.0% (0/209)	1.0% (2/209)	22.5% (47/209)	62.2% (130/209)	13.9% (29/209)	0.5% (1/209)
[1, 2]	98	0.0% (0/98)	0.0% (0/98)	1.0% (1/98)	37.8% (37/98)	59.2% (58/98)	2.0% (2/98)
>2	23	0.0% (0/23)	0.0% (0/23)	4.3% (1/23)	8.7% (2/23)	30.4% (7/23)	56.5% (13/23)

Table E-27: Trend Accuracy; Calibration 3 or 4 times a day, Abdomen							
Percent of Matched Pairs-in Each YSI Rate Range for Each SG Rate Range							
SG Rate Ranges (mg/dL/min)	Numbered of Paired SG-YSI	YSI (mg/dL/min)					
		<-2	[-2, -1]	[-1, 0]	[0, 1]	[1, 2]	>2
<-2	17	41.2% (7/17)	47.1% (8/17)	5.9% (1/17)	5.9% (1/17)	0.0% (0/17)	0.0% (0/17)
[-2, -1]	105	2.9% (3/105)	32.4% (34/105)	60.0% (63/105)	3.8% (4/105)	1.0% (1/105)	0.0% (0/105)
[-1, 0]	273	0.4% (1/273)	6.2% (17/273)	72.5% (198/273)	20.1% (55/273)	0.7% (2/273)	0.0% (0/273)
[0, 1]	199	0.5% (1/199)	0.5% (1/199)	22.6% (45/199)	63.3% (126/199)	12.6% (25/199)	0.5% (1/199)
[1, 2]	98	0.0% (0/98)	0.0% (0/98)	2.0% (2/98)	36.7% (36/98)	59.2% (58/98)	2.0% (2/98)
>2	17	0.0% (0/17)	0.0% (0/17)	5.9% (1/17)	11.8% (2/17)	41.2% (7/17)	41.2% (7/17)

Table E-28: Trend Accuracy; Calibration every 12 hours, Buttock							
Percent of Matched Pairs-in Each YSI Rate Range for Each SG Rate Range							
SG Rate Ranges (mg/dL/min)	Numbered of Paired SG-YSI	YSI (mg/dL/min)					
		<-2	[-2, -1]	[-1, 0]	[0, 1]	[1, 2]	>2
<-2	35	37.1% (13/35)	45.7% (16/35)	17.1% (6/35)	0.0% (0/35)	0.0% (0/35)	0.0% (0/35)
[-2, -1]	83	7.2% (6/83)	31.3% (26/83)	59.0% (49/83)	2.4% (2/83)	0.0% (0/83)	0.0% (0/83)
[-1, 0]	272	0.0% (0/272)	4.8% (13/272)	69.9% (190/272)	21.7% (59/272)	2.9% (8/272)	0.7% (2/272)
[0, 1]	199	0.0% (0/199)	0.5% (1/199)	22.1% (44/199)	60.8% (121/199)	15.6% (31/199)	1.0% (2/199)
[1, 2]	97	0.0% (0/97)	0.0% (0/97)	4.1% (4/97)	36.1% (35/97)	54.6% (53/97)	5.2% (5/97)
>2	23	0.0% (0/23)	0.0% (0/23)	0.0% (0/23)	26.1% (6/23)	34.8% (8/23)	39.1% (9/23)

Table E-29: Trend Accuracy; Calibration 3 or 4 times a day, Buttock							
Percent of Matched Pairs-in Each YSI Rate Range for Each SG Rate Range							
SG Rate Ranges (mg/dL/min)	Numbered of Paired SG-YSI	YSI (mg/dL/min)					
		<-2	[-2, -1]	[-1, 0]	[0, 1]	[1, 2]	>2
<-2	31	41.9% (13/31)	38.7% (12/31)	19.4% (6/31)	0.0% (0/31)	0.0% (0/31)	0.0% (0/31)
[-2, -1]	83	7.2% (6/83)	32.5% (27/83)	56.6% (47/83)	3.6% (3/83)	0.0% (0/83)	0.0% (0/83)
[-1, 0]	261	0.0% (0/261)	5.0% (13/261)	71.6% (187/261)	21.1% (55/261)	2.3% (6/261)	0.0% (0/261)
[0, 1]	194	0.0% (0/194)	0.5% (1/194)	22.2% (43/194)	62.9% (122/194)	13.4% (26/194)	1.0% (2/194)
[1, 2]	94	0.0% (0/94)	0.0% (0/94)	4.3% (4/94)	36.2% (34/94)	56.4% (53/94)	3.2% (3/94)
>2	22	0.0% (0/22)	0.0% (0/22)	0.0% (0/22)	22.7% (5/22)	36.4% (8/22)	40.9% (9/22)

## Precision

Precision of the system was evaluated by comparing the results from two separate sensors worn on the same subject at the same time.

Data from two sensors worn at the same time for 11 subjects, both inserted in the abdomen, provided 772 pairs of CGM measurements, with a mean PARD during the study of 7.83% and a coefficient of variation (%CV) of 5.7%.

Data from two sensors worn at the same time for 18 subjects, one inserted in the abdomen and one in the buttock, provided 1302 pairs of CGM measurements, with a mean PARD during the study of 11.33% and a coefficient of variation (%CV) of 7.8%.

Data from two sensors worn at the same time for 10 subjects, both inserted in the buttock, provided 695 pairs of CGM measurements, with a mean PARD during the study of 10.93% and a coefficient of variation (%CV) of 8.1%.

### **Sensor life**

After the first successful calibration, 64.3% of sensors worn in the abdomen operated more than six days and up to the full seven days of wear (144 to 168 hours). The mean functional sensor life for sensors worn in the abdomen insertion site over the course of the study was 122.1 hours, with a median functional life of 128.4 hours.

After the first successful calibration, 81.3% of sensors worn in the buttock operated more than six days and up to the full seven days of wear (144 to 168 hours). The mean functional sensor life for sensors worn in the buttock insertion site over the course of the study was 142.7 hours, with a median functional life of 158.1 hours.

### **Safety**

There were no moderate or severe device-related or procedure-related adverse events, device-related or procedure-related serious adverse events, or unanticipated adverse device effects through seven days of use.

## **F. Alert performance for user ages 7 through 13**

The CGM system enables your device to display SG readings, glucose trend arrows, glucose trend graphs, and SG alerts (for example, High and Low Limit Threshold alerts, High and Low Predictive alerts, and Rise and Fall rate-of-change alerts).

The high and low limit alerts (Threshold alerts) let the user know when the SG is at or above the high limit or at or below the low limit. Using only a high or low limit alert may reduce the number of false alerts, but does not provide a warning before reaching a high or low limit.

Predictive alerts notify users that their SG level may soon reach a high or low limit setting. Users may select how early they would like to be notified before their SG level reaches a high limit setting. The earliest warning is 30 minutes before

reaching a high, but users can reduce the amount of warning down to 5 minutes. Users will receive a warning approximately 30 minutes prior to when their SG level is predicted to reach their low limit setting. In general, the earlier the warning, the more time a user will have to react to a potential high or low, but this also increases the potential for false alerts.

A predictive alert is simply an estimation of a future SG level compared to the high or low limit setting. If the predicted SG value is above the high limit or below the low limit, then a predictive alert is sounded even though the current SG level has not crossed the high or low limit. The predicted SG level is calculated using the current SG level, the derivative of previous SG readings (the trend or slope of the SG readings) and the amount of early warning duration the user selects.

The device will always alert the user when the CGM system reads that the user is below 50 mg/dL, regardless of the high threshold, low threshold, or predictive alerts that the user sets.

### Glucose TRUE Alert Rate

The glucose true alert rate is the rate at which the BG confirmed that the CGM alert was triggered correctly. For example

**True Threshold Hypoglycemic alert rate** alerted when the CGM system read that the user was below the low threshold and the user's BG was actually below that low threshold.

**True Threshold Hyperglycemic alert rate** alerted when the CGM system read that the user was above the high threshold and the user's BG was actually above that high threshold.

**True Predictive Hypoglycemic alert rate** alerted when the CGM system predicted that the user would reach below the low threshold and the user's BG was actually below that low threshold within 15 or 30 minutes.

**True Predictive Hyperglycemic alert rate** alerted when the CGM system predicted that the user would reach above the high threshold and the user's BG was actually above that high threshold within 15 or 30 minutes.

The true alert rate is important because it is necessary that users be notified when their BG is low (or high) so that they can correct the low (or high) BG. A high true alert rate indicates that when the CGM system says that their glucose values are, or will reach a specified threshold, the user's BG is likely to be at or approaching that threshold.

For example, per the following table, when wearing the sensor in the abdomen, the low glucose alerts would have correctly indicated that the user was below (i.e. threshold only), or predicted to reach below the threshold (i.e. predictive only), or both (predictive and threshold) 44.4%, 28.6%, or 36.4% of the time within 30 minutes (or 44.4%, 14.3%, or 27.3% of the time within 15 minutes) when the user had BG values lower than 70 mg/dL.

mg/dL	Insertion Site	Glucose TRUE Alert Rate					
		Threshold Only		Predictive Only		Threshold & Predictive	
		30 min	15 min	30 min	15 min	30 min	15 min
50	Abdomen	33.3% (1/3)	33.3% (1/3)	12.5% (1/8)	12.5% (1/8)	18.2% (2/11)	18.2% (2/11)
	Buttock	25.0% (1/4)	25.0% (1/4)	11.1% (1/9)	11.1% (1/9)	16.7% (2/12)	16.7% (2/12)
60	Abdomen	25.0% (1/4)	25.0% (1/4)	8.3% (1/12)	8.3% (1/12)	12.5% (2/16)	12.5% (2/16)
	Buttock	60.0% (3/5)	60.0% (3/5)	25.0% (3/12)	16.7% (2/12)	35.3% (6/17)	29.4% (5/17)
70	Abdomen	44.4% (4/9)	44.4% (4/9)	28.6% (4/14)	14.3% (2/14)	36.4% (8/22)	27.3% (6/22)
	Buttock	60.0% (6/10)	60.0% (6/10)	36.8% (7/19)	26.3% (5/19)	40.7% (11/27)	33.3% (9/27)
80	Abdomen	33.3% (4/12)	33.3% (4/12)	31.6% (6/19)	15.8% (3/19)	32.3% (10/31)	22.6% (7/31)
	Buttock	61.1% (11/18)	61.1% (11/18)	46.2% (12/26)	38.5% (10/26)	51.2% (22/43)	46.5% (20/43)
90	Abdomen	55.0% (11/20)	55.0% (11/20)	46.2% (12/26)	30.8% (8/26)	47.7% (21/44)	38.6% (17/44)
	Buttock	70.8% (17/24)	70.8% (17/24)	58.3% (21/36)	44.4% (16/36)	62.5% (35/56)	53.6% (30/56)
180	Abdomen	78.4% (40/51)	78.4% (40/51)	66.2% (47/71)	66.2% (47/71)	70.5% (79/112)	70.5% (79/112)
	Buttock	83.3% (40/48)	81.3% (39/48)	64.3% (45/70)	62.9% (44/70)	70.6% (77/109)	68.8% (75/109)
220	Abdomen	87.5% (21/24)	87.5% (21/24)	60.0% (27/45)	57.8% (26/45)	68.2% (45/66)	66.7% (44/66)
	Buttock	75.0% (21/28)	75.0% (21/28)	51.0% (25/49)	49.0% (24/49)	58.3% (42/72)	56.9% (41/72)
250	Abdomen	81.3% (13/16)	81.3% (13/16)	53.1% (17/32)	46.9% (15/32)	63.0% (29/46)	58.7% (27/46)
	Buttock	73.3% (11/15)	73.3% (11/15)	41.2% (14/34)	35.3% (12/34)	50.0% (23/46)	45.7% (21/46)
300	Abdomen	77.8% (7/9)	77.8% (7/9)	44.4% (8/18)	44.4% (8/18)	55.6% (15/27)	55.6% (15/27)
	Buttock	57.1% (4/7)	57.1% (4/7)	31.3% (5/16)	31.3% (5/16)	38.1% (8/21)	38.1% (8/21)

**Note:** Given the small sample size of data available in the low range, the alert performance in the 50 mg/dL and 60 mg/dL should be interpreted with caution and may not reflect actual use performance.

## Glucose FALSE Alert Rate

The glucose false alert rate is the rate at which the BG did not confirm that the CGM alert was triggered correctly. For example:

**False Threshold Hypoglycemic alert rate** alerted when the CGM system read that the user was below the low threshold but the user's BG was actually above that low threshold.

**False Threshold Hyperglycemic alert rate** alerted when the CGM system read that the user was above the high threshold but the user's BG was actually below that high threshold.

**False Predictive Hypoglycemic alert rate** alerted when the CGM system predicted that the user would be below the low threshold but the user's BG was actually above that low threshold within 15 or 30 minutes.

The false alert rate is important because it is necessary that users be correctly notified when their BG is low (or high) so that they can correct the low (or high) BG. A low false alert rate indicates that when the CGM system says that their glucose values are, or will reach a specified threshold, the user's BG is likely to be at or approaching that threshold.

For example, per the following table, when wearing the sensor in the abdomen, the high glucose threshold alerts would have incorrectly indicated that the user was above (i.e. threshold only), or predicted to reach above the threshold (i.e. predictive only), or both (threshold and predictive) 21.6%, 33.8%, or 29.5% of the time within 30 minutes (or 21.6%, 33.8%, or 29.5% of the time within 15 minutes) when the user had BG less than 180 mg/dL.

mg/dL	Insertion Site	Glucose FALSE Alert Rate					
		Threshold Only		Predictive Only		Threshold & Predictive	
		30 min	15 min	30 min	15 min	30 min	15 min
50	Abdomen	66.7% (2/3)	66.7% (2/3)	87.5% (7/8)	87.5% (7/8)	81.8% (9/11)	81.8% (9/11)
	Buttock	75.0% (3/4)	75.0% (3/4)	88.9% (8/9)	88.9% (8/9)	83.3% (10/12)	83.3% (10/12)
60	Abdomen	75.0% (3/4)	75.0% (3/4)	91.7% (11/12)	91.7% (11/12)	87.5% (14/16)	87.5% (14/16)
	Buttock	40.0% (2/5)	40.0% (2/5)	75.0% (9/12)	83.3% (10/12)	64.7% (11/17)	70.6% (12/17)
70	Abdomen	55.6% (5/9)	55.6% (5/9)	71.4% (10/14)	85.7% (12/14)	63.6% (14/22)	72.7% (16/22)
	Buttock	40.0% (4/10)	40.0% (4/10)	63.2% (12/19)	73.7% (14/19)	59.3% (16/27)	66.7% (18/27)
80	Abdomen	66.7% (8/12)	66.7% (8/12)	68.4% (13/19)	84.2% (16/19)	67.7% (21/31)	77.4% (24/31)
	Buttock	38.9% (7/18)	38.9% (7/18)	53.8% (14/26)	61.5% (16/26)	48.8% (21/43)	53.5% (23/43)
90	Abdomen	45.0% (9/20)	45.0% (9/20)	53.8% (14/26)	69.2% (18/26)	52.3% (23/44)	61.4% (27/44)
	Buttock	29.2% (7/24)	29.2% (7/24)	41.7% (15/36)	55.6% (20/36)	37.5% (21/56)	46.4% (26/56)
180	Abdomen	21.6% (11/51)	21.6% (11/51)	33.8% (24/71)	33.8% (24/71)	29.5% (33/112)	29.5% (33/112)
	Buttock	16.7% (8/48)	18.8% (9/48)	35.7% (25/70)	37.1% (26/70)	29.4% (32/109)	31.2% (34/109)

**Table F-2: Glucose FALSE Alert Performance using Calibration every 12 hours**

mg/dL	Insertion Site	Glucose FALSE Alert Rate					
		Threshold Only		Predictive Only		Threshold & Predictive	
		30 min	15 min	30 min	15 min	30 min	15 min
220	Abdomen	12.5% (3/24)	12.5% (3/24)	40.0% (18/45)	42.2% (19/45)	31.8% (21/66)	33.3% (22/66)
	Buttock	25.0% (7/28)	25.0% (7/28)	49.0% (24/49)	51.0% (25/49)	41.7% (30/72)	43.1% (31/72)
250	Abdomen	18.8% (3/16)	18.8% (3/16)	46.9% (15/32)	53.1% (17/32)	37.0% (17/46)	41.3% (19/46)
	Buttock	26.7% (4/15)	26.7% (4/15)	58.8% (20/34)	64.7% (22/34)	50.0% (23/46)	54.3% (25/46)
300	Abdomen	22.2% (2/9)	22.2% (2/9)	55.6% (10/18)	55.6% (10/18)	44.4% (12/27)	44.4% (12/27)
	Buttock	42.9% (3/7)	42.9% (3/7)	68.8% (11/16)	68.8% (11/16)	61.9% (13/21)	61.9% (13/21)

**Note:** Given the small sample size of data available in the low range, the alert performance in the 50 mg/dL and 60 mg/dL should be interpreted with caution and may not reflect actual use performance.

## Glucose Correct Detection Rate

Glucose Correct Detection Rate is the rate that the device alerted when it should have alerted. For example, the BG was below the hypoglycemic threshold, or above the hyperglycemic threshold, and the device sounded an alert.

Glucose detection rates are important because it is necessary that users be notified when their BG is low (or high) so that they can correct the low (or high) BG. A high glucose correct detection rate indicates that users can have confidence that they will be notified by the device if their BG is low or high.

For example, per the following table, when wearing the sensor in the abdomen, the threshold alert, the predictive alert, or both (threshold and predictive) notified the user 100%, 100%, or 100% of the time within 30 minutes (or 100%, 100%, or 100% within 15 minutes) when the user had BG less than 50 mg/dL.

**Table F-3: Glucose Correct Detection Alert Performance using Calibration every 12 hours**

mg/dL	Insertion Site	Glucose Correct Detection Rate					
		Threshold Only		Predictive Only		Threshold & Predictive	
		30 min	15 min	30 min	15 min	30 min	15 min
50	Abdomen	100.0% (1/1)	100.0% (1/1)	100.0% (1/1)	100.0% (1/1)	100.0% (1/1)	100.0% (1/1)
	Buttock	100.0% (1/1)	100.0% (1/1)	100.0% (1/1)	100.0% (1/1)	100.0% (1/1)	100.0% (1/1)
60	Abdomen	50.0% (1/2)	50.0% (1/2)	50.0% (1/2)	50.0% (1/2)	50.0% (1/2)	50.0% (1/2)
	Buttock	100.0% (3/3)	100.0% (3/3)	100.0% (3/3)	66.7% (2/3)	100.0% (3/3)	100.0% (3/3)
70	Abdomen	80.0% (4/5)	80.0% (4/5)	80.0% (4/5)	40.0% (2/5)	80.0% (4/5)	80.0% (4/5)
	Buttock	85.7% (6/7)	85.7% (6/7)	85.7% (6/7)	71.4% (5/7)	85.7% (6/7)	85.7% (6/7)
80	Abdomen	66.7% (4/6)	66.7% (4/6)	83.3% (5/6)	50.0% (3/6)	83.3% (5/6)	66.7% (4/6)
	Buttock	85.7% (12/14)	85.7% (12/14)	85.7% (12/14)	78.6% (11/14)	85.7% (12/14)	85.7% (12/14)



mg/dL	Insertion Site	Glucose Correct Detection Rate					
		Threshold Only		Predictive Only		Threshold & Predictive	
		30 min	15 min	30 min	15 min	30 min	15 min
90	Abdomen	91.7% (11/12)	91.7% (11/12)	91.7% (11/12)	66.7% (8/12)	91.7% (11/12)	91.7% (11/12)
	Buttock	86.4% (19/22)	86.4% (19/22)	90.9% (20/22)	72.7% (16/22)	95.5% (21/22)	86.4% (19/22)
180	Abdomen	95.1% (39/41)	95.1% (39/41)	100.0% (41/41)	100.0% (41/41)	100.0% (41/41)	100.0% (41/41)
	Buttock	97.5% (39/40)	95.0% (38/40)	100.0% (40/40)	100.0% (40/40)	100.0% (40/40)	100.0% (40/40)
220	Abdomen	92.6% (25/27)	85.2% (23/27)	96.3% (26/27)	88.9% (24/27)	96.3% (26/27)	88.9% (24/27)
	Buttock	95.7% (22/23)	95.7% (22/23)	100.0% (23/23)	95.7% (22/23)	100.0% (23/23)	100.0% (23/23)
250	Abdomen	77.8% (14/18)	77.8% (14/18)	88.9% (16/18)	83.3% (15/18)	88.9% (16/18)	83.3% (15/18)
	Buttock	68.8% (11/16)	62.5% (10/16)	100.0% (16/16)	93.8% (15/16)	100.0% (16/16)	100.0% (16/16)
300	Abdomen	80.0% (8/10)	80.0% (8/10)	100.0% (10/10)	90.0% (9/10)	100.0% (10/10)	90.0% (9/10)
	Buttock	60.0% (3/5)	60.0% (3/5)	100.0% (5/5)	100.0% (5/5)	100.0% (5/5)	100.0% (5/5)

**Note:** Given the small sample size of data available in the low range, the alert performance in the 50 mg/dL and 60 mg/dL should be interpreted with caution and may not reflect actual use performance.

## Glucose Missed Detection Rate

The Missed Detection Rate is the rate that the device did not alert when it should have. For example, the BG was below the hypoglycemic threshold, or above the hyperglycemic threshold, and the device did not sound a threshold or predictive alert.

Missed detection rates are important because it is necessary that users be notified when their BG is low (or high), so that they can correct the low (or high) BG. A low missed detection rate indicates that users can have confidence that they will be notified by the device if their BG is low or high.

For example, per the following table, when wearing the sensor in the abdomen, the threshold alert, predictive alert, or both alerts (threshold and predictive) did not sound 0%, 0%, or 0% of the time within 30 minutes (or 0%, 0%, or 0% within 15 minutes) when the user had BG less than 50 mg/dL.

mg/dL	Insertion Site	Glucose Missed Detection Rate					
		Threshold Only		Predictive Only		Threshold & Predictive	
		30 min	15 min	30 min	15 min	30 min	15 min
50	Abdomen	0.0% (0/1)	0.0% (0/1)	0.0% (0/1)	0.0% (0/1)	0.0% (0/1)	0.0% (0/1)
	Buttock	0.0% (0/1)	0.0% (0/1)	0.0% (0/1)	0.0% (0/1)	0.0% (0/1)	0.0% (0/1)
60	Abdomen	50.0% (1/2)	50.0% (1/2)	50.0% (1/2)	50.0% (1/2)	50.0% (1/2)	50.0% (1/2)
	Buttock	0.0% (0/3)	0.0% (0/3)	0.0% (0/3)	33.3% (1/3)	0.0% (0/3)	0.0% (0/3)

mg/dL	Insertion Site	Glucose Missed Detection Rate					
		Threshold Only		Predictive Only		Threshold & Predictive	
		30 min	15 min	30 min	15 min	30 min	15 min
70	Abdomen	20.0% (1/5)	20.0% (1/5)	20.0% (1/5)	60.0% (3/5)	20.0% (1/5)	20.0% (1/5)
	Buttock	14.3% (1/7)	14.3% (1/7)	14.3% (1/7)	28.6% (2/7)	14.3% (1/7)	14.3% (1/7)
80	Abdomen	33.3% (2/6)	33.3% (2/6)	16.7% (1/6)	50.0% (3/6)	16.7% (1/6)	33.3% (2/6)
	Buttock	14.3% (2/14)	14.3% (2/14)	14.3% (2/14)	21.4% (3/14)	14.3% (2/14)	14.3% (2/14)
90	Abdomen	8.3% (1/12)	8.3% (1/12)	8.3% (1/12)	33.3% (4/12)	8.3% (1/12)	8.3% (1/12)
	Buttock	13.6% (3/22)	13.6% (3/22)	9.1% (2/22)	27.3% (6/22)	4.5% (1/22)	13.6% (3/22)
180	Abdomen	4.9% (2/41)	4.9% (2/41)	0.0% (0/41)	0.0% (0/41)	0.0% (0/41)	0.0% (0/41)
	Buttock	2.5% (1/40)	5.0% (2/40)	0.0% (0/40)	0.0% (0/40)	0.0% (0/40)	0.0% (0/40)
220	Abdomen	7.4% (2/27)	14.8% (4/27)	3.7% (1/27)	11.1% (3/27)	3.7% (1/27)	11.1% (3/27)
	Buttock	4.3% (1/23)	4.3% (1/23)	0.0% (0/23)	4.3% (1/23)	0.0% (0/23)	0.0% (0/23)
250	Abdomen	22.2% (4/18)	22.2% (4/18)	11.1% (2/18)	16.7% (3/18)	11.1% (2/18)	16.7% (3/18)
	Buttock	31.3% (5/16)	37.5% (6/16)	0.0% (0/16)	6.3% (1/16)	0.0% (0/16)	0.0% (0/16)
300	Abdomen	20.0% (2/10)	20.0% (2/10)	0.0% (0/10)	10.0% (1/10)	0.0% (0/10)	10.0% (1/10)
	Buttock	40.0% (2/5)	40.0% (2/5)	0.0% (0/5)	0.0% (0/5)	0.0% (0/5)	0.0% (0/5)

**Note:** Given the small sample size of data available in the low range, the alert performance in the 50 mg/dL and 60 mg/dL should be interpreted with caution and may not reflect actual use performance.

### III. Performance data for users 2 through 6 years old

#### G. Device Performance data for users ages 2 through 6

The clinical data presented in this section was obtained from studies (users ages 2 through 6) using the MiniMed 670G system. The MiniMed 770G system uses the same SmartGuard Auto Mode technology as the MiniMed 670G system. Therefore, this clinical data also applies to the MiniMed 770G system.



**CAUTION:** Since the study presented below did not include a control group, no claims regarding effectiveness can be made. However, it does support that the device is relatively safe for use.

The SmartGuard technology has two levels that include the 1) Suspend on low and Suspend before low that automatically suspends insulin based on CGM and 2) Auto mode that automatically calculates insulin dosing using CGM. A study was

performed to evaluate for safety in a multi-center, single arm, clinical investigation.<sup>10</sup> Study subjects included persons aged 2 to 6 years of age diagnosed with type 1 diabetes mellitus and who were on pump therapy for more than 90 days prior to screening. All study subjects had an HbA1C less than 10.0% at the time of screening visit.

For the first level of SmartGuard technology, the "Suspend before low" feature, subjects 2-6 years of age were set up but did not participate in frequent sample testing.

For this study, there were 47 subjects in the 2-6 year old cohort that entered the run-in phase. During the run-in phase, 1 subject withdrew. Therefore, 46 subjects in the 2-6 year old cohort entered the study-phase. The second level of SmartGuard technology, the "Auto Mode" feature, was evaluated during the 3-month study phase. Subjects 2-6 years of age are not required to participate in a hotel study. Instead, they will participate in an out-of-home study for 5 consecutive days, 4-6 hours per day. During that 5 day period, subjects should engage in significant activity/exercise. Such activities could include utilizing gym play areas appropriate for toddlers and young children, swimming, and playground games. Evidence of geographic location and exercise/activity will be documented by daily photograph. In addition, investigational center staff will be present daily for the 4-6 hours of exercise during the 5 day period.

During this study, data was collected for subjects 2-6 years old for over 6697 patient days (prior to Run-In + Run-In + Study periods). Subjects used the 670G system during the run-in and study periods without any reported device-related serious adverse events, such as severe hypoglycemia or diabetic ketoacidosis. Compared to Manual Mode used during the Run-In phase, use of Auto Mode was associated with reduction in mean sensor glucose values, an increase within the range of 71 to 180 mg/dL and a lower percentage of glucose values in the hyperglycemic and hypoglycemic ranges. There was a reduction in mean HbA1c from  $8.0 \pm 0.9\%$  (median 8.1%) at the baseline to  $7.5 \pm 0.6\%$  (median 7.5%) at the end of study. There was a small change in mean total daily dose of insulin/kg ( $0.8 \pm 0.1$  baseline to  $0.8 \pm 0.2$  end of study) and modest increase in weight. Weight gain would also be expected for pediatric patients 2-6 years of age as part of the normal growth process.

---

<sup>10</sup> Medtronic Inc., Clinical Study Report, CEP302 Data Analysis From Subjects 2-6 Years of Age. 10927511DOC. July 2019.

Of the 138 adverse events reported through the end of the study period, 39% (N=54) were classified as device related, including glycemic events (severe hyperglycemia) and skin issues (abscess, dermatitis, skin infection at the infusion set site and skin irritation). Of the 54 device-related adverse events, 49 were severe hyperglycemia events that were thought to be device related. There were no procedure related events.

There were 86 reports of severe hyperglycemia and there was no diabetic ketoacidosis while on the MiniMed 670G System during the study. The majority of these severe hyperglycemic events (81/86) were mild in intensity. Ketone levels were available for 83 of the 86 severe hyperglycemia episodes and the majority of ketone levels (57/86) were low (0.6–1.5 mmol/L).

Of the 49 device related episodes of severe hyperglycemia, 46 were believed to be due to infusion set issues such as occlusion, bent cannula or cannula pull out. These issues are typically seen in relatively high rates in the pediatric population (causes provided in Table G-1 and Table G-2). Unlike insulin pump therapy which may or may not have alerts associated with infusion set failure, the MiniMed 670G System has fixed alarms (high alerts) that serve as an additional mitigation for subjects.

**Table G-1. Run in Period Severe Hyperglycemia:**

Cause	Total
Infusion set change	9
Occlusion alarm	0
Infusion set fell out	0
Bent or Kinked Cannula	0
Total	9

**Table G-2. Study Period Severe Hyperglycemia**

Cause	Total
Infusion set change	29
Occlusion alarm	3
Infusion set fell out	2
Bent or Kinked Cannula	1
Infusion set change or safe basal	1
Safe basal	1
Suspend before low suspension	1
Automatic & manual suspensions	1
Total	39

The following table shows the time spent per day in specific glucose ranges during the run-in and study phases by all subjects.

Glucose Range (mg/dL)	Run-In Phase	Study Phase
	Time in Glucose Range (min) Mean±SD	Time in Glucose Range (min) Mean±SD
≤50	7.5±8.8	7.4±6.5
≤60	22.4±20.2	21.4±13.6
≤70	51.9±37.7	49.7±23.7
>70–180	797.6±191.6	915.5±134.8
>180	590.5±211.1	474.8±142.6
>250	210.6±136.0	153.5±85.4
>300	75.0±70.8	53.5±41.2
>350	23.9±30.8	16.6±16.4

The following table shows the ranges of changes in HbA1C observed in the study and indicates the number of subjects that demonstrated each type of change in HbA1C observed.

HbA1C Change Range	Number of Subjects (% of Subjects) with Change in A1C					
	Baseline A1C (%)	Decrease >1%	Decrease 0 to 1%	No Change	Increase 0 to 1%	Increase > 1%
5% ≤ A1C < 6%	-	-	-	-	-	-
6% ≤ A1C < 7%	0 (0.0%)	0 (0.0%)	0 (0.0%)	6 (13.0%)	0 (0.0%)	
7% ≤ A1C < 8%	2 (4.3%)	7 (15.2%)	0 (0.0%)	4 (8.7%)	0 (0.0%)	
8% ≤ A1C < 9%	4 (8.7%)	11 (23.9%)	1 (2.2%)	2 (4.3%)	0 (0.0%)	
9% ≤ A1C < 10%	5 (10.9%)	2 (4.3%)	0 (0.0%)	0 (0.0%)	0 (0.0%)	
Overall	11 (23.9%)	20 (43.5%)	1 (2.2%)	12 (26.1%)	0 (0.0%)	

Note: For the blank cells (-), there are no subjects age 2-6 with a baseline A1C in this category.

The following table shows the number of subjects that spent a specific range of time in specific glucose ranges during the study phase.

Time Range	Number of Subjects (% of Subjects) in the Glucose Range (mg/dL) Indicated							
	≤ 50 mg/dL	≤ 60 mg/dL	≤ 70 mg/dL	70 to 180 mg/dL	> 180 mg/dL	> 250 mg/dL	>300 mg/dL	>350 mg/dL
0 to 15 mins	41 (89.1%)	17 (37.0%)	0 (0.0%)	0 (0.0%)	0 (0.0%)	1 (2.2%)	11 (23.9%)	28 (60.9%)
15 to 30 mins	4 (8.7%)	21 (45.7%)	8 (17.4%)	0 (0.0%)	0 (0.0%)	2 (4.3%)	5 (10.9%)	9 (19.6%)
30 to 45 mins	1 (2.2%)	5 (10.9%)	16 (34.8%)	0 (0.0%)	0 (0.0%)	1 (2.2%)	7 (15.2%)	6 (13.0%)
45 mins to 1 hr	0 (0.0%)	2 (4.3%)	12 (26.1%)	0 (0.0%)	0 (0.0%)	1 (2.2%)	6 (13.0%)	2 (4.3%)
1-4 hr	0 (0.0%)	1 (2.2%)	10 (21.7%)	0 (0.0%)	3 (6.5%)	34 (73.9%)	17 (37.0%)	1 (2.2%)

Time Range	Number of Subjects (% of Subjects) in the Glucose Range (mg/dL) Indicated							
	≤ 50 mg/dL	≤ 60 mg/dL	≤ 70 mg/dL	70 to 180 mg/dL	> 180 mg/dL	> 250 mg/dL	>300 mg/dL	>350 mg/dL
4-8 hr	0 (0.0%)	0 (0.0%)	0 (0.0%)	0 (0.0%)	18 (39.1%)	7 (15.2%)	0 (0.0%)	0 (0.0%)
8-12 hr	0 (0.0%)	0 (0.0%)	0 (0.0%)	3 (6.5%)	22 (47.8%)	0 (0.0%)	0 (0.0%)	0 (0.0%)
12-16 hr	0 (0.0%)	0 (0.0%)	0 (0.0%)	25 (54.3%)	3 (6.5%)	0 (0.0%)	0 (0.0%)	0 (0.0%)
16-20 hr	0 (0.0%)	0 (0.0%)	0 (0.0%)	17 (37.0%)	0 (0.0%)	0 (0.0%)	0 (0.0%)	0 (0.0%)
20-24 hr	0 (0.0%)	0 (0.0%)	0 (0.0%)	1 (2.2%)	0 (0.0%)	0 (0.0%)	0 (0.0%)	0 (0.0%)

Glucose Range (mg/dL)	Study Phase Time in Glucose Range (min) Mean±SD
≤ 50	6.2±5.4
≤ 60	18.1±11.4
≤ 70	42.4±19.8
70-180	805.1±139.8
>180	371.9±106.1
>250	107.7±56.5
>300 mg/dL	32.3±23.9
>350 mg/dL	7.7±7.5
All	1219.4±93.0

The pediatric pivotal clinical trial of the 670G suggested that the system was safe; however, this trial had a number of limitations which included the following:

- The study involved a relatively small number of patients.
- There was no control group for comparison purposes.
- The amount of time the system was used in the Manual mode was much shorter than the time it was programmed to the Auto mode.
- Additionally, for each subject, the study period lasted only three months.

Due to these limitations, the results of the clinical trial must be interpreted with caution and you should understand that your individual results when using the 670G system may be significantly different from those of the subjects who participated in the trial.

## **H. Guardian Sensor (3) Performance in users ages 2 through 6**

### **CGM performance**

The use of the Guardian Sensor (3) with the Guardian Link (3) transmitter enables CGM technology. The transmitter transmits sensor glucose values calculated by the real-time algorithm to a primary display device, allowing you to monitor your sensor glucose values.

### Clinical study description

The performance of the Guardian Sensor (3) was evaluated in a clinical study.<sup>11, 12</sup> This in-patient (in-clinic) and outpatient (at home) study included subjects 2 to 6 years in age. The study design was a multi-center, prospective single sample correlational design without controls.

All subjects were assigned to treatment. Each subject was instructed to wear two Guardian™ Sensor (3) sensors in the abdomen and/or buttock.

1. One Guardian Sensor (3) connected to the Guardian Connect Transmitter, which transmitted to the Guardian Connect app, a standalone CGM display device.
2. One Guardian Sensor (3) connected to the Guardian Link (3) transmitter, which served as a glucose sensor recorder (GSR, transmitter/recorder for sensor integrated pump systems).

The sensor glucose data collected by the blinded GSRs were retrospectively processed through the real-time CGM algorithm. This is the same algorithm used in the Guardian™ Connect and pump CGM systems. Thus, all data is representative of real-time sensor usage.

The CONTOUR®NEXT LINK 2.4 Wireless Meter was the study meter used for all calibrations in this study, and was the only meter evaluated with the Guardian Sensor (3) CGM systems. The sensor has not been tested with other meters. Therefore, the performance with other blood glucose meters may differ from the performance with the CONTOUR NEXT LINK 2.4 Wireless Meter described below. Subjects aged 2-6 years old were randomly assigned to which day to come in for the FST and their parents chose the area for sensor placement.

---

11 Medtronic Inc., A Performance Evaluation of the Enlite® and Enlite 3 Glucose Sensor to Support Use in Children; Phase 2 (Enlite 3). 10542175DOC March 2016.

12 Medtronic Inc., Engineering Report: CEP249 (Analysis of Data From Subjects 2-6 Years of Age). 10901316DOC May 2019.

Frequent Sample Testing (FST) was performed on day 1, 3, or 7, for 6 hours each, over the life of the sensor. Reference blood glucose values were obtained every 5 to 30 minutes with a Blood Glucose Meter (BGM) for subjects for whom YSI testing was not believed to be appropriate due to the subject's size and age (all but two of the subjects in the 2-6 year old age group). Reference BG values were obtained every 5 to 15 minutes using a Yellow Springs Instrument (YSI®) Glucose Analyzer for the remaining two subjects in the 2-6 year old age group. During the FSTs, the subjects were instructed to calibrate the sensors once every 12 hours, or as requested by the display device. During home use (outside the clinic), subjects were instructed to calibrate both sensors three to four times spread throughout the day.

The overall number of subjects that participated in FST procedures on day 1, 3, or 7 were 6, 7, and 8, respectively. During the FST procedures, glucose challenges were limited to 30 minutes of exercise. Therefore, there were a limited number of glucose values in the high and low glucose ranges.

During the study, the meter was used for confirmation of alarms, treatment decisions and sensor calibrations.

## **Results**

### **Sensor accuracy**

The following information highlights the Guardian Sensor (3) performance from 21 subjects (2 to 6 years old) wearing the Guardian Link (3) Transmitter that served as a glucose sensor recorder (GSR, transmitter/recorder for sensor-integrated pump systems) and the Guardian Connect Transmitter, which transmitted to the Guardian Connect app (a standalone CGM display device) during FST.

### **Mean absolute relative difference, by number of daily calibrations**

Table H-1 shows the sensor accuracy measured by the mean absolute relative difference (MARD). MARD represents the average relative difference (regardless if positive or negative) between the sensor glucose (SG) values and the paired blood glucose values measured by YSI (or BGM).



YSI or BGM Glucose Ranges (mg/dL)	Abdomen Insertion Site				Buttock Insertion Site			
	Calibration every 12 hours		Calibration 3 or 4 times a day		Calibration every 12 hours		Calibration 3 or 4 times a day	
	Number of Paired SG-YSI or BGM	Mean Absolute Relative Difference (%)	Number of Paired SG-YSI or BGM	Mean Absolute Relative Difference (%)	Number of Paired SG-YSI or BGM	Mean Absolute Relative Difference (%)	Number of Paired SG-YSI or BGM	Mean Absolute Relative Difference (%)
Overall	62	10.7	62	10.96	195	10.1	159	10.05
40-60*	-	-	-	-	2	21.5	2	23
61-80*	1	7	1	7	12	14.76	12	11.51
81-180	26	10.12	26	10.12	99	10.72	78	11.54
181-300	30	11.9	30	11.98	73	7.09	60	6.03
301-350	5	6.73	5	9.46	8	6.63	7	7.5
351-400	-	-	-	-	1	7.71	-	-

\*For glucose ranges  $\leq 80$  mg/dL, the differences in mg/dL are included instead of percent difference (%).

**Note:** SG Readings are within 40-400 mg/dL.

**Note:** For the blank cells (-), there are no paired points in this reference range.

## Percent agreement, by number of daily calibrations

In Tables H-2 through H-9, the agreement of the SG values to paired YSI (or BGM) values were assessed by calculating the percentage of SG values that were within 15%, 20%, 30%, 40% and greater than 40% of the paired YSI (or BGM) values. For readings less than or equal to 80 mg/dL, the absolute difference in mg/dL between the SG and paired YSI (or BGM) values were calculated.

Results are shown for defined YSI (or BGM) ranges when calibrating every 12 hours and calibrating three or four times a day for sensors.

YSI or BGM Glucose Ranges (mg/dL)	Number of Paired SG-YSI or BGM	Percent of SG Within 15/15% of YSI or BGM	Percent of SG Within 20/20% of YSI or BGM	Percent of SG Within 30/30% of YSI or BGM	Percent of SG Within 40/40% of YSI or BGM	Percent of SG >40/40% of YSI or BGM
Overall	62	72.6	85.5	96.8	100	0
$\geq 40-60^*$	-	-	-	-	-	-
$>60-80^*$	1	100	100	100	100	0
$>80-180$	26	80.8	88.5	96.2	100	0
$>180-300$	30	60	80	96.7	100	0
$>300-350$	5	100	100	100	100	0
$>350-400$	-	-	-	-	-	-

**Table H-2: Agreement (%) of SG-YSI (or BGM) paired points within YSI (or BGM) glucose ranges on Frequent Sample Testing (FST) Days 1, 3, and 7; Calibration every 12 hours, Abdomen**

YSI or BGM Glucose Ranges (mg/dL)	Number of Paired SG-YSI or BGM	Percent of SG Within 15/15% of YSI or BGM	Percent of SG Within 20/20% of YSI or BGM	Percent of SG Within 30/30% of YSI or BGM	Percent of SG Within 40/40% of YSI or BGM	Percent of SG >40/40% of YSI or BGM
*For glucose ranges $\leq 80$ mg/dL, agreement was based on 15/20/30/40 mg/dL.						
Note: Sensor glucose readings are within 40-400 mg/dL.						
Note: For the blank cells (-), there are no paired points in this reference range.						

**Table H-3: Agreement (%) of SG-YSI (or BGM) paired points within YSI (or BGM) glucose ranges on Frequent Sample Testing (FST) Day 1; Calibration every 12 hours, Abdomen**

YSI or BGM Glucose Ranges (mg/dL)	Number of Paired SG-YSI or BGM	Percent of SG Within 15/15% of YSI or BGM	Percent of SG Within 20/20% of YSI or BGM	Percent of SG Within 30/30% of YSI or BGM	Percent of SG Within 40/40% of YSI or BGM	Percent of SG >40/40% of YSI or BGM
Overall	11	72.7	100	100	100	0
$\geq 40-60^*$	-	-	-	-	-	-
$>60-80^*$	-	-	-	-	-	-
$>80-180$	1	100	100	100	100	0
$>180-300$	10	70	100	100	100	0
$>300-350$	-	-	-	-	-	-
$>350-400$	-	-	-	-	-	-
*For glucose ranges $\leq 80$ mg/dL, agreement was based on 15/20/30/40 mg/dL.						
Note: Sensor glucose readings are within 40-400 mg/dL.						
Note: For the blank cells (-), there are no paired points in this reference range.						

**Table H-4: Agreement (%) of SG-YSI (or BGM) paired points within YSI (or BGM) glucose ranges on Frequent Sample Testing (FST) Days 1, 3, and 7; Calibration 3 or 4 times a day, Abdomen**

YSI or BGM Glucose Ranges (mg/dL)	Number of Paired SG-YSI or BGM	Percent of SG Within 15/15% of YSI or BGM	Percent of SG Within 20/20% of YSI or BGM	Percent of SG Within 30/30% of YSI or BGM	Percent of SG Within 40/40% of YSI or BGM	Percent of SG >40/40% of YSI or BGM
Overall	62	71	83.9	98.4	100	0
$\geq 40-60^*$	-	-	-	-	-	-
$>60-80^*$	1	100	100	100	100	0
$>80-180$	26	80.8	88.5	96.2	100	0
$>180-300$	30	60	80	100	100	0
$>300-350$	5	80	80	100	100	0
$>350-400$	-	-	-	-	-	-
*For glucose ranges $\leq 80$ mg/dL, agreement was based on 15/20/30/40 mg/dL.						
Note: Sensor glucose readings are within 40-400 mg/dL.						
Note: For the blank cells (-), there are no paired points in this reference range.						

**Table H-5: Agreement (%) of SG-YSI (or BGM) paired points within YSI (or BGM) glucose ranges on Frequent Sample Testing Day 1; Calibration 3 or 4 times a day, Abdomen**

YSI or BGM Glucose Ranges (mg/dL)	Number of Paired SG-YSI or BGM	Percent of SG Within 15/15% of YSI or BGM	Percent of SG Within 20/20% of YSI or BGM	Percent of SG Within 30/30% of YSI or BGM	Percent of SG Within 40/40% of YSI or BGM	Percent of SG >40/40% of YSI or BGM
Overall	11	72.7	100	100	100	0
>60-80*	-	-	-	-	-	-
>80-180	1	100	100	100	100	0
>180-300	10	70	100	100	100	0
>300-350	-	-	-	-	-	-
>350-400	-	-	-	-	-	-

\*For glucose ranges  $\leq 80$  mg/dL, agreement was based on 15/20/30/40 mg/dL.

Note: Sensor glucose readings are within 40-400 mg/dL.

Note: For the blank cells (-), there are no paired points in this reference range.

**Table H-6: Agreement (%) of SG-YSI (or BGM) paired points within YSI (or BGM) glucose ranges on Frequent Sample Testing (FST) Days 1, 3, and 7; Calibration every 12 hours, Buttock**

YSI or BGM Glucose Ranges (mg/dL)	Number of Paired SG-YSI or BGM	Percent of SG Within 15/15% of YSI or BGM	Percent of SG Within 20/20% of YSI or BGM	Percent of SG Within 30/30% of YSI or BGM	Percent of SG Within 40/40% of YSI or BGM	Percent of SG >40/40% of YSI or BGM
Overall	195	81.5	88.7	97.4	98.5	1.5
$\geq 40-60^*$	2	50	50	50	100	0
>60-80*	12	75	83.3	91.7	91.7	8.3
>80-180	99	78.8	85.9	97	98	2
>180-300	73	84.9	93.2	100	100	0
>300-350	8	100	100	100	100	0
>350-400	1	100	100	100	100	0

\*For glucose ranges  $\leq 80$  mg/dL, agreement was based on 15/20/30/40 mg/dL.

Note: Sensor glucose readings are within 40-400 mg/dL.

**Table H-7: Agreement (%) of SG-YSI (or BGM) paired points within YSI (or BGM) glucose ranges on Frequent Sample Testing (FST) Day 1; Calibration every 12 hours, Buttock**

YSI or BGM Glucose Ranges (mg/dL)	Number of Paired SG-YSI or BGM	Percent of SG Within 15/15% of YSI or BGM	Percent of SG Within 20/20% of YSI or BGM	Percent of SG Within 30/30% of YSI or BGM	Percent of SG Within 40/40% of YSI or BGM	Percent of SG >40/40% of YSI or BGM
Overall	93	71	83.9	96.8	97.8	2.2
$\geq 40-60^*$	1	100	100	100	100	0
>60-80*	10	70	80	90	90	10
>80-180	46	63	78.3	95.7	97.8	2.2
>180-300	31	77.4	90.3	100	100	0
>300-350	4	100	100	100	100	0
>350-400	1	100	100	100	100	0

\*For glucose ranges  $\leq 80$  mg/dL, agreement was based on 15/20/30/40 mg/dL.

Note: Sensor glucose readings are within 40-400 mg/dL.

**Table H-8: Agreement (%) of SG-YSI (or BGM) paired points within YSI (or BGM) glucose ranges on Frequent Sample Testing (FST) Days 1, 3, and 7; Calibration 3 or 4 times a day, Buttock**

YSI or BGM Glucose Ranges (mg/dL)	Number of Paired SG-YSI or BGM	Percent of SG Within 15/15% of YSI or BGM	Percent of SG Within 20/20% of YSI or BGM	Percent of SG Within 30/30% of YSI or BGM	Percent of SG Within 40/40% of YSI or BGM	Percent of SG >40/40% of YSI or BGM
Overall	159	84.3	88.7	96.2	97.5	2.5
≥40-60*	2	50	50	50	50	50
>60-80*	12	75	91.7	100	100	0
>80-180	78	78.2	83.3	93.6	96.2	3.8
>180-300	60	93.3	95	100	100	0
>300-350	7	100	100	100	100	0
>350-400	-	-	-	-	-	-

\*For glucose ranges ≤ 80 mg/dL, agreement was based on 15/20/30/40 mg/dL.

**Note:** Sensor glucose readings are within 40-400 mg/dL.

**Note:** For the blank cells (-), there are no paired points in this reference range.

**Table H-9: Agreement (%) of SG-YSI (or BGM) paired points within YSI (or BGM) glucose ranges on Frequent Sample Testing Day 1; Calibration 3 or 4 times a day, Buttock**

YSI or BGM Glucose Ranges (mg/dL)	Number of Paired SG-YSI or BGM	Percent of SG Within 15/15% of YSI or BGM	Percent of SG Within 20/20% of YSI or BGM	Percent of SG Within 30/30% of YSI or BGM	Percent of SG Within 40/40% of YSI or BGM	Percent of SG >40/40% of YSI or BGM
Overall	70	74.3	81.4	94.3	97.1	2.9
≥40-60*	1	100	100	100	100	0
>60-80*	10	80	90	100	100	0
>80-180	37	59.5	70.3	89.2	94.6	5.4
>180-300	19	94.7	94.7	100	100	0
>300-350	3	100	100	100	100	0
>350-400	-	-	-	-	-	-

\*For glucose ranges ≤ 80 mg/dL, agreement was based on 15/20/30/40 mg/dL.

**Note:** Sensor glucose readings are within 40-400 mg/dL.

**Note:** For the blank cells (-), there are no paired points in this reference range.

### Agreement when CGM reads “Below 40 mg/dL” or “Above 400 mg/dL”

The real-time CGM systems display glucose values between 40 mg/dL and 400 mg/dL. It displays “Below 40 mg/dL” when the SG value detected is below 40 mg/dL. It displays “Above 400 mg/dL” when the SG value detected is above 400 mg/dL. Tables H-10 through H-13 illustrate the number and percentage of the paired YSI (or BGM) values in different blood glucose levels when the CGM system displays “Below 40 mg/dL” (LOW) or “Above 400 mg/dL” (HIGH).

**Table H-10: The number and percentage of YSI (or BGM) values collected when CGM displays 'Below 40 mg/dL' (LOW); Calibration every 12 hours.**

CGM Display	Insertion Site	CGM-YSI or BGM pairs	YSI (or BGM) (mg/dL)					Total
			<55	<60	<70	<80	>80	
LOW	Abdomen	Cumulative, n	0	0	0	0	0	0
		Cumulative %	0%	0%	0%	0%	0%	0%
	Buttocks	Cumulative, n	0	0	0	0	0	0
		Cumulative %	0%	0%	0%	0%	0%	0%

**Table H-11: The number and percentage of YSI (or BGM) values collected when CGM displays 'Below 40 mg/dL' (LOW); Calibration 3 or 4 times a day.**

CGM Display	Insertion Site	CGM-YSI or BGM pairs	YSI (or BGM) (mg/dL)					Total
			<55	<60	<70	<80	>80	
LOW	Abdomen	Cumulative, n	0	0	0	0	0	0
		Cumulative %	0%	0%	0%	0%	0%	0%
	Buttocks	Cumulative, n	0	0	0	0	0	0
		Cumulative %	0%	0%	0%	0%	0%	0%

**Table H-12: The number and percentage of YSI (or BGM) values collected when CGM displays 'Above 400 mg/dL' (HIGH); Calibration every 12 hours.**

CGM Display	Insertion Site	CGM-YSI or BGM pairs	YSI (or BGM) (mg/dL)					Total
			>340	>320	>280	>240	<240	
HIGH	Abdomen	Cumulative, n	0	0	1	1	0	1
		Cumulative %	0%	0%	100%	100%	0%	100%
	Buttocks	Cumulative, n	0	0	0	0	0	0
		Cumulative %	0%	0%	0%	0%	0%	0%

**Table H-13: The number and percentage of YSI (or BGM) values collected when CGM displays 'Above 400 mg/dL' (HIGH); Calibration 3 or 4 times a day.**

CGM Display	Insertion Site	CGM-YSI or BGM pairs	YSI (or BGM) (mg/dL)					Total
			>340	>320	>280	>240	<240	
HIGH	Abdomen	Cumulative, n	0	0	1	1	0	1
		Cumulative %	0%	0%	100%	100%	0%	100%
	Buttocks	Cumulative, n	0	0	0	0	0	0
		Cumulative %	0%	0%	0%	0%	0%	0%

### Concurrence of SG and YSI or BGM values

The following tables show the percentage of concurring SG readings with FST reference values.

**Table H-14: Overall concurrence of YSI (or BGM) values and SG readings using YSI (or BGM) ranges on FST Days 1, 3, and 7; Calibration every 12 hours, Abdomen**

Percent of Matched Pairs-in Each SG Glucose Range for Each YSI (or BGM) Glucose Range												
YSI or BGM Glucose Ranges (mg/dL)	Number of Paired SG-YSI or BGM	SG (mg/dL)										
		<40	≥40-60	>60-80	>80-120	>120-160	>160-200	>200-250	>250-300	>300-350	>350-400	>400
B) ≥40-60	-	-	-	-	-	-	-	-	-	-	-	-
C) >60-80	1	0.0% (0/1)	0.0% (0/1)	100.0% (1/1)	0.0% (0/1)	0.0% (0/1)	0.0% (0/1)	0.0% (0/1)	0.0% (0/1)	0.0% (0/1)	0.0% (0/1)	0.0% (0/1)
D) >80-120	11	0.0% (0/11)	0.0% (0/11)	0.0% (0/11)	63.6% (7/11)	36.4% (4/11)	0.0% (0/11)	0.0% (0/11)	0.0% (0/11)	0.0% (0/11)	0.0% (0/11)	0.0% (0/11)
E) >120-160	10	0.0% (0/10)	0.0% (0/10)	0.0% (0/10)	20.0% (2/10)	60.0% (6/10)	20.0% (2/10)	0.0% (0/10)	0.0% (0/10)	0.0% (0/10)	0.0% (0/10)	0.0% (0/10)
F) >160-200	11	0.0% (0/11)	0.0% (0/11)	0.0% (0/11)	0.0% (0/11)	18.2% (2/11)	63.6% (7/11)	18.2% (2/11)	0.0% (0/11)	0.0% (0/11)	0.0% (0/11)	0.0% (0/11)
G) >200-250	6	0.0% (0/6)	0.0% (0/6)	0.0% (0/6)	0.0% (0/6)	16.7% (1/6)	0.0% (0/6)	33.3% (2/6)	50.0% (3/6)	0.0% (0/6)	0.0% (0/6)	0.0% (0/6)
H) >250-300	19	0.0% (0/19)	0.0% (0/19)	0.0% (0/19)	0.0% (0/19)	0.0% (0/19)	0.0% (0/19)	21.1% (4/19)	47.4% (9/19)	21.1% (4/19)	5.3% (1/19)	5.3% (1/19)
I) >300-350	5	0.0% (0/5)	0.0% (0/5)	0.0% (0/5)	0.0% (0/5)	0.0% (0/5)	0.0% (0/5)	0.0% (0/5)	20.0% (1/5)	80.0% (4/5)	0.0% (0/5)	0.0% (0/5)
J) >350-400	-	-	-	-	-	-	-	-	-	-	-	-

Note: For the blank cells (-), there are no paired points in this reference range.

**Table H-15: Overall concurrence of YSI (or BGM) values and SG readings using YSI (or BGM) ranges on FST Day 1; Calibration every 12 hours, Abdomen**

Percent of Matched Pairs-in Each SG Glucose Range for Each YSI (or BGM) Glucose Range												
YSI or BGM Glucose Ranges (mg/dL)	Number of Paired SG-YSI or BGM	SG (mg/dL)										
		<40	≥40-60	>60-80	>80-120	>120-160	>160-200	>200-250	>250-300	>300-350	>350-400	>400
B) ≥40-60	-	-	-	-	-	-	-	-	-	-	-	-
C) >60-80	-	-	-	-	-	-	-	-	-	-	-	-
D) >80-120	-	-	-	-	-	-	-	-	-	-	-	-
E) >120-160	1	0.0% (0/1)	0.0% (0/1)	0.0% (0/1)	0.0% (0/1)	0.0% (0/1)	100.0% (1/1)	0.0% (0/1)	0.0% (0/1)	0.0% (0/1)	0.0% (0/1)	0.0% (0/1)
F) >160-200	4	0.0% (0/4)	0.0% (0/4)	0.0% (0/4)	0.0% (0/4)	0.0% (0/4)	50.0% (2/4)	50.0% (2/4)	0.0% (0/4)	0.0% (0/4)	0.0% (0/4)	0.0% (0/4)
G) >200-250	2	0.0% (0/2)	0.0% (0/2)	0.0% (0/2)	0.0% (0/2)	0.0% (0/2)	0.0% (0/2)	50.0% (1/2)	50.0% (1/2)	0.0% (0/2)	0.0% (0/2)	0.0% (0/2)
H) >250-300	4	0.0% (0/4)	0.0% (0/4)	0.0% (0/4)	0.0% (0/4)	0.0% (0/4)	0.0% (0/4)	0.0% (0/4)	75.0% (3/4)	25.0% (1/4)	0.0% (0/4)	0.0% (0/4)
I) >300-350	-	-	-	-	-	-	-	-	-	-	-	-

**Table H-15: Overall concurrence of YSI (or BGM) values and SG readings using YSI (or BGM) ranges on FST Day 1; Calibration every 12 hours, Abdomen**

Percent of Matched Pairs-in Each SG Glucose Range for Each YSI (or BGM) Glucose Range												
YSI or BGM Glucose Ranges (mg/dL)	Number of Paired SG-YSI or BGM	SG (mg/dL)										
		<40	≥40-60	>60-80	>80-120	>120-160	>160-200	>200-250	>250-300	>300-350	>350-400	>400
J) >350-400	-	-	-	-	-	-	-	-	-	-	-	-

Note: For the blank cells (-), there are no paired points in this reference range.

**Table H-16: Overall concurrence of YSI (or BGM) values and SG readings using YSI (or BGM) ranges on FST Days 1, 3, and 7; Calibration 3 or 4 times a day, Abdomen**

Percent of Matched Pairs-in Each SG Glucose Range for Each YSI (or BGM) Glucose Range												
YSI or BGM Glucose Ranges (mg/dL)	Number of Paired SG-YSI or BGM	SG (mg/dL)										
		<40	≥40-60	>60-80	>80-120	>120-160	>160-200	>200-250	>250-300	>300-350	>350-400	>400
B) ≥40-60	-	-	-	-	-	-	-	-	-	-	-	-
C) >60-80	1	0.0% (0/1)	0.0% (0/1)	100.0% (1/1)	0.0% (0/1)	0.0% (0/1)	0.0% (0/1)	0.0% (0/1)	0.0% (0/1)	0.0% (0/1)	0.0% (0/1)	0.0% (0/1)
D) >80-120	11	0.0% (0/11)	0.0% (0/11)	0.0% (0/11)	63.6% (7/11)	36.4% (4/11)	0.0% (0/11)	0.0% (0/11)	0.0% (0/11)	0.0% (0/11)	0.0% (0/11)	0.0% (0/11)
E) >120-160	10	0.0% (0/10)	0.0% (0/10)	0.0% (0/10)	20.0% (2/10)	60.0% (6/10)	20.0% (2/10)	0.0% (0/10)	0.0% (0/10)	0.0% (0/10)	0.0% (0/10)	0.0% (0/10)
F) >160-200	11	0.0% (0/11)	0.0% (0/11)	0.0% (0/11)	0.0% (0/11)	18.2% (2/11)	63.6% (7/11)	18.2% (2/11)	0.0% (0/11)	0.0% (0/11)	0.0% (0/11)	0.0% (0/11)
G) >200-250	6	0.0% (0/6)	0.0% (0/6)	0.0% (0/6)	0.0% (0/6)	16.7% (1/6)	0.0% (0/6)	33.3% (2/6)	50.0% (3/6)	0.0% (0/6)	0.0% (0/6)	0.0% (0/6)
H) >250-300	19	0.0% (0/19)	0.0% (0/19)	0.0% (0/19)	0.0% (0/19)	0.0% (0/19)	0.0% (0/19)	26.3% (5/19)	42.1% (8/19)	21.1% (4/19)	5.3% (1/19)	5.3% (1/19)
I) >300-350	5	0.0% (0/5)	0.0% (0/5)	0.0% (0/5)	0.0% (0/5)	0.0% (0/5)	0.0% (0/5)	20.0% (1/5)	20.0% (1/5)	60.0% (3/5)	0.0% (0/5)	0.0% (0/5)
J) >350-400	-	-	-	-	-	-	-	-	-	-	-	-

Note: For the blank cells (-), there are no paired points in this reference range.

**Table H-17: Overall concurrence of YSI (or BGM) values and SG readings using YSI (or BGM) ranges on FST Day 1; Calibration 3 or 4 times a day, Abdomen**

Percent of Matched Pairs-in Each SG Glucose Range for Each YSI (or BGM) Glucose Range												
YSI or BGM Glucose Ranges (mg/dL)	Number of Paired SG-YSI or BGM	SG (mg/dL)										
		<40	≥40-60	>60-80	>80-120	>120-160	>160-200	>200-250	>250-300	>300-350	>350-400	>400
C) >60-80	-	-	-	-	-	-	-	-	-	-	-	-
D) >80-120	-	-	-	-	-	-	-	-	-	-	-	-

**Table H-17: Overall concurrence of YSI (or BGM) values and SG readings using YSI (or BGM) ranges on FST Day 1; Calibration 3 or 4 times a day, Abdomen**

Percent of Matched Pairs-in Each SG Glucose Range for Each YSI (or BGM) Glucose Range												
YSI or BGM Glucose Ranges (mg/dL)	Number of Paired SG-YSI or BGM	SG (mg/dL)										
		<40	≥40-60	>60-80	>80-120	>120-160	>160-200	>200-250	>250-300	>300-350	>350-400	>400
E) >120-160	1	0.0% (0/1)	0.0% (0/1)	0.0% (0/1)	0.0% (0/1)	0.0% (0/1)	100.0% (1/1)	0.0% (0/1)	0.0% (0/1)	0.0% (0/1)	0.0% (0/1)	0.0% (0/1)
F) >160-200	4	0.0% (0/4)	0.0% (0/4)	0.0% (0/4)	0.0% (0/4)	0.0% (0/4)	50.0% (2/4)	50.0% (2/4)	0.0% (0/4)	0.0% (0/4)	0.0% (0/4)	0.0% (0/4)
G) >200-250	2	0.0% (0/2)	0.0% (0/2)	0.0% (0/2)	0.0% (0/2)	0.0% (0/2)	0.0% (0/2)	50.0% (1/2)	50.0% (1/2)	0.0% (0/2)	0.0% (0/2)	0.0% (0/2)
H) >250-300	4	0.0% (0/4)	0.0% (0/4)	0.0% (0/4)	0.0% (0/4)	0.0% (0/4)	0.0% (0/4)	0.0% (0/4)	75.0% (3/4)	25.0% (1/4)	0.0% (0/4)	0.0% (0/4)
I) >300-350	-	-	-	-	-	-	-	-	-	-	-	-
J) >350-400	-	-	-	-	-	-	-	-	-	-	-	-

Note: For the blank cells (-), there are no paired points in this reference range.

**Table H-18. Overall concurrence of YSI (or BGM) values and SG readings using YSI (or BGM) ranges on FST Days 1, 3, and 7; Calibration every 12 hours, Buttock**

Percent of Matched Pairs-in Each SG Glucose Range for Each YSI (or BGM) Glucose Range												
YSI or BGM Glucose Ranges (mg/dL)	Number of Paired SG-YSI or BGM	SG (mg/dL)										
		<40	≥40-60	>60-80	>80-120	>120-160	>160-200	>200-250	>250-300	>300-350	>350-400	>400
B) ≥40-60	2	0.0% (0/2)	50.0% (1/2)	0.0% (0/2)	50.0% (1/2)	0.0% (0/2)	0.0% (0/2)	0.0% (0/2)	0.0% (0/2)	0.0% (0/2)	0.0% (0/2)	0.0% (0/2)
C) >60-80	12	0.0% (0/12)	25.0% (3/12)	33.3% (4/12)	41.7% (5/12)	0.0% (0/12)	0.0% (0/12)	0.0% (0/12)	0.0% (0/12)	0.0% (0/12)	0.0% (0/12)	0.0% (0/12)
D) >80-120	31	0.0% (0/31)	0.0% (0/31)	0.0% (0/31)	87.1% (27/31)	12.9% (4/31)	0.0% (0/31)	0.0% (0/31)	0.0% (0/31)	0.0% (0/31)	0.0% (0/31)	0.0% (0/31)
E) >120-160	45	0.0% (0/45)	0.0% (0/45)	0.0% (0/45)	17.8% (8/45)	60.0% (27/45)	22.2% (10/45)	0.0% (0/45)	0.0% (0/45)	0.0% (0/45)	0.0% (0/45)	0.0% (0/45)
F) >160-200	41	0.0% (0/41)	0.0% (0/41)	0.0% (0/41)	0.0% (0/41)	17.1% (7/41)	65.9% (27/41)	17.1% (7/41)	0.0% (0/41)	0.0% (0/41)	0.0% (0/41)	0.0% (0/41)
G) >200-250	31	0.0% (0/31)	0.0% (0/31)	0.0% (0/31)	0.0% (0/31)	0.0% (0/31)	16.1% (5/31)	77.4% (24/31)	6.5% (2/31)	0.0% (0/31)	0.0% (0/31)	0.0% (0/31)
H) >250-300	24	0.0% (0/24)	0.0% (0/24)	0.0% (0/24)	0.0% (0/24)	0.0% (0/24)	4.2% (1/24)	16.7% (4/24)	70.8% (17/24)	8.3% (2/24)	0.0% (0/24)	0.0% (0/24)
I) >300-350	8	0.0% (0/8)	0.0% (0/8)	0.0% (0/8)	0.0% (0/8)	0.0% (0/8)	0.0% (0/8)	0.0% (0/8)	62.5% (5/8)	25.0% (2/8)	12.5% (1/8)	0.0% (0/8)
J) >350-400	1	0.0% (0/1)	0.0% (0/1)	0.0% (0/1)	0.0% (0/1)	0.0% (0/1)	0.0% (0/1)	0.0% (0/1)	0.0% (0/1)	0.0% (0/1)	100.0% (1/1)	0.0% (0/1)



**Table H-19. Overall concurrence of YSI (or BGM) values and SG readings using YSI (or BGM) ranges on FST Day 1; Calibration every 12 hours, Buttock**

Percent of Matched Pairs-in Each SG Glucose Range for Each YSI (or BGM) Glucose Range												
YSI or BGM Glucose Ranges (mg/dL)	Number of Paired SG-YSI or BGM	SG (mg/dL)										
		<40	≥40-60	>60-80	>80-120	>120-160	>160-200	>200-250	>250-300	>300-350	>350-400	>400
B) ≥40-60	1	0.0% (0/1)	100.0% (1/1)	0.0% (0/1)	0.0% (0/1)	0.0% (0/1)	0.0% (0/1)	0.0% (0/1)	0.0% (0/1)	0.0% (0/1)	0.0% (0/1)	0.0% (0/1)
C) >60-80	10	0.0% (0/10)	30.0% (3/10)	40.0% (4/10)	30.0% (3/10)	0.0% (0/10)	0.0% (0/10)	0.0% (0/10)	0.0% (0/10)	0.0% (0/10)	0.0% (0/10)	0.0% (0/10)
D) >80-120	14	0.0% (0/14)	0.0% (0/14)	0.0% (0/14)	78.6% (11/14)	21.4% (3/14)	0.0% (0/14)	0.0% (0/14)	0.0% (0/14)	0.0% (0/14)	0.0% (0/14)	0.0% (0/14)
E) >120-160	21	0.0% (0/21)	0.0% (0/21)	0.0% (0/21)	14.3% (3/21)	47.6% (10/21)	38.1% (8/21)	0.0% (0/21)	0.0% (0/21)	0.0% (0/21)	0.0% (0/21)	0.0% (0/21)
F) >160-200	19	0.0% (0/19)	0.0% (0/19)	0.0% (0/19)	0.0% (0/19)	31.6% (6/19)	47.4% (9/19)	21.1% (4/19)	0.0% (0/19)	0.0% (0/19)	0.0% (0/19)	0.0% (0/19)
G) >200-250	11	0.0% (0/11)	0.0% (0/11)	0.0% (0/11)	0.0% (0/11)	0.0% (0/11)	18.2% (2/11)	72.7% (8/11)	9.1% (1/11)	0.0% (0/11)	0.0% (0/11)	0.0% (0/11)
H) >250-300	12	0.0% (0/12)	0.0% (0/12)	0.0% (0/12)	0.0% (0/12)	0.0% (0/12)	8.3% (1/12)	16.7% (2/12)	58.3% (7/12)	16.7% (2/12)	0.0% (0/12)	0.0% (0/12)
I) >300-350	4	0.0% (0/4)	0.0% (0/4)	0.0% (0/4)	0.0% (0/4)	0.0% (0/4)	0.0% (0/4)	0.0% (0/4)	50.0% (2/4)	25.0% (1/4)	25.0% (1/4)	0.0% (0/4)
J) >350-400	1	0.0% (0/1)	0.0% (0/1)	0.0% (0/1)	0.0% (0/1)	0.0% (0/1)	0.0% (0/1)	0.0% (0/1)	0.0% (0/1)	0.0% (0/1)	100.0% (1/1)	0.0% (0/1)

**Table H-20. Overall concurrence of YSI (or BGM) values and SG readings using YSI (or BGM) ranges on FST Days 1, 3, and 7; Calibration 3 or 4 times a day, Buttock**

Percent of Matched Pairs-in Each SG Glucose Range for Each YSI or BGM Glucose Range												
YSI or BGM Glucose Ranges (mg/dL)	Number of Paired SG-YSI or BGM	SG (mg/dL)										
		<40	≥40-60	>60-80	>80-120	>120-160	>160-200	>200-250	>250-300	>300-350	>350-400	>400
B) ≥40-60	2	0.0% (0/2)	50.0% (1/2)	0.0% (0/2)	50.0% (1/2)	0.0% (0/2)	0.0% (0/2)	0.0% (0/2)	0.0% (0/2)	0.0% (0/2)	0.0% (0/2)	0.0% (0/2)
C) >60-80	12	0.0% (0/12)	25.0% (3/12)	33.3% (4/12)	41.7% (5/12)	0.0% (0/12)	0.0% (0/12)	0.0% (0/12)	0.0% (0/12)	0.0% (0/12)	0.0% (0/12)	0.0% (0/12)
D) >80-120	23	0.0% (0/23)	0.0% (0/23)	8.7% (2/23)	73.9% (17/23)	13.0% (3/23)	4.3% (1/23)	0.0% (0/23)	0.0% (0/23)	0.0% (0/23)	0.0% (0/23)	0.0% (0/23)
E) >120-160	36	0.0% (0/36)	0.0% (0/36)	0.0% (0/36)	11.1% (4/36)	61.1% (22/36)	27.8% (10/36)	0.0% (0/36)	0.0% (0/36)	0.0% (0/36)	0.0% (0/36)	0.0% (0/36)
F) >160-200	33	0.0% (0/33)	0.0% (0/33)	0.0% (0/33)	0.0% (0/33)	6.1% (2/33)	72.7% (24/33)	18.2% (6/33)	3.0% (1/33)	0.0% (0/33)	0.0% (0/33)	0.0% (0/33)
G) >200-250	27	0.0% (0/27)	0.0% (0/27)	0.0% (0/27)	0.0% (0/27)	0.0% (0/27)	18.5% (5/27)	70.4% (19/27)	11.1% (3/27)	0.0% (0/27)	0.0% (0/27)	0.0% (0/27)
H) >250-300	19	0.0% (0/19)	0.0% (0/19)	0.0% (0/19)	0.0% (0/19)	0.0% (0/19)	0.0% (0/19)	10.5% (2/19)	78.9% (15/19)	10.5% (2/19)	0.0% (0/19)	0.0% (0/19)

**Table H-20. Overall concurrence of YSI (or BGM) values and SG readings using YSI (or BGM) ranges on FST Days 1, 3, and 7; Calibration 3 or 4 times a day, Buttock**

Percent of Matched Pairs-in Each SG Glucose Range for Each YSI or BGM Glucose Range													
YSI or BGM Glucose Ranges (mg/dL)	Number of Paired SG-YSI or BGM	SG (mg/dL)											
		<40	≥40-60	>60-80	>80-120	>120-160	>160-200	>200-250	>250-300	>300-350	>350-400	>400	
I) >300-350	7	0.0% (0/7)	0.0% (0/7)	0.0% (0/7)	0.0% (0/7)	0.0% (0/7)	0.0% (0/7)	0.0% (0/7)	0.0% (0/7)	71.4% (5/7)	14.3% (1/7)	14.3% (1/7)	0.0% (0/7)
J) >350-400	-	-	-	-	-	-	-	-	-	-	-	-	-

Note: For the blank cells (-), there are no paired points in this reference range.

**Table H-21. Overall concurrence of YSI (or BGM) values and SG readings using YSI (or BGM) ranges on FST Day 1; Calibration 3 or 4 times a day, Buttock**

Percent of Matched Pairs-in Each SG Glucose Range for Each YSI (or BGM) Glucose Range													
YSI or BGM Glucose Ranges (mg/dL)	Number of Paired SG-YSI or BGM	SG (mg/dL)											
		<40	≥40-60	>60-80	>80-120	>120-160	>160-200	>200-250	>250-300	>300-350	>350-400	>400	
B) ≥40-60	1	0.0% (0/1)	100.0% (1/1)	0.0% (0/1)	0.0% (0/1)	0.0% (0/1)	0.0% (0/1)	0.0% (0/1)	0.0% (0/1)	0.0% (0/1)	0.0% (0/1)	0.0% (0/1)	0.0% (0/1)
C) >60-80	10	0.0% (0/10)	30.0% (3/10)	40.0% (4/10)	30.0% (3/10)	0.0% (0/10)	0.0% (0/10)	0.0% (0/10)	0.0% (0/10)	0.0% (0/10)	0.0% (0/10)	0.0% (0/10)	0.0% (0/10)
D) >80-120	13	0.0% (0/13)	0.0% (0/13)	7.7% (1/13)	69.2% (9/13)	15.4% (2/13)	7.7% (1/13)	0.0% (0/13)	0.0% (0/13)	0.0% (0/13)	0.0% (0/13)	0.0% (0/13)	0.0% (0/13)
E) >120-160	16	0.0% (0/16)	0.0% (0/16)	0.0% (0/16)	6.3% (1/16)	50.0% (8/16)	43.8% (7/16)	0.0% (0/16)	0.0% (0/16)	0.0% (0/16)	0.0% (0/16)	0.0% (0/16)	0.0% (0/16)
F) >160-200	13	0.0% (0/13)	0.0% (0/13)	0.0% (0/13)	0.0% (0/13)	0.0% (0/13)	69.2% (9/13)	23.1% (3/13)	7.7% (1/13)	0.0% (0/13)	0.0% (0/13)	0.0% (0/13)	0.0% (0/13)
G) >200-250	7	0.0% (0/7)	0.0% (0/7)	0.0% (0/7)	0.0% (0/7)	0.0% (0/7)	14.3% (1/7)	71.4% (5/7)	14.3% (1/7)	0.0% (0/7)	0.0% (0/7)	0.0% (0/7)	0.0% (0/7)
H) >250-300	7	0.0% (0/7)	0.0% (0/7)	0.0% (0/7)	0.0% (0/7)	0.0% (0/7)	0.0% (0/7)	0.0% (0/7)	71.4% (5/7)	28.6% (2/7)	0.0% (0/7)	0.0% (0/7)	0.0% (0/7)
I) >300-350	3	0.0% (0/3)	0.0% (0/3)	0.0% (0/3)	0.0% (0/3)	0.0% (0/3)	0.0% (0/3)	0.0% (0/3)	0.0% (0/3)	66.7% (2/3)	0.0% (0/3)	33.3% (1/3)	0.0% (0/3)
J) >350-400	-	-	-	-	-	-	-	-	-	-	-	-	-

Note: For the blank cells (-), there are no paired points in this reference range.

## Percent Agreement Post Calibration

The agreement of the SG values to paired YSI (or BGM) values was assessed for every 2-hour period post sensor calibration. For readings less than or equal to 80 mg/dL, the absolute difference in mg/dL between the SG and paired YSI (or BGM) values was calculated.

Tables H-22 through H-25 show the percent agreement rates post calibration for sensors inserted into the abdomen and buttock.

**Table H-22. Agreement rates for every 2-hour period post calibration period; Calibration every 12 hours, Abdomen**

Time after calibration	No. paired YSI or BGM-sensor points	Percentage (%) Agreement				
		± 15% (± 15 mg/dL)	± 20% (± 20 mg/dL)	± 30% (± 30 mg/dL)	± 40% (± 40 mg/dL)	> ±40% (± 40 mg/dL)
0-2 hours	20	65	85	100	100	0
2-4 hours	16	68.8	93.8	100	100	0
4-6 hours	11	90.9	90.9	100	100	0
6-8 hours	8	62.5	62.5	87.5	100	0
8-10 hours	6	100	100	100	100	0
10-12 hours	1	0	0	0	100	0

**Table H-23. Agreement rates for every 2-hour period post calibration period; Calibration 3 or 4 times a day, Abdomen**

Time after calibration	No. paired YSI or BGM-sensor points	Percentage (%) Agreement				
		± 15% (± 15 mg/dL)	± 20% (± 20 mg/dL)	± 30% (± 30 mg/dL)	± 40% (± 40 mg/dL)	> ±40% (± 40 mg/dL)
0-2 hours	24	62.5	79.2	100	100	0
2-4 hours	13	61.5	92.3	100	100	0
4-6 hours	11	90.9	90.9	100	100	0
6-8 hours	8	62.5	62.5	87.5	100	0
8-10 hours	6	100	100	100	100	0
10-12 hours	-	-	-	-	-	-

Note: For the blank cells (-), there are no paired points in this reference range.

**Table H-24. Agreement rates for every 2-hour period post calibration period; Calibration every 12 hours, Buttock**

Time after calibration	No. paired YSI or BGM-sensor points	Percentage (%) Agreement				
		± 15% (± 15 mg/dL)	± 20% (± 20 mg/dL)	± 30% (± 30 mg/dL)	± 40% (± 40 mg/dL)	> ±40% (± 40 mg/dL)
0-2 hours	64	85.9	92.2	98.4	100	0
2-4 hours	60	78.3	86.7	95	96.7	3.3
4-6 hours	52	75	84.6	98.1	98.1	1.9
6-8 hours	11	90.9	90.9	100	100	0
8-10 hours	4	100	100	100	100	0
10-12 hours	4	100	100	100	100	0

**Table H-25. Agreement rates for every 2-hour period post calibration period; Calibration 3 or 4 times a day, Buttock**

Time after calibration	No. paired YSI or BGM-sensor points	Percentage (%) Agreement				
		± 15% (± 15 mg/dL)	± 20% (± 20 mg/dL)	± 30% (± 30 mg/dL)	± 40% (± 40 mg/dL)	> ±40% (± 40 mg/dL)
0-2 hours	84	86.9	90.5	97.6	98.8	1.2
2-4 hours	46	87	91.3	93.5	93.5	6.5
4-6 hours	22	63.6	72.7	95.5	100	0

Time after calibration	No. paired YSI or BGM-sensor points	Percentage (%) Agreement				
		± 15% (± 15 mg/dL)	± 20% (± 20 mg/dL)	± 30% (± 30 mg/dL)	± 40% (± 40 mg/dL)	> ±40% (± 40 mg/dL)
6-8 hours	5	100	100	100	100	0
8-10 hours	2	100	100	100	100	0
10-12 hours	-	-	-	-	-	-

Note: For the blank cells (-), there are no paired points in this reference range.

## Trend Accuracy

Tables H-26 through H-29 show, for each SG rate-of-change range, percentage of SG-YSI (or BGM) paired values that fell into different YSI (or BGM) rate-of-change ranges. The tables show the trend accuracy for sensors inserted into the abdomen or buttock.

Percent of Matched Pairs-in Each YSI (or BGM) Rate Range for Each SG Rate Range							
SG Rate Ranges (mg/dL/min)	Number of Paired SG-YSI or BGM	YSI (or BGM) (mg/dL/min)					
		<-2	[-2, -1]	[-1, 0]	[0, 1]	[1, 2]	>2
<-2	2	0.0% (0/2)	50.0% (1/2)	0.0% (0/2)	50.0% (1/2)	0.0% (0/2)	0.0% (0/2)
[-2, -1]	7	14.3% (1/7)	57.1% (4/7)	0.0% (0/7)	28.6% (2/7)	0.0% (0/7)	0.0% (0/7)
[-1, 0]	6	0.0% (0/6)	33.3% (2/6)	50.0% (3/6)	16.7% (1/6)	0.0% (0/6)	0.0% (0/6)
[0, 1]	7	0.0% (0/7)	14.3% (1/7)	14.3% (1/7)	57.1% (4/7)	0.0% (0/7)	14.3% (1/7)
[1, 2]	5	0.0% (0/5)	0.0% (0/5)	60.0% (3/5)	20.0% (1/5)	20.0% (1/5)	0.0% (0/5)
>2	3	0.0% (0/3)	0.0% (0/3)	33.3% (1/3)	33.3% (1/3)	0.0% (0/3)	33.3% (1/3)

Percent of Matched Pairs-in Each YSI (or BGM) Rate Range for Each SG Rate Range							
SG Rate Ranges (mg/dL/min)	Number of Paired SG-YSI or BGM	YSI (or BGM) (mg/dL/min)					
		<-2	[-2, -1]	[-1, 0]	[0, 1]	[1, 2]	>2
<-2	2	0.0% (0/2)	50.0% (1/2)	0.0% (0/2)	50.0% (1/2)	0.0% (0/2)	0.0% (0/2)
[-2, -1]	7	14.3% (1/7)	57.1% (4/7)	0.0% (0/7)	28.6% (2/7)	0.0% (0/7)	0.0% (0/7)
[-1, 0]	6	0.0% (0/6)	33.3% (2/6)	50.0% (3/6)	16.7% (1/6)	0.0% (0/6)	0.0% (0/6)
[0, 1]	8	0.0% (0/8)	12.5% (1/8)	25.0% (2/8)	50.0% (4/8)	0.0% (0/8)	12.5% (1/8)
[1, 2]	4	0.0% (0/4)	0.0% (0/4)	50.0% (2/4)	25.0% (1/4)	25.0% (1/4)	0.0% (0/4)
>2	3	0.0% (0/3)	0.0% (0/3)	33.3% (1/3)	33.3% (1/3)	0.0% (0/3)	33.3% (1/3)

Table H-28. Trend Accuracy; Calibration every 12 hours, Buttock							
Percent of Matched Pairs-in Each YSI (or BGM) Rate Range for Each SG Rate Range							
SG Rate Ranges (mg/dL/min)	Number of Paired SG-YSI or BGM	YSI (or BGM) (mg/dL/min)					
		<-2	[-2, -1]	[-1, 0]	[0, 1]	[1, 2]	>2
<-2	3	66.7% (2/3)	33.3% (1/3)	0.0% (0/3)	0.0% (0/3)	0.0% (0/3)	0.0% (0/3)
[-2, -1]	8	0.0% (0/8)	62.5% (5/8)	12.5% (1/8)	12.5% (1/8)	12.5% (1/8)	0.0% (0/8)
[-1, 0]	13	0.0% (0/13)	7.7% (1/13)	30.8% (4/13)	30.8% (4/13)	23.1% (3/13)	7.7% (1/13)
[0, 1]	6	0.0% (0/6)	16.7% (1/6)	16.7% (1/6)	16.7% (1/6)	50.0% (3/6)	0.0% (0/6)
[1, 2]	7	0.0% (0/7)	0.0% (0/7)	0.0% (0/7)	42.9% (3/7)	57.1% (4/7)	0.0% (0/7)
>2	7	0.0% (0/7)	0.0% (0/7)	0.0% (0/7)	0.0% (0/7)	42.9% (3/7)	57.1% (4/7)

Table H-29. Trend Accuracy; Calibration 3 or 4 times a day, Buttock							
Percent of Matched Pairs-in Each YSI (or BGM) Rate Range for Each SG Rate Range							
SG Rate Ranges (mg/dL/min)	Number of Paired SG-YSI or BGM	YSI (or BGM) (mg/dL/min)					
		<-2	[-2, -1]	[-1, 0]	[0, 1]	[1, 2]	>2
<-2	3	66.7% (2/3)	33.3% (1/3)	0.0% (0/3)	0.0% (0/3)	0.0% (0/3)	0.0% (0/3)
[-2, -1]	8	0.0% (0/8)	62.5% (5/8)	12.5% (1/8)	12.5% (1/8)	12.5% (1/8)	0.0% (0/8)
[-1, 0]	13	0.0% (0/13)	7.7% (1/13)	38.5% (5/13)	30.8% (4/13)	15.4% (2/13)	7.7% (1/13)
[0, 1]	6	0.0% (0/6)	16.7% (1/6)	0.0% (0/6)	16.7% (1/6)	66.7% (4/6)	0.0% (0/6)
[1, 2]	7	0.0% (0/7)	0.0% (0/7)	0.0% (0/7)	42.9% (3/7)	57.1% (4/7)	0.0% (0/7)
>2	7	0.0% (0/7)	0.0% (0/7)	0.0% (0/7)	0.0% (0/7)	42.9% (3/7)	57.1% (4/7)

## Precision

Precision of the System was evaluated by comparing the results from two separate sensors worn on the same subject at the same time.

Data from two sensors worn at the same time for 2 subjects, both inserted in the abdomen, provided 124 pairs of CGM Measurements, with a mean Percent Absolute Relative Difference (PARD) during the study of 10.29% and a coefficient of variation (%CV) of 7.6%.

Data from two sensors worn at the same time for 2 subjects, one inserted in the abdomen and one in the buttock, provided 108 pairs of CGM Measurements, with a mean Percent Absolute Relative Difference (PARD) during the study of 6.98% and a coefficient of variation (%CV) of 4.7%.

Data from two sensors worn at the same time for 11 subjects, both inserted in the buttock, provided 754 pairs of CGM Measurements, with a mean PARD during the study of 5.98% and a coefficient of variation (%CV) 4.2%.

## Sensor life

After the first successful calibration, 50% of sensors worn in the abdomen operated more than six days and up to the full seven days of wear (144 to 168 hours). The mean functional sensor life for sensors worn in the abdomen insertion site over the course of the study was 142.1 hours, with a median functional life of 163.2 hours.

After the first successful calibration, 72.2% of sensors worn in the buttock operated more than six days and up to the full seven days of wear (144 to 168 hours). The mean functional sensor life for sensors worn in the buttock insertion site over the course of the study was 146.4 hours, with a median functional life of 166.8 hours.

## Safety

There were no moderate or severe device-related or procedure-related adverse events, device-related or procedure-related serious adverse events, or unanticipated adverse device effects through seven days of use.

## I. Alert performance for users ages 2 through 6

CGM enables your device to display sensor glucose readings, glucose trend arrows, glucose trend graphs, and sensor glucose alerts (for example, High and Low Limit Threshold alerts, High and Low Predictive alerts, and Rise and Fall rate-of-change alerts).

The high and low limit alerts (**Threshold alerts**) let the user know when the sensor glucose is at or above the high limit or at or below the low limit. Using only a high or low limit alert may reduce the number of false alerts, but does not provide a warning before reaching a high or low limit.

**Predictive alerts** notify users that their sensor glucose level may soon reach a high or low limit setting. Users may select how early they would like to be notified before their sensor glucose level reaches a high limit setting. The earliest warning is 30 minutes before reaching a high, but users can reduce the amount of warning time down to 5 minutes. Users will receive a warning approximately 30 minutes prior to when their sensor glucose level is predicted to reach their low limit setting. In general, the earlier the warning, the more time a user will have to react to a potential high or low, but this also increases the potential for false alerts.

A predictive alert is simply an estimation of a future sensor glucose level compared to the high or low limit setting. If the predicted sensor glucose value is above the high limit or below the low limit, then a predictive alert is sounded even though

the current sensor glucose level has not crossed the high or low limit. The predicted sensor glucose level is calculated using the current sensor glucose level, the derivative of previous sensor glucose readings (the trend or slope of the sensor glucose readings) and the amount of early warning duration the user selects.

The device will always alert the user when the CGM reads that the user is below 50 mg/dL, regardless of the high/low threshold and/or predictive alerts that the user sets.

**Glucose TRUE Alert Rate**

The glucose true alert rate is the rate at which the blood glucose confirmed that the CGM alert was triggered correctly. For example:

**True Threshold Hypoglycemic alert rate** alerted when the CGM read that the user was below the low threshold and the user’s blood glucose was actually below that low threshold.

**True Threshold Hyperglycemic alert rate** alerted when the CGM read that the user was above the high threshold and the user’s blood glucose was actually above that high threshold.

**True Predictive Hypoglycemic alert rate** alerted when the CGM predicted that the user would reach below the low threshold and the user’s blood glucose was actually below that low threshold within 15 or 30 minutes.

**True Predictive Hyperglycemic alert rate** alerted when the CGM predicted that the user would reach above the high threshold and the user’s blood glucose was actually above that high threshold within 15 or 30 min.

The true alert rate is important because it is necessary that users be notified when their blood glucose is low (or high) so that they can correct the low (or high) blood glucose. A high true alert rate indicates that when the CGM says that their glucose values are, or will reach a specified threshold, the user’s blood glucose is likely to be at or approaching that threshold.

For example, per the following table, when wearing the sensor in the Buttocks, the low glucose alerts would have correctly indicated that the user was below (i.e. threshold only), or predicted to reach below the threshold (i.e. predictive only) or both (predictive and threshold) 100%, 40%, or 57.1 % of the time within 30 minutes (or 100%, 40% or 57.1% of the time within 15 minutes) when the user had blood glucose values lower than 70 mg/dL.

mg/dL	Insertion Site	Glucose TRUE Alert Rate					
		Threshold Only		Predictive Only		Threshold & Predictive	
		30 min	15 min	30 min	15 min	30 min	15 min
50	Abdomen	-	-	-	-	-	-
	Buttock	0.0% (0/1)	0.0% (0/1)	0.0% (0/1)	0.0% (0/1)	0.0% (0/2)	0.0% (0/2)
60	Abdomen	-	-	0.0% (0/1)	0.0% (0/1)	0.0% (0/1)	0.0% (0/1)
	Buttock	100.0% (1/1)	100.0% (1/1)	25.0% (1/4)	25.0% (1/4)	40.0% (2/5)	40.0% (2/5)
70	Abdomen	0.0% (0/1)	0.0% (0/1)	0.0% (0/4)	0.0% (0/4)	0.0% (0/5)	0.0% (0/5)
	Buttock	100.0% (2/2)	100.0% (2/2)	40.0% (2/5)	40.0% (2/5)	57.1% (4/7)	57.1% (4/7)
80	Abdomen	25.0% (1/4)	25.0% (1/4)	16.7% (1/6)	0.0% (0/6)	20.0% (2/10)	10.0% (1/10)
	Buttock	40.0% (2/5)	40.0% (2/5)	33.3% (3/9)	22.2% (2/9)	35.7% (5/14)	28.6% (4/14)
90	Abdomen	50.0% (2/4)	50.0% (2/4)	50.0% (3/6)	33.3% (2/6)	50.0% (5/10)	40.0% (4/10)
	Buttock	100.0% (8/8)	100.0% (8/8)	81.8% (9/11)	63.6% (7/11)	88.9% (16/18)	77.8% (14/18)
180	Abdomen	100.0% (7/7)	100.0% (7/7)	80.0% (8/10)	70.0% (7/10)	85.7% (12/14)	78.6% (11/14)
	Buttock	89.7% (26/29)	89.7% (26/29)	84.8% (28/33)	81.8% (27/33)	85.7% (48/56)	83.9% (47/56)
220	Abdomen	100.0% (4/4)	100.0% (4/4)	50.0% (5/10)	50.0% (5/10)	61.5% (8/13)	61.5% (8/13)
	Buttock	90.0% (18/20)	85.0% (17/20)	62.1% (18/29)	55.2% (16/29)	70.5% (31/44)	63.6% (28/44)
250	Abdomen	100.0% (5/5)	100.0% (5/5)	83.3% (5/6)	83.3% (5/6)	90.9% (10/11)	90.9% (10/11)
	Buttock	80.0% (12/15)	73.3% (11/15)	65.2% (15/23)	56.5% (13/23)	70.3% (26/37)	62.2% (23/37)
300	Abdomen	60.0% (3/5)	60.0% (3/5)	40.0% (2/5)	40.0% (2/5)	50.0% (5/10)	50.0% (5/10)
	Buttock	66.7% (4/6)	66.7% (4/6)	35.0% (7/20)	30.0% (6/20)	42.3% (11/26)	38.5% (10/26)

**Note:** Given the small sample size of data available in the low range, the alert performance in the 50 mg/dL and 60 mg/dL should be interpreted with caution and may not reflect actual use performance.

**Note:** For the blank cells (-), there are no evaluable events in this reference range.

## Glucose FALSE Alert Rate

The glucose false alert rate is the rate at which the blood glucose did not confirm that the CGM alert was triggered correctly. For example:

**False Threshold Hypoglycemic alert rate** alerted when the CGM read that the user was below the low threshold but the user's blood glucose was actually above that low threshold.

**False Threshold Hyperglycemic alert rate** alerted when the CGM read that the user was above the high threshold but the user's blood glucose was actually below that high threshold.

**False Predictive Hypoglycemic alert rate** alerted when the CGM predicted that the user would be below the low threshold but the user's blood glucose was actually above that low threshold within 15 or 30 minutes.



**False Predictive Hyperglycemic alert rate** alerted when the CGM predicted that the user would be above the high threshold but the user's blood glucose was actually below the high threshold within 15 or 30 minutes.

The false alert rate is important because it is necessary that users be correctly notified when their blood glucose is low (or high) so that they can correct the low (or high) blood glucose. A low false alert rate indicates that when the CGM says that their glucose values are, or will reach a specified threshold, the user's blood glucose is likely to be at or approaching that threshold.

For example, per the following table, when wearing the sensor in the buttock, the high glucose threshold alerts would have incorrectly indicated that the user was above (i.e. threshold only), or predicted to reach above the threshold (i.e. predictive only), or both (threshold and predictive) 10.3%, 15.2% or 14.3% of the time within 30 minutes (or 10.3%, 18.2%, or 16.1% of the time within 15 minutes) when the user had blood glucose less than 180 mg/dL.

mg/dL	Insertion Site	Glucose FALSE Alert Rate					
		Threshold Only		Predictive Only		Threshold & Predictive	
		30 min	15 min	30 min	15 min	30 min	15 min
50	Abdomen	-	-	-	-	-	-
	Buttock	100.0% (1/1)	100.0% (1/1)	100.0% (1/1)	100.0% (1/1)	100.0% (2/2)	100.0% (2/2)
60	Abdomen	-	-	100.0% (1/1)	100.0% (1/1)	100.0% (1/1)	100.0% (1/1)
	Buttock	0.0% (0/1)	0.0% (0/1)	75.0% (3/4)	75.0% (3/4)	60.0% (3/5)	60.0% (3/5)
70	Abdomen	100.0% (1/1)	100.0% (1/1)	100.0% (4/4)	100.0% (4/4)	100.0% (5/5)	100.0% (5/5)
	Buttock	0.0% (0/2)	0.0% (0/2)	60.0% (3/5)	60.0% (3/5)	42.9% (3/7)	42.9% (3/7)
80	Abdomen	75.0% (3/4)	75.0% (3/4)	83.3% (5/6)	100.0% (6/6)	80.0% (8/10)	90.0% (9/10)
	Buttock	60.0% (3/5)	60.0% (3/5)	66.7% (6/9)	77.8% (7/9)	64.3% (9/14)	71.4% (10/14)
90	Abdomen	50.0% (2/4)	50.0% (2/4)	50.0% (3/6)	66.7% (4/6)	50.0% (5/10)	60.0% (6/10)
	Buttock	0.0% (0/8)	0.0% (0/8)	18.2% (2/11)	36.4% (4/11)	11.1% (2/18)	22.2% (4/18)
180	Abdomen	0.0% (0/7)	0.0% (0/7)	20.0% (2/10)	30.0% (3/10)	14.3% (2/14)	21.4% (3/14)
	Buttock	10.3% (3/29)	10.3% (3/29)	15.2% (5/33)	18.2% (6/33)	14.3% (8/56)	16.1% (9/56)
220	Abdomen	0.0% (0/4)	0.0% (0/4)	50.0% (5/10)	50.0% (5/10)	38.5% (5/13)	38.5% (5/13)
	Buttock	10.0% (2/20)	15.0% (3/20)	37.9% (11/29)	44.8% (13/29)	29.5% (13/44)	36.4% (16/44)
250	Abdomen	0.0% (0/5)	0.0% (0/5)	16.7% (1/6)	16.7% (1/6)	9.1% (1/11)	9.1% (1/11)
	Buttock	20.0% (3/15)	26.7% (4/15)	34.8% (8/23)	43.5% (10/23)	29.7% (11/37)	37.8% (14/37)
300	Abdomen	40.0% (2/5)	40.0% (2/5)	60.0% (3/5)	60.0% (3/5)	50.0% (5/10)	50.0% (5/10)
	Buttock	33.3% (2/6)	33.3% (2/6)	65.0% (13/20)	70.0% (14/20)	57.7% (15/26)	61.5% (16/26)

mg/dL	Insertion Site	Glucose FALSE Alert Rate					
		Threshold Only		Predictive Only		Threshold & Predictive	
		30 min	15 min	30 min	15 min	30 min	15 min
<p><b>Note:</b> Given the small sample size of data available in the low range, the alert performance in the 50 mg/dL and 60 mg/dL should be interpreted with caution and may not reflect actual use performance.</p> <p><b>Note:</b> For the blank cells (-), there are no evaluable events in this reference range.</p>							

## Glucose Correct Detection Rate

Glucose Correct Detection Rate is the rate that the device alerted when it should have alerted. For example, the blood glucose was below the hypoglycemic threshold, or above the hyperglycemic threshold, and the device sounded an alert.

Glucose detection rates are important because it is necessary that users be notified when their blood glucose is low (or high) so that they can correct the low (or high) blood glucose. A high glucose correct detection rate indicates that users can have confidence that they will be notified by the device if their blood glucose is low or high.

For example, per the following table, when wearing the sensor in the buttock, the threshold alert, the predictive alert, or both (threshold and predictive) notified the user 50.0%, 50.0% or 50.0% of the time within 30 minutes (or 50.0%, 50.0% or 50.0% within 15 minutes) when the user had blood glucose less than 60 mg/dL.

mg/dL	Insertion Site	Glucose Correct Detection Rate					
		Threshold Only		Predictive Only		Threshold & Predictive	
		30 min	15 min	30 min	15 min	30 min	15 min
50	Abdomen	-	-	-	-	-	-
	Buttock	-	-	-	-	-	-
60	Abdomen	-	-	-	-	-	-
	Buttock	50.0% (1/2)	50.0% (1/2)	50.0% (1/2)	50.0% (1/2)	50.0% (1/2)	50.0% (1/2)
70	Abdomen	-	-	-	-	-	-
	Buttock	66.7% (2/3)	66.7% (2/3)	66.7% (2/3)	66.7% (2/3)	66.7% (2/3)	66.7% (2/3)
80	Abdomen	100.0% (1/1)	100.0% (1/1)	100.0% (1/1)	100.0% (1/1)	100.0% (1/1)	100.0% (1/1)
	Buttock	40.0% (2/5)	40.0% (2/5)	60.0% (3/5)	40.0% (2/5)	60.0% (3/5)	40.0% (2/5)
90	Abdomen	66.7% (2/3)	66.7% (2/3)	100.0% (3/3)	66.7% (2/3)	100.0% (3/3)	100.0% (3/3)
	Buttock	80.0% (8/10)	80.0% (8/10)	90.0% (9/10)	60.0% (6/10)	90.0% (9/10)	80.0% (8/10)
180	Abdomen	84.6% (11/13)	84.6% (11/13)	92.3% (12/13)	84.6% (11/13)	92.3% (12/13)	84.6% (11/13)
	Buttock	100.0% (58/58)	98.3% (57/58)	100.0% (58/58)	91.4% (53/58)	100.0% (58/58)	100.0% (58/58)

**Table I-3. Glucose Correct Detection Alert Performance using Calibration every 12 hours**

mg/dL	Insertion Site	Glucose Correct Detection Rate					
		Threshold Only		Predictive Only		Threshold & Predictive	
		30 min	15 min	30 min	15 min	30 min	15 min
220	Abdomen	100.0% (8/8)	100.0% (8/8)	100.0% (8/8)	87.5% (7/8)	100.0% (8/8)	100.0% (8/8)
	Buttock	91.7% (33/36)	86.1% (31/36)	97.2% (35/36)	86.1% (31/36)	100.0% (36/36)	94.4% (34/36)
250	Abdomen	100.0% (8/8)	100.0% (8/8)	100.0% (8/8)	87.5% (7/8)	100.0% (8/8)	100.0% (8/8)
	Buttock	84.0% (21/25)	84.0% (21/25)	96.0% (24/25)	84.0% (21/25)	96.0% (24/25)	88.0% (22/25)
300	Abdomen	100.0% (4/4)	100.0% (4/4)	100.0% (4/4)	75.0% (3/4)	100.0% (4/4)	100.0% (4/4)
	Buttock	62.5% (5/8)	62.5% (5/8)	100.0% (8/8)	87.5% (7/8)	100.0% (8/8)	100.0% (8/8)

**Note:** Given the small sample size of data available in the low range, the alert performance in the 50 mg/dL and 60 mg/dL should be interpreted with caution and may not reflect actual use performance.

**Note:** For the blank cells (-), there are no evaluable events in this reference range.

## Glucose Missed Detection Rate

The Missed Detection Rate is the rate that the device did not alert when it should have. For example, the blood glucose was below the hypoglycemic threshold, or above the hyperglycemic threshold, and the device did not sound a threshold or predictive alert.

Missed detection rates are important because it is necessary that users be notified when their blood glucose is low (or high), so that they can correct the low (or high) blood glucose. A low missed detection rate indicates that users can have confidence that they will be notified by the device if their blood glucose is low or high.

For example, per the following table, when wearing the sensor in the buttocks, the threshold alert, predictive alert, or both alert (threshold and predictive) did not sound 50.0%, 50.0% or 50.0% of the time within 30 minutes (or 50.0%, 50.0% or 50.0% within 15 minutes) when the user had blood glucose less than 60 mg/dL.

**Table I-4. Glucose Missed Detection Alert Performance using Calibration every 12 hours**

mg/dL	Insertion Site	Glucose Missed Detection Rate					
		Threshold Only		Predictive Only		Threshold & Predictive	
		30 min	15 min	30 min	15 min	30 min	15 min
50	Abdomen	-	-	-	-	-	-
	Buttock	-	-	-	-	-	-
60	Abdomen	-	-	-	-	-	-
	Buttock	50.0% (1/2)	50.0% (1/2)	50.0% (1/2)	50.0% (1/2)	50.0% (1/2)	50.0% (1/2)
70	Abdomen	-	-	-	-	-	-
	Buttock	33.3% (1/3)	33.3% (1/3)	33.3% (1/3)	33.3% (1/3)	33.3% (1/3)	33.3% (1/3)

**Table I-4. Glucose Missed Detection Alert Performance using Calibration every 12 hours**

mg/dL	Insertion Site	Glucose Missed Detection Rate					
		Threshold Only		Predictive Only		Threshold & Predictive	
		30 min	15 min	30 min	15 min	30 min	15 min
80	Abdomen	0.0% (0/1)	0.0% (0/1)	0.0% (0/1)	100.0% (1/1)	0.0% (0/1)	0.0% (0/1)
	Buttock	60.0% (3/5)	60.0% (3/5)	40.0% (2/5)	60.0% (3/5)	40.0% (2/5)	60.0% (3/5)
90	Abdomen	33.3% (1/3)	33.3% (1/3)	0.0% (0/3)	33.3% (1/3)	0.0% (0/3)	0.0% (0/3)
	Buttock	20.0% (2/10)	20.0% (2/10)	10.0% (1/10)	40.0% (4/10)	10.0% (1/10)	20.0% (2/10)
180	Abdomen	15.4% (2/13)	15.4% (2/13)	7.7% (1/13)	15.4% (2/13)	7.7% (1/13)	15.4% (2/13)
	Buttock	0.0% (0/58)	1.7% (1/58)	0.0% (0/58)	8.6% (5/58)	0.0% (0/58)	0.0% (0/58)
220	Abdomen	0.0% (0/8)	0.0% (0/8)	0.0% (0/8)	12.5% (1/8)	0.0% (0/8)	0.0% (0/8)
	Buttock	8.3% (3/36)	13.9% (5/36)	2.8% (1/36)	13.9% (5/36)	0.0% (0/36)	5.6% (2/36)
250	Abdomen	0.0% (0/8)	0.0% (0/8)	0.0% (0/8)	12.5% (1/8)	0.0% (0/8)	0.0% (0/8)
	Buttock	16.0% (4/25)	16.0% (4/25)	4.0% (1/25)	16.0% (4/25)	4.0% (1/25)	12.0% (3/25)
300	Abdomen	0.0% (0/4)	0.0% (0/4)	0.0% (0/4)	25.0% (1/4)	0.0% (0/4)	0.0% (0/4)
	Buttock	37.5% (3/8)	37.5% (3/8)	0.0% (0/8)	12.5% (1/8)	0.0% (0/8)	0.0% (0/8)
<p><b>Note:</b> Given the small sample size of data available in the low range, the alert performance in the 50 mg/dL and 60 mg/dL should be interpreted with caution and may not reflect actual use performance.</p> <p><b>Note:</b> For the blank cells (-), there are no evaluable events in this reference range.</p>							

## Appendix A: Open Source Software disclosure





# Open Source Software disclosure

## Open Source Software disclosure

This document identifies the Open Source Software that may be separately called, executed, linked, affiliated, or otherwise utilized by this product.

Such Open Source Software is licensed to users subject to the terms and conditions of the separate software license agreement for such Open Source Software.

Use of the Open Source Software by you shall be governed entirely by the terms and conditions of such license.

The source and object code, and applicable license for any Open Source Software can be obtained at the following site(s):

- LZ4-compression library (v1.9.1): <http://www.lz4.org>
- SWIG (v3.0.12): <http://www.swig.org>
- FNV-1 hash algorithm (v5.1): <http://www.isthe.com/chongo/tech/comp/fnv/> and <http://www.isthe.com/chongo/src/fnv/fnv64.c>
- CRC32 algorithm: <https://opensource.apple.com/source/xnu/xnu-792.13.8/bsd/libkern/crc32.c>









# Glossary

<b>active insulin</b>	Bolus insulin that has been delivered by the pump and is still working to lower your BG levels.
<b>active insulin adjustment</b>	The amount of insulin that is subtracted from your BG correction bolus to account for the active insulin that is tracked by the Bolus Wizard feature.
<b>Active Insulin Time</b>	A Bolus Wizard setting that lets you set the length of time that bolus insulin is tracked as active insulin.
<b>Activity Guard</b>	An attachment that can be used to ensure that the reservoir stays secure during activity, or when the pump is worn by a child.
<b>alarm</b>	An audible beep or vibration with a message to inform you that the pump is no longer delivering insulin. Alarms require immediate action.
<b>Alarm History</b>	A feature that stores information about recent alarms and alerts.
<b>alert</b>	An audible beep or vibration with a message to inform you of a situation that may require your attention.
<b>Alert before high</b>	An alert that occurs when you are approaching your high limit.
<b>Alert before low</b>	An alert that occurs when you are approaching your low SG value.
<b>Alert Limits</b>	The values that you set to determine when low and high glucose alerts are triggered.

<b>Alert on high</b>	An alert that occurs when your SG value reaches or rises above your high limit.
<b>Alert on low</b>	An alert that occurs when your SG value reaches or falls below your low limit.
<b>Auto Basal</b>	The automatically adjusted basal insulin delivered by Auto Mode based on your SG values.
<b>Auto Mode</b>	Auto Mode is an insulin delivery feature that automatically controls basal insulin delivery to regulate BG levels to a target SG value.
<b>Auto Mode Bolus feature</b>	The Auto Mode Bolus feature assists the user in calculating a recommended bolus amount based on optional carbohydrate intake and optional BG measurement. The user may enter one or both of the two optional inputs. This feature utilizes the Carb Ratio setting to compute the bolus.
<b>Auto Suspend</b>	An alarm that you set to suspend insulin delivery and trigger an alarm if no buttons are pressed for a specified period of time. Clearing the alarm resumes basal insulin delivery.
<b>Awake mode</b>	A state in which the pump screen is on. Unless you are actively using another screen, your Home screen appears.
<b>basal insulin</b>	Insulin that is continuously delivered by the pump to meet your individual insulin needs between meals and during sleep.
<b>basal pattern</b>	A set of one or more basal rates that covers a 24-hour period.
<b>basal rate</b>	The amount of continuous basal insulin that you program your pump to automatically deliver per hour.
<b>BG</b>	Abbreviation for blood glucose. See <i>blood glucose (BG)</i> .
<b>BG meter</b>	A device that measures glucose levels in the blood.
<b>BG Targets</b>	The high and low values to which your BG is corrected when using the Bolus Wizard feature.
<b>Block Mode</b>	A feature that restricts the ability to change all settings. You can still perform certain functions, such as

	suspending insulin delivery, reviewing history, testing your pump, or clearing alarms and alerts.
<b>blood glucose (BG)</b>	Glucose that is present in the blood, commonly measured by a BG meter.
<b>Bolus BG Check reminder</b>	A reminder that you set just after you program a bolus. The reminder tells you to check your BG when the time period that you specified has passed.
<b>bolus insulin</b>	Insulin used to cover an expected rise in BG levels due to carbohydrates, or to lower a high BG value down to your target range.
<b>Bolus Speed</b>	A feature that lets you choose the speed at which your device delivers bolus insulin.
<b>Bolus Wizard feature</b>	A feature that uses your individual Bolus Wizard settings to calculate an estimated bolus amount based on the BG values and carbs that you enter. These settings include Carb Ratio, Insulin Sensitivity Factor, BG Target range, and Active Insulin Time.
<b>calibrate</b>	The process of using a meter BG reading to calculate SG values.
<b>Calibration reminder</b>	Set the Calibration reminder to notify you when your next calibration is due.
<b>cannula</b>	Short, thin, and flexible tube placed in the tissue below the skin. Insulin is delivered through the cannula into the body.
<b>carb ratio</b>	The number of grams of carbohydrates covered by one unit of insulin. The carb ratio is used to calculate bolus amounts.
<b>CGM</b>	Abbreviation for continuous glucose monitoring. See <i>continuous glucose monitoring (CGM)</i> .
<b>continuous glucose monitoring (CGM)</b>	A monitoring tool that uses a glucose sensor placed below the skin to continuously measure the amount of glucose in your interstitial fluid.
<b>correction bolus</b>	Insulin used to lower a high BG value down to your target range.

<b>Daily History</b>	A feature that displays the actions that you performed using your device.
<b>diabetic ketoacidosis (DKA)</b>	A serious condition that occurs when the insulin levels are low, BG levels are elevated, and the body uses fat for energy. This process produces ketones which upset the body's acid-base balance, leading to a potentially life threatening situation.
<b>Dual Wave bolus</b>	A type of bolus that provides a dose of insulin delivered as a combination of a Normal Bolus followed by a Square Wave bolus.
<b>Easy Bolus feature</b>	A feature that lets you deliver a Normal Bolus in preset increments using only audio or vibrate confirmation.
<b>Event Marker</b>	A feature that lets you record events, such as BG readings, injections, carbohydrates, and exercise.
<b>food bolus</b>	A dose of insulin you give to cover an expected rise in glucose levels from carbohydrates.
<b>High limit</b>	The value you set to determine when the pump will alert you of a high SG condition.
<b>infusion set</b>	Tubing that connects to the reservoir on one end, and has a needle or cannula on the other end, that you insert into your body. Insulin travels from the pump through the infusion set into your body.
<b>infusion site</b>	The location on the body where the infusion set is inserted.
<b>insulin sensitivity factor</b>	The amount that BG is reduced by one unit of insulin. The insulin sensitivity factor is used to calculate correction bolus amounts.
<b>interstitial fluid</b>	The fluid that surrounds the cells in the body.
<b>ISIG</b>	The signal created by the sensor that is used to calculate your SG value. Typically used by Medtronic technical support representatives when troubleshooting.
<b>lock</b>	A pump feature that prevents accidental button presses.

<b>Low limit</b>	The value you set to determine when the pump will alert you of a low SG condition, and also used for determining if insulin delivery should be suspended.
<b>Manual Bolus</b>	A feature that lets you enter and deliver a dose of insulin in the amount that you have determined is necessary.
<b>Manual Mode</b>	Manual Mode refers to system functions other than Auto Mode. In other words, if Auto Mode is not active, the system is in Manual Mode.
<b>Max Basal Rate</b>	A feature that lets you set the maximum amount of basal insulin that can be delivered per hour.
<b>Max Bolus</b>	A feature that lets you set the maximum bolus amount that can be delivered in one dose.
<b>meter</b>	A term for any BG meter.
<b>Missed Meal Bolus reminder</b>	A reminder that a bolus was not delivered during time periods that you specify, often set around your meal times.
<b>Normal Bolus</b>	A type of bolus that provides an entire dose of insulin immediately.
<b>notifications</b>	All notifications are designed to get your attention and convey different types of information. They include alarms, alerts, reminders, and messages.
<b>occlusion</b>	A blockage or crimp of the cannula or tubing that prevents proper insulin flow.
<b>piston</b>	The part of the insulin pump that engages the reservoir and moves insulin through the tubing.
<b>Power save mode</b>	A state in which your pump is fully functional, but the screen goes dark to save power. You can set how long it takes for your screen to enter power save mode with the Backlight setting.
<b>Preset Bolus</b>	A feature that lets you set up and save a bolus for specific meals or snacks that you frequently eat or drink.
<b>Preset Temp Basal</b>	A feature that lets you set up and save temporary basal rates for repeated use.

<b>reminder</b>	A type of notification that you can set to help you remember to do something.
<b>reservoir</b>	The small container that you fill with insulin and insert into your delivery device.
<b>Resume basal alert</b>	An alert that can be set to occur when your pump has automatically resumed basal insulin delivery after a Suspend before low or Suspend on low event because your SG values have met the necessary criteria. This alert always occurs if basal insulin delivery has resumed because the two-hour maximum suspend time has elapsed.
<b>Rewind</b>	A feature used when you change a reservoir. It returns the piston to its start position and lets a new reservoir be placed into the pump.
<b>Rise Alert</b>	An alert that tells you if your SG value is rising rapidly.
<b>sensitivity</b>	See <i>insulin sensitivity factor</i> .
<b>sensor (glucose sensor)</b>	The small part of the continuous glucose monitoring system that you insert just below your skin to measure glucose levels in your interstitial fluid.
<b>sensor glucose (SG)</b>	Glucose that is present in the interstitial fluid and is measured by a glucose sensor.
<b>Set Change reminder</b>	A reminder that you can set to change your infusion set.
<b>SG</b>	Abbreviation for sensor glucose. See <i>sensor glucose (SG)</i> .
<b>Sleep mode</b>	A state in which your pump is fully functional, but the screen is dark. Your pump automatically enters sleep mode when you have not pressed any buttons for about two minutes.
<b>SmartGuard suspend</b>	SmartGuard suspend features include Suspend before low and Suspend on low.
<b>SmartGuard technology</b>	A feature that can automatically stop and resume basal insulin delivery based on your SG values and low limit. SmartGuard Auto Mode can automatically adjust basal insulin delivery based on SG values.



<b>Square Wave bolus</b>	A bolus delivered evenly over a specified time period.
<b>Suspend before low</b>	A feature that suspends insulin delivery when the sensor predicts the SG value is approaching your low limit.
<b>Suspend Delivery</b>	This feature stops all insulin delivery until you resume it. Only the basal insulin restarts when delivery is resumed.
<b>Suspend on low</b>	A feature that suspends insulin delivery when your SG value reaches or falls below your low limit.
<b>Temp Basal rate (temporary basal rate)</b>	A feature that lets you temporarily increase or decrease your current basal rate for a duration of time that you specify.
<b>transfer guard</b>	The plastic piece that comes attached to the reservoir. It is used to connect the reservoir to the insulin vial while the reservoir fills with insulin.
<b>transmitter</b>	A device that connects to a glucose sensor. The transmitter collects data measured by the sensor and wirelessly sends this data to monitoring devices.







# Index

## A

- accessories 33
- active insulin
  - about 98
  - adjustment 98
  - clearing settings 166
  - Home screen 45
  - injection warning 98
  - viewing amount 46
- Active Insulin cleared alert 247
- Active Insulin Time
  - about 93
  - changing 98
- Alarm History 145
- alarms
  - about 243
  - audio options 245
  - Auto Mode 275
  - Auto Suspend 247
  - Battery failed 248
  - Battery not compatible 248
  - Bolus not delivered 248
  - Bolus stopped 248
  - CGM 264
  - Critical pump error 249
  - Delivery limit exceeded 249
  - emergency siren 245
  - Fill Cannula? 251
  - Insert battery 252
  - Insulin flow blocked 253, 254, 255
  - Loading incomplete 255
  - Manage Settings error 257
  - Max Fill reached 257
  - No reservoir detected 258
  - notification light 244
  - overview 244
  - pump 246, 280
  - Pump error 259, 260
  - Pump restarted 261
  - red icon 244
  - Replace battery now 261
  - sensor 264
  - siren 245
  - Stuck button 264
- Alert before high SG setting 180
- Alert before low
  - about 184
- Alert on high SG setting 180
- Alert on low
  - about 187
- Alert Silence 215
  - in Auto Mode 236
- alerts
  - about 243
  - Active Insulin cleared 247
  - audio options 245
  - Auto Mode 275
  - BG not received 267
  - Calibrate now 267
  - Calibration not accepted 268
  - CGM 264
  - Change sensor 268, 269
  - Check connection 269
  - Check settings 249

- Device not compatible 250
- Device not found 251
- Lost sensor signal 269
- Low battery Pump 256
- Low battery transmitter 269
- Low reservoir 256
- No calibration occurred 271
- notification light 245
- overview 245
- Possible signal interference 272
- pump 246, 280
- Replace battery 261
- Reservoir estimate 262
- Rise alert 272
- sensor 264
- Sensor alert occurred 272
- Sensor expired 273
- Sensor signal not found 273
- silencing 215
- Transmitter battery depleted 275
- yellow icon 245
- areas, for inserting infusion set 128
- arrows, trend 214
- audio
  - options 52
  - settings 161
  - silencing 215
  - vibrate 48
- Auto Mode
  - about 221
  - alarms 275
  - Alert Silence 236
  - alerts 275
  - Auto Mode Bolus 234
  - Block mode in 230
  - conditions affecting startup 224
  - Enter BG 233
  - exiting 239
  - Home screen 227
  - messages 275
  - prepare for using 222
  - Readiness 51, 177, 225
  - Readiness status screen 52
  - returning to 239
  - Safe Basal 228
  - sensor graph 232
  - Setting Temp Target 230
  - setting up 223
  - SmartGuard suspend features and SmartGuard Auto Mode 225 using 228
  - Auto Mode Bolus 234
    - about 234
  - Auto Suspend alarm 247
  - awake mode 60
- B**
- backlight
  - battery use 39
  - setting up 163
- basal
  - about 65
  - current delivery 79
  - daily delivery amount 142
  - delivery 65
  - history 141, 143
  - Home screen 45
  - max basal rate 67
  - patterns 68
  - Preset Temp basal rate 76
  - rate 65
  - settings 66
  - summary 141
  - Temp Basal 73
- basal patterns
  - about 68
  - adding 72
  - changing 72
  - deleting 72
  - example 68
- battery
  - about 39
  - alarm 248, 252, 261
  - alert 256, 261
  - compartment location 37
  - disposal 42
  - inserting 40

- pump clip 42
    - removing 42
    - replacing 40
    - types 39
  - Battery failed alarm 248
  - Battery not compatible alarm 248
  - BG
    - Home screen 45
    - sensor calibration 207
  - BG meter readings
    - average 144
    - manual high 144
    - manual low 144
    - summary 144
  - BG not received alert 267
  - BG target
    - Bolus Wizard 93
    - setting up 97
  - Block Mode
    - in Auto Mode 230
    - status bar 51
    - using 162
  - blood glucose
    - Home screen 45
    - sensor calibration 207
  - bolus
    - about 85
    - daily delivery amount 142
    - delivery speed 90
    - history 141, 143
    - increment setting 90, 91
    - Max bolus 89
    - reminders 155
    - setting delivery speed 90
    - settings 89
    - summary 141, 143
    - types 85
  - Bolus BG Check reminder, about 154
  - bolus deliveries
    - about 85
    - Auto Mode Bolus 88, 234
    - Bolus Wizard 87, 92
    - delivery rate 90
    - Dual Wave 106
    - Easy Bolus 89, 109
    - Manual Bolus 88, 103
    - Max bolus setting 89
    - Normal bolus 100, 103
    - options 87
    - preset bolus 88, 112
    - resume message 262, 263
    - Square Wave 103
    - stopping 114
    - types 85
  - Bolus Estimate Setup 94
  - Bolus not delivered alarm 248
  - Bolus stopped alarm 248
  - bolus types
    - Dual Wave 86
    - examples 86
    - Normal 85
    - Square Wave 86
  - Bolus Wizard
    - Active Insulin Time 93
    - alerts 99
    - BG target 93
    - Dual Wave 107
    - High BG alert 99
    - injection warning 98
    - Insulin Sensitivity Factor 93
    - Low BG alert 99
    - Max Bolus exceeded alert 100
    - Normal bolus 100
    - Square Wave 104
- C**
- calibrate
    - error 268, 269
    - sensor 206
    - when to 208
  - Calibrate now alert 267
  - calibration
    - guidelines 209
    - icon 50
  - Calibration not accepted alert 268
  - Calibration reminder 157
  - cannula alarm 251

- carb ratio 96
- CareLink Personal Software 148
- CareLink uploader not found. message 281
- Change sensor alert 268, 269
- Check connection alert 269
- Check settings alert 249
- cleaning
  - pump 295
  - transmitter 296
- clearing
  - active insulin 166
  - pump settings 165
- connection, failure 204
- Consumable
  - infusion set 30
  - reservoir 30
- continuous glucose monitoring
  - about 173
  - alarms 264
  - alerts 264
  - calibrating sensor 206
  - examples 188
  - high SG settings 179
  - home screen 175
  - low SG settings 180
  - messages 264
  - pairing pump, transmitter 201
  - sensor feature, turning on 194
  - sensor glucose reading 213
  - sensor graph 213
  - settings 178
- correction estimate 305, 306
- Critical pump error 249

**D**

- Daily History 145
- date
  - changing 170
  - Startup Wizard 43
- delivery 52
  - basal 52
  - bolus 52
  - options 52
  - stop bolus 52
  - suspend all 52
- Delivery limit exceeded alarm 249
- Device Limit message 250
- Device not compatible alert 250
- Device not found alert 251
- Display Options
  - setting up 163
- disposal, pump 298
- Dual Wave 86
  - about 106
  - Bolus Wizard 107
  - example 86
  - Manual bolus 108
  - resume message 262, 263
  - setting up 107

**E**

- Easy Bolus
  - about 109
  - Manual bolus 111
  - setting up 110
  - step size 110
- electromagnetic emissions 319
- electromagnetic immunity 320
- emergency
  - kit 6
  - siren 245
- emissions 319
- Enter BG
  - in Auto Mode 233
- event markers
  - about 148
  - blood glucose 148
  - exercise 149
  - food 149
  - injection 148
  - setting up 148
- Exiting Auto Mode 239

**F**

- Fill Cannula? alarm 251



food estimate 305, 306, 307

## G

glucose alerts, silencing 215

graph, sensor 213

Auto Mode 232

## H

High BG, Bolus Wizard warning 99

High Limit SG setting 179

high SG settings

about 179

entering 194

history

about 141

ISIG 147

pump settings, viewing 167

summary 141

Home screen

about 45

active insulin amount 45

basal delivery 45

BG reading 45

bolus delivery 45

CGM, with 175

display 39

sensor glucose 175

sensor glucose reading 175

sensor graph 175

sensor status icons 175

status bar 45

time 45

trend arrows 175

## I

icons

Home screen 46

sensor status 175

SmartGuard 186

SmartGuard suspend 178

infusion set

about 119

best insertion sites 129

fill cannula alarm 251

fill tubing 127

inserting 128

reservoir alarm 255

reservoir removal 119

rotating sites 129

setting up 119

type 30

Insert battery alarm 252

inserting

infusion set 128

reservoir 125

sensor 204

insulin

basal 65

basal patterns 68

bolus 85

flow blocked alarm 253, 254, 255

icon 48

Max Fill reached alarm 257

insulin delivery

Block Mode 162

resuming 80, 188, 200

stopping 80, 114

suspending 80, 161, 181, 185

Insulin flow blocked alarm 253, 254, 255

Insulin Sensitivity Factor

about 93

setting up 97

ISIG

history 147

## L

language

changing 163

starting 43

light, red 244

Loading incomplete alarm 255

Lost sensor signal alert 269

Low battery Pump alert 256

- Low battery transmitter alert 269
- Low BG, Bolus Wizard warning 99
- Low limit 181
- low management mode
  - summary 144
- Low Reservoir
  - alert 155, 256
  - reminder 155
- low SG settings
  - about 180
  - entering 197
  - examples 188

## M

- main menu
  - accessing 51
- Manage Settings error alarm 257
- managing, pump settings 164
- Manual bolus
  - Dual Wave 108
  - Easy Bolus 111
  - Normal bolus 103
  - Square Wave 106
- max basal
  - alarm 249
  - rate 66
  - setting 67
- max bolus
  - alarm 249
  - exceeded 100
  - setting 89
  - warning 90
- Max Fill reached alarm 257
- Menu screen
  - audio options 52
  - basal 52
  - bolus 52
  - enter BG 52
  - options 52
  - status 52
  - suspend delivery 52

- messages
  - about 243
  - audio options 246
  - Auto Mode 275
  - blue icon 246
  - CareLink uploader not found. 281
  - CGM 264
  - continuous glucose monitoring 264
  - Device Limit 250
  - overview 246
  - pump 246, 280
  - Resume bolus 262
  - Resume Dual bolus 262, 263
  - Resume Square bolus 263
  - sensor 264
  - Sensor connected 273

- meter
  - pairing, pump 136
- Missed Meal Bolus reminder 155
- modes
  - Block 162
  - power 60
- mute alerts 215

## N

- No calibration occurred alert 271
- No reservoir detected alarm 258
- Normal bolus
  - about 100
  - Bolus Wizard 100
  - delivery 100
  - example 86
  - Manual bolus 103
  - resume message 262
- notification light 244, 245
- notifications 53

## O

- Occlusion detection
  - alarm 313
- ordering supplies 33

## P

- pair device 201
  - pump, meter 136
  - pump, transmitter 201
- patterns, basal
  - about 68
  - adding 72
  - changing 72
  - copying 72
  - deleting 72
  - example 68
- personal reminder 153
- Possible signal interference alert 272
- power save mode 60
- preset bolus
  - about 112
  - changing 113
  - deleting 113
  - delivering 114
  - renaming 113
  - setting up 112
- Preset Bolus
  - Dual Wave 112
  - Square Wave 112
- Preset Temp basal rate
  - about 66, 76
  - editing 77
  - managing 76
  - setting up 76
  - starting 77
- previous screen 39
- pump
  - alarms 246, 280
  - alerts 246, 280
  - buttons 38
  - cleaning 295
  - connection status 49
  - deleting, transmitter 204
  - messages 246, 280
  - navigation 42
  - notification light 38
  - overview 37
  - pairing, meter 136

- pairing, transmitter 201
  - parts illustration 37
  - rewinding 120
  - settings 288
  - storing 296
  - unlocking 45
  - warranty vi
- pump clip 33
  - remove battery cap 42
- pump disposal 298
- Pump error alarm 259, 260
- Pump restarted alarm 261
- pump security 28
- pump settings
  - clearing 165
  - managing 164
  - restoring 165
  - saving 164
  - viewing history 167

## Q

- quick status 53

## R

- rate, basal
  - about 65
  - Preset Temp 66
  - Temp 66, 73
- red light 244, 245
- reminders
  - about 153
  - Bolus BG Check 154
  - Calibration 157
  - Low Reservoir 155
  - Missed Meal Bolus 155
  - Personal 153
  - Set Change 156
- Replace battery alert 261
- Replace battery now alarm 261
- reservoir
  - about 119
  - compartment image 37
  - inserting 125

- Loading incomplete alarm 255
- Low Reservoir alert 256
- Max Fill reached alarm 257
- No reservoir detected alarm 258
- ordering 33
- plunger rod 123
- removal 119
- Reservoir estimate at 0 U 262
- setting up 119
- transfer guard 123
- type 30
- Reservoir estimate alert 262
- restoring, pump settings 165
- Resume basal alert 188
- Resume bolus message 262
- Resume Dual bolus message 262, 263
- Resume Square bolus message 263
- resuming SmartGuard suspended delivery 80
- resuming suspended delivery 188, 200
- return to previous screen 39
- returning to Auto Mode 239
- Rise Alert
  - responding to 272
  - SG setting 180
- Rise Limit SG setting 180

## S

- Safe Basal
  - Auto Mode 228
- saving
  - power 60
  - pump settings 164
- screen
  - Active Insulin Time 98
  - Alarm History 145
  - Audio Options 161
  - Auto Suspend 162
  - Basal Pattern Setup 72
  - BG Check 154
  - BG Target 97
  - Block Mode 162
  - Bolus Estimate Setup 98

- Bolus Increment 91
- Bolus Speed 92
- Carb Ratio 96
- Display Options 163
- Dual/Square Wave 104
- Easy Bolus 110
- Enter Date 44
- Enter Time 43
- Event Markers 148
- Fill Cannula 131
- Fill Tubing 128
- Home 45
- Language 43, 163
- Low Reservoir 156
- Manual Bolus 103
- Max Basal/Bolus 90
- Missed Meal Bolus 155
- New Reservoir 121
- Personal reminder 153
- Preset Bolus Setup 113
- Preset Temp Setup 76
- Select Time Format 43
- Self Test 169
- Sensitivity 97
- Sensor Demo 169
- Sensor Settings 194
- Set Change 156
- SG Review 146
- Summary 142
- Temp Basal 75
- Time and Date 170
- Welcome screen 43

- scroll bar 39, 59
- select 39
- sensor
  - alarms 264
  - alerts 264
  - BG not received alert 267
  - calibrating 206, 209
  - calibration alert 267, 268
  - calibration icon 50
  - expired alert 273
  - feature, turning off 210
  - feature, turning on 194

- graph 175
- inserting 204
- life icon 51, 177
- messages 264
- pair 201
- removing 210
- settings 194
- status icons 175
- summary 144
- trend arrows 175
- Sensor alert occurred
  - responding to 272
- sensor alerts, silencing 215
- Sensor connected message 273
- Sensor Demo 169
- Sensor expired alert 273
- sensor glucose
  - arrows 214
  - graph 213
  - high SG settings 179
  - history 213
  - low SG settings 180
  - rise alert 272
  - sensor alert occurred 272
- sensor graph
  - about 213
  - trend arrows 214
- Sensor signal not found alert 273
- serial number, pump 29
- Set Change reminder 156
- Setting Temp Target
  - in Auto Mode 230
- settings
  - basal 66
  - bolus 89
  - Bolus Wizard 93
  - CGM 178
  - low SG 180
  - startup 43
- SG average 144
- SG Std. Dev. 144
- silencing alerts 215
- siren 245
- sleep mode 60
- SmartGuard
  - about 174
  - Auto Mode 221
  - icon 178, 186
- SmartGuard suspend features
  - and Auto Mode 225
- SmartGuard suspended delivery, resuming
  - manually 80
- Square Wave 86
  - about 103
  - Bolus Wizard 104
  - example 86
  - Manual bolus 106
  - resume message 262, 263
  - setting up 104
- starting
  - sensor 205
- Startup Wizard
  - about 43
  - re-entering settings 288
  - using 43
- status 52
- status bar
  - about 46
  - audio mode 48
  - Auto Mode Readiness icon 51, 177
  - Block Mode 51
  - CGM, with 175
  - CGM, without 45
  - Connection icon 49
  - icons 47
  - insulin amount 48
  - sensor calibration 50
  - sensor life 51, 177
  - time 45
- status screens
  - about 52
  - Auto Mode Readiness 52
  - notifications 53
  - pump 53
  - quick status 53
  - sensor 53
  - settings review 53

- stopping
  - bolus 114
  - insulin delivery 80
- storage mode 296
- Stuck button alarm 264
- summary screen
  - about 141
  - basal 142
  - BG meter readings 144
  - bolus 142, 143
  - overview 142
  - total carbs 142
  - total daily dose 142
  - viewing 142
- supplies, ordering 33
- Suspend before low
  - about 181
  - examples 192
  - unavailable 183
- Suspend on low
  - about 185
  - example 193
  - unavailable 186
- suspended delivery, resuming
  - automatically 188
  - manually 200
- suspending insulin delivery 80, 161, 181, 185
- system security 28

## T

- temp basal rate
  - about 74
  - percent 74
  - preset 66
  - rate 74
  - starting 75
  - types 74
- Temp Target
  - setting in Auto Mode 230
- Time before high SG setting 180
- time, current changing 170

- transmitter
  - communication 49
  - deleting, from pump 204
  - pairing, pump 201
- Transmitter battery depleted alert 275
- trend arrows 175, 214
- troubleshooting 285
- tubing
  - filling 127
  - image 37
  - Max Fill reached alarm 257

## U

- unavailable
  - Suspend before low 183
  - Suspend on low 186
- unlocking 45

## V

- viewing history, pump settings 167

## W

- warranty vi



# Medtronic



**Medtronic MiniMed**  
18000 Devonshire Street  
Northridge, CA 91325 USA  
1 800 646 4633  
+1 818 576 5555  
[www.medtronicdiabetes.com](http://www.medtronicdiabetes.com)

M998590A012\_2



MinimiMed™ 770GG