



User Manual for  
*HE500OSW232*



# Cscape Programming and Reference Manual

*Re-Order from*   
***Omegamation™***  
***1-888-55-66342***  
***1-888-55-OMEGA***  
***omegamation.com***



## PREFACE

This manual explains how to use Cscape Software.

Copyright (C) 2002 Horner APG, LLC., 640 North Sherman Drive Indianapolis, Indiana 46201. All rights reserved. No part of this publication may be reproduced, transmitted, transcribed, stored in a retrieval system, or translated into any language or computer language, in any form by any means, electronic, mechanical, magnetic, optical, chemical, manual or otherwise, without the prior agreement and written permission of Horner APG, Inc.

All software described in this document or media is also copyrighted material subject to the terms and conditions of the Horner Software License Agreement.

Information in this document is subject to change without notice and does not represent a commitment on the part of Horner APG.

Cscape, SmartStack and CsCAN are trademarks of Horner APG.

DeviceNet is a trademark of the Open DeviceNet Vendor Association (OVDA), Inc.

***For user manual updates, contact Horner APG Technical Support Division, at (317) 916-4274 or visit our website at [www.heapg.com](http://www.heapg.com).***

## LIMITED WARRANTY AND LIMITATION OF LIABILITY

Horner APG,LLC. ("HE-APG") warrants to the original purchaser that the Cscape Software manufactured by HE-APG is free from defects in material and workmanship under normal use and service. The obligation of HE-APG under this warranty shall be limited to the repair or exchange of any part or parts which may prove defective under normal use and service within two (2) years from the date of manufacture or eighteen (18) months from the date of installation by the original purchaser whichever occurs first, such defect to be disclosed to the satisfaction of HE-APG after examination by HE-APG of the allegedly defective part or parts. THIS WARRANTY IS EXPRESSLY IN LIEU OF ALL OTHER WARRANTIES EXPRESSED OR IMPLIED INCLUDING THE WARRANTIES OF MERCHANTABILITY AND FITNESS FOR USE AND OF ALL OTHER OBLIGATIONS OR LIABILITIES AND HE-APG NEITHER ASSUMES, NOR AUTHORIZES ANY OTHER PERSON TO ASSUME FOR HE-APG, ANY OTHER LIABILITY IN CONNECTION WITH THE SALE OF THIS Cscape Software. THIS WARRANTY SHALL NOT APPLY TO THIS Cscape Software OR ANY PART THEREOF WHICH HAS BEEN SUBJECT TO ACCIDENT, NEGLIGENCE, ALTERATION, ABUSE, OR MISUSE. HE-APG MAKES NO WARRANTY WHATSOEVER IN RESPECT TO ACCESSORIES OR PARTS NOT SUPPLIED BY HE-APG. THE TERM "ORIGINAL PURCHASER", AS USED IN THIS WARRANTY, SHALL BE DEEMED TO MEAN THAT PERSON FOR WHOM THE Cscape Software IS ORIGINALLY INSTALLED. THIS WARRANTY SHALL APPLY ONLY WITHIN THE BOUNDARIES OF THE CONTINENTAL UNITED STATES.

In no event, whether as a result of breach of contract, warranty, tort (including negligence) or otherwise, shall HE-APG or its suppliers be liable of any special, consequential, incidental or penal damages including, but not limited to, loss of profit or revenues, loss of use of the products or any associated equipment, damage to associated equipment, cost of capital, cost of substitute products, facilities, services or replacement power, down time costs, or claims of original purchaser's customers for such damages.

**To obtain warranty service, return the product to your distributor with a description of the problem, proof of purchase, post paid, insured and in a suitable package.**

## ABOUT PROGRAMMING EXAMPLES

Any example programs and program segments in this manual or provided on accompanying diskettes are included solely for illustrative purposes. Due to the many variables and requirements associated with any particular installation, Horner APG cannot assume responsibility or liability for actual use based on the examples and diagrams. It is the sole responsibility of the system designer utilizing Cscape Software to appropriately design the end system, to appropriately integrate the Cscape and to make safety provisions for the end equipment as is usual and customary in industrial applications as defined in any codes or standards which apply.

**Note: The programming examples shown in this manual are for illustrative purposes only. Proper machine operation is the sole responsibility of the system integrator.**

**REVISIONS TO THIS MANUAL**

1. Revised Section 4.2 Controller Resources tables; Also, added OCS300 table.
2. Revised Section 5.2 (added SR% Registers)
3. Replaced and renamed Chapter 6 to indicate hardware references and other appropriate resources to consult.
4. Revised Table 14.1; added additional shortcut key assignments.
5. Added new objects in Chapter 16 and new property screens:  
Note (Fig. 16.17);  
Slider (Fig. 16.25);  
Alarms (Fig. 16.28);  
Back Screen object (no property screen).
6. Revised Sections 16.1, 16.3, 16.5, 16.7.1-.3, 16. 8-9.
7. Revised Figures 16.2, 16.11-16, 16.18-24 to update property screens.



## Table of Contents

PREFACE .....	3
LIMITED WARRANTY AND LIMITATION OF LIABILITY .....	4
CHAPTER 1: INTRODUCTION.....	11
1.1 Scope .....	11
1.2 Topics Overview.....	11
1.3 User Reference Information .....	11
1.3.1 Product Overview .....	11
1.4 Requirements.....	12
1.5 Distribution.....	13
1.6 Installation .....	13
1.6.1 Installation Results.....	13
1.7 Technical Support .....	13
CHAPTER 2: LADDER ELEMENTS .....	15
2.1 Program Elements Covered in this Manual.....	15
2.2 Alarm Handling Function Block.....	16
2.2.1 Overview.....	16
2.2.2 Alarm Status Registers - Alarm Control Block .....	17
2.2.3 User Interface Settings .....	18
2.2.4 Time Stamp Registers .....	18
2.2.5 Power Flow .....	18
2.2.6 Viewing the Alarm Handler Status .....	19
2.3 Boolean Elements .....	20
2.4 Display Elements.....	21
2.4.1 How to Use Display Screens .....	21
2.4.2 How to Create a Display Coil.....	21
2.4.3 Multiple Active Screens .....	24
2.5 Logic (Bitwise) Operator Elements.....	24
2.5.1 General .....	24
2.5.2 Power Flow Through the Element .....	24
2.5.3 Configuring Logic Elements.....	25
2.6 Math Operations .....	27
2.6.1 Performance.....	27
2.6.2 Configuring Math Operation Elements.....	27
2.6.3 Math Operations .....	27
2.6.4 Advanced Math Operations .....	31
2.7 Math Equation Element.....	35
2.7.1 Useful Math Feature of Cscape .....	35
2.7.2 Power Flow Through the Element .....	35
2.7.3 Configuring Math Equations .....	36
2.7.4 Typing Shortcut .....	36
2.7.5 Register Designation.....	37
2.7.6 Numeric Constants .....	37
2.7.7 Operators .....	37
2.8 Compare Elements.....	38
2.8.1 General .....	38
2.8.2 Power Flow Through the Element .....	38
2.9 Program Control Jump, Label, Call, Return and End Elements : .....	41
2.9.1 Label Element .....	41
2.9.2 Jump Element .....	42
2.9.3 Call Element .....	43
2.9.4 Return Element .....	44
2.9.5 End Program Element .....	44
2.10 Conversion Elements.....	44

2.10.1	General .....	44
2.10.2	Caveats of Conversion .....	44
2.10.3	Configuring Conversion Elements .....	45
2.11	Timer and Counters .....	47
2.12	Shift and Rotate Elements .....	52
2.12.1	General .....	52
2.12.2	Configuring Shift and Rotate Elements .....	52
2.12.3	Shift vs. Rotate .....	53
2.13	Data Move Elements .....	55
2.13.1	Single Data Moves .....	55
2.13.2	Multi Data Moves .....	62
2.13.3	Multi Rotate Data Moves .....	65
2.14	Set Real Time Clock Element .....	68
2.15	Network Elements .....	69
2.15.1	Net Get Words .....	69
2.15.2	Net Put Words .....	69
2.15.3	Net Get Heartbeat .....	70
2.15.4	Net Put Heartbeat .....	70
2.16	String Handling Elements .....	71
2.16.1	Overview .....	71
2.16.2	Special Characters (String) .....	71
2.17	Communication Elements .....	73
2.17.1	Configuring Serial Port Elements (Communication) .....	73
2.18	Special Elements .....	80
2.18.1	Overview .....	80
2.18.2	Stepper Move Element .....	80
2.18.3	Stepcalc Motion Profile Calculator .....	82
2.18.4	PID Elements .....	83
2.19	Miscellaneous Elements .....	89
2.19.1	Comments .....	89
CHAPTER 3:	CSCAPE DATA TYPES .....	91
3.1	Overview .....	91
3.2	Data Formats .....	91
3.3	Storage Order .....	92
CHAPTER 4:	AVAILABLE CONTROLLER RESOURCES .....	93
4.1	Overview .....	93
4.2	Tables of Internal Resources .....	93
4.3	Using More than 2048 %R Registers .....	95
CHAPTER 5:	SYSTEM REGISTERS .....	97
5.1	General .....	97
5.2	System Registers .....	97
CHAPTER 6:	HARDWARE REFERENCES (WIRING DIAGRAMS, PIN-OUTS, ETC.) .....	109
6.1	Hardware References .....	109
CHAPTER 7:	FLOATING POINT (REAL) NUMBERS .....	111
CHAPTER 8:	STP100 SMARTSTACK MODULE .....	113
8.1	General .....	113
8.2	Command Bits .....	113
8.3	Status Bits .....	114
8.4	Position Feedback Registers .....	114
8.5	Command Data Outputs .....	115
8.6	Indexed Moves .....	116
8.7	Issuing Commands .....	117
CHAPTER 9:	USING ANALOG VALUES WITH CSCAPE AND THE OCS .....	119
9.1	Overview .....	119
9.2	Analog Conversion .....	119
9.3	Resolution .....	119



9.4	Quantitization Step Size.....	120
9.5	Quantitized Value .....	121
9.6	Normalized Analog Values .....	121
9.7	UNIPOLAR SIGNALS .....	122
9.8	Caveats (Analog Circuits).....	123
9.9	Noise.....	123
CHAPTER 10: THERMOCOUPLES & RESISTANCE TEMPERATURE DEVICES (RTD) .....		125
10.1	General.....	125
10.2	Resistance Temperature Device (RTD).....	125
10.3	Thermocouples (THM) .....	125
10.4	Cold Junction Compensation.....	127
10.5	SmartStack Input Values .....	128
CHAPTER 11: FORCING PHYSICAL AND NETWORK I/O .....		131
11.1	Enabling Forcing .....	131
11.2	Forcing a Contact or Coil .....	131
11.3	Registers .....	132
11.4	Indicators of Forcing .....	133
11.5	Viewing a List of Forced Items.....	133
CHAPTER 12 : PID CONTROLS .....		135
12.1	Terminology .....	135
12.2	Overview .....	135
12.3	Proportional Control.....	136
12.4	Bias.....	137
12.5	Integral Control.....	137
12.6	Derivative Control .....	138
12.7	PID.....	138
12.8	TUNING PID LOOPS.....	139
CHAPTER 13: UPDATING FIRMWARE .....		143
13.1	General.....	143
13.2	Update Wizard .....	144
CHAPTER 14: SHORTCUT KEYS IN CSCAPE .....		147
14.1	Shortcut Key Assignments .....	147
CHAPTER 15: TEXT CHARACTER .....		149
CHAPTER 16: GRAPHIC EDITOR.....		151
16.1	Graphical Overview .....	151
16.2	Object Description .....	151
16.3	Object Placement (Editing).....	152
16.4	Object Grouping .....	153
16.5	Object Properties .....	155
16.6	Screen Description .....	160
16.7	Toolbar Reference.....	162
16.7.1	Tools toolbar .....	163
16.7.2	Object toolbar .....	164
16.7.3	Drawing Primitives toolbar.....	165
16.8	Tools Reference.....	165
16.9	Object Reference .....	169
16.10	Drawing Primitive Reference.....	198
16.11	Suggested Order of the Visual System Design Process.....	198
INDEX.....		201



## CHAPTER 1: INTRODUCTION

### 1.1 Scope

This reference manual is designed for the beginner to intermediate programmer using Cscape Software. A basic level of understanding of Cscape operation is assumed as this manual does not provide step-by-step instructions on how to use Cscape. If instructions are needed, refer to the on-line **Cscape Help**.

### 1.2 Topics Overview

Topics in this manual have been specifically selected to assist the user through the programming process and to provide reference information. The topics that are covered include:

- User Reference Information (Product Overview, Requirements, Distribution and Installation)
- Ladder Elements (including Special Elements)
- Cscape Data Types
- Available Controller Resources
- System Registers
- Wiring Diagrams and Pin-outs
- Floating Point (Real) Numbers
- STP100 SmartStack Modules
- PID Controls
- Using Analog Values With Cscape and Operator Control Station (OCS)
- Thermocouple and Resistance Temperature Devices (RTD)
- Updating Firmware
- Shortcut Keys in Cscape
- Text Characters
- Using the Graphics Editor

Note: **Cscape** stands for **C**ontrol **S**tation **C**entral **A**pplication **P**rogramming **E**nvironment.

### 1.3 User Reference Information

#### 1.3.1 Product Overview

The complete *Control Station* product line can be programmed using Cscape, which is a single application programming package.

Included in Cscape are:

- The "drag and drop" Ladder Program Editor
- Integrated Operator Interface Programming
- Controller Configurator, including I/O Configuration
- Project Navigator, for organization of large projects
- Real-time Debugger

Firmly based in Microsoft Windows technology, Cscape provides an intuitive and familiar interface that is easy to learn and use. Use of the mouse-based interface reduces typing to a minimum. Most elements can be specified and placed using the mouse alone.

When a network (CAN, DeviceNet, etc) is provided by the controller products, Cscape can use the network to upload, download, and monitor any GE Fanuc controller residing on the network. Using the Network Pass Through Connection, Cscape can talk to any unit from one position. It is no longer necessary to make a direct physical connection to a unit to be programmed. Cscape can make a logical connection to the unit from any other unit on the network.

Configuration of attached controllers is handled by Cscape. Using Network Pass Through features, any unit can be programmed through a physical connection to any other unit.

Once the ladder program is written, it is automatically checked for syntax errors before it is downloaded. The source code causing syntax errors can be located through a simple click of the mouse.

Ladder source code can be protected from unauthorized viewing or editing by using "OEM Sections". Rungs of ladder code are marked as "OEM Sections", and can be viewed or edited only by personnel with proper security clearance.

Cscape programs can be "self-documenting". That is, it is possible to save the actual source code, comments, and element names to the target unit. Although this takes up valuable memory inside the controller, the complete program – source code, comments, and names – are available to individuals with a sufficient security clearance and the Cscape software. Disk files are not necessary

Physical errors or those errors originating from an outside source can be located by using the Cscape Debugger. This provides a real-time connection to all affected controllers. The user is able to view inputs and outputs and see the subsequent impact of each input and output as they are happening.

Cscape supports the complete GE Fanuc OCS line. Cscape can be manually configured for a specific product, and programs can be written before the hardware is available. Once connected to the network Cscape can automatically configure controllers.

Cscape is capable of supporting multiple ladder program files at one time. The programmer can develop a project which contains all source code files, hardware descriptions, and hardware configuration. Cscape can also debug *all* OCS units simultaneously from a single PC.

#### 1.4 Requirements

A personal Computer running Microsoft's Windows 95™, Windows 98™, Windows 2000™ or Windows NT™ Version 4.0 or later:

- 16MB of RAM Memory, minimum.
- Mouse
- 1 free serial port
- 800x600, 256 color video display recommended
- 20 MB of hard disk space

Additional hard disk space will be needed to store any ladder programs that are written. If the computer uses a serial mouse, a second serial port must be provided for use by Cscape. Serial Port parameters used by Cscape are not user-definable. For reference, the Cscape serial port parameters are set at 9600 baud, 8 data bits, no parity, and 1 stop bit.

## 1.5 Distribution

Cscape may be provided on two or more floppy diskettes, or on a single CD-ROM. There is no difference in the functionality caused by the distribution method.

In the case of floppy diskettes, the diskettes are clearly labeled **DISK 1**, **DISK 2**, etc. During the installation process you will be asked to insert Disk 2 and any subsequent diskettes, if necessary.

In the case of CD-ROM, there is only one disk provided.

## 1.6 Installation

The Cscape Distribution disk contains an Installation Wizard.

On floppy diskette 1 or on the CD-ROM locate and run the `SETUP.EXE` program. Complete instructions are included.

There is only one point where a relatively important decision must be made. You will be asked to choose a directory in which to install Cscape.

The default directory is `C:\Program Files\Cscape`. This will be acceptable for most installations. Some customers, though, may wish to customize this. The most common "custom" directory is `C:\Cscape`.

In any case, it is important that you remember the Cscape "home" directory path, be it `C:\Program Files\Cscape`, `C:\Cscape`, or something else.

### 1.6.1 Installation Results

A successful Cscape installation performs the following actions:

- a. The specified Cscape "home" directory will be created if it does not already exist.
- b. A special PROJECTS directory will be created in the Cscape "home" directory, `[home]\PROJECTS`.
- c. The Cscape executable will be installed in the "home" directory.
- d. Cscape Help Files will be installed in the "home" directory.
- e. Cscape will be attached to the Start Menu by placing a group in the `C:\Windows\Start Menu\Programs` directory. This group contains shortcuts that can be copied to the desktop or to the Start Menu itself.

## 1.7 Technical Support

### North America:

(317) 916-4274 or visit our website at [www.heapg.com](http://www.heapg.com).

### Europe:

(+) 353-21-4321-266

NOTES

## CHAPTER 2: LADDER ELEMENTS

### 2.1 Program Elements Covered in this Manual

The following Program Elements are available for use:

<b>Table 2.1 – Program Elements</b>	
Alarm Handling Function Block	(Alarm Setup Screen and Alarm Status Screen)
Boolean Operations	(NO Contact, NC Coil, POS Coil...)
Display Elements	(System Screens, Alarm Screens, User Screens)
Logic Elements	(AND, NOT< XOR...)
Math Operations	(Add, Sub, Sin...) and Advanced Math
Math Equation	(%R1 = 1 + %R45...)
Comparison Elements	(>, <=, =...)
Program Controls	<b>(Jump, Label, Subroutine, Return, End of Program)</b>
Conversion Operations	(INT, DINT, REAL)
Timers and Counters	(On Delay, Count Up...)
Shift and Rotate Elements	(Shift Left, Rotate Right)
Data Move Operations	(WORD, DWORD, Block, Indirect Move)
Real Time Elements	(Set Real Time Clock)
String Handling Elements	(String Move, String Compare)
Network Elements	(Get/Put Data, heartbeat)
Communications Elements	(Close Comm Port, Comm Port Transmit...)(Send, Modbus, Modem...)
Special Operations	(Stepper, PID...)
Miscellaneous Elements	(Comment, Vert bar)

## 2.2 Alarm Handling Function Block

### 2.2.1 Overview

The alarm handling function block provides automatic display screen selection based on the current state of one or more alarms. The alarm handling function block also acts as an alarm database controller in that each alarm may be time stamped, counted, acknowledged, and cleared. Versatility is provided by allowing the user to create a custom alarm screen for each defined alarm. This typically includes a user-defined message and information from the alarm database such as alarm status, alarm count and time/date stamp information. Once a defined alarm occurs, its associated alarm screen is automatically displayed. Once the displayed alarm is acknowledged and cleared (usually user intervention provided through the OCS keypad), the previous display screen (or other pending alarms) is displayed.

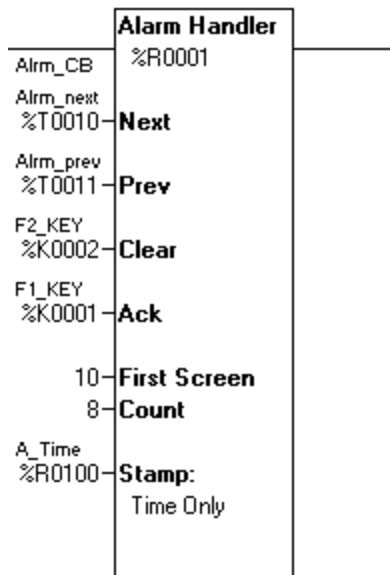

Figure 2. 1 - Dialog Alarm Handling



2.2.2 Alarm Status Registers - Alarm Control Block

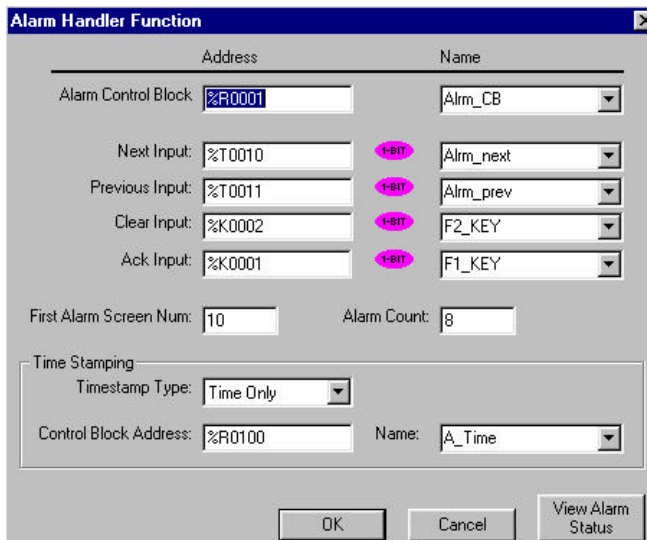

Figure 2.2 – Alarm Handler Function

Registers

Each alarm requires one 16-bit status register. The registers for multiple alarms are defined in a contiguous block called the Alarm Control Block. One bit is written to this register to indicate that the alarm is active. The register also contains sections that indicates the Acknowledge and Pending status and contains a count for the alarm. By placing the alarm status registers in a section of retentive memory (%R, %M...), the alarm states are retained through a power cycle.

The following table shows how the bits in the alarm status word (control block) are allocated:

16-12	11	10	9	8-1
Undefined except for Special Bits*	Acknowledge	Pending	Active	Alarm Count

a. **\*Special Status Bits**

- Bit 16 of the first status word turns ON when any alarm is pending. (The alarms may or may not have been acknowledged.)
- Bit 15 of the first status word turn ON when any alarm is unacknowledged.

b. **Alarm Count** - This is a BYTE counter that counts how many times an alarm occurs. The count only increments when the pending bit goes from low to high. To count another alarm event the alarm must be acknowledged, cleared and reactivated. When the count reaches a maximum of 255, it no longer changes until reset. This count can be reset by writing directly to this portion of the register using one of the BYTE instructions.

c. **Active** - This bit is set by the user's ladder program to indicate an alarm condition has occurred. For example, if the alarm is to indicate an over-temperature condition, have the ladder logic perform a compare function, and then, set this bit if the compare indicates the temperature is greater than a setpoint.

- d. **Pending** - This bit is set by the function block when an alarm has occurred (active bit goes from high to low), and the alarm has not been cleared.
- e. **Acknowledge** - This bit is set by the function block after a pending alarm has been acknowledged.

### 2.2.3 User Interface Settings

When alarms are displayed (one or more alarms pending and power flow enabled to the block), there are four inputs that control the user interface to the function block. These inputs have no affect if there are no pending alarms or if there is no power flow to the alarm handler function block.

- a. **Next** - When this input transitions from low to high, the next (higher alarm number) pending alarm is shown on the display. If the highest alarm is displayed, the alarm number is not incremented further.
- b. **Prev** - When this input transitions from low to high, the previous (lower alarm number) pending alarm is shown on the display. If the lowest alarm is displayed, the alarm number is not decremented further.
- c. **Clear** - When this input transitions from low to high, the currently displayed alarm is cleared if it has already been acknowledged. If it has not been acknowledged, this input has no effect. Once an alarm is cleared, an active bit turned ON in the status register causes the pending bit to be set, the alarm count to increment and a time stamp (if enabled) to be recorded again.
- d. **Ack** - When this input transitions from low to high, the currently displayed alarm is marked as acknowledged. This sets the Acknowledge bit in the status register and allows the alarm to be cleared.
- e. **First Alarm Screen Num (First Screen)** - Defines the first in a block of screens that are used to display alarm information. Alarm 1 causes the screen defined by First Screen to be displayed, Alarm 2 causes the first screen plus one to be displayed.
- f. **Alarm Count (Count)** - Sets the total number of alarms defined. This number also sets how many registers are used for status registers, how many text screens are reserved for alarm display, and how many registers are reserved for time stamping (if enabled).

### 2.2.4 Time Stamp Registers

Time stamping can be set to one of three modes:

- a. **None** - No time stamping is performed and no additional register space is required.
- b. **Time Only** - The time is recorded when each alarm's pending bit becomes active. Each alarm requires three (3) registers starting at the block defined by the time-stamping control block. The time is recorded in the same format as the real-time-clock is stored in the system registers.
- c. **Time and Date** - The time and date is recorded when each alarm's pending bit becomes active. Each alarm requires six (6) registers starting at the block defined by the time-stamping control block. The time and date is recorded in the same format as the real-time-clock is stored in the system registers.

### 2.2.5 Power Flow

This function block only displays the pending alarms when power flow to the function block is ON. Alarm screens are displayed by modifying %SR2 to force a screen based on the pending alarms and the NEXT and PREV inputs.

When power flow into the function block is OFF, the block continues to monitor the alarm active bits to record alarm conditions including incrementing the alarm count, but it does not display the alarms.

### 2.2.6 Viewing the Alarm Handler Status

From the alarm function block properties you can press the **View Alarm Status** button to view the following dialog:

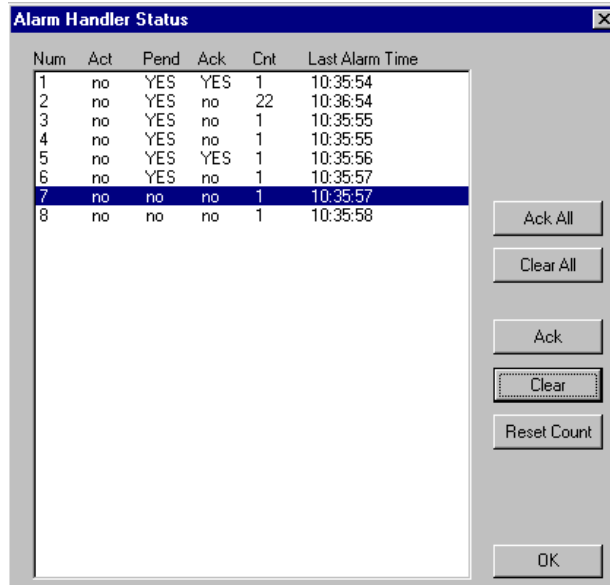

Figure 2.3 - Alarm Handler Status

This dialog allows viewing real-time information for the alarms for the currently connect target controller. Alarms can be acknowledged, cleared or the alarm counter can be cleared from this dialog.

### 2.3 Boolean Elements

The following Boolean Elements are covered:

- a. Normally Open Contact



Power is passed if the associated reference is ON.

- b. Normally Closed Contact



Power is passed if the associated reference is OFF.

- c. Normally Open Coil



The associated reference is set ON if the coil receives power.

- d. Normally Closed Coil



The associated reference is set OFF if the coil receives power.

- e. Positive Transition Coil



If the associated discrete reference is OFF when the coil receives power, the reference is set ON for one logic scan.

- f. Negative Transition Coil



If the associated discrete reference is ON and the coil is not receiving power, the reference is set ON for one logic scan.

- g. Set Coil

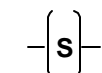

The associated discrete reference is set ON if coil receives power. It remains set until it is reset by a Reset Coil.

h. Reset Coil



The associated discrete reference is set OFF if coil receives power. It remains set until it is set by a Set Coil.

## 2.4 Display Elements

### 2.4.1 How to Use Display Screens

**Cscape** supports the OCS product lines built-in screens.

When a coil is used with a %D register it becomes a screen display coil. This allows ladder to easily control the screen number being shown on the display. When a coil is used as a screen display coil there are two options **force screen** and **switch screen**.

**Force Screen** - This displays a screen as long as the coil is active. This will override any other user screen being displayed. If more than one force screen is active at one time, the one that appears last in the ladder program is the one that is displayed. When a screen is being forced, its screen number can be read from %SR2, the alarm screen number.

**Switch Screen** - This allows the ladder program to switch the operator to a screen, but does not force this screen to remain active. The operator may choose to switch screen after the screen switch using various navigation methods(menus, screen jumps, scrolling...). Only one switch screen coil should be active at one time. If a switch screen is active and another one becomes active it will have no affect, however writing to %SR1 will change the screen while the switch screen is active.

**NOTE:** Power does not flow through the display coil. [See Next]

### 2.4.2 How to Create a Display Coil

To create a display screen start with a coil:



Enter %D, then the screen number or press the "Screen >" button to see the screen picker.

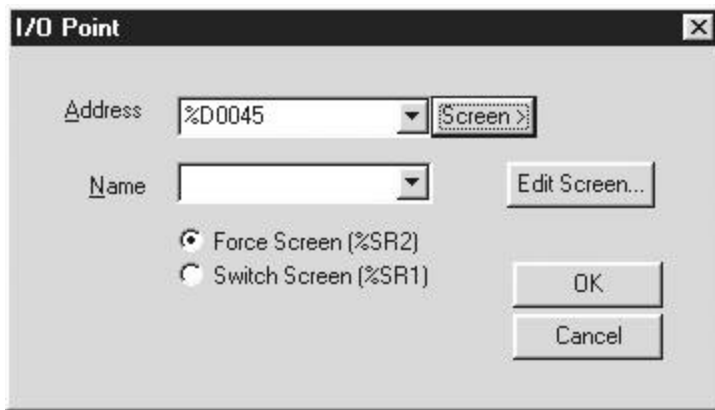

Figure 2.4

Decide if you want a force screen or switch screen, then press OK.

The coil now expands to show a thumbnail of the screen if available.

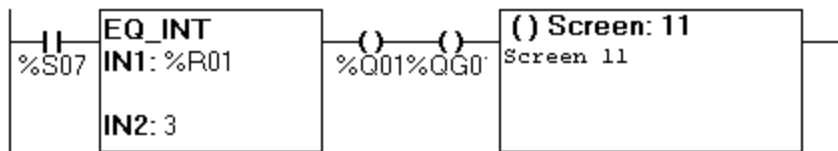

Figure 2.5

**Power Flow through the Element**

Power does *not* flow through the Display Screen coil. The Display Screen Coil must be the last (right-most) element on the rung. In order to activate multiple output coils on the same rung, the Display coil %D must be the *last* coil on the rung.

**Acceptable**



**Not Acceptable**

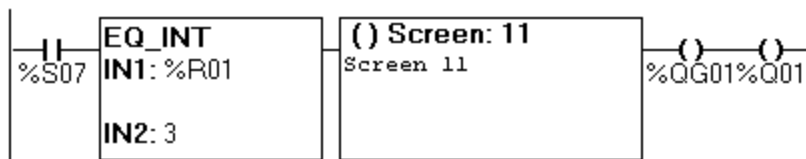

## Using Screen Number System Registers

### See Also: System Registers

The controllers contain system registers that allow the user, alarm and system screen numbers to be read and/or written.

The following is a definition of the three types of screens:

#### **System Screens -**

These are the predefined screens that make-up the system menu. System screen one is viewed by pressing the system key on the controller. Additional system screens can be viewed by navigating the various menus that make-up the system menu. Any system screen can also be displayed by writing a screen number to the system screen system register. System screens are shown even if alarm or user screens are active.

#### **Alarm Screen -**

These screens are programmer defined screens that are forced to display using a %D coil in ladder logic. The alarm screen system register can be read to determine which screen is being forced as an alarm. Writing to the alarm screen system register does not affect operations because the ladder processor calculates and writes the alarm screen number each scan. These screens can be marked as **Alarm** when creating the screens, but screens that are not marked as **Alarm**, but are forced using %D coils are considered alarm screens in this context.

#### **User Screen -**

If a system screen and alarm screen is not displayed, a user screen is displayed. The If more than one user screen exist (programmer not defined as Alarm), the operator can switch between screens using the UP and DOWN keys on the controller. Reading the user screen system register allows the ladder program to monitor the operators movement through the screens as they scroll using the UP and DOWN keys. Writing to the user screen system register allows the ladder program to directly control the screen being displayed.

### 2.4.3 Multiple Active Screens

If more than one screen is activated during any one program scan, the *last processed* screen is displayed. This happens in the following code:

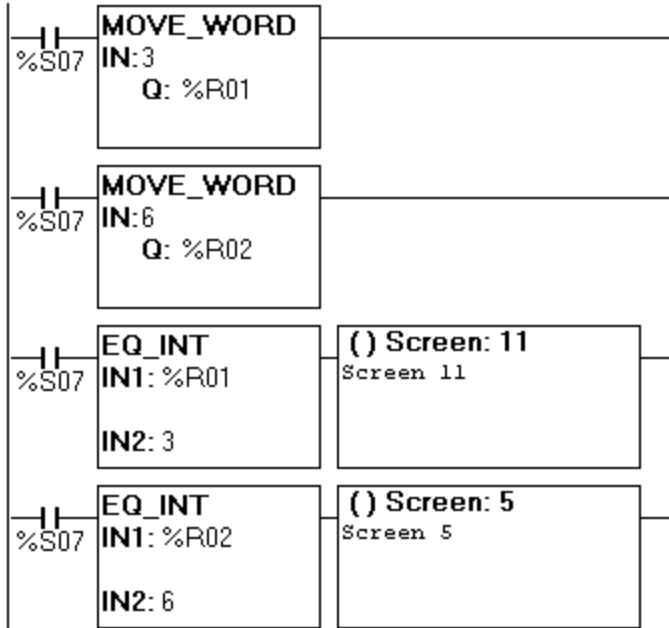

#### MULTIPLE ACTIVE SCREENS

In this case, both Screen 11 and Screen 5 are active, but Screen 5 is displayed, because it is the *last* screen processed in the scan of this logic.

This situation is *not* wrong logically or syntactically, so no errors are reported during compile or run. It is the programmer's responsibility to determine if this situation is acceptable or provide corrective action if necessary.

## 2.5 Logic (Bitwise) Operator Elements

### 2.5.1 General

**NOTE:** Bitwise Elements (AND, OR, etc.) operate on WORDS (string of 16 bits) or DWORDS (string of 32 bits).

When using constants with Bitwise elements, enter them as 16 or 32-bit UNSIGNED values. Operations are performed on the *bit patterns* of the register. After the operation, the results are stored in a third result register. Neither input is changed.

### 2.5.2 Power Flow Through the Element

These elements are always TRUE. Power always passes through these elements without dependency on the output value.



### 2.5.3 Configuring Logic Elements

To configure the element, double click it, and then enter the **Register Type and Offset** (address) for both input registers and the output register. Three (3) registers are required for proper operation of these elements: **IN1**, **IN2**, and **Q** (result) except the **NOT** function, which requires only one input and one output register.

Either input can be an unsigned WORD or DWORD constant, **1**, **23056**, **45**, etc. In fact, *both* inputs can be constants

The **Q** (result) register *must* be specified using **Register Type and Offset**

These functions can operate on either 16-bit integer values or 32-bit value. From the **Type** drop-down list, select either **Word** (16-bit) or **DWord** (32-bit). Both values must be of the same data type, WORD or DWORD.

**NOTE:** It is not possible to use both a 16-bit register and a 32-bit register in the same element..

In most cases these elements operate on registers capable of holding **Word** or **Dword** values such as **%R** or **%AI**. It is possible, however, to use discrete (**Boolean**) points by specifying a Register Type and Offset such as **%Q17**. The Offset used must be on a 16-bit boundary **1**, **17**, **33**, etc.

#### AND

This element performs a bit-wise AND on two registers and places the output in a third.

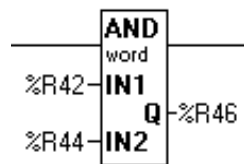

**BITWISE AND**

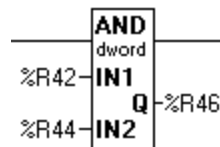

**BITWISE AND DWORD**

For example,

```
%R41 = 0000000000000111 ( 7 )
AND   %R42 = 0000000000001010 (10 )
RESULT %R43 = 0000000000000010 ( 2 )
```

**OR**

This element performs a bit-wise OR between two registers, and places the output in a third.

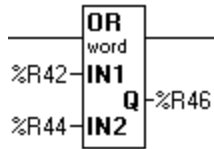

**BITWISE OR**

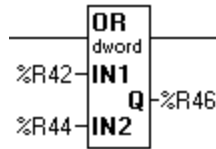

**OR DWORD**

```

%R41 = 0000000000000111 ( 7)
OR    %R42 = 0000000000001010 (10)
RESULT %R43 = 0000000000001111 (15)
    
```

**NOT**

This element performs a bit-wise NOT on a single register and places the output in a second register.

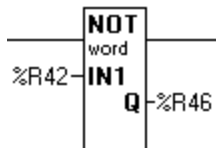

**BITWISE NOT**

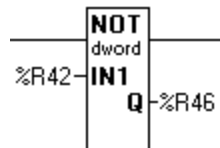

**NOT DWORD**

```

%R41 = 0000000000001010 (10)
NOT   %R43 = 1111111111110101 (65525 (unsigned) or -11(signed))
    
```

**EXCLUSIVE OR**

This element performs a bit-wise EXCLUSIVE OR between two registers and places the output in a third.



**BITWISE XOR**

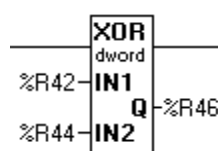

**XOR DWORD**

```

%R41 = 0000000011111111 (255)
XOR   %R42 = 0000000010100101 (165)
RESULT %R43 = 000000001011010 (90)
    
```

## 2.6 Math Operations

**NOTE:** The Math Operations work on INT (16-bit) or DINT (32-bit) SIGNED integer values and REAL (floating-point) values.

### 2.6.1 Performance

**INT** (16-bit) and **DINT** (32-bit) operations are very close to each other in performance and can be used interchangeably without noticeably affecting the OCS's performance.

REAL (floating point) operations always take more time to execute and can be *significantly* slower than the INT or DINT counterpart. Try to keep values in INT or DINT format whenever possible and for as long as possible.

For example, temperatures are often measured using a thermocouple, whose values are converted to binary form by a Thermocouple Interface SmartStack module. The value obtained from the Thermocouple Interface module is always in INT (16-bit) format, even though it represents a fractional number of degrees. The first thought is to convert the binary value to its Real value (degrees and fractions of degree). However, it is more likely that any necessary mathematical operations can be written to use this raw value (saving any conversion to a Real value) (if and when the value is displayed to the user).

Power flow through these elements is ON or TRUE if the element completes properly. Power Flow is OFF or FALSE if an error occurs such as overflow, underflow, divide by zero.

### 2.6.2 Configuring Math Operation Elements

To configure the element, double click it, and then enter the **Register Type and Offset** (address) for both input registers and the output register. Three (3) registers are required for proper operation of these Math Elements. Either **IN1** or **IN2** or both can be signed constants. **Q** *must* be a register reference.

In the **Type** box select either INT (16-bit), DINT (32-bit) or REAL (32-bit) operations. For INT operation, only single 16-bit registers (**%R43**, **%AI02**, etc) are affected. For DINT (32-bit) and REAL (32-bit) operations, registers are accessed in 32-bit pairs, **%R43 and %R44**, etc.

**NOTE:** Both inputs and the output must be of the same type, INT, DINT, or REAL.

### 2.6.3 Math Operations

#### ADD

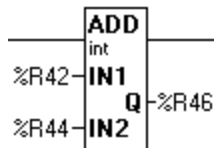

**INTEGER ADD**

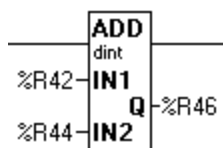

**DINT ADD**

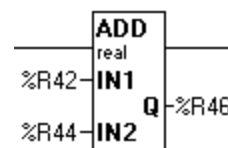

**REAL ADD**

This element adds **IN1** and **IN2**, and places the result in **Q**.

$$Q = IN1 + IN2$$

**Subtract**

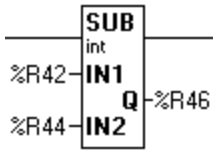

**INTEGER  
SUBTRACT**

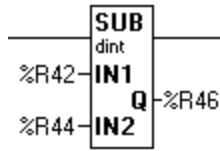

**DINT  
SUBTRACT**

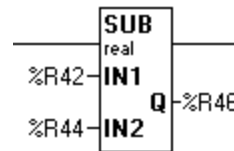

**REAL  
SUBTRACT**

This element subtracts **IN2** from **IN1** and places the results in **Q**.  
 $Q = IN1 - IN2$

**Multiply**

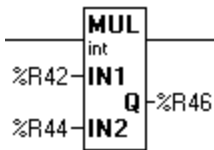

**INTEGER MULTIPLY**

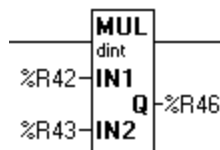

**DINT MULTIPLY**

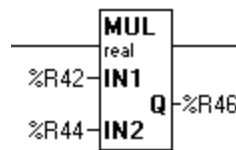

**REAL MULTIPLY**

This element multiplies **IN1** and **IN2** and places the results in **Q**.  
 $Q = IN1 * IN2$

**Divide**

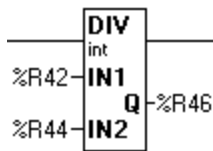

**ELEMENT INTEGER DIVIDE**

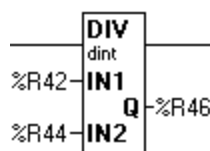

**ELEMENT DINT DIVIDE**

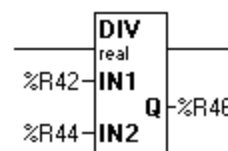

**ELEMENT REAL DIVIDE**

This element divides **IN1** by **IN2** and places the result in **Q**.  
 $Q = IN1 / IN2$

If the values are INT or DINT, any remainder is lost. For example, given the **IN2** value of 5, the following is a table of some Integer Divide values:

IN1	IN2	Q
10	5	2
11	5	2
12	5	2
13	5	2
14	5	2
15	5	3
16	5	3
17	5	3
18	5	3
19	5	3
20	5	4
21	5	4
22	5	4
23	5	4
24	5	4
25	5	5

MOD (modulo)

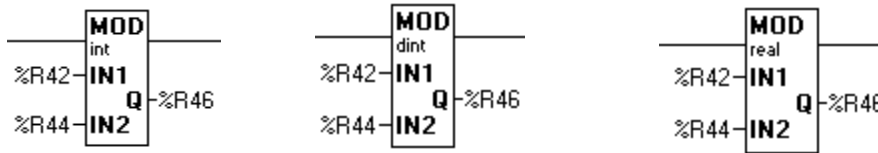

INTEGER MOD      ELEMENT DINT MOD      ELEMENT REAL MODULO

This element divides **IN1** by **IN2** (the modulus) and places the remainder in **Q**.  
**Q = remainder(IN1 / IN2)**

For example, given the **IN2** value of 5, the following is a table of some modulo values:

IN1	IN2	Q
0	5	0
1	5	1
2	5	2
3	5	3
4	5	4
5	5	0
6	5	1
7	5	2
8	5	3
9	5	4
10	5	0
11	5	1
12	5	2
13	5	3
14	5	4
15	5	0

Performing the Modulo function on Real Numbers can appear to behave strangely if the internal workings are not understood. For example,  $3.12 \text{ MOD } 2.1 = 1.02$ . This can be better illustrated using long division:

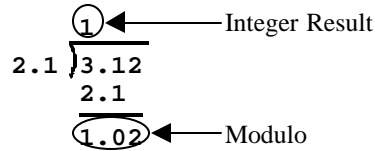

**Square Root**

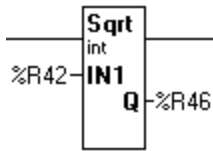

**INTEGER SQRT**

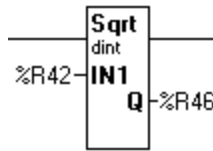

**DINT SQRT**

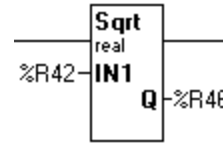

**REAL SQUARE ROOT**

This element figures the square root of the value in IN1 and places the result in Q.  
 $Q = \text{SQR}(IN1)$

This element has its primary use with REAL data types. This element *does* work with INT (16-bit) or DINT (32-bit) data, but the results of the square root function are seldom integers. The result placed in Q is truncated to the integer value.

IN1	Actual	Q
0	0	0
1	1.000	1
2	1.414	1
3	1.73	1
4	2.000	2
5	2.236	2
6	2.449	2
7	2.645	2
8	2.828	2
9	3.000	3
10	3.162	3
11	3.316	3
12	3.464	3
13	3.605	3
14	3.741	3
15	3.872	3
16	4.000	4

**Absolute Value**

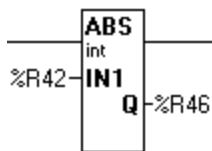

**ABS**

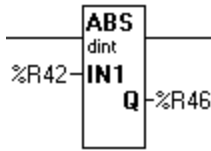

**DINT ABS**

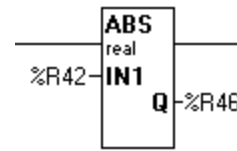

**REAL ABS**

This element takes the value of **IN1** strips off the sign, and places the results in **Q**.

$$Q = ABS(IN1)$$

The result is always positive.

#### 2.6.4 Advanced Math Operations

**NOTE:** The Advanced Math functions operate on REAL (floating point) numbers only.

#### Radians

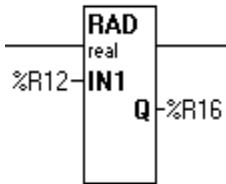

#### RADIANS

The value **IN1** is converted from DEGREES to RADIANS, and the result placed into **Q**. **IN1** is expressed in DEGREES. **Q** is expressed in RADIANS.

$$Q = RAD(IN1)$$

#### Degrees

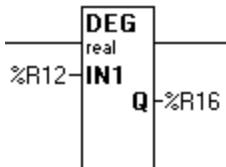

#### DEGREES

The value **IN1** is converted from RADIANS to DEGREES, and the result placed into **Q**. Input values are expressed in RADIANS. Output values are expressed in DEGREES.

$$Q = DEG(IN1)$$

#### Sine

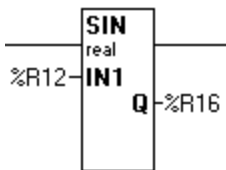

#### SINE

The SINE of the value **IN1** is placed into **Q**. Values in **IN1** are expressed in RADIANS. Output values range from -1 to +1.

$$Q = SIN(IN1)$$

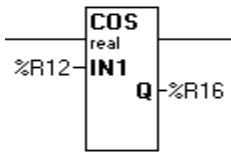
**Cosine****COSINE**

The COSINE of the value **IN1** is placed into **Q**. Values in **IN1** are expressed in RADIANS. Output values range from -1 to +1.

$$Q = \text{COSIN}(\text{IN1})$$

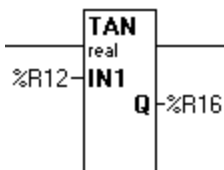
**Tangent****TANGENT**

The TANGENT of the value **IN1** is placed into **Q**. Values in **IN1** are expressed in RADIANS.

$$Q = \text{TAN}(\text{IN1})$$

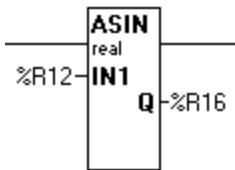
**Arc Sine****ARC SINE**

The ARC SINE of the value **IN1** is placed into **Q**. Input values must be in the range -1 to +1. Output values are expressed in RADIANS.

$$Q = \text{ASIN}(\text{IN1})$$

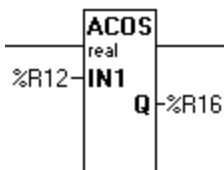
**Arc Cosine****ARC COSINE**

The ARC COSINE of the value **IN1** is placed into **Q**. Input values must be in the range -1 to +1. Output values are expressed in RADIANS.

$$Q = \text{ACOSIN}(\text{IN1})$$



### Arc Tangent

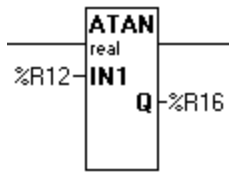

#### ARC TANGENT

The ARC TANGENT of the value **IN1** is placed into **Q**. Output values are expressed in RADIANS.

$$Q = \text{ATAN}(\text{IN1})$$

### Exponentiate

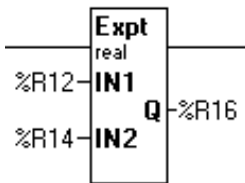

#### EXPONENTIATE

This function raises **IN1** to the **IN2** power and places the result in **Q**.

$$Q = \text{IN1}^{\text{IN2}}$$

### Common Logarithm

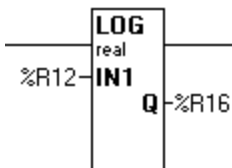

#### ELEMENT LOG.

This function determines the common (base 10) logarithm of **IN1** and places that value into **Q**.

$$Q = \text{LOG}(\text{IN1})$$

### Exponent

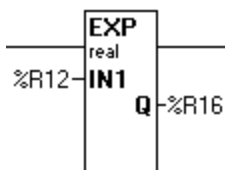

#### EXPONENT

This function determines the value of *e* (the base of natural logarithms) raised to the **IN1** power and places the result in **Q**.

$$Q = e^{\text{IN1}}$$

## Natural Logarithm

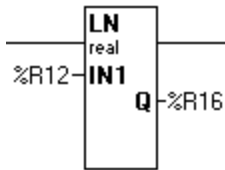

### ELEMENT LN

This function determines the natural log of **IN1** and places the result in **Q**.

$$Q = \text{LN}(\text{IN1})$$

## Scaling

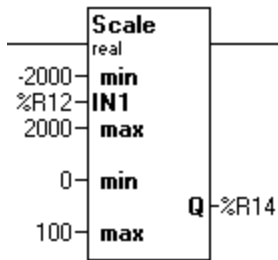

### SCALING

**Note:** Scaling works only with INT and Floating Point (real) numbers. If Double Integer values are used it is necessary to convert inputs to Real format before scaling and possibly convert the scaled value back to Double Integer.

Cases often arise when numbers on one scale need to be translated to another scale. For example, the raw output of a level transmitter needs to be converted into a 0-to-100-percent scale. Doing so is called **scaling**.

In the Scaling Element configuration dialog, select a **Register Type and Offset** reference or select a Named Variable that is the raw Input Value.

The Minimum and Maximum Ranges indicated the expected or nominal values that the Input can be expected to attain. This is the range of values that corresponds to the expected output range. Select **Register Type and** reference or select a Named Variable that is the Output Value.

The Minimum and Maximum Ranges indicate the range of value that the Input signal is converted to.

For example, suppose that one is monitoring the fill level of a tank of liquid. This device sends back raw data that ranges from -5000 (empty) to +5000 (full). The values are to be converted to a range of 0 (zero) to 100 percent. Configure the element thus:

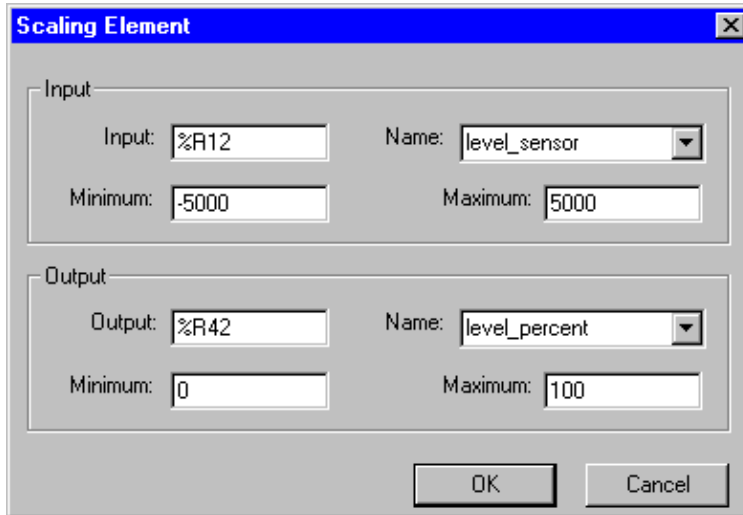

EXAMPLE SCALING ELEMENT

## 2.7 Math Equation Element

**NOTE:** The Math Equation element operates on 16-bit SIGNED Integers 32-bit SIGNED integers or 32-bit REAL numbers

### 2.7.1 Useful Math Feature of Cscape

**Cscape** contains a feature to allow potentially complicated math operations to be expressed in standard mathematical notation and then be performed in a single program element. This can reduce or eliminate many program rungs which makes the resulting program simpler to write and easier to understand.

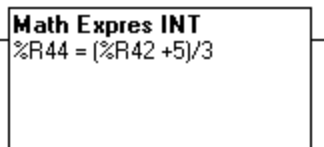

MATH EXPRESSION

### 2.7.2 Power Flow Through the Element

Power flow through the element is ON or TRUE if the equation is solved successfully. If any math error occurs (e.g., divide by zero), the power flow through the element is OFF or FALSE.

If any math error occurs, the value placed into the left side of the equation is invalid.

### 2.7.3 Configuring Math Equations

To configure a math equation, double click on the element, and then type in the desired equation in the format:

[result] = [equation]  
 [result] must be a register, typically %R.  
 = is a REQUIRED equal sign.  
 [equation] is the equation to be performed.

The TOTAL length of the equation string is limited to 80 characters. This includes the result location specification and equal sign (%R5 = ) and the equation itself.

The *complete* equation can be configured to use either **INT** (16-bit), **DINT** (32-bit) or **REAL** values. Note that *all references* in the equation are of the type selected.

**NOTE:** It is not possible to mix INT (16-bit), DINT (32-bit) or REAL values in the same equation.

**NOTE:** Multiplication must be explicitly shown. %R4 = 4(%R1 + 4) is NOT valid. It must be expressed as %R4 = 4 \* (%R1 + 4).

### 2.7.4 Typing Shortcut

In order to save typing time and to reduce the possibilities of typing errors, available operations are selected from the **More** menu .

First, place the cursor in the equation at the point where an operation is to appear, and then click the **More** button . A pop up menu appears:

Add	+
Subtract	-
Multiply	*
Divide	/
Modulo	MOD
Square Root	SQRT()
Absolute Value	ABS()

#### MENU MORE POPUP

After the operation is inserted, move the cursor into position to edit the operation, if necessary.

### 2.7.5 Register Designation

The result of the equation *must* be placed in a register. Typically, this is a %R, although other registers (%AQ...) can be used. The size of the register, 16- or 32-bits, is determined by the setting of the **Type** box. 16- or 32-bit groups of Boolean registers (e.g., referencing %Q17, thus specifying register %Q17 - %Q32) can also be used.

The register can be specified using either its **predefined name** or the **type** and **offset** of the register:

```
Temp_Result = [equation]
%R10 = [equation]
```

**NOTE:** Since Names are valid, Register Types *must* be preceded with % (percent sign) in order for them to be properly recognized as register references.

### 2.7.6 Numeric Constants

Numeric constants may be used by simply entering them:

```
(* This element converts readings
   from Centigrade to Fahrenheit *)
%R22 = (%R15 * (9/5)) + 32
```

**Warning:** If INT or DINT math is performed, this equation may not produce the expected results.

### 2.7.7 Operators

Equations are entered in standard mathematical format. The expected orders of precedence are used:

```
ABS()           Highest
SQRT()
LOG()
EXP()
LN()
SIN()
COS()
TAN()
ASIN()
ACOS()
ATAN()
DEG()
RAD()
EXPT
* (multiply)
/ (divide)
MOD
+ (add)
- (subtract)
=               Lowest
```

Operational order can be changed by using parenthesis ( ). Nested parenthesis ( ( ) ) may be as deep as necessary, provided the 80 character limit of the equation string is not exceeded.

For example, the following math equation is valid:

$$\%R22 = (\%R15 * \%R16) + (\%R15 / \%R16)$$

If %R15 contains 25 and %R16 contains 5, then %R22 contains 130 after the element is completed.

## 2.8 Compare Elements

**NOTE:** Compare Elements (EQ\_INT, etc.) operate on unsigned BYTE (8-bit) values 0 to +255, Signed Integer (16-bit) values, -32768 to +32767, Signed Double Integer (32-bit) values, -2147483648 to +2147483647, or Floating Point values, +/-3.40282e-38 to +/-3.40282e+38.

### 2.8.1 General

Compare Elements take the values of two BYTE (8-bit), Integer (16-bit) SIGNED values, Double Integer (32-bit) SIGNED values or Floating Point (32-bit) values and performs a comparison on the two values in the form `IN1[comparison]IN2`, such as `IN1<IN2`.

### 2.8.2 Power Flow Through the Element

When the comparison is TRUE, power is passed through the element to its output, which can be used to set or clear an indicator coil. For example:

Given:	Comparison	Power Flower
IN1 = 6    IN2 = 3	IN1 > IN2	TRUE
IN1 = 6    IN2 = 3	IN1 < IN2	FALSE
IN1 = 6    IN2 = 3	IN1 = IN2	FALSE
IN1 = 3    IN2 = 6	IN1 > IN2	FALSE
IN1 = 3    IN2 = 6	IN1 < IN2	TRUE
IN1 = 3    IN2 = 6	IN1 = IN2	FALSE

### 2.8.3 Configuring Compare Element

To configure the element, double click it, and then enter the Register Type and (address) for both inputs. Either input can be a BYTE integer, double integer or real constant, (1,23056, 4.23e+5 etc). In fact, *both* inputs can be constants, but the result of the comparison would be a fixed TRUE or FALSE.

From the **Type** drop-down list select either BYTE (8-bit) INT (16-bit) or DINT (32-bit). Both values and the result must be of the same data type, BYTE, Integer, Double Integer, or Real.

**NOTE:** It is not possible to mix register types; 16-bit integer, 32-bit double integer, or 32-bit floating-point (real).

In most cases, these elements operate on registers capable of holding INT or DINT values such as %R or %AI. It is possible, however, to use discrete Boolean points by specifying a Register Type and Offset such as %Q17. The Offset used must be on a 16-bit boundary (1, 17, 33, etc). When the configuration is complete, the element indicates whether INT, DINT or values are used.

**EQUAL**

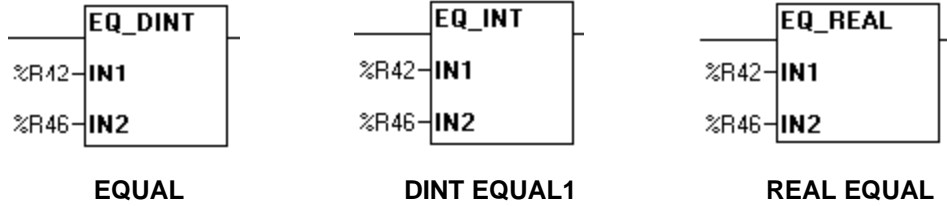

The EQUAL element compares two values, and passes power when the two values are equal in value. The values can be constants or register type and offsets.

**NOT EQUAL**

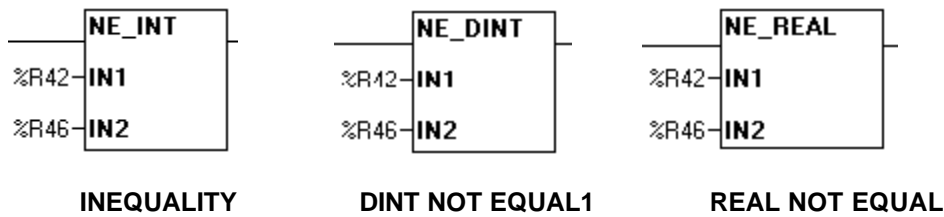

The NOT EQUAL element compares two values and passes power when the two values are not equal in value. The values can be constants or register type and offsets.

**LESS THAN**

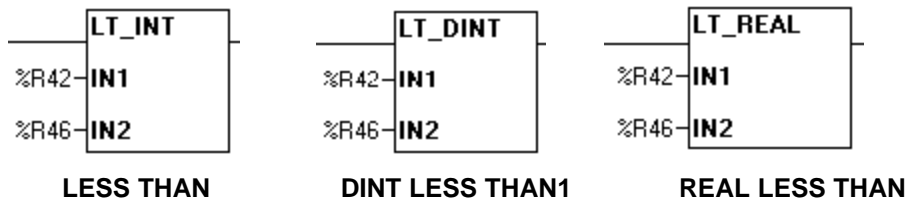

The LESS THAN element compares two values and passes power when IN1 is less than IN2. The values can be constants or register type and offsets.

**GREATER THAN**

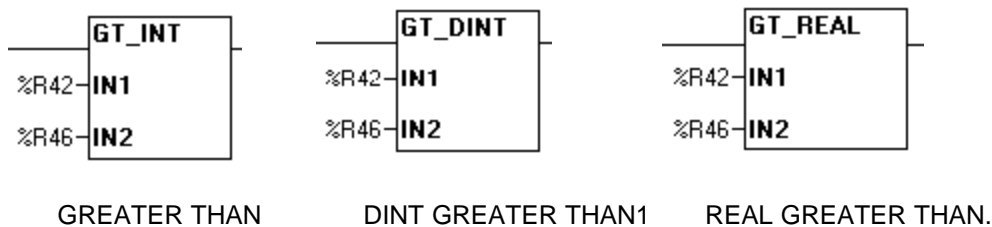

The GREATER THAN element compares two values and passes power when IN1 is greater than IN2. The values can be constant or register type and offsets.

**LESS THAN OR EQUAL**



**LESS THAN OR EQUAL    DINT LESS THAN EQUAL1    REAL LESS THAN EQUAL**

The LESS THAN OR EQUAL TO element compares two values and passes power when **IN1** is less than or equal to **IN2**. The values can be constant or register type and offsets.

**GREATER THAN OR EQUAL**

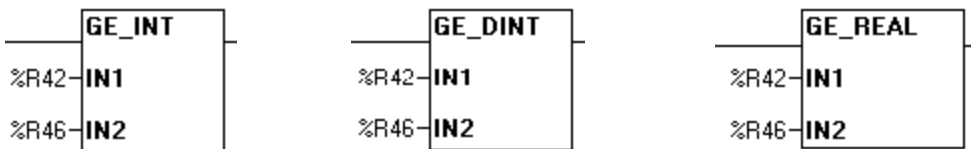

**GREATER THAN DINT OR EQUAL    GREATER THAN EQUAL1    REAL GREATER THAN EQUAL**

The GREATER THAN OR EQUAL TO element compares two values and passes power when **IN1** is greater than or equal to **IN2**. The values can be constant or register type and offsets.

**LIMIT**

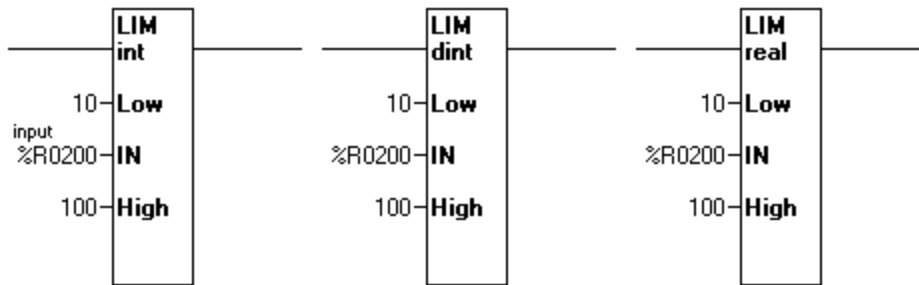

**Limit Function**



This functions determines if an input(IN) values is numerically in the range defined by the Low and High.

**IN** - This defines the **Register Type and Offset** (address) for comparison.

**Low** - This is either a constant or a **Register Type and Offset** (address) for the lower limit of comparison.

**High** - This is either a constant or a **Register Type and Offset** (address) for the upper limit of comparison.

**If Low <= High:**

This function passes power if the input is **inside** the range between Low and High (inclusive).

For example, if Low = 10 and High = 100 when the INPUT is between 10 and 100 the function passes power. If the input is 9 or lower OR 101 or higher this function would **not** pass power.

**If Low > High:**

This function passes power if the input is **outside** the range between Low and High (inclusive).

For example, if Low = 100 and High = 10 when the INPUT is between 11 and 99 the function does **not** pass power. If the input is 10 or lower OR 100 or higher this function will pass power.

**2.9 Program Control Jump, Label, Call, Return and End Elements :**

*2.9.1 Label Element*



A label allows a position in the ladder program to be named. This name can be used with a JUMP or CALL instruction to cause program execution to change from one section to another.

Note: There can only be one label with a particular label name in a program. Labels can be inserted without matching jumps, but a jump must be matched with a label.

### 2.9.2 Jump Element

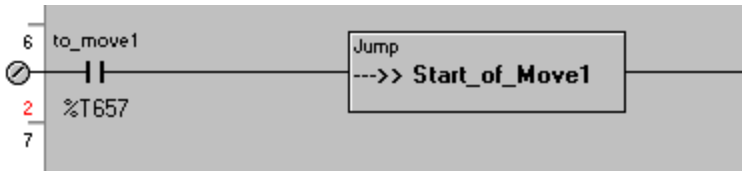

Use the JUMP element to cause a portion of the logic to be bypassed. The JUMP can be either a forward or a backward JUMP. Logic execution will continue at the LABEL specified.

When the JUMP is active all coils within its scope are frozen. This includes coils associated with timers, counters, relays...

No elements can be placed after the jump element. When the jump is active program execution jumps directly from the jump element to the associated label.

Note: To avoid creating an endless loop with backward JUMP elements, a backwards JUMP must contain a way to make it conditional.

To find the associated label, right-click on a Jump or Call:

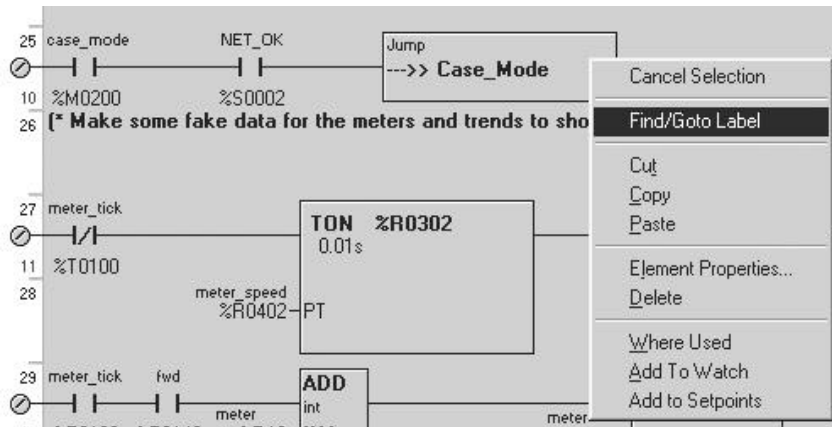

2.9.3 Call Element



Use the CALL element to call a subroutine. If power flow into the CALL is on, execution will move to the portion of ladder defined by a LABEL. When a RETURN element is executed in the subroutine, the execution will resume on the rung following the CALL element. You can nest (calling a subroutine inside a subroutine) up to 8 levels deep. If more than 8 levels of nesting are attempted, the controller will stop and the logic error flag in the diagnostics will be set. No elements can be placed after a CALL element.

Example:

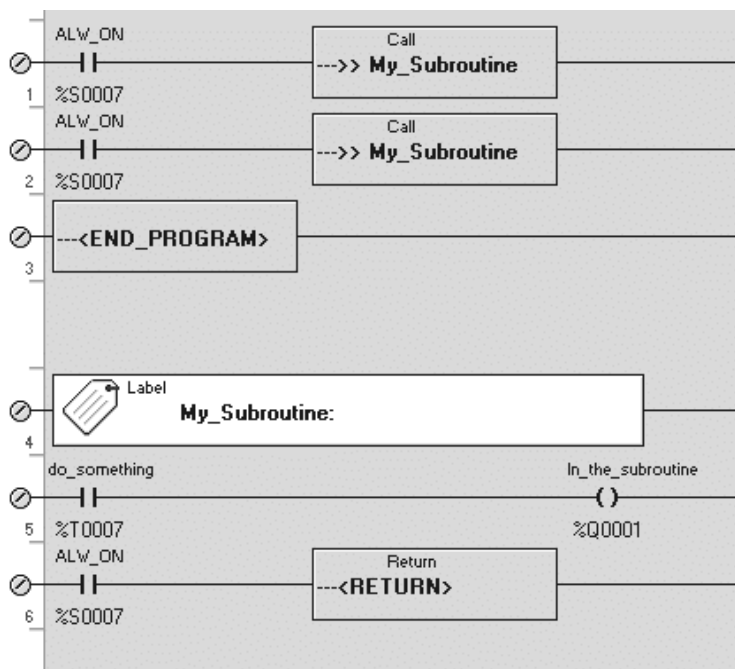

1. Start on rung 1, CALL the subroutine.
2. Execute first line of subroutine, rung 5 (rung 4 is only a LABEL indicating the start of a section).
3. Execute rung 6, the RETURN causes execution to start on the rung after the last CALL, rung 2.
4. Execute rung 2, CALL the subroutine again.
5. Execute first line of subroutine, rung 5 (rung 4 is only a LABEL indicating the start of a section).
6. Execute rung 6, the RETURN causes execution to start on the rung after the last CALL, rung 3.
7. Execute rung 3, END PROGRAM ends this scan. After I/O and other processing start over at rung 1.

### 2.9.4 Return Element



Use the RETURN element to return from a subroutine call. If power flow is enabled, this will return ladder execution to the rung following the last CALL. If a RETURN is executed without a CALL, the controller will stop and the Logic Error diagnostic flag will be set. No elements can be placed after a RETURN element.

### 2.9.5 End Program Element



Use this element to end the program scan. This element does not need a contact before it. When this element is executed the scan is immediately finished, I/O is read, other housekeeping is performed and another scan is started. This can be used to separate a main section of ladder from subroutines as seen in the example above, or can be used to temporarily disable a portion of the ladder program for testing.

## 2.10 Conversion Elements

### 2.10.1 General

Conversion elements are included to provide an easy method to convert between different data types. The primary data types are **INT** (16-bit), **DINT** (32-bit), and **REAL** (32-bit). Conversions are necessary, for example, when an analog input value needs to be converted from Double Integer type to Real type before engineering unit (EU) formulas are applied.

**NOTE:** Numeric constants are not allowed in either the Source nor Destination fields.

### 2.10.2 Caveats of Conversion

Conversion is made by value - not storage size. All **INT** values can be converted to **DINT** or **REAL**. Some **DINT** (32-bit) values can be successfully converted to **INT** (16-bit) format. Some **REAL** (32-bit) values can be converted to **DINT** (32-bit) or **INT** (16-bit).

**NOTE:** It is the programmers responsibility to ensure that all expected values fit into the destination register's size and format.

In some cases, precision can be lost. If, for example, when converting a **DINT** to **REAL** the **DINT** contains 7 digits ("2123789") the **REAL** value is truncated to the six-digit precision used by Real Numbers ("2.12378E+06").

Data can be lost. When converting **REAL** to **INT** or **DINT**, any fractional part of the number is rounded. (REAL)1.23654E+02 = (INT)124.

Such losses are NOT considered errors. The element continues to function normally, but downstream elements, which depend on these values, can not produce the expected results.

It is an error to attempt to convert a large number into a type, which can contain that number. This occurs most often when converting DINT to INT but can also occur when converting REAL to either INT or DINT.

If this overflow occurs there is no power flow through the element, and the result is undefined.

### 2.10.3 Configuring Conversion Elements

#### INTEGER TO REAL

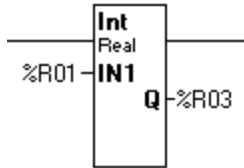

#### Conversion Int To Real

This converts the INT (16-bit) value in IN1 to a REAL (32-bit) value in Q. Note that IN1 is a 16-bit value and Q is a 32-bit value.

#### DOUBLE INTEGER TO REAL

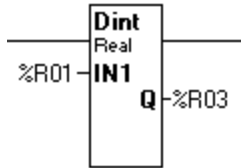

#### Conversion Dint To Real

This converts the DINT (32-bit) value in IN1 to a REAL (32-bit) value in Q. Note that IN1 is a 32-bit value and Q is a 32-bit value.

#### REAL TO INTEGER

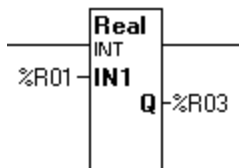

#### Conversion Real To Int

This converts the REAL (32-bit) value in IN1 to a INT (16-bit) value in Q. Note that IN1 is a 32-bit value and Q is a 16-bit value.

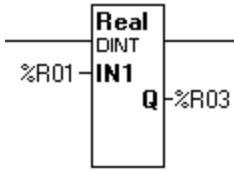
**REAL TO DOUBLE INTEGER****Conversion Real To Dint**

This converts the `REAL` (32-bit) value in `IN1` to a `DINT` (32-bit) value in `Q`. Note that `IN1` is a 32-bit value and `Q` is a 32-bit value.

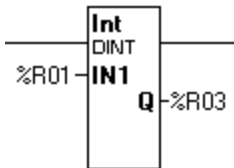
**INTEGER TO DOUBLE INTEGER****Conversion Int To Dint**

This converts the `INT` (16-bit) value in `IN1` to a `DINT` (32-bit) value in `Q`. Note that `IN1` is a 16-bit value and `Q` is a 32-bit value.

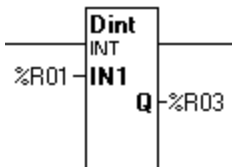
**DOUBLE INTEGER TO INTEGER****Conversion Dint To Int**

This converts the `DINT` (32-bit) value in `IN1` to a `INT` (16-bit) value in `Q`. Note that `IN1` is a 32-bit value and `Q` is a 16-bit value.

## 2.11 Timer and Counters

The timers and counters are control register based. Each element **requires two (2)** consecutive registers.

### Configuring Timer Elements

To configure the element, double click it, and then select the proper values from the configuration dialog box.

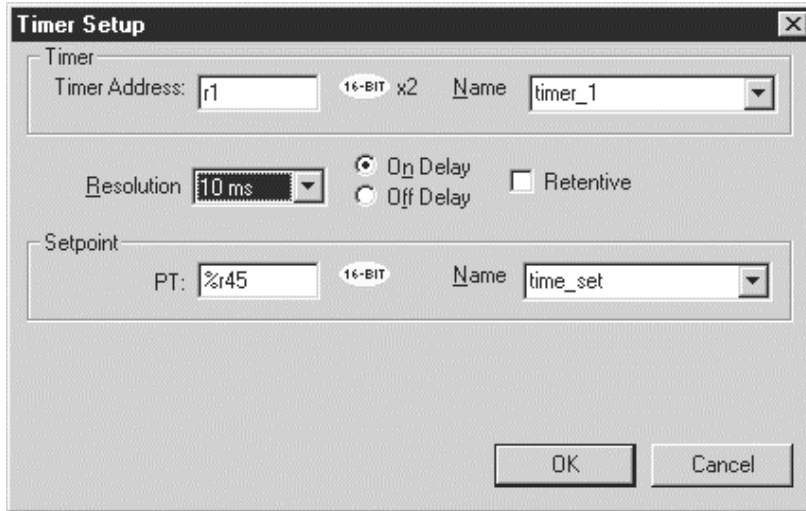

**Configuring Timer Elements**

**Timer Address** - Type in the **Register Type and Offset** to be used by this timer. Each timer requires two (2) consecutive addresses.

**PT (Setpoint)** - This is the timeout period expressed *in timebase units*. For example, if the resolution (timebase value) is 100 milliseconds and the timeout value is "20", the timeout period is 2000 milliseconds or 2 seconds. This entry can also use a Register reference.

**Resolution** - This is the timebase value. Use the drop-down list to select either 10 milliseconds or 100 milliseconds.

**On Delay/Off Delay** - This selects the action of the timer.

**Retentive** - Only the ON DELAY TIMER can be marked as retentive. **(Covered later in this section.)**

**Reset Input Address** - If the timer is **retentive**, this defines the **Register Type and Offset** used to reset the timer. This box appears only if the timer is retentive.

**Reset Input Name** - If the timer is **retentive**, this defines the Register used to reset the timer can be selected by name. This box appears only if the timer is retentive.

### Register Usage

Each Timer/Counter requires two (2) consecutive 16-bit registers (%R). They are arranged like so

%Rx	Accumulator		
%Rx+1	Power Bit 16	Enabled Bit 15	Reserved Bits 14 - 1

### On Delay Timer

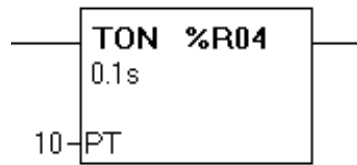

#### Timer On Delay

**Note:** Only the On Delay Timer is retentive. (When power flow is removed from the element, it does not clear the elapsed time.)

When power is supplied to the TON the output becomes inactive and the TON counts up to the preset value at a rate determined by the configured timebase. When the internal accumulator reaches the Preset Value, the output becomes active and counting stops.

When power is removed from the element, the TON resets to zero.



The timebase is user definable in 10mS or 100mS "ticks". When power is applied to the element, counting proceeds using this timebase.

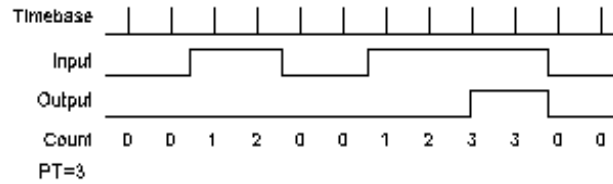

ON Delay Timer Diagram

Retentive On Delay Timer

A Retentive On Delay Timer is a special case of the "standard" On Delay Timer, but differs from the standard timer in that the Retentive Timer does *not* reset when the input is brought inactive (off). The Retentive Timer requires that a reset signal be applied to the element in order for the timer to be reset.

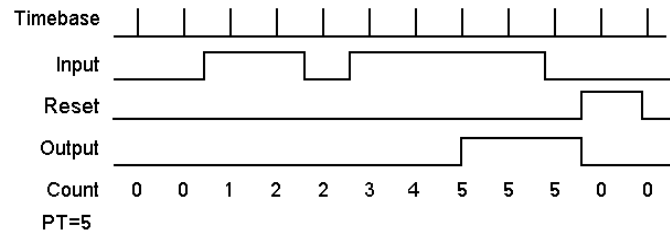

Retentive On Delay Timing Diagram

**Note:** Resetting the Retentive Timer requires the use of a contact under software control of the controller.

Since the Retentive Timer is retentive, any value appearing in registers assigned to the element can be invalid immediately after a down load. One approach is to reset the timer in combination with the First Scan bit:

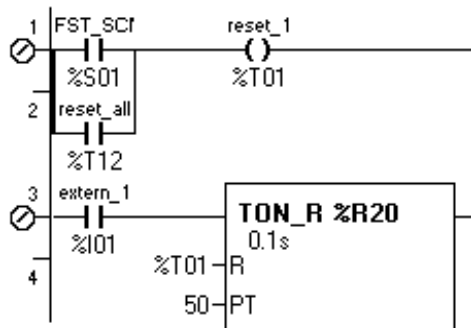

Example Reset Retentive Time

**Off Delay Timer**

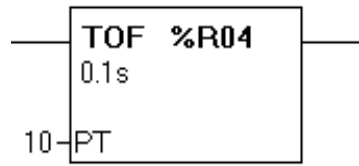

**Timer OFF Delay**

**NOTE:** Only the On Delay Timer may be retentive (when power flow is removed from the element it does not clear the elapsed time).

When power is removed from the TOF the output becomes active, and the TOF counts up to the preset value at a rate determined by the configured timebase. When the internal accumulator reaches the Preset Value, the output becomes inactive and counting stops.

When power is supplied to the element, the TOF resets to zero.

The timebase is user definable in 10mS or 100mS ticks. When power is applied to the element, counting proceeds at this timebase.

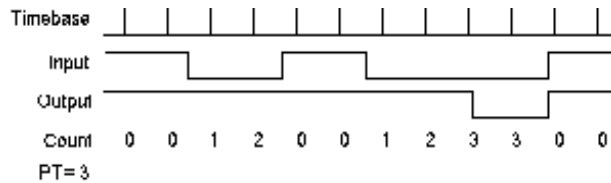

**OFF Delay Timing Diagram**

**Configuring Counter Elements**

To configure the element, double click it, and then select the proper values from the configuration dialog box.

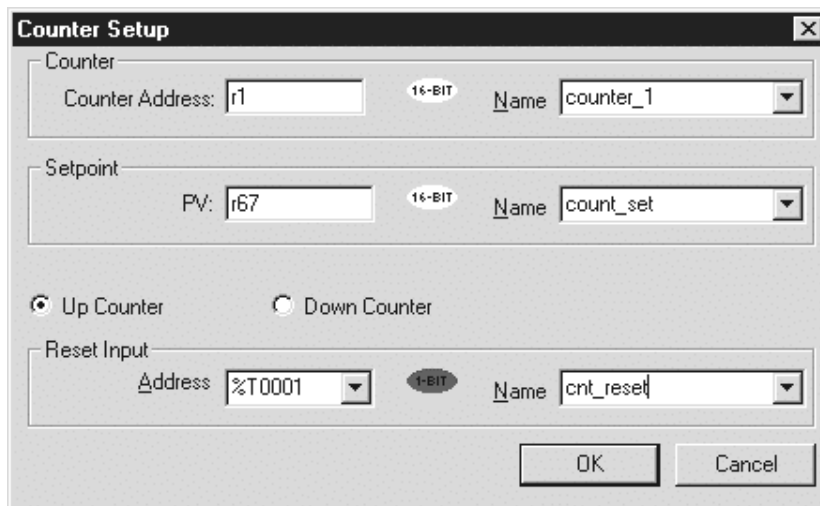

**Counter Setup**

**Counter Address** - Type in the **Register Type and Offset** to be used by this timer. Each counter requires two (2) consecutive addresses.

**PV (Setpoint)** - This is the **preset value** for the counter. When the counter reaches this value, its output becomes TRUE, thus passing power to any other elements on this rung.

**Up Counter/Down Counter** - This determines the direction of count - UP or DOWN.

**Reset Input Address** - This determines which point is used to reset the timer. This should be a **Boolean** point. In this box, select the **Register `Type and Offset**.

**Reset Input Name** - If the point used to reset the timer has **already been named** (highly recommended) one can select it by name rather than by Type and Offset.

**NOTE:** The Reset Input must be configured even if it is not used.

### Counter Operation

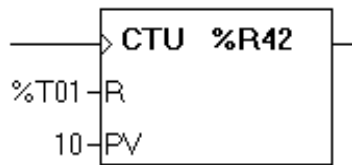

**Counter Operation**

The counter counts inactive-to-active transitions of its input power. When the count reaches some preset value, the output becomes active, but the counter continues to count input pulses. The Counter can be reset at any time by applying power to the Reset input.

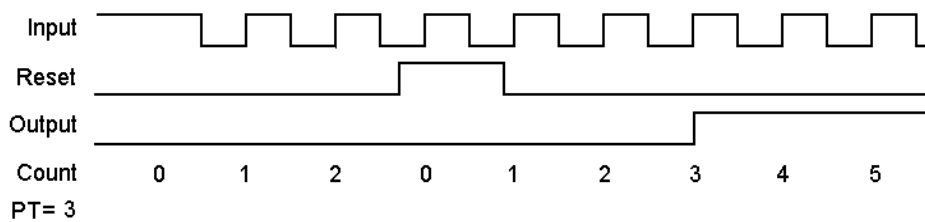

**Note:** The Reset Input must be configured even if it is not used.

## 2.12 Shift and Rotate Elements

**Note:** Shift and Rotate Elements operate on WORD Integer (16-bit) DWORDS.

### 2.12.1 General

Operations are performed on the *bit patterns* of the register. After the operation, the results are stored in a result register. The input register is not changed.

**Power flow through the SHIFT elements is determined by the *last* bit shifted out of the register. For example, if %R41 contains 21770 (0101010100001010) and the number of shifts is 4, then:**

Shift	Power Flow	Value
0	0	010101010000101 (unshifted)
1	0	101010100001010
2	0	010101000010100
3	0	101010000101000
4	1	010100001010000

The power output is determined after the last shift. Any preceding bits do not affect the power output and are lost.

Power flow through the ROTATE elements is always TRUE regardless of the state of the last bit rotated out.

### 2.12.2 Configuring Shift and Rotate Elements

To configure the element, double click it, and then enter the **Register Type and Offset** for the input register, the output register, and the shift count ("N").

Values for the Input and Shift Count ("N") can also be fixed INT or DINT values. The Output ("Q") *must* be a Register Reference (%R, etc).

These elements work on 16-bit or 32-bit registers.

**NOTE:** With a Shift Element referencing a Word register, a shift count (N) larger than 15 loads all bits in the register with 0. With a Rotate Element, a shift count (N) of 16 returns the value to its original state. With a Shift Element referencing a DWord register, a shift count (N) larger than 31 loads all bits in the register with 0. With a Rotate Element, a shift count (N) of 32 returns the value to its original state.

2.12.3 Shift vs. Rotate

The difference between the two functions is the use of the data that is shifted out.

In the SHIFT functions, shifted out data is lost, except for the bit shifted out during the final shift, which is then used as the power status of the element. This determines whether or not power is passed through the element. If a 0 bit is the last bit shifted out power is not passed through the element. If the last bit shifted out is 1 power *is* passed through the element.

SHIFT LEFT

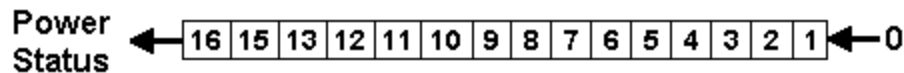

SHIFT LEFT

SHIFT RIGHT

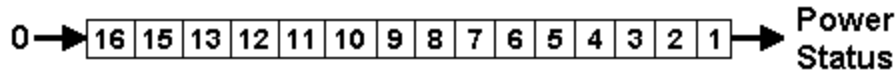

SHIFT RIGHT

In the ROTATE functions the shifted out data is re-circulated back to the other end of the data field. No data is lost. It is rotated into the other end of the field.

ROTATE LEFT

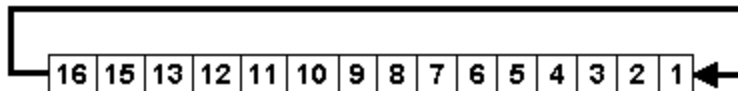

ROTATE LEFT

ROTATE RIGHT

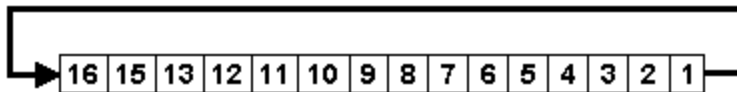

ROTATE RIGHT

**BITWISE SHIFT LEFT**

This element performs a LOGICAL SHIFT LEFT on the input register, and places the result in the output register. During the shift, **0** bits are shifted into the right end of the value. The value is shifted by **N** counts. Both **IN1** and **N** can be either register designation (**%R**, **%AI**, etc) or **integer** values (8, 23). **Q** must be a Register Offset Address.

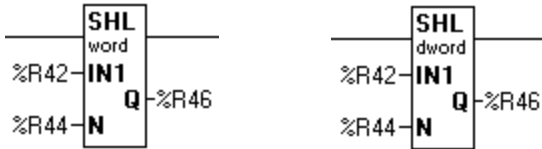
**BITWISE SHIFT LEFT****DWORD SHIFT LEFT**

```
%R41 = 0000000100010000 (544)
SHL 8 %R43 = 0001000000000000 (4096)
Power Flow = ON (TRUE)
```

**BITWISE SHIFT RIGHT**

This element performs a LOGICAL SHIFT RIGHT on the input register and places the result in the output register. During the shift, **0** bits are shifted into the left end of the value. The value is shifted by **N** counts. Both **IN1** and **N** can be either register designation (**%R**, **%AI**) or **integer** values (8, 23). **Q** must be a Register Offset Address.

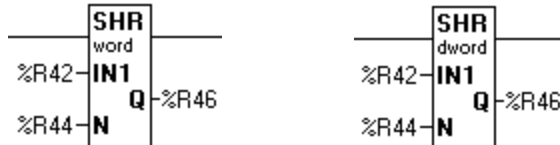
**BITWISE SHIFT RIGHT****DWORD SHIFT RIGHT**

```
%R41 = 1000000000000000 (32768)
SHR 8 %R43 = 0000000010000000 (128)
Power Flow = OFF (FALSE)
```

**BITWISE ROTATE LEFT**

This element performs a ROTATE LEFT on the input register, and places the result in the output register. During the shift, the "output bit" is returned to the first bit on the right end of the value. The value is shifted by N counts. Both IN1 and N may be either register designation (%R, %AI, etc) or integer values (8, 23, etc). Q must be a Register Offset Address.

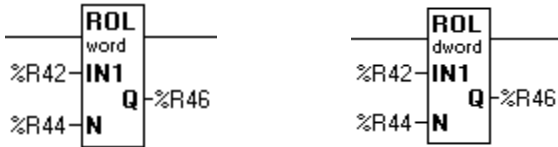

**BITWISE ROTATE LEFT      DWORD ROTATE LEFT**

```
%R41 = 1010010100111100 (42300)
ROL 11 %R43 = 1110010100101001 (58665)
```

**BITWISE ROTATE RIGHT**

This element performs a ROTATE RIGHT on the input register, and places the result in the output register. During the shift, the output bit is returned to the first bit on the left end of the value. The value is shifted by N counts. Both IN1 and N can be either register designation (%R, %AI) or integer values (8, 23). Q must be a Register Offset Address.

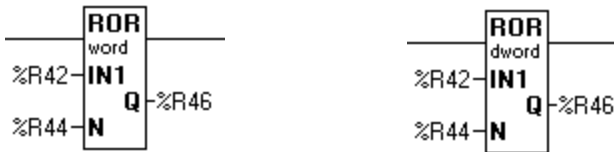

**BITWISE ROTATE RIGHT      DWORD ROTATE RIGHT**

```
%R41 = 1010010100111100 (42300)
SHR 11 %R43 = 1010011110010100 (42900)
```

**2.13 Data Move Elements**

*2.13.1 Single Data Moves*

Data Move elements allow the movement of data between registers (i.e, read an Analog Input [%AI]) and place it into a storage register, %R. Data Moves can also be used to move constant values into registers, move blocks of data from one location to another or to fill a block of registers with the same value.

The values in the source registers are not changed except if, during a Block Move or Block Fill element, the operation of the element overwrites the source register.

**a. Type Checking**

There is no type checking. Values are moved in a bit-wise fashion without regard to the type or polarity of the source nor destination. The Block Move instructions can be used to move WORD, DWORD or REAL value from source to destination. Note that each DWORD or REAL value moves two (2) WORD registers.

**b. Power Flow Through The Element**

Power flow through the element is always TRUE after the element completes.

The exception to this is the Indirect Move Element. In this case, the move is considered invalid and power flow is FALSE if either the source or destination register contains 0 (zero) or the length of the move exceeds the number of elements available in the controller.

**c. Configuring Data Move Elements**

To configure the element, double click it, and enter the element, double-click it, and enter the Register Type and Offset (address) for the input and output registers.

For the Register Move and Block Fill elements, a numeric constant can be specified as the **SOURCE**. In this case, the numeric value is placed into the output register. The **DESTINATION** *must* be specified using Register Type and Offset addressing.

For the Block Move element, **SOURCE** and **DESTINATION** must be Register type and Offset addresses. Neither can be a numeric constant. The **COUNT** value determines how many registers are moved or filled during the operation of this single element.

In the case of the Register Move instruction the Count value is fixed at 1. For the Block Move and Block Fill elements, the **COUNT** value can be a number in the range of 0 (zero) to the maximum number of registers of this type available in this controller. For %R registers in the OCS products, the upper limit is 2048.

For the Move Word element, selected the Data **Type** (**WORD**) or (**DWORD**) to be moved.

**SINGLE REGISTER MOVE**

**NOTE:** **Move\_Word** can operate on either 16-bit or 32-bit data, as selected by the user.

This moves either a register or register pair (32-bit) or a constant value into another register or register pair (32-bit).

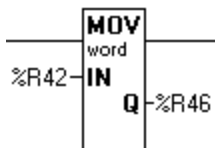
**a. MOVE WORD**



**b. MOVE DWORD**

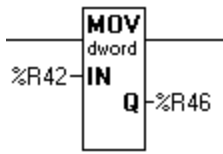

During configuration from the **Type** box, select either WORD (16-bit) or DWORD (32-bit). For example, if before the element is performed, the registers contain:

%R42	34567
%R43	12
%R44	63
%R45	127
%R46	82

After the element is finished, the registers contains

%R42	34567
%R43	12
%R44	63
%R45	127
%R46	34567

The **IN** value can also be configured as an unsigned numeric constant. For example if **IN** is configured as the value **1492**, register **%R46** contains the value **1492** after the element completes.

**WARNING:** If the **IN** value is a *signed* numeric constant, it is treated as an unsigned number when the element is configured. For example, if **IN** is configured as **-1**, the value **65535** is used.

For DWORD (32-bit) Moves, two sequential registers are effected. For example, if the value in **%R42** and **%R43** is **103582**, registers **%R44** and **%R45** contain the value **103582** after the element is completed.

**BLOCK REGISTER MOVE**

**NOTE:** The `Block_Move` element operates on 16-bit data *only*.

This element moves a block of registers from one location to another location.

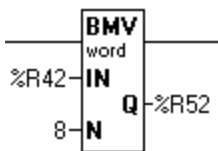

**BLOCK MOVE WORD**

**WARNING:** If the **IN** value is a *signed* numeric constant, it is treated as an unsigned number when the element is configured. For example, if **IN** is configured as **-1**, the value **65535** is used.

Using the above illustration as an example, if before the element is performed, the registers contain:

%R42	65535	%R50	0
%R44	65535	%R51	0
%R44	65535	%R52	0
%R45	65535	R53	0
%R46	65535	%R54	0
%R47	65535	%R55	0
%R48	65535	%R56	0
%R49	65535	%R57	0

After the element is finished the registers contain:

%R42	65535	%R50	65535
%R44	65535	%R51	65535
%R44	65535	%R52	65535
%R45	65535	%R53	65535
%R46	65535	%R54	65535
%R47	65535	%R55	65535
%R48	65535	%R56	0
%R49	65535	%R57	0

## INDIRECT MOVE

**NOTE:** The `Indirect_Move` element operates on 16-bit data *only*.

Operation of this element is similar to the `Block_Move` instruction. A block of data is moved from one location in memory to another.

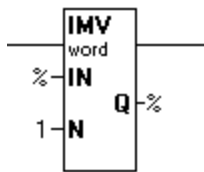

## MOVE INDIRECT

Refer to **Power Flow Through the Element**.

The difference, though, is how the element obtains the *address* of the source block (`IN`), the destination block (`Q`) or both. In this case, one has the option of specifying the address *directly* in **Register Type and Offset** format or *indirectly*.

With the *Indirect format*, the register specified contains the offset of the first `%R` register to be moved. In the case of the destination, the register contains the address or offset of the first `%R` register of the destination block.

**NOTE:** Indirect addressing uses *only* to `%R` registers. The *source* or *destination* register itself can be any register. Any register can be specified if the `INDIRECT` box is unchecked.

Either **IN**, **Q** or both can be *direct* or *indirect*. Constant values, however, are not allowed. For example, configure the element such that **IN** is %AI1, **Q** is %R12, and both indirect boxes are checked, and that four (4) words are to be moved. The configured element appears:

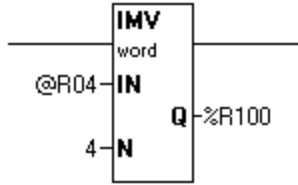

**INDIRECT MOVE**

Note the use of the special @ character indicating that the associated register is used as an indirect value.

When this element receives power, the value is taken from %AI1 and used as a pointer to the beginning of a block in %R registers. The value in %R12 is used as a pointer to the destination block in %R registers. Four (4) 16-bit words are moved.

In this example, if %AI1 contains "56" and %R12 contain "100", the following occurs. Note that only %R registers are effected because the Indirect box is checked for both source and destination. If before the move, the registers contain:

%AI1	56	%R12	100
%R55	123	%R99	1
%R56	45	%R100	2
%R57	28	%R101	3
%R58	20789	%R102	4
%R59	1	%R103	5
%R60	15	%R104	6

After move, the registers contain:

%AI1	56	%R12	100
%R55	123	%R99	1
%R56	45	%R100	45
%R57	28	%R101	28
%R58	20789	%R102	20789
%R59	1	%R103	1
%R60	15	%R104	6

**BLOCK FILL**

**NOTE:** The `Block_Fill` element operates on 16-bit data *only*.

This element fills a block of registers with a given value. The `IN` value can be either an integer constant or the value contained in another register.

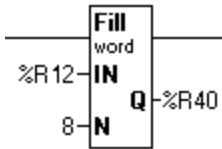
**BLOCK FILL**

**WARNING:** If the `IN` value is a *signed* numeric constant, it is treated as an unsigned number when the element is configured. For example, if `IN` is configured as '-1', the value '65535' is used.

Using the above illustration as an example, the registers contain the following before the move operation is performed:

%R12	1234
%R40	3221
%R41	4632
%R42	65535
%R43	32456
%R44	1
%R45	0
%R46	10
%R47	812
%R48	0
%R49	5

After the element is completed the registers contain:

%R12	1234
%R40	1234
%R41	1234
%R42	1234
%R43	1234
%R44	1234
%R45	1234
%R46	1234
%R47	1234
%R48	0
%R49	5

## MOVE CONSTANT

The Move Constant Data function allows a table of constants to be loaded into a group of consecutive controller registers. The table of constants can contain INT, UDINT, DINT, UDINT or REAL types. All entries in the table must be of the same type.

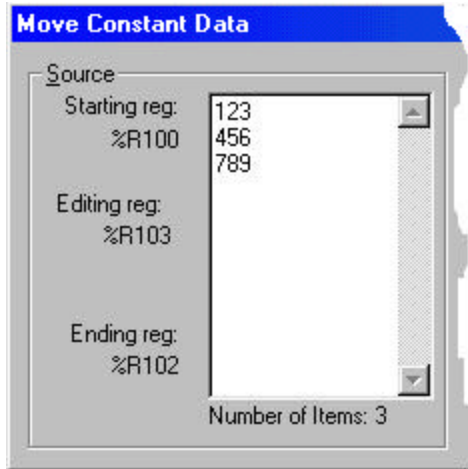

### CONST DATA

Assuming the following constant INT table:

**NOTE:** Constant data can be copied and pasted to/from other Windows application including Microsoft Excel and Word.

**NOTE:** REAL numbers less than zero must contain a leading zero (e.g., **.999** is valid, **0.999** is valid).

After the element is completed the registers contain:

%R100	123
%R101	456
%R102	789

## 2.13.2 Multi Data Moves

**MULTI SHIFT DATA MOVE**

This function allows an array of BITS, BYTES, WORDS, and DWORDS to be shifted left or right a variable numbers of elements.

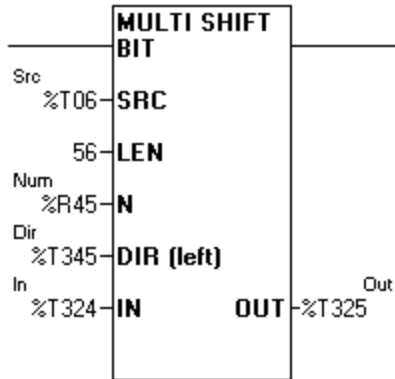
**MULTI SHIFT BIT****a. Power Flow**

When the input to this function block is high it completes a shift as specified by the parameters every scan. This function is not edge sensitive. This function always passes power flow.

**b. Multi Shift Move Terminology**

**SRC** - This is the starting BIT, BYTE, WORD or DWORD for the array to be shifted. After the data is shifted it is stored in the array of data starting at this location. BIT arrays can start at any location (%I1, %I6, %R1.1, and %R4.7...). BYTE, WORD, and DWORD arrays must start on a WORD boundary (%I1, %I17, %I33, %R1, and %R2...).

**LEN** - This is the number of BITS, BYTES, WORDS, or DWORDS in the array. This must be a constant number from 1 to 32767.

**N** - This is the number of elements to shift. This can be a constant or a WORD variable.

**DIR** - This is the direction to shift. If this input is high the data is shifted to the left. If this input is low the data is shifted to the right.

Examples:

BITS Left by 1: %T2 <- %T1 & T3 <- %T2...

BYTES Left by 1: %R1(high byte) <- %R1(low byte) %R2(low byte) <- %R1(high byte)...

WORDS Left by 1: %R2 <- R1 %R3 <- %R2...

DWORDS Left by 1: %R3, %R4 <- %R1, %R2 %R5, %R6 <- %R3, %R4

BITS Right by 1: %T2 -> %T1 & T3 -> %T2...

BYTES Right by 1: %R1(high byte) -> %R1(low byte) %R2(low byte) -> %R1(high byte)...

WORDS Right by 1: %R2 -> R1 %R3 -> %R2...

DWORDS Right by 1: %R3, %R4 -> %R1, %R2 %R5, %R6 -> %R3, %R4

**IN** - This is the BIT, BYTE, WORD, or DWORD to shift into the array.

**OUT** - This is the last BIT, BYTE, WORD or DWORD shifted out of the array.

**c. Examples Multi Shift Word Moves**

The graphic below is used with the following examples of Multi-Shift Word Moves.

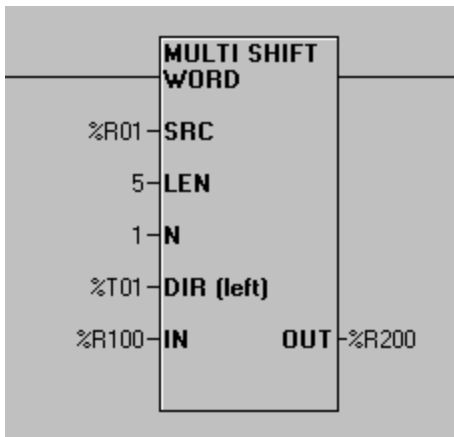

MULTI SHIFT WORD (Illustrates Example 1, 2, and 3)

**EXAMPLE 1:**

Start with the registers in the following state:

%R1        1  
%R2        2  
%R3        3  
%R4        4  
%R5        5  
%T1        TRUE  
%R100      123  
%R200      0

After one scan with power flow to the function high:

%R1	<b>123</b>
%R2	<b>1</b>
%R3	<b>2</b>
%R4	<b>3</b>
%R5	<b>4</b>
%T1	TRUE
%R100	123
%R200	<b>5</b>

After a second scan with power flow to the function high:

%R1	<b>123</b>
%R2	<b>123</b>
%R3	<b>1</b>
%R4	<b>2</b>
%R5	<b>3</b>
%T1	TRUE
%R100	123
%R200	<b>4</b>

Notice the flow of data from the input though the array of WORDS (%R1 to %R5) and finally to the output.

### **EXAMPLE 2:**

Start again with the registers in the following state:

%R1	1
%R2	2
%R3	3
%R4	4
%R5	5
%T1	TRUE
%R100	123
%R200	0

After one scan with power flow high, change the input (%R100) to 456:

%R1	<b>123</b>
%R2	<b>1</b>
%R3	<b>2</b>
%R4	<b>3</b>
%R5	<b>4</b>
%T1	TRUE
%R100	<b>456</b>
%R200	<b>5</b>

After a second scan with power flow to the function high:

%R1	<b>456</b>
%R2	<b>123</b>
%R3	<b>1</b>
%R4	<b>2</b>
%R5	<b>3</b>
%T1	TRUE
%R100	456
%R200	<b>4</b>



**EXAMPLE 3**

Start with the registers in the following state (note the DIRECTION is now right):

```
%R1      1
%R2      2
%R3      3
%R4      4
%R5      5
%T1      FALSE
%R100    123
%R200    0
```

After one scan with power flow to the function high:

```
%R1      2
%R2      3
%R3      4
%R4      5
%R5      123
%T1      TRUE
%R100    123
%R200    1
```

After a second scan with power flow to the function high:

```
%R1      3
%R2      4
%R3      5
%R4      123
%R5      123
%T1      TRUE
%R100    123
%R200    2
```

Notice the flow of data from the input, through the array of WORDS (%R5 to %R1) and finally to the output.

2.13.3 *Multi Rotate Data Moves*

This function allows an array of BITS, BYTES, WORDS, and DWORDS to be rotated left or right a variable numbers of elements.

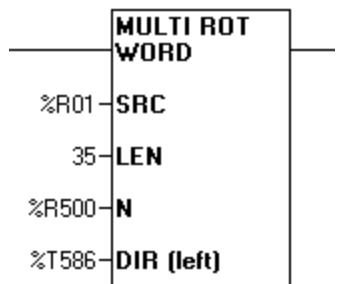

**MULTI ROTATE WORD**

**a. Power Flow**

When the input to this function block is high it completes a rotate as specified by the parameters every scan. This function is not edge sensitive. This function always passes power flow.

**b. Multi Rotate Data Move Terminology**

**SRC** - This is the starting BIT, BYTE, WORD or DWORD for the array to be rotated. After the data is rotated it is stored in the array of data starting at this location. BIT arrays can start at any location (%I1, %I6, %R1.1, %R4.7...). BYTE, WORD, and DWORD arrays must start on a WORD boundary (%I1, %I17, %I33, %R1, %R2...).

**LEN** - This is the number of BITS, BYTES, WORDS, or DWORDS in the array. This must be a constant number from 1 to 32767.

**N** - This is the number of elements to rotate. This can be a constant or a WORD variable.

**DIR** - This is the direction to rotate. If this input is high the data is rotated to the left. If this input is low the data is rotated to the right.

Examples:

BITs Left by 1: %T2 <- %T1 & T3 <- %T2...

BYTEs Left by 1: %R1(high byte) <- %R1(low byte) %R2(low byte) <- %R1(high byte)...

WORDs Left by 1: %R2 <- R1 %R3 <- %R2...

DWORDs Left by 1: %R3, %R4 <- %R1, %R2 %R5, %R6 <- %R3, %R4

BITs Right by 1: %T2 -> %T1 & T3 -> %T2...

BYTEs Right by 1: %R1(high byte) -> %R1(low byte) %R2(low byte) -> %R1(high byte)...

WORDs Right by 1: %R2 -> R1 %R3 -> %R2...

DWORDs Right by 1: %R3, %R4 -> %R1, %R2 %R5, %R6 -> %R3, %R4

**c. Examples of Multi Rotate Word Moves**

The graphic below is used for the following Multi Rotate Word Moves examples.

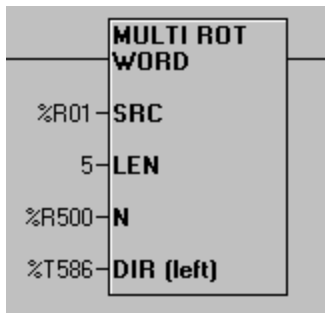

**MULTI ROTATE WORD**

**Example 1**

Start with the registers in the following state:

%R1	1
%R2	2
%R3	3
%R4	4
%R5	5
%T586	TRUE
%R500	1

After one scan with power flow to the function high:

%R1	5
%R2	1
%R3	2
%R4	3
%R5	4
%T586	TRUE
%R500	1

After a second scan with power flow to the function high:

%R1	4
%R2	5
%R3	1
%R4	2
%R5	3
%T586	TRUE
%R500	1

**Example 2**

Start with the registers in the following state (note the DIRECTION is now right):

%R1	1
%R2	2
%R3	3
%R4	4
%R5	5
%T586	FALSE
%R500	1

After one scan with power flow to the function high:

%R1	2
%R2	3
%R3	4
%R4	5
%R5	1
%T586	FALSE
%R500	1

After a second scan with power flow to the function high:

%R1	3
%R2	4
%R3	5
%R4	1
%R5	2
%T586	FALSE
%R500	1

## 2.14 Set Real Time Clock Element

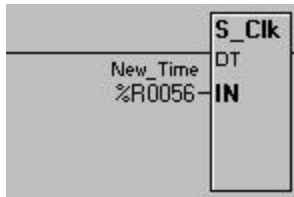

This function allows the real time clock in the controller to be set from the ladder program. This allows the clock on several devices to be synchronized over the network, or allow the time to be adjusted based on a algorithm in ladder.

The input to this function is six consecutive WORD registers. The register should be in the following format:

Register 1	New Seconds
Register 2	New Minutes
Register 3	New Hours(24 hour format)
Register 4	New Date
Register 5	New Month (1 = January)
Register 6	New Year (4 digit format)

This function passes power if the supplied new time and date are valid. An example of invalid time would be hour = 50 or month = 100.

The day of the week is automatically calculated and updated in the real time clock (%SR50).

## 2.15 Network Elements

### 2.15.1 Net Get Words

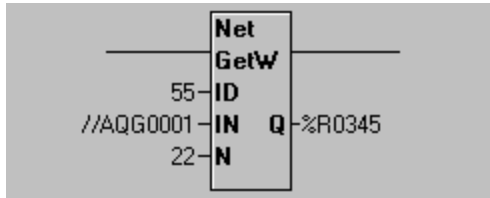

This element allows global data from any device on the network to be copied into any set of registers. If the device defined by the source ID has not transmitted data, this function block will not pass power flow and will can a request for the data to be sent. Once the request data has been received, power flow from this function block will turn on.

This function works with CsCAN or DeviceNet networks.

**ID** - This register or constant defines the source for the global data. If the ID is not valid, the function will do nothing and will not pass power.

**IN** - This defines the starting point for the requested global data. This can be a %AQG or %QG register. Note that %QG registers must be on a word boundary (1, 17, 33...). This is a network register, a register assigned and produced by the transmitting ID.

**N** - This defines the number of words to get from the source ID. This has a range of 1 to 32.

**Q** - This defines the starting register for the destination of the data. This is a register in the controller.

### 2.15.2 Net Put Words

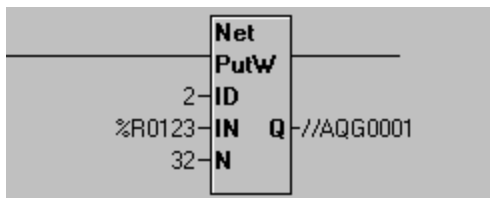

This element allows sending global data using multiple networks IDs. This function is not edge sensitive, every scan that this function is encountered it will copy the data from the source registers attempt to transmit the data.

This function only works with CsCAN networks.

The function passes power if the ID is legal and in the range defined by the network ID and the total number of ID assigned to that node.

**ID** - This is a register or constant for the ID to use when transmitting data on the network. It must be in the range defined by the primary network ID and the total nodes allocated for this target.

**IN** - This is the starting register for the source data to send on the network. This is a register local to the controller.

**N** - This is the number of words to send on the network.

**Q** - This is the starting register for the destination of the data. Note that %QG registers must be on a word boundary (1, 17, 33...). This is a network register assigned to the network ID.

### 2.15.3 Net Get Heartbeat

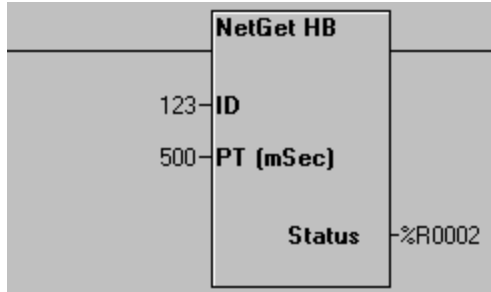

This function allows the detection of a network heartbeat from another device. This function does not generate any network traffic.

This function works only with CsCAN networks.

This function will not pass power flow if the ID is not in the legal range or if the device being monitored does not send a heartbeat message in the timeout defined by PT.

**ID** - This is a register or constant defining the ID of the device to monitor for a heartbeat.

**PT** - This is the maximum amount of time to wait for the heartbeat from the monitored device. This timeout should be greater than the rate the device is sending heartbeat messages. Depending on network traffic and scan rates the GET timeout should be 10 to 1000 milliseconds greater than the PUT. This has a range of 1 to 6553 milliseconds.

**Status** - This register is currently used for internal record keeping. Do not allow other function to write to this register.

### 2.15.4 Net Put Heartbeat

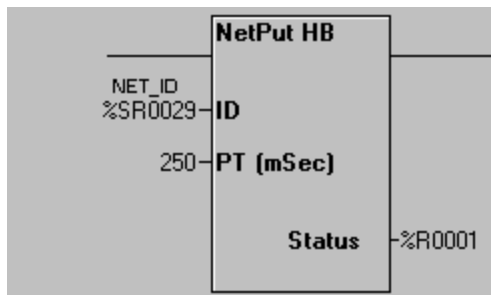

This function allows a device to transmit a heartbeat CsCAN message at a given rate to indicate to other devices it is on-line and operating normally. This function does generate network traffic. The message generated normally does not affect bandwidth, but if many devices send heartbeat messages frequently it may cause reduction in bandwidth.

This function will not pass power flow if the ID is not in the legal range.

This function works only with CsCAN networks.

**ID** - This register or constant is usually the primary network ID of the device (%SR29), but can be in the range defined by the primary network ID and the total number of IDs assigned to this device.

**PT** - This is how often in milliseconds to send the heartbeat message. This has a range of 1 to 6553.

**Status** - This register is currently used for internal record keeping. Do not allow other function to write to this register.

## 2.16 String Handling Elements

### 2.16.1 Overview

A string is a succession of characters. **Cscape** strings are delimited (prefixed and suffixed) by the Single Quote character ( ' ). **Cscape** strings can be zero characters in length.

The following are some valid **Cscape** strings. Note the placement of the Single Quote characters.

- 'Hot' Length = 3
- '' Length = 0
- ' ' A single SPACE character. Length = 1

Any 8-bit binary value is acceptable in a string not just **ASCII** characters. However, the usefulness of non-ASCII characters is limited by the display capabilities of the unit for which they are intended.

### 2.16.2 Special Characters (String)

Because the Single Quote ( ' ) is used to delimit strings, the Single Quote can not be inserted directly into a **Cscape** String. In order to insert a Single Quote, a two-character combination is used. The marker character is the Dollar Sign \$. Using this method, several other useful Special Character combinations are available.

Combination	Printed Interpretation
\$\$	Dollar Sign
\$'	Single Quote
\$L or \$l	Line Feed
\$N or \$n	New Line
\$P or \$p	Form Feed (page feed)
\$R or \$r	Carriage Return
\$T or \$t	Tab

The New Line character (\$N) provides an implementation-independent means of defining the end of data for both physical and file I/O. When printed, the effect is that of ending the current line of text and resuming printing at the beginning of the next line.

## Hexadecimal Numbers

Hexadecimal numbers are also accepted. Hexadecimal number can be entered by using the Dollar Sign followed by two hexadecimal characters:

Combination	Printed Interpretation
\$0D	Carriage return (same as \$R)
\$0D\$0A	CR/LF sequence (same as \$R\$L)
\$00	Null characters
\$FF	Binary value 255

A hexadecimal number must contain *exactly* two (2) characters. Possible characters are 0-9, A-F, and a-f. The conversion is not case sensitive.

Hexadecimal number must be exactly two characters. If the number can be represented with one hexadecimal character (i.e., \$a), the string must contain a leading 0 (i.e.: \$0a).

## String Move Element

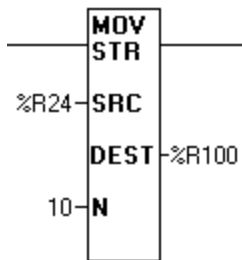

### MOVE STRING

When power is applied to this element, it moves the programmed number of characters from SOURCE to DESTINATION.

**SOURCE** can be either a **Register Type and Offset** reference, or a string constant. String constants must be delimited with the Single Quote character ( '). (For example, "This is a test.")

**DESTINATION** must be a Register Type and Offset Reference.

**N** is the number of character to move, and must be a decimal constant.

If SOURCE is a string constant (i.e., the first character is a Single Quote), then the **Number of Characters** entry box is disabled, and contains the count of the number of characters typed in. Note that a hexadecimal sequence ('\$0A') appearing in a string constant is counted as a single character.



### String Compare Element

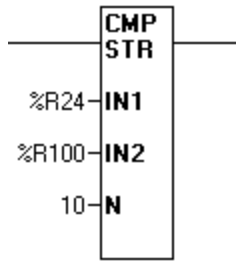

#### String Compare

When power is applied to this element, it compares the programmed number of characters from **IN1** with any characters appearing at **IN2**. If the comparison is TRUE (the two strings are equal), then power flow through the elements is TRUE.

**IN1** may be either a **Register Type and Offset** reference, or a string constant. String constants must be delimited with the Single Quote character ( ' ); for example, "This is a test."

**IN2** must be a Register Type and Offset Reference.

**N** is the number of character to compare and must be a decimal constant. If **IN1** is a string constant (i.e., the first character is a Single Quote), then the **Number of Characters** entry box is disabled, and contains the count of the number of characters typed in. Note that a hexadecimal sequence ('\$0A') appearing in a string constant is counted as a single character.

## 2.17 Communication Elements

### 2.17.1 Configuring Serial Port Elements (Communication)

#### Open Comm Port

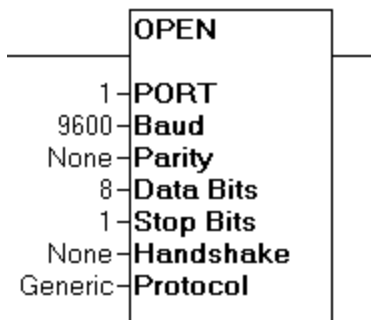

#### Serial Port Open

The Open Port element creates a channel to the desired comm port. The operational parameters (baud rate, etc) are also set by this element. The channel remains open until closed by the Close Port element or the controller is taken out of RUN mode.

The configuration dialog consists of a number of drop-down selection lists. Make the selection of the comm port's operational parameters from these lists.

**NOTE:** In the current release of the OCS hardware there is only one comm port available, Port 1.

Power flow through the element is TRUE if the element completes successfully or if the port is already open. If one attempts to open a port that does not exist, power flow through the element is FALSE.

The selected port can not be used for programming using the CsCAN protocol if it has been otherwise opened by this element. OCS units with only one comm port can still be programmed by using a **Pass Through Connection** from another unit.

### Close Comm Port

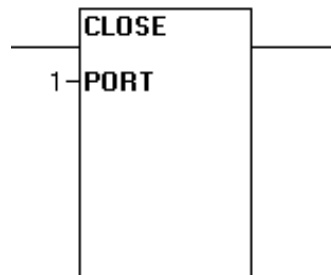

#### SERIAL PORT CLOSE

This element closes the channel to the selected port. There are no operational parameters except the Port Number. This entry must be a decimal constant.

Power flow through the element is TRUE if the element completes successfully or if the port is already closed. If an attempt is made to close a port that does not exist, power flow through the element is FALSE

If the selected port had been previously used as a CsCAN programming port, that function is again available.

### Comm Port Transmit

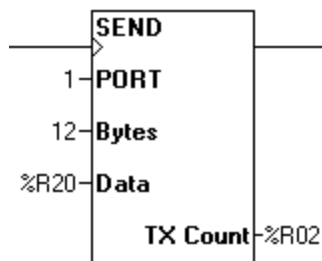

#### SERIAL PORT SEND

If the port has been successfully opened, this element sends a specified number of bytes to the internal transmit buffer for the selected comm port.

**PORT** is the comm port previously open by the ladder program.

**NOTE:** In the current release, the only available comm port is Port 1.

**BYTES** may be specified as either a **Register Type and Offset** reference or as a decimal constant. This value indicates the number of bytes to be transmitted.

**DATA** is the address of the data to be sent. This must be specified as a Register Type and Offset reference.

**TX COUNT** contains the actual number of bytes transferred to the port's internal buffer (or -1 when the function is not). This location must be specified as a Register Type and Offset reference.

When power is applied to the element, the TX Count register contains the number of characters actually transferred to the comm port transmit buffer. If power is not applied to the element, this register contains -1 (negative one).

Power flow through the element is FALSE until the requested number of characters have been transferred to the comm port transmit buffer (at which time the power flow is TRUE). It is possible that the element can not transfer all data in one program **scan time**.

If the port is not open, the Transmit Element does nothing, and power flow through the element is FALSE.

If the value contained in BYTES is greater then 255, the element does nothing and power flow through the element is FALSE.

The number of bytes can be either a **Register Type and Offset** references or a decimal constant. The maximum acceptable value is 255 bytes. When using a Register Type and Offset address, if the register contains a value less than 0 (zero) or greater than 255, the element does nothing, and power flow through the element is FALSE.

### Comm Port Receive

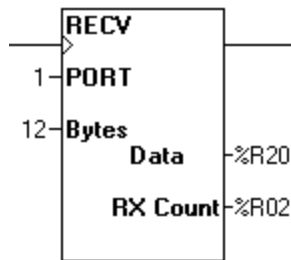

### Serial Port Receive

If the port has been successfully opened, this element receives a specified number of bytes from the selected comm port.

**PORT** is the comm port previously opened by the ladder program.

**NOTE:** In the current release, the only available comm port is Port 1.

**BYTES** can be specified as either a **Register Type and Offset** reference or as a decimal constant. This value indicates the maximum number of bytes to be received.

**DATA** is the address where the received data is to be stored. This must be specified as a Register Type and Offset reference.

**RX COUNT** contains the number of bytes to be copied from the port's internal buffer to the registers at **DATA** (or -1 when the function is not.)

|

f the port is not opened the Receive Element does nothing, and power flow through the element is FALSE.

Power flow through the element is FALSE until the requested number of characters has been received from the comm port buffer (at which time the power flow will be TRUE). It is possible that the element can not transfer all data in one program **scan time**, especially at slower baud rates.

The **BYTES** can be a **Register Type and Offset** references. The maximum acceptable value is 255 bytes. When using a Register Type and Offset address, if the register contains a value less than 0 (zero) or greater than 255, the element does nothing, and power flow through the element is FALSE.

### MODEM CONTROL

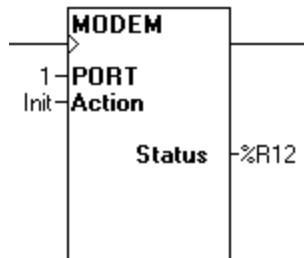

**Modem Control**

This element allows the OCS to control an attached modem. Port Number is the COMM port to which the modem is attached.

**NOTE:** In the current release, the only available comm port is Port 1.

Status is the Type and Offset\_of a WORD (16-bit) register used to hold the results of the element.

The status can take on the following values while operating:

Value	Status
0	The modem completed the operation successfully
1	The modem successfully connected
2	The modem detected an incoming ring
3	The modem lost carrier or did not receive a carrier on a dial
4	The modem indicated an error (check dial or init string)
-1	The function is not active
-2	The function has started, but not completed an operation
-3	The command timed-out (modem did not respond)

Action is the action to be taken. From the drop down list select one of the following:

INITIALIZE - Send the specified Initialization String to the modem.

AUTO DIAL - Cause the modem to dial, given the specified phone number and method (tone or pulse).

AUTO ANSWER ON - Turns ON the modem's Auto-Answer features (if available) and sets the specified number of rings.

Once a modem connection is made using AUTO DIAL or AUTO ANSWER, the serial send, receive, Modbus slave and Modbus master function blocks can be used to exchange data with a remote location. If remote CsCAN communications is desired after the modem connection is established, the serial port can be closed to switch back to CsCAN mode.

**MODBUS SLAVE**

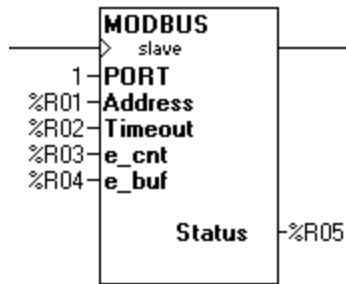

**Modbus Slave**

**PORT** is the comm port previously opened by the ladder program with **Protocol** set to Modbus ASCII or Modbus RTU.

**NOTE:** In the current release, the only available comm port is Port 1.

**ADDRESS** can be specified as either a **Register Type and Offset** reference or as a decimal constant (with a range of 1 to 247). This specifies the Modbus address the controller uses to respond to Modbus request.

**Timeout** can be specified as either a **Register Type and Offset** reference or as a decimal constant (with a range of 0 to 1023). This specifies the amount of time that passes between request from the master before the in-activity timeout bit is set in the status word. This parameter is in terms of 100 milliseconds (i.e., 100 = 10.0 Sec).

**e\_cnt** (Required only if Exception Message support is enabled) is specified as a **Register Type and Offset** reference. This contains the number of bytes in the Message Data buffer to send. Transition from zero to a non-zero value triggers the transmission of one Exception Message.

**e\_buf** (Required only if Exception Message support is enabled) is specified as a **Register Type and Offset** reference. This is the first register number of an array, which contains the Exception Message (first message byte is contained in referenced word register low value byte)

**STATUS** is the Type and Offset reference of a WORD (16-bit) register used to hold the results of the element.

Status bit assignment:

Bit Number	Status
1	Inactivity Timeout
4	Valid message received (toggles)
5	Parity error (single pass)
6	Frame Error (single pass)
7	Overrun error (single pass)
8	Crc/Checksum error (single pass)
9	Exception message send (reset when e_cnt = 0)
10	Exception message exceeds send buffer size (reset when e_cnt = 0)
11	Attempt to send exception message when transmit busy (reset when e_cnt = 0)

## Master Mapping

To access a controller's point over Modbus, the master must be configured as to the point's type and offset. This is usually accomplished with one of two methods. The first method uses the traditional addressing scheme where the high digit represents the point's type and the lower digits represent the point's offset (starting with point 1). Since only four types can be represented in this manner, the Modbus function packs several controller data tables into a single point type array.

The Traditional RTU Reference column below specifies the starting address of each controller table. The second method requires the master to be configured with the specific Modbus command and offset. The supported Modbus commands and the associated offset are also illustrated in the following table.

Controller Reference	Maximum Range	Traditional Modbus Reference	Modbus Command(s)	Modbus Offset
%I1	2048	10001	Read Input Status (2)	00000
%IG1	256	13001		03000
%S1	256	14001		04000
%K1	256	15001		05000
%Q1	2048	00001	Read Coil Status (1) Force Coil (5) Force Multiple Coils (15)	00000
%M1	2048	03001		03000
%T1	2048	06001		06000
%QG1	256	09001		09000
%AI1	512	30001	Read Input Register (4)	00000
%AIG1	32	33001		03000
%SR1	32	34001		04000
%AQ1	512	40001	Read Holding Register (3) Load Register (6) Load Multiple Registers (16)	00000
%R1	2048	43001		03000
%AQG1	32	46001		06000

## MODBUS MASTER

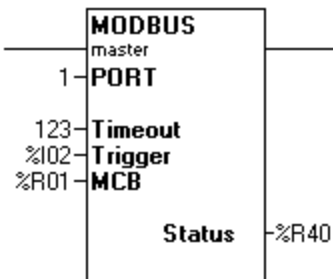

### Modbus Master

**PORT** is the comm port previously open by the ladder program with **Protocol** set to Modbus ASCII or Modbus RTU.

**NOTE:** In the current release, the only available comm port is Port 1.

**Timeout** may be specified as either a **Register Type and Offset** reference, or as a decimal constant (with a range of 0 to 1023). This specifies the amount of time that is allowed between a Modbus command and its response. This parameter is in terms of 100 milliseconds (i.e., 100 = 10.0 Sec).

**Trigger** -is specified as a bit **Register Type and Offset** reference. When this bit goes from an off to on transition, the block transmits the Modbus message defined by the message control block (MCB). When this input is low, the status word is cleared.

**MCB (Message Control Block)** - is specified as a **Register Type and Offset** reference. This register is the first of six (6) registers that contain the control information for this block

- Word 1 Slave ID** - value from 1 to 247 indicating the device to receive the message
- Word 2 Modbus Command** - Modbus command to send to the slave (see supported commands)
- Word 3 Slave Offset** - Starting point in the Modbus slave for data to read or write
- Word 4 Data Length** - Amount of data to read or write
- Word 5 Controller Reference Type** - Enumerated controller register type (see register type enumeration)
- Word 6 Controller Reference Offset** - Controller register number -1

The following example reads 32 bits of data starting with bit 17, from slave ID 34, and placed the data in the controller registers starting with %R425:

- Word 1 = 34 (Slave ID is 34)
- Word 2 = 1 (Modbus command #1 = Read Coil Status)
- Word 3 = 16 (Start with the 16th bit)
- Word 4 = 32 (Read 32 bits)
- Word 5 = 8 (Destination reference type is %R)
- Word 6 = 424 (Destination offset is 424 [425-1])

**STATUS** is the Type and Offset reference of a WORD (16-bit) register used to hold the results of the element.

Status bit assignment:

Bit Number	Status
1	Request Succeeded (OK)
2	Request Failed (See additional errors below)
3	ID out of range
4	Length exceeds Modbus frame
5	Command not supported
6	Invalid controller reference
7	Reserved
8	Reserved
9	Timeout Expired
10	Frame or parity error
11	Invalid checksum / crc from slave
12	Invalid format from slave
13	Slave rejected the command
14	Slave rejected the address
15	Slave rejected the data
16	Slave device error

This function passes power flow if the associated port is opened and ready for communications.

## 2.18 Special Elements

### 2.18.1 Overview

Special Elements are those which have a functions which are outside the classifications of "normal" ladder logic elements. They include the Stepper Motor Module Configurator and PID Functions.

### 2.18.2 Stepper Move Element

#### a. General

The Stepper Move element provides the necessary interface between **Cscape** and the STP100 Single Axis Stepper Controller SmartStack module.

The STP100 module requires either seven (7) or fourteen (14) consecutive Analog Output (%AQ) registers. To program the STP100 module, appropriate data must be moved into the assigned %AQ registers, typically using seven or 14 Move Word elements.

The purpose of the Stepper Move element is to act as a gathering point to organize information from different points in the ladder program and transfer this data to the STP100 module with *one* instruction.

Additionally, the Stepper Move element provides a built in Stepper Motion Calculator that can calculate a Movement Profile graph based on user-selected values.

#### b. Configuration of the Stepper

**NOTE:** Verify the SmartStack module configuration before completing the Element Configuration.

The various entries must be completed by the programmer. Values can be entered as numeric constants **Register Type and Offset**, or registers can be referenced by Name.

**INDEXED MOVE** -- Check this box to enable the Indexed Move features of this element. *The SmartStack module must also be configured to produce Indexed Moves.* If Indexed Move is enabled, the element requires seven (7) additional registers (14 total).

**STEPPER STARTING %AQ** -- This contains the address of the first %AQ register assigned to the Stepper SmartStack module. This information can be taken from the Stepper Module SmartStack Configuration.

**DESTINATION POSITION** -- This is a *32-bit* register. This register contains the position where the move is to end. Values range is -8,388,608 to +8,388,607

**VELOCITY RESOLUTION** -- This is a *16-bit* register. Values range from 20 to 65535.

**BASE VELOCITY** -- This is a *16-bit* register. Values range from 1 to 8190.

**RUNNING VELOCITY** -- This is a *16-bit* register. Values range from 2 to 8191.

**ACCELERATION TIME** -- This is a *16-bit* register. Times are listed in milliseconds (mS). Values range from 1 to 27300.

**DECELERATION TIME** -- This is a *16-bit* register. Times are listed in milliseconds (mS). Values range from 0 to 27300.



The following registers are used only for Index Move operations:

**INDEX DESTINATION POSITION** -- This is a 32-bit register.

**INDEX DECELERATION** -- This is a 16-bit register.

**INDEX WINDOW OPEN** -- This is a 32-bit register.

**INDEX WINDOW CLOSED** -- This is a 32-bit register.

**c. Operation**

In operation, the Stepper Element gathers the indicated information and writes all values as a group to the Stepper Controller SmartStack Module. [Technically, the actual write operation does not take place until the next I/O cycle.] This is a great convenience as to do this the normal way would require six or ten individual elements. The Stepper Move instruction requires only one element.

The registers assigned to the Stepper Controller SmartStack Module are assigned by default when the controller is configured. The exact position of the module in the %I, %Q, %AI, and %AQ spaces is determined by the number of SmartStack modules attached to this controller, and the physical position of the HE800STP100 module within the stack. This is a typical setup based on the STP100 being the first (or only) SmartStack module, and indexing is not selected:

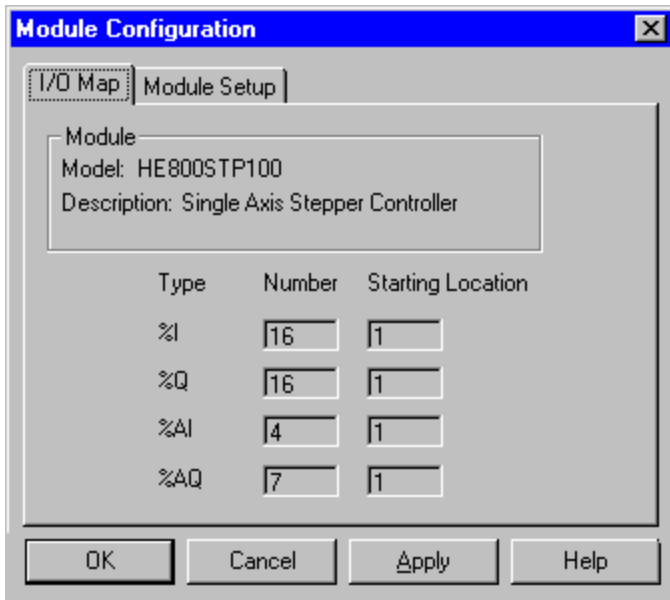

**Stepper Config**

Note the **STARTING LOCATION** indicated for this module, in particular those for %AQ. This information is used in the configuration screen. In this example, the Stepper Controller lives at address %AQ01 and requires seven (7) consecutive registers. This information belongs in the **stepper starting %AQ** box of the element configuration screen.

**NOTE:** If the module *and the element* are configured to accept Indexed Moves, the element requires fourteen (14) consecutive %AQ registers.

First ensure that the SmartStack module is free to operate by checking the **Status Bits**, %I1 to %I16. If *any* Error Bit is set, the source of the error must be cleared, and the **CLEAR ERRORS** command issued. Condition of the Status Bits depends on the previous command. Do not issue a new command (except the **IMMEDIATE STOP** or **DECELERATE AND STOP** command) until the previous command has completed.

When this element receives power, the values from the configured constants or registers are loaded into the STP100, preparing it for the next command. [Technically, the actual write operation does not take place until the next **I/O cycle**]

**NOTE: DO NOT** execute the Stepper Move element until the previous command is complete.

Commands are issued by setting the appropriate **command bit** in the Stepper Modules %Q address space after the Stepper Move element has completed.

### 2.18.3 Stepcalc Motion Profile Calculator

**Cscape** contains a built in Motion Profile Calculator.

**NOTE:** Use of the Motion Profile Calculator does *not* effect the OCS registers.

In operation, one can enter experimental values into the Motion Profile Calculator. The calculator then determines whether or not the values are valid for the Stepper Move element, and if they are, then key values are presented to see if the move is within the capabilities of the stepper motor hardware. Finally, one can view a graph or profile of the intended move.

**Velocity Resolution, Base Velocity, Running Velocity, Acceleration Time, and Deceleration Time** are all values that are intended to be placed into the corresponding Stepper Controller Registers through the Stepper Move element. In order for StepCalc to operate, these values *must* be entered.

The **Number of Pulses** entry is optional. This value is used if a trapezoidal move is to be profiled. Possible values for this entry are in the range 0 to +16777215. Entering 0 (zero) is used to profile JOG or TRIANGULAR moves.

The other entries are adjusted and the profile recalculated. The *maximum* possible settings are:

VELOCITY RESOLUTION -- Values range from 20 to 65535.

BASE VELOCITY -- Values range from 1 to 8190.

RUNNING VELOCITY -- Values range from 2 to 8191. Value must be greater than BASE VELOCITY.

ACCELERATION TIME -- Values range from 1 to 27300.

DECELERATION TIME -- Values range from 0 to 27300.

These values may be more severely limited by the other values entered into the calculator. StepCalc issues a warning if a value is exceeded.

Once acceptable value are entered, press the **UPDATE** button. The value displayed in the dialog is recalculated and displayed. To see the resulting Motion Profile, press the **Calc/Graph** button.

#### 2.18.4 PID Elements

##### a. General

**Cscape** provides two (2) PID (Proportional / Integral / Derivative) elements: **Independent** and **ISA**. These two elements differ only in how the proportional gain ( $K_p$ ) component effects final outcome. These are the two equations used:

**Independent PID**  $CV_{out} = (K_p * Error) + (K_i * Error * dt) + (K_d * Derivative) + CV_{Bias}$

##### ISA PID

$CV_{out} = K_p * (Error + (Error * dt / T_i) + (T_d * Derivative)) + CV_{Bias}$

Where:

$dt = \text{Internal elapsed time clock} - \text{previous elapsed time clock}$

$Derivative = (Error - \text{previous Error})/dt$

-or-

$Derivative = (pv - \text{previous PV})/dt$   
[User selectable during configuration].

$T_i = \text{Integral time}$

$T_d = \text{Derivative time}$

From these equation, one can see that in the Independent PID the  $K_p$  value is used alone while in the ISA PID, the  $K_p$  value is used to factor both the  $K_i$  and  $K_d$  values.

The Independent PID is the standard function, but the ISA PID is a bit easier to tune.

## b. PID Register Usage

Either PID element requires an array of fifteen (15) WORD (16-bit) registers. These will presumably be of type %R. This is called the Reference Array.

Offset	Parameter	Units	Range	Description
0	Sample Period	10 mS	0 to 65535	The shortest time, in 10mS increments, allowed between PID solutions
1	Dead Band +	PV Counts	0 to 32000	Defines the Upper and Lower Dead Band limits in terms of PV counts. Set both to 0 (zero) if no dead band is required. Both should be set to 0 (zero) until the PID is tuned. A Dead Band might then be necessary to prevent small changes in CV values due to slight variations in error.
2	Dead Band -	PV Counts	0 to 32000	
3	Proportional Gain (Kp)	Percent	0 to 327.67%	Sets the Proportional Gain (Kp) factor in terms of percent. 100 sets unity gain (gain of 1)
4	Derivative Gain (Kd)	10 mS	0 to 327.67 seconds	Entered as a time with a resolution of 10 mS. In the PID equation this has the effect: $K_d * \Delta \text{Error} / dt$
5	Integral Rate (Ki)	1000 second	0 to 32.767 repeats per second	Entered as a number of repeats per second -- effectively the integration rate. In the PID equation this has the effect: $K_i * \text{Error} * dt$
6	CV Bias	CV Counts	-32000 to +32000	Number of CV counts added to the output before the rate and amplitude clamps
7	CV Upper Clamp	CV Counts	-32000 to +32000	Number of CV Counts that represent the highest and lowest value for CV. CV Upper Clamp must be more positive the CV Lower Clamp
8	CV Lower Clamp	CV Counts	-32000 to +32000	
9	Minimum Slew Time	Seconds of full travel	0 to 32000 seconds to move 32000 CV counts	Determines how fast the CV value can change
10	Config Word	N/A	N/A	Internal Use - Do not modify this value
11	Manual Command	CV Counts	Tracks CV in Auto mode; sets CV in Manual Mode.	In the Automatic mode this register tracks the CV value. In the Manual Mode, this register contains the value that is output to the CV within the clamp and slew limits.
12	Internal SP	Used by OCS	N/A	Tracks SP in
13	Internal PV	Used by OCS	N/A	Tracks PV in
14	Internal CV	Used by OCS	N/A	Tracks CV out

Each PID element must use a distinctly separate Reference Array, even if the values are identical to an exiting PID element. There can be no overlapping of PID elements.

Registers at offset 0 through 9 must be configured before the PID element is used. This is most easily done using the Tune features of the Cescape PID Element Configuration. These registers can, however, be manipulate by the ladder program as well.

c. Independent PID Element / ISA PID Element

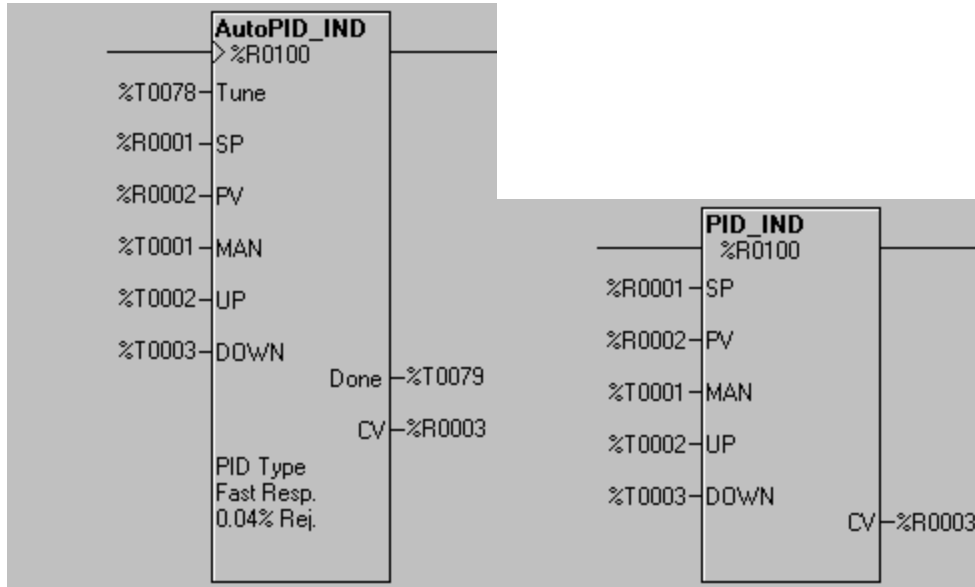

**PID Element With and Without Auto Tuning**

The element is configured to accept five (5) external variables -- two word (16-bit) values and three (3) binary (1 bit) values. The element outputs one word (16-bit) variable and one single-bit variable.

The element uses an array of fifteen (15) word (16-bit) registers, presumably type %R. This is known as the Reference Array (see below).

In operation, when the element receives power, and the Manual Input does not receive power, the element is placed in the Automatic Mode. The element first determines if its sample time period has elapsed. If the time period has elapsed, the PID algorithm is solved and the Control Variable (CV) is updated.

If power is applied to the element and power is also applied to the Manual input, the element operates in the Manual Mode. The Control Variable (CV) is updated using the value in the Manual Command Parameter in the reference array. If the UP or DOWN inputs are also active, the CV count is incremented or decremented by one CV count on every PID solution.

In either manual or automatic modes, the CV Output value is limited by both the CV Clamp Value and the CV Slew Limit value. If the Internal CV value exceeds either clamp value or the rate of change of the Internal CV exceeds the Slew Limit, the value of CV Output is clamped at the limit. CV Output moves away from the clamp value at such time as the Internal CV values drops below the clamp or the slew rate drops below the CV Slew Rate limit. This provides an anti-windup protection and bumpless transfer between automatic and manual modes.

If the element receives power, it solves the PID equation *only* if the sample time period has been exceeded. Setting the Sample Time Period to 0 indicates that the equation is to be solved every time the element is enabled, but in no case the element executes faster than once every 10 milliseconds. For example, if the OCS scan time is 9 milliseconds, and Sample Time Period is set to 0 (zero), the element executes once every other scan, or 18 mS. The element can not execute in the first scan, because the 10 millisecond minimum limit has not been met. The element can not again execute until the next scan, 9 milliseconds later.

#### d. Configuration of PID

The elements are configured from the PID Element Configuration Screen

**PID ADDRESS** -- Enter a **Register Type and Offset** address, or select a Named register. This is the base address of fifteen (15) consecutive WORD (16-bit) registers that the PID element uses to store its parameters. This value may NOT be a decimal constant.

**SETPOINT** -- Enter a **Register Type and Offset** address, or select a Named register. This is the location of the User-defined Process Setpoint value. This value may also be entered as a signed 16-bit decimal constant.

**PROCESS VARIABLE** -- Enter a **Register Type and Offset** address or select a Named register. This is the location (typically %AI) of the Process Variable value coming in from the process. This value may NOT be a decimal constant.

**CONTROL VARIABLE**-- Enter a **Register Type and Offset** address, or select a Named register. This is the location (typically %AQ) of the Control Variable value going out to the process. This value may NOT be a decimal constant.

**MANUAL INPUT** -- Enter **Register Type and Offset** address or select a Named register that is the User-controlled Manual Input bit. This register is a Boolean (1-bit) register, presumably %T.

**UP INPUT** -- Enter a **Register Type and Offset** address or select a Named register that is the User-controlled UP Input bit. This register is a Boolean (1-bit) register, presumably %I.

**DOWN INPUT** -- Enter a **Register Type and Offset** address or select a Named register that is the User-controlled DOWN Input bit. This register is a Boolean (1-bit) register, presumably %I.

**TUNE** -- Click on the TUNE button to invoke the PID Element Tuning Dialog.

e. PID Autotune

The autotuning PID blocks add a number of new features to control the autotuning function. An edge triggered boolean AUTOTUNE input starts the autotuning cycle. This input needs to be held high during the autotuning cycle. If it is negated during the AUTOTUNE cycle, the controller stops autotuning and reverts to the previous settings. At the conclusion of the AUTOTUNE cycle, the specified controller coefficients are updated and the AUTOTUNE DONE output from the block is set to true. The PID block now reverts to the previous state, either automatic or manual. At this point the AUTOTUNE input may be removed which will cause the AUTOTUNE DONE output to be negated. The block will then be ready for another autotune cycle. The new tuning coefficients are available in their respective registers.

Apart from the autotuning function, operation of the autotuning PID blocks is identical to that of the non-autotuning PID blocks.

Auto tune PID allows the PID controller to perform an experiment on your process and use the results to calculate PID coefficients that match your process and the desired PID operation.

When auto tune PID is enable this dialog allows the entry of auto tuning parameters:

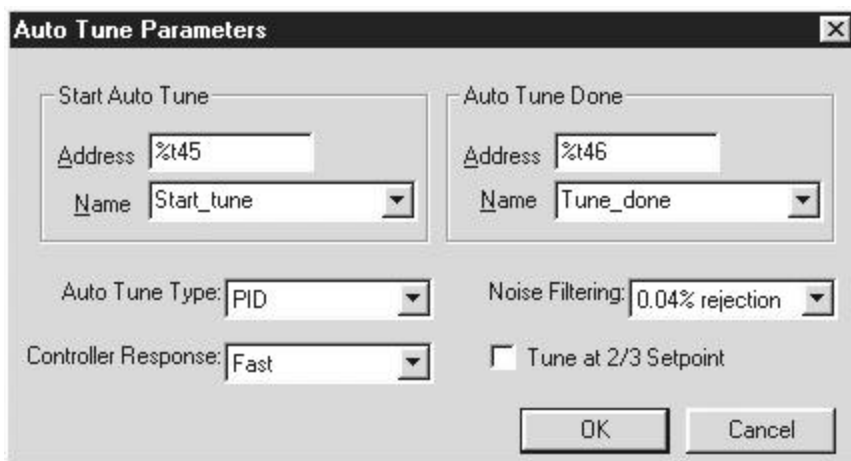

**Start Auto Tune** - This is a **Register Type and Offset** that defines an input bit that controls when the function should start the auto tune process.

**Auto Tune Done** - This is a **Register Type and Offset** that defines an output bit that is set by the function when the auto tune is complete.

**Auto Tune Type** - This options allows the auto tune procedure to calculate terms for PID, PI or P terms.

**Controller Response** - This option defines the relative speed of the PID loop once it is tuned.

**Noise Filtering** - This option defines how far above and below the setpoint the process must go when performing the auto tune experiment. Processes with more noise should be setup with a high percentage.

**Tune at 2/3 Setpoint** - This allows the auto tuning experiment to change the output based on 2/3 the set point. Use this option when it is not desired for the process to travel above the setpoint during the auto tuning experiment.

### Using the Auto Tune Function

Prior to autotuning it is necessary to partially set up the PID block as before. Specifically, the *Setpoint*, *Sample Period*, *Upper and Lower Clamp*, *Error Term*, and *Output Polarity* need to be set correctly. The previous values of the proportional, integral, and derivative coefficients do not affect the results of autotuning.

The default settings for the autotune cycle produce *Proportional*, *Integral*, and *Derivative coefficients* using the standard Ziegler-Nichols rules. This is suitable for many typical processes with delay and one or two equal lags and with a fairly quiet process variable.

Non-default settings may be selected to improve the autotuning behavior in certain circumstances. These selections only affect the generation of autotuning coefficients.

The controller type field defaults to PID but can be set to PI, Proportional/Integral, or just P, Proportional control. PI control tends to be more stable with processes that do not have any delay, just lags. Full PID control can give better response for processes with delay. The full PID tuning rules assume that the process has a moderate delay and may not be suitable for other processes. These modes are produced by the autotuning algorithm by setting the unused coefficients to zero. These may subsequently be manually increased to enable the other modes.

The response field can be used to increase the controller damping to decrease overshoot and ringing. For a typical Ziegler-Nichols process, the default FAST response produces some overshoot and a 4:1 decay ring down. MEDIUM produces a slight overshoot. SLOW produces no overshoot. With processes that are outside the optimum range for Ziegler-Nichols rules, the VERY SLOW response may be necessary for adequate response.

During autotuning the algorithm detects the process passing above and below the active setpoint. Hysteresis is applied to the setpoint to avoid false indications due to process noise. The default hysteresis band is 0.04% of full scale. For noisy processes, this may need to be increased for proper autotuning. the NOISE SUPPRESSION setting results in the following noise rejection values.

Higher noise rejection values also cause the autotuning algorithm to select somewhat slower, more stable coefficients. For noisy processes, it is also recommended that PI rather than PID control be selected.

### How Auto Tuning Works

The auto tuning function block performs an experiment on the process to be controlled and uses the results to calculate the PID coefficients. While auto tuning the output is moved back and forth between the upper and lower clamps. The time for the process to move from a percentage (based on noise filtering) above and below the setpoint is recorded along with overshoot and undershoot readings. Once this experiment is complete, the data collected is used to calculate the new PID coefficients.



## 2.19 Miscellaneous Elements

Miscellaneous Elements include Comments  and the Vertical Branch. 

### 2.19.1 Comments

Comments allow entering descriptive text into the program.

Comments can be downloaded to the controller. Comments do not affect the run time of the program, but they can reduce the available memory in the controller if downloaded.

#### a. Add Vertical Branch

To insert a Vertical Continuation, click on the Vertical Branch tool.  Note the change in the mouse cursor.

Move the mouse cursor to the location where the Vertical Branch is designed, the single click the mouse.

#### b. Delete Vertical Branch

To delete a Vertical Branch, click on the Vertical Branch tool. Move the mouse cursor over the continuation to be removed. When the cursor indicates a pencil eraser, single click the mouse.

**Warning:** Removing a Vertical Branch can cause elements to be disconnected. Repair those flaws before downloading the program.

### EXAMPLE

The following code can be used as a safety interlock. Note the use of the Vertical Branch bars to provide the logical OR handling of the three switches.

%I01 is a normally open manually activated switch. %I02 and %I03 represent safety interlock switches that generate a logic HIGH when their associated door is CLOSED.

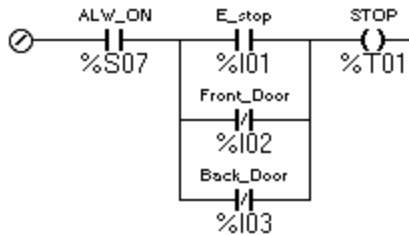

#### Vertical Branch

Thus, pressing E-stop OR opening Front\_Door OR opening Back\_Door generates the stop bit.

NOTES

## CHAPTER 3: CSCAPE DATA TYPES

### 3.1 Overview

In **Cscape**, data can be stored or used in a variety of different formats. The format used depends on how the information is to be interpreted. Typical interpretations are binary bit patterns, unsigned numbers, signed numbers, floating point values, and strings.

### 3.2 Data Formats

Type	Name	Description
<b>BOOL</b>	Boolean	A single bit. It can contain only the values '0' or '1'.
<b>BYTE</b>	Byte	A string of 8 consecutive bits. Byte values are used where the value of the data is not as important as the bit patterns (shifts and rotates).
<b>WORD</b>	Word	A string of 16 consecutive bits. Word values are used where the value of the data is not as important as the bit patterns (shifts and rotates).
<b>DWORD</b>	Double Word	A string of 32 consecutive bits. Dword values are used where the value of the data is not as important as the bit patterns (shifts and rotates).
<b>INT</b>	Integer	A 16-bit signed value. Integers are used where the value of the data is expected to be in the range of -32,768 to +32,767
<b>SINT</b>	Short Integer	An 8-bit signed value. Short Integers are used where the value of the data is expected to be in the range of -128 to +127.
<b>DINT</b>	Double Integer	A 32-bit signed value. Double Integers are used where the value of the data is expected to be in the range of -2,147,483,648 to +2,147,483,647.
<b>UINT</b>	Unsigned Integer	A 16-bit unsigned value. Unsigned Integers are used where the value of the data is expected to be in the range of 0 (zero) to 65,535.
<b>USINT</b>	Unsigned Short Integer	An 8-bit unsigned value. Unsigned Short Integers are used where the value of the data is expected to be in the range of 0 (zero) to 255
<b>UDINT</b>	Unsigned Double Integer	A 32-bit unsigned value. Unsigned Double Integers are used where the value of the data is expected to be in the range of 0 (zero) to 4,294,967,296.
<b>REAL</b>	Floating Point	A 32-bit value. Values are stored and operated on in IEEE single precision (six digit) format. Values range from -3.40282E+38 to +3.40282E+38.
<b>STRING</b>	String	A variable-length succession of characters. Each character is represented by one byte.

Typically, any Data Type may use any **Controller Register**. For example a **DINT** value may use either word (%R) or Boolean (%I) registers. There is a restriction, however, if Boolean registers are used. In this case, the value may be assigned only on a suitable boundary. For example, **DWORD**, **DINT**, and **UDINT** values may be assigned to Boolean registers only on **WORD** (16 bit) boundaries -- 1, 17, 33, etc.

Care must be taken when assigning non-Boolean data types to %I and %Q registers. For example, if a **WORD** data type is assigned to %I registers, the I/O Scan of the controller will overwrite any change made to the data by the Ladder Logic program. To prevent this, the programmer should insure that the data assigned to %I points is only read by the program (any data written will be over-written by the I/O Scan), or that there is no physical I/O assigned to the %I locations used.

The bits in word registers may be used as Boolean values. In this case, Bit Offset Addressing is used to specify the **Register Type, Offset** and Bit Offset for the required bit.

### 3.3 Storage Order

32-bit values (**DWORD**, **DINT**, **UDINT**) occupy 32 consecutive bits of data, or two (2 consecutive 16-bit registers. For example, if a **DINT** is defined at Register %R43, the 32-bit value is contained in %R43 and %R44.

For 32-bit values, data is stored Low Order Word first. For example, if a **DINT** is defined at Register %R43 and contains the value "6540", (0000000000000001 000000000000100) register %R43 will contain "4" and %R44 will contain "1".

Byte values (such as **STRINGS**) are stored High Order Byte first. For example, to store the string "31" in register %R43, store the HEX value 3133 (decimal 12595).

## CHAPTER 4: AVAILABLE CONTROLLER RESOURCES

### 4.1 Overview

This chapter covers the Internal Resources of the OCS line of controllers.

### 4.2 Tables of Internal Resources

The following tables lists the Internal Resources of the GE Fanuc OCS line of controllers.

**NOTE:** This information is supplied for example and comparison purposes *only and is subject to change without notice*. Refer to the User Manual included with the purchased controller model for complete up-to-date information.

#### Text Based OCS Models

Resource	MiniOCS	OCS100	OCS200	OCS110	OCS210
%I Registers	2048	2048	2048	2048	2048
%Q Registers	2048	2048	2048	2048	2048
%AI Registers	512	512	512	512	512
%AQ Registers	512	512	512	512	512
%IG Registers	64/0**	64/0**	64/0**	64/0**	64/0**
%QG Registers	64/0**	64/0**	64/0**	64/0**	64/0**
%AIG Registers	32/16**	32/16**	32/16**	32/16**	32/16**
%AQG Registers	32/16**	32/16**	32/16**	32/16**	32/16**
%T Registers	2048	2048	2048	2048	2048
%M Registers	2048	2048	2048	2048	2048
%R Registers	2048	2048	2048	9999***	9999***
%K Registers	10	10	12	10	12
%D Registers	200	200	200	200	200
%S Registers	16	16	16	16	16
%SR Registers	64	64	64	64	64
Ladder Code memory	64K	64K	64K	128K	128K
Screen Memory	64K	64K	64K	128K	128K
Display	2x20 LCD	2x20 LCD	4x20 LCD	2x20 LCD	4x20 LCD
	text	text	text	text	text
Keypad	16	17	32	17	32
Screens	200	200	200	200	200
Fields per Screen	16	16	16	16	16
Text Tables	200	200	200	200	200
Items per Table	20	20	20	20	20

\* RCS Models have no display or keypad, but the remote text term still allows viewing a virtual display and keypad from Cscape.

\*\* Devicenet models have 16 network words and no network bits. Device without networking capabilities have no network registers.

\*\*\* Extended %R registers from 2049 to 9999 can currently only be used by move ladder instructions.

**Graphic OCS Models**

<b>Resource</b>	<b>OCS250</b>	<b>OCS3xx</b>
%I Registers	2048	2048
%Q Registers	2048	2048
%AI Registers	512	512
%AQ Registers	512	512
%IG Registers	64/0**	64/0**
%QG Registers	64/0**	64/0**
%AIG Registers	32/16**	32/16**
%AQG Registers	32/16**	32/16**
%T Registers	2048	2048
%M Registers	2048	2048
%R Registers	9999***	9999***
%K Registers	10	5
%D Registers	300	300
%S Registers	16	16
%SR Registers	64	64
Ladder Code Memory	128K	256K
Graphic Objects Memory	256K	256K
String Memory	128K	128K
Text Table Memory	128K	128K
Bitmap Memory	256K	256K
Display	240x128 LCD graphic	320x240 LCD STN or TFT
Colors	16	16
Keypad	36	6
Screens	300	300
Fields per Screen	50	50
Text Tables	200	200
Items per Table	20	20

\* RCS Models have no display or keypad, but the remote text term still allows viewing a virtual display and keypad from Cscape.

\*\* Devicenet models have 16 network words and no network bits. Device without networking capabilities have no network registers.

\*\*\* Extended %R registers from 2049 to 9999 can currently only be used by move ladder instructions.

**RCS Models**

Resource	MiniRCS	RCS210
%I Registers	2048	2048
%Q Registers	2048	2048
%AI Registers	512	512
%AQ Registers	512	512
%IG Registers	64/0**	64/0**
%QG Registers	64/0**	64/0**
%AIG Registers	32/16**	32/16**
%AQG Registers	32/16**	32/16**
%T Registers	2048	2048
%M Registers	2048	2048
%R Registers	2048	2048
%K Registers	10	12
%D Registers	200	200
%S Registers	16	16
%SR Registers	64	64
Ladder Code memory	64K	64K
Display	2x20 Virtual*	4x20 Virtual*
Keypad	17 Virtual*	32 Virtual*
Screens	200	200
Fields per Screen	16	16
Text Tables	200	200
Items per Table	20	20

\* RCS Models have no display or keypad, but the remote text term still allows viewing a virtual display and keypad from Cscape.

\*\* Devicenet models have 16 network words and no network bits. Device without networking capabilities have no network registers.

\*\*\* Extended %R registers from 2049 to 9999 can currently only be used by move ladder instructions.

### 4.3 Using More than 2048 %R Registers

Some controllers contain additional battery back RAM for extending %R registers beyond 2048. Currently these additional registers beyond 2048 can only be used by move ladder instructions. This allows ladder based data logging, recipes, or general storage to take advantage of the additional retentive memory.

The following is a list of instructions enabled for extended %R registers:

- Move
- Block Move
- Block Fill
- Indirect Move
- Move Constant Data

Other features of Cscape that support the extended %R registers include I/O name management, setpoints, watch window, debug, and element usage.

Note: These extended registers can not currently be directly displayed on the text or graphics display or accessed by enhanced smart stack modules (Ethernet).

NOTES



## CHAPTER 5: SYSTEM REGISTERS

### 5.1 General

System registers are special registers that display and/or control system operations in the controller.

### 5.2 System Registers

SR #	Name	Min	Max
1	User Screen Number	0	200
2	Alarm Screen Number	0	200
3	System Screen Number	0	10
4	Self Test Result		
5	Controller Mode (RUN)	0	2
6	Scan Rate Avg		
7	<i>Reserved</i>		
8	<i>Reserved</i>		
9	Edit Buffer Low		
10	Edit Buffer High		
11	Ladder Size Low		
12	Ladder Size High		
13	User Text Size Low		
14	User Text Size High		
15	System Text Size Low		
16	System Text Size High		
17	I/O Config Size Low		
18	I/O Config Size High		
19	Net Config Size Low		
20	Net Config Size High		
21	Security Data Size Low		
22	Security Data Size High		
23	Ladder CRC		
24	User Text CRC		
25	System Text CRC		
26	I/O Config CRC		
27	Net Config CRC		
28	Security Data CRC		
29	Network ID Low	1	253
30	<i>Reserved</i>		
31	Network Required	0	1
32	LCD Contrast	1	40
33	Key Toggle Mode	0	1
34	Serial Protocol		
35	Serial Number Low Serial Number High Model Number		
38	Engine Version		
39	BIOS Version		
40	FPGA Version		
41	LCD Columns		
42	LCD Rows		
43	Keypad Type		
44	RTC Seconds	0	59

SR #	Name	Min	Max
45	RTC Minutes	0	59
46	RTC Hours	0	23
47	RTC Day of Month	1	31
48	RTC Month	1	12
49	RTC Year	1996	2095
50	RTC Day of Week	1	7
51	Network Error Count		
52-55	<i>Reserved</i>		
56	Last Key		
57	LCD Backlight		
58	<i>User LEDs</i>		
59-192	<i>Reserved</i>		

**SR01 User Screen Number**

Ladder: Read/Write

Text: Rear/Write

Min: 0 Max: 200 (based on OCS200/100 as of printing)

*This register displays/controls the current user scrollable screen. Setting this register to 0 displays no user screens.***SR02 Alarm Screen Number**

Ladder: Read/Write

Text: Rear/Write

Min: 0 Max: 200 (based on OCS200/100 as of printing)

*This register displays/controls the current alarm screen.***SR03 System Screen Number**

Ladder: Read/Write

Text: Rear/Write

Min: 0 Max: 10 (based on OCS200/100 as of printing)

*This register displays/controls the system screen. Setting this register to 0 displays no system screen.***SR04 Self Test Result**

Ladder: Read

Text: Read

*This register displays the bit-mapped result of the self tests.***SR05 Controller Mode**

Text: Read/Write

*This register can display / control the RUN, DO I/O, or IDLE mode of the controller.**0 = IDLE 1 = DO I/O 2 = RUN***SR06 Scan Rate Avg**

Ladder: Read

Text: Read

*This register displays the average scan rate of the controller in tenths of milliseconds.**(123 = 12.3 mSec)***SR07 to SR08 RESERVED**

**SR09 + SR10 Edit Buffer Low and High**

Ladder: Read  
Text: Read

*This 32-bit register displays the intermediate value of a 1, 8, 16, or 32-bit value being edited on the text screen.*

**SR11 + SR12 Program Size Low and High**

Ladder: Read  
Text: Read

*This 32-bit registers displays the number of bytes used by the currently loaded program.*

**SR13 + SR14 User Text Screen Size Low and High**

Ladder: Read  
Text: Read

*This 32-bit registers displays the number of bytes used by the currently loaded user text screens and text tables.*

**SR15 + SR16 System Text Screen Size Low and High**

Ladder: Read  
Text: Read

*This 32-bit registers displays the number of bytes used by the currently loaded system text screens.*

**SR17 + SR18 I/O Configuration Size Low and High**

Ladder: Read  
Text: Read

*This 32-bit registers displays the number of bytes used by the currently loaded I/O configuration.*

**SR19 + SR20 Network Configuration Size Low and High**

Ladder: Read  
Text: Read

*This 32-bit registers displays the number of bytes used by the currently loaded network configuration.*

**SR21 + SR22 Security Data Size Low and High**

Ladder: Read  
Text: Read

*This 32-bit registers displays the number of bytes used by the currently loaded security data.*

**SR23 Program CRC**

Ladder: Read  
Text: Read

*This register displays the CRC value used for error detection for the currently loaded program.*

**SR24 User Text CRC**

Ladder: Read Text: Read

*This register displays the CRC value used for error detection for the currently loaded user text screens and text tables.*

**SR25 System Text CRC**

Ladder: Read  
Text: Read

*This register displays the CRC value used for error detection for the currently loaded system text screens.*

**SR26 I/O Configuration CRC**

Ladder: Read

Text: Read

*This register displays the CRC value used for error detection for the currently loaded I/O configuration.*

**SR27 Network Configuration CRC**

Ladder: Read

Text: Read

*This register displays the CRC value used for error detection for the currently loaded network configuration.*

**SR28 Security Data CRC**

Ladder: Read

Text: Read

*This register displays the CRC value used for error detection for the currently loaded security data.*

**SR29 Network ID**

Ladder: Read

Text: Read/Write

Min: 1 Max: 253 (based on OCS200/100 in CsCAN mode as of printing)

*This register displays or sets the controller's network ID.*

**SR30 RESERVED****SR31 Network Required**

Ladder: Read

Text: Read

*This register displays the status of the network required flag. If this value is a "1" the network is required and any networking errors causes the controller to report an error. If this value is a 0 the network is not required and networking errors is ignored.*

**SR32 LCD Contrast**

Ladder: Read

Text: Read/Write

Min: 1 Max: 40 (based on OCS200/100 as of printing)

*This register allows the LCD contrast to be displayed or modified. This only applies to controllers with LCD displays.*

**SR33 Key Toggle Mode**

Ladder: Read/Write

Text: Read/Write

Min: 0 Max: 1 (based on OCS200/100 as of printing)

*This register displays or sets the mode for the keyboard. When this register is a 0, the keypad is in momentary mode. When this register is 1, it is in toggle mode. This only applies to controllers with keypads.*

**SR34 Serial Protocol**

Ladder: Read

Text: Read

*This register displays the current serial protocol for PORT 1 on the controller.*

0	Firmware Update
1	CsCAN
2	Generic Ladder controlled serial
3	Modbus RTU
4	Modbus ASCII

**SR35 + SR36 Serial Number Low and High**

Ladder: Read

Text: Read

*This 32-bit register displays the electronic serial number of the controller. This differs from the serial number printed on shipping or production labels.*

**SR37 Model Number**

Ladder: Read

Text: Read

*This register displays the binary number associated with the model. For example, OCS100s, OCS200s, and RCS210s all have different model numbers.*

**SR38 Engine Version**

Ladder: Read

Text: Read

*This register displays the firmware engine version. There is an implied decimal point after the second digit (12345 = 123.45).*

**SR39 BIOS Version**

Ladder: Read

Text: Read

*This register displays the firmware bios version. There is an implied decimal point after the second digit (12345 = 123.45).*

**SR40 FPGA Version**

Ladder: Read

Text: Read

*This register displays the FPGA(an additional software programmed hardware device found on most controllers) version. There is an implied decimal point after the first digit (12345 = 1234.5).*

**SR41 LCD Columns**

Ladder: Read

Text: Read

*This register displays the number of columns on the text LCD display or virtual display.*

**SR42 LCD Rows**

Ladder: Read

Text: Read

*This register displays the number of rows on the text LCD display or virtual display.*

**SR43 Keypad Type**

Ladder: Read

Text: Read

*This register displays the keypad type.*

**SR44 Real Time Clock Seconds**

Ladder: Read

Text: Read

Min: 0 Max: 59

*This register displays the seconds from the real time clock.***SR45 Real Time Clock Minutes**

Ladder: Read

Text: Read

Min: 0 Max: 59

*This register displays the minutes from the real time clock.***SR46 Real Time Clock Hours**

Ladder: Read

Text: Read

Min: 0 Max: 23

*This register displays the hours from the real time clock.***SR47 Real Time Clock Day of the Month**

Ladder: Read

Text: Read

Min: 1 Max: 31

*This register displays the day of the month from the real time clock.***SR48 Real Time Clock Month**

Ladder: Read

Text: Read

Min: 1 Max: 12

*This register displays the month from the real time clock. 1 = January ... 12 = December.***SR49 Real Time Clock Year**

Ladder: Read

Text: Read

Min: 1996 Max: 2095

*This register displays the four digit year from the real time clock. This is Year 2000 compliant.***SR50 Real Time Clock Day of the Week**

Ladder: Read

Text: Read

Min: 1 Max: 7

*This register displays the day of the week from the real time clock. 1 = Sunday, 2 = Monday .**7 = Saturday***SR51 Network Error Count**

Ladder: Read

Text: Read

*This register displays the number of recorded networking errors.***SR52 to SR55 RESERVED**

Ladder: NONE

Text: NONE

*These registers are reserved for future use*

**SR56 Last Key**

Ladder: Read

Text: Read

*This register displays the last keystroke recorded from the keypad.*

*The following table describes the codes produced by the various key events:*

*Note: Not all controllers have keys corresponding to all key events.*

<b>Key Event</b>	<b>Code</b>
No Key	0
F1	1
F2	2
F3	3
F4	4
F5	5
F6	6
F7	7
F8	8
F9	9
F10	10
F11	11
F12	12
Enter	13
+/-	14
. (dot)	15
0	16
1	17
2	18
3	19
4	20
5	21
6	22
7	23
8	24
9	25
System	26
Escape	27
Left	28
Right	29
Up	30
Down	31
Shift	32
Soft Key 1	34
Soft Key 2	35
Soft Key 3	36
Soft Key 4	37
Soft Key 5	38
Soft Key 6	39
Soft Key 7	40
Soft Key 8	41
Release	255

**SR57 LCD Backlight**

Ladder: Read/Write

Text: Read/Write

*This register displays/controls the LCD backlight.*

0	= Backlight OFF
non-zero	= Backlight ON

**SR58 User LEDs**

Ladder: Read/Write

Text: Read/Write

*This registers controls the keypad LEDs on the OCS250. Writing to bit one turns on the LED below the F1 key, writing to bit two turns on the LED below the F2 key.***SR61 Num Ids**

Ladder: Read

Display: Read

This register indicates the number of CsCAN network IDs reserved by the target.

**SR63 Serial Protocol 2**

Ladder: Read

Display: Read

This register displays the current serial protocol for PORT 2 on the controller.

0	Firmware Update (not valid)
1	CsCAN (not valid)
2	Generic Ladder controlled serial
3	Modbus RTU
4	Modbus ASCII

**SR62 to SR180 RESERVED**

Ladder: NONE

Display: NONE

These registers are reserved for future use.

**SR181 Alarms Unacknowledged**

Ladder: Read

Display: Read

*This register is a bitmapped indicator of the advanced alarm manager. Each bit shows if a group has an unacknowledged alarm. For example, if bit one is ON there is an unacknowledged alarm in group one.***SR182 Alarms Active**

Ladder: Read

Display: Read

*This register is a bitmapped indicator of the advanced alarm manager. Each bit shows if a group has an active alarm. For example, if bit one is ON there is an active alarm in group one.***SR183 System Beep**

Ladder: Read

Display: Read

*This register indicates if the system beeper is enabled. If enabled system keypresses and errors are indicated with tones.*



**SR184 User Beep**

Ladder: Read/Write

Display: Read/Write

This register allows the beeper to be controlled via ladder or operator actions.

1	Beeper ON
0	Beeper OFF

**SR185 Screen Saver**

Ladder: Read

Display: Read

This register indicates if the screen saver is enabled.

0	Screen saver is disabled
1	Screen saver is enabled

**SR186 Screen Saver Time**

Ladder: Read

Display: Read

This register indicates the timeout for the screen saver in minutes. If the screen saver is not enabled (See SR185), this register is not used.

**SR187 Network Usage (Avg)**

Ladder: Read

Display: Read

This register indicates the average total CAN network usage. The value is indicated in tenths of a percent. For example, 25 represents 2.5 percent of the total network bandwidth.

**SR188 Network Usage (Min)**

Ladder: Read

Display: Read

This register indicates the minimum total CAN network usage. The value is indicated in tenths of a percent. For example, 25 represents 2.5 percent of the total network bandwidth.

**SR189 Network Usage (Max)**

Ladder: Read

Display: Read

This register indicates the maximum total CAN network usage. The value is indicated in tenths of a percent. For example, 25 represents 2.5 percent of the total network bandwidth.

**SR190 Network TX Usage (Avg)**

Ladder: Read

Display: Read

This register indicates the average CAN network usage transmitted by this device. The value is indicated in tenths of a percent. For example, 25 represents 2.5 percent of the total network bandwidth.

**SR191 Network TX Usage (Min)**

Ladder: Read

Display: Read

This register indicates the minimum CAN network usage transmitted by this device. The value is indicated in tenths of a percent. For example, 25 represents 2.5 percent of the total network bandwidth.

**SR192 Network TX Usage (Max)**

Ladder: Read

Display: Read

This register indicates the maximum CAN network usage transmitted by this device. The value is indicated in tenths of a percent. For example, 25 represents 2.5 percent of the total network bandwidth.

**PREDEFINED I/O POINTS**

Certain I/O Points (memory references) have been predefined. These points are immediately available for use in the programs.

Point	Name	Function
%S01	FST_ScN	Indicate First Scan
%S02	NET_OK	Network is OK
%S03	T_10MS	10mS timebase
%S04	T_100MS	100mS timebase
%S05	T_1SEC	1 second timebase
%S06	IO_OK	I/O is OK
%S07	ALW_ON	Always ON
%S08	ALW_OFF	Always OFF
%K01	F1_Key	Function Key 1 image
%K02	F2_Key	Function Key 2 image
%K03	F3_Key	Function Key 3 image
%K04	F4_Key	Function Key 4 image
%K05	F5_Key	Function Key 5 image
	.	
	.	
%K0x	Fx_Key	Function Key X image

**EXAMPLE #1**

For example, many functions must be called every logic scan regardless of the condition of an other inputs. The ALW\_ON point is used for this purpose:

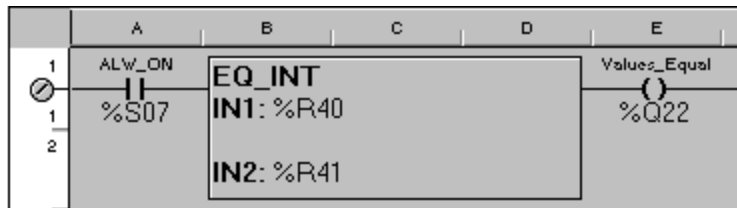

**Alw\_On Example**

**EXAMPLE #2**

The Function Keys are used to provide user-selected input to a program. For example, the following code displays a screen whenever Function Key 4 is pressed:

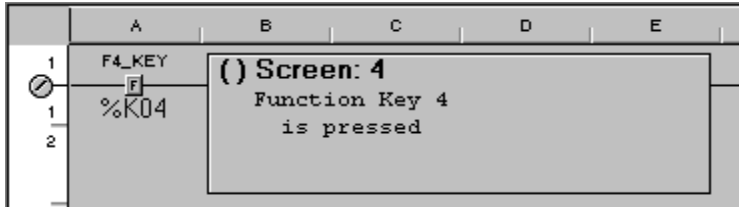

**F4\_Key Example**

NOTES

## CHAPTER 6: HARDWARE REFERENCES (WIRING DIAGRAMS, PIN-OUTS, ETC.)

### 6.1 Hardware References

The following references provide in-depth information regarding installation, wiring, pin-outs, and other technical information for the OCS product line.

<b>Operator Control Station (OCS)</b> OCS1XX / 2XX Graphic OCS250	<i>Control Station Hardware User Manual</i> (MAN0227) provide in-depth information regarding installation, wiring, pin-outs, and other technical information
<b>Remote Control Station (RCS)</b> RCS2XX	
<b>SmartStack Modules</b>	<i>SmartStack Modules User Manual</i> (SUP0246) contains individual data sheets for each module and covers specifications, wiring, and configuration.
<b>Color-Touch Screen</b> OCS300 OCS301 OCS350 OCS351	<i>Color-Touch OCS Hardware</i> (MAN0465)
<b>Fiber Optic Extension System</b> FOX104 / 404	
<b>SmartStack Fiber Optic Expansion Module</b> FOX100 / 110	
<b>Fiber Media Converter</b> SFX100	
<b>Additional References</b>	
<i>DeviceNet<sup>®</sup> Implementation Using Control Station Modules</i> (SUP0326) covers the implementation of Control Station products in a DeviceNet network.	
<i>SmartStack Ethernet Module User Manual</i> (SUP0341-02) covers the SmartStack Ethernet Module for use in Ethernet networks.	

NOTES

## CHAPTER 7: FLOATING POINT (REAL) NUMBERS

A number, which contains an explicit decimal point is known as a REAL or Floating Point number. The numbers are termed "real," because they reflect the real value of a measurement (to the accuracy of the system) in whole units and fractional parts of units without artificial truncation to some less-precise format such as integers.

The location of the decimal point (thus determining the number of whole units and fractional parts) is contained with the number itself. Since for any given real number the decimal point can be in a different position, real numbers are often called floating point. In **Cscape**, the terms "real" and "floating point" are used interchangeably.

### REAL Numbers Format

Real numbers are usually input and displayed as a six digit field:

```
3.12159
654321
```

If the number is too large or too small to be represented using only six digits, the number is displayed as a six-digit field plus an exponent:

```
1.03647e+12
9.73157e-22
```

For display purposes, the format consists of a six-digit value with floating decimal point, and an optional exponent. If the number to be displayed can be displayed in six digits or less, there is no exponent:

```
+3.14159
-654321
12
.001357
-.000032
```

The sign, '+' or '-', is optional. If the sign is not included, then '+' is assumed.

Numbers with more decimal places are displayed using Scientific Notation. This displays a six-digit number with decimal point and an exponent. The exponent part is indicated by the letter 'E' or 'e', the sign of the exponent ('+' or '-') and a two-digit number that is the exponent. For example:

```
.0000000004567    = 4.567e-10
3143286945        = 3.14329e+09
```

Note that in the second example some precision is lost, because there are only six significant digits possible.

Internally, floating point numbers are stored in single-precision 32-bit IEEE format. This format uses a 23-bit mantissa (the value portion), an 8-bit exponent, and a single sign bit.

It is important to note that 32 bits are required for storage. In the OCS this requires two (2) consecutive 16-bit word registers, presumably %R.

**RANGE**

Given the single precision 32-bit IEEE format, acceptable values range from +/-3.40282E+38 (a very small fractional number) to +/-3.40282E+38 (a very large integer number).

**SIGNIFICANT DIGITS**

The real number format supports six (6) significant digits. When more than six (6) significant digits are displayed, only the first six can be counted on for accuracy.

$$\begin{array}{rcl} 3.14159265 & = & 3.14159 \\ 2535.00000045 & = & 2535 \end{array}$$
**ENTERING FLOATING POINT VALUES**

All floating numbers must adhere to the above format.

If an exponent is included, the mantissa (value) portion must also contain a decimal point. Note that if the entered format is *other than*  $x.yyy$ , the decimal point is moved and the exponent adjusted accordingly:

$$\begin{array}{rcl} 123.456e+3 & = & 123456 \quad \text{[The actual value can be displayed with six digits and no exponent]} \\ 143.643E-12 & = & 1.43643E-10 \quad \text{[Decimal point is moved and exponent adjusted]} \end{array}$$

A decimal point must be included to reduce any ambiguities. For example,  $123e10$  should be entered as  $123.0e10$ , or better still  $1.23e12$  (**Cscape** will automatically convert to this format).

Neither the mantissa nor the exponent may contain spaces. "123 45e-12" and "4.3256e -23" will not be interpreted correctly because of the embedded spaces.

Both the mantissa and the exponent may contain a sign, + or -; i.e.: "-1.3245e+12" or "4.243e-8". If the sign is missing then the associated part is assumed to be positive, "1.2345e10".

**ERRORS**

**OVERFLOW** is the most common error. This occurs when the result of a real number operation is greater than  $+3.40282E+38$  or less than  $-3.40282E-38$ . For example, the equation  $1.2345E-20 * 2.3456E-20$  certainly causes this problem.

**INFINITY**

In case of an overflow result, power flow through the offending element is OFF, and the resulting value is set to Positive Infinity (if the value is greater than  $+3.40282E+38$ ) or Negative Infinity (if the value is less than  $-3.40282E+38$ ).

**NOT A NUMBER (NAN)**

If an infinity result is passed through to other calculations, the result can be undefined. This is known as **Not a Number (NAN)**.

In the case of a NAN result, power flow through the offending element is OFF.

If a NAN result is passed through to another element, it feeds through to successive elements.



## CHAPTER 8: STP100 SMARTSTACK MODULE

### 8.1 General

**NOTE:** This is a general overview. Please refer to the User Manual (SUP0270) shipped with the module for more complete discussion of this module's programming and use.

STP100 Single Axis Stepper Controller SmartStack module provides Absolute, Relative, and Indexed stepper move operations for a single axis.

This module uses sixteen (16) Digital Input points (%I), sixteen (16) Digital Output points (%Q), four (4) Analog Input points (%AI), and either seven (7) or fourteen (14) Analog Output points (%AQ), depending the operational mode.

To facilitate STP100 programming, Cscape provides a special Stepper Move function block. The function block acts as a Data Move block to load fixed or variable data into the STP100's %AQ registers. It leaves only the actual sending of the command to be handled at the program's convenience.

### 8.2 Command Bits

The sixteen (16) Digital Output points (%Q) are used as Command Bits.

Point	Description
%Q1	Reserved
%Q2	Reserved
%Q3	Reserved
%Q4	Find Origin Up
%Q5	Find Origin Down
%Q6	Jog Up
%Q7	<b>Jog Down</b>
%Q8	Move Relative
%Q9	Move Absolute
%Q10	Resume Move
%Q11	Move Indexed
%Q12	Reserved
%Q13	Set Current Position
%Q14	Clear Error(s)
%Q15	Decelerate and Stop
%Q16	Immediate Stop

Only one command bit is active at a time. If more than one bit is ON at a time, the bit with the highest number takes precedence. Note that this gives the IMMEDIATE STOP command the highest priority.

Immediately after power up, the Power Up Error Status Bit is ON. The CLEAR ERRORS command must be the first command issued. No other commands are accepted if any error bit is ON.

All command bits are positive (OFF to ON) edge sensitive. The JOG UP and JOG DOWN command are also negative edge sensitive (ON to OFF) as these commands require both a **begin** and **end** signal.

**Note:** The CLEAR ERROR(S) command *must* be issued before any other command is issued. This is an important safety feature.

Not all commands are available at all times. For example, if a MOVE command is in progress, only the DECELERATE AND STOP or IMMEDIATE STOP commands are accepted.

### 8.3 Status Bits

The sixteen (16) Digital Input (%I) points are used as Status Bits:

Point	Description
%I1	Emergency Stop Error
%I2	Lower End Limit Stop Error
%I3	Upper End Limit Stop Error
%I4	Illegal Move Error
%I5	Motor Stalled Error
%I6	Future Use
%I7	Future Use
%I8	Power Up/Watch Dog Error
%I9	Preempted Move is Resumable
%I10	Current Position Valid
%I11	Future Use
%I12	Future Use
%I13	At Home
%I14	Accelerating
%I15	Decelerating
%I16	Moving

Bits 1 through 8 are Error Bits. The condition causing the error is present if the Error Bit is ON. The module does not function so long as any Error Bit is ON. These bits are cleared by issuing the Bit 8, Power Up/WatchDog Error, is TRUE immediately after power up or watchdog timeout and prevents operation of the module until the CLEAR ERROR command is issued.

The CLEAR ERROR command must therefore be the first command issued. No other command is accepted while any error bit is TRUE.

Bits 9 through 16 are Status Bits. The status (ON or OFF) of these bits indicates the status of the condition referenced by these bits. These are NOT errors, and the module continues to function normally in accordance with these bits. These bits are *not* effected by the CLEAR ERRORS command.

### 8.4 Position Feedback Registers

The four (4) Analog Input (%AI) points are used as two (2) DINT (32-bit) registers. The first two points are combined as a single 32-bit register, and the second two points are combined as a 32-bit register.

**NOTE:** Under **Cscape**, references to these register pairs would be specified as DINT.

Point	Description	Range
%AI1	Motor Position Low Word	-8,388,608 - +8,388,607
%AI2	Motor Position High Word	
%AI3	Encoder Position Low Word	-8,388,608 - +8,388,607
%AI4	Encoder Position High Word	

Immediately after reset, the value in these registers is 0 (zero) and is considered invalid as indicated by the CURRENT POSITION VALID Status Bit remaining FALSE.

The Motor Position value remains invalid until either FIND HOME command is issued or the SET CURRENT POSITION command is issued.

If the Motor Position is invalid, the MOVE ABSOLUTE command is not accepted.

### 8.5 Command Data Outputs

These registers contain the data by which the commands operate.

Point	Data Size	Description	Range
%AQ1	32-bit	Destination Low Word	-8,388,608 - +8,388,607
%AQ2		Destination High Word	
%AQ3	16-bit	Velocity Divisor	20 - 65,535
%AQ4	16-bit	Base Velocity	1 - 8,190
%AQ5	16-bit	Running Velocity	2 - 8,191
%AQ6	16-bit	Acceleration Time (mS)	1 - 27,300
%AQ7	16-bit	Deceleration time (mS)	0 - 27,300

The first two points are combined to form a single 32-bit register. This contains the location where the stepping stops. Depending on the instruction issued, this position is an absolute reference from the Origin position or a relative position from the current position.

The **Velocity Divisor** determines the resolution for the Base Velocity and Running Velocity. Refer to the STP100 User Manual for a more complete discussion of this register.

The **Base Velocity** determines the first velocity used when a move starts, and the last velocity used when a move stops.

The **Running Velocity** is the top speed at which the move eventually operates.

In normal operation, a move starts at the Base Velocity, accelerates to the **Running Velocity**, decelerates to the **Base Velocity**, and then stops. The Accelerating, Decelerating, and Moving Status Bits reflects the current operational state.

The **Acceleration Time** is the amount of time the stepper allocates for accelerating between **Base Velocity** and **Running Velocity**.

**Deceleration Time** is the amount of time the stepper allocates for decelerating from **Running Velocity** to **Base Velocity**. If 0 (zero) is selected, the stepper automatically uses the **Acceleration Time** setting.

## 8.6 Indexed Moves

The STP100 can perform indexed moves. To do so, the SmartStack module must be configured to accept an external Index Input, and the Stepper Move function block must also be configured to match.

**NOTE:** All Indexed Moves are relative.

Configuring the Stepper Move Element adds seven (7) additional registers, six of which are combined with each other to form three (3) 32-bit unsigned registers and one (1) 16-bit unsigned register.

Point	Data Size	Description	Range
%AQ8	32-bit	Indexed Destination Position	1 – 16,777,215
%AQ9	16-bit	Indexed Deceleration Time	0 - 27,300
%AQ10	32-bit	Index Window Begin Position	1 – 16,777,215
%AQ11	32-bit	Index Window End position	1 – 16,777,215
%AQ12			
%AQ13			
%AQ14			

The Indexed Move command looks at an external input called INDEX-. This normally expects to see a switch closure or some other electromechanical (optical, magnetic, etc.) device. The input is active LOW. If the Stepper Controller sees the INDEX- input low during the window, the Stepper Controller moves the motor to an alternate position.

The window is defined by the Index Window Begin Position and the Index Window End Position. The INDEX- input is honored *only* while the Stepper Controller is within this range.

**NOTE:** The window period is further limited to that time when the stepper has reached Running Velocity. If the window is defined such that the window attempts to open during acceleration, the window does not open until Running Velocity is reached. Also, the window closes automatically if the move starts to decelerate. If the stepper never reaches Running Velocity, the Index Window does not open.

If the INDEX- input occurs during the window, the Stepper Controller redefines the destination position of the move to be Indexed Destination Position, (%AQ8 / %AQ9) relative to the Current Motor Position (%AI1 / %AI2) at the time INDEX- became active. The deceleration of the move is determined by the Indexed Deceleration Time.

### 8.7 Issuing Commands

The first step to issuing commands is to see that no errors exist. Immediately after Power Up or Reset, the Power Up Error Bit is set, so the first command issued must be the CLEAR ERROR(S) command.

A simple flow chart indicates how the CLEAR ERROR(S) command is affected:

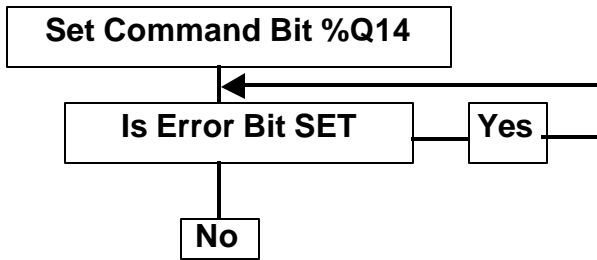

**STEPPER COMMAND FLOW CHART**

At power-up, the position registers (%A11 - %A14) are cleared to zero, and the Current Position Valid status bit (%I9) is OFF. As long as the %I9 bit is off, the Absolute Move command (%Q9) is disabled, because the actual absolute position is unknown. The program needs to issue a FIND Origin UP, FIND Origin DOWN, or SET CURRENT POSITION command in order to validate the position.

Current Position can become invalid (0) if the motor stops suddenly. This can be caused by an Emergency Stop, Lower Limit Error, Upper Limit Error, and Motor Stalled Error or by issuing an IMMEDIATE STOP command.

Other commands are issued in a similar manner:

- a. If there are any errors present, correct the source of the errors then issue the Clear Errors command.
- b. Setup the values for the Stepper Move function block, and then apply power to the Stepper Move function block.
- c. Set the appropriate Command Bit to ON.
- d. Check the appropriate status bits for the command.
- e. Do not issue another command until this command either completes successfully or errors out.

NOTES

## CHAPTER 9 USING ANALOG VALUES WITH CSCAPE AND THE OCS

### 9.1 Overview

Many process control programs require more than simple ON/OFF, OPEN/CLOSED binary control. They must deal with temperatures, flow rates, and levels, which vary in a continuous manner from some minimum to some maximum level. Various sensors are used to measure the quantity and convert it to a voltage or current level. The voltage or current signal is thus a representation or *analog* of the actual quantity.

Digital computers, (i.e. OCS products or a desktop PC) can not deal directly with varying voltage levels. Digital computers accept only two voltage levels -- 0 (zero) and +V. There is a considerable amount of acceptable variation in the definition of those values! In order for an analog voltage or current to be used by a digital computer, a circuit called an *Analog-to-Digital Converter (ADC)* is used. This circuit accepts a voltage or current that is designed to fall within a given range and convert that value into a binary representation that is suitable for use by the digital computer.

For the OCS, there are two classes of ADC Input cards -- straight analog inputs cards, and thermocouple/RTD input cards. The straight card is as described above. A voltage or current analog of some measurement is input into the card. The card then converts this analog value to a binary value to be used by the OCS. The value can represent any measurable quantity -- flow rate, weight, percent used, etc.

The thermocouple/RTD cards are used to measure temperature. Although conceptually identical to the straight card, the thermocouple/RTD card is calibrated to produce readings in degrees or fractions of a degree and is thus much more specific than the straight card.

### 9.2 Analog Conversion

An analog signal can vary smoothly between two distinct values. Mathematically, it is said that an analog signal consists of an infinite number of discrete points between Point A and Point B.

To be useful to the digital computer, the analog signal must be *quantitized* into a finite number of discrete levels. The number of levels is determined by the capabilities of **ADC Module**.

There are several methods used to quantitize the analog signal into discrete levels. *Successive Approximation* is very common, because it offers the best compromise between speed and cost. *Flash Converters* offer extremely high speeds at increased costs. *Dual Slope* converters are highly accurate, very slow, and somewhat more expensive.

Regardless of the method used, the ADC quantizes the analog signal into a series of discrete values or steps. Any analog value within the proper range is converted to a single acceptable binary value. For example, the converter might be designed such that any analog value between 9.9975 volts and 1.0025 volts is converted as 1.000 volts. Any analog value from 9.9925 volts to 9.9975 volts is converted as 9.995 volts. A binary value representing this voltage is then returned to the host computer.

### 9.3 Resolution

The size of the quantization steps is determined by the ADC's *resolution*. Resolution is determined by the number of bits in the binary value that the converter produces. Common values are 10-bit, 12-bit, and 14-bit converters. A 12-bit Analog to Digital Converter produces 12-bit numbers to be read by the OCS.

Given the number of bits of resolution, the number of discrete steps is determined by the formula 2-to-the Nth power, where "N" is the number of bits resolution. Thus, a 10-bit converter has 1024 discrete steps, a 12-bit converter has 4096 discrete steps, and a 14-bit converter has 16384 discrete steps.

Note that *resolution* does NOT describe *accuracy*. Accuracy is concerned with how well the converter *does the job it was designed to do*. A lowly 8-bit converter (256 discrete steps) can be more accurate than a poorly designed or failing 16-bit converter.

#### 9.4 Quantization Step Size

The resolution tells us how small a quantization Step Size is possible. Another way of saying this is how small a change in the analog signal can be measured by the ADC. First, though, we must know the possible values of the incoming analog signal, and then configure an appropriate RANGE for the ADC module. The ADC RANGE selected must be able to handle *all* possible input values or accept all values that are not produced through an error on the part of the process being measured.

In order to produce consistent readings, most SmartStack ADC modules conform to one of the following ranges:

Range	Min. Range	Max. Range
0-to-+10 volts	0 Volts	+10.24 Volts
+/-10 volts	-10.24 Volts	+10.24 Volts
0-to-+5 volts	0 Volts	+5.12 Volts
+/-5 volts	-5.12 Volts	+5.12 Volts
0-to-20 mA	0 mA	+20.48 mA
+/-20 mA	-20.48 mA	+20.48 mA

Most SmartStack ADC modules allow software configuration for two or more of these various ranges.

Once the range for the ADC product is determined, simple math will tell us the quantization step size:

$$\text{Step Size} = (\text{Maximum range} - \text{Minimum Range}) / \text{Resolution}$$

This is best illustrated with an example. Given an ADC product with 12-bit resolution and a +/-10V range [don't forget the over range]:

$$\begin{aligned} \text{Step Size} &= (+1024 - (-10.24)) / 4096 \\ \text{Step Size} &= 20.48 / 4096 \\ \text{Step Size} &= 0.005 \text{ volts} = 5 \text{ millivolts} \end{aligned}$$

Or, with a 0-to-+5 Volt range::

$$\begin{aligned} \text{Step Size} &= (+5.12 - 0) / 4096 \\ \text{Step Size} &= 5.12 / 4096 \\ \text{Step Size} &= 0.00125 \text{ volts} = 1.25 \text{ millivolts} \end{aligned}$$

**NOTE:** It is important that the over range capability of SmartStack modules be included as part of the computation.

In the first example, this tells us that any change in the analog input signal *of at least 5 millivolts* should produce a change in the binary value. This is the smallest change in signal that can be *reasonably expected* to be recovered as a change in the binary value.

It does *not* say that a smaller change does *not* produce a change in the binary value. A change might be produced depending on both the before and after analog values. To *guarantee* a change in the binary value, the signals must change by *at least 5 millivolts*.



This value is also referred to as "1 LSB." A change in the binary value of 1 count represents a change of 5 millivolts in the analog signal.

Another term that is often used is "1/2 LSB." In this case, the value is 2.5 millivolts or 1/2 of the "1 LSB" value.

### 9.5 Quantitized Value

As previously discussed, the ADC module converts the continuously-variable analog input to series of discretely quantitized values. Then what quantitized value is produced for any given analog input?

Again, refer to the range and resolution of the ADC Module. Given a range of +/- 10V (Actually +/-10.24 to account for SmartStack over range capabilities) and 12-bit (4096 step) resolution, it is determined that the step size is 5 millivolts.

Due to alignment, the most negative analog input (in this case -10.24 volts) produces a binary value of "000" (zero). The conversion points are offset by 1/2 LSB, so inputting a value of less than -10.2375 volts produces a binary value of "0000". Inputting a value between -10.2375 and -10.2325 volts produces a binary reading of "0001" and so on until an analog input of greater than +10.2375 is applied, and the binary reading is "4095". In this system, if the analog input is exactly 0.000 (zero) volts, the converter binary value is "2048."

If the resolution of the converter is changed *but not the range*, the converted value is different. For example, if the SmartStack module is replaced with a 14-bit version (16384 steps) the step size is 1.25 millivolts. If the range is kept at +/-10.24 volts, the -10.24 volts input is converted to "0." The +10.24 volt input is converted to "16383", and 0.000 volts is converted to "8192."

### 9.6 Normalized Analog Values

It is obvious that any ladder program using these values are aware of the ADC module used and that upgrading the ADC module requires rewriting the ladder program to accommodate the new values.

**Cscape** and the OCS products provide for *normalized* values to be returned from the SmartStack module to the ladder program. Normalized values have been converted from the resolution-dependent raw binary value to a consistent range of -32000 to +32000 (given nominal positive and negative analog input values). The value is also offset such that the polarity of the normalized value tracks the polarity of the input signal (i.e., positive voltages are represented by positive normalized values and negative voltages are represented by negative normalized values). An analog input signal of exactly 0.000 volts is recovered to a converted binary value of "000."

Normalization works by assigning the most negative normalized value to represent the most negative analog value, and the most positive normalized value to the most positive analog value. For a +/-10V range, "-32768" represents -10.24 volts, and "+32767" represents +10.24 volts

Although this same feat could have been handled by a few rungs of ladder logic programming, normalization is handled by the OCS before the value is every presented to the ladder program. Normalization is completely invisible to the program.

Given any analog input value, the expected normalized value can easily be determined:

$$\text{Converted Value} = (\text{Input Value} / \text{Max Range}) * 32768$$

Where: Max Range is the maximum acceptable input value (including over range) for the configured range. +/-10V = "10.24"; +/-5 = "5.12", +/-20 mA = "20.48".

For example, the analog input is 4.23 volts. Given a range of +/-10V:

$$\begin{aligned} \text{Converted Value} &= (4.23 \text{ Value} / 10.24) * 32768 \\ \text{Converted Value} &= .41308 * 32768 \\ \text{Converted Value} &= 13536 \end{aligned}$$

But given a range of +/-5 volts:

$$\begin{aligned} \text{Converted Value} &= (4.23 \text{ Value} / 5.12) * 32768 \\ \text{Converted Value} &= .826127 * 32768 \\ \text{Converted Value} &= 27072 \end{aligned}$$

Not all values between -32768 and +32767 are available. This is because the resolution of the converter divides the possible normalized values into 2-to-the-Nth steps. For example, using a 12-bit converter and a +/-10 volt range, the possible range of normalized values (65535) is divided into 4096 steps of 16 counts each. Each step represents 5 millivolts.

Thus, if 0.000 volts produces a normalized reading of 0 (zero), then an input of positive 5 millivolts produces a normalized reading of "0016," an input of positive 10 millivolts produces a normalized reading of "0032," and an input of negative 20 millivolts produces a normalized reading of "-0064", etc.

There is also some mathematical inaccuracy involved in the normalization process. The step size is not exactly 16 counts (in this example). Therefore, the expected normalized value itself varies by +/-1 count.

Exact, single point readings are not often required, however. In most case the normalized values are further processed into ranges -- Low/Medium/High, or a percentage of some arbitrary scale. In those rare cases where the exact pinpointing of some value is necessary, the desired value is "bracketed" using program elements:

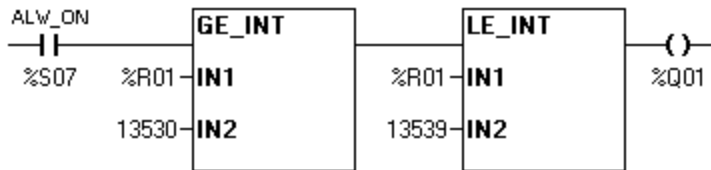

#### EXAMPLE TEMPERATURE BRACKETING

The above rung states that any normalized value between "13530" and "13539" activates the output coil. The expected value of 13536 +/-1 is within this range.

### 9.7 UNIPOLAR SIGNALS

Signals, which range only positive (or only negative) with respect to the 0.0 reference are know as *unipolar* signals. Signals, which range both positive and negative with respect to 0.0 reference, are know as *bipolar* signals.

Unipolar signals are treated the same as bipolar signals. However, when the SmartStack module is configured for a unipolar range (0-to-+10V, for example), the full resolution of the ADC is applied to this range. The *apparent* resolution is thus doubled, because the physical range is halved when compared to its bipolar counterpart (+/-10V). Thus, for unipolar signals, a smaller change in input can be resolved.

This does not change the expected normalized value. However, any ladder logic bracketing can need to be tightened as the unipolar step size is smaller due to the decreased range.

### 9.8 Caveats (Analog Circuits)

Analog circuits are notoriously fickle concerning temperature and drift. (That's one reason why the world went digital in items like CDs, music synthesizers, and cellular phones). It is extremely difficult to get an analog circuit aligned *EXACTLY*. Therefore, the converted values may not be exactly as determined using the mathematics described.

It is suggested to try some experiments using known values from the process and see what values they actually convert to. The converted values should be close to ideal but may vary by several counts. Use the actual values in your ladder code and do not insist on the absolute ideals.

Analog values can drift with time and temperature. While the SmartStack modules have very little analog circuitry to drift, the analog input signal might. If readings appear to drift from the normal values determined experimentally, suspect problems at the *source* of the voltage - not in the SmartStack module.

### 9.9 Noise

Noise plays a large role in any analog installation. Noise must be reduced to an absolute minimum, especially where 14-bit and 16-bit converters are used. Sources of noise include power supply ripple, hum, and switching noise, electromagnetically induced noise (noise picked up when the wires in the system acts as an antenna), and ground-induced noise ("ground loops"). Most of the noise is produced by the input source itself - not the ADC.

The greater the ADC resolution, the smaller the acceptable noise value. Given a +/-10 volts range and a 10-bit ADC, the noise level *could be* as great as 0.02 volts (20 millivolts), but using a 12-bit converter, the noise is kept below 5 millivolts.

A pure input source (zero noise) is impossible. Some noise creeps into the system, even with exceptional efforts to reduce it. The effects of the noise on the converted reading (and thus the normalized value) are determined by the resolution of the converter and the value of the analog input. The amount of noise in the system must be known and reduced to an acceptable value.

For example, assume that the converters quantization points are set up such that any reading *less than* -0.0025 volts produces a binary value of "2047", any value *greater than* +0.0025 volts will produce a binary value of "2049", and any value *between* -0.0025 and +0.0025 produces a binary value of "2048". [This describes an ADC with +/-10V range and 12-bit resolution.]

For the first example, assume that the input voltage is *EXACTLY* 0.000 volts, and has a noise level of 4 millivolts. This is the sum of all possible noise sources. With this information we understand that *at any possible instant* the instantaneous voltage level to be converted could range from -0.002 to +0.002 volts. From the above information, all of these possible voltage levels will be properly converted to a binary value of "2048".

For the second example, assume that the input voltage is *EXACTLY* +0.001 volts, and has a noise level of 4 millivolts. *At any possible instant* the instantaneous voltage level to be converted ranges from -0.0001 to +0.003 volts. +0.003 volts is converted as a binary value of "2049." Depending on exactly when the conversion takes place, the converted binary value is either "2048" or "2049."

For the third example, assume an input voltage of *EXACTLY* 0.000 volts, and a noise level of 6 millivolts. In this case, the instantaneous voltage ranges from -0.003 to +0.003 volts. The converted binary values are "2047", "2048" or "2049", depending on when the conversion takes place.

This is often called "bobble." Due the acknowledged presence of noise in the system, a small amount of bobble is acceptable but must be accounted for. The goal is to keep the amount of bobble to +/-1 binary count from the expected value. This would represent a noise level less than 1 LSB, or less than 5 millivolts in the above example. More noise (and thus more bobble) is acceptable in some systems.

Bobble in the converted values is normalized. In the above example, each bobble in the converted binary reading represents 16 counts (+/-1 count) in the normalized value. In the above examples, a binary reading of "2048" is normalized to "0000 +/-1," a binary value of "2047" is normalized to "-0016 +/-1", and a binary value of "2049" is normalize to "+0016 +/-1." In order to accept this amount of noise in the system, use ladder logic to bracket the value for 0.000 volts (presumably "0000") between "-0017" and "+0017".

Of course, the acceptable noise level is determined in part by the ADC resolution. Using a 10-bit converter instead of the 12-bit converter increases the acceptable noise levels by a factor of four.

See Also: Thermocouple And Resistance Temperature Devices (Rtd).

## CHAPTER 10: THERMOCOUPLES & RESISTANCE TEMPERATURE DEVICES (RTD)

### 10.1 General

Thermocouple and RTD input SmartStack modules work on the same principle as the straight **ADC modules**, but their output is converted to degrees rather than an arbitrary -32000-to-+32000 scale. Also, the thermocouple input modules provide software linearization of the readings while the straight ADC module converts the values as received, and performs only a normalization process.

### 10.2 Resistance Temperature Device (RTD)

A Resistance Temperature Device (RTD) is a device that behaves as a temperature-dependent resistor. It is made of platinum and the resistance versus temperature "transfer curve" is well known. RTD devices are generally useful in the temperature range of -200°C to +600°C. The standard RTD measures 100.00 ohms at 0.0°C. 200 ohms, 500 ohms, and 1000 ohms are also commonly available.

RTDs are also rated in terms of *ALPHA* (also know as Temperature Coefficient of Resistance or TCR). This is a measure of the devices curve. *Alpha* is a direct result of the purity of the platinum used with higher *alphas* representing the purest platinum. Typically alphas for RTDs are in the 0.00375 to 0.003927 range; 0.003927 represents the purest device. Most common devices have alpha of .00385. The most important point to know about alpha is that when one replaces an exist RTD one must replace it with one with a matching alpha.

The change in resistance of the RTD is measured using a Wheatstone Bridge circuit. The Wheatstone Bridge works by providing a four-legged resistance bridge, one of whose legs is the RTD device. Any change in the RTD resistance unbalances the bridge, and the resulting current flow can be measured and converted to a voltage, which is then sent to an **Analog-to-Digital Converter (ADC)** circuit. The ADC converts the voltage reading to a binary value usable by a digital computer.

For any change in temperature, the change in RTD resistance is very small. So small, in fact, that it is often overloaded (swamped) by the resistance of the wires used to connect the RTD to the RTD Input Module. Because of this, two variations of the RTD are most often used. These are called "Three Wire" and "Four Wire" RTDs. By adding the extra wires, the resistance of the wire can be placed into the measurement circuit such that the resistances of the leads wires cancel each other making the RTD resistance the dominant factor in determining the reading.

### 10.3 Thermocouples (THM)

A thermocouple, in it's basic simplicity, is just two pieces of wire made from dissimilar metals which is then twisted together. Thermocouples make use of the Seebeck Effect. Mr. Seebeck discovered that any two dissimilar metal wires, when wrapped together or fused at one end generates a voltage when the junction was heated.

The amount of voltage generated is determined by the two metals and the amount of heat applied. This is called the Seebeck Coefficient. The Seebeck Coefficient, however, is very low (typically only a few microvolts per degree change in temperature, and at most only a few millivolts maximum output). Also, (the transfer curve the relationship between amount of heat and voltage output) tends to be non-linear.

Further experimentation over the past 170 years has developed combinations of metals and alloys that produce a relatively high output level (although still in the microvolt-per-degree region) and can withstand various environmental factors such as higher heat, corrosive atmospheres or radioactivity.

Here are some common thermocouple metals and alloys:

Copper	100% pure copper
Iron	100% pure iron
Platinum	100% pure platinum
	45% nickel 55% copper
Chromel	90% nickel 10% chromium
Alumel	95% nickel 2% aluminum, 2% manganese, 1% silicon
Nicrosil	84.6% nickel 14% chromium 1.4% silicon
Nisil	95.6% nickel 4.4% silicon

Various combinations of wires have become available over the years and have been accepted by the American National Standard Institute (ANSI) primarily because of the repeatability of the transfer curve for these combinations.

Type	Positive Lead	Negative Lead	Range	Special Features
C	5% Rhenium	26% Rhenium	- 4200 °F	Poor oxidation. Must be used in vacuum, hydrogen, or inert atmosphere.
E	Chromel	Constantan	-300 - 1650 F	May drift in 600 - 1100 F range.
J	100% iron	Constantan	0 - 1500 °F	Stable. No drift in 700 - 1000 F range
K	Chromel	Alumel	-300 - 2300 °F	May drift in 600 - 1000 F range.
T	100% copper	Constantan	-300 - 660 °F	Very stable for low temp ranges.
N	Nicrosil	Nisil	0 - 2300 °F.	More stable in 600 - 1100 F range More resistant to nuclear radiation than Type K
R	13% rhodium	100% platinum	0 - 2700 °F.	High resistance to oxidation and corrosion. Can be contaminated by hydrogen or carbon vapors
S	10% rhodium	100% platinum	0 - 2700 °F.	Can be contaminated by hydrogen or carbon vapors
B	30% rhodium	6% rhodium	1600 - 3100 °F	High resistance to oxidation and corrosion. Can be contaminated by hydrogen or carbon vapors.
<p><b>NOTE:</b> Not all thermocouple types are supported by SmartStack modules.  <b>NOTE:</b> Ranges given are approximate. Sensors from specific manufacturers may have more specific ranges.  <b>NOTE:</b> Type 'C' is not ANSI standard.</p>				

Below is a chart of some of the more common thermocouple transfer curves:

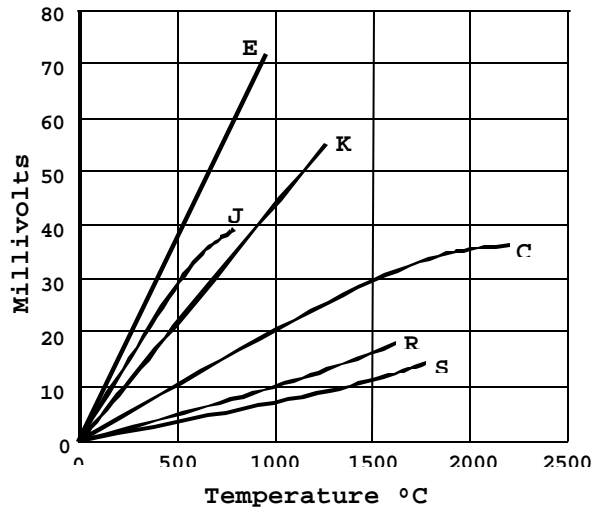

Although the voltage output of a thermocouple is very small, it can be converted to a binary reading using an **ADC circuit**. Even though the transfer curve is non-linear, once the ANSI Type is known, the reading can be converted to a linear binary reading using computer software. It is important, then, that the SmartStack module be properly configured for the thermocouple type to be used and that the thermocouple type not be changed without reconfiguring the SmartStack module.

The Seebeck Effect is also the major drawback of thermocouples. *ANY* two dissimilar metals will generate a voltage when junctioned. This means that standard copper wire can NOT be used to extend the leads of a thermocouple (except the positive lead of the Type T) because the copper/other metal junction will introduce its own Seebeck voltage, thus causing an error in the voltage.

Thermocouple installations must use special Thermocouple Extension Wire. In fact, all metal-to-metal junctions in the installation -- jacks, plugs, patch panels, etc. -- must be of the same Type as the thermocouple. This can get quite expensive if the sensing junction is located a significant distance from the Thermocouple Input card.

Thermocouple Extension Wire is made of the exact same materials as the thermocouple itself, but exhibit a lower temperatures range and are thus lower in cost. Compensating Alloy wires may also be used. Compensating Alloys are alloys that exhibit Seebeck Coefficients identical to the thermocouple, but are also lower cost.

#### 10.4 Cold Junction Compensation

But dissimilar metal junctions simply can not be avoided completely. There will also be a dissimilar metal junction at the point where the thermocouple (or extension) wires enters the Thermocouple Input card. This junction will also generate Seebeck voltage, and thus introduce errors into the system. This error, though, can be compensated for using Cold Junction Compensation.

The classic method of Cold Junction Compensation is to use a second, identical type thermocouple wired in series with the measuring junction. The second thermocouple is kept at a constant temperature, ideally 0°C, thus the terminology *Cold Junction*.

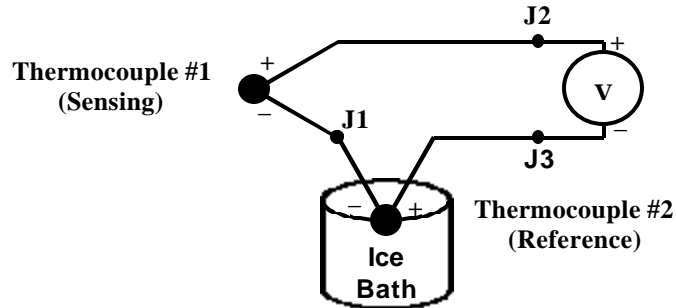

In operation, the two negative leads of the thermocouples are connected together at J1. Since these wires are of the same material there is no Seebeck voltage from this junction. The two remaining positive leads are taken to the input terminals of the Thermocouple Input card. There will be a Seebeck voltage produced by these junctions, but it will be identical at both connectors. Since the two voltages are on opposite sides of the measuring device they cancel each other out.

With the above wiring, the voltage from Thermocouple #2 subtracts from that of Thermocouple #1. But thermocouple #2 is held at a constant 0°C, and the amount of voltage produced by this thermocouple at this temperature is well known by ANSI standards. It is a simple matter to use the digital computer to correct for this constant error by simply adding it back into the reading.

But maintaining a constant 0°C temperature can in itself be expensive and time consuming. SmartStack Thermocouple Input Modules also allow for both Internal and Remote Cold Junction Compensation. With Internal Compensation, a semiconductor temperature sensing device is placed near the wiring connectors on the SmartStack module, where the thermocouple wires are attached to the SmartStack module. The SmartStack module can now measure the temperature at the input connection and mathematically correct the thermocouple voltage readings. With the SmartStack module this compensation is automatic. Note, however, that proper Thermocouple Extension Wires *must* be used between the thermocouple and the Smartstack module.

With Remote Compensation, the semiconductor sensing device is placed in a remote head terminal block. The thermocouple is also attached to the head, thus the Seebeck Effect is located at the "head joints". The head can be located some distance from the host computer, presumably near but not in the environment to be measured. Signals from the thermocouple and the semiconductor device are brought back to the SmartStack module using standard (low cost) copper wiring, whose junctions (and any possible Seebeck Effect) are also at the "head joints".

The SmartStack and OCS can now measure the temperature at the head end, and mathematically correct the thermocouple voltage readings. Of course, the SmartStack has the automatic Internal Compensation, which must be disabled, but this is also automatic with the SmartStack module.

## 10.5 SmartStack Input Values

SmartStack Thermocouple and RTD input modules are designed to return readings that are already calibrated in degrees. Both Centigrade (°C) and Fahrenheit (°F) conversions are available. Resolution is usually 0.05°, 0.1°, or 0.5°.

The value returned is a signed integer that represents a fraction of a degree. For example, if the temperature is 100°C and the resolution is set for 0.5°C, the reading returned is 200. This means that the temperature is 200 increments of 0.5° each. The same temperature can be represented as 1000 increments of 0.1° each or 2000 increments of 0.05° each.



It is recommended that Thermocouple and RTD readings be maintained and manipulated in their integer format whenever possible. This avoids the use of time-consuming Real Number (floating point) elements.

If fractions of a degree are not required, simple integer math elements can be used to convert the value directly to degrees:

If the setting is 0.5 degree

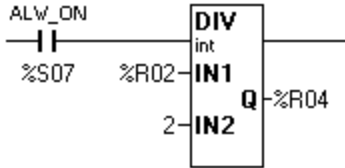

**Example Divide By Two**

If the setting is 0.1 degree

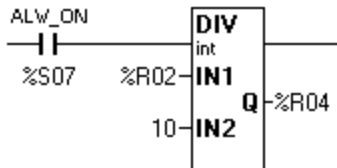

**Example Divide By 10**

If the setting is 0.05 degree

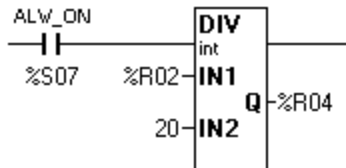

**Example Divide By 20**

NOTES

## CHAPTER 11: FORCING PHYSICAL AND NETWORK I/O

**Warning:** Forcing I/O allows physical inputs to be overridden or physical outputs to be activated. Without full knowledge of the system this can cause personal injury or equipment damage.

### 11.1 Enabling Forcing

Forcing must be enabled on the controller before forcing registers. Select the **Debug** menu, then goto the **Forcing sub menu** and select **Forcing Enabled**.

If items are forced and the **Forcing Enabled** is turned OFF, the controller no longer forces the I/O but retains the list of forced items. Re-enabling the forcing resumes forcing using the last set of forcing states. The Forcing Enable and Forcing Table are stored in battery-backed memory on the controller and are retained through a power cycle.

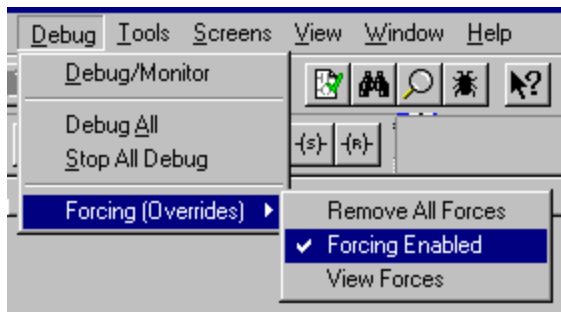

Figure 11.1

Selecting the **Remove All Forces** from the Forcing sub menu does not disable forcing but clears the list of registers being forced.

### 11.2 Forcing a Contact or Coil

Once forcing is enabled, start debugging the ladder program that contains the registers to force. Currently, only contacts and coils referencing %I, %Q, %IG, %QG, %AI, %AQ, %AIG, and %AQG can be forced.

Right-click on the contact or coil that is to be forced and select the Force sub menu. Now select Force ON to force the register ON(1), Force OFF to force the register OFF (0), or Remove Force to stop forcing the register and allow normal ladder control of the register.

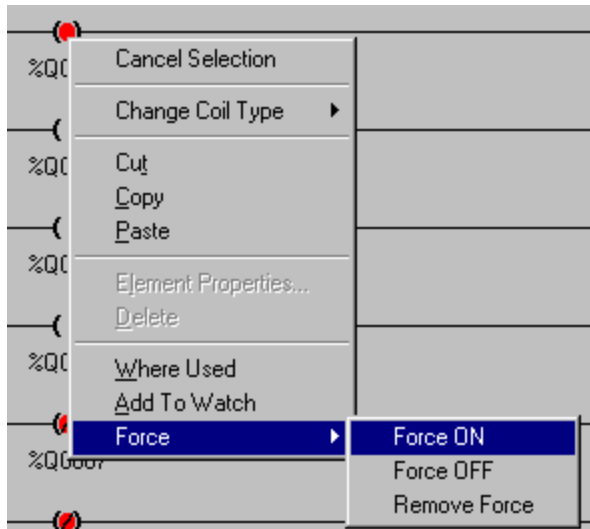

Figure 11.2

**Note:** Forcing is intended to simulate physical or network inputs and to stimulate physical or network outputs for testing purposes. When an output is forced, ladder logic is still allowed to write and change the forced register. Once the ladder scan is complete, the register is updated with its forced value, and the physical output is updated. For example, if %Q1 is forced ON, yet a coil turns %Q1 OFF, any contacts after the coil act as if %Q1 is OFF. When the scan is complete, %Q1 is forced ON before the physical outputs are updated.

The following is a list of events completed during the scan loop:

1. Read the physical and network inputs
2. Override any forced inputs
3. Execute the ladder logic
4. Override any forced outputs
5. Write the physical and network outputs
6. Go back to item 1

### 11.3 Registers

When a register is forced and the program is being debugged, the forced state is indicated by a black box filled with yellow around the contact or coil. Contacts or coils that are forced ON are filled with RED while contacts or coils that are forced OFF are not filled.

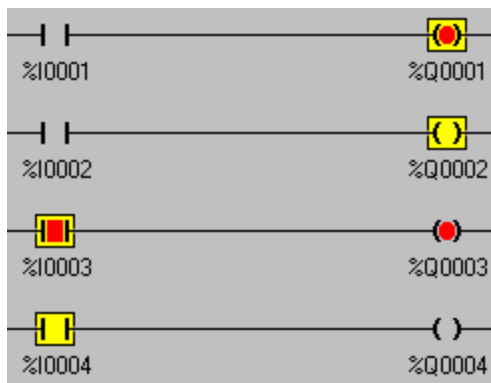

Figure 11.3

### 11.4 Indicators of Forcing

When one or more registers are forced and forcing is enabled, the status bar shows [FORCED] after the target status. When forcing is not enabled OR no items are being forced, the status bar shows [no forces].



Figure 11.4

When forcing is enabled, %S12 becomes active. When forcing is enabled and one or more registers are being forced, %S11 becomes active.

When %S11 is active, the controller flashes the OK LED to indicate one or more registers are being overridden.

### 11.5 Viewing a List of Forced Items

To view a list of the registers being forced, select the Debug menu, then the Forcing sub menu, and then choose View Forces. This displays the dialog shown below.

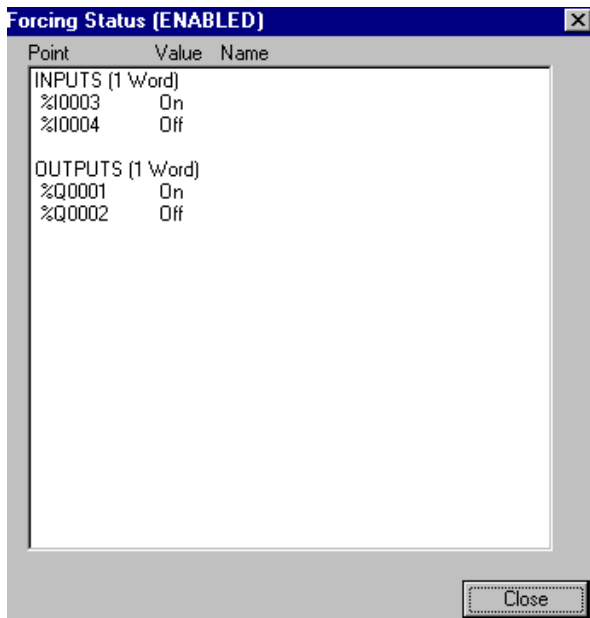

Figure 11.5 – Dialog View Forcing

The title bar of this dialog shows (ENABLED) or (DISABLED) to indicate if forcing is enable or disabled on the target controller. The forcing table is divided into two sections: INPUTS and OUTPUTS. INPUTS indicate contacts that were forced while OUTPUTS indicate coils that are being forced. Under each of these sections is a list of registers and the current force state (ON or OFF) of the register.

Because forcing information is stored in battery-backed ram, there is a limit to the number of contacts and coils that can be forced. After the title **INPUTS** or **OUTPUTS** there is a number of **WORDS** used in the forcing table, "(1 Word)". Every 16 consecutive register bits require 1 WORD of forcing space. At the time of printing the controller limit was set to 42 WORDs of forcing, which allows a combination of up to 672 contacts and coils to be forced. If the registers forced are not sequential, this number can be lower. Cscape keeps track of this resource and generates an error message if the forcing table becomes full.

## CHAPTER 12 : PID CONTROLS

### 12.1 Terminology

Some terms need to be defined in order for a meaningful discussion of PID performance to be presented.

PID  
Setpoint  
Control Variable  
Process Variable  
Bias  
Proportional Control  
Integral Control  
Derivative Control

K -- Process Open Loop Gain as figured by  $PV_{step} / CV_{step}$ .

K<sub>p</sub> -- Proportional Gain. This is the amount of Error Value that is ultimately fed back to the system. Sometimes called Controller Gain (K<sub>c</sub>).

K<sub>i</sub> -- Integral Gain. Actually a time period defining how often the Error is "integrated". Faster time is the equivalent of higher gain in the Integral portion.

K<sub>d</sub> -- Derivative Gain. This tells how much of the rate-of-change is fed back to the system.

SP -- Setpoint. This is the value that the the process needs to reach and maintain.

PV -- Process Variable. This is the measured output of the process -- temperature, pressure, etc.

CV -- Control Variable. This is the result of the PID function which is applied to the process in order to control it. This value contains components of Proportional, Integral, Derivative, and Bias.

### 12.2 Overview

In a typical industrial process, one often wants to control some parameter of a process such as heat or pressure. This can be done in an *open loop* fashion:

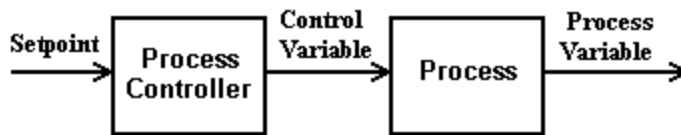

**NON-LOOPED CONTROL**

In such a system, the Process Controller accepts some value from the user. This value is called the *Setpoint*. The Process Controller then generates a value to be sent to the process called the *Control Variable*. The desired parameter is the *Process Variable*, which changes in response to the value sent by the Process Controller.

The problem with this system is that there is no way for the Process Controller to determine if the process is actually producing the proper Process Variable. The Process Controller must assume that the process completes its job quickly and accurately. In many cases, this is sufficient.

But these assumptions are often incorrect or inaccurate. The process may simply be inaccurate in itself. For example, a heater can be told to produce 350 degrees but actually produces 400 degrees. There is also the possibility that changes in the process itself may produce errors. For example, adding hot or cold materials to a process certainly changes the temperature of the process.

Any change in the system that produces a change in the *Process Variable* is called a *disruption*. A disruption can be caused by purposely changing the Setpoint or can be a side effect of some process activity like adding or subtracting material from the process. The control system needs to respond equally well to disruptions at either point and to both positive-going and negative-going changes.

Most process control systems use *feedback*. This is called a *closed loop system*. In these systems, the *Process Variable* is measured, and that value returned to the Process Controller:

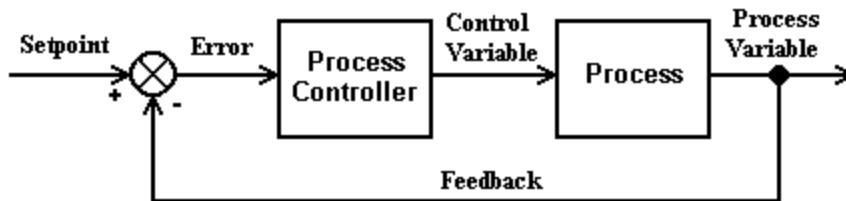

**PROCESS WITH FEEDBACK**

Such a process can respond to both changes in the Setpoint value and to changes in the process or *load*. Change the setpoint, and the controller tries to drive the process to the new value. Change the value of the *Process Variable* and the controller tries to drive the process back to the Setpoint value.

The question in this situation is, "What do we do with the feedback?" In most applications, the feedback is subtracted from the setpoint to produce a value called *Error*. The magnitude of Error is determined by the difference between the Setpoint value and the Process Variable value. For example, a simple temperature controller might accept a setpoint of 350 degrees. The Process Variable measures 200 degrees. Therefore, the Error value is 150 degrees.

The first thought is to add the Error to the Setpoint, and use this value to drive the process towards the desired value in less time. In the above example, adding the 350 degrees Setpoint and the 150 degrees Error attempts to drive the process to 500 degrees, which would have the effect of causing the process to heat up faster.

On the next reading, the Process Variable is found to be 250 degrees making the Error 100 degrees. The controller adds the Error to the Setpoint and tries to drive the process towards 450 degrees. Further readings find the process warmer. The Error is smaller, and the process moves slowly towards the final temperature.

The problem with such an arrangement is that the process can change too much before the changes from the controller can affect it. In the above example, the process might actually go to 400 or more degrees before the controller can bring it back down. Conversely, the temperature can drop significantly before the controller makes the necessary changes.

### 12.3 Proportional Control

A controller, which performs the above action is known as a *Proportional Controller*. In practice, Error is actually a portion (often expressed in percent) of the full-range error. In the above example, if the Error is 150 degrees, the controller might be programmed to add only 20% - 30% of the full error value. The process takes longer to change since it is not being driven as hard, but full control is more accurate.



The following is a graph of a typical process under Proportional control only:

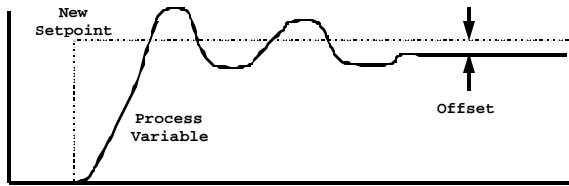

Proportional control often has an *Offset* factor. That is, the process almost never has 0 error. This can be caused by a variety of reasons, all of which are outside the realm of control of the Proportional function.

On the other hand, adding too much Proportional control can cause the process to oscillate and go further out of control:

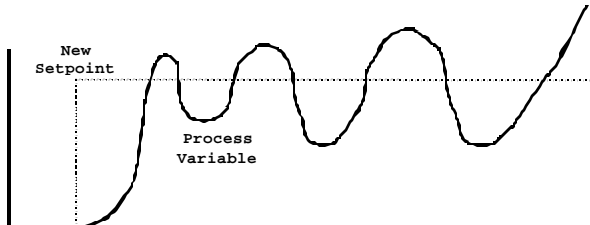

There is almost always a lag or time delay in the process. Most Process Variables can not change instantly. This is especially true of heat-related processes. Change in heat can be very slow. Pressure changes and flow rates can also be tardy. These are all due to physical factors in the system and are usually outside the realm of control of the Process Controller.

#### 12.4 Bias

If the offset in a process is constant, it can be removed by simply adding an equal-but-opposite value, called *BIAS*. This is a fixed value, which is determined by the user but is no changed or operated on by the PID control. Many processes can be effectively controlled using on Proportional control and a little bias.

#### 12.5 Integral Control

Integral functions are added to reduce the offset error amount. The Integral function works by measuring how long an error lasts and produces an additional error value that is added into the equation. This value is tuned such that it almost completely eliminates the Proportional Offset error.

The collecting and smoothing of values over time is known as *integration*. Because of the integrating action, the Integral portion of the control does not take full effect until the Process Variable starts to approach a steady-state (i.e., correction value become less and less significant) value. Quick changes in error are "smoothed out" by the integrating action, and have less effect on the process. As the Process Variable approaches steady-state, the Integral Error value becomes more important, and thus, serves to reduce the offset introduced by the Proportional control.

The problem with Integral control is that it does not respond well to quick changes in either the Setpoint or Process Variable. Although Integral control helps *keep* the process at a particular Setpoint, if either the Setpoint or Process Variable changes quickly, the Integral control has little effect.

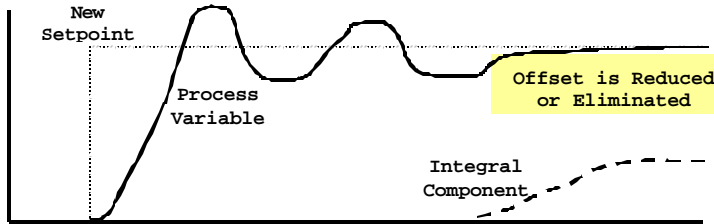

Many processes respond well to Proportional-plus-Integral Control. In this case, Bias is reduced to 0 (zero).

### 12.6 Derivative Control

The Derivative Control is introduced to handle quick changes in the process. The Derivative Control produces yet a third error signal based on the *slope* of the Error, or how much the error value changes in a given time period. When a change is first requested, the Error Slope is relatively steep and the Derivative portion of the error is significant. As the process reaches steady state the Error Slope will be shallow, and the effect of the Derivative control is reduced.

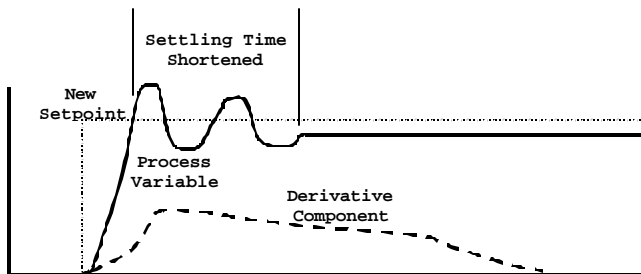

### 12.7 PID

Proportional-only control is sufficient for a large number of processes, but neither Integral nor Derivative control alone is sufficient to control a process. Integral and Derivative are helpers, which respond to differing condition of the process.

PID is an acronym for **P**roportional **I**ntegral **D**erivative. PID is a function that applies all three methods simultaneously in order to generate the controller output value. Not only is such a function concerned with the raw error (proportional), but it also considers how long the error has been in effect (integral) and how quickly the error value is changing (derivative).

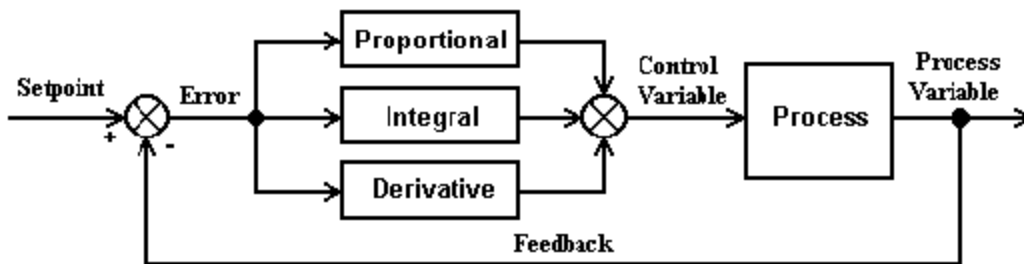

When the process is first disrupted, the Proportional component attempts to make changes in the Controller Output. The Derivative aspect measures how great those changes are and adds a bit more of its value, thus making the controller act more aggressively to bring the process back to the setpoint. The Integral aspect has little effect here, because the error values vary greatly.

As the process comes more into control, the magnitude of the Error begins to reduce. The Proportional component is still driving the process towards the setpoint, but with the change in errors becoming smaller and smaller, the Derivative component begins to be reduced. The Integral component, seeing that the error value is approaching a steady state value, begins to assert itself in order to reduce the errors due to offset.

Once the process reaches steady state, the Proportional component is producing very small error values and is attempting to produce some offset value. The Integral component measures how long the Error stays at one value, and produces its own error signal to compensate. Since the rate of change in Error is small, the Derivative component is almost non-existent.

There are two common methods of implementing a PID function -- the Independent Method and the ISA Method.

**Independent PID** =  $(K_p * \text{Error}) + (K_i * \text{Error} * dt) + (K_d * \text{Derivative}) + \text{CVBias}$

#### ISA PID

$\text{CVout} = K_p * (\text{Error} + (\text{Error} * dt / T_i) + (T_d * \text{Derivative})) + \text{CVBias}$

Where:

**dt** = Internal elapsed time clock - previous elapsed time clock

**Derivative** =  $(\text{Error} - \text{previous Error})/dt$

--or--

**Derivative** =  $(pv - \text{previous PV})/dt$

[User selectable during configuration].

**Ti** = Integral time

**Td** = Derivative time

The Independent PID is considered the standard. Although both methods provide the same results, the ISA PID is often easier to tune.

**CVBias** is an additive term separate from the PID components. This is most commonly used where only the Proportional ( $K_p$ ) term is used (a **proportional-only** element). This forces CV Output to some non-zero value when the Process Variable (PV) is equal to the Setpoint (SP). **CVBias** is generally not used (set to 0) if the Integral term is used.

## 12.8 TUNING PID LOOPS

The object of a PID loop is, given a change in either the Setpoint **SP** or Process Variable **PV**, generate a Control Variable **CV** such that **PV** is driven towards and eventually stabilized at a value equal to the **SP**. This is done as rapidly as possible and with minimum fluctuations about the final value.

In order to meet these goals, the PID system must be tuned. That is, proper values must be selected for  $K_p$ ,  $K_i$ , and  $K_d$  such that for any disruption in the process the process is returned to the desired value as quickly and as accurately as possible. These two requirements are usually mutually exclusive. A process can be controlled quickly but with less accuracy, or slower but more accurate. It is up to the process engineer to determine the optimal compromise between these two points and make adjustment to the PID function (tune it) accordingly.

PID Tuning is considered difficult.

Users often use the trial and error method of tuning. Adjust the  $\kappa_p$ ,  $\kappa_i$ , and  $\kappa_d$  parameters and watch the process handle the next disturbance. If the control of the process is adequate, quit. Otherwise, tweak another control and try again. This process is time-consuming.

An experienced process engineer usually has some feel for the process, and can make better estimates of the PID values. This is easier if the relationships among  $\kappa_p$ ,  $\kappa_i$ , and  $\kappa_d$  are understood.

Simply put, the  $\kappa_p$  (proportional) control is the major factor in controlling the loop. Most loops can be brought into approximate control using Proportional only. The first step is to disable the Integral and Derivative controls and bring the process into alignment using only the Proportional Control. Using Proportional only usually results in an Offset Error. That is, the actual Process Variable value differs from the Setpoint value by a small, relatively constant amount. If the offset is small and remains constant, it can often be cancelled using the  $CV_{Bias}$  value. Otherwise, set  $CV_{Bias}$  to 0 (zero) and try using Integral control.

The  $\kappa_i$  (Integral) control was intended to reduce this error by adding an offset that is based on *how long* a specific error is present. The longer the error is present, the more effect the Integral control has. So with the Proportional Control properly set, begin to increase the  $\kappa_i$  until the error is minimized, if not completely eliminated.

Most processes respond well to just these two adjustments, proportional and integral. However, one can find that the  $PV$  wobbles too much around the final value. This is known as a *damped oscillation*.  $\kappa_p$  need to be adjusted just below the point that the process begins to oscillate and goes further out of control.

These oscillations can sometimes be further damped using the  $\kappa_d$  (Derivative) control. The Derivative Control works on *how fast* the  $PV$  (and thus the resulting error) changes. The maximum rate of change occurs just after any disturbance, which is also when the  $\kappa_p$  is oscillating. By increasing the  $\kappa_d$ , the oscillations can be further damped to bring the process into control more quickly.

PID tuning depends on the user's knowledge of the process to be controlled.  $\kappa_p$ ,  $\kappa_i$ , and  $\kappa_d$  are determined by the processes' characteristics, which must be understood before tuning can be performed.

There are two things that must be known about the process:

How big is the change in Process Value when Control Value is change by a fixed amount?

How quickly does Process Value change in response to a change in Control Value?

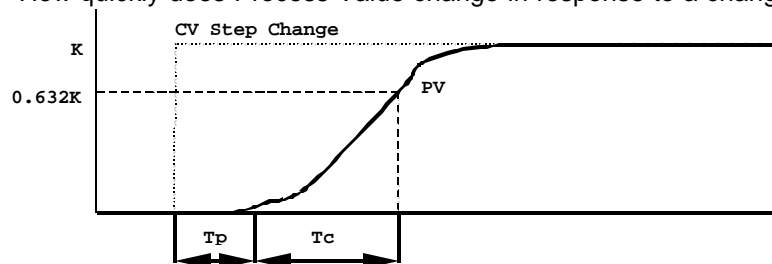

The change in  $PV$  is simply measured. When compared with  $CV$  using a simple equation, the OPEN LOOP GAIN ( $\kappa$ ) of the system is obtained:

$$\text{Open Loop Gain } (\kappa) = PV_{\text{step}} / CV_{\text{step}}$$

If a step change in  $CV$  causes an identical step change in  $PV$ , the Open Loop Gain ( $\kappa$ ) is one (unity). If a step change in  $CV$  causes a step change in  $PV$  that is less than  $CV$ , the Open Loop Gain ( $\kappa$ ) is less than 1. If a small step change in  $CV$  causes a large change in  $PV$ , the Open Loop Gain ( $\kappa$ ) is greater than 1.

Most processes won't see any change in  $PV$  for some time after  $CV$  changes. This is called Pipeline Delay Time ( $T_P$ ) or Dead Time. (Not to be confused with DEAD BAND.)

The Time Constant ( $T_C$ ) of the process is defined as the time between when the  $PV$  first starts to change and the time when  $PV$  reaches 63.2% of the expected final  $PV$  value.

a. Find  $K$  and  $T_C$

Some experimenting must be done in order to obtain the desired values. This is best done by placing the PID Element into the MANUAL mode, make a small change in  $CV$ , and then plot the change in  $PV$ . For slow processes this can be done manually, but a strip chart recorder might be helpful.

The change in  $CV$  is large enough to cause a measurable change in  $PV$  but not so large as to completely disrupt the process being controlled.

The plot looks similar to the above graphic, and  $K$ ,  $T_C$ , and  $T_P$  are easily measurable.

b. Tune the Process

If  $K$ ,  $T_C$ , and  $T_P$  are known we can use the following equations can be used to estimate starting values for  $K_P$ ,  $K_I$ , and  $K_D$  in a Proportional / Integral / Derivative (PID) control:

$$K_P = (1.2 * T_C) / (K * T_P)$$

$$K_I = (0.6 * T_C) / (K * T_P * T_P)$$

$$K_D = (0.6 * T_C) / K$$

$T_C$  and  $T_P$  are time units. It is important to ensure that both are expressed in identical units (i.e., milliseconds, seconds, hours, or whatever time frame is appropriate to the process). However, for use in the Cscape PID TUNE dialog, these values must be expressed 10mS intervals (eg: "100" = 10mS \* 100 = 1 second).

If Proportional-only control ( $K_I$  and  $K_D = 0$ ) is desired, use the equation:

$$K_P = T_C / (K * T_P)$$

Or for Proportional / Integral control ( $K_D = 0$ ), use the equations:

$$K_P = 0.9 * T_C / (K * T_P)$$

$$K_I = 0.3 * K_P / T_P$$

These equations are known as the Ziegler-Nichols tuning method, which were developed by John Zeigler and Nathaniel Nichols in the 1940's.

NOTES

## CHAPTER 13: UPDATING FIRMWARE

### 13.1 General

**NOTE:** Firmware can be updated only on the OCS/RCS line. Refer to the User Manual that came with the controller to determine if the controller accepts firmware updates from **Cscape**.

**NOTE:** OCS Firmware **Revision 7.16 or greater** is required to allow firmware upgrades using **Cscape**.

The OCS product line contains flash memory based firmware. Using a proprietary protocol, the operational firmware inside the OCS can be updated in the field using the **Cscape** Editor. With this feature new versions of firmware can be released to the field almost instantaneously using the Internet or other electronic mail facilities.

From the Main Menu, select **File|Update Firmware...** The user is asked if they wish to stop the OCS and prepare for firmware update. Select **Yes** to continue or **No** to abort the firmware update process.

**WARNING:** Updating the firmware can erase any ladder logic program that exists in the OCS. Be sure that there is a copy of the ladder logic program so that it can be loaded into the OCS later, if necessary.

If accepted, the Firmware Update Dialog appears:

If the *complete path* to the new firmware disk file is known, type it in to the **Select Firmware File** edit box. Otherwise, use the **Browse Button** to locate the desired file.

**NOTE:** For distribution, most firmware update files are delivered in ASCII-HEX format and has the file extension **.HEX**.

After selecting the proper file, click the Send Button to begin the process.

If the old firmware revision in the OCS/RCS unit is at least 7.16, and communications between the OCS/RCS and **Cscape** are operating properly, the firmware update process is automatic.

After the process is complete, the controller is automatically reset to allow the new firmware to take effect.

**WARNING:**  
It is the user's responsibility to ensure that the updated firmware is the correct version.

## 13.2 Update Wizard

**NOTE:** Firmware can be updated only on the OCS/RCS line. Refer to the User Manual of the controller to determine if the controller accepts firmware updates from **Cscape**.

**NOTE:** OCS Firmware **Revision 7.16 or greater** is required to allow firmware upgrades using **Cscape**.

The OCS product line contains flash memory based firmware. Using a proprietary protocol, the operational firmware inside the OCS can be updated in the field using the **Cscape** Editor. With this feature new versions of firmware can be released to the field almost instantaneously using the Internet or other electronic mail facilities.

### Using the Firmware Update Wizard

Connect the controller to update to the serial port of the PC. From the Main Menu, select **File|Firmware Update Wizard**. The following dialog appears.

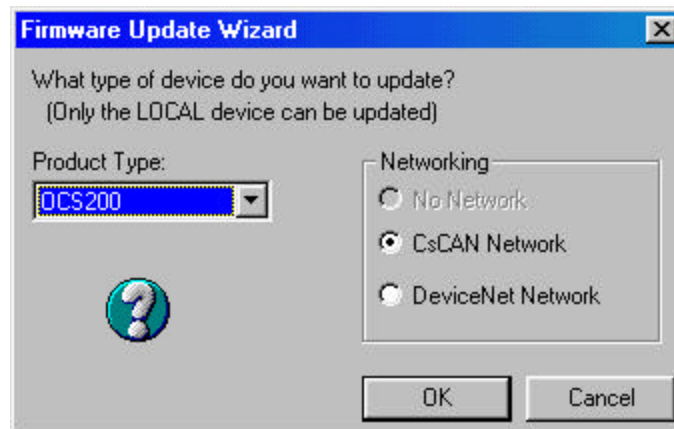

**Firmware Wizard**

The product type should be selected. If not, select the product to update from the drop-down list. Next, select the type of networking desired. Press OK.

**Note:** If a controller was purchased without a network, loading firmware that supports a network will not be allowed. If a controller was purchased with a network, loading firmware that does not support a network is not allowed.

**Note:** The wizard assumes the firmware is stored in the firmware directory located in the same directory as the Cscape program. Unless the user changes this, it is handled during the installation process.

The manual firmware update dialog is now shown with the filename for the update automatically selected. Press **Send** to start the update process. Wait for the dialog to indicate that update process is complete



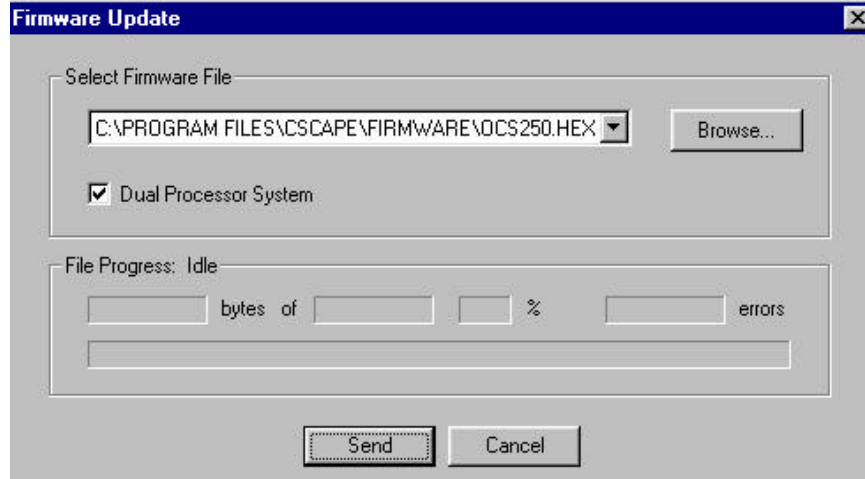

Firmware Update For Wizard

### Manually Loading Firmware

From the Main Menu, select **File|Update Firmware...** The user is asked if they wish to stop the OCS and prepare for firmware update. Select **Yes** to continue or **No** to abort the firmware update process.

**WARNING:** Updating the firmware can erase any ladder logic program that exists in the OCS. Be sure that there is a copy of the ladder logic program so that it can be loaded into the OCS later, if necessary.

If accepted, the Firmware Update Dialog appears:

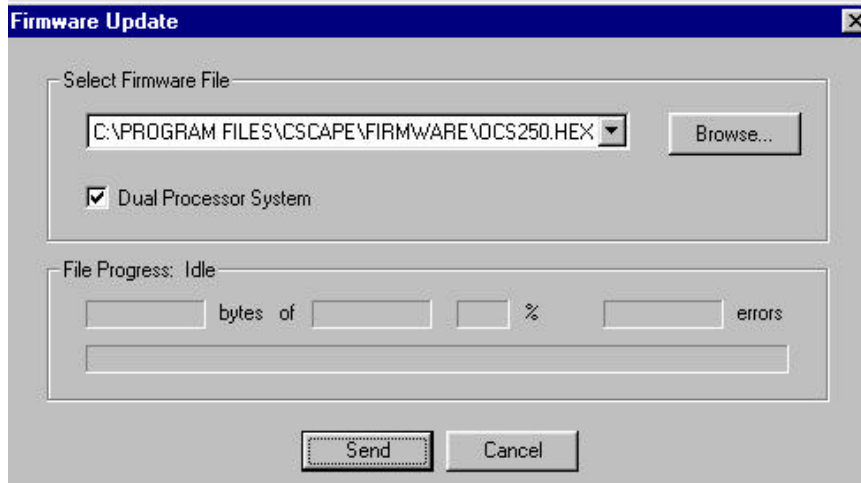

If the *complete path* to the new firmware disk file is known, type it in to the **Select Firmware File** edit box. Otherwise, use the Browse Button to locate the desired file.

**NOTE:** For distribution, most firmware update files are delivered in ASCII-HEX format and has the file extension **.HEX**.

After selecting the proper file, click the Send Button to begin the process.

If the old firmware revision in the OCS/RCS unit is at least 7.16, and communications between the OCS/RCS and **Cscape** are operating properly, the firmware update process is automatic.

After the process is complete, the controller is automatically reset to allow the new firmware to take effect.

**WARNING:**

It is the user's responsibility to ensure that the updated firmware is the correct version.

**Updating the OCS250**

Previous versions of Cscape required multiple steps to update the firmware in an OCS250. Now only a single process is required to update the firmware on an OCS250 as described in this section.

## CHAPTER 14: SHORTCUT KEYS IN CSCAPE

### 14.1 Shortcut Key Assignments

<b>Key</b>	<b>Functions</b>
<F1>	Context Sensitive Help
<F2>	Select Normally Open (N/O) Contact
<F3>	Select Normally Closed (N/C) Contact
<F4>	Select Branch Element
<F5>	Select Comment Element
<F9>	Select Normally Open (N/O) Coil
<ESC>	Deselect element (arrow cursor)
<CTRL><N>	Open New File
<CTRL><O>	Open Existing File
<CTRL><S>	Save File
<CTRL><J>	Open Project
<CTRL><P>	Print
<CTRL><X>	Cut Selected Elements
<CTRL><C>	Copy Selected Elements
<CTRL><V>	Paste Selected Elements
<CTRL><Z>	Undo last edit
<CTRL><A>	Select All Elements
<CTRL><F>	Find a Register
<CTRL><H>	Replace a Register
<CTRL><Y>	Redo last undo
<CTRL><G>	Goto Rung or Line
<LEFT>	Move selection to the left object
<RIGHT>	Move selection to the right object
<UP>	Move selection up to the next object
<DOWN>	Move selection down to the next object
<DEL>	Deletes selected item
<ENTER>	Edits selected object
<SHIFT><LEFT>	Scrolls screen left
<SHIFT><RIGHT>	Scrolls screen right
<SHIFT><UP>	Scrolls screen up
<SHIFT><DOWN>	Scrolls screen down

NOTES

## CHAPTER 15: TEXT CHARACTER

The following Text Character Chart is provided.

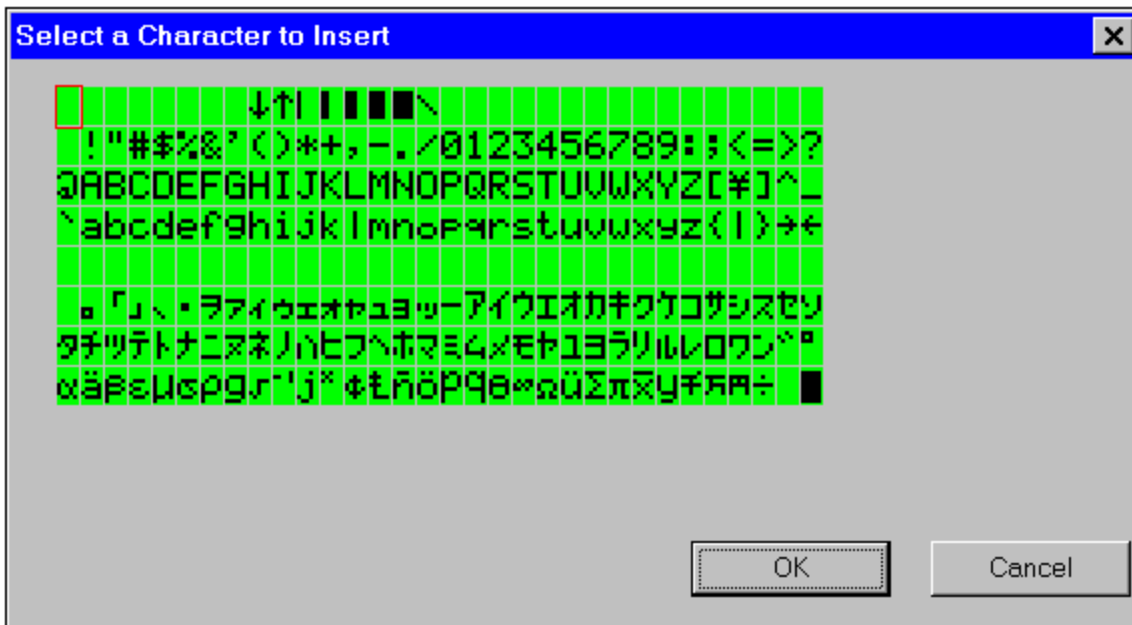

Figure 15.1 – ASCII Chart

NOTES

## CHAPTER 16: GRAPHIC EDITOR

### 16.1 Graphical Overview

When the Cscape editor's target is configured for the Graphical Display Mode and the **Screens/View-Edit Screens** menu function is selected, a graphical screen development environment is provided that is different than that provided when configured for text-based OCS models. Fields and alignment are no longer restricted to characters and character positions, but are now graphical representations with unrestricted placement. With the higher pixel resolution of the graphics screen, more information can be displayed at one time over that of the text based systems. Because powerful tools are provided, the user can create very elaborate, informative and decorative screens. However, when development time is critical, the straight-forward design of graphical objects and associated configuration keeps screen development time to a minimum.

Note: Graphic OCS250 and Color Touch OCS Models use the Graphic Editor function.

The following sections describe how to create, move and configure graphical representations that are herein referred to as objects. This chapter covers object definition, object placement, object grouping and object configuration in generalities. Thereafter, both the tools and objects are covered in detail in their respective reference section.

### 16.2 Object Description

An object is a graphical representation on the OCS display screen that conveys information to an operator and optionally allows modification of that information. This information may be presented as a Numeric value (with font and color variations) or as an animated icon such a picture of a switch. This product contains a complete set of these predefined objects that are targeted for Panel replacement or MMI (Man Machine Interface) applications. When building the application, up to 50 different objects may be placed on any one screen; however, there are some limitations on the number of certain object types that may be in the application (see Object Reference: Data Trend).

An object is either static or dynamic (animated). Static objects are drawing primitives such as lines, rectangles, ellipses and text that do NOT animate (change) with the life of the screen and are generally created to provide decorative and informative backgrounds. Dynamic objects are those such as animated ICONS, bitmaps and text value fields that will change visually and reflect the current state of the attached I/O.

An object requires configuration of a set of properties that effect functionality and display. For example, a switch object may emulate one of several different switch functions such as momentary, toggle, force-on or force-off. Additionally, the switch may be displayed as a push button or as a toggle switch; with or without a border or legend.

### 16.3 Object Placement (Editing)

This section covers the actual placement, sizing and deletion of the object on the current screen.

#### a. Inserting an object

*Once the user enters the graphical editor, the first display screen is displayed and ready to accept an object. To select and place an object on the screen:*

- Click on the desired object on the object toolbar.
- Press and hold the left mouse button once the cursor is on the desired location of the upper left corner of the object.
- Pull the mouse down and to the right until the desired object size is reached then release the mouse.

The object then appears on the screen. Note that if snap-to-grid is enabled, the object may 'snap' to the nearest grid dimensions instead of than defined with the mouse clicks.

#### b. Selecting objects (Uncovered / Covered) (Total Number of Objects Selected and Order of Selection)

**Uncovered objects:** Pressing **TAB** selects the next object on the screen. Selection is denoted by a RED selection band (rectangle with sizing handles in the corners and sides) outlining the object. Should a new object be inserted or the user click on another object, the former object is no longer selected and is no longer outlined with the RED selection band.

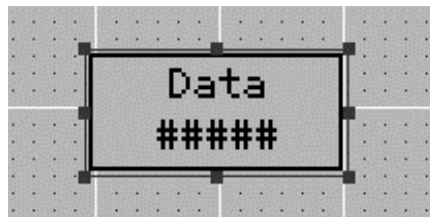

**Figure 16.1 - Selected Object**

When an object is selected, the area immediately within the selection band is the object's bounding rectangle. When placed on a screen, an object generally displays a border outline on its bounding rectangle as the default configuration. To select an object when editing, simply click anywhere within or on that bounding rectangle.

**Covered objects:** In the case of layered objects, click on the visible portion of the object. If an object is completely covered, it may be temporarily brought to the foreground (made visible) and selected (see Tools Reference: To Back) OR you can press **CTRL + TAB** to select the next object behind the currently selected object.

**Exception:** An exception to the selection process occurs with the drawing primitives such as circles and rectangles. When the object's background is a solid color, selection is as defined above. However, should the object have a transparent background, the user must click directly on the object's bounding rectangular border to select that object.



**Total Number of Objects Selected and Order of Selection:** When an object is selected, the Graphics Editor shows the total number of objects selected and the order of the currently selected object.

**Example: X of Y** (appears on the Graphic Editor)  
where X = order (1 equals front)  
Y = total number of objects

c. Moving an object

- Select object
- Place the cursor within the object bounding rectangle (crossing lines with arrow heads appear).
- Press and hold left mouse button
- Move to desired location and release mouse button

d. Sizing an object

- Select object
- Place the cursor within a sizing handle (rectangle) on the RED selection band on the side to move (single line with arrow heads will appear)
- Press and hold left mouse button
- Drag object edge to new location and release mouse button

e. Layering objects (front vs. back)

Dynamic objects are generally NOT transparent and will cover a portion of an existing object if placed over that existing object. In some cases this may be the desired outcome such as placing a numeric display object on top of a meter object. Objects will be layered in the order that they are inserted on the screen. However the user may alter that ordering (see Tools Reference: To Front/To Back).

- Right click on object and select To Front or To Back from pop-up menu.

f. Deleting an object

- Selecting object and press DEL key  
[OR]
- Right click object within bounding rectangle and selecting DELETE from the pop-up menu.

## 16.4 Object Grouping

Objects may be grouped together and treated as a single entity. This new entity can then be deleted, cut, copied, or saved to a file. In addition, all objects within a group may be aligned to any side or centered horizontally or vertically.

a. Temporary Grouping objects

- From the Tools toolbar select the Group Selector.
- Click and drag a selector band around the objects to be selected starting in the upper left corner.

The objects are now temporally grouped and right clicking with-in that group will invoke a pop-up menu for group operations. If the group operation is NOT to permanently group the objects, the grouping will be lost after that selected group operation.

b. Permanent Grouping objects

- Temporally select a group of objects.
- Right click within the group and select Group from the menu.

If the objects are permanently grouped, thereafter selecting any of the objects will select the group. When a group is selected, it will be outlined with a red selection band with handles. To indicate that the selection is actually a group instead of a single object, the selection band will be dashed.

c. Ungrouping objects

- Select the group
- Right click within the group and select Ungroup from the menu

d. Moving a group

- Select the group
- Move the cursor to the center of the group until it changes to the movement icon.
- Press and hold left mouse button while dragging the group to the new location and release mouse button.

e. Cut, Copy and Pasting groups

- Select the group
- Right click within the group and select Cut or Copy from the menu.

Once a group is copied to the clipboard, it may be pasted to any screen using the right click menu.

f. Deleting a group

- Select the group.
- Press the DEL key

[OR]

- Right click within the group and select Delete from the menu.

g. Saving a group

- Select the group.
- Right click within the group and select Save.
- Select the filename and location from the Save As dialog

Once a group is saved as a file, it can be brought in to any application though the **Grouping/Import Group** menu option.

h. Import a group

- Select **Grouping/Import Group** from the menu bar.
- Select a file to import from the menu and click OK.
- Group will be placed on screen, click on group and move to the desired location.

As part of this distribution, a small library of groups is provided. This library provides templates (virtual menus and virtual control panels) and animated objects (pipes, valves, pumps and tanks) which the user may import, position and size appropriately. These objects are located under appropriated directories starting at the directory opened with the Grouping/Import Group menu.

i. Aligning objects in a group

- Select the group.
- Right click within the group and select Align.
- Select the appropriate action.

### 16.5 Object Properties

Once an object is placed on the screen, that object's properties must be configured. These properties define the functionality and display format of the object. The object's property configuration is accessed through that particular object's properties dialog box. To access an object's property dialog box, double click with-in the objects bounding rectangle.

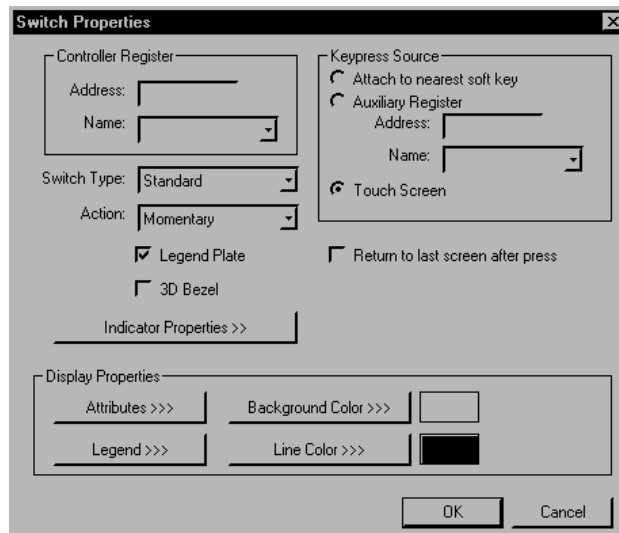

Figure 16.2 – Property Dialog

The following sections describe those properties that typically apply to all the objects. For a definition of object specific properties, refer to the specific object in the object reference that follows.

a. Controller register Section

This section specifies the main OCS register that is associated with the object. Depending on the individual objects functionality, this register may be read, written or both by the object. This section may contain up to three fields. The first field contains the action register designation (i.e. %R12). The second field allows the register selection by alias name. The third field is only present on objects that accept multiple data sizes and is used to select binary (1bit) or analog (8, 16 or 32 bits).

b. Keypress Source Section

On objects (i.e. switch) that require additional binary input from the operator in the form of a keypress, a keypress source section is present. This section allows selection of a softkey, OCS register (function key or external switch), or touch selection for touch screen models.

For models that support softkeys, the keys that are labeled > and < on each side of the physical display area function as softkeys. When selecting this option, the object attaches to the closest available softkey. In addition, the object visually contains a pointer to direct the operator to the appropriate softkey.

Only one object/per screen can be attached to any particular softkey. Softkeys are only available to the graphics portion of the application.

Alternately, an OCS register(s) can be used for operator input such as the Function keys (F1-F10) [addresses %k1-%k10] that are located below the display area. However, since Function keys are available to either the ladder or graphics portion of the application, use care to avoid overlapping functionality. Since any OCS register with the appropriate bit type may be used, external I/O could be used as an alternate input source.

Some objects (i.e. Screen Jump) also provide a cursor selection option in this section. Selecting cursor selection allows the OCS's keypad arrow keys to select an object, then an Edit/Enter keystroke provides the input. Object selection is displayed as a dashed rectangle drawn around the selected object.

The Keypress Source Section provides for a touch selection option for touch screen models.

c. Display Properties Section

This section configures generic display properties such as Drawing the Border, Flashing, Input Enable, Line and Background color, and Legends.

Most of the objects allow certain attributes such a Flash, Border and Enable Input to be configured to the users preference. Additionally, some of these attributes may be either set dynamically at run-time through an auxiliary OCS register or statically at application development time. Clicking on the Attributes>>> button invokes the following dialog box, which allows individual configuration of these attributes.

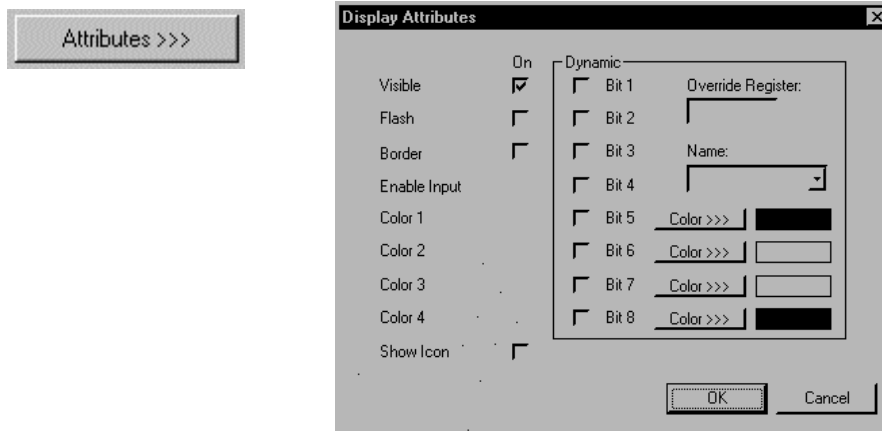

Figure 16.3 – Display Attributes

*Visible:*

**Graphic OCS (e.g., OCS250):** Currently, all objects are always visible. This option can not be changed.

**Color-Touch Screen (e.g., OCS3xx):** Objects can be selected as

- **Visible** (This Visible ON option checked)
- **Invisible** (Both the Visible ON and Dynamic option unchecked)
- **Dynamically Visible** (Visible Dynamic option checked).

**Visible** objects are always displayed.

**Invisible** objects are not displayed, but their touch operations continue to function. For example, a series of *invisible* screen jump objects can be placed over a bitmap that represents a map of a plant floor. Upon touching a particular section of the bitmap containing an invisible screen jump, a detailed screen is immediately displayed showing detailed information about the selected portion of the plant.

**Dynamically Visible** objects are shown when the first bit of the override register is set; objects are hidden when the first bit is cleared. When a dynamic object is hidden, its touch operations are also disabled.

*Flash:*

When statically set, an object will flash the data display continuously or the animation ICON when the associated control register is in the ON state. When dynamically overridden, a three state display can be created: OFF, ON solid and ON flash, depending both on the state of the control register and the Override Register.

*Border:*

This attribute, available only statically, provides a decorative border (rectangle) around the object. This border is typically removed to allow either a more elaborate border to be drawn with the drawing primitives or no border at all.

*Enable Input:*

This attribute, optionally available only as dynamically overridden, allows the object or the object editor to ignore keystrokes or touch strokes directed to that object. This allows run-time determination on whether to restrict input access to that object. This allows the user to create operator privilege or in-motion lockout of object modification. If this box is NOT checked, the associated object always accepts input.

*Color:*

This attributes allow colors to be assigned to objects when an the assigned bit (Bits 5 - 8) is ON

*Show Icon:*

This attribute, available only statically on certain objects such as the Switch and Screen Jump object provides the option to display the ICON.

Most of the objects allow descriptive text (legend) to be included within the objects bounding rectangle. Clicking on the Legend>>> button invokes the following dialog box, which allows creation and placement these legends.

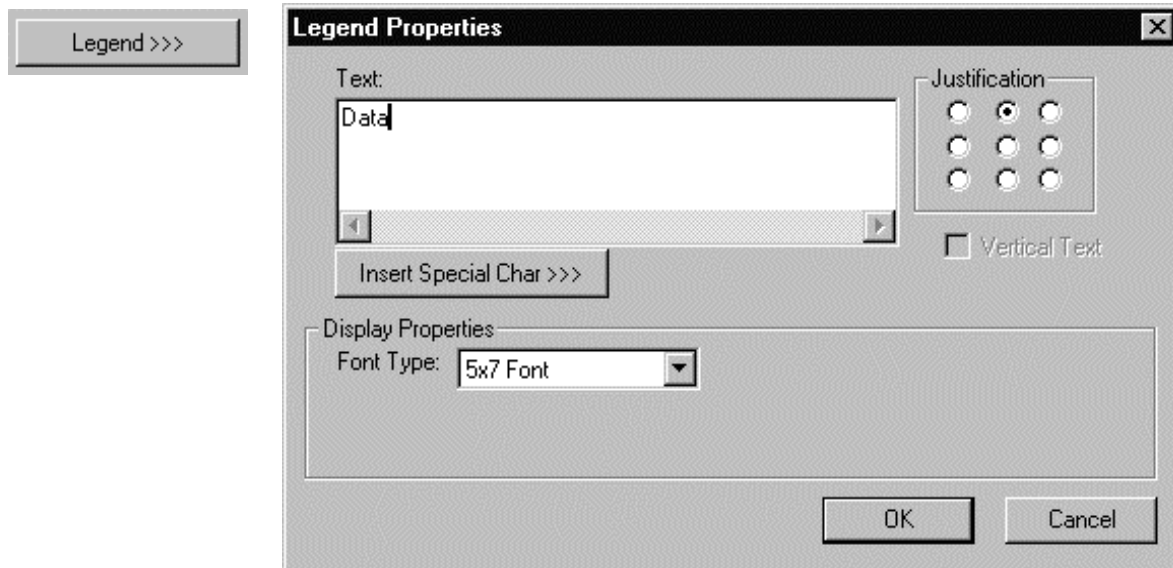

Figure 16.4 – Legend Properties

*Text:*

This field is used to enter the Legend text. Returns may be inserted for multiple lines. If vertical space allows, text too long to fit within the object (that does not contain returns) is automatically wrapped to produce multiple lines. If vertical or horizontal space is insufficient, excess legend text is truncated.

*Justification:*

Select the location within the object for the legend text. The following is an example of the different placement options. Each object contains an instance of the same switch with a different legend position.

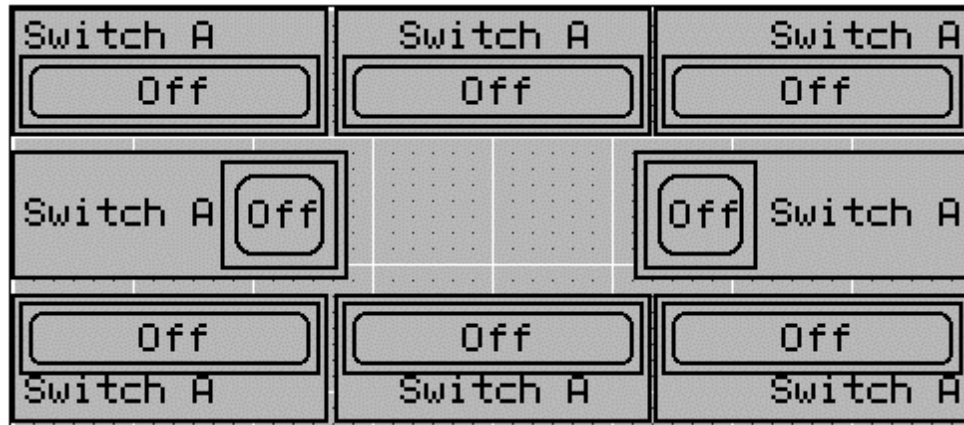

**Figure 16.5 – Switch Screen**

Note that the animation part of the object may resize or reposition depending on the position (justification) of the legend. Different positioning provides different legend functionality (i.e. in a numeric entry field a (top or bottom) legend could specify the OCS register, or a (left) legend could specify a operator input prompt or a (right) legend could specify engineering units).

*Insert Special Chars*

This button allows a pop-up selection of the special characters provided by the currently selected font. This allows access to special characters such as the ° (degree) sign.

*Font Type:*

The legend font may be selected independently of any other text contained in the same object.

*Background Color:*

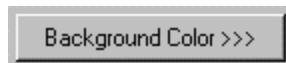

This button selects the background or fill color object (the OCS250 only supports 2 colors: Black and White).

*Line Color:*

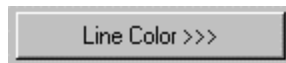

This button selects the foreground color of the object. This includes the legend, border (if enabled) and animation lines (text).

**Data Color**

This button selects the color of the data for the object.

**16.6 Screen Description**

A screen is the display area that provides a background color and contains a collection of user-configured objects. Up to 300 of these screens can be stored in the OCS250. Since one screen is presented at a time, the OCS250 contains mechanisms that allow the operator to change the current display screen. These mechanisms allow switching screens from the front panel, ladder program or network. In addition, three priority levels of screen control exist that allow the current screen to be interrupted by either the system menu or an alarm screen. This section defines screen numbering, attributes and methods available to change screens.

**a. Initial screen**

Each user-created screen is assigned a screen number. This number is used to identify the screen both in the editing environment and in the run-time environment (indirect screen references). Screen numbers begin at 1 and go to 300. The first screen that is displayed at power-up and at any non-RUN to RUN mode change is referred to as the Initial screen. The Initial screen is also the return screen when recovering from an Undefined or Invalid screen (ESC key). While the default Initial screen number is 1, the Initial screen number is modifiable by the editor through the **Screens/Set Initial Screen** menu or on the right click display menu.

**b. Screen properties**

Each screen has two configurable properties: background color and comments. The background color, which defaults to white, may be set to black through the **Screens/Set background...** menu or through the right click display menu. Individual object foreground and background colors may also be modified to match this color scheme. Each screen may also contain a hidden comment section, which the designer may use for design comments or documentation. The comment editor is accessed through **Screens/Comments...** menu or through a button on the tools toolbar.

**c. Screen priority levels**

Screen display control is prioritized at three levels: USER, ALARM and SYSTEM MENU. The SYSTEM MENU has highest priority in that it can always interrupt the current screen when the System keys are pressed. The next priority level is that of the ALARM screen. An ALARM screen can interrupt the current USER screen when activated by the Force Screen function of the Switch Screen coil from ladder code. If neither the SYSTEM MENU nor ALARM screen is active, the current USER screen will be displayed.

The priority level is actually controlled by 3 system controller registers (%SR1-3). %SR1 controls the lowest priority level or USER screen and should always contain a screen number between 1 and 300. %SR1 is modified when the Screen Jump object or the Switch Screen ladder coil (Switch Screen) is used to change the USER screen. %SR1 is initialized with the Initial screen number at power-up and non-RUN to RUN mode changes. %SR2 controls a higher priority or ALARM screen and should contain a screen number between 0 and 300. %SR2 is modified when the Switch Screen ladder coil (Force Screen) is used to display an ALARM screen. The ALARM screen is removed once the associated Switch Screen ladder coil no longer passes power (%SR2 returns to zero). %SR3 controls the highest priority or SYSTEM MENU screen and should contain either a 0 or a 1. %SR3 is modified when the front panel 'systemkeys are used to display the system menu. The SYSTEM MENU is removed once the operator presses the ESC key to exit (%SR3 returns to zero).



Generally, registers %SR1-3 are not accessed directly by the operator but may be used to monitor the current display level. An example is when the ladder application may be used to block screens (power Switch Screen coil if %SR1 is equal to certain screen numbers) to create a password privilege scheme.

d. Screen control with Screen Jump Object

From the operators view, screen navigation on the OCS250 is different from the text-based models in that the operator is no longer required to incrementally index through the screens with the OCS arrow keys. The OCS250 provides a Screen Jump object that may be tied to a specific key or I/O point to activate a screen switch (jump). This provides a more structured or directed way of navigating through screens. Screen Jump objects can be displayed on a screen as individual objects or grouped to create virtual menus. Virtual menus allow the operator to scroll a cursor through a list of screens and then press Edit/Enter to jump to the selected screen. A Screen Jump object can be configured with an absolute screen number or receive a screen number indirectly through an OCS register at run-time allowing program dependent screen navigation.

When a screen is created with the editor, there is NO specific indication on whether that screen will be displayed under USER or ALARM screen priority level. The priority level is determined at run-time through indirect control of the %SR(1-3) system registers. Normally, all objects will function on any particular screen regardless of the screen priority level (USER or ALARM). However, the Screen Jump object is an exception in that it will only effect a screen change if the current screen priority level is at USER. For more information on the Screen Jump object, refer to the Screen Jump object in the object reference.

e. Screen jump queue

Included in the screen jump mechanism is a screen jump queue. The Screen Jump object can optionally save its associated screen's number to the queue before effecting the jump. When the operator is finished with the information on the new screen, the front panel ESC key can then be used to return to the screen effecting the jump. This allows operators to back out of help screens, action warning screens, or a sequence of virtual menus by pressing the ESC key for each level.

Up to 16 jump levels can be queued with the last 16 jumps being stored. Once all of the screen jumps are popped from the queue, the ESC key will not effect the last remaining screen. The ESC key only restores previous screens if the current privilege level is at USER. Pressing the ESC key when the current privilege level is at ALARM will NOT cause a screen change or effect the screen jump queue. Note that the queue is automatically flushed if the USER screen (%SR1) is changed remotely (ladder Switch Screen coil or network).

f. Screen cursor (run-time)

Screens that contain (Text) Data objects that are editable or Binary objects whose keypress source is set to cursor selectable will display an object cursor. This cursor will be visible as a dashed line around the bounding rectangle of the currently selected object. On the initial display of a screen, the upper-leftmost object selectable will be selected. The operator, with the use of the arrow keys, can select a different selectable object. Once an object is selected, an additional keystroke will be required to enter the object's editor. For (Text) Data objects, an alpha-numeric key will invoke the selected objects editor. For Binary objects, the Edit/Enter key will begin the binary input action.

When selecting objects, the direction of the arrow key pressed defines the direction of cursor movement. The OCS250 will attempt to select the closest object in that direction. When determining the closest object, the only objects considered will be those whose center falls within a plus-or-minus 45 degree angle from the center of the currently selected object (in the direction of the arrow key). This method allows a selection path to any object regardless of its position on the screen; however, it is strongly recommended that selectable objects always be perpendicularly placed to reduce operator confusion.

Note that since an object's relative location is based on the object's center, the user should also use consistent object sizes when laying out the selectable objects.

When selecting objects that are fully or partially covered, that object will be placed on top of the other objects as long as that object is selected. If no object falls within the direction of the arrow key, no cursor change will occur. Screens that contain NO selectable objects will not display a screen cursor.

## 16.7 Toolbar Reference

The editor provides 3 different toolbars (Tools, Objects and Drawing Primitives). Each toolbar may be docked or floating. The menu option **View/Restore Toolbar** restores and docks any closed toolbars. The following reference provides a brief description of each toolbar selection. Each toolbar selection is given a more comprehensive description in its respective toolbar reference (Tools reference, Object reference and Drawing primitive reference) provided later in this manual.

16.7.1 Tools toolbar

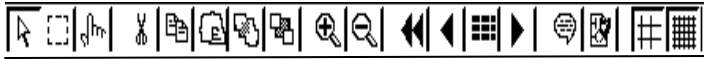





































Table – Tools Toolbar Button Definitions	
 <p><b>Selector:</b> The Selector arrow is the default tool that appears on-screen unless another operation is active. The Selector arrow selects, moves and resizes objects.</p>	 <p><b>Back Screen:</b> Pressing this button moves back to the last screen viewed. (The last screen viewed can be located several screens away from the current screen – it is <u>not</u> limited to the previous screen located immediately before the current screen.)</p>
 <p><b>Group Selector:</b> The Group Selector is used to select a group of objects. Once grouped, the object(s) can be moved, aligned and deleted as a single object.</p>	 <p><b>Previous Screen:</b> Pressing this button jumps to the previous screen located just before the current screen.</p>
 <p><b>Operator Simulator:</b> Upon pressing this button, the Operator Simulator icon appears on-screen. To animate objects including switches, indicators, and meters, drag the Operator Simulator icon to desired object and left-click the mouse. In some instances, each left-click of the mouse changes the state of the object. In other instances, each left click steps through a series of static bitmaps, frame-by-frame, which gives the illusion of motion much like moving pictures.</p>	 <p><b>View Screen Thumbnails (goto screen):</b> This presents the user a display of 20 condensed screens from which one can be selected to jump too. Display can be scrolled (20 screens at a time) to access all 300 screens.</p>
 <p><b>Cut/Copy/Paste:</b> These functions allow objects or groups to be cut, copied or pasted to the current or newly selected screen.</p>	 <p><b>Next Screen:</b> Pressing this button jumps to the next screen located just after the current screen.</p>
 <p><b>To Front:</b> If multiple objects are overlapped, this function causes the selected object to be drawn last or on top of the other objects.</p>	 <p><b>View/Edit Screen Comments:</b> This function is used to store notes and questions with the current screen, which are used strictly for the use of the programmer. They are not printed or displayed on the target OCS250. If comments exist for the current display screen, the Comments button animates and flashes as an indicator to the user.</p>
 <p><b>To Back:</b> If multiple objects are overlapped, this function causes the selected object to be drawn first or covered by the other objects.</p>	 <p><b>Error Check:</b> Checks screens for various warnings and errors.</p>
 <p><b>Zoom In :</b> To magnify the representation of the OCS unit on-screen, click the Zoom In button. Continue to click this button until the desired size is reached.</p>	 <p><b>Snap to Primary Grid:</b> When pressed, this button causes inserted or moved objects to snap to the primary grid lines. This button does <u>not</u> affect the Static Text object or Drawing Primitives.</p>
 <p><b>Zoom Out:</b> To de-magnify the representation of the OCS unit on-screen, click the Zoom Out button. Continue to click this button until the desired size is reached.</p>	 <p><b>Snap to Secondary Grid:</b> When pressed, this button causes inserted or moved Static Text objects or Drawing Primitives to snap to the secondary grid lines. If the Snap to Primary Grid button is disabled, this button will also cause the other object types to snap to the secondary grid.</p>





## 16.7.2 Object toolbar



	<b>Static Text:</b> Used to type text anywhere on-screen. Text is displayed as typed.		<b>Slider:</b> This object allows an analog value to be adjusted with a simulated slider and/or trim buttons (Color Touch models).
	<b>Numeric Data:</b> Formats numeric data that is either read from a specific register, or if desired, is written to the register.		<b>Screen Jump:</b> Formats a screen jump to a specific screen number address / number. Screen jumps can be tied to a soft key on the OCS screen or a controller register.
	<b>Time Data:</b> Formats the time / date display that is read from registers, or if desired, is written to registers.		<b>Bar Graph:</b> Formats a bar graph associated with a specific source register. Scale ranges are selected by the user.
	<b>Password Data:</b> Formats a password that is written into a register.		<b>Meter:</b> Formats a meter associated with a specific source register. Scale ranges are selected by the user.
	<b>Text Table:</b> Creates a text table and formats the text in the table that is read from a register, or if desired, is written to the register.		<b>Static Bitmap:</b> Allows the user to select, copy, and paste a bitmap from a file or add a bitmap into the default bitmap directory. It also allows the editing of a bitmap via a bitmap editor selected by the user.
	<b>ASCII Data:</b> Formats text that is read from a register, or if desired, is written to the register.		<b>Animation Object:</b> This button allows the user to copy and paste 2 or more static bitmaps into a series of frames. After doing so, the bitmaps can be animated to depict motion or state changes. Bitmaps are <u>not</u> animated using this button
	<b>Note:</b> Allows the operator to leave note by writing on screen (Color Touch models).		<b>Data Trend Box:</b> Creates and formats a Data Trend Box which tracks one or more variables over time. Four types of trend boxes are available. Up to 4 trends (registers) can be graphed in each Data Trend Box using Configure Pens. A Trigger address is required to activate the trending process for each Data Trend Box.
	<b>Indicator (Lamp):</b> Displays and formats an indicator that is associated with a source register. Indicator types include round or square lamps or bulbs. <u>Not</u> on the Color Touch models.)		<b>X-Y Graph:</b> Creates and formats an X-Y Graph which represents variations of a variable in comparison to variations of one or more other variables. A number of values can be plotted or located by means of x-y coordinates. Up to 4 different variations (registers) can be graphed using Configure Pens. A Trigger Refresh address is required to reset the registers and reactivate the plotting process.
	<b>Switch:</b> Displays and formats a switch that is associated with a write register. Switch types include standard, round, square or rocker switches. Switches can be tied to a soft key on the OCS screen or controllers register.		<b>Alarm:</b> Displays alarm summaries or logs as a list or an indicator button (Color Touch models).
	<b>Selector Object:</b> Displays and formats a multi-position switch that is associated with a write register. Position switch types include one-, two-, three- or four-position switches. Position switches can be tied to a soft key on the OCS screen or a controller register.		

16.7.3 Drawing Primitives toolbar



 <p><b>Rectangle:</b> A drawing tool used to create and format rectangular and square shapes.</p>	 <p><b>Line:</b> A drawing tool used to create and format lines.</p>
 <p><b>Ellipse:</b> A drawing tool used to create and format ellipses and circle shapes.</p>	 <p><b>Rounded Rectangle:</b> A drawing tool used to create and format rounded rectangular shapes.</p>

16.8 Tools Reference



**Selector:**

The Selector arrow is a default tool that appears on-screen unless another operation is active. The Selector arrow selects, moves and resizes single objects (or objects) that have been grouped together.

When the left mouse button is clicked, handles appear which are used to resize the object.

To move an object, left-click on the object and hold the button down while dragging the object to the desired spot.

When the right mouse button is clicked on the object, the pull-down menu below appears.

Cut	Ctrl + X
Copy	Ctrl+C
Paste	Ctrl+V
<b>D</b> elete	
To Front	
To Back	
Edit Legend >>>	

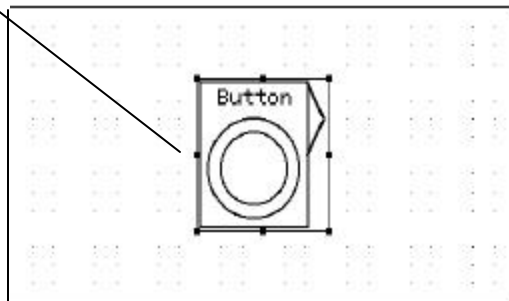

When the right mouse button is clicked *outside* the object, the pull-down menu below appears.

Paste	Ctrl+V
Select All	
Set Background	
Import Group	
Preview	
Zoom To	
Goto Screen	
Set as Initial Screen	

Figure 16.6 - Using the Selector Button

**Group Selector**

: The Group Selector is used to select and move multiple objects.

To select multiple objects, click the left mouse button and drag it over the objects. A box with handles surround the grouped objects. To remove the box, left-click on the box or anywhere within the box.

When the right mouse button is clicked on the object, the following pull-down menu appears.

Cut	
Copy	Ctrl+C
Paste	Ctrl+V
Delete	
Save Group	
Group	
UnGroup	
Align Objects	

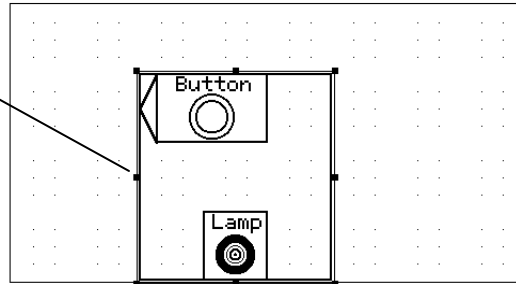

To move a grouped object, left-click on the object and hold the button down while dragging the object to the desired spot.

When the right mouse button is clicked *outside* the object, the pull-down menu below appears.

Paste	Ctrl+V
Select All	
Set Background	
Import Group	
Preview	
Zoom To	
Goto Screen	
Set as Initial Screen	

**Figure 16.7 - Using the Group Selector Button**

**Operator Simulator:**

Upon pressing this button, the Operator Simulator icon appears on-screen. To animate objects including switches, indicators, and meters, drag the Operator Simulator icon to desired object and left-click the mouse. In some instances, each left-click of the mouse changes the state of the object. In other instances, each left click steps through a series of static bitmaps, (frame-by-frame), which gives the illusion of motion similar to that of moving pictures.

**To Front:**

Upon pressing this button, the selected object will be ordered such that it is the last object painted. If this object is in a group of overlapped objects, it will be visually placed on top.

**To Back:**

Upon pressing this button, the selected object will be ordered such that it is the first object painted. If this object is in a group of overlapped objects, it will be visually placed on the bottom. Note that if a object that is selectable is placed to the back, it will visually be painted last (brought to foreground) when it is selected.



Zoom In :

To magnify the representation of the OCS unit on-screen, click the Zoom In button. Continue to click this button until the desired size is reached.



Zoom Out:

To de-magnify the representation of the OCS unit on-screen, click the Zoom Out button. Continue to click this button until the desired size is reached.



Back Screen:

Pressing this button moves back to the last screen viewed. (The last screen viewed can be located several screens away from the current screen – it is not limited to the previous screen located immediately before the current screen.)



Previous Screen:

Pressing this button jumps to the previous screen.



View Screen Thumbnails (goto screen):

This presents the user a display of 20 condensed screens from which one can be selected to jump too. Display can be scrolled (20 screens at a time) to access all 300 screens



Next Screen:

Pressing this button jumps to the next screen.



View/Edit Screen Comments:

The Comments button is a documentation tool used to store notes and questions that are strictly for the use of the programmer. They are not printed or provided on-screen for other operators. When comments are created as part of a screen, the Comments button animates and alternates between a default callout containing comments (shown) and a blank callout without comments. Whenever an operator jumps to that particular screen, the Comments Icon on the toolbar blinks as described.



Figure 16.8 – Animated Comment Toolbar button

When the Comments button is pressed, the following screen appears allowing the programmer to document information, etc. Whenever the screen is selected, the Comments button blinks to indicate that comments are attached to the screen. To view the comments, press the Comments button. To remove comments, the comments must be deleted.



Figure 16.9 – Edit Screen Comments Dialog

**Error Check:**

This causes the editor to do an error check on the graphics objects without leaving the graphics editor.

**Snap to Primary Grid:**

When pressed, the concurrent insertion and moving of an object will cause that object to size and position itself to the nearest primary grid lines. The Static Text object and drawing primitives are not effected by this button. The primary grid is factory defaulted to size objects proportionally to the softkeys on each side of the display screen.

**Snap to Secondary Grid:**

When pressed, the concurrent insertion and moving of a Static Text object or drawing primitives will cause that object to size and position itself to the nearest secondary grid markers. If the Snap to Primary Grid button is off, when this button is pressed, the remaining objects will also snap to the secondary grid markers.

The **Snap to Primary Grid** and **Snap to Secondary Grid** buttons are useful tools for aligning, sizing and spacing multiple objects. The buttons are used in relationship to the grid lines and grid markers (dotted guides located between grid lines) displayed on the OCS250 display. Objects snapped to grid will be located ON the upper and left grids and just INSIDE the lower and right grids. To modify the spacing of the primary and secondary grid, access the **View/Grid Settings** menu.

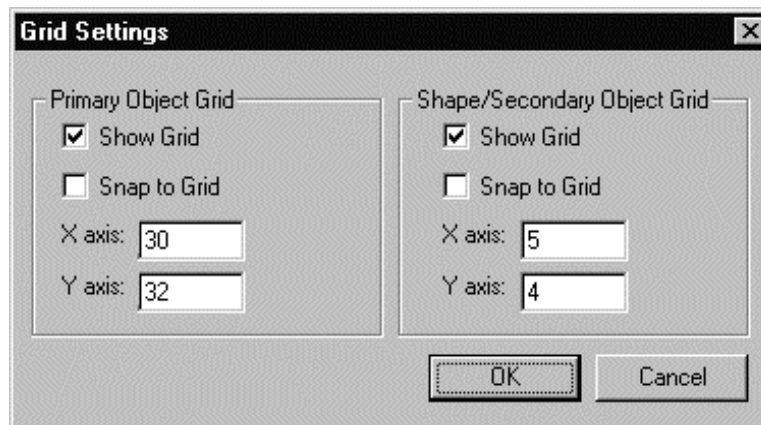

Figure 16.10 – Grid Settings Dialog



The primary grid specifications control the grid lines while the secondary grid specifications control the grid markers. The **X and Y axis** fields specify the number of pixels to the next grid line/marker (not including starting grid pixel). The **Show grid** checkboxes simply control whether the associated grid line/marker is displayed. The **Snap to grid** checkboxes will follow/or control the Snap to primary/secondary grid buttons on the tool bar.

## 16.9 Object Reference

**T** Static Text:  
Used to display text anywhere on-screen.

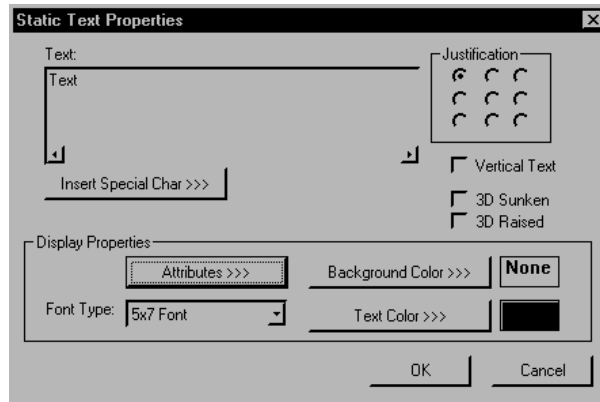

Figure 16.11 – Static Text Properties

### **Object Specific Properties:**

- **Caption**

Actual text is displayed on screen. Object will auto-wrap lines to fit object. Text too large to fit screen will be truncated.

- **Justification**

Specifies the location of the caption in the bounding rectangle. Action duplicates legend placement as in objects that support Legends.

- **Vertical Text**

Text is placed in a vertical row. (Return is placed after each character.)

- **Insert Special Character**

Allows insertion of special characters contained in the selected font that are not part of the ANSI character set.

- **3D Sunken / 3D Raised**

Adds 3D dimensions to the object if desired.

### **Object Behavior**

- **Background Color**

Under display properties, the background color has an additional selection of Tran(sparent) that is not available on other objects. This selection allows the Text object to be placed on top of other objects and only the text is painted. That is, the bounding rectangle is NOT filled with a background color.

123

### **Numeric Data:**

Formats numeric data that is either read from a specific register, or if desired, is written to the register.

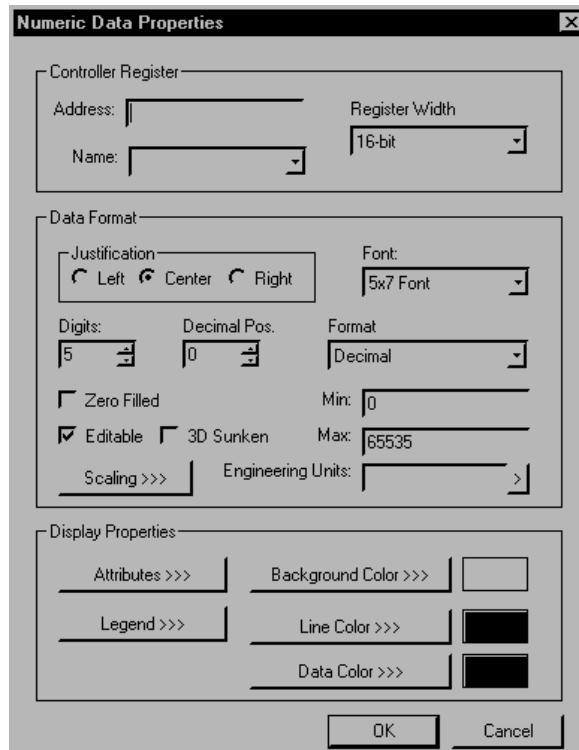

**Figure 16.12 – Numeric Data Properties**

**Object Specific Properties:**

- **Justification**

Specifies the location with-in the object's rectangular bounds that the numeric value will be displayed. Additionally, the actual number of displayed digits should be less than the number of digits reserved. Those digits may be centered or left justified as specified by this field.

- **Font**

Specifies font used to display numeric value.

- **Format**

Specifies format on how the numeric data is displayed

Binary - each digit represents the binary state of the corresponding bit of the input value.

Decimal - displays register value as unsigned value.

Signed Decimal - displays register value as signed value.

Hexidecimal - displays register value as hexidecimal [0-F]

Real/Floating Point - displays register value as floating point value [xx.xx] (must be associated to a 32 bit register which contains a number in IEEE float format)

Scientific Notation - displays register value in scientific notation [x.xxe±xx]

- **Digits**

Specifies the (maximum) number of digits to display. If the actual value is too large to fit in the number specified, an overflow indicator will be displayed as discussed below. Note that the object must also be sized large enough for all of the specified digits to be displayed. This can easily be determined by comparing the number # characters visually displayed by the editor with the number of digits specified.

- **Decimal Place**

For decimal formats, a decimal point (.) is visually placed in the display at this location and does not effect the 16/32 bit signed value numerically. For floating point format, this field will determine the number of decimal digits displayed. The number of integer digits displayed is the number of digits (minus) the number of decimal digits. For scientific notation format, this value will determine the number of decimal digits displayed. The number of integer digits allowed for entry is the number of digits (minus) the number of decimal digits. The number of displayed integer digits is always one. The number of exponent digits is always two.

- **Zero Fill**

This checkbox causes the value to be displayed with leading zeros to fill out all specified digits.

- **Editable**

This checkbox allows the object to be selected and the numeric value to be changed. When checked a **Min** and **Max** field will be displayed which will limit values entered by the user.

- **3D Sunken / 3D Raised**

Adds 3D dimensions to the object if desired.

- **Engineering units**

This field allows a short single line of text to be entered specifying the engineering units of the value (i.e. °F, mV, lbs., etc...)

### **Object Behavior**

- **Control register types (binary or analog)**

This object will accept any register type and size; however, Register Width field must specify 1-bit type for discrete register types (%I, %Q, etc). Register Width must specify the number of bits to convert for an analog value.

- **Functionality**

The current OCS register value is converted to the specified format every 150ms. and displayed in the object. If editable, a new value may be entered which is written to the control register.

If a value is not displayable in the current format, the display digits are filled with:

- '+' - If current value is too large to fit in digits.
- '>' - If current value is greater than maximum (editable mode only).
- '<' - If current value is less than minimum (editable mode only).
- 'e' - If current value is floating point infinity or NAN.

- **Object Editor (editable checkbox enabled)**

Both INSERT and OVERSTRIKE modes are supported by this object. To invoke object editor:

1. Select object (outlined with dashed line) with arrow keys and press Edit/Enter key.
2. Unused digits will be zero filled and entire field will be highlighted (INSERT mode)
3. Once in INSERT mode, pressing the first numeric key will clear the current value and replace with the numeric value of the key. Thereafter, any numeric key will shift the new value left and place the new key value in the one's position.
4. To change to OVERSTRIKE mode, press either the Left or Right key. The display will change from the entire field being hi-lighted to a single character hi-lighted.
5. Once in OVERSTRIKE mode, the hi-lighted character may be modified by either pressing a numeric key <or> increment/decrement the value with the Up/Down keys respectively. Note that the increment/decrement will roll-over higher power digits.
6. To accept the new value in either mode, press the Edit/Enter key. To reject the new value, press the Esc key and the previous value will be restored. In either case, the object will leave edit mode and display the value non highlighted.

Hexadecimal format editing exceptions:

1. All numeric keys with the exception of the 2ABC or 3DEF keys function as specified above. However, pressing the 2ABC or the 3DEF key consecutively will cycle through each of the key choices [ i.e. 2-A-B-C ].
2. After the 2ABC or 3DEF key is pressed the appropriated number of times to display the correct hexadecimal digit, the next digit position may be selected by pressing the decimal point (.) key.

Floating Point / Scientific format editing exceptions:

1. Only INSERT mode is supported
2. Each field (integer, decimal and exponent) will limit the operator from entering more than the number of digits specified.
3. To insert a Real/Floating point number:
  - insert integer digits
  - insert a decimal point
  - insert decimal digits
4. To insert a Scientific number
  - insert integer digits
  - insert a decimal point
  - insert decimal digits
  - press the decimal point key again to display the **E**
  - insert exponent digits.

**Object Display Attributes:**

- Border (static)
- Flash (static or dynamic)
- Enable Input (dynamic)



Time Data:  
Formats the time display that is written into a register.

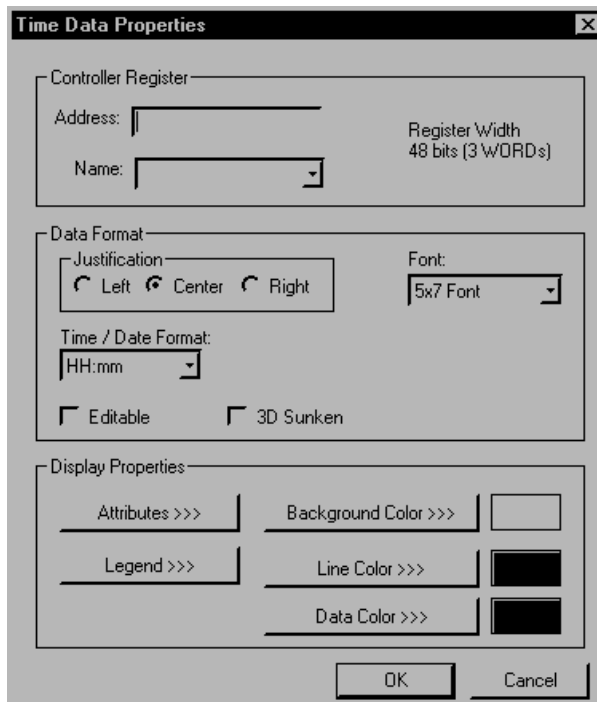

Figure 16.13 – Time (/Date) Data Properties

**Object Specific Properties:**

- **Justification**

Specifies the location (within the object's rectangular bounds) that the time or date will be displayed.

- **Font**

Specifies font used to display the time or data value.

- **Format**

Specifies how the time or date will be displayed. A drop-down menu displays a variety of combinations which can be displayed, the following defines the format codes.

HH = Hour (24 hour mode)	mmm = month [ Jan - Dec ]
hh = Hour (12 hour mode)	mm = month [ 01-12 ]
mm = Minutes	dd = day [ 01-31 ]
ss = Seconds	yy = year [ 96-95 ]
xM = AM / PM indicator	yyyy = year [ 1996 - 2095 ]

- **Editable**

This checkbox allows the object to be selected and the time or date value to be changed.

- **3D Sunken / 3D Raised**

Adds 3D dimensions to the object if desired.

**Object Behavior**

- **Control register ( starting reference of 3 consecutive registers )**

This object may be reference to %SR44 to access system time, %SR47 to access system date or any 16-bit boundary that uses 48 consecutive bits for the format specified.

	Time Format	Date Format:
register16 + 0:	seconds	day of month
register16 + 1:	minutes	month
register16 + 2:	hours	year

- **Functionality**

Current register value is converted to specified time/date format every 150ms and displayed in the object. If editable, a new value may be entered, which is written to the control register.

- **Object Editor (editable checkbox enabled)**

1. Select object with arrow keys and press Edit/Enter key
2. First field will be highlighted (SELECT mode).
3. Select field to edit with Left or Right keys (i.e. hours, minutes, etc...)
4. Increment/Decrement value by pressing Up/Down keys respectively (Direct numeric entry is NOT supported).
5. To accept the new value in either mode, press the Edit/Enter key. To reject the new value, press the Esc key and the previous value will be restored. In either case, the object will leave edit mode and display the current time or date non highlighted.

**Object Display Attributes:**

- Border (static)
- Flash (static or dynamic)
- Enable Input (dynamic)



**Password Data:**

Allows a 32 bit value to be written to an OCS register with the display field covered.

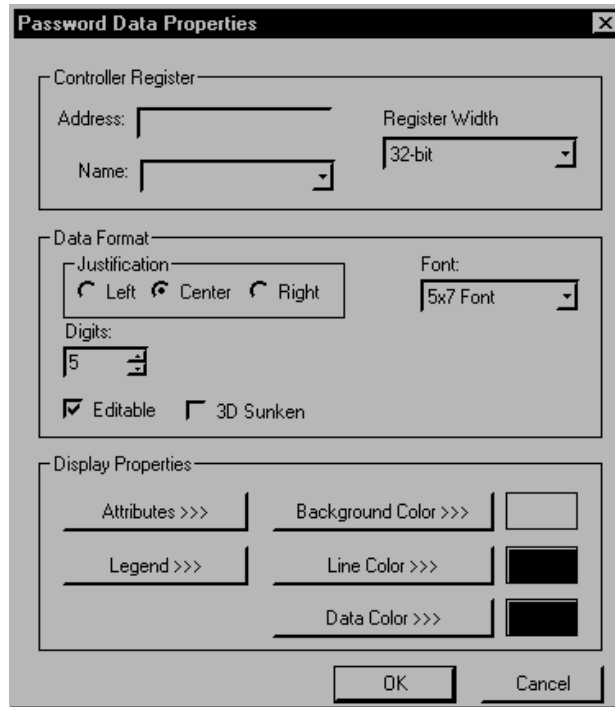

**Figure 16.14 – Password Data Properties**

**Object Specific Properties**

- **Justification**  
Specifies the location (within the object's rectangular bounds) that the password will be located.
- **Font**  
Specifies font used for covering character \*.
- **Digits**  
Specifies the maximum number of digits allowed for display/entry.
- **3D Sunken / 3D Raised**  
Adds 3D dimensions to the object if desired.

**Object Behavior**

- **Control Register**

Register must be on 16 bit boundary and uses 32 bits

- **Functionality**

Used to enter 32 bit unsigned integer password without displaying actual numeric characters.

When editing an \* will appear in the current digit position being inserted.

When editing is complete, all digit positions will be filled with \*'s unless the current register value is greater than the number of digits. In that case, all digit positions will be filled with +.

- **Object Editor (editable checkbox enabled)**

1. Select object with arrow keys and press Edit/Enter key.
2. Entire field will be highlighted (INSERT MODE).
3. Type in new value using numeric keys (value will be covered with an \*.)
4. To accept the new value, press the Edit/Enter key. To reject the new value, press the Esc key and the previous value will be restored. In either case, the object will leave edit mode and display the entire field of \* non-highlighted.

**Object Display Attributes:**

Border (static)

Flash (static or dynamic)

Enable Input (dynamic)



Text Table Data:

Creates a text table and formats the text in the table that is read from a register, or if desired, is written to the register.

**Text Table Data Properties**

Controller Register

Address:  Register Width: 16-bit

Name:

Data Format

Justification:  Left  Center  Right Font: 5x7 Font

Digits: 5 Text Table Number: 1

Editable  3D Sunken

Display Properties

Attributes >>> Background Color >>>

Legend >>> Line Color >>>

Data Color >>>

OK Cancel

**Figure 16.15 – Text Table Data Properties**



### ***Object Specific Properties***

- **Justification**

Specifies the location within the object's rectangular bounds that the Text will be displayed. For Text fields shorter than the specified number of digits, the fields will be shifted appropriately to the specified justification. For Text fields larger than specified number of digits, characters will be clipped on to the right side of the text.

- **Font**

Specifies font used to display the enumerated text.

- **Digits**

Specifies the maximum number of enumerated Text characters displayed.

- **Edit Text Table**

Invokes text table editor that allows text to be added, deleted or modified from any text table.

- **Editable**

This checkbox allows the objects enumerated value to be changed with arrow keys.

- **3D Sunken / 3D Raised**

Adds 3D dimensions to the object if desired.

### ***Object Behavior***

- **Controller Register**

This object will accept any register type and size; however, Register Width field must specify 1-bit type for discrete register types (%I, %Q, etc). Register Width will also specify the number of bits to convert for an analog value

- **Functionality**

The value in controller register will determine which text table string will be displayed. When the control register value changes, the object searches through the text table (least to greatest enumerated value) until it finds an enumerated value greater than or equal to that of the control register value. Then, the enumerated value's corresponding string is displayed by the object within the limitations of digits and justification specified. When searching for the corresponding enumerated value, both the control register and enumerated values will be treated as unsigned integers.

If editable, the object editor allows selection of one of the text table strings which results in the corresponding enumerated value being written to the controller register.

- **Object Editor (editable checkbox enabled)**

1. Select object with arrow keys and press Edit/Enter key
2. Entire field will be highlighted and editor will be in SELECT mode
3. Increment/Decrement through enumerated text list by pressing Up/Down key respectively.
4. To accept the new value, press the Edit/Enter key. To reject the new value, press the Esc key and the previous value will be restored. In either case, the object will leave edit mode and display the entire field of \* non-highlighted.

**Object Display Attributes:**

- Border (static)
- Flash (static or dynamic)
- Enable Input (dynamic)

**ASCII Data:**

Formats text that is read from a register, or if desired, is written to the register.

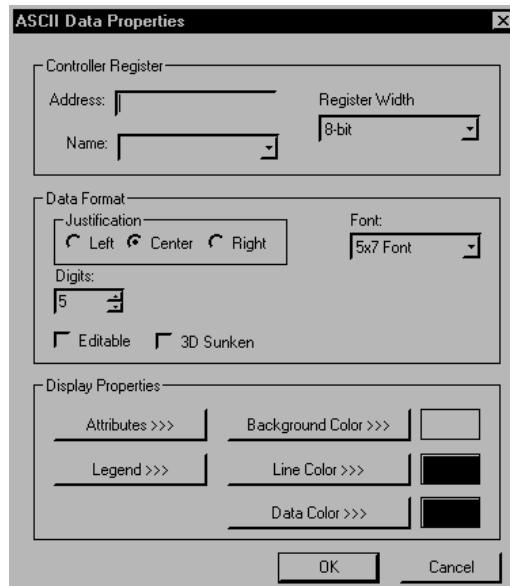

**Figure 16.16 – ASCII Data Properties**

**Object Specific Properties**

- **Justification**

Specifies the location, within the object's rectangular bounds, that the Text will be displayed.

- **Font**

Specifies font used to display the Text.

- **Digits**

Specifies the number of Text characters allowed for display/entry.

- **3D Sunken / 3D Raised**

Adds 3D dimensions to the object if desired.

## Object Behavior

- **Control Register**

Register must be on 16-bit boundary and may refer to a consecutive group containing up to two 8-bit ASCII characters per 16-bit word.

- **Functionality**

Text string starting at the specified control register is moved to the objects display every 150ms. Text is expected to be in the form of 8-bit ANSI characters (two per word register) with the leftmost digit in the least significant 8-bits of the control register. The digits property specifies the expected length of the text string. Note that NULL (zero) 8-bit values are NOT used to indicate the end-of-string to the object. Should the object encounter a NULL 8-bit value before filling all of the specified digits, that position is displayed as a SPACE ' ' character and the object will continue retrieving 8-bit values to fill up digit positions.

If editable, a new value may be entered which is written to the control register(s).

- **Object Editor (editable checkbox enabled)**

1. Select object with arrow keys and press Edit/Enter key.
2. Entire field will be highlighted and editor will be in CLEAR mode
3. Pressing any alpha-numeric key will clear field, set leftmost character to key pressed, set each remaining position to space ' ' character, and change editor to OVERWRITE mode.
4. While in OVERWRITE mode, Left or Right key may be used to move to desired digit.

Under this object editor, each of the numeric keys may be pressed a consecutive number of times to select one of several ASCII characters assigned to that one key. As long as the same physical key is pressed, the cursor will not move. To move to the next position, press a different key or when the next character is the same as the current, the arrow key can advance the cursor.

5. To accept the new value, press the Edit/Enter key. To reject the new value, press the Esc key and the previous value will be restored. In either case, the object will leave edit mode and display the entire field of \* non-highlighted.

- **Multiplexed key definitions:**

- [1] - ' ', Q, Z, q, z, 1
- [2] - A, B, C, a, b, c, 2
- [3] - D, E, F, d, e, f, 3
- [4] - G, H, I, g, h, i, 4
- [5] - J, K, L, j, k, l, 5
- [6] - M, N, O, m, n, o, 6
- [7] - P, R, S, p, r, s, '7
- [8] - T, U, V, t, u, v, 8
- [9] - W, X, Y, 'w, x, y, 9
- [0] - 0
- [+/-] - +, -, \*, /, =, (, ), }
- [.] - ., ?, :, ; (,), ('), (")

### Object Display Attributes:

- Border (static)
- Flash (static or dynamic)
- Enable Input (dynamic)



**Note:** Allows the operator to leave note by writing on screen.

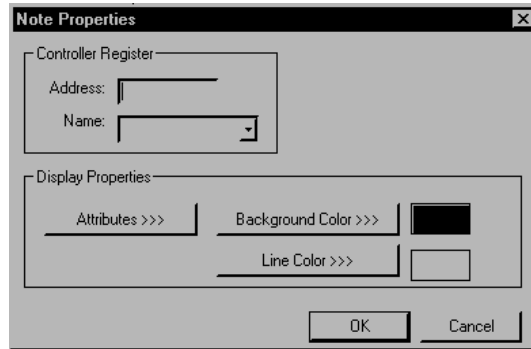

**Figure 16.17 – Note Properties**

### Object Specific Properties

None

### Object Behavior

- Controller Register
- Only accepts bit register references.

### Functionality

This object displays a note area where the operator can "write" on the screen with a stylus or finger. When this object contains no message the controller register is cleared. When a message is saved (by the operator pressing the save button) the controller register is set. Currently only one note object is allowed per program. The note data is currently not retentive and is cleared by a power cycle.

### Object Display Attributes

- Visible (static or dynamic)
- Border (static)
- Flash (static or dynamic)
- Enable Input (dynamic)



**Indicator (Lamp):**

Displays and formats an indicator that is associated with a source register. Indicator types include round or square lamps or bulbs.

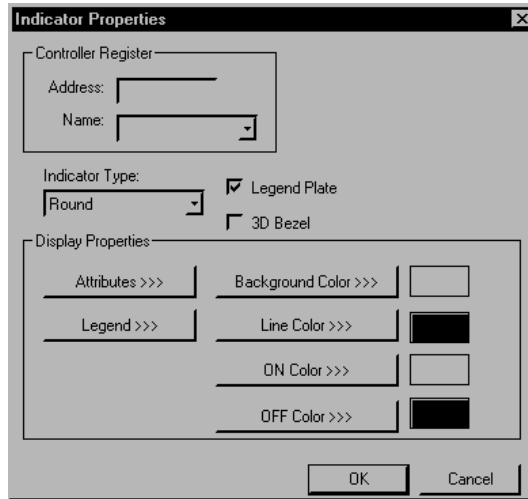

**Figure 16.18 – Indicator Properties**

**Object Specific Properties**

- **Indicator Type**  
Specifies the type of display (animation) ICON [ Round, Square or Bulb ]
- **Legend Plate**  
Creates a virtual Legend Plate consisting of a legend, border, and a background color.
- **3D Bezel**  
Provides a Bezel attribute for the object if desired.

**Object Behavior**

- **Control Register**  
This object will only accept register types on bit boundaries.
- **Functionality**  
Object (animation) ICON reflects current state of Control Register. For the round and square types, the area within the boundary is filled with the line color when ON and with the background color when OFF. For the bulb type, light rays will be drawn when ON and erased when OFF.

**Object Display Attributes:**

Border (static)

Flash (static or dynamic)

ON Color &gt;&gt;&gt;

ON Color / OFF Color:

OFF Color &gt;&gt;&gt;

Allows the selection of colors to denote ON and OFF states of the Indicators.

**Switch:**

Displays and formats a switch that is associated with a write register.

**Figure 16.19 – Switch Properties****Object Specific Properties**

- **Keypress Source**  
Specifies the location of the source for the switch. This may be either a softkey or an auxiliary register.
- **Touch Screen**  
Used with OCS3xx models.
- **Switch Type**  
Specifies the type of display (animation) ICON [Standard, Round, Square, or Rocker]

- **Switch Action**  
Specifies the switch action emulated when the keypress source is pressed.
  - Momentary - Controller register will be set ON will key is down. When key is released, controller register will be set OFF.
  - ON - Controller register will be set ON when key is pressed.
  - OFF - Controller register will be set OFF when key is pressed.
  - Toggle - Controller register will be toggled when key is pressed.
- **Legend Plate**  
Creates a virtual Legend Plate consisting of a legend, border, and a background color.
- **3D Bezel**  
Provides a Bezel attribute for the object if desired.
- **Show On/Off state caption**  
When checked, the animation ICON will contain one of two text strings designating the current state of the target device.
- **State Properties (button)**  
Enabled when Show On/Off state caption checked. Invokes state text dialog box which allows the state text strings to be re-defined and/or specify whether the state determination is based off the switch object's controller register or a definable auxiliary register.
- **Return to last screen after press**  
Essentially emulates an ESC keypress immediately after the switch action. If screens have been queued, by a previous screen jump object, that previous screen will become current. If no screen has been queue, no screen change will occur. This feature provides the functionality of an OK and Cancel type dialog buttons which allow returning from that screen once a choice is made.

### Object Behavior

- **Controller Register**  
This object will only accept register types on bit boundaries.
- **Functionality**

For the toggle action, any change in the keypress state or for the remaining actions, any low-to-high change in the keypress state will cause the object to generate that specified action in the controller register. If the keypress source is an auxiliary register, a change will not be recognized until the first low-to-high transition. This prevents a Function key (F1-F10) assigned as the keypress source from generating an erroneous action on entry to this screen should that same key used to generate the screen jump.

For standard, round and rectangular types, the outer area of the object's (animation) ICON will indicate when the Controller Register is ON or OFF. This outer area (bezel) is filled with the Line Color when ON and filled with the Background Color when OFF. For the rocker type, the upper portion will appear pressed when ON and the lower portion will appear pressed when OFF. Note that this animation follows the state of the control register and not the actual keypress source. Should the network or ladder rung modify the state of the control register, that change would be reflected in the animation.

Optionally, the inner area may also show an On/Off state caption. Both the ON and OFF state strings can be redefined and may follow the state of the switch (controller register) or a target device (auxiliary register) that may be controlled by more than just this switch register.

#### Object Display Attributes:

- Border (static)
- Enable Input (dynamic)
- Show ICON (static)



Selector:

Displays and formats a multi-position switch that is associated with a write register.

Figure 16.20 – Selector Properties

#### Object Specific Properties

- **Positions**

Selects number of visual selector positions. This is limited from 1 to 4.

- **Items**

Invokes Editor, which defines the text to be displayed in each switches position and the Total Items if only one switch position is configured.

- **Touch Screen**

Used with OCS3xx models.



### Object Behavior

- **Controller Register**

This object will only accept register types on 16-bit boundaries and will consume 16-bits (word).

- **Functionality**

This function emulates a single or multi-position-interlocked selector switch. Each switch position on the object will be tied to a keypress source (softkeys or an auxiliary OCS register). For softkeys, the object consumes the consecutive number of softkeys as specified by the position's property. For an auxiliary reference, the object consumes the consecutive number of register bits specified by the positions property (auxiliary reference must fall on 16-bit boundary).

For the multi-position switch, a keypress (low-to-high transition) on a switch position will cause the object to write the position of that keypress [0-3] to the specified controller register. The position displayed closest to the top of the screen will be associated with the first keypress source. Should multiple keypress bits toggle at the same time (possible only with auxiliary reference), the lowest keypress source bit will be prioritized.

With the single position switch, only one position (and only one keypress source) controls the object. On each keypress (low-to-high transition), the object will increment through the number of Total Items [0-(Total Items-1)] and writing that value to the controller reference.

The object will highlight the last selected switch position. Note that this animation follows the state of the control register and not the actual keypress source. Should the network or a ladder rung modify the state of the control register, that change would be reflected in the animation.

### Object Display Attributes:

- Border (static)
- Enable Input (dynamic)

*ON Color / OFF Color:*



Allows the selection of colors to denote ON and OFF states of the Indicators.



Screen Jump:

Formats a screen jump to a specific screen number address / number.

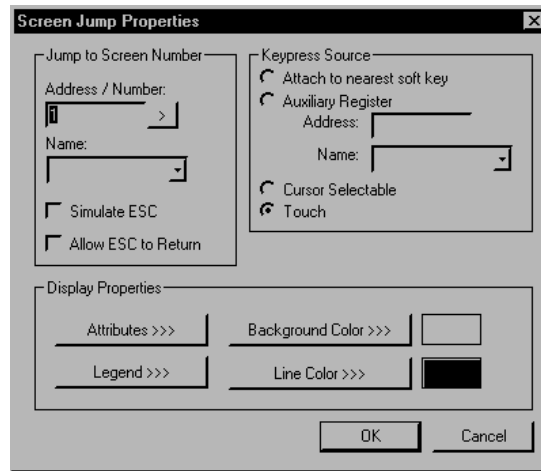

Figure 16.21 – Screen Jump Properties

### Object Specific Properties

- **Address / Number**

Specifies the page number (directly or indirectly) by specifying an OCS register to jump too. In addition, the user may also specify and increment or decrement value. This value, which must be preceded by either a (+) or (-), indicates to the object the number of screens to jump forward or backward from the current screen.

- **Touch Screen**

Used with OCS3xx models.

- **Allow ESC to Return**

This selection allows up to 16 screens to be saved in a screen queue when the screen jump occurs. Thereafter, if the operator presses the ESC key after the jump to the specified screen, the saved screen is popped from the queue and a jump back to that screen is performed. The screen queue will save up to the last 16 screen jumps. When no screens are queued, the ESC key does not cause a screen change.

**OCS3xx models:** There is no physical ESC key; a screen jump key can be programmed to function as an ESC key.

### Object Behavior

- **Functionality**

This object accepts 1 of 3 different types of keypress sources (softkey, auxiliary reference or cursor selectable). When the object receives input from its selected source, it switches screens to that specified in the screen reference. Should the **Allow ESC to Return** property be enabled, the object will also queue the current screen before switching to the new screen.

When attached to a keypress source of softkey or an auxiliary register, a low-to-high transition on that keypress source initiates the screen switch. When cursor selection is specified, the page object must first be selected with the arrow keys, then the Edit/Enter key must be pressed to initiate the screen change.

This object only initiates a screens change if the current operating level is a USER (%SR2 = zero). Should the current screen displaying be generated at the ALARM lever (%SR2 != zero), a screen jump object will have no effect.

**Object Display Attributes:**

- Border (static)
- Enable Input (dynamic)
- Show ICON (static)



**Bar Graph:**

Formats a bar graph associated with a specific source register.

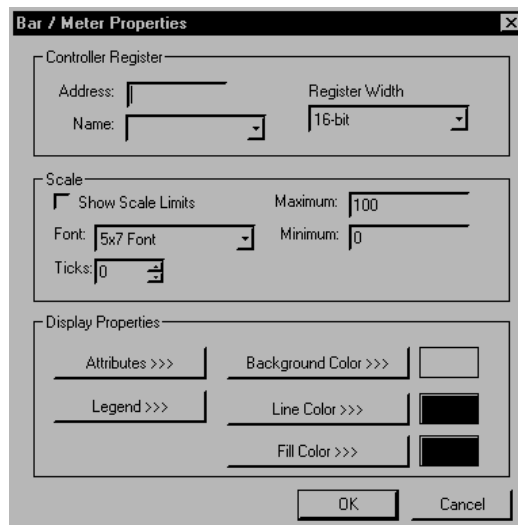

**Figure 16.22 – Bar / Meter Properties**

**Object Specific Properties**

- **Show scale limits**  
Enables display of specified limits on ends of object.
- **(Scale limits) Font**  
Font used to display limits
- **(Scale limits) Maximum and Minimum**  
Establishes the range of the controller register value represented.

- **Ticks**  
Specifies number of tick marks (divisions) displayed on the edge of the object

#### Object Behavior

- **Controller Register**  
Only accepts register references on 16-bit boundaries. Treats the register as a 16-bit signed integer.
- **Functionality**  
This object continuously samples the specified controller. The sampled value is visually scaled between the high and low limits with the high limit being 100% of bar filled, and the low limit being 0% of the bar filled.

The sizing of the object determines the fill direction. If the width is greater than the height, fill is from left-to-right. Otherwise, the fill is from top-to-bottom.

#### Object Display Attributes

None



Meter: **Refer to Figure 16.22.**

Formats a meter associated with a specific source register.

#### Object Specific Properties

- **Show scale limits**  
Enables display of specified limits in jewel cover area of object.
- **(Scale limits) Font**  
Font used to display limits
- **(Scale limits) Maximum and Minimum**  
Establishes the range of the controller register value represented.
- **Ticks**  
Specifies number of tick marks (divisions) displayed on meter arc.

#### Object Behavior

- **Controller Register**  
Only accepts register references on the 16-bit boundaries. Treats the register as a 16-bit signed integer.
- **Functionality**  
This object continuously samples the specified controller register. The sampled value is then visually scaled between the high and low limits with the high limit setting the needle to the rightmost position, and the low limit setting the needle to the leftmost position.

#### Object Display Attributes

None



Static Bitmap:  
Displays single bitmap

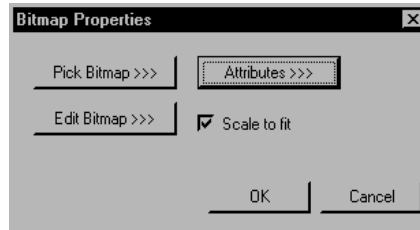

Figure 16.23 – Bitmap Properties

### Object Specific Properties

- **Pick Bitmap**  
Displays a dialog that allows the user to access a bitmap file.
- **Edit Bitmap**  
Invokes configured bitmap editor with selected bitmap. Note that the **Tools/Set Bmp Editor...** must be configured to the file location of a bitmap (bmp) editor. Generally this is MS Paint which is supplied as part of the Windows or NT operating system.
- **Scale to Fit**  
Resizes as imported bitmap to match the bounds of object. If not selected, the object's lower-right bounds are recalculated to match the bitmap's dimensions. If the bitmap is larger than the screen, it is clipped appropriately.

### Object Behavior

- **Functionality**  
Allows insertion of a Window's Bitmap file (.BMP) on to a display screen. The bitmap is painted once when the screen is initialized.

### Object Display Attributes

None



Animation:

Displays bitmap (frame) based on enumerated value of controller register

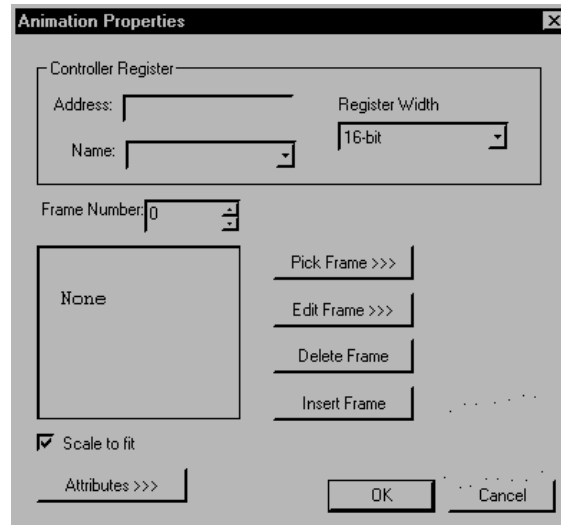

Figure 16.24 – Animation Properties

### Object Specific Properties

- **Frame number**  
Selects the frame number to associate a bitmap too.
- **Pick Frame (button)**  
Displays dialog that allows user to access a bitmap file.
- **Edit Frame (button)**  
Invokes configured bitmap editor with selected frame bitmap. Note that the **Tools/Set Bmp Editor...** must be configured to the file location of a bitmap (bmp) editor. Generally this is MS Paint, which is supplied as part of the Windows or NT operating system.
- **Delete Frame (button)**  
Deletes the bitmap at the current frame number and moves all of the bitmaps at higher frame numbers down by one. Deletes a bitmap from a sequence of frames.
- **Insert Frame (button)**  
Moves all bitmaps at and above the current frame number up by one. Opens up space in a sequence for the addition (Pick) of a bitmap.

- **Scale to Fit**  
Resizes imported bitmaps to match bounds of the object. If not selected, the object's lower-right bounds are recalculated to match the first frame bitmap's dimensions. If the bitmap is larger than the screen or the first frame bitmap, it is clipped appropriately.

**Object Behavior**

- **Controller Register**  
This object will accept any register type and size; however, Register Width field must specify 1-bit type for discrete register types (%I, %Q, etc). Register Width will also specify the number of bits to convert for an analog value
- **Functionality**  
Allows insertion of one of several Window's Bitmap file(s) (.BMP) on a display screen based on the state of the control register. The control register is sampled continuously and treated as an unsigned value. When the sampled value changes, the bitmap associated with the frame number equal to the sampled value is displayed. If the sampled value is greater than the largest defined frame number, the bitmap associated with the largest defined frame number is displayed.

**Object Display Attributes**  
None

 **Slider:** This object allows an analog value to be adjusted with a simulated slider and/or trim buttons. (Color Touch models)

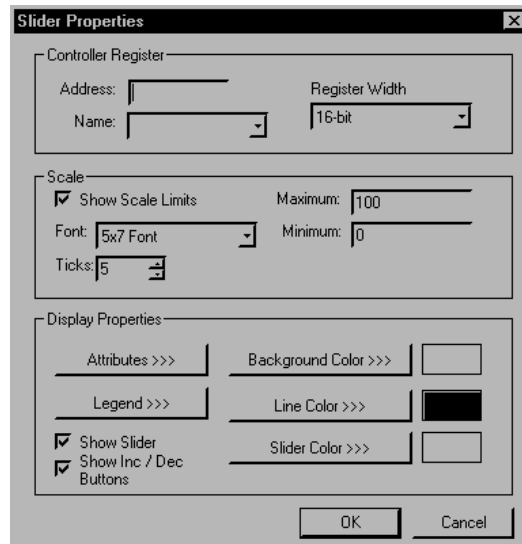

**Figure 16.25 – Slider Properties**

- **Slider**  
This object allows an analog value to be adjusted with a simulated slider and/or trim buttons. (Color Touch models)

### Object Specific Properties

- Show scale limits
- Enables display of specified limits on ends of slide scale.
- (Scale limits) Font  
Font used to display limits.
- (Scale limits) Maximum and Minimum  
Establishes the range of the slider object. Slider limits value output value based on these limits (during movement only).
- Ticks  
Specifies the number of tick marks (divisions) displayed on slide scale. If tick marks are not desired, set number to zero.
- Show slider  
Enables (sizes object) the slider control. If only trim buttons are desired, un-select this option.
- Show inc/dec buttons  
Enables (sizes object) the trim buttons. If only the slider control is desired, un-select this option. Object operation is not defined with both Show slider and Show inc/dec buttons un-selected.

### Object Behavior

- Controller Register  
Only accepts register references on 16-bit boundaries. Treats register as 16-bit signed integer.
- Functionality (Slider)  
This object continuously samples the specified controller register and updates the slider position appropriately. On slider movement by touch, the controller register is updated with a value proportional to the position of the slider with respect to the upper and lower limit. On touch, the slider color will invert to acknowledge that it is responding to movement. The slider is represented in 3D when enabled.
- Functionality (Trim)  
On touch, the trim buttons will increment or decrement the controller register by a value of one depending on the respective button pushed. If touch is maintained on the respective button for longer than 1 second, the control enters auto-repeat mode which increments (or decrements) the control register at a linear rate of 1 change per 100mS. The controls are limited to not increment (or decrement) past the respective limits. The controls are represented in 3D when enabled.



**Object Display Attributes**

- Visible (static or dynamic)
- Border (static)
- Flash (static or dynamic)
- Enable Input (dynamic)



**Data Trend:**

Creates and formats a Data Trend which tracks one or more variables over time. Four types of trend boxes are available. Up to 4 trends (registers) can be graphed in each Data Trend Box using Configure Pens. A Trigger address is required to activate the trending process for each Data Trend Box.

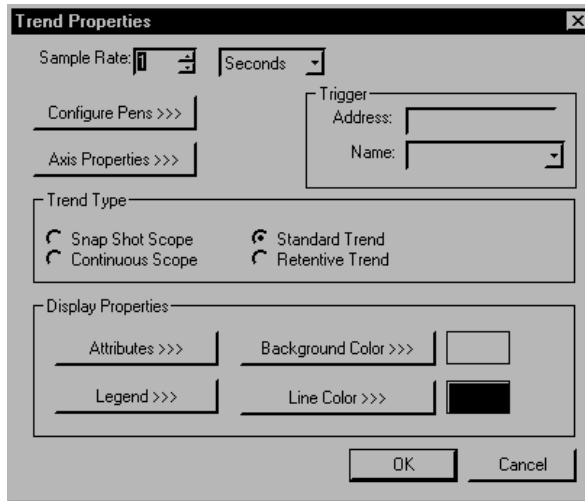

**Figure 16.26 – Trend Properties**

### Object Specific Properties

- **Sample Rate**  
Elapsed time between samples. Generally, units are variable between 1-9999 while the Base is dependent on the trend type. For standard and retentive trends the base is selectable between Seconds, Minutes and Hours. For the other trend types, the base is limited to Milliseconds only.
- **Configure Pens (button)**  
Accesses dialog for specifying the number of pens and each pen's associated control register. Up to four pens can be specified with one of three styles [solid, dotted or dashed].
- **Axis Properties (button)**  
Accesses dialog for defining each axis label, limits (Y-scaling) and ticks.
- **Trend Type**  
Specifies one of the four modes of operation supported.
- **Trigger**  
OCS register (1-bit) reference which controls when trend is active, halted or cleared.

### Object Behavior

- **Functionality**

Once triggered, the control register for each of the defined pens is sampled at the specified sample rate and plotted to the objects display area. Triggering is level sensitive in that the trend will be active while the trigger is high and the OCS is in RUN mode. In all modes trending will cease when the trigger register is set low. On the detection of a low-to-high transition of the trigger by the object, previous trend data will be cleared before the new trace begins. On RUN-STOP-RUN cycles, previous trend data will NOT be cleared and trending will continue if the associated trigger was maintained high through the transition (assumes NO screen change for snap-shot and continuous modes).

Each control register value is treated as a 16-bit signed value and vertically scaled (and limited) to the Y-Min and Y-Max values presented in the Axis Dialog.

#### 1. Snap shot scope (high speed)

This mode allows capture of up to one object display's width of data after triggering. Object is only active and can only hold data while its associated screen is being displayed. Minimum sample rate is 10ms.

#### 2. Continuous scope (high speed)

This mode allows continuous updating of data after trigger (screen scrolls once display width full). Object is only active and can only hold data while its associated screen is being displayed. Minimum sample rate is 50ms.

#### 3. Standard trend

This mode allows continuous updating of data after trigger regardless of whether the object's associated screen is being displayed. Additionally, the object's screen does NOT need to be displayed for trigger control. The screen containing the object only needs to be visible for viewing data. If trending is continued through a RUN-STOP-RUN cycle, a vertical dashed line marks that event in the trend data.

#### 4. Retentive trend

Behaves as Standard trend with the exception that the object's last display width of data is retained in battery-backed memory and is restored to the object at power-up. If the trend is running at a power-cycle, a vertical dashed line marks that event in the trend data.

On the horizontal axis of the object's trend display area, each sample consumes one screen pixel's width. The editor will display the width and height (respectively) of the object's trend display area in a small white box on the trend object. The user may use the width dimension to determine the total number of samples that the trend object can display.

There is a limit to the number of standard and retentive type trend objects supported in a program. The limit is actually based on the number of configured pens, which is 16 for the retentive trends and an overall limit of 32 pens for any mix of standard and retentive trends.

### Object Display Attributes

Border



#### X-Y Graph:

Creates and formats a X-Y Graph which represent variations of a variable in comparison to variations of one or more other variables. A number of values can be plotted or located by means of x-y coordinates. Up to 4 different variations (registers) can be graphed using Configure Pens. A Trigger Refresh address is required to reset the registers and reactivate the plotting process.

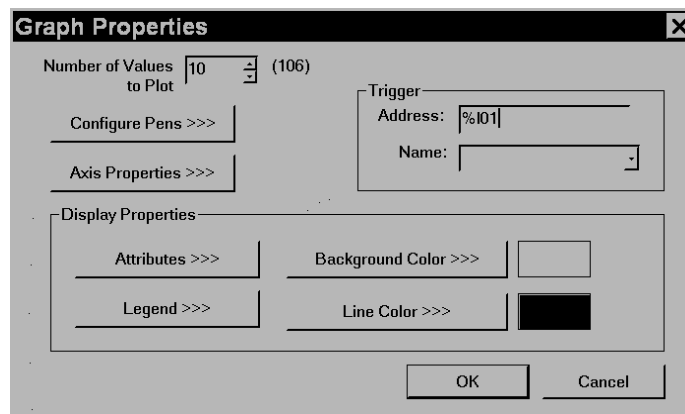

Figure 16.27 – X/Y Graph Properties

### Object Specific Properties

- **Number of values to plot**  
Actual number of consecutive register values to plot per pen. Do not exceed the maximum number (width of display area) that is displayed next to this field in parentheses.
- **Configure Pens (button)**  
Accesses dialog for specifying the starting controller register and associated pen style for each pen. Up to four pens can be specified with one of three styles [solid, dotted or dashed].
- **Axis Properties (button)**  
Accesses dialog for defining each axis label, limits (Y-scaling) and ticks.
- **Trigger**  
OCS register (1-bit) reference which controls when plot is calculated and displayed.

## Object Behavior

- **Functionality**

Once triggered, the object will plot the data for each configured pen starting with the associated controller reference and continuing with consecutive registers for the *Number of values to plot*. The first plot begins on the Y axis with the following points proportionally spaced and connected. Each control register value is treated as a 16-bit signed value and vertically scaled (and limited) to the Y-Min and Y-Max values presented in the Axis Dialog.

The editor will display the width and height (respectively) of the object's trend display area in a small white box on the trend object. The user may use the width dimension to determine the total number of samples that the trend object can display.

## Object Display Attributes

Border



**Alarm:** Displays alarm summaries or logs as a list or an indicator button. (Color Touch models.)

Figure 16.28 – Alarms Properties

## Object Specific Properties

- **Alarms**

Displays alarm summaries or logs as a list or an indicator button. (Color Touch models)

### Object Specific Properties

- **Summary/History**  
Specify which log to access. Summary contains the current alarm states while the History log maintains a history of each alarm change.
- **Display alarm button/icon only**  
Specifies which indicator to present: a partial list or just a button (w/optional icon) is displayed.
- **Unacked Only (available on partial list attachment to summary log only)**  
Only unacknowledged alarms are displayed on the partial list. This allows the user to ignore acknowledged active alarms. This option does NOT affect the alarm viewer, which displays all active and/or unacknowledged alarms.
- **Allow Operator to Clear**  
Enables the Clear/Clear All buttons when displaying the alarm viewer. When enabled, the operator is allowed to clear (remove) entries from either the summary or history logs.
- **Font**  
Specifies font used by both the partial list and the alarm viewer.
- **Date**  
This checkbox enables the display of the date of occurrence for each alarm in both the partial list and the alarm viewer. The corresponding list box allows selection of the specific date format.
- **Time**  
This checkbox enables the display of the time of occurrence for each alarm in both the partial list and the alarm viewer. The corresponding list box allows selection of the specific time format.
- **State**  
The checkbox enables the display of the state of each alarm in both the partial list and the alarm viewer.
- **Alarm Groups to Display**  
Selects which group(s) of alarms to be display by both the partial list and the alarm viewer.
- **Background Color**  
When button/icon only mode is selected, this selection is NOT available. The objects background color is determined by the highest alarm state in the objects associated alarm log and the colors specified in the Alarm Configuration menu.

### 16.10 Drawing Primitive Reference

The following shape drawing primitives allow the user to provide decorative backgrounds, borders and shapes for a screen.

1. **Rectangle**
2. **Circle**
3. **Rounded Rectangle**
4. **Line**

These objects may be layered and are updated if the dynamic field of a object beneath the drawing primitive is updated. Note that each shape counts as an object in the object-per-page limit.

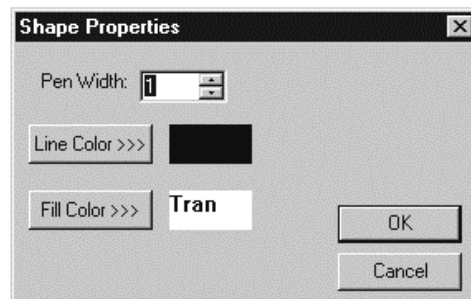

**Figure 16.29 – Shape Properties**

- Each primitive's pen width and drawing color is configurable. Primitives whose center is enclosed by the outline uses the fill color for the interior.
- *If a primitive has transparent fill color, selection of the object can NO longer be achieved by clicking anywhere in the objects center. To select this type of object, the cursor must be moved to the objects line edge before clicking.*

### 16.11 Suggested Order of the Visual System Design Process

The following plan is an example of approaching the visual system design process.

1. Decide what the overall objectives are for the visual system design.
2. Determine the processes and events that can be visually displayed.
  - What automated I/O devices provide feedback?
3. Determine data that an operator needs to know and events that need to be monitored.
  - What data is an operator likely to request? When?
  - What events need to be monitored and/or acted upon by an operator?
4. Define the I/O devices involved and give each device a name.

5. At this time, the programmer can choose to write a Ladder Program using Cscape software or to create graphic screens or develop both simultaneously.
  - What devices and information need to be displayed on a particular screen?
  - Is the objective of the screen to depict a process event (i.e., an alarm screen indicating that a machine is jammed?)
  - Is the objective of the screen to allow the operator to request data or to take appropriate action such as acknowledging an alarm condition?

NOTES



## INDEX

Absolute Value .....	30	Call Element .....	43
ADC circuit .....	127	Caveats (Analog Circuits).....	123
ADD.....	27	Close Comm Port .....	74
Advanced Math Operations Elements		Cold Junction Compensation.....	127
ARC COSINE .....	32	Comm Port Receive .....	75
ARC SINE .....	32	Comm Port Transmit.....	74
Arc Tangent .....	33	Command Bits.....	113
Common Logarithm .....	33	Command Data Outputs.....	115
COSINE .....	32	Comments	
DEGREES .....	31	As Documentation .....	12
Exponent .....	33	Common Logarithm .....	33
Exponentiate.....	33	Communications Elements	
Natural Logarithm.....	34	CLOSE COMM PORT .....	74
RADIANS .....	31	COMM PORT RECEIVED.....	75
Scaling .....	34	COMM PORT TRANSMIT.....	74
SINE .....	31	MODBUS MASTER.....	78
Alarm .....	196	MODBUS SLAVE .....	77
Alarm Handling Function .....	16	MODEM CONTROL .....	76
Alarm Status Registers .....	17	OPEN COMM PORT .....	73
Power Flow.....	18	<i>Compare Elements</i>	
Registers .....	17	Configuring .....	38
Special Status Bits.....	17	EQUAL .....	39
Status .....	19	GREATER THAN.....	39
Time Stamp Registers .....	18	GREATER THAN OR EQUAL.....	40
User Interface Settings .....	18	LESS THAN.....	39
Analog Conversion .....	119	LESS THAN OR EQUAL.....	40
Analog Values, Cscape and OCS .....	119	Limit .....	40
AND.....	25	NOT EQUAL .....	39
Animation .....	190	<i>Power Flow</i> .....	38
Arc Cosine .....	32	Configuration	
Arc Sine .....	32	OCS Hardware .....	12
Arc Tangent .....	33	Configuration of the Stepper.....	80
ASCII Data.....	178	Controller	
Back Screen.....	167	Configuration.....	12
Bar Graph .....	187	Conversion Elements .....	44
Bias .....	137	Caveats of Conversion.....	44
Bitmap .....	189	<i>Configuring</i> .....	45
BITWISE ROTATE LEFT .....	55	DINT TO INT.....	46
BITWISE ROTATE RIGHT.....	55	DINT TO REAL .....	45
BITWISE SHIFT LEFT .....	54	DOUBLE INTEGER TO REAL.....	45
BITWISE SHIFT RIGHT.....	54	INT TO DINT.....	46
BLOCK FILL.....	60	INTEGER TO REAL .....	45
BLOCK MOVE WORD .....	57	REAL TO DOUBLE INTEGER.....	46
Block Register Move .....	57	REAL TO INTEGER .....	45
Boolean Elements.....	20	Cosine .....	32
Negative Transition Coil .....	20	Counter Elements, Configuring .....	50
Normally Closed Coil .....	20	Counter Operation .....	51
Normally Closed Contact .....	20	Cscape	
Normally Open Coil .....	20	Shortcut Keys.....	147
Normally Open Contacts .....	20	Data Formats .....	91
Positive Transition Coil .....	20	Data Move Elements	
Reset Coil .....	21	BLOCK FILL .....	60
Set Coil.....	20	INDIRECT MOVE .....	58

MOVE CONSTANT .....	61	Tools Reference .....	165
Data Move Elements .....	55	Tools Toolbar .....	163
BLOCK MOVE WORD .....	57	GREATER THAN .....	39
BLOCK REGISTER MOVE .....	57	GREATER THAN OR EQUAL .....	40
Configuring .....	56	Group Selector .....	166
MOVE DWORD .....	57	Hexadecimal Numbers .....	72
MOVE WORD .....	56	Independent PID Element / ISA PID Element ..	85
Multi Rotate Data Moves .....	65	Indexed Moves .....	116
Power Flow .....	56	Indicator (Lamp) .....	181
Single Data Moves .....	55	Indirect Move .....	58
Single Register Move .....	56	INFINITY .....	112
Type Checking .....	56	Insert Special Character .....	169
Data Trend .....	193	Installation .....	13
Data Types		Installation Results .....	13
Storage Order .....	92	INTEGER TO DOUBLE INTEGER .....	46
Data Types, Cscope .....	91	INTEGER TO REAL .....	45
Debug .....	12	Integral Control .....	137
Multiple Units .....	12	Internal Resources .....	93
Degrees .....	31	Issuing Commands .....	117
Derivative Control .....	138	Jump Element .....	42
Display Coil .....	21	K and Tc .....	141
Display Elements .....	21	LESS THAN .....	39
Display Screens .....	21	LESS THAN OR EQUAL .....	40
Distribution .....	13	LIMIT .....	40
Divide .....	28	<i>Logic (Bitwise) Elements</i>	
DOUBLE INTEGER TO REAL .....	45	AND .....	25
Drawing Primitive Reference .....	198	Configuring .....	25
End Program Element .....	44	Exclusive OR .....	26
EQUAL .....	39	NOT .....	26
Error Check .....	168	OR .....	26
ERRORS .....	112	Power Flow .....	24
EXCLUSIVE OR .....	26	Master Mapping .....	78
Exponent .....	33	Math Equation Element	
FLOATING POINT VALUES .....	112	Configuring .....	36
Forcing		Numeric Constants .....	37
Enabling .....	131	Operators .....	37
Forcing Contact or Coil .....	131	Power Flow .....	35
Indicators .....	133	Register Designation .....	37
Registers .....	132	Typing .....	36
Viewing Forced Items .....	133	Useful Math Feature .....	35
Graphic Editor .....	151	Math Operations Elements .....	27
Background Color .....	170	Absolute Value .....	30
Displaying time or date .....	174	ADD .....	27
Drawing Primitives Toolbar .....	165	Configuring .....	27
Engineering units .....	171	DIVIDE .....	28
Font .....	171	MOD .....	29
Format, Decimal .....	171	MULTIPLY .....	28
Format, Numeric data .....	171	Square Root .....	30
Object Description .....	151	SUBTRACT .....	28
Object Grouping .....	153	Meter .....	188
Object Placement .....	152	Miscellaneous Elements	
Object Properties .....	155	ADD Vertical Branch .....	89
Object Reference .....	169	Deleter Vertical Branch .....	89
Object Toolbar .....	164	MOD (modulo) .....	29
Screen Description .....	160	MODBUS MASTER .....	78
Toolbar Reference .....	162	Modbus Slave	

Master Mapping .....	78	Position Feedback Registers .....	114
MODBUS SLAVE .....	77	Power Connector .....	109
MODEM CONTROL .....	76	Previous Screen .....	167
MOVE CONSTANT .....	61	<i>Process Variable</i> .....	136
MOVE DWORD .....	57	Product Overview .....	11
MOVE WORD .....	56	Program Control .....	41
Multi Data Moves		Call Element .....	43
MULTI ROTATE WORD, Examples .....	66	Jump Element .....	42
MULTI SHIFT DATA MOVE .....	62	Label Element .....	41
MULTI SHIFT WORD, Examples .....	63	Program Elements .....	15
Multi Data Moves : .....	62	Proportional Control .....	136
Multi Rotate Data Move		Quantization Step Size .....	120
Terminology .....	66	Quantitized Value .....	121
Multi Rotate Data Moves		Radians .....	31
Power Flow .....	66	RANGE .....	112
Multi Rotate Word Moves		REAL Numbers Format .....	111
Examples .....	66	REAL TO DOUBLE INTEGER .....	46
Multi Shift Data Move		REAL TO INTEGER .....	45
Power Flow .....	62	Registers, Extending %R .....	95
Terminology .....	62	Requirements .....	12
MULTI SHIFT DATA MOVE .....	62	Resistance Temperature Device (RTD) .....	125
Multi Shift Word Moves		Resolution .....	119
Examples .....	63	Resources, Controller .....	93
Multiplexed key definitions .....	179	Predefined I/O Points .....	106
Multiply .....	28	Retentive On Delay Timer .....	49
Natural Logarithm .....	34	Return Element .....	44
Network Elements		ROTATE LEFT .....	53
<i>Net Get Heartbeat</i> .....	70	ROTATE RIGHT .....	53
<i>Net Get Words</i> .....	69	Scaling .....	34
<i>Net Put Heartbeat</i> .....	70	Scope .....	11
<i>Net Put Words</i> .....	69	Screen Jump .....	186
Next Screen .....	167	Screens	
Noise .....	123	Alarm .....	23
Normalized Analog Values .....	121	System .....	23
NOT .....	26	User .....	23, 24
NOT A NUMBER (NAN) .....	112	Seebeck Effect .....	127
NOT EQUAL .....	39	Selector .....	184
Note .....	180	Set Real Time Clock Element	
Number System Registers .....	23	Shift and Rotate Elements .....	52
Numeric Data .....	170	BITWISE ROTATE LEFT .....	55
OCS250		BITWISE ROTATE RIGHT .....	55
Updating .....	146	BITWISE SHIFT LEFT .....	54
OEM Code .....	12	BITWISE SHIFT RIGHT .....	54
Off Delay Timer .....	50	Configuring .....	52
On Delay Timer .....	48	Power Flow .....	52
Open Comm Port .....	73	ROTATE LEFT .....	53
Operator Simulator .....	166	ROTATE RIGHT .....	53
OR .....	26	SHIFT LEFT .....	53
Pass-Through Connection .....	12	SHIFT RIGHT .....	53
Password Data .....	175	Shift vs. Rotate .....	53
PID .....	138	SHIFT LEFT .....	53
Configuring .....	86	SHIFT RIGHT .....	53
PID Controls .....	135	SIGNIFICANT DIGITS .....	112
PID Elements		Sine .....	31
Independent and ISA PIDS .....	85	SINGLE REGISTER MOVE .....	56
PID Register Usage .....	84	Slider .....	191

SmartStack Input Values .....	128	Text Character Chart .....	149
SmartStack Stepper Module.....	113	Text Table Data.....	176
Snap to Primary Grid .....	168	Thermocouples (THM) .....	125
Snap to Secondary Grid .....	168	Time Data.....	173
Special Characters		Timer and Counters .....	47
Hexadecimal Numbers .....	72	Configuring .....	47
Special Elements		Register Usage .....	48
Stepper.....	80	To Back .....	166
Square Root .....	30	To Front .....	166
Static Text.....	169	Tuning PID Loops .....	139
Status Bits.....	114	Type Checking .....	56
Storage Order .....	92	UNIPOLAR SIGNALS .....	122
String Compare Element .....	73	Update Wizard.....	144
String Handling Elements		Manually Loading Firmware .....	145
String Move Element .....	72	User Reference Information.....	11
String Move Elements		Vertical Text .....	169
MOVE STRING .....	72	View/Edit Screen Comments .....	167
Subtract .....	28	Visual System Design Process	
Switch.....	182	Suggested Order of .....	198
System Registers .....	97	X-Y Graph .....	195
Tangent .....	32	Zoom In .....	167
Technical Support .....	13	Zoom Out .....	167

