

MAY 2021
05-0978-100

Xerox[®] Duplex Combo Scanner

Scanner User Guide for Microsoft[®] Windows.

© 2021 Xerox Corporation. All rights reserved. Xerox® is a registered trademark of Xerox Corporation in the United States and/or other countries. Visioneer is a trademark licensee of Xerox®. BR24495

Content © 2021 Visioneer, Inc. All rights reserved. The Visioneer brand name and OneTouch® logo are registered trademarks of Visioneer, Inc.

Reproduction, adaptation, or translation without prior written permission is prohibited, except as allowed under the copyright laws. Copyright protection claimed includes all forms of matters of copyrightable materials and information now allowed by statutory or judicial law or hereinafter granted, including without limitation, material generated from the software programs which are displayed on the screen such as styles, templates, icons, screen displays, looks, etc.

Document Version: 05-0978-100 (May 2021)

ISIS® is a registered trademark of EMC²® Corporation in the United States and/or other countries.

Adobe®, Adobe® Acrobat®, Adobe® Reader®, and the Adobe® PDF logo are registered trademarks of Adobe Systems Incorporated in the United States and/or other countries.

Post-It® is a registered trademark of 3M in the United States and/or other countries.

Microsoft is a U.S. registered trademark of Microsoft Corporation. Windows™ and SharePoint® are registered trademarks of Microsoft Corporation.

ZyINDEX is a registered trademark of ZyLAB International, Inc. ZyINDEX toolkit portions, Copyright © 1990-1998, ZyLAB International, Inc.

TWAIN™ is a trademark of TWAIN Working Group.

Intel® and Pentium® are trademarks of Intel Corporation in the United States and/or other countries.

Universal Serial Bus is a trademark of USB Implementers Forum, Inc. (USB-IF).

Kensington® is a registered trademark of ACCO Brands Corporation.

All other products mentioned herein may be trademarks of their respective companies and are hereby acknowledged.

Changes are periodically made to this document. Changes, technical inaccuracies, and typographic errors will be corrected in subsequent editions. Information is subject to change without notice and does not represent a commitment on the part of Visioneer.

The software described is furnished under a licensing agreement. The software may be used or copied only in accordance with the terms of such an agreement. It is against the law to copy the software on any medium except as specifically allowed in the licensing agreement. No part of this document may be reproduced or transmitted in any form or by any means, electronic or mechanical, including photocopying, recording, or information storage and retrieval systems, or translated to another language, for any purpose other than the licensee's personal use and as specifically allowed in the licensing agreement, without the express written permission of Visioneer.

Restricted Rights Legend

Use, duplication, or disclosure is subject to restrictions as set forth in contract subdivision (c)(1)(ii) of the Rights in Technical Data and Computer Software Clause 52.227-FAR14. Material scanned by this product may be protected by governmental laws and other regulations, such as copyright laws. The customer is solely responsible for complying with all such laws and regulations.

Table of Contents

1 Safety	1-1
Safety Introduction	1-1
Operational Safety Information	1-1
Electrical Information	1-2
Warning - Electrical Safety Information	1-2
Electrical Supply	1-2
Disconnect Device	1-3
Emergency Power Off	1-3
Maintenance Information	1-3
Product Safety Certification	1-3
Environmental Health and Safety Contacts	1-4
2 Welcome	2-1
What's in the Box	2-1
System Requirements	2-2
Documentation	2-2
Xerox® Duplex Combo Scanner Features	2-3
3 Assemble the Scanner	3-1
Connect the Power Cord	3-2
4 Installation	4-1
Install the Software and Connect the Scanner	4-1
Installing the Scanner Driver	4-4
Connect the USB Cable and Turn on the Power	4-5
Installing Visioneer OneTouch	4-7
Installing Additional Applications	4-8
View the User Guides	4-9
Register Your Scanner	4-10
5 Loading Documents to Scan	5-1
Scanning from the Automatic Document Feeder (ADF)	5-1
Supported Document Types	5-1
Documents to Avoid Scanning	5-1
Unsupported Document Types	5-2
Preparing Documents for Scanning	5-2
Loading Documents	5-3
Scanning from the Flatbed Glass	5-3

Supported Document Types	5-3
Loading Documents.....	5-3
Scanning Interfaces	5-5
6 Maintenance	6-1
Safety Precautions.....	6-1
Hardware Properties.....	6-1
Device Settings.....	6-2
Driver Settings	6-3
Clearing Paper Jams.....	6-3
Cleaning the Scanner.....	6-4
Cleaning Inside the Automatic Document Feeder	6-4
Cleaning the Scanner Glass	6-6
Calibrating Your Scanner	6-6
Calibration Error.....	6-8
Replacing the ADF Pad Assembly.....	6-8
Troubleshooting.....	6-11
Error Light Troubleshooting Codes.....	6-13
Uninstalling Your Scanner	6-14
Xerox® Duplex Combo Scanner Specifications.....	6-16
Xerox® Duplex Combo Scanner Parts List	6-17
7 Appendix A: Regulatory Information	7-1
Basic Regulations.....	7-1
United States (FCC Regulations).....	7-1
European Union.....	7-1
Turkey (RoHS Regulation)	7-2
Copy Regulations.....	7-2
United States	7-2
Canada	7-3
Other Countries.....	7-4
8 Appendix B: Compliance Information	8-1
Product Recycling & Disposal.....	8-1
USA & Canada.....	8-1
European Union.....	8-1
ENERGY STAR for the USA.....	8-1

1. Safety

Safety Introduction

Notices and Safety

Please read the following instructions carefully before operating the machine and refer to them as needed to ensure the continued safe operation of your machine.

Your Xerox® product and supplies have been designed and tested to meet strict safety requirements. These include safety agency evaluation and certification, and compliance with electromagnetic regulations and established environmental standards.



The safety and environment testing and performance of this product have been verified using Xerox® materials only. Unauthorized alterations, which may include the addition of new functions or connection of external devices, may impact the product certification. Please contact your Xerox representative for more information.

Operational Safety Information

Your Xerox® equipment and supplies have been designed and tested to meet strict safety requirements. These include safety agency examination, approval, and compliance with established environmental standards.

To ensure the continued safe operation of your Xerox® equipment, follow these safety guidelines at all times:

Do these:

- Always follow all warnings and instructions that are marked on or supplied with the equipment.
- Always use materials specifically designated for this product, the use of other materials may result in poor performance and create a hazardous situation. Do not use aerosol cleaners, they may be explosive and flammable under certain conditions.
- Always exercise care when moving or relocating equipment.
- Always locate the machine on a solid support surface that has adequate strength to support the weight of the machine.
- Always locate the machine in an area that has adequate ventilation and room for servicing.
- Always unplug this equipment from the electrical outlet before cleaning.

Note: Your Xerox® machine is equipped with an energy saving device to conserve power when the machine is not in use. The machine may be left on continuously.

Do not do these:

- Never use a ground adapter plug to connect the equipment to a power outlet that lacks a ground connection terminal.

- Never attempt any maintenance function that is not specifically described in this documentation.
- Never remove covers or guards that are fastened with screws. There are no operator serviceable areas within these covers.
- Never locate the machine near a radiator or any other heat source.
- Never override or “cheat” any of the electrical or mechanical interlock devices.
- Never place this equipment where people might step on or trip on the power cord.



Caution: This device is not intended for use in the direct field of view at visual display workplaces

To avoid incommoding reflections at visual display workplaces this device must not be placed in the direct field of view.

Electrical Information

WARNING - ELECTRICAL SAFETY INFORMATION

1. The power receptacle for the machine must meet the requirements stated on the data plate on the rear of the machine. If you are not sure that your electrical supply meets the requirements, please consult your local power company or an electrician for advice.
2. The socket outlet shall be installed near the equipment and shall be easily accessible.
3. Use the power cable that is supplied with your machine. Do not use an extension cord or remove or modify the power cord plug.
4. Plug the power cable directly into a correctly grounded electrical outlet. If you are not sure whether or not an outlet is correctly grounded, consult an electrician.
5. Do not use an adapter to connect any Xerox® equipment to an electrical outlet that lacks a ground connection terminal.
6. Do not place this equipment where people might step or trip on the power cable.
7. Do not place objects on the power cable.
8. Do not override or disable electrical or mechanical interlock devices.
9. Do not push objects into slots or openings on the machine. Electrical shock or fire may result.

ELECTRICAL SUPPLY

- This product shall be operated from the type of electrical supply indicated on the product's data plate label. If you are not sure that your electrical supply meets the requirements, please consult your local power company for advice.



- Always connect equipment to a correctly grounded power outlet. If in doubt, have the outlet checked by a qualified electrician.



WARNING: This equipment must be connected to a protective earth circuit

This equipment is supplied with a plug that has a protective earth pin. This plug will only fit into an earthed electrical outlet. This is a safety feature. If you are unable to insert the plug into the outlet, contact your electrician to replace the outlet.

DISCONNECT DEVICE

The power cable is the disconnect device for this equipment. It is attached to the side of the machine as a plug-in device. To remove all electrical power from the equipment, disconnect the power cable(s) from the electrical outlet.

Emergency Power Off

If any of the following conditions occur, turn off the machine immediately and disconnect the power cable(s) from the electrical outlet(s).

- The equipment emits unusual odors or makes unusual noises.
- The power cable is damaged or frayed.
- A wall panel circuit breaker, fuse, or other safety device has been tripped.
- Liquid is spilled into the machine.
- The machine is exposed to water.
- Any part of the machine is damaged.

Maintenance Information

1. Any operator product maintenance procedures will be described in the user documentation supplied with the product.
2. Do not carry out any maintenance on this product which is not described in the customer documentation.
3. Do not use aerosol cleaners. The use of cleaners that are not approved may cause poor performance of the equipment, and could cause a dangerous condition.
4. Use supplies and cleaning materials only as directed in this manual.
5. Do not remove covers or guards that are fastened with screws. There are no parts behind these covers that you can maintain or service.
6. Do not perform any maintenance procedures unless you have been trained to do them by an authorized local dealer or unless a procedure is specifically described in the user manuals.

Product Safety Certification

This product is certified by the following Agency using the Safety standards listed:

Standard
UL60950-1 (USA)
CSA 22.2 No. 60950-1 (Canada)
IEC 60950-1, IEC 62368-1

Environmental Health and Safety Contacts

Contact Information

For more information on Environment, Health, and Safety in relation to this Xerox® product and supplies, please contact the following customer help lines:

North America & Europe (Phone): 1-800-ASK-XEROX
--

North America & Europe (Fax): 1-585-422-8217

2. Welcome

Your new Xerox® scanner can quickly scan stacks of documents with the Automatic Document Feeder (ADF), or single pages on the Flatbed glass.

What's in the Box

Before proceeding, check the contents of the box. If items are missing or damaged, contact the dealer where you purchased the scanner.

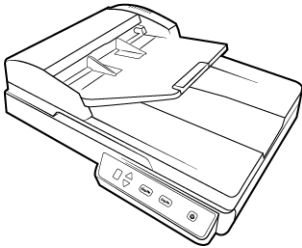

Xerox® Duplex Combo Scanner



Quick Install Guide

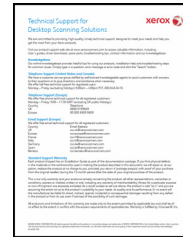

Technical Support Card

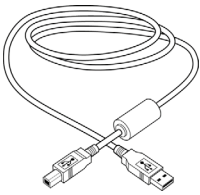

USB Cable

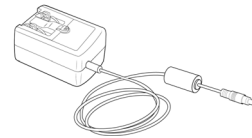

Power Supply

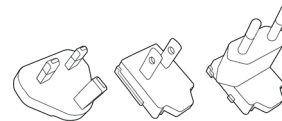

Power plug adapter

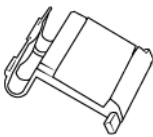

Spare ADF Pad

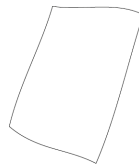

Calibration Page

System Requirements

	Minimum	Recommended
Processor	2Ghz Intel Core 2 Duo	2.0GHz i3 6th generation
USB Port	An available Universal Serial Bus (USB) 2.0 port	An available Universal Serial Bus (USB) 2.0 port
OS	Microsoft® Windows® operating system: <ul style="list-style-type: none"> • 32-bit or 64-bit Windows 7 (Service Pack 1) • 32-bit or 64-bit Windows 8 / 8.1 • 32-bit or 64-bit Windows 10 	Microsoft® Windows® operating system: <ul style="list-style-type: none"> • 64-bit Windows 7 (Service Pack 1) • 64-bit Windows 8 / 8.1 • 64-bit Windows 10
RAM	2 gigabyte (GB) of internal memory (RAM)	4 gigabyte (GB) of internal memory DDR4(RAM)
Hard Drive Space	<ul style="list-style-type: none"> • 350 MB for the scanner driver • 1 GB for Visioneer OneTouch • 1 to 2 GB for each additional application 	<ul style="list-style-type: none"> • 350 MB for the scanner driver • 1 GB for Visioneer OneTouch • 1 to 2 GB for each additional application
Monitor*	Color quality of 16-bit or 32-bit Resolution set to at least 1024 x 768 pixels	Color quality of 16-bit or 32-bit Resolution set to at least 1024 x 768 pixels

*Refer to your Windows documentation for instructions on setting the color quality and resolution for the monitor.

Documentation

The following printed documentation is provided in the box:

- **Installation guide**—abbreviated scanner setup and installation instructions.
- **Technical support card**—contact information for technical support and customer service, and a brief overview of our standard product warranty.

The following soft-copy documentation is available on the installation disc:

- **Scanner user guide**—instructions for scanner setup, installation, operation, maintenance, safety, and warranty.
- **OneTouch scanning guide**—instructions for configuring and scanning using OneTouch.
- **TWAIN scanning guide**—instructions for accessing and scanning using the TWAIN interface.
- **Patch code sheets**—use with an application that supports detection of patch code data when using the TWAIN interface. The patch code page layouts have been specifically designed for your scanner. The file contains Patch 1 layouts for A4 and U.S. Letter size pages.

Make sure you print the correct page size for the paper in your printer. Also, make sure the application you are using is not set to automatically scale the page to fit on the paper in your printer.

Xerox® Duplex Combo Scanner Features

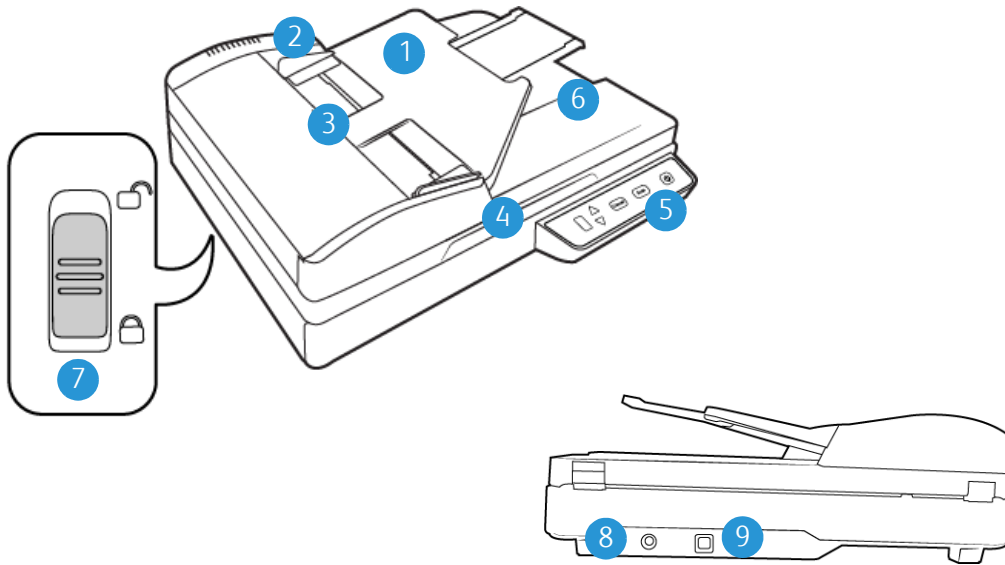

1. **Input Tray**—Holds the documents in the Automatic Document Feeder for scanning.
2. **Paper Guides**—Guides adjust to support various document widths.
3. **Automatic Document Feeder**—Feeds documents through the scanner during scanning.
4. **Scanner Lid**—Lift lid to place an item on the flatbed glass for scanning.
5. **Control panel**—OneTouch scanning controls.
 - **LED Number**—The selected OneTouch function for the Scan button.
 - **Function buttons**—Selects the scan setting for the OneTouch buttons. Press the up or down arrow to cycle through the settings.
 - **Simplex Button**—Press to scan single-sided documents.
 - **Duplex Button**—Press to scan double-sided documents.
 - **Status light / Power Button**—Turns the scanner's power off and indicates the scanner's status.
6. **Output Tray**—Holds documents after being scanned through the Automatic Document Feeder.
7. **Lock**—Locks or unlocks the scanning head; located on the underside of the scanner.
8. **Power jack**—Connects the power cord to the scanner.
9. **Universal Serial Bus (USB) port**—Connects the scanner to the computer.

3. Assemble the Scanner

1. Remove the scanner from its protective foam and plastic bag.
2. Remove all shipping tape from the top and bottom of the scanner.

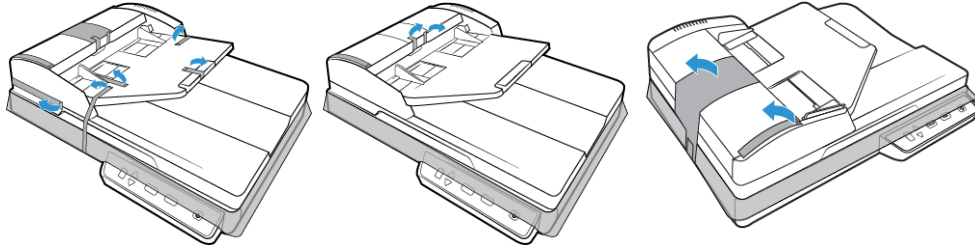

3. Lift the scanner lid. Remove any tape and protective foam from around or on the flatbed glass.

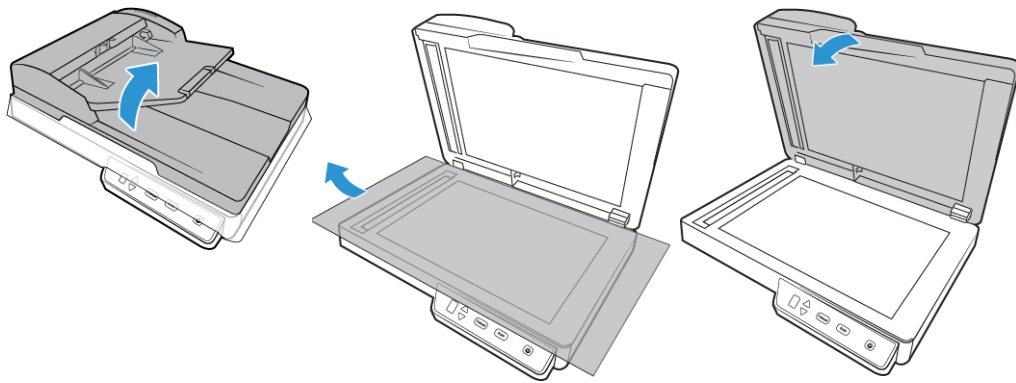

4. Open the automatic document feeder cover and remove any tape or protective foam from inside the feeder. Close the feeder cover when you are finished.

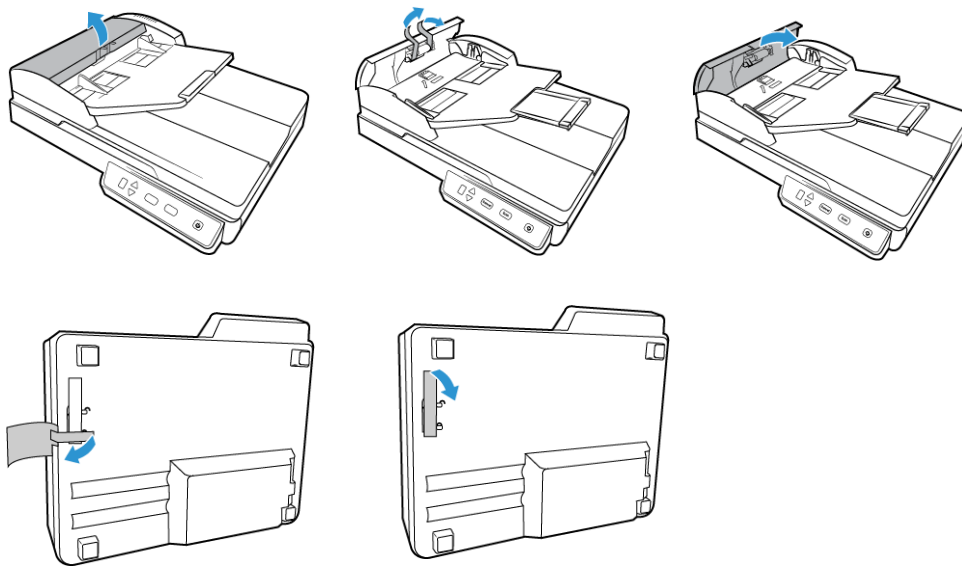

- Slide the locking tab on the bottom of the scanner to its unlocked position. The scanner will not scan when locked.

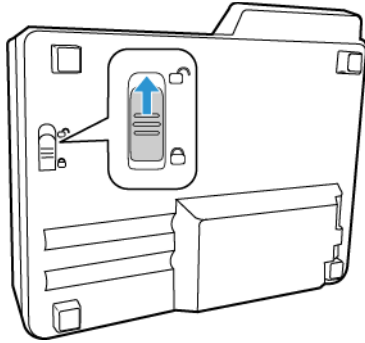

Connect the Power Cord

Note: Only use the power supply (WA-36A24R made by APD) included with your scanner. Connecting any other type of power supply may damage your scanner, and will void its warranty.

Assemble the power adapter:

- Select the power plug adapter that is appropriate for the wall outlet in your country.

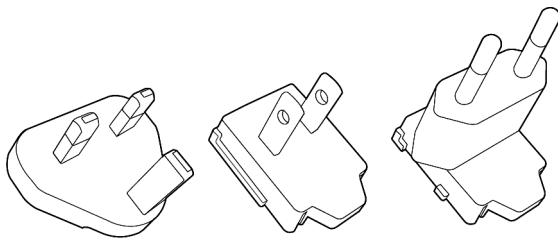

U.K., North America, Europe

- Slide the power plug adapter into the power supply base.

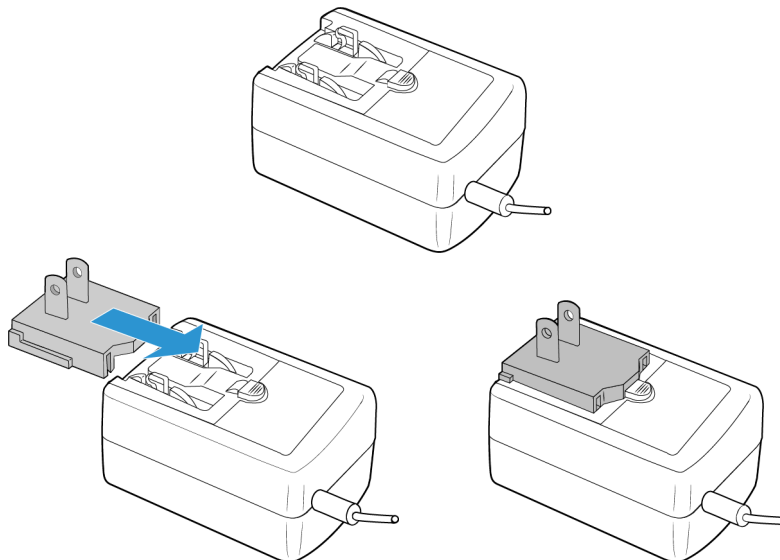

- Plug the power supply into the power port on the scanner.

4. Plug the power cord into the power supply and into a wall outlet.

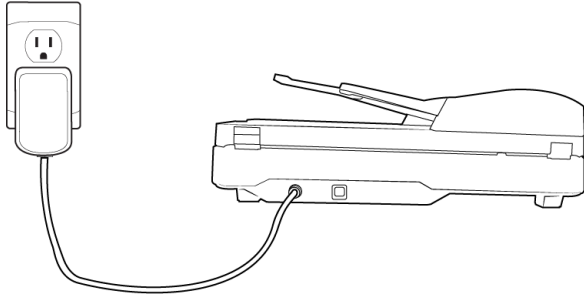

4. Installation

Please make sure of the following before you begin installation:

- If you are prompted to reboot during installation, please select "No". Finish installing the rest of the software, then close all open windows and reboot your computer.
- The information in this guide may cover software not provided with the scanner you purchased. Please disregard any information about the software not applicable to your scanner.
- If your computer has AntiVirus or AntiSpyware software running, you may encounter alerts or messages during installation asking you to allow the installation to proceed. Although the messages will differ based on the software your computer is running, in each case you should allow the installation to proceed if that option is available. Alternatively, you can turn off the AntiVirus or AntiSpyware software before installing your scanner, but if you do, make sure to turn it back on again when installation is finished.
- If your computer is running Windows 7 or later, you may see the Windows User Account Control screen asking you to confirm system changes. Click the **Yes** button to allow the installation to proceed.

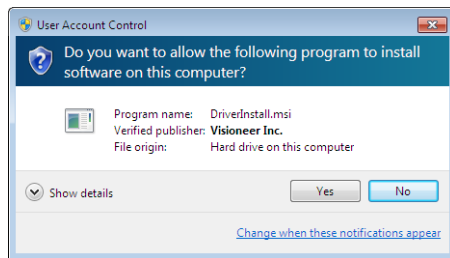

Install the Software and Connect the Scanner

1. Start Microsoft Windows and make sure that no other applications are running.
2. Go to www.visioneer.com/install.
3. Launch the installer, once the download is complete.
4. Plug the USB cable into the USB port on the scanner then into a USB port on the computer. Turn on the scanner power.

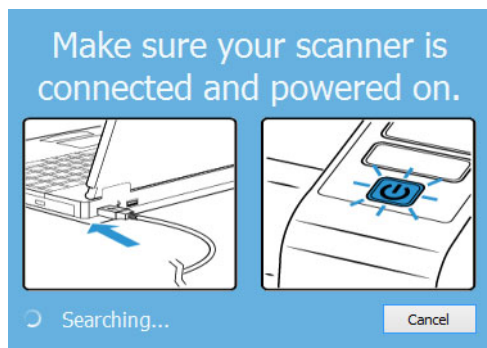

5. Click **OK**.

6. Select your scanner from the list.

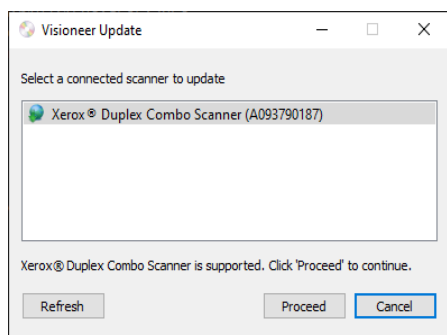

7. Click **Proceed**.
8. The Select Language window opens. Click the drop-down menu arrow and select the language to use. Click **OK**.

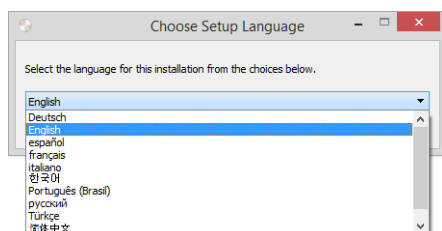

9. Make sure the boxes for **Scanner Driver** and **Visioneer OneTouch** are selected, as well as any other applications you want to install.

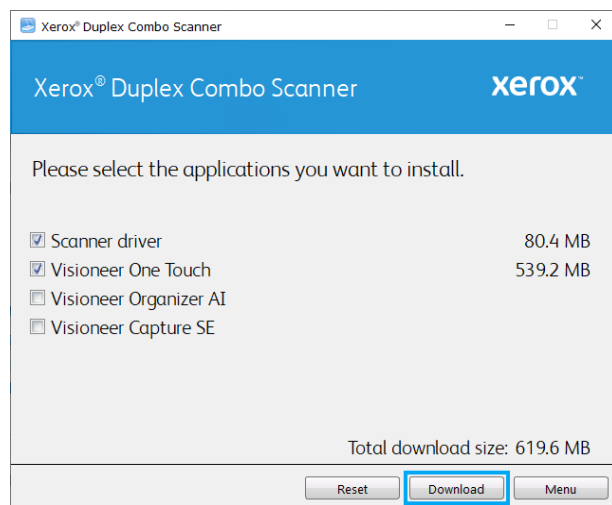

Note: The software provided with your scanner may differ slightly from the list shown in the window.

10. If a version of the software is already installed on the system, the option will be greyed out. However, if there is a newer version available, it will be possible to download and install.
11. The software will have to first be downloaded by clicking **Download**. The total size of the download is shown at the bottom.

12. After the download has begun, it can be paused. If changes to the selections are required, it is necessary to click **Reset** while the download is paused. This will allow the settings to be changed.

Note: Clicking the Reset button in either the Main menu or the Install menu will cause both partially completed and previously downloaded files to be deleted. In order to be installed they will have to be downloaded again.

13. Once all software has been downloaded, click **Install**.

INSTALLING THE SCANNER DRIVER

The scanner driver installation will start first.

1. The Welcome screen for the scanner driver Setup Wizard opens. Click **Next**.

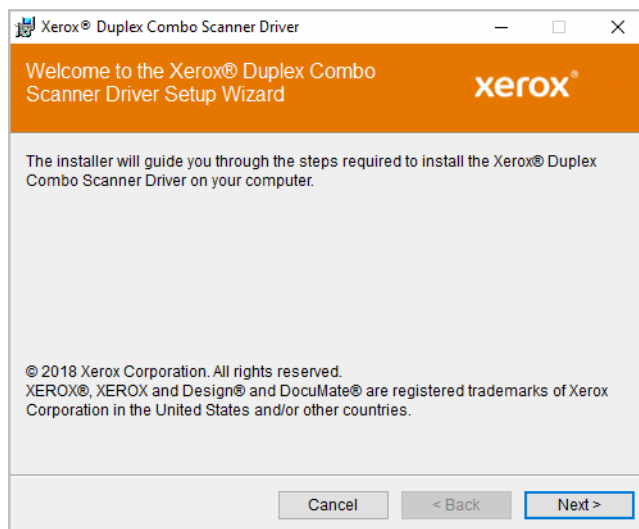

Note: there may be an option in the installation window to remove any current scanning profiles. You will see this prompt if you already have a previous version of the scanner driver installed. Select the option in the installation window only if you want the existing profiles *removed*.

2. On the Xerox License Agreement window, read the license agreement. If you accept the terms, select **I Agree** then click **Next**.

If you choose not to accept the license agreement, click **Cancel**. Click **Close** on the Installation Interrupted window.

3. The software will now be installed.

4. **Stop** when you see the “Complete the installation by connecting your hardware” window. Do not click **OK** yet. Leave the window open and proceed to the next section.

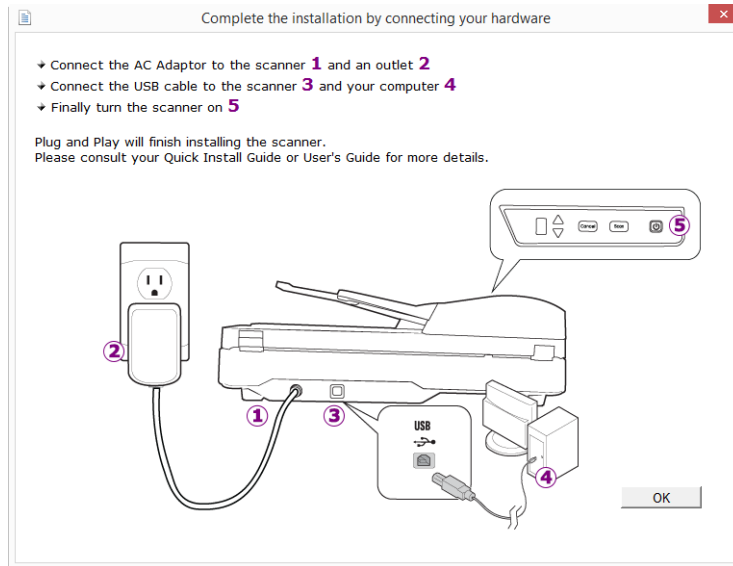

Note: If you do not see this on-screen diagram for connecting the scanner, stop and follow the instructions below.

CONNECT THE USB CABLE AND TURN ON THE POWER

If you did not connect the scanner earlier, proceed with the instructions below.

1. Remove any tape from the USB cable.
2. Plug the USB cable into the USB port on the scanner then into a USB port on the computer. Check your computer's manual for USB port locations.

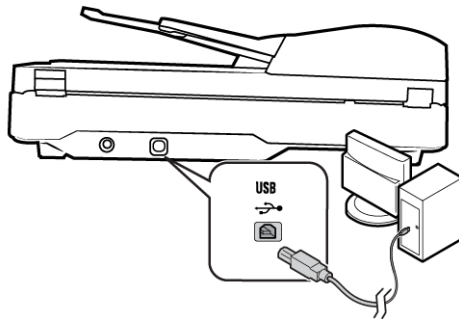

If the plug does not attach easily, make sure that you are plugging it in correctly. Do not force the plug into either connection.

3. Turn on the scanner power.

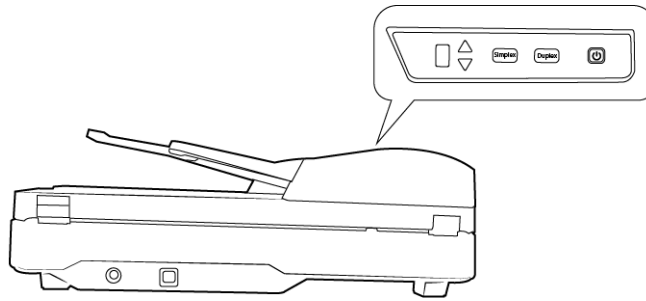

The status light comes on and flashes indicating that the scanner is receiving power.

Your computer recognizes that a scanner has been plugged into the USB port and automatically loads the appropriate software to run the scanner.

4. When you're certain that the software has completely loaded, return to the "Complete the installation by connecting your hardware" window.

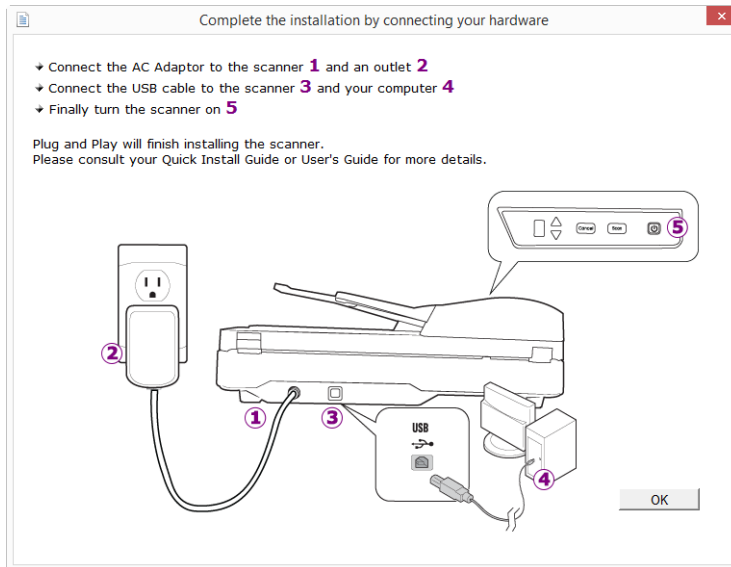

5. Click **OK** to complete the installation process.

- Click **Close** on the Installation Complete window to close and exit the driver installer.

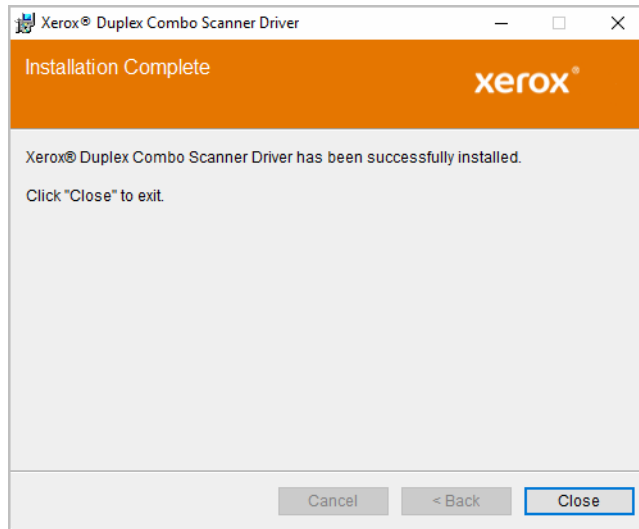

INSTALLING VISIONEER ONETOUCH

The Visioneer OneTouch software installation will start automatically after you click **Close** on the driver Installation Complete window.

- Click **Next** on the Welcome to the OneTouch Setup Wizard.

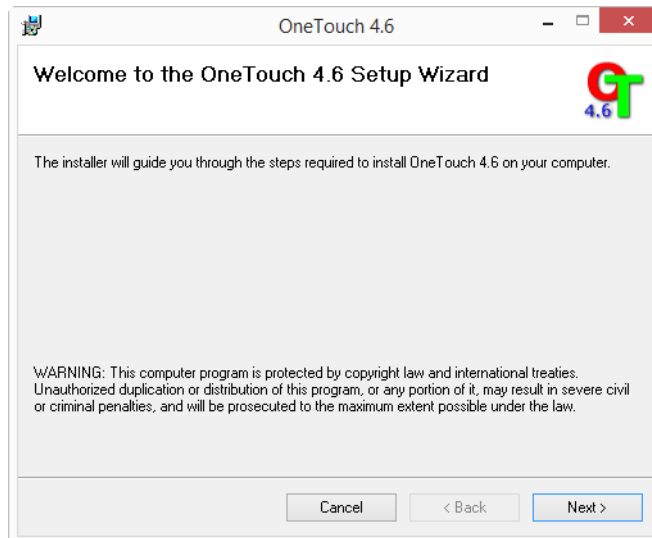

Note: there may be an option in the installation window to remove any current scanning profiles. You will see this prompt if you already have a previous version of OneTouch installed. Select the option in the installation window only if you want the existing profiles *removed*.

- On the Visioneer License Agreement window, read the license agreement. If you accept the terms, select **I Agree** then click **Next**.

If you choose not to accept the license agreement, the installation will terminate and OneTouch will not be installed.

- Click **Close** on the Installation Complete window to close and exit the software installer.

- After OneTouch is installed, a splash screen will be displayed while it initializes and searches for installed scanners. Please wait for this screen to disappear before attempting to use OneTouch.



Note: If you selected other software to install during installation, that software will automatically start after you click **Close** on the Installation Complete window. Follow the instructions on-screen to install each application you selected.

Installing Additional Applications

- Return to the Main menu and click **Install software**.
- If a version of the software is already installed on the system, the option will be greyed out. However, if there is a newer version available, it will be possible to download and install.
- The software will have to first be downloaded by clicking **Download**.
- Once all software has been downloaded, click **Install**.
- Follow the instructions on the screen to install each of the additional applications.

View the User Guides

- Launch Visioneer Update, go to the main menu and click on **View user guides**.

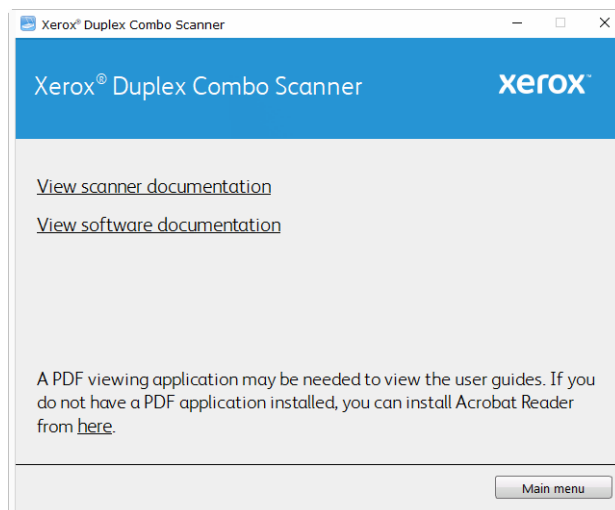

- Click on **View scanner documentation** to access the scanner user guide and scanning guides for OneTouch and TWAIN.

- **Scanner user guide**—Instructions for scanner setup, installation, operation, maintenance, safety, and warranty
- **OneTouch scanning guide**—Instructions for configuring and scanning using OneTouch
- **TWAIN scanning guide**—Instructions for accessing and scanning using the TWAIN interface

Click on **View software documentation** to access the user guides for the software applications provided with the scanner.

From either of these user guide windows, click on the **User guide menu** button to return to the main user guide window, then select the other documentation section to view the user guides.

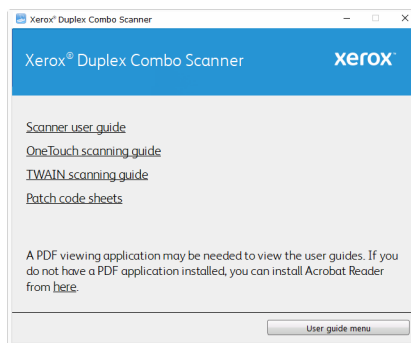

Scanner documentation window

3. Click the links of the guides you want to view.
4. When you're finished, click **Main menu** to return to the Main menu window and click **Exit**.

Register Your Scanner

Registering your scanner is important as it provides you with access to our free telephone support service. Registration also gives you free access to software updates for your scanner.

You will need an active internet connection to register your scanner. If you do not have internet access you can contact our customer service department to register the scanner. Please refer to the Technical Support Card, that you received with the scanner, for our customer service contact information.

1. Open an Internet Explorer window, or any other Internet browser you have installed on your computer.
2. In the web address field type www.xeroxscanners.com.
3. Press Enter on your computer's keyboard or click the option on screen to go to the web address.
4. When the Xerox® scanners web page loads click on **Register Your Product**.
5. Fill in the registration form, all required fields have an asterisk (*).
A valid email address is required for registration.
6. You will be asked to enter the serial number for the scanner, it is located on the back or underside of the scanner.
7. After filling in the form, click on **Submit Your Registration** to complete the registration.

5. Loading Documents to Scan

Always remove any staples or paper clips from documents before inserting them into the scanner. Staples and paper clips can jam the feed mechanism and scratch the internal components. Also remove any labels, stickers, or Post-It™ notes that may come off during the scanning process and get stuck in the scanner. Misuse as described here will void your scanner's warranty.

Please go to www.xeroxscanners.com, select your product, and then click the "Warranty Program" link to view the warranty terms and conditions for your scanner.



Scanning from the Automatic Document Feeder (ADF)

SUPPORTED DOCUMENT TYPES

You can scan the following types of documents and cards with this scanner.

- Maximum amount of paper in the input tray
 - Approximately 35 pages of 20 lb (75–80 g/m²) new printer paper
- Document size
 - Minimum size (width x length) – 3 x 5.9 inches (76 x 150 mm)
 - Maximum size (width x length) – 8.5 x 14 inches (216 x 356 mm)
 - Maximum length with long document enabled
 - 118 inches (2997 mm) up to 300dpi
 - 59 inches (1499mm) at 400dpi

We recommend scanning one page at a time when the documents you are scanning are longer than 14 inches (356 mm).

- Valid mixed document size sets without long document enabled
 - Scanner minimum to maximum

Arrange the documents so that all items are centered in the stack. The document sensor, paper separation, and feed rollers are located in the middle of the paper path. If smaller items are offset from the center they will not be detected. This will cause feeding issues and paper jams.

- Paper thickness between 16–28 lb paper (60–105 g/m²)

DOCUMENTS TO AVOID SCANNING

The documents in this list can be scanned, but please note that scanning documents of this type will reduce the life of the scanner. Maintenance will be required more often and replaceable parts will wear faster. These types of documents will jam more frequently and damage to the original documents may occur. If you do choose to scan these document types, do not scan large batches. This type of use is not covered under the scanner warranty and alters replacement parts life expectancy.

We recommend you limit the amount or completely avoid scanning documents that are in this list.

- Curled, wrinkled or folded documents may cause paper jams or multiple pages being fed through the scanner at one time.
- Perforated or punched paper that could tear when the separation roller engages.
- Coated paper or photographs where the coating can flake off during scanning and leave residue in the scanner.
- Extremely smooth, shiny, or highly textured paper may cause the paper feed rollers to slip across the page and cause the scanner to report a paper jam.
- Carbonless copy paper may tear while being fed through the scanner and the pressure of the rollers may leave streaks on the page. The chemical coating on this paper will rub off on the rollers during the scan process, increasing the frequency of miss-feeds and paper jams.
- Partially transparent paper such as tracing paper as any images from the opposite side of the page or black background will appear in the scanned images.

UNSUPPORTED DOCUMENT TYPES

Do not scan the following types of documents as they may cause damage to the scanner.

- Items outside of the specified supported sizes, thickness, and weight defined in this document.
- Non-rectangular or irregularly shaped paper will cause the scanner to detect and report document skew errors or paper jams.
- Carbon paper that will leave residue in the scanner and on the rollers that will transfer to the next set of documents scanned.
- Documents with hard items attached such as paper clips, binder clips, and staples.
- Documents with wet ink or white-out.
- Thermal or photosensitive paper.
- Overhead projector sheets, plastic film, camera film, and any other type of transparent or partially transparent plastic item.
- Documents that have been glued together.
- Cloth or metallic sheets.

PREPARING DOCUMENTS FOR SCANNING

- Fan the documents to make sure all pages in the stack are separated.

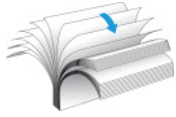

- Bend and then flatten the document stack to make sure the horizontal edges are aligned to help prevent paper from skewing while being pulled through the scanner.

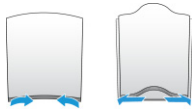

- Pinch the ends to align the leading edges slantwise to help prevent multiple pages from being fed through at a single time.

**LOADING DOCUMENTS**

1. Adjust the paper guides for the width of the documents being scanned. If needed, pull out the input tray extension and flip up the paper stop.

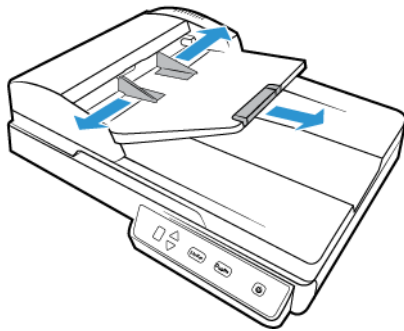

2. Load the documents *face up* with their tops into the Automatic Document Feeder.

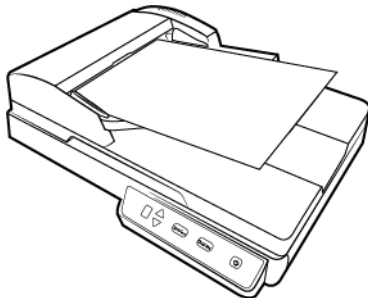

3. You can now scan the documents using the scanner buttons, OneTouch, or one of the other scanning interfaces.

Scanning from the Flatbed Glass

SUPPORTED DOCUMENT TYPES

You can scan the following types of documents with this scanner.

- Document size
 - Minimum size (width x length) – 0.5 x 0.5 inches (13 x 13 mm)
 - Maximum size (width x length) – 8.5 x 11.70 inches (216 x 297 mm)

LOADING DOCUMENTS

Use the Flatbed glass to scan documents on light weight paper, such as credit card receipts, or items that cannot be scanned with the Automatic Document Feeder, such as pages in a book or plastic cards.

Note: You must remove any pages from the Automatic Document Feeder before scanning from the Flatbed glass. If pages are in the Automatic Document Feeder, they will be scanned instead of the page on the Flatbed glass.

1. Open the scanner lid and place the page on the scanner glass, *face down*.
2. Align the item with the arrow on the reference frame then close the cover.

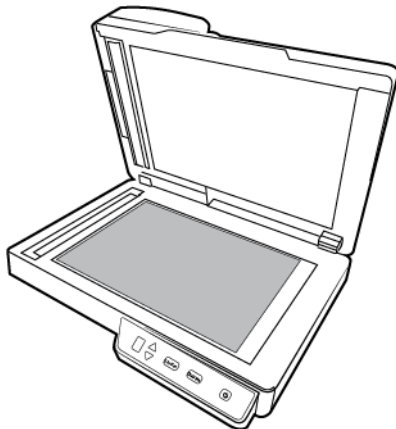

3. You can now scan the document using the scanner buttons, OneTouch, or one of the other scanning interfaces.

Scanning Interfaces

- **Scanner Control Panel**—When you press the Simplex or Duplex button on the scanner, the scanner starts scanning using the settings for the current LED number. The scanned image is then sent to a destination on your computer or network drive.

OneTouch Button Panel—Use this scan option when you want to scan from the computer screen. Scanning from the on-screen OneTouch Button Panel is the same as selecting a scanning option on the scanner, except you click an icon that represents the function.



Scanner Control Panel

OneTouch Button Panel

Please see the OneTouch Scanning Guide on the installation disc for instructions. You can also click the **Help** button in the OneTouch Properties window to open the instructions in an Internet browser.

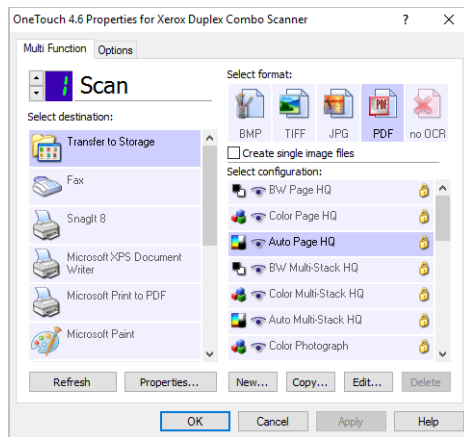

- **TWAIN and WIA Interface**—this option uses your scanner’s TWAIN interface to scan. Select scanning options before scanning, put the document in the scanner, then click the **Scan** button in the TWAIN interface window.

Please see the TWAIN Scanning Guide on the installation disc for instructions. You can also click the **Help** button in the TWAIN interface to open the instructions in an Internet browser.

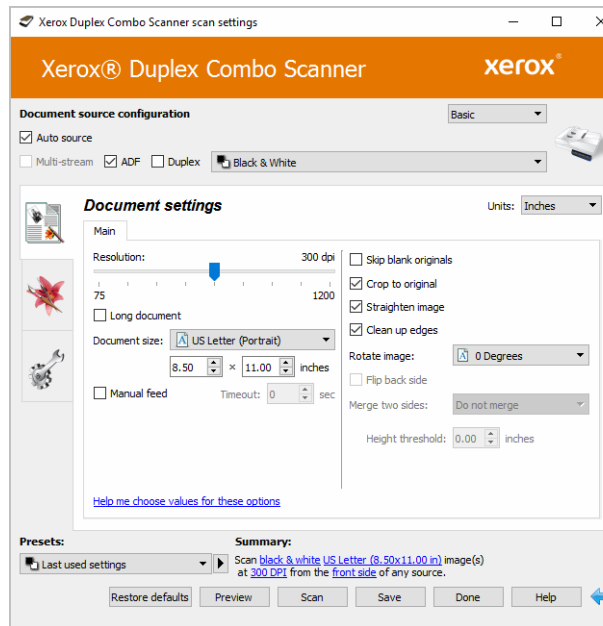

- **ISIS Interface**—This option uses the ISIS interface for scanning. Please refer the user manual for your ISIS scanning application for instructions on scanning with the ISIS interface.

6. Maintenance

This section contains information about maintenance, troubleshooting, uninstalling, scanner specifications, and spare parts.

Safety Precautions

When servicing the scanner you should take the following precautions to ensure your safety and prevent damage to the scanner.

Do These

- Wear protective gloves when cleaning the scanner with Isopropyl rubbing alcohol. Rubbing alcohol may irritate sensitive skin.
- Only perform scanner maintenance as described in this chapter.
- Keep the scanner and cleaning supplies away from any open flame or heat source as any form of alcohol is flammable.
- Always read the instructions in each section carefully, the instructions are specific to the part you are installing or servicing.
- Move the scanner to an area that has adequate room for opening the scanner.
- If your scanner has a power cord and/or power switch, always turn off the scanner and unplug the power cord before performing maintenance, unless the maintenance instructions below specifically state to leave the scanner plugged in and powered on.
- Always unplug the USB cable from the scanner before performing maintenance, unless the maintenance instructions below specifically state to leave the scanner plugged in.
- Wear an anti-static strap to prevent electrostatic discharge when touching metal components.
- Keep all cleaning supplies, scanner parts and accessories out of the reach of children.

Do Not Do These

- Never attempt installation of any part not described in this manual.
- Never service the scanner near a radiator or any other heat source.
- Never use aerosol sprays or compressed air, or attempt to lubricate parts with an oil or silicon spray.
- Never service the scanner in an area where there are open liquid containers.
- Never pour or spill liquid on the scanner or any of its components.

Hardware Properties

You can use the scanner's properties page to keep track of scanner maintenance, change some of the hardware options, configure the scanner interface behavior, and adjust application options that may be available for your scanner.

To open the scanner hardware properties page:

- **Windows 7** or later—from the Windows Control Panel, open **Hardware and Sound** and then **Devices and Printers**. Right-click on the scanner and then select **Scan properties** from the list.

DEVICE SETTINGS

The Device Settings tab shows the hardware information for your scanner. The options on the Device Settings tab will be available based on whether or not the scanner hardware supports the feature. Some features described herein may not be available for the current scanner. Please disregard any information about features that you do not see in the interface for your scanner.

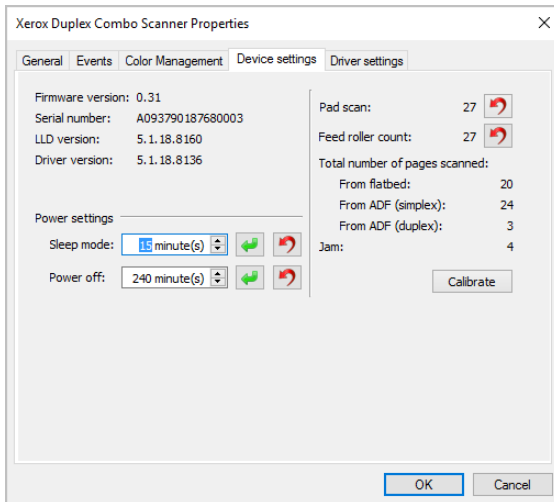

Scanner Details

- **Firmware version**—this is the scanner’s hardware processor version number.
- **Serial number**—the scanner’s unique identification number.
- **LLD version**—the scanner’s base driver version. This is not the OneTouch software revision, TWAIN or WIA driver versions.
- **Driver version**—this is the version of the scanner’s TWAIN driver.

Scanner Settings

- **Counters**—click the reset button next to the counter you want to set back to 0.

Power Settings

- **Sleep mode**—sleep mode is the low-power state when the scanner is not in use. You can adjust the amount of time you want the scanner to wait before it goes into low power.
 - Click the green enter button to save any changes in the Sleep mode field.
 - Click the red reset button to reset to the default timeout value.
- **Power off**—input the number of minutes you want the scanner to wait before it turns itself off.
 - Click the green enter button to save any changes in the power off field.
 - Click the red reset button to reset to the default timeout value.

DRIVER SETTINGS

The options in this panel are for configuring how the TWAIN interface will behave in some scenarios. Please see the TWAIN scanning guide on the installation disc for instructions.

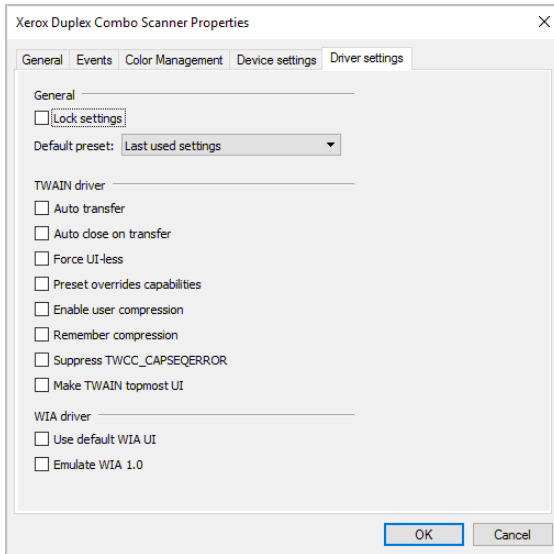

Clearing Paper Jams

If your scanner stops scanning due to a paper jam in the Automatic Document Feeder, a warning opens after a few moments.

1. Open the Automatic Document Feeder cover.

Do not attempt to remove a jammed page with the scanner closed.

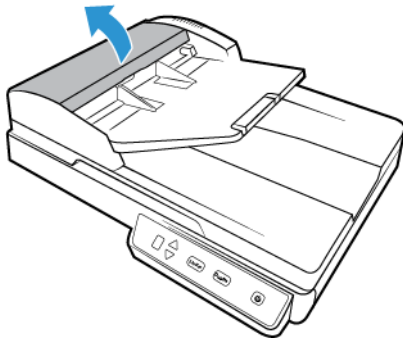

2. Remove the jammed page from the scanner.

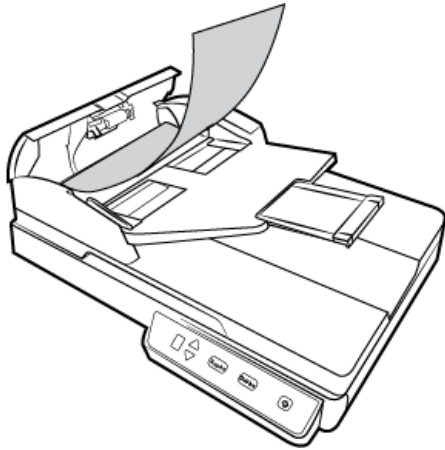

3. Close the ADF cover. Carefully press down on the ADF cover until it locks in place with a “click”.

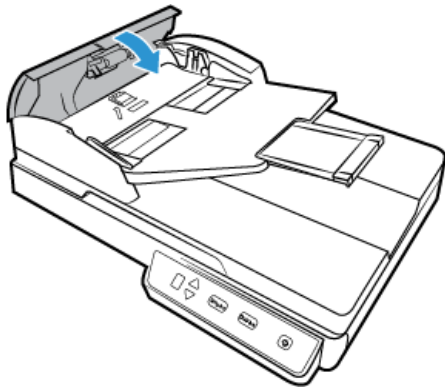

To reduce the number of paper jams, smooth and straighten the paper before scanning, adjust the guides to the paper size, and insert the paper evenly into the ADF.

Cleaning the Scanner

Regular maintenance of your scanner can help to ensure continual optimal performance.

Using a soft, lint-free cloth, wipe down all plastic surfaces on the scanner.

CLEANING INSIDE THE AUTOMATIC DOCUMENT FEEDER

Cleaning the inside of the scanner helps to keep your scanner operating at optimum performance. You should clean the inside of the scanner at least once a week or after 1,000 pages have been scanned. If you are getting frequent paper jams, multiple pages feeding at the same time, or you're seeing lines in the scanned image, it is time to clean the scanner.

Note: Be careful when cleaning the rollers. All of the rollers, except the free rollers, are designed to rotate in one direction only. Do not force the roller to rotate in the opposite direction. Forcing the roller to rotate will damage it, and cause the scanner to feed pages incorrectly.

1. Wet a soft cloth with some Isopropyl rubbing alcohol (70%).

2. Open the Automatic Document Feeder cover.

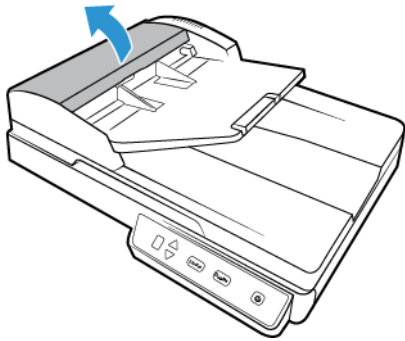

3. Wipe the feed roller from side to side. Rotate the roller to clean its entire surface.

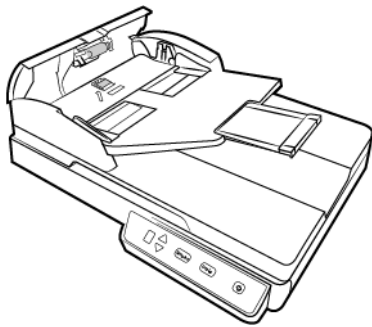

4. Close the ADF cover. Carefully press down on the ADF cover until it locks in place with a “click”.

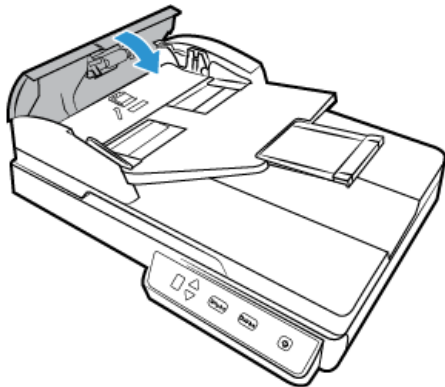

5. Wipe clean the glass strip on the underside of the duplex lamp module. Wipe clean the glass strip in the body of the scanner.

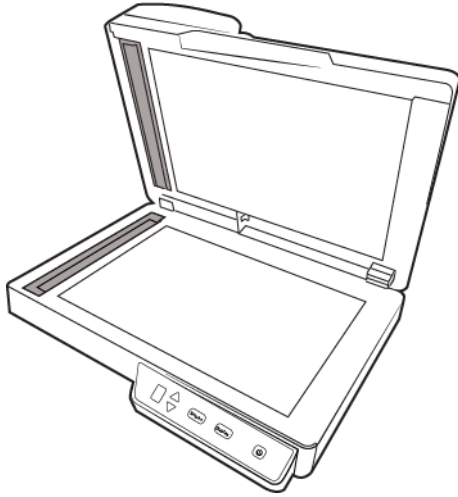

CLEANING THE SCANNER GLASS

Scanning items that have excessive amounts of dirt or dust may dirty the glass. To ensure the best quality scanned item, wipe the scanner glass with a soft, dry, clean cloth to rid the glass of dust or other debris.

If any residue remains after wiping the glass with a dry cloth, try adding a few drops of Isopropyl alcohol (rubbing alcohol) to the cloth and wipe off the residue.



Calibrating Your Scanner

If your scanned images have black or colored vertical lines and cleaning does not resolve the problem, this may be a sign that you need to perform a calibration.

The scanner should be calibrated as part of your monthly maintenance of the scanner. If the scanner is used daily you may need to calibrate the scanner more often. You will need to have the calibration page ready.

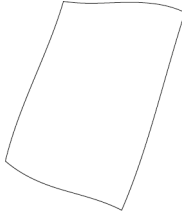

! Caution: do *not* attempt to calibrate the scanner with any other type of document (i.e. white paper or a copy of the calibration page).

The calibration routine will fail and indicate the failed calibration by flashing a red LED on the scanner. A calibration page was included with your scanner, if you do not have one available, you can order a replacement from the Parts & Accessories page for your scanner at www.xeroxscanners.com.

To calibrate the scanner:

1. Open the scanner's hardware properties page as described on page 6-1.
2. Click on the **Device Settings** tab.

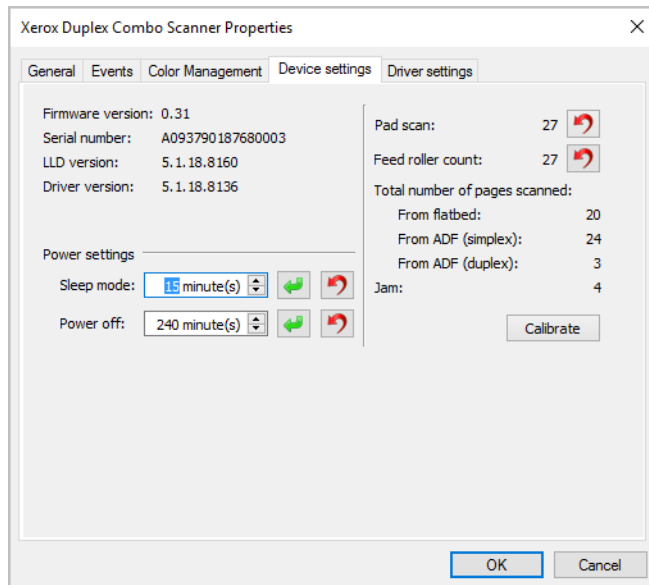

3. Click on the **Calibrate** button to start the calibration utility.

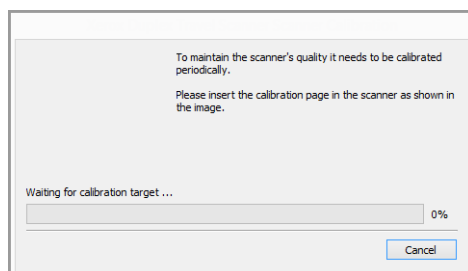

4. Place the calibration page in the scanner as shown in the following image.

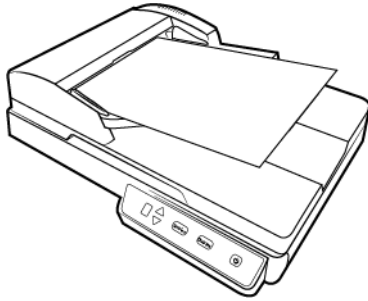

5. The scanner pulls in the calibration page and feeds it slowly through the paper path.
6. When calibration is complete the scanner will clear the calibration page out of the scanner. Remove the calibration page when the utility prompts you to. Do not forcefully pull the page out of the scanner, the scanner will release the page when it has fully exited out of the scanner.

CALIBRATION ERROR

If there is an error during calibration or if the scanner should disconnect during calibration. The error will display on-screen. If you see a message that calibration failed, please run the calibration utility again.

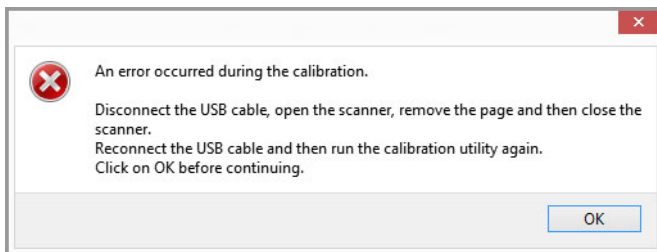

Note: if you attempted to calibrate the scanner with any page other than the calibration page provided with your scanner, the calibration routine will fail. You will need to power cycle the scanner, through unplug then re-plug of the USB cable, and then restart the calibration.

Replacing the ADF Pad Assembly

Problems with documents feeding into the ADF is an indication that the pad is wearing thin. The usage life of the ADF pad varies by what type of documents are generally scanned. Scanning large batches of heavily textured paper and embossed plastic cards will cause the ADF pad to wear faster. Large continuous batch scanning will also cause the ADF pad to wear faster. The ADF pad can be used to scan up to 30,000 pages.

You received a replacement pad in the original scanner box, you can also order a new one. Replacement parts can be purchased from the Parts & Accessories page for your scanner at www.xeroxscanners.com.

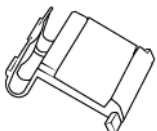

To replace the ADF Pad:

1. Open the Automatic Document Feeder cover.

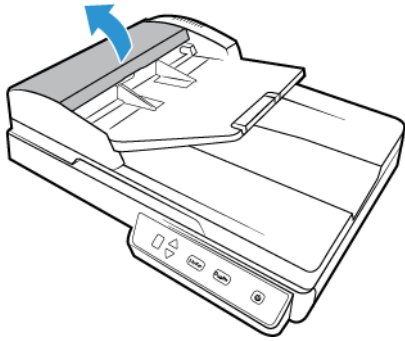

2. Squeeze the plastic clamp that holds the pad assembly in place.

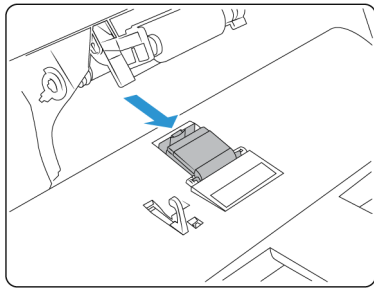

3. Rotate the ADF pad until it is able to slide free.

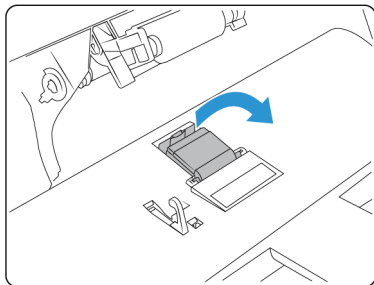

4. Lift the pad up and out of the scanner.

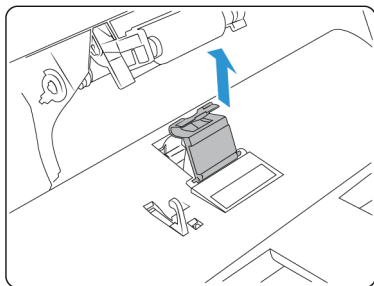

5. Remove the tensions spring that is located under the ADF pad.

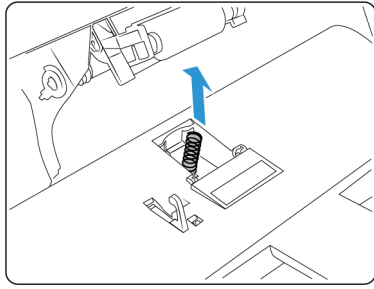

6. Place the new tension spring in the scanner.

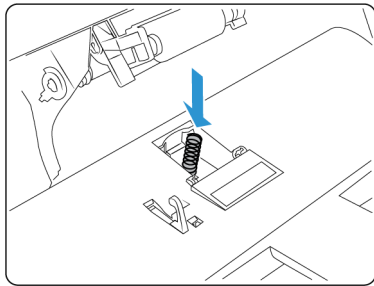

7. Place the new ADF pad in the scanner and rotate it back into place.

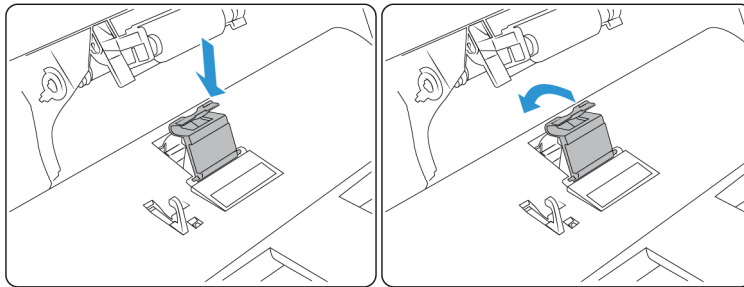

8. Press down on the ADF pad until you hear a "click" when it locks in place.
9. Close the scanner when you're finished.

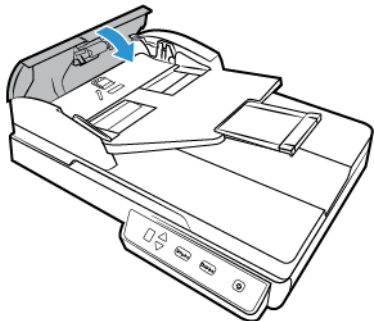

Troubleshooting

Problem: The scanner won't scan. What's wrong?

Check for one of these possible causes:

- **Are the cables loose or not plugged in securely?** Inspect the cable connections. Make sure the cables are plugged in securely.
- **Is the scanner's status light on?** Turn on the scanner's power. If the status light doesn't come on, plug the power supply into another electrical outlet. If you are using a UPS battery back-up or power strip, try plugging the scanner directly to a wall outlet.
- **Did you restart the computer and scanner?** If the scanner gets a paper jam, or loses connection because of an error, try restarting your computer and power cycling the scanner.
- **Did you plug the scanner into a USB hub?** If you're using a USB hub to connect the scanner try plugging the scanner's USB cable directly to the back of the computer. It is not recommended that you use the scanner with a USB hub, if you are using a hub, the hub must have its own power supply.
- **Is the USB cable 6' or less?** If you are using a USB cable that is longer than 6' you may lose connection to the scanner. The recommended USB cable length is 6' or less, the USB cable provided with your scanner is within this range.
- **Did you select another image source in the scanning software?** If you use multiple imaging devices with your computer, such as a camera, all-in-one printer, or another scanner, you may have selected another source for images. Make sure Xerox® Simplex Combo Scanner is selected as the scanner.

Problem: Why does my scanner not function after performing a system restore on Windows?

The system restore process may have corrupted some of the driver components. It is recommended that you reinstall your scanner driver. Please refer to "Uninstalling Your Scanner" on page 6-14 for installation instructions.

Problem: Why won't my scanner buttons work after scanning with Windows Image Acquisition (WIA)?

After performing a scan using the WIA interface you must close the application you were using before scanning with the buttons on the scanner. This does not occur when scanning using the TWAIN or ISIS interface.

Problem: Why won't my scanner work after the computer has been sitting idle for several hours?

To resolve the problem, simply turn off the scanner power then turn it back on again.

This may occur after Windows goes into power saving mode to "hibernate" the computer into a low power state. When you move your mouse or type on the keyboard it "wakes" the computer back up and restores full power to the system. This power fluctuation during the computer's hibernating period may sometimes cause the scanner to lose communication to the computer.

Problem: The installation will not complete successfully. If installation finishes, the scanner's OneTouch options do not seem to work properly.

A likely cause is that some driver programs are already installed on your computer for another scanner. Or you previously had another Visioneer® or Xerox® scanner and that driver program is still on your computer. They are interfering with the installation and OneTouch options, and you need to remove those other drivers and re-install your Xerox® scanner. Please see the documentation that you received with the other scanner for the steps to remove its driver programs.

Problem: My computer keeps giving me out of hard drive space error messages.

The minimum requirement of free hard drive space is for the installation of the scanner driver and basic, low resolution, scanning. High resolution scans result in files that can be over 1 gigabyte in size. Free up some space on your hard drive for the software to be able to save the scanned images.

Problem: The paper jams the ADF.

To reduce the number of paper jams, smooth and straighten the paper before scanning, and adjust the guides to the paper size. Paper fed into the ADF at an angle can cause the feed mechanism to jam. If paper jams are occurring more frequently, try cleaning the roller with a soft cloth dampened with Isopropyl rubbing alcohol. Excessive dust on the roller can make it appear worn and will cause issues feeding paper. See "Cleaning Inside the Automatic Document Feeder" on page 6-4 for cleaning instructions.

Problem: The ADF won't feed pages properly.

A dirty or worn ADF pad assembly or dirt on the roller can cause documents to feed in skewed at an angle, or multiple pages to feed at the same time. Try cleaning the roller first. See "Cleaning Inside the Automatic Document Feeder" on page 6-4. If that doesn't solve the problem, the pad assembly may need to be replaced. It is user replaceable. See "Replacing the ADF Pad Assembly" on page 6-8 for the steps to replace the pad.

Problem: If the USB cable is disconnected during a scan, the scanner does not reconnect when the USB cable is plugged back in.

Unplug the power cable from the scanner, and then plug it back in.

If the scanner does not reconnect:

1. Unplug the power cable from the scanner.
2. Restart your computer.
3. After the restart is complete, plug the power cable back in.

Problem: The scans from the input tray are always crooked.

Make sure to align the paper guides to the edges of the paper. If you are scanning small items that are smaller than the paper guides' minimum adjustment, scan these items from the front feed tray instead.

Problem: The scans from the ADF are always crooked.

Make sure to align the paper guides to the edges of the paper. If you are scanning small items that are smaller than the paper guides' minimum adjustment, scan these items on the Flatbed glass instead.

Problem: The paper jams about halfway through the scan.

Check the flatbed glass to make sure no items are on it when you scan from the ADF. Multiple items placed on the Flatbed glass will raise the lid slightly. When that occurs, the pages are unable to feed back out of the ADF and the pages can jam.

ERROR LIGHT TROUBLESHOOTING CODES

Normal Operation

- **Steady blue:** indicates the scanner is ready to scan.
- **Slow flashing blue:** indicates the scanner is in low power mode.
- **Rapid flashing blue:** indicates the scanner is waking up from low power mode.
- **Steady red:** the scanner is busy.
- **Flashing red:** the scanner is reporting an error.

Error Codes

The status light indicates the current state of the scanner. If your scanner experiences hardware problems, the status light turns red and will flash a specific number of times, pause, and then repeat the same number of flashes. The number of flashes between pauses indicates the hardware error code. The LED display will also flash an "E" then the error code number that matches the status light's blinking pattern.

Descriptions of the most common patterns are listed below. In all cases, you should turn off the scanner and check the scanner setup. Make sure the USB cable is plugged into the scanner and computer. Make sure the power cord is plugged into the scanner and into a wall outlet. Contact Xerox Technical Support if you experience a different blinking pattern.

Error Code	Problem Description	Solution
0	Scanner is not connected to the computer (The LED does not flash "E" and the status light remains blue.)	A cable may be loose. Check that the scanner's cables are correctly attached to the computer. If the scanner still does not connect, re-boot the computer.
3	The scanner was locked when you tried to scan.	Turn off the scanner, slide the locking tab to the unlocked position, then turn the scanner back on. See page 1-3 for the lock's location. If the problem persists, reboot your computer.
4	Paper jam	Open the ADF cover and remove the jammed page. See "Clearing Paper Jams" on page 6-3.
6	The scanner's cover is open	The ADF door is not closed all the way. Open the scanner then close it again. Push down on the lid until it locks into place.

Error Code	Problem Description	Solution
1, 2, 7 or 8	The lamp in the scanner body or lid has malfunctioned	This usually occurs if the power was disconnected during a scan. Turn the scanner off, then back on again. If the problem persists, turn off the scanner, re-start the computer, then turn the scanner on. If the problem continues, and your scanner's power is plugged into a surge protector or UPS battery backup, try plugging the scanner power directly into a wall outlet.
All Other Codes	An internal part in the scanner may have malfunctioned	Turn off the power to your scanner, then turn it back on. If the problem persists, re-boot your computer. If the problem still persists, contact Xerox Technical Support.

Uninstalling Your Scanner

Use the options in the Windows Control Panel to remove the scanner driver and modules, and any other software provided with the scanner.

Please leave the scanner's USB cable plugged into the computer while uninstalling the scanner driver. Unplug the USB cable when directed to do so in the instructions below.

Open the list of installed programs in the Windows Control panel.

- Windows 7 and later: Open Programs and Features

Uninstalling the scanner driver:

1. In the list of installed programs click on Xerox® Duplex Combo Scanner driver.
2. Click the **Change/Remove** or **Uninstall** button.
3. Click **Yes** when asked to confirm that you want to remove the driver.

When the driver uninstallation is complete the progress window will automatically close.

4. Turn off the scanner and unplug the USB cable.
5. Reboot the computer if you are prompted to do so.

Follow these instructions to remove any of the other software you installed with your scanner. Depending on the software provided with your scanner, and which applications you installed during the scanner setup, the application list may include:

- Visioneer OneTouch
- Visioneer OneTouch OCR module

Uninstalling Visioneer Acuity™:

Visioneer Acuity is automatically installed when you install the scanner driver using the installation disc. You can also download the Visioneer Acuity module from the support pages for your scanner at www.xeroxscanners.com. Visioneer Acuity is a utility with advanced image processing options to instantly improve the visual clarity of anything you scan.

1. In the list of installed programs select **Visioneer Acuity Assets**.
2. Click **Yes** when asked to confirm you want to remove the software.

Depending on the method of installation, and your scanner model, there may be multiple entries

for Visioneer Acuity in the installed programs list. The additional entries in this list are the image processing libraries needed to support various scanner models. These additional items will be called “Visioneer Acuity Assets” followed by a version number. In the scenario described here, when you want to uninstall Visioneer Acuity make sure you select and uninstall Visioneer Acuity. If you uninstall one of the entries labeled as an “asset” you will still need to uninstall the main Visioneer Acuity utility.



Xerox® Duplex Combo Scanner Specifications

Scanner Specifications	
Document Requirements (ADF)	
Minimum Item Size	3 x 5.9 inches (76 x 150 mm)
Maximum Item Size	8.5 x 14 inches (216 x 356 mm)
Capacity	35 pages of 20lb printer paper (75–80 gsm)
Paper Thickness	16–28 lbs. (60–125 gsm)
Document Requirements (Flatbed)	
Minimum Item Size	0.5 x 0.5 inches (13 x 13 mm)
Maximum Item Size	8.5 x 11.70 inches (216 x 297 mm)
Item Thickness	0.39 inch (10 mm)
General Specifications	
Optical Resolution	600 dpi
Output Bit Depth	24-bit color, 8-bit grayscale, 1-bit bitonal (black & white)
Scan Method	Duplex Automatic Document Feeder (ADF) Simplex U.S. Letter / A4 Flatbed
Image Sensor	CIS (Contact Image Sensor)
Light Source	RGB LED lamp
Interface	Hi-Speed USB 2.0, compatible with USB 1.1
Certifications	UL/C-UL, FCC CLASS B, CE, CB, WEEE, RoHS, ENERGY STAR, MEXICO ENERGY (CFE), RCM, USB-IF, CCC
Operating Temperature	40° ~ 95° F (5° ~ 35° C without condensation)
Relative Humidity	10% ~ 90%
Scanner Dimensions (Trays Extended)	
Width	15.8 inches (402 mm)
Depth	13 inches (330 mm)
Height	5.5 inches (139 mm)
Weight	5.94 pounds (2.7 kg)
Power Information	
Power Supply	APD (WA-36A24R) DC Jack, 2P, 100–240Vac, 24Vdc, 1.5A, 36W, Class 1, ENERGY STAR, RoHS
Scanner Rating	24Vdc, 1.5A
Power consumption	≤ 15 Watts (during operation) ≤ 6.0 Watts (on standby) < 2.0 Watts (power save after 15 minutes without scanning) ≤ 0.5 Watt (power off)
Cable Information	
USB cable	1850 mm, 28AWG, with core, RoHS compliant

Scanner Specifications	
Software Information	
Supported Operating Systems	Microsoft Windows –32-bit or 64-bit 7 (Service Pack 1) –32-bit or 64-bit 8 / 8.1 –32-bit or 64-bit 10
Scanner Drivers	TWAIN, WIA, ISIS
Bundled Software	Visioneer® OneTouch® Visioneer® Acuity Module

* Speeds achieved using a computer with suitable specifications.

Xerox® Duplex Combo Scanner Parts List

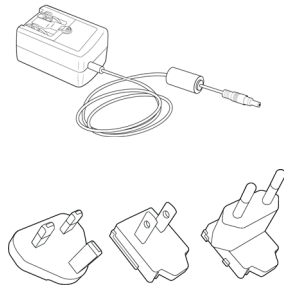
Part Name	Part Number	
ADF Pad	57-0156-000	
USB Cable	35-0118-000	
Power Supply Power Adapter Plugs	37-0100-000	

7. Appendix A: Regulatory Information

Basic Regulations

UNITED STATES (FCC REGULATIONS)



This equipment has been tested and found to comply with the limits for a Class B digital device, pursuant to Part 15 of the FCC Rules. These limits are designed to provide reasonable protection against harmful interference in a residential installation. This equipment generates, uses, and can radiate radio frequency energy and, if not installed and used in accordance with the instruction manual, may cause harmful interference to radio communications.

However, there is no guarantee that interference will not occur in a particular installation. If this equipment does cause harmful interference to radio or television reception, which can be determined by turning the equipment off and on, the user is encouraged to try to correct the interference by one or more of the following measures:

- Reorient or relocate the receiving antenna.
- Increase the separation between the equipment and receiver.
- Connect the equipment into an outlet on a circuit different from that to which the receiver is connected.
- Consult the dealer or an experienced radio/TV technician for help.

This device complies with Part 15 of the FCC Rules. Operation is subject to the following two conditions: (1) This device may not cause harmful interference, and (2) this device must accept any interference received, including interference that may cause undesired operation.

Changes and modifications to this equipment not specifically approved by Xerox® may void the user's authority to operate this equipment.

Shielded cables must be used with this equipment to maintain compliance with FCC regulations.

EUROPEAN UNION

The CE mark applied to this product, symbolizes our declaration of conformity with the following applicable European Union Directives, as of the dates indicated:



September 8, 2017:	Council Directive 2014/35/EU as amended. Approximation of the laws of the member states related to low voltage equipment.
August 12, 2016:	Council Directive 2014/30/EU as amended. Approximation of the laws of the member states related to electromagnetic compatibility.

This machine is certified as Class 1 LED product. This means that this machine does not produce hazardous laser radiation.

A full declaration of conformity, defining the relevant directives and referenced standards, can be obtained from your Xerox Limited representative or by contacting:

Environment, Health and Safety
 Xerox (NL)
 Sint Jansweg 15
 NL-5928 RC Venlo
 Telephone 1-800-ASK-XEROX

TURKEY (ROHS REGULATION)

In compliance with Article 7 (d) We hereby certify “It is in compliance with the EEE Regulation”.
 (“EEE yönetmeliğine uygundur“)

Copy Regulations

UNITED STATES

Congress, by statute, has forbidden the reproduction of the following subjects under certain circumstances. Penalties of fine or imprisonment may be imposed on those guilty of making such reproductions.

1. Obligations or Securities of the United States Government, such as:

Certificates of Indebtedness	National Bank Currency	Coupons from Bonds
Federal Reserve Bank Notes	Silver Certificates	Gold Certificates
United States Bonds	Treasury Notes	Federal Reserve Notes
Fractional Notes	Certificates of Deposit	Paper Money

Bonds and Obligations of certain agencies of the government, such as FHA, etc.

Bonds. (U.S. Savings Bonds may be photographed only for publicity purposes in connection with the campaign for the sale of such bonds.)

Internal Revenue Stamps. (If it is necessary to reproduce a legal document on which there is a canceled revenue stamp, this may be done provided the reproduction of the document is performed for lawful purposes.)

Postage Stamps, canceled or uncanceled. (For philatelic purposes, Postage Stamps may be photographed, provided the reproduction is in black and white and is less than 75% or more than 150% of the linear dimensions of the original.)

Postal Money Orders.

Bills, Checks, or Drafts of money drawn by or upon authorized officers of the United States.

Stamps and other representatives of value, of whatever denomination, which have been or may be issued under any Act of Congress.

2. Adjusted Compensation Certificates for Veterans of the World Wars.
3. Obligations or Securities of any Foreign Government, Bank, or Corporation.

4. Copyrighted material, unless permission of the copyright owner has been obtained or the reproduction falls within the “fair use” or library reproduction rights provisions of the copyright law. Further information of these provisions may be obtained from the Copyright Office, Library of Congress, Washington, D.C. 20559. Ask for Circular R21.
5. Certificates of Citizenship or Naturalization. (Foreign Naturalization Certificates may be photographed.)
6. Passports. (Foreign Passports may be photographed.)
7. Immigration Papers.
8. Draft Registration Cards.
9. Selective Service Induction Papers that bear any of the following Registrant’s information:

Earnings or Income	Dependency Status	Court Record
Previous military service	Physical or mental condition	

Exception: U. S. Army and Navy discharge certificates may be photographed.

10. Badges, Identification Cards, Passes, or Insignia carried by military personnel, or by members of the various Federal Departments, such as FBI, Treasury, etc. (unless photograph is ordered by the head of such department or bureau.)
11. Reproducing the following is also prohibited in certain states: Automobile Licenses — Drivers’ Licenses — Automobile Certificates of Title.

The above list is not all inclusive, and no liability is assumed for its completeness or accuracy. In case of doubt, consult your attorney.

CANADA

Parliament, by statute, has forbidden the reproduction of the following subjects under certain circumstances. Penalties of fines or imprisonment may be imposed on those guilty of making such copies.

1. Current bank notes or current paper money.
2. Obligations or securities of a government or bank.
3. Exchequer bill paper or revenue paper.
4. The public seal of Canada or of a province, or the seal of a public body or authority in Canada, or of a court of law.
5. Proclamations, orders, regulations or appointments, or notices thereof (with intent to falsely cause same to purport to have been printed by the Queen’s Printer for Canada, or the equivalent printer for a province).
6. Marks, brands, seals, wrappers or designs used by or on behalf of the Government of Canada or of a province, the government of a state other than Canada or a department, board, Commission or agency established by the Government of Canada or of a province or of a government of a state other than Canada.
7. Impressed or adhesive stamps used for the purpose of revenue by the Government of Canada or of a province or by the government of a state other than Canada.

8. Documents, registers or records kept by public officials charged with the duty of making or issuing certified copies thereof, where the reproduction falsely purports to be a certified copy thereof.
9. Copyrighted material or trademarks of any manner or kind without the consent of the copyright or trademark owner.

The above list is provided for your convenience and assistance, but it is not all inclusive, and no liability is assumed for its completeness or accuracy. In case of doubt, consult your solicitor.

OTHER COUNTRIES

Copying certain documents may be illegal in your country. Penalties of fine or imprisonment may be imposed on those found guilty of making such reproductions.

- Currency notes
- Bank notes and cheques
- Bank and government bonds and securities
- Passports and identification cards
- Copyright material or trademarks without the consent of the owner
- Postage stamps and other negotiable instruments

Note: this list is not inclusive and no liability is assumed for either its completeness or accuracy. In case of doubt, contact your legal counsel.

8. Appendix B: Compliance Information

Product Recycling & Disposal

USA & CANADA

If you are managing the disposal of your Xerox® product, please note that the product may contain lead, mercury, Perchlorate, and other materials whose disposal may be regulated due to environmental considerations. The presence of these materials is fully consistent with global regulations applicable at the time that the product was placed on the market. For recycling and disposal information, contact your local authorities. In the United States, you may also refer to the Electronic Industries Alliance web site: <http://www.eiae.org>.

Perchlorate Material - This product may contain one or more Perchlorate-containing devices, such as batteries. Special handling may apply, please see: <http://www.dtsc.ca.gov/hazardouswaste/perchlorate/>.

EUROPEAN UNION

RoHS and WEEE Compliance

This product is compliant with RoHS Regulations of the European Parliament and Council Directive on the Restrictions of the Use of Certain Hazardous Substances in Electrical and Electronic Equipment (2011/65/EU), and with the Waste Electrical and Electronic Equipment (WEEE) Directive (2012/19/EU).

Some equipment may be used in both a domestic/household and a professional/business application.

Professional/Business Environment

Application of this symbol on your equipment is confirmation that you must dispose of this equipment in compliance with agreed national procedures. In accordance with European legislation, end of life electrical and electronic equipment subject to disposal must be managed within agreed procedures.



ENERGY STAR for the USA

Energy Program Compliance

The Xerox® Duplex Combo Scanner is ENERGY STAR qualified under the ENERGY STAR Program Requirements for Imaging Equipment.



The ENERGY STAR and ENERGY STAR MARK are registered United States trademarks. The ENERGY STAR Imaging Equipment Program is a team effort between U.S., European Union and Japanese governments and the office equipment industry to promote energy-efficient copiers, printers, fax, multifunction machine, personal computers, and monitors. Reducing product energy consumption helps combat smog, acid rain and long-term changes to the climate by decreasing the emissions that result from generating electricity.

Xerox® equipment is preset at the factory. Your machine will be delivered with the timer for switching to Power Save Mode from the last scan set at 15 minutes.