



[www.fleet.vdo.com](http://www.fleet.vdo.com)

## Digital tachograph – DTCO<sup>®</sup> 4.0

Instruction manual for contractors and drivers



**VDO**

## Legal notice

### Described product

- Digital tachograph DTCO 1381 Release 4.0 (also DTCO 4.0)
- Version: ADR (ex version)

### Manufacturer

Continental Automotive GmbH  
P.O. Box 1640  
78006 Villingen-Schwenningen  
Germany  
[www.fleet.vdo.com](http://www.fleet.vdo.com)

### Original Instruction Manual

© 11.2018  
Continental Automotive GmbH

This publication is protected by copyright. Any rights derived from the copyright remain with Continental Automotive GmbH.

Reprinting, translations and reproductions are not permitted unless authorised in writing by the manufacturer.

This is an original document of Continental Automotive GmbH.



## Contents

<b>Legal notice</b> .....	<b>2</b>	2.2.2 Departure from legal requirements .....	18
<b>1 About this document</b> .....	<b>9</b>	2.2.3 Obligations of the contractor .....	18
1.1 Data protection .....	9	2.3 Intended use .....	18
1.1.1 Personal ITS data .....	10	<b>3 Device description</b> .....	<b>21</b>
1.1.2 Personal VDO data .....	10	3.1 Display and operational elements .....	21
1.2 Designations .....	10	3.2 Features .....	21
1.3 Function of this document .....	11	3.3 Details to the display and operating elements .....	21
1.4 Target group .....	11	3.3.1 Display (1) .....	22
1.4.1 Storage .....	11	3.3.2 Menu buttons (2) .....	22
1.4.2 Contact person .....	11	3.3.3 Card drawer 1 (3) .....	22
1.5 Symbols and signal words .....	11	3.3.4 Driver 1 combination button (4) .....	22
1.6 Conventions .....	12	3.3.5 Driver 2 combination button (5) .....	22
1.7 Menu display .....	12	3.3.6 Card drawer 2 (6) .....	22
1.8 Additional information .....	13	3.3.7 Tear-off edge (7) .....	22
1.8.1 Quick guide .....	13	3.3.8 Printer drawer (8) .....	22
1.8.2 Information via the internet .....	13	3.3.9 Front interface (9) .....	22
<b>2 For your safety</b> .....	<b>15</b>	3.4 Key settings (overview) .....	23
2.1 Basic safety information .....	15	3.5 Remote control .....	23
2.1.1 DTCO 4.0 ADR (Ex version) .....	16	3.6 Stand-by mode (display) .....	23
2.2 Legal requirements .....	16	3.6.1 Exiting stand-by mode .....	24
2.2.1 Obligations of the driver .....	17	3.7 ADR version (Ex version) .....	24
		3.7.1 Special safety instructions .....	24
		3.7.2 Particularities in relation to the operation .....	25
		3.8 Operating modes (overview) .....	25

3.9	Tachograph card (overview) .....	26	4.3.1	Language .....	43
3.9.1	Driver card .....	27	4.4	Removing the card .....	43
3.9.2	Company card .....	27	4.5	Handling of the cards .....	44
3.9.3	Control card .....	28	4.6	Downloading data .....	45
3.9.4	Workshop card .....	28	4.6.1	From driver or company card .....	45
3.9.5	Access rights of the tachograph cards .....	28	4.6.2	Data identification .....	46
3.10	Saved data .....	29	4.6.3	Downloading from the mass memory .....	46
3.10.1	Driver card .....	30	4.6.4	Remote-controlled download (option) .....	46
3.10.2	Company card .....	30	<b>5</b>	<b>Operation by the driver .....</b>	<b>48</b>
3.10.3	Mass memory (in the device) .....	30	5.1	Driver card functions .....	48
3.11	Time zones .....	31	5.2	Shift start – Inserting driver card .....	48
3.12	Pictograms (overview) .....	32	5.2.1	1. Inserting card .....	48
3.13	Country symbols .....	35	5.2.2	2. Setting activity .....	51
3.13.1	Spanish regions .....	37	5.2.3	Country entry (manual entry) .....	51
3.14	Automatic activities after ignition on/off (default) .....	38	5.2.4	Aborting the entry procedure .....	52
<b>4</b>	<b>Operation (general) .....</b>	<b>40</b>	5.3	Setting activities .....	52
4.1	Displays .....	40	5.3.1	Possible activities .....	53
4.1.1	Display after ignition on .....	40	5.3.2	Changing activities .....	53
4.1.2	Displays during journey .....	40	5.3.3	Automatic setting .....	53
4.1.3	Messages .....	41	5.3.4	Recording activities manually .....	54
4.1.4	Display after ignition off .....	41	5.4	Shift end – removing driver card .....	54
4.2	Navigating within menus .....	41	5.5	Manual entries (Entry / Addition) .....	56
4.2.1	Menus while vehicle is stationary .....	41	5.5.1	Card requests during the manual entry .....	57
4.3	Inserting card .....	41	5.5.2	Adding activity rest time .....	58

5.5.3	Continuing activities.....	59	7.2	Second menu level – menu functions .....	79
5.5.4	Continuing activities and preceding others with activities .....	60	7.2.1	Menu functions (overview).....	80
5.6	Driver / vehicle change.....	60	7.2.2	Navigating within menu functions .....	81
5.6.1	Case 1 – Crew operation .....	61	7.2.3	Menu access lock .....	82
5.6.2	Case 2 – Shift end .....	61	7.2.4	Leaving menu functions .....	82
5.6.3	Case 3 – Mixed operation.....	61	7.2.5	Menu point printout driver 1/ driver 2 .....	83
5.7	Inserting driver card for the first time .....	62	7.2.6	Menu point printout vehicle.....	84
5.7.1	Data usage .....	62	7.2.7	Menu point Entry driver 1/driver 2.....	87
5.7.2	Registration process.....	62	7.2.8	Menu point entry vehicle.....	90
<b>6</b>	<b>Operation by the contractor.....</b>	<b>65</b>	7.2.9	Menu point display driver 1/ driver 2 .....	92
6.1	Functions of the company card .....	65	7.2.10	Menu point display vehicle.....	93
6.2	Menu functions in the company mode .....	65	<b>8</b>	<b>Messages .....</b>	<b>96</b>
6.3	Registration – inserting company card .....	66	8.1	Meaning of messages .....	96
6.4	Inserting member state and vehicle registration number .....	67	8.1.1	Characteristics of the messages.....	96
6.5	Removing company card .....	69	8.1.2	Acknowledgement of messages .....	97
<b>7</b>	<b>Menus.....</b>	<b>72</b>	8.2	Special messages .....	97
7.1	First menu level – Standard values.....	72	8.2.1	Production status .....	97
7.1.1	Display in stationary vehicle .....	72	8.2.2	OUT (out of scope of regulation) .....	98
7.1.2	Display the times of the driver card .....	73	8.2.3	Ferry/train .....	98
7.1.3	Setting the language.....	73	8.3	Overview of possible events.....	99
7.1.4	VDO Counter (option).....	74	8.4	Overview of possible malfunctions .....	102
			8.5	Driving time warnings .....	103
			8.5.1	VDO Counter display (option).....	104
			8.6	Overview of possible operational notes .....	105
			8.6.1	Operational notes as information.....	108

<b>9</b>	<b>Print</b> .....	<b>111</b>			
9.1	Notes for printing.....	111			
9.2	Starting print.....	111			
9.3	Cancelling print .....	111			
9.4	Replacing the printer paper.....	112			
9.4.1	End of paper .....	112			
9.4.2	Replacing the paper roll.....	112			
9.5	Clear paper jam.....	113			
9.6	Retaining printouts .....	113			
9.7	Printouts (examples) .....	114			
9.7.1	Daily printout of the driver card.....	114			
9.7.2	Events / faults from the driver card .....	115			
9.7.3	Daily printout of the vehicle .....	116			
9.7.4	Events / faults from the vehicle.....	117			
9.7.5	Speeding events.....	118			
9.7.6	Technical data .....	118			
9.7.7	Driver activities .....	119			
9.7.8	v-diagram.....	119			
9.7.9	Status D1/D2 diagram (option).....	120			
9.7.10	Speed profiles (option) .....	120			
9.7.11	Rotation frequency profiles (option) .....	120			
9.7.12	Inserted tachograph cards .....	121			
9.7.13	Printout in local time .....	121			
9.8	Explanation to the printouts.....	121			
9.8.1	Key to the data blocks .....	121			
9.9	Data set for events or faults .....	129			
9.9.1	Coding of data set purpose.....	129			
9.9.2	Coding for more detailed description .....	131			
<b>10</b>	<b>Maintenance and inspection obligation</b> .....	<b>133</b>			
10.1	Cleaning .....	133			
10.1.1	Cleaning the DTCO 4.0 .....	133			
10.1.2	Cleaning tachograph card.....	133			
10.2	Compulsory inspection .....	133			
<b>11</b>	<b>Troubleshooting</b> .....	<b>136</b>			
11.1	Data backup by the workshop.....	136			
11.2	Overvoltage/undervoltage .....	136			
11.2.1	Power interruption.....	136			
11.3	Error card communication .....	137			
11.3.1	Printer drawer defect .....	138			
11.3.2	Automatic ejection of tachograph card .....	138			
<b>12</b>	<b>Technical data</b> .....	<b>140</b>			
12.1	DTCO 4.0 .....	140			
12.2	Paper roll.....	141			
<b>13</b>	<b>Appendix</b> .....	<b>143</b>			
13.1	Declaration of conformity.....	143			
13.2	Certification of activities (extract) .....	144			

13.3 Optional accessories ..... 145

    13.3.1 DLKPro Download Key ..... 145

    13.3.2 DLKPro TIS-Compact ..... 145

    13.3.3 DTCO® Smart Link ..... 145

    13.3.4 DLD® Short Range II and  
        DLD® Wide Range II ..... 146

    13.3.5 Cleaning cards and cleaning wipes ..... 146

13.4 VDO online shop ..... 146

**14 Change overview ..... 148**

    14.1 Release overview ..... 148

**Index ..... 149**

Service Only!

## **About this document**

**Data protection**

**Designations**

**Function of this document**

**Target group**

**Symbols and signal words**

**Conventions**

**Menu display**

**Additional information**



## About this document

### ■ Data protection

The DTCO 4.0 must meet numerous data protection requirements pursuant to Regulation (EU) 165/2014 as well as the current version of Implementing Regulation (EU) 2016/799. In addition, the DTCO 4.0 fulfils the requirements of the General Data Protection Regulation (EU) 2016/679, as amended.

This affects in particular:

- The driver's consent to the processing of personal ITS data
- The driver's consent to the processing of personal VDO data

The first time that the driver card is inserted into the DTCO 4.0 and after the manual addition on the tachograph, the driver is asked if he consents to the processing of his personal data.

#### IMPORTANT

For further data protection information, especially in relation to the scope of the data collection and the data use, please contact your employer and/or customer. Please note that Continental Automotive GmbH acts solely as a processor according to the instructions for your employer/customer.

#### IMPORTANT

Please note that any given consent can be revoked at any time. Any data processing based on your consent carried out up to the revocation is not affected by this.

→ *Changing settings to personal ITS data* [▶ 88]

→ *Changing settings to personal VDO data* [▶ 89]

#### IMPORTANT

The data is saved in the tachograph and, after reaching the maximum data volume, systematically overwritten one by one, starting with the oldest entries – after one year at the earliest.

External devices communicating with the tachograph can access the data described below, provided the driver has consented to the recording.

#### IMPORTANT

Real-time data can be retrieved at any time in the vehicle network, irrespective of the driver's consent. If no other data protection concept exists, this data may only leave the vehicle network with the driver's consent.

### ► Personal ITS data

Personal ITS data (ITS: Intelligent Transport System) include, for example:

- Driver's first and last name
- Driver card number
- Date of birth

➔ *Shift start – Inserting driver card*  
[▶ 48]

### ► Personal VDO data

Personal additional data which are not defined in the Implementing Regulation (EU) 2016/799 Annex 13 and are displayed in real time.

The following personal additional data are recorded subject to the driver's consent:

- D1/ D2-Status inputs
- Engine speed profiles
- Speed profiles
- the 4 Hz speed signal

#### IMPORTANT

The 4 Hz speed signal records emergency stops in the tachograph. It is always only the last event that is recorded.

➔ *Registration – inserting company card*  
[▶ 66]

#### IMPORTANT

For further information about data collection, please contact your employer.

### ■ Designations

The following designations are used in this instruction manual:

- The DTCO 1381 Release 4.0 is referred to as DTCO 4.0.
- The covered interface on the front of the DTCO 4.0 is used both for downloading data and for parameter setting. It is referred to as the front interface.
- The AETR Agreement (**A**ccord **E**uropéen sur les **T**ransports **R**outiers) specifies provisions for the driving and rest times for cross-border transport. It therefore also forms part of this manual.
- **Mixed operation** Mixed operation Means the mixed use of vehicles with analogue and digital tachographs.
- **Crew operation** Means a journey with 2 drivers.
- **Mass memory** Is the data memory in the device.

- **Out** (Out of Scope) throughout this manual means leaving the scope of a regulation.

## ■ Function of this document

This document is an instruction manual and outlines the correct use, complying with the operation specified in Regulation (EU) 165/2014, of the digital tachograph DTCO 4.0.

The instruction manual is designed to help you comply with the legal requirements in connection with the DTCO 4.0.

This document is valid for the DTCO 4.0. It does not apply for older device generations.

## ■ Target group

This instruction manual is aimed at drivers and contractors.

Please read the manual carefully and familiarise yourself with the device.

### ► Storage

Please always have this manual at hand in your vehicle.

### ► Contact person

If you have any questions or requests, please contact your authorised specialist workshop or service partner.

## ■ Symbols and signal words

### RISK OF EXPLOSION!

The note EXPLOSION RISK refers to an **imminent** danger of explosion.

Non-compliance may result in severe injury or death.

### WARNING

The note WARNING refers to **possible** danger.

Non-compliance may result in serious injuries or death.

### CAUTION

The note CAUTION refers to the risk of minor injuries.

Non-compliance may result in minor injuries.

### ATTENTION

The note ATTENTION contains important information to avoid data loss, prevent damage to the device and comply with legal requirements.

### IMPORTANT

A NOTE provides you with advice or information which, if not adhered to, could result in malfunctions.

## ■ Conventions

1. Open...  
Actions are numbered if several steps are to be performed in a particular order.
- Select...  
Actions are not numbered if they are not followed by another step or if the steps are optional.
- a. Display sequence...  
If displays show a sequence of sub-steps of an action, they are marked with letters in alphabetical order.

## ■ Menu display

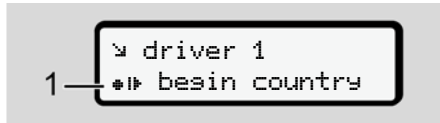

Fig. 1: Sample menu display

Flashing lines or characters in the menu display are shown in *italics* (1).

### Definitions

**Driver 1** = the person who is currently driving the vehicle or will be driving it.

**Driver 2** = the person not driving the vehicle.

## ■ Additional information

### ▶ Quick guide

- The **Quick guide for drivers** is designed to provide a brief overview over the essential operating steps.

### ▶ Information via the internet

On the internet under [www.fleet.vdo.com](http://www.fleet.vdo.com), you will find:

- Additional information about the DTCO 4.0
- Information about the third party licence
- This instruction manual in PDF format
- Contact details
- Requirements placed on external GNSS antennas to be operated by the DTCO 4.0

## **For your safety**

**Basic safety information**

**Legal requirements**

**Intended use**

Service Only

## For your safety

### ■ Basic safety information

#### WARNING

##### Distraction due to device messages

There is a risk of distraction if messages are displayed on the device while driving or if the card is automatically ejected.

- Do not let yourself get distracted by this, but focus all of your attention on the traffic.

#### CAUTION

##### Risk of injury at the card drawer

You and others may sustain an injury on an open card drawer.

- Only open the card drawer to insert or remove a tachograph card.

#### ATTENTION

##### Arranging training for the DTCO 4.0

According to Regulation (EU) 165/2014, transport companies are obliged to train their drivers in the use of digital tachographs and to provide evidence of such training.

Non-compliance may result in a fine and extended liability in the event of damage.

- Arrange regular training for your drivers.

#### ATTENTION

##### Preventing damage to the DTCO 4.0

In order to prevent the DTCO 4.0 from getting damaged, please note the following points:

- The DTCO 4.0 has been installed and sealed by authorised persons. Do not interfere with the DTCO 4.0 and its supply cables.
- Insert only the corresponding tachograph cards into the card slot.
- Use only paper rolls with approval mark which have been approved and recommended by the manufacturer (original VDO printer paper).  
→ *Replacing the printer paper* [[p 112](#)]
- Do not use sharp-edged or pointed objects to press the button elements.

**⚠ ATTENTION****Do not damage sealings and seals**

Otherwise, the DTCO 4.0 is in an unlicensed state and the data is no longer reliable.

**⚠ ATTENTION****Do not manipulate data**

It is forbidden to falsify, suppress or destroy tachograph recordings, the tachograph cards and the printed documents.

**⚠ ATTENTION****Do not manipulate the DTCO 4.0**

Any person carrying out modifications to the tachograph or the signal supply which impact on the registration and storage of the tachograph, especially with fraudulent intent, violates legal provisions.

**▶ DTCO 4.0 ADR (Ex version)**

For better clarity, all details (particularities in relation to the operation and relevant safety information) regarding the ex version ADR have been summarised in one single chapter.

**⚠ RISK OF EXPLOSION!****Explosion risk due to residual voltages and open interfaces**

In explosive areas, pressing the buttons of the DTCO 4.0, inserting cards or opening the printer tray or the front interface poses an explosion risk.

- Please observe the instructions for the transport and handling of hazardous goods in explosive environments.

→ *ADR version (Ex version)* [▶ 24]

**■ Legal requirements****⚠ ATTENTION****Legal requirements of other countries**

This instruction manual does not list the legal requirements of individual countries, and these must also be observed.

The use of tachographs is regulated by the following regulations and directives:

- Regulation (EU) 165/2014
- Regulation (EC) 561/2006
- Directive 2006/22/EC

The most recent versions apply.

By means of these Regulations, the European Parliament assigns a number of duties and responsibilities to the driver of the vehicle as well as to its owner (contractor).

In addition, the respective national laws must also be observed.



Without any claim to completeness or validity, the following key points can be highlighted:

### ► Obligations of the driver

- The driver must ensure that the driver card and the tachograph will be used properly.
- Behaviour in the event of malfunctions of the tachograph:
  - The driver must write down on a separate sheet or on the back of the printout any details about the activities which are no longer properly recorded or printed by the tachograph.
    - ➔ *Recording activities manually* [▶ 54]
  - If a return to the contractor's site cannot occur within a week, the tachograph must be repaired by an authorised specialist workshop.
- Documents to be carried for mixed operation (use of vehicles with chart and digital tachograph):
  - Driver card

- Daily printouts
- Charts
- Hand-written records
  - ➔ *Driver / vehicle change* [▶ 60]
- Documents to be carried during sick leave and holidays if a manual entry into the tachograph was not possible.
- Pursuant to Directive 2006/22/EC of the European Commission, the driver must carry proof of the following circumstances of the past 28 days:
  - Period in which the driver was on convalescence holiday.
  - Period in which the driver was on recreation holiday.
  - Period for a journey which was undertaken outside of the scope of Regulation (EC) 561/2006 or the AETR.

### IMPORTANT

A print template of the form is available on the internet at:  
[ec.europa.eu](http://ec.europa.eu)

- In case of loss, theft, damage or malfunction of the driver card, the driver must create a daily printout at the start and at the end of the journey and include personal details. If required, the standby times and other work times must be added manually.
  - ➔ *Recording activities manually* [▶ 54]
- In case of damage or malfunction of the driver card: Hand over the driver card to the competent authority or report the loss appropriately. Request the replacement card within seven calendar days.
- Drivers may continue driving without a driver card for a period of 15 calendar days, if this is necessary for the return of the vehicle to the company's site.
- If the authority of a foreign member state replaces the driver card: Promptly notify your competent authority of the reason.
- After the expiry of the driver card's validity, the driver must continue to carry the card inside the vehicle for at

least 28 calendar days (German “Fahrpersonalverordnung” = regulation concerning driving personnel).

### ► Departure from legal requirements

In order to ensure the safety of persons, of the vehicle or its load, departures from the applicable legal requirements may be necessary.

In such cases, the driver must record the type and reason for such departure manually, at the latest on arrival at a suitable stopping place. E.g.:

- On the chart
- On a printout from the DTCO 4.0
- In the work schedule

### ► Obligations of the contractor

The calibration and repair of the DTCO 4.0 must only be carried out by an authorised specialist workshop.

➔ *Compulsory inspection* [▶ 133]

- The first time you insert the company card, the DTCO 4.0 will ask you to enter the following vehicle data:
  - Member state
  - Vehicle registration number.
    - ➔ *Inserting member state and vehicle registration number* [▶ 67]
- After a vehicle transfer: Have an authorised specialist workshop enter the following calibration data into the DTCO 4.0:
  - Member state
  - Vehicle registration number
- Register/deregister the company at the start/end of the vehicle use in the DTCO 4.0.
  - ➔ *Registration – inserting company card* [▶ 66]
- Make sure that there is a sufficient number of paper rolls available for the printer inside the vehicle.
- Monitor the proper functioning of the tachograph, e.g. by inserting the company card.
- Follow the legally required intervals stipulated for the inspection of the tachograph: Inspection at least every two years.
- Regularly download the data from the mass memory of the DTCO 4.0 and of the driver cards and store them according to the legal requirements.
- Supervise the proper use of the tachograph by the drivers. Check driving times and rest periods periodically and point out any discrepancies.

## ■ Intended use

The digital tachograph DTCO 4.0 is a recording device to monitor and register speed, kilometres driven and driving times and rest periods.

This document describes the operation of the digital tachograph DTCO 4.0.

The data prepared by this tachograph supports you in your daily tasks:

- It helps you, the driver, among other things, to comply with the social legislation relating to road transport.
- It helps you, the contractor, to keep an eye on the driver and vehicle usage (by means of suitable evaluation programmes).

In the case of the ADR version of the DTCO 4.0, this must only be operated in accordance with the requirements of ATEX Directive 2014/34/EU.

### IMPORTANT

The DTCO 4.0 can be used for a maximum of 15 years, after which period the certificate will expire.

Once the certificate has expired, the tachograph must be replaced.

## **Device description**

### **Display and operational elements**

#### **Features**

#### **Details to the display and operating elements**

#### **Key settings (overview)**

#### **Remote control**

#### **Stand-by mode (display)**

#### **ADR version (Ex version)**

#### **Operating modes (overview)**

#### **Tachograph card (overview)**

#### **Saved data**

#### **Time zones**

#### **Pictograms (overview)**

#### **Country symbols**

#### **Automatic activities after ignition on/off (default)**

## Device description

### ■ Display and operational elements

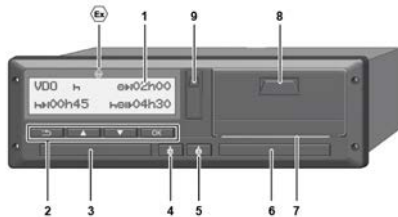



Fig. 2: Frontal view of the DTCO 4.0

- (1) Display
  - (2) Menu buttons
  - (3) Card drawer 1 with cover
  - (4) Combination button driver-1
  - (5) Combination key driver 2
  - (6) Card drawer 2 with cover
  - (7) Tear-off edge printer
  - (8) Printer drawer
  - (9) Front interface
-  Label for ADR version (ex version – option)

The DTCO 4.0 can be operated remotely using optional accessories.

### ■ Features

The digital tachograph DTCO 4.0 and its system components is the vehicle unit of a trip recorder or control unit and complies with the technical specifications pursuant Regulation (EU) 165/2014 as well as Implementing Regulation (EU) 2016/799 Annex I C, as amended.

The DTCO 4.0 permanently records driver- and vehicle-related data.

Errors within a component, the device or the operation are indicated in the device and saved immediately after they have occurred.

In the case of the ADR version, the DTCO 4.0 complies with ATEX Directive 2014/34/EU and the ADR Agreement, Part 9.

## ■ Details to the display and operating elements

### ▶ Display (1)

Contrast and brightness of the display cannot be changed.

The dimming (after ignition off) can be changed in the workshop.

→ *Menu display* [▶ 12]

### ▶ Menu buttons (2)

Please use the following buttons to enter, display or print data:

▲/▼ **Press the button of the desired direction several times:** Scroll through the menu level to the desired function.

**Keep the button pressed:** Scroll automatically.

OK **Press the button briefly:** Confirm the function/selection.

⏏ **Press the button briefly:** Return to the previous entry field, abort the country entry or exit the menu levels step by step

### ▶ Card drawer 1 (3)

The driver 1 who will drive the vehicle inserts his driver card into the card drawer 1.

→ *Shift start – Inserting driver card* [▶ 48]

### ▶ Driver 1 combination button (4)

⏏ **Press the button briefly:** Change activity.

→ *Setting activities* [▶ 52]

**Keep the button pressed:** (at least 2 seconds): Open the card drawer.

### ▶ Driver 2 combination button (5)

⏏ **Press the button briefly:** Change activity.

→ *Setting activities* [▶ 52]

**Keep the button pressed:** (at least 2 seconds): Open the card drawer.

### ▶ Card drawer 2 (6)

Driver 2, who is not driving the vehicle at this moment in time, inserts his driver card into drawer 2 (crew operation).

→ *Shift start – Inserting driver card* [▶ 48]

### ▶ Tear-off edge (7)

You can tear off the paper printout of the printer at the tear-off edge.

### ▶ Printer drawer (8)

Printer drawer for inserting the paper roll.

→ *Replacing the printer paper* [▶ 112]

### ▶ Front interface (9)

The download of the data and the parametrisation is done through the front interface (workshop).

The front interface is located under a cover.

The access rights to the functions of this interface depend on the inserted tachograph card.

→ *Access rights of the tachograph cards* [ 28]

## ■ Key settings (overview)

The key settings of the DTCO 4.0 include:

- Entering the vehicle registration number and the country of registration (if not already carried out by the workshop)
  - *Inserting member state and vehicle registration number* [ 67]
- Activity changes when the ignition is off
  - *Automatic activities after ignition on/off (default)* [ 38]
- Recording of speed and engine speed profiles
  - *Printing speed profiles (option)* [ 87]
- D1/D2 Status detection
  - *Shift start – Inserting driver card* [ 48]
- VDO Counter display (option)
  - *VDO Counter (option)* [ 74]

## ■ Remote control

The DTCO 4.0 can be remotely controlled. To do this, you will need:

- DTCO® SmartLink (pluggable Bluetooth interface)
- Device with Bluetooth interface, e.g. smartphone or test device
- Application software (app) on the device

→ *DTCO® Smart Link* [ 145]

You can activate the remote control on the DTCO 4.0 yourself and then use a licence code to link the tachograph with your mobile device.

→ *Activating remote control* [ 89]

## Entering the vehicle registration number

The entry of the vehicle registration number and the authorising member state can also be carried out via an app in connection with the DTCO® SmartLink.

3

## ■ Stand-by mode (display)

In the operating mode **Operation**, recognisable in the display by the pictogram , the DTCO 4.0 switches to Stand-by mode in the following circumstances:

- Ignition of the vehicle is off.
- There is no notification.

In case of **Ignition off**, the display is dimmed.

After approx. 1 minute (customer-specific value), the display turns off completely – the DTCO 4.0 is in stand-by mode.

Optionally, an additional dimming value can be set (workshop).

### ► Exiting stand-by mode

By pressing any button or **Ignition on**, the stand-by mode is exited.

The display turns on again; no further action occurs.

## ■ ADR version (Ex version)

The ADR version of the DTCO 4.0 is marked with an ex symbol on the front plate.

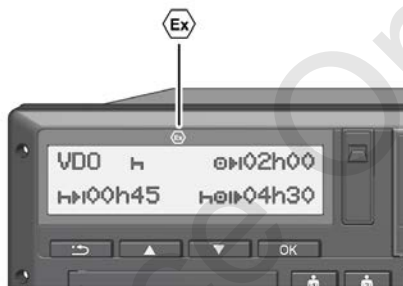

Fig. 3: Ex symbol on the front

The ADR version of the DTCO 4.0 is authorised for operation in explosive environments.

- Ex zone: Zone II
- Ambient temperature: -20 °C to +65 °C.

## ► Special safety instructions

The following additional safety information should be observed with the ADR version of the DTCO 4.0:

### RISK OF EXPLOSION!

#### Observe instructions

- Please observe the instructions for the transport and handling of hazardous goods in explosive environments.



### RISK OF EXPLOSION!

#### Please observe the following when loading and unloading hazardous goods:

- Both card drawers must be closed.
- The printer drawer must be closed.
- The cover flap of the front interface must be closed.
- Do not press any buttons on the tachograph.
- No workshop, control or company card must be inserted.

#### ► Particularities in relation to the operation

To prevent explosions, the ADR version of the DTCO 4.0 is reduced to internal functions only with the ignition switched off in corresponding hazard areas (unlike the standard version).

Therefore, you must switch on the ignition outside of the hazard area if you wish to operate the ADR version of the DTCO 4.0.

### ■ Operating modes (overview)

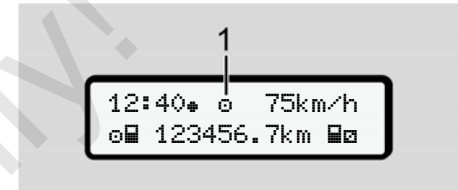





Fig. 4: Operating mode display

#### (1) Display of the operating mode

The DTCO 4.0 has 4 operating modes which depend on the tachograph card inserted:

- Operation  (journey/driver)  
Standard display with or without driver card inserted  
→ *Shift start – Inserting driver card* [► 48]
- Company  (contractor)  
Display after inserting the company card  
→ *Registration – inserting company card* [► 66]
- Control   
(not part of this manual)

- Calibration †  
(not part of this manual)

Depending if and which tachograph cards have been inserted, the DTCO 4.0 automatically switches to one of the following operating modes:

**Overview of operating modes of inserted tachograph cards**

Operating modes		Card drawer 1				
		No card	Driver card	Company card	Control card	Workshop card
Card drawer 2	<b>No card</b>	Operational	Operational	Company	Control	Calibration
	<b>Driver card</b>	Operational	Operational	Company	Control	Calibration
	<b>Company card</b>	Company	Company	Company (*)	Operation	Operational
	<b>Control card</b>	Control	Control	Operational	Control (*)	Operational
	<b>Workshop card</b>	Calibration	Calibration	Operational	Operational	Calibration (*)

(\*) In these states, the DTCO 4.0 only uses the tachograph card inserted in card drawer 1.

## ■ Tachograph card (overview)

You will obtain the legally required tachograph cards by requesting them from the authorities of the respective EU member state.

→ *Legal requirements* [▶ 16]

### IMPORTANT

You may use first generation tachograph cards according to (EU)3821/85, Annex I B, as well as second generation cards according to Implementing Regulation (EU)2016/799, Annex I C, as amended.

However, only second generation workshop cards may be used.

Holders of a tachograph card are entitled to use the DTCO 4.0. Areas of activity and access rights are prescribed by law.

→ *Access rights of the tachograph cards* [▶ 28]

### IMPORTANT

In order to prevent data loss, please handle your tachograph carefully and also observe the instructions of the authorities issuing the tachograph cards.

#### ▶ Driver card

You use your driver card to register as the driver with the tachograph.

The DTCO 4.0 starts to display and store all activities of that driver.

You can print or download (if a driver card is inserted) the data.

Thus, the driver card is designed for the normal driving operation (as a single driver or in crew operation).

#### ▶ Company card

You use the company card to register as the keeper or owner of the vehicle with the DTCO 4.0. This enables you to access company data.

The company card is used to display, print and download the data saved in the mass memory as well as the data of a driver card - which is inserted into the other card drawer.

### IMPORTANT

In addition, the company card entitles you – for the first time and if not yet carried out by a workshop – to enter the authorised member state and the vehicle registration number. If in doubt, please contact an authorised specialist workshop.

Equipped with an adequate fleet management system, you are also entitled to use the company card to download user data remotely.

### IMPORTANT

The company card is designed for keepers and owners of vehicles with integrated digital tachograph and must

3

not be transferred to other persons.  
The company card is not designed for driving.

#### ► **Control card**

(Not part of this manual)

The control card of the official of a control body (e.g. police) allows access to the mass memory.

All saved data and the data of an inserted driver card are accessible. They can be displayed, printed or downloaded via the front interface.

#### ► **Workshop card**

(Not part of this manual)

Persons from an authorised specialist workshop authorised in programming, calibrating, activating and inspecting etc, are issued the workshop card.

#### ► **Access rights of the tachograph cards**

The access rights of the data saved in the mass memory of the DTCO 4.0 are regulated by law and are only released with the corresponding tachograph card.

		Without card	Driver card	Company card	Control card	Workshop card
Print	<b>Driver data</b>	X	V	V	V	V
	<b>Vehicle data</b>	T1	T2	T3	V	V
	<b>Parameters</b>	X	V	V	V	V
Display	<b>Driver data</b>	T1	T2	T3	V	V
	<b>Vehicle data</b>	V	V	V	V	V
	<b>Parameters</b>	X	T2	V	V	V
Read out	<b>Driver data</b>	X	X	T3	V	V
	<b>Vehicle data</b>	X	X	V	V	V
	<b>Parameters</b>	X	V	V	V	V

**Meanings:**

<b>Driver data</b>	Driver card data
<b>Vehicle data</b>	Data in the data memory
<b>Parameter data</b>	Data for the device adjustment/calibration
<b>V</b>	Unlimited access rights
<b>T1</b>	Driver activities of the last eight days without driver identification data
<b>T2</b>	Driver identification only for the inserted card
<b>T3</b>	The associated company's driver activities
<b>X</b>	not possible

## ■ Saved data

### ▶ Driver card

In general, the driver card contains:

- Data identifying the driver.
  - ➔ *Personal ITS data* [▶ 10]

After each vehicle operation, the following data is stored on the driver card chip:

- Insertion and removal of the card
- Vehicles used
- Date and odometer reading
- Driver's activities, for normal driving operation at least 28 days
- Kilometres travelled
- Country entries
- Status information (single or crew operation)
- Occurred events/malfunctions
- Information concerning control activities
- Specific conditions:
  - Journeys with status ferry/train

- Journeys with status Out of scope

If the chip memory is full, the DTCO 4.0 will overwrite the older data.

➔ *Obligations of the driver* [▶ 17]

### ▶ Company card

In general, the company card contains:

- Data for identifying the company and for authorising access to saved data
  - Company
  - Driver card

After each operation, the following data is stored on the company card chip:

- Type of activity
  - Registering/deregistering
  - Downloading the data from the data memory
  - Downloading the data from the driver card
- Period (from/to) for which the data was downloaded

- Vehicle identification
- Identity of the driver card from which the data was downloaded

If the chip memory is full, the DTCO 4.0 will overwrite the older data.

➔ *Obligations of the contractor* [▶ 18]

### ▶ Mass memory (in the device)

- Over a period of at least 365 calendar days, the mass memory collects and saves the data according to Implementing Regulation (EU) 2016/799 Annex I C, as amended.
- The evaluation of activities is done in intervals of one calendar minute, whereby the DTCO 4.0 grades the longest continuous activity per interval.
- The DTCO 4.0 can store approx. 168 hours' worth of speed values in the resolution of one second. Each second of the values are thus saved exactly with date and time.

- Saved speed values with a high resolution (one minute before and one minute after an unusual deceleration) support the analysis in the event of an accident.

This data can be read out via the front interface (only with contractor card):

- Downloading the driver card data
- Downloading the mass memory with a download key (option)

## ■ Time zones

The factory time setting of the DTCO 4.0 is in UTC time.

Time entries are saved by the DTCO 4.0 in UTC time.

The UTC time corresponds to time zone **0** on earth's 24 time zones (–12...0...+12h).

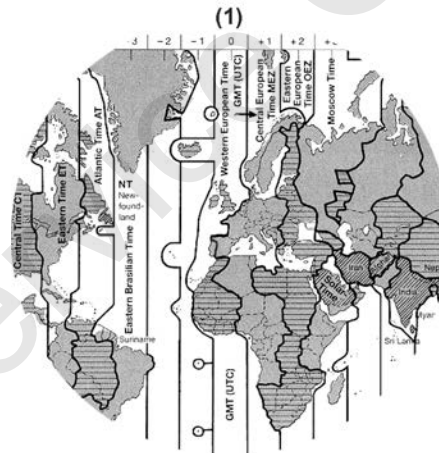

Fig. 5: Time zones in Europe

### (1) Time zone **0** = UTC

Time zone difference	State
00:00 (UTC)	GB / P / IE / IS
+ 01:00 h	A / B / BIH / CZ / D / DK / E / F / H / HR / I / L / M / N / NL / PL / S / SK / SLO / SRB
+ 02:00 h	BG / CY / EST / FIN / GR / LT / LV / RO / TR / UA
+ 03:00 h	RUS

### Converting to UTC time

UTC time = Local time – (TD + SU)

TD = Time zone difference

SU = Summer time (only for summer time)

(TD + SU = time difference to be set)

3

**Example:**

Local time in Germany = 15:30 (day-light-savings time)

















UTC time = Local time – (TD + SU)  
 = 3.30 p.m. – (01:00 h + 01:00 h)

















**UTC time = 13:30**

In this menu, you can set the local time:

➔ *Set Local time* [ 91]

**■ Pictograms (overview)**

Operating modes	
	Company
	Control
	Operational
	Calibration
	Production status
Persons	
	Company
	Controller
	Driver
	Workshop / inspection centre
	Manufacturer
Activities	
	Standby time
	Driving time
	Break time and rest period
	Other working time
	Valid interruption / break
	Unknown

Devices / functions	
	Card drawer 1; Driver 1
	Card drawer 2; Driver 2
	Tachograph card (read correctly)
	Tachograph card inserted; relevant data read.
	Clock
	Printer / printout
	Entry
	Display
	Licence code
	External storage; downloading data (copying)
	Data transmission running
	Sensor
	Vehicle/vehicle unit/DTCO 4.0
	Tyre size
	Low voltage
	Overvoltage
	Voltage interruption



Devices / functions	
R	Remote control
Miscellaneous	
!	Event
×	Malfunction
⚠	Operating instruction/ working time warnings
⏰	Shift beginning
📍	Location
🔒	Safety
➤	Speed
🕒	Time
Σ	Total / summary
⏸	End of shift
M	Manual entry of activities
Specific conditions	
OUT	Recording equipment not required
🚢	Vehicle located on a ferry or on a train

Qualifiers	
24h	Daily
I	Weekly
II	Two weeks
➔	From or to

### Pictogram combinations













Miscellaneous	
📍	Control location
🕒➔	Start time
➔🕒	End time
OUT➔	Start Out of scope: Recording equipment not required
➔OUT	End Out of scope
🚢➔	Start Ferry/train
➔🚢	End Ferry/train
📍➔	Location at start of working day (shift start)
➔📍	Location at end of working day (shift end)
🚗➔	From vehicle













Miscellaneous	
🖨	Printout driver card
🚗🖨	Printout vehicle/ DTCO 4.0
🚗➔	Entry vehicle/ DTCO 4.0
🖨	Display driver card
🚗🖨	Display vehicle/ DTCO 4.0
🕒	Local time
🕒🏢	Local time company













Cards	
🖨	Driver card
🏢	Company card
🖨	Control card
🔧	Workshop card
🖨---	No card inserted

Driving	
🕒	Crew operation
🕒	Total driving time of double weeks

3

Printouts	
	Daily driver activities (daily value) from the driver card
	Events and malfunctions from the driver card
	Daily driver activities (daily value) from the DTCO 4.0
	Events and malfunctions from the DTCO 4.0
	Speeding events
	Technical data
	Driver activities
	Periods with activated remote control
	v-diagram
	Status D1/D2 diagram (option)
	Speed profiles (option)
	Rotation frequency profiles (option)
	Sensor information
	Safety information

Displaying	
	Daily driver activities (daily value) from the driver card
	Events and malfunctions from the driver card
	Daily driver activities (daily value) from the vehicle/ DTCO 4.0
	Events and malfunctions from the vehicle/ DTCO 4.0
	Speeding events
	Technical data
	Cards
	Company
Events	
	Insertion of an invalid tachograph card
	Time overlap
	Insertion of driver card while driving
	Speeding
	Motion data error

Events	
	Time adjustment (by workshop)
	Card conflict
	Driving without valid driver card
	Last card process not completed correctly
	Interruption of the power supply
	Security breach
	Missing GNSS signal
	Time conflict
	Communication error DSRC
	Speeding control
	Vehicle motion conflict
Malfunctions	
	Card malfunction
	Printer malfunction
	Internal malfunction DTCO 4.0
	Download malfunction

Malfunctions	
✕T	Sensor malfunction
✕Z	Internal GNSS error
✕Y	Internal DSRC error

Driving time warnings	
⚠	Break!

Manual entry process	
H/*/⊠	Entry Activities
?	Entry Unknown activity
H#?	Entry Location at shift end
#H?	Entry Location at shift start

Operational notes	
⚠	Wrong entry
⚠	Menu access not possible
⚠	Please enter
⚠T	Printout not possible
⚠T0	No paper
⚠TZ	Printout delayed
⚠	Faulty card
⚠c	Eject the card

Operational notes	
⚠	Incorrect card
⚠	Ejection not possible
⚠Z	Process delayed
⚠?	Recording inconsistent
⚠A	Internal fault
⚠1	Invalid in days ...
⚠S	Calibration in days ...
⚠T1	Downloading of driver card data in days ...

VDO Counter (option)	
⚠	Remaining driving time
⚠0	Beginning of the next driving time
⚠H	Future driving time
⚠H	Remaining break time / rest period
⚠H	Remaining time to start, daily, weekly rest time

## ■ Country symbols

Country abbreviations	
<b>A</b>	Austria
<b>AL</b>	Albania
<b>AND</b>	Andorra
<b>AR</b>	Armenia
<b>AZ</b>	Azerbaijan
<b>B</b>	Belgium
<b>BG</b>	Bulgaria
<b>BIH</b>	Bosnia and Herzegovina
<b>BY</b>	Belarus
<b>CH</b>	Switzerland
<b>CY</b>	Cyprus
<b>CZ</b>	Czech Republic
<b>D</b>	Germany
<b>DK</b>	Denmark
<b>E</b>	Spain *
<b>EC</b>	European Community
<b>EST</b>	Estonia
<b>EUR</b>	Rest of Europe

3

Country abbreviations	
<b>F</b>	France
<b>FIN</b>	Finland
<b>FL</b>	Liechtenstein
<b>FR/FO</b>	Faroes
<b>GE</b>	Georgia
<b>GR</b>	Greece
<b>H</b>	Hungary
<b>HR</b>	Croatia
<b>I</b>	Italy
<b>IRL</b>	Ireland
<b>IS</b>	Iceland
<b>KZ</b>	Kazachstan
<b>L</b>	Luxembourg
<b>LT</b>	Lithuania
<b>LV</b>	Latvia
<b>M</b>	Malta
<b>MC</b>	Monaco
<b>MD</b>	Republic of Moldavia
<b>MK</b>	Macedonia
<b>MNE</b>	Montenegro

Country abbreviations	
<b>N</b>	Norway
<b>NL</b>	The Netherlands
<b>P</b>	Portugal
<b>PL</b>	Poland
<b>RO</b>	Romania
<b>RSM</b>	San Marino
<b>RUS</b>	The Russian Federation
<b>S</b>	Sweden
<b>SK</b>	Slovakia
<b>SLO</b>	Slovenia
<b>SRB</b>	Serbia
<b>TJ</b>	Tajikistan
<b>TM</b>	Turkmenistan
<b>TR</b>	Turkey
<b>UA</b>	Ukraine
<b>UK</b>	United Kingdom, Alderney, Guernsey, Jersey, Isle of Man, Gibraltar
<b>UZ</b>	Uzbekistan
<b>V</b>	Vatican City

Country abbreviations	
<b>WLD</b>	Rest of the world

\* Spanish regions: → *Spanish regions*  
[ 37]

### ► Spanish regions

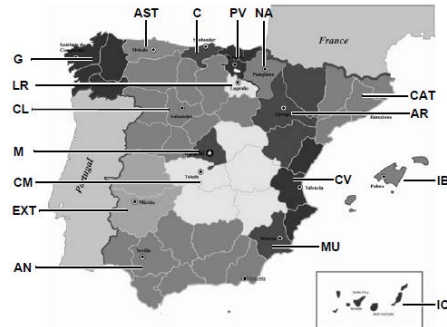

Fig. 6: Regions in Spain

#### Abbreviation of Spanish regions

<b>AN</b>	Andalusia
<b>AR</b>	Aragon
<b>AST</b>	Asturias
<b>C</b>	Cantabria
<b>CAT</b>	Catalonia
<b>CL</b>	Castile-León
<b>CM</b>	Castile-La Mancha
<b>CV</b>	Valencia
<b>EXT</b>	Extremadura

#### Abbreviation of Spanish regions

<b>V</b>	Galicia
<b>IB</b>	Balearic islands
<b>IC</b>	Canary Islands
<b>LR</b>	La Rioja
<b>M</b>	Madrid
<b>MU</b>	Murcia
<b>NA</b>	Navarra
<b>PV</b>	Basque Community

## ■ Automatic activities after ignition on/off (default)

### Automatically set activity ...

#### ... after ignition on

#### ... after ignition off

Driver 1				Driver 2				Information about the DTCO 4.0	
<input type="checkbox"/>	H	Break / rest time		<input type="checkbox"/>	H	Break / rest time		Type:	
<input type="checkbox"/>	✱	Other working time		<input type="checkbox"/>	✱	Other working time		No:	
<input checked="" type="checkbox"/>	☑	Standby time		<input checked="" type="checkbox"/>	☑	Standby time		Year:	
<input type="checkbox"/>	?	No change		<input type="checkbox"/>	?	No change		Setting date:	_____
<input type="checkbox"/>	H	Break / rest time		<input type="checkbox"/>	H	Break / rest time		Signature:	_____....
<input type="checkbox"/>	✱	Other working time		<input type="checkbox"/>	✱	Other working time			
<input checked="" type="checkbox"/>	☑	Standby time		<input checked="" type="checkbox"/>	☑	Standby time			
<input type="checkbox"/>	?	No change		<input type="checkbox"/>	?	No change			

### IMPORTANT

The vehicle manufacturer may have programmed already defined settings of the activity after Ignition on/off.

- Mark (✓) the set functions in the table.

### IMPORTANT

The exception is the addition of activities on the driver card. During the Manual Entry, this option is disabled. There is no modification of the activity after Ignition on/off.

The automatic setting after Ignition on/off is evident in the standard display. The activity flashes for approx. 5 seconds and subsequently, the previous display reappears.

➔ *Displays* [▶ 40]

Standard settings:

➔ *Setting activities* [▶ 52]

## **Operation (general)**

**Displays**

**Navigating within menus**

**Inserting card**

**Removing the card**

**Handling of the cards**

**Downloading data**

Service Only!

## Operation (general)

### ■ Displays

#### ► Display after ignition on

After switching on the ignition or after Stand-by, the standard display appears (a).

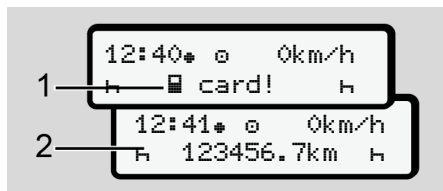

Fig. 7: Display after ignition on

If no tachograph card is inserted into card drawer 1, for 20 seconds, note (1) (card missing) is displayed, afterwards display (2).

#### ► Displays during journey

While driving, the displays (a), (b) or (c) (Option) can appear. . .

By pressing a menu button you can change the display.

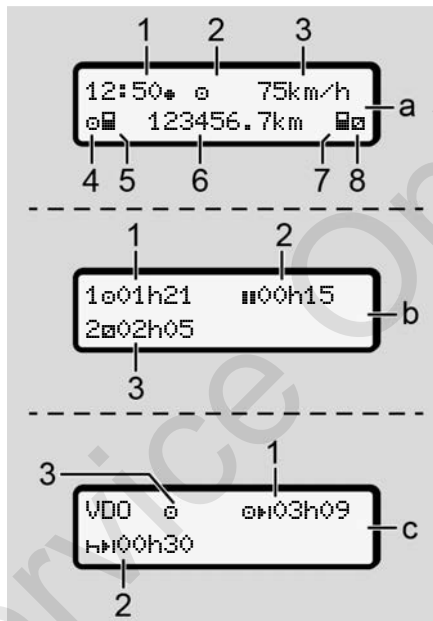

Fig. 8: Displays during journey

#### Standard display (a):

- (1) Time  
with symbol = local time  
without symbol = UTC time

- (2) Operating mode symbol Operation
- (3) Speed
- (4) Activity, driver 1
- (5) Card symbol, driver 1
- (6) Odometer total
- (7) Card symbol, driver 2
- (8) Activity, driver 2

#### Display Driving and rest times (b):

- (1) Driving time Driver 1 since a valid rest time
- (2) Valid rest time in break intervals of at least 15 minutes and subsequent 30 minutes
- (3) Times of driver 2:  
Current activity availability time and duration of activity.



**IMPORTANT**

**Type and source of the danger**

If no driver card is inserted, times are displayed that are assigned to the respective card slot 1 or 2.

**Display remaining driving and rest times (option VDO Counter) (c):**

- (1) Remaining driving time (H flashing = this part of the display is currently active).
- (2) Next valid rest time/ daily or weekly rest time .
  - VDO Counter (option) [▶ 74]
- (3) The current activity is shown.

**▶ Messages**

Messages are displayed independently of the current activity.

The following causes result in a message being displayed:

!	Event
×	Malfunction
	Driving time warning
	Operating note

→ *Meaning of messages* [▶ 96]

**▶ Display after ignition off**

After Ignition off the following is displayed:

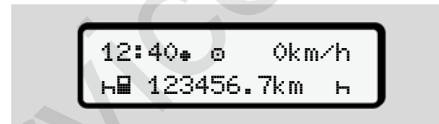

Fig. 9: Display after ignition off

**■ Navigating within menus**

- Select the desired function, activity or numeric value with the keys in the entry field.
- Confirm your selection with the button

**▶ Menu while vehicle is stationary**

When the vehicle is not moving and driver card is inserted, you can call up other data of the driver card.

→ *Second menu level – menu functions* [▶ 79]

## ■ Inserting card

### ⚠ ATTENTION

#### Ensuring road safety

- As a driver, only insert the card while the vehicle is stationary.
- Inserting the card while the vehicle is moving is possible but not permitted. This is saved as an event.

Always keep the card drawers closed.

The card drawer covers must not be removed to prevent dust and dirt or spray water getting into the card drawer.

### IMPORTANT

#### Selection of the card drawer

- Card drawer 1 (left card drawer) for the card of the person driving the vehicle.
- For crew operation: Card drawer 2 (right drawer) for the card of the accompanying driver.
- For the company card: Freely selectable card drawer.

### IMPORTANT

To operate the ADR version, the ignition must be switched on.

Please take note of the special safety information for the operation of the ADR version of theDTCO 4.0 in explosive environments.

→ *ADR version (Ex version)* [ 24]

1. Keep the combination button **Driver 1** or **Driver 2** pressed for more than 2 seconds.



Fig. 10: Requesting card (combination button)

2. The card feed comes out. Carefully fold down the card feed cover.



Fig. 11: Folding down cover

3. Insert your card – chip up and arrow facing forward – into the card drawer.



Fig. 12: Inserting a card

4. Carefully fold up the card feed cover.

5. Push the card feed into the card drawer until it engages. The information on the chip is read. While a card is being read in card drawer 1, another card can be inserted into card drawer 2:

- Crew operation: the driver card of the second, accompanying driver.
- Reading the card and mass memory data: the company card.

Depending on which card is inserted, menu-driven operating steps follow.

- For the first and (if inserted) second driver card  
→ *Shift start – Inserting driver card* [▶ 48]
- For the company card  
→ *Registration – inserting company card* [▶ 66]

### ▶ Language

The language displayed depends on:

- Card inserted into card slot 1
- Tachograph card with the higher significance, for example company card, control card

As an alternative to the automatic language setting, you can set the desired language.

→ *Setting the language* [▶ 73]

## ■ Removing the card

### IMPORTANT

You must only remove the cards when the vehicle is stationary.

### ⚠ ATTENTION

#### Protection from misuse

Remove the driver card from the card drawer:

- At the end of the shift
- When changing drivers or vehicles

### IMPORTANT

To operate the ADR version, the ignition must be switched on.

Please take note of the special safety information for the operation of the ADR version of the DTCO 4.0 in explosive environments.

→ *ADR version (Ex version)* [▶ 24]



Fig. 13: Requesting card (combination button)

1. Keep the combination button **Driver 1** or **Driver 2** pressed for more than 2 seconds. Subsequently, the display will show:
  - The name of the card holder
  - A status bar showing the transfer of data onto the card chip
  - The deregistration prompt
2. Use the buttons **▲** to select the desired function:
  - Driver card:  
Selection of the country you are currently in.

### IMPORTANT

If the country is not entered within a minute, the card ejection is terminated.

- Company card:
  - (a) **Yes** if you wish to deregister the company on the DTCO 4.0.
  - (b) **No** if the company lock should stay activated.

### IMPORTANT

If the company lock is deactivated, the saved data of your company will still be locked for an external company.

3. Please confirm your selection using the button **OK**.

### IMPORTANT

A note is displayed in the following cases:

- Periodic inspection of the DTCO 4.0
- Validity of the company or driver card about to expire
- The download of the driver card data is due.

The card feed of the corresponding slot comes out

4. Remove the card.
5. Carefully fold up the card feed cover.
6. Push the card feed into the card slot until it engages.

## ■ Handling of the cards

- Do not bend or fold the tachograph card and do not use them for anything other than their intended purpose.
- Do not use damaged tachograph cards.
- Keep all contact surfaces clean, dry, and free of grease and oil (always use a protective cover).
- Protect the card from direct sunlight (do not leave it lying on the instrument panel).
- Do not place it in direct proximity to strong electromagnetic fields.
- Do not use the card beyond its period of validity. Apply for a new tachograph card in a timely manner before expiry.

## ■ Downloading data

### ► From driver or company card

#### RISK OF EXPLOSION!

#### In case of the ADR version, explosion risk through residual voltages and open interfaces

In explosive areas, pushing the buttons of the DTCO 4.0, inserting cards, opening the printer drawer or opening the front interface pose an increased explosion risk.

- The cover flap must be closed.
- No data must be downloaded.

#### IMPORTANT

To download data, only one driver card must be inserted. Otherwise, no data will be transferred.

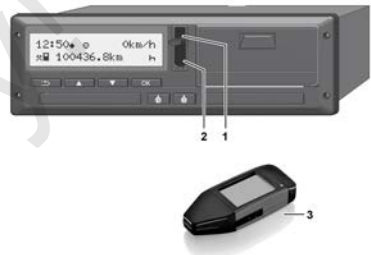

Fig. 14: Connecting to the front interface

1. Fold up the cover flap (1) of the front interface.
2. Insert the Download Key (3) into the front interface (2).  
The download starts automatically.

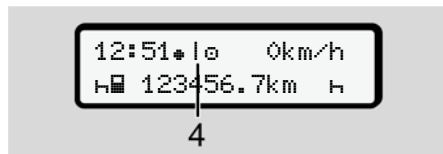

Fig. 15: Pictogram: Data transfer

During the data transfer, the corresponding pictogram (4) is displayed.

**IMPORTANT**

Possible loss of data during the transfer onto the download key.

Do not interrupt the connection to the front interface during the data transfer.

3. Please close the cover flap **(1)** after downloading the data.

**► Data identification**

The copied data is assigned a digital signature (identification).

This signature allows to assign the data to a specific driver card and to check its completeness and authenticity.

**IMPORTANT**

Detailed information about the readout software or the download key is included in the corresponding documentation.

**► Downloading from the mass memory**

Data can only be downloaded from the mass memory with the company card.

You can set on the download key which data (card or mass memory) is to be downloaded.

**► Remote-controlled download (option)**

A fleet management system (remote operation) also enables a remote-controlled download of the data after successful authentication of a company card.

**IMPORTANT**

Detailed information about the hardware and software components required for this as well as their usage is included in the corresponding documentation.

## **Operation by the driver**

**Driver card functions**

**Shift start – Inserting driver card**

**Setting activities**

**Shift end – removing driver card**

**Manual entries (Entry / Addition)**

**Driver / vehicle change**

**Inserting driver card for the first time**

Service Only

## Operation by the driver

### ■ Driver card functions

The driver uses the driver card to identify himself on the DTCO 4.0.

It is used for normal driving operations and allows the storage, display, printout or (with driver card inserted) download of activities.

#### IMPORTANT

The driver card is not transferable.

#### IMPORTANT

Menus for the display and the printout of driver data are only available if a corresponding card is inserted.

For example, the menu point `Printout driver 2` is only displayed if a driver card is inserted into card drawer 2.

### ■ Shift start – Inserting driver card

#### IMPORTANT

Operation by driver corresponds to operating mode `Operation` according to Implementation Regulation (EU) 2016/799 Annex I C, as amended.  
→ *Operating modes (overview)* [ 25]

#### IMPORTANT

To operate the ADR version, the ignition must be switched on.

Please take note of the special safety information for the operation of the ADR version of the DTCO 4.0 in explosive environments.

→ *ADR version (Ex version)* [ 24]

#### ► 1. Inserting card

At the start of your shift (start of your workday), insert your driver card into the card drawer.

→ *Inserting card* [ 41]

By inserting the driver card, the language stored on the card is set on the display.

#### IMPORTANT

You can set the language in the menu.

→ *Setting the language* [ 73]

The menu displayed guides you step by step to the complete operational readiness of the DTCO 4.0:



a. welcome  
16:00\* 14:00UTC

Fig. 16: Greeting display

Greeting text: For approx. 3 seconds, the set local time `16:00*` and the UTC time `14:00 UTC` are displayed (time difference = 2 hours).

No entries are possible while the card is being read.

If a button is pressed, a message is displayed:



please wait!

or

Ejection not possible xx

The card information is being read:

b. 1 Maier  
----- o

Fig. 17: Reading the card information

The left side displays the number of the card drawer into which the card is inserted.

Next to it is the name of the driver (read from the driver card).

A status bar shows further readings are taken from the driver card.

c. last withdrawal  
15.04.18 16:31\*

Fig. 18: Display of the last removal

For approx. 4 seconds, date and time of the last card removal are displayed in local time (symbol \*).

### IMPORTANT

Pay attention to the completeness of the driver data.

According to the Regulation, any activities which cannot be recorded on the driver card must be entered manually.

Afterwards, the prompt for a manual addition is displayed:

d. 1M entry  
addition? No  
addition? yes

Fig. 19: Addition as an option

- You can add activities;
  - ➔ *Manual entries (Entry / Addition)* [ 56]
  - If you do not want to add **any activities**, select **No**; to continue, see step i.
  - By selecting **Yes**, the DTCO 4.0 asks you to make manual entries; subsequent display:

e. M 15.04.18 16:31  
H 18.04.18 07:35

Fig. 20: Entry options

M = Manual entry

H = Entry field of the activity is flashing

5

The time between removal (1st row) and the current insertion process (2nd row) is displayed in local time.

➔ *Setting activities* [▶ 52]

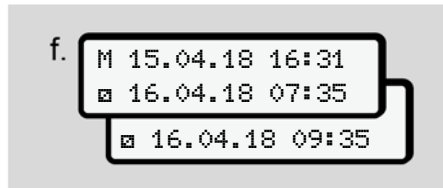

Fig. 21: 2. Row = Entry block

- You can enter the required information (flashing entry fields) in the following order: Activity/day/month/year/hour/minute.

The process ends when the time of the insertion process has been reached.

Next, the prompt to enter the country is displayed.

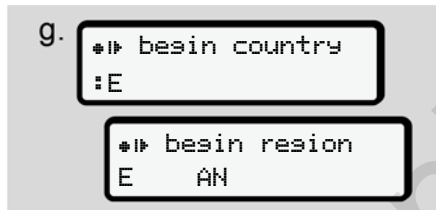



Fig. 22: Selection of the country

- Select the country and region, if applicable, for which the addition is for and confirm your selection with .
- ➔ *Country symbols* [▶ 35]

### IMPORTANT

For Spain, you must also state the region.

### IMPORTANT

You can press the button  to terminate the entry if you would like to continue your shift immediately.

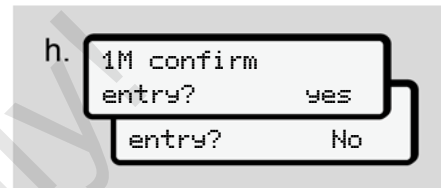

Fig. 23: Confirming the entry

- Please confirm your entry with Yes or No.
- First insertion  
The first time the driver card is inserted, additional prompts are displayed:  
➔ *Inserting driver card for the first time* [▶ 62]

The standard display follows.

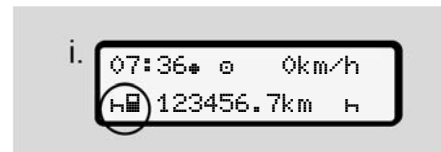

Fig. 24: Standard display with inserted card.

The symbols displayed have the following meaning:

-  = The driver card is in the card slot.

- ■ = You can start your journey, the data has been read.

### IMPORTANT

The symbol ■ is displayed for both card drawers.

If the cards are inserted for driver 1 and driver 2, the journey can commence as soon as the symbol ■ is displayed for driver 1.

## ► 2. Setting activity

Use the combination button of the corresponding card slot ■ to set the activity you would like to perform.

→ *Setting activities* [► 52]

- For a change of local time: Set the time to the current local time.  
→ *Set Local time* [► 91]

The DTCO 4.0 is ready.

### IMPORTANT

The start of the journey ends any started manual entry – also for driver 2.

### ⚠ ATTENTION

It is essential that you set the activity to H during a break or rest time.

Malfunctions on the DTCO 4.0 or the system components are shown in the display.

- Confirm the message with the button .  
→ *Meaning of messages* [► 96]

## ► Country entry (manual entry)

### Indicating the country at start of shift



Fig. 25: Entry option - Start country

- Select symbol ■? Start country and confirm.
- Selecting country and confirming.  
→ *Country symbols* [► 35]

### IMPORTANT

In Spain, you must also indicate the region in which your journey commences.  
→ *Spanish regions* [► 37]

5

### Indicating country at shift end

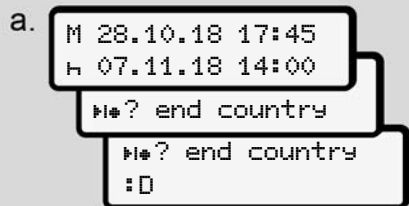

Fig. 26: Entry - End country

- In the first entry field H, select symbol H\*? Select End country and confirm.  
This is only possible if the time of the first manual entry does not correspond with the time of the country entry for the last card removal.
- Select and acknowledge the country.

### Selecting the countries

When making another selection, the previously entered country is displayed first.

By pressing the buttons **▲**/**▼** the four previously entered countries are displayed.

Symbol: Colon in front of the country symbol #B

The subsequent selection occurs in alphabetical order, starting with letter A:

- Button **▲**: A, Z, Y, X, ... etc.
- Button **▼**: A, B, C, D, ... etc.

#### IMPORTANT

By pressing and holding of button **▲**/**▼** you can accelerate the selection (auto repeat function).

#### ► Aborting the entry procedure

If no entry occurs within 30 seconds, the following display is shown:

Fig. 27: Entry prompt on the display

If within a further 30 seconds the button **OK** is pressed, you can continue the entry.

Otherwise, or at the start of the journey, the standard display (a) is shown in the display.

Data already entered is discarded to ensure that only correct data and data confirmed by you is stored. This concerns the remote entry and the direct entry on the DTCO 4.0.

Requesting the card by pressing the combination button **ESC** interrupts the Manual entry.

## ■ Setting activities

### ► Possible activities

The following activities can be set:

⊗	Driving time (automatic when driving)
✱	All other working times
☒	Standby times (waiting times, co-driver time, sleep cabin time during the journey for driver 2)
⌂	Breaks and rest times

### ► Changing activities

#### IMPORTANT

Setting the activities is only possible when the vehicle is stationary.

- Press the combination button  for driver 1.  
The standard display is shown.

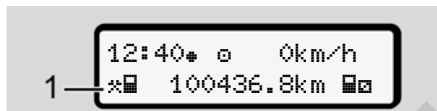



Fig. 28: Standard display with activity (1)

- Press the combination button , until the required activity appears in the display (1).
- In crew operation: As co-driver (driver 2), press button .

### ► Automatic setting

The DTCO 4.0 automatically sets the following activities:

for ...	Driver 1	Driver 2
Journey	⊗	☒
Vehicle stop	✱	☒

#### IMPORTANT

Ensure the correct calculation of the VDO Counter (option):

- It is essential that you set activity ⌂ at the end of a shift or break.

### Automatic setting after ignition on/off (default)

After Ignition on/off, the DTCO 4.0 can switch to a defined activity, for example ⌂.

This activity can only be programmed with a company card or by an authorised specialist workshop.

The activity (1) and/or (2), which automatically changes due to Ignition on or Ignition off, is shown in the standard display. It will flash for approx. 5 seconds.

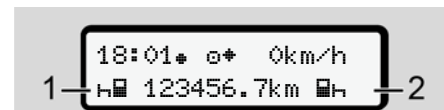

Fig. 29: Flashing of the activity in standard display

After Ignition on, the previous display is shown.

5

**Example:**

You have selected the Counter and are switching the ignition off. When switching on the ignition, the Counter is displayed again after 5 seconds.

**▶ Recording activities manually****IMPORTANT**

Observe Regulation.

According to Regulation (EU) 165/2014, activities which cannot be recorded on the driver card must be added manually.

In the following cases, activities must be recorded manually:

- In case of a faulty DTCO 4.0
- In case of loss, theft, damage or malfunction of the driver card

In these cases, you must create a daily printout on the DTCO 4.0 at the start and at the end of the journey or shift.

On the back of the printout, you can add your activities manually and complete the printout with personal details.



Fig. 30: Manual recording of activities

**Symbol meanings**

⊗	First and last name
⊗	Number of the driver card or the driving licence
ANo .	Vehicle registration number
⊕ ⊕	Location at the beginning of the shift
⊕ ⊕	Location at the end of the shift
⊕ km	Odometer reading at the end of the shift
km ⊕	Odometer reading at the beginning of the shift
km	Kilometres travelled
Date	Date
Sig.	Personal signature

**IMPORTANT**

Please observe the legal requirements applicable in your country.

## ■ Shift end – removing driver card

### IMPORTANT

To protect personal data, you should remove your driver card at the end of each shift.

You can only remove the driver card when the vehicle is stationary.

### IMPORTANT

To operate the ADR version, the ignition must be switched on.

Please observe the special safety notes for the operation of the ADR version in explosive environments.

→ *ADR version (Ex version)* [▶ 24]

1. At the end of your shift (end of your working day) or when changing vehicles, set the corresponding activity, e.g. rest time H.  
→ *Setting activities* [▶ 52]
2. Press the button  for at least 2 seconds.



Fig. 31: Transferring the shift data

The number of the card drawer and the driver's surname are displayed. A status bar shows the description process of the driver card.

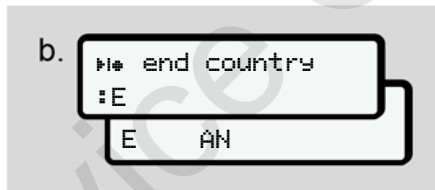





Fig. 32: Current location information

3. Choose the country with the buttons  /  and confirm the selection with button .
- *Indicating the country at start of shift* [▶ 51]

### IMPORTANT

If the country is not entered within a minute, the card ejection is terminated.

4. Remove your driver card from the card drawer.  
→ *Removing the card* [▶ 43]  
This also applies for driver changeovers in crew operation. Next, insert your driver card into the other drawer.  
The display shows:

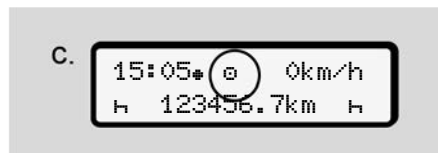

Fig. 33: Standard display without cards

5. If required, use the print menu to print out the saved activities and events.  
→ *Second menu level – menu functions* [▶ 79]

**IMPORTANT**

If you would like a printout of the past 24 hours, please wait – if possible – until the following day.

This way, you ensure that the last activity is also fully included in the printout.

### ■ Manual entries (Entry / Addition)

If, having inserted the driver card, you answered the prompt **Entry Addition?** with **Yes** (step d), the manually changeable entries are displayed (step e).

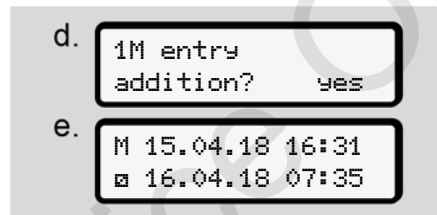

Fig. 34: Displays regarding modification options

You can only make the entries one after the other (buttons **▲**/**▼** and **⏎**).

If you made an incorrect entry, you can go back using the button **↶** and repeat the entry.

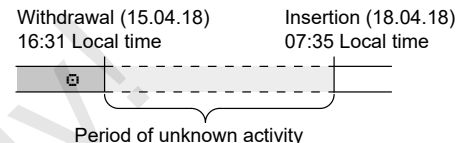

Fig. 35: Examples for period with unknown activity

The following entries are possible:

- Activity rest time **H** add:  
→ *Adding activity rest time* [▶ 58]
- Continue working time:  
→ *Continuing activities* [▶ 59]
- Continue working time, end working time and/or precede a working time with activities:  
→ *Continuing activities and preceding others with activities* [▶ 60]

These options after inserting your driver card also generally apply for the selection of your current activity.



### ► Card requests during the manual entry

1. Use the button  to request the card for ejection.  
The prompt for manual entry is displayed:

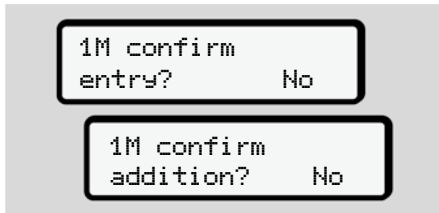





Fig. 36: Addition as an option

2. Use the buttons   to select No and confirm with button .
3. Continue with step 3.  
→ Shift end – removing driver card  
[▶ 54]

The manual entry is terminated. The DTCO 4.0 saves the activity ? for the unknown period.

5

## ► Adding activity rest time

```

graph TD
    A["last withdrawal  
15.04.18 16:31"] --> B["1M entry  
addition? yes"]
    B --> C((1))
    C --> D["M 15.04.18 16:31  
H 18.04.18 07:35  
H 18.04.18 07:35"]
    D --> E["•> besin country  
:D"]
    E --> F["1M entry  
Res. Number? yes"]
    F --> G["07:36 • 0km/h  
H 123456.7km H"]
  
```

Withdrawal (15.04.18) 16:31 Local time	Insertion (18.04.18) 07:35 Local time

Please note: The entry is in local time.

- a. After selecting **Yes** for an addition:
- b. Select and confirm the activity **H** using button **OK**.  
The display moves to the next flashing entry field. If you keep the button **OK** pressed, the display moves to the last entry of the display.
- c. Also confirm the last entry of the minutes using button **OK**.
- d. Follow the menu guidance.

### ► Continuing activities

Withdrawal (24.02.18)  
23:32 Local time

Insertion (25.02.18)  
02:30 Local time

00:20 Local time

Add activities

Please note: The entry is in local time.

- Select and confirm that first activity  $\star$  using button **OK**.
- Enter first the day and then the time and confirm both using button **OK**.
- Select and confirm the second activity  $\square$  using button **OK**.
- Again, enter day and time and confirm using button **OK**.
- Also confirm the last entry of the minutes using button **OK**.
- Follow the menu guidance.

5

► Continuing activities and preceding others with activities

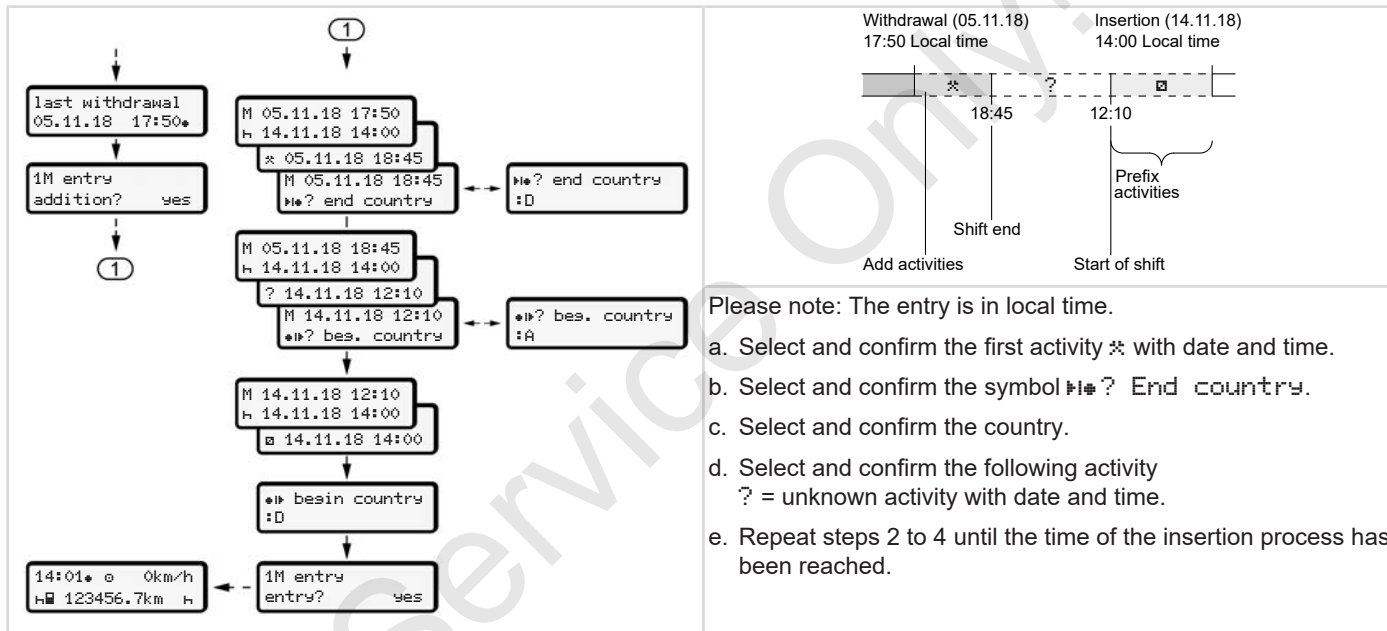

Please note: The entry is in local time.

- Select and confirm the first activity \* with date and time.
- Select and confirm the symbol H#? End country.
- Select and confirm the country.
- Select and confirm the following activity ? = unknown activity with date and time.
- Repeat steps 2 to 4 until the time of the insertion process has been reached.

## ■ Driver / vehicle change



Fig. 37: Changing driver card



### ► Case 1 – Crew operation

Driver 2 becomes driver 1.

- a. Removing driver cards from the card drawers and insert into the other card drawer.
- b. Setting required activity:
  - ➔ *Setting activities* [▶ 52]

### IMPORTANT

During crew operation, the card of driver 1 can be inserted first in order to be able to start the journey quickly. While the card of driver 1 is read, the card of driver 2 can be inserted.

The journey can be started as soon as the symbol  for driver 1 and the symbol  for driver 2 is displayed.

### ► Case 2 – Shift end

Driver 1 and/ or driver 2 leave the vehicle.

- a. The person in question creates a daily printout, if necessary, requests his driver card and removes the driver from the card drawer.
- b. The new vehicle crew inserts the driver card, depending on the function (driver 1 or driver 2) into the card drawer.

### ► Case 3 – Mixed operation

Driving operating with different tachograph types.

- For example, an analogue trip recorder with chart recording or ...
- Digital tachograph with driver card according to Regulation (EU) 165/2014, e.g. DTCO 4.0.

In the case of an inspection, the driver must be able to produce the following for the current week and the past 28 days:

- Driver card **(1)**,
- relevant daily printouts from the digital tachograph **(2)**, for example in the event of damage of malfunction of the driver card,
- filled in charts **(3)**,
- manual records of the activities.

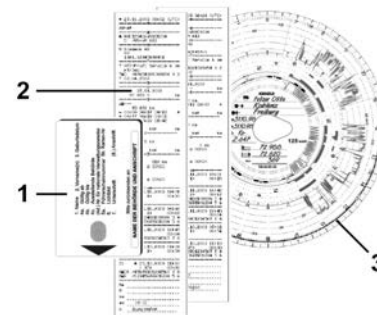

Fig. 38: Examples for the documents to be carried

5

**IMPORTANT**

Please observe the legal requirements applicable in your country.

## ■ Inserting driver card for the first time

### ► Data usage

When you insert your driver card for the first time, you will be asked about the protection of your personal data and whether you agree to the processing of personal data.

→ *Data protection* [▶ 9]

### ► Registration process

The prompt occurs automatically in the course of the first registration on the DTCO 4.0.

It occurs after selecting the country.

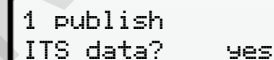

```
1 publish
ITS data?  yes
```

Fig. 39: Requesting personal data

1. Use the buttons **▲**/**▼** to select Yes or No.

2. Acknowledge with the button **OK**.  
A message about the storage of the entry is displayed:



```
entry stored
```

Fig. 40: Confirmation of save process

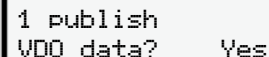

```
1 publish
VDO data?  Yes
```

Fig. 41: Requesting personal special data

3. Use the buttons **▲**/**▼** to select Yes or No.
4. Acknowledge with the button **OK**.  
A message about the storage of the entry is displayed:



```
entry stored
```

Fig. 42: Confirmation of the second save process

Next follows the normal registration on the DTCO 4.0.

→ *Shift start – Inserting driver card*  
[▶ 48]

### IMPORTANT

The settings are saved for up to 88 different tachograph cards.

You can change the setting:

→ *Changing settings to personal ITS data* [▶ 88]

Service Only!

## **Operation by the contractor**

**Functions of the company card**

**Menu functions in the company mode**

**Registration – inserting company card**

**Inserting member state and vehicle registration number**

**Removing company card**

Service Only



## Operation by the contractor

### ■ Functions of the company card

#### IMPORTANT

The purpose of the company card is solely the data management of the company, not the driving operation.

If you are driving with the company card, the message !🚗 Driving without valid card is displayed.

#### IMPORTANT

Observing the country requirements.

The company ensures the correct use of the company cards.

- Please observe the legal requirements applicable in your country.

The company card is used by a company to identify itself on the DTCO 4.0.

The first time the company card is inserted, the company registers on the DTCO 4.0 so that it is run as the tachograph of this company until it deregisters or a different company card is inserted. Thus, the access rights to the data assigned to the company will be ensured.

Within its entitlement level, the company card offers the following possibilities:

- Registering and deregistering the company on the DTCO 4.0, e.g. in case of a vehicle sale, lease expiry
- Entering the member state and the vehicle's registration number  
➔ *Inserting member state and vehicle registration number [ 67]*
- Accessing the mass memory data and the data assigned to the company, e.g. events, malfunctions, speed, driver name
- Accessing the data on an inserted driver card
- Accessing the front interface to automatically download the mass memory data

In the EU, the data must be downloaded every 3 months from the mass memory.

An addition, it is useful to download the data in the following cases:

- Sale of the vehicle
- Immobilisation of the vehicle,
- Replacement of the DTCO 4.0

## ■ Menu functions in the company mode

The navigation within the menu functions always follows the same system.

➔ *Navigating within menus* [ 41]

If the company card is inserted into drawer 2, all main menus which are assigned to this card drawer remain locked.

➔ *Menu access lock* [ 82]

In this case, you can only display, print out or download data from a driver card inserted in card drawer 1.

➔ *First menu level – Standard values* [ 72]

## ■ Registration – inserting company card

### IMPORTANT

Operating by the contractor corresponds to operating mode *Contractor*, according to the Implementing Regulation (EU) 2016/799 Annex I C, as amended.

- Insert the company card into a free drawer;  
➔ *Inserting card* [ 41]  
By inserting the company card, the language stored on the card is set on the display.

### IMPORTANT

You can set your preferred language individually.

➔ *Setting the language* [ 73]

The menu displayed guides you step by step to the complete operational readiness of the DTCO 4.0:

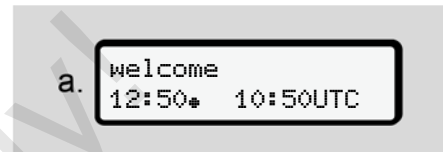

Fig. 43: Greeting display

Greeting text: For approx. 3 seconds, the set local time 12:50\* and the UTC time 10:50 UTC are displayed (time difference = 2 hours in summer time).

### IMPORTANT

No entries are possible while the card is being read.

If a button is pressed, a message is displayed.

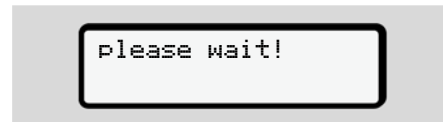
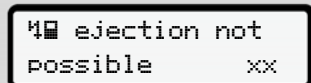

Fig. 44: Message – option I

Or



ejection not possible xx

Fig. 45: Message – option II

The card information is being read:

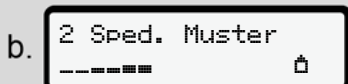

b. 2 Sped. Muster  
-----

Fig. 46: Reading the card information

The left side displays the number of the card drawer into which the card is inserted.

Next to it is the company designation (read by the company card).

A status bar shows the further company card reading process.

- Insert – if prompted – the country symbol and the vehicle registration of the vehicle:  
→ *Inserting member state and vehicle registration number* [p. 67]

- If not yet carried out on this DTCO 4.0, the company is now registered:



c. company locked-in  
/  
already locked-in

Fig. 47: Registering in the company

By registering, the company lock is now activated until cancelled.

This ensures that company-specific and personal data of the drivers which are assigned to this company, are access protected.

The standard display follows.

The DTCO 4.0 is in operating mode COMPANY, symbol .

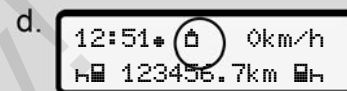

d. 12:51 0km/h  
123456.7km

Fig. 48: Standard display with inserted company card

**Result:** The DTCO 4.0 is ready.

- You can only download mass memory data in order to archive and evaluate these according to legal requirements.  
→ *Downloading data* [p. 45]
- You can also access the data of an inserted driver card, e.g. to download it.
- Malfunctions on the DTCO 4.0 or the system components are shown in the display. Confirm the message with the button .
- *Meaning of messages* [p. 96]

6

## ■ Inserting member state and vehicle registration number

By default, the country symbol and the vehicle registration number are entered during the installation and calibration by the authorised specialist workshop.

If this was not the case, the DTCO 4.0 will ask you to do so at the first insertion of the company card.

The entries are saved in the DTCO 4.0.

### IMPORTANT

Correctly inserting registration number  
You may only enter the vehicle registration number into the DTCO 4.0 once.

Therefore, insert the registration exactly as written on the number plate of the vehicle.

Afterwards, a change can only be performed by an authorised specialist workshop holding a workshop card.

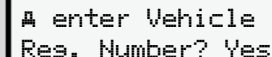

Fig. 49: Request to enter the vehicle registration number

1. Use the buttons **▲** **▼** to select **Yes** and confirm with button **OK**.  
The request to enter the member state is displayed:



Fig. 50: Selection option Country

2. Select the country symbol of the member state using the buttons **▲** **▼** and confirm using the button **OK**.

Next follows the request to enter the vehicle registration number. The first position to be entered is flashing —.

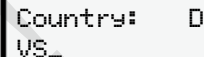

Fig. 51: Entering the vehicle registration number

3. Select the required characters using the buttons **▲** **▼** and confirm using the button **OK**.

### IMPORTANT

Using the button **↵** you can navigate back step by step and amend entries.

- The next position to be entered is flashing —.
4. Repeat step 3 until you have entered the complete registration number. A maximum of 13 characters are allowed.
  5. Confirm the entered registration number again using the button **OK**.  
Upon confirmation, a control printout is automatically created:

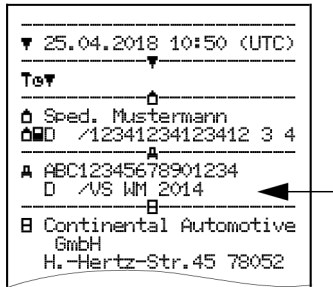

Fig. 52: Control printout

- The vehicle registration number is shown again on the display – once again allowing the option to amend any mistakes:

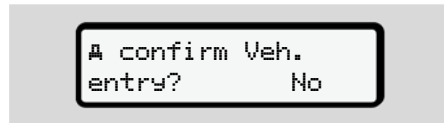

Fig. 53: Selection to confirm

6. Check if the vehicle registration number on the printout is correct.
7. Using buttons **▲/▼**:
  - to select **No** if the vehicle registration number is incorrect and confirm using button **OK**.

The display to step 1 is shown again and you may repeat your entries.

- **Yes** if the vehicle registration number is correct and confirm using button **OK**.

The country symbol and the vehicle registration number are saved on the DTCO 4.0.

If a change is required, e.g. due to a change of location, contact an authorised specialist workshop holding a workshop card.

## ■ Removing company card

### IMPORTANT

To protect the data of your company and to prevent any misuse of the card itself, you should not leave it inside the vehicle.

You can only remove the company card from the card drawer when the vehicle is stationary.

### IMPORTANT

To operate the ADR version, the ignition must be switched on.

Please take note of the special safety information for the operation of the ADR version of the DTCO 4.0 in explosive environments.

➔ *ADR version (Ex version)* [ 24]

6



Fig. 54: Requesting card (combination button)

Keep the combination button for card drawer 1 or card drawer 2 pressed down for at least 2 seconds.



Fig. 55: Transferring usage data

The name of the company is displayed.

A status bar displays the writing process of the company card.

The request to deregister the company is displayed.

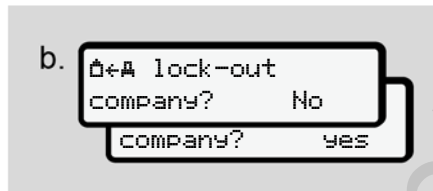

Fig. 56: Deregistering the company on the DTCO 4.0

- Use the buttons **▲** / **▼** to select:
  - No**: The company is not deregistered and the company lock remains activated.
  - Yes**: The company is deregistered and the company lock is deactivated.

Confirm using button **OK**.

### IMPORTANT

Despite the deactivated company lock, the saved data of your company remain locked for any external companies.

### IMPORTANT

A note is periodically displayed when a periodic inspection of the DTCO 4.0 is due or the validity of the company card is about to expire.

- Remove your company card from the card drawer.  
→ *Removing company card* [ 69]  
The display shows:

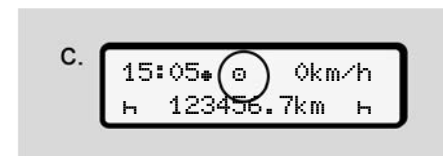

Fig. 57: Standard display without cards

The DTCO 4.0 is once again in operating mode **Operation**, symbol **0**.

## Menus

First menu level – Standard values

Second menu level – menu functions

Service Only

## Menus

### ■ First menu level – Standard values

#### ► Display in stationary vehicle

This chapter describes the menus of the DTCO 4.0 which can be selected in a stationary vehicle.

Starting point is the standard display (a), which is shown after Ignition on in the display. (Default).

#### IMPORTANT

If activated, option VDO Counter may also be displayed as the standard display.

#### IMPORTANT

Menu functions for the display and the printout of driver data are only available if a corresponding card is inserted.

This way, e.g. the menu point Printout driver 2 is only displayed if a driver card is inserted into card drawer 2.

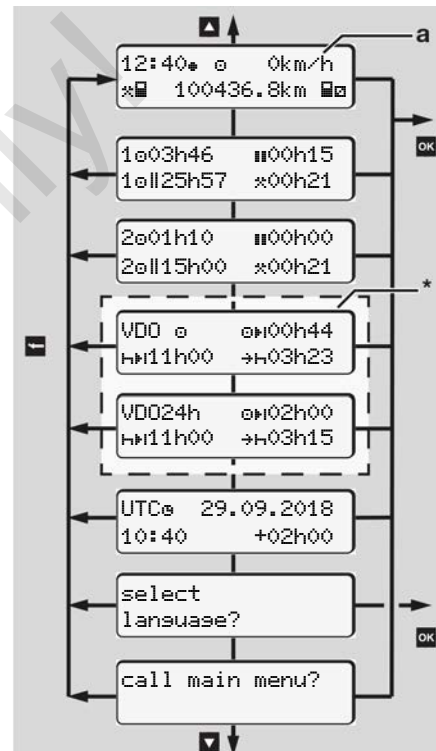

Fig. 58: First menu level (\*=option VDO Counter)



Based on the standard display (a) as well as the corresponding inserted card, you can use button **▼** **▶** to request the following information:

- Standard display (a) (e.g. after Ignition on)
- Two menus with information about the times of the inserted driver cards (1 = driver 1, 2 = driver 2)
  - ➔ *Display the times of the driver card* [ 73]
- (VDO) = Daily/weekly planning using the VDO Counters (option)
  - ➔ *VDO Counter (option)* [ 74]
- (UTC) = The UTC time with date as well as the set time difference (offset) for the local time
  - ➔ *Set Local time* [ 91]
- The menu for setting the required language
  - ➔ *Setting the language* [ 73]

Use the key **⏪** to return directly to the standard display (a).

By pressing the button **OK** you will go to the second level – to the Menu functions.  
 ➔ *Second menu level – menu functions* [ 79]

▶ **Display the times of the driver card**

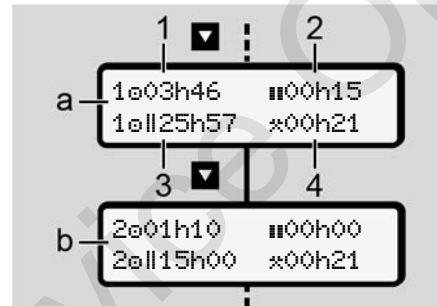

Fig. 59: Data of the driver card 1 or 2

(a)	Times of driver 1
(b)	Times of driver 2
(1)	Driving time ⌚ Driver 1 since a valid rest time

(2)	Valid rest time <b>   </b> in intervals of at least 15 minutes and following 30 minutes, according to Regulation (EG) 561/2006
(3)	Sum of driving times over two weeks
(4)	Duration of the set activity

**IMPORTANT**

If no driver card is inserted, the times – except (3)– are displayed which correspond to the last status of card drawer 1 or 2, respectively.

▶ **Setting the language**

By default, the language of the application (issuing authority) is assigned to each driver card for the display.

You can change this default setting at every DTCO 4.0 by setting a different language.

The DTCO 4.0 remembers the set language via the card number of the inserted card.

7

Up to 5 languages can be stored.

1. Use the buttons **▲** / **▼** to select the function **Select language?** and press the button **OK**.
2. Use the buttons **▲** / **▼** to select the desired language and confirm your selection with the button **OK**.

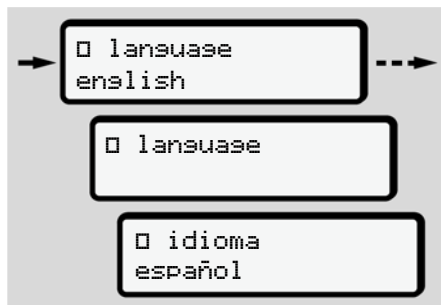

Fig. 60: Choosing the required language

3. The DTCO 4.0 displays the successful language storage in the newly selected language.

### ► VDO Counter (option)

#### IMPORTANT

The VDO Counter can be activated optionally.

If necessary, contact your authorised specialist workshop.

The VDO Counter (option) supports your daily-/weekly planning by displaying the remaining driving and rest times.

#### IMPORTANT

Observe legal requirements.

Due to possible different interpretations of Regulation (EC) 561/2006 and the AETR provisions by the national super-

visory authorities and due to additional system restrictions, the following continues to apply without restriction:

The VDO Counter does not dispense the user from the duty to record and independently evaluate driving, rest, standby and other working times in order to observe applicable provisions.

In other words: The VDO Counter does not claim to be a generally valid, error-free display of the legal provisions.

Further information on the VDO Counter are available on the Internet at [www.fleet.vdo.com](http://www.fleet.vdo.com).

**IMPORTANT**

In order for the VDO Counter to display valid information, the following conditions must be met for the evaluation of data:

- A complete addition of your activities to the driver card.  
→ *Manual entries (Entry / Addition)* [ 56]
- A correct setting of the current activity – no remote control; e.g. no unintentional setting of the activity working time: ✱ instead of daily rest time H.  
→ *Setting activities* [ 52]
- The entry of ferry/train and your current activity.  
→ *Ferry/train: Entering start/end* [ 90]

**Description of the VDO Counter display**

Fig. 61: VDO Counter - display creation

**IMPORTANT**

The flashing H means: This display part is currently active.

- (1) **Currently set activity**
- (2) **? = User note**

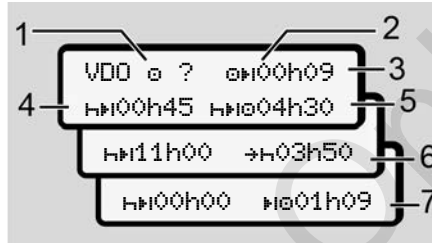
Periods with unknown activity ? or insufficient data (e.g. use of a new driver card) are stored on the driver card.

The VDO Counter evaluates missing activities such as activity H. If a relevant time overlap is detected in

the driver activities, this is displayed by the symbol ! instead of the symbol ?. And the driver activity.

- (3) **Remaining driving time 0H**

When driving: Display how much longer you are permitted to drive.  
(0H00h00 = driving time complete)

- (4) **Remaining rest time HH**

Length of the next required break/rest time.

If the set activity is H, the remaining break/rest time is counted back.  
(HH00h00 = Break complete).

- (5) **Future driving time HH0**

Length of the future driving time after observing the break / rest time.

- (6) **Latest start daily rest time +H**

If the set activity is ✱, the remaining time to the start of your required daily rest time, for example, is displayed.

7

**(7) Beginning of the next driving time**

The next driving time can only commence after this time has expired.

**VDO Counter – displays while driving****IMPORTANT**

Please observe the working time specific country rules.

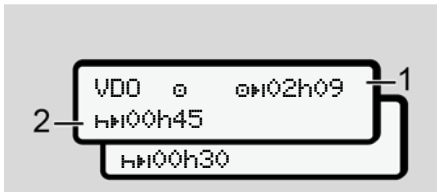

Fig. 62: Activity ⑤ - remaining driving time vs.daily rest time

- (1) Remaining driving time
- (2) At the latest after the end of the driving time displayed (1) a break or continuation of the cumulated break must occur.

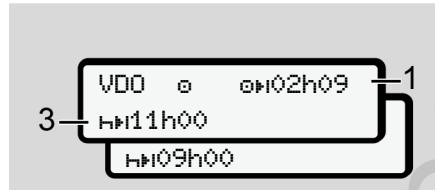

Fig. 63: Activity ⑤ –remaining driving time vs. daily rest time

- (3) At the latest after the end of the driving time displayed (1), a mandatory rest time must follow.

If permitted, this rest time can occur in two parts, whereas the second part must include a continuous period of 9 hours.

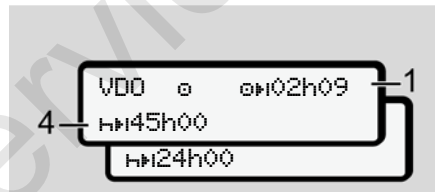

Fig. 64: Activity ⑤ –remaining driving time vs. weekly rest time

- (4) At the latest after the end of the driving time displayed (1), a periodic weekly rest time must follow. If permitted, the pending weekly rest time can be shortened.

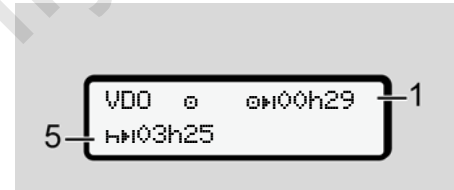

Fig. 65: Activity ⑤ – ferry/train vs. continuation of rest time

- (5) The VDO Counter recognises time spent on a ferry/train.

**Requirement:** Correct entry of this function:

→ *Ferry/train: Entering start/end* [ 90 ]

At the latest after the end of the driving time (1), the daily rest time must be continued.



Fig. 66: Activity @ – Out of scope

- (6) The display of the remaining driving time is active (H flashing), counting down occurs.

The VDO Counter evaluates the activity @ as well as the activity \*

**IMPORTANT**

Please be aware that the calculations of the driving and rest times for the VDO Counter are based on Regulation (EC) 561/2006 and not the Implementing Regulation (EU) 2016/799 Annex I C, as amended.

Therefore, there may be discrepancies to the standard displays of the DTCO 4.0.

**VDO Counter – displays for rest time activity**

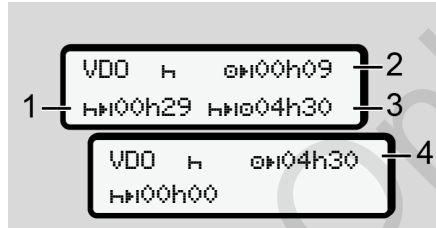

Fig. 67: Activity H – rest time vs. available driving test

- (1) Remaining rest time
- (2) Remaining driving time, if the rest time (1) is not observed.
- (3) Period of the next available driving time after the end of the rest time displayed (1).
- (4) Available driving time after a valid rest time.

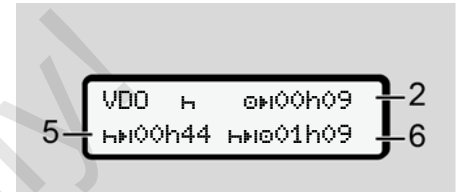

Fig. 68: Activity H – rest time vs. available daily driving time

- (5) Remaining rest time.
- (6) Length of the available daily driving time after the end of the rest time (5).

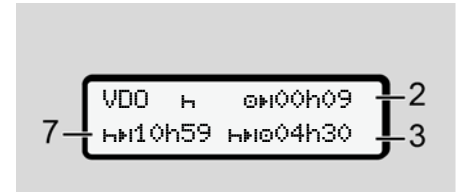

Fig. 69: Activity H – daily rest time

- (7) Remaining daily rest period. If permitted, split into 3 + 9 hours.

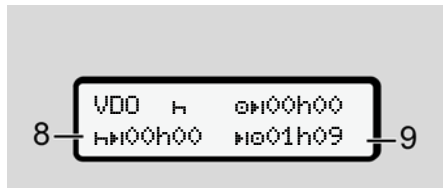

Fig. 70: Activity H – End of rest time

**(8) Valid rest time complete.**

The display 00h00 flashes for 10 seconds. If the rest time is continued, the VDO Counter changes to the period of the next daily or weekly rest time.

**(9) Beginning of the next driving time.**

Situation: The maximum weekly driving time or double weekly driving time has already been reached.

Although the valid interruption was observed, the VDO Counter recognises that a new driving period is only possible after the end of the displayed time.

**VDO Counter – Displays for activity working time**

**IMPORTANT**

Please observe the working time specific country rules.

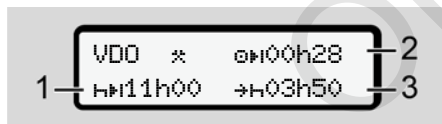

Fig. 71: Activity \* - working time vs. rest time

- (1) Duration of the next daily rest period
- (2) Remaining driving time
- (3) Beginning of the next daily rest period. At the latest before the end of the time displayed, a daily rest time must commence.

**Note:**

The VDO Counter evaluates the activity  during an interruption of the driving time comparable to the activity H (except the daily rest time).

Use keys  /  to retrieve further information.

**VDO Counter – displaying daily values**

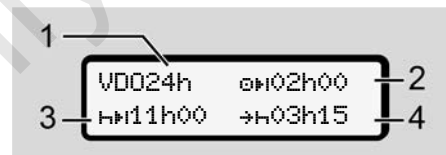

Fig. 72: Activity \*/# - daily values

- (1) Symbol for the display of the daily values
- (2) Remaining daily driving time
- (3) Duration of the next daily rest period
- (4) At the latest before the end of the time displayed, a daily rest time must commence.

### VDO Counter – displaying weekly values

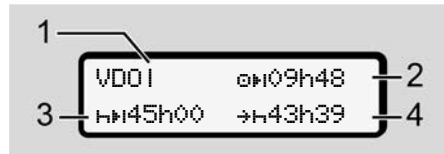

Fig. 73: Activity - weekly values

- (1) Symbol for the display of the weekly values since the last weekly rest time
- (2) Remaining weekly driving time
- (3) Length of the weekly rest time. At the latest after six daily driving times, a weekly rest period must follow.
- (4) At the latest before the displayed time comes to an end, the weekly rest period must start.

#### IMPORTANT

The displays in relation to weekly rest time (3) and (4) may be deactivated for the transnational passenger transport.

If the evaluation of the weekly values in the VDO Counter is deactivated, the values are not displayed.

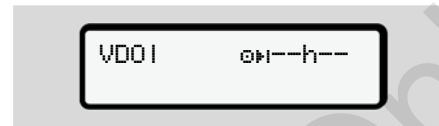

Fig. 74: Display deactivated calculation

### VDO Counter – status display

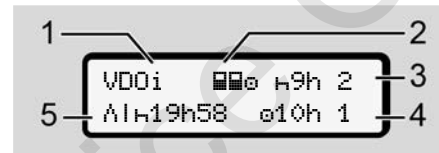

Fig. 75: VDO Counter – status display

- (1) Symbol for the status display
- (2) Symbol for crew operation  
Is displayed if crew operation is used since the start of work. The VDO Counter observes the rules applicable in these calculations.
- (3) In this week, two more reduced daily rest times are permitted (max. 3x per week possible).

- (4) In this week, one more extended daily driving time of a maximum of 10 hours is permitted (max. 2x per week possible).
- (5) Reconciliation of a shortened weekly rest time  
Due to a shortened weekly rest time, the time displayed must be reconciled, with a rest time of at least 9 hours.

#### IMPORTANT

The display for a shortened weekly rest time (5) may be deactivated for the transnational passenger transport.

If the evaluation of the weekly values in the VDO Counter is deactivated, the values are not displayed.

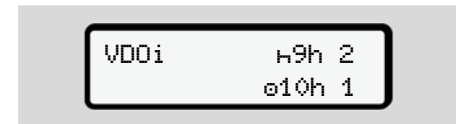

Fig. 76: Display deactivated calculation

## ■ Second menu level – menu functions

You can access the second menu level by pressing **■** on the first menu level or selecting the menu point retrieving menu functions.

➔ *First menu level – Standard values*  
[ 72]

### IMPORTANT

If you have selected a menu point, but do not make an entry within 30 seconds, the DTCO 4.0 returns to the first menu level.

All inputs not confirmed up to that time are rejected.

### IMPORTANT

The menu functions may be called up only if the vehicle is stationary.

If you and your vehicle are not in an explosive environment, the ignition must be switched on to operate the ADR version.

### ► Menu functions (overview)

```
>Printout ■▼ driver 1 1)
|-- 24h■▼ daily value
|-- !x■▼ event
|-- ■▼ activities
▼
>Printout ■▼ driver 2 2)
|-- 24h■▼ daily value
|-- !x■▼ event
|-- ■▼ activities
▼
>Printout A▼ vehicle
|-- 24hA▼ daily value
|-- !xA▼ event
|-- >>▼ speed
|-- Te▼ techn. data
|-- ■▼ v-diagram
|-- ■▼ cards
|-- ■▼ status D1/D2
|-- %v▼ v-profiles
|-- %n▼ n-profiles
```

```
▼
>Entry ▼ driver 1
|-- ●► basin country
|-- ■► end country
|-- ?▼ settings
|-- R remote control
▼
>Entry ▼ driver 2
|-- ●► basin country
|-- ■► end country
|-- ?▼ settings
|-- R remote control
▼
>Entry A▼ vehicle
|-- OUT+ start/+OUT end
|-- ●+ start/+● end
  ferry/train
|-- ● local time
|-- ● local time com-
  pany
|-- $ licence code
▼
```



```
>Display [M] driver 1 1)
|-- 24h[M] daily value
|-- !x[M] event
  ▾
>Display [M] driver 2 2)
|-- 24h[M] daily value
|-- !x[M] event
  ▾
>Display [A] vehicle
|-- 24h[A] daily value
|-- !x[A] event
|-- >>[O] speed
|-- T[O] techn. data
|-- [B][O] cards
|-- [C] company
---
```

> Menu point

\* Option

- 1) Menu functions only with driver card inserted in card drawer 1.
- 2) Menu functions only with driver card inserted in card drawer 2.

► Navigating within menu functions

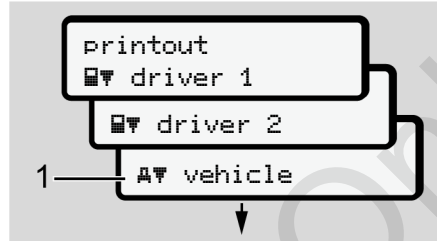

Fig. 77: Scrolling in (main) menu

1. Use the buttons **▲/▼** to navigate to the required main menu (grey fields of previous list, e.g. to the printout of the vehicle data (1).  
The flashing in the 2nd row (displayed in italics) (1) indicates that further selection options are possible.

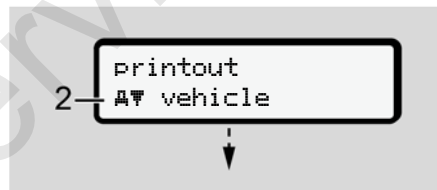

Fig. 78: Choosing a menu point

2. Press button **OK**, if you want to get to the required function (2) with possible further selection options.



Fig. 79: Choosing a menu function

The chosen menu point (3) is displayed, the further selectable functions are flashing in the 2nd row (4).

The display of the display and print menus is based on the inserted driver cards in driver drawer 1 and 2:

- If a driver card is inserted into card drawer 1, printout driver 1 is displayed.
- If a driver card is inserted into card drawer 2, printout driver 2 is displayed.

7

- If no driver cards are inserted, only `printout vehicle` is displayed.

This does not apply for the input menus.

3. Use the buttons `▲` / `▼` to select the required menu point, e.g. the printout of the daily value (4) and confirm your selection with the button `OK`.

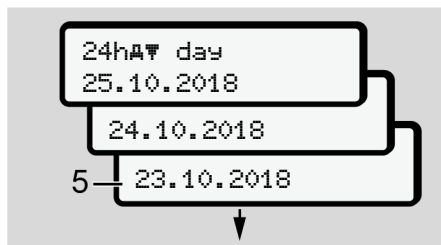

Fig. 80: Selection required day

4. Use the buttons `▲` / `▼` to select the required day and confirm that selection with button `OK`.

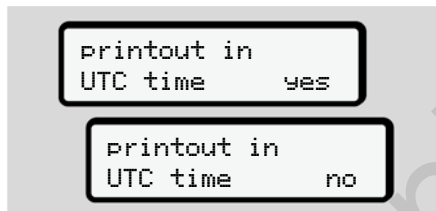

Fig. 81: No = printout in local time

5. Use the buttons `▲` / `▼` to select the required printout type and confirm the selection with the button `OK`. For 3 seconds, the DTCO 4.0 indicates that a printout has started. You can cancel the printout.  
→ *Canceling print [ 111]*

Next, the last selected menu point is displayed.

6. Further procedure:

- Select another printout with the keys `▲` / `▼`.
- Using the button `ESC` you return to the next higher menu level.

### ► Menu access lock

According to the regulations, access to stored data is regulated via access rights and implemented by corresponding tachograph cards.

Display example of a missing authorisation:

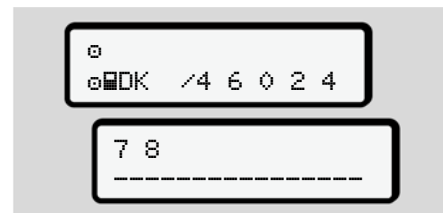

Fig. 82: Missing authorisation

The expected data display is incomplete. Personal data is partially or completely masked.

### ► Leaving menu functions

#### Automatically

The menu is exited automatically in the following situations:

- after a tachograph card is inserted or requested
- After 1 min inactivity
- With start of journey

**Manually**

1. Press button .
  - The initiated selection or entry is terminated.
  - The next higher selection level is displayed again.
  - The following prompt is displayed:

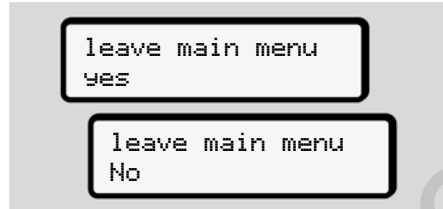





Fig. 83: Leaving menu function

2. Use the buttons  /  to select Yes and confirm with the button . Or use the button  to skip the query. The display shows the standard display (a) again.

**► Menu point printout driver 1/ driver 2**

Using this menu point, you can print out the data of an inserted driver card.

**Note:**

- The procedure is identical for both driver cards.
- You can select the desired printing type prior to every printout.

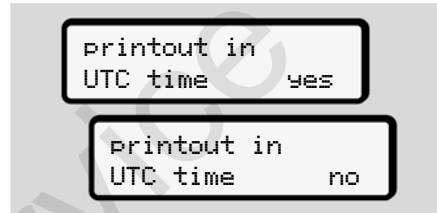

Fig. 84: No = Printout in local time

**Print daily value**

**IMPORTANT**

If possible, create the printout in the morning for the previous day. This way, you ensure that the last registered activity of the previous day is included.

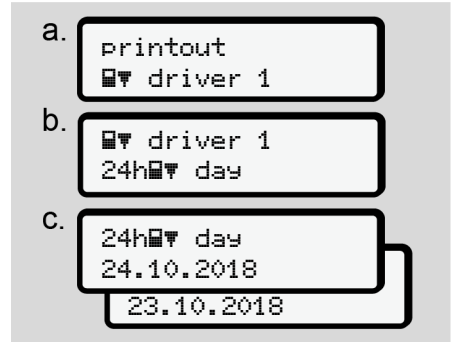

Fig. 85: Menu sequence printout – daily value for driver 1

Based on the selection, all activities of the selected day are printed.

→ *Printouts (examples) [▶ 114]*

7

**Print events**

Fig. 86: Menu sequence printout - events

Based on the selection, the saved events and malfunctions or those still active are printed.

→ *Technical data* [▶ 118]

**Printing activities**

Fig. 87: Menu sequence printout - activities

From the selected day onwards, a printout of all activities of the last 7 calendar days follows.

→ *Driver activities* [▶ 119]

**► Menu point printout vehicle**

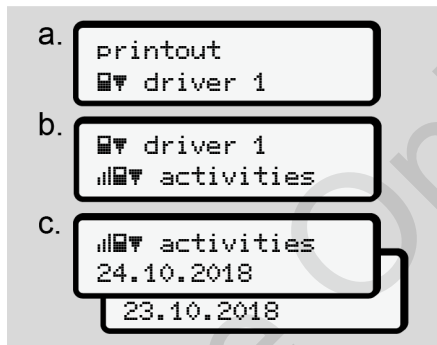
You can use this menu point to print out the vehicle data from the mass memory.

Select the required function (described below).

Next, the required time is prompted.

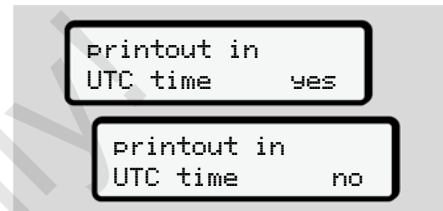

Fig. 88: No = Printout in local time

**Print daily value****IMPORTANT**

If possible, create the printout in the morning for the previous day. This way, you ensure that the last registered activity of the previous day is included.

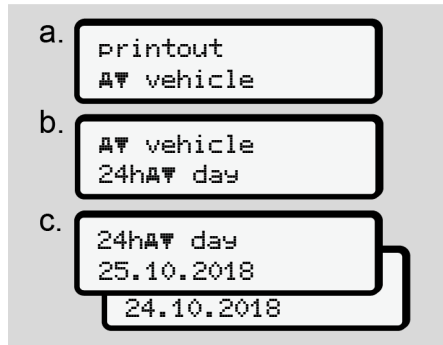

Fig. 89: Menu sequence printout - daily value for driver 1 and driver 2

Based on the selection, all driver activities are printed, separated chronologically by driver 1/ driver 2.

→ *Daily printout of the vehicle* [▶ 116]

**Printing out events [vehicle]**



Fig. 90: Menu sequence printout - events vehicle

Based on the selection, the saved events and malfunctions or those still active are printed.

→ *Events / faults from the vehicle* [▶ 117]

**Print instances of speeding**



Fig. 91: Menu sequence - Speeding

Based on the selection, excess speeds of the speed value set on the DTCO 4.0 are printed.

→ *Speeding events* [▶ 118]

**Print technical data**

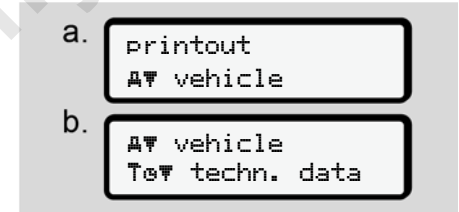

Fig. 92: Menu sequence - technical data

Based on the selection, data regarding vehicle registration, sensor identification and calibration are printed.

→ *Technical data* [▶ 118]

7

### Printing information on inserted tachograph cards

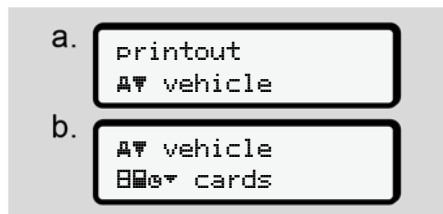

Fig. 93: Menu sequence printout – Info tachograph cards

The data of all inserted tachograph cards is printed.

➔ *Inserted tachograph cards* [ 121]

### Printing v-diagram

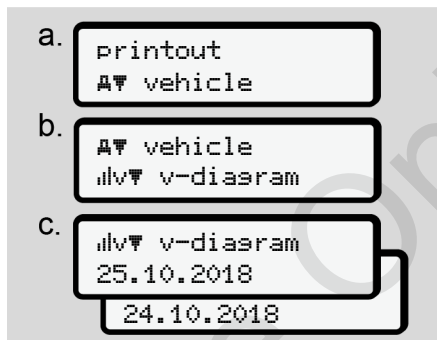

Fig. 94: Menu sequence printout - v-diagram

From the selected day onwards, a printout of the speed profile is performed.

➔ *v-diagram* [ 119]

### Printing status D1/ D2 (option)

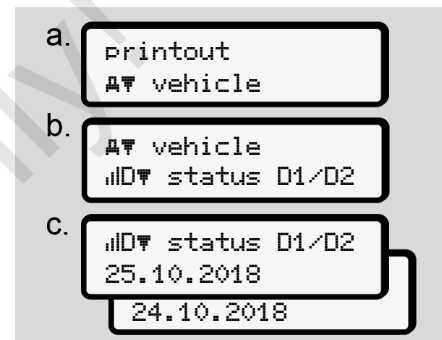

Fig. 95: Menu sequence printout - status D1/ D2

From the selected day onwards, a printout of the status inputs of the last 7 calendar days.

➔ *Status D1/D2 diagram (option)* [ 120]

**Printing speed profiles (option)**

Fig. 96: Menu sequence printout - speed profile

Based on the selection, a profile printout of the speeds driven is performed.

→ *Speed profiles (option)* [ 120]

**Printing speed profiles (option)**

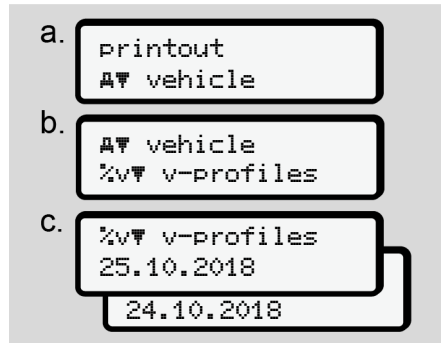
Fig. 97: Menu sequence printout - speed profiles

Based on the selection, a profile printout of the motor speed is performed.

→ *Rotation frequency profiles (option)* [ 120]

► **Menu point Entry driver 1/driver 2**

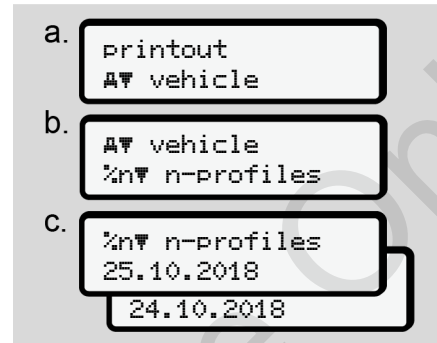
**Enter country**

In addition to entering the country when inserting or removing the driver card, this can be done in this menu point.

**IMPORTANT**

According to the Regulation, both driver 1 and driver 2 must enter the country in which the shift starts or ends, into the tachograph.

**Note:**

- The procedure is identical for both drivers.

**Start country**

Select the listed functions step by step.

7

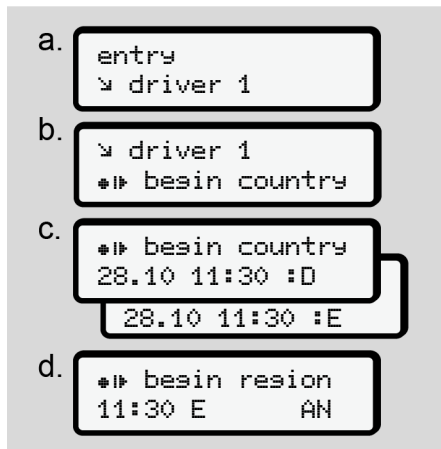

Fig. 98: Menu sequence entry - start country

If you have selected Spain as the country, you will automatically be prompted to enter the region (step d).

### End country

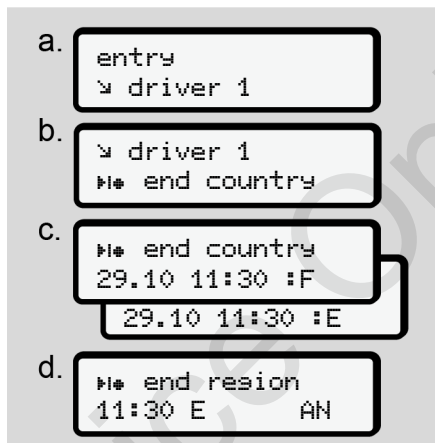

Fig. 99: Menu sequence entry - end country

If you have selected Spain as the country, you will automatically be prompted to enter the region (step d).

### Changing settings to personal ITS data

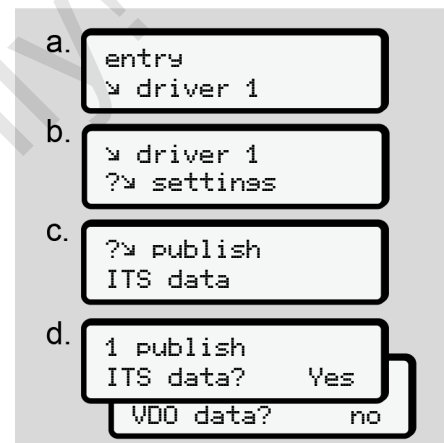

Fig. 100: Menu sequence entry - personal data

➔ Inserting driver card for the first time  
 [▶ 62]



### Changing settings to personal VDO data

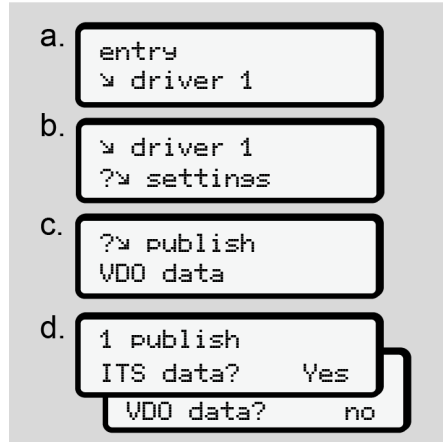

Fig. 101: Menu sequence entry - personal special data

➔ *Inserting driver card for the first time*  
[ 62]

### Activating remote control

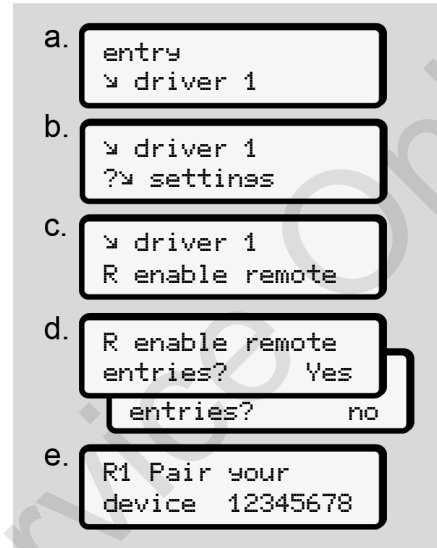

Fig. 102: Menu sequence entry - activating remote control

#### Requirements:

- A DTCO® SmartLink (option) is attached to the tachograph.
- A Bluetooth-enabled device creates a link to the DTCO® SmartLink.

Proceed as follows to create a link between the DTCO® SmartLink and your terminal device:

1. The display of the DTCO 4.0 shows a digit sequence (**step e**).
2. Insert this digit sequence into your Bluetooth-enabled device.

Both devices are now linked and ready for remote control.

#### IMPORTANT

When using the remote control, the user is responsible for the legal completeness and correctness and recognises this by using the remote control.

The use of the remote control is not part of the legal tachograph system. It is used on the operator's own responsibility.

The periods during which a remote control was used, can be printed and displayed.

➔ *Daily printout of the vehicle* [ 116]

7

### ► Menu point entry vehicle

#### Out inserting start/end

If you are driving the vehicle outside of the scope of the Regulation, you can set function `Out of scope` in the following menu and terminate, if required.

The following journeys can be outside of the scope:

- Journeys on non-public roads
- Journeys outside of the AETR states
- Journeys during which the total vehicle weight does not require the prescribed use of the DTCO 4.0.

Select the listed functions step by step.

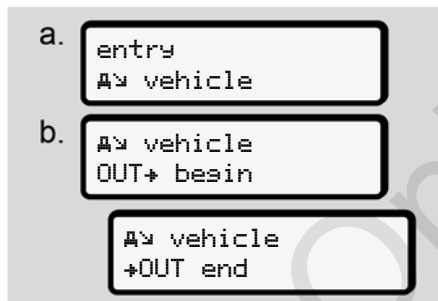

Fig. 103: Menu sequence entry - Out start/end

#### IMPORTANT

The setting `Out of scope` is ended automatically when you remove or insert a driver card.

#### Ferry/train: Entering start/end

Enter the time of the vehicle spent on a ferry or a train as soon as you have taken your position for shipping.

#### IMPORTANT

According to Regulation (EU)2016/799, Annex I C, as amended, recording `Ferry/train` must be started before the vehicle's engine is switched off on the ferry/train.

1. Select the following menu points:



Fig. 104: Menu sequences entry - Ferry/train

2. Set the start or end of the time spent on the ferry/train.

Recording of `Ferry/train` is ended as soon as this is switched off in the menu or the driver card is removed.

**IMPORTANT**

If the card is removed on the ferry/train and re-inserted, the entry Ferry/train must be reset.

**Set Local time**

**IMPORTANT**

Firstly, familiarise yourself with the chapter *Time zones* before you make a change.  
 → *Time zones* [ 31]

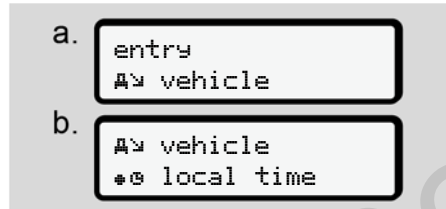

Fig. 105: Menu sequence entry - local time

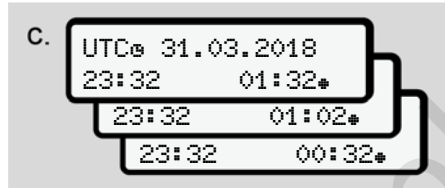

Fig. 106: Menu sequence entry - entering local time

For the standard display, you can adjust the time to the local time zone as well as to the start or end of the summer time.

The latter is carried out in steps of ± 30 minutes.

**IMPORTANT**

Please observe the legal requirements applicable in your country.

**Setting the company local time**

In order to simplify the calculation of the working times, the DTCO 4.0 provides a working time counter which refers to the local time of the company.

This information can be called up via the front interface.

1. Select the following menu points:

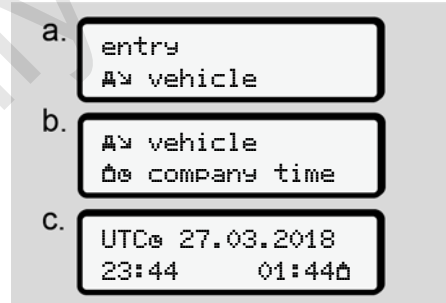

Fig. 107: Menu sequence entry - local time

2. In step b, enter date and time of the company headquarters as well as the deviation to the UTC time.

**Unlocking additional functions**

By entering a licence code into the DTCO 4.0, you can unlock additional functions.

7

- a. 
- b. 
- c. 

Fig. 108: Menu sequence entry - licence code

**IMPORTANT**

If the licence code has already been entered, it will be displayed in full and cannot be changed.

In this case, the additional functions are already activated.

**IMPORTANT**

The licence code can be purchased via the VDO online shop.

➔ [VDO online shop](#) [▶ 146]

**▶ Menu point display driver 1/ driver 2**

You can use this menu point to display the data of your inserted driver card.

**IMPORTANT**

Comparable to a printout, the data is shown on the display, whereby one row of the printout (24 characters) is shown split in two rows.

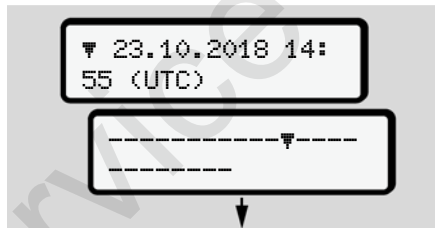



Fig. 109: Example for the data display

If, during scrolling through the information, you scroll back using buttons  /  you can only call up approx. 20 previous rows of the printout.

Use the button  to leave the display.

Note:

- Calling up the functions to display the data is identical with the ones for printing the data. Therefore, they are not described any further below.
- It is possible to call up every display in local time.

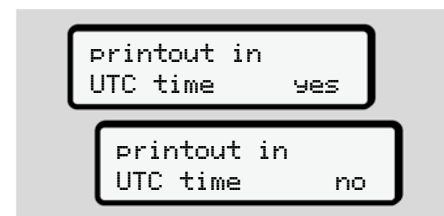

Fig. 110: No – printout in local time

- Select the possible displays for driver 1 or driver 2 step by step.

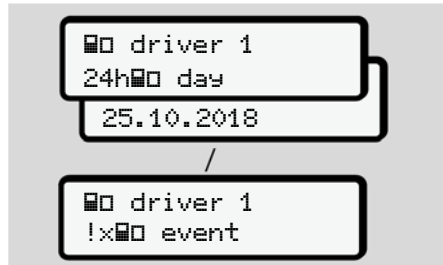

Fig. 111: Menu sequence display for driver 1

All activities of the selected days or all saved events or malfunctions or which are still active can be displayed by scrolling.

► **Menu point display vehicle**

You can use this menu point to display the data from the mass memory.

**IMPORTANT**

Comparable to a printout, the data is shown on the display, whereby one row of the printout (24 characters) is shown split in two rows.

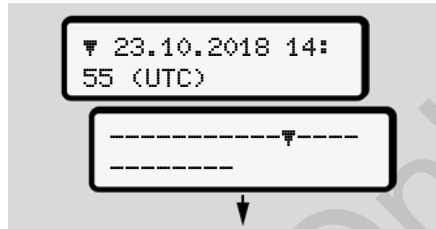

Fig. 112: Example for the data display

If, during scrolling through the information, you scroll back using buttons **▲/▼** you can only call up approx. 20 previous rows of the printout.

Use the button **■** to leave the display.

Note:

- Calling up the functions to display the data is identical with the ones for printing the data. Therefore, they are not described any further below.
- It is possible to call up every display in local time.

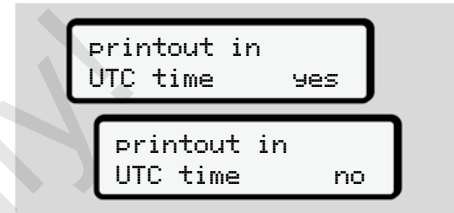

Fig. 113: No - display in local time

Select the displayed functions step by step:

- displaying all driver activities in chronological order.
- displaying all saved or still active events and malfunctions.
- displaying the instances when the set speed was exceeded.
- displaying data about vehicle identification, sensor identification, and calibration.

7

Or

- displaying the number of the company card of the registered company. If no company is displayed, \_\_\_\_ is displayed.

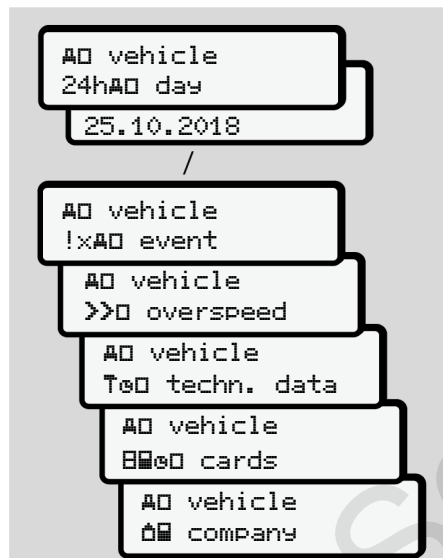

Fig. 114: Menu sequence display for vehicle

## **Messages**

**Meaning of messages**

**Special messages**

**Overview of possible events**

**Overview of possible malfunctions**

**Driving time warnings**

**Overview of possible operational notes**

Service Only

## Messages

### ■ Meaning of messages

Errors in a component, in the device or in the operation are shown as a message in the display immediately after their occurrence.

Note the following features:

!	Event
×	Malfunction
⏸	Driving time warning
ℹ	Operating note

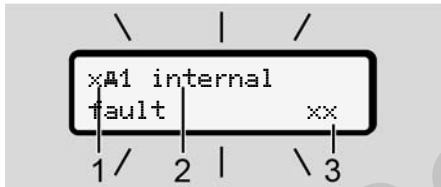

Fig. 115: Display of a message (flashing intermittently)

(1) Pictogram combination, if necessary, with card drawer number

(2) Plain text of the message

(3) Error code

#### **! WARNING**

##### **Distraction due to device messages**

There is a risk of distraction if messages are displayed on the device while driving or if the card is automatically ejected.

- Do not let yourself get distracted by message, but focus fully on the traffic.

#### **IMPORTANT**

In case of messages regarding a tachograph card, the number of the corresponding card drawer is displayed next to the pictogram.

### ► Characteristics of the messages

#### **Events, malfunctions**

- For the display of events or malfunctions, the background lighting of the display flashes for approx. 30 seconds. The cause is displayed with pictogram, plant text of the message and error code.
- You must confirm this message by pressing button **OK**.
- The DTCO 4.0 saves (according to the storage rules of the Regulation) the event of the malfunction both in the mass memory and the driver card. You can display or print this data through the menu function.

#### **IMPORTANT**

If an event keeps repeating itself, consult an authorised specialist workshop.



**IMPORTANT****Procedure in case of malfunctions**

In case of a malfunction of the tachograph, you as the driver are obliged to record the details about activities which the tachograph no longer correctly records or prints on a separate sheet or on the back of the printout.

→ *Recording activities manually* [▶ 54]

**Driving time warnings**

- The message **Driving time warning** warns the driver when he exceeds the driving time.
- This message is displayed with flashing background lighting and must be confirmed by pressing the button **OK**.

**Operational notes**

The operating notes are displayed **without** flashing background lighting and disappear (except for individual messages) automatically after 3 or 30 seconds.

**DTCO 4.0-enabled display instruments**

If a display instrument is installed in the vehicle which can communicate with the DTCO 4.0, the function control **T** indicates messages of the DTCO 4.0.

**IMPORTANT**

For detailed information, please read the operating manual for your vehicle.

**► Acknowledgement of messages**

1. Press button **OK**. You have confirmed the message and the background lighting stops flashing.
2. Re-press the button **OK**. The message disappears and the previously set standard display is shown.

**Notes:**

An operating note disappears after pressing the button **OK** for the first time. If there are several messages, you must confirm the messages one by one.

**■ Special messages****► Production status**

Fig. 116: Standard display production status

If the DTCO 4.0 is not activated as the control device, the **production status** is displayed, symbol **⊞** (1).

The DTCO 4.0 accepts solely the workshop card.

**IMPORTANT**

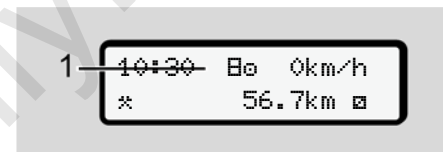
Get an authorised specialist workshop to put the DTCO 4.0 into operation properly.

8

### ► OUT (out of scope of regulation)

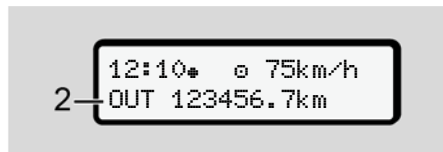

Fig. 117: Standard display - Out of scope

If the vehicle is driven outside of the scope of the Regulation, the symbol **OUT (2)** is displayed.

→ *Designations [ 10]*

You can set this function via the menu  
→ *Out inserting start/end [ 90]*

Press any button to change to a different display.

### ► Ferry/train

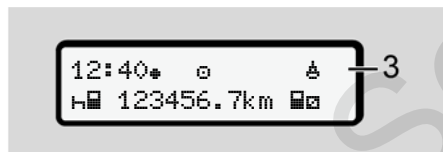

Fig. 118: Standard display - ferry/train

If the symbol **⚓ (3)** lights up, the vehicle is on a ferry or on a train.

You can set this function through the menu.

→ *Ferry/train: Entering start/end [ 90]*

### IMPORTANT

Please ensure that this function and its current activity are set before the shipping process commences.

Press any button to change to a different display.

### ■ Overview of possible events

Message	Possible causes	Measure
!@ Security breach	Error in the data memory; data security in the DTCO 4.0 is no longer ensured. The data from the sensor are no longer reliable. The DTCO 4.0 housing was opened without authorization.	Confirm message.
!@1 security breach	The card lock is disturbed or defective. The DTCO 4.0 no longer detects a tachograph card that was previously inserted correctly. The identity or authenticity of the tachograph card is not proper or the data recorded on the tachograph card is not reliable.	Confirm message. If the DTCO 4.0 detects security breaches which no longer guarantee the correctness of the data on the tachograph card, the tachograph card is automatically ejected – even while driving. Reinsert tachograph card or get it checked.
!+ voltage interruption	The voltage was disconnected or the supply voltage of the DTCO 4.0/ sensor was too low or too high. This message can also be displayed when the engine is started.	Confirm message.
! sensor malfunction	The communication with the sensor is interrupted. This message will also be displayed after a voltage interruption.	Confirm message.
! Movement conflict	Contradiction in the evaluation of the vehicle movement between sensor and an independent signal source. The function (ferry/train) might not have been set during the shipping process.	Confirm message. Consult an authorised specialist workshop.
! GNSS missing	No position data over three hours cumulative driving time.	Confirm message.

8

Message	Possible causes	Measure
!e time conflict	There is a difference of more than one minute between the time of the internal clock of the DTCO 4.0 and the time information from the GNSS signal.	Confirm message.
!Y DSRC communication malfunction	A communication error has occurred between the DTCO 4.0 and the external DSRC-CAN module.	Confirm message. In case of repeated occurrences, consult an authorised specialist workshop.
!e driving without valid card	Driving commenced without a driver card or without a valid driver card in card drawer 1. The message is also displayed if an unauthorised card combination is inserted before or after the journey.	Confirm message. Stop vehicle and insert valid driver card. If necessary, remove inserted company card/control card from the DTCO 4.0.
!e1 Insert while driving	The driver card was inserted after driving has begun.	Confirm message.
!e1 Time overlap	The set UTC time of this tachograph is behind the UTC time of the previous tachograph. This produces a negative time difference.	Confirm message. Confirm message. Identify the tachograph with the incorrect UTC time and make sure that an authorised specialist workshop inspects and corrects the tachograph.
!e1 Card invalid	The tachograph card has either expired, is not yet valid, or the authentication has failed. An inserted driver card which has become invalid after a change of day will be automatically written to and ejected (without request) after the vehicle becomes stationary.	Confirm message. Check tachograph card and insert it again.

Message	Possible causes	Measure
!☐☐ Card conflict	Both tachograph cards must not be inserted into the DTCCO 4.0 together. For example, the company card is inserted together with a control card.	Confirm message. Remove the corresponding tachograph card from the card drawer.
!☐A1 Card not closed	The driver card was not properly removed from the last tachograph. In some cases driver-based data will not be saved.	Confirm message.
>> Speed too high	The set authorised maximum speed was exceeded for longer than 60 seconds.	Confirm message. Reduce speed.

### ■ Overview of possible malfunctions

Message	Possible cause	Measure
xA Device faults	Serious fault in the DTCO 4.0, subsequent causes can be possible: Unexpected program or process time error.	Confirm message.
	Button elements blocked or pressed simultaneously for some time.	Check proper function of the button elements.
	Communication fault with external devices.	Get connecting cables or function of the external devices checked by an authorised specialist workshop.
	Communication fault with the instrument display.	Get connecting cables or function of the display instrument checked by an authorised specialist workshop.
	Fault at pulse output.	Get connecting cables or function of the connected control device checked by an authorised specialist workshop.
xA1 Device fault	Fault in the card mechanics, e.g. card lock is not closed.	Remove tachograph card and insert it again.
xA Time fault	UTC time of the DTCO 4.0 is not plausible or does not run properly. To avoid an inconsistency of the data, newly inserted driver/company cards are not accepted.	Confirm message.

Message	Possible cause	Measure
x7 Printer fault	The printer's supply voltage has failed or the temperature sensor for the printing head is defective.	Confirm message. Repeat process, possibly switching off/on ignition first.
x7 Download fault	Fault while downloading the data to an external device.	Confirm message. Repeat data download. Get connection cables (e.g. loose contact) or external device checked by an authorised specialist workshop.
x8 Sensor fault	The sensor indicates an internal fault after a self-test.	Confirm message.
x81 Card fault	During the reading/description process of the tachograph card, a communication fault has occurred, e.g. by dirty contacts.	Confirm message. Clean tachograph card contacts and re-insert card.
x82 Card fault	The data might not be fully recorded onto the driver card.	
x8 Internal GNSS fault	An error has occurred on the GNSS device: <ul style="list-style-type: none"> <li>• Internal device error.</li> <li>• Short circuit of an external GNSS antenna (option).</li> <li>• No connection to the external GNSS antenna (option)</li> </ul>	Confirm message. Consult an authorised specialist workshop.
x7 Internal DSRC fault	An internal error on the DSRC module has occurred. An error has occurred on the antenna or it is not connected.	Confirm message. Get the DSRC module and connection cables as well as the function of the external antenna checked by an authorised specialist workshop.

8

## ■ Driving time warnings

Message	Meaning	Measure
<pre> M01 Break! 1e04h15 00h15           </pre>	Take a break. This message is displayed after a continuous driving time of 04:15 hours.	Confirm message. Please plan a rest break soon.
<pre> M01 Break! 1e04h30 00h15           </pre>	Driving time exceeded. This message is displayed after a continuous driving time of 04:30 hours.	Confirm message. Take a break.

### IMPORTANT

The DTCO 4.0 registers, stores and calculates the driving times on the basis of the rules specified by the Regulation. It warns you, the driver, early on about exceeding your driving time.

However, these cumulated driving times do not pre-empt the legal interpretation for Continuous driving time.

### ► VDO Counter display (option)

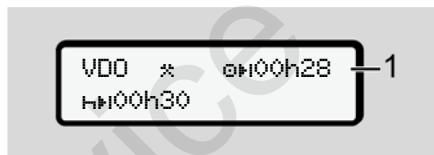



Fig. 119: VDO Counter – display

After confirming the second driving time warning, the VDO Counter indicates that your driving time (**1**) is complete (does not apply in case of Out of scope).

Take a break immediately.



### ■ Overview of possible operational notes

Message	Meaning	Measures
<pre> ┌┐ Entry please </pre>	If no entry occurs during the manual entry process, this prompt is displayed.	Press button  and continue entry.
<pre> ┌┐ Printout not possible </pre>	<p>A printout is not possible at the moment:</p> <ul style="list-style-type: none"> <li>• because with ADR versions, the ignition is switched off,</li> <li>• because the temperature of the thermal printing head is too high,</li> <li>• the printer interface is occupied by another active process, e.g. a printout in progress,</li> <li>• or because the supply voltage is too high or too low.</li> </ul> <p>A display is not possible at the moment because with ADR versions, the ignition is switched off.</p>	<p>You can request a printout as soon as the problem is removed.</p> <p>Switch on ignition and call the desired display again.</p>
<pre> ┌┐ Printout delayed </pre>	An ongoing printout is interrupted or delayed because the temperature of the thermal printing head is too high.	Wait to cool. The printout will continue automatically as soon as the permissible condition has been reached.
<pre> ┌┐ no paper </pre>	The printer has no paper or the printer drawer is not correctly inserted. The print request will be rejected and/or a printout in progress will be interrupted.	<p>Insert new roll of paper.</p> <p>Insert printer drawer correctly.</p> <p>An interrupted print process must be re-started via the menu function.</p>

8

Message	Meaning	Measures
4E Ejection not possible	<p>Requesting the tachograph card will be rejected.</p> <ul style="list-style-type: none"> <li>because data might be read in or transferred,</li> <li>the driver card needs to be read-in again within the registration time of one minute,</li> <li>a daily change occurs after UTC time,</li> <li>the vehicle is moving,</li> <li>or with ADR versions, the ignition is switched off.</li> </ul>	<p>Wait until the DTCO 4.0 releases the function or eliminate the cause: Stop the vehicle or switch on the ignition. Then request the tachograph card again.</p>
4E?1 Record inconsistent	<p>There is an inconsistency in the order of the dates in the data recorded on the driver card.</p>	<p>This message can be displayed until the faulty records have been overwritten by new data. If the message is displayed permanently, get the tachograph card checked.</p>
4Ec Eject card	<p>An error occurred when writing data on the driver card.</p>	<p>While the card is ejected, a new attempt is made to communicate with the card. If this attempt also fails, a printout of the last activities saved for this card is started.</p>
4E1 Card faulty	<p>An error has occurred when processing the inserted tachograph card. The tachograph card is not accepted and is ejected.</p>	<p>Clean the contacts of the tachograph card and insert it again. If the message is displayed again, check if another tachograph card is read in correctly.</p>

Message	Meaning	Measures
4E1 Wrong card	The inserted card is not a tachograph card. The card is not accepted and is ejected.	Insert valid tachograph card.
4A1 Device malfunction	Malfunction in the card mechanics, e.g. card lock is not closed.	Remove tachograph card and insert it again.
4A Device malfunction	Malfunction at pulse output.	Check connecting cables or function of the connected control device.
4A Device malfunction	The DTCO 4.0 has a serious malfunction or there is a serious time error. For example, an unrealistic UTC time. The tachograph card is not accepted and is ejected.	Make sure that an authorized specialist workshop checks the tachograph as soon as possible and replaces it, if necessary. Observe the note displayed in case of a malfunction of the tachograph. → <i>Events, malfunctions</i> [ 96]

8

## ► Operational notes as information

Message	Meaning	Measures
☐ No data!	It is not possible to use the menu function: <ul style="list-style-type: none"> <li>• No driver card is inserted into the card drawer.</li> <li>• A company card/control card is inserted into the card drawer.</li> </ul>	These notes disappear automatically after 3 seconds. No steps must be taken.
Printout started ...	Acknowledgement of the selected function.	
Entry saved	Response that the DTCO 4.0 has stored the entry.	
Display not possible!	No data can be displayed as long as the printing is in progress.	These notes disappear automatically after 3 seconds. No steps must be taken.
please wait!	The tachograph card has not yet been read completely. It is not possible to call up menu functions.	
☐AS Calibration in days 18	The next periodic inspection is due, for example in 18 days. Required inspections due to technical changes cannot be taken into account. An authorised specialist workshop can program from what day onwards this note is displayed. ➔ <i>Compulsory inspection [ 133]</i>	
☐☐1 Invalid in days 15	The released tachograph card will be invalid in 15 days, for example. An authorised specialist workshop can program from what day onwards this note is to be displayed.	

<b>Message</b>	<b>Meaning</b>	<b>Measures</b>
 Download in days 7	The next download of data from the driver card will be due in 7 days, for example (default). An authorised specialist workshop can program from what day onwards this note is to be displayed.	

## **Print**

**Notes for printing**

**Starting print**

**Cancelling print**

**Replacing the printer paper**

**Clear paper jam**

**Retaining printouts**

**Printouts (examples)**

**Explanation to the printouts**

**Data set for events or faults**

## Print

### ■ Notes for printing

#### IMPORTANT

At the start of each printout, there is an empty space of approx. 5 cm.

#### IMPORTANT

If desired, the printout can be customised with a company logo.

### ■ Starting print

#### IMPORTANT

Print requirements:

- The vehicle is stationary.
- For ADR version of the DTCO 4.0: The ignition is switched on.
- The paper roll is inserted.
- The printer drawer is closed.



driver 1  
24h day

Fig. 120: Example printout - daily value

1. Use the buttons **▲** and **▼** and button **OK** to select the required menu point Printout driver 1 > Daily value:  
→ *Navigating within menu functions* [ 81]
2. Select and confirm the required day and print type (UTC time or local time).

3. The printout starts after approx. 3 seconds.  
Wait until the printout is complete.
4. Tear off the printout at the tear-off edge.

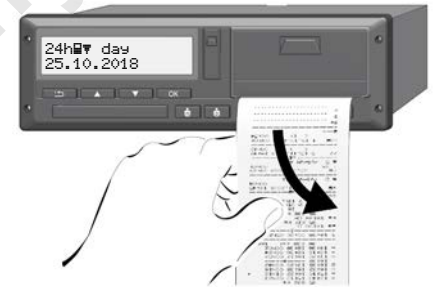

Fig. 121: Tearing off printout

#### IMPORTANT

Make sure that the card drawers are closed when tearing off a printout to avoid paper particles getting into the drawers or the card feed getting damaged.

9

## ■ Cancelling print

- Press button **OK** again to cancel the printout early.  
The following prompt is displayed:

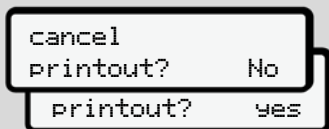

Fig. 122: Cancel print

- Select required function using buttons **▲/▼** and confirm using button **OK**.

## ■ Replacing the printer paper

### ▶ End of paper

- The approaching end of a paper roll is indicated by a coloured marking on the back of the printout.
- When the paper has run out, the following message is displayed:



Fig. 123: Notice - no paper

- If the paper runs out during a printout: After inserting a new paper roll, restart the printout using the menu function.

### ▶ Replacing the paper roll

#### IMPORTANT

Use only original VDO printer paper bearing the following marks:

- Tachograph type (DTCO 4.0) with approval mark **84**
- Approval mark **174** or **189**.

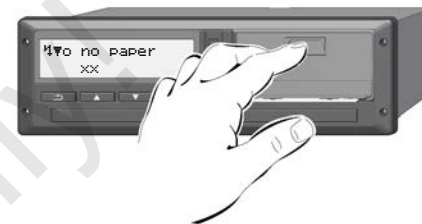

Fig. 124: Press the unlock button

1. Press the unlock are on the printer panel inwards.  
The printer drawer opens.

#### ⚠ CAUTION

#### Danger of burns

The button may be hot.

- Do not reach into the printer compartment after having removed the printer drawer.



**IMPORTANT****Damage by objects**

To prevent the printer getting damaged:

- Do not insert any objects into the printer compartment.

2. Hold the printer drawer on both sides and pull it out of the printer.

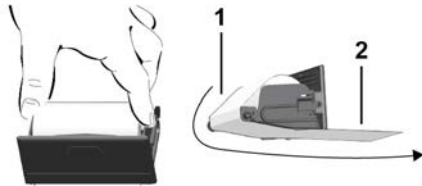

Fig. 125: Insert paper roll

3. Insert the new paper roll end down into the printer drawer.
4. Guide the paper with the part printed grey to the feed over the guide pulley (1).

**IMPORTANT**

Make sure that the paper roll in the printer drawer does not get jammed and the start of the paper roll (2) is visible under the edge of the printer drawer (tear-off edge).

5. Push the printer drawer into the printer compartment until it engages.

The printer is ready for operation.

**■ Clear paper jam**

In case of paper jam:

1. Open the printer drawer.
2. Separate the crumpled paper from the paper roll and remove any remaining paper from the printer drawer.
3. Reinsert the paper roll and push the printer drawer into the printer compartment until it engages.
  - ➔ *Replacing the printer paper* [▶ 112]

9

## ■ Retaining printouts

Take care that the printouts will not be damaged by strong light, sunlight, moisture, or heat (making them illegible).

The holder of the vehicle / the company must retain the legal printouts for at least 1 year.

## ■ Printouts (examples)

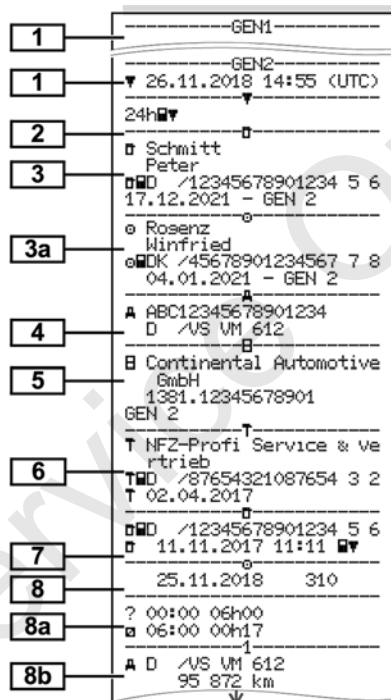

## ► Daily printout of the driver card

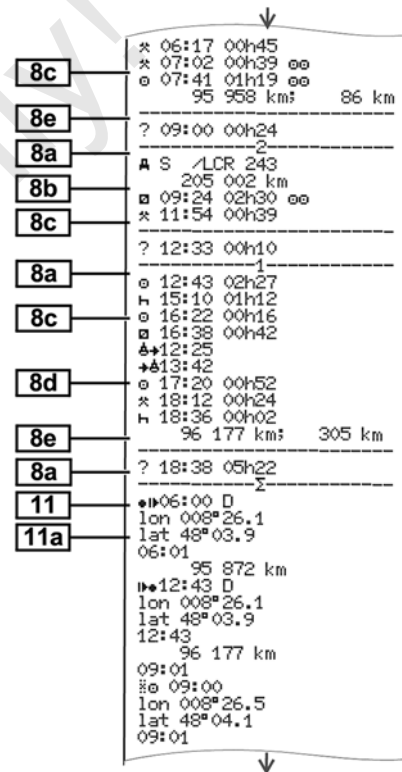

↓

<b>11d</b>	<pre> 18:38 CH 205 408 km 04h54 317 km * 02h27 03h29 01h14 ? 11h56 00 04h28 !x x 0 10.11.2018 12:45 00h04 A D /VS VM 612 </pre>
<b>12</b>	<pre> !x x 0 10.11.2018 12:45 00h04 A D /VS VM 612 </pre>
<b>12c</b>	<pre> !x ! 0 05.08.2018 09:23 !34 ( 0) 00h01 A D /VS VM 612 </pre>
<b>13</b>	<pre> A D /VS VM 612 !x &gt;&gt; 5 15.11.2018 16:42 ( 2) 00h12 0DK /98765432109876 5 4 0F /12345678901234 5 6 </pre>
<b>13c</b>	<pre> &gt;&gt; 4 15.10.2018 11:10 ( 95) 00h30 0DK /45678901234567 7 8 0F /12345678901234 5 6 x 0 10.11.2018 12:45 00h04 0DK /45678901234567 7 8 </pre>
<b>22</b>	<pre> • Friedrichshufen • Schmitt Peter • Rosenz Winfried </pre>

### Particularities in relation to daily printout of driver card

**8f**

0DK /12345678901234 5 6
0 11.11.2018 11:11
25.11.2018 310
-----? !00 ?
? 00:00 06h00
0 06:00 00h17
-----1

**8g**

A D /VS VM 612
95 872 km
* 06:17 00h45
* 07:02 00h39 00
0 07:41
-----km? km
• 06:00 0
95 872 km
0 00h00 km

**8h**

-----0
0 25.11.2018 310
-----OUT
-----1
A D /VS VM 612
95 872 km
! 00:00 07h02
* 07:02 00h39

### ► Events / faults from the driver card

<b>1</b>	-----GEN1
<b>1</b>	-----GEN2
<b>2</b>	▼ 11.11.2018 11:11 (UTC)
<b>3</b>	!x 80 km/h
<b>3a</b>	0 Schmitt Peter
<b>4</b>	0DK /12345678901234 5 6
<b>12a</b>	17.12.2021 - GEN 2
<b>12c</b>	0 Rosenz Winfried
	0DK /45678901234567 7 8
	04.01.2021 - GEN 2
	A ABC12345678901234
	D /VS VM 612
	!+ 04.04.2018 02:14
	06h03
	A S /LCR 243
	!0 04.11.2018 18:12
	00h01
	A D /VS VM 612
	!0 10.02.2018 08:12
	00h05
	A D /S VD 432
	!+ 12.12.2017 10:15
	00h10
	A D /VS VM 612
	! 10.05.2018 08:45
	00h01
	A D /VS VM 612

↓

↓

<b>12c</b>	! 05.08.2018 09:23 !22 00h01 A D /VS VM 612
<b>12b</b>	! 17.04.2018 16:04 !11 01h02 A D /VS VM 612
<b>12c</b>	x 10.11.2018 12:45 00h04 A D /VS VM 612
<b>12c</b>	x 11.02.2018 18:02 00h03 A D /VS VM 612
<b>22</b>	x 20.12.2017 01:54 00h04 A D /S VD 432
	D+ Ulm D Schmitt Peter o Rosenz Winfried

## ► Daily printout of the vehicle

<b>1</b>	▼ 27.11.2018 16:55 (UTC)
<b>2</b>	24hA▼
<b>3</b>	D Schmitt Peter D /12345678901234 5 6 17.12.2021 - GEN 2
<b>4</b>	A ABC12345678901234 D /VS VM 612
<b>5</b>	B Continental Automotive GmbH 4.0.12345678901 GEN 2
<b>6</b>	T NFZ-Profi Service & Ve rtrieb T /87654321087654 3 2 T 02.04.2021
<b>7</b>	D /12345678901234 5 6 D 11.11.2017 11:11 ▼ PPPPP
<b>9</b>	25.11.2018 95 872 - 96 284 km
<b>10</b>	o 1
<b>10a</b>	95 872 km h 00:00 06h17 95 872 km 0 km
<b>10b</b>	o Rosenz Winfried D /45678901234567 8 04.01.2019
<b>10c</b>	A+S /LCR 243 24.11.2018 18:54
<b>10d</b>	95 872 km M

↓

↓

<b>10e</b>	* 06:17 00h45 * 07:02 00h39 oo o 07:41 01h19 oo 95 958 km 86 km
<b>10g</b>	o 95 958 km * 09:00 00h05 95 958 km 0 km
<b>10a</b>	o 95 958 km
<b>10b</b>	o Mustermann Heinz-Dieter D /12345678901234 5 6 16.06.2018 - GEN 2
<b>10c</b>	A+D /M MS 680 24.11.2016 18:5
<b>10d</b>	95 958 km
<b>10f</b>	* 09:05 00h25 o 09:30 02h55 o 12:25 01h18 A+12:25 +13:42
<b>10e</b>	* 13:46 00h03 * 13:48 00h45 oo * 14:33 00h35 oo h 15:08 01h02 oo
<b>10g</b>	96 206 km 248 km
	o 96 206 km h 16:10 00h20 96 206 km 0 km
	o Anton Max D /56789567895678 9 5 25.10.2018

↓

	<pre> A+D /VS VM 612 25.11.2018 16:30  96 206 km o 16:30 00h56 * 17:26 01h11 96 274 km# 68 km  ----- o 96 274 km * 18:37 00h23 o 19:00 00h21 h 19:21 04h39 96 284 km# 10 km  ----- o 95 872 km h 00:00 07h02 h 00:00 07h02 </pre>
10a	
10h	
10a	
11	<pre> ----- 1e 00h21 10 km * 00h28 o 00h00 h 11h16  2e 00h00 o 12h16 h 07h02  ----- o Rosenz Winfried oDK /45678901234567 7 8 h# 09:00 D 95 958 km # 09:00 lon 008° 26.5 lat 48° 04.1 09:01 o 01h19 86 km * 01h24 o 00h00 h 00h00 o 01h58 </pre>
11b	
11c	
11e	

13	<pre> ----- !o 1 25.11.2018 19:01 ( 1) 00:20 ----- o ----- 13c &gt;&gt; 5 15.11.2018 16:42 ( 2) 00h12 oDK /98765432109876 5 4 oMF /12345678901234 5 6  ----- x 0 10.11.2018 12:45 00h04 oDK /45678901234567 7 8  ----- iRe o+ 17.11.2018 14:34 +s 17.11.2017 15:29  ----- o Linde Schmitt Peter o+ +s o </pre>
13c	
22	
23	

### Particularities in relation to daily printout of driver card

10i	<pre> ----- 1 OUT ----- o Rosenz Winfried oDK /45678901234567 7 8 04.01.2019 ??S /LCR 243 </pre>
-----	--

### ► Events / faults from the vehicle

1	<pre> v 24.10.2018 16:07 (UTC) </pre>
2	<pre> !xA </pre>
3	<pre> o Schmitt Peter oDK /12345678901234 5 6 17.12.2021 - GEN 2 </pre>
4	<pre> A ABC12345678901234 D /VS VM 612 </pre>
13a	<pre> !A !o 0 10.08.2018 08:12 ( 0) 00h01 oDK /12345678901234 5 6 oMF /12345678901234 5 6 </pre>
13c	<pre> !o 0 10.08.2018 08:20 ( 0) 00h03 oDK /12345678901234 5 6 oMF /12345678901234 5 6  !o 1 15.10.2018 07:02 ( 1) 00h54  o ----- !o 2 15.10.2018 07:02 ( 1) 00h54  o ----- !o 3 15.03.2017 07:56 ( 1) 00h01 oMF /12345678901234 5 6 oB /22335578901234 1 2  &gt;&gt; 4 15.10.2018 11:10 ( 95) 00h30 oDK /45678901234567 7 8 oMF /12345678901234 5 6 </pre>

↓

```

!ID 0 17.04.2018 16:04
!17 ( 0) 01h02
eDK /45678901234567 7 8
eF /12345678901234 5 6
TUK /54321987654321 9 8

!ID 0 05.08.2018 09:23
!22 ( 0) 00h01
eDK /45678901234567 7 8
xA

xI 0 10.08.2018 07:00
00h02
dD /12341234123412 3 4

13b xI 0 05.05.2017 07:15
00h14
dD /12345678901234 5 6
eF /12345678901234 5 6

13c xI 6 05.05.2017 07:15
00h14
dD /12345678901234 5 6
eF /12345678901234 5 6

xV 0 12.09.2018 21:00
00h01
—

xA 0 02.06.2018 21:00
00h30
dD /12341234123412 3 4

Linda
Schmitt Peter

```

## ► Speeding events

```

1 ▼ 24.10.2018 14:50 (UTC)
2 >>▼ 90 km/h
3 o Mustermann
Heinz-Dieter
eF /12345678901234 5 6
16.06.2021 - GEN2
A ABC12345678901234
D /US VM 612
>>>
19 >>13.03.2018 14:15
>>>17.04.2018 17:44 ( 7)
21 >>>24.05.2017 14:02 00h06
98 km/h 92 km/h ( 1)
21c o Förster
Thomas
eD /98765432109876 5 4
>>>(365)
21a >>>15.10.2018 11:10 00h30
98 km/h 95 km/h ( 95)
o Rosenz
Winfried
eDK /45678901234567 7 8

21b >>>16.05.2018 17:10 00h15
94 km/h 92 km/h ( 12)
21c o Mustermann
Heinz-Dieter
eF /12345678901234 5 6

23 o Mustermann Heinz

```

## ► Technical data

```

1 ▼ 25.10.2018 14:50 (UTC)
2 Te▼
3 d Spedition Mustermüller
dD /12341234123412 3 4
o Mustermann
Heinz-Dieter
eF /12345678901234 5 6
16.06.2021 - GEN2
A ABC12345678901234
D /US VM 612
B Continental Automotive
GmbH
H.-Hertz-Str.45 78052
US-Villinen
4.0.12345678901234567
GEN 2
e1-84
12345678
2018
V 4xxx 17.04.2018
15 l 87654321
e1-175
02.02.2018 09:15
16 T Fa. Mustermann & NFZ-
Hersteller
17 Schillerstr. 10 Muster
17a kirchen
TID /45678901234567 8 9
21.01.2018
17b T 08.03.2016 (1)
A ABC12345678901234
↓
```

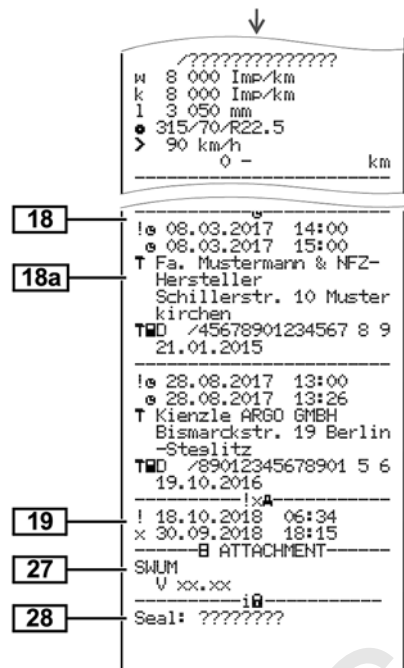

## ► Driver activities

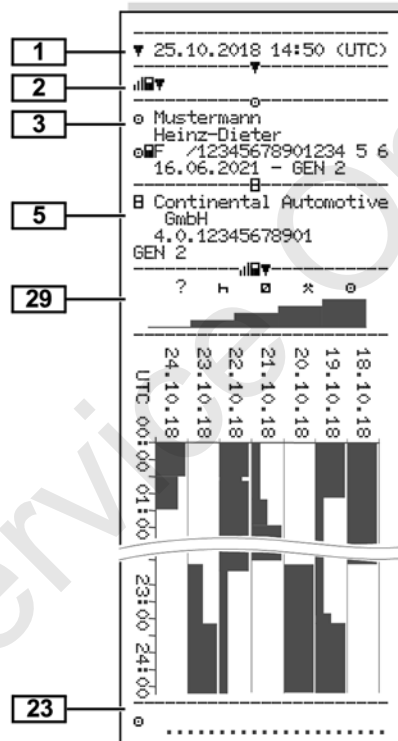

## ► v-diagram

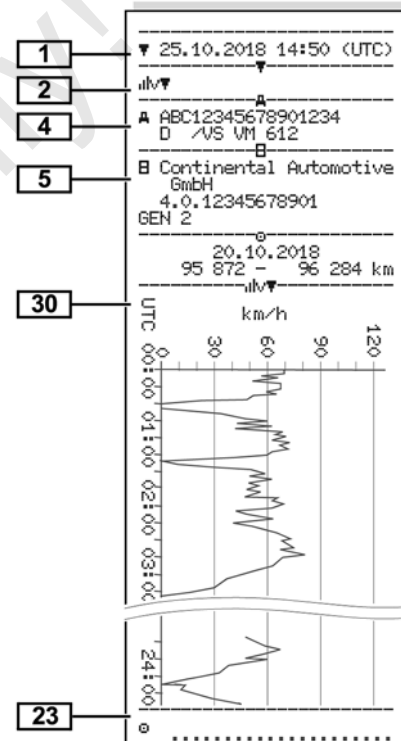

## ► Status D1/D2 diagram (option)

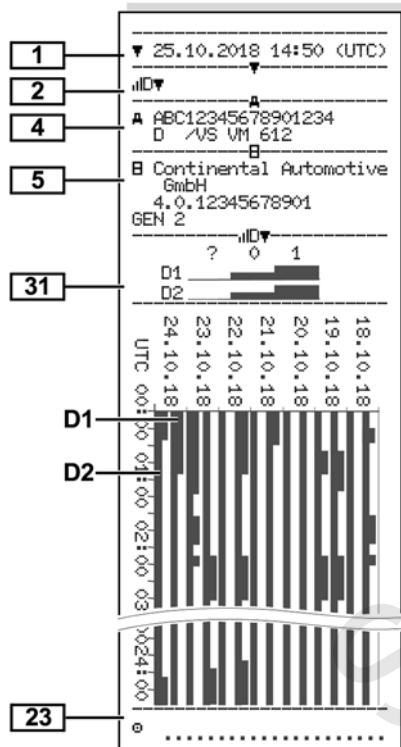

## ► Speed profiles (option)

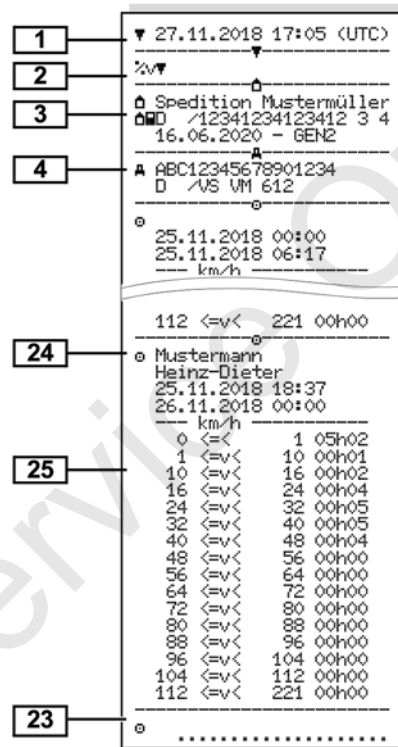

## ► Rotation frequency profiles (option)

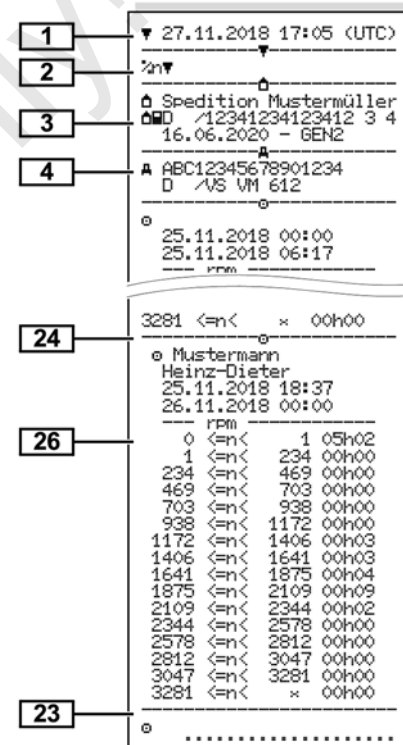



### ► Inserted tachograph cards

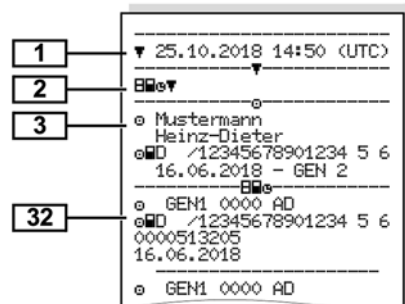

### ► Printout in local time

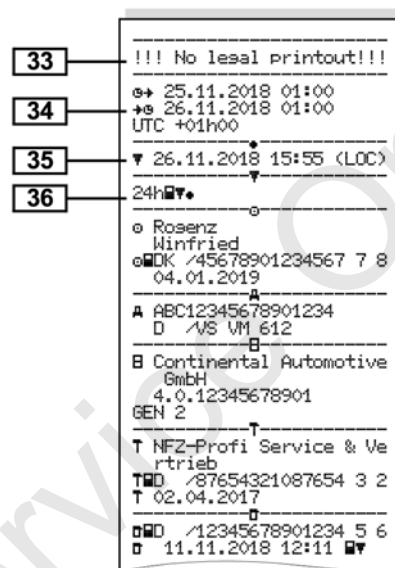

### ■ Explanation to the printouts

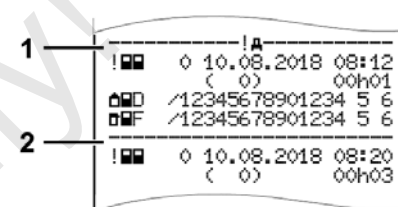

Fig. 126: Notes to the printout

Each printout consists of data blocks designated by block identifiers (1).

A data block contains one or several data records that are identified by means of a data record identifier (2).

#### ► Key to the data blocks

- [1] Generation of tachograph card according to Annex IB (GEN1) and Annex IC (GEN2).  
Date and time of the printout in UTC time.

9

**IMPORTANT**

The shown printouts to the driver cards show a case where first and second generation driver cards are inserted into the DTCO 4.0.

Special cases:

- If only a first generation driver card is inserted for the printout, the daily printout is carried out as in previous versions of the DTCO, without the identification GEN1 and GEN2.
- When printing out a second generation driver card in the DTCO 4.0 of a day on which the cards were inserted into a DTCO 3.0 or older, all blocks are printed out, but are empty. For the activities, the time display is shown as 00:00.

**[2]**

Type of printout:

- $\Sigma 4h \square \square \square$  = Daily printout of the driver card
- $! \times \square \square \square$  = Events/malfunctions of the driver card

**[3]**

- $\Sigma 4h \square \square \square$  = Daily printout of the DTCO 4.0
- $! \times \square \square \square$  = Events/malfunctions of the DTCO 4.0
- $\gg \square$  = Speeding

The set value of the legally permitted maximum speed set is also printed.

- $T \square \square$  = Technical data
- $\square \square \square \square$  = Driver activities
- $\square \square \square \square$  = v-diagram

Optional printouts:

- $\square \square \square \square$  = Status D1/D2 diagram\*
- $\% \square \square \square$  = Speed profiles\*
- $\% n$  = Rotation frequency profiles\*

\* = Option

Information about the cardholder of the inserted tachograph card:

$\square$  = Controller

$\square$  = Driver

$\square$  = Contractor

$T$  = Workshop/Inspection body

- Name
- First name
- Card identification
- Card valid until ...
- Generation of the tachograph card (GEN1 or GEN2)

For non-personal tachograph cards, the name of the control body, the company or the workshop is printed instead of the name.

**[3a]**

Information about the cardholder of the other tachograph card

**[4]**

Vehicle identification:

- Vehicle identification number
- Registering member state and vehicle registration number

**[5]**

Identification of the tachograph:

	<ul style="list-style-type: none"> <li>Tachograph manufacturer</li> <li>Part number of the DTCO 4.0</li> <li>Generation of the vehicle unit (GEN1 or GEN2)</li> </ul>		<ul style="list-style-type: none"> <li>Calendar day of the printout and the usage meter (number of days that the card was used)</li> </ul>	<b>[8e]</b>	Withdrawal of driver card: <ul style="list-style-type: none"> <li>Odometer reading and route driven since the last insertion</li> </ul>
<b>[6]</b>	Most recent calibration of the tachograph: <ul style="list-style-type: none"> <li>Name of workshop</li> <li>Workshop identification</li> <li>Date of calibration</li> </ul>	<b>[8a]</b>	?= Period, card not inserted: <ul style="list-style-type: none"> <li>Manually inserted activities after inserting the driver card with pictogram, start and length</li> </ul>	<b>[8f]</b>	<b>Warning:</b> Inconsistent data recording possible as this day has been save twice on the tachograph card
<b>[7]</b>	Most recent control: <ul style="list-style-type: none"> <li>Control card identification</li> <li>Date, time and type of control</li> <li> <ul style="list-style-type: none"> <li>Download from the driver card</li> <li>Download from the DTCO 4.0</li> <li>Print</li> <li>Display</li> </ul> </li> </ul>	<b>[8b]</b>	Insertion of driver card into slot (card drawer 1 or card drawer 2): <ul style="list-style-type: none"> <li>Registering member state and vehicle registration number</li> <li>Odometer reading when card inserted</li> </ul>	<b>[8g]</b>	Activity not complete: <ul style="list-style-type: none"> <li>For printout with inserted driver card, length of the activity and daily summaries may be incomplete</li> </ul>
<b>[8]</b>	List of all driver activities in the order they appear:	<b>[8c]</b>	Activities of the driver card: <ul style="list-style-type: none"> <li>Start and length as well as driving status</li> <li>Crew operation</li> </ul>	<b>[8h]</b>	The specific condition OUT of scope was activated at the start of the day
		<b>8d</b>	Specific conditions: <ul style="list-style-type: none"> <li>Example of entry time and pictogram: Ferry or train</li> </ul>	<b>[9]</b>	Start of the list of all driver activities in the DTCO 4.0: <ul style="list-style-type: none"> <li>Calendar day of the printout</li> <li>Odometer reading at 00:00 and 23:59</li> </ul>
				<b>[10]</b>	Chronology of all activities from card drawer 1

<b>[10a]</b>	<p>Time period in which no driver card was inserted in card drawer 1:</p> <ul style="list-style-type: none"> <li>• Odometer reading at the beginning of the time period</li> <li>• Set activity or activities in this time period</li> <li>• Odometer reading at the end of the time period and distance traveled</li> </ul>	<b>[10d]</b>	<ul style="list-style-type: none"> <li>• Odometer reading at insertion of the driver card</li> <li>• <b>!</b> = a manual entry was performed</li> </ul>	<b>[11]</b>	Daily summary
<b>[10b]</b>	<p>Insertion of the driver card:</p> <ul style="list-style-type: none"> <li>• Last name of driver</li> <li>• First name of driver</li> <li>• Card identification</li> <li>• Card valid until ...</li> </ul>	<b>[10e]</b>	<p>List of activities:</p> <ul style="list-style-type: none"> <li>• Pictogram of the activity, start and length as well as driving status</li> <li>• <b>☐☐</b> = Crew operation</li> </ul>	<b>[11a]</b>	Entered locations:
<b>[10c]</b>	<ul style="list-style-type: none"> <li>• Registering member state and vehicle registration number of the previous vehicle</li> <li>• Date and time card was removed from the previous vehicle</li> </ul>	<b>[10f]</b>	<p>Entry time and pictogram of a specific condition:</p> <ul style="list-style-type: none"> <li>• <b>⚓+</b> = Start ferry/train</li> <li>• <b>+⚓</b> = End ferry/train</li> <li>• <b>OUT+</b> = Start (control device not required)</li> <li>• <b>+OUT</b> = End</li> </ul>	<ul style="list-style-type: none"> <li>• <b>⚓!</b> = Start time with country and region, if required (Spain)</li> <li>• <b>!</b> = End time with country and region, if required (Spain)</li> <li>• Vehicle odometer reading</li> </ul> <p>Position data (only for second generation driver cards)</p> <ul style="list-style-type: none"> <li>• Chronological listing of position data at start and end of working time as well as after every three hours cumulative driving time</li> </ul>	
		<b>[10g]</b>	<p>Withdrawal of driver card:</p> <ul style="list-style-type: none"> <li>• Odometer reading and distance travelled</li> </ul>	<b>[11b]</b>	Summary of times with no driver card in card drawer 1:
		<b>[10h]</b>	Chronology of all activities from card drawer 2	<ul style="list-style-type: none"> <li>• Entered locations in chronological order (no entry in example)</li> <li>• Total activities from card drawer 1</li> </ul>	
		<b>[10i]</b>	<p>The specific condition <b>OUT of SCOPE</b> was activated at the start of the day.</p>		

<p><b>[11c]</b></p>	<p>Summary of periods no driver card in card drawer 2:</p> <ul style="list-style-type: none"> <li>Entered locations in chronological order (no entry in example)</li> <li>Total activities from card drawer 2</li> </ul>	<ul style="list-style-type: none"> <li>•  = Start time with country and region, if required (Spain)</li> <li>•  = End time with country and region, if required (Spain)</li> <li>• Position data (chronological), after every three hours cumulative driving time and up to shift end (here only shift end)</li> <li>• Activities from this driver with: Total driving time and distance travelled, total work and total availability time, total rest time, total time in crew activities.</li> </ul>	<p>Row 1:</p> <ul style="list-style-type: none"> <li>• Pictogram of the event or fault</li> <li>• Date and beginning</li> </ul> <p>Row 2:</p> <ul style="list-style-type: none"> <li>• Events which are subject to a safety violation are broken down with an additional coding → <i>Data set for events or faults</i> [ 129]</li> <li>• Duration of the event or malfunction</li> </ul> <p>Row 3:</p> <ul style="list-style-type: none"> <li>• Registering member state and vehicle registration number of the vehicle in which the events or malfunctions occurred</li> </ul>
<p><b>[11d]</b></p>	<p>Daily summary Total values of activities from the driver card:</p> <ul style="list-style-type: none"> <li>Total driving time and distance travelled</li> <li>Total working and standby time</li> <li>Total rest time and unknown time</li> <li>Total time in crew activities</li> </ul>	<p><b>[12]</b> List of the five most recent saved events or faults on the driver card</p>	<p><b>[13]</b> List of the last five saved or still active events/malfunctions of the DTCO 4.0</p>
<p><b>[11e]</b></p>	<p>Summary of the activities, chronologically arranged by driver (cumulative for each driver for both card drawers):</p> <ul style="list-style-type: none"> <li>Last name, first name, card identification of the driver</li> </ul>	<p><b>[12a]</b> List of all saved events on the driver card, arranged according to type of fault and date</p>	<p><b>[13a]</b> List of all recorded or continuing events of the DTCO 4.0</p>
		<p><b>[12b]</b> List of all saved faults on the driver card, arranged according to type of fault and date</p>	
		<p><b>[12c]</b> Data record of the event or fault</p>	

<b>[13b]</b>	List of all recorded or continuing malfunctions of the DTCO 4.0	<ul style="list-style-type: none"> <li>• Row 3:</li> <li>• Identification of the driver cards inserted at the start or at the end of the event or the malfunction (maximum of four entries)</li> <li>•  is displayed if no driver card is inserted</li> </ul>	<ul style="list-style-type: none"> <li>• Date/time of the last coupling with the DTCO 4.0</li> </ul>
<b>[13c]</b>	<p>Data record of the event or fault</p> <p>Row 1:</p> <ul style="list-style-type: none"> <li>• Pictogram of the event or fault</li> <li>• Coding of data record purpose. → <i>Data set for events or faults</i> [▶ 129]</li> <li>• Date and beginning</li> <li>• Row 2:</li> <li>• Events which are subject to a security violation are broken down with an additional coding → <i>Coding for more detailed description</i> [▶ 131]</li> <li>• Number of similar events on that day → <i>Number of similar events</i> [▶ 130]</li> <li>• Duration of the event or malfunction</li> </ul>	<p><b>[14]</b> Identification of the tachograph:</p> <ul style="list-style-type: none"> <li>• Tachograph manufacturer</li> <li>• Address of the tachograph manufacturer</li> <li>• Part number</li> <li>• Type approval number</li> <li>• Serial number</li> <li>• Year of manufacture</li> <li>• Version and date of installation of the user software</li> </ul>	<p><b>[16]</b> Identification of the GNSS module</p>
			<p><b>[17]</b> Calibration data</p>
			<p><b>[17a]</b> Listing of the calibration data (in data records):</p> <ul style="list-style-type: none"> <li>• Name and address of the workshop</li> <li>• Workshop identification</li> <li>• Workshop card valid until ...</li> </ul>
			<p><b>[17b]</b> Date and purpose of the calibration:</p> <p>1 = Activation; recording of known calibration data at the time of activation</p> <p>2 = First installation, first calibration data after activating the DTCO 4.0</p> <p>3 = Installation after repair – replacement device; first calibration data in the current vehicle</p> <p>4 = regular verification</p>

	<p>5= Entry of vehicle registration number by contractor</p> <ul style="list-style-type: none"> <li>• Vehicle identification number</li> <li>• Authorizing member state and official registration number</li> <li>• ¼ = Vehicle characteristic coefficient</li> <li>• k = set constant in the DTCO 4.0 for speed adjustment</li> <li>• l = actual tyre circumference</li> <li>• m = Tyre size</li> <li>• &gt; = Legally approved maximum speed</li> <li>• Old and new odometer reading</li> </ul>	<ul style="list-style-type: none"> <li>• Name of workshop that set the time</li> <li>• Address of workshop</li> <li>• Workshop identification</li> <li>• Workshop card valid until ...</li> </ul> <p>The 2. Data set shows that the set UTC time was corrected by an authorised specialist workshop</p>	<p><b>[21]</b> First instance of over-speeding since the most recent calibration</p>
		<p><b>[19]</b> The most recently recorded event and the current fault:</p> <p>! = Most recent event, date, and time</p> <p>× = last malfunction, date and time</p>	<p><b>[21a]</b> The five most serious cases of over-speeding in the last 365 days</p>
		<p><b>[20]</b> Information at the control</p> <p>Over-speedings:</p> <p>Date and time of the most recent control</p>	<p><b>[21b]</b> The last ten recorded cases of over-speeding. For each day the most severe instance of over-speeding is recorded.</p>
<p><b>[18]</b></p>	<p>Time settings</p>	<p>Date and time of the most recent control</p>	<p><b>[21c]</b> Entries in cases of over-speeding (in chronological order after highest Ø speed):</p> <ul style="list-style-type: none"> <li>• Date, time, and duration of over-speeding</li> <li>• Highest speed and Ø over-speeding, number of similar events on that day</li> <li>• Last name of driver</li> <li>• Card identification of the driver</li> </ul> <p>If within a block no data set exists for a case of over-speeding, &gt;&gt;---- is displayed.</p>
<p><b>[18a]</b></p>	<p>Listing of all available data about time setting:</p> <ul style="list-style-type: none"> <li>• Date and time, old</li> <li>• Date and time, changed</li> </ul>	<p>Date and time of the first instance of over-speeding since the most recent control and the number of subsequent over-speeding instances</p>	

[22]	<p>Periods with activated remote control:</p> <ul style="list-style-type: none"> <li>•  = Start time</li> <li>•  = End time</li> </ul> <p>Recording is made separately for driver 1 and driver 2. The times of both drivers are indicated on the printout, even when they are the same.</p>	<p>Missing information about the cardholder means: no driver card inserted in card drawer 1.</p> <ul style="list-style-type: none"> <li>• Beginning of the profile recording with date and time</li> <li>• End of the profile recording with date and time</li> </ul> <p>New profiles are created:</p> <ul style="list-style-type: none"> <li>• by inserting/removing a tachograph card in card drawer 1,</li> <li>• by a day change,</li> <li>• by a correction of the UTC time</li> <li>• By a voltage interruption.</li> </ul>	<p>The speed profile is split into 16 zones. During installation, the individual ranges can be adjusted individually.</p>
[23]	<p>Handwritten information:</p> <ul style="list-style-type: none"> <li>•  = Location of the control</li> <li>•  = Signature controller</li> <li>•  = Start time</li> <li>•  = End time</li> <li>•  = Signature driver</li> </ul>	<p>[25] Recording of speed profiles:</p> <ul style="list-style-type: none"> <li>• List of the defined speed ranges and period in this range</li> <li>• Area: <math>0 \leq v &lt; 1</math> = vehicle is stationary</li> </ul>	<p>[26] Recording of rpm profiles:</p> <p>List of defined engine rotation frequency areas and period in this area:</p> <p>Area: <math>0 \leq n &lt; 1</math> = Engine off  Area: <math>3281 \leq n &lt; x</math> = unlimited</p> <p>The rotation frequency profile is split into 16 zones. During installation, the individual ranges can be adjusted individually.</p>
[24]	<p>Information about the cardholder of the recorded profile:</p> <ul style="list-style-type: none"> <li>• Last name of driver</li> <li>• First name of driver</li> <li>• Card identification</li> </ul>		<p>[27] Manufacturer-specific data:</p> <ul style="list-style-type: none"> <li>• Version number of the software upgrade module (SWUM)</li> </ul>
			<p>[28] Number of the housing seal on the DTCO 4.0</p>
			<p>[29] Recording of the activities:</p> <ul style="list-style-type: none"> <li>• Legend of the symbols</li> </ul>



	<ul style="list-style-type: none"> <li>From the selected day, a diagram showing the activities of the last seven calendar days is created</li> </ul>
[30]	Recording of the speed profile of the selected day
[31]	<p>Recording of additional work groups, such as use of blue light, siren etc.:</p> <ul style="list-style-type: none"> <li>Legend of the symbols</li> <li>From the selected day on, there is a diagram of status inputs D1/D2 of the last 7 calendar days;</li> </ul>
[32]	Chronological listing of inserted driver cards
[33]	<p>Please note:</p> <p>No authorised printout.</p> <p>According to the Regulation (e.g. retention requirement), a printout in local time is invalid</p>
[34]	<p>Period of the printout in local time:</p> <p>⊕⊖= Start of recording</p>

	<p>⊕⊖= End of recording</p> <p>UTC +01h00 = Difference between UTC time and local time.</p>
[35]	Date and time of the printout in local time (LOC).
[36]	Type of printout, e.g. SYMBOL in local time

## ■ Data set for events or faults

For each detected event or fault, the DTCO 4.0 registers and stores the data based on predetermined rules.

	⊖F /12345678901234 5 6
	⊖B /22335578901234 1 2
1	→ 4 15.10.2018 11:10 ( 45) 00h30
2	⊖Dk /45678901234567 7 8
	⊖F /12345678901234 5 6

(1) Purpose of the data set

(2) Number of similar events on that day

The data record purpose (1) indicates why the event or fault was recorded. Events of similar type which occur several times on the same day, are shown on position (2).

### ► Coding of data set purpose

The following overview shows the events and malfunctions, sorted by error type (cause) and assignment of the data set purpose.

9

Pictogram	Cause	Purpose
	Card conflict <sup>2)</sup>	0
	Journey without valid card <sup>2)</sup>	1 / 2 / 7
	Insertion while driving	3
	Card not closed	0
	Speed too high <sup>2)</sup>	4 / 5 / 6
	Voltage interruption	1 / 2 / 7
	Sensor malfunction	1 / 2 / 7
	Movement conflict <sup>2)</sup>	1 / 2
	Security breach	0
	Time overlap <sup>1)</sup>	-
	Card invalid <sup>3)</sup>	-

tab. 1: Events

Pictogram	Cause	Purpose
	Card fault	0
	Internal fault	0 / 6
	Printer malfunction	0 / 6

Pictogram	Cause	Purpose
	Malfunctions during download	0 / 6
	Sensor malfunction	0 / 6

tab. 2: Malfunctions

1) This event will be saved only on the driver card.

2) This event/this malfunction is only stored in the DTC 4.0.

3) This event is not stored by the DTCO 4.0.

### Overview Data record purpose

Purpose	Meaning
0	One of the most recent event or malfunction.
1	The longest event of one of the last 10 days on which an event occurred.
2	One of the five longest events in the last 365 days.

Purpose	Meaning
3	The last event of one of the last 10 days on which an event occurred.
4	The most serious event of one of the last 10 days on which an event occurred.
5	One of the 5 most serious events in the last 365 days.
6	The first event or the first malfunction after the last calibration.
7	An active event or an ongoing malfunction.

### Number of similar events

Purpose	Meaning
0	The storage Number of similar events is not required for this event.
1	On this day, an event of this type has occurred.

Purpose	Meaning
2	Two events of this type appeared on this day, but only one was saved.
n	On this day, n events of this type have occurred and only one was stored.

### ► Coding for more detailed description

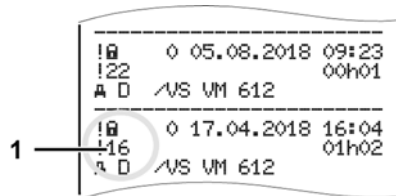

Fig. 127: Notes about coding

Events which are subject to a safety violation are broken down using an additional coding (1).

### Security Breach Codes relating to the DTCO 4.0

Code	Meaning
10	No additional information
11	Failed authentication of the sensor
12	Authentication error of driver cards
13	Unauthorised changes to the sensor
14	Integrity error; the authenticity of the data on the driver card is not assured.
15	Integrity error, the authenticity of the saved user data is not assured.
16	Internal data transmission error
18	Manipulation of the hardware

### Safety-breaching attempts on the impulse sensor

Code	Meaning
20	No additional information

Code	Meaning
21	Failed authentication
22	Integrity error, the authenticity of the memory data is not assured.
23	Internal data transmission error
24	Unauthorised opening of the housing
25	Manipulation of the hardware

## Maintenance and inspection obligation

Cleaning

Compulsory inspection

Service Only!

## Maintenance and inspection obligation

### ■ Cleaning

#### ► Cleaning the DTCO 4.0

- Clean the DTCO 4.0 with a lightly moistened cloth or a microfibre cleaning cloth.

The latter is available at your competent Sales & Service Centre.

### ▲ ATTENTION

#### Avoid damage

- Do not use any abrasive cleaning agents and not solvents or petrol.

#### ► Cleaning tachograph card

- Clean any dirty tachograph contacts with a lightly moistened cloth or a microfibre cleaning cloth.

The latter is available at your competent Sales & Service Centre.

### ▲ ATTENTION

#### Avoid damage

Do not use solvents or petrol to clean the tachograph contacts.

### ■ Compulsory inspection

No preventive maintenance work is required for the DTCO 4.0.

- However, you should get an authorised specialist workshop to check the correct working order of the DTCO 4.0 at least every two years.

Inspections are required when the following has occurred:

- The vehicle has been modified, for example in connection with the rotating pulse count or the tyre circumference.
- Repairs were carried out on the DTCO 4.0.
- The vehicle registration number has changed.
- The UTC time differs by more than 20 minutes.

**⚠ ATTENTION****Observe inspection**

- Please ensure that the installation plaque is replaced after every inspection and that it contains the mandatory details.
- Please make sure that the voltage supply of the DTCO 4.0 is not disconnected for more than one month in total within the specified inspection obligation, for example due to disconnection of the battery from the vehicle. This causes the battery of the DTCO 4.0 to discharge and therefore to fail. The DTCO 4.0 is no longer usable and must be discarded.

**IMPORTANT**

Faulty entry in the KITAS 4.0 2185

- A power cut can result in a faulty entry in the KITAS 4.0 2185.

## Troubleshooting

Data backup by the workshop

Overvoltage/undervoltage

Error card communication

Service Only!

## Troubleshooting

### ■ Data backup by the workshop

The authorised workshops can download the data from the DTCO 4.0 and hand it over to the company.

If a download of the data is not possible, the workshops are instructed to certify this to the contractor.

#### **⚠ ATTENTION**

#### Data backup

- Archive the data or carefully keep the documentation for possible requests by control bodies.

### ■ Overvoltage/undervoltage

Supply voltages of the DTCO 4.0 which are too low or too high are shown in the standard display (a):

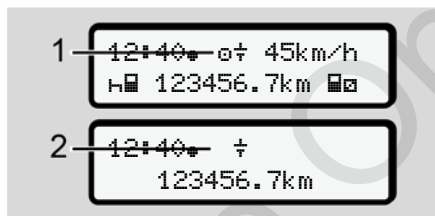

Fig. 128: Display - malfunction in the supply voltage

#### IMPORTANT

If one of the card drawers is open during an over or undervoltage, do not insert a tachograph card.

#### Case 1: ⚡ (1) Overvoltage

#### IMPORTANT

In case of overvoltage the display is switched off and the buttons are locked.

The DTCO 4.0 continues to save any activities. The functions print or display of data as well as the insertion or removal of tachograph cards are not possible.

#### Case 2: ⚡ (2) Undervoltage

This case corresponds to a power interruption.

The standard display is shown.

The DTCO 4.0 cannot fulfil its task as a control device. The driver's activities will not be recorded.

#### ► Power interruption

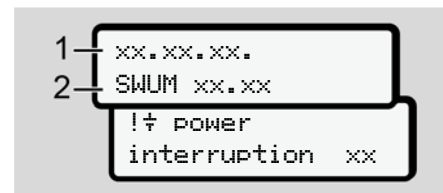

Fig. 129: Display - Voltage interruption



After a voltage interruption, for approx. 5 seconds, the version of the operating software (1) and the version of the software upgrade module (2) are displayed.

Next, the DTCO 4.0 ! $\frac{1}{2}$  signals a voltage interruption.

### **⚠ ATTENTION**

#### **Constant display of $\frac{1}{2}$**

- If, with correct board voltage, the symbol  $\frac{1}{2}$  is shown constantly: Please consult an authorised specialist workshop.
- In case of a defect in the DTCO 4.0 you are obliged to record any activities manually.  
→ *Recording activities manually*  
[ 54]

### ■ Error card communication

If an error occurs in the card communication, the driver is requested to remove his card.



Fig. 130: Display - Remove card

To do this, press button **OK**.

While the card is ejected, a new attempt is made to communicate with the card. If this attempt also fails, a printout of the last activities saved for this card is started.

### **IMPORTANT**

With this printout, the driver can still document his activities.

The printout must be signed by the driver.

The driver can add all activities on the printout (except for driving times) until the driver card is inserted again.

### **IMPORTANT**

The driver can create a daily printout of the vehicle unit and add and sign his additional activities until the driver card is inserted again.

### **IMPORTANT**

For extended absences – e.g. During a daily or weekly rest time – the driver card should be removed from the card drawer.

**► Printer drawer defect**

If the printer drawer is defect, it can be replaced.

- Contact an authorised specialist workshop.

**► Automatic ejection of tachograph card**

If the DTCO 4.0 detects a malfunction in the card communication, it will try to transfer the existing data onto the tachograph card.

The driver is informed about the malfunction through the message  eject card and instructed to remove the driver card.

The printout of the activities last saved for the driver card is performed automatically.

→ *Recording activities manually* [ 54]

## Technical data

DTCO 4.0

Paper roll

Service Only!

**Technical data****■ DTCO 4.0**



<b>DTCO 4.0</b>	
Measurement range end value	220km/h (according to Annex IC) 250km/h (for other vehicle uses)
LC display	2 lines with 16 characters each
Temperature	Operational: -20 to +70 °C storage: -20 to +85 °C
Voltage	12V or 24V DC
Weight	600g (+/- 50g)
Power input	Standby: 12V: max. 30 mA; 24 V:max. 20 mA operational: 12V: max. 5.0 A; 24 V: max. 4.2 A
EMV/EMC	ECE R10
Thermal printing mechanism	Character size: 2.1 x 1.5mm Printing width: 24 characters/row Speed: approx. 15 – 30mm/sec. Printout of diagrams
Protection type	IP 54
<b>DTCO 4.0 ADR Ex version</b>	
Ex zone	Zone 2
Temperature class	T6 Operational: -20 to +65 °C

### ■ Paper roll

Environmental conditions	Temperature: -25 °C to +70 °C
Dimensions	Diameter: ca. 27.5 mm Width: 56.5 mm Length: ca. 8m
Order no.	1381.90030300 Original replacement paper rolls are available from your competent Sales & Service Centre.

#### IMPORTANT

Use only original VDO printer paper bearing the following marks:

- Tachograph type (DTCO 4.0) with approval mark  **84**
- Approval mark  **174** or  **189**.

## **Appendix**

**Declaration of conformity**

**Certification of activities (extract)**

**Optional accessories**

**VDO online shop**

Service Only

## Appendix

## ■ Declaration of conformity

13

**Interior**

**Continental**

**EU-Konformitätserklärung**  
EU Declaration of Conformity

Nr. HOM\_007

Wir erklären hiermit als Hersteller, dass die nachstehend beschriebene Einrichtung bei bestimmungsgemäßer Verwendung die Anforderungen der Richtlinie Nr. 2014/53/EU (RED Richtlinie) und wenn anwendbar die Anforderungen der Richtlinie Nr. 2014/34/EU für Geräte und Schutzsysteme zur Vermeidung in explosionsgefährdeten Bereichen erfüllt.

Wir as manufacturer hereby declare that the following described equipment when used for its intended purpose is in conformity with the relevant Union harmonization legislation, Directive No. 2014/52/EU (RED Directive) and if applicable Directive No. 2014/34/EU for equipment and protective systems for use in potentially explosive atmospheres.

**Hersteller**  
Manufacturer  
Continental Automotive GmbH  
Heinrich-Hertz-Str. 45, 78632 Villingen-Schwenningen

**Gerät**  
Equipment  
Intelligenter Fahrschreiber Typ DT100 1381  
Smart tachograph type DT100 1381

**Gerätevarianten**  
Variants of the equipment  
Varianten mit GNSS und DSRC:  
variants with GNSS and DSRC:  
DT100 1381.x.x.x.x.1.x  
DT100 1381.x.x.x.x.2.x  
DT100 1381.x.x.x.x.3.x  
Varianten mit GNSS und DSRC:  
variants with GNSS and DSRC:  
DT100 1381.x.x.x.x.4.x  
DT100 1381.x.x.x.x.5.x  
DT100 1381.x.x.x.x.6.x

**ADR Varianten:**  
variants for ADR vehicles:  
DT100 1381.2.x.x.x.x.x  
DT100 1381.3.x.x.x.x.x  
DT100 1381.4.x.x.x.x.x  
DT100 1381.7.x.x.x.x.x

**TÜV 184025-06/TEC**  
Anwender für alle oben genannten Varianten  
Applicable for the above mentioned variants

**TÜV 03 ATEX 2324 X**  
Nur anwendbar für ADR Varianten  
Only applicable for ADR variants

**Benannte Stelle**  
Notified body  
Nur für Funkzulassung der RED Varianten anwendbar  
Only applicable for RED certification

**CTC advanced GmbH** Untertürkheimer Str. 6-10,  
66117 Saarbrücken, DE 0682

Continental Automotive GmbH  
78632 Villingen-Schwenningen  
Tel: +49 (0)720 610  
www.continental-tyre.com

Geprüfter Anwender:  
General Customer:  
Harald Bahmann  
UStId. Nr. DE181606603

StB der Gesellschaft: Hersteller  
Harald Bahmann  
HFB 0424  
UStId. Nr. DE181606603

Fig. 131: EC Declaration of Conformity – 1

- 2 -

**Continental**

Nur anwendbar für ADR Varianten:  
Only applicable for ADR variants:

**TÜV NORD CERT GmbH**, Geschäftsstelle Hannover, Am TÜV 1,  
30519 Hannover, **CE 0044**

Nur anwendbar für ADR Varianten:  
Only applicable for ADR variants:  
EN 11312(G, Ex ec) (B) IIC T6

**Verwendete harmonisierte Normen**  
Used/harmonized standards

Anwendbar für alle oben genannten Varianten nach **RED**  
Richtlinie:  
Applicable for the above mentioned variants according **RED**  
Directive:  
EN 300 674-1 V1.2.1, EN 300 674-2 V2.1.1;  
EN 303 413 V1.1.1

Draft EN 301 489-1 V2.3.0, Final Draft EN 301 489-3 V2.1.1;  
Draft EN 301 489-19 V2.1.0

EN 62368-1:2014 IAC:2015 A11:2017  
EN 62479:2010

Nur anwendbar für **ADR Varianten**:  
Only applicable for **ADR variants**:  
EN 60075-0:2012+A11:2013;  
EN 60075-7:2015;  
EN 60075-11:2012

**Andere angewandte Richtlinien**  
Other used directives

VO (EU) Nr. 165/2014, VO (EU) 2016/796, ECE R10 Rev. 05

Villingen, Schwelmungen, der  
Continental Automotive GmbH

Winfried Rogentz  
Head of Homologation

Name / Name  
Funktion / function

Unterschrift  
signature

Dr. Harald Jordan  
Head TTS Product and Project  
Quality

Name / Name  
Funktion / function

Unterschrift  
signature

Diese Erklärung bescheinigt die Übereinstimmung mit den genannten Richtlinien, in person keine Beschriftungs- oder Halbsatzgarantie nach §43 BGG. Bei Sachmängeln oder mangelhaften Produktinformationen sind zu beachten.  
This declaration certifies the conformity to the specified directives but does not imply any warranty for properties. The safety documentation accompanying the product shall be considered in detail.

Fig. 132: EC Declaration of Conformity - 2



■ **Certification of activities (extract)**

**BESCHÜDIGUNG VON TÄTIGKEITEN (1)**  
**(VERORDNUNG (EG) Nr. 91/2006 ODER AETR (1))**

Für jede Fahrt nachzuschreiben auszufüllen und zu unterschreiben.  
Zusammen mit dem Original-Kontrollaufzeichnungen aufbewahren.  
Falsche Beschreibungen stellen einen Verstoß gegen geltendes Recht dar.

**Von Unternehmen auszufüllender Teil**

1 Name des Unternehmens: \_\_\_\_\_  
 2 Straße, Hausnr., Postleitzahl, Ort, Land \_\_\_\_\_  
 3 Telefon-Nr. (mit internationaler Vorwahl) \_\_\_\_\_  
 4 Fax-Nr. (mit internationaler Vorwahl) \_\_\_\_\_  
 5 E-Mail-Adresse: \_\_\_\_\_

**Ich, deutsche Unternehmensleiter**

6 Name und Vorname: \_\_\_\_\_  
 7 Position im Unternehmen: \_\_\_\_\_

**erkläre, dass sich der Fahrer/die Fahrerin:**

8 Name und Vorname: \_\_\_\_\_  
 9 Geburtsdatum (Tag, Monat, Jahr): \_\_\_\_\_  
 10 Nummer des Führerscheins, des Personalausweises oder des Reisepasses: \_\_\_\_\_  
 11 während im Unternehmen tätig ist seit (Tag, Monat, Jahr): \_\_\_\_\_

**im Zeitraum:**

12 von (Uhrzeit/Tag/Monat/Jahr): \_\_\_\_\_  
 13 bis (Uhrzeit/Tag/Monat/Jahr): \_\_\_\_\_

14  sich im Kontrollbereich befindet (1)  
 15  sich im Erholungsbus befindet (1)  
 16  sich im Urlaub oder in Ruhezeit befindet (1)  
 17  ein von Anwendungsbereich der Verordnung (EG) Nr. 91/2006 oder der AETR ausgenommenes Fahrzeug genutzt hat (1)  
 18  andere Tätigkeiten aus Leistungsvertrag ausgeübt hat (1)  
 19  zur Verfügung steht (1)

20 Ort: \_\_\_\_\_ Datum: \_\_\_\_\_  
 Unterschrift \_\_\_\_\_

21 Ich, der Fahrer/die Fahrerin, bestätige, dass ich im vorstehend genannten Zeitraum kein oder den Anwendungsbereich der Verordnung (EG) Nr. 91/2006 oder der AETR betreffendes Fahrzeug genutzt habe.

22 Ort: \_\_\_\_\_ Datum: \_\_\_\_\_  
 Unterschrift des Fahrer/die Fahrerin \_\_\_\_\_

(1) Eine entsprechende und zureichende Fälschung dieses Formblatts ist verfügbar unter der Internetadresse <http://ec.europa.eu>.  
 (2) Europäische Unionen oder die Arbeit der internationalen Straßenverkehrs bestmögliche Fahrer/karte.  
 (3) Nur ein Mitgliedstaat.

Fig. 133: Certification of activities

■ **Optional accessories**

▶ **DLKPro Download Key**



You can use the DLKPro download key to legally download and archive data from the DTCO 4.0.

Order number: **A2C59515252** with enabling the card reader.

▶ **DLKPro TIS-Compact**



Using the DLKPro TIS-Compact, you can legally download, archive and visualise data from the DTCO 4.0 and from the driver card.

Order Numbers:

- Europe – **A2C59515262** with enabling the card reader.
- France - **A2C59516565** with enabling the card reader.

▶ **DTCO® Smart Link**



The DTCO® SmartLink serves as a wireless connection from the DTCO 4.0 to a Bluetooth-enabled device (e.g. smartphone).

Order number DTCO® SmartLink Pro for iOS and Android: **1981-2000000101**

13

### ► DLD® Short Range II and DLD® Wide Range II



Using the DLD Short Range II and the DLD Wide Range II, you can transfer download data via the wireless network or GPRS to your fleet management system or an evaluation software.

Order Numbers:

- DLD Short Range II – **A2C59516619**
- DLD Wide Range II – **A2C59516626**

### ► Cleaning cards and cleaning wipes



Use the cleaning cards to clean the card slots with the DTCO 4.0.

The cleaning wipes serve for the cleaning of your driver and/or company cards.

Order Numbers:

- cleaning cards – **A2C59513382** (12 cards)
- cleaning wipes – **A2C59511849** (12 wipes)
- cleaning wipes (set) – **A2C59511838** (6 cards/ 6 wipes)

### ■ VDO online shop

The online shop for VDO products and services:



[www.vdoshop.co.uk](http://www.vdoshop.co.uk)

**Change overview**

**Release overview**

Service Only!

## Change overview

## ■ Release overview

This instruction manual is valid for the following version of the DTCO:

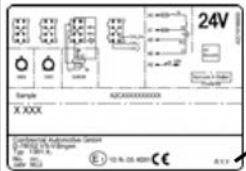
Release status (visible on type plate)	Instruction manual	Changes on the instruction manual
 <p>Rel. 4.0</p>	BA00.1381.40 100 102	Complete revision and structuring of the manual

### IMPORTANT

For the release status of the tachograph in installed state, please see the printout **Technical data**.

➔ *Technical data* [▶ 118]

### IMPORTANT

This instruction manual is not suitable for older versions of the DTCO.

**Index****Symbols**

Menu levels ..... 80

**A**

## Activating

Remote control ..... 89

## Activities

adding - when card inserted ..... 49

Enter and add rest time ..... 58

## Addition

Manual entry ..... 56

manually - when card inserted ..... 49

ADR version ..... 21, 24

AETR Agreement ..... 10

**B**

Brightness ..... 22

**C**

Calibration ..... 26

Cancellation of the entry ..... 52

## Card

Downloading data ..... 45

Handling ..... 45

plug ..... 42

request ..... 57

Card drawer ..... 21, 22

Certification of activities ..... 145

## Change

Personal ITS data settings ..... 88

Change: Personal VDO data settings ..... 89

Changing activities ..... 22

Cleaning ..... 133

cleaning cards (accessories) ..... 146

cleaning wipes (accessories) ..... 146

Clear paper jam ..... 113

Combination button ..... 21, 22

Company (operation mode) ..... 25

## Company card

Data ..... 30

Display number ..... 94

First insertion ..... 66

Functions of the company card ..... 65

Compulsory tachograph inspections ..... 133

Contact partner ..... 11

Contact person ..... 11

Contrast ..... 22

Control (operating mode) ..... 25

## Country

When card inserted.....	50
Country entry (manual entry).....	51
Country symbols	
Spanish regions.....	37
Table with overview.....	36
Crew operation.....	10, 61

**D**

Data	
Download from mass data.....	46
Download from the card.....	45
Identification.....	46
Data backup by the workshop.....	136
Data protection.....	9
Data storage.....	30
Defaults	
Automatic activities.....	38
Designations.....	10
Digital signature.....	46
Dimming.....	24
Dimming (display).....	22
Display.....	21, 22

Display (a).....	40
Driver 1/ Driver 2.....	92
Driving and rest periods.....	40
Low voltage / overvoltage.....	136
Standard displays during trip.....	40
VDO Counter (option).....	104
Vehicle.....	93
Display in stationary vehicle.....	72
Display the times of the driver card.....	73
DLD Short Range II.....	146
DLD Wide Range II.....	146
DLKPro Download Key.....	145
DLKPro TIS-Compact.....	145
Download Key.....	45, 145
Driver / vehicle change	
Inserting cards.....	61
Mixed operation.....	61
Shift end.....	61
Driver 1 - definition.....	13
Driver card	
Data.....	30
First insertion.....	50, 62
Functions.....	48
remove.....	55
Driving and rest periods.....	40
Driving time warning.....	104
Driving time warnings	

Message .....	97
DTCO 1381 Release 4.0 .....	10
DTCO® SmartLink .....	145

**E**

EC 2006/22 .....	16
EC 561/2006 .....	16
Enter vehicle registration number .....	68
Entry	
Driver 1/ Driver 2 - country .....	87
Driver 1/ Driver 2 - start country .....	87
End country .....	88
Ferry / train .....	90
Local time .....	91
Local time company .....	91
Unlocking additional functions .....	91
Vehicle - Out start/end .....	90
Error messages .....	96, 103
EU 165/2014 .....	11, 16
Events	
Overview .....	101
Ex-device .....	24

**F**

Faults	
Overview .....	103
Ferry / train	

Entry .....	90
Message .....	98
Front interface .....	10, 21, 22

**I**

Ignition off	
Display .....	41
Intended use .....	19
Internet	
Online Shop .....	146

**L**

Language	
Displayed language .....	43
Set manually .....	73
When card inserted .....	48
Leave scope (out) .....	98
Leaving menu functions .....	82
Local time	
When card inserted .....	50
Local time company Entry .....	91

**M**

Malfunctions	
Message .....	96
Manual addition	

When card inserted.....	49
Manual entries.....	56
Continuing activities.....	59
Manual entry	
Correction possibility.....	56
Precede activities with others activities .....	60
Mass memory.....	30
Definition.....	10
Downloading data.....	46
Menu access lock.....	82
Menu buttons.....	21, 22
In the Menu.....	41
Menu display.....	13
Menu functions	
Leaving - automatically.....	82
Leaving - manually.....	83
Messages.....	96, 107
Causes.....	41
Confirm.....	97
Display in the display.....	41
Faults.....	103
Ferry / train.....	98
Meaning.....	96
Production status.....	97
Mixed operation.....	10

**N**

navigate

In menu functions.....	81
------------------------	----

**O**

Online Shop.....	146
Operation (operating mode).....	25
Out (leave scope).....	98
Out of Scope.....	11

**P**

Personal data.....	10
Pictograms (overview).....	32
Print.....	111
Activities.....	84
Cancel printout.....	112
Daily value.....	85
Events.....	84
Events [vehicle].....	85
Information tachograph cards.....	86
Rotation frequency profiles (option).....	87
Speed profiles (option).....	87
Speeding events.....	85
Status D1/ D2 (option).....	86
Technical data.....	85
v-diagram.....	86
Print data	
Starting print.....	111
Print: Daily value.....	83



Printer .....	21
Printer paper	
Replacing; replacing paper .....	112
Printout	
Driver 1/ Driver 2 .....	83
Vehicle .....	84

**R**

Recording activities .....	54
Register company .....	67
Release overview .....	148
Remote control .....	23
Remote-controlled download .....	46
Removing company card .....	70

**S**

Service partner .....	11
Setting activities	
Automatic setting; .....	53
Changing activities .....	53
Detailed description .....	53
When card inserted .....	51
Signature data .....	46
Standard display (a) .....	40
Standard displays .....	72
Stand-by .....	24

**T**

tachograph card .....	27
Cleaning .....	133
plug .....	42
Tachograph cards: Automatic ejection .....	138
Target group .....	11
Technical data .....	140
Time zones .....	31

**U**

UTC time .....	31
----------------	----

**V**

VDO Counter	
Description .....	74
Description of the display .....	75
Display .....	41
Display daily values .....	78
Display weekly values .....	79
Displays for rest time activity .....	77
Displays for working time activity .....	78
Status display .....	79
Voltage	

Interruption..... 137

**W**

Warning - Driving time ..... 104

Service Only!

Service Only!

Continental Automotive GmbH  
P.O. Box 1640  
78006 Villingen-Schwenningen  
Germany  
[www.fleet.vdo.com](http://www.fleet.vdo.com)

A2C19916900  
41232776 OPM 000 AA  
BA00.1381.40 100 102  
Language: English



Service Only!

**VDO**