



MTS-5100 USER'S MANUAL

**MTS-5100
PROTECTIVE
RELAY TEST SYSTEM**

USER's MANUAL

**First Edition
August 2012**



Unit #1, 4060B Sladeview Crescent
Mississauga, Ontario L5L 5Y5, Canada
Tel: 905-828-6469 Fax: 905-828-6850

www.mantatest.com
support@mantatest.com



Pay special attention to the warnings and safety instructions that accompany the above symbol wherever it is found within this manual!



MTS-5100 User's Manual

All rights reserved by Manta Test Systems Inc. No part of this publication may be reproduced or distributed in any form or by any means without the permission of Manta Test Systems Inc.

The information and specifications contained within from Manta Test Systems are believed to be accurate and reliable at the time of printing. However, because of the nature of this product, specifications and features shown in this manual are subject to change without notice.

The features and capabilities described herein reflect those available in MTS-5100 firmware release 2.00

August 2012

Document ID# CU S001 01B

MANTA TEST SYSTEMS
Unit #1, 4060B Sladeview Crescent
Mississauga, Ontario L5L 5Y5, Canada
Tel: 905-828-6469 Fax: 905-828-6850
www.mantatest.com
support@mantatest.com

Toll-free technical support (USA & Canada): 1-800-233-8031

TABLE OF CONTENTS

Section 1. INTRODUCTION

| | | |
|--------|--|-----|
| 1.1. | GENERAL DESCRIPTION | 1-1 |
| 1.2. | DISTINCTIVE FEATURES | 1-1 |
| 1.3. | APPLICATIONS | 1-2 |
| 1.3.1. | Waveform Playback Applications | 1-3 |
| 1.4. | TERMINOLOGY | 1-3 |
| 1.4.1. | Static Relay Testing | 1-3 |
| 1.4.2. | Dynamic Relay Testing | 1-4 |
| 1.4.3. | Waveform Playback | 1-4 |
| 1.4.4. | In-Panel Testing | 1-4 |
| 1.5. | TECHNICAL SUPPORT | 1-5 |
| 1.6. | SAFETY CONSIDERATIONS | 1-5 |
| 1.7. | LIMITED PRODUCT WARRANTIES | 1-6 |
| 1.7.1. | Hardware | 1-6 |
| 1.7.2. | Software & Firmware | 1-6 |
| 1.7.3. | Separate Extended Warranty for Hardware Products | 1-6 |
| 1.7.4. | Exclusion of other Warranties | 1-7 |
| 1.7.5. | Extension of Warranty | 1-8 |

Section 2. SPECIFICATIONS

| | | |
|-------|---------------------------------------|-----|
| 2.1. | INPUTS | 2-1 |
| 2.2. | OUTPUTS | 2-2 |
| 2.3. | METERING | 2-3 |
| 2.4. | COMPUTED VALUES | 2-3 |
| 2.5. | STATE SEQUENCING | 2-3 |
| 2.6. | RAMPING | 2-4 |
| 2.7. | WAVEFORM PLAYBACK | 2-4 |
| 2.8. | PHASE/FREQUENCY SYNCHRONIZATION | 2-4 |
| 2.9. | DATA INTERFACES | 2-4 |
| 2.10. | ADDITIONAL STANDARD FEATURES | 2-5 |
| 2.11. | ACCESSORIES INCLUDED | 2-5 |
| 2.12. | APPLICATION SOFTWARE | 2-5 |
| 2.13. | PHYSICAL CHARACTERISTICS | 2-6 |

Section 3. OPERATION SUMMARY

| | | |
|--------|----------------------------------|------|
| 3.1. | FRONT PANEL LAYOUT | 3-1 |
| 3.2. | AUXILIARY INPUT-OUTPUTS | 3-5 |
| 3.3. | BASIC APPLICATIONS | 3-7 |
| 3.3.1. | Getting Started | 3-7 |
| 3.3.2. | Safety & other precautions | 3-8 |
| 3.3.3. | Manual Test Menu | 3-10 |
| 3.4. | RELAY TESTING | 3-13 |
| 3.4.1. | Quickstart Procedure | 3-13 |

| | | |
|--------|--|------|
| 3.5. | ADDITIONAL FEATURES..... | 3-17 |
| 3.5.1. | Paralleling Currents | 3-17 |
| 3.5.2. | Frequency and DC Control | 3-21 |
| 3.5.3. | Multiple Frequencies | 3-22 |
| 3.5.4. | DC Current..... | 3-22 |
| 3.5.5. | Increasing Voltage Output..... | 3-22 |
| 3.6. | PRODUCTIVITY MODES | 3-24 |
| 3.6.1. | Differential Relay Testing..... | 3-24 |
| 3.6.2. | Synchronizing Relay Testing | 3-29 |
| 3.6.3. | Instantaneous Overcurrent Relay Test Mode..... | 3-36 |
| 3.6.4. | Distance (Impedance) Relay Test Mode | 3-38 |
| 3.7. | HELP SYSTEM..... | 3-45 |
| 3.8. | SETUP MENU..... | 3-47 |
| 3.8.1. | Customize | 3-50 |
| 3.8.2. | Calibration | 3-51 |
| 3.8.3. | Set Up Network | 3-51 |
| 3.8.4. | Software Upgrade | 3-51 |
| 3.8.5. | Factory Diagnostics | 3-51 |
| 3.8.6. | Reset to factory defaults..... | 3-51 |
| 3.8.7. | Save..... | 3-51 |
| 3.9. | COMMUNICATIONS & REMOTE CONTROL MENU..... | 3-52 |

Section 4. DETAILED OPERATION

| | | |
|--------|--|------|
| 4.1. | FAULT STATES: PREFault, FAULT, POSTFAULT | 4-1 |
| 4.1.1. | Prefault State..... | 4-1 |
| 4.1.2. | Fault State | 4-2 |
| 4.1.3. | Multiple Faults..... | 4-3 |
| 4.1.4. | Fault Duration | 4-4 |
| 4.1.5. | Postfault State | 4-5 |
| 4.1.6. | Frozen Readings | 4-6 |
| 4.2. | FAULT MODES: PICKUP & TIMING..... | 4-7 |
| 4.2.1. | PICKUP Fault Mode..... | 4-7 |
| 4.2.2. | TIMING Fault Mode..... | 4-7 |
| 4.3. | FAULT TYPES: 3-Ø PRODUCTIVITY SHORTCUTS..... | 4-9 |
| 4.3.1. | Φ-N Fault Type..... | 4-11 |
| 4.3.2. | Φ-Φ Fault Type..... | 4-12 |
| 4.3.3. | 3Φ (Φ-N) Fault Type | 4-14 |
| 4.3.4. | 3Φ (Φ-Φ) Fault Type | 4-15 |
| 4.4. | STATUS INPUTS CONFIGURATION | 4-17 |
| 4.4.1. | Basic Configuration | 4-18 |
| 4.4.2. | Fault State Control | 4-20 |
| 4.4.3. | Status Inputs Active Indication | 4-22 |
| 4.5. | PROGRAMMABLE TIMERS | 4-22 |
| 4.5.1. | Timer Start: Event..... | 4-23 |
| 4.5.2. | Timer Start: When | 4-24 |
| 4.5.3. | Timer Stop: Event and When..... | 4-24 |
| 4.6. | DIGITAL OUTPUTS CONFIGURATION | 4-25 |

| | | |
|---------|---|------|
| 4.6.1. | Delay..... | 4-25 |
| 4.6.2. | Function..... | 4-26 |
| 4.6.3. | Digital Outputs Status Indicator..... | 4-27 |
| 4.7. | AMPLIFIER CONFIGURATION..... | 4-28 |
| 4.7.1. | 6-Current Transformer Differential Test..... | 4-29 |
| 4.8. | ADVANCED SETTINGS..... | 4-30 |
| 4.8.1. | Fault Incidence Angle (FIA)..... | 4-30 |
| 4.8.2. | GPS-Synchronized Fault..... | 4-32 |
| 4.8.3. | K-Factor, K-Factor Angle..... | 4-32 |
| 4.8.4. | Maximum Fault Duration Enabled, Number of Fault States..... | 4-32 |
| 4.8.5. | Phase Sequence..... | 4-32 |
| 4.8.6. | Postfault State Enable..... | 4-33 |
| 4.8.7. | System Time Constant..... | 4-33 |
| 4.8.8. | V4 Powers Relay..... | 4-34 |
| 4.8.9. | Save and Restore Settings..... | 4-34 |
| 4.9. | ADDITIONAL DISPLAY INFORMATION..... | 4-34 |
| 4.9.1. | Nothing..... | 4-35 |
| 4.9.2. | Fault Timer (cycles @ Frequency 1)..... | 4-35 |
| 4.9.3. | Fault Timer (cycles @ System Frequency)..... | 4-35 |
| 4.9.4. | Fault Timer (seconds)..... | 4-35 |
| 4.9.5. | FIA (Fault Incidence Angle)..... | 4-36 |
| 4.9.6. | Input Power Control..... | 4-36 |
| 4.9.7. | System Time Constant..... | 4-36 |
| 4.9.8. | Frequency 1..... | 4-36 |
| 4.9.9. | Frequency 2..... | 4-36 |
| 4.9.10. | I0..... | 4-36 |
| 4.9.11. | I1..... | 4-36 |
| 4.9.12. | I2..... | 4-36 |
| 4.9.13. | I0 Angle..... | 4-36 |
| 4.9.14. | I1 Angle..... | 4-36 |
| 4.9.15. | I2 Angle..... | 4-36 |
| 4.9.16. | IR..... | 4-37 |
| 4.9.17. | I Unbalance..... | 4-37 |
| 4.9.18. | K-Factor (Zero Sequence Compensation Factor)..... | 4-37 |
| 4.9.19. | K-Factor Angle..... | 4-37 |
| 4.9.20. | RMS AC Line Voltage..... | 4-37 |
| 4.9.21. | RMS AC Line Current..... | 4-37 |
| 4.9.22. | Power: Real (W)..... | 4-37 |
| 4.9.23. | Power: Reactive (VAR)..... | 4-38 |
| 4.9.24. | Power: Apparent (VA)..... | 4-38 |
| 4.9.25. | Power Factor..... | 4-38 |
| 4.9.26. | Transducer DC Current..... | 4-38 |
| 4.9.27. | Transducer DC Voltage..... | 4-38 |
| 4.9.28. | V/Hz..... | 4-38 |
| 4.9.29. | V0..... | 4-38 |
| 4.9.30. | V1..... | 4-38 |
| 4.9.31. | V2..... | 4-39 |

| | | |
|---------|--|------|
| 4.9.32. | V0 Angle..... | 4-39 |
| 4.9.33. | V1 Angle..... | 4-39 |
| 4.9.34. | V2 Angle..... | 4-39 |
| 4.9.35. | V Unbalance..... | 4-39 |
| 4.9.36. | Z (Ohms)..... | 4-39 |
| 4.9.37. | Z (Angle)..... | 4-39 |
| 4.9.38. | R (Ohms)..... | 4-39 |
| 4.9.39. | X (Ohms)..... | 4-39 |
| 4.9.40. | Z0 (Ohms)..... | 4-39 |
| 4.9.41. | Z0 (Angle)..... | 4-40 |
| 4.9.42. | Z1 (Ohms)..... | 4-40 |
| 4.9.43. | Z1 (Angle)..... | 4-40 |
| 4.9.44. | Z2 (Ohms)..... | 4-40 |
| 4.9.45. | Z2 (Angle)..... | 4-40 |
| 4.9.46. | Z0/Z1..... | 4-40 |
| 4.9.47. | Z0/Z1 (Angle)..... | 4-40 |
| 4.9.48. | Additional Display Settings..... | 4-40 |
| 4.10. | RAMPING OUTPUT CHANNELS..... | 4-41 |
| 4.11. | SEQUENCE OF EVENTS (SOE) RECORDER..... | 4-43 |
| 4.12. | OSCILLOSCOPE DISPLAY..... | 4-45 |
| 4.12.1. | Horizontal Zoom and Position..... | 4-46 |
| 4.12.2. | Oscilloscope Trigger..... | 4-47 |
| 4.12.3. | Oscilloscope Cursors..... | 4-49 |

Section 5. DATA INTERFACES

| | | |
|--------|--|------|
| 5.1. | RS-232 SERIAL..... | 5-2 |
| 5.2. | USB..... | 5-4 |
| 5.3. | ETHERNET..... | 5-6 |
| 5.3.1. | Windows 98 Configuration..... | 5-7 |
| 5.3.2. | Windows 2000 Configuration..... | 5-8 |
| 5.3.3. | Windows NT Workstation Configuration..... | 5-9 |
| 5.3.4. | Windows XP, Vista, and Window 7 Configuration..... | 5-10 |
| 5.3.5. | MTS-5100 Configuration..... | 5-11 |
| 5.3.6. | Web Server..... | 5-12 |
| 5.3.7. | Ethernet File Management..... | 5-13 |

Section 6. GPS OPERATION

| | | |
|------|---|-----|
| 6.1. | RECEPTION OF SATELLITE GPS SIGNALS..... | 6-1 |
| 6.2. | USING AN EXISTING GPS SIGNAL..... | 6-3 |
| 6.3. | REMOTE SYNCHRONIZATION..... | 6-3 |
| 6.4. | END-TO-END TESTING..... | 6-4 |

Section 7. WAVEFORM PLAYBACK

| | | |
|------|------------------------------------|-----|
| 7.1. | DOWNLOADING WAVEFORM DATA..... | 7-1 |
| 7.2. | ACCESSING WAVEFORM DATA FILES..... | 7-3 |
| 7.3. | VIEWING WAVEFORM DATA FILES..... | 7-4 |

| | | |
|--------|---------------------------------------|------|
| 7.4. | CONFIGURING WAVEFORM DATA FILES | 7-5 |
| 7.4.1. | Configuring Digital Outputs | 7-8 |
| 7.5. | INITIATING WAVEFORM PLAYBACK | 7-9 |
| 7.6. | SEQUENCE OF EVENTS | 7-10 |
| 7.7. | FILE STORAGE/RETRIEVAL | 7-11 |
| 7.7.1. | Save Settings File | 7-12 |

Section 8. MASTER-SLAVE OPERATION

| | | |
|------|-----------------------------------|-----|
| 8.1. | SLAVE SYSTEM CONFIGURATION | 8-1 |
| 8.2. | MASTER SYSTEM CONFIGURATION | 8-2 |
| 8.3. | APPLICATIONS | 8-4 |

Section 9. SOFTWARE UPGRADE

| | | |
|------|--------------------|-----|
| 9.1. | INTRODUCTION | 9-1 |
| 9.2. | PROCEDURE | 9-1 |

Section 10. STATUS MESSAGES

| | | |
|-------|---------------------------|------|
| 10.1. | STATUS MESSAGE LIST | 10-2 |
|-------|---------------------------|------|

LIST OF ILLUSTRATIONS

| Title | Page # |
|---|---------------|
| Figure 3.1 FRONT PANEL LAYOUT | 3-1 |
| Figure 3.2 AUXILIARY INPUT-OUTPUTS | 3-5 |
| Figure 3.3 STARTUP DISPLAY | 3-7 |
| Figure 3.4 MANUAL TEST MENU | 3-10 |
| Figure 3.5 AMPLIFIER CONFIGURATION MENU | 3-17 |
| Figure 3.6 2-CH. MEDIUM CURRENT PARALLEL CONNECTIONS | 3-18 |
| Figure 3.7 SINGLE PHASE HIGH CURRENT PARALLEL CONNECTIONS | 3-19 |
| Figure 3.8 PARALLELED CURRENT MANUAL TEST DISPLAY | 3-20 |
| Figure 3.9 FREQUENCY CONTROL | 3-21 |
| Figure 3.10 HIGH VOLTAGE CONFIGURATION | 3-23 |
| Figure 3.11 HIGH VOLTAGE OUTPUT CONNECTIONS | 3-23 |
| Figure 3.12 SELECT PRODUCTIVITY MODE MENU | 3-24 |
| Figure 3.13 DIFFERENTIAL RELAY TEST CONFIGURATION | 3-25 |
| Figure 3.14 DIFFERENTIAL RELAY SLOPE TEST MODE | 3-26 |
| Figure 3.15 DIFFERENTIAL RELAY HARMONIC RESTRAINT TEST MODE... | 3-27 |
| Figure 3.16 SYNCHROCHECK RELAY TEST MODE | 3-29 |
| Figure 3.17 SYNCHROCHECK RELAY: WIRING TYPE SELECTION | 3-31 |
| Figure 3.18 OVERCURRENT RELAY TEST MODE | 3-36 |
| Figure 3.19 FROZEN OVERCURRENT TEST RESULTS | 3-37 |
| Figure 3.20 IMPEDANCE RELAY TEST MODE | 3-38 |
| Figure 3.21 CONFIGURE TEST SETTINGS MENU | 3-39 |
| Figure 3.22 AUTOMATIC MODE IMPEDANCE TEST | 3-41 |
| Figure 3.23 AUTOMATIC MODE CONFIGURE TEST SETTINGS | 3-41 |
| Figure 3.24 AUTOMATIC MODE REACH CONFIGURATION | 3-42 |
| Figure 3.25 TEST REPORTS MENU | 3-43 |
| Figure 3.26 HTML TEST REPORT | 3-44 |
| Figure 3.27 MANUAL TEST MENU HELP SCREEN | 3-45 |
| Figure 3.28 FRONT CONTROLS HELP SCREEN | 3-46 |
| Figure 3.29 SETUP MENU | 3-47 |
| Figure 3.30 CUSTOMIZATION MENU | 3-50 |
| Figure 3.31 REMOTE CONTROL MENU | 3-52 |
| Figure 3.32 REMOTE CONSOLE SCREEN | 3-53 |
| | |
| Figure 4.1 PREFault TO FAULT TO POSTFAULT TRANSITIONS | 4-1 |
| Figure 4.2 ADVANCED SETTINGS MENU | 4-3 |
| Figure 4.3 MAXIMUM DURATION SETTING | 4-4 |
| Figure 4.4 FROZEN READINGS | 4-6 |

| | |
|--|------|
| Figure 4.5 PICKUP AND TIMING MODE CHARACTERISTICS..... | 4-8 |
| Figure 4.6 THREE PHASE FAULT CONTROL..... | 4-10 |
| Figure 4.7 ROTATE FAULT CONTROL..... | 4-10 |
| Figure 4.8 PHASE-TO-NEUTRAL FAULT..... | 4-11 |
| Figure 4.9 PHASE-TO-PHASE FAULT..... | 4-12 |
| Figure 4.10 THREE PHASE FAULT (Φ -N)..... | 4-14 |
| Figure 4.11 THREE PHASE FAULT (Φ - Φ)..... | 4-15 |
| Figure 4.12 DEFAULT I/O SETUP MENU..... | 4-18 |
| Figure 4.13 I/O FAULT STATE CONTROL..... | 4-20 |
| Figure 4.14 STATUS INPUTS ACTIVE INDICATION..... | 4-22 |
| Figure 4.15 PROGRAMMABLE TIMER SETUP MENU..... | 4-23 |
| Figure 4.16 PROGRAMMABLE TIMERS DATA READOUT..... | 4-24 |
| Figure 4.17 DIGITAL OUTPUTS SETUP MENU..... | 4-25 |
| Figure 4.18 DIGITAL OUTPUTS STATUS INDICATION..... | 4-27 |
| Figure 4.19 AMPLIFIER CONFIGURATION MENU..... | 4-28 |
| Figure 4.20 6-CURRENT TRANSFORMER DIFFERENTIAL TEST..... | 4-29 |
| Figure 4.21 ADVANCED SETTINGS MENU..... | 4-30 |
| Figure 4.22 FAULT INCIDENCE ANGLE EXAMPLES..... | 4-31 |
| Figure 4.23 SYSTEM TIME CONSTANT EFFECT..... | 4-33 |
| Figure 4.24 DISPLAY SETUP MENU..... | 4-35 |
| Figure 4.25 RAMPS SETUP MENU..... | 4-41 |
| Figure 4.26 SEQUENCE OF EVENTS RECORDER..... | 4-43 |
| Figure 4.27 GRAPHICAL SEQUENCE OF EVENTS..... | 4-44 |
| Figure 4.28 OSCILLOSCOPE DISPLAY..... | 4-45 |
| Figure 4.29 OSCILLOSCOPE ZOOM FUNCTION..... | 4-46 |
| Figure 4.30 OSCILLOSCOPE TRIGGER SETUP..... | 4-47 |
| Figure 4.31 OSCILLOSCOPE CURSORS..... | 4-49 |
| | |
| Figure 5.1 AUXILIARY INPUTS-OUTPUTS..... | 5-1 |
| Figure 5.2 SETUP MENU..... | 5-2 |
| Figure 5.3 RS-232C COMMUNICATIONS..... | 5-3 |
| Figure 5.4 USB STORAGE DEVICE INSERTED..... | 5-4 |
| Figure 5.5 FILE SELECTION LISTS..... | 5-5 |
| Figure 5.6 WINDOWS 98 NETWORK CONFIGURATION DATA..... | 5-7 |
| Figure 5.7 WINDOWS 2000 NETWORK CONFIGURATION DATA..... | 5-8 |
| Figure 5.8 WINDOWS NT NETWORK CONFIGURATION DATA..... | 5-9 |
| Figure 5.9 WINDOWS XP NETWORK CONFIGURATION DATA..... | 5-10 |
| Figure 5.10 NETWORK SETUP MENU..... | 5-11 |
| Figure 5.11 ETHERNET PING RESULTS..... | 5-12 |
| Figure 5.12 WEB SERVER SCREEN..... | 5-12 |
| Figure 5.13 ETHERNET FILE TRANSFER..... | 5-13 |

Figure 6.1 SETUP MENU 6-1

Figure 6.2 GPS STATUS DISPLAYS..... 6-2

Figure 6.3 GPS-SYNCHRONISED FAULT..... 6-5

Figure 6.4 FAULT INITIATION COUNTDOWN 6-5

Figure 7.1 WAVEFORM PLAYBACK FILE SELECTION 7-3

Figure 7.2 WAVEFORM FOLDER SELECTION 7-3

Figure 7.3 WAVEFORM PLAYBACK FILE DISPLAY 7-4

Figure 7.4 WAVEFORM PLAYBACK SETUP 7-5

Figure 7.5 WAVEFORM CHANNEL SCALING 7-6

Figure 7.6 DIGITAL OUTPUT PROGRAMMING..... 7-8

Figure 7.7 WAVEFORM PLAYBACK RESULTS 7-9

Figure 7.8 WAVEFORM PLAYBACK SEQUENCE OF EVENTS 7-10

Figure 7.9 SAVE/RESTORE RESULTS FILES 7-11

Figure 7.10 FOLDER NAME ENTRY 7-12

Figure 8.1 SLAVE MODE MENU..... 8-1

Figure 8.2 DEFAULT MASTER CONTROL DISPLAY 8-2

Figure 8.3 AMPLIFIER CONFIGURATION MENU 8-3

Figure 8.4 MODIFIED MASTER CONTROL DISPLAY..... 8-3

Figure 8.5 CURRENT CONNECTIONS FOR 3X4 PARALLEL OUTPUTS 8-4

Figure 8.6 LINE DIFFERENTIAL RELAY TEST CONNECTIONS..... 8-5

1. INTRODUCTION

1.1. GENERAL DESCRIPTION

The MTS-5100 Protective Relay Test System is a compact product containing all the features required to perform comprehensive testing of virtually any protective relay device or system. Ease-of-use was a primary design consideration to enhance the productivity of even relatively inexperienced users.

Comprehensive manual-controls give instant access to advanced functions with an easy-to-use interface that does not need an external control computer. A full color VGA graphic display provides intuitive control menus, complete operational status information, detailed help screens, and vector displays of complex polyphase output signals.

Four AC/DC high voltage output channels and six AC/DC high-current output channels provide all the high-VA sources needed for testing both modern processor-based relays and older, higher burden electromechanical relays. Twelve status inputs and four digital outputs provide monitoring and simulation capabilities respectively for the digital outputs and inputs of both complex relays and the systems in which they are incorporated. A full range of conventional interfaces including USB and Ethernet provide convenient access to offline storage and high-speed data exchange with an external computer.

1.2. DISTINCTIVE FEATURES

- Compact, easy-to-carry package; one person can transport a complete test system.
- Comprehensive manual-controls including a keypad to quickly and precisely set of any parameter; rotary dial to intuitively and continuously modify any parameter; function buttons to select menus; and dedicated state control buttons to control AC/DC output channels.
- Bright full color VGA graphic display for intuitive control menus, color coded status and setting information, and polyphase vector displays.
- Extensive built-in help screens with tutorial information on use and applications plus connection diagrams.
- Advanced polyphase control modes provide single-command control of voltage to current phase relationships, current or voltage amplitudes, and rotation of fault relationships to adjacent phase.

- 12 status input channels accept voltage or dry contact inputs, allow multiple relay output monitoring without moving wires, and can provide multichannel analog waveform capture.
- 4 contact outputs provide high-voltage rated dry contacts to simulate breaker position switches, permissive trip receive signals, etc.
- 4 high-voltage AC/DC sources for flexible polyphase testing.
- 6 high-current AC/DC sources for flexible 1/2/3/6-phase configurations, differential testing, and ability to be paralleled for high current.
- Low-level measurement inputs accept DCV/mA outputs from AC transducers
- Standard GPS inputs accept antenna or external IRIG-B timing signal, for precise synchronizing during end-to-end testing of transmission line protection systems.
- RS-232C and Ethernet interfaces allow convenient connection to an external computer for automated testing and facilitate high-speed transfer of large data files such as complex waveforms.
- USB drivers for USB memory devices as well as keyboard, numeric keypad, and mouse control.
- Very high-power-output, high-compliance-voltage current sources, to allow in-panel testing of high-burden electromechanical protective relay systems without the need to remove or short out portions of the system, resulting in much more realistic fault simulations.

1.3. APPLICATIONS

- Static and dynamic testing and calibration of virtually any protective relay, including:

| | |
|--------------------------------|--------------------------|
| Timed overcurrent/undercurrent | Under/overvoltage |
| Impedance/Distance | MHO |
| Under/overfrequency | Frequency rate-of-change |
| Directional overcurrent | Line Differential |
| Synchrocheck | Motor Protection |
| Transformer Differential | Reverse power |
| Volts-per-Hertz | Loss of excitation |
| Out-of-step | DC Timer/Auxiliary |
| Reclosing/Synchronizing | Negative sequence |
| Multi-function distance | Pilot wire |

- Testing of relay systems, in both static and dynamic modes, while installed in their panels for more realistic testing.
- Sequence of event recording via table or graphical display automatically and continuously records the MTS-5100's analog output channels and the relay's output operation during tests.
- Meter Calibration
- Transducer calibration: 1- and 3-phase voltage, current, phase, frequency, Watt, VAR and Power Factor transducers.
- Circuit breaker contact timing

1.3.1. Waveform Playback Applications

Play relay event reports or simulated faults in Comtrade format to:

- Perform fault and misoperation analysis
- Fault simulation, harmonic sourcing, and transient simulation for relay and relay system testing
- Inrush current simulation/testing (including DC offset)
- Ground resistance testing
- Playback of multiple and evolved faults.
- Digital fault recorder testing.
- Playback of EMTP calculated waveforms to relays and relay systems for simulation of hypothetical or predicted system faults.
- Simulation of non-zero source impedance for testing impedance relays. (Performed with the assistance of EMTP simulation output).
- Generation of user-defined power waveforms for relay sensitivity testing.
- Testing of pilot wire relaying systems.
- Power system modeling.
- Relay qualification and acceptance testing.

1.4. TERMINOLOGY

The following section clarifies terminology defining various approaches to relay testing.

The MTS-5100 Protective Relay Test System is very versatile, and may be used in all these types of relay testing.

1.4.1. Static Relay Testing

Static relay testing is performed by slowly varying inputs to accurately locate pickup points to obtain repeatable measurements.

1.4.2. Dynamic Relay Testing

This form of testing is performed using instantaneous steps of voltage and current inputs.

To closely simulate conditions during in-service operation, the voltages and currents are typically stepped from a nominal level to a pre-determined fault level. The MTS-5100 has the unique ability to perform dynamic testing under manual control.

1.4.3. Waveform Playback

Waveform playback refers to the regeneration of digitized voltage and current waveforms at CT/PT secondary levels. The waveform data may originate from any of the following sources:

- a) Fault records from digital fault recorders
- b) Digital simulation output e.g. from Electromagnetic Transient Program (EMTP)
- c) Event reports from microprocessor-based relays
- d) User-defined waveforms
- e) Fault record libraries

Playback of these waveforms allow actual and hypothetical fault events to be re-created. Analysis of protective relay system performance can also be carried out as a result of these events. Real-time simulation and analysis of system response to transients and other abnormal conditions is further permitted.

For a more detailed discussion of this application, see the paper “Protective Relay Digital Fault Recording and Analysis” by Elmo Price, Conference of Protective Relay Engineers, Texas A&M University, April, 1998.

1.4.4. In-Panel Testing

This refers to testing of relays and relay systems while they’re installed in panels and equipment racks. This involves injecting voltages and currents directly to the panel to test complete system response, and to verify correct input/output wiring and phasing.

1.5. TECHNICAL SUPPORT

The design of this instrument reflects decades of experience in the electric power industry. Manta Test Systems recognizes, however, that there will be testing situations encountered which were not considered during product design, and we want it to be the product which best serves your specific needs.

Manta Test Systems encourages any user questions, problems or suggestions to be forwarded to us directly to us via the Email address provided on the front cover or in the customer support area of our website.



1.6. SAFETY CONSIDERATIONS

This instrument can generate high levels of current and voltage. Incorrect usage may cause personal injury or damage to the instrument.

The user must be qualified to work safely in the intended application environment of this instrument. Non-adherence to the following minimum requirements constitutes misuse of the MTS-5100, and the manufacturer accepts no liability for damages arising from such misuse:

- 1) The instrument case must always be effectively grounded. The integrity of the power supply cord ground should always be verified before use.
- 2) All leads and connectors should be in good condition and rated for the appropriate voltage and current carrying requirements.
- 3) The output channels must not be connected to live signals or live equipment.
- 4) All output channels must be turned off before making changes in connections.
- 5) Never exceed the following maximum ratings:
 - a. 300V_{rms} to ground on any input (power or control)
 - b. 300VAC/DC differential to external trigger inputs

1.7. LIMITED PRODUCT WARRANTIES

1.7.1. Hardware

Manta Test Systems warrants that its hardware products, and the hardware components of its products, shall be free from defects in materials and workmanship under normal use and service for a period of one year from the date such products are shipped from Manta Test Systems.

Provided that Manta Test Systems receives notice of any defects in materials or workmanship of its hardware products, or hardware components of its products, within such one-year period, Manta shall, at its option, either repair or replace the defective hardware product or hardware component, if proven to be defective.

Recommended calibration interval: 1 year.

1.7.2. Software & Firmware

Manta Test Systems warrants that its software products, and the software and firmware components of its products, shall not fail to execute their programming instructions under normal use and service, due to defects in materials and workmanship, if properly installed on intended hardware, for a period of one year from the date such products are shipped from Manta Test Systems.

Provided Manta Test Systems receives notice of such defects within the warranty period, it shall, at its option, either repair or replace the software or firmware media, if proven to be defective.

1.7.3. Separate Extended Warranty for Hardware Products

Aside from the standard warranty set forth above, Manta Test Systems offers a separate extended warranty plan for all hardware products (excluding cables, batteries and accessories) which may be purchased, and extends the standard warranty by one additional year.

The extended warranty is issued under the same terms, conditions and exclusions as the standard warranty set forth herein. Pricing is based upon the cost of the product, and the average cost of servicing and calibration. Refer to the Manta Test Systems price list available from your local representative, or Manta Test Systems, for extended warranty pricing for specific products. The extended warranty must be purchased and paid for within three months from the date the product is shipped from Manta Test Systems.

EXCLUSION OF OTHER WARRANTIES AND LIMITATION OF REMEDIES

1.7.4. Exclusion of other Warranties

THE FOREGOING WARRANTIES ARE EXCLUSIVE, AND ARE IN LIEU OF ANY AND ALL OTHER WARRANTIES (WHETHER WRITTEN, ORAL OR IMPLIED) INCLUDING, BUT NOT LIMITED TO, WARRANTY OF MERCHANTABILITY IN OTHER RESPECTS THAN AS SET FORTH ABOVE, AND WARRANTY OF FITNESS FOR A PARTICULAR PURPOSE.

Limitation of Liability and Remedies

IT IS UNDERSTOOD AND AGREED THAT MANTA TEST SYSTEMS' LIABILITY AND PURCHASER'S SOLE REMEDY, WHETHER IN CONTRACT, UNDER ANY WARRANTY, IN TORT (INCLUDING NEGLIGENCE), STRICT LIABILITY OR OTHERWISE, SHALL NOT EXCEED THE COST OF REPAIR OR REPLACEMENT OF MANTA TEST SYSTEMS' PRODUCTS, AS SET FORTH ABOVE, AND, UNDER NO CIRCUMSTANCES, SHALL MANTA TEST SYSTEMS BE LIABLE FOR ANY SPECIAL, INCIDENTAL, OR CONSEQUENTIAL DAMAGES, INCLUDING, BUT NOT LIMITED TO, PERSONAL INJURY, PROPERTY DAMAGE, DAMAGE TO OR LOSS OF EQUIPMENT, LOST PROFITS OR REVENUE, COSTS OF RENTING REPLACEMENTS, AND OTHER ADDITIONAL EXPENSES.

FURTHERMORE, IT IS UNDERSTOOD AND AGREED THAT MANTA TEST SYSTEMS SHALL NOT BE LIABLE FOR ANY DAMAGES, LOSSES OR EXPENSES AS A RESULT OF THE PURCHASER'S OR ANYONE ELSE'S:

- I. NEGLIGENCE (WHETHER DEEMED ACTIVE OR PASSIVE),
- II. MISUSE, ABUSE, OR MODIFICATION OF MANTA TEST SYSTEMS PRODUCTS,
- III. USE OR OPERATION OF PRODUCTS NOT IN CONFORMITY WITH THE SPECIFICATIONS AND INSTRUCTIONS FURNISHED BY MANTA TEST SYSTEMS FOR ITS PRODUCTS,
- IV. REPAIR OR MAINTENANCE OF MANTA TEST SYSTEMS' PRODUCTS BY PERSONS OR ENTITIES NOT AUTHORIZED BY MANTA TEST SYSTEMS, OR
- V. DAMAGE TO, OR DESTRUCTION OF, PRODUCTS, DURING DELIVERY TO MANTA TEST SYSTEMS FOR ANY REASON.

Limitation of Warranty Regarding Software

Manta Test Systems does not warrant that the operation of the software, firmware or hardware shall be uninterrupted or error free.

1.7.5. Extension of Warranty

At the discretion of Manta Test Systems, the warranty may be extended for a product which has been returned for service shortly after its warranty period has expired.

2. SPECIFICATIONS

NOTE: All specifications are preliminary and are subject to change. All AC quantities are RMS values, except as otherwise noted. Power outputs are specified for nominal 120VAC/60Hz or 240VAC/50Hz power input, and 25°C ambient operating temperature. Derating applies for lower input power voltages and higher ambient temperatures.

For all current output channels, maximum obtainable current will vary inversely with load impedance. For extended operation at high power output levels, ensure adequate cooling (i.e. verify air intakes and exhaust ports are unrestricted).

2.1. INPUTS

Mains Supply

Single phase: 1800 VA max

Operating Range: 100-240VAC (auto ranging), 47-63 Hz

Status Inputs

12 channels AC/DC voltage sensing, independently isolated

Channels 1-12 also monitor NC or NO wet/dry contact status

Voltage range: 0-225 VAC, ± 300 VDC

Threshold range: 1-225 V

Threshold resolution: 0.2 V

Input impedance: > 750 Kohm

Programmable contact de-bounce delay: 0.0 - 999.9 mSec, 0.1 mSec resolution

Any channel programmable for start/stop trigger, or pulse time measurement

Waveform capture mode accuracy $\pm 1.5\%$ of reading $\pm 0.5\%$ range

Waveform capture mode sampling interval 100 microseconds

Transducer Inputs

Measures low level outputs from AC transducers

Maximum input level: ± 20 mA DC or ± 10 VDC

Measurement accuracy greater of: 0.1% of reading or 0.05% of full scale

GPS Antenna Input

Active antenna, low gain, BNC connector

IRIG-B Input

AM or TTL level, BNC connector

2.2. OUTPUTS

Voltage

4 channels AC/DC voltage, overload, short circuit and over temperature protected
0-250 V rms phase-neutral, direct coupled (0-350 V DC)
0-750 V rms (1-phase output: V1 + V2 @ 180° + V4)
Setting resolution: 0.01 V
Accuracy¹: greater of 0.15% of setting or 0.01 V rms (for > 5% of range)
Current: 0.5Arms continuous maximum, 1.5 A peak maximum
Power: 85 VA AC per phase, all phases loaded, 250 VA AC single phase
50 W DC per phase
V4 only: 150W, 200VA maximum power
0-50% superimposed harmonic, 2nd to 50th harmonic
Peak output: 355Vpk maximum
Bandwidth: (-3dB point) 3 kHz
Noise & distortion at max. power: < 0.5% guar., < 0.2% typ. For > 3% range

Current

6 channels AC/DC current, overload, open circuit and over temperature protected
0-30 A rms per channel phase-neutral, direct coupled
3-phase: 0-60 A rms, 1phase: 0-180² A rms
Accuracy¹: greater of 0.25% of setting or 0.01 A rms (for > 5% of range)
Setting resolution: 0.001 A rms
Power: 450 VA maximum per channel
3-phase: 3 x 900 VA², 1-phase: 1 x 2400VA²
Compliance: 45 V rms (63Vpk)
0-5 A DC @ 60W per channel
Accuracy: greater of 0.5% of setting or 0.015 A dc (for > 5% of range)
Bandwidth: (-3 dB point) 3 kHz
Noise & distortion at max. power: < 1% for > 3% range
0-50% superimposed harmonic, 2nd to 50th harmonic

AC Outputs Frequency/Phase

Frequency range: DC, 10-3000 Hz
Frequency resolution: 0.001Hz
Frequency accuracy: < ±1us (GPS synchronized) or < ±1 ppm typ.^{1,3} (no GPS)
Capable of generating 2 simultaneous frequencies
Phase angle range: 0-359.9°, resolution 0.1°
Phase angle accuracy¹: ±0.25° guar., ±0.1° (relative channel to channel)

¹ For frequencies 47-63Hz

² Transient; dependant on line, load and channel configuration

³ Less than 10ppm guaranteed

Digital Outputs

4 channels fully isolated form A contacts

Maximum rating: 0.4A resistive at 250 VDC, 5 Arms at 240 VAC

Available functions: 52A, 52B, unblock, permissive, and custom

Programmable transition delay: 6.0-9999.9 mSec

IRIG-B Output

5V TTL level, BNC connector

2.3. METERING**Time Measurement**

Fault timer plus four independent timer channels, measure time interval of fault duration or external start trigger to external stop trigger

0 -99999 sec or 0 - 99999 cycles, autoranging scale

Resolution: 0.1 ms (for times <1 sec) or 1ms (for times \geq 1sec)

Accuracy: ± 0.5 ppm of reading $\pm 50\mu$ s

Sequence of Events Recording

Records state changes on all contact/voltage inputs, contact outputs, and output state changes.

Resolution 0.1 ms

2.4. COMPUTED VALUES

See Section 4.9 for more details:

Impedance ($Z\Omega$, $Z\emptyset$, R, X, $Z0\Omega$, $Z0\emptyset$, $Z1\Omega$, $Z1\emptyset$, $Z2\Omega$, $Z2\emptyset$, $Z0/Z1$, $Z0/Z1\emptyset$)

% slope for current differential relays (3 methods), % harmonic current

V/Hz, V & I percent unbalance

Sequence components: V0, V1, V2, I0, I1, I2 and associated angles

Residual Current, Unbalance, K-Factor, Power (W, VAR, VA), PF

2.5. STATE SEQUENCING

Available states include Off, Prefault, Fault 1-8, and Postfault

State duration infinite or 0-9999.9999 seconds

State change control infinite, fixed duration, or dynamic based on contact/voltage input

Point-on-wave programmable from 0-359° for Prefault-Fault 1 transition

DC offset exponentially decaying, user controllable

2.6. RAMPING

Independent linear ramps programmable for each state

AC current each channel 0- $\pm 100,000$ A/s

AC voltage each channel 0- $\pm 100,000$ V/s

Phase angle each channel 0- $\pm 9,000.0^\circ$ /s

Frequency each frequency source 0- ± 20 Hz/sec

2.7. WAVEFORM PLAYBACK

Programmable from IEEE C37.111 COMTRADE format files, 1991 or 1999 standard

Reproduces analog and digital waveforms

Channel assignment and scaling performed on front panel user interface

Maximum duration 1 minute from internal memory

Peak output levels: ± 350 V for voltage channels
 ± 42.4 A for current channels

2.8. PHASE/FREQUENCY SYNCHRONIZATION

Ability to synchronize phase, frequency and time of multiple instruments:

Synchronize reference is internal clock (in master-slave mode), internal GPS receiver, or external IRIG-B signal (AM or TTL, electrically isolated)

Internal receiver requires external active low gain antenna (provided)

IRIG-B output type TTL (electrically isolated)

Internal GPS accuracy ± 1 microsecond subject to selective availability

Synchronous start of Prefault or Fault 1 in non-waveform playback mode, or start of file in waveform playback mode

2 frequency sources for synchrocheck and islanding condition tests

2.9. DATA INTERFACES

All interfaces are fully isolated from AC/DC inputs and outputs, and digital inputs and outputs. Ground where present such as RS-232, GPS antenna, USB and Video ground are connected to frame ground.

RS-232 Serial Port

Standard 9 pin male DB-9 wired as DCE (Data Communications Equipment)

Standard baud rates from 4800 to 115.2k baud

Ethernet Port

10Base-T/100Base-TX/1000Base-T, complies with Ethernet IEEE 802.3 standards

Connector: Standard RJ45 connector

Speed: 10/100/1000 Mb per second

USB Ports

Connectors: Standard 4 pin USB receptacles:
2x type “A” Host Port, 1x type “B” Slave Port (optional)
Format/Speed: Standard USB 2.0 (480 Mbps)

2.10. ADDITIONAL STANDARD FEATURES

- Numerical and phasor display of voltage and current output parameters
- Independent direct adjustment of all voltage and current amplitudes and phase angles
- All output parameters may be adjusted off-line
- Adjustment by numeric keypad or dial
- AC output amplitudes, phase angles and frequencies controllable in simultaneous multi-phase fashion
- Single-input control of phase-to-neutral, phase-to-phase, and 3-phase voltage, current and phase angles
- Single-action rotation of fault parameters to next phase
- Parameter display active and updated while under computer control
- Internal clock/calendar
- Audible feedback tone
- User programmable default output voltages, frequency, phase rotation, DC voltage, and communications settings
- Auto configuration for synchronizing, current differential, instantaneous over-current, and impedance relay tests

2.11. ACCESSORIES INCLUDED

- Front panel cover
- Shipping/transport case with rollers and telescoping handle
- Users manual
- Outdoor use GPS antenna with 100 foot cable
- AC power cord
- RS-232 cable
- Ethernet crossover cable
- Footswitch
- Test Lead Kit

2.12. APPLICATION SOFTWARE

- *RapidReporter*[®]
- Remote Console
- End-to-End Settings Generator

2.13. PHYSICAL CHARACTERISTICS

- 18.9”W x 14.5”H x 11.7”D (48.0cm W x 36.8cm H x 29.7cm D)
- Weight: 49 lbs (22.2 kg) without front protective cover
- Display: 10.4 inch diagonal TFT-LCD, SVGA resolution (800 X 600 pixels)
- Operating temperature 14° to 122°F (-10° to 50°C)
- Storage temperature -22° to 158°F (-30° to 70°C)

3. OPERATION SUMMARY

3.1. FRONT PANEL LAYOUT

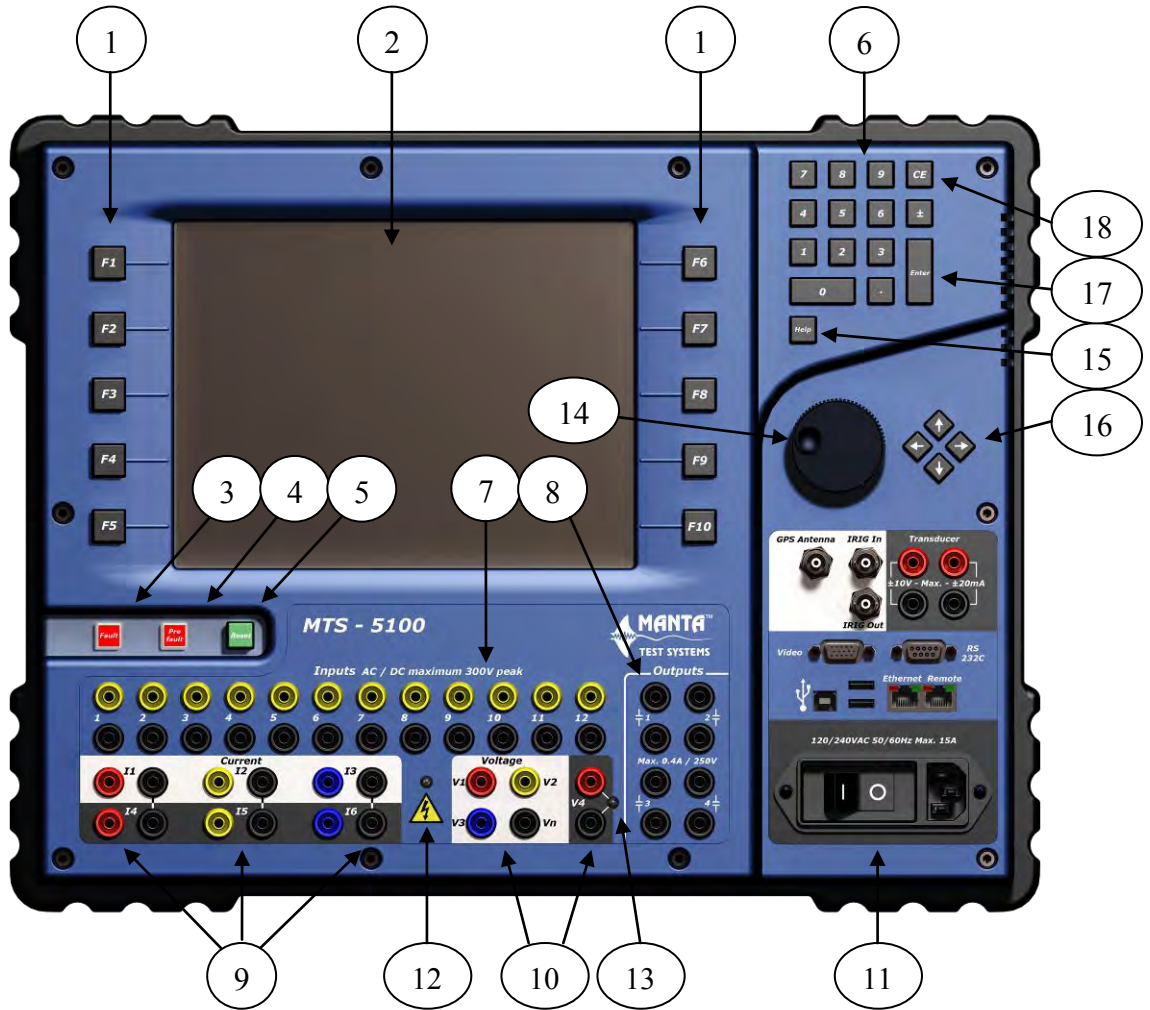

Figure 3.1 FRONT PANEL LAYOUT

1) FUNCTION BUTTONS

These ten pushbuttons are used to activate menu options that appear adjacent to the pushbuttons on the display screen. The option labels change according to the active menu.

2) DISPLAY SCREEN

All user information and menus appear here. The 800 X 600 color SVGA screen is an active matrix format with high intensity backlighting for good visibility in high ambient light conditions (readable in direct sunlight).

3) FAULT BUTTON

This pushbutton activates the Fault 1 state. A momentary press (less than 300 mSec) latches the AC/DC current and voltage outputs into Timing fault mode, where they will remain until the user presses RESET, or an operation of an external device sensed by one of the INPUT channels causes a transition to another Fault state or Postfault state. Pressing and holding the button for more than 300 mSec will activate the Pickup fault mode, where the output channels remain active only as long as the button is held, and will not be tripped off by any transitions sensed at the INPUT channels. Presence of an active Timing mode output is indicated on the display by a rapidly flashing red background and the text *Generating Fault* in the fault status box, at the bottom left edge of the display. Presence of an active Pickup mode is indicated by a steady red background in the fault status box, plus the text *Generating Static Fault*. An active output from either fault type will also illuminate the AC Output Warning LED, see item 12 below.

4) PREFault BUTTON

This pushbutton activates the Prefault state, typically used when it is desired to establish a specific stable state prior to the appearance of a programmed Fault state. If pressed, any voltages and/or currents that have been programmed for Prefault state will appear at the outputs. Presence of an active Prefault state is indicated on the display by a slowly flashing red background and the text *Generating Prefault* in the fault status box, at the bottom left edge of the display. A Prefault output will also illuminate the AC Output Warning LED, see item 12 below.

5) RESET BUTTON

This pushbutton aborts a test in progress. The first press will turn off all AC/DC output channels, and freeze the readings of all output parameters plus elapsed time(s), the second press will reset the timer(s) and output readings. If the output channels have already been tripped off, and readings frozen, as the result of a trip signal sensed by the INPUTs during a dynamic fault, the first press will reset the timer(s) and output readings. It will also turn off Prefault state if pressed when that state is active.

6) **KEYPAD**

This numeric keypad may be used to input the desired value of amplitude, phase, or frequency of any output source. It is also used for numeric input that may be required for advanced menu options.

7) **STATUS INPUT TERMINALS**

These terminals are used to monitor the operation or status of dry contacts and/or AC/DC voltage signals (Channels 1-12) in the device(s) under test. Each input pair is high impedance, and galvanically isolated, allowing connection into live equipment. They are programmable for debounce time and function, and may also be used to capture analog waveform signals. See Section 4.4 and 4.11 for details.

8) **CONTACT OUTPUT TERMINALS**

These terminals provide programmable normally-open or normally-closed dry contact outputs, whose action can be slaved to the operation of the main AC/DC outputs, or operated at specified times in a fault sequence. See Section 4.6 for further details.

9) **CURRENT OUTPUTS**

The 6 programmable AC/DC current outputs appear at these terminals. Current output channels may be paralleled to increase the amount of current available.

10) **VOLTAGE OUTPUTS**

The 4 programmable AC/DC voltage outputs appear at these terminals. By default channels V1, V2, and V3 are AC and V4 is DC. However V4 has a higher output power capability.

11) **MAINS POWER INLET/POWER SWITCH**

The mains power cord is connected to the input socket on this component. The AC power switch incorporates a circuit breaker, so an overload will cause the switch to automatically trip to the off position. This eliminates the need for replaceable fuse protection.



12) AC OUTPUT WARNING LED

This red warning LED flashes whenever any current or voltage output channel is active or armed for GPS activation. Output wiring must never be handled when this LED is illuminated.



13) V4 WARNING LED

This warning LED is illuminated whenever voltage channel V4 is active. V4 will commonly be used to power DC operated devices under test. It will often be in continuous use independent of the operation of the AC output channels. Output wiring on channel V4 must never be handled when this LED is on.

14) DIAL

This rotary dial is used both for continuous variation of output parameters, and for selection of menu items. Turning the dial slowly makes fine adjustments. Turning the dial at a moderate speed and high speed makes medium and coarse adjustments respectively.

15) HELP PUSHBUTTON

This button brings up Help text on the display with information relevant to the displayed screen or function menu. Pressing and holding the HELP button will allow you to save a screenshot of the displayed screen in *.png* format.

16) CURSOR CONTROL PUSHBUTTONS

The arrow pushbuttons move the cursor to the location of a parameter the user wishes to change with the keypad or dial.

17) ENTER PUSHBUTTON

This button is pushed to lock in a numeric setting which has been programmed by the keypad or dial.

18) CLEAR-ENTRY PUSHBUTTON

This button is pushed to clear a numeric setting which is being entered.

3.2. AUXILIARY INPUT-OUTPUTS

Technical information on the GPS and data interfaces is available in Sections 6 GPS OPERATION and Section 5 DATA INTERFACES respectively.

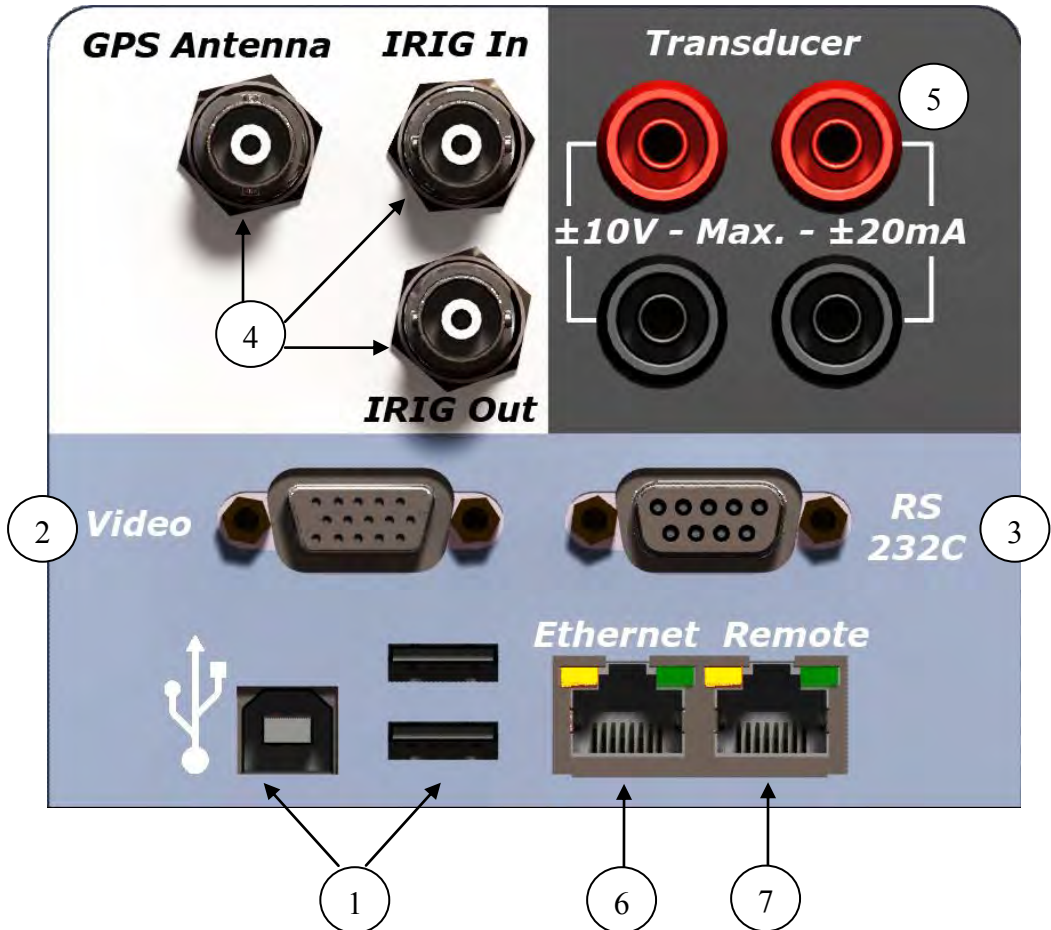

Figure 3.2 AUXILIARY INPUT-OUTPUTS

1) USB CONNECTORS

Standard USB 2.0 peripherals such as a USB data storage drive, mouse or keyboard may be connected to these USB Type-A ports. A square Type-B port is provided for future remote control functionality.

2) VIDEO CONNECTOR

A standard computer monitor or projector may be connected to this output for a larger view of the display data. This can be useful in training situations where several people wish to view the information simultaneously.

3) RS-232 SERIAL PORT

This standard DTE connected serial port provides a communication facility for older computers which do not have Ethernet or USB capability.

4) GPS CONNECTORS

The GPS Antenna input is for connection of an external antenna to the on-board Global Positioning Satellite (GPS) receiver. This facilitates precise timing of testing sequences at physically separate locations, such as end-to-end testing. The IRIG IN input allows connection to standard IRIG-B encoded serial data. The IRIG OUT output allows the MTS-5100 to act as an IRIG-B source. Using the output as a follower (passing the input signal through to the output), allows the MTS-5100 to be inserted into the middle of an existing TTL format IRIG-B loop without disabling downstream devices, or provide a synchronizing signal to a second MTS-5100 when doing very high current testing.

5) TRANSDUCER INPUTS

A transducer signal of up to ± 10 VDC or ± 20 mADC may be connected to these measurement inputs. This feature provides high accuracy measurement of the output of transducers. The MTS-5100 transducer inputs are isolated from each other and all other connectors; however, it is recommended that the transducer's outputs and the MTS-5100 transducer inputs be isolated from all external devices.

6) ETHERNET CONNECTOR

This standard RJ-45 network jack allows connection to an external computer. Typical applications are remote control of the MTS-5100, transferring files to and from a computer, and high-speed data downloading for complex waveform generation.

7) REMOTE CONNECTOR

This RJ-45 jack enables connection to a second MTS-5100, MTS-5000 or other slave box, for master/slave remote control of one by the other. Typical applications include: 2, 3, or 4 winding differential protection or providing very high 3-phase or single-phase currents.

3.3. BASIC APPLICATIONS

3.3.1. Getting Started

- Connect mains power to mains power inlet.
- Turn on the Power switch.

Following the initialization sequence, the startup display shown below will appear.

Select any menu item by pressing the pushbutton immediately to the left or right of the menu item. To select Manual Test for example, the user would press the F1 button.

Throughout this manual, the screen displays will not include the graphic illustration of the accompanying pushbuttons, but will refer to them in the written description. Text which appears on the display will be in italics to distinguish it from text in the manual. In the example just given, the instruction would read “Press *Manual Test* [F1]”.

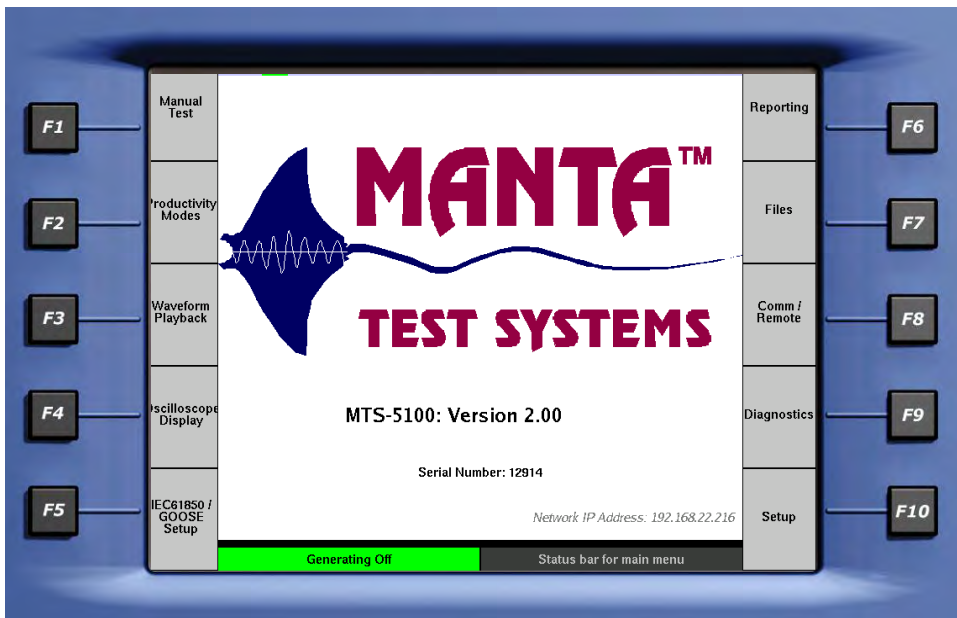

Figure 3.3 STARTUP DISPLAY

Note that the installed firmware version is displayed on the lower portion of the display. Certain operating features described in this manual may only be available with the same or later firmware version as listed on the reverse side of the first page of this manual.

3.3.2. Safety & other precautions

3.3.2.1. SAFETY.



- The red AC Output Warning LED between the AC voltage and current output terminals indicates when any V1-V3 voltage or I1-I6 current outputs are potentially live. It will flash to warn that the outputs are enabled.



- Whenever the Fault Status Box at the bottom left side of the display is flashing red, there are potentially live AC/DC outputs.

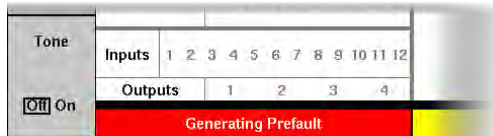

- The DC voltage output may be live at all times. This is indicated by the red LED beside the V4 voltage output terminals, and red background of the DCV data.

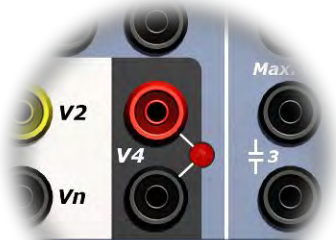

- NEVER contact an exposed metallic part of the output circuit with bare hands when it is connected to any output of the test system!

UNDER NO CIRCUMSTANCES ATTEMPT TO ALTER OUTPUT WIRING WHEN ANY OF THE ABOVE LIVE OUTPUT INDICATORS ARE ACTIVE!

3.3.2.2. *ISOLATION.*

- All AC/DC outputs are isolated from the AC input supply and case/earth ground to a maximum of 300 VAC/DC. All voltage neutrals (V1-3) are connected together but are isolated from case/earth ground. The neutral for the 4th voltage channel is isolated from the V1-3 neutral and case/earth ground. Current terminal neutrals are common in pairs (I1 & I4, I2 & I5, I3 & I6), but are isolated from the other pairs and case/earth ground.
- The Status Inputs and Outputs are isolated from each other, from the AC input supply, from the AC/DC outputs, and from the case/earth ground.

3.3.2.3. *PROTECTION.*

- The AC voltage outputs are protected from short circuits, overloads and over temperature.
- The AC current outputs are protected from open circuits, overloads and over temperature.

3.3.2.4. *PRECAUTIONS.*

- **DO NOT CHANGE CONNECTIONS WHILE OUTPUTS ARE ENERGIZED!**
- Turn outputs off before making current and voltage connection changes. Connections from the MTS-5100 to the device(s) under test should always be the last made and first disconnected.
- **DO NOT OPEN/CLOSE A CURRENT CIRCUIT WHILE OUTPUTS ARE ENERGIZED!**
- **NEVER** contact an exposed metallic part of the output circuit with bare hands when it is connected to any output of the test system!

3.3.3. Manual Test Menu

Most manual testing will be controlled from the Manual Test Menu. At the Startup Menu shown in Figure 3.3, press *Manual Test* [F1] and the Manual Test Menu will appear as shown in Figure 3.4 below.

NOTE: Only data displayed in [blue](#) may be directly modified. Dark grey signifies computed or automatically generated data, such as the Fault Timer reading in Figure 3.4.

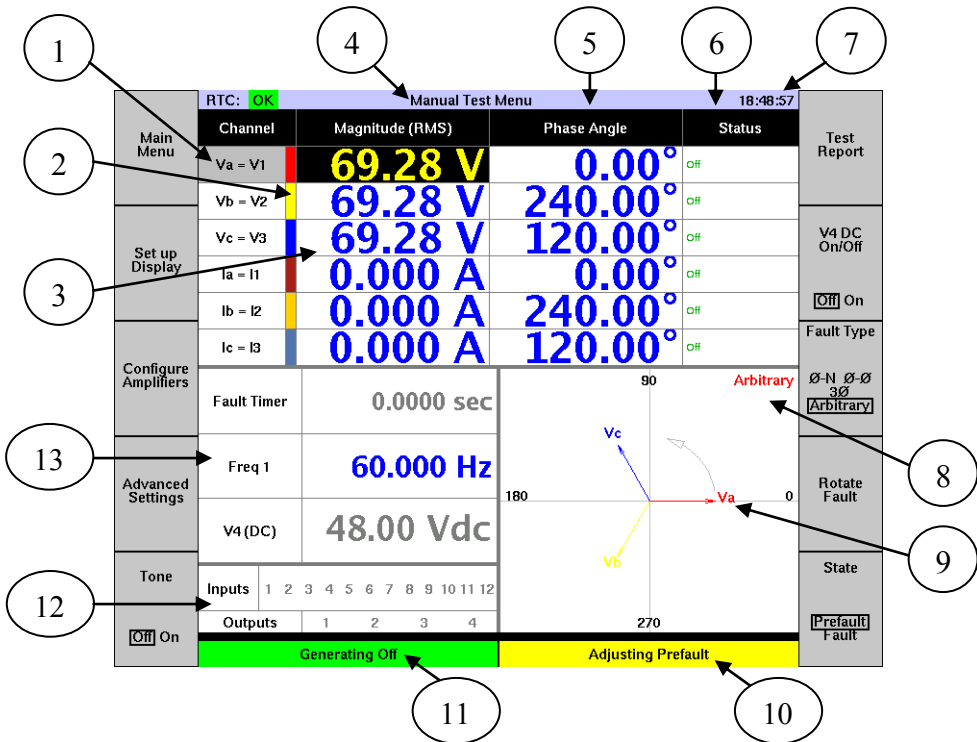

Figure 3.4 MANUAL TEST MENU

1) **OUTPUT CHANNELS**

Lists the number and type of output channels available in the present configuration. The length of this list will vary depending on configuration.

2) **OUTPUT CHANNEL COLOR BAR**

Identifies the color assigned to the corresponding channel on the Vector Display, see item 9.

3) OUTPUT CHANNEL MAGNITUDE

Lists the present setting of the output channel in volts or amps RMS.

4) MENU IDENTIFICATION BAR

Identifies the currently selected menu, which is Manual test in the example.

5) PHASE ANGLE VALUE

Lists the phase angle setting of the current or voltage on that channel.

6) STATUS DATA

Lists information on active status, and abnormal conditions such as over temperature, open circuit output, ramping, etc. Messages include *Off*, *On*, *Clip*, *Overload*, and others. See Section 10 for a full listing of messages.

7) TIME/GPS INFORMATION

This shows the current time in 24-hour or UTC format, depending on whether the system is selected for internal, or external (GPS) timing source respectively. The GPS time will only be precise when the internal GPS receiver is locked on to a number of satellites, as indicated by the lock status information at the left edge of the Menu Identification Bar (*OK* or *NO*), or an external IRIG-B signal is supplied to the IRIG IN input. Refer to Section 6: GPS Operation for further information.

8) FAULT TYPE/PHASE

Lists the currently selected fault mode, as controlled by the *Fault Type* button [F8], and the fault phase, controlled by the *Rotate Fault* button [F9].

9) VECTOR DISPLAY

This displays the amplitude and phase relationships of all the active output AC voltage and current channels as a phasor diagram. The color of the individual vectors identifies the channel, as noted in item 2 above. Voltage vectors have an open-ended arrow, and current vectors have a closed-end arrow. By default the individual vectors are all identified by text labels as well. Phase rotation is indicated by the light grey curved arrow and the relative position of the phase vectors. In the illustration, the direction arrow is counterclockwise, so an observer on the x-axis/ 0-degree line would see the phasors go by in an A-B-C sequence. The display also contains in the upper right corner information about the fault mode selected for adjustment, including fault type and phase. For information on modifying colors in this display see Section 3.8.1. Customize.

10) SELECTED FAULT BOX

This color-coded box identifies which of the available Prefault, Fault, or Post-fault states is currently selected for modification. The color of the box changes according to the fault selection, which is controlled by the *State* button [F10].

11) FAULT STATUS BOX

This color-coded box identifies the output status of the selected fault, labeled in the Selected Fault Box and shown graphically in the Vector Display. A green background accompanied by the text *Generating Off* always means the voltages V1, V2, and V3 and all output current channels are offline. A red background always means that all enabled currents and V1-V3 voltages are online and that hazardous voltages may therefore be present. Text identifying the fault mode currently active at the outputs will accompany the red background, for example *Generating Static Fault*, *Generating Fault 2*, etc.

12) DIGITAL INPUT/OUTPUT STATUS

This area provides information on the on/off status and configuration of all inputs and outputs. A solid red box around the input number indicates the input is closed. A red outline box around the input number indicates the input contact is set for voltage sensing. The absence of a red outline box indicates the contact is set to monitor dry contacts.

13) DYNAMIC DISPLAY AREA

This area provides data from an extensive range of user selectable displays, which may be programmed in the Display Setup Menu, entered via the *Set Up Display* button [F2]. See Section 4.9 ADDITIONAL DISPLAY INFORMATION for more information.

3.4. RELAY TESTING

3.4.1. Quickstart Procedure

The following procedure illustrates the minimum steps required to test basic types of protective relays.

ENSURE YOU ARE FAMILIAR WITH THE SAFETY PRECAUTIONS 3.3.2.1 TO 3.3.2.4 BEFORE PROCEEDING!

The factory default settings which appear on the instrument (see Figure 3.4) when selecting *Manual Test* [F1] are:

VA = V1 = 69.28V @ 0.0 Deg

VB = V2 = 69.28V @ 240.0 Deg

VC = V3 = 69.28V @ 120.0 Deg

IA = I1 = 0.0A @ 0.0 Deg

IB = I2 = 0.0A @ 240.0 Deg

IC = I3 = 0.0A @ 120.0 Deg

V4 = 48VDC

Fault Type = Arbitrary

Fault Phase = A

Frequency 1 = 60.00Hz

Channels 1-6 Status Inputs set to tone when closed and stop any FAULT mode.

Note that the user can change the default settings to match their preferences, but this discussion assumes factory default settings including phase rotation A-B-C.

Connections:

- Connect the relay's AC inputs to the appropriate test-set voltage and current outputs.
- Connect the relay's output contact(s) to the test-set's Status Input(s). By default, Inputs 1-12 sense dry contact operation.

Output Adjustments/Selections:

- Press *State* [F10] to select Fault mode, as indicated by a box around *Fault*, and *Adjusting Fault* in the Selected Fault box.

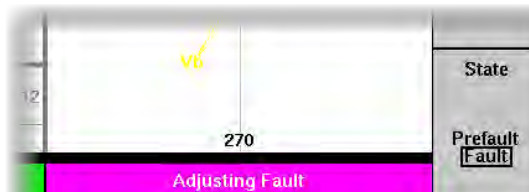

- The 'cursor', indicated by a darker background color and yellow text as shown below, will be initially be located on the Magnitude cell of the VA channel.

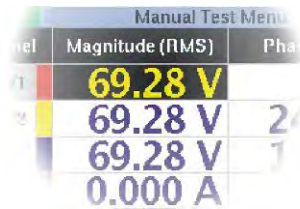

| Channel | Magnitude (RMS) | Phase |
|---------|-----------------|-------|
| V1 | 69.28 V | |
| V2 | 69.28 V | 24 |
| V3 | 69.28 V | 1 |
| I1 | 0.000 A | |

The position of the cursor indicates which parameter may be adjusted by the keypad and/or dial. In the above example, it would be the voltage amplitude of AC output V1.

- Move the cursor to the desired parameter cell by pressing the arrow keys,



and use the keypad and/or dial to enter the desired setting. NOTE: only cells containing blue text may be selected via the arrow keys, and modified.

- For large or precise numeric parameter changes enter the desired value on the keypad, and press ENTER when complete, or move to another cell via the arrow keys.
- For small or incremental changes to a numeric parameter, rotate the dial; clockwise increases the value, counterclockwise decreases it. The rate of change is velocity sensitive, so rotating it faster makes larger changes, rotating it slower makes smaller changes.

- Note that if any key on the keypad is pressed, new function keys appear until the keypad sequence is completed. These include *Delete Last Character* [F6], *Abort Changes* [F9], *Accept Changes* [F10], and when appropriate +/- [F4]. This adds the ability to modify an entry on the fly without having to re-enter the complete number, and enables the entry of negative numbers.
- Some cells permit the selection of a parameter rather than modifying a numeric quantity, for example selecting Frequency 1, 2 or DC as described in Section 3.5.2 Frequency Control. In this case, rotate the dial. A selection list drops down, and moving the dial scrolls through it. Leaving the cursor on the desired selection a few seconds, or pressing ENTER, locks it in.

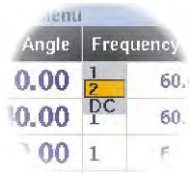

- If it is desired to have an audible tone when Inputs 1-6 operate, press *Tone On/Off* [F5].

Energizing Output Channels

V4 Voltage

The V4 output channel can operate independently and power a relay with DC voltage, or act as a standard AC/DC voltage that will turn on and off with the other voltage channels. By default, the V4 voltage is set to provide DC voltage to a relay and V4 (DC) magnitude is shown in the dynamic display area. If DC voltage is required to power a relay being tested, the V4 voltage output may be energized independently of the AC channels by pressing *V4 On/Off* [F7]. The red warning LED between the V4 output terminals will illuminate whenever the output is live, and the background of the V4 (DC) data cell will turn red.

By default, the DC voltage level is locked to the value specified in the Setup Menu and is accessible by pressing *Setup* [F10] in the Startup display (see Figure 3.3). Control of the DC voltage magnitude may be unlocked at any time without altering the default value by pressing *Configure Amplifiers* [F3] in most test menus, then *Allow V4*

Adjustment [F6] in the Amplifier Configuration Menu. The screen will change to the previously selected menu and the cursor will move to the V4 (DC) field. The V4 (DC) magnitude may be adjusted with the keypad or dial, as described in the previous section. When the adjustments to V4 (DC) are complete, you can move the cursor to another setting with the arrow keys. V4 (DC) will revert back to the unchangeable state to prevent unintentional changes to the DC voltage. If you wish to change the V4 (DC) magnitude again, return to the Configure Amplifiers menu and repeat the steps described above.

To use V4 as a regular voltage channel, press *Advanced Setting* [F4] and press the UP arrow button to select the "V4 Powers Relay" row and use the dial to select "No". Press *Back to Test Menu* [F1] and V4 has moved from the Dynamic Display area to the Output Channel area where the magnitude and phase angle can be adjusted exactly like V1-V3.

AC Voltage/Current

Once all parameters have been set, press the red FAULT button to initiate the test. The programmed fault levels will be applied to the output channels, and the timer is started. If the FAULT button is just pressed momentarily (<300 mSec) the output channels will latch on and stay energized until a trip signal is sensed on Status Inputs 1-6, or the RESET button is pushed. This state is referred to as Timing mode. See Section 4.2.2 TIMING Fault Mode for more details.

If the FAULT button is held on, the outputs will remain energized until the button is released, and any trip signals on the Input(s) will have no effect on the AC outputs. This state is referred to as Pickup mode. See Section 4.2.1 PICKUP Fault Mode for more details.



When the AC/DC output channels are energized, the red AC Output Warning LED will flash, the text in the Fault Status Box will read *Generating Fault*, and the background of the box will flash red. If Pickup mode is engaged as described in the previous paragraph, the Fault Status Box will read *Generating Static Fault* and its background will turn red.

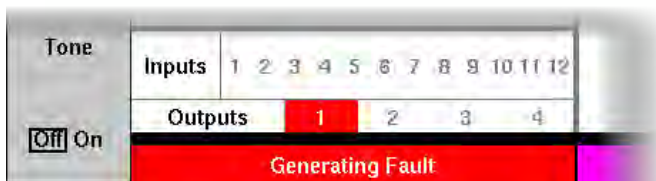

If Timing mode was engaged when the relay under test operates; the status input(s) will be activated, the trip tone will sound briefly, the output channels will switch off, and the timing, voltage, phase, and frequency readings will be frozen. The label below the vector display will state *Captured Fault Values*. The Fault Status box on the display will turn green, display *Generating Off*, and the AC Output Warning LED will turn off. Press RESET to clear the frozen readings.

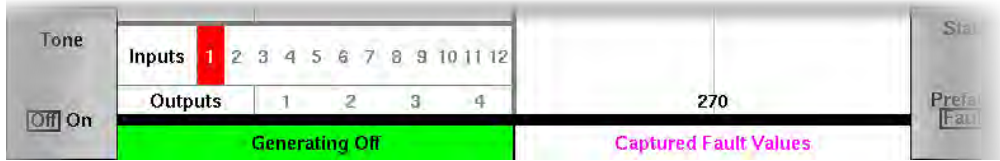

3.5. ADDITIONAL FEATURES

3.5.1. Paralleling Currents

Some applications require more current than can be produced by a single AC current channel. You can increase the amount of current available by paralleling channels, which automatically sets the amplitude, phase angle and frequency of each current to be identical to that of the others in its group. The MTS-5100 can automatically make these adjustments so that only a single amplitude, phase angle, and frequency need to be specified for all paralleled channels. Press *Configure Amplifiers* [F3] in the Manual Test Menu (Figure 3.4) to enter the Amplifier Configuration Menu.

| Back to Test Menu | | RTC: OK Amplifier Configuration Menu 16:44:34 | | | | Allow V4 Adjustment | |
|---|--|--|-----------|--------------------|---------|---------------------|---------|
| | | Parallel Amplifier Setup | | | | | |
| | | Source | Group | Ungrouped | Group A | Group B | Group C |
| | | I1 | Group A | | 30 Amps | | |
| | | I2 | Group A | | 30 Amps | | |
| | | I3 | Group B | | | 30 Amps | |
| Voltage Outputs (V1, V2, V3) | | I4 | Ungrouped | 30 Amps | | | |
| | | I5 | Ungrouped | 30 Amps | | | |
| | | I6 | Ungrouped | 30 Amps | | | |
| Off <input type="checkbox"/> | | Total Current: | | | 60 A | 30 A | 0 A |
| Current Outputs (I1 to I6) | | Current Amplifier Parallel Operation | | | | | |
| Off 1-3 <input type="checkbox"/> 4-6 <input type="checkbox"/> | | Parallel None | | | | | |
| Slave Voltage Outputs (V1s, V2s, V3s) | | Set each current source to one of the three parallel groups, or to "Ungrouped" to run that source independently. | | | | | |
| | | Note: current channels that are paralleled are phase locked to each other, but require external connections to be made | | | | | |
| Off <input type="checkbox"/> On <input type="checkbox"/> | | Parallel Three-phase Pairs | | | | | |
| Slave Current Outputs (I1s, I2s, I3s) | | Parallel All | | | | | |
| Off <input type="checkbox"/> On <input type="checkbox"/> | | Generating Off | | Adjusting Prefault | | | |

Figure 3.5 AMPLIFIER CONFIGURATION MENU

Any combination of parallel channels is possible by assigning individual channels to one of three groups. Any grouped channels will be replaced by a single group entry which will automatically assign the correct magnitude and phase angle to all of the channels in a group, to produce the specified magnitude and phase angle. In Figure 3.5, channels I1 and I2 have been grouped together into Group A for a maximum output of 60A and Channel I3 has been placed into Group B with a maximum output of 30A.

A dedicated *Parallel All* [F10] button is available to quickly parallel all active channels based on the Current Outputs (I1 to I6) [F3] selection. On returning to the Manual Test Menu, there will be a single row of cells for adjusting the current of all of the grouped channels simultaneously (see Figure 3.8). To restore individual channel control, press *Parallel None* [F8] in the Amplifier Configuration Menu.

Although the system automatically makes the individual amplitude, phase, and frequency adjustments to each current channel, the outputs of all grouped channels must physically be paralleled externally, as shown below in Figure 3.6 for the configuration in Figure 3.5.

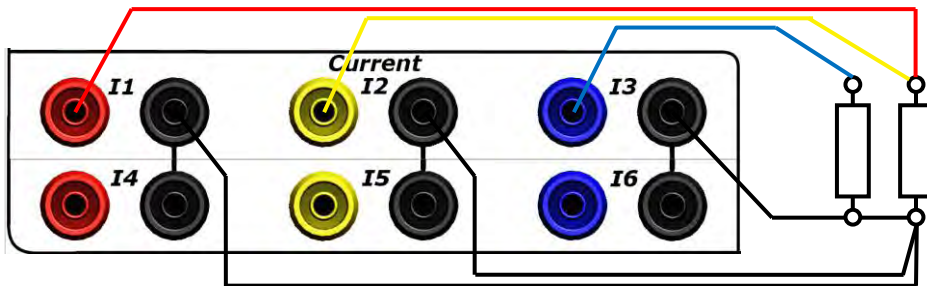

Figure 3.6 2-CH. MEDIUM CURRENT PARALLEL CONNECTIONS



NOTE: ONCE A CURRENT SOURCE IS ASSIGNED TO A PARALLEL GROUP, IT MUST BE CONNECTED IN PARALLEL WITH THE OTHERS OF ITS GROUP. THE TOTAL CURRENT SETTING APPLIED TO A PARALLEL GROUP IS DIVIDED EQUALLY AMONG THE SOURCES IN THE GROUP, AND ANY SOURCE NOT CONNECTED WILL CLIP.

The connection in Figure 3.7 is used when the highest possible current is required using 3 channels, for example when testing instantaneous overcurrent elements. Note that the compliance voltage available is equal to that of a single current channel generating one third of the total current. So, if the $V=IR$ voltage drop across the relay at the desired current level exceeds the compliance, voltage clipping will occur, and an alarm warning *Clip* will appear in the Status cell of the affected channels. Paralleling channels is the way to increase compliance voltage at relatively high currents.

To maximize the compliance voltage available at the relay terminals, i.e. to maximize the current available without clipping, use the largest gauge wiring possible and ensure all connections from the wiring to the relay inputs are firmly tightened.

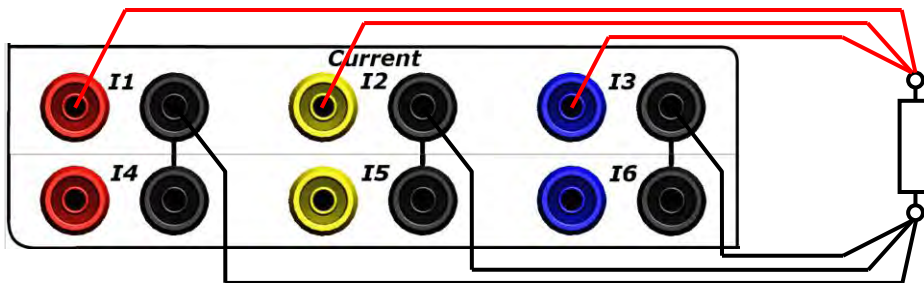

Figure 3.7 SINGLE PHASE HIGH CURRENT PARALLEL CONNECTIONS

In any of the possible parallel current connection combinations, the amplitude, phase angle and frequency within each group will automatically be matched. Press *Manual Test Menu* [F1] to return to the Manual Test display. There will be a single row of information presented about each group as shown below (Figure 3.8) which matches the configuration above (Figure 3.7).

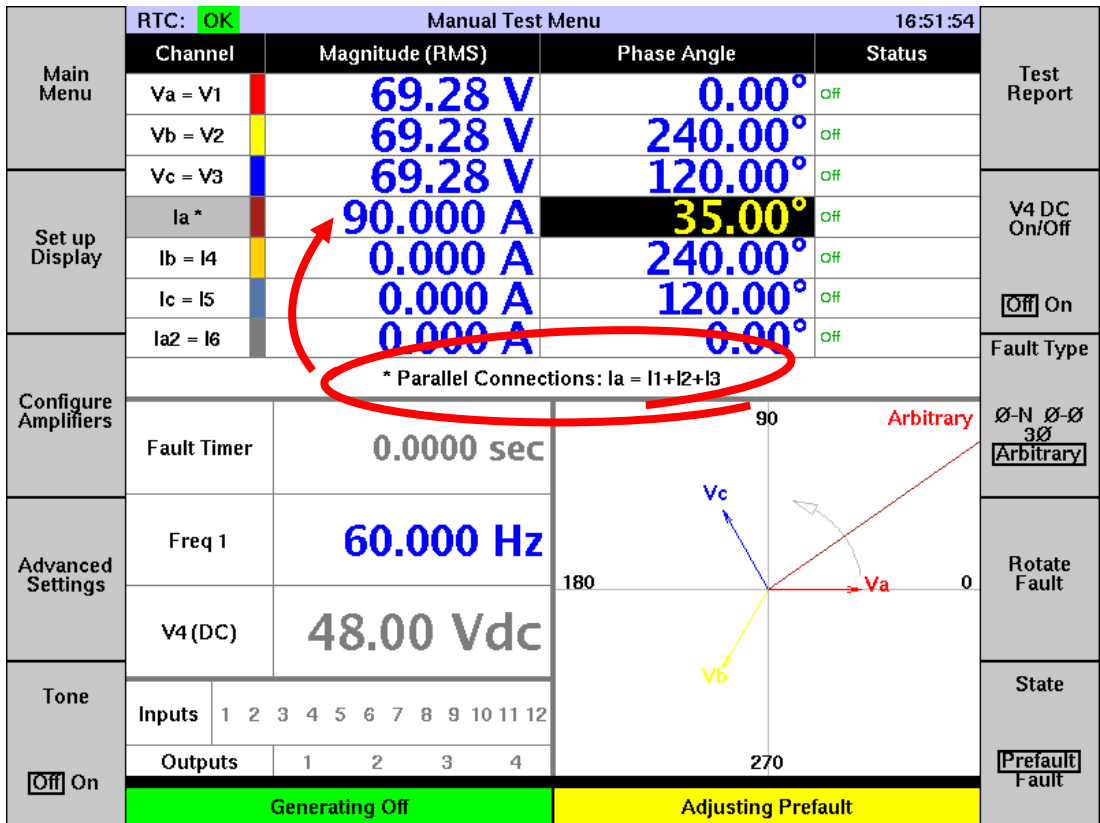

Figure 3.8 PARALLELED CURRENT MANUAL TEST DISPLAY

The current amplitude setting will equal the sum of the currents from all the paralleled sources in each group, and the listing in the source column will show all the sources connected in that group. Any amplitude setting applied with the keypad or dial will automatically be divided among the sources so the total current available equals the setting. Any phase angle setting applied with the keypad or dial will be applied to all sources in the group.

3.5.2. Frequency and DC Control

By default all AC output channels are synchronized to the same frequency, whose value is shown in the *Freq 1* cell in the Dynamic Display area (see Figure 3.4). To change the frequency, move the cursor to the *Freq 1* cell, and enter the desired value with the keypad or dial.

To display and control two different frequencies and/or DC, enable the Frequency column on the manual test display by pressing *Advanced Settings* [F4], then the Show Frequency Column button [F10] on the *Advanced Settings* Menu (see Figure 4.20). For synchrocheck relay testing there is a convenient automatic setup mode described in Section 3.6.2.

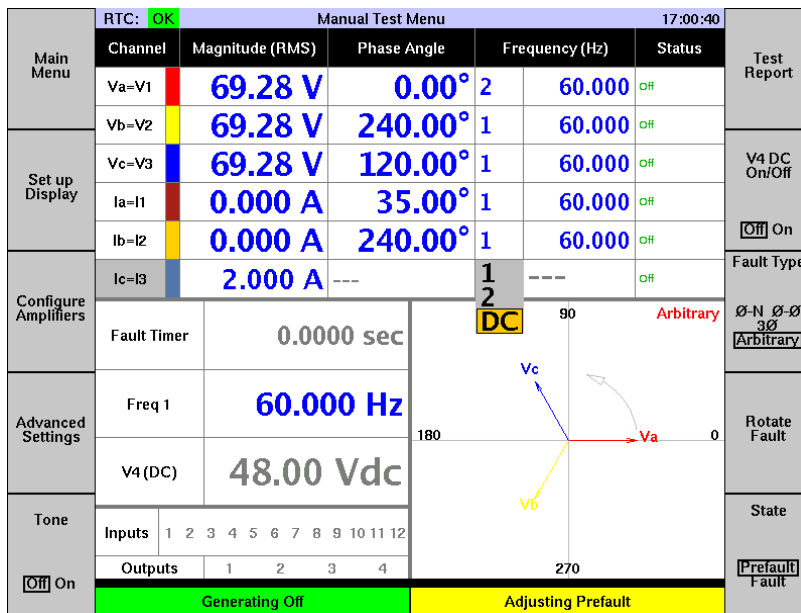

Figure 3.9 FREQUENCY CONTROL

Once the frequency column is turned on, move the cursor to the smaller left hand box in the *Frequency (Hz)* column of the channel whose frequency you wish to set differently than the others, and turn the dial to select Frequency 2 or DC. In the screen above, Va has been set to Frequency 2 and Ic is being selected for DC. Moving the cursor to the larger right hand box under the *Frequency (Hz)* column will allow all channels set to the same frequency number to be adjusted simultaneously by the keypad or dial.

3.5.3. Multiple Frequencies

The most common application for two frequencies is for testing synchrocheck relays, so a dedicated Productivity Mode is provided to configure the system for this application. See Section 3.6.2 for further information.

3.5.4. DC Current

The most common application for DC current is to verify the operation of current-activated trip indicators found in some electromechanical relays. Any current source can be allocated to this function. In Figure 3.9 on the previous page, Ic is being selected for DC operation, as described in the underlying text. A shortcut key has also been supplied to simplify the setup procedure when only I1-I3 is available on the screen. Press *Configure Amplifiers* [F3] from any menu that has a Configure Amplifiers selection and press *Set I3 to DC* [F9]. The frequency columns will automatically appear and I3 will be set to output DC current. To return the output channels to their default configuration, press *Configure Amplifiers* [F3] from any menu that has a Configure Amplifiers selection and press *Set all Channels to AC* [F9].

3.5.5. Increasing Voltage Output

The standard 0-250 VAC range of the voltage output channels is rated in line-ground voltages which can apply up to 433VAC line-line to any three-phase system.

Single-phase voltages greater than 250VAC and up to 433VAC can be easily applied by connecting the voltage input to V1 and V2 (instead of V1 and Vn) and pressing *Fault Type* [F8] until Φ - Φ is selected and ensuring that *Rotate Fault* [F9] indicates that A-B is selected. Alternatively, you can select a *3 Φ Fault Type* [F8] and the select *Φ - Φ from 3 Φ Voltages* [Φ - Φ]. The Fault Voltage Magnitude will be the applied voltage between V1 and V2.

For a single phase voltage up to 500 VAC, connect the load across the ‘hot’ outputs of two channels (V1 and V2 for the example in Figure 3.10, as wired in Figure 3.11). Set the phase angle of the second channel plus or minus 180 degrees from the other channel to which it is connected. The total voltage will then be the sum of the amplitudes set on each channel.

| Main Menu | RTC: OK | Manual Test Menu | | | 11:36:24 | Sequence of Events |
|----------------|---------|------------------|-------------|--------|-----------|--------------------|
| | Channel | Magnitude (RMS) | Phase Angle | Status | | |
| Set up Display | VA - V1 | 150.00 V | 0.00 | off | V4 On/Off | |
| | VB - V2 | 150.00 V | 180.00 | off | | |
| | VC - V3 | 69.28 V | 120.00 | off | | |
| | IA - I1 | 0.000 A | 60.00 | off | | |
| | IB - I2 | 0.000 A | 240.00 | off | | |

Figure 3.10 HIGH VOLTAGE CONFIGURATION

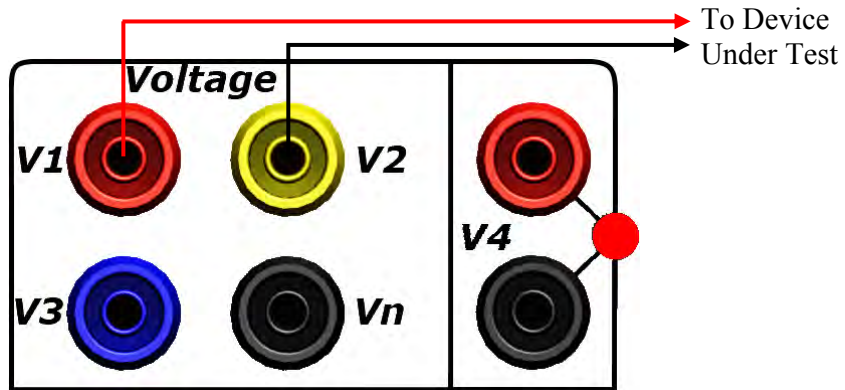

Figure 3.11 HIGH VOLTAGE OUTPUT CONNECTIONS



**CAUTION!! USE EXTREME CARE WHEN HIGH VOLTAGE TESTING
NEVER SOME IN CONTACT WITH ENERGIZED WIRING
DISABLE OUTPUTS BEFORE CONNECTING WIRING
INATTENTION CAN KILL!!**

3.6. PRODUCTIVITY MODES

Productivity Modes are special, built-in routines that automatically configure the MTS-5100 for the unique requirements of common relay testing applications. When these modes are selected; the display is revised to present the AC output parameters required for the test, connection diagrams, special vector displays, automatic computing of settings and results, and pushbutton selection of multiple test modes. All of these features can dramatically simplify and speed up performance relay testing.

To access Productivity Modes from the Manual Test Menu, press *Main Menu* [F1] to return to the MTS-5100 Main Menu, then *Select Productivity Mode* [F2] and a list of all of the available productivity modes are displayed (see Figure 3.12).

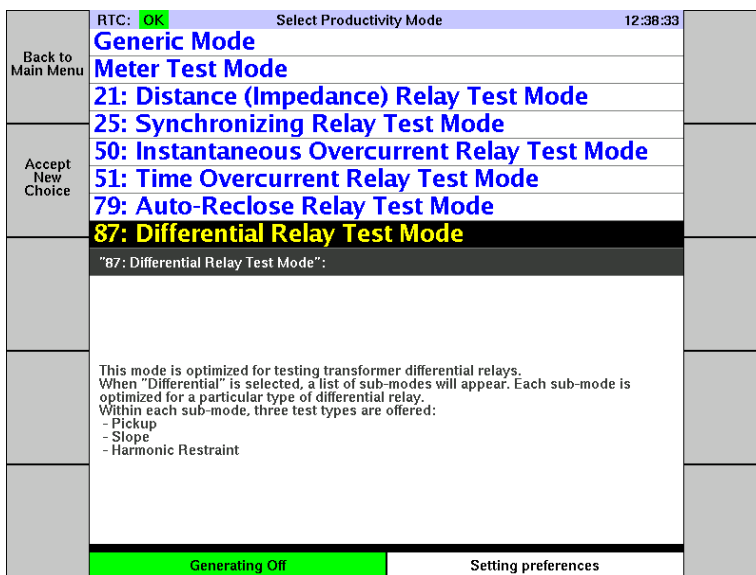

Figure 3.12 SELECT PRODUCTIVITY MODE MENU

3.6.1. Differential Relay Testing

The Productivity Mode selection for differential relay testing contains both generic and device-specific options. To access it, go to the Select Productivity Mode Menu as described above.

Move the cursor to the *87: Differential Relay Test Mode* option with the dial or arrow keys, and press *Accept New Choice* [F2] or enter. You can now choose from a list of available differential relays in the productivity mode library. Select Generic 87 Relay with the dial or arrow keys and press *Accept New Choice* [F2] or ENTER to see an example of a Differential Productivity Mode.

| Exit Differential Test Mode | | RTC: OK Differential Mode: Generic 87 Relay 13:24:21 | | | | Sequence of Events |
|-------------------------------------|-----------------|---|----------------------------|---|-----------------|--|
| Channel | Magnitude (RMS) | Phase Angle | Status | | | |
| Ia1 * | 0.000 A | 0.00° | Off | | | |
| Ia2 = I3 | 0.000 A | 180.00° | Off | | | |
| * Parallel Connections: Ia1 = I1+I2 | | | | | | |
| Set up Display | | % of Tap | 0.0 % | Generic 87 Relay | | V4 DC On/Off |
| | | Fault Ia | 0.000 A | <p style="text-align: center;">MTS-5100 Current Sources</p> | | <input type="checkbox"/> Off <input type="checkbox"/> On |
| Configure Amplifiers | | Winding 1 | 5.0 : 5 | | | |
| | | Winding 2 | 5.0 : 5 | | | |
| | | Fault Timer | 0.0000 sec | | | |
| Advanced Settings | | V4 (DC) | 48.00 Vdc | | | <input type="checkbox"/> Pickup <input type="checkbox"/> Slope <input type="checkbox"/> Harmonic Restraint |
| Tone | | Inputs | 1 2 3 4 5 6 7 8 9 10 11 12 | | | State |
| | | Outputs | 1 2 3 4 | | | <input type="checkbox"/> Prefault <input type="checkbox"/> Fault |
| | | Generating Off | | | Adjusting Fault | |

Figure 3.13 DIFFERENTIAL RELAY TEST CONFIGURATION

The Differential Mode: Generic 87 Relay screen starts in the Pickup Test Mode as selected by the *Differential Relay Test Mode* button [F9]. Start a pickup test by making the connection as shown in the connection diagram. The Ia1 arrow refers to the channel labeled Ia1* in the Output Channel area. The asterisk is defined as "Parallel Connections: Ia1 = I1 + I2" and, therefore, a test lead is connected from the I1 Red terminal to the relay's Winding 1 current input with the polarity mark as shown by the red dot beside the Ia1 arrow in the diagram. Because Ia1 = I1 + I2, another test lead is connected between the I2 polarity (White terminal) and the same relay current input I1 is connected to. Two additional conductors are added between the I1 and I2 black conductors and the non-polarity current connection on the relay to complete the circuit shown on the left-hand side of the connection diagram.

The right-side of the connection diagram indicates that Ia2 is connected to the Winding 2 terminals and the Output Channel area indicates Ia2 = I3. Therefore, connect a test lead between the blue terminal of I3 and the relay's Winding 2 current terminal marked for polarity. Another test lead is connected between the I3 black terminal and the relay's Winding 2 non-polarity current terminal.

Most productivity modes have dedicated screens for the three standard test sequences that are controlled by the [F9] button called: *Pickup*, *Slope*, and *Harmonic Restraint*. The *Exit Differential Test Mode* [F1] button clears the special setup mode and returns to the Select Productivity Mode menu.

3.6.1.1. Pickup Mode

Refer to Figure 3.13 on the previous page. Adjust the *Winding 1* and *Winding 2* ratios to match the tap settings on the relay being tested. Then select the *Fault Current 1* cell, press FAULT, and increase the current with the keypad or dial until the relay operates. Pickup is often specified in % of tap value, so this percentage value is automatically calculated from the current and winding settings.

The BDD and HU specific Pickup Test screens have provision for winding 1 >= winding 2 and winding 2 > winding 1 tests, and include the actual relay terminal numbers on the diagram. Current will be injected to the winding with the higher setting to ensure the correct test results.

3.6.1.2. Slope

Press [F9] to select *Slope* mode as shown.

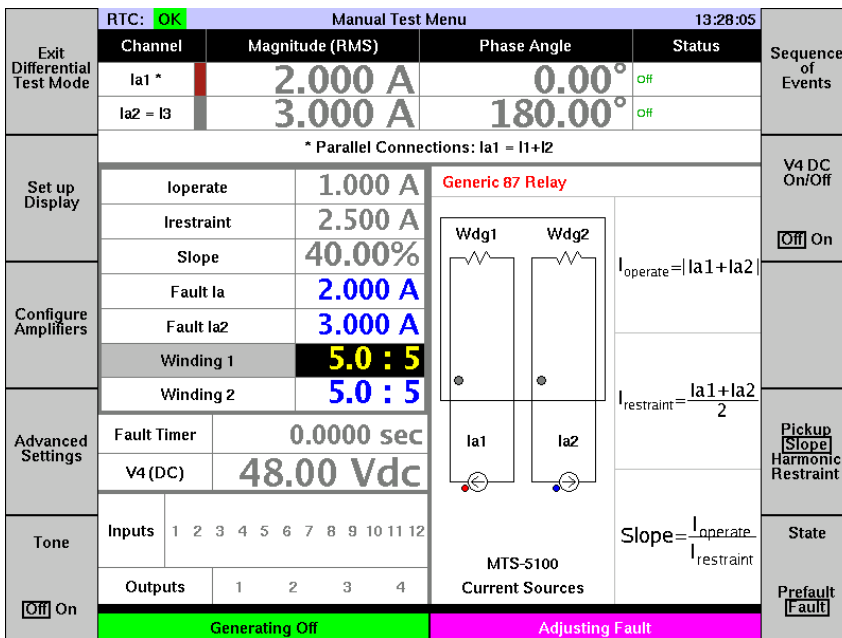

Figure 3.14 DIFFERENTIAL RELAY SLOPE TEST MODE

The Winding 1 and Winding 2 current taps set in *Pickup* mode will be carried over, and the phase angle relationship of the two currents is automatically set to 180° to simulate an external fault with the current sources sharing a common neutral. Note that an additional +/-30° may be necessary if the transformer is a Wye-Delta configuration. Typically one current will be fixed to a value recommended by the manufacturer, and the second current varied until the relay operates. The % slope will be automatically calculated based on the Ioperate and Irestraint values, and displayed in the Dynamic Display Area.

The BDD and HU specific screens selected by the [F8] button have provisions for winding 1 >= winding 2 and winding 2 > winding 1 tests and include the actual relay terminal numbers on the diagram. The manufacturer's recommended restraint current should be entered into the current channel defined by Irestraint = ??? on the right-hand side of the connection diagram. Vary the operate current as per the manufacturer's recommendations by adjusting the current defined as Ioperate on the right side of the connection diagram. The formula for calculating slope changes depending on the mode selected, but the correct formula is automatically selected and displayed with the calculated result in the Dynamic Display Area. However, the manufacturer's specified chart for slope tests is recommended when evaluating results.

As in the previous test, additional information is available at any time by pressing the HELP key.

3.6.1.3. Harmonic restraint

Press [F9] to select *Harmonic Restraint* mode as shown.

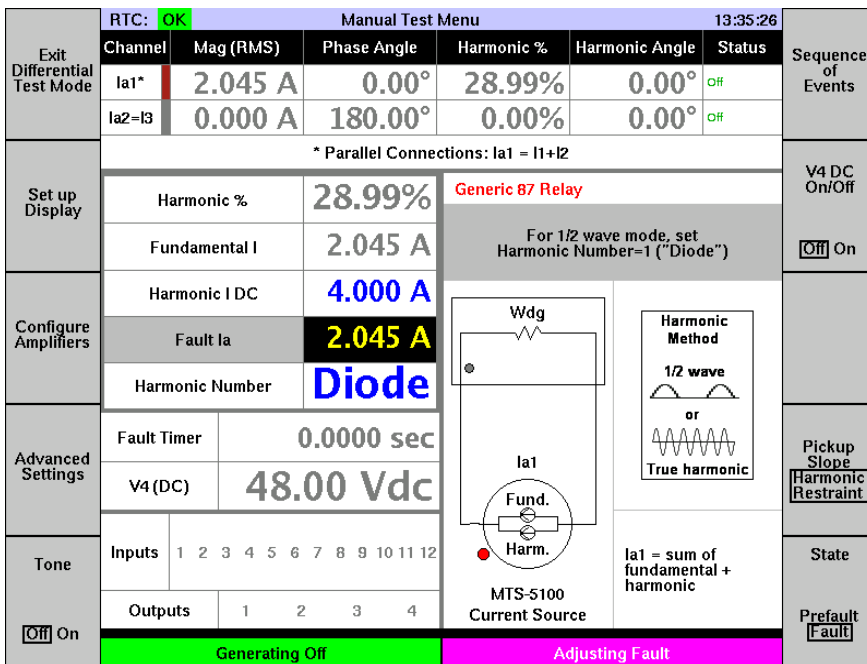

Figure 3.15 DIFFERENTIAL RELAY HARMONIC RESTRAINT TEST MODE

There are two methods offered to perform this test. The classic 'Diode' method was originally employed with electromechanical relays using half-wave rectified DC current via a series diode combined with pure AC current, to produce a variable percentage of

2nd harmonic content according to a specific formula. The *Diode* selection in the Harmonic *Number* cell produces a current waveform identical to this approach.

The second method combines a fundamental (2nd, 4th, or 5th) harmonic frequency to simulate the distorted inrush current that the harmonic restraint feature is designed to recognize. A different formula is used to calculate % harmonic content. The desired harmonic number can be selected in the *Harmonic Number* cell.

For the Diode method, move the cursor to Harmonic Number and turn the dial counter-clockwise until "Diode" is visible, and press enter or wait a few seconds for the value to be locked in. Then alter the Harmonic I DC and Fault Current 1 values as per the manufacturer's recommended procedures to cause the relay to operate or block operation. For BDD and HU relays using the Diode method, set the harmonic current to 0.8X tap setting and then increase the Fault Current 1 until the relay operates. The Harmonic % will be automatically calculated and should match the manufacturer's specifications.

As in the other differential test modes, the BDD and HU screens offer additional options and terminal connection information.

3.6.2. Synchronizing Relay Testing

Select 25: *Synchronizing Relay Test Mode* from the Select Productivity Mode Menu. Specific help is available via the HELP key.

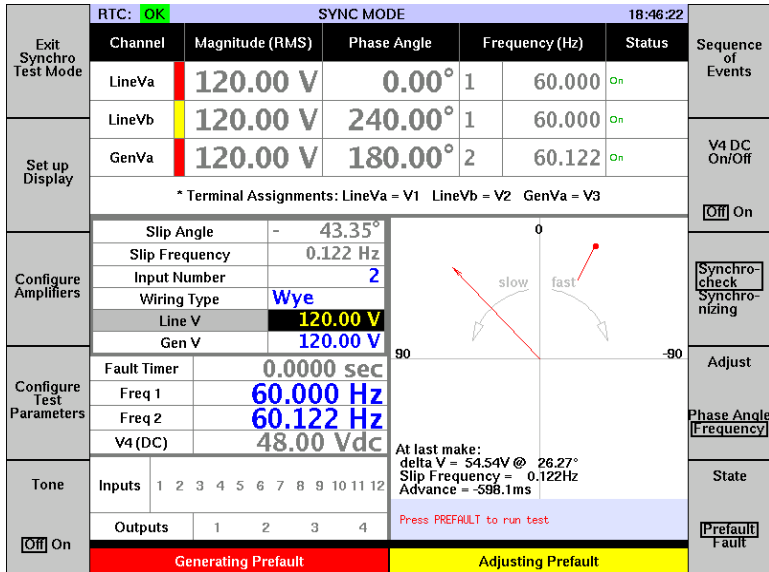

Figure 3.16 SYNCHROCHECK RELAY TEST MODE

Two types of relays may be selected in this mode via the F8 button, namely *Synchrocheck* relays and *Synchronizing* relays. Synchrocheck relays are typically used to supervise breaker close operations where different static phase angles, or slowly changing parameters between two power systems may be present. Synchronizing relays supervise or automatically control the closure of a generator breaker where variable voltage, frequency, and/or phase angles are usually present. Since generator breakers are normally closed with the generator frequency slightly higher than the system frequency (to ensure outgoing power flow), it is important that the breaker operate time is considered to ensure that all parameters will still be within acceptable limits when the breaker closes. Selecting *Synchronizing* therefore adds a *Breaker Close Time* input cell and changes the phase-angle adjustment in the synchrocheck function to Freq 2 to more accurately simulate a generator synchronizing procedure.

| | |
|----------------|----------|
| Slip Angle | 180.00° |
| Slip Frequency | 0.106 Hz |
| Input Number | 2 |
| BKR Close Time | 0.0ms |

Once a breaker close time has been specified, it will be included in the *Advance* time data captured in the Vector Display (see Figure 3.16).

The vectors in the Vector Display function as a synchroscope. The *LineVA* and *LineVB* vectors remain fixed, and the *GenVA* rotates clockwise or counterclockwise depending on the relative frequency and/or phase angle of the two vectors. The Slip Angle and Slip Frequency data in the Dynamic Display Area are updated continuously.

Each time the contact of the relay under test operates, there will be a ‘lollipop’ marker left on the display showing where closure of the relay contact (or breaker in *Synchronizing* mode) occurred. Specific data about the voltage difference, slip frequency, and advance time in milliseconds at that time are recorded on the bottom of the Vector Display. Advance time is the time that it would take from the relay contact closure (or breaker closure in *Synchronizing* mode) to reach 0 degrees phase difference at the slip frequency when the contact closed. In other words, for a given phase angle at closure, the higher the frequency slip rate, the closer the (advance) time is to 0 degrees.

Generator synchronizing relays sometimes monitor conditions following output contact closure to ensure that the breaker closed successfully and that generator parameters are now locked to line parameters. When *Synchronizing* is selected, the test is initiated in Prefault mode but following contact closure and the specified breaker close time delay, the system automatically switches to Fault state and locks the Generator parameters to the Line VA parameters, simulating successful synchronizing. See Section 4.1 for more information on fault states.

Connect V1 (and V2 if required) to the bus voltage inputs of the relay under test, and V3 to the generator voltage inputs of the relay. Connect the relay close contact to Status Input designated by the Status Input setting. All tests are performed in the Prefault state.

3.6.2.1. *Wiring Types*

You can now choose from 3 different wiring types.

1. **Wye** – Single phase testing where the synchronizing relay uses a single phase-to-neutral signal on either side of the circuit breaker.
2. **Delta** – Multi-phase testing where the synchronizing relay uses:
 - a. 1-phase, phase-to-phase signals on both sides of the circuit breaker
 - b. 3-phase, phase-to-phase signals on one side of the breaker and a 1-phase, phase-to-phase signal on the other side of the circuit breaker
 - c. 3-phase, phase-to-phase signals on both sides of the circuit breaker
3. **Delta-Y** – Multi-phase testing where the synchronizing relay uses a 3-phase signals on one side of the breaker and a 1-phase, phase-to-neutral signal on the other side of the circuit breaker

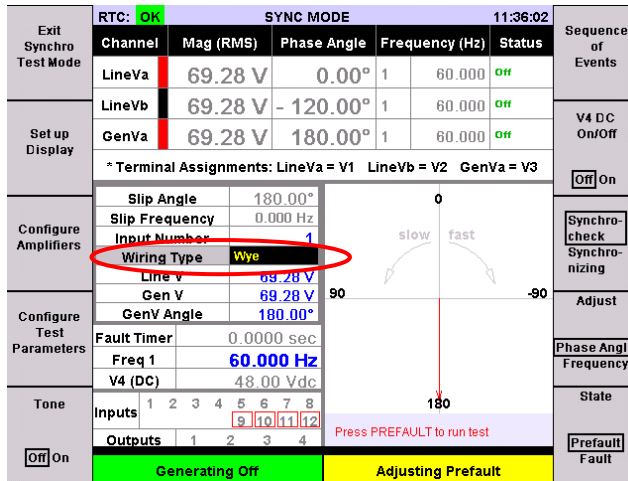
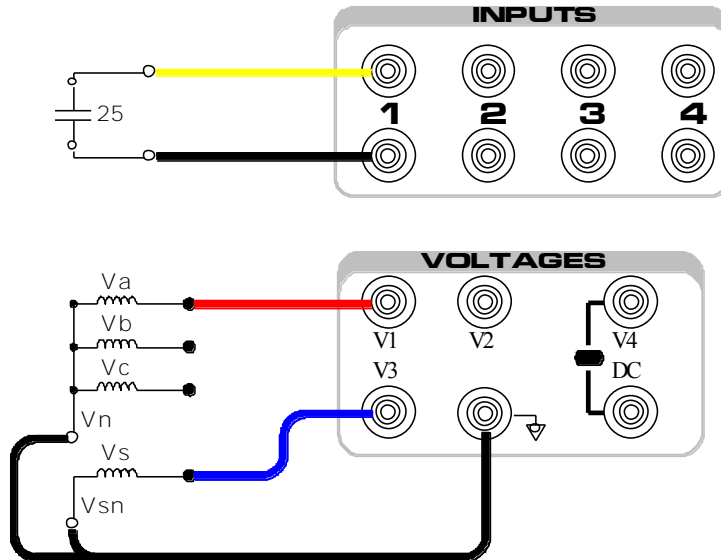

Figure 3.17 SYNCHROCHECK RELAY: WIRING TYPE SELECTION

Determine which connection type the relay requires and connect as per the following scenarios (Input 1 and 25 output remains constant for all tests):

Synchrocheck Relay: Wiring Type = Wye

Synchronizing Voltage = Van



Synchrocheck Relay: Wiring Type = Delta

Single Phase Synchronizing Voltage = V_{ab}

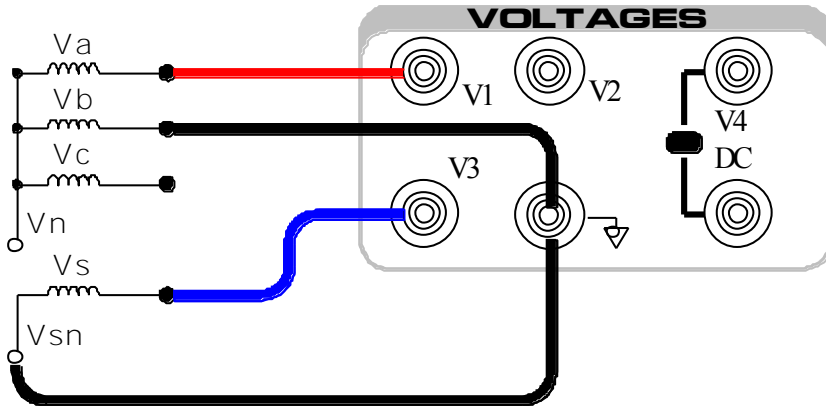

Three Phase Synchronizing Voltage = V_{ab}

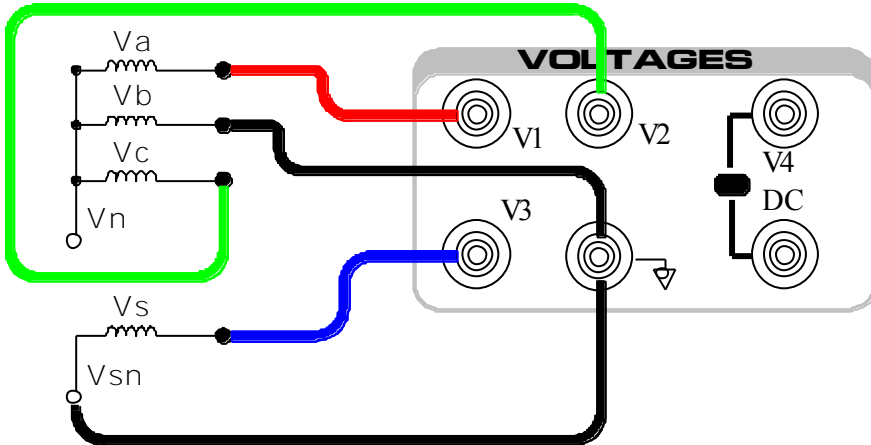

Synchrocheck Relay: Wiring Type = Delta (cont'd)

Six Phase Synchronizing Voltage = V_{ab}

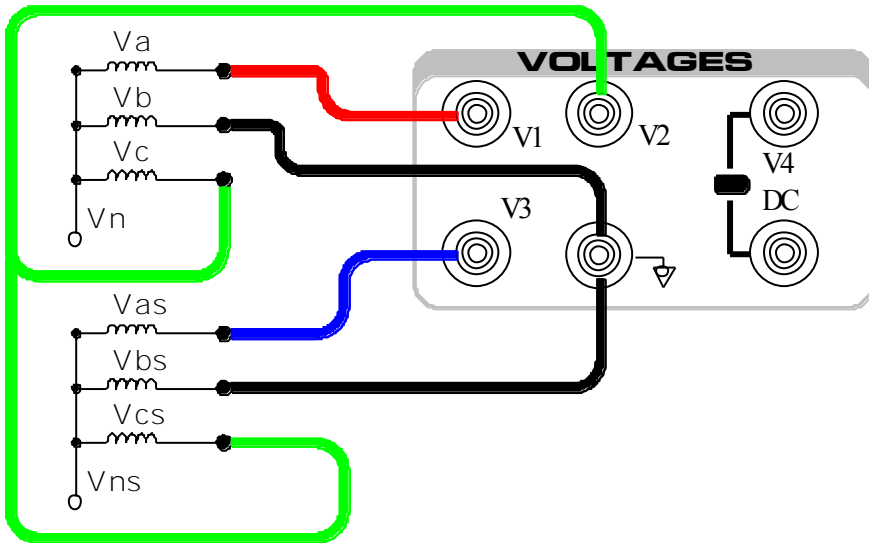

Synchrocheck Relay: Wiring Type = Delta-Y

Three Phase Synchronizing Voltage = V_{an}

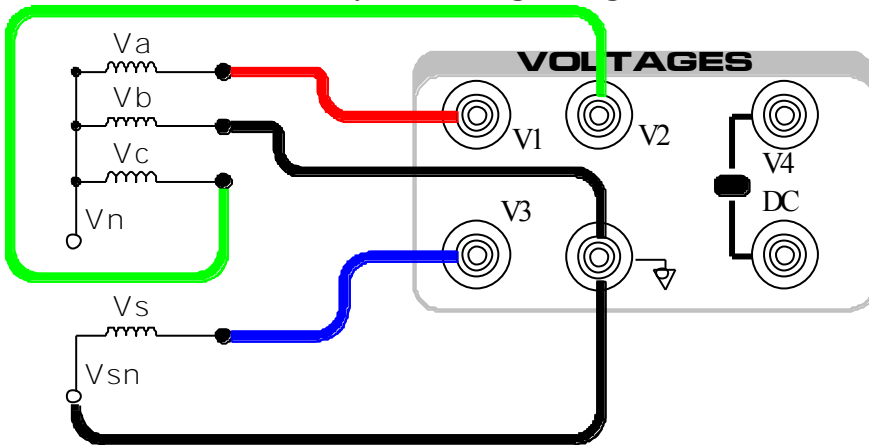

3.6.2.2. *Phase Angle Limit Check*

Ensure *Synchrocheck* mode [F8] is selected. Select *Phase Angle* on the *Adjust* key [F9]. Verify that *LineVA* and *GenVA* voltage levels are identical and set at nominal levels. Verify that the Freq 1 setting is also nominal which is set to control all Voltage channels. Use the arrow keys to select the *V Angle 2* setting and set it to 45°. The *GenVA* vector will lead the *LineVA* reference vector by 45° that should be outside the operation setpoint of most synchrocheck relays. Press PREFault and decrease the phase angle slowly (rotate the dial counterclockwise) until the relay operates. The message at the bottom of the display will record *Delta V* in terms of xV @ y° (see Figure 3.16). Record the phase angle value and continue to rotate the dial until the relay drops out. Slowly rotate the dial in the opposite direction until the relay operates. The captured phase angle value at this point is the second of the two phase angle limit points.

3.6.2.3. *Voltage Limit Check*

Set the V angle 2 phase angle to 0° with the keypad or dial, then select the *Gen V* cell with the arrow keys. Raise the voltage with the dial until the relay drops out, and record the captured *Delta V* voltage. Lower the voltage until the relay picks up again and record the voltage for the Overvoltage or Delta V relay setting test. Continue lowering it until it drops out a second time. The captured voltage at this point should be recorded as the Live Line/Generator setting or the Min Voltage setting test results. You can continue lowering the voltage to determine the Dead Line/Generator setting. These tests can be repeated for *Line V* input, if desired, by setting the *Gen V* setting at the nominal voltage and follow the previously described steps varying the *Line V* instead off *Gen V*.

3.6.2.4. *Slip Frequency Limit Check*

Set the *Line V* and *Gen V* voltages to their nominal voltages with the keypad or dial, then select *Frequency* on the *Adjust* button [F9]. The cursor will move to the *Frequency (Hz)* cell of *GenVA* which is now set to Freq 2. Raise Freq 2 with the dial so the *Slip Frequency* reading in the Dynamic Display Area remains less than the setting of the relay. Verify that the relay contact closes each time the rotating vector passes through 0°. Increase the frequency for a *Slip Frequency* reading just over the expected value and verify that the relay no longer operates around 0°. Decreasing the frequency to slightly below the slip frequency setting should cause the relay to operate again, confirming the operate point value.

3.6.2.5. *Breaker Advance Time Check*

As noted above, the MTS-5100 can simulate a generator successfully synchronizing to a power system in *Synchronizing* mode. A synchronizing relay must be able to accommodate the fixed close time delay of a generator breaker across a significant range of frequency slip rates to ensure breaker closure at, or close to, 0° phase difference. If the relay is functioning correctly, and the *Breaker Close Time* value in *Synchronizing* mode is set equal to the relay's breaker advance time setting, the captured Delta V results in the Vector Display should always be close to 0 degrees, and never exceed the phase angle limits determined above.

To measure the relay's advance time setting directly, simply set the *Breaker Close Time* to zero in *Synchronizing* mode. Initiate the test by pressing Prefault with a frequency slip rate within the operate range. The captured *Advance* reading, i.e. the time to reach 0°, should equal the relay setting.

Press *Exit Synchro Test Mode* [F1] to leave the 25: Synchronizing Relay test Mode.

3.6.3. Instantaneous Overcurrent Relay Test Mode

Select *50: Instantaneous Overcurrent Relay Test Mode* from the Select Productivity Mode Menu.

| | | | | | |
|--|---------------------------------------|----------------------------|---|-------------------|-----------------------------|
| RTC: OK | | Manual Test Menu | | | 18:52:22 |
| Exit Inst. Overcurrent Test Mode | Channel | Magnitude (RMS) | Phase Angle | Status | Test Report |
| | la * | 85.500 A | 0.00° | off | |
| Set up Display | * Parallel Connections: la = I1+I2+I3 | | | | V4 DC On/Off |
| | | | | | <input type="checkbox"/> On |
| Configure Amplifiers | Generated Current | 95.0 % | Instantaneous overcurrent (50) relay test mode Pickup test instructions: Configure the settings to match your relay, then press PREFault. The test ends when the relay trips or the maximum level has been applied. Press F6 to view or save a test report. | | |
| | Generated Current | 85.500 A | | | |
| | Max duration | 0.1667 s | | | |
| | Max cycles | 10.0000 cyc | | | |
| | Pickup Level | 90.000 A | | | |
| | Start Level | 95.0 % | | | |
| Configure Test Parameters | Max Level | 105.0 % | Parallel All Currents | | |
| | Step | 1.0 % | | | |
| | Input Number | 1 | | | |
| | Fault Timer | 0.0000 sec | | | |
| | Freq 1 | 60.000 Hz | | | |
| Tone | Freq 2 | 60.000 Hz | Test Type | | |
| | V4 (DC) | 48.000 Vdc | | | |
| | Inputs | 1 2 3 4 5 6 7 8 9 10 11 12 | | | |
| Off <input type="checkbox"/> | Outputs | 1 2 3 4 | Pickup Timing | | |
| | Generating Off | | | Adjusting Fault 1 | |

Figure 3.18 OVERCURRENT RELAY TEST MODE

The Instantaneous Overcurrent selection can generate short pulses of high current which step through a specified range to quickly identify the operate point and operate time of the instantaneous element. Since these elements usually operate at high levels, on-screen provision is made for paralleling all current sources, *Parallel All Currents* [F8].

The default settings of: 6.000 cycles/0.1000 seconds per current pulse, a 95% to 105% of nominal setting span of current output, and a 1% step increase of current after each 1-second delay interval; are suitable for most applications but all can be modified in their respective cells of the Dynamic Display area. The duration should exceed the expected pickup time. The *Start Level/Max Level* values should be outside your expected tolerance and the Step should be sensitive enough to obtain a valid test result.

Select the *Pickup Level* cell and enter the expected operate value for the relay being tested. If the value is more than a single current source can provide, the system will not accept the value until *Parallel All Currents* [F8] is pressed or the current amplifiers have been grouped correctly in the *Configure Amplifiers* [F3] menu. Note that if the currents are grouped in any way, it is important to ensure that all current sources are externally paralleled. See Section 3.5.1 for more information.

Press FAULT, and the current will be applied in a series of brief pulses that will increase in magnitude until; the relay operates, the specified Maximum level is reached, or the RESET button is pushed.

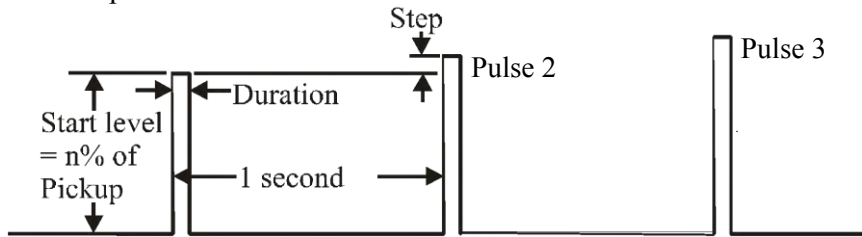

$$Pulse\ 2 = (Pickup\ Level * Start\ level) + (Pickup\ Level * Step)$$

$$Pulse\ 3 = (Pickup\ Level * Start\ level) + (2 * Pickup\ Level * Step)$$

If the relay operates while a pulse is being generated, the current level, timing values, and % error are captured as shown below.



Figure 3.19 FROZEN OVERCURRENT TEST RESULTS

The instantaneous element's operate time is usually slower at the threshold of operation than it is for a value 5-10% above that level. Any timing test should be performed at least 10% into the pickup zone. You can test element timing by pressing *Test Type* [F9] to select *Timing* mode. This automatically configures a single current pulse set 10% above the nominal operate value. Press PREFault to initiate the test, and the captured value will be displayed on the screen as shown in Figure 3.19 above. Remember to reset the relay's target before each new test, as the effort to trip the target has some influence on the timing.

3.6.4. Distance (Impedance) Relay Test Mode

Select *Distance (Impedance) Relay Test Mode (21)* on the Select Productivity Mode Menu; (see Figure 3.12).

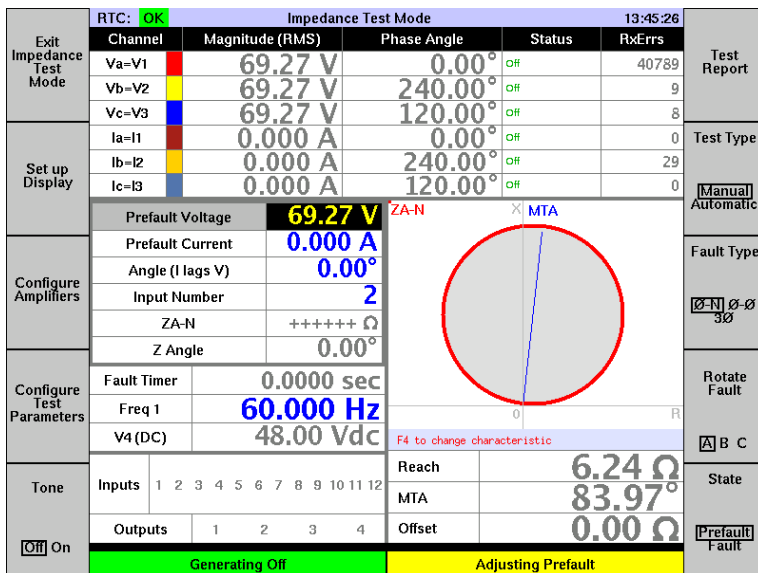

Figure 3.20 IMPEDANCE RELAY TEST MODE

As indicated by the *Test Type* button [F7] there are both manual and automatic test modes available for impedance relays. There is also a *Fault Type* button [F8] to select one of the three standard fault modes, depending on the type of relay to be tested.

By default the system is configured for a generic test mode that can be used for nearly any impedance relay, but additional specific test modes for popular electromechanical relays and impedance characteristic definitions are also available. This test process example will assume test procedures for a Φ - Φ KD-4 electromechanical relay. Reference will be made at times to other options, and the HELP key will provide additional information as appropriate. Test connections vary depending on relay type, but all use the Input Number setting in under the Angle (I lags V) setting to sense operation.

3.6.4.1. Manual Test

Press *Fault Type* [F8] to select Φ - Φ test mode. Next press *Configure Test Parameters* [F4] to bring up the Configure Test Parameters menu, then press *Settings Format* [F3] until the KD-4 option (item 3) is selected as shown on the next page. This option can be used with KD-4, KD-10, and KD-11 type relays.

| Back to Test Menu | RTC: OK Configure Test Settings Menu 13:57:22 | | | | | | | | | | | | | | | | | | | | | | | | | | | | | | | | | |
|-------------------|--|---|-------------|-------|--|-----------------|--------------------|--|-------------|---------------|--------|--------|---------------|-------|----------|-------|-------|---|--|--------------|--------|--|-----|--------|--|-----|---|--|-------------|---|--|----------|-----|--|
| | 1) Use the F3 key to select a group of relay settings that match the relay type under test 2) Enter the relay settings, then return to the previous menu by pressing the F1 key | | | | | | | | | | | | | | | | | | | | | | | | | | | | | | | | | |
| Settings Format | KD-4/10/11 Format settings notes i) Reach = $(T * S) / (1 + W)$ ii) Enter either M or L&R; the other is computed iii) MTR should be 75 degrees for KD-4 | | | | | | | | | | | | | | | | | | | | | | | | | | | | | | | | | |
| | generic 1 2 [3] | <table border="1"> <thead> <tr> <th>Description</th> <th colspan="2">Value</th> </tr> </thead> <tbody> <tr> <td>Settings Format</td> <td colspan="2">KD-4, KD-10, KD-11</td> </tr> <tr> <td>Reach / MTA</td> <td>3.44 Ω</td> <td>75.00°</td> </tr> <tr> <td>Offset</td> <td>0.00 Ω</td> <td>0.00°</td> </tr> <tr> <td>K-Factor</td> <td>0.000</td> <td>0.00°</td> </tr> <tr> <td>T</td> <td></td> <td>4.060</td> </tr> <tr> <td>L Lead</td> <td></td> <td>.06</td> </tr> <tr> <td>R Lead</td> <td></td> <td>.00</td> </tr> <tr> <td>M</td> <td></td> <td>0.18</td> </tr> <tr> <td>S</td> <td></td> <td>1</td> </tr> <tr> <td>MTA</td> <td></td> <td>75.00°</td> </tr> </tbody> </table> | Description | Value | | Settings Format | KD-4, KD-10, KD-11 | | Reach / MTA | 3.44 Ω | 75.00° | Offset | 0.00 Ω | 0.00° | K-Factor | 0.000 | 0.00° | T | | 4.060 | L Lead | | .06 | R Lead | | .00 | M | | 0.18 | S | | 1 | MTA | |
| Description | Value | | | | | | | | | | | | | | | | | | | | | | | | | | | | | | | | | |
| Settings Format | KD-4, KD-10, KD-11 | | | | | | | | | | | | | | | | | | | | | | | | | | | | | | | | | |
| Reach / MTA | 3.44 Ω | 75.00° | | | | | | | | | | | | | | | | | | | | | | | | | | | | | | | | |
| Offset | 0.00 Ω | 0.00° | | | | | | | | | | | | | | | | | | | | | | | | | | | | | | | | |
| K-Factor | 0.000 | 0.00° | | | | | | | | | | | | | | | | | | | | | | | | | | | | | | | | |
| T | | 4.060 | | | | | | | | | | | | | | | | | | | | | | | | | | | | | | | | |
| L Lead | | .06 | | | | | | | | | | | | | | | | | | | | | | | | | | | | | | | | |
| R Lead | | .00 | | | | | | | | | | | | | | | | | | | | | | | | | | | | | | | | |
| M | | 0.18 | | | | | | | | | | | | | | | | | | | | | | | | | | | | | | | | |
| S | | 1 | | | | | | | | | | | | | | | | | | | | | | | | | | | | | | | | |
| MTA | | 75.00° | | | | | | | | | | | | | | | | | | | | | | | | | | | | | | | | |
| Advanced Settings | Generating Off | Adjusting Prefault | | | | | | | | | | | | | | | | | | | | | | | | | | | | | | | | |

Figure 3.21 CONFIGURE TEST SETTINGS MENU

As indicated in the *settings notes* area of the menu, when the tap setting data is entered to match the relay under test, the resulting impedance setting is calculated automatically. The default values are valid KD-4 tap settings, but ensure the actual in-service settings are entered.

Settings Format [F3] items 1 and 2 can define an impedance using rectangular or polar definitions which will allow you to define an impedance (transmission line, for example) to allow you to test using the system parameters instead of the relay settings.

When finished, press *Back to Test Menu* [F1]. The computed reach, MTA and offset values will appear beneath the impedance diagram (see Figure 3.20).

Press *State* [F10] to select *Fault* state. In the Three Phase Parameters box (see at left),

| | |
|------------------|----------------|
| ic = I3 | 5.000 A |
| Prefault Voltage | 120.00 V |
| Prefault Current | 5.000 A |
| Angle (I lags V) | 75.00° |
| Input Number | 2 |
| ZA-B | 24.00 Ω |
| Fault Timer | 0.0000 sec |

set the current to a safe continuous value (typically 5 amps), the phase angle to the expected Maximum Torque Angle (MTA), and return the cursor to the *Fault Voltage* cell. Press FAULT, and lower the voltage with the keypad or dial until the relay operates. This will be the reach at the MTA. The computed reach (ZA-B) should be close to the theoretical reach shown below the impedance circle

display. The three phase current and voltage vectors are automatically set up for this simple one-control-input test method. See Section 4.3 for a full explanation of this three phase control process.

The most effective way to determine the operate point is to make a rapid initial adjustment of the voltage with the dial to bring the computed reach within about 10% of the expected operate point, and then more slowly lower the voltage until a relay trip is detected, freezing the readings. To verify the frozen reading, press and hold FAULT while slowly passing back and forth through the operating point. See Section 4.2 Fault Modes: Pickup & Timing, for a description of this process. Note that the border of the impedance circle on the display changes from red to green as the relay enters the operate area.

To continue the reach at MTA tests, select the next phase via *Rotate Fault* [F9] and repeat the above process. Repeat this step for the third phase.

To verify the reach at points other than the MTA, set *Angle (I lags V)* to the desired value and repeat the above steps.

Note that it is possible to achieve the same test results by setting the voltage at a reduced level and increasing the current until the relay trips. The drawback to this approach is that it may require very high currents, especially for short reach settings and phase angles farther away from the MTA, which increases the risk of overheating the relay. The variable voltage method is inherently a safer process.

To check the MTA, lower the voltage 10-30% below the trip point at the MTA and move the cursor to the *Angle (I lags V)* cell. Press and hold FAULT and use the dial to lower the phase angle until the relay drops out. Reverse direction and record the angle when the relay picks up. Repeat these steps on the other side of the circle by increasing the angle until the relay drops out, reverse direction, and record the angle when the relay picks up. The MTA is the average of these two points. Repeat for the remaining two phases via selections on the *Rotate Fault* button [F9].

3.6.4.2. *Automatic Test*

The MTS-5100 is capable of performing the above test sequences automatically, and generate a formatted report of the results which can be saved internally or imported directly to an external computer. There are a few additional test parameters which must be specified to define the auto procedures, though in many cases the default settings of these will be adequate.

The following example will describe the Φ - Φ element testing procedure for a KD-4 relay. Press *Test Type* [F7] to select *Automatic*. As shown Figure 3.22, this will generate some additional menu selections: *Test Report* [F6], an *All* selection under *Test Phase(s)* [F9], and three test functions via *Auto Test* [F10]. Note that the cells in the Three Phase Parameters box where adjustments are made in manual mode are now greyed-out, because the test parameters are based on settings specified in the Configure Test Settings Menu or the settings area under the impedance circle on the Impedance Test Mode screen as shown in Figure 3.22.

| | | | | | | |
|------------------------------|---|----------------------------|-----------------------|--------|----------------|---------------------|
| Exit Impedance Test Mode | RTC: OK Impedance Test Mode 14:01:29 | | | | | Test Report |
| | Channel | Magnitude (RMS) | Phase Angle | Status | RxErrs | |
| | Va=V1 | 37.75 V | 323.41° | off | 40789 | |
| Set up Display | Vb=V2 | 37.75 V | 276.59° | off | 9 | Test Type |
| | Vc=V3 | 69.28 V | 120.00° | off | 8 | |
| | Ia=I1 | 5.130 A | 255.00° | off | 0 | |
| Configure Amplifiers | Ib=I2 | 5.130 A | 75.00° | off | 29 | Manual Automatic |
| | Ic=I3 | 0.000 A | 120.00° | off | 0 | |
| | Fault 1 Voltage | 30.00 V | | | | |
| Fault 1 Current | 5.130 A | | | | | |
| Angle (I lags V) | 135.00° | | | | | |
| Input Number | 2 | | | | | |
| ZA-B | 2.92 Ω | | | | | |
| Configure Test Parameters | Max duration | 20.0000 s | Test Phase(s) | | | |
| | Fault Timer | 0.0000 sec | | | | |
| | Freq 1 | 60.000 Hz | | | | |
| Tone | V4 (DC) | 48.00 Vdc | A-B B-C C-A All | | | |
| | Inputs | 1 2 3 4 5 6 7 8 9 10 11 12 | | | | |
| | Test Voltage | 30.0 V | | | | |
| Off <input type="checkbox"/> | Test Current | 5.13 A | Auto Test | | | |
| | Start angle (left) | 135° | | | | |
| | Start angle (right) | 15° | | | | |
| Generating Off | | Adjusting Fault 1 | | | Reach Op. Time | |

Figure 3.22 AUTOMATIC MODE IMPEDANCE TEST

Select Φ - Φ fault [F8], *Reach* [F10], then press *Configure Test Parameters* [F4].

| | | | | | | |
|--------------------------------------|--|--------------------|--------|--|--|---------------------------------------|
| Back to Test Menu | RTC: OK Configure Test Settings Menu 14:08:45 | | | | | Configure Relay Settings |
| | 1) Use the F3 key to select a group of relay settings that match the relay type under test 2) Enter the relay settings, then return to the previous menu by pressing the F1 key | | | | | |
| Settings Format | KD-4/10/11 Format settings notes i) Reach = $(T * S) / (1 + H)$ ii) Enter either M or L&R; the other is computed iii) MTA should be 75 degrees for KD-4 | | | | | Configure Automatic MTA Test |
| | Description | | Value | | | |
| | Settings Format | KD-4, KD-10, KD-11 | | | | |
| | Reach / MTA | 3.44 Ω | 75.00° | | | |
| | Offset | 0.00 Ω | 0.00° | | | |
| generic 1 2 <input type="checkbox"/> | K-Factor | 0.000 | 0.00° | | | Configure Automatic Reach Test |
| | T | 4.060 | | | | |
| | L Lead | .06 | | | | |
| | R Lead | .00 | | | | |
| Advanced Settings | M | 0.18 | | | | Configure Automatic Operate Time Test |
| | S | 1 | | | | |
| | MTA | 75.00° | | | | |
| Generating Off | | Adjusting Fault 1 | | | | |

Figure 3.23 AUTOMATIC MODE CONFIGURE TEST SETTINGS

Note that additional options are now available on F6 to F9. Enter the actual tap settings as described in Section 3.6.4.1 select relay KD-4 via Settings Format [F3].

To check the auto test settings press *Configure Automatic Reach Test* [F8].

| RTC: OK Configure Test Settings Menu 14:31:36 | | | | | | | | | | | | | | | | |
|--|---|-----------------------|-------------------------------|----------------------------|-----------------|--------------------|----------------------------|-------------------|---------------|--------|--------|---------------|-------|----------|-------|-------|
| Back to Test Menu | Press the F6, F7, F8 or F9 key to edit/view relay characteristics and automated test settings. | | | | | | | | | | | | | | | |
| Fault Type \emptyset -N \emptyset - \emptyset 3 \emptyset | Reach Test Settings Notes: i) Changing relay settings will automatically update the reach and MTA values on this page. ii) In most cases the default test setting values will correctly test the relay, if elements other than the one under test are disabled. iii) During the test, the range of the value being varied (I or V) is 15% above and below the value shown here. | | | | | | | | | | | | | | | |
| Value to Vary Voltage Current | <table border="1"> <thead> <tr> <th>Description</th> <th colspan="2">Value</th> </tr> </thead> <tbody> <tr> <td>Settings Format</td> <td colspan="2">KD-4, KD-10, KD-11</td> </tr> <tr> <td>Reach / MTA</td> <td>3.44 Ω</td> <td>75.00°</td> </tr> <tr> <td>Offset</td> <td>0.00 Ω</td> <td>0.00°</td> </tr> <tr> <td>K-Factor</td> <td>0.000</td> <td>0.00°</td> </tr> </tbody> </table> | Description | Value | | Settings Format | KD-4, KD-10, KD-11 | | Reach / MTA | 3.44 Ω | 75.00° | Offset | 0.00 Ω | 0.00° | K-Factor | 0.000 | 0.00° |
| Description | Value | | | | | | | | | | | | | | | |
| Settings Format | KD-4, KD-10, KD-11 | | | | | | | | | | | | | | | |
| Reach / MTA | 3.44 Ω | 75.00° | | | | | | | | | | | | | | |
| Offset | 0.00 Ω | 0.00° | | | | | | | | | | | | | | |
| K-Factor | 0.000 | 0.00° | | | | | | | | | | | | | | |
| Pulse Ramp | <table border="1"> <tbody> <tr> <td>Number of Test Points</td> <td>3</td> </tr> <tr> <td>Offset between Test Points</td> <td>10°</td> </tr> <tr> <td>Test Voltage</td> <td>101.99V</td> </tr> <tr> <td>Max. Test Current</td> <td>12.89A</td> </tr> </tbody> </table> | Number of Test Points | 3 | Offset between Test Points | 10° | Test Voltage | 101.99V | Max. Test Current | 12.89A | | | | | | | |
| Number of Test Points | 3 | | | | | | | | | | | | | | | |
| Offset between Test Points | 10° | | | | | | | | | | | | | | | |
| Test Voltage | 101.99V | | | | | | | | | | | | | | | |
| Max. Test Current | 12.89A | | | | | | | | | | | | | | | |
| Advanced Settings | <table border="1"> <tbody> <tr> <td>Prefault Voltage</td> <td>69.28 volts (\emptyset-N)</td> </tr> <tr> <td>Max. Operate Time</td> <td>0.10 s</td> </tr> <tr> <td>Setting Notes</td> <td>Max V at 3.96 ohms, 75.00°</td> </tr> </tbody> </table> | Prefault Voltage | 69.28 volts (\emptyset -N) | Max. Operate Time | 0.10 s | Setting Notes | Max V at 3.96 ohms, 75.00° | | | | | | | | | |
| Prefault Voltage | 69.28 volts (\emptyset -N) | | | | | | | | | | | | | | | |
| Max. Operate Time | 0.10 s | | | | | | | | | | | | | | | |
| Setting Notes | Max V at 3.96 ohms, 75.00° | | | | | | | | | | | | | | | |
| Generating Off | | | | | | | | | | | | | | | | |
| Adjusting Fault 1 | | | | | | | | | | | | | | | | |

Figure 3.24 AUTOMATIC MODE REACH CONFIGURATION

There a number of settings to review starting with *Value to Vary* [F3] that allows the test to be conducted with variable current (i.e. fixed voltage). Variable voltage is the inherently safer and recommended choice as detailed in the previous section. The reach is computed from the relay settings in the previous step, and the *Fault Type* [F2] was specified on the previous screen. The MTS-5100 uses this information to calculate a fixed value and a maximum value to perform the tests using the default settings. Often the default settings will be adequate, and no adjustments will be required.

Note that the default calculated value for the fixed parameter can be modified, for example in the above screen the fixed current could be set lower, and this will automatically adjust the maximum variable parameter value.

Some electromechanical relays, like the KD series, recommend voltage be applied throughout the test process to keep the relevant internal coils warm. Some processor-based relays require the presence of a healthy prefault voltage before they will operate because blocking elements like the LOP (Loss of Potential) may prevent the element from operating. The default *Prefault Voltage* setting is usually appropriate.

The *Max. Operate Time* can be important if multiple impedance zones output to the same trip signal point. For example, Zone 2 relays typically pick up for all Zone 1 faults, but their trip outputs are time delayed. The default 0.1 second value cuts off the applied

fault before a typical Zone 2 could trip. Conversely, if testing a Zone 2 element, this time can be adjusted to exceed the expected Zone 2 delay, ensuring the fault is applied long enough to allow operation. Press *Back to Test Menu* [F1] when finished.

Press PREFault to start the test. The system begins applying a series of short pulsed outputs to the relay, and reports progress on the test in the area beneath the RX diagram. Press RESET to abort the test at any time. If All is selected in Test Phase(s) [F9], the productivity mode will perform the reach test on all phase combinations in sequence, and reports the as-found results below the RX diagram when completed. The as-found points are also plotted graphically for comparison to the theoretical values. To view a formatted version of the report press *Test Report* [F6].

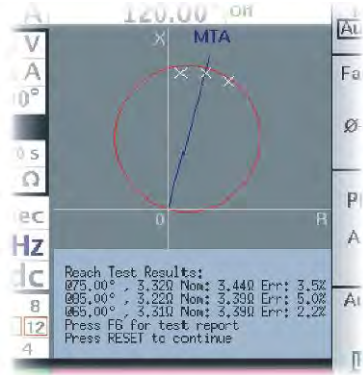

| | | | | | | | | |
|----------------------------------|---|----------------|-------------------|-------------------|--------------|--------------|------------------|--------------------|
| Press F1 When Done Viewing | RTC: OK | | Test Reports Menu | | | 11:22:26 | View | |
| | Reach Test Results (A-B) | | | January 6, 2006 | | 11:01:47 | | |
| | Angle | Voltage | Current | Znom | Zmeas | Error | [A-B] B-C C-A | |
| | 85.00° | 104.35 V | 15.921 A | 3.39Ω | 3.28 Ω | 3.3% | | |
| | 75.00° | 104.35 V | 15.501 A | 3.44Ω | 3.37 Ω | 2.2% | | |
| | 65.00° | 104.35 V | 15.560 A | 3.39Ω | 3.35 Ω | 1.0% | | |
| | Test Settings | | | | | | | |
| | Description | | | Value | | | | |
| | Reach / MTA | | | 3.44 Ω | 75.00° | | | |
| | Prefault Voltage | | | 69.28 V | | | | |
| | Test Voltage | | | 104.35 V | | | | |
| | Max. Operate Time | | | 0.1 seconds | | | | |
| | Generating Off | | | Adjusting Fault 1 | | | | Save as HTML |

Figure 3.25 TEST REPORTS MENU

The *View* button [F8] allows you to select which phase combination report to view. It is possible to save the report to the MTS-5100 internal memory, or an external USB drive from the *Save* [F10] button. Files saved to internal memory can be transferred at a later time to an external USB drive. For a detailed explanation of internal file storage and retrieval see Section 7.7 File Storage/Retrieval. See Section 5.2 USB for USB file handling information.

| Distance Relay Test Report | | | | | |
|--|--|--|--|----------------|--|
| Test Mode: Distance (Impedance) Relay Test Mode (21) | | | | Location: | |
| Type of Test: Reach 0-0 | | | | Relay Type: | |
| Time of Test: January 6, 2006 11:01:47 | | | | Relay Serial#: | |
| Test Equipment: Manta Test Systems Inc. MTS-5000 | | | | Tested By: | |

| Reach Test Results (A-B) | | | | | |
|--------------------------|----------|----------|-------|--------|-------|
| Angle | Voltage | Current | Znom | Zneas | Error |
| 85.00° | 104.35 V | 15.921 A | 3.39Ω | 3.28 Ω | 3.3% |
| 75.00° | 104.35 V | 15.501 A | 3.44Ω | 3.37 Ω | 2.2% |
| 65.00° | 104.35 V | 15.560 A | 3.39Ω | 3.35 Ω | 1.0% |

| Reach Test Results (B-C) | | | | | |
|--------------------------|----------|----------|-------|--------|-------|
| Angle | Voltage | Current | Znom | Zneas | Error |
| 85.00° | 104.35 V | 16.571 A | 3.39Ω | 3.15 Ω | 7.1% |
| 75.00° | 104.35 V | 15.750 A | 3.44Ω | 3.31 Ω | 3.7% |
| 65.00° | 104.35 V | 15.705 A | 3.39Ω | 3.32 Ω | 2.0% |

| Reach Test Results (C-A) | | | | | |
|--------------------------|----------|----------|-------|--------|-------|
| Angle | Voltage | Current | Znom | Zneas | Error |
| 85.00° | 104.35 V | 16.210 A | 3.39Ω | 3.22 Ω | 5.0% |
| 75.00° | 104.35 V | 15.715 A | 3.44Ω | 3.32 Ω | 3.5% |
| 65.00° | 104.35 V | 15.741 A | 3.39Ω | 3.31 Ω | 2.2% |

| Test Settings | | | | | |
|-------------------|-------------|--------|--|--|--|
| Description | Value | | | | |
| Reach / MTA | 3.44 Ω | 75.00° | | | |
| Prefault Voltage | 69.28 V | | | | |
| Test Voltage | 104.35 V | | | | |
| Max. Operate Time | 0.1 seconds | | | | |

Figure 3.26 HTML TEST REPORT

Figure 3.26 depicts the report when saved as an HTML file that contains information on settings, theoretical and as-found results, type of test, date and time. Since it can be directly imported into Word in this format, the only additional work necessary for a complete final report is to enter the location, relay specifics and tester’s identity in the upper right corner via the computer’s keyboard. If additional data such as a company logo is desired, just import the file into a preformatted template file containing this data.

The MTA test is similar but has fewer parameters, and the default settings rarely need to be altered. In the Impedance Test Mode screen (Figure 3.22) press *Auto Test* [F10] to select *MTA*. To check the auto test settings, press *Configure Test Parameters* [F4], then *Configure Automatic MTA Test* [F7], then *Back to Test Menu* [F1]. You can also check the settings underneath the RX diagram.

Press PREFault to initiate the test. As will be seen on the RX diagram, this test is executed by smoothly ramping the phase angle, instead of applying pulsed test signals. It will be necessary to block the trip signal from any out-of-zone elements that may be in parallel with the element under test during this sequence. Press RESET to abort the test sequence at any time. You may save a report of the results using the Save [F10] button as described previously.

The Operate Time test is selected and run in a similar manner. By extending the maximum operate time to >Zone 2 delay (if present) the latter time can be verified.

3.7. HELP SYSTEM

There is extensive on-board help available to describe many of the operating features of the MTS-5100 which is accessible at any time by pressing the HELP button. The information which appears is specific to the menu which is in use at that time. Pressing HELP when in the Manual Test Menu, for example, will produce the help screen below.

| | | |
|------------------------------|---|--|
| | RTC: OK Arbitrary 15:58:01 | |
| Press HELP When Done Viewing | Help Topics - Use Arrows or Rotary Knob to Select | Function keys used in this menu |
| | Introduction | |
| | Screen Layout | Settings and values shown in this menu |
| | FAULT button operation | |
| | Basic Operation | |
| | Productivity Modes | |
| | Parallel Operation of Current Channels | |
| | DC and Multi-frequency | |
| Custom Help Index | <p>Introduction</p> <p>This menu is the main screen for the manual testing facility. The manual testing facility allows you to configure currents, voltages, phase angles, etc., to be generated by the test set. A complete set of generation settings is available for each of 10 fault states:</p> <p>Pre-fault: Usually defines the normal waveforms seen by the relay under test when no fault has occurred.</p> | Calculator |
| Front Panel Controls Help | <p>Fault 1 to Fault 8: Defines waveforms for fault conditions, or pauses between faults. A setting in the Advanced Settings menu defines the number of fault states, which is 1 by default. If that setting is set to 1, the "Fault 1" state is shown as "Fault".</p> <p>Post-fault: (if enabled in the Advanced Settings menu) Defines waveforms seen by the relay after tripping.</p> | |
| Main Help Index | <p>Press HELP when finished viewing help</p> | |
| | Generating Off | Adjusting Prefault |

Figure 3.27 MANUAL TEST MENU HELP SCREEN

This layout is typical of the Help screens. The *Main Help Index* [F5] brings up an overview of the Help system itself, product specifications, lists phone and Internet contact information for Manta, and details the changes that comprise the current and preceding firmware releases.

The *Front Panel Controls Help* [F4] brings up an overview of the front panel controls, and pressing any of the latter brings up additional information as below. There is even an animated overview of the dial use available.

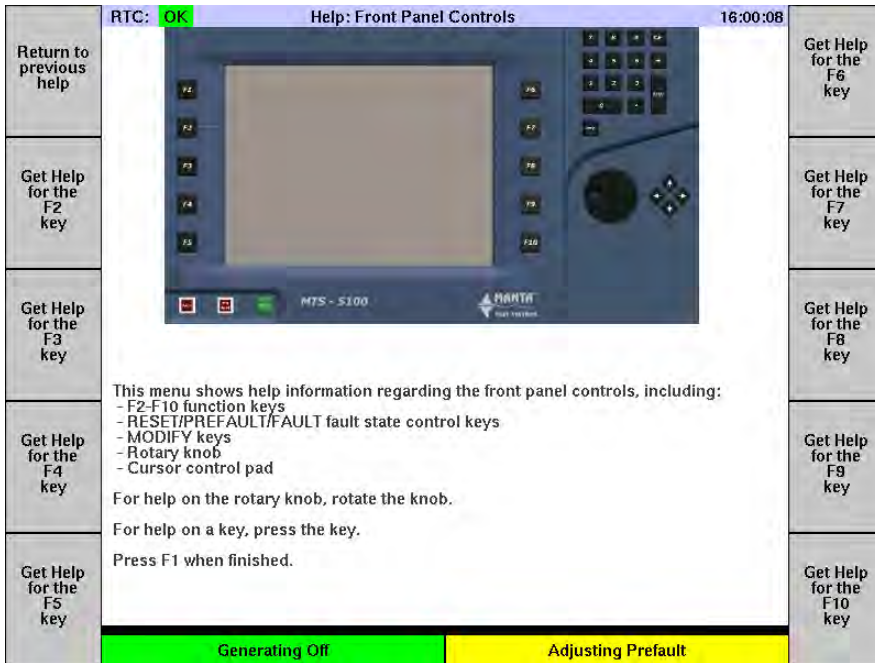
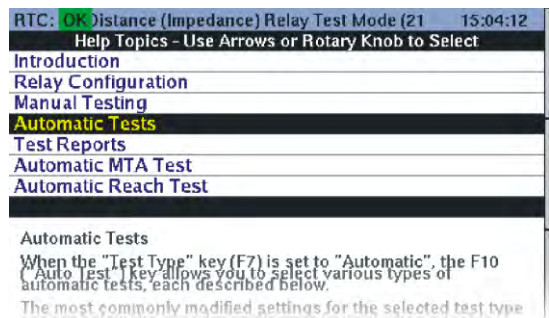

Figure 3.28 FRONT CONTROLS HELP SCREEN

In the initial help screen (Figure 3.27) there are also two buttons available for explanations of the controls and settings within the originating menu. Press *Function keys used in this menu* [F6] for example. A written description is given for all the function keys, whose operations are typically unique to that menu. Moving the cursor over a function key listing with the dial or arrow keys will bring up the desired information.

Settings information is available via *Settings and values shown in this menu* [F7].

The HELP system can be particularly useful when using the Productivity Modes described in the previous section, since there may be multiple tests, and multiple configurations and settings for a given test, depending on the specific relay selected. See the Impedance Relay test HELP to the right. Use HELP to provide context-sensitive information as required.



3.8. SETUP MENU

A number of significant but infrequently modified functions are accessed through the Setup Menu that allows the user to configure the MTS-5100 basic operation to their preferences. These settings are stored when saved and will be applied each time the MTS-5100 is powered up. To access it from the Manual Test Menu *press Main Menu* [F1], then in Main Menu *press Setup* [F10].

| RTC: OK Setup Menu 14:19:55 | | |
|------------------------------------|--|---------------------|
| | Description | Value |
| Main Menu | Backlight Intensity | 10/10 |
| | LCD Color Scheme | Normal |
| | Keypress Tone | Off |
| | Beep on Clip Condition | On |
| Customize | Suppress measurement errors | Yes |
| | Serial Port Baud Rate | 9600 baud |
| | Time and Synchronization Source | Internal |
| | Signal Source for IIRIG Output | IIRIG-B Output |
| | Entry range for phase angles | 0 to +360 |
| | Normal Phase Sequence | A->B->C |
| | Meaning of Positive Angles | Leading |
| | Direction of Rotation | Counterclockwise |
| | System Frequency | 60.000 Hz |
| | Nominal V4 DC Voltage | 48.00 Vdc |
| Factory Diagnostics | Nominal Ø-Ø Voltage | 120.00 V |
| | Default Input Power Control | 5 |
| | Prevent Excessive AC Draw | Yes |
| | GPS Delay | 0.0ms |
| Calibration | Internal RTC Time (MMDDhhmmYYYY) | 0 |
| | "Signal Source for IIRIG Output" Setting: This setting determines what signal will be emitted from the "IIRIG Out" BNC connector. | |
| | "IIRIG-B Output" = an IIRIG-B time signal, synchronized to the selected time and synchronization source. | |
| Set up Network | "Pulse per second" = one 100ms pulse per second, synchronized to the selected time and synchronization source. | |
| | "Frequency 1" = squarewave, synchronized to frequency 1 in manual test and productivity modes. Emitted only while generating. | |
| Generating Off | | Setting preferences |

Figure 3.29 SETUP MENU

Selecting any item on the list with the arrow keys will provide additional information about the selection in the lower part of the display. If a new selection of any parameter is made and you then return directly to the Main Menu without saving, the new selection will be active only until the instrument is powered down. To make a selection the new default upon power-up, it is necessary to press *Save* [F10] before leaving the Setup Menu.

- *Backlight Intensity* controls the brightness of the display.
- *LCD Color Scheme* modifies some on-screen colors to optimize legibility under different conditions. For use in direct sunlight, "High Contrast" should be selected.
- *Keypress Tone* enables a beep upon each operation of the manual controls to provide additional feedback, if desired.

- *Beep on Clip Condition* provides an audible warning beyond the visual *Status* column warnings of a clipping condition, usually due to an open current circuit or too high current burden for the current output specified.
- *Suppress measurement errors*: This selection will suppress the error message *MeasError* that can appear in the *Status* column of the current amplifiers under certain abnormal operating conditions such as high frequency operation. This option should be set to Yes unless a Manta technical support representative instructs you to set it to No.
- *Serial Port Baud Rate*: for further information see Section 5.1 RS-232C SERIAL.
- *Time and Synchronization Source*: for further information see Section 6.2 USING AN EXISTING GPS SIGNAL. When the default *Internal* is selected, the time and date will be displayed based on the MTS-5100's internal Real Time Clock. The Real Time Clock time and date may be adjusted via the *Internal RTC Time* selection near the bottom of the list. The other selections available are *GPS Receiver* and *Ext. IRIG-B* which will change the MTS-5100 displayed date and time to the selected signal source.
- *Signal Source for IRIG Out* determines what type of TTL signal will be emitted from the IRIG-B output BNC connector: IRG-B time signal, 1PPS (one pulse per second), or Frequency 1.
- *Entry range for phase angles* permits phase angles to be specified either in 0°-360° format for GE SR relays, ±180° format (for SEL relays), or -360°-0° format (for GE UR relays).
- *Normal Phase Sequence* changes the default phase sequence to be generated by the MTS-5100 (A-B-C or A-C-B).
- *Meaning of Positive Angles* defines the use of positive angles – either leading (SEL Relays) or lagging (GE relays).
- *Direction of Rotation* defines the “normal” direction with respect to your power system.
- *System Frequency* allows the default system frequency to be specified.
- *Nominal V4 DC Voltage* sets the default voltage which will be available from the V4 DC voltage output terminals. This voltage setting will appear in the Dynamic Display area of the Manual Test Menu. It can be set to any voltage level between 0-350VDC, however the safest option is to set it for the lowest DC voltage level normally encountered in your testing work, and manually raising it via this

option as required, without saving it, to prevent inadvertent application of high voltage to a low voltage system. You may also temporarily change the V4DC voltage in any menu with a Configure Amplifiers button.

- *Nominal Φ - Φ Voltage* sets the default level for all Φ - Φ voltage levels. The individual Φ -N levels that appear as the amplitude setting of voltage channels in the Manual Test Menu correspond to the Φ - Φ setting divided by the square root of 3.
- *Default Input Power Control* controls the tradeoff between high compliance voltage and low power consumption. This entry sets the default power control applied at test-set start-up. The highest value (10) provides maximum compliance voltage on the current channels, but will cause the test set to draw maximum inrush current from the test location's power outlet. When driving low burden relays, a setting of 3 is often adequate for currents up to 30A. A default Input Power Control setting greater than 5 should only be used if the location power supply is a dedicated 15A breaker, otherwise high-current operation may trip the location circuit breaker.
- *Prevent Excessive AC Draw* is intended to prevent loss of control (hang or reboot) when the AC line sags/dips during high-power tests. Turning off (disabling) this feature is not recommended and may result in undetermined behavior/operation of the MTS-5100. Only disable this feature if you are absolutely sure you need to. If in doubt, please contact Manta technical support for applications assistance.
- *GPS Delay* setting adds an optional delay to GPS-synchronized fault start times, to match the delays imposed by other types of test equipment. This setting should be about 1.2ms to synchronize with a Manta MTS-1710, 0ms for a Manta MTS-5000, and 33.3ms for the Doble F6xxx. To synchronize with another vendor's test set, consult the manufacturer's literature and/or measure the relative timing to determine the appropriate setting value. This setting should always be zero except when doing end-to-end testing between this MTS-5100 and another test set which is not an MTS-5100 or MTS-5000.
- *"Internal RTC Time (MMDDhhmmYYYY)"* setting allows manual adjustment of the internal Real Time Clock time, in the format: month, day, hour, minute, year, as indicated by the alphabetic characters. When the MTS-5100 is connected to a valid GPS or IRIG-B signal, the time setting will automatically be extremely accurate. The internal clock setting however, in the absence of these references, can drift slowly over time. The present system time is shown in the upper right corner of most displays, and can be adjusted via this selection if necessary.

- In addition to the selections above, there are a number of pushbutton selections giving access to additional setup screens.

3.8.1. Customize

Customize [F3] enables control over some aspects of the data and colors used on the Manual Test menu and other displays.

| RTC: OK Customization Menu 16:43:14 | |
|--|--|
| | Description Value |
| Back to Setup Menu | Custom Timer Name 1 Custom 1 |
| | Custom Timer Name 2 Custom 2 |
| | Custom Timer Name 3 Custom 3 |
| | Custom Timer Name 4 Custom 4 |
| | Custom Timer Name 5 Custom 5 |
| Customize Input Names | Virtual Channel Naming Convention a,b,c |
| | V1/I1 Terminal Color Red |
| | V2/I2 Terminal Color Yellow |
| | V3/I3 Terminal Color Blue |
| | Diagram Background Color White |
| | Scaling of Waveform Groups Together |
| | F4 Key Action on the Main Menu Oscilloscope Display |
| | F5 Key Action on the Main Menu IEC61850 / GOOSE Setup |
| | F5 Key Action on the Manual Menu Tone On/Off |
| | "Virtual Channel Naming Convention" Setting: |
| | This setting defines the naming convention for virtual channels. Virtual channel names appear in the manual test menu, as a way of referencing paralleled currents, or phases which might map to remote terminals on a slave unit. |
| | The naming convention for physical channels is always 1,2,3, to match the markings beside the terminals on the front panel. |
| | The setting, once saved, takes effect the next time the unit is powered on. |
| | Save |
| | Generating Off |
| | Customizing |

Figure 3.30 CUSTOMIZATION MENU

Virtual Channel naming is described in Figure 3.30 above. The *Terminal* and *Background* selections control the colors of the vectors and background respectively of the vector display.

The *Custom Input Names* [F2] selection refer to the names which may be assigned to input channels 1 through 12 when activity on those inputs is recorded in the Sequence of Events recorder text or graphic displays. If one of these five cells is selected, an *Edit Text* [F6] pushbutton becomes available. Press the pushbutton to bring up the edit window as shown, and enter the desired name as indicated. You may also use a USB keyboard to enter the names. For more information on the Sequence of Events Recorder, see Section 4.11.

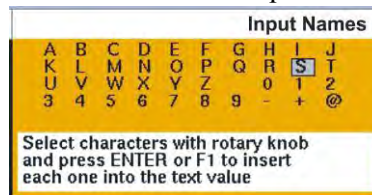

3.8.2. Calibration

This selection gives access to calibration constants used in the equipment, and is provided primarily for factory service use. It is password protected to prevent inadvertent changes to the calibration data.

3.8.3. Set Up Network

This selection is provided to give access to data used to configure the Ethernet connection to an external computer. For more details refer to Section 5 DATA INTERFACES, item 5.3.

3.8.4. Software Upgrade

This selection is provided to give access to files which upgrade the firmware revision of the instrument. Upgrading or downgrading the MTS-5100 is easily performed by selecting an upgrade file in the list with the dial or arrow keys, pressing Load Selected File [F5] or ENTER, and then following the introductions on the screen (Press F1, turn power on an off). The complete upgrade procedure should take less than one minute. For further details see Application Note AN5-1 in Section 9.

3.8.5. Factory Diagnostics

This is a password protected area used for factory diagnostics and servicing.

3.8.6. Reset to factory defaults

Pressing *Reset to factory defaults* [F9] will return all of the settings in the Setup Menu to their default settings, which can be useful if a number of custom settings are causing confusion in operation of the instrument.

3.8.7. Save

If adjustments are made in some of the settings in the Setup Menu, and *Save* [F10] is pressed before exiting via *Main Menu* [F1], these new settings will be saved, and thus present the next time the instrument is powered up. If settings adjustments are made but not saved in this manner, i.e. the user goes directly to *Main Menu*, the new settings will be active as long as the instrument is powered up, but will revert to the original settings at the next power-up.

3.9. COMMUNICATIONS & REMOTE CONTROL MENU

This menu gives access to the various remote control mechanisms for controlling the MTS-5100 using an external PC. From the Main Menu press *Remote Control* [F8].

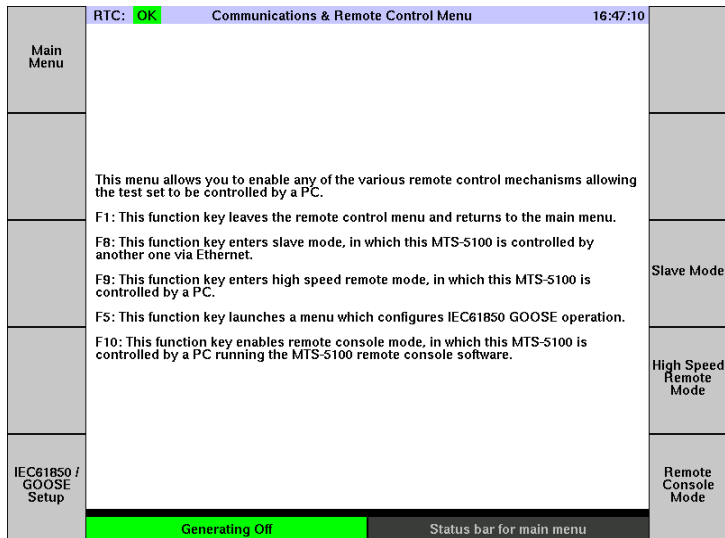

Figure 3.31 REMOTE CONTROL MENU

Slave Mode allows two MTS-5100 systems to run in a master-slave configuration where the master controls the operation of both systems. See Section 8 Master-Slave Operation for further details.

High Speed Remote Mode enables near-real-time control of AC/DC outputs via high-speed Ethernet data. It is used only in specialized testing applications.

Remote Console Mode is used in conjunction with Manta's MTS-5050 Remote Console software, an emulation of the MTS-5100's control panel, display, and I/O status indicators which can be run on a desktop or laptop computer. The emulation can run in stand-alone mode; or when connected to an MTS-5100 via Ethernet, it can control most of the latter's functions from the computer's keyboard and mouse.

Installation of the MTS-5050 software requires an encryption key, which is available from Manta support staff. The first time the program is run, an activation screen will appear with a machine ID code unique to the computer along with instructions to send that number to Manta's technical support department via email. When the activation key is received, you can enter it in the activation screen. The software uses the network driver currently in use to generate the machine ID, so you may need to enter multiple activation keys. However, the software remembers each key and it only needs to be entered once.

Once installed, running the program brings up a preliminary control screen to select the stand-alone simulation mode, or remote control mode for a connected MTS-5100. The operation of these 2 modes is virtually identical, except that some functions requiring physical components (such as networking), are not available on the simulation. When connected to an MTS-5100, settings may be modified, and output states turned on/off, etc., just as from the actual manual interface.

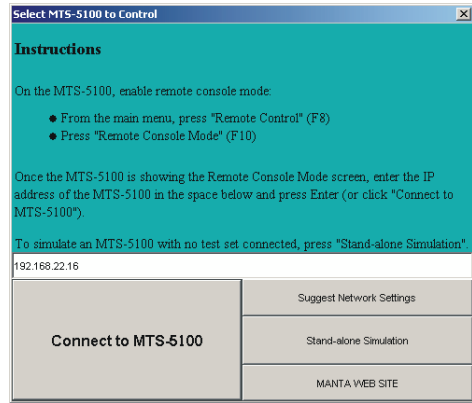

To enable the latter mode on the MTS-5100, first establish a functional Ethernet link and record the IP address of the MTS-5100; see Section 5.3 Ethernet, for details. Enter the IP address on the instruction screen where prompted, and click the Connect to MTS-5100 button. This will bring up the Remote Console display.

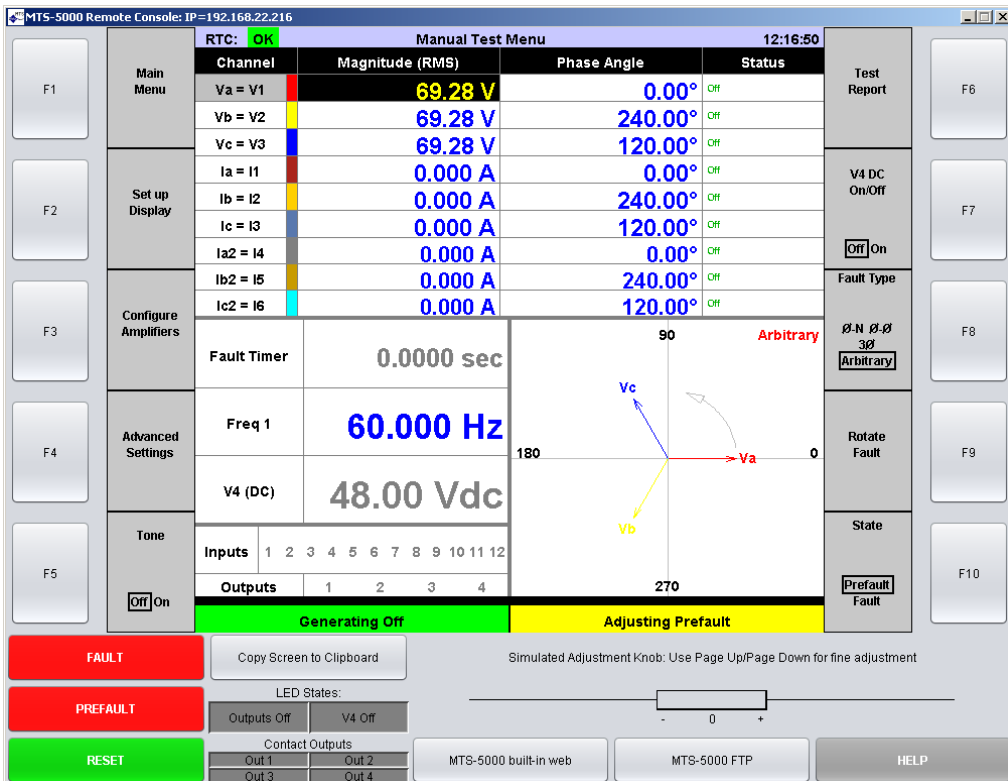

Figure 3.32 REMOTE CONSOLE SCREEN

The display on the MTS-5100 will not change from the previous state except that the message on it will display “*Connected to a remote console. Press F1 to exit.*” The display on the PC as shown in Figure 3.32 will respond to commands by mouse clicking on the appropriate areas on the screen. The PC keyboard’s F1-F10 keys will also control the respective F1-F10 display buttons.

The display LED output status indicators follow the status of the actual LEDs. Similarly, the Contact Output indicators follow the status of the actual contact outputs.

Clicking and dragging the Simulated Adjustment Dial bar will modify parameters on a continuous basis, the speed of adjustment depending on how far to the left or right it is dragged. Numeric adjustments can also be made directly via the PC’s numeric keys. Cursor movement may be controlled by the physical PC cursor keys, or by clicking in the desired cell.

The stand-alone simulation mode can: be a useful training aid, allow a preview of more complex configurations and operating sequences, or create and save pre-configured test plans without having to power-up an MTS-5100 system.

The Copy Screen to Clipboard button can be useful in developing illustrations for written training material or test instructions, as it copies what would appear on the MTS-5100 display (at the time the button is clicked) directly to the Windows Clipboard, from where it may be pasted into Paint, Word, or other Windows programs.

4. DETAILED OPERATION

4.1. FAULT STATES: PREFault, FAULT, POSTFAULT

Up to 10 independent fault states may be programmed into the MTS-5100 to simulate the states and dynamic transitions between them found in a real-world power system. The individual states are labeled Prefault, Fault 1 through 8, and Postfault, and all enabled states are displayed in the State [F10] description. The currently selected state is defined by the black box around the state description.



As indicated below, the transition from Prefault to Fault will usually be initiated by a control input to the MTS-5100, and the transition from Fault to another Fault state or Postfault will usually be initiated by the MTS-5100 sensing operation of the equipment under test.

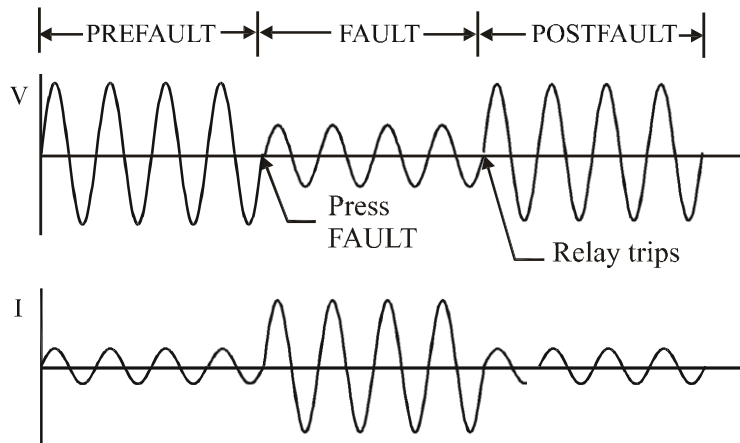

Figure 4.1 PREFault TO FAULT TO POSTFAULT TRANSITIONS

4.1.1. Prefault State

Prefault state is used to simulate healthy power system conditions prior to the occurrence of a fault. Typically, balanced three-phase voltage and current conditions are found during the period. Many modern protective relays monitor and use these prefault conditions to determine the type and location of fault. When testing certain aspects of these types of protective devices, it is not sufficient to simply switch from a no-AC

condition to a fault condition. Conversely, some types of testing require that no AC be present during the prefault state. Pressing the PREFault button at any time will turn on the AC/DC output channels, generating the programmed Prefault values.

To program values offline for the Prefault state, press the *State* button [F10] in the Manual Test Menu until *Adjusting Prefault* appears in the Selected Fault box, and *Prefault* is highlighted on the *State* [F10] label.



By default, there is 120V phase-to-phase balanced three phase voltage and no current. Enter any desired current, voltage, and phase parameters with the keypad or dial.

To turn on Prefault state AC/DC output channels, press the red PREFault button. The text in the Fault Status box will change from *Generating Off* to *Generating Prefault*, the background color of the box will change from green to slowly flashing red, and the AC Output Warning LED will flash.

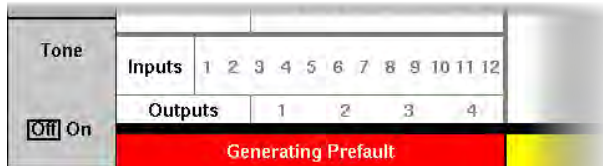

Subsequently pressing the FAULT button will transition the AC/DC output channels to the programmed Fault values. Pressing the RESET button when in Prefault state will turn off the programmed Prefault AC output values.

4.1.2. Fault State

The Fault state is used to simulate power system conditions during a fault. Typically one or more phases of the voltage will decrease while the current increases, and the phase angle between the voltage and current may change during the fault period.

To program values offline for the Fault state, press the *State* button [F10] in the Manual Test Menu until *Adjusting Fault* appears in the Selected Fault box. By default there is 120V phase-to-phase balanced three phase voltage and no current. Enter any desired current, voltage and phase parameters with the keypad or dial.

To turn on Fault state AC/DC output channels, press the red FAULT button. The text in the Fault Status box will change to *Generating Fault*, the background color of the box will change to rapidly flashing red, and the AC Output Warning LED will flash. By default, the timer will begin running.

4.1.3. Multiple Faults

It is possible to configure multiple fault states to simulate, for example, evolving faults or post-reclosure faults, using programmable features provided for the status inputs. Any input may be programmed to switch the AC/DC output channels to any one of ‘n’ possible fault configurations, where ‘n’ is the maximum number of fault states specified in the *Advanced Settings* Menu, accessible by pressing *Advanced Settings* [F4] in the Manual Test Menu.

| | | | |
|---|--|------------------------|--|
| RTC: OK | | Advanced Settings Menu | 17:33:40 |
| Back to Test Menu | Description | | Setting |
| | Breaker Clearing Time | | 0.0 ms |
| | Fault Incidence Angle (FIA) | | 0° |
| | GPS-Synchronized Fault | | Off |
| Set up I/O and Timers | Input Power Control | | 5 |
| | K-Factor | | 0.000 |
| | K-Factor Angle | | 0.00° |
| | Maximum Fault Duration Enabled | | Off |
| | Number of Fault States | | 1 |
| | Normal Phase Sequence | | A->B->C |
| Set up Ramps | Phase Sequence to Generate | | Positive |
| | Postfault State Enable | | Off |
| | System Time Constant | | 0 ms |
| | V4 Powers Relay | | Yes |
| | Description of "Number of Fault States" Setting: | | |
| <p>This setting enables multiple fault states. The default value of 1 causes the manual test feature to use the traditional PREFault, FAULT and (optionally) POSTFAULT states. Numbers greater than one enable additional fault states.</p> <p>For example, if set to 3, generation can progress through PREFault, FAULT, FAULT2, FAULT3 and POSTFAULT. Since no front panel buttons are available to initiate the additional fault states, you must either configure status inputs or set maximum fault state durations to use this feature.</p> | | | <p>Show Harmonics Columns</p> <p><input type="checkbox"/> Off <input type="checkbox"/> On</p> <p>Show Frequency Column</p> <p><input type="checkbox"/> Off <input type="checkbox"/> On</p> |
| Generating Off | | Adjusting Prefault | |

Figure 4.2 ADVANCED SETTINGS MENU

Select *Number of Fault States* with the arrow keys and enter the desired number with the keypad or dial. For detailed information on programming the status inputs, see Section 4.4. Any given input can be programmed to only be active during a specified fault state, and to initiate a different fault state when being triggered, so a sequential progression of multiple faults may be programmed.

To select each additional fault state for programming, press *State* [F10] until the desired fault is indicated in the Selected Fault box and on the *State* label.

When all faults, and the status inputs controlling their initiations, have been programmed, the entire sequence may be initiated by pressing the FAULT button.



4.1.4. Fault Duration

While still in the *Advanced Settings* [F4] Menu you may wish to enable the Maximum Fault Duration feature. This can be useful in preventing continuous application of fault values if the device under test fails to operate, especially when high current levels have been specified. It will determine the maximum interval a fault is applied before the next fault state is automatically initiated. Select *Maximum Fault Duration Enabled* to *Seconds*, *Cycles*, or *Both* with the arrow keys and dial. This will add an additional cell or cells to the Dynamic Display area as shown below, allowing independent duration times to be specified for any Prefault, Fault or Postfault state.

| | |
|------------------|------------|
| Maximum Duration | 0.3500 s |
| Fault Timer | 0.0000 sec |
| Freq 1 | 60.000 Hz |
| V4 (DC) | 48.00 Vdc |

Figure 4.3 MAXIMUM DURATION SETTING

Note that if the duration for a given fault state is left at the default setting (0.000), that fault state, once initiated, will remain energized until either the status input programmed to trip that state off is triggered, or the RESET button is pressed. If the Maximum Fault Duration setting is greater than 0.000, the MTS-5100 will start an internal timer when the timed state starts. Any input that would normally stop the test will operate normally and the RESET button will stop the test if either operates before the internal timer reaches the Maximum Fault Duration specified for the test. If no input changes state or stop command is issued before the timer reached the Maximum Fault Duration setting, the MTS-5100 will automatically transition to the next fault state. If there is no other fault state enabled in the sequence, the test will stop and any outputs will be turned off. It is important to realize that if the Fault Timer and Maximum Fault Duration setting are the same after a test, it is unlikely that the device under test operated.

Maximum Fault Duration can automate a complete multi-state sequence that is initiated by pressing one button, PREFault.

4.1.5. Postfault State

The Postfault state is used to simulate power system conditions after a fault has been cleared from the faulted section of the power system and can be used to simulate a successful reclosure, for example. The Postfault state is disabled by default. Enable it from the Manual Test Menu by pressing *Advanced Settings* [F4], then use the arrow keys to select the *Postfault State Enable* option, and set it to *On* with the dial (see Figure 4.2). Press *Back to Test Menu* [F1] and note that *Postfault* is now listed as an available state on the *State* [F10] label. To program Postfault conditions, press *State* [F10] to select it as shown.

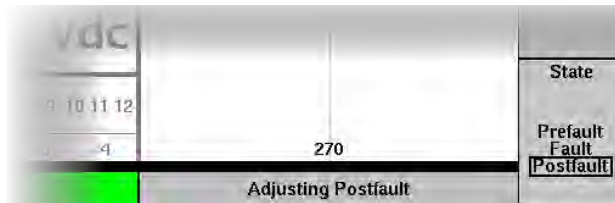

Enter any desired voltage, current and phase values with the arrow keys, keypad, and/or dial.

Entry into Postfault state is usually controlled by the status input channels. By default most of these are active in Fault states 1-8 but numerous options are available, see Section 4.4 for more details. Triggering of any active status input channel programmed *Go To Postfault* will then force the transition to Postfault state. The system will also automatically switch to Postfault state if a *Maximum Duration* fault time has been specified for the preceding fault state and that time expires. See Section 4.1.4 on the preceding page for details.

It is possible to delay the appearance of a programmed Postfault state for a specified time after the appearance of a trip signal, to simulate the 'dead time' which is often included in reclosure protection systems. Program the system for one additional fault state beyond that required in the test application, program that fault for no current or voltage outputs, and set the *Maximum Duration* time for the desired 'dead time'. See sections 4.1.3 and 4.1.4 on the preceding pages for details. Now initiate the fault sequence, and when the final fault (zero-output dead time) reaches the Maximum Duration time, Postfault will be initiated.

4.1.6. Frozen Readings

Most test results are interested in AC, DC and time delays present at the moment the device under test operated. Any event that causes a transition to Postfault state will freeze the timer and displayed output values where they were at the moment of transition, even though the programmed Postfault values are now being generated. These values may of course be very different from the values present at the trip point.

The Fault Status box on the Manual Test Menu will indicate *Generating Postfault* with a slowly flashing red background, and the AC Output Warning LED will flash, as a warning that live output values are present. The Selected Fault box however will indicate *Captured Fault Values*, and the AC values and timer reading shown are frozen values captured at the transition to Postfault state.

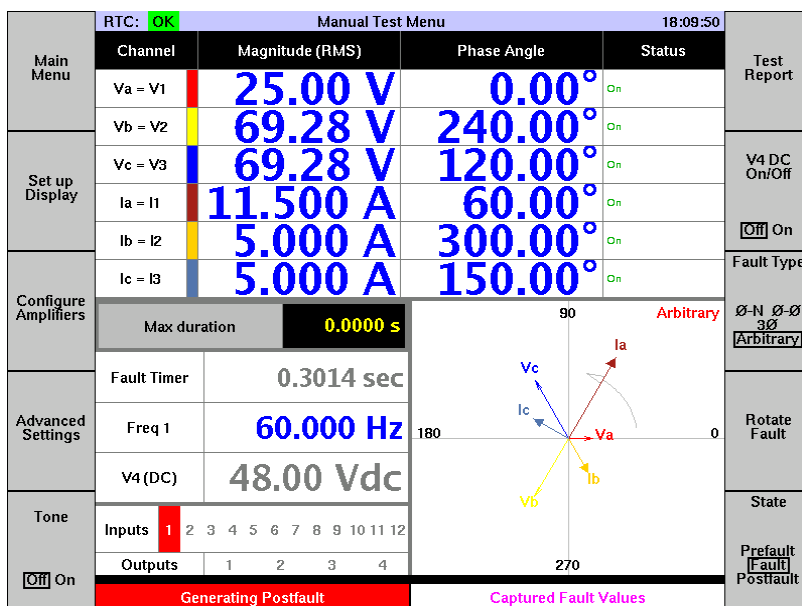

Figure 4.4 FROZEN READINGS

The Postfault values will continue to be generated until the RESET button is pressed, unless an input signal programmed to clear Postfault appears. In the example above, a maximum 5 second duration Fault cleared in just 0.3014 seconds, but the frozen Fault values remain on the screen until the RESET button is pushed or another fault is initiated.

4.2. FAULT MODES: PICKUP & TIMING

For a majority of testing applications, a single Fault state and sometimes a Prefault state will be sufficient to accomplish most tests. In this type of application, there are two Fault modes available, Pickup (Static Fault) and Timing (Dynamic Fault). Use of these modes is determined by the nature of the test being performed.

4.2.1. PICKUP Fault Mode

PICKUP Fault Mode refers to the operation mode used when determining the pickup or operate level of the Device Under Test (DUT) and is described by the test set as a Static Fault. When the FAULT button is depressed and held for more than 300 mSec, the MTS-5100 exits Prefault state (if energized) and enters into Static Fault state. The system remains in the Static Fault state only as long as the FAULT button is held depressed. Any trip signals from the DUT will be annunciated on the Digital Input/Output Status box of the display, but will not trip off the AC/DC output channels nor freeze the timer reading. This permits the operator to pass through the pickup/dropout points repeatedly to verify operation without the need to keep resetting the AC/DC output channels. As soon as the FAULT button is released, the system returns to Prefault state (if enabled) or turns the AC/DC output channels off.

If performing extensive pickup testing, using a foot switch to control the MTS-5100 will free the operator's hands to make adjustments. Any contact closure including the standard foot operated switch plugged into Input 12 will have the same effect as pressing the FAULT button.

4.2.2. TIMING Fault Mode

TIMING Fault Mode refers to the operation mode used to perform timing tests or automated fault sequences, i.e. Dynamic Testing. Pressing the FAULT button momentarily (<300 mSec) initiates TIMING fault mode labeled as a Dynamic Fault on the MTS-5100. The AC/DC output channels latch on until the DUT operates, as detected by a status input channel, or until RESET is pressed. The timer is started at the moment the Fault AC outputs appear.

Detection of a trip signal from the DUT freezes the timer and all AC readings, trips off the Fault AC/DC output channels, and either leaves the output channels de-energized or forces the system into Postfault state (if enabled). Any subsequent trip signal detected will be annunciated by the input channel status indicator, but will not change the AC output status. Once the frozen readings have been recorded, pressing RESET will reset the timer and frozen readings. If the DUT fails to trip, pressing RESET will turn off the Fault AC/DC output channels.

TIMING fault mode can be remotely controlled by programming any status that input's *Enable In* and *Go To* modes, see Section 4.4.2.1 and 4.4.2.2 for details. Input 11 is programmed from the factory to automatically switch from Prefault to Fault when the input changes state. Any status input configured for *Go To Postfault* will trip the fault off as described above.

The following table summarizes the key aspects of these two fault modes.

| | Pickup mode | Timing Mode |
|--|----------------------------------|--|
| Press Fault button | Press and hold | Momentary press <300mSec |
| Timer runs, AC/DC Output channels alive until... | Fault button released | Trip Signal sensed or Press RESET |
| Response to input operation | Visual/Audible status indication | Status indication, trips AC/DC output channels off, freezes readings and timer |
| Application | Manual pickup checks | Timing Checks Automatic fault sequences |

Figure 4.5 PICKUP AND TIMING MODE CHARACTERISTICS

4.3. FAULT TYPES: 3-Ø PRODUCTIVITY SHORTCUTS

The descriptions of AC output control covered so far have focused on individual current, voltage and phase adjustments using the default *Arbitrary* adjustment mode. A very significant portion of protective relay testing work however involves testing of three phase devices, which can require multiple amplitude and phase adjustments to check a single operating point.

Arbitrary mode is a good tool for:

- New users who have used test systems from other manufacturers in the past
- Simple protective elements or relays (electromechanical)
- Complex test plans that require specific magnitudes, angles, frequencies, waveforms shapes, and harmonics to be generated on specific channels

However, the majority of relay tests are performed to check relay operation during the most common system faults, Phase-Neutral, Phase-Phase, and Three-Phase. A simple phase-ground test can require more than 15 setting changes in order to correctly simulate a phase-ground fault in Arbitrary mode. The same test could be performed in the Φ -N Fault Type test mode with as few as three setting changes.

Correctly simulating a phase-phase fault using Arbitrary mode would require more setting changes than the phase-neutral test plan as well as some significant vector arithmetic in order to apply the correct Φ - Φ voltages (Angles and magnitudes must change simultaneously), Φ - Φ current (Currents are equal and opposite), and Φ - Φ angle (Φ - Φ current lags Φ - Φ voltage which is no longer 0 degrees). In the Φ - Φ Fault Type test mode, the Fault Voltage, Current, and Angle are all supplied by the user and the MTS-5100 performs the arithmetic and applies the correct magnitudes and angles to correctly simulate a realistic Φ - Φ fault.

Three-phase faults require all three voltage and current magnitudes and angles to change simultaneously while maintaining 120 degrees per channel. The MTS-5100 makes all of the necessary adjustments automatically and in real time using the 3 Φ Fault Type test mode.

Further adjustments are also required when, for example, the phase-to-phase configuration referred to above must be transferred to the adjacent phase pair, say from A-B to B-C. This could require either a physical rotation of the AC output leads, or adjustments to nearly all the amplitude and phase settings. The Rotate Fault [F9] button will make all of the required calculations and immediately make the necessary changes to apply the next phase combination.

The *Fault Type* and *Rotate Fault* selections available on the MTS-5100 offer a major productivity boost for this type of work, with the following benefits:

- Automatic configuration of output channels for all major 3-phase fault types
- Simultaneous adjustments of multiple parameters with single keypad or dial
- Direct control of phase-to-phase parameters, with automatic adjustment of relevant phase-to-ground output channels
- One-button transfer of fault configuration to adjacent phases

To engage the three-phase fault modes from the Manual Test Menu, press *Fault Type* [F8]. Figure 4.6 shows a Phase-to-Phase fault selection.

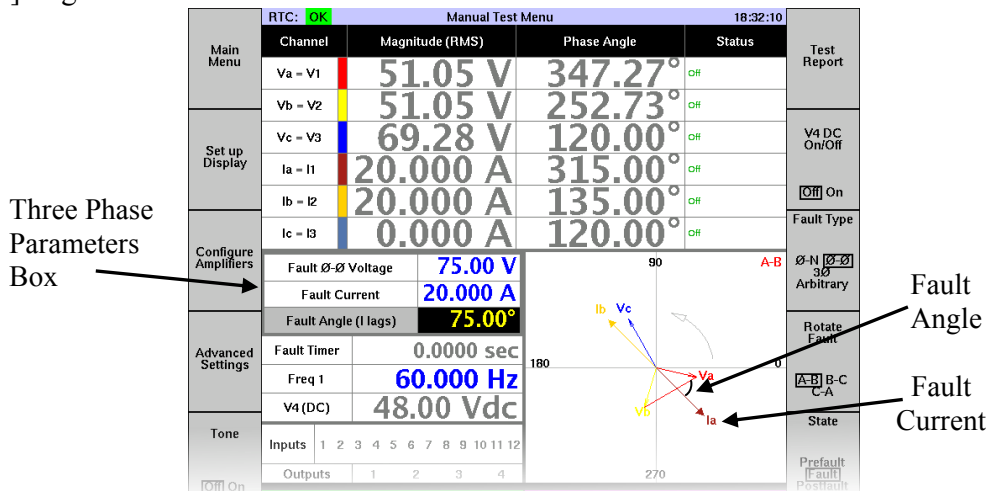

Figure 4.6 THREE PHASE FAULT CONTROL

Note that when any fault type except *Arbitrary* is selected, a 3-cell Three Phase Parameter box appears above the data cells of the Dynamic Display area. The V/I/Φ parameters in the box are blue, indicating they may be adjusted by the keypad or dial. The cells above, where individual channel adjustments are made in *Arbitrary* mode, are now greyed-out, and cannot be modified directly with the keypad or dial. Notice the effect on these readings of pressing *Rotate Fault* [F9].

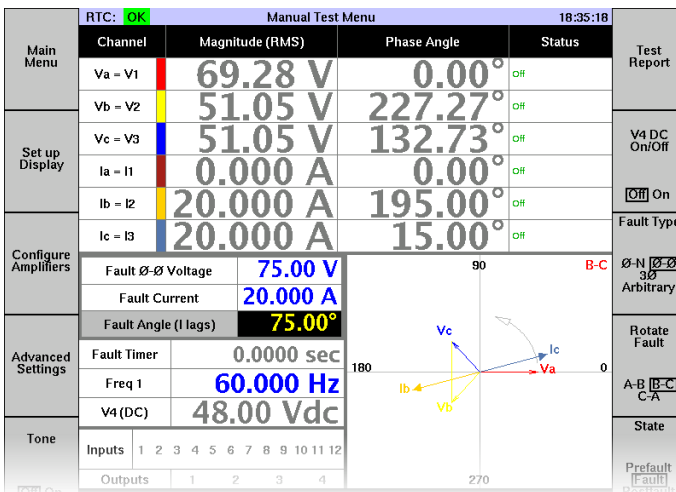

Figure 4.7 ROTATE FAULT CONTROL

4.3.1. Φ -N Fault Type

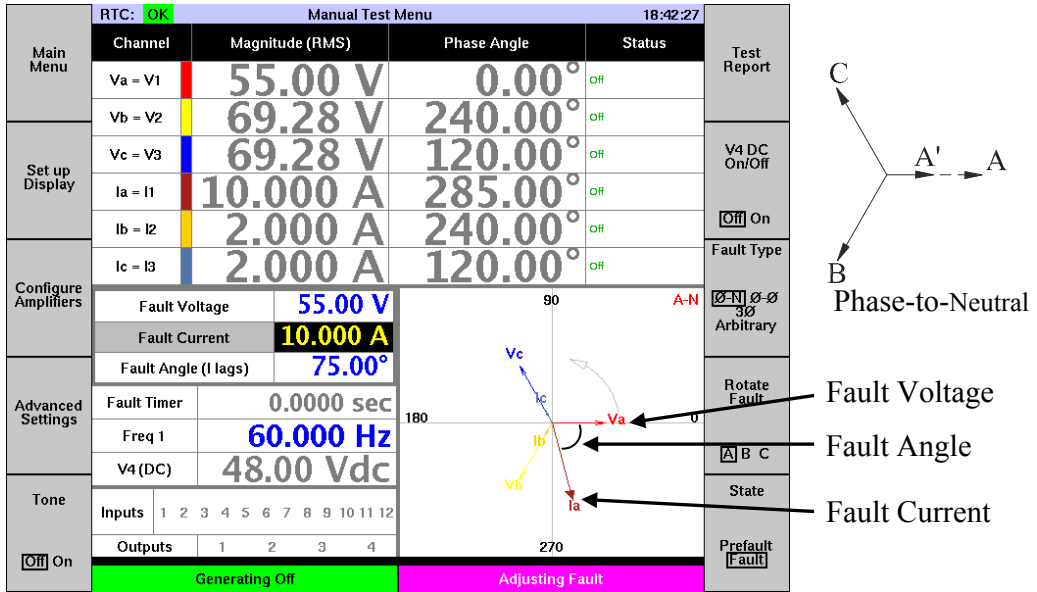

Figure 4.8 PHASE-TO-NEUTRAL FAULT

The Φ -N Fault type will display and allow convenient adjustment of any single Φ -N voltage and current, for simulation of single phase faults. Note that any settings applied in Prefault mode will be the default setting in Fault mode on non-faulted phases; in Figure 4.8, for example, the Prefault currents were set to 2.000 amps and B and C phases will generate 2.000 A in the FAULT mode.

Once the fault Φ -N voltage, current, and phase relationships are set, they can be applied to any desired phase (A-N, B-N, or C-N) by pressing the *Rotate Fault* [F9] button. The faulted voltage and current, plus the programmed phase angle between them, will rotate to the next phase. Figures 4.6 and 4.7 on the preceding page illustrate this effect in a phase-to-phase fault.

The fault selected at any time is indicated by text in the upper right corner of the phasor display, as well as the highlighted selections on the *Fault Type* and *Rotate Fault* labels, in the above illustration A-N, Φ -N, and A respectively.

This fault mode can also be very useful for single-phase testing when identical relays are installed in each of the three phases. By connecting the wiring for all phases at the start, once tests are completed on the first phase's devices, it is only necessary to press *Rotate Fault* [F9] to transfer the test settings and active output channels to the next phase.

4.3.2. Φ - Φ Fault Type

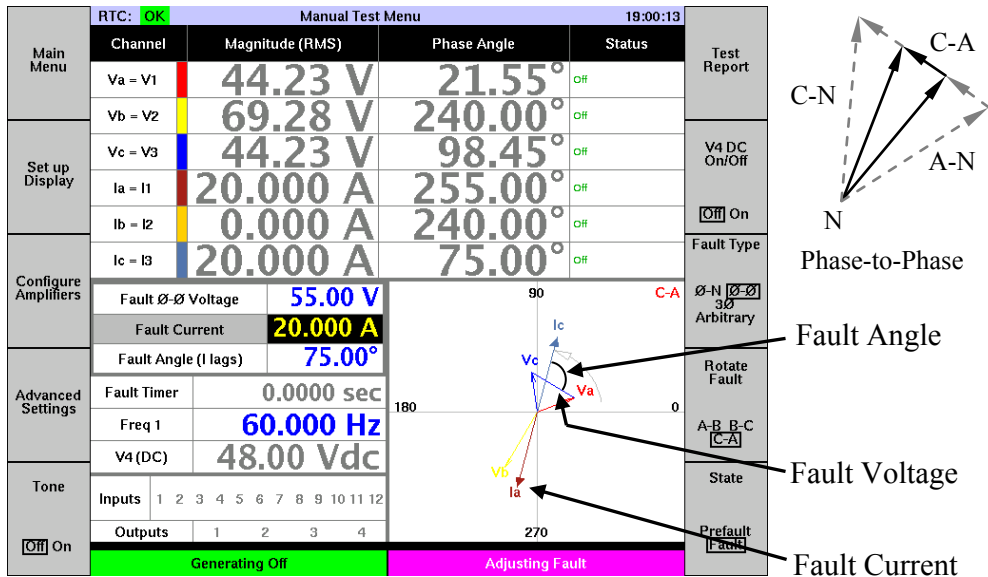

Figure 4.9 PHASE-TO-PHASE FAULT

The Φ - Φ Fault type allows direct control of the phase-to-phase voltage and current. The keypad or dial will simultaneously change the amplitude and phase of two selected Φ -N voltages, resulting in the desired change of the Φ - Φ voltage. See the vector diagram in the upper right corner of Figure 4.9 above for an example. The phase angle of the Φ - Φ vector does not change, but its amplitude does. Notice how the same 55 volt fault value as specified in the Φ -N fault of the previous Section (see Figure 4.8) results in much different individual amplitude and phase settings for the faulted phases (see Figure 4.9). A single input specification has automatically calculated and applied four parameter changes.

A major advantage of this ease of adjustment is that when testing Φ - Φ elements of impedance relays, the current may be fixed at a safe level and only the voltage modified.

In a Φ - Φ fault the fault current flows out one phase and back the other, so current in the two faulted phases is equal in amplitude but opposite in direction. As above, a single input specification has automatically calculated and output four parameter changes.

The phase angle relationships between voltage and current in a Φ - Φ fault is not immediately obvious from looking at the individual voltage and current source phase angles, since the sources are configured Φ -N. In *Arbitrary* mode the necessary Φ -N settings must be calculated from the Φ - Φ values using geometrical formulae. By specifying the desired fault phase angle in the Three Phase Parameter box however, the

necessary phase angles are automatically calculated and applied to the current output channels. Here, a single input specification has automatically calculated and applied two parameter changes.

Once the fault voltages, currents and phase angle are set, they can be applied to any pair of phases (A-B, B-C, C-A) by pressing the *Rotate Fault* [F9] button. The fault voltage and current, plus the specified angle between them, will rotate to the next phase. This is illustrated in Figures 4.6 and 4.7.

The fault selected at any time is indicated by text in the upper right corner of the phasor display, as well as the highlighted selections on the *Fault Type* and *Rotate Fault* labels, in the above illustration *C-A*, Φ - Φ , and *C-A* respectively.

4.3.3. 3Φ (Φ-N) Fault Type

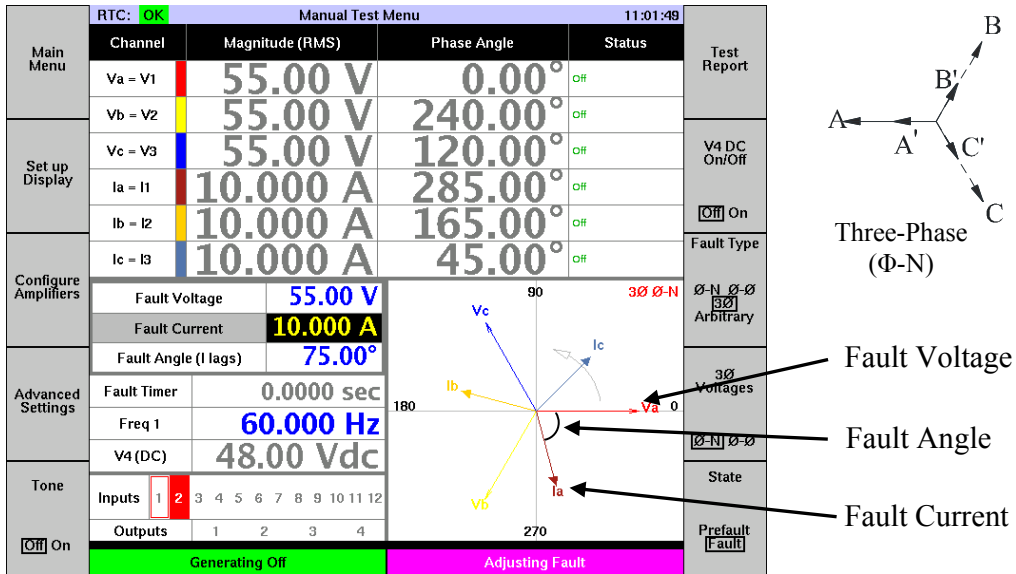

Figure 4.10 THREE PHASE FAULT (Φ-N)

The 3Φ (Φ-N) fault type enables the symmetrical collapsing or expansion of all 3Φ voltages and currents; and phase-locks the angles 120 degrees apart. After selecting 3Φ on the *Fault Type* [F8] button, a new selection button 3Φ *Fault Values* [F9] appears below it that defaults to Φ-N on the latter button.

When *Fault Voltage* within the Three Phase Parameters box is selected, the keypad or dial will simultaneously adjust the amplitude of all three voltage vectors but leave their phase angles unchanged. Notice how the same 55 volts fault value specified in previous examples results in different individual amplitude and phase settings for all the voltage phases (see Figures 4.8 and 4.9). A single input specification has automatically calculated and output three parameter changes.

The Φ-N Fault Current adjustments are identical in nature to the Fault Voltage. Again, a single input specification automatically calculates and outputs three parameter changes.

The *Fault Angle* value specified will automatically calculate and apply the three current phase angle adjustments necessary to generate the desired phase angle between the individual voltages and currents.

4.3.4. 3Φ (Φ-Φ) Fault Type

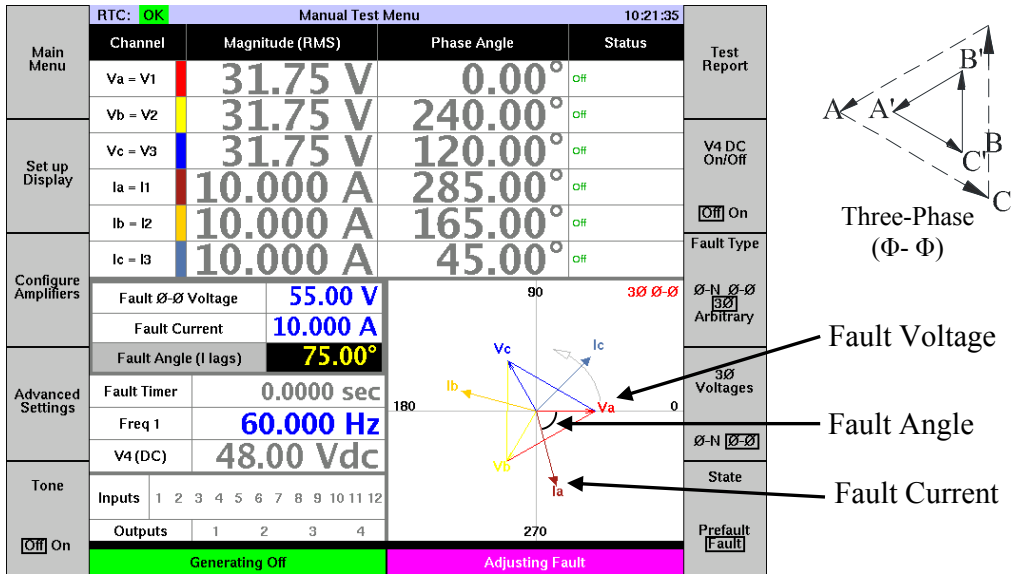

Figure 4.11 THREE PHASE FAULT (Φ-Φ)

You can use the 3Φ (Φ-Φ) to automatically calculate Φ-Φ values for devices configured to monitor Φ-Φ values or simulate Delta and Open-Delta systems by connected the V1, V2, and V3 channels to the device's phase voltage inputs and leaving the black voltage terminal on the MTS-5100 open. Most devices configured for Delta voltages require a jumper from VB to VN on the device to operate correctly.

The 3Φ (Φ-Φ) Fault type enables the symmetrical collapsing or expansion of the entire 3Φ voltage and current triangles from the nominal values. When this fault type is selected, the keypad or dial simultaneously change the amplitude of all three phases of (Φ-Φ) voltage or current (Φ-N); see the vector diagram for voltages in the upper corner of Figure 4.11 above.

Note that when 3Φ is selected by the *Fault Type* [F8] button, a new selection button 3Φ *Fault Values* [F9] appears and [F9] should be pressed until Φ-Φ is selected.

When *Fault Voltage* within the Three Phase Parameters box is selected, the keypad or dial will simultaneously adjust the amplitude of all three voltage vectors but leave their phase angles unchanged. Notice how the same 55 volts fault value as specified in previous examples results in different individual amplitude and phase settings for all the voltage phases (see Figure 4.8 and 4.10). A single input specification has automatically

calculated and output three parameter changes, modifying the Φ -N voltage output channels to obtain the specified Φ - Φ voltage.

The Φ - Φ *Fault Current* adjustments are still Phase-Neutral as described in the previous section. Again, a single input specification automatically calculates and outputs three parameter changes.

The *Fault Angle* value specified will automatically calculate and apply the three current phase angle adjustments necessary to generate the desired phase angle between the applied Φ -N voltage and Φ -N current for accurate test results. Notice on the vector display that both the Φ -N and Φ - Φ voltages are shown. The voltage sources, and the Φ - Φ vectors derived from them, are shown.

The fault selected at any time is indicated by text in the upper right corner of the phasor display, as well as the highlighted selections on the *Fault Type* and *3 Φ Fault Values* labels, in the previous illustration 3 Φ (Φ - Φ), 3 Φ , and Φ - Φ respectively.

4.4. STATUS INPUTS CONFIGURATION

The 12 status inputs are used to sense operation of the device(s) under test, or to initiate specific functions of the MTS-5100.

- They may be configured to sense changes in status of dry contacts or DC voltages.
- An audible tone may be assigned to any input to indicate change of state.
- The voltage sensing threshold and debounce time (the time in milliseconds an input signal must remain at a changed level before recognition) are programmable.
- The inputs may be programmed to respond only during a specific fault state, and to force the system to another specific fault state.
- They may be used to control 4 independent timers.
- The input impedance of each input exceeds 750kohms and each input pair is galvanically isolated from both the other inputs and all other circuitry of the MTS-5100.
- All inputs can perform waveform capture using the Oscilloscope Display mode (See Section 4.12).

The most common application of status inputs is to detect the operation of the trip output contact(s) of protective relays. The large number of inputs allow simultaneous monitoring of multiple outputs on complex microprocessor-based relays, the trip outputs of multiple relays installed in the three phases of a protective relay system, and/or key operating points in the trip output circuitry of a complete protection system. This allows efficient manual or automated testing without relocating the operation sensing leads between tests.

The inputs are used to monitor digital status, i.e. on or off state, of dry contacts or DC voltage levels. The MTS-5100 incorporates a Sequence of Events recorder function that is driven by the status inputs which records status of all inputs in both tabular and graphical form. See Section 4.11 for detailed information on this function.

All 12 channels of status inputs are also capable of waveform capture, functioning as a multi-channel oscillograph. This can be very useful in applications such as measuring the magnitude, shape, and difference between waveforms. See Section 4.12 Oscilloscope Display for detailed information on this function.

To check or modify configuration of the status inputs from the Manual Test Menu, press *Advanced Settings* [F4], then *Set up I/O and Timers* [F2] to bring up the I/O Setup Menu.

| | | | | | | |
|---------------------------------|---|--|------|-----------------------|----------|---|
| Back to Advanced Settings Menu | | RTC: OK I/O Setup Menu 14:19:52 | | | | Configure Inputs |
| | | Inputs | | | | |
| | # | Name | Type | Level | Debounce | Tone |
| | 1 | Trip | Dry | 6.0 V | 0.0 ms | Yes |
| | 2 | Trip | Dry | 6.0 V | 0.0 ms | Yes |
| Use Input 12 for Footswitch | 3 | Trip | Dry | 6.0 V | 0.0 ms | Yes |
| | 4 | Trip | Dry | 6.0 V | 0.0 ms | Yes |
| | 5 | Trip | Dry | 6.0 V | 0.0 ms | Yes |
| | 6 | Trip | Dry | 6.0 V | 0.0 ms | Yes |
| No <input type="checkbox"/> Yes | 7 | Close | Dry | 6.0 V | 0.0 ms | No |
| | 8 | Close | Dry | 6.0 V | 0.0 ms | No |
| | 9 | Trip | Dry | 6.0 V | 0.0 ms | No |
| | 10 | 52A | Dry | 6.0 V | 0.0 ms | No |
| | 11 | 52B | Dry | 6.0 V | 0.0 ms | No |
| | 12 | Footswitch | Dry | 6.0 V | 0.0 ms | No |
| Set all Inputs to Wet | This menu configures the basic operational characteristics of each status input. Press F7 to configure the state transitions triggered by each input. | | | | | Configure Timers |
| | You may select a name for each status input channel. The selected names appear on sequence of events screens, including the graphical sequence of events display. | | | | | |
| Set all Inputs to Dry | The first five names are customizable, via the Customization Menu. Press HELP for more details. | | | | | Reset Status Input Settings to Factory Defaults |
| | Generating Off | | | | | |
| | | | | Input 1 reading: 9.0V | | |

Figure 4.12 DEFAULT I/O SETUP MENU

By default, Input 1-10 are configured for dry contact operation sensing, no debounce, enabled in any fault state, triggering forces the system to Postfault mode and stops the Fault Timer. The audio tone is enabled for inputs 1-6. Separate setup screens are provided via F6 and F7 for basic input configuration and Fault State Control.

4.4.1. Basic Configuration

Press *Configure Inputs* [F6]. Move the cursor to the cell associated with the parameter to be modified, then rotate the dial to view and select the desired option. The selection can be locked to the new value by: leaving the selection on the option for a couple of seconds, pressing ENTER, or pressing an arrow key to move to the next cell.

4.4.1.1. Input Name

Making a selection under *Name* in the manner described above will generate the list shown at the right. The list contains the name of functions commonly encountered in protective relaying, as well as 5 customizable names. These labels will assist in identifying the function associated with each input as they are recorded in the text or graphic Sequence of Events Recorder displays and this setting will not affect operation in any way. For information on creating custom names see Section 3.8.1. For information on the Sequence of Events recorder see Section 7.6.

- Custom 1
- Custom 2
- Custom 3
- Custom 4
- Custom 5
- 52A
- 52B
- BF Initiate
- Block
- Bus Blocking
- Bus Initiate
- Close
- Echo
- Fault Detector
- Local/Remote
- Lockout
- Permissive Rx
- Permissive Tx
- Reclose Initiate
- Trip
- Unblock**

4.4.1.2. *Contact Type*

The *Type* column identifies whether the input will sense a *Dry* or *Wet* contact operation. Dry mode senses the operation of an isolated relay output contact. Wet contact mode will sense the presence of voltage. Input number 12 may be selected for *Footswitch* mode via button F2. The Footswitch mode senses operation of an external foot-operated switch or other contact, and will put the MTS-5100 in Static Fault or PICKUP mode. When the contact or footswitch is opened, the system will return to the previous state, typically Prefault or OFF. An input configured for Selection of *Wet* mode is indicated by a red square around that input's status indicator (Figure 4.14).

Most trigger signals are normally open, that is they change from no continuity or no voltage to closed contact or voltage presence. The MTS-5100 inputs are configured by default to be triggered by a change of state however, so normally closed signals will also trigger an input when they go open. It is also possible to configure the inputs to only respond to a specific direction of state transition, see Section 4.4.2.3.

4.4.1.3. *Threshold Level*

The *Level* column allows programming of a voltage threshold detection level. When Wet contact sensing is selected, the default threshold level is 10 VDC, i.e. the voltage must exceed that level to be considered closed. Enter a new threshold value with the keypad or dial if desired. Note the following:

- The inputs will sense presence of AC voltage, but because of the continuous fluctuation of level it is not suitable for precision timing applications.
- The *Threshold* level may be adjusted to any value between 0.1-250 VDC.
- To ensure reliable triggering set the level about 10% below the maximum level expected. Too low a setting may cause false triggering from noise pickup.
- If the input has been set for *Dry* contact sensing, the corresponding *Level* cell (6v by default) will allow adjustment between 0-30V for unusual dry contact resistance levels.

4.4.1.4. *Debounce Time*

The *Debounce* column allows the time an input signal must be sustained before it is considered as valid to be programmed. This is most likely to be a factor when testing electromechanical relays operating just over their minimum pickup level, where contact bounce may be a factor. Typically the debounce time in such a case would be set to roughly equal the pickup time of high-speed auxiliary relays driven by the device under test. Any Debounce time set greater than 0.00 will increase the actual measured time by the Debounce value.

4.4.1.5. *Tone*

This selection determines if an audible tone will be produced whenever the input is triggered to On. Note that there is also a separate master enable button for the audio tone, located on the Manual Test Menu. Press *Tone* [F5] to enable or disable the tone on all channels without modifying the individual channel configurations.

4.4.2. **Fault State Control**

Press *Configure Fault State Control* [F7]. This menu permits customization of the fault state transitions controlled by the input channels.

| | | | | | | | |
|--|--|----------------|-----------|------------|---|-------------------------------|------------------|
| | | I/O Setup Menu | | | | 13:05:02 | |
| Back to Advanced Settings Menu | Inputs | | | | | | Configure Inputs |
| | # | Name | Enable In | Go To | When | | |
| | 1 | Trip | Fault 1-8 | Same State | Edge | | |
| Use Input 12 for Footswitch <input type="checkbox"/> No <input checked="" type="checkbox"/> Yes | 2 | Trip | Fault 1-8 | Reset | Edge | Configure Fault State Control | |
| | 3 | Trip | Fault 1-8 | Prefault | Edge | | |
| | 4 | Trip | Fault 1-8 | Fault | Edge | | |
| | 5 | Trip | Fault 1-8 | Fault 2 | Edge | | |
| | 6 | Trip | Fault 1-8 | Fault 3 | Edge | | |
| | 7 | Close | Fault 1-8 | Fault 4 | Edge | | |
| | 8 | Close | Fault 1-8 | Fault 5 | Edge | Configure Outputs | |
| | 9 | Trip | Fault 1-8 | Fault 6 | Edge | | |
| | 10 | 52A | Fault 1-8 | Fault 7 | Edge | | |
| | 11 | 52B | Prefault | Fault 8 | Edge | | |
| | 12 | BF Initiate | Prefault | Postfault | Edge | | |
| | This menu configures the state transitions triggered by each status input. Press F6 to configure the basic operational characteristics of each input. If input 12 is defined as a footswitch by pressing F2, pressing the footswitch will generate static fault conditions, and releasing it will return to the previous state (usually "off" or "prefault"). | | | | | | Configure Timers |
| Configure | Inputs enabled in "Any State" are ignored when not generating. | | | | Reset Status Input Settings to Factory Defaults | | |
| Press HELP for more details. Generating Off Input 1 reading: - 0.4V | | | | | | | |

Figure 4.13 I/O FAULT STATE CONTROL

4.4.2.1. *Enable In*

This column defines in which fault state a trigger action on the input will be recognized. Rotating the dial with the cursor over a cell in the *Enable In* column will scroll through the available options, which include:

Any State - The input will be enabled in any prefault, fault, or postfault state.

Prefault - A trigger action will only be recognized if Prefault state is active.

Fault - A trigger action will only be recognized if Fault state is active (no multiple faults programmed) or Fault 1 active (multiple faults programmed).

Fault 2 - A trigger action will only be recognized if Fault 2 state is active. Similar options are offered for Fault 3 through Fault 8.

Postfault - A trigger action will only be recognized if Postfault state is active.

Fault 1-8 - A trigger action will be recognized in any Fault state.

4.4.2.2. *Go To*

This column defines what state will be energized when the input is triggered in the state defined by the *Enable In* column. Rotating the dial with the cursor over a cell in the *Go To* column will scroll through the available options, which include:

Same State - A trigger action will not force a new fault state, the existing one will be maintained.

Reset - A trigger sensed in this mode clears any frozen readings if in Postfault mode, and interrupts the output channels if in Fault mode. It has the same action, in other words, as pressing the RESET pushbutton.

Prefault - A trigger action will force the AC/DC output channels to the Prefault state.

Fault - A trigger action will force the AC/DC output channels to the Fault state. This can be used to initiate a fault sequence from an external contact operation rather than from pressing the FAULT button.

Fault 2 - A trigger action will force the AC/DC output channels to the Fault 2 state. This can be used to initiate a multiple fault sequence from an external signal such as a reclosure relay. Similar options are offered for Fault 3 through Fault 8.

Postfault - This is the default option for most inputs. A trigger action will freeze the timer and AC output readings, and force the AC/DC output channels to Postfault state. Note that the AC/DC output channels will only be energized in Postfault state if it has been enabled, otherwise the output channels will turn off.

4.4.2.3. *When*

Cells in this column permit the programming of an input to respond only to a specific transition direction. The default *Any Edge* setting means that the first status transition detected in the state in which the input is enabled (see 4.2.2.1 above) will trigger the input (Normally-open or Normally-closed contacts will operate the input). Depending on the system being monitored by the input however, there may be cases where it is desired to generate a trigger response by detecting a specific direction of transition, which in turn requires ignoring the initial transition.

The available *Rising* (Normally-open operating) and *Falling* (Normally-closed operating) settings allow the trigger response to be precisely programmed. Note that this is directly analogous to the rising edge/falling edge capability found on the trigger controls of most oscilloscopes.

4.4.3. Status Inputs Active Indication

A visual indicator of the status of the input channels, to verify each channel is responding correctly to the signal for which it is configured, is provided in the lower part of the Dynamic Display Area.

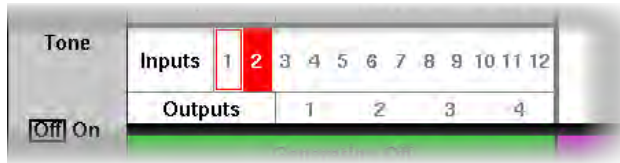

Figure 4.14 STATUS INPUTS ACTIVE INDICATION

As illustrated, it shows the trip sensing status of each input by highlighting active channels in red, in this case channel 2. Note that in this example channel 1 is configured for Wet operation, i.e. voltage presence sensing, as indicated by the square red outline.

4.5. PROGRAMMABLE TIMERS

A primary application of the status inputs of the MTS-5100 is to determine the timing of events driven by the AC/DC output channels of the system. By default, the Fault timer is configured to start timing when the FAULT state is active and to stop when the FAULT state is de-activated, i.e. Status Input 1-10 operating..

In many applications, such as in-panel system tests or multi-output relay tests, the ability to record multiple timing events simultaneously may be desired. The MTS-5100 provides four additional timers, which may be configured independently to start and stop from any status input trigger or fault state initiation.

To select and program these timers, from the Manual Test Menu press *Advanced Settings* [F4], *Set up I/O and Timers* [F2], then *Configure Timers* [F9]. By default all the timers will be disabled.

| Back to Advanced Settings Menu | RTC: OK | | I/O Setup Menu | | 15:48:48 | | Configure Inputs | |
|---|---------------------|----------------|----------------|------|-------------------------|------|-------------------------------|--|
| | Programmable Timers | | | | | | | |
| Display Timers in Seconds Cycles Both | # | Name | Start | | Stop | | Configure Fault State Control | |
| | | | Event | When | Event | When | | |
| | 1 | Timer 1 | None | On | None | Off | Configure Outputs | |
| | 2 | Timer 2 | None | On | None | Off | | |
| | 3 | Timer 3 | None | On | None | Off | | |
| | 4 | Timer 4 | None | On | None | Off | | |
| <p>This menu defines the operation of the user-programmable timers.</p> <p>Any timer for which the Start Event setting is not "None" will appear on the main Manual Test Menu.</p> <p>The "When" settings define the event condition to start or stop the timer. For a status input, "On" means "Closed" or "Voltage Present". For a fault state, "On" means "On Entry To" and "Off" means "On Exit From".</p> <p>Use the F2 key to select the type of value to show for each configured timer. The "cycles" timers are based on the frequency 1 setting for the Fault 1 state.</p> | | | | | | | | |
| | | | Generating Off | | Input 1 reading: - 0.6V | | | Configure Timers |
| | | | | | | | | Reset Timer Settings to Factory Defaults |

Figure 4.15 PROGRAMMABLE TIMER SETUP MENU

4.5.1. Timer Start: Event

Settings in this column determine what event will start the timer running. The options for this selection include:

None - The default selection, which disables the timer

Prefault - entry into or exit from this fault state, depending on the setting of the *When* column being *On* or *Off* respectively

Fault - entry into or exit from the default Fault state, depending on the setting of the *When* column being *On* or *Off* respectively

Fault 2 - 8 - entry into or exit from the Fault state 2, 3 ... 8, depending on the setting of the *When* column being *On* or *Off* respectively

Postfault - same as Fault, above

Input 1-12 - Transition of the specified input to an 'On' state (i.e. appearance of a closed contact or voltage presence) or to an 'Off' state (i.e. contact opening or voltage disappearing), depending on the setting of the *When* column being *On* or *Off* respectively

4.5.2. Timer Start: When

Settings in this column determine what type of transition of the event defined in the *Event* column above will start the timer running. The options for this selection include:

On - Entry into the fault state specified under *Event*, or sensing of a contact closure or voltage appearance at any status input channel

Off - The exit from a specified state, or the sensing of a contact opening or voltage disappearance at any status input channel

4.5.3. Timer Stop: Event and When

The options for programming a stop event and timing are identical to those described above for starting the timers. Notice that the timer readouts can be configured for *Seconds*, *Cycles*, or *Both* via pushbutton F2.

Once any programmable timer has been configured in this matter, its data readout will automatically be included in the information in the Dynamic Display Area of the Manual Test Menu.

| | | | |
|---|-------------|----------------------------|-----|
| Fault Current | | 10.000 A | |
| Fault Angle (I lags) | | 75.00° | |
| Advanced Settings | Fault Timer | 0.0000 sec | |
| | Freq 1 | 60.000 Hz | |
| | Timer 1 | 0.0000 sec | |
| | Timer 2 | 0.0000 sec | |
| | Timer 3 | 0.0000 sec | |
| | Timer 4 | 0.0000 sec | |
| V4 (DC) | | 48.00 Vdc | |
| Tone | Inputs | 1 2 3 4 5 6 7 8 9 10 11 12 | 180 |
| | Outputs | 1 2 3 4 | |
| <input type="checkbox"/> Off <input checked="" type="checkbox"/> On | | Generating Off | |

Figure 4.16 PROGRAMMABLE TIMERS DATA READOUT

The timer data readouts may be selected for seconds, cycles, or both, via pushbutton *Display Timers in* [F2] (see the left side menu in Figure 4.15). Note that the cycle selection will count cycles based on the Freq 1 setting that may not be the same for relays or other devices that count cycles based on the system frequency (Typically 60 Hz).

4.6. DIGITAL OUTPUTS CONFIGURATION

The digital outputs are isolated relay contacts which can be configured normally open (NO) or normally closed (NC), and programmed to operate at specific times in the Prefault/Fault/Postfault sequence. They can be used to simulate contacts of devices like circuit breakers, or to switch DC voltage for logic elements of a protective relay system. This permits complete testing of complex relays or relay systems which monitor the status of external equipment as part of their operational logic. Be careful not to exceed the maximum contact ratings of 0.4A resistive at 250VDC, or 5 Arms at 240 VAC.

By default, output #1 is a NO contact whose status is controlled by the Fault state. To configure the outputs, press *Advanced Settings* [F4] in the Manual Test Menu, *Set up I/O and Timers* [F2] in the Advanced Settings Menu, then *Configure Outputs* [F8] in the I/O Setup Menu.

| Back to Advanced Settings Menu | RTC: OK | | I/O Setup Menu | | 16:07:57 | Configure Inputs | |
|--------------------------------|--|--------|----------------|----------------------|----------|-------------------------------|---|
| | # | Delay | Function | Breaker Operate Time | | | |
| | 1 | 6.0 ms | Fault | N/A | N/A | Configure Fault State Control | |
| | 2 | 6.0 ms | Off | N/A | N/A | | |
| | 3 | 6.0 ms | Off | N/A | N/A | | |
| | 4 | 6.0 ms | Off | N/A | N/A | Configure Outputs | |
| | There are four contact outputs, each of which is the output of a relay (i.e., the output becomes shorted when active). Each contact output has a delay setting, causing it to change state that long after its associated condition (the "Function" setting) becomes true. The minimum delay (6.0ms) is approximately the time it takes the MTS-5100's output relay to close. Press HELP for more details. | | | | | Configure Timers | |
| Configure Custom Output States | Generating Off | | | | | Input 1 reading: 8.7V | Reset Output Settings to Factory Defaults |

Figure 4.17 DIGITAL OUTPUTS SETUP MENU

4.6.1. Delay

The *Delay* column specifies the time delay before the contact operates, following initiation of a state. Move the cursor to a Delay cell and enter the desired time delay with the dial or keypad. The minimum delay of 6ms is the approximate pickup time of the relay, and may vary ± 1 ms.

4.6.2. Function

The *Function* column cells determine the contact operating characteristic. Move the cursor to the desired channel cell and rotate the dial to view and select the desired option. The following options are available:

Off - The output channel does nothing.

On - The output is always ON in all states.

Fault - The contact is closed during Fault state, and open at all other times (Prefault and Postfault). To simulate a remote permissive trip signal, a delay proportional to the actual permissive signal delays would be programmed in the *Delay* cell.

Fault 2 - The contact is closed during Fault 2 state, and open at all other times (Prefault and Postfault). Similar options are offered for Fault 3 through Fault 8.

Postfault - The contact is closed when in the Postfault state and Off in all other states. The output contact transition time can be modified with the Delay setting.

52A -The contact simulates operation of a circuit breaker NO auxiliary contact, i.e. the contact is closed during Prefault and Fault, but opens in Postfault state. If a Breaker Operate Time is specified in the *Open* column, the opening of the contact following sensing of a trip trigger will be delayed by that time. A time delay specified in the *Close* column will apply in the event the system is configured to simulate a reclosure operation. In this case, the contact would remain open until the specified time after a reclosure signal causes the system to transition from Postfault to Fault state.

52B - The contact simulates operation of a circuit breaker NC auxiliary contact, i.e. the contact is open during Prefault and Fault, but closes in the Postfault state. Operation is the inverse of the 52A described above.

Permissive - The output contact will turn on in any Fault state (Fault, Fault 1-8) and turn off in any other state after the Delay time has passed for any transition (On or Off).

Unblock - The contact is normally closed, but opens during Fault state. A delay proportional to the actual unblock signal delays should be programmed for this state.

Mimic - This allows an output contact to be controlled by a status input, so that it follows the opening and closing of the latter. The *Mimic 1* selection will cause the output to follow input 1. Similar options are available for mimicing inputs 2 through 12.

Custom - Custom allows the output to be on or off in any state (Including when channels are off) as defined in the Configure Custom Output States [F5] menu. Select output to change position and the output status (On/Off) in any state using the arrow keys and dial. The output must be set to Custom for the Custom Output States Menu settings to be applied. A delay timer can be set to delay contact closure or opening for the pre-set delay.

4.6.3. Digital Outputs Status Indicator

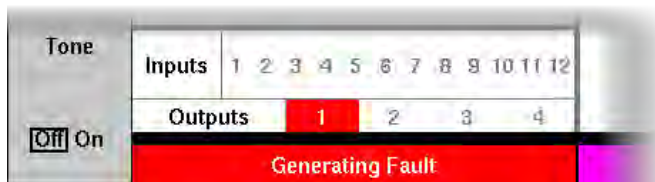

Figure 4.18 DIGITAL OUTPUTS STATUS INDICATION

The status indicator is located in the Dynamic Display Area of the Manual Test Menu. Any channels which are currently active are highlighted in red, for example the default Fault-configured output 1 as shown above.

4.7. AMPLIFIER CONFIGURATION

Many applications will not require the full complement of current and voltage sources. Disabling sources not currently in use will simplify the Manual Test Menu display, since only enabled sources are listed there. The text size will be increased when fewer sources are listed in the display, enhancing readability. Press *Configure Amplifiers* [F3] from the Manual Test Menu to open the Amplifier Configuration Menu.

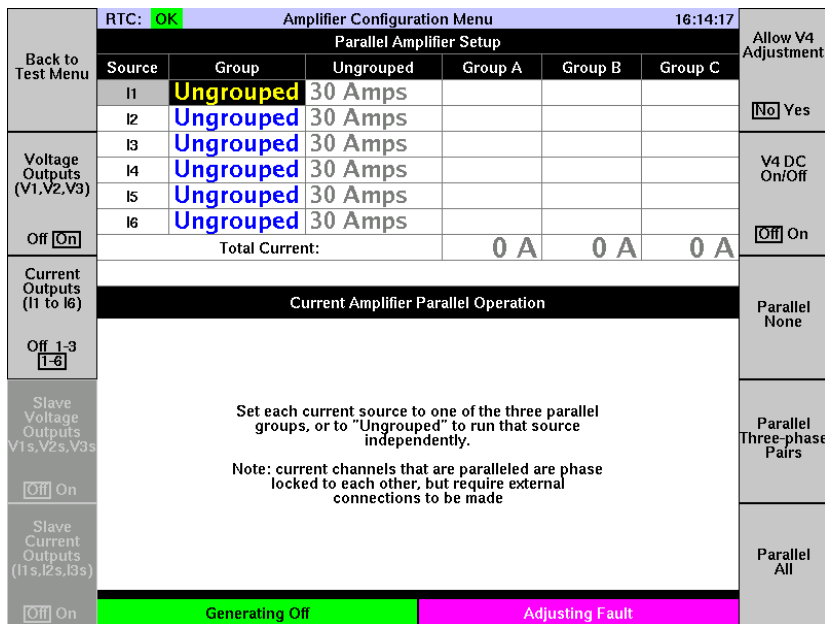

Figure 4.19 AMPLIFIER CONFIGURATION MENU

As shown, there are dedicated buttons to enable/disable the voltage sources [F2] and 3 or 6 currents [F3].

As described in Section 3.4.1, the V4 voltage output adjustment may be unlocked from the default value in this menu, by pressing *Allow V4 Adjustment* [F6].

Parallel operation of the current sources may also be configured here, as described in Section 3.5.1.

If two MTS-5100 systems are configured to run in master-slave mode, the slave unit voltages and currents may be enabled/disabled by the F4 and F5 buttons respectively, which will in turn be enabled as shown by their light grey background. See Section 8 MASTER-SLAVE OPERATION for further details.

4.7.1. 6-Current Transformer Differential Test

Figure 4.20 shows the high-current connections required for a 6-current transformer differential relay test using a single MTS-5100.

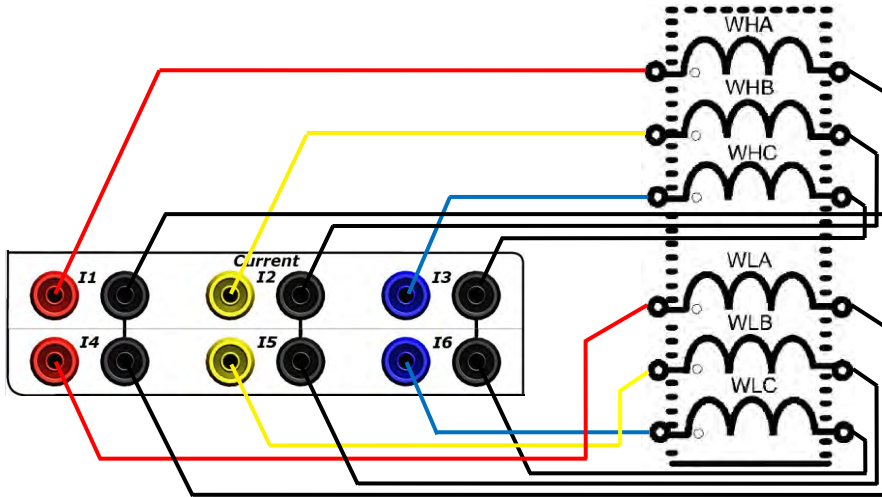

Figure 4.20 6-CURRENT TRANSFORMER DIFFERENTIAL TEST

Neutral wiring: If the tests are performed at relatively low levels, where the total current of all six phases of the MTS-5100 will not exceed 30 amps, the individual current leads from each current source neutral to the relay winding ‘non-spot’ terminals may be reduced to a single lead between the test set and the relay. The current source neutrals must then be jumpered together and any non-spot terminals must in turn be connected to the other two non-spot terminals with jumper conductors. This will reduce the number of longer test leads running from the MTS-5100.

See Section 8 to use Master Slave mode for paralleling currents from two MTS-5100’s allowing for current levels of 6 x 60A.

4.8. ADVANCED SETTINGS

A number of less commonly used configurations can be set up from the Advanced Settings Menu. To access these in the Manual Test Menu, press *Advanced Settings* [F4].

| RTC: OK Advanced Settings Menu 16:31:05 | |
|--|--|
| | Description Setting |
| Back to Test Menu | Breaker Clearing Time 0.0 ms |
| | Fault Incidence Angle (FIA) 0° |
| | GPS-Synchronized Fault off |
| | Input Power Control 5 |
| Set up I/O and Timers | K-Factor 0.000 |
| | K-Factor Angle 0.00° |
| | Maximum Fault Duration Enabled off |
| | Number of Fault States 1 |
| | Normal Phase Sequence A->B->C |
| | Phase Sequence to Generate Positive |
| Set up Ramps | Postfault State Enable off |
| | System Time Constant 0 ms |
| | V4 Powers Relay Yes |
| | Description of "Breaker Clearing Time" Setting: |
| This setting causes the test set to continue generating fault currents and voltages for a short time after the relay under test operates. It is intended to simulate the time taken by a breaker to open the circuit. The fault timer indicates the time up to the point where the status input changed state, so it does not include the breaker clearing time. The setting applies only to transitions from a Fault state (i.e. "Fault 1" to "Fault 8"), into Posfault of "Off", and only when the transition is caused by a status input event. Pushing the Reset button, for example, turns the outputs off without delay. | |
| Generating Off | |
| Adjusting Fault | |

Save and Restore Settings

Show Harmonics Columns
 On

Show Frequency Column
 On

Figure 4.21 ADVANCED SETTINGS MENU

4.8.1. Fault Incidence Angle (FIA)

This selection allows precise setting of the point-on-wave at which the system output channels switch into the fault state. Electromechanical and digital relays behave differently in response to variations in fault incidence angle. Modern high-speed digital relay's operate time, in particular, will vary for varying fault incidence angles. For more information, see Manta Test Systems' application note "Effect of DC Offset on Instantaneous Element Performance".

This feature allows any angle from 0-360° to be specified, as well as a random angle. Fault incidence or inception angle is defined as: The instantaneous electrical waveform angle of the current flowing in the shunt fault path (in the case of a shunt fault), immediately following inception of the fault. Figure 4.22 on the following page illustrate some examples.

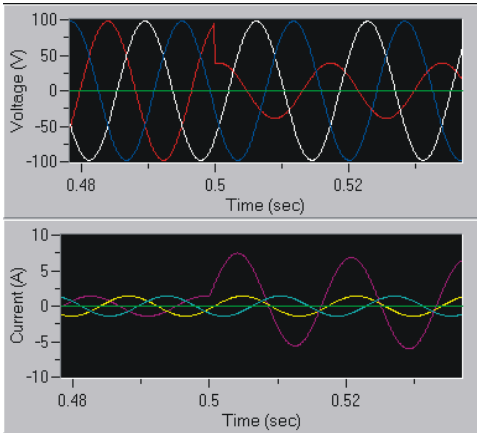

A-G Fault @ 0 Deg.

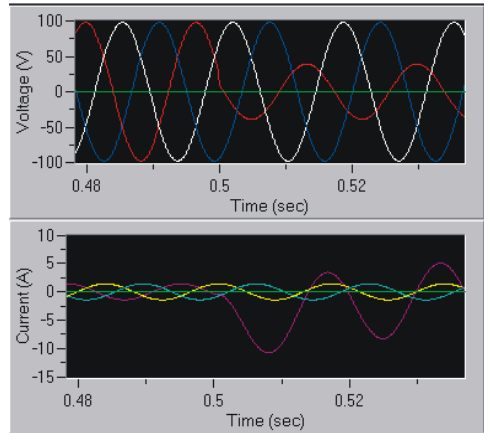

A-G Fault @ 90 Deg.

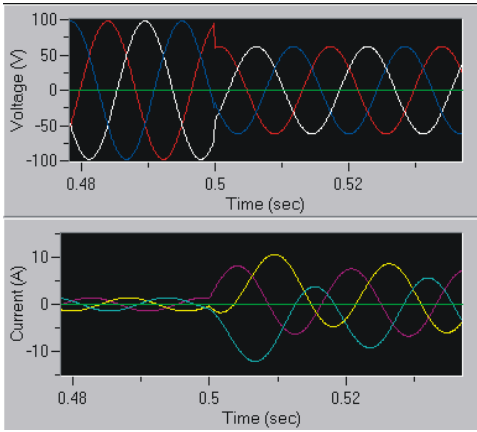

3 Phase Fault @ 0 Deg.

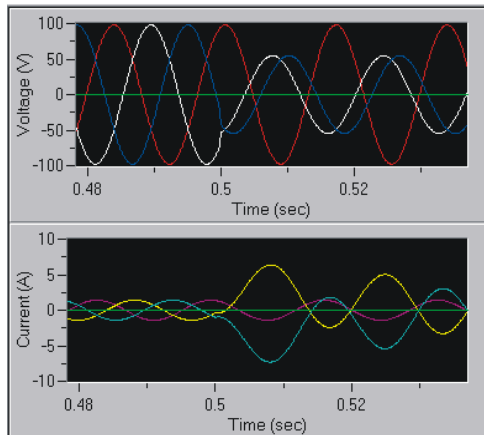

B-C Fault @ 90 Deg.

Figure 4.22 FAULT INCIDENCE ANGLE EXAMPLES

Note that when the fault type is set to 3-phase, the fault incidence angle is referred to the IA fault current. Note also that for proper realistic current waveforms, the system time constant (see item 4.8.7 below) must be set to a realistic non-zero value (e.g. 15 - 50ms), otherwise instantaneous phase/amplitude changes not representative of real world currents may cause unpredictable relay response yielding invalid test results.

The graphical sequence of events display feature (see Section 4.11) can be used to view the test waveforms.

For “Arbitrary” fault type, the internal reference phasor (always set to 0 degrees) is the reference for the fault incidence angle setting. Note that when GPS time synchronization is enabled, the fault incidence angle setting is not available (as indicated by the text *N/A* that appears in the FIA cell), since in that mode the fault transition point is determined by GPS time rather than FIA. The FIA may still be controlled in a GPS-initiated test however by starting in Prefault state and varying the Prefault duration.

If it is desired to display the FIA on the Manual Test Menu, to observe the timing and other results affected by its modification, it can be selected via the Display Setup Menu, see Section 4.9.5.

4.8.2. GPS-Synchronized Fault

This selection arms the system for synchronized fault initiations (usually at different locations). Available selections are *Off*, *10 Seconds*, and *1 Minute*. For detailed explanations of this feature see Section 6 GPS OPERATION, and Section 7.5 INITIATING WAVEFORM PLAYBACK.

4.8.3. K-Factor, K-Factor Angle

These settings provide the magnitude (or angle) of the K-Factor used in the calculation of impedance in a phase-to-neutral fault. Both the K-Factor (or angle) and the resulting impedance value are available as user-selectable quantities for display or test reports.

The MTS-5100 uses the following equation for A-to-neutral impedance:

$$Z_a = V_a / (I_a + (K * IR)) \quad \text{where } IR = I_a + I_b + I_c = 3 * I_0$$

and all quantities are vectors (not magnitudes)

The foregoing formula is used by many relay vendors, including SEL. If your relay uses I_0 (zero-sequence current) instead of IR (residual current), you should set the K-Factor magnitude to three times the provided value. The required K-Factor angle is not affected. This value may be displayed in the Dynamic Display section of the Manual Test Menu, see Section 4.9.18.

4.8.4. Maximum Fault Duration Enabled, Number of Fault States

For detailed explanations of these features, see Section 4.1.3 and 4.1.4.

4.8.5. Phase Sequence

The default phase sequence of the system at power-up is determined by the setting in the Setup Menu, accessible by pressing *Setup* [F10] in the Main Menu that appears at power-up. Use this selection on the Advanced Settings Menu. Options are A->B->C and A->C->B to temporarily reverse the phase sequence.

4.8.6. Postfault State Enable

For a detailed explanation of this feature, see Section 4.1.5 Postfault State.

4.8.7. System Time Constant

This setting enables the generation of an exponentially decaying DC offset to the AC current outputs at each state transition. For accurate results the number input via the keypad or dial should correspond to the actual power system value at the location of the test. This feature is essential for testing many modern high-speed (sub-cycle) relays.

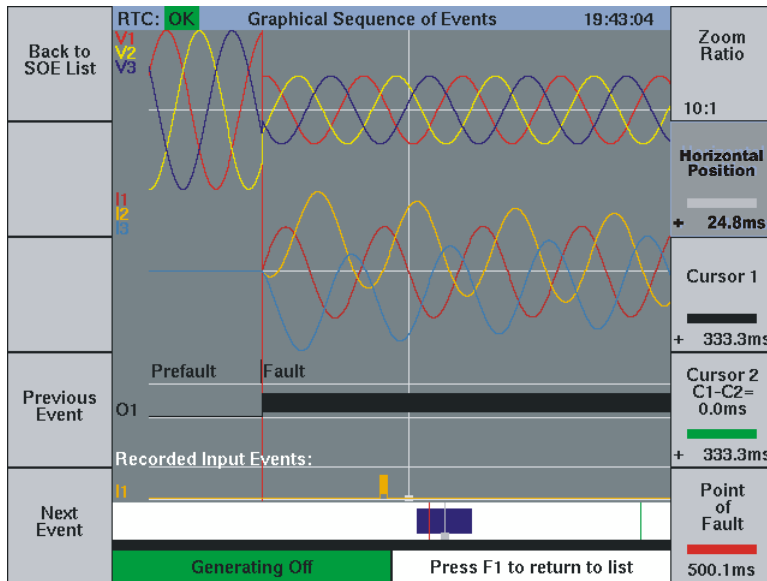

Figure 4.23 SYSTEM TIME CONSTANT EFFECT

Note in Figure 4.23 the effect of specifying a 50 ms system time constant for a symmetrical 3-phase fault with a 0° fault incidence angle (FIA), applied to a high-speed distance relay. Observe the offset in the B and C phase currents, while the A phase shows no offset, having been initiated at the specified 0°. The short pulse on input 1 (I1) at the bottom of the display is the negative sequence overcurrent element of the relay, which in this case no longer operated inappropriately once the time constant was adjusted slightly higher.

The time constant value may be displayed in the Dynamic Display area of the Manual Test Menu, see Section 4.9.7 System Time Constant.

4.8.8. V4 Powers Relay

This setting determines the characteristics of the V4 voltage output. If you set V4 to power a relay, it will produce an adjustable DC voltage with a function key to turn it on and off. If you select V4 not to power a relay, it acts like the other three voltages (typically as a “bank 2 VA” output), and is therefore programmable for AC or DC generation.

4.8.9. Save and Restore Settings

An additional feature available within the *Advanced Settings* Menu is the ability to save and recall MTS-5100 settings. This can be useful for storing more complex test configurations to minimize setup time when using that configuration in the future. Detailed information on the procedure to follow after pressing *Save and Restore Settings* [F7] is available in Section 7.7.1 Save Settings File. NOTE: special software is available from Manta to directly generate multi-part settings files from customer generated MS Excel fault setting files.

4.9. ADDITIONAL DISPLAY INFORMATION

The Dynamic Display Area (see Figure 3.4) by default contains basic time and frequency data by default, and includes the Three Phase Parameters box when any of the three-phase Fault modes are selected. Up to 8 items of data may be displayed in this area at the same time, even if the Three Phase Parameters box is present. The text size is automatically scaled to give the largest display possible for the selected data. To alter the default display, or add additional data, press *Set Up Display* [F2] from the Manual Test Menu.

4.9.5. FIA (Fault Incidence Angle)

This selection enables the display of the specified fault incidence angle, as explained in Section 4.8.1.

4.9.6. Input Power Control

This selection displays the current value of the Input Power Control setting that controls the tradeoff between high compliance voltage and low power consumption, as explained in Section 3.8, Setup.

4.9.7. System Time Constant

This selection displays the current System Time Constant setting from the Advanced Setting Menu. When a non-zero value is specified here, the value will be used to calculate the appropriate DC offset at the initiation of any fault, see 4.8.7 for details.

4.9.8. Frequency 1

This is the default selection for row 2, identifying the default system frequency, Freq 1.

4.9.9. Frequency 2

This option allows the second Frequency setting to be displayed, Freq 2. Freq 2 can be assigned to selected AC output channels at the same time as the others output Frequency 1 as described in Section 3.5.3.

4.9.10. I0

This option displays the magnitude for the zero sequence component of the AC output current.

4.9.11. I1

This option displays the magnitude for the positive sequence component of the AC output current.

4.9.12. I2

This option displays the magnitude for the negative sequence component of the AC output current.

4.9.13. I0 Angle

This option displays the zero sequence current phase angle (in degrees).

4.9.14. I1 Angle

This option displays the positive sequence current phase angle (in degrees).

4.9.15. I2 Angle

This option displays the negative sequence current phase angle (in degrees).

4.9.16. IR

This option displays the fundamental Magnitude of Residual Current (or “neutral current”). This is the sum of the three individual current vectors in a 3Φ configuration. Its magnitude indicates the amount of current with a return path other than the powered lines, such as a neutral wire or the earth. The phase angle of residual current is the same as the phase angle of zero-sequence current (“I0 Angle”). The displayed value does not include the contribution of harmonics to the residual current.

4.9.17. I Unbalance

This option displays the percent current unbalance. Current unbalance is defined as the magnitude of (I2/I1), expressed as a percentage.

4.9.18. K-Factor (Zero Sequence Compensation Factor)

The settings provided the magnitude of the K-Factor used in the calculation of impedance in a phase-to-neutral fault. Both the K-Factor and the resulting impedance value are available as user-selectable quantities for display or test reports.

The MTS-5100 uses the following equation for A-to-neutral impedance:

$$Z_a = V_a / (I_a + (K * IR)) \quad \text{where } IR = I_a + I_b + I_c = 3 * I_0$$

and all quantities are vectors (not magnitudes)

The forgoing formula is used by many relay vendors, including SEL. If your relay uses I0 (zero-sequence current) instead of IR (residual current), you should set the K-Factor magnitude to three times the provided value. The required K-Factor angle is not affected.

4.9.19. K-Factor Angle

This option enables display of the angle of the zero compensation factor in degrees, as explained in the previous item.

4.9.20. RMS AC Line Voltage

This option displays the measured voltage of the Mains AC. It is useful for diagnostic purposes when running the test set from a source with low line voltage (e.g. at the end of a long extension cord with significant voltage drop).

4.9.21. RMS AC Line Current

This option displays the measured current from the Mains AC. It is useful for diagnostic purposes.

4.9.22. Power: Real (W)

This option displays the three-phase Real Power (secondary watts) and is calculated on a phase by phase basis using the sum of:

$$\text{magnitude of } V_i \times \text{magnitude of } I_i \times \text{COS}(\text{angle between } V_i \text{ and } I_i) \quad \text{for } i = a, b, c.$$

4.9.23. Power: Reactive (VAR)

This option displays the three-phase Reactive Power (secondary var) and is calculated on a phase by phase basis using the sum of:

magnitude of V_i × magnitude of I_i × SIN(angle by which V_i leads I_i) for $i = a, b, c$.

4.9.24. Power: Apparent (VA)

This option displays the three-phase Reactive Power (secondary var) and is calculated on a phase by phase basis using the sum of:

magnitude of V_i × magnitude of I_i for $i = a, b, c$.

4.9.25. Power Factor

This option enables the display of Power Factor as calculated by:

Three-Phase Real Power ÷ Three-Phase Reactive Power

Note that a positive results indicates current is lagging voltage (because of the way Three-Phase Reactive Power is defined).

4.9.26. Transducer DC Current

This option enables display of the DC output current from an external transducer via the Transducer 20 mA inputs. This enables accuracy checks to be performed on external AC driven transducers, by comparing the AC/DC output value of the MTS-5100 to the DC current produced by the transducer driven by the AC current and/or voltage. The maximum accuracy possible is determined by the sum of the errors of the voltage and/or current sources used plus the error of the DC input. See Section 2 Specifications for the relevant accuracy figures.

4.9.27. Transducer DC Voltage

This option enables display of the DC output voltage from an external transducer via the Transducer 10V inputs.

4.9.28. V/Hz

Volts per Hertz. In arbitrary mode, this is defined as the highest phase-to-neutral voltage magnitude, divided by Frequency 1. In the other modes: Prefault state it is defined as the magnitude of Prefault Voltage divided by Frequency 1, and for Fault state it is defined as the Magnitude of Fault Voltage divided by Frequency 1.

4.9.29. V0

This option displays the magnitude for the zero sequence component of the AC output voltage.

4.9.30. V1

This option displays the magnitude for the positive sequence component of the AC output voltage.

4.9.31. V2

This option displays the magnitude for the negative sequence component of the AC output voltage.

4.9.32. V0 Angle

This option displays the zero sequence voltage phase angle (in degrees).

4.9.33. V1 Angle

This option displays the positive sequence voltage phase angle (in degrees).

4.9.34. V2 Angle

This option displays the negative sequence voltage phase angle (in degrees).

4.9.35. V Unbalance

This option displays the percent voltage unbalance. Voltage unbalance is defined as the magnitude of $(V2/V1)$, expressed as a percentage.

4.9.36. Z (Ohms)

This option will compute and display impedance based on the fault voltage, the fault current, and (if appropriate) the K-Factor specified above (see 4.9.18). It automatically chooses the appropriate formula based on fault type selection. It can be very useful for testing impedance relays, as it eliminates the need to perform a complex calculation to verify the impedance value at which the relay operates.

4.9.37. Z (Angle)

This option will compute and display the angle of the fault impedance based on the fault voltage, the fault current, and (if appropriate) the K-Factor specified above (see 4.9.18). It automatically chooses the appropriate formula based on fault type selection. It can be very useful for testing impedance relays, as it eliminates the need to perform a complex calculation to verify the angle of the impedance value at which the relay operates.

4.9.38. R (Ohms)

This option will compute and display the real component of the fault impedance based on the fault type.

4.9.39. X (Ohms)

This option will compute and display the imaginary component of the fault impedance based on the fault type.

4.9.40. Z0 (Ohms)

This option will compute and display the magnitude of the zero sequence impedance.

4.9.41. Z0 (Angle)

This option will compute and display the angle of the zero sequence impedance.

4.9.42. Z1 (Ohms)

This option will compute and display the magnitude of the positive sequence impedance.

4.9.43. Z1 (Angle)

This option will compute and display the angle of the positive sequence impedance.

4.9.44. Z2 (Ohms)

This option will compute and display the magnitude of the negative sequence impedance.

4.9.45. Z2 (Angle)

This option will compute and display the angle of the negative sequence impedance.

4.9.46. Z0/Z1

This option will compute and display the (vector) ratio of the zero sequence impedance vector and the positive sequence impedance vector.

4.9.47. Z0/Z1 (Angle)

This option will compute and display the phase angle of the (vector) ratio of the zero sequence impedance vector and the positive sequence impedance vector.

4.9.48. Additional Display Settings

These two additional settings affect other areas of the display.

Backlight Intensity increases or decreases the brightness of the display. This can override the default setting in the Setup Menu accessible from the Main Menu screen (see Figure 5.2).

Show Vector Labels will turn off or on the text labels on the vector display. By default the labels are on.

4.10. RAMPING OUTPUT CHANNELS

All AC output channels can have their magnitude, angle and frequency ramped from a custom start point at a custom stop point at a custom ramp rate. This can be very useful during tests where it is desired to continuously vary a parameter at a specific rate. For example in testing a frequency rate-of-change relay. Voltages, currents, phase angles and frequencies may be ramped simultaneously, both up and down, in both any energized state. To access ramping from the Manual Test Menu, press *Advanced Settings* [F4], then in the *Advanced Settings* Menu (see Figure 4.21) press *Set up Ramps* [F3] to open the Ramps Setup Menu.

| | | | | | |
|--|--|-------------|-----------------|------------|-------------------|
| Advanced Settings Menu | RTC: OK Ramps Setup Menu 00:13:02 | | | | |
| | Frequency ramps, common to all modes | | | | |
| | Description | Start Value | End Value | Ramp Rate | Enable |
| | Frequency 1 | 60.000 Hz | 52.000 Hz | 1.000 Hz/s | Yes |
| | Frequency 2 | 60.000 Hz | 60.000 Hz | 0.000 Hz/s | No |
| Mode-specific ramp parameters for Arbitrary mode | | | | | |
| | Description | Start Value | End Value | Ramp Rate | Enable |
| | Fault Va Fund | 69.28 V | 20.00 V | 10.000 V/s | On |
| | Fault Va Angle | 0.00° | 0.00° | 0.00°/s | Off |
| | Fault Vb Fund | 69.28 V | 69.28 V | 0.000 V/s | Off |
| | Fault Vb Angle | 240.00° | 240.00° | 0.00°/s | Off |
| | Fault Vc Fund | 69.28 V | 69.28 V | 0.000 V/s | Off |
| | Fault Vc Angle | 120.00° | 120.00° | 0.00°/s | Off |
| | Fault Ia Fund | 2.000 A | 5.000 A | 1.000 A/s | On |
| | Fault Ia Angle | 0.00° | 0.00° | 0.00°/s | Off |
| | Fault Ib Fund | 0.000 A | 0.000 A | 0.000 A/s | Off |
| | Fault Ib Angle | 240.00° | 240.00° | 0.00°/s | Off |
| | Fault Ic Fund | 0.000 A | 0.000 A | 0.000 A/s | Off |
| | Fault Ic Angle | 120.00° | 120.00° | 0.00°/s | Off |
| | | | | | State |
| | | | | | Prefault Fault |
| Generating Off | | | Adjusting Fault | | |

Figure 4.25 RAMPS SETUP MENU

The Ramp Settings Menu will show any AC settings that were available before entering the Advanced Settings Menu. Figure 4.25 displays the ramping options in Arbitrary mode. If any other Fault Type was selected before entering the menu, the available options would be Prefault/Fault (1-8)/Postfault Voltage, current, and angle. With the cursor and arrow keys, select those parameters you wish to ramp, and go through the following steps:

- Enter the initial or *Start* value
- Enter the final or *Stop* value
- Enter the *Ramp Rate*
- Select *Enable* to *On*

If the final value is smaller than the initial value, the parameter will ramp downwards, if it is larger the parameter will ramp upwards. All ramps begin when the ramp-enabled fault state is initiated. An individual ramp stops when the energized state is stopped by an external trigger or maximum fault duration, the RESET button is pressed, or the ramp *Stop* value is reached. Multiple parameters may be ramped simultaneously. Different ramps may be programmed for different fault states, so ensure the desired fault state is selected via the *State* [F10] button.

Figure 4.25 is an example of multiple ramps, programmed for Fault state. Frequency 1 will ramp downwards at 1 Hz/ second (for 2 seconds), the VA channel will ramp downwards at 10 V/s, and the IA channel will ramp upwards at 1 A/s.

Ramping will begin at the entry into the state for which it is programmed.

4.11. SEQUENCE OF EVENTS (SOE) RECORDER

The MTS-5100 is capable of capturing and displaying in text format all state changes of the status inputs, output contacts, and output state changes, with 0.1 millisecond resolution. This can be very useful in documenting test results, particularly when in-panel testing of complete protective relay systems is being conducted. To access the display, press Test Report [F6], and then *Sequence of Events* [F6] from the Manual Test Menu.

| RTC: OK | | Manual TestSequence of Events | | 16:39:56 |
|---------------------------------------|------------------|-------------------------------|----------------------------------|------------------|
| Back to Test Menu | Evt# | Time (ms) | Event Description | Report |
| | 1 | - | 135.5 | |
| Show Times Relative to Selected Event | 2 | 0.0 | Entered Fault state | Show Graphically |
| | 3 | 6.1 | Output Contact 1 ON | |
| | 4 | 13.6 | Input Status 1 (BF Initiate) ON | |
| | 5 | 45.7 | Input Status 2 (BF TRIP) ON | |
| | 6 | 45.7 | Entered Postfault state | |
| | 7 | 51.8 | Output Contact 1 OFF | |
| | 8 | 57.2 | Input Status 1 (BF Initiate) OFF | |
| | 9 | 89.2 | Input Status 2 (BF TRIP) OFF | |
| | 10 | 195.3 | END | |
| | Clear Event List | | | |
| | | | | |
| | | | | |
| | | | | |
| | | | | |
| | | | | |
| | | | | |
| | | | | |
| | | | | |
| | | | | |

Figure 4.26 SEQUENCE OF EVENTS RECORDER

Because of the high resolution, contact bounce will sometimes result in multiple events being recorded for a single status input, unless the debounce delay has been adjusted appropriately. If more events are captured than may be displayed on a single screen, use the arrow keys or dial to scroll down or up through the list.

Normally the timing of all events is relative to the point at which the system entered Fault mode, as shown in Figure 4.26. It is possible however to re-initialize the timing reference point to any event in the list, by scrolling to the event with the arrow keys, and pressing *Show Times Relative to Selected Event* [F2].

It is also possible to show the sequence of events list in graphical form by pressing *Show Graphically* [F7]. The event depicted in Figure 4.26 above is shown graphically in Figure 4.27.

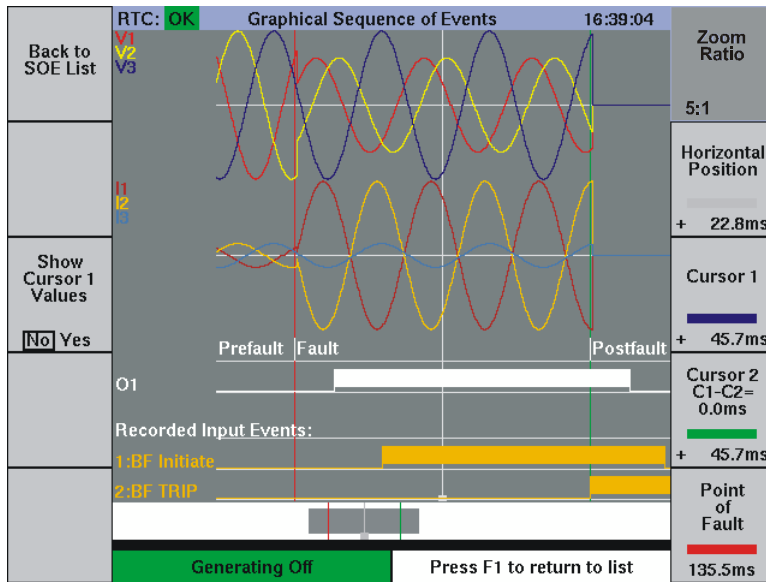

Figure 4.27 GRAPHICAL SEQUENCE OF EVENTS

Notice how the digital status of Inputs 1 and 2, and Output 1, correlate to the analog AC waveforms associated with the Prefault, Fault, and Postfault states listed in the SOE text of Figure 4.27. Although only two inputs and one output are depicted in the graphical SOE above, all inputs and outputs that change state during the captured event will be added automatically. The display will rescale as necessary to show all the information. Note that Input 1 and I2 have been assigned custom names; see Section 3.8.1 for details on this procedure.

The more events that are captured (excessive contact bounce for example) or the longer a test sequence runs (a postfault state that does not stop after a trip, for example) the longer it could take to process the data required to generate the graphical display. Keep this in mind when capturing events for display, and remember to clear any captured event by pressing *Clear Event List* [F5] in the SOE display before recording a new event.

The graphical SOE recorder is very similar in appearance and function to the graphical Waveform Playback display used to show the waveform data contained in Comtrade format waveform files, see Section 7.3 Viewing Waveform Files. Screens from either display may be saved to a PC via the Screen Capture options via the Web Server (see Section 5.3.6) or by pressing and holding the HELP button.

Controls for the display are explained in more detail in the following section.

4.12. OSCILLOSCOPE DISPLAY

The MTS-5100 status inputs are capable of capturing waveform data when connected to AC voltage signals from the MTS-5100 outputs, or other sources with a response time of 100 microseconds. To access this function from the Manual Test Menu, press *Main Menu* [F1], then *Oscilloscope Display* [F4].

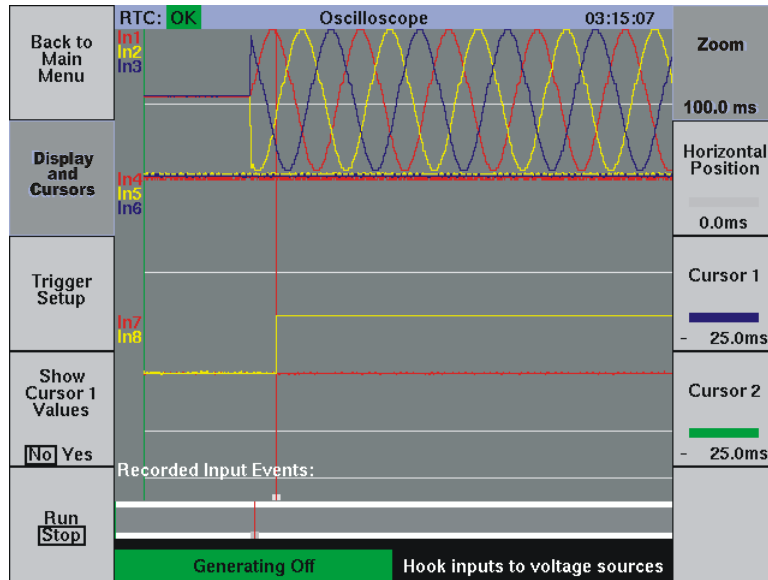

Figure 4.28 OSCILLOSCOPE DISPLAY

Figure 4.28 shows the default screen with a balanced three-phase 60Hz voltage applied to inputs 1-3. Use voltage-output clamp-on c.t.s for current waveforms. In this example, a DC signal on input 8 was used to trigger a single-shot capture, with 25% pre-trigger data.

The oscilloscope display looks very similar to the graphical sequence of events display shown on the previous page. An important distinction between the two however, is that the SOE display waveform is automatically generated directly from the digital data used to control the output amplifiers, whereas the oscilloscope display is generated by digitizing analog voltage waveforms applied to the status inputs, and requires a trigger signal, like an oscilloscope, to capture the waveform data.

Another way of stating this is that the SOE display shows theoretical waveforms, while the oscilloscope shows measured waveforms.

4.12.1. Horizontal Zoom and Position

This function has automatic amplitude scaling for each group of inputs (1-3, 4-6, 7-9, & 10-12) and a fixed data capture length of 100 mSec, as shown in Figure 4.28. To see any portion of the waveform in greater horizontal (i.e. time) detail, such as the 20 mSec window shown below, press *Zoom* [F6] and rotate the dial to zoom in or out on the captured data. The zoom level is displayed beside the *Zoom* key.

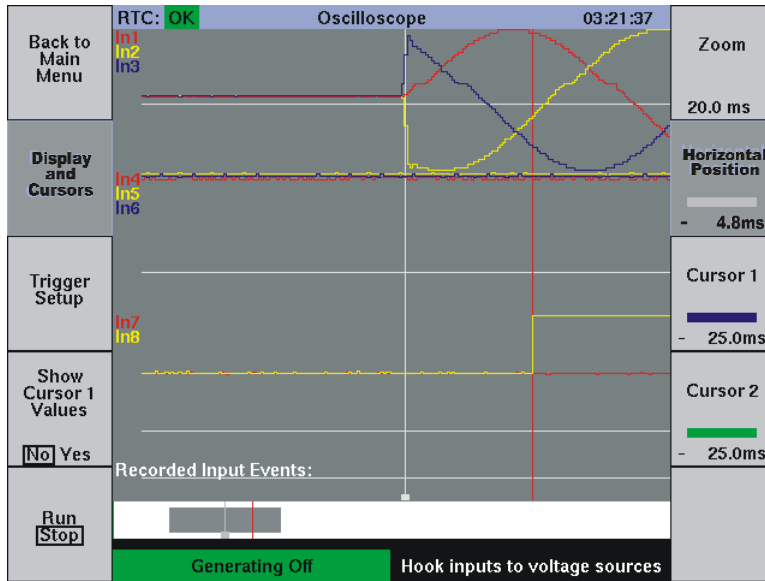

Figure 4.29 OSCILLOSCOPE ZOOM FUNCTION

The white bar at the bottom of the display represents the full 100 mSec data buffer, and the grey rectangle displays the size of data block selected for display via the *Zoom* button. Compare the 20 mSec block above to the 100 mSec block on the previous page.

The *Horizontal Position* button [F7] enables the ‘zoomed’ block of data to be moved anywhere within the full time range of the event (100 mSec in Figure 4.29). The grey rectangle will move right or left with clockwise or counterclockwise rotation of the dial to show where you are at any time within the entire time range.

The vertical red line in Figures 4.27 and 4.28 is the trigger point. By default, the Zoom function is centered on the trigger time line. If the *Horizontal Position* control is used to move the ‘zoomed’ data block, subsequent Zoom operations will be centered on the mid-point of the data. The time indication (ex.4.8 mSec) in the *Horizontal Position* control is the time from this view’s mid-point to the trigger point.

4.12.2. Oscilloscope Trigger

Trigger functions for the oscilloscope are similar to those found on conventional digital storage oscilloscopes by permitting capture of 1-shot events, allowing pre-trigger waveform viewing, and displaying a continuous-update view of live waveforms. Waveform capture is not automatically based on an input channel state change or fault state change as it is for the graphic SOE display, so a trigger signal must be correctly configured to capture events controlled from the Manual Test Menu. Press *Trigger Setup* [F3].

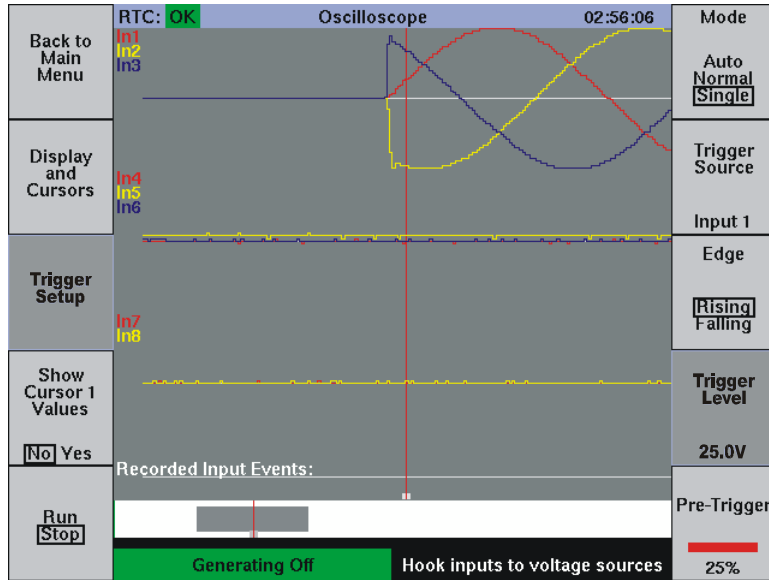

Figure 4.30 OSCILLOSCOPE TRIGGER SETUP

Mode [F6] configures the system for *Auto* (default), *Normal*, or *Single* trigger operation. The first two selections are for viewing continuous live waveforms. *Auto* is the easiest to use, since it automatically generates a trigger from the internal clock signal. This produces a continuous update of the display even in the absence of an external trigger. *Normal* mode uses a trigger from an external source, as determined by the *Trigger Source* [F7], *Edge* [F8], and *Trigger Level* [F9] settings.

Trigger Source [F7] allows the signal on any status input from 1-12 to be selected as the trigger source. Rotate the dial to select any input channel connected to a signal suitable for triggering.

To freeze a display at any time during *Auto* or *Normal* mode, press *Run/Stop* [F5]. To release the frozen display and renew updating, press *Run/Stop* again. If at any time the display does not seem to be updating, check that *Run* is selected.

Single mode is used to capture one-shot events such as a COMTRADE file based fault sequence, or a short manual-controlled fault sequence terminated by a relay trip. NOTE: This is the mode that must be used if it is desired to capture waveforms on the output of the MTS-5100 itself rather than external waveforms. In *Auto* mode, and *Normal* mode (except when a valid trigger sequence appears once only) the repeated triggering causes the waveform data to be continuously updated, and since exiting from the Manual Control Menu turns off the AC/DC output channels, no waveforms will remain on the oscilloscope display when it is reselected.

If monitoring the MTS-5100 AC/DC outputs channels with its own input channels, select all input channels to Type: *Wet*, see Section 4.4.1.2 for details. The default *Dry* setting produces a small DC voltage on the input terminals, necessary for measuring the open/closed status of isolated (dry) contacts. Although the *Dry* configuration will not be damaged by external voltage, the internally generated DC voltage can cause errors in measuring the external voltage.

Notice in Figure 4.30 on the previous page, how input 1 has been programmed to generate a trigger on a rising edge at a level of 25 volts, via the *Edge* [F8] and *Trigger Level* [F9] controls. The red vertical trigger cursor intersecting the input 1 (69VRMS) voltage waveform at +25V verifies that this is where the trigger occurred. In this manner the presence of output voltage alone can be used to trigger capture of the output waveforms.

The output contact of a relay under test can also be used to trigger the capture of a fault event. Any input programmed to sense relay operation can be selected via *Trigger Source* [F7] to initiate the waveform capture. Ensure for this method of capture that the *Pre-Trigger* [F10] setting, the percentage of the 100 mSec data buffer allocated to pre-trigger data, is large enough to ensure capture of the complete event resulting in operation of the trip contact.

A third method of triggering, useful in long multi-fault sequences which can exceed the available 100 mSec data capture buffer, is to enable a trigger signal only in a specified fault state. Any input can be programmed to trigger this way, see Section 4.4.2.1. Select the programmed input via *Trigger Source* [F7].

Once the trigger has been set by any of the above methods, enable the trigger action by selecting *Run* [F5], and exit to the Manual Test Menu ([F1] + [F1]) to initiate the test. After running the test, return to the oscilloscope display. F5 will now display *Stop* and the captured waveform will be visible. Remember to re-enable the trigger via F5 before each new event.

4.12.3. Oscilloscope Cursors

There are two cursors available to enable accurate time and/or amplitude measurements to be made on captured waveforms. Press *Display and Cursors* [F2].

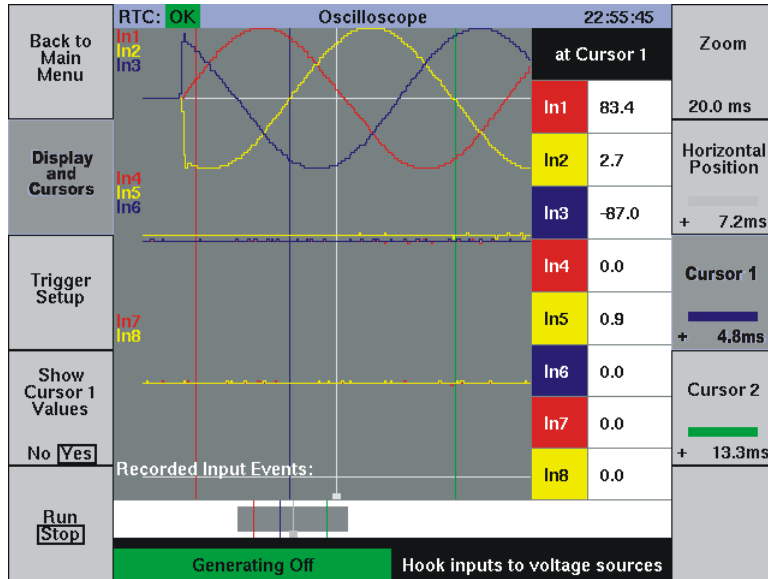

Figure 4.31 OSCILLOSCOPE CURSORS

Cursor 1 [F8] and *Cursor 2* [F9] buttons enable control via the dial of the blue and green vertical cursor lines respectively. The time readouts that appear in the control labels (4.8 and 13.3 ms) indicate the difference in time between the cursor positions and the trigger point.

To access information about the signal amplitude at the cursor, press *Show Cursor 1 Values* [F4] to select *Yes*. The column of data labeled *at Cursor 1* will appear on the right side of the display as shown above. It will remain in place when the *Cursor 1* [F8] control is again selected to enable movement of the blue Cursor 1 line.

Note that when first selected the cursors may not be visible in the main display, especially if it has been expanded with the *Zoom* control. By default they are located at the extreme left edge of the white 100ms bar at the bottom of the display. By rotating the dial clockwise initially when a cursor is selected, the cursor line will appear in the white bar, and if moved into the grey rectangle will be visible in the main display, as shown above.

5. DATA INTERFACES

As may be seen in previous sections, the MTS-5100 is capable of very complex tasks through the use of its manual interface and graphical display. There are additional capabilities possible when interfaced to an external computer. These include remote control of the system, the ability to replay complex waveforms generated by waveform capture devices (including some protective relays) or specialized simulation software, and fully automated test sequences under the control of external computer programs. The three types of data interface described below allow convenient interfacing to virtually any type of notebook or desktop computer. The connectors for all three are located with the Auxiliary Input-Outputs.



Figure 5.1 AUXILIARY INPUTS-OUTPUTS

5.1. RS-232 SERIAL

The serial port is suitable for applications requiring relatively low rates of data transmission. These include remote control via Manta’s MTS-2150 control software. For applications requiring transfer of large amounts of data, such as downloading complex waveform data, the higher-speed Ethernet or USB ports are a better choice.

The standard DB-9 female connector is wired as a DCE (Data Communications Equipment) interface. It provides a communication facility for older computers which may not have an Ethernet interface. The data format is 8 bits, no parity, and no handshaking protocol. A standard DB-9 straight-thru cable is used to make the connection, see your Information Technology (IT) support person for assistance if necessary. It will be necessary to set the baud rate of the interface to the same as that in the software program on the computer with which it will be communicating, as described below.

If it is necessary to change the baud rate from the Manual Test Menu, press *Main Menu* [F1] to return to the menu which is always shown when the instrument is first turned on, then press *Setup* [F10] to reach the Setup Menu.

| RTC: OK Setup Menu 01:17:24 | | |
|--|--|---|
| | Description | Value |
| Main Menu | Backlight Intensity | 10/10 |
| | LCD Color Scheme | Normal |
| | Keypress Tone | Off |
| | Beep on Clip Condition | On |
| | Suppress measurement errors | Yes |
| | Serial Port Baud Rate | 9600 baud |
| | Time and Synchronization Source | Internal |
| | IRIG-B Output Signal Source | IRIG-B Output |
| | Entry range for phase angles | 0 to +360 |
| | Normal Phase Sequence | A->B->C |
| | Meaning of Positive Angles | Leading |
| | Direction of Rotation | Counterclockwise |
| Customize | System Frequency | 60.000 Hz |
| | Nominal V4 DC Voltage | 48.00 Vdc |
| | Nominal Ø-Ø Voltage | 120.00 V |
| | Default Input Power Control | 5 |
| | Prevent Excessive AC Draw | Yes |
| Calibration | GPS Delay | 0.0ms |
| | Internal RTC Time (MMDDhhmmYYYY) | 0 |
| | "Serial Port Baud Rate" Setting: | |
| Set up Network | This setting adjusts the serial port baud rate. The setting takes effect immediately when changed. | |
| | Other aspects of serial port configuration are not adjustable. The serial port always runs with 8 data bits, no parity and no handshaking. | |
| | | In general, this setting should not be adjusted via serial port communications, as it causes communications to fail due to a mis-matched baud rate. |
| Generating Off | | Setting preferences |

Figure 5.2 SETUP MENU

Move the cursor to the *Serial Port Baud Rate* cell and select a baud rate appropriate to the application. The available rates are 4800, 9600, 19.2k, 38.4k, 57.6k, and 115.2k baud. Press *Save* [F10], and this new selection will also become the default value each time the instrument is powered up.

The Hyper-Terminal program supplied with most Windows-based computers can be used as a quick test to verify RS-232C connections and settings. When baud rates have been matched as above, type *HELP* and press *ENTER* on the computer keyboard. If communications are correctly setup a message similar to that below will be returned from the MTS-5100.

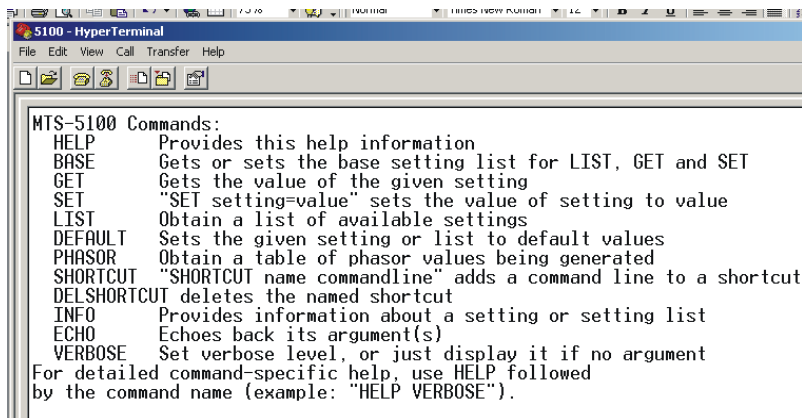

```
5100 - HyperTerminal
File Edit View Call Transfer Help
[Icons]
MTS-5100 Commands:
HELP      Provides this help information
BASE      Gets or sets the base setting list for LIST, GET and SET
GET       Gets the value of the given setting
SET       "SET setting=value" sets the value of setting to value
LIST      Obtain a list of available settings
DEFAULT   Sets the given setting or list to default values
PHASOR    Obtain a table of phasor values being generated
SHORTCUT  "SHORTCUT name commandline" adds a command line to a shortcut
DELSHORTCUT deletes the named shortcut
INFO      Provides information about a setting or setting list
ECHO      Echoes back its argument(s)
VERBOSE   Set verbose level, or just display it if no argument
For detailed command-specific help, use HELP followed
by the command name (example: "HELP VERBOSE").
```

Figure 5.3 RS-232C COMMUNICATIONS

5.2. USB

The USB interface is capable of relatively high-speed rates of data transmission. Unlike Ethernet, it is an easy-to-use ‘Plug and Play’ interface which requires no preset configuration to work properly. The availability of compact inexpensive large-capacity ‘USB Drives’ makes it the interface of choice to download large waveform files as well as for uploading individual test configurations and results. To download waveform files, simply insert a USB drive containing COMTRADE formatted files (ASCII or binary format) into either of the USB ports in the I/O Panel. After a brief delay the following screen will appear on the display:

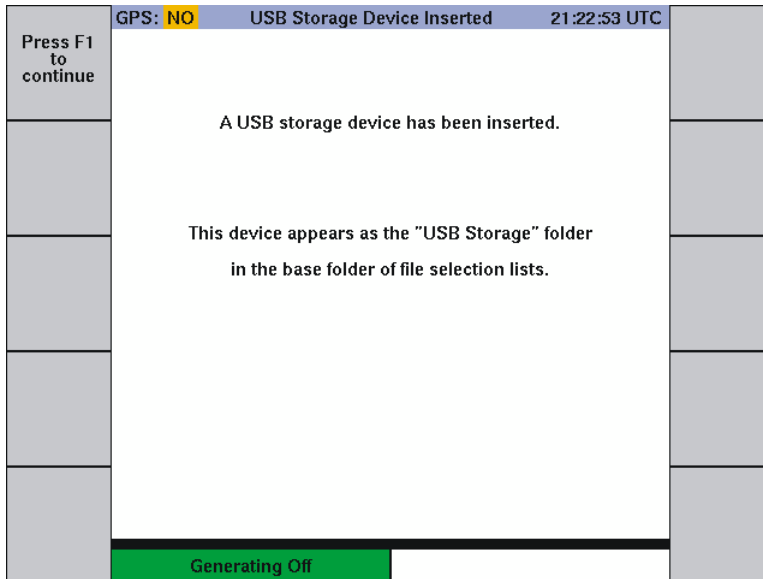

Figure 5.4 USB STORAGE DEVICE INSERTED

Once recognized, the files on the USB drive will appear in the file selection lists of the MTS-5100. The two file lists most likely to be used are the Save/Restore Manual Test Settings list and the Waveform Playback Files Selection list, illustrated below.

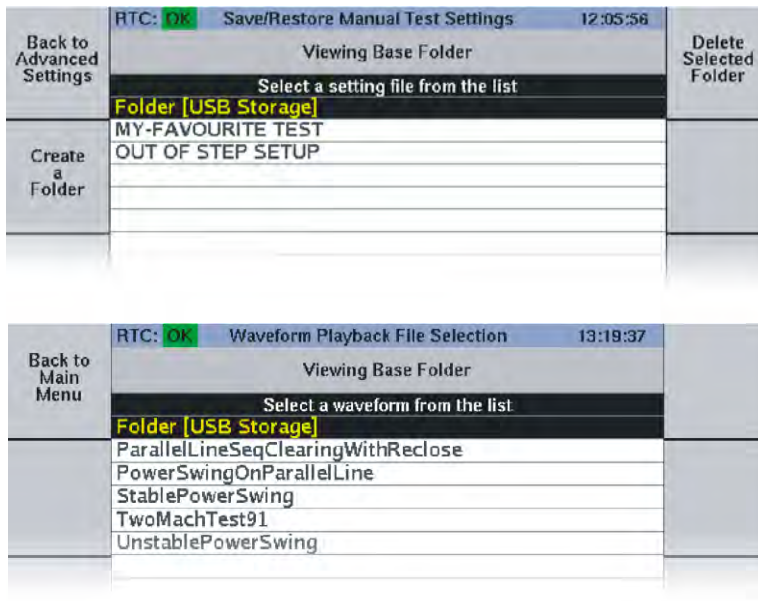

Figure 5.5 FILE SELECTION LISTS

Figure 5.5 shows the upper file list for Test Settings. It is accessed from the Manual Test Menu by pressing *Advanced Settings* [F4], then *Save and Restore Settings* [F7] in the *Advanced Settings* Menu.

The lower file list for Waveform Playback, in Figure 5.5, is accessed from the Manual Test Menu by pressing *Main Menu* [F1], then *Waveform Playback* [F3] in the Main Menu. For further information on waveform playback see Section 7.2 ACCESSING WAVEFORM DATA FILES.

To select files from the USB drive, use the arrow keys to select the USB drive on the list, press *Enter Selected Folder* [F5] to open it, and rotate the dial to select from the files list.

5.3. ETHERNET

Although configuration may initially be somewhat complex, once successfully established it is a robust high-speed method for data exchange. It is the preferred method for using Manta's software programs to communicate with or control the MTS-5100. These programs include the following:

- MTS-2150 Monitoring and Control software
- MTS-2170 Power System Model software
- MTS-5050 Remote Console
- *RapidReporter*[®]

Direct connection to a computer requires the use of an RJ-45 Ethernet cable – either CAT 5e or CAT 6. A suitable cable is provided with each new system when shipped from the factory. Note that the cross-over or straight-through patch cables commonly used to connect computers to Ethernet networks will both work due to the auto sensing of the MTS-5100's Ethernet port.

For successful Ethernet communication, in general the computer and the MTS-5100 should have the same subnet mask setting, and an IP address identical except for the last digit group. The computer should also be configured for a static IP address, not to obtain one automatically.

The first action therefore is to obtain the current configuration of the computer. A quick check that can be done from most Windows environments is to type the DOS command “ipconfig” from within a DOS window, which is accessible via the Command Prompt program usually listed in Programs>Accessories, OR by pressing the  + ‘R’ key combination and typing cmd <enter>.



```
Microsoft Windows [Version 5.00.2195]
(C) Copyright 1985-2000 Microsoft Corp.

C:\Documents and Settings\Administrator>ipconfig

Windows 2000 IP Configuration

Ethernet adapter Local Area Connection:

    Connection-specific DNS Suffix  . : 
    IP Address . . . . . : 192.168.22.68
    Subnet Mask . . . . . : 255.255.255.0
    Default Gateway . . . . . : 192.168.22.1

C:\Documents and Settings\Administrator>
```

For a more detailed explanation of how to access the required information within specific Windows versions, see the following sections.

5.3.1. Windows 98 Configuration

Click *Start, Settings, Control Panel, Network*, then the *Configuration* tab of the *Network* window. Double click on the *TCP/IP* icon (see Figure 5.6), and click the *IP Address* tab of the *TCP/IP Properties* window.

If the *Specify an IP address* button is already selected, record the IP Address and Subnet mask data.

If the *Obtain an IP address automatically* button is selected, click on the *Specify an IP address* button, and enter the data shown in Figure 5.6.

Click the OK button to return to the main screen. If you have changed the settings, you will be asked if you want to restart the computer to make the settings take effect, so click *Yes*.

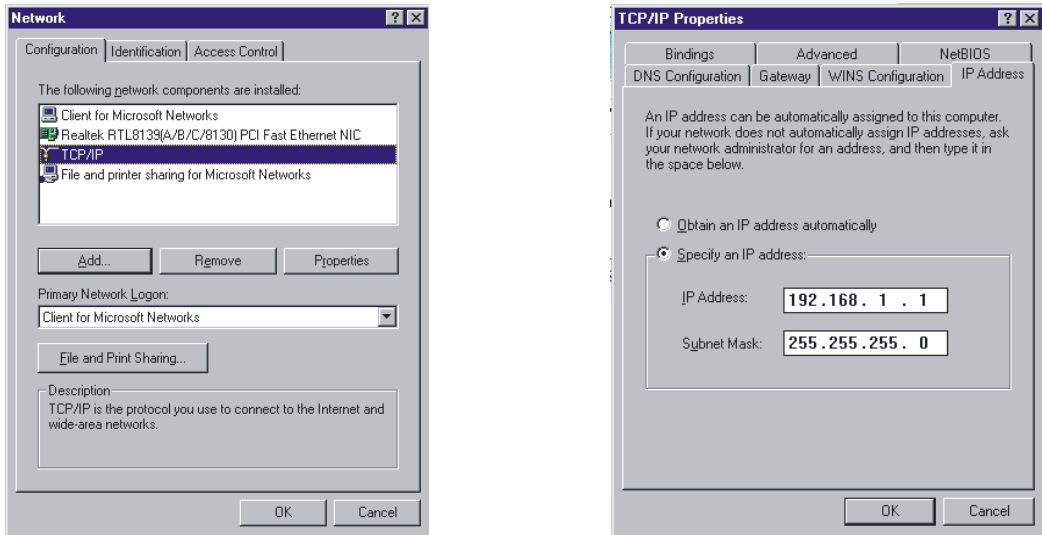

Figure 5.6 WINDOWS 98 NETWORK CONFIGURATION DATA

5.3.2. Windows 2000 Configuration

Click *Start, Settings, Network & Dial-Up Connection, Local Area Connection*, then the *Properties* button of the *Local Area Connection Status* window. Double click on the *Internet Protocol (TCP/IP)* icon (see Figure 5.7) on the *Local Area Connection Properties* window to bring up the *General* tab of the *Internet Protocol (TCP/IP) Properties* window.

If the *Use the following IP address* button is already selected, record the IP Address and Subnet mask data.

If the *Obtain an IP address automatically* button is selected, click on the *Use the following IP address* button, and enter the data shown in Figure 5.7 in the *Use the following IP address* fields.

Click the OK button to return to the main screen.

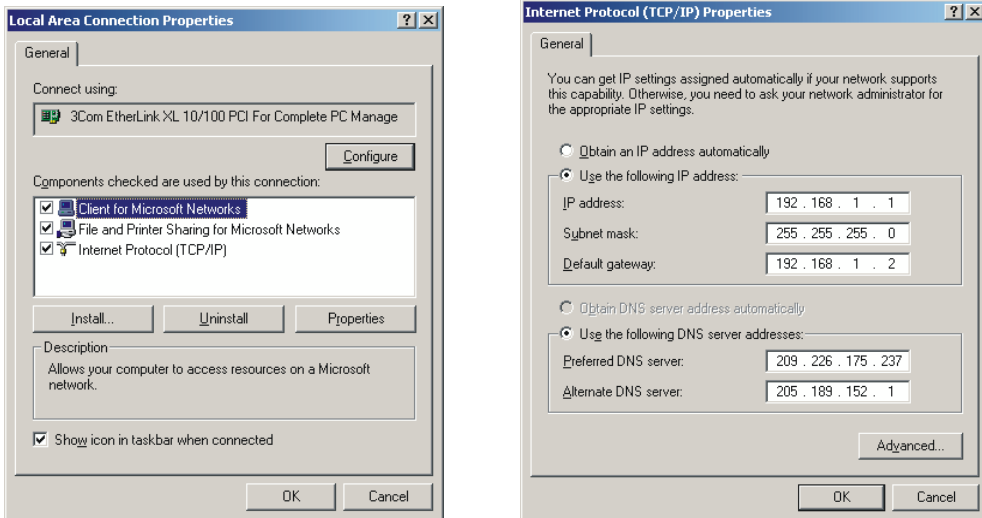

Figure 5.7 WINDOWS 2000 NETWORK CONFIGURATION DATA

5.3.3. Windows NT Workstation Configuration

Click *Start, Settings, Control Panel, Network*, then the *Protocols* tab of the *Network* window. Double click on the *TCP/IP Protocol* icon (see Figure 5.8) on the *Network* window to bring up the *IP Address* tab of the *Microsoft TCP/IP Properties* window.

If the *Specify an IP address* button is already selected, record the IP Address and Subnet mask data.

If the *Obtain an IP address from a DHCP server* button is selected, click on the *Specify an IP address* button, and enter the data shown in Figure 5.8 in the *Specify an IP address* fields.

Click the OK button to return to the main screen.

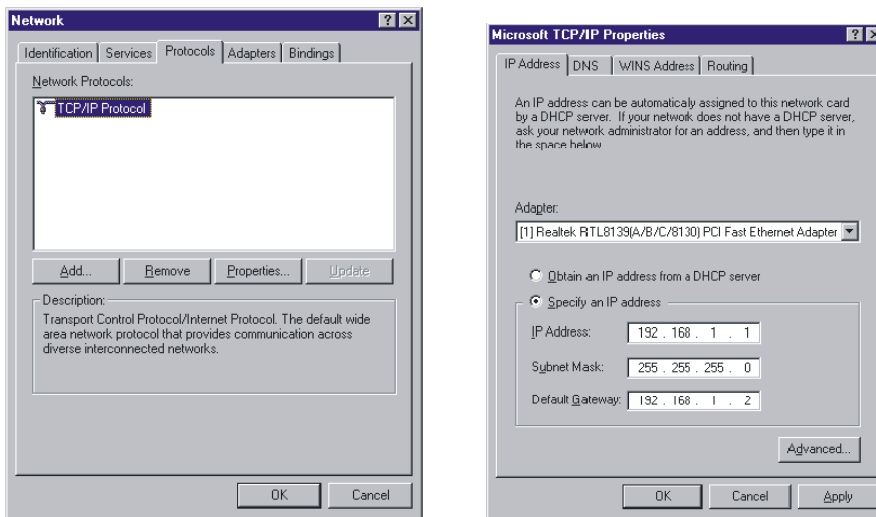

Figure 5.8 WINDOWS NT NETWORK CONFIGURATION DATA

5.3.4. Windows XP, Vista, and Window 7 Configuration

Click *Start*, *Control Panel*, *Network Connections*, *Local Area Connection*, then the *Properties* button of the *Local Area Connection Status* window. Double click on the Internet Protocol TCP/IP icon (see Figure 5.9) on the *Local Area Connection Properties* window to bring up the *General* tab of the *Internet Protocol (TCP/IP) Properties* window.

If the *Use the Following IP address* button is already selected, record the IP Address and Subnet mask data.

If the *Obtain an IP address automatically* button is selected, click on the *Use the Following IP address* button, and enter the data shown in Figure 5.9 in the *Use the Following IP address* fields.

Click the OK button to return to the main screen.

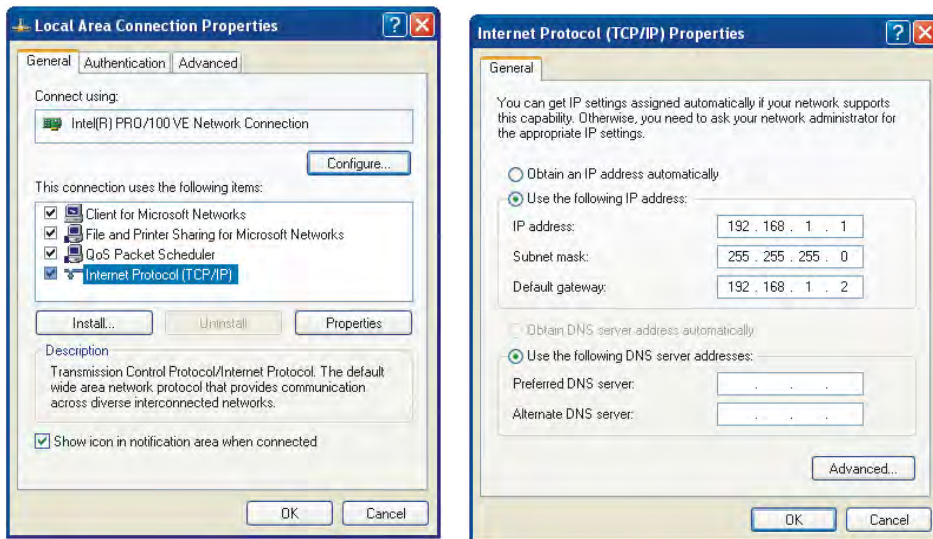

Figure 5.9 WINDOWS XP NETWORK CONFIGURATION DATA

5.3.5. MTS-5100 Configuration

Once the computer Ethernet configuration is known, it is necessary to check the MTS-5100 for compatible settings. From the Manual Test Menu press *Main Menu* [F1], then *Setup* [F10], then *Set up Network* [F5].

| RTC: OK | | Network Setup Menu | | 02:15:44 | |
|----------------|---------------------------|---------------------|--|----------|--|
| Accept Changes | Description | Setting | | Advanced | |
| | IP Address Source | Static (Settings) | | | |
| Cancel Changes | Actual IP Address | 192.168.22.16 | | | |
| | Static IP Address Setting | 192.168.22.16 | | | |
| | Subnet Mask | 255.255.255.0 | | | |
| | Gateway IP Address | 192.168.22.1 | | | |
| | DNS Server 1 | 0.0.0.0 | | | |
| | DNS Server 2 | 0.0.0.0 | | | |
| | DNS Server 3 | 0.0.0.0 | | | |
| Generating Off | | Setting preferences | | | |

Figure 5.10 NETWORK SETUP MENU

Scroll to *Static IP Address Setting* and enter the IP address recorded during the appropriate Windows check in the preceding sections, identical except for the last digit group. For example, in Figure 5.10, the setting shown would be compatible with a computer having an IP address of 192.168.22.15. Press *Accept Changes* [F1], *Main Menu* [F1], and *Manual Test* [F1] to return to the Manual Test Menu.

To verify the connection is now functioning, enter the Command prompt or DOS screen on your computer. This is usually done by clicking Start, Programs, Accessories, Command Prompt. In the window that opens, type a command to ‘ping’ the MTS-5100 address; in the above example you would type “ping 192.168.22.16” followed by Enter. If the configuration is correct, some data will be returned from the MTS-5100 (see Figure 5.11).

If the ‘ping’ test fails, you may have to modify Ethernet settings on your computer. There are additional instructions available to set up this interface included in the Manta software programs that use an Ethernet interface. If necessary, see your IT technician for further assistance.

```

MS-DOS Prompt
C:\WINDOWS>ping 192.168.22.16

Pinging 192.168.22.16 with 32 bytes of data:

Reply from 192.168.22.16: bytes=32 time<10ms TTL=255
Reply from 192.168.22.16: bytes=32 time<10ms TTL=255
Reply from 192.168.22.16: bytes=32 time<10ms TTL=255
Reply from 192.168.22.16: bytes=32 time<10ms TTL=255

Ping statistics for 192.168.22.16:
    Packets: Sent = 4, Received = 4, Lost = 0 (0% loss),
    Approximate round trip times in milli-seconds:
        Minimum = 0ms, Maximum = 0ms, Average = 0ms

C:\WINDOWS>

```

Figure 5.11 ETHERNET PING RESULTS

5.3.6. Web Server

The MTS-5100 incorporates a built-in web server, so it is possible to communicate with it via PC browser software such as Microsoft Internet Explorer. Entering the MTS-5100 IP address, as established in the preceding section, into the Address box of the browser, and pressing the Enter key brings up a screen (see below) from which you may upgrade firmware, upload/download files, or do screen captures via Ethernet.



Figure 5.12 WEB SERVER SCREEN

Screen captures can be useful in developing training or support material, assisting in customer support troubleshooting, or saving test results such as graphic sequence of events displays. See Section 9, Application Note AN5-1 for instructions on firmware upgrading via this screen. Refer to the following section for information on file management.

5.3.7. Ethernet File Management

Clicking on the link Manage Files Using FTP in the web server screen (see previous page) will open a Windows Explorer style page in the web browser, listing accessible files on the MTS-5100.

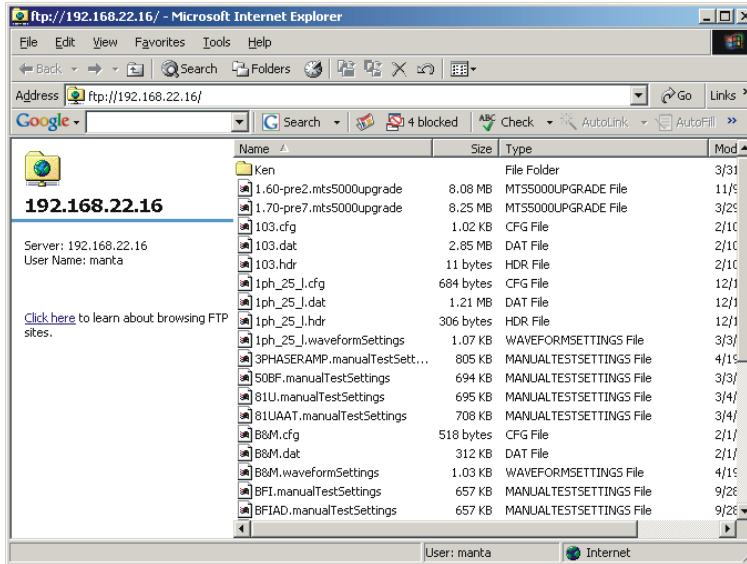

Figure 5.13 ETHERNET FILE TRANSFER

This offers a convenient way to download digital waveform files from the MTS-5100 directly to a desktop or laptop computer.

You can also transfer files in both directions between the MTS-5100 and computer by opening your ftp client software (such as Filezilla) or Windows Explorer and typing ftp:[MTS-5100 IP Address] in the address bar (ex. ftp:192.168.22.16). You will be asked for a user name (manta) and a password (mts5000) which will grant you access to the non-critical files stored on the MTS-5100. If you check the box to remember settings, you will not have to enter the user name and password again. You can move files in either direction using standard commands such as cut/copy/paste in Windows Explorer.

6. GPS OPERATION

The MTS-5100 features an on-board Global Positioning System (GPS) receiver, which allows ultra-precise time synchronization of 2 or more MTS-5100 systems. This means that it is possible, for example, to have 2 systems at physically separate locations, such as the two ends of a high voltage transmission line, accurately control their phase and/or frequency relationships with respect to each other. An obvious application is testing of transmission line differential protection systems which monitor phase relationships between the line terminals.

A second important capability this feature makes possible is synchronous end-to-end testing of transmission line protection systems, in which simulated faults are initiated at exactly the same time at the terminals of the line.

The GPS receiver decodes precise time data transmitted from a group of space-based satellites with on-board atomic clocks. This permits timing accuracy to ± 1 microsecond at each receiver location. To receive this information, the receiver must be connected to an external antenna.

6.1. RECEPTION OF SATELLITE GPS SIGNALS

Before using the GPS receiver facility, it is necessary to select it as the time reference source. From Manual Test Menu press *Main Menu* [F1], then *Setup* [F10].

| GPS: NO | | Setup Menu | 02:52:37 UTC |
|---|--|-------------------------|---------------------------|
| | Description | Value | |
| Main Menu | Backlight Intensity | 10/10 | Software Upgrade |
| | LCD Color Scheme | Normal | |
| | Keypress Tone | Off | |
| | Beep on Clip Condition | On | |
| | Suppress measurement errors | Yes | |
| Customize | Serial Port Baud Rate | 115.2 kbaud | Factory Diagnostics |
| | Time and Synchronization Source | Internal | |
| | IRIG-B Output Signal Source | GPS Receiver | |
| | Entry range for phase angles | Ext. IRIG-B 0 to 360 | |
| | Normal Phase Sequence | A->B->C | |
| | Meaning of Positive Angles | Leading | |
| | Direction of Rotation | Counterclockwise | |
| | System Frequency | 60.000 Hz | |
| | Nominal V4 DC Voltage | 48.00 Vdc | |
| | Nominal \emptyset - \emptyset Voltage | 120.00 V | |
| Calibration | Default Input Power Control | 5 | Reset to factory defaults |
| | Prevent Excessive AC Draw | Yes | |
| | GPS Delay | 0.0ms | |
| Set up Network | Internal RTC Time (MMDDhhmmYYYY) | 0 | Save |
| | "Time and Synchronization Source" Setting: | | |
| This setting selects the source of time and synchronization information. In order to synchronize two test sets you must either set both sets to something other than "Internal" or chain the IRIG-B output of test set #1 to the IRIG-B input of test set #2 and select "Ext. IRIG-B" on test set #2. | | | |
| If the "Save" softkey has been pressed in the setup menu, this setting is restored each time the unit is powered on. | | | |
| Generating Off | | Setting preferences | |

Figure 6.1 SETUP MENU

Move the cursor to *Time and Synchronization Source*, rotate the dial, and select *GPS Receiver*. Note that the default selection *Internal* refers to the internal real-time clock. The text GPS: NO should now appear in the upper left corner of the Manual Test display. Return to the Manual Test Menu by pressing *Main Menu* [F1] and *Manual Test* [F1].

Connect the supplied antenna via the BNC connector marked GPS Antenna (see Section 5). Carry the antenna out of doors to any location that has a clear view of a large arc of open sky, and place it on any suitable object, with the rounded upper surface facing approximately straight up. It is important that this location is away from the side of any building or structures that may obscure its view of the open sky, as the very low-level satellite signals necessary for correct operation of the receiver are easily blocked. Correct operation can be verified by observing information on the Manual Test Menu.

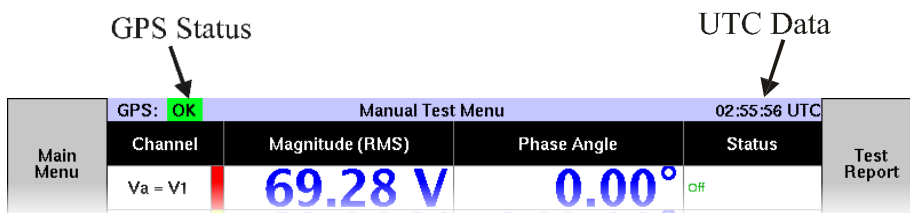

Figure 6.2 GPS STATUS DISPLAYS

The GPS Status display at the top left of the display will change from *NO* in an amber box to *OK* (or *LS*) in a green box if the receiver successfully locks on to the GPS signals (GPS lock should occur within two minutes). On the top right of the display, a 6-digit number which updates once per second is visible. This number corresponds to the Coordinated Universal Time (also known as Greenwich Mean Time), in Figure 6.2, for example, the time is 2 hours, 55 minutes, and 56 seconds past midnight. Note that if the GPS signal is lost, this data will continue to update, but it is being maintained by the GPS receiver's internal clock signal, which will not be precise enough for synchronization with a second remote system. *LS* indicates the Leap Second information which is transmitted once each 12 minutes has not yet been received, so the absolute time may be out by several seconds (currently 13 sec). Therefore it may take up to 12 minutes for *LS* to change to *OK*.

If *OK* or *LS* status cannot be achieved within 5 minutes, try relocating the antenna for a better sky view. Note that it still takes up to 1 minute in a new location to lock on, so do not move the antenna continuously while monitoring the status display. The *OK* status may also appear for up to a minute after the antenna is disconnected or signal lock is lost.

6.2. USING AN EXISTING GPS SIGNAL

In some locations such as underground substations, or crowded urban areas with restricted sky view, it may not be possible to provide a usable signal for the internal GPS receiver. Since many substations have an IRIG-B signal derived from a permanently installed GPS receiver, it may be possible to make use of this data instead. The IRIG IN and IRIG OUT connectors in the Auxiliary I/O panel allow the user to tap into an existing signal with an appropriately terminated shielded coax cable.

If an existing output is available, the data from it is routed to the IRIG IN connector. This port will accept either TTL or AM format data. If no output is available but the input to one of the installed devices in the data stream is accessible, the MTS-5100 may be inserted in series with the data stream. Note that the data output from the MTS-5100 IRIG OUT connector uses TTL format, so it is important to verify the downstream equipment will function correctly with TTL data. If it does, the IRIG-B signal source is routed to IRIG IN, and the IRIG OUT output is routed to the installed device input. In either application it will be necessary to purchase or construct BNC coax cables of adequate length with an appropriate connector at the installed device ends.

Once a successful connection has been made into the installed data stream, the new signal source must be manually selected. From the Manual Test Menu press *Main Menu* [F1], then press *Setup* [F10] in the Main Menu. In the Setup Menu, use the arrow keys to select *Time and Synchronization Source*, and select *Ext IRIG-B* with the dial (see Figure 6.1).

6.3. REMOTE SYNCHRONIZATION

As soon as a GPS lock is achieved via either of the above procedures, and the status indicator shows *OK*, any other MTS-5100 system anywhere in the world which is also GPS locked in this manner will automatically be phase locked to your system. Frequency lock is also available just by applying the same frequency setting at both ends.

Differential line protection systems may easily be tested under these conditions by verbally coordinating tests at the terminals, via voice channel or telephone.

6.4. END-TO-END TESTING

This advanced testing procedure requires simultaneous application of simulated faults at two or more terminals of a transmission line. Ideally, the fault values will be calculated independently for each terminal, based on their distance from the fault location. This means that different values would be generated at each location except for a fault equidistant from each location. By initiating these faults at precisely the same time, and using installed facilities such as fibre optic or power line carrier to transmit and receive co-ordination data, a very accurate simulation is performed, and important system performance data that is unavailable during static or single terminal testing may be captured.

To derive the most useful information from end-to-end testing, it is necessary to design a series of tests which will exercise as fully as possible all aspects of the protective relay system while minimizing the number of tests to be performed. This requires a thorough understanding of the protection scheme used, characteristics of the protection devices and communication equipment, and the ability to calculate expected fault values based on power system characteristics and fault type.

If the test scenarios are a series of manually-programmed faults, these will have to be programmed at the time of the test, as described in Section 4 Detailed Operation. For further information, refer to the following Application Notes, available from Manta:

- Time Synchronized End-to-End Testing of Line Protections with the MTS-5000
- Enhanced Time Synchronized End-to-End Testing of Line Protections with the MTS-5000

Except where only a very few test cases will be run, or where the intent is to modify test cases during the test sequence, a more efficient way to program multiple faults is to use the Ethernet or USB interfaces to download waveform data to the MTS-5100, see Section 5 DATA INTERFACES for more details.

A second essential aspect of end-to-end testing is reliable communication links between all terminals, preferably voice channels or telephone, since it will be necessary that each terminal initiate the appropriate test scenario at the same time.

Once each terminal has isolated the Equipment Under Test (EUT), made all necessary test wiring connections, powered up their test equipment, loaded the appropriate fault data, and has successfully established GPS synchronizing as described above; each user may arm their equipment for GPS-triggered fault initiation. Press *Advanced Settings* [F4] in the Manual Test Menu, and move the cursor to *GPS-Synchronized Fault* in the Advanced Settings Menu. Rotate the dial to select either 10 seconds or 1 minute.

| GPS: OK | | Advanced Settings Menu | | 02:45:38 |
|-----------------------|---|------------------------|--------------------|----------|
| | | Description | Setting | |
| Back to Test Menu | Breaker Clearing Time | | 0.0 ms | |
| | Fault Incidence Angle (FIA) | | N/A | |
| Set up I/O and Timers | GPS-Synchronized Fault | Off | | |
| | Input Power Control | 10 Seconds | | |
| | K-Factor | 1 Minute | | |
| | K-Factor Angle | | 0.000 | |
| | Maximum Fault Duration Enabled | Off | 0.00° | |
| | Number of Fault States | | 1 | |
| | Normal Phase Sequence | A->B->C | | |
| | Phase Sequence to Generate | Positive | | |
| | Postfault State Enable | Off | | |
| | System Time Constant | | 0 ms | |
| Set up Ramps | V4 Powers Relay | Yes | | |
| | Description of "GPS-Synchronized Fault" Setting: | | | |
| | This setting allows you to synchronize fault generation to the selected time and synchronization source. If the GPS or IRIG-B signal is lost, the setting is disabled. The setting is never disabled if the time source is "Internal". | | | |
| | If set, pressing the FAULT key will not immediately cause a transition to the Fault state. Instead, the state change will be held off until the next exact multiple of the given number of seconds. An on-screen countdown timer appears during the interval. For example, if the FAULT key is pressed at 11:22:33, and the GPS sync setting is 10 seconds, the transition to Fault will occur at 11:22:40. | | | |
| | By configuring multiple test sets to use this setting, end-to-end testing can be synchronized precisely. This setting works well in combination with the maximum fault state duration setting, so that both ends pass through a series of generation fault states at precisely the same time. | | | |
| | Generating Off | | Adjusting Prefault | |
| | <input type="checkbox"/> Show Harmonics Columns <input checked="" type="checkbox"/> On | | | |
| | <input type="checkbox"/> Show Frequency Column <input checked="" type="checkbox"/> On | | | |

Figure 6.3 GPS-SYNCHRONISED FAULT

Press *Manual Test Menu* [F1] to return to the Manual Test Menu. Once all terminals participating in the test are ready, press the FAULT button. The AC Output warning LED will begin to flash, and a countdown indication of seconds remaining to fault initiation appears in the Fault Status box. This process may also be initiated by pressing PREFault, if it is desired to establish stable Prefault conditions as for example in testing a differential line protection system.

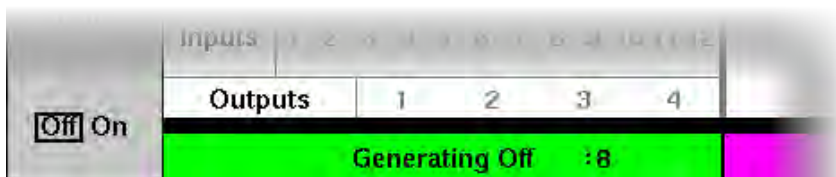

Figure 6.4 FAULT INITIATION COUNTDOWN

At either the next 10 second or 1 minute interval after pressing PREFault or FAULT, the MTS-5100 will automatically generate the programmed fault.

The actual time delay between pressing PREFault or FAULT and the fault initiation will vary depending on how long it will take to reach the above interval. By referring to the current UTC time displayed in the upper right corner, all participants can verbally agree to press the appropriate buttons at an appropriate time. If the FAULT button was pressed at UTC time 15:20:22 for example, and a delay of 10 seconds was specified, there would be a delay of 8 seconds until Fault state initiated, as shown in Figure 6.4.

If PREFault was pressed first, it would be necessary to press FAULT to initiate transition to the Fault state, and as before this will occur at the above time interval.

Once a successful synchronized fault event has run, the results may be recorded, and the next test in the sequence initiated. The status inputs recording feature and multiple timer capabilities of the MTS-5100 are very useful in capturing results data, see Section 4.11 SEQUENCE OF EVENTS RECORDER, Section 4.12 OSCILLOSCOPE DISPLAY, Section 7.6 SEQUENCE OF EVENTS and Section 4.5 PROGRAMMABLE TIMERS for details.

7. WAVEFORM PLAYBACK

The default AC output waveforms from the MTS-5100 are clean low-distortion sine waves, except when harmonic distortion is intentionally introduced to test the response to harmonics. It is also possible to introduce a DC offset to AC waveforms at the point of fault initiation by use of the System Time Constant setting, see Section 4.8.7 System Time Constant for more information. In the real world however there are many cases where the waveforms seen by protective relays may contain significant distortion which can cause misoperation or delayed operation. Use of this real-world data can be valuable when analyzing the response of protective relays to these less-than-perfect input waveforms. Waveform sources can include digital fault recorders, EMTP or other software programs, and the digital memory of the relays themselves.

A second case where use of predetermined waveforms may be beneficial is in the use of a sequence of specific predetermined fault states, which if carefully chosen, may fully exercise all key aspects of the protective relay system in a relatively short time span. This can eliminate the need to do much more time-consuming conventional ‘calibration’ style testing.

In either type of application, the waveform must be in COMTRADE format. This is the IEEE standard for digital waveform data exchange, and is widely used in digital waveform recorders and waveform generating software.

7.1. DOWNLOADING WAVEFORM DATA

In virtually all applications, the waveform data to be used will initially reside on an external PC which has either uploaded and/or processed stored data from a recorder or relay, or has run software to synthesize data. Two of the standard data interfaces on the MTS-5100 may be used to download the data:

- Ethernet port, requires precise configuration, but very high speed, and interfaces to office networks.
- USB port, no configuration required, USB drives are inexpensive, high speed, highly portable, and easy to interface to a networked PC.

For further information on these interfaces see Section 5 DATA INTERFACES.

The MTS-5100 has substantial on-board storage available for waveforms (currently ~7.5GB), so it is feasible to download a large number of suitably-labeled files. Maximum playback time per file listed in the specifications Section 2.7. The Ethernet interface may be employed for this, but the current firmware for the instrument only supports FTP protocol for Ethernet data transfers; see Section 5.3.7 Ethernet File Management. For the purposes of this description, it will be assumed that a USB drive is used to store and download the waveform data, as it is easier and more convenient to use.

Before attempting waveform downloading, ensure that the data is IEEE C37.111 COMTRADE format, 1991 or 1999 standard. Not all COMTRADE files are in this format, especially older ones from the time period when the COMTRADE format first emerged. The software used to process and download the data should be able to identify the format, refer to the manufacturer of the software for assistance if necessary.

When using a USB drive to download the data, the MTS-5100 can read all the files available on the USB drive, and it is only necessary to download the file to be used for the current test. All the USB files may be stored in the MTS-5100 internal memory if desired however, see Section 7.7 FILE STORAGE/RETRIEVAL for details.

Shortly after the USB drive is inserted in one of the USB connectors, a message screen appears on the display stating *“A USB storage device has been inserted. This device appears as the “USB Storage” folder in the base folder of the selection lists.”* Press F1 to clear the message screen and return to the Manual Test Menu.

7.2. ACCESSING WAVEFORM DATA FILES

To access USB waveform files from the Manual Test Menu, press *Main Menu* [F1], then *Waveform Playback* [F3] to bring up the Waveform Playback File Selection screen. The USB files can be copied to the MTS-5100 file system via *Copy File From USB* [F10], or downloaded for immediate use as described below.

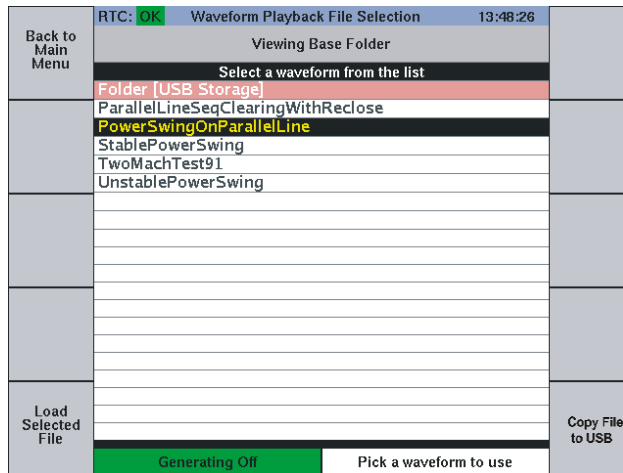

Figure 7.1 WAVEFORM PLAYBACK FILE SELECTION

Scroll the cursor through the list of folders and files to the USB device with the arrow keys or dial, then press *Enter Selected Folder* [F5].

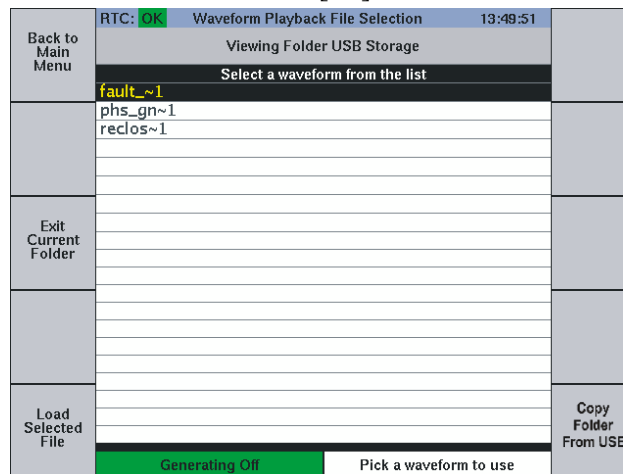

Figure 7.2 WAVEFORM FOLDER SELECTION

Scroll to the desired file within the folder, and press *Load Selected File* [F5]. As the file is being loaded and processed, status bargraphs show momentarily, then the waveform appears on a new screen *Waveform Playback File* “filename” (see Figure 7.3).

7.3. VIEWING WAVEFORM DATA FILES

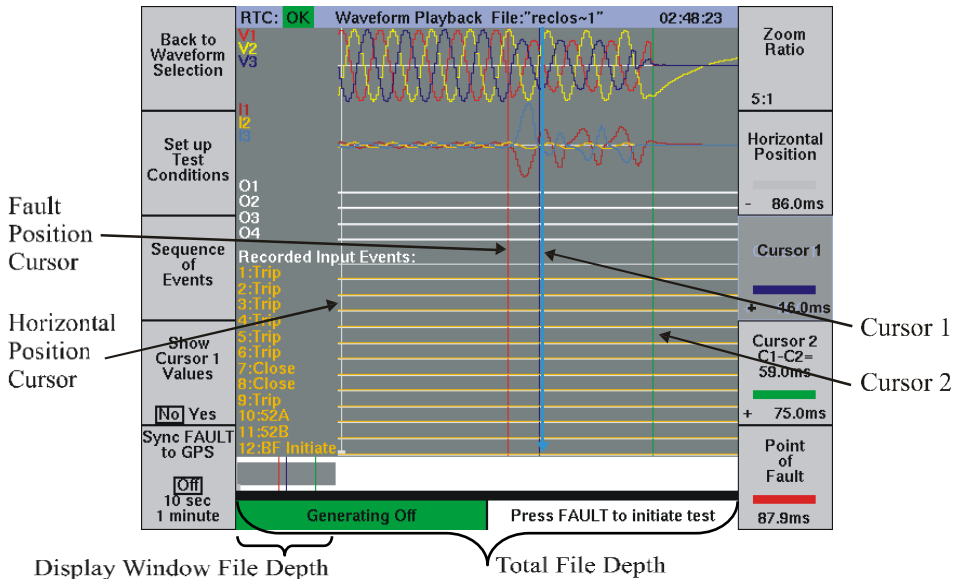

Figure 7.3 WAVEFORM PLAYBACK FILE DISPLAY

A number of zoom, scrolling and cursor features are provided to allow even very large files to be viewed at desired zoom level and precise timing measurements to be taken.

The display window file depth bar at the lower left of the display conveys how much of the total file is currently shown in the main display window. The total file depth is indicated by the width of the entire file depth window, so in Figure 7.3 approximately 25% of the entire file is visible in the main display window. See section 4.12 OSCILLOSCOPE DISPLAY for more details regarding control of the waveform display.

It is possible to zoom in on any portion of the entire file. Zooming is centered about the Horizontal Position. Press *Horizontal Position* [F7] and move the Horizontal cursor with the dial to the place on the horizontal (time) axis you wish to zoom in on. Press *Zoom Ratio* [F6] and rotate the dial clockwise or counterclockwise to zoom in or out respectively on that point.

Timing measurements are most often taken with respect to the point at which a fault is initiated. By default, the red Point of Fault cursor will be located at the first transition point, but it can be moved via *Point of Fault* [F10] and rotating the dial. Cursor 1 readout is always with respect to the point of fault, and Cursor 2 readout displays the time between Cursor 1 and 2.

Show Cursor 1 Values [F4] will display V and I amplitudes at the Cursor 1 location.

Note that GPS synchronized fault initiation and Sequence of Events viewing are accessible from this screen via the *Synch FAULT to GPS* and *Sequence of Events* buttons F5 and F3 respectively. See Section 6 GPS OPERATION, Section 7.5 INITIATING WAVEFORM PLAYBACK, and Section 7.6 SEQUENCE OF EVENTS for more information.

7.4. CONFIGURING WAVEFORM DATA FILES

Before initiating a test using the waveform data it is necessary to ensure that the current and voltage channels have been assigned appropriately, and amplitudes specified by the data will not exceed the capabilities of the MTS-5100. Press *Set up Test Conditions* [F2] to bring up the Waveform Playback Setup screen. Note: an additional file with the extension ".waveformSettings" is created whenever a change is made in the Set up Test Conditions menu to save the configuration. Be sure you copy this file when you manually transfer Comtrade files from one machine to another.

| | | RTC: OK | Waveform Playback Setup | | 16:22:34 |
|--------------------------------|--------------------------|--|-------------------------|------------------------------------|-------------------------|
| Back to Waveform Playback | Analog Channels | | | | |
| | Comtrade Analog Waveform | | | | |
| Configure Channel Scaling | V1 | | 1 | Voltage VA (V) | |
| | V2 | | 2 | Voltage VB (V) | |
| | V3 | | 3 | Voltage VC (V) | |
| | V4 | | 4 | Voltage (Spare) (V) | |
| Configure Inputs | I1 | | 5 | Current IA (A) | |
| | I2 | | 6 | Current IB (A) | |
| | I3 | | 7 | Current IC (A) | |
| Advanced Settings | I4 | | | | |
| | I5 | | | | |
| | I6 | | | | |
| | Outputs | | | | |
| | Delay | | | | |
| | # | Function | Open | Close | Comtrade Digital Signal |
| 1 | COMTRADE | 0ms | 0ms | 1 Contact Terminal: 37-39 (active) | |
| 2 | COMTRADE | 0ms | 0ms | — | |
| 3 | 52A/Invert 1 | 0ms | 0ms | — | |
| 4 | 52A/Invert 2 | 0ms | 0ms | 6 Contact Terminal: 58-64 (active) | |
| Auto Configure Channel Mapping | Generating Off | | | | |

Figure 7.4 WAVEFORM PLAYBACK SETUP

COMTRADE files may contain more, or fewer than, the 4 voltages and 6 currents that the MTS-5100 provides. Any analog data channel can be assigned to any MTS-5100 output channel. It is possible that a COMTRADE current channel might inadvertently be assigned to a voltage output channel. It is possible to assign any COMTRADE channel to any MTS-5100 output channel by moving the cursor to a given output channel and selecting any data channel by rotating the dial.

For many applications however, the *Auto-Configure Channel Mapping* button [F5] will be the fastest and easiest way to map data to output channels. Pressing it will automatically assign the first three voltage data channels available to the three voltage output channels, the first three current data channels to the three current output channels, and the first four status data channels to the four digital output contacts.

It is also necessary to ensure that the AC output values specified by the data channels are within the capabilities of the MTS-5100. To access the appropriate setup screen press *Configure Channel Scaling* [F2].

| Back to Waveform Setup | Waveform Channel Scaling | | | | | | 03:19:54 | | Get Ratios From CFG File |
|--|--------------------------|-----------------|-----|-------------|---|----------------|----------|--------|--------------------------|
| | Chnl | Min/Max in file | | CT/PT Ratio | | Scaled Min/Max | | | |
| V1 | - 81 | + 81 | 1 : | | 1 | | - 81 | + 81 | |
| V2 | - 81 | + 85 | 1 : | | 1 | | - 81 | + 85 | |
| V3 | - 81 | + 81 | 1 : | | 1 | | - 81 | + 81 | |
| I1 | - 13 | +7769m | 5 : | | 5 | | - 13 | +7769m | |
| I2 | -1769m | +1378m | 5 : | | 5 | | - 1769m | +1378m | |
| I3 | -7653m | + 17 | 5 : | | 5 | | - 7653m | + 17 | |
| Instructions | | | | | | | | | |
| Set the scaling for each channel high enough that none of the scaled values exceed 42.43 amps or 212.13 volts. To parallel multiple current channels, use the same scaling ratio for each channel, and set each channel to use the same data from the COMTRADE file. By wiring the current channels in parallel, the output current will be the sum of the scaled currents shown above. | | | | | | | | | |
| Generating Off | | | | | | | | | |

Figure 7.5 WAVEFORM CHANNEL SCALING

The maximum values referred to in the display are peak values, which are equivalent to RMS values multiplied by the square root of 2 (i.e. 1.414). Since the MTS-5100 can generate maximum current and voltage of 30 ARMS and 250 VRMS respectively, the corresponding peak current and voltage amplitudes are 42.4A and 328.5V respectively, as noted in the display. Remember that you can parallel current channels together to produce higher currents.

The *CT/PT Ratio* values may be revised if the raw file data would result in AC output values exceeding the capability of the MTS-5100. Ideally the raw data corresponds to the actual secondary current that would be seen by a relay, but since it may originate from a variety of sources, this may not always be the case. Data from a program emulating power system behavior, for example, might produce data representing

primary current and voltage values only, and the end user would have to specify local current transformer (CT) and voltage transformer (VT) values to get correct secondary values. Even when the data does correspond to local secondary values, it may specify too high a value, particularly for current. Note that available current output levels may be increased by using two or more MTS-5100 current channels per phase current required. More current can be added by using two MTS-5_00 systems in master-slave configuration as described in Section 8 MASTER-SLAVE OPERATION.

When scaling of the data is necessary, there are several considerations to be kept in mind. First is that the same scaling factor should be applied to all phases of each parameter in use. Second is that the nature of the device being tested should be considered in modifying the scaling factor. Impedance relays for example monitor the ratio of current to voltage, so both parameters should be modified by the same amount even though one set of them (typically voltage) would produce acceptable output values. Third is that when doing synchronized testing with another location, which may have different CT and/or PT ratios, it is important to ensure that appropriate values are applied at all locations participating in the test. It is possible, for example, that the local values, would have to be rescaled to maintain the correct relationship to values at other terminals which would exceed equipment capabilities.

Follow these steps to use more than one output channel for a phase current larger than 30 Amps.

1. Select the channels you wish to parallel.
2. Assign each of the selected channels to be the same data (COMTRADE) channel.
3. Ensure the CT ratio is correct on all channels.
4. Multiply the right-hand blue number (to the right of the colon) by the number of channels paralleled in each channel row (i.e. Two parallel channels changes from 5:5 to 5:10. Three parallel channels changes from 5:5 to 5:15)

Once appropriate scaling has been verified or modified, return to the Waveform Setup display by pressing *Back to Waveform Setup* [F1]. If it is desired to change the labels on any input channels (see Figure 7.3), press *Configure Inputs* [F3]. See Section 3.8.1 for a description of this process. Otherwise, press "Back to Waveform Playback [F1].

7.4.1. Configuring Digital Outputs

In some cases, especially actual fault files which have captured digital events like DC permissive trip signals as well as AC waveforms, it may be useful to program the MTS-5100 output channels to emulate one or more of these digital events. An example would be using an output channel to switch DC voltage to simulate the appearance of a permissive trip signal, which had been captured by a digital input channel on the recording device which generated the Comtrade file.

The lower portion of the Waveform Playback Setup screen (Figure 7.4) provides a way to map selected Comtrade signal channels to output channels on the MTS-5100. NOTE: do not confuse the COMTRADE signal channels with the MTS-5100 input channels. The COMTRADE signal channel names are assigned within the device or program which generated the file, and may have no relationship to the MTS-5100 input functions.

| Outputs | | | | |
|---------|--------------|-------|-------|------------------------------------|
| # | Function | Delay | | Comtrade Digital Signal |
| | | Open | Close | |
| 1 | COMTRADE | 0ms | 0ms | 1 Contact Terminal: 37-39 (active) |
| 2 | COMTRADE | 0ms | 0ms | — |
| 3 | 52A/Invert 1 | 0ms | 0ms | — |
| 4 | 52A/Invert 2 | 0ms | 0ms | 6 Contact Terminal: 58-64 (active) |

Figure 7.6 DIGITAL OUTPUT PROGRAMMING

The first column *Function* in the Outputs programming portion of the Waveform Playback Setup display is set by default to Off for all channels unless the Auto Configure Channel Mapping option was selected and digital signals are present in the Comtrade file. Each channel may be set to simulate a breaker auxiliary switch (52A or 52B) controlled by trip sensing on inputs 1 through 4. In this event, the open and close time delays may be specified in the Open and Close columns respectively. If Output 1 is set to be "52A/Invert 1" for example, Output 1 will open if Input 1 is enabled after the Open time delay.

If COMTRADE is selected, the time delay cells will be greyed-out, but the *Comtrade Digital Signal* cell will be active. Move the cursor to this cell and rotate the dial to select from the available Comtrade signal channels to be used to control that output channel.

The Timed selection programs the output to open and close based on the Open and Close Delays.

7.5. INITIATING WAVEFORM PLAYBACK

With the waveform data loaded and properly configured as described in the previous sections, simply press the FAULT button to immediately initiate playback when performing local tests. The output waveforms will be played continuously until either a trip signal operates that is programmed to stop the test, the complete waveform event has been played back, or the operator presses the RESET button.

GPS synchronized fault playback requires at least two test locations to initiate the sequences at exactly the same time. In this event, once all participating locations have confirmed they are ready, everyone selects their *Synch FAULT to GPS* [F5] setting to the same value (10 seconds or 1 minute; see the bottom left corner of Figure 7.3), then presses their FAULT button. The AC Output Warning LED will begin to flash, and when all locations will begin waveform playback the GPS time displayed in the upper right corner of the display reaches the next 10 seconds or 1 minute mark. See Section 6 GPS OPERATIONS for further details.

The Waveform Playback File display will update as shown in Figure 7.7 to record any activity on the MTS-5100 digital inputs and/or outputs.

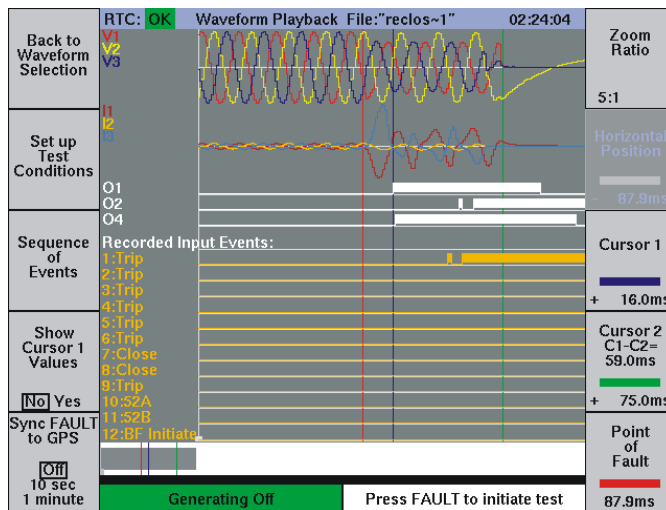

Figure 7.7 WAVEFORM PLAYBACK RESULTS

Compare the display above to that in Figure 7.3. Note that the AC waveforms are identical, but the digital input and output traces show the response of the system under test. The programming applied to the digital output channels is identical to that illustrated in Figure 7.6, i.e. Outputs 1 and 4 are mapped to Comtrade Digital Signal channels, Output 2 is set to *52B/Mimic 1*, and Output 3 is set to *Off*. Channels set to *Off* will not appear on the display.

Each time the test is run again, the display will overwrite the existing one with the new test results. To save a copy of the results, or to view the events in text format, press *Sequence of Events* [F3].

7.6. SEQUENCE OF EVENTS

A tabular sequence of events record is accessible from the graphic Waveform Playback display by pressing *Sequence of Events* [F3] in that display. Shown below is the tabular version of the event shown graphically on the previous page.

| RTC: OK Form Playback Events "Waveform Playbac 02:47:12 | | | |
|---|------|-----------|--------------------------------|
| Back to Waveform Playback | Evt# | Time (ms) | Event Description |
| | 1 | - 87.9 | START |
| | 2 | - 87.9 | Scroll Position |
| | 3 | 0.0 | POINT OF FAULT |
| | 4 | + 16.0 | Cursor 1 |
| Output Events | 5 | + 16.1 | Output 1 (O/C PICKUP I->) On |
| | 6 | + 17.1 | Output 4 (Relay PICKUP L2) On |
| Hide [Show] | 7 | + 45.2 | Input 1 (Trip) ON |
| | 8 | + 47.2 | Input 1 (Trip) OFF |
| | 9 | + 51.2 | Output 2 (S2B/Mimic 1) On |
| | 10 | + 53.2 | Output 2 (S2B/Mimic 1) Off |
| | 11 | + 53.3 | Input 1 (Trip) ON |
| | 12 | + 59.3 | Output 2 (S2B/Mimic 1) On |
| | 13 | + 75.0 | Cursor 2 |
| | 14 | + 95.1 | Output 1 (O/C PICKUP I->) Off |
| | 15 | + 114.1 | Output 4 (Relay PICKUP L2) Off |
| | 16 | + 129.4 | Input 1 (Trip) OFF |
| Save and Restore Results | 17 | + 135.4 | Output 2 (S2B/Mimic 1) Off |
| | 18 | + 736.1 | Output 1 (O/C PICKUP I->) On |
| | 19 | + 739.1 | Output 4 (Relay PICKUP L2) On |
| | 20 | + 782.3 | Input 1 (Trip) ON |
| | 21 | + 788.3 | Output 2 (S2B/Mimic 1) On |
| | 22 | + 815.1 | Output 1 (O/C PICKUP I->) Off |
| View This Event | 23 | + 829.1 | Output 4 (Relay PICKUP L2) Off |
| | 24 | + 839.3 | Input 1 (Trip) OFF |
| | 25 | + 845.3 | Output 2 (S2B/Mimic 1) Off |
| Generating Off | | | |

Figure 7.8 WAVEFORM PLAYBACK SEQUENCE OF EVENTS

All timing events are reported with respect to the *Point of Fault*. Compare the text information in this display to the waveform traces and cursor positions on the previous page. To minimize the data appearing on the screen, there is an *Output Events Hide/Show* button [F2] which controls visibility of the digital outputs actions. The digital outputs are usually only of interest if they have been programmed to perform a specific function within the fault sequence.

To view the related waveform data at a specific point on the record, scroll the cursor to that point with the dial, and press *View This Event* [F5]. This will return the screen to the waveform display, with the Horizontal Display cursor located at the exact data point.

To save the complete graphical and tabular data, press *Save and Restore Results* [F4]. The following section describes the process.

7.7. FILE STORAGE/RETRIEVAL

To store the sequence of events record for later recall, press *Save and Restore Results* [F4]. The resulting screen shown below will list all existing folders and individual files, and provides buttons for creating, editing and saving them.

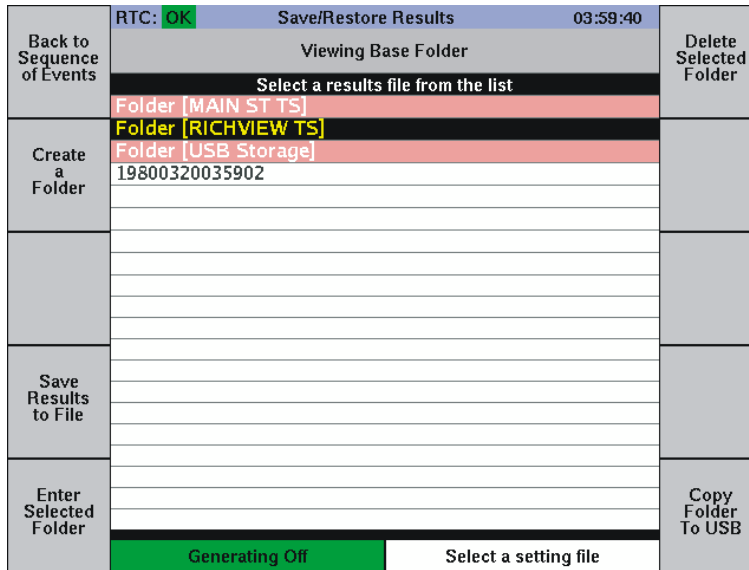

Figure 7.9 SAVE/RESTORE RESULTS FILES

The folders and files are similar in concept to what is found on a PC, i.e. a single data storage location is called a file, and a folder is a container for files. This means that multiple files associated with a particular substation, for example, can be kept within a single folder identified with the name of that station. This makes it easier to manage large numbers of files. The screen may list both files and folders. Folders are a different color to differentiate them from files.

To store the results in an existing folder, select the folder from the list by scrolling the cursor to it with the arrow keys or dial. One may enter, delete, or exit from that folder with the *Enter Selected Folder*, *Delete Selected Folder*, or *Exit Current Folder* buttons F5, F6, or F3 respectively. Note that if a file is selected in this manner instead of a folder, the labels on buttons F5 and F6 change to *Enter Selected File* and *Delete Selected File* respectively.

During initial use of the MTS-5100 there will be no folders, and it will be necessary to create them. To make a new folder press *Create a Folder* [F2]. This will bring up the Folder Name Entry screen which allows alphanumeric text to be generated to label the folder.

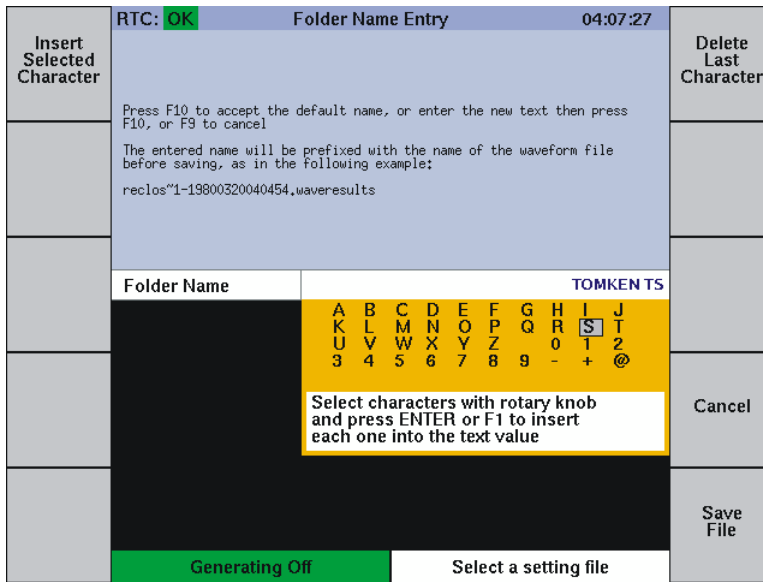

Figure 7.10 FOLDER NAME ENTRY

A unique folder name can be generated using the dial to select text or numbers and entering them with the *Insert Selected Character* button [F1]. The name appears immediately above the character grid. Edit as required with the *Delete Last Character* button [F6] and press *Save File* [F10] when completed. This will return you to the Save/Restore Results screen (Figure 7.9), still within the folder just created. To see the name of the new folder, press *Exit Current Folder* [F3].

To add a file to the new folder, instead of exiting from it, press *Save Settings to a File* [F4]. This will return you to the File Name Entry screen, identical to the Folder Name Screen of Figure 7.10 above except the text “Folder” is replaced by “File”. Follow the same procedure to generate a name for the file. The instructions regarding default naming in the upper part of Figure 7.10 refer to files not folders.

Note: You may use a compatible USB keyboard connected to a USB port to enter the folder/file names via a keypad.

7.7.1. Save Settings File

It is also possible to save MTS-5100 test configurations in a file for subsequent rapid setup of complex tests. Pressing *Save and Restore* [F7] in the *Advanced Settings* Menu will bring the user to the Save/Store Results screen of Figure 7.9. Creation of folders and/or files for this application is identical to the process described in the preceding Section 7.7. See Section 4.8.9 for further details.

8. MASTER-SLAVE OPERATION

A unique feature of the MTS-5100 is its ability to work in a master-slave configuration with a second MTS-5100, MTS-5000, or MTS slave channel box. With an MTS-5100 & MTS-5000 connected, for example, up to 9 currents plus 7 voltages can be controlled from a single manual interface. Using this example configuration, applications include 3-phase testing at up to 90 amps per phase, single phase testing at up to 270 amps, testing of modern transformer differential relays, synchrocheck relay checks with up to 6 voltages, and bench testing of line differential relay systems.

The only additional hardware required to configure 2 systems for master-slave operation is an RJ-45 Ethernet cable, either CAT 5e or CAT 6. A suitable cable has been provided with your system at the time of purchase. Plug this cable into the RJ-45 *Remote* jack (see Figure 5.1).

8.1. SLAVE SYSTEM CONFIGURATION

Power-up both systems, and choose the system which is to operate in slave mode. Enter the Remote Menu on the Slave unit by pressing from the Main Menu, *Remote Control* [F8]. Press *Slave Mode* [F2] to enter the Slave Mode Menu.

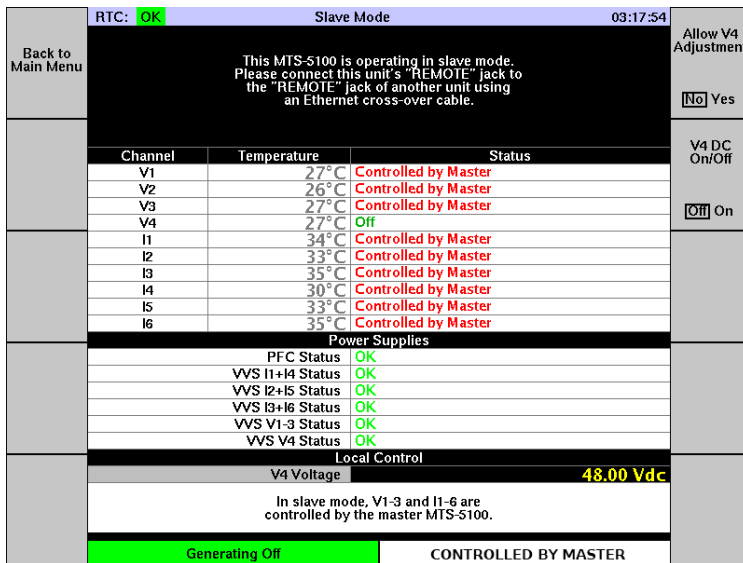

Figure 8.1 SLAVE MODE MENU

With successful communication established between the 2 units, the display will look like Figure 8.1. The slave unit retains local control for the V4 DC output via *V4 On/ Off* [F6]. Do not press any other buttons on the slave unit until testing requiring master-slave configuration is complete.

8.2. MASTER SYSTEM CONFIGURATION

When *Slave Mode* is selected on one system, the other system automatically assumes master configuration. With an MTS-5100 & MTS-5000 connected, for example, the master unit's Manual Test Menu will by default display all 9 current and 6 voltage channels, which may be manually controlled in the normal manner via the cursor and keypad or dial. Note: the slave channels are indicated with a “s” suffix (i.e. V1_s)

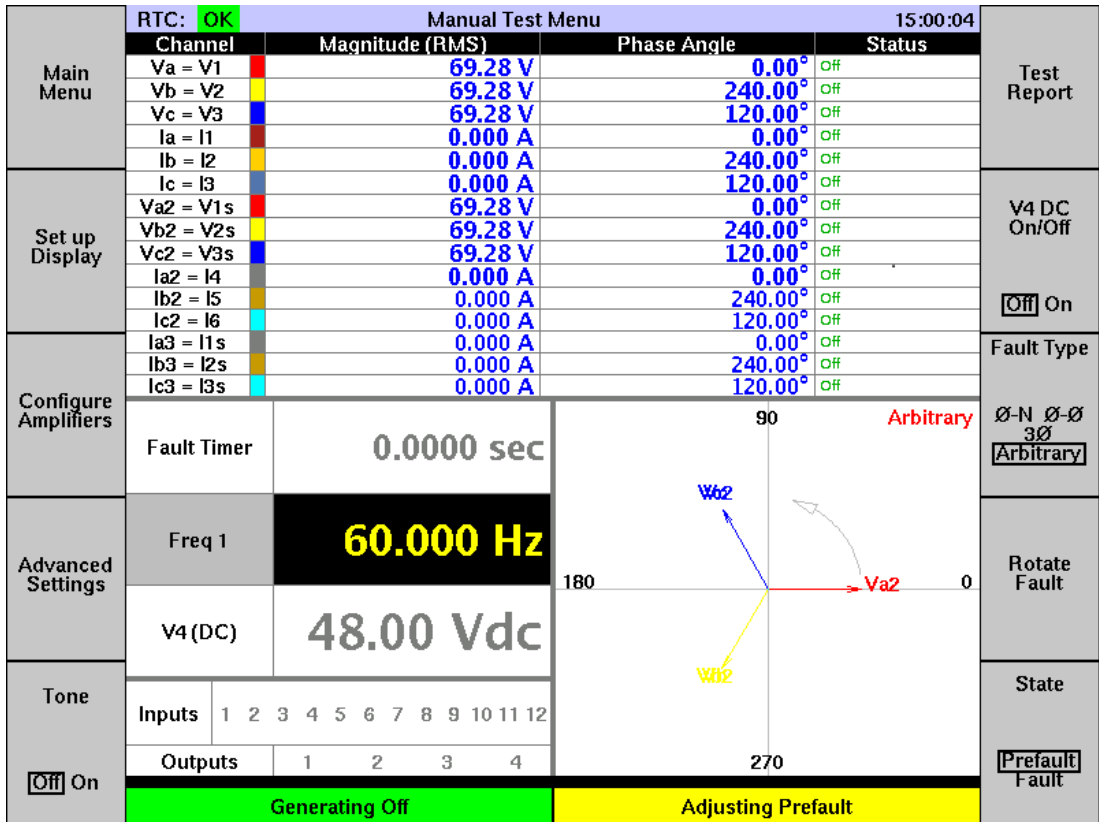

Figure 8.2 DEFAULT MASTER CONTROL DISPLAY

Most testing applications will not require the full complement of individually controllable sources as shown above. Disabling voltage sources which are not required and paralleling currents as needed will simplify the control display and will increase the text size on the display.

Optimize the control interface by selecting only the sources required for the application by pressing *Configure Amplifiers* [F3].

| RTC: OK | | Amplifier Configuration Menu | | | | | 15:06:51 |
|---------------------------------------|---|------------------------------|-------|-----------|---------|---------|---------------------|
| | | Parallel Amplifier Setup | | | | | Allow V4 Adjustment |
| | | Source | Group | Ungrouped | Group A | Group B | Group C |
| Back to Test Menu | I1 | Group A | | 30 Amps | | | |
| | I2 | Group B | | | 30 Amps | | |
| | I3 | Group C | | | | 30 Amps | |
| | I1s | Group A | | 30 Amps | | | |
| | I2s | Group B | | | 30 Amps | | |
| | I3s | Group C | | | | 30 Amps | |
| Voltage Outputs (V1, V2, V3) | I4 | Group A | | 30 Amps | | | |
| | I5 | Group B | | | 30 Amps | | |
| Off [On] | I6 | Group C | | | | 30 Amps | |
| | Total Current: | | | | 90 A | 90 A | 90 A |
| Current Outputs (I1 to I6) | Current Amplifier Parallel Operation | | | | | | |
| | <p>Set each current source to one of the three parallel groups, or to "Ungrouped" to run that source independently.</p> <p>Note: current channels that are paralleled are phase locked to each other, but require external connections to be made</p> | | | | | | |
| Off [1-3] [1-6] | Parallel None | | | | | | |
| | Parallel Three-phase Pairs | | | | | | |
| Slave Voltage Outputs (V1s, V2s, V3s) | Parallel All | | | | | | |
| | <p>Generating Off</p> <p>Adjusting Preault</p> | | | | | | |

Figure 8.3 AMPLIFIER CONFIGURATION MENU

In the example above, the currents have been paralleled via *Parallel Three-phase Pairs* [F9], and the slave unit voltages disabled via *Slave Voltage Outputs* [F4].

| RTC: OK | | Manual Test Menu | | | | 15:08:30 |
|----------------------|--|----------------------------|-----------------|--------------|--------|---------------------------|
| | | Channel | Magnitude (RMS) | Phase Angle | Status | Test Report |
| Main Menu | Va - V1 | | 69.28 V | 0.00° | Off | |
| | Vb - V2 | | 69.28 V | 240.00° | Off | |
| | Vc - V3 | | 69.28 V | 120.00° | Off | |
| Set up Display | Ia * | | 75.000 A | 0.00° | Off | |
| | Ib * | | 75.000 A | 240.00° | Off | |
| | Ic * | | 75.000 A | 120.00° | Off | |
| Configure Amplifiers | * Parallel Connections: Ia = I1+I1s+I4 Ib = I2+I2s+I5 Ic = I3+I3s+I6 | | | | | Fault Type |
| | Fault Timer | 0.0000 sec | | 90 Arbitrary | | Off-N Off-Off [Arbitrary] |
| Advanced Settings | Freq 1 | 60.000 Hz | | 180 | | Rotate Fault |
| | V4 (DC) | 48.00 Vdc | | 0 | | |
| Tone | Inputs | 1 2 3 4 5 6 7 8 9 10 11 12 | | | | State |
| | Outputs | 1 2 3 4 | | | | 270 |
| Off [On] | | Generating Off | | | | Adjusting Fault |

Figure 8.4 MODIFIED MASTER CONTROL DISPLAY

Note the cleaner appearance of the display after the above changes.

8.3. APPLICATIONS

Although the systems automatically make the individual amplitude, phase, and frequency adjustments to paralleled current channels, the outputs of all parallel channels must physically be paralleled externally, as shown below.



NOTE: ONCE A CURRENT SOURCE IS ASSIGNED TO A PARALLEL GROUP, IT MUST BE CONNECTED IN PARALLEL WITH THE OTHERS OF ITS GROUP OR SHORT CIRCUITED. ANY PARALLELED SOURCE NOT CONNECTED WILL OVERLOAD (CLIP).

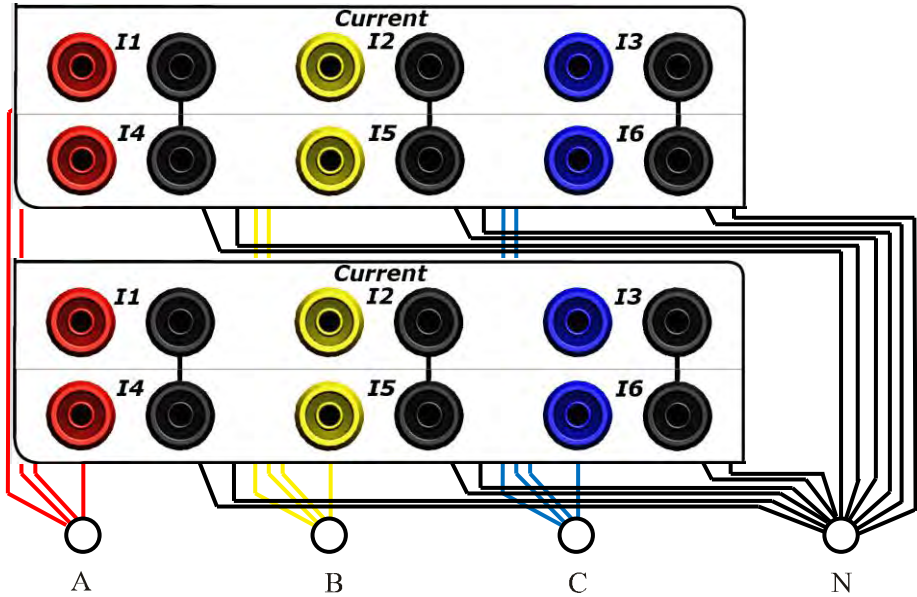

Figure 8.5 CURRENT CONNECTIONS FOR 3X4 PARALLEL OUTPUTS

Note that the maximum compliance voltage available is equal to that of a single current channel only, so if the $V=IR$ voltage drop across the test load at the desired current level exceeds the compliance voltage, clipping will occur, and an alarm warning *Clip* will appear in the Status cell of the affected channel(s).

To maximize compliance voltage available at the relay terminals, i.e. to maximize the current available without clipping, use the largest gauge wiring possible and ensure all connections from the wiring to the relay inputs are tight. It is also important to supply individual leads from each channel's neutral terminal as shown, even though they are all internally connected, to avoid overloading the neutral lead.

Figure 8.6 shows current connections required for bench testing a high-current line differential relay protection system.

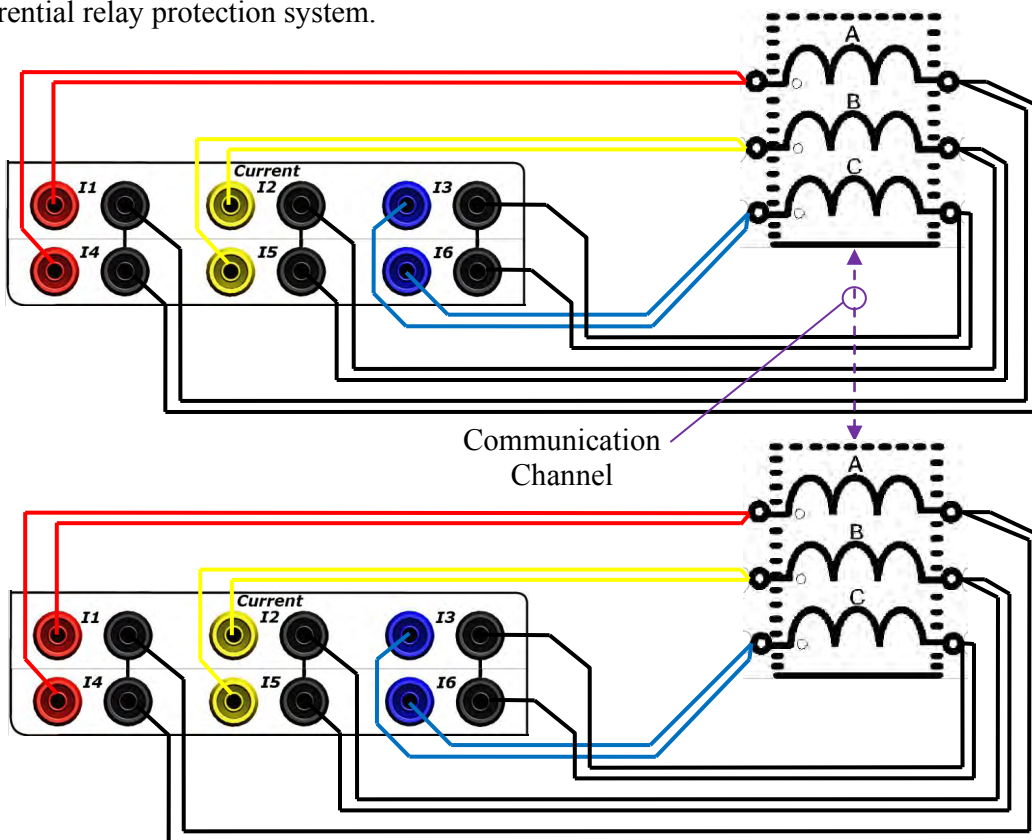

Figure 8.6 LINE DIFFERENTIAL RELAY TEST CONNECTIONS

These connections are identical to those used for testing an in-service line differential protection system, except that appropriate communication link(s) between the two relays must be established for the duration of the test. Bench testing in this manner allows the performance of the system to be verified at a single location, without establishing a GPS lock to synchronize the MTS-5100 systems.

The connections shown in Figure 8.6 are suitable for high-current testing (6 x 60A) using two MTS-5100 systems. If the individual currents from an MTS-5100 system will not exceed 30 amps, and remote locations are not involved, see Section 4.7.1 for testing a 6-current differential transformer with a single MTS-5100 (6 x 30A configuration).

For in-service testing of line differential relays using master-slave configurations at each end to achieve higher phase currents, it is only necessary to connect a GPS antenna or IRIG-B signal to the master unit at each location.



AN5-1 Application Note

9. SOFTWARE UPGRADE

9.1. INTRODUCTION

The MTS-5100 uses FLASH memory for program storage. This makes software upgrades in the field a quick and simple process. Software upgrades take approximately two minutes. The only hardware required is a standard USB drive loaded with the appropriate upgrade software, which can be downloaded from Manta.



9.2. PROCEDURE

Power-up the MTS-5100, and when the MTS-5100 Main Menu is displayed record the software version.



Press *Setup* [F10], then *Software Upgrade* [F6].

Insert the USB drive into either of the USB ports on the right side of the case. After approximately 10 seconds the message “A USB Storage device has been Inserted” should appear.



Press F1 to proceed to the next screen shown below. If necessary use the arrow keys to select "Folder [USB Storage]".



Press *Enter Selected Folder* [F5]. If necessary use the arrow keys to select the desired upgrade file.



Press *Copy File From USB* [F10] and WAIT until the button turns from dark grey to light grey again. This loads the file into the MTS-5100's on-board files.

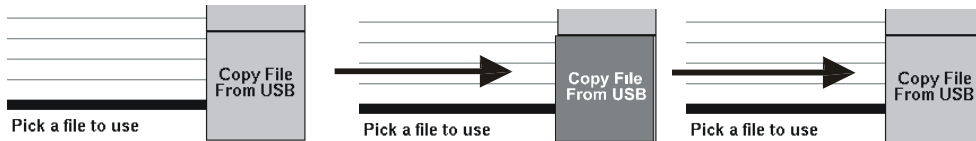

Press *Exit Current Folder* [F3] and remove the USB memory stick. Wait for the following screen, then press F1 *Press F1 to Continue*.

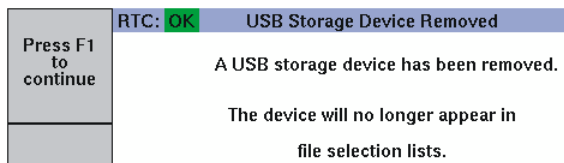

Turn off the mains power to the MTS-5100, wait several seconds, and power it on again.

From the Main Menu press *Setup* [F10], then *Software Upgrade* [F6].

If necessary use the arrow keys to select the upgrade file just uploaded.

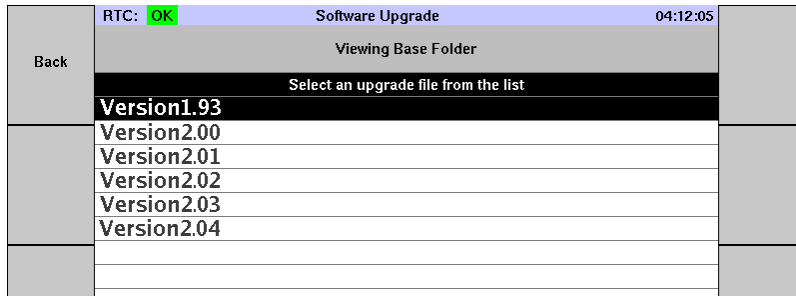

Press *Load selected File* [F5], and wait for the following screen to appear.

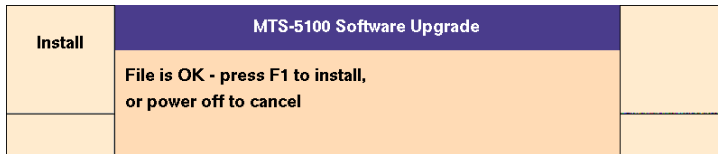

Press *Install* [F1], and wait for the following screen to appear.

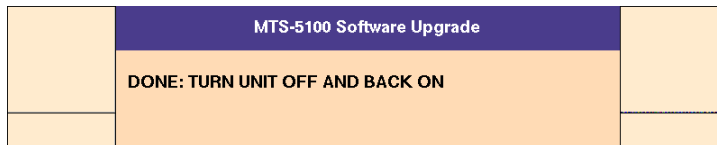

Turn off the mains power to the MTS-5100, wait several seconds, and power it on again.

In most cases the screen on the following page will be displayed the first time the unit is powered up after a software upgrade.

| Back to Previous Menu | RTC: OK Forced Shutdown 04:10:09 | | | | | | | | | | | | | | | | | | | | | | | | | | | | | | | | | | | | | | | | | | | | | | | | | | | | |
|--|---|--------------------------|---------|-------------|--------|----|-----|----------------|----|-----|----------------|----|-----|----------------|----|-----|----------------|----|-----|----------------|----|-----|----------------|----|-----|----------------|----|-----|----------------|----|-----|----------------|----|-----|----------------|-----|-----|---------|-----|-----|---------|-----|-----|---------|-----|-----|---------|-----|-----|---------|-----|-----|---------|
| Generation has been disabled because an amplifier has encountered a problem. The reason for the shutdown was: I1 loading new firmware (takes about 15 seconds) | | | | | | | | | | | | | | | | | | | | | | | | | | | | | | | | | | | | | | | | | | | | | | | | | | | | | |
| <table border="1" style="width: 100%; border-collapse: collapse;"> <thead> <tr> <th style="width: 20%;">Channel</th> <th style="width: 40%;">Temperature</th> <th style="width: 40%;">Status</th> </tr> </thead> <tbody> <tr><td>V1</td><td>0°C</td><td>Loading 1-3...</td></tr> <tr><td>V2</td><td>0°C</td><td>Loading 1-3...</td></tr> <tr><td>V3</td><td>0°C</td><td>Loading 1-3...</td></tr> <tr><td>V4</td><td>0°C</td><td>Loading 1-3...</td></tr> <tr><td>I1</td><td>0°C</td><td>Loading 1-3...</td></tr> <tr><td>I2</td><td>0°C</td><td>Loading 1-3...</td></tr> <tr><td>I3</td><td>0°C</td><td>Loading 1-3...</td></tr> <tr><td>I4</td><td>0°C</td><td>Loading 1-3...</td></tr> <tr><td>I5</td><td>0°C</td><td>Loading 1-3...</td></tr> <tr><td>I6</td><td>0°C</td><td>Loading 1-3...</td></tr> <tr><td>V1s</td><td>0°C</td><td>MISSING</td></tr> <tr><td>V2s</td><td>0°C</td><td>MISSING</td></tr> <tr><td>V3s</td><td>0°C</td><td>MISSING</td></tr> <tr><td>I1s</td><td>0°C</td><td>MISSING</td></tr> <tr><td>I2s</td><td>0°C</td><td>MISSING</td></tr> <tr><td>I3s</td><td>0°C</td><td>MISSING</td></tr> </tbody> </table> | | | Channel | Temperature | Status | V1 | 0°C | Loading 1-3... | V2 | 0°C | Loading 1-3... | V3 | 0°C | Loading 1-3... | V4 | 0°C | Loading 1-3... | I1 | 0°C | Loading 1-3... | I2 | 0°C | Loading 1-3... | I3 | 0°C | Loading 1-3... | I4 | 0°C | Loading 1-3... | I5 | 0°C | Loading 1-3... | I6 | 0°C | Loading 1-3... | V1s | 0°C | MISSING | V2s | 0°C | MISSING | V3s | 0°C | MISSING | I1s | 0°C | MISSING | I2s | 0°C | MISSING | I3s | 0°C | MISSING |
| Channel | Temperature | Status | | | | | | | | | | | | | | | | | | | | | | | | | | | | | | | | | | | | | | | | | | | | | | | | | | | |
| V1 | 0°C | Loading 1-3... | | | | | | | | | | | | | | | | | | | | | | | | | | | | | | | | | | | | | | | | | | | | | | | | | | | |
| V2 | 0°C | Loading 1-3... | | | | | | | | | | | | | | | | | | | | | | | | | | | | | | | | | | | | | | | | | | | | | | | | | | | |
| V3 | 0°C | Loading 1-3... | | | | | | | | | | | | | | | | | | | | | | | | | | | | | | | | | | | | | | | | | | | | | | | | | | | |
| V4 | 0°C | Loading 1-3... | | | | | | | | | | | | | | | | | | | | | | | | | | | | | | | | | | | | | | | | | | | | | | | | | | | |
| I1 | 0°C | Loading 1-3... | | | | | | | | | | | | | | | | | | | | | | | | | | | | | | | | | | | | | | | | | | | | | | | | | | | |
| I2 | 0°C | Loading 1-3... | | | | | | | | | | | | | | | | | | | | | | | | | | | | | | | | | | | | | | | | | | | | | | | | | | | |
| I3 | 0°C | Loading 1-3... | | | | | | | | | | | | | | | | | | | | | | | | | | | | | | | | | | | | | | | | | | | | | | | | | | | |
| I4 | 0°C | Loading 1-3... | | | | | | | | | | | | | | | | | | | | | | | | | | | | | | | | | | | | | | | | | | | | | | | | | | | |
| I5 | 0°C | Loading 1-3... | | | | | | | | | | | | | | | | | | | | | | | | | | | | | | | | | | | | | | | | | | | | | | | | | | | |
| I6 | 0°C | Loading 1-3... | | | | | | | | | | | | | | | | | | | | | | | | | | | | | | | | | | | | | | | | | | | | | | | | | | | |
| V1s | 0°C | MISSING | | | | | | | | | | | | | | | | | | | | | | | | | | | | | | | | | | | | | | | | | | | | | | | | | | | |
| V2s | 0°C | MISSING | | | | | | | | | | | | | | | | | | | | | | | | | | | | | | | | | | | | | | | | | | | | | | | | | | | |
| V3s | 0°C | MISSING | | | | | | | | | | | | | | | | | | | | | | | | | | | | | | | | | | | | | | | | | | | | | | | | | | | |
| I1s | 0°C | MISSING | | | | | | | | | | | | | | | | | | | | | | | | | | | | | | | | | | | | | | | | | | | | | | | | | | | |
| I2s | 0°C | MISSING | | | | | | | | | | | | | | | | | | | | | | | | | | | | | | | | | | | | | | | | | | | | | | | | | | | |
| I3s | 0°C | MISSING | | | | | | | | | | | | | | | | | | | | | | | | | | | | | | | | | | | | | | | | | | | | | | | | | | | |
| Power Supplies | | | | | | | | | | | | | | | | | | | | | | | | | | | | | | | | | | | | | | | | | | | | | | | | | | | | | |
| PFC | | 40.3°C OK | | | | | | | | | | | | | | | | | | | | | | | | | | | | | | | | | | | | | | | | | | | | | | | | | | | |
| VVS I1+I4 | 0.0°C | 0.0°C OK | | | | | | | | | | | | | | | | | | | | | | | | | | | | | | | | | | | | | | | | | | | | | | | | | | | |
| VVS I2+I5 | 0.0°C | 0.0°C OK | | | | | | | | | | | | | | | | | | | | | | | | | | | | | | | | | | | | | | | | | | | | | | | | | | | |
| VVS I3+I6 | 0.0°C | 0.0°C OK | | | | | | | | | | | | | | | | | | | | | | | | | | | | | | | | | | | | | | | | | | | | | | | | | | | |
| VVS V1-3 | 0.0°C | 0.0°C OK | | | | | | | | | | | | | | | | | | | | | | | | | | | | | | | | | | | | | | | | | | | | | | | | | | | |
| VVS V4 | 0.0°C | 0.0°C OK | | | | | | | | | | | | | | | | | | | | | | | | | | | | | | | | | | | | | | | | | | | | | | | | | | | |
| Wait for the condition to clear before using F1 to exit this display | | | | | | | | | | | | | | | | | | | | | | | | | | | | | | | | | | | | | | | | | | | | | | | | | | | | | |
| GENERATION DISABLED | | Status bar for main menu | | | | | | | | | | | | | | | | | | | | | | | | | | | | | | | | | | | | | | | | | | | | | | | | | | | |

This occurs only when the new software also requires new firmware to be loaded into each amplifier. After about 15 seconds the status message for all amplifiers will change to *Off*.

Verify that the unit powers up in a normal fashion, and that the desired software version has been loaded.

| | | |
|--|--|---------------|
| Manual Test |  <h1 style="color: #800040; margin: 0;">MANTA™</h1> <h2 style="color: #800040; margin: 0;">TEST SYSTEMS</h2> <div style="border: 1px solid black; border-radius: 50%; width: 150px; height: 40px; margin: 10px auto; display: flex; align-items: center; justify-content: center;"> MTS-5100: Version 2.00 </div> <p style="font-size: small;">Serial Number: 12914</p> <p style="font-size: x-small; color: #800040;">Network IP Address: 192.168.22.216</p> | Reporting |
| Productivity Modes | | Files |
| Waveform Playback | | Comm / Remote |
| Oscilloscope Display | | Diagnostics |
| IEC61850 / GOOSE Setup | | Setup |
| Generating Off Status bar for main menu | | |

10. STATUS MESSAGES

The *Status* column of the MTS-5100 conveys information on equipment status as well as warning and error messages. By far the most common messages are *On* and *Off* as the AC/DC output channels are turned on and off respectively. Occasionally an abnormal operating condition may bring in an alarm as shown below.

The message in this example is caused by clipping of the IA current channel, the most common alarm type. Some less common situations may shut down all output channels and generate the following display.

| | | |
|-------------|--------|----------------------------|
| Phase Angle | Status | Sequence of Events |
| 0.00 | On | V4 On/Off |
| 240.00 | On | |
| 120.00 | On | |
| 0.00 | CLIP | |
| 240.00 | On | [Off] On |
| 120.00 | On | Fault Type |
| | | Ø-N Ø-Ø 3Ø Arbitrary |

| RTC: OK | | Forced Shutdown | | 13:49:34 |
|---|-------------|-----------------------|--|-----------------------------|
| Generation has been disabled because an amplifier has encountered a problem. The reason for the shutdown was: V3 overload - waiting for user to clear the error | | | | |
| Channel | Temperature | | | Status |
| V1 | 28°C | | | Off |
| V2 | 28°C | | | Off |
| V3 | 28°C | | | Off |
| V4 | 28°C | | | Off |
| I1 | 33°C | | | Off |
| I2 | 34°C | | | Off |
| I3 | 35°C | | | Off |
| I4 | 32°C | | | Off |
| I5 | 33°C | | | Off |
| I6 | 34°C | | | Off |
| V1s | 0°C | | | MISSING |
| V2s | 0°C | | | MISSING |
| V3s | 0°C | | | MISSING |
| I1s | 0°C | | | MISSING |
| I2s | 0°C | | | MISSING |
| I3s | 0°C | | | MISSING |
| Power Supplies | | | | |
| PFC | | 39.6°C | | OK |
| VVS I1+I4 | 26.0°C | 26.2°C | | OK |
| VVS I2+I5 | 25.7°C | 32.3°C | | OK |
| VVS I3+I6 | 32.7°C | 29.5°C | | OK |
| VVS V1-3 | 24.5°C | 24.2°C | | OK |
| VVS V4 | 24.1°C | 26.4°C | | OK |
| Wait for the condition to clear before using F1 to exit this display | | | | |
| CHECK WIRING | | Captured Fault Values | | |
| | | | | CLEAR ERROR CONDITION |

Note that different colors are used to differentiate message classes, and that the *Forced Shutdown* display offers some additional information on system conditions.

10.1. Status Message List

Listed below are the messages that may appear in the Status column, with explanation of their meanings, and actions if any to be taken.

On - The output channel associated with this status cell is turned on.

Off - The output channel associated with this status cell is turned off.

CONTROLLED BY MASTER - This message indicates that the output channels are being remotely controlled by a second MTS-5100 in a master-slave configuration, and will not respond to local manual control.

CLIP - The output channel associated with this status cell is clipping, i.e. the amplifier in that channel can not produce a sinusoidal output voltage high enough to supply the connected load with the programmed current or voltage.

In most cases this will be a current channel, and the cause will be an open current circuit or too high a load burden for the specified current. In either case the output channels should be turned off until the problem is rectified. The system may be programmed to produce a warning beep for this condition, see Section 3.8 Setup Menu.

An open circuit is usually due to a lead falling off a terminal, or an incorrect connection. Verify the connections integrity before re-energizing the output.

Excess current load clipping may be rectified by reducing burden by shorting out elements of the output circuit which are not currently being tested, or by running the test at reduced current level.

clip - This remains on for a few seconds after clipping has been detected. It can be useful to indicate a problem during short-duration current pulses. Text is displayed in lower case denoting a short duration clip.

OPEN - The output of the associated current channel is clipping while the current at the terminals is very low, indicating that the output is either disconnected or it is connected to a high-impedance load. When the OPEN indication is shown, the compliance voltage for the channel is restricted to a touch-safe level (under 15V). If a low-impedance load is re-connected, the OPEN status clears after a few seconds, and compliance voltage is no longer restricted.

SHORTED - The output of the voltage amplifier associated with this alarm may be shorted. Turn the output channels off and correct the output wiring.

HOT - The output amplifier associated with this status cell is overheating. This is most likely to occur with the current amplifiers, when they are delivering high power. High ambient temperatures can contribute to this condition.

To minimize the occurrence of this condition, ensure all cooling inlets and exhausts are free and unrestricted. Leave the equipment powered up with fans running but output channels off to cool it down. If necessary to do tests at high power levels, reduce the duty cycle of the tests.

TOO HOT - The power supply is overheating. This condition may affect all output channels. Same resolution as for *Hot* alarm.

OVERLOAD - The output amplifier associated with this status cell is overheating due to too high output power requirements. This is most likely to occur when testing complete racks of electromechanical relays, or when very high output power settings are being specified.

The output load must be decreased by shorting current elements or removing voltage elements not under test, or by specifying lower output levels.

Loading n...n - This is a transient message, normally only appearing while the equipment software is being upgraded. It clears when the update process is complete. Other messages that may also appear briefly during this process are: *MISSING*, *Loading*, *Loading n-F*, *READING CAL*, *SAVING CAL*, *CAL CHANGED*, and *NOT CALIBRATED*.

MISSING - This message may appear if an amplifier has been removed for service.

NOT CALIBRATED - If this message appears during normal operation, the calibration factors for that channel may have been lost. Contact Manta for assistance.

OFFLINE - This may indicate an internal problem with the channel. Other messages of this nature are *FAILED*, and *SHUT DOWN*. Contact Manta for assistance.

INDEX**A**

AC line
 current, 4-37
 prevent excessive AC draw, 3-49
 voltage, 4-37
ac voltage/current, 2-2, 3-16
accessories, 2-5
advanced settings, 4-30
alarm, 10-1
amplifier configuration, 3-17, 4-28, 8-3
application software, 2-5
applications, 1-2
auxiliary input-outputs, 3-5, 5-1

B

backlight intensity, 4-40
basic applications, 3-7
breaker advance time, 3-35
breaker operate time, 4-26
breaker simulation, 4-25, 4-26

C

calibration, 3-51
captured fault values, 3-17
clipping, 3-19, 8-4, 10-1
 warning, 3-48
compliance voltage, 2-2, 3-19, 8-4
computed values, 2-3
computer interfacing, 5-1
comtrade files, 5-4, 7-1, 7-2, 7-5
current outputs, 3-3
cursor, 3-14
cursor control pushbuttons, 3-4, 3-14
customize, 3-50

D

data interfaces, 2-4, 5-1
dc current, 3-22
dc offset, 4-33, 7-1
dc voltage, 3-15
 default settings, 3-48
 output, 3-8
 switching, 4-25

 default settings, 3-13
 diagnostics, 3-51
 dial, 3-4, 3-14
 differential line protection, 6-3
 differential relay, 3-24
 6-current xformer differential, 4-29
 harmonic restraint, 3-27
 pickup, 3-26
 slope, 3-26
 digital input/output status, 3-12
 digital outputs, 2-3, 4-25
 status indication, 4-27
 terminals, 3-3
 display screen, 3-2
 customize, 3-50
 display setup menu, 4-35
 dry contact, 4-17
 dynamic display area, 3-12, 4-34
 dynamic relay testing, 1-4

E

end-to-end testing, 6-4
energizing output channels, 3-15
enter pushbutton, 3-4
error messages, 10-1
ethernet, 5-6
 configuration, 5-11
 connector, 3-6
 file management, 5-13
 set up, 3-51
 specifications, 2-4
 web server, 5-12
 windows 2000 configuration, 5-8
 windows 98 configuration, 5-7
 windows nt workstation configuration, 5-9
 windows xp configuration, 5-10

F

factory diagnostics, 3-51
fault button, 3-2
fault duration, 4-32
fault incidence angle, 4-30, 4-36
fault modes, 4-7
 characteristics, 4-8
 pickup, 3-2, 4-7
 timing, 3-2, 4-7
fault playback applications, 1-3

- fault states, 4-1, 4-32
 - fault, 4-2
 - fault duration, 4-4
 - frozen readings, 4-6
 - multiple faults, 4-3
 - postfault, 4-5
 - prefault, 4-1
- fault status box, 3-8, 3-12, 3-16
- fault type/phase, 3-11
- fault types, 4-9
 - 3 Φ (Φ -N) Fault, 4-14
 - 3 Φ (Φ - Φ) Fault, 4-15
 - arbitrary, 4-9
 - Φ -N Fault, 4-11
 - Φ - Φ Fault, 4-12
- files
 - accessing, 5-5, 5-13, 7-3
 - retrieving, 7-11
- firmware upgrade, 3-51
- firmware version, 3-7, 3-45
- foot switch, 4-7
- forced shutdown, 10-1
- frequency
 - frequency 1, 4-36
 - frequency 2, 4-36
- frequency control, 3-21
 - multiple frequencies, 3-22
 - system frequency, 3-48
- frequency specifications, 2-2
- front panel layout, 3-1
- frozen readings, 3-17
- function buttons, 3-1

G

- GenVa, 3-34
- getting started, 3-7
- gps delay, 3-49
- gps operation, 6-1
 - antenna input, 2-1
 - connectors, 3-6
 - end-to-end testing, 6-4
 - irig-b signal, 6-3
 - reception of signals, 6-1
 - remote synchronization, 6-3
 - status displays, 6-2
 - time information, 3-11
- gps-synchronized fault, 4-32
- graphical sequence of events, 4-44

H

- harmonic distortion, 3-27, 7-1
- help system, 3-45
 - pushbutton, 3-4
- high speed remote mode, 3-52
- hot alarm, 10-3

I

- impedance ohms display, 4-39
- impedance relay, 4-12, 4-39
- impedance relay test mode, 3-36
 - automatic test, 3-40
 - html test report, 3-44
 - manual test, 3-38
- in-panel testing, 1-4
- input power control, 3-49, 4-36
- inputs, 2-1, see status inputs
- IR, 4-37
- irig-b, 6-3
 - input, 2-1, 3-6
 - output, 2-3
- isolation, 3-9

K

- keypad, 3-3, 3-14, 3-15
- keypress tone, 3-47
- K-Factor, 4-32, 4-37
 - angle, 4-37

L

- LCD
 - backlight intensity, 3-47
 - colour scheme, 3-47
- LineVA, 3-34

M

- manual test menu, 3-10
- master-slave, 8-1
 - connector, 3-6
 - line differential relay, 8-5
- menu identity bar, 3-11
- metering, 2-3
- mimic, 4-27

N

negative sequence, 4-36, 4-39
network setup, 3-51
neutral current, 4-37

O

off-line adjustments, 3-13
open circuit, 10-2
oscilloscope display, 4-45
 cursors, 4-49
 trigger, 4-47
 zoom and position, 4-46
output adjustments/selections, 3-13
output channels, 3-10
 value, 3-11
outputs, 2-2
overcurrent relay, 3-36
overload alarm, 10-3

P

paralleling currents, 3-17, 8-4
parameter selection, 3-15
permissive, 4-26
phase angle format, 3-48
phase angle value, 3-11
phase sequence, 3-48, 4-32
phase specifications, 2-2
phase/frequency synchronization, 2-4, 6-1, 8-1
phase-to-phase voltage default, 4-1
physical characteristics, 2-6
pickup mode, 3-16
positive angles, 3-48
positive sequence, 4-36, 4-38, 4-39
postfault enable, 4-33
power
 apparent, 4-38
 factor, 4-38
 reactive, 4-38
 real, 4-37
power switch, 3-3
precautions, 3-9
prefault button, 3-2
productivity modes, 3-24
protection, 2-2, 3-9

Q

quickstart procedure, 3-13

R

r(ohms), 4-39
ramping, 4-41
 specifications, 2-4
relay testing, 3-13
remote console mode, 3-52
remote control menu, 3-52
reset button, 3-2
reset to factory defaults, 3-51
residual current, 4-37
rotate fault, 4-10
rs-232 serial, 3-48, 5-2
 baud rate, 5-2
 connector, 3-6
 specifications, 2-4
rtc time, 3-48

S

safety, 1-5, 3-8
save settings, 3-51, 4-34, 5-5, 7-12
selected fault box, 3-12
selection list, 3-15
sequence of events, 2-3, 4-17, 4-43, 7-10
 file storage/retrieval, 7-11
settings, save and restore, 4-34
setup menu, 3-47
slave mode, 3-52
slave mode menu, 8-1
software upgrade, 3-51, 9-1
specifications, 2-1
startup display, 3-7
state sequencing, 2-3, 4-3
static relay testing, 1-3
status data, 3-11
status inputs, 4-17
 active indication, 4-22
 contact type, 4-19
 custom name, 3-50
 custom names, 4-18
 debounce time, 4-19
 fault state control, 4-20
 input name, 4-18
 setup menu, 4-18
 specifications, 2-1

- terminals, 3-3
- threshold level, 4-19
- waveform capture, 4-17
- status messages, 10-1
- synchrocheck relay, 3-29
 - breaker advantage check, 3-35
 - phase angle limit check, 3-34
 - slip frequency check, 3-34
 - voltage limit check, 3-34
- wiring types, 3-30
 - delta, 3-32
 - delta-Y, 3-33
 - wye, 3-31
- system time constant, 4-33, 4-36

T

- technical support, 1-5
- three phase parameter box, 3-39, 4-10
- time and synchronization source, 3-48, 6-2
- time/gps information, 3-11
- timer (cycles), 4-35
- timer (seconds), 4-35
- timers, programmable, 4-22
 - specifications, 2-3
 - start event, 4-23
 - start when, 4-24
 - stop, 4-24
- timing mode, 3-16
- tone, 3-15, 4-20
- tone, keypress, 3-47
- transducers
 - dc current, 4-38
 - inputs, 3-6
 - measurement accuracy, 2-1

U

- unbalance, 4-37
- unblock, 4-26
- usb, 5-4
 - file transfers, 7-2
 - specifications, 2-5

V

- V/Hz, 4-38
- V4 powers relay, 4-34
- vector display, 3-11
 - background colors, 3-50
- vector labels, 4-40
- video connector, 3-6
- virtual channel, 3-50
- voltage output, increasing, 3-22
- voltage outputs, 3-3
- voltage unbalance, 4-39

W

- warning led, 3-4, 3-8
- warranties, 1-6
- waveform capture, 4-17, 4-45
- waveform playback, 1-4, 7-1
 - accessing data files, 7-3
 - channel scaling, 7-6
 - comtrade, 7-2
 - configuring data files, 7-5
 - configuring digital outputs, 7-8
 - downloading data, 7-1
 - initiating playback, 7-9
 - specifications, 2-4
 - viewing data files, 7-4

X

- x(ohms), 4-39

Z

- z(angle), 4-39
- z(ohms), 4-39
- z0(angle), 4-40
- z0(ohms), 4-39
- z0/z1, 4-40
- z0/z1(angle), 4-40
- z1(angle), 4-40
- z1(ohms), 4-40
- z2(angle), 4-40
- z2(ohms), 4-40
- zero sequence, 4-36, 4-38, 4-39