



PROFESSIONAL MEDICAL PRODUCTS

Gima S.p.A. - Via Marconi, 1 - 20060 Gessate (MI) Italy
Italia: tel. 199 400 401 - fax 199 400 403
Export: tel. +39 02 953854209/221/225 - fax +39 02 95380056
gima@gimaitaly.com - export@gimaitaly.com
www.gimaitaly.com

Name: Vital Signs Monitor

Model: PC-900

Type: Vital Signs-SNET Monitor

REF 35122

ATTENTION: The operators must carefully read and completely understand the present manual before using the product.



GIMA S.p.A.
Via Marconi, 1 20060, Gessate (MI) Italy
Made in P.R.C.





This Manual is written and compiled in accordance with the IEC 60601-1 (Medical electrical equipment Part1: General requirements for safety) and MDD 93/42/EEC. It complies with both international and enterprise standards and is also approved by State Technological Supervision Bureau. The Manual is written for the current VITAL Vital Signs Monitor.

The Manual describes, in accordance with the Vital Signs Monitor's features and requirements, main structure, functions, specifications, correct methods for transportation, installation, usage, operation, repair, maintenance and storage, etc. as well as the safety procedures to protect both the user and equipment. Refer to the respective chapters for details.

The Manual is published in English and we have the ultimate right to explain the Manual. No part of this manual may be photocopied, reproduced or translated into another language without the prior written consent. We reserve the right to improve and amend it any time without prior notice. Amendments will however be published in a new edition of this manual.

Marks in the Manual:

-  **Warning: must be followed to avoid endangering the operator and the patient.**
-  **Attention: must be followed to avoid causing damage to the monitor.**
-  **Note: some important information and tips about operations and application.**

Instructions to User

Dear Users,

Thank you very much for purchasing our product. Please read the following information very carefully before using this device.

Read these instructions carefully before using this monitor. These instructions describe the operating procedures to be followed strictly. Failure to follow these instructions can cause monitoring abnormality, equipment damage and personal injury. The manufacturer is NOT responsible for the safety, reliability and performance issues and any monitoring abnormality, personal injury and equipment damage due to user's negligence of the operation instructions. The manufacturer's warranty service does not cover such faults.

- ☛ **WARNING-PACEMAKER PATIENTS.** This monitor may continue to count the pacemaker rate during occurrences of cardiac arrest or some arrhythmias. Do not rely entirely upon this monitor ALARMS. Keep pacemaker patients under close surveillance.
- ☛ **Monitoring a single person at a time.**
- ☛ **The monitor is defibrillator proof.** Verify that the accessories can function safely and normally and the monitor is grounded properly before conducting defibrillation.
- ☛ **Disconnect the monitor and sensors before MRI scanning.** Use during MRI could cause burns or adversely affect the MRI image or the monitor's accuracy.
- ☛ **If you have any doubt to the grounding layout and its performance, you must use the built-in battery to power the monitor.**
- ☛ **All combinations of equipment must be in compliance with standard of IEC 60601-1-1 for medical electric system requirements.**
- ☛ **Check SpO₂ probe application site periodically (every 30 minutes) to determine circulation, positioning and skin sensitivity.**
- ☛ **The SpO₂ measurement of this monitor may not work for all testees. If stable readings can not be obtained at any time, discontinue use.**
- ☛ **Do not immerse the monitor or its accessories in liquid to clean.**
- ☛ **Do not use accessories other than those provided/recommended by the manufacturer.**
- ☛ **Each time the monitor is used, check the alarm limits to ensure that they are appropriate for the patient being monitored.**
- ☛ **The monitor is intended only as an adjunct in patient assessment. It must be used in conjunction with clinical signs and symptoms.**
- ☛ **When taking the measure of an infant or neonate's (less than 10 years old) blood pressure, do NOT operate in the adult mode. The high inflation pressure may cause lesion or even body putrescence.**
- ☛ **The monitor is prohibited from applying to those who have severe hemorrhagic tendency or who are with sickle cell disease for they may develop partial bleeding when this monitor is used to take**

the blood pressure measurement.

- **DO NOT** take blood pressure measurement from a limb receiving ongoing transfusion or intubations or skin lesion area, otherwise, damages may be caused to the limb.
- Continuous use of SpO₂ sensor may result in discomfort or pain, especially for those with microcirculatory problem. It is recommended that the sensor should **NOT** be applied to the same place for over two hours, change the measuring site periodically if necessary.
- SpO₂ measuring position must be examined more carefully for some special patient. Do **NOT** install the SpO₂ sensor on the finger with edema or vulnerable tissue.
- To prevent the risk of the short circuit and to ensure the ECG signal quality, the equipment must be properly grounded.
- Although biocompatibility tests have been performed on all the applied parts, some exceptional allergic patients may still have anaphylaxis. Do **NOT** apply to those who have anaphylaxis.
- All the connecting cables and rubber tubes of the applying parts should be kept away from the patient's cervix to prevent any possible suffocation of the patient.
- All the parts of the monitor should **NOT** be replaced at will. If necessary, please use the components provided by the manufacturer or those that are of the same model and standards as the accessories along with the monitor which are provided by the same factory, otherwise, negative effects concerning safety and biocompatibility etc. may be caused.
- **DO NOT** stare at the infrared light of SpO₂ sensor when switch it on, for the infrared may do harm to the eye.
- If the monitor falls off accidentally, please do **NOT** operate it before its safety and technical indexes have been tested minutely and positive testing results obtained.
- It is recommended to take the blood pressure measurement manually. The automatic or continuous mode should be used at the presence of a doctor/nurse.
- Please peruse the relative content about the clinical restrictions and contraindication.
- When disposing of the monitor and its accessories, the local law should be followed.

Table of Contents

CHAPTER 1 OVERVIEW	1
1.1 FEATURES.....	1
1.2 PRODUCT NAME AND MODEL.....	1
1.3 INTENDED USE	1
1.4 SAFETY.....	1
1.5 SYMBOLS ON THE MONITOR.....	2
CHAPTER 2 OPERATING PRINCIPLE.....	3
2.1 OVERALL STRUCTURE	3
2.2 CONFORMATION.....	3
CHAPTER 3 INSTALLATION AND CONNECTION.....	4
3.1 APPEARANCE.....	4
3.1.1 Front Panel.....	4
3.1.2 Side Panel	6
3.1.3 Rear Panel.....	7
3.2 INSTALLATION.....	8
3.2.1 Opening the Package and Check	8
3.2.2 Connecting the Power Supply	8
3.2.3 Starting the Monitor.....	8
3.3 SENSOR PLACEMENT AND CONNECTION.....	9
3.3.1 ECG Cable Connection.....	9
3.3.2 Blood Pressure Cuff Connection	11
3.3.3 SpO ₂ Sensor Connection.....	14
3.3.4 TEMP Transducer Connection	16
3.3.5 Loading printing paper	16
3.3.6 Battery Installation.....	18
CHAPTER 4 OPERATIONS	19
4.1 INITIAL MONITORING SCREEN	19
4.1.1 Default Display Screen Description	19
4.1.2 Operation Instructions	20
4.2 ECG MONITORING SCREEN.....	22
4.2.1 Display Screen Description	22
4.2.2 Operation Instructions	22
4.3 TREND GRAPH DISPLAY	23
4.3.1 Screen Description.....	23

4.3.2 Operation Instructions	23
4.4 NIBP LIST SCREEN	24
4.4.1 Operation Instructions	24
4.5 SpO ₂ LIST SCREEN	25
4.5.1 Operation Instructions	25
4.6 ECG RECALL SCREEN	25
4.6.1 Operation Instructions	26
4.7 SETUP MENU SCREEN	26
4.7.1 ECG and Temperature Setup	27
4.7.2 SpO ₂ Setup	28
4.7.3 NIBP Setup	29
4.7.4 Nurse Call	32
4.7.5 System Setup	32
4.7.6 Patient Info	33
4.7.7 Date/Time	34
4.7.8 Recover Default Settings	34
4.8 POWER SAVING MODE	34
CHAPTER 5 ALARM	35
5.1 ALARM PRIORITY	35
5.2 ALARM MODES	35
5.3 ALARM SILENCE	36
5.4 ALARM SETTING	36
5.5 VERIFY ADJUSTABLE ALARM FUNCTION	36
CHAPTER 6 TECHNICAL SPECIFICATIONS	37
6.1 ECG MONITORING	37
6.2 TEMP MONITORING	38
6.3 NIBP MONITORING	38
6.4 SpO ₂ MONITORING	39
6.5 PULSE RATE MONITORING	39
6.6 DATA RECORDING	39
6.7 OTHER TECHNICAL SPECIFICATIONS	39
6.8 OPERATING ENVIRONMENT	39
6.9 CLASSIFICATION	40
6.10 GUIDANCE AND MANUFACTURER'S DECLARATION-ELECTROMAGNETIC COMPATIBILITY	41

CHAPTER 7 PACKAGING AND ACCESSORIES	45
7.1 PACKAGING	45
7.2 ACCESSORIES	45
CHAPTER 8 MONITORING PARAMETER	46
8.1 ECG MONITORING	46
8.1.1 How to Obtain High Quality ECG and Accurate Heart Rate Value.....	46
8.1.2 Factors affecting ECG signal.....	47
8.2 NIBP MONITORING	47
8.2.1 Measuring Principle.....	47
8.2.2 Factors affecting NIBP measuring.....	48
8.2.3 Clinical Limitations	49
8.3 SpO ₂ MONITORING	49
8.3.1 Measuring Principle.....	49
8.3.2 SpO ₂ Measurement Restrictions (interference reason).....	50
8.3.3 Low SpO ₂ measuring value caused by pathology reason.....	50
8.3.4 Clinical Limitations	50
8.3.5 Points to be noted in SpO ₂ and Pulse Measuring	51
8.4 TEMPERATURE MONITORING.....	51
CHAPTER 9 TROUBLESHOOTING	52
9.1 NO DISPLAY ON THE SCREEN	52
9.2 EXCESSIVE ECG SIGNAL INTERFERENCE OR TOO THICK BASELINE.....	52
9.3 NO BLOOD PRESSURE AND PULSE OXYGEN MEASURES	52
9.4 BLANK PRINTING PAPER	52
9.5 SYSTEM ALARM	52
CHAPTER 10 MAINTENANCE	53
10.1 SERVICE AND EXAMINATION	53
10.1.1 Daily Examination.....	53
10.1.2 Routine Maintenance	53
10.1.3 Battery Maintenance.....	53
10.1.4 Service	54
10.2 CLEANING, STERILIZATION AND DISINFECTION.....	54
10.3 CLEANING, STERILIZATION AND DISINFECTION OF ACCESSORIES	55
10.4 STORAGE	55
10.5 TRANSPORTATION	55

CHAPTER 11 APPENDIX.....	56
11.1 PROMPT INFORMATION EXPLANATIONS	56
11.2 DEFAULT ALARMING VALUES AND SETUP RANGE	57
11.3 ABBREVIATION OF ARRHYTHMIA.....	58
11.4 ACCESSORIES LIST	59
11.5 INSTRUCTIONS FOR SpO ₂ PROBE.....	60

Chapter 1 Overview

1.1 Features

- ✧ Blood Pressure, SpO₂ and Pulse Rate are displayed by big, bright digital LEDs;
- ✧ ECG waveform, SpO₂ plethysmogram and system parameters are displayed on color LCD;
- ✧ Accurate NIBP measurement with hardware and software over-pressure protection;
- ✧ Unique SpO₂ measuring technique ensures sensitive and accurate SpO₂, Pulse Rate and Perfusion Index measurement;
- ✧ HR and SpO₂ trend curve display for last 12, 24 or 96 hours;
- ✧ 12000 groups of NIBP measurements (nonvolatile) can be stored and reviewed by list;
- ✧ Up to 120-hour ECG waveform can be stored and recalled;
- ✧ Audible & visible alarm with 3 levels of alarm events;
- ✧ Nurse call output is available;
- ✧ With tourniquet function;
- ✧ NIBP measurement is applicable to adult, pediatric and neonate by patient selection;
- ✧ Built-in printer is optional to print out waveforms, and text information.

1.2 Product Name and Model

Name: VITAL Vital Signs Monitor

Model: Vital

1.3 Intended Use





















This Monitor is a multi-functional instrument designed for monitoring the vital physiological signs of adult and pediatric patients. With the functions of real-time recording and displaying parameters, such as ECG, heart rate, non-invasive blood pressure, functional oxygen saturation, body temperature, and so on, it allows comprehensive analysis of patient's physiological conditions.

This instrument is applicable for use in hospitals and clinical institutions. The operation should be performed by qualified professionals only.

1.4 Safety

- a) This device conforms to IEC60601-1, electric safety classification: Class I, with Type BF and CF applied parts.
- b) This device can resist against the discharge of defibrillator and the interference of electro-surgical unit.
- c) This device can monitor the patients with pace-maker.
- d) DO NOT use this device while the patient is under MRI scanning.

1.5 Symbols on the Monitor

	Adult Patient		Waveform Freeze
	Pediatric Patient		Pulse sync indicator
	Neonatal Patient		Setup Menu
	NIBP Start/Cancel		AC Power
	Alarm Silence		DC Power
	Print		Type BF applied part
	Up		Type CF applied part with defibrillator protection
	OK		Warning, refer to User Manual.
	Down		Equal potential terminal
	ECG Lead Selection		Nurse call output

Chapter 2 Operating Principle

2.1 Overall Structure

The overall structure of the monitor is shown in Fig. 2.1.

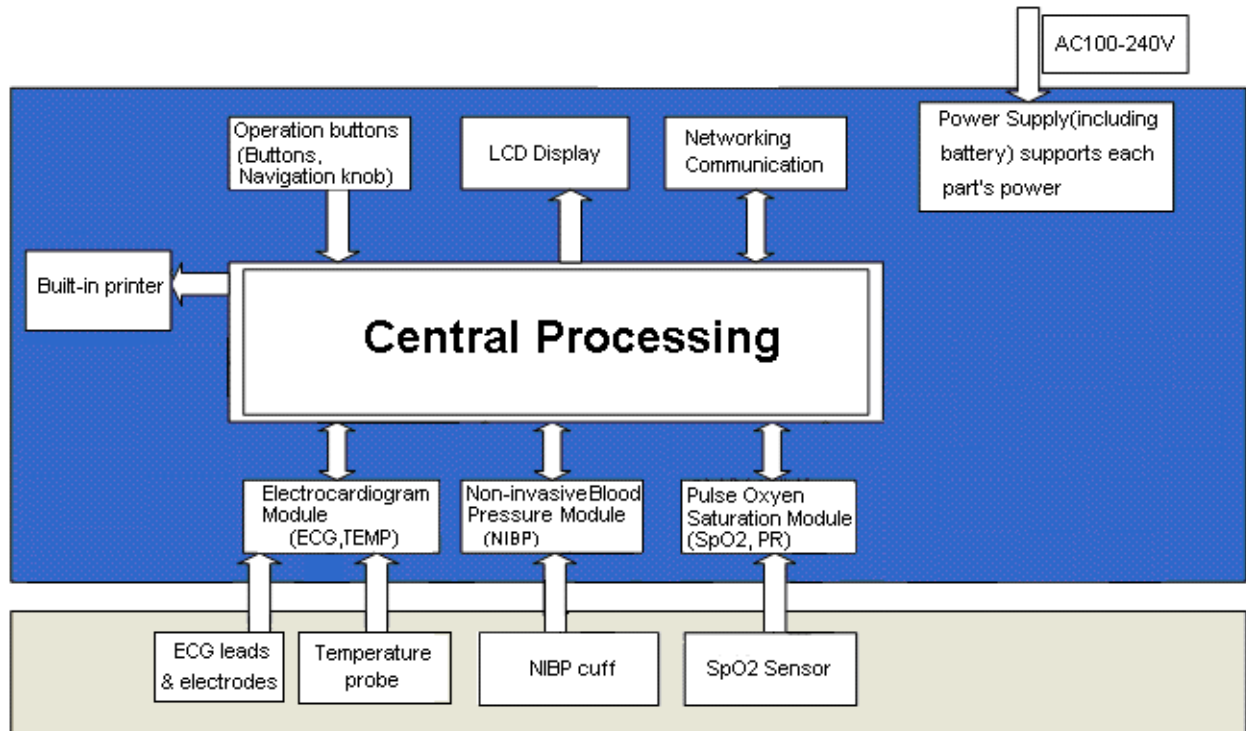

Figure 2.1

2.2 Conformation

VITAL Vital Signs Monitor is module designed product; it consists of ECG/TEMP module (optional), NIBP module (optional), SpO₂ module (optional), main control unit, printer module (optional), display panel, and power supply block etc. and the related accessories for ECG, NIBP, SpO₂ and Temperature measurement.

☞ According to different needs, you can customize the module configuration by choosing necessary modules. Therefore, your monitor may not have all the monitoring functions and accessories.

1. ECG/TEMP module measures ECG signal and detects heart rate with ECG lead wires and electrodes, it also measures temperature with temperature probe.
2. The SpO₂ module detects and calculates pulse rate and oxygen saturation (SpO₂), and provides plethysmogram and perfusion index as well.
3. The NIBP module performs the measurement of blood pressure by non-invasive way of oscillometric technology, including the diastolic, systolic and mean arterial pressure. The cuffs are designed for adult, pediatric and neonate respectively.
4. The main control unit is in charge of LED and LCD display, keyboard input, data storage, printing and networking function.

Chapter 3 Installation and Connection

3.1 Appearance

3.1.1 Front Panel

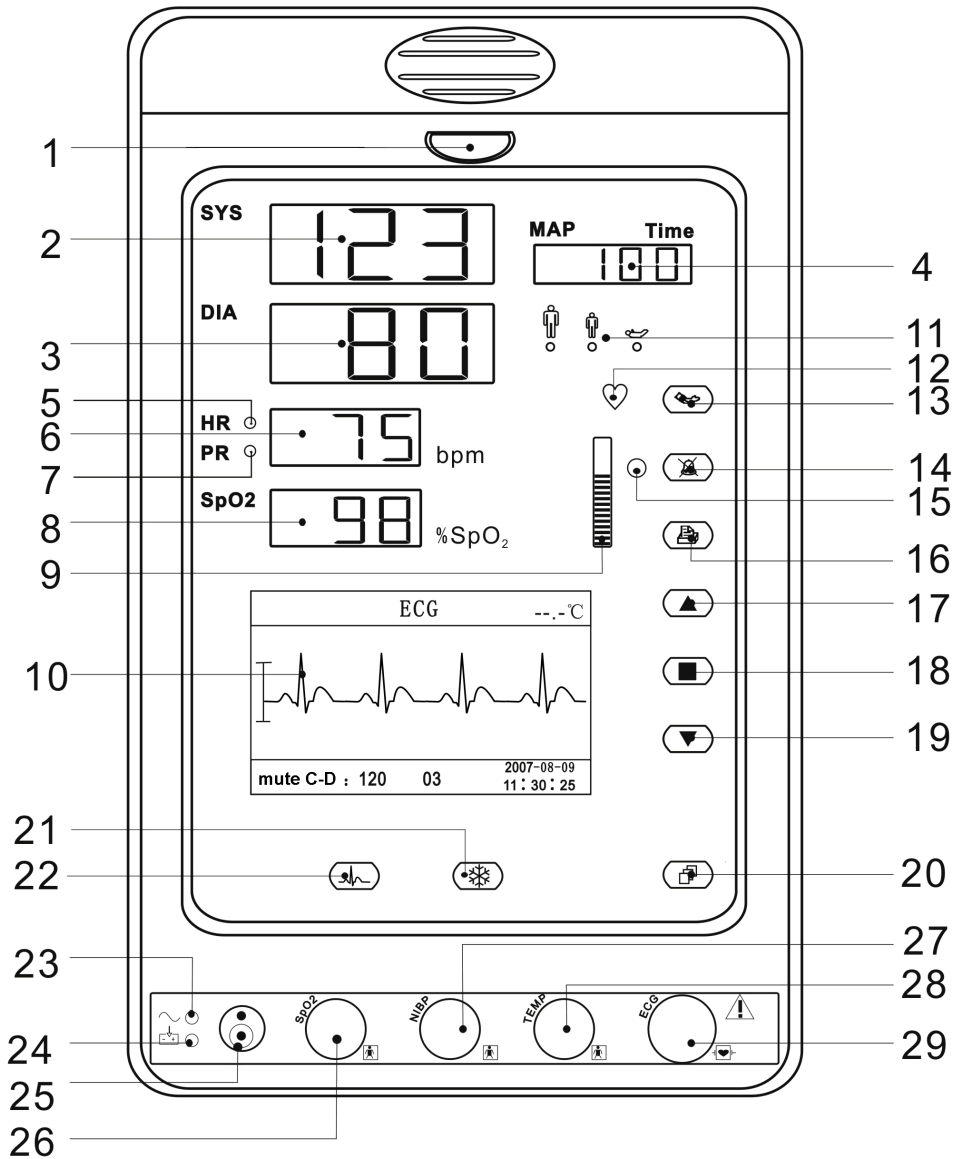

Figure 3.1 Front panel illustration

Description:

1 Alarm indicator

Indicator	Alarm Level	Alarm Event
Red flashing	High priority alarm	Exceeding the limits, low battery voltage
Orange flashing	Medium priority alarm	Leads or probe off
Green light	Normal	

- 2 **SYS:** display systolic pressure value.
- 3 **DIA:** display diastolic pressure value.
- 4 **MAP:** When NIBP measurement mode is set to “manual” and “STAT”: Display mean arterial pressure or measuring time of the latest group of NIBP measurement; they will be displayed alternately. The format of NIBP measuring time is “hh:mm”. If the tourniquet is in use, the cuff pressure will be displayed here; When NIBP measurement mode is set to “AUTO”: Display real-time pressure value during measurement. Countdown time will be displayed in the MAP when the measurement finishes. Countdown time has two formats (>1 hour HH: mm; <1 hour mm: ss).

Note: two formats to display NIBP value: “×××mmHg” and “××.×kPa”. Refer to section “4.4.2 NIBP Setup” to set the unit of NIBP value; the conversion relation between “mmHg” and “kPa”: 1mmHg=0.133kPa.



- 5 **HR(priority indicator):** if HR indicator is on, it indicates that the numerical value beside is HR measuring value;
- 6 **Display HR or PR value:** when the set of “Setup Menu→ System→priority” is “HR”, it shows HR value here preferentially; if the set is “PR”, PR value will be shown preferentially.
- 7 **PR(priority indicator):** if PR indicator is on, it indicates that the numerical value beside is pulse rate value; Unit: “bpm (beats per minute)”.

If SpO₂ and NIBP are monitoring at the same time, only the PR value measured through SpO₂ probe is displayed here and the PR measuring by NIBP measurement is undergoing and recorded in NIBP list.

- 8 **SpO₂:** Display SpO₂ value; Unit: “%”.

- 9 : Bar-graph of pulse intensity.

10 **LCD panel**

- 11 **Pulse sync indicator patient category indicator:**  for adult;  for pediatric;  for neonate; Patient category is selected under sub-menu “Patient Info” within the setup menu.

- 12 **Pulse sync indicator:** Cardio-pulse/pulse sync indicator. When HR priority indicator is on, its flashing is synchronized with heart beat; When PR priority indicator is on, its flashing is synchronized with pulse.

- 13  **NIBP:** start/cancel NIBP measurement.

- 14  **Alarm silence key:** Enable/disable alarm silence function. When the alarm silence indicator on the left of keys is on, it means the system is in alarm silence status and it lasts this status for 2 minutes. When finishing counting down, the system will resume normal alarm status automatically, if alarm event occurs at this time the alarm sound will be effective again.

 **DO NOT silence the audible alarm or decrease its volume if patient safety could be compromised.**

15 **Alarm silence indicator:** When it is on, it indicates that the monitor stays in alarm silence status.

16  **Print:** the internal printer is optional, press this key to print the current measuring data;

17 ▲ Up: shift cursor forward/upward

18 □ OK: to confirm selection or modification

19 ▼ Down: shift cursor backward/downward

20  **Display:** short time pressing to shift LCD display modes; longtime pressing to enter into Setup Menu display screen.

21  **Waveform Freeze:** freeze the current displayed waveform.

22  **ECG Lead Selection:** select ECG leads among I, II, III, aVR, aVL, aVF and V.

23 ~: AC Power indicator

24 : DC Power indicator

	AC Power indicator	DC Power indicator	Descriptions
Status	ON (green)	ON (green)	this device is using mains power supply
	ON (green)	ON (orange)	this device is using mains power supply and the battery is being recharged.
	OFF	ON (green)	the battery is being used
	OFF	ON (orange, blinking)	the battery is being used, but battery voltage is low, the beeper also gives warning.
	ON (green)	OFF	the battery is being recharged while the device is off

25 : Power button: Press power button for 3 seconds to start the monitor or shut off the monitor.

Note: Short time pressing power button for entering the Power Saving Mode screen, then according to your need to make the device stay in the power saving mode or exit from power saving mode (this function is optional and needs hardware support).

26 **SpO₂:** SpO₂ sensor connector

27 **NIBP:** NIBP hose connector

28 **TEMP:** TEMP probe connector

29 **ECG:** ECG cable connector

3.1.2 Side Panel

The built-in thermal printer is in the left panel. It is easy for user to print waveform and data.

3.1.3 Rear Panel

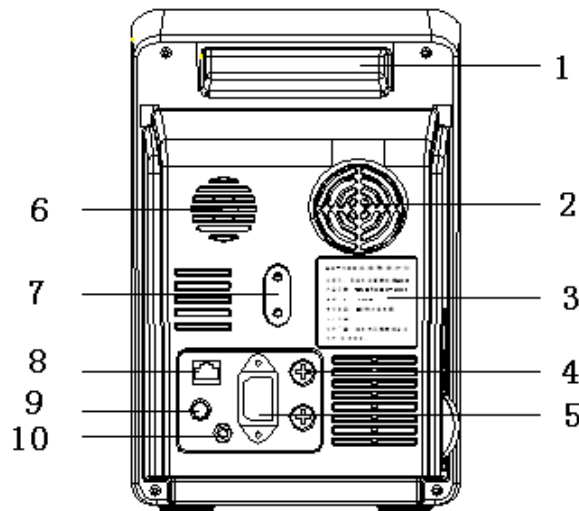









Figure 3.2 Rear Panel

Introduction to the rear panel:

- 1 **Handle**
- 2 **Fan**
- 3 **Nameplate**

	CE mark
	Serial number
	Date of manufacture
	Authorised representative in the European community
	Manufacturer (including address and date)
	Disposal of this device according to WEEE regulations

- 4 **“FUSE T3.15 A”**: Fuse holder. Fuse specification: T3.15AL/250V $\Phi 5 \times 20$ mm.
- 5 **“AC100~240V”** : AC power supply socket
- 6 **Loudspeaker**
- 7 **Mounting hole for hanging the monitor**
- 8 **NET**: serial communication port which is used to network with central monitoring system (optional);
- 9 **Nurse-call connector**
- 10 : Equipotential ground terminal

3.2 Installation

3.2.1 Opening the Package and Check

1. Open the package, take out the monitor accessories from the box carefully and place it in a safe stable and easy to watch position.
2. Open the accompanying document to sort the accessories according to the packing list.
 - ◆ Inspect the monitor for any mechanical damages
 - ◆ Check all the accessories for any scratch or deformity, especially on connector, wire and probe parts

 You can customize the module configuration by choosing necessary modules to meet your own needs. Therefore, your monitor may not have all the monitoring functions and accessories.

If in doubt, please contact the local dealer or our company in case of any problems. We are to offer you the best solution for your satisfaction.

3.2.2 Connecting the Power Supply

1. When powered by AC mains power supply:

- ◆ Make sure that the AC power supply is 100-240VAC, 50/60Hz.
- ◆ Use the power cable prepared by the manufacturer. Insert one end of it to the power port of the monitor and the other end to the grounded three-phase power jack.
- ◆ To eliminate potential differences, the monitor has a separate connection to the equipotential grounding system. Connect one end of the provided ground cable to equipotential grounding port on the rear of the monitor, and connect the other end to one point of the equipotential grounding system.

Caution: ensure that the monitor is grounded correctly.

-  After the supply mains has been interrupted when power switch remains in the “on” position and is restored after a period of time that is longer than 30 seconds, the monitor will run by the last settings when restarting the monitor.

2. When powered by built-in battery

- ◆ Caution: it's better to recharge the battery after it is used up, the charging time should be 13~15 hours long.
- ◆ The provided battery of the monitor must be recharged after transportation or storage. So if the monitor is switch on without being connected to the AC power socket, it may not work properly due to insufficient power supply.

3.2.3 Starting the Monitor

The system performs self-test and enters initial display after switching on the monitor, and the orange alarm indicator blinks to inform that the user can begin operating it.

- ◆ Check all the applicable functions to make sure that the monitor works normally.
- ◆ If the battery is applied please recharge it after using the monitor to ensure sufficient power storage. It will take minimal 8 hours to charge battery from depletion to 90% charge.

- 🔔 Do not use the device to monitor the patient if there are indications of damage or reminders of error. Please contact the local dealer or our company.
- 🔔 It's recommended to delay 1 minute to start it again.

3.3 Sensor Placement and Connection

3.3.1 ECG Cable Connection

ECG measurement is to collect the ECG signal via the ECG electrodes. Electrode connects the patient and the lead. The lead connects the monitor. The locations of the electrodes are very important for obtaining accurate ECG signals.

1. Connect the cable to the right-panel connector marked with the ECG icon.
2. Select electrodes to be used. Use only one type of electrode on the same patient to avoid variations in electrical resistance. For ECG monitoring, it is strongly recommended to use silver/silver chloride electrodes. When dissimilar metals are used for different electrodes, the electrodes may be subject to large offset potentials due to polarization. Using dissimilar metals may also increase recovery time after defibrillation.
3. Prepare the electrode sites according to the electrode manufacturer's instructions.
4. Skin clean
 - Clean and dry-abrade skin to ensure low sensor impedance. Mild soap and Water is recommended as a skin cleanser.

Note: Alcohol is not recommended as a skin cleanser; it leaves a film layer that may cause high sensor impedance. If alcohol is used, ensure 30-second dry time.

- Dry-abrading the skin gently with a dry wash cloth, gauze, or skin preparation product is helpful to remove the non-conductive skin layer.



The symbol indicates that the cable accessories are designed to have special protection against electric shocks, and is defibrillator proof.

The locations of the electrode are in the following Figure:

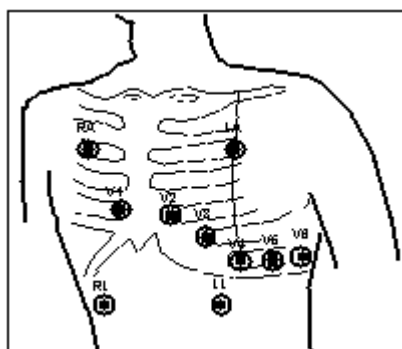

Figure 3.3 Electrode Location

Note: If skin rash or other unusual symptoms develop, remove electrodes from patient.

5. After starting the monitor, if the electrodes become loose or disconnected during monitoring, the system will display “LEAD OFF” on the screen to alarm the operator.

🔔 **It might not display ECG wave with 3 leads. The 5 leads should be used to have ECG wave.**

6 The ECG leads and their corresponding locations are as follows:

Symbol		Position
RA		The intersection between the centerline of the right clavicle and Rib 2
LA		The intersection between the centerline of the left clavicle and Rib 2
LL		Left part of the upper abdomen
RL		Right part of the upper abdomen
C (V) Chest electrode	C1(V1)	The electrodes are placed in different places, the different lead forms will display.
	C2(V2)	
	C3 (V3)	
	C4 (V4)	
	C5 (V5)	
	C6 (V6)	

Table 3-1

Safety Instructions for ECG Monitoring

- ☛ Use the same type electrode on a patient. If skin rash or other unusual symptom occurs, remove electrodes from patient. Do not attach electrodes on the patient with an inflammation of the skin or scores on skin.
- 🔔 VITAL Vital Signs Monitor can only be equipped with ECG leads provided by our company; using ECG leads supplied by other companies may cause improper performance or poor protection while using defibrillator.
- 🔔 Electric parts of electrodes, leads and cable are forbidden to contact any other conductive parts (including ground).
- 🔔 VITAL Vital Signs Monitor can resist against defibrillator and electrosurgical unit. Readings may be inaccurate for a short time after or during using defibrillator or electrosurgical unit.
- 🔔 Transient caused by cable circuitry blocks while monitoring may be similar to the real heartbeat waveform, as a result resistance heart rate alarm rings. If you put the electrodes and cable in proper places according to this manual's instructions and the instructions for using electrode, the chance of this transient occurring will be decreased.
- ☛ Besides the improper connection with electrosurgical unit may cause burns, the monitor may be damaged or arouse deviations of measurement. You can take some steps to avoid this situation, such as do NOT use small ECG electrodes, choosing the position which is far away from the estimated Hertzian waves route, using larger electrosurgical return electrodes and connecting with the patient properly.
- 🔔 ECG leads may be damaged while using defibrillator. If the leads are used again, please do the functional check first.

- 🔔 When removing the ECG cable, hold the head of the connector and pull it out.
- 🔔 When the monitor is inoperable due to an overload or saturation of any part of the amplifier, it will prompt “Lead off” to remind operator.
- 👉 No predictable hazard will be caused by the summation of leakage currents when several item of monitor are interconnected.

3.3.2 Blood Pressure Cuff Connection

1. Connect the cable to the right-panel connector marked with the NIBP icon.
2. Unveil and wrap the cuff around patient’s upper arm.

Requirements of the cuff:

- 1) Appropriate cuff should be selected according to the age of the subject. Its width should be 2/3 of the length of the upper arm. The cuff inflation part should be long enough to permit wrapping 50-80% of the limb concerned. See the table below for the dimensions:

Note: The size of the cuff selected should suit the subjects while measuring.

Cuff Model	Arm Circumference	Cuff Width
Small-sized Pediatric Cuff	6cm~ 11cm	4.5cm
Middle-sized Pediatric Cuff	10cm~ 19cm	8cm
Large-sized Pediatric Cuff	18cm~ 26cm	10.6cm
Adult Cuff	25cm~ 35cm	14cm

Table 3-2

- 🔔 When putting on the cuff, unveil and wrap it around the upper arm evenly to appropriate tightness.
- 2) Remember to empty the residual air in the cuff before the measurement is commenced.
 - 3) Locate the cuff in such a way that the “φ” mark is at a location where the clearest pulsation of brachial artery is observed.
 - 4) The cuff should be tightened to a degree where insertion of one finger is allowed.
 - 5) The lower end of the cuff should be 2cm above the elbow joint.

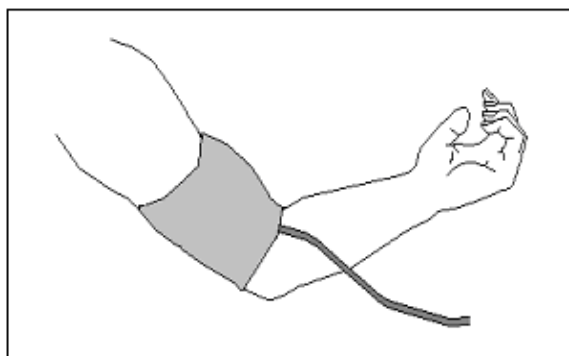

Figure 3.4 Cuff Placement

➤ **Pressure Accuracy Verification**

Pressure Accuracy Verification is a function to inspect the accuracy of pressure measurement by the NIBP module inside the device. Technician or equipment manager should do pressure accuracy verification every half year or year in order to check if the pressure measurement still conforms to the requirement of product performance. If the deviation is beyond the declared specification, it is permitted to return it to factory for repair or calibration.

Before verification, please connect the monitor to a standard pressure meter as the reference equipment like a mercury pressure meter

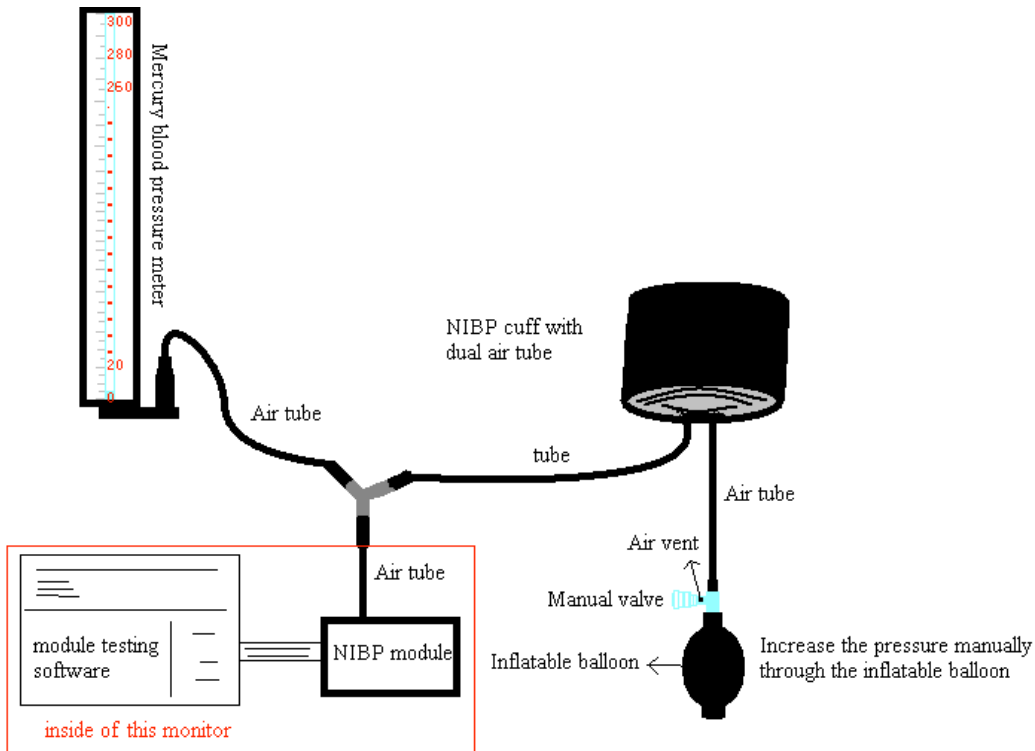

Figure 3.5 Connection of Pressure calibration fixture

Mode 1: The inflation can be activated by Monitor so the pressure will increase automatically until it exceeds the limit value specified in table A. This pressure limit value depends on the patient type selection as shown in table A:

Adult	240mmHg
Child	200mmHg
Neonate	120mmHg

Table A

During the inflation, the Monitor will close the deflating valve, and the pressure value will be shown during the process. If there is no manual deflation operation, the pressure will persist until deflation by manual operation, so it is necessary to use a manual valve for doing adequate deflation in several steps to verify the pressure accuracy in the full scale of measurement range.

Mode 2: No automatic inflation by Monitor during the pressure accuracy verification.

Increase the pressure manually by the pumping balloon, and the verification can be done by applying different pressure value manually. If the increased pressure exceeds the given limit as shown in table B, the Monitor will deflate automatically because of over-pressure protection.

Adult	300mmHg
Child	240mmHg
Neonate	140mmHg

Table B

- 🔔 **After the verification, do press the button again to return to normal working mode, then continue other operation, or the NIBP key will be invalid.**
- 🔔 **Pressure accuracy verification must be operated by technician or equipment manager. Doctor or nurse is not allowed to do the verification, it is very dangerous especially when the pressure cuff is still on patients.**

➤ **Air Leakage Check**

In order to avoid significant error of blood pressure measurement or even no measurement result caused by air leakage in the pneumatic system including the cuff during measuring, it is recommended to check if there is leak in the pneumatic system as well.

- 🔔 **Please remove the cuff from patient while performing the leakage check.**

Safety Instructions for NIBP Monitoring

- 🔔 When taking the measurement of a pediatric or an infant or neonate's (less than 10 years old) blood pressure, do NOT operate in the adult mode. The high inflation pressure may cause lesion or even body putrescence.
- 🔔 It is recommended to take the blood pressure measurement manually. Automatic measurement should be used at the presence of a doctor/nurse.
- 🔔 NIBP monitoring is prohibited to those who have severe hemorrhagic tendency or with sickle cell disease, or partial bleeding will appear.
- 🔔 Pay attention to the color and sensitivity of the limb when measuring NIBP; make sure the blood circulation is not blocked. If blocked, the limb will discolor, please stop measuring or remove the cuff to other positions. Doctor should examine this timely.
- 🔔 Confirm your patient category (adult, pediatric or neonate) before measurement.
- 🔔 Do NOT bind NIBP cuff on limbs with transfusion tube or intubations or skin lesion area, otherwise, damages may be caused to the limbs.
- 🔔 If the time of the automatic pattern noninvasive blood pressure measurement is too long, the body connected with the cuff will possibly occur the purpura, lack the blood and the neuralgia. In order to protect patient, it is requested to inspect the luster, the warmth and the sensitivity of the body far-end frequently. Once observes any abnormality, please immediately stop the blood pressure measurement.
- 🔔 The patient should lie on the back so that the cuff and the heart are in a horizontal position and the most accurate measure is taken. Other postures may lead to inaccurate measurement.
- 🔔 Do not speak or move before or during the measurement. Ensure that the cuff will not be hit or touched by other objects.

- The measures should be taken at appropriate intervals. Continuous measurement at too short intervals may lead to pressed arm, reduced blood flow and lower blood pressure, and resulting inaccurate measure of blood pressure. It is recommended to take measurement at intervals of more than two minutes.
- When an adult is monitored, the machine may fail in giving the blood pressure measure if the infant mode is selected.
- Prior to use of the cuff, empty the cuff until there is no residual air inside it to ensure accurate measurement.
- Do NOT twist the cuff tube or put heavy things on it.
- When unplugging the cuff, hold the head of the connector and pull it out.



The symbol indicates that the cable and accessories are designed to have special protection against electric shocks, and is defibrillator proof.

3.3.3 SpO₂ Sensor Connection

SpO₂ sensor is a very delicate part. Please follow the steps and procedures in operating it. Failure to operate it correctly can cause damage to the SpO₂ sensor.

Operation procedure:

1. Connect the SpO₂ sensor to the connector labeled “SpO₂”. **When unplugging the probe, be sure to hold the head of the connector and pull it out.**
2. If the finger clip SpO₂ sensor is used, insert one finger into the sensor (index finger, middle finger or ring finger with short nail length) as shown in the figure below.

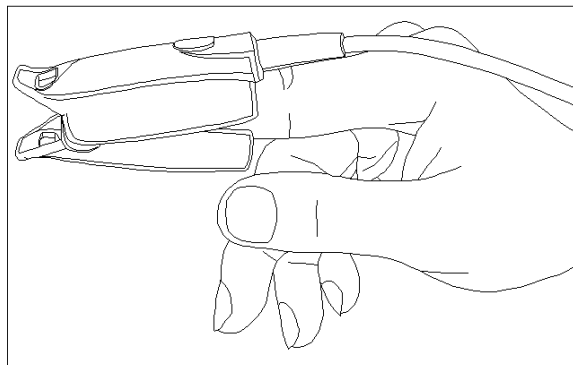

Figure 3.6 Finger clip SpO₂ sensor placement

When selecting a sensor, consider the patient’s category, adequacy of perfusion, availability of probe site and anticipated monitoring duration. Use only SpO₂ probes provided by our company with this monitor. Read the following table for SpO₂ probe information. Refer to Chapter 11.5 for the detailed instructions of each SpO₂ probe.

SpO ₂ Probe	Patient Category
SpO ₂ Finger clip Sensor (reusable)	Pediatric
SpO ₂ Finger rubber Sensor(reusable)	Adult
SpO ₂ Finger clip Sensor(reusable)	Adult

3. If the neonate SpO₂ sensor is used, please follow Figure 3.7 to connect.

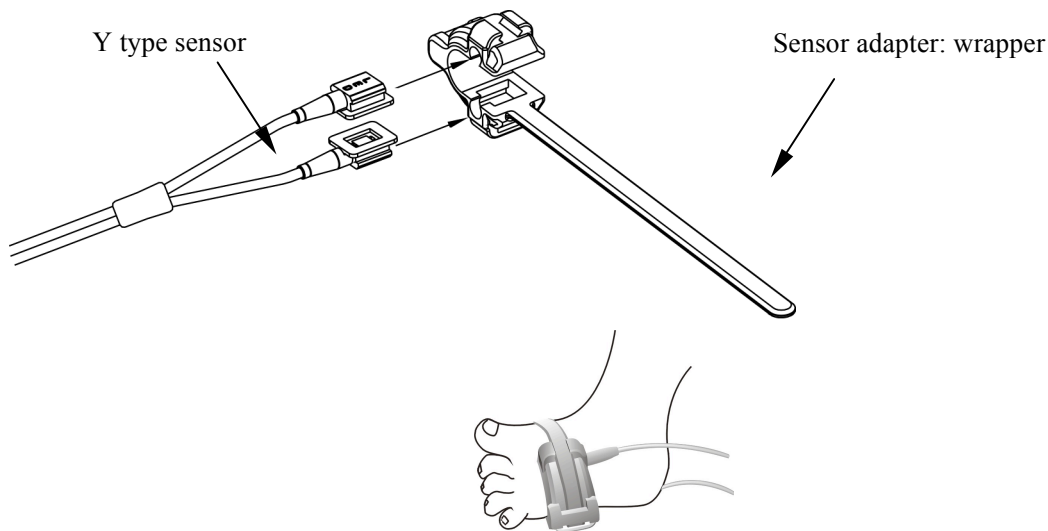

Figure 3.7 Neonate SpO₂ sensor placement

High ambient light sources such as surgical lights (especially those with a xenon light source), bilirubin lamps, fluorescent lights, infrared heating lamps, and direct sunlight can interfere with the performance of an SpO₂ sensor. To prevent interference from ambient light, ensure that the sensor is properly applied, and cover the sensor site with opaque material.

Failure to take this action in high ambient light conditions may result in inaccurate measurements.

If patient movement presents a problem, verify that the sensor is properly and securely applied; move the sensor to a less active site; use an adhesive sensor that tolerates some patient motion; or use a new sensor with fresh adhesive backing.

For reusable sensors, follow the sensor directions for use for cleaning and reuse. For single-patient use sensors, use a new sensor for each patient. Do not sterilize any sensor by irradiation, steam, or ethylene oxide.

Safety Introductions for SpO₂ Monitoring

- Continuous use of SpO₂ sensor may result in discomfort or pain, especially for those with microcirculatory problem. It is recommended that the sensor should NOT be applied to the same place for over two hours, change the measuring site periodically if necessary.
- SpO₂ measuring position must be examined more carefully for some special patient. Do NOT place the SpO₂ sensor on the finger with edema or fragile tissue.
- 🔔 If sterile packaging of SpO₂ sensor is damaged, do not use it any more.
- 🔔 Check the SpO₂ sensor and cable before use. Do NOT use the damaged SpO₂ sensor.
- 🔔 When the temperature of SpO₂ sensor is abnormal, do not use it any more.
- Please do not allow the cable to be twisted or bended.
- Do NOT put the SpO₂ sensor and pressure cuff on the same limb, otherwise the NIBP measuring will affect SpO₂ measuring and cause the alarm error.
- Using nail polisher or other cosmetic product on the nail may affect the accuracy of measurement.
- The fingernail should be of normal length.
- The SpO₂ sensor can not be immersed into water, liquor or cleanser completely, because the sensor has no capability to resist the harmful ingress of water

3.3.4 TEMP Transducer Connection

Connecting methods:

1. Attach the transducers to the patient firmly;
2. Connect the cable to TEMP probe connector in the front panel.

Note: When unplugging the probe, be sure to hold the head of the connector and pull it out.

3.3.5 Loading printing paper

Operation procedures for loading printing paper:

1. Press both “OPEN” notches with force on printer shield with two thumbs to open it.
2. Move the tab of rubber roller lock at the left 90° upwards to unlock it, refer to the following figure with mark ①.
3. Cut one end of the paper into triangle, and load the paper from the underside of the rubber roller.
4. Turn the roller clockwise to get the paper rolled, and put the paper roll into the compartment.
5. Pull the paper out of paper slot on the shield.
6. Move the tab of the rubber roller lock 90° downwards to lock it.
7. Put the shield back in position and secure it.

Operation procedures for taking out printing paper roll:

- 1~2 steps are the same with the 1~2 steps mentioned above for loading printing paper.
3. Roll the loading roller anti-clockwise and pull the paper out.
- 4~5 steps are the same with the 6~7 steps mentioned above for loading printing paper.

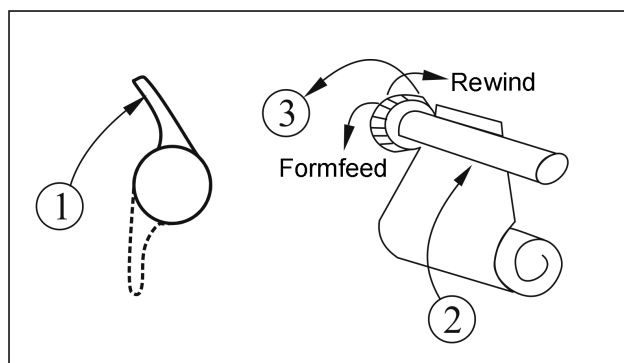

Figure 3.8 Loading and taking out printing paper

P8 printer may be used due to the different configuration.

P8 printer operation instruction:

Power indicator: green light shows the power is on, while the monitor is out of power, the green light is off.

Error indicator: red light is constant which shows the printer is out of paper, or the printing paper does not install well. When the printer installs normally, the red light is off.



Figure 3.9 P8 printer

Loading printing paper:

Step 1: press and hold down the cartridge button to open the paper cartridge;

Step 2: Install the paper to the printer properly, pull the paper out of the printer for 2 cm, as shown in figure 3.10.

Step 3: Close the printer cover along the direction of arrow, as shown in figure 3.10.



Figure 3.10 printing paper

3.3.6 Battery Installation

1. Ensure that the monitor is not connected to AC power supply and the monitor is turned off.
2. Open the battery cover and place the battery in the direction as shown in Fig. 3.11 to insert the battery into any one of battery compartments. Do not insert battery with their polarities reversed.
3. Move the battery baffle to secure battery.
4. Close the battery cover.

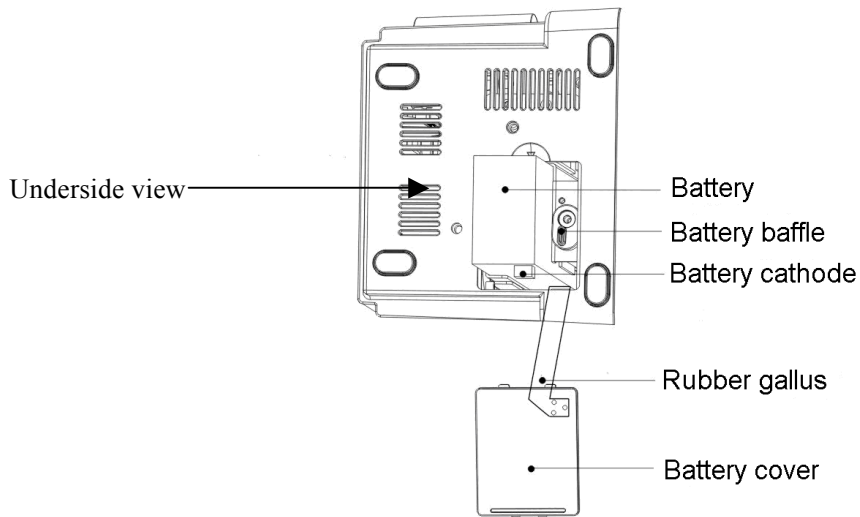

Figure 3.11 Battery Installation

Note:

- **Do not insert battery terminal with its polarities reversed, or the monitor can not be started.**
- **Please take out the battery before transport or storage.**

Chapter 4 Operations

4.1 Initial Monitoring Screen

When the parameter configuration of monitor is “ECG+SpO₂+NIBP”, once powered up, the LCD will display the initial monitoring screen, this is the default display screen as well.

When the parameter configuration of monitor is “SpO₂+NIBP”, the screen will not display ECG waveform and data, but the operation is similar.

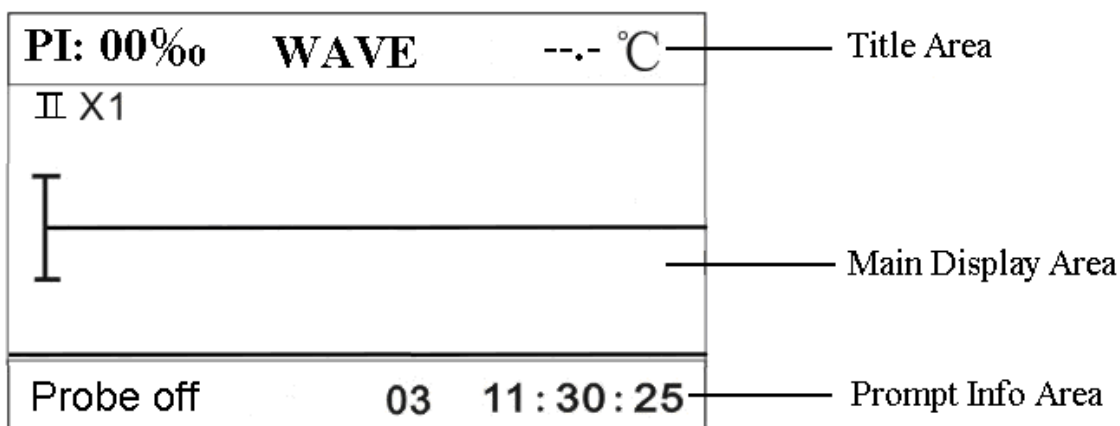

Figure 4.1 ECG & SpO₂ monitoring screen (Lead off & Probe off)

Insert the ECG cable and SpO₂ probe cable into the socket labeled “ECG” and “SpO₂”, then attach the ECG leads to the electrodes placed on human body, clip the SpO₂ probe on patient’s finger. The LCD will display ECG waveform and plethysmogram at the same time (as shown in Figure 4.2).

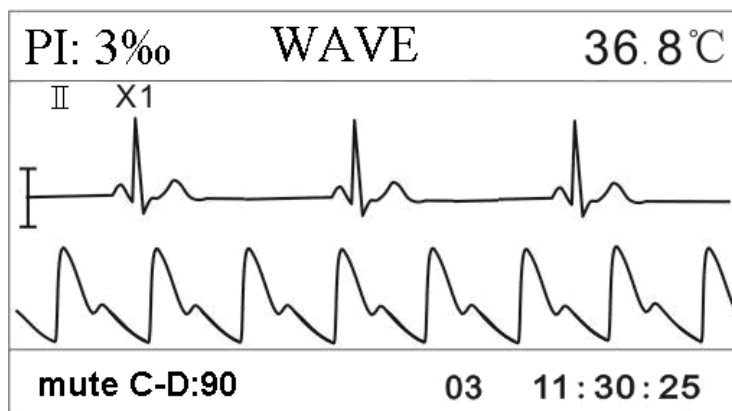

Figure 4.2 ECG & SpO₂ monitoring screen (Default display screen)

4.1.1 Default Display Screen Description

Title area:

- ✧ “II ×1”: ECG lead status and ECG waveform scale.
- ✧ “ECG”: indicate the current monitoring parameter is ECG.
- ✧ “36.8°C”: temperature numerical value

- ◇ **“PI: 3%”**: the perfusion index is 3%; it displays only when “Setup Menu→SpO₂→PI Display” is set as “ON”.

Note: PI display function is optional and it needs hardware support.

Main display area:

- ◇ When ECG leads is attached on the patient and connected to the monitor well, ECG waveform will be displayed in the main display area. Meanwhile HR value will show on digital LED.
- ◇ When SpO₂ probe is clipped on the patient and connected to the monitor well, SpO₂ plethysmogram will be displayed in the main display area.

Prompt Info:

- ◇ Status or event indication segment:

This segment will display the ECG leads status, probe status, alarm silence counting-down timer, automatic NIBP measurement counting-down timer, over limit warning and other error messages for technical warning. If more than one event occurs or more status appears, the indication message will be displayed alternately at this segment.

“NIBP C-D: XXX”: the counting-down timer of NIBP measurement is XXX seconds. This prompt message appears only when the NIBP measuring mode is set as “AUTO X”.

“mute C-D: XXX”: the counting-down timer of alarm silence is XXX seconds. This prompt message appears only when the alarm silence is enabled.





- ◇ Patient ID segment:

“03”: Patient ID number.

- ◇ Real time clock segment:

“11:30:25”: the current time.

4.1.2 Operation Instructions

- ◇  **key**: select ECG lead. When ECG is monitored, press this key to switch the ECG lead among I, II, III, aVR, aVL, aVF and V.
- ◇  **key**: freeze ECG waveform or Plethysmogram on the screen.
- ◇  **key**: shift display mode among 5 display views: ECG & SpO₂ monitoring screen (default screen), ECG monitoring screen, trend graph screen, NIBP list screen and ECG waveform recall screen.
- ◇  **key**: print ECG waveform. Press it again to stop printing.
- ◇  **key**: start/cancel NIBP measurement.
- ◇ **“▲”/“▼”key**: change ECG waveform scale.

- ◇ “” key: short press this key (about 1 second) to turn on or turn off the alarm sound temporarily; Long time press it to enter into the alarm setup shortcut menu as shown in figure 4.3. If not turn off “ECG Lead off” and “SpO₂ Probe off” manually after alarm lasts for 5 minutes, system will resume alarm silence status.

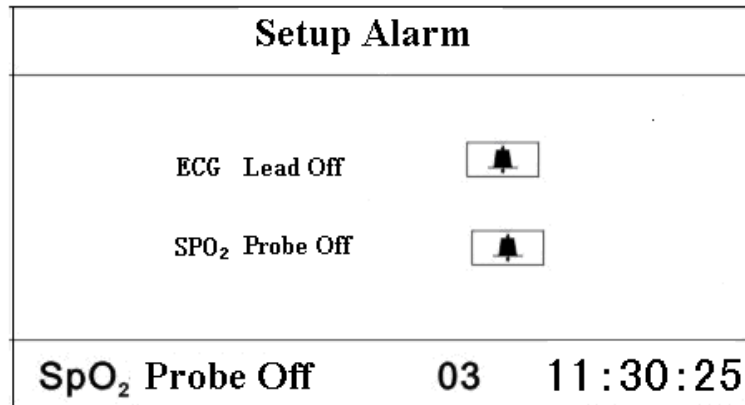



Figure 4.3 Alarm setup shortcut screen

Alarm setup operation description:

1. Press “▲” key or “▼” key to move cursor to select parameter.
2. Press “■” key to confirm and enter into corresponding alarm parameter setup screen; Press “▲” key or “▼” key again to turn off corresponding lead off alarm.
3. Press “” to exist from Setup Menu Screen.

4.2 ECG Monitoring Screen

Short pressing “ Display” key to shift the screen view to ECG monitoring screen, as shown in Figure 4.4.

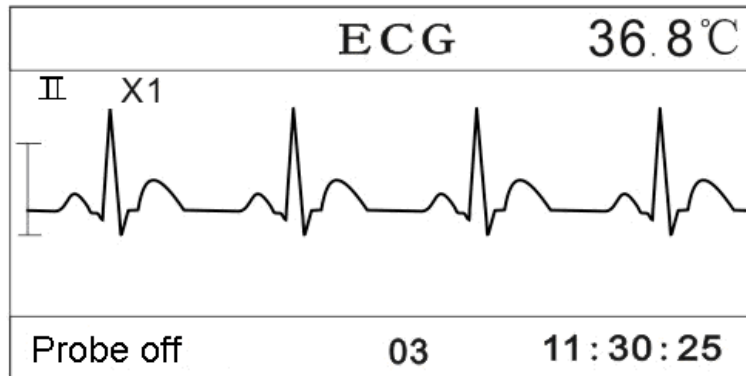

Figure 4.4 ECG Monitoring Screen

Note: if you need to store the measuring data, please set the option of “store” as “on” on ECG TEMP setting screen.

4.2.1 Display Screen Description

Title area:

- ✧ “II X1”: ECG lead status and ECG waveform scale.
- ✧ “ECG”: indicate the current monitoring parameter is ECG.
- ✧ “36.8°C”: temperature numerical value







Main display area:

- ✧ When ECG leads is attached on the patient and connected to the monitor well, ECG waveform will be displayed in the main display area.

Prompt Info:

- ✧ “Probe off”: the SpO₂ sensor is disconnected from the monitor or off from the patient.
- ✧ “03”: Patient ID number.
- ✧ “11:30:25”: the current time.

4.2.2 Operation Instructions

- ✧ “” key: select ECG lead. When ECG is monitored, press this key to switch the ECG lead among I, II, III, aVR, aVL, aVF and V.
- ✧ “” key: freeze ECG waveform or Plethysmogram on the screen.
- ✧ “” key: shift display mode.
- ✧ “” key: print ECG waveform. Press it again to stop printing.
- ✧ “” key: start/cancel NIBP measurement.
- ✧ “” key: Alarm silence switch, press it to enable/disable alarm silence.
- ✧ “▲”/“▼”key: change ECG waveform scale.

4.3 Trend Graph Display

Short pressing “ Display” key to shift the screen view to trend graph display screen, as shown in Figure 4.5.

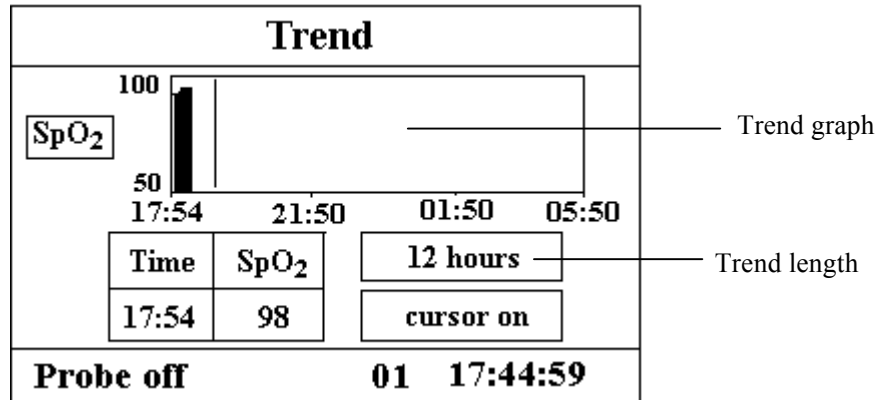

Figure 4.5 Trend Graph

4.3.1 Screen Description

- ✧ “**12 hours**”**: the trend length of trend graph**; three options: “12”, “24” or “96” hours; when the selection is 12 hours, the upper trend graph will display SpO₂ trend curve for last 12 hours.
- ✧ “**cursor on**”**: enable the display of cursor on trend graph**, i.e. the vertical cursor line displayed in trend graph, so the user can move the cursor to inspect the SpO₂ value at the given time.
- ✧ “**SpO₂**”**: indicate that the trend graph beside it is SpO₂ trend**. Let the cursor stay here and press“**■**” key to confirm, then press “**▲**” key or “**▼**” key again to select trend graph type:
 - “**SpO₂**”**: SpO₂ trend graph**
 - “**HR**”**: HR trend graph**

4.3.2 Operation Instructions

1. Press “**▲**” key or “**▼**” key to highlight “trend length” or “cursor on” selection.
2. Press “**■**” key to confirm.
3. Press “**▲**” key or “**▼**” key again to select value of trend length (12/24/96 hours) if the selecting box stays in “trend length” option, or to move the cursor if the selecting box stays in “cursor on” option.

Instructions for viewing the trend curve:

- Select “cursor on” and press “**■**” key to confirm, and “cursor on” becomes “cursor off” , then you can press “**▲**” key or “**▼**” key to move the vertical cursor, the list box below will display SpO₂/HR value and the time value at the point where the cursor stays. Move cursor back and forth this way, you can view the SpO₂/HR trend (12/24/96 hours long). Press “**■**” key again to exit trend viewing.
- When pressing “**▲**” key or “**▼**” key to move cursor, the moving step is variable. The rule is that the initial step is 1 point, after pressing “**▲**” or “**▼**” key towards the same direction for 5 times, the step becomes 5 points, and with 5 more pressing the step becomes 10, then 20. No matter what

step is, as long as you press “▲” or “▼” key towards the other direction, the step becomes 1 and towards the other direction.

4. Press:

“” key: press this key to shift to next display view.

“” key: Press it to print the current displayed trend graph.

“” key: start/cancel NIBP measurement

“” key: alarm silence switch; press it to enable/disable alarm silence.

4.4 NIBP List Screen

Short pressing “ Display” key to shift the screen to NIBP List screen, as shown in Figure 4.6.

PID	time	SYS/DIA/MAP	PR
01	2010-04-07 09:15	100/73/95	70
01	2010-04-07 09:16	105/75/96	69
01	2010-04-07 09:17	102/73/94	68
01	2010-04-07 09:19	101/71/90	69
mute C-D:90		100	16:35:24

Figure 4.6 NIBP List

The first column is the date, the second column is NIBP measuring time, the third column is NIBP value, and the fourth column is pulse rate (measured by NIBP module). Up to 12000 groups of nonvolatile data can be stored in the monitor. “SYS/DIA/MAP” indicates the value of “systolic pressure/diastolic pressure/mean arterial pressure”.

4.4.1 Operation Instructions

On NIBP List screen, if NIBP measurement is more than 8 groups, press “▲” key or “▼” key to turn to previous/next page for view other measurement values. If NIBP measurement is not more than 8 groups, the keys “▲” or “▼” are not effective.

◇ “” key: press this key to shift to next display view.

◇ “” key: print NIBP list.

◇ “” key: start/cancel measuring NIBP.

◇ “” key: alarm silence switch; press it to enable/disable alarm silence.

◇

4.5 SpO₂ List Screen

Short pressing “ Display” key to shift the screen to SpO₂ List screen, as shown in Figure 4.7





PID	time	SpO ₂	PR
01	2012-05-25 09:15	98	70
01	2012-05-25 09:16	95	69
01	2012-05-25 09:17	99	68
01	2012-05-25 09:19	100	69
		01	16:35:24

Figure 4.7 SpO₂ List

The first column is the date, the second column is SpO₂ measuring time, the third column is SpO₂ value, and the fourth column is pulse rate. Up to 2000 groups data which are lately measured can be stored in the monitor when it is out of power..

4.5.1 Operation Instructions

On SpO₂ List screen, if SpO₂ value measurement is more than 8 groups, press “▲” key or “▼” key to turn to previous/next page for view other measurement values. If SpO₂ measurement is not more than 8 groups, the keys “▲” or “▼” are not effective.

- ◇ “” key: short press this key to shift to next display view. Long press to enter the screen of Empty history records, the user can delete all SpO₂ records according to prompt.
- ◇ “” key: print SpO₂ list if the monitor equips with built-in printer, press this key again to stop printing
- ◇ “” key: start/cancel measuring NIBP.
- ◇ “” key: alarm silence switch; press it to enable/disable alarm silence.

4.6 ECG Recall Screen

Short pressing “ Display” key to shift the screen to Default ECG Recall screen, as shown in Figure 4.8. On this screen, the latest 120-hour ECG data stored in monitor can be reviewed.

recall			
PID	stsr	end	view
03	2010-01-14 16:00:34	16:01:54	
03	2010-01-14 10:35:12	11:14:42	
		03	11:30:25

Figure 4.8 Default ECG Recall Screen

4.6.1 Operation Instructions

1. Press “■” key to confirm “view”.
2. Then press “▲” key or “▼” key to shift yellow selecting box to choose a record. After pressing “■” key to confirm, its recorded ECG waveform will display on screen.

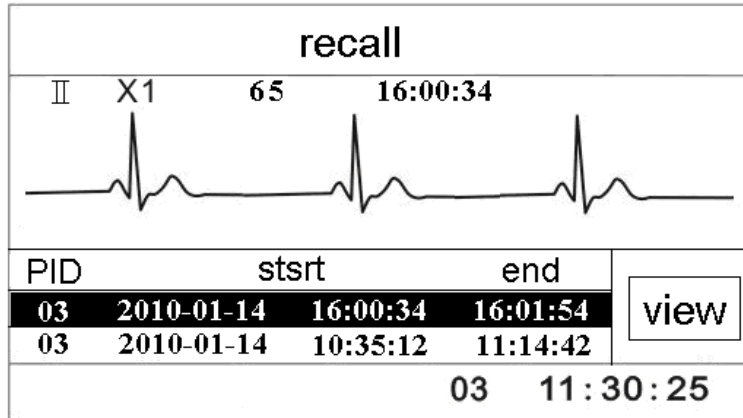

Figure 4.9 Recalled ECG Waveform

3. Press “▲” key or “▼” key to turn to the previous/next page to view recalled ECG waveform.
4. Press “■” to back to Default ECG Recall screen.

Note: If the setting of “store” on ECG TEMP setting screen is “off”, thereafter the ECG data measured will not be stored.

4.7 Setup Menu Screen

At any display view screen, long time press “ Display” key to shift the screen to Setup Menu screen, as shown in Figure 4.10. All the functional parameters of the system can be set through Setup Menu.

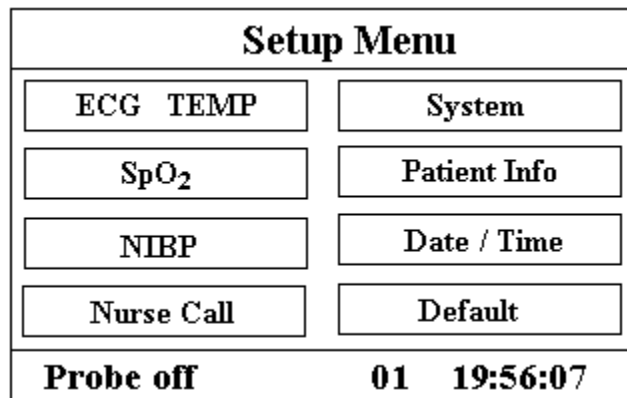





Figure 4.10 Setup Menu Screen

There are 8 functional groups for setting parameters: “ECG TEMP, SpO₂, NIBP, Nurse Call, System, Patient Info, Date/Time and Default” on the Setup Menu Screen.

1. Press “▲” key or “▼” key to shift cursor to corresponding functional group setting.
2. Press “■” key to confirm and enter into corresponding functional parameter setup screen.
3. Press “” key under the setup menu will print ECG waveform.

4. Press “” to exist from Setup Menu Screen.

 At Setup Menu Screen or its submenu screen, when pressing “” key, the default display screen will be printed.

The following will cover each functional parameter’s setting up.







Note: If you disable Hi and Lo limit alarm function of parameter monitoring, all the alarms related to its parameter monitoring will be disabled as well.

4.7.1 ECG and Temperature Setup

ECG/TEMP			
Lead	<input type="text" value="I"/>	Gain	<input type="text" value="X1"/> <input type="text" value="1mV"/> <input type="text" value="on"/>
Enhancement mode	<input type="text" value="off"/>	store	<input type="text" value="on"/>
HR	<input checked="" type="checkbox" value="on"/>	Hi	<input type="text" value="180"/> <input type="text" value="Lo"/> <input type="text" value="40"/>
TEMP	<input checked="" type="checkbox" value="on"/>	Hi	<input type="text" value="180"/> <input type="text" value="Lo"/> <input type="text" value="40"/>
Unit	<input type="text" value="°C"/>	Temperature probe	<input type="text" value="KRK"/>
Probe off		01	19:30:07

Figure 4.11 ECG/TEMP Setup Screen

Screen Description:

- ✧ “**Lead**”： ECG lead selection: I, II, III, AVR, AVL, AVF or V.
- ✧ “**Gain**”： ECG waveform scale:
 - “×1/4”- Waveform scaled with 1/4 of the base gain
 - “×1/2”- Waveform scaled with half of the base gain
 - “×1”- Waveform scaled with base gain
 - “×2”- Waveform scaled with twice of the base gain
- ✧ “**1mV**”： generating internal 1mV calibration signal. This signal is used to test the function of the machine. It is not used during normal operation. The default set is off.
- ✧ “**Enhancement mode**”： the switch of ECG enhancement mode.
- ✧ “**HR** ”： HR alarm switch; “” indicates HR alarm is on; “” indicates HR alarm is off.
- ✧ “**HR Hi/Lo**”： high/low limit of HR alarm.
- ✧ “**TEMP** ”： temperature alarm switch; “” indicates temperature alarm is on; “” indicates temperature alarm is off.
- ✧ “**TEMP Hi/Lo**”： high/low limit of temperature alarm.
- ✧ “**Unit**”： body temperature unit. Two options: “°C” or “°F”. Conversion relation: 1°F = (°C×1.8) +32.

- ◇ “Store”: decide whether to store ECG data or not. If your selection is “off”, thereafter the ECG data measured will not be stored.
- ◇ “T probe”: the type of temperature probe “KRK”.

4.7.2 SpO₂ Setup

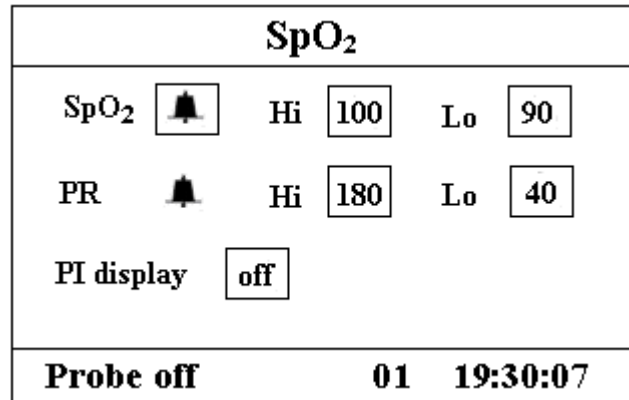

Figure 4.12 SpO₂ Setup Screen

Screen Description:

- ◇ “SpO₂ ”: SpO₂ alarm switch; “” indicates SpO₂ alarm is on; “” indicates SpO₂ alarm is off.
- ◇ “SpO₂ Hi”: high limit of SpO₂ alarm; range: “1~100”.
- ◇ “SpO₂ Lo”: low limit of SpO₂ alarm; range: “0~99”.
- ◇ “PR ”: pulse rate alarm switch; “” indicates PR alarm is on; “” indicates PR alarm is off.
- ◇ “PR Hi”: high limit of PR alarm; range: “22~250”.
- ◇ “PR Lo”: low limit of SpO₂ alarm; range: “0~248”.
- ◇ “PI display”: “on” means PI display is enabled; “off” means PI display is disabled.

Operation Instructions

1. Press “▲” key or “▼” key to move cursor to select parameter.
2. Press “■” key to confirm and active this parameter setting.
3. Press “▲” key or “▼” again to adjust or modify parameter value.
4. Press “■”key again to confirm and save the setting.
5. Press “ ” key to return to upper level screen.

4.7.3 NIBP Setup

NIBP					
SYS		Hi	<input type="text" value="100"/>	Lo	<input type="text" value="90"/>
DIA		Hi	<input type="text" value="180"/>	Lo	<input type="text" value="40"/>
MAP		Hi	<input type="text" value="180"/>	Lo	<input type="text" value="40"/>
Initial Pressure			<input type="text" value="150"/>	unit	<input type="text" value="mmHg"/>
NIBP Mode			<input type="text" value="manual"/>		>>
01 19:44:50					

Figure 4.13A NIBP Setup

Tourniquet			
pressure	<input type="text" value="140"/>	duration	<input type="text" value="40"/>
Alert T	<input type="text" value="05"/>		
<input type="button" value="Start"/>			
Probe off 01 19:44:50			

Figure 4.13B Tourniquet Setup

Adjust Setup	
NIBP Cali Mode 1	<input type="button" value="Stop"/>
NIBP Cail Mode 2	<input type="button" value="Start"/>
Gas Leak	<input type="button" value="Start"/>
Cuff Error	04 15: 27: 26

Figure 4.13C Adjust Setup

NIBP Setup Screen Description:

- ◇ “SYS ”: systolic pressure alarm switch; “” indicates systolic pressure alarm is on; “” indicates systolic pressure alarm is off.
- ◇ “SYS Hi”: high limit of systolic pressure alarm; range: “32~250” mmHg.
- ◇ “SYS Lo”: low limit of systolic pressure alarm; range: “30~248” mmHg.
- ◇ “DIA ”: diastolic pressure alarm switch; “” indicates diastolic pressure alarm is on; “” indicates systolic pressure alarm is off.
- ◇ “DIA Hi”: high limit of diastolic pressure alarm; range: “22~230” mmHg.
- ◇ “DIA Lo”: low limit of diastolic pressure alarm; range: “20~228” mmHg.
- ◇ “MAP ”: mean arterial pressure alarm switch; “” indicates mean arterial pressure alarm is on; “” indicates mean arterial pressure alarm is off.
- ◇ “MAP Hi”: high limit of mean arterial pressure alarm; range: “28~242” mmHg.
- ◇ “MAP Lo”: low limit of mean arterial pressure alarm; range: “26~240” mmHg.
- ◇ “Mode”: NIBP measuring mode, “manual”, “AUTO 1”, “AUTO 2” ... “AUTO 240” and “STAT” etc. options. “AUTO 1” means NIBP measurement takes once every one minute automatically; “AUTO 60” means NIBP measurement takes once every 60 minutes automatically; In AUTO mode, the counting-down timer is displayed in the “Prompt Info” area.

- ◇ **“Initial pressure setup”**: Cuff pre-inflation pressure value is default
 - for neonates**: pre-inflation range: 60~80mmHg, default value: “70” mmHg;
 - for infants**: pre-inflation range: 80~140 mmHg, default value: “100” mmHg;
 - for adults**: pre-inflation range: 80~200mmHg, default value: “150” mmHg.

Note: In order to avoid inappropriate initial pressure value to do harm to patients, pre-inflation pressure value will resume the default value when measurement mode shifts or changing patient type or rebuilding patients’ files.

- ◇ **“unit”**: unit of the blood pressure value;
“mmHg” or “kPa” can be selected. Conversion: 1kPa=7.5mmHg.
- ◇ **“>>”**: Page down icon. When cursor stays in the “unit” field, press “▼” key to enter Tourniquet Setup.

Tourniquet Setup Screen Description:

- ◇ **“Pressure”**: when you use Tourniquet function, you need to preset a cuff pressure for hemostasia. The pressure is adjustable, and its adjusting limit is different for different patient category:
 - for neonates**: preset range: 70~100mmHg, default value: “90” mmHg;
 - for infants**: preset range: 80~130 mmHg, default value: “110” mmHg;
 - for adults**: preset range: 80~180mmHg, default value: “140” mmHg.If the pressure drops down slowly under 10mmHg compared with the preset value due to little air leakage in the pneumatic system when time passes by, the monitor will re-inflate to maintain the cuff pressure close to the preset pressure value.

Note: the unit of cuff pressure is the same with the NIBP unit in NIBP Setup.
- ◇ **“Duration”**: After presetting the cuff pressure, you need to set the time period for maintaining the preset pressure after inflation. “5, 6, 7,...120” minutes adjustable. The default value is “40” minutes.
If the set value is “xx” minutes, the monitor will count down from “xx” minutes automatically when starting cuff inflation. When time is up, it will deflate automatically.
- ◇ **“Alert T”**: the alert time for reminding user that the operation of tourniquet is going to be end after this time period. 1 to 60 minutes adjusting range with 1 minute step, the default value is “5” minutes. If the set value is “xx” minutes, the monitor will produce alarm sound until ending deflation when counting down time reaches to “xx” minutes. The alarm type is high priority alarm. (For example: the duration is 40 minutes, the alert time is 5 minutes, the alarm will ring for prompt when the duration counting down to 5 minutes. The Prompt Info area starts to prompt: TOUR C-D 300 seconds.)
- ◇ **“Start”**: shift cursor to “Start” and press “■” key, “Start” becomes “Stop” and meanwhile the blood cuff starts being inflated; Pressing “Stop” button can stop using this function. After deflation, it will change to “Start” again.

NIBP Calibration Setup Descriptions:

NIBP Cali Mode 1: Inflating the Pump. Move the cursor to NIBP Cali Mode 1”Start” button, click the OK button to begin the NIBP calibration. (Meanwhile, the “Start” shifts to “Stop”, after the calibration the “Stop” shifts to “Start”)

NIBP Cali Mode 2: Receiving the exterior pressure. The exterior pressure source pressurize to the module to proceed the pressure calibration. Move the cursor to NIBP calibration mode 2”Start” button, click the OK button to begin the NIBP calibration.(Meanwhile, the “Start” shifts to “Stop”, after the calibration the “Stop” shifts to “ Start”)

Gas leak: Move the cursor to Gas leak ”Start” button, click the OK button, the pump inflates to certain pressure and then the valve will be closed for leak detection for ten seconds, then the blood pressure module will deflate automatically and the screen displays measurements.

- ☞ The NIBP calibration and Gas leak detection can only be carried on when the NIBP measurement is set to mode “Manual”.
- ☞ Other buttons are disabled except “■” OK button and “⊙” Power button during NIBP calibration and Gas leak detection.
- ☞ Make sure the “■” OK button is off after the test, or the user could not do other operations.

NIBP Mode Setup Shortcut Screen Descriptions:

In waveform display screen or trend graphic screen or NIBP list screen longtime press “”key about 3 seconds can enter into the screen shown in Figure 4.13D. Please refer to “NIBP Setup Screen Description” for more detailed information.

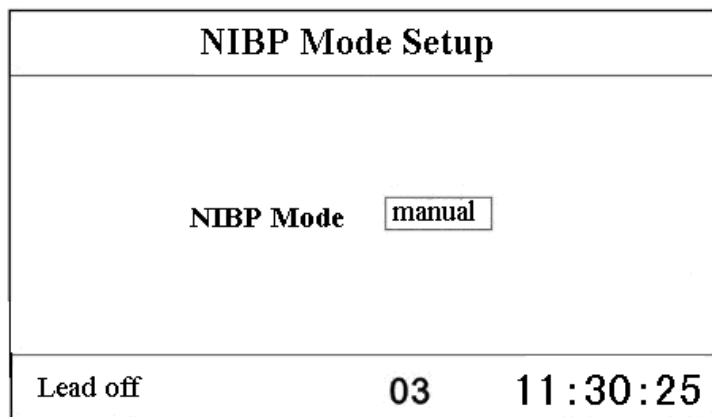

Figure 4.13D NIBP Mode Setup Shortcut Screen

4.7.4 Nurse Call

Nurse Call	
Output level	<input type="text" value="low"/>
Source: ALM	<input type="checkbox"/> H <input type="checkbox"/> M <input type="checkbox"/> L
Duration	<input type="text" value="pulse"/>
Probe off 01 20:14:50	

Figure 4.14 Nurse Call Setup Screen

Screen Description:

- ✧ **“Output level”**: two options “low” or “high” output levels are available.
 When the calling system in hospital works in “Normal Open” mode, “low level” should be selected.
 When the calling system in hospital works in “Normal Close” mode, “high level” should be selected
- ✧ **“Source”**: three kinds of alarm sources can trig the nurse call: high level alarm, medium level alarm and low level alarm (multi-optional). If you don’t make choice, nurse call signal will not be sent out.
- ✧ **“Duration”**: two options “pulse” or “continuous” output modes are available;
“continuous”: the continuous mode of output means the nurse call signal will keep until the selected alarm source(es) disappear, i.e. the signal will last from starting alarm to stopping alarm.
“pulse”: the output nurse call signal is pulse signal which lasts for 1 second. When several alarms occur at the same time, only one pulse signal will be sent out.

Note: Nurse Call function can not be regarded as main alarm notice method, please do not entirely relay on it. You should combine parameter values with alarm level and patient’s clinical behavior and symptom to determine patient’s status.

4.7.5 System Setup

System			
Volume	<input type="text" value="00"/>	key beep	<input type="text" value="off"/>
language	<input type="text" value="ENG"/>	priority	<input type="text" value="HR"/>
care mode	<input type="text" value="Demo"/>	BT sound	<input type="text" value="on"/>
01 20:14:50			

Figure 4.15 System Setup Screen

Screen Description:

- ✧ **“Volume”**: set beeper volume, “1~7” level adjustable, the factory default is 03. It is recommended that the alarm volume shouldn’t be adjusted lower than the factory default value unless the nursing personnel keeps close attention and surveillance on the patients and the device at all times.
- ✧ **“key beep”**: to turn on/off key beep;
- ✧ **“Language”**: language selection. “ENG” for English.
- ✧ **“priority”**: priority of “PR” value or “HR” value display. The default set is “HR”.
- ✧ **“care mode”**: “Demo” shows the demo waveforms and data. In the demo state, all the signals and data are generated from the monitor for demonstration and testing purpose. When the mode “Demo” is selected, the user can test whether the visual and audible alarm system runs normally by raising or lowering the alarm limit to trigger the monitor to alarm.
 “Real” shows the real time waveform, i.e. normal monitoring status;
- ✧ **BT sound**: adjust the volume of pulse beeping sound. “0~7” level adjustable. “0” means switching off the sound.

4.7.6 Patient Info

Patient Info		
ID	01	
category	adult	
Probe off	01	12:14:50

Figure 4.16 Patient Info Screen

Screen Description:

- ✧ **“ID”**: change or set current patient’s ID number, 0~100 adjustable;
- ✧ **“category”**: change or set the category of current patient; three options “adult” ,“pediatric” and “neonate”, the default is “adult”.

Note: If the patient ID is changed, the history data (except NIBP list) will be cleared, that means SpO₂ trend graph and HR trend graph will become empty.

4.7.7 Date/Time

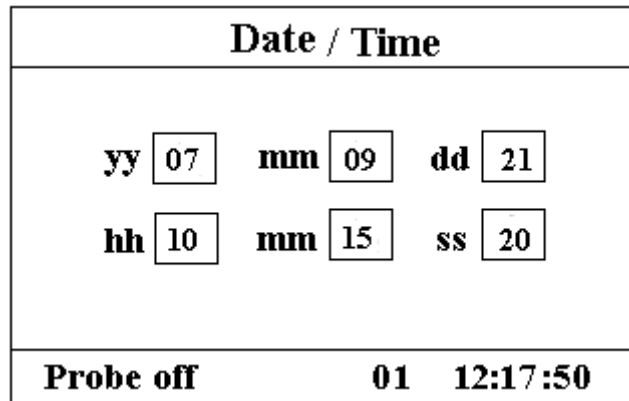

Figure 4.17 Data/Time Setup Screen

Screen Description:

- ✧ “yy 07 mm 09 dd 21”: date setting, “07-09-21” shows the date is September 21st, 2007.
- ✧ “hh 10 mm 15 ss 20”: time setting, “09: 20: 21” shows the time is 10:15:20.

4.7.8 Recover Default Settings

On Setup Menu screen, press “▲” button or “▼” button to shift cursor to “Default”, and then press “■” button, all the setting parameters will be reset to factory default setting value.

4.8 Power Saving Mode

On the initial display screen, you can make the monitor stay in power saving mode for power saving. Short time press power button to shift screen to “Power Saving Mode” display screen, as shown in Figure 4.18.

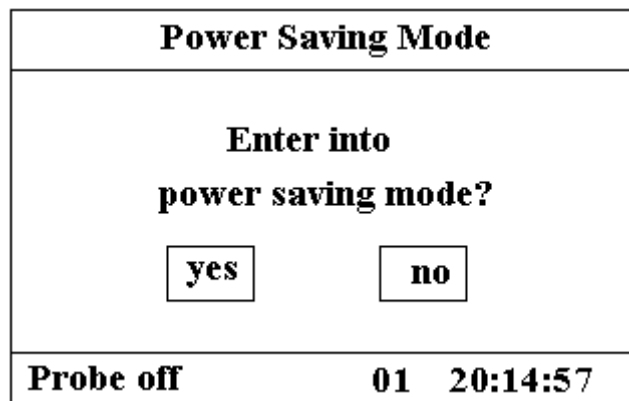

Figure 4.18 Power Saving Mode

Press “▲” button or “▼” button to shift cursor to “yes” or “no” and press “■” button to confirm. If your selection is “yes”, all the numerical values displayed on digital LEDs display become darker and the monitor stays in power saving mode.

Short time press power button again to shift screen to “Power Saving Mode” display screen for exiting the sleeping mode.

Chapter 5 Alarm

5.1 Alarm Priority

High Priority:

TOUR C-D: XXX seconds
 PR Over limit
 SpO₂ over limit
 SYS over limit
 DIA Over limit
 MAP Over limit
 NIBP error 1#
 NIBP error 2#
 NIBP error 3#
 NIBP error 4#
 NIBP error 5#
 Air leak
 Cuff error
 NIBP over range
 Over motion
 Over pressure
 NIBP timeout

Medium Priority:

Probe Off

5.2 Alarm modes

When an alarm occurs, the monitor responds with visual alarm indications (which are shown by two ways: alarm indicator and alarm message description) and audible alarm indications.

Visual Alarm Indicators

The flashing rates for the three categories of alarms are shown in the table below.

Indicator Color	Alarm Category	Flashing Rate
Red flashing	High priority alarm	2 Hz
Yellow flashing	Medium priority alarm	0.5 Hz
Yellow light	Low priority alarm	Constant(on)(non-flashing)

Table 5.1

Refer to Chapter 11.2 Alarm Information for detailed alarm message descriptions.

Audible Alarm Indications

The audible alarm has different tone pitch and on-off beep patterns for each priority category. These are summarized in the Table below.

Alarm Category	Tone Pitch	Beep Chain
High priority alarm	~400Hz	10 beeps pause 3 sec.
Medium priority alarm	~500Hz	3 beeps pause 5 sec.
Low priority alarm	~500Hz	Single beep

Table 5.2

Note: Visual alarm indicators can not be suspended or removed. Audible alarms may be decreased in volume or silenced as described.

5.3 Alarm Silence

Press  key to set or activate the system alarm. In the monitoring screen, press “Alarm” to set the alarm timer. There are four options of alarm silent time: 2 minutes, 5 minutes, 10 minutes and 20 minutes. The time shows up on the upper left corner of the screen. When the alarm timer is activated, the system begins to count down. If alarm occurs during that period, the system alarm will be activated automatically and the monitor will give alarm. If there is no alarm during that period, when the set time has passed the system alarm will be activated as well.

When the monitor alarms, press  key to suspend the alarm and set the alarm silence time.

- **DO NOT silence the audible alarm or decrease its volume if patient safety could be compromised.**
- zero value alarm occurs must be on the condition of probe not off. If SpO₂ value is zero displayed on the screen instead of normal value, the zero value alarm will be automatically activated if the state lasts for about 7 seconds.

5.4 Alarm Setting

In the Mode Selection screen, move the cursor to the “SETUP”, and press it to enter system setup screen.

 Limits setup: Move the gray cursor to the High or Low limits of the alarm settings, and press the “Alarm” key to turn ON or OFF the alarm for the setting. Yellow color shows ON status, and gray color shows the OFF status.

Refer to Chapter 11.2 for detailed Default Alarming Values of All Parameters and Setup Range.

- **Whenever the monitor is used, check the alarm limits to ensure that they are appropriate for the patient being monitored.**

5.5 Verify Adjustable Alarm Function

To verify adjustable alarm function, select “Demo” for the item of Mode in system parameter settings menu and adjust alarm limits or change alarm setting, then pay a close attention to the alarm. If the alarm is sent out according to your setting, it means the alarm function is effective.

Chapter 6 Technical Specifications

6.1 ECG Monitoring

1. Input signals range in amplitude: $\pm (0.5 \text{ mVp} \sim 5 \text{ mVp})$
2. Heart rate display range: 15 bpm \sim 350 bpm
3. Heart rate display accuracy: $\pm 1\%$ or ± 2 bpm, whichever is greater.
4. Heart rate averaging: Averages the recent eight beats having RR intervals falling within the acceptable limits.
5. Heart rate alarm delay time: $\leq 10\text{s}$
6. Response time to change in heart rate:
 - Change from 80 bpm to 120 bpm: $< 8 \text{ sec}$
 - Change from 80 bpm to 40 bpm: $< 8 \text{ sec}$
7. Tall T-wave rejection: Rejects all T-wave less than or equal to 120% of 1mV QRS.
8. Sensitivity selection:
 - $\times 1/4$, 2.5mm/mV tolerance: $\pm 5\%$
 - $\times 1/2$, 5mm/mV tolerance: $\pm 5\%$
 - $\times 1$, 10mm/mV tolerance: $\pm 5\%$
 - $\times 2$, 20mm/mV tolerance: $\pm 5\%$
9. Sweeping speed: 25mm/s tolerance: $\pm 10\%$
10. ECG noise level: $\leq 30\mu\text{V}_{\text{p-p}}$.
11. ECG input loop current: $\leq 0.1\mu\text{A}$
12. Differential input impedance: $\geq 5\text{M}\Omega$
13. Common-mode rejection ratio (CMRR): $\geq 105\text{dB}$
14. Time constant: $\geq 0.3\text{s}$
15. Frequency response: 0.67 Hz \sim 40 Hz (+ 0.4 d B)
- 3.0 d B

Additional declarations to conform the particular standard of IEC 60601-2-27 “Medical electrical equipment – Part 2-27: Particular requirements for the safety, including essential performance, of electrocardiographic monitoring equipment”		
Direct current for respiration, leads-off sensing, and active noise suppression	Applied current less than 0.1 microamperes.	
Response to irregular rhythm	A1 Ventricular bigeminy-80BPM A2 Slow alternating ventricular bigeminy-60BPM A3 Rapid alternating ventricular bigeminy-120BPM A4 Bidirectional systoles-90BPM	
Time to ALARM for tachycardia	<u>Waveform B1, Amplitude</u>	<u>Average Time to Alarm</u>
	0.5 mV	<8 sec
	1 mV	<8 sec
	2mV	<8 sec
	<u>Waveform B2, Amplitude</u>	<u>Average Time to Alarm</u>
	1mV	<8 sec
	2mV	<8 sec
	4mV	<8 sec

6.2 TEMP Monitoring

1. TEMP measuring range: 21.0 °C ~50.0 °C
2. TEMP measuring accuracy: not greater than 0.2 °C for TEMP measuring range from 25.0°C~45.0 °C
3. TEMP responding time: ≤150s

6.3 NIBP Monitoring

1. Measuring method: Oscillometric Technique
2. Pneumatic pressure measuring range: 0 mmHg~300mmHg
3. Accuracy of pressure measurement: ±3 mmHg
4. Cuff inflation time: <10 seconds (typical adult cuff)
5. Measurement time on the average: < 90 seconds
6. Air release time while the measurement is canceled: ≤2 seconds (typical adult cuff)
7. Initial cuff inflation pressure

Adult: 175 mmHg Infant: 135 mmHg Neonate: 65 mmHg

8. Overpressure protection limit

Adult: ≤ 300 mmHg Infant: ≤ 240mmHg Neonate: ≤ 150 mm

9. NIBP measurement range:

press (unit)		Adult	Infant	Neonate
SYS	mmHg	40~255	40~200	40~135
MAP	mmHg	20~215	20~165	20~110
DIA	mmHg	10~195	10~150	10~95

10. NIBP accuracy:

Maximal mean difference: ±5 mmHg

Maximal standard deviation: 8 mmHg

Measurement mode: Manual, Auto, STAT

6.4 SpO₂ Monitoring

1. Transducer: dual-wavelength LED

Wavelength: Red light: 660 nm, Infrared light: 905 nm.

Maximal optical output power: less than 2mW maximum average

2. SpO₂ measuring range: 35%~100%
3. SpO₂ measuring accuracy: Arms is not greater than 3% for SpO₂ range from 70% to 100%
*NOTE: Arms is accuracy defined as root-mean-square value of deviation according to ISO 9919
4. Low perfusion performance: the declared accuracy is attained when the pulse amplitude modulation ratio is as low as 0.4%.

6.5 Pulse Rate monitoring

1. Pulse rate measuring range: 30bpm~240bpm
2. Pulse rate measuring accuracy: ± 2 bpm or $\pm 2\%$, whichever is greater.

6.6 Data Recording

1. Sensitivity selection tolerance: $\pm 5\%$
2. Recording speed: 25mm/s
3. Recording speed accuracy: $\pm 10\%$
4. Hysteresis: ≤ 0.5 mm
5. Frequency response: Monitoring mode: 0.5~40Hz
6. Time constant: Monitoring mode: ≥ 0.3 s

6.7 Other Technical Specifications

1. AC power supply voltage: 100~240VAC
2. AC power frequency: 50/60 Hz
3. Fuse specification: T3.15AL/250V $\Phi 5 \times 20$ mm.
4. Internal power supply: 12VDC (rechargeable)
5. Battery specification: 12V 2.3AH (sealed lead-acid battery)

6.8 Operating Environment

Working Environment

Ambient temperature range: 5°C ~ 40°C

Relative humidity: 30 ~ 80%

Atmospheric pressure: 70kPa ~106kPa

Transport and Storage Environment

Ambient temperature range: -20°C ~ 60°C

Relative humidity: 10 ~ 95%

Atmospheric pressure: 50.0kPa ~107.4kPa

6.9 Classification

Safety standard	IEC 60601-1
The type of protection against electric shock	Class I equipment.
The degree of protection against electric shock	Type BF, CF applied parts
Electro-Magnetic Compatibility:	Group I, Class A

6.10 Guidance and manufacturer's declaration-Electromagnetic compatibility

Table 1

**Guidance and manufacturer's declaration-electromagnetic emission-
for all EQUIPMENT AND SYSTEM**

<p>VITAL Vital Signs Monitor is intended for use in the electromagnetic environment specified below. The customer or the user of the equipment or system should assure that it is used in such an environment.</p>		
Emissions test	Compliance	Electromagnetic environment-guidance
RF emissions CISPR 11	Group 1	VITAL Vital Signs Monitor uses RF energy only for its internal function. Therefore, its RF emissions are very low and are not likely to cause any interference in nearby electronic equipment.
RF emissions CISPR 11	Class A	VITAL Vital Signs Monitor is suitable for use in all establishments other than domestic and those directly connected to the public low-voltage power supply network that supplies buildings used for domestic purposes.
Harmonic emissions IEC61000-3-2	Class A	
Voltage fluctuations/flicker emissions IEC61000-3-3	Complies	

Table 2

**Guidance and manufacturer's declaration-electromagnetic immunity
for all EQUIPMENT AND SYSTEMS**

<p>VITAL Vital Signs Monitor is intended for use in the electromagnetic environment specified below. The customer or the user of the equipment or system should assure that it is used in such an environment.</p>			
Immunity test	IEC60601 test level	Compliance level	Electromagnetic environment -guidance
<p>Electrostatic discharge(ESD) IEC61000-4-2</p>	<p>±6 kV contact ±8kV air</p>	<p>±6 kV contact ±8kV air</p>	<p>Floors should be wood, concrete or ceramic tile. if floors are covered with synthetic material, the relative humidity should be at least 30%</p>
<p>Electrical transient/burst fast IEC61000-4-4</p>	<p>±2kV for power Supply lines ±1 kV for input/output lines</p>	<p>±2kV for power Supply lines ±1 kV for input/output lines</p>	<p>Mains power quality should be that of a typical commercial or hospital environment.</p>
<p>Surge IEC 61000-4-5</p>	<p>±1kV line (s) to line(s) ±2kV line(s) to earth</p>	<p>±1kV differential mode ±2kV common mode</p>	<p>Mains power quality should be that of a typical commercial or hospital environment.</p>
<p>Voltage dips, short interruptions and voltage variations on power supply input lines IEC61000-4-11</p>	<p><5 % U_T (>95 % dip in U_T) for 0,5 cycle 40 % U_T (60 % dip in U_T) for 5 cycles 70 % U_T (30 % dip in U_T) for 25 cycles <5 % U_T (>95 % dip in U_T) for 5 s</p>	<p><5 % U_T (>95 % dip in U_T) for 0,5 cycle 40 % U_T (60 % dip in U_T) for 5 cycles 70 % U_T (30 % dip in U_T) for 25 cycles <5 % U_T (>95 % dip in U_T) for 5 s</p>	<p>Mains power quality should be that of a typical commercial or hospital environment. If the user of the equipment or system requires continued operation during power mains interruptions, it is recommended that the equipment or system be powered from an uninterruptible power supply or a battery.</p>
<p>Power frequency(50Hz/60Hz) magnetic field IEC61000-4-8</p>	<p>3A/m</p>	<p>3A/m</p>	<p>Power frequency magnetic fields should be at levels characteristic of a typical location in a typical commercial or hospital environment.</p>
<p>NOTE U_T is the a.c. mains voltage prior to application of the test level.</p>			

Table 3

Guidance and manufacturer’s declaration – electromagnetic immunity-for EQUIPMENT and SYSTEM that are not LIFE-SUPPORTING

VITAL Vital Signs Monitor is intended for use in the electromagnetic environment specified below. The customer or the user of VITAL Vital Signs Monitor should assure that it is used in such an electromagnetic environment.

IMMUNITY test	IEC 60601 test level	Compliance level	Electromagnetic environment - guidance
Conducted RF IEC 61000-4-6	3 Vrms 150 kHz to 80 MHz	3V	<p>Portable and mobile RF communications equipment should be used no closer to any part of VITAL Vital Signs Monitor, including cables, than the recommended separation distance calculated from the equation applicable to the frequency of the transmitter.</p> <p>Recommended separation distance</p> $d = 1.2 \sqrt{P}$ $d = 1.2 \sqrt{P} \quad 80 \text{ MHz to } 800 \text{ MHz}$ $d = 2.3 \sqrt{P} \quad 800 \text{ MHz to } 2,5 \text{ GHz}$ <p>Where P is the maximum output power rating of the transmitter in watts (W) according to the transmitter manufacturer and d is the recommended separation distance in metres (m).^b</p> <p>Field strengths from fixed RF transmitters, as determined by an electromagnetic site survey,^a should be less than the compliance level in each frequency range.^b</p> <p>Interference may occur in the vicinity of equipment marked with the following symbol.</p> 
Radiated RF IEC 61000-4-3	3 V/m 80 MHz to 2.5 GHz	3 V/m	

NOTE 1: At 80 MHz and 800 MHz, the higher frequency range applies.

NOTE 2: These guidelines may not apply in all situations. Electromagnetic propagation is affected by absorption and reflection from structures, objects and people.

a: Field strengths from fixed transmitters, such as base stations for radio (cellular / cordless) telephones and land mobile radios, amateur radio, AM and FM radio broadcast and TV broadcast cannot be predicted theoretically with accuracy. To assess the electromagnetic environment due to fixed RF transmitters, an electromagnetic site survey should be considered. If the measured field strength in the location in which VITAL Vital Signs Monitor is used exceeds the applicable RF compliance level above, VITAL Vital Signs Monitor should be observed to verify normal operation. If abnormal performance is observed, additional measures may be necessary, such as re-orienting or relocating VITAL Vital Signs Monitor.

b: Over the frequency range 150 kHz to 80 MHz, field strengths should be less than 3V/m.

Table 4

Recommended separation distances between portable and mobile RF communications equipment and The equipment or system- for EQUIPMENT and SYSTEM that are not LIFE-SUPPORTING

VITAL Vital Signs Monitor is intended for use in an electromagnetic environment in which radiated RF disturbances are controlled. The customer or the user of the equipment or system can help prevent electromagnetic interference by maintaining a minimum distance between portable and mobile RF communications equipment (transmitters) and the equipment or system as recommended below, according to the maximum output power of the communications equipment.

Rated maximum output power of transmitter W	Separation distance according to frequency of transmitter m		
	150kHz to 80MHz $d = 1.2 \sqrt{P}$	80MHz to 800MHz $d = 1.2 \sqrt{P}$	80MHz to 2,5GHz $d = 2.3 \sqrt{P}$
0,01	0.12	0.12	0.23
0,1	0.38	0.38	0.73
1	1.2	1.2	2.3
10	3.8	3.8	7.3
100	12	12	23

For transmitters rated at a maximum output power not listed above, the recommended separation distance d in meters (m) can be determined using the equation applicable to the frequency of the transmitter, where p is the maximum output power rating of the transmitter in watts (W) according to the transmitter manufacturer.

NOTE 1: At 80 MHz and 800 MHz, the separation distance for the higher frequency range applies.

NOTE 2: These guidelines may not apply in all situations. Electromagnetic propagation is affected by absorption and reflection from structures, objects and people.

Chapter 7 Packaging and Accessories

7.1 Packaging

The product is packed in high quality corrugated cartons with foam inside to protect the equipment against damage in the shipping and handling process.

Weight: Details see the indication on the outer package.

Dimension: 360(L)×320(W)×410(H) (mm)

7.2 Accessories

(1) ECG cable with lead wire	One set
(2) ECG electrodes	Twenty five pieces
(3) NIBP cuff	One piece
(4) SpO ₂ probe	One piece
(5) Temperature probe	One piece
(6) Power cord	One piece
(7) Grounding wire	One piece
(8) User manual	One copy
(9) Quality Certificate	One copy
(10) Warranty	Two copies
(11) Packing list	Two copies

Note: The accessories are subject to change. Detailed items and quantity see the Packing List.

Chapter 8 Monitoring Parameter

8.1 ECG Monitoring

8.1.1 How to Obtain High Quality ECG and Accurate Heart Rate Value

The electrocardiogram (ECG or EKG) is primarily a tool for evaluating the electrical events within the heart. The action potentials of cardiac-muscle cells can be viewed as batteries that cause charge to move throughout the body fluids. These currents represent the sum of the action potentials occurring simultaneously in many individual cells and can be detected by recording electrodes at the surface of the skin. The figure below shows the system of the heart.

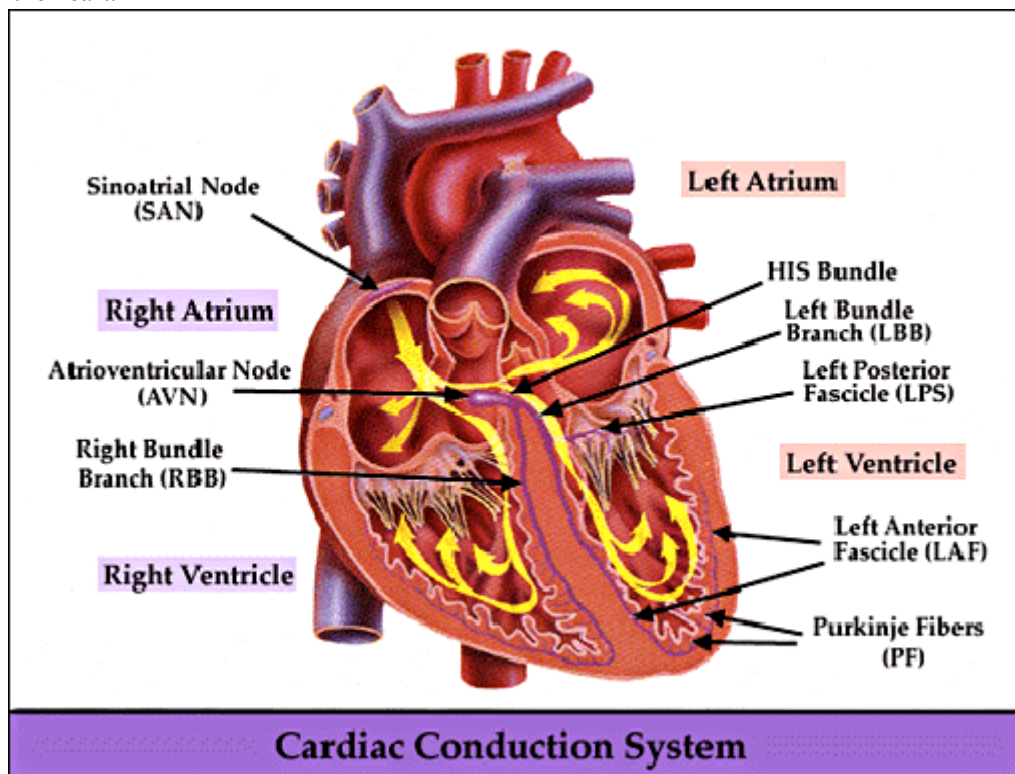

First of all, the hospital should be equipped with a 100~240V power supply system with a typical grounding wire. If big interference in ECG continues, connect one end of the grounding wire provided with this equipment to the grounding wire on the back panel of this monitor, and the other end to the special grounding wire, water pipe or radiator.

A common ECG plate electrode used together with this monitor has short shelf life. Generally, the shelf life is only one month after the package is opened. When outdated plate electrode is used, due to skin's contact impedance and big electrode potential, the chance of interference will be increased, and the ECG baseline will have an unstable inclination. Therefore, always use valid plate electrodes.

8.1.2 Factors affecting ECG signal

- ✧ Interference from Electrosurgical Unit;
- ✧ Doesn't filter the interference waveform;
- ✧ Poor grounding;
- ✧ Electrodes are not placed properly;
- ✧ Use expired electrode or use disposable electrode repeatedly;
- ✧ The skin placed electrode is unclean or poor contact caused by scurf and hair;
- ✧ Electrode long-time used.

8.2 NIBP Monitoring

8.2.1 Measuring Principle

Blood pressure may be measured in an invasive way (whereby the sensor will be inserted into blood vessel directly) or a non-invasive way. The non-invasive way includes several methodologies, such as the Korotkoff Sound Method and oscillating method. The Korotkoff Sound Method is used as a conventional way, whereby stethoscope is used to measure the blood pressure. By the oscillating method, an inflation pump will fill the air, and release it slowly. A computer will record change of the cuff pressure when the air is released. With this record, the blood pressure value will be determined. First of all, make sure the signal quality judgment by computer meets the requirements of accurate calculation (such as sudden limb movement or cuff being hit during the measurement). If the answer is negative, give up the calculation. If the answer is positive, proceed with calculation of the blood pressure value.

As change of the blood pressure is recorded by electric sensor, which sensitivity is much higher than that of human ears, the oscillating method uses different definitions for measurement of diastolic pressure, mean arterial pressure and systolic pressure from the Korotkoff Sound Method. When the oscillating method is used, the circuit in the measuring apparatus will separate the amplitude of the cuff pressure from its change with pulsation. With the oscillating method, the blood pressure at the maximum amplitude of cuff pressure is defined as the mean arterial pressure. The blood pressure at amplitude of cuff pressure forward reduced according to proper proportion is defined as systolic pressure, while the blood pressure at amplitude of cuff pressure backward reduced according to proper proportion is defined as diastolic pressure. The maximum change of pulse pressure occurs at these two points. They are equivalent to the point with pulse sound and the point without pulse sound respectively in the Korotkoff Sound Method.

When the risk of invasive monitoring method outweighs its advantage of accuracy, non-invasive monitoring method shall be used.

Comparison between blood pressure measuring methods

To overcome the effect of human hearing variation and air release speed on measurement accuracy when the conventional Korotkoff Sound Method is used to take measure of blood pressure, people have been dedicated to study of automatic measurement of blood pressure. By now, automatic blood pressure measuring system based on the principle of oscillating method is mature. In practice, however, various problems are encountered, such as why the measures taken by the oscillating method is lower or higher than

those taken by Korotkoff Sound Method? Why the measures are inclined to decline? Why, in some cases, no result is obtained in spite of the inflation actions? Why the measure values have big discreteness and even abnormal data in some cases? Why the SpO₂ waveforms may disappear suddenly? ...and so on. The following explanations are devised to give the answers.

The Oscillating method vs. the Korotkoff Sound Method

Blood pressure measurement by the oscillating method and Korotkoff Sound Method has good correlation with the invasive measurement. Notwithstanding, any of the non-invasive blood pressure measurements has its one-sidedness when it is compared to the invasive measurement. The oscillating method has its advantages over the Korotkoff Sound Method in less error, higher reliability and stability. Their differences may be reflected in the following aspects.

1. The measures by the Korotkoff Sound Method are liable to effect of human factors. For example, different people may have different sound judging ability, or different reactivity when listening to heart sound and reading mercury meter. The air release speed and subjectivity may also affect the judgment. By the oscillating method, the computation is accomplished by the computer, thus relieving the possibility of effect due to human factor.
2. With the Korotkoff Sound Method, the measure is taken on the basis of appearance and disappearance of heart sound. The air release speed and heart rate may have direct effect on the measurement accuracy. It also has the disadvantages of rapid air release and poor accuracy. In the contrast, with the oscillating method, the determination is calculated on the basis of cuff pressure oscillatory waveform envelope, and the air release speed and heart rate has little effect on the measurement accuracy.
3. Statistics show that, when measuring the hypertension, the measure taken by the oscillating method is likely to be lower than that taken by the Korotkoff Sound Method. When measuring the hypotension, the measure taken by the oscillating method is likely to be higher than that by the Korotkoff Sound Method. But, it doesn't mean the advantages or disadvantages between the oscillating method and the Korotkoff Sound Method. Comparison with the results taken by more accurate method, let's say comparison of the invasive pressure result with the output value by the blood pressure measuring simulator, will show which method has more accurate results. In addition, higher or lower value should be a statistical concept. It is recommended those used to adopt the Korotkoff Sound Method use different physiological calibration for values determined by the oscillating method.
4. The studies have shown that the Korotkoff Sound Method has the worst accuracy when it comes to measurement of hypotension, while the oscillating method has worse accuracy when it comes to measurement of controlled hypertension relief.

8.2.2 Factors affecting NIBP measuring

- ✧ Select a cuff of appropriate size according to the age of the subject.
- ✧ Its width should be 2/3 of the length of the upper arm. The cuff inflation part should be long enough to permit wrapping 50-80% of the limb concerned.

Prior to use of the cuff, empty the cuff until there is no residual air inside it to ensure accurate measurement.

Make the cuff mark ϕ in the position where artery pulsates obviously, the effect will be best.

The lower part of cuff shall 2cm above the elbow joint.
- ✧ Do not wrap the cuff on too thick clothes(especially for cotton-padded clothes and sweater) to take measurement;
- ✧ The testee shall lie in bed or sit in chair, make the cuff and heart at the same level, the result will be most accurate, other postures may have inaccurate result;

- ✧ During measuring, do not move your arm or the cuff;
- ✧ The measuring interval shall longer than 2 minutes, in continuous measurement, too short interval may cause arm extrusion, blood quantity increases, then cause blood pressure increases.
- ✧ Keep the patient still and stop talking before and during measuring;
- ✧ The patient's mood also can affect the measuring result, when exciting, the blood pressure goes up.
- ✧ The measuring result also affected by time, lower in the morning and higher in the evening;

8.2.3 Clinical Limitations

1. Serious angiospasm, vasoconstriction, or too weak pulse.
2. When extremely low or high heart rate or serious arrhythmia of the subject occurs. Especially auricular fibrillation will lead to unreliable or impossible measurement.
3. Do not take the measurement when the subject is connected with an artificial heart-lung machine.
4. Do not take the measurement when the subject uses diuresis or vasodilator.
5. When the subject is suffering from major hemorrhage, hypovolemic shock and other conditions with rapid blood pressure change or when the subject has too low body temperature, the reading will not be reliable, for reduced peripheral blood flow will lead to reduced arterial pulsation.
6. Subject with hyperadiposis;

In addition, statistics show that 37% people report blood pressure difference of no less than 0.80kPa(6mmHg) between the left and right arms, and 13% people report difference of no less than 1.47kPa (11mmHg).

Note: Some practitioners may report big discreteness or abnormal value of the blood pressure measures when the oscillating method is used. As a matter of fact, the so-called “big discreteness” must be a term in the sense of statistical significance of mass data. Abnormal data may be observed in some individual cases. It is normal in the scientific experiments. It may be caused by an apparent reason, or by an unknown factor in some cases. Such individual doubtful experimental data may be identified and eliminated using the special statistical technique. It is not a part of this manual. The practitioner may eliminate the apparently unreasonable data according to the experience.

8.3 SpO₂ Monitoring

8.3.1 Measuring Principle

Based on Lamber-Beer law, the light absorbance of a given substance is directly proportional with its density or concentration. When the light with certain wavelength emits on human tissue, the measured intensity of light after absorption, reflecting and attenuation in tissue can reflect the structure character of the tissue by which the light passes. Due to that oxygenated hemoglobin (HbO₂) and deoxygenated hemoglobin (Hb) have different absorption character in the spectrum range from red to infrared light (600nm~1000nm wavelength), by using these characteristics, SpO₂ can be determined. SpO₂ measured by this monitor is the functional oxygen saturation -- a percentage of the hemoglobin that can transport oxygen. In contrast, hemoximeters report fractional oxygen saturation – a percentage of all measured hemoglobin, including dysfunctional hemoglobin, such as carboxyhemoglobin or methahemoglobin.

8.3.2 SpO₂ Measurement Restrictions (interference reason)

- ✧ Intravascular dyes such as indocyanine green or methylene blue
- ✧ Exposure to excessive illumination, such as surgical lamps, bilirubin lamps, fluorescent lights, infrared heating lamps, or direct sunlight.
- ✧ Vascular dyes or external used color-up product such as nail enamel or color skin care
- ✧ Excessive patient movement
- ✧ Placement of a sensor on an extremity with a blood pressure cuff, arterial catheter, or intravascular line
- ✧ Exposure to the chamber with high pressure oxygen
- ✧ There is an arterial occlusion proximal to the sensor
- ✧ Blood vessel contraction caused by peripheral vessel hyperkinesias or body temperature decreasing

8.3.3 Low SpO₂ measuring value caused by pathology reason

- ✧ Hypoxemia disease, functional lack of HbO₂
- ✧ Pigmentation or abnormal oxyhemoglobin level
- ✧ Abnormal oxyhemoglobin variation
- ✧ Methemoglobin disease
- ✧ Sulfhemoglobinemia or arterial occlusion exists near sensor
- ✧ Obvious venous pulsations
- ✧ Peripheral arterial pulsation becomes weak
- ✧ Peripheral blood supply is not enough

8.3.4 Clinical Limitations

- ✧ As the measure is taken on the basis of arteriole pulse, substantial pulsating blood stream of subject is required. For a subject with weak pulse due to shock, low ambient/body temperature, major bleeding, or use of vascular contracting drug, the SpO₂ waveform (PLETH) will decrease. In this case, the measurement will be more sensitive to interference.
- ✧ For those with a substantial amount of staining dilution drug (such as methylene blue, indigo green and acid indigo blue), or carbon monoxide hemoglobin (COHb), or methionine (Me+Hb) or thiosalicylic hemoglobin, and some with icterus problem, the SpO₂ determination by this monitor may be inaccurate.
- ✧ The drugs such as dopamine, procaine, prilocaine, lidocaine and butacaine may also be a major factor blamed for serious error of SpO₂ measurements.
- ✧ As the SpO₂ value serves as a reference value for judgment of anemic anoxia and toxic anoxia, the measurement result of some patients with serious anemia may also present as good SpO₂ value.

8.3.5 Points to be noted in SpO₂ and Pulse Measuring

- ✧ The finger should be properly placed (see the attached illustration of this instruction manual), or else it may cause inaccurate measurement result.
- ✧ Make sure that capillary arterial vessel beneath the finger is penetrated through by red and infrared lights.
- ✧ The SpO₂ sensor should not be used at a location or limb tied with arterial or blood pressure cuff or receiving intravenous injection.
- ✧ Do not fix the SpO₂ sensor with adhesive tape, or else it may result in venous pulsation and consequential inaccurate measurement result of SpO₂.
- ✧ Make sure the optical path is free from any optical obstacles like adhesive tape.
- ✧ Excessive ambient light may affect the measuring result. It includes fluorescent lamp, dual ruby light, infrared heater, and direct sunlight etc.
- ✧ Strenuous action of the subject or extreme electrosurgical interference may also affect the accuracy.
- ✧ Please do not use the SpO₂ sensor when having the MRI, or burn may be caused by faradism.
- ✧ Always observe the plethysmogram (waveform), which is auto-scaled within the range of 100. The SpO₂ reading may be unlikely true when the waveform is not smooth or irregular. If in doubt, rely on your clinical judgment, rather than the monitor readout.
- ✧ A functional tester cannot be used to assess the accuracy of the pulse oximeter monitor or a SpO₂ sensor. However, a functional tester, such as SpO₂ simulator can be used to check how accurately a particular pulse oximeter is reproducing the given calibration curve. Before testing the oximeter by a functional tester, please firstly ask the manufacturer which calibration curve is used, if necessary, request the manufacturer for its dedicated calibration curve and download it into the tester.

8.4 Temperature Monitoring

The sensor is thermo-resistor type (25°C 5kΩ) and is supplied with constant micro current. Calculating the temperature of measured part through measuring the voltage. There is a period responding time, so the accurate temperature value display after a while. The temperature monitoring can be divided into two measuring method: measure through body surface temperature and through the temperature inside the body cavity (placed in mouth or anus).

Normal value: body surface: 36.5°C ~37°C; inside body cavity: 36.5°C ~37.7°C

Notes:

- Attach the TEMP transducer to the patient; generally if the TEMP transducer and skin doesn't contact closely, the measured value becomes lower, so for those who have requirement for temperature, add a proper martial to transducer and fix it with adhesive tape to make them contact firmly.
- Especially for pediatric patient, they like sports, pay more attention to the transducer fixing.

Chapter 9 Troubleshooting

9.1 No Display on the Screen

Shut down the machine and unplug the power. Use a universal meter to check if the outlet has proper voltage, if the power cable is in good condition, and if the power cable is properly connected with this apparatus or outlet. Remove the fuse from the back cover of this machine, and make sure it is in good condition.

9.2 Excessive ECG Signal Interference or Too Thick Baseline

1. Check if the plate electrodes are properly located, and if valid plate electrodes are used.
2. Check whether the lead wires are inserted properly. If no ECG curve is displayed, check if the ECG lead wires are broken.
3. Make sure the mains outlet has standard grounding wire.
4. Check if the grounding wire of the apparatus is properly grounded.

9.3 No Blood Pressure and Pulse Oxygen Measures

1. Check if the blood pressure cuff is properly wrapped around the arm according to the operating instructions, if the cuff leaks, and if the inlet is closely connected with the NIBP jack on the side panel. Check if the indicator of the pulse oxygen probe flashes and if the pulse oxygen probe is properly connected to the SpO₂ jack on the side panel.
2. If the problems still exist, please contact the local dealer.

9.4 Blank Printing Paper

1. Check whether the printing paper is installed with its face reversed. Please reinstall it and let the sensitive page face upward.
2. If the problems still exist, please contact the local dealer.

9.5 System Alarm

1. When the parameter value is higher or lower than the alarm limits, the alarm will ring. Please check whether the alarm limit value is proper or the condition of the patient.
2. Probe off. Please check the connection of the probes.

Note: In case of trouble of this machine in the service, follow the instructions below to eliminate the problem first. If the attempt fails, contact the dealer in your local area or the manufacturer. Do not open the cabinet without permission.

Chapter 10 Maintenance

10.1 Service and Examination

10.1.1 Daily Examination

Before using the monitor, the checks below should be carried out:

- Check the monitor for any mechanical damage;
- Inspect the exposed parts and the inserted parts of all the leads, and the accessories;
- Examine all the functions of the monitor that are likely to be used for patient monitoring, and ensure that it is in good working condition;
- Make sure that the monitor is grounded properly.
- Pay close attention to the fluctuation of the local power supply voltage. A manostat is recommended when necessary.
- In case any indication of damage about the function of the monitor is detected and proven, it is not allowed to apply it to the patient for any monitoring.

10.1.2 Routine Maintenance

After each maintenance or the yearly maintenance, the monitor can be thoroughly inspected by qualified personnel, including function and safety examinations. The designed life of this monitor is 5 years. In order to ensure its long service life, please pay attention to the maintenance.

- ⚠ **If the hospital fails to carry out a satisfactory maintenance program about the monitor, it may get disabled and harm the patient's safety and health.**
- ⚠ **In case of ECG leads damage or aging, please replace the lead.**
- ⚠ **If there is any indication of cable and transducer damage or they deteriorate, they are prohibited from any further use.**
- 🔔 **The adjustable units in the monitor such as potentiometer are not allowed to adjust without permission to avoid unnecessary failures that affect normal application.**

10.1.3 Battery Maintenance

- ⚠ **Please pay attention to the polarity of battery, do NOT insert it into battery compartment with reversed polarities;**
- ⚠ **Do NOT use the batteries manufactured by other companies, if being inserted, the device will may be damaged;**
- ⚠ **In order to avoid damaging the battery, do NOT use other power supply device to charge the battery;**

- ⚠ After battery ageing phenomenon occurring, to avoid explosion risk do NOT throw the battery into fire.
- ⚠ Do not hit or strike it with force;
- ⚠ Do not use this battery on other devices;
- ⚠ Do not use this battery below -10°C or above 40°C;
- ⚠ Dispose of the battery, the local law should be followed.
- 🔔 In order to maintain battery supply time and prolong battery lifetime, please charge the battery every one or two months if don't use battery for a long time. And do charge battery at least 12-15 hours every time. Before connect to AC, do start monitor with battery's power supply, until battery power is used up and monitor turn off automatically, then connect monitor to AC and have it charged for 12-15 hours continuously. The speed of charge will be the same no matter whether the monitor is working or not. The reason why discharge the battery before charge is to avoid the decrease of capacity caused by battery's memory effect. If the monitor won't be used for a long time, do have it charged fully before conservation.
- 🔔 When starting the monitor by battery power only which is short of supply, monitor will turn off automatically. In order to avoid the damage to battery caused by excessive discharge, please pay attention to following. After monitor turns off automatically, there is still small drain current inside battery, so it is suggested that user should press the power button again to cut off the power supply. If battery keeps in a state of small drain current, battery will be damaged and can't be repaired because of excessive discharged. It is recommended to use the battery once a month to ensure its strong power supply capacity and long service life, and recharge it after running out of the power.
- 🔔 If battery is damaged, please replace with same type and specification battery marked by "CCC" or "CE" in time, or contact the company directly

10.1.4 Service

If the monitor has functional malfunction or is not working, please contact the local dealer or our company, and we are to offer the best solution as soon as possible for your satisfaction. Only qualified service engineer specified by the manufacture can perform the service. Users are not permitted to repair it by themselves.

10.2 Cleaning, Sterilization and Disinfection

- Kept the monitor from dust.
- It is recommended to clean the outer shell and screen of the monitor to keep it clean. Only non-corrosive cleanser such as clear water is permitted.
- Use the cloth with alcohol to wipe the surface of the monitor and transducers, and dry it with dry and clean cloth or simply air-dry.
- The monitor can be sterilized and disinfected, please clean it first.
- ⚠ Switch off the monitor and disconnect the power cable before cleaning.
- ⚠ Do not let the liquid cleanser flow into the connector jack of the monitor to avoid damage.

- **Clean the exterior of the connector only.**
- 🔔 **Dilute the cleanser.**
- 🔔 **Do not let any liquid flow into the shell or any parts of the monitor.**
- 🔔 **Do not let the cleanser and disinfectant stay on its surface.**
- 🔔 **Do not perform high pressure sterilization to the monitor.**
- 🔔 **Do not put any parts of the monitor or its accessories in the liquid.**
- 🔔 **If the monitor is accidentally wetted it should be thoroughly dried before use. The rear cover can be removed by qualified service technician to verify absence of water.**
- 🔔 **Do not pour the disinfectant on its surface while sterilization.**

10.3 Cleaning, Sterilization and Disinfection of Accessories

It is recommended to clean the accessories (including sensor, leads and plugs) with a piece of gauze which has been soaked in 75% Alcohol or 70% Isopropanol before use.

- **Do not use damaged accessories.**
- **Accessories can not be entirely immersed into water, liquor or cleanser.**
- **Do not use radial, steam or epoxyethane to disinfect accessories.**
- **Do wipe off the remained alcohol or isopropanol on the accessories after disinfection, for good maintenance can extend the life of accessories.**

10.4 Storage

If the equipment will not be used for long period of time, wipe it clean and keep it in the packaging, which shall be kept in a dry and good ventilation place free from dust and corrosive gases.

Storage environment: ambient temperature: -20~60°C
 relative humidity: 10%~95%
 atmosphere: 50kPa~107.4kPa

10.5 Transportation

This monitor should be transported by land (vehicle or railway) or air in accordance with the contractual terms. Do not hit or drop it with force.

Chapter 11 Appendix

11.1 Prompt information explanations

Mute C-D: XXX seconds	Alarm silence count down: XXX seconds
NIBP C-D: XXX seconds	NIBP auto measuring cycle count down: XXX seconds
TOUR C-D: XXX seconds	Tourniquet alert count down: XXX seconds
Probe off	SpO ₂ probe falls off
PR over limit	PR value exceeds the high/low alarm limit
SpO ₂ over limit	SpO ₂ value exceeds the high/low alarm limit
SYS over limit	Systolic pressure value exceeds the high/low alarm limit
DIA over limit	Diastolic pressure value exceeds the high/low alarm limit
MAP over limit	MAP value exceeds the high/low alarm limit
NIBP error 1#	Sensor or other hardware error
NIBP error 2#	Very weak signal because of the cuff, or the patient has very weak pulse
NIBP error 3#	Blood pressure amplifier overflow due to excessive movement
NIBP error 4#	Leaking during the pneumatic device testing
Cuff error	Cuff is not wrapped correctly, or is not connected
NIBP error 5#	Abnormal condition of CPU, such as register overflow, divided by zero
Air leak	Air moving part, tube or the cuff leak air
NIBP over range	The measurement range exceeds 255mmHg (for neonates: over 135 mmHg)
Over motion	The repeated measurement due to moving, excessive noise during the stepping inflation and measuring pressure and pulse, e.g. during patient shaking motion
Over pressure	Cuff press exceeds the safety limit value of software. Limit value for adult: 290mmHg; Limit value for pediatric: 145mmHg; Or caused by cuff extrusion or flapping cuff with force.
NIBP timeout	Adult measurement is more than 120 seconds, neonate measurement is more than 90 seconds.

11.2 Default Alarming Values and Setup Range

The default alarming value:

Mode		Adult	Pediatric	Neonate
Parameter				
HR	High limit	180bpm	200bpm	220bpm
	Low limit	40bpm	50bpm	50bpm
SYS	High limit	180mmHg	130mmHg	110mmHg
	Low limit	60mmHg	50mmHg	50mmHg
DIA	High limit	120mmHg	90mmHg	90mmHg
	Low limit	50mmHg	40mmHg	30mmHg
MAP	High limit	160mmHg	110mmHg	100mmHg
	Low limit	50mmHg	40mmHg	30mmHg
SpO ₂	High limit	100%	100%	100%
	Low limit	90%	85%	85%
Pulse rate	High limit	180bpm	200bpm	220bpm
	Low limit	40bpm	50bpm	50bpm
TEMP	High limit	39.0°C	39.0°C	39.0°C
	Low limit	35.0°C	35.0°C	35.0°C

The high and low limits setting range:

Mode		Adult	Pediatric	Neonate
Parameter				
HR	High limit	(1~350) bpm	(1~350) bpm	(1~350) bpm
	Low limit	(0~349) bpm	(0~349) bpm	(0~349) bpm
SYS	High limit	(30~280) mmHg	(30~200) mmHg	(30~135) mmHg
	Low limit	(29~279) mmHg	(29~199) mmHg	(29~134) mmHg
DIA	High limit	(11~232) mmHg	(11~150) mmHg	(11~100) mmHg
	Low limit	(10~231) mmHg	(10~149) mmHg	(10~99)mmHg
MAP	High limit	(21~242) mmHg	(21~165) mmHg	(21~110) mmHg
	Low limit	(20~241) mmHg	(20~164) mmHg	(20~109)mmHg
SpO ₂	High limit	1~100%	1~100%	1~100%
	Low limit	0~99%	0~99%	0~99%
Pulse rate	High limit	(1~300) bpm	(1~350) bpm	(1~350) bpm
	Low limit	(0~299) bpm	(0~349) bpm	(0~349) bpm
TEMP	High limit	(0.1~60) °C	(0.1~60) °C	(0.1~60) °C
	Low limit	(0~59.9) °C	(0~59.9) °C	(0~59.9) °C

11.3 Abbreviation of arrhythmia

1. ECG TACHY
2. ECG BRADY
3. ECG VPCEST
4. MISS BEAT
5. VE EARLY
6. SVE EARLY
7. VE COUPLET
8. SVE COUPLET
9. VE RUN
10. SVE RUN
11. VE SHORT RUN
12. SVE SHORT RUN
13. VE BIGEMINY
14. SVE BIGEMINY
15. VE TRIGEMINY
16. SVE TRIGEMINY
17. VE INSERT
18. SVE INSERT
19. VE RONT
20. SVE RONT

11.4 Accessories List

Part No.	Part Name	Remark
15010513	ECG cable	
5101-0101310	ECG electrode	
15044051	Adult SpO ₂ Finger clip sensor	
15044061	Adult SpO ₂ Finger rubber sensor	Optional
15044041	Pediatric SpO ₂ Finger clip sensor	Optional
15044063	Neonate SpO ₂ Y-type sensor	Optional
15024402	Adult NIBP cuff(25~35cm)	
15021402	Small-sized Pediatric NIBP cuff	Optional
15022402	Middle-sized Pediatric NIBP cuff	Optional
15023402	Large-sized Pediatric NIBP cuff	Optional
15020400	Neonate NIBP cuff(5.4*9.1cm)	Optional
15084120	Skin TEMP probe	
5101-5236310	Thermal printer paper	Optional
2903-0000000	Power cord	
2911-0003032	Grounding wire	
900093	Net wire	Optional

For more information regarding the accessories, please contact your local sales representative or the manufacturer.

Note: Part no. is subject to change without prior notice, please refer to the label of parts or packlist.

11.5 Instructions for SpO₂ Probe

Instructions for Neonate SpO₂ Y-type Sensor

Intended Use

When used with a compatible patient monitor or a pulse oximeter device, this sensor is intended to be used for continuous, non-invasive functional arterial oxygen saturation (SpO₂) and pulse rate monitoring for neonates (1-3 kg).

Contraindications

This sensor is contraindicated for use on active patients or for prolonged use.

Instructions for Use

- 1) Insert the two sensor tips into the slots on the rubber wrap (A); place the sensor on the neonate's foot (B), wrap the rubber belt around the foot and tighten accordingly (C).
- 2) Plug the sensor into the oximeter and verify proper operation as described in the oximeter operator's manual.
- 3) Inspect the monitoring site every 4 hours for skin integrity.

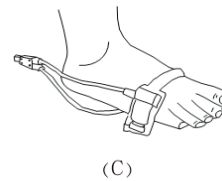
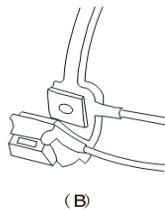
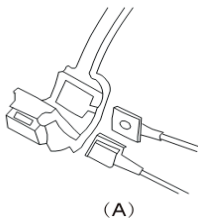

Cleaning & Disinfection

Unplug the sensor before cleaning or disinfecting. Surface-clean sensor and cable with a soft gauze pad by saturating it with a solution such as 70% isopropyl alcohol. If low-level disinfection is required, use a 1:10 bleach solution.

Warnings

- 1) Some factors may affect the accuracy of saturation measurements. Such factors include: excessive
- 2) patient motion, fingernail polish, use of intravascular dyes, excessive light, poorly perfused finger, extreme finger sizes or improper placement of the sensor.
- 3) The sensor must be checked for skin integrity at least every 4 hours. Because individual skin condition affects the ability of the skin to tolerate sensor placement, it may be necessary to change the sensor site.
- 4) Do not use NIBP or other constraining instruments on same appendage as sensor for blood flow interrupted by NIBP cuff or circulatory patient condition will result in no pulse found or loss of pulse.
- 5) Do not use the sensor during MRI scanning. Carefully route cables to reduce the possibility of patient entanglement or strangulation.
- 6) Do not alter or modify the sensor. Alterations or modifications may affect performance or accuracy.
- 7) Do not use the sensor if the sensor or the sensor cable appears damaged.

Caution: Do not sterilize by irradiation steam, or ethylene oxide.

Instructions for Pediatric SpO₂ Finger Clip Sensor

Intended Use

When used with a compatible patient monitor or a pulse oximeter device, the sensor is intended to be used for continuous, non-invasive functional arterial oxygen saturation (SpO₂) and pulse rate monitoring for pediatric patients weighing between 10~40kg.

Contraindications

This sensor is contraindicated for use on active patients or for prolonged use.

Instructions for Use

- 1) With the upper and lower jaws open, place an index finger evenly on the base of the clip. Push the finger tip against the stop so that it is over the sensor window (A). If an index finger cannot be positioned correctly, or is not available, other fingers can be used.
- 2) Note: When selecting a sensor site, priority should be given to an extremity free of an arterial catheter, blood pressure cuff, or intravascular infusion line.
- 3) Spread open the rear tabs of the sensor to provide even force over the length of the pads (B).
- 4) The sensor should be oriented in such a way that the cable is positioned along the top of the hand (C).
- 5) Plug the sensor into the oximeter and verify proper operation as described in the oximeter operator's manual.
- 6) Inspect the monitoring site every 4 hours for skin integrity.
- 7) Before each use, surface-clean sensor and cable with a soft gauze pad by saturating it with a solution such as 70% isopropyl alcohol. If low-level disinfection is required, use a 1:10 bleach solution.

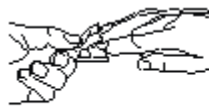

(A)



(B)



(C)

Caution: Do not sterilize by irradiation steam, or ethylene oxide.

Warnings

- 1) Some factors may affect the accuracy of saturation measurements. Such factors include: excessive patient motion, fingernail polish, use of intravascular dyes, excessive light, poor blood perfusion in the finger, extreme finger sizes or improper placement of the sensor.
- 2) Using the sensor in the presence of bright lights may result in inaccurate measurements. In such cases, cover the sensor site with an opaque material.
- 3) The sensor must be moved to a new site at least every 4 hours. Because individual skin condition affects the ability of the skin to tolerate sensor placement, it may be necessary to change the sensor site more frequently with some patients. If skin integrity changes, move the sensor to another site.
- 4) Do not apply tape to secure the sensor in place or to tape it shut; venous pulsation may lead to inaccurate saturation measurements.
- 5) Do not immerse sensor as it causes short.
- 6) Do not use NIBP or other constructing instruments on same appendage as sensor for blood flow interrupted by NIBP cuff or circulatory patient condition will result in no pulse found or loss of pulse.
- 7) Do not use the sensor or other oximetry sensors during MRI scanning.
- 8) Carefully route cables to reduce the possibility of patient entanglement or strangulation.
- 9) Do not alter or modify the sensor. Alterations or modifications may affect performance or accuracy.
- 10) Do not use the sensor if the sensor or the sensor cable appears damaged.

Instructions for Adult SpO₂ Finger Rubber Sensor

Intended Use

When used with a compatible patient monitor or a pulse oximeter device, this SpO₂ sensor is intended to be used for continuous, non-invasive functional arterial oxygen saturation (SpO₂) and pulse rate monitoring for patients weighing greater than 50kg.

Contraindications

This sensor is contraindicated for use on active patients or for prolonged use.

Instructions for Use

- 1) Hold the sensor with its opening towards the patient's index finger (A). The sensor should be oriented in such a way that the sensor side with a finger tip sign is positioned on the top.
- 2) Insert the patient's index finger into the sensor until the fingernail tip rests against the stop at the end of the sensor. Adjust the finger to be placed evenly on the middle base of the sensor. Direct the cable along the top of the patient's hand. Apply adhesive tape to secure the cable (B). If an index finger cannot be positioned correctly, or is not available, other fingers can be used.
- 3) Plug the sensor into the oximeter and verify proper operation as described in the oximeter operator's manual.
- 4) Inspect the monitoring site every 4 hours for skin integrity.

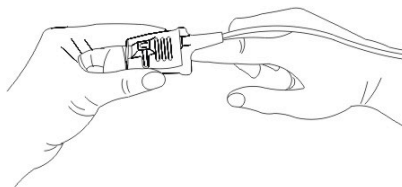

(A)

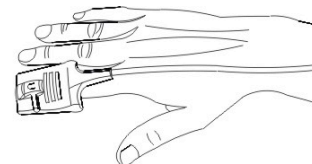

(B)

Cleaning & Disinfection

Unplug the sensor before cleaning or disinfecting. Surface-clean sensor and cable with a soft gauze pad by saturating it with a solution such as 70% isopropyl alcohol. If low-level disinfection is required, use a 1:10 bleach solution.

Caution: Do not sterilize by irradiation steam, or ethylene oxide.

Warnings

- 1) This sensor is for use only with compatible patient monitors or pulse oximeter devices. Use of this sensor with instruments other than compatibles may result in improper performance.
- 2) Some factors may affect the accuracy of saturation measurements. Such factors include: excessive patient motion, fingernail polish, use of intravascular dyes, excessive light, poorly perfused finger, extreme finger sizes or improper placement of the sensor.
- 3) The sensor site must be checked for skin integrity at least every 4 hours. Because individual skin condition affects the ability of the skin to tolerate sensor placement, it may be necessary to change the sensor to another finger.
- 4) Do not use NIBP or other constraining instruments on same appendage as sensor for blood flow interrupted by NIBP cuff or circulatory patient condition will result in no pulse found or loss of pulse. Do not use the sensor during MRI scanning.
- 5) Carefully route cables to reduce the possibility of patient entanglement or strangulation.
- 6) Do not alter or modify the sensor. Alterations or modifications may affect performance or accuracy.
- 7) Do not use the sensor if the sensor or the sensor cable appears damaged.

Instructions for Adult SpO₂ Finger Clip Sensor

Intended Use

When used with a compatible patient monitor or a pulse oximeter device, the sensor is intended to be used for continuous, non-invasive functional arterial oxygen saturation (SpO₂) and pulse rate monitoring for patients weighing greater than 40kg.

Contraindications

This sensor is contraindicated for use on active patients or for prolonged use.

Instructions for Use

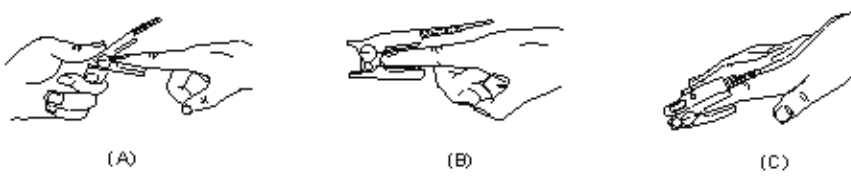
- 1) With the upper and lower jaws open, place an index finger evenly on the base of the clip. Push the finger tip against the stop so that it is over the sensor window (A). If an index finger cannot be positioned correctly, or is not available, other fingers can be used.
 - 2) Note: When selecting a sensor site, priority should be given to an extremity free of an arterial catheter, blood pressure cuff, or intravascular infusion line.
 - 3) Spread open the rear tabs of the sensor to provide even force over the length of the pads (B).
 - 4) The sensor should be oriented in such a way that the cable is positioned along the top of the hand (C).
- 
- 5) Plug the sensor into the oximeter and verify proper operation as described in the oximeter operator's manual.
 - 6) Inspect the monitoring site every 4 hours for skin integrity.
 - 7) Before each use, surface-clean sensor and cable with a soft gauze pad by saturating it with a solution such as 70% isopropyl alcohol. If low-level disinfection is required, use a 1:10 bleach solution.

Caution: Do not sterilize by irradiation steam, or ethylene oxide.

Warnings

- 1) Some factors may affect the accuracy of saturation measurements. Such factors include: excessive patient motion, fingernail polish, use of intravascular dyes, excessive light, poorly perfused finger, extreme finger sizes or improper placement of the sensor.
- 2) Using the sensor in the presence of bright lights may result in inaccurate measurements. In such cases, cover the sensor site with an opaque material.
- 3) The sensor must be moved to a new site at least every 4 hours. Because individual skin condition affects the ability of the skin to tolerate sensor placement, it may be necessary to change the sensor site more frequently with some patients. If skin integrity changes, move the sensor to another site.
- 4) Do not apply tape to secure the sensor in place or to tape it shut; venous pulsation may lead to inaccurate saturation measurements.
- 5) Do not immerse sensor as it causes short.
- 6) Do not use NIBP or other constraining instruments on same appendage as sensor for blood flow interrupted by NIBP cuff or circulatory patient condition will result in no pulse found or loss of pulse.
- 7) Do not use the sensor or other oximetry sensors during MRI scanning.
- 8) Carefully route cables to reduce the possibility of patient entanglement or strangulation.
- 9) Do not alter or modify the sensor. Alterations or modifications may affect performance or accuracy.
- 10) Do not use the sensor if the sensor or the sensor cable appears damaged.



Disposal: *The product must not be disposed of along with other domestic waste. The users must dispose of this equipment by bringing it to a specific recycling point for electric and electronic equipment. For further information on recycling points contact the local authorities, the local recycling center or the shop where the product was purchased. If the equipment is not disposed of correctly, fines or penalties may be applied in accordance with the national legislation and regulations.*

GIMA WARRANTY CONDITIONS

Congratulations for purchasing a GIMA product. This product meets high qualitative standards both as regards the material and the production. The warranty is valid for 12 months from the date of supply of GIMA.

During the period of validity of the warranty, GIMA will repair and/or replace free of charge all the defected parts due to production reasons. Labor costs and personnel traveling expenses and packaging not included. All components subject to wear are not included in the warranty. The repair or replacement performed during the warranty period shall not extend the warranty. The warranty is void in the following cases: repairs performed by unauthorized personnel or with non-original spare parts, defects caused by negligence or incorrect use. GIMA cannot be held responsible for malfunctioning on electronic devices or software due to outside agents such as: voltage changes, electro-magnetic fields, radio interferences, etc. The warranty is void if the above regulations are not observed and if the serial code (if available) has been removed, cancelled or changed.

The defected products must be returned only to the dealer the product was purchased from. Products sent to GIMA will be rejected.