

Spectralink 84-Series Wireless Telephone

# User Guide

## Copyright Notice

© 2013 Spectralink Corporation All rights reserved. Spectralink™, the Spectralink logo and the names and marks associated with Spectralink's products are trademarks and/or service marks of Spectralink Corporation and are common law marks in the United States and various other countries. All other trademarks are property of their respective owners. No portion hereof may be reproduced or transmitted in any form or by any means, for any purpose other than the recipient's personal use, without the express written permission of Spectralink.

All rights reserved under the International and pan-American Copyright Conventions. No part of this manual, or the software described herein, may be reproduced or transmitted in any form or by any means, or translated into another language or format, in whole or in part, without the express written permission of Spectralink Corporation.

Do not remove (or allow any third party to remove) any product identification, copyright or other notices.

## Notice

Spectralink Corporation has prepared this document for use by Spectralink personnel and customers. The drawings and specifications contained herein are the property of Spectralink and shall be neither reproduced in whole or in part without the prior written approval of Spectralink, nor be implied to grant any license to make, use, or sell equipment manufactured in accordance herewith.

Spectralink reserves the right to make changes in specifications and other information contained in this document without prior notice, and the reader should in all cases consult Spectralink to determine whether any such changes have been made.

NO REPRESENTATION OR OTHER AFFIRMATION OF FACT CONTAINED IN THIS DOCUMENT INCLUDING BUT NOT LIMITED TO STATEMENTS REGARDING CAPACITY, RESPONSE-TIME PERFORMANCE, SUITABILITY FOR USE, OR PERFORMANCE OF PRODUCTS DESCRIBED HEREIN SHALL BE DEEMED TO BE A WARRANTY BY SPECTRALINK FOR ANY PURPOSE, OR GIVE RISE TO ANY LIABILITY OF SPECTRALINK WHATSOEVER.

## Warranty

The *Product Warranty and Software License and Warranty* and other support documents are available at <http://support.spectralink.com>.

## Contact Information

### US Location

800-775-5330

Spectralink Corporation  
2560 55th Street  
Boulder, CO 80301

[info@spectralink.com](mailto:info@spectralink.com)

### Denmark Location

+45 7560 2850

Spectralink Europe ApS  
Langmarksvej 34  
8700 Horsens

[infodk@spectralink.com](mailto:infodk@spectralink.com)

# Contents

<b>Chapter 1: Understanding Your Handset</b> .....	<b>8</b>
<b>Understanding Session Types</b> .....	<b>8</b>
<i>Telephone Calls</i> .....	8
<i>Push-to-Talk (PTT) Broadcasts</i> .....	8
<i>Instant Messaging Chats</i> .....	8
<i>Application Alerts</i> .....	9
<b>Understanding the Session Manager</b> .....	<b>9</b>
<b>Understanding the Handset Features</b> .....	<b>11</b>
<i>LED Indicator</i> .....	12
<b>Chapter 2: Before Using Your Handset</b> .....	<b>13</b>
<b>Charging the Battery Pack for the First Use</b> .....	<b>13</b>
<b>Powering Up and Powering Down Your Handset</b> .....	<b>13</b>
<b>Registering Your Handset</b> .....	<b>13</b>
<b>Initializing the Handset</b> .....	<b>14</b>
<b>Logging In and Signing In</b> .....	<b>14</b>
<i>Logging In to Shared Handsets</i> .....	14
<b>Restarting and Updating Your Handset</b> .....	<b>17</b>
<b>Chapter 3: Getting Started</b> .....	<b>18</b>
<b>The Home Screen</b> .....	<b>18</b>
<b>Understanding the Four Home Screen Icons</b> .....	<b>19</b>
<i>Contacts / Call Lists</i> .....	19
<i>Messages</i> .....	19
<i>Settings</i> .....	20
<i>Applications</i> .....	20
<b>Shortcut Menus</b> .....	<b>21</b>
<b>Understanding the Status Bar Icons</b> .....	<b>21</b>
<b>Navigating Screens, Menus, and Sessions</b> .....	<b>23</b>
<i>Navigating In and Out of the Session Manager</i> .....	24
<b>Entering Text, Numbers, and Special Characters</b> .....	<b>25</b>
<i>Entering and Editing Data</i> .....	25
<b>Locking and Unlocking the Keypad</b> .....	<b>27</b>
<b>Using the Headsets and Speakerphone</b> .....	<b>29</b>
<i>Audio Path Priorities</i> .....	29
<b>Hearing Aid Compatibility</b> .....	<b>29</b>
<b>Chapter 4: Using Telephony Applications</b> .....	<b>30</b>
<b>Making Calls</b> .....	<b>30</b>

<i>Making an Emergency Call</i> .....	30
<i>Multiple Call Methods</i> .....	31
<b>Using the Dialer</b> .....	<b>33</b>
<i>Using the Autocomplete Feature</i> .....	33
<i>Opening the Dialer from the Home Screen</i> .....	34
<i>Opening the Dialer from the Session Screen</i> .....	34
<b>Managing Calls</b> .....	<b>35</b>
<i>Session Icons</i> .....	35
<i>Answering Incoming Calls</i> .....	36
<i>Managing Incoming Calls</i> .....	36
<b>Managing Active Calls</b> .....	<b>37</b>
<b>Transferring Calls</b> .....	<b>39</b>
<b>Setting up Conference Calls</b> .....	<b>40</b>
<b>Managing Conference Calls</b> .....	<b>41</b>
<b>Forwarding Calls</b> .....	<b>43</b>
<b>Enabling and Disabling Do Not Disturb (DND)</b> .....	<b>45</b>
<i>Enabling and Disabling DND on All Lines</i> .....	45
<i>Enabling and Disabling DND for Individual Lines</i> .....	46
<b>Using the Speed Dial List</b> .....	<b>46</b>
<b>Accessing Voicemail</b> .....	<b>48</b>
<b>Chapter 5: Push-to-Talk (PTT) and Paging</b> .....	<b>50</b>
<b>Using the Push-to-Talk Feature</b> .....	<b>50</b>
<i>Sending PTT Broadcasts</i> .....	51
<i>Receiving PTT Transmissions</i> .....	52
<i>Configuring PTT</i> .....	55
<b>Using the Paging Feature</b> .....	<b>57</b>
<i>Sending a Page</i> .....	57
<i>Receiving a Page</i> .....	59
<i>Paging Configuration</i> .....	60
<b>Chapter 6: Using the Contact Directory</b> .....	<b>62</b>
<b>Editing Contacts</b> .....	<b>62</b>
<b>Managing Your Contacts</b> .....	<b>63</b>
<b>Using Call Lists</b> .....	<b>65</b>
<b>Searching and Saving with the Corporate Directory</b> .....	<b>67</b>
<i>Searching the Corporate Directory</i> .....	67
<i>Saving Corporate Directory Search Results</i> .....	67
<b>Chapter 7: Instant Messaging</b> .....	<b>69</b>
<b>Understanding IM Contact Names</b> .....	<b>69</b>
<b>Understanding IM Status Icons</b> .....	<b>70</b>
<b>Managing Your IM Contacts</b> .....	<b>71</b>

<b>Initiating an Instant Messaging Session .....</b>	<b>72</b>
<i>Understanding the Chat Window .....</i>	<i>72</i>
<b>Managing Instant Message Sessions .....</b>	<b>73</b>
<b>Reading and Managing Stored Messages.....</b>	<b>75</b>
<b>Chapter 8: Using the Calendar .....</b>	<b>77</b>
<b>Chapter 9: Pairing and Connecting a Bluetooth Headset .....</b>	<b>80</b>
<i>Pairing Versus Connecting .....</i>	<i>80</i>
<i>Turning On and Managing the Bluetooth User Feature Options .....</i>	<i>81</i>
<i>Receiving Push-To-Talk Calls .....</i>	<i>84</i>
<b>Chapter 10: Using the Barcode Reader (8450/8452/8453 only) .....</b>	<b>85</b>
<b>General Operating Instructions .....</b>	<b>86</b>
<b>Handset Barcode Applications .....</b>	<b>87</b>
<i>Scanning to an Input Field.....</i>	<i>87</i>
<i>Scanning to an Application Prompt.....</i>	<i>88</i>
<b>Sending Barcode Data to PC Applications using QBC .....</b>	<b>88</b>
<i>Barcode Scanning in One-to-One Mode.....</i>	<i>89</i>
<i>Barcode Scanning in Many-to-Many Mode.....</i>	<i>89</i>
<b>Chapter 11: Personal Alarms .....</b>	<b>91</b>
<i>Suspending the Personal Alarm Monitor.....</i>	<i>92</i>
<i>The Warning State .....</i>	<i>93</i>
<i>The Alarm State .....</i>	<i>93</i>
<i>Emergency Dial.....</i>	<i>94</i>
<i>Personal Alarm Monitor State during Charging.....</i>	<i>95</i>
<b>Chapter 12: Applications.....</b>	<b>96</b>
<b>Web Applications.....</b>	<b>96</b>
<i>Navigating a website .....</i>	<i>96</i>
<i>Entering text.....</i>	<i>96</i>
<i>Softkeys .....</i>	<i>96</i>
<b>Custom Applications .....</b>	<b>97</b>
<i>The Open Application Interface .....</i>	<i>97</i>
<b>Chapter 13: Customizing your Handset .....</b>	<b>98</b>
<b>Customizing a Profile .....</b>	<b>98</b>
<i>Setting Unique Ring Tones for Contacts.....</i>	<i>100</i>
<i>Change the Alerting Characteristics .....</i>	<i>100</i>
<i>Changing the Ring Settings for OAI Applications.....</i>	<i>101</i>
<b>Customizing the Handset Display and Other Preferences.....</b>	<b>101</b>

<i>Language</i> .....	101
<i>Time &amp; Date</i> .....	101
<i>Headset Ringing</i> .....	102
<i>Corporate Directory (if enabled)</i> .....	102
<i>Background</i> .....	102
<i>Auto Answer</i> .....	102
<i>On-Hook Dialing</i> .....	102
<i>Multi Key Answer</i> .....	102
<i>Presence (if IM is available)</i> .....	102
<i>Paging/PTT Configuration</i> .....	102
<i>Calendar Settings (if available)</i> .....	103
<i>Adjusting the Backlight</i> .....	103
<b>Chapter 14: Chargers and Battery Packs</b> .....	<b>104</b>
<b>Charging the Battery Pack</b> .....	<b>104</b>
<b>Charger Options</b> .....	<b>104</b>
<i>Using the Dual Charger</i> .....	105
<i>Using the USB Charger</i> .....	106
<i>Using the Quad Charger</i> .....	107
<i>Using the 12-Bay Charger</i> .....	107
<b>About Battery Packs</b> .....	<b>108</b>
<i>Indications of Low Battery</i> .....	109
<b>Battery Safety Notices</b> .....	<b>110</b>
<i>Notes on Battery Packs</i> .....	110
<b>Appendix A: Cleaning and Drying the Handset</b> .....	<b>112</b>
<b>Appendix B: Settings Menu</b> .....	<b>114</b>
<b>Basic Settings and Preferences</b> .....	<b>114</b>
<b>Advanced Settings</b> .....	<b>115</b>
<b>Feature Settings</b> .....	<b>115</b>
<b>Status</b> .....	<b>115</b>
<b>Appendix C: Safety Information</b> .....	<b>116</b>
<b>Industry Canada Notice</b> .....	<b>117</b>
<b>Chargers and Battery Packs</b> .....	<b>117</b>
<b>Wireless Telephones</b> .....	<b>118</b>
<i>Operational Warnings</i> .....	118
<b>Electromagnetic Interference and Compatibility</b> .....	<b>119</b>
<i>Facilities</i> .....	119
<i>Pacemakers</i> .....	119
<i>Other Medical Devices</i> .....	120
<i>Use While Driving</i> .....	120

<i>FCC Statement</i> .....	120
<b>Specific Absorption Rate (SAR) Information: Spectralink 84-Series Wireless Telephones</b> .....	<b>120</b>
<i>Handset operation normal position</i> .....	122

# Chapter 1: Understanding Your Handset

This user guide shows you how to operate your Spectralink 84-Series Wireless Telephone.

In this chapter, you will learn about the four types of communication sessions your handset supports and how their alerting methods differ. To maximize the capabilities of this device, you will learn how to manage each type of session using the Session Manager.

Additionally, this chapter orients you to the physical features of the handset.

Your handset will work within your facility only when it is in contact with the WLAN and Local Area Network (LAN). It will not work beyond the RF coverage area of the wireless LAN. Contact your system administrator if you have questions about your facility's RF coverage area.



## **Note: Configurable features**

Many of the features detailed in this Guide are configurable by your system administrator and may not follow the exact steps outlined here. Contact your system administrator for more information if you have trouble understanding how to use certain features.

## *Understanding Session Types*

Your handset is capable of four communication types — voice telephone calls, Push-to-Talk broadcasts, application alerts, and instant messaging (IM) chats. Communication using one of these types is called a *session*. The system administrator for your facility determines which communication types are available and the options for each type.

### **Telephone Calls**

Voice telephone calls are typical audio-only calls. Voice calls use the voice call icon.

### **Push-to-Talk (PTT) Broadcasts**

PTT enables you and all subscribed users to send and receive broadcasts over a PTT channel; PTT is a collaborative broadcast mode. PTT broadcasts transmit audio over a built-in speakerphone. You can send and receive page and PTT transmissions with your handset if your system administrator has enabled this feature.

### **Instant Messaging Chats**

Instant messaging (IM) enables you to chat in real time with IM contacts you have entered in your directory or with contacts that start a chat with you. A system administrator must configure



and enable IM. Presence icons in the Session Manager indicate availability and identify IM contacts.

## Application Alerts

Some facilities may use custom application alerts, such as a nurse call system in a hospital, while other facilities might use a Web browser application such as a Webcam. To see which custom applications the system administrator has made available, open the Applications icon on the Home Screen. Your system administrator will give you information about the custom applications available on your handset.

## Understanding the Session Manager

The Session Manager screen displays each type of communication session — calls, broadcasts, chats, and alerts — in a separate cell. You can manage up to eight communication sessions at a time in any combination with four sessions visible at once. Each session displays as a color-coded cell in the Session Manager. Each session cell displays a call icon indicating call status, line number, the name and extension/channel of the party, and the call duration, as shown next:

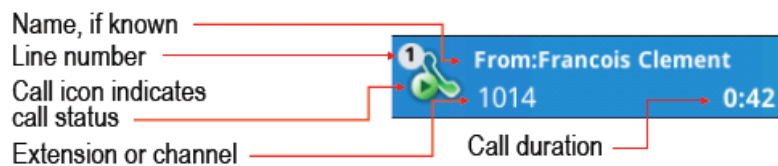

Cell color indicates cell status:

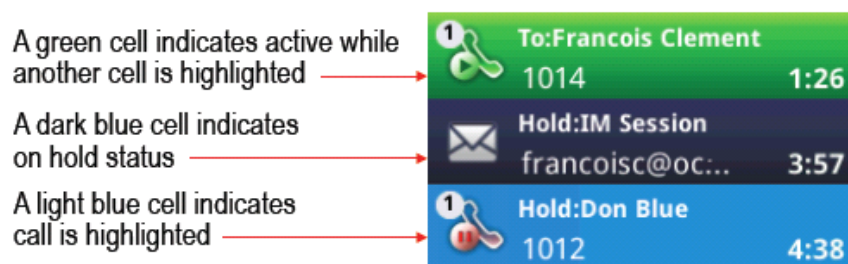

When a cell is highlighted, softkeys display that you can press to affect that call while other cells remain unaffected. Use the ▲ and ▼ and **OK** navigation keys to scroll to, highlight, and select cells.

In the example shown next, the Session Manager on the left shows a light blue call cell showing that the call is active. Note the softkeys at the bottom of the screen — you can put this call on hold, mute the audio, change your speaker options, or access other features using the Features softkey. The Session Manager on the right shows a green call cell that is active — note the active call icon — but the other call on hold is highlighted. Since the blue call is on hold, the

Resume softkey option displays. As the Mute and Speaker options do not pertain to a call on hold, these softkeys do not display. The Features softkey remains pertinent and therefore visible for both active and held calls.

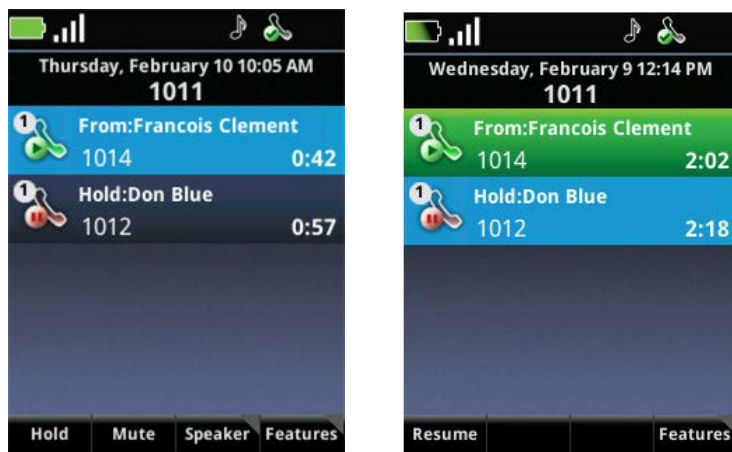

In another example, suppose you have a conference call with two other people, an incoming PTT broadcast, an application on hold, and an instant messaging chat. You can display up to eight session cells with four visible at once. Scroll with the navigation keys to view, highlight, and select the other cells.

You can navigate to the Home screen while sessions are active in the Session Manager. Whenever you are at the Home screen and there are active sessions, a green banner displays with the message *Active Sessions – Press*  to indicate that pressing the Back key will return you to the Session Manager.



## Understanding the Handset Features

The front, back, and side views of your handset will orient you to the location of the keys, buttons, and other physical features documented in this guide.



## Side View

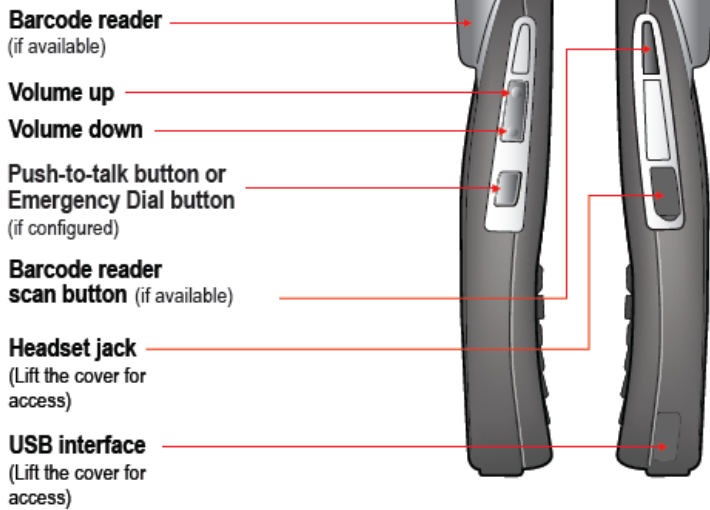

## Rear View

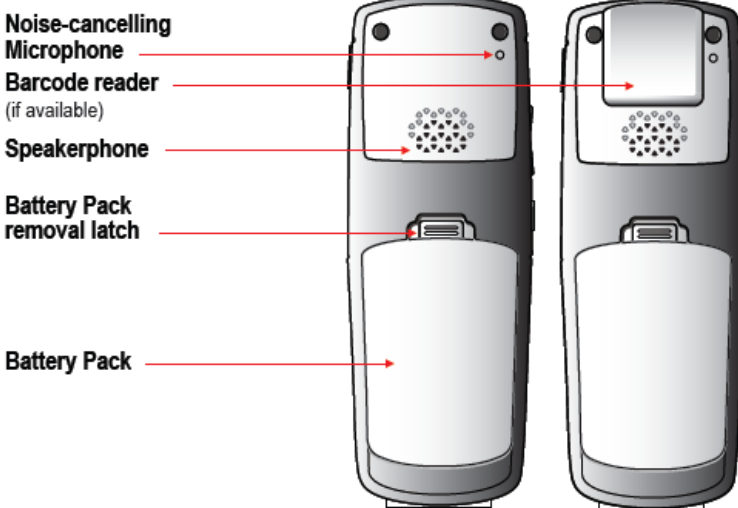

## LED Indicator



The LED indicator, located at the top right of the handset, indicates the following conditions:

- **Steady even blink** Indicates an incoming telephony call to your handset
- **Slow uneven blink** Indicates an unchecked voicemail/IM message
- **Quick uneven blink** Indicates inadequate Wi-Fi signal strength

# Chapter 2: Before Using Your Handset

When you first receive your handset, you need to fully charge the Battery Pack in order to maximize the Battery Pack's storage capacity and lifespan. You may also need to familiarize yourself with turning the handset on and off and learn about the various audio options available to you. Additionally, your facility may have security standards that require you to enter your unique credentials, such as a domain name, user name, and password, so that the handset will correctly register with your system. This chapter covers all of these subjects.

## *Charging the Battery Pack for the First Use*

Take a moment to learn how to charge your handset properly. It is critical to fully charge the Battery Pack before the first use of the handset in order to maximize the Battery Pack's storage capacity and lifespan. The Battery Pack is fully charged when the Battery life indicator becomes solid green (  ).

## *Powering Up and Powering Down Your Handset*

Once the Battery Pack is fully charged and you have correctly attached it to the handset, the handset will power on. Press the red **End** key for about two seconds to power down the handset. Press it again to turn it back on.



### **Warning: Loss of data**

Do not remove the Battery Pack to power off the handset, as you will lose personal data. If you need to replace the Battery Pack, log off or power off the handset and then remove the Battery Pack.



## *Registering Your Handset*

Generally, your system administrator will deploy your handset with multiple other handsets. In this case, your system administrator will configure the handset parameters beforehand so that the handset will register with the system and be ready to use when you turn it on.

The system administrator must register the handset or it will not work. If your handset does not work when you turn it on, contact your system administrator.

## Initializing the Handset

When you turn on the handset, it will cycle through an initializing sequence. Allow this sequence to continue until you see the Home screen and the registration icon (  ) in the Status Bar. The initializing sequence is as follows:

- 1 A facility logo displays for about 15 seconds.
- 2 The screen message displays: **Starting application, press Cancel to interrupt**. If you press the Cancel softkey, you will interrupt the startup cycle. Do not press the Cancel softkey unless directed by your system administrator.
- 3 The Home screen displays with the registration successful icon in the Status Bar (  ).  
If registration fails, you will see an icon showing registration failed (  ). For a summary of these icons, see [Understanding the Status Bar Icons](#).  
If registration fails, turn the handset off and then back on. Contact your system administrator if registration continues to fail after several attempts.

## Logging In and Signing In

There are two situations requiring you to enter credentials in order to access handset features. One, if you are using a shared handset and two, if you use an application that requires connecting to an external server. These two situations are separate and require separate types of credentials. This section explains both logging in to shared handsets and signing in to an external server.

### Logging In to Shared Handsets

System administrators can deploy the handsets on an assigned basis — one handset per person — or on a shared basis where several persons use the same handset. You do not need to log in with an assigned handset. If you are using a shared handset, basic call features may be available, but you will need to log in to the server with the handset in order to save and access your own contacts and settings.

In a shared deployment, you can log in using any handset. When you are finished using the handset, log out. If you are not sure whether you are using assigned or shared handsets, and to get your login information, see your system administrator.

#### To log in with a shared handset:

- 1 From the Home screen, press the **Features** softkey, and select **Login**.  
The User Login screen displays.

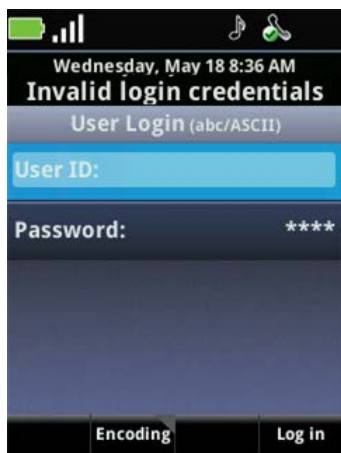

The message *Invalid login credentials* message at the top of the screen indicates that you'll need to enter your login information.

- 2 Enter your User ID and Password, and press the Log in softkey.

The message *Verifying Credentials. Please wait* will display.

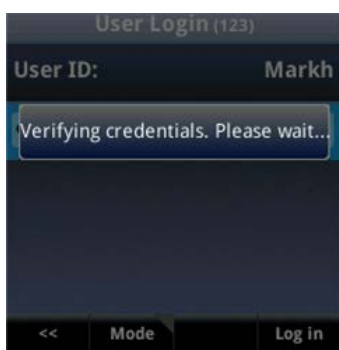

Once the credentials are verified, you can access your personal contacts and settings.

#### To log out with a shared handset:

- 1 From the Home screen, press the **Features** softkey, and select **Log out**.



A Log out prompt will display the question *Are you sure?*

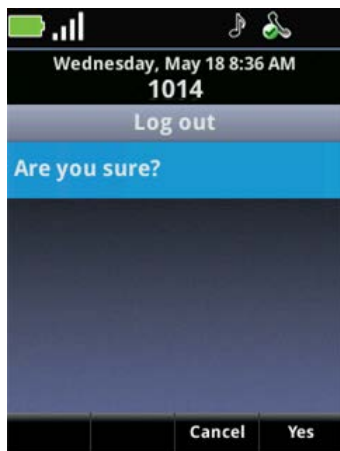

- 2 Press the **Yes** softkey to log out.

### Signing in with Sign In Credentials

Certain applications available on your handset, including Microsoft® Lync® Instant Messaging and Calendaring, require you to connect to an external server. Connecting to an external server requires you to enter Domain, User name, and Password credentials. Contact your system administrator for your sign in information for access to applications with this requirement.

#### To sign in to an external application server:

- 1 From the Home screen, go to **Settings > Basic Settings > Login Credentials**. Your screen will display the Login Credentials if this is your first time signing in.

If your system administrator has enabled applications requiring access to a server, the Domain field may already be completed. If not, enter the domain address provided by your administrator.

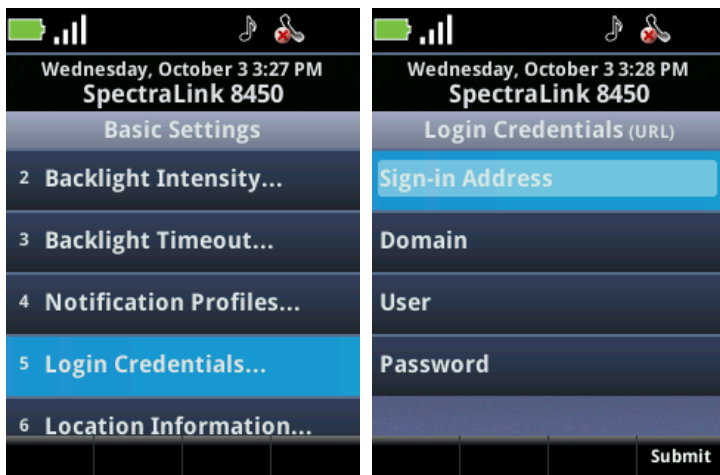

- 2 Enter your credentials and press the **Submit** softkey.



Your personal IM presence and Calendar information are now saved. You will now have access to the server applications.



**Note: Login failure**

If your login fails several times, your account becomes locked and inaccessible. If this happens, notify your system administrator.

## *Restarting and Updating Your Handset*

Customer support services or your system administrator may advise you to restart your handset or update configuration software.

**To restart your handset:**

- Navigate to **Settings > Basic Settings > Restart Phone** and follow support directions.

**To update handset configuration:**

- Navigate to **Settings > Basic Settings > Update Configuration** and follow support directions.

# Chapter 3: Getting Started

This chapter shows you how to use the Home screen, the Status Bar icons, the softkeys, the shortcut menus, navigation, and text entry.

## The Home Screen

The Home screen is the first display you will see. At the top, the Status Bar displays icons that give you information about the status of your handset. Under the Status Bar, the date and time and the handset's Extension number or other identification display. The Profile banner shows you the current ring settings the handset is set to use.

When you press the ◀ or ▶ key on the handset's keypad, you can rotate the four Home screen icons: Messages, Settings, Contacts/Call Lists, and Applications. Only three icons are visible at once. This section explains the features associated with each icon.

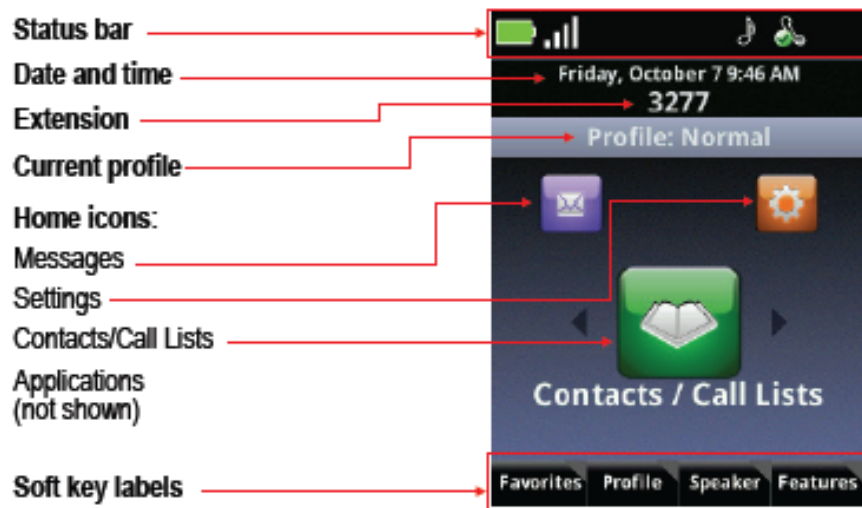

## Understanding the Four Home Screen Icons

This section explains how to navigate the four Home screen icons and the features associated with each icon.

### Contacts / Call Lists

The Contacts/Call Lists icon by default faces front on the Home screen. Pressing the **OK** button opens the Contacts / Call Lists screen where you can store contacts in the Contact Directory, search for contacts in the Corporate Directory, and access the Call Lists that store previous call sessions.



### Messages

If your facility activates voicemail and instant messaging, you can access call information and message history. Rotate the Messages icon to the front and press the **OK** button to access your voicemail messages and display information on specific calls. See [Accessing Voicemail](#) and [Reading and Managing Stored Messages](#) for more information.



## Settings

Open the Settings icon to access settings that customize your handset.



## Applications

Some facilities use custom applications such as a barcode reader or a nurse call system. If your facility uses one or more custom applications, you can access them from the Applications icon.

Contact your system administrator if you have questions about any application listed on this menu.



## Shortcut Menus

The softkeys at the bottom of the display screen are context-sensitive, meaning that they change depending on which screen you are displaying at the time. These softkeys enable you to select specific handset functions and features. The gray triangles in the upper right corner of the softkeys indicate that there is a shortcut menu with additional options. When you press a softkey, a menu opens. The following example shows the menu for the Speaker softkey.



When a softkey menu displays, there are two ways to choose a menu item. Use the ▲ and ▼ navigation keys to scroll through the shortcut menu and press the **OK** key. Or, press the number of the option on the keypad. Grayed options are not available.



### User Tip: Speed

Using the number option to choose menu items is faster than scrolling with the navigation keys and pressing the **OK** button.

## Understanding the Status Bar Icons

The Status Bar icons give you information about the status of your handset. Up to eight icons can display in the Status Bar and each icon has a fixed position. Each of the Status Bar icons and their definitions are shown next in **Table 1: Status Bar Icons**

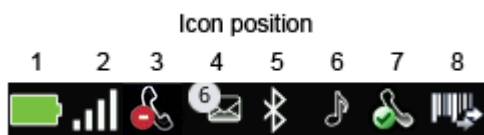

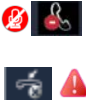

Table 1: Status Bar Icons

Position	Icon(s)	Description
1		The Battery life indicator is in the first, left-most icon position. In this example, the green battery icon shows that the handset is fully charged.
2		The signal strength icon in the second position shows the signal strength of a wireless Access Point (AP). If location services is activated in your facility, the green location icon sits above the signal strength icon. If the handset cannot connect to an AP, a red X appears over the grayed out AP signal strength bars (no signal icon).
3		The Mute, Do Not Disturb, Missed Call and Warning icons share the same position. The mute indicator has priority and displays whenever the microphone is muted. The DND feature is controlled on the Feature Settings menu. The Missed Call icon displays when you have missed a call and the caller has not left a voicemail message. Missed calls are listed and cleared on the Contacts/Call Lists icon. . The Warning icon displays when an event occurs which may indicate an issue with the handset operation. To determine the type of event check Settings > Status > Diagnostics > Warnings. Contact the telephone system administrator if the condition does not clear up within a few minutes or by power cycling the telephone.
4		The Messages icon displays when there is a voicemail or an instant message available. Messages are accessed and cleared on the Messages icon.
5		The Bluetooth connect status icon indicates Bluetooth availability. The Bluetooth symbol with a headset indicates that a headset is paired. The Personal Alarm icons indicate the Suspend, Monitoring and Alarm conditions, respectively. All three are available on the 8441 and 8453 only. The red icon displays during alarm conditions on the 8440/8450/8452 if configured.
6		The User Profile icon indicates the active notification profile: Normal, Silent, Meeting, Custom
7		The Registration icon indicates whether the handset is connected to its SIP and/or Lync server and operational. The green checkmark indicates successful connection. A green dot means that a call is active; a red dot means a call is on hold. The red x indicates failure to connect to its server. The shadow indicates the handset is registered to a shared line.
8		The barcode icon shows the connection status of the bar code reader to a QBC <sup>1</sup> application in a PC: connected in the multi-mode, connected in the single mode or not connected. Available on the 8450/8452/8453 only.

<sup>1</sup> For more information on QBC, see [Sending Barcode Data to PC Applications using QBC](#).

## Navigating Screens, Menus, and Sessions

You can use the keypad to navigate the screens, menus, and sessions. The following table lists the functions you can perform using specific keys.

Table 2: Navigating using specific keys

<i>Function</i>	<i>Applicable Keys</i>
To scroll up and down through menu options or session cells	Press the ▲ and ▼ keys to move the highlighter through menu options and session cells.
To select an option	Press the <b>OK</b> button to select the highlighted option.
To scroll left and right through text	Press the ◀ and ▶ keys to move the insertion point left and right or to scroll to the next home screen icon choice.
To cancel your current edit session	Press the <b>Cancel</b> softkey to cancel any edits and return to the previous screen.
To return to the previous menu	Press the <b>Cancel</b> softkey or <b>Back</b> key to return to the previous menu.
The <b>End</b> key executes all these actions	Hangs up a call Rejects an incoming call Exits a conference call Turns off the handset (when held down for 2 seconds)
To replace text	When the contents of a cell are highlighted in yellow, a key entry will delete the entire field. Use the Nav keys to move the cursor while preserving existing content.

## Navigating In and Out of the Session Manager

The Session Manager is activated by active sessions of all types and displays each call in its current state in a separate session cell. The following example shows one active call and a second call on hold.



From the Session Manager, you can go to the Home screen by pressing the **Home** key or the **Back** key on the handset's keypad. Navigating to the Home screen from the Session Manager during active calls is useful if you want to navigate handset menus or perform handset functions while in an active call.

If you leave the Session Manager when session cells are present, a green banner, shown next, displays the message *Active Sessions – Press*  above the softkeys to alert you to active sessions.



Press the **Back**  key to return to the Session Manager. Press the left or right Nav keys to scroll to the next Home screen icon choice.



## Entering Text, Numbers, and Special Characters

When dialing calls or entering contact information, you will need to enter characters other than numbers. The **Mode** softkey enables you to enter alphanumeric and special characters (abc... 123... @#&...). The Encoding softkey enables you to use the keyboard to change the way you enter characters per the table below.

### Mode and Encoding softkey options

<i>Mode softkey options</i>	<i>Encoding softkey options</i>
1 Abc	1 Abc (first character in CAPs)
2 ABC	2 ABC (all characters in CAPs)
3 abc	3 abc (all characters in lower case)
4 123	4 123 (all numeric)
	6 Latin
	7 Katakana
	8 Unicode
	9 Cyrillic

### Entering and Editing Data

When you are at an entry screen, an Encoding softkey displays so you can specify how you want to enter data. When you press the Encoding softkey, the following screen will display:

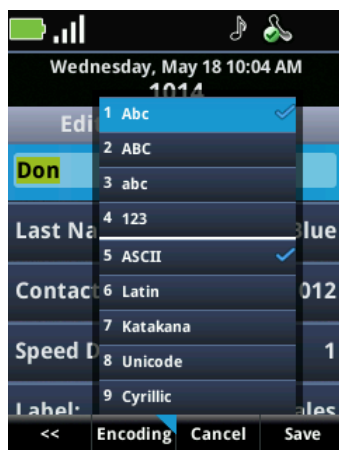

**To enter letters and numbers:**

Press the **Encoding** softkey to display a shortcut menu with the following data entry options:

- Leading caps (Abc )
- Uppercase (ABC)
- Lowercase (abc)
- Numerical (123)

Press a keypad key one or more times to enter the characters or numbers that display on the key.

For example, if you're in ABC mode:

- To enter A, press 2
- To enter B, press 22
- To enter C, press 222
- To enter 2, press 2222

For example, if you're in 123 mode:

- To enter 2, press 2.

**To enter special characters:**

- 1 Select one of the alphabetic options from the Encoding softkey menu. You cannot access special characters when you are in Numerical (123) mode.

The mode you select displays in the screen title.

- 2 Use the asterisk (\*), zero (0), hash (#) and 1 keys to enter special characters by pressing the key until the desired character is selected:

**Special characters**

Key	Number of presses								
	1	2	3	4	5	6	7	8	9
1	!		'	^	\	@	:	1	
*	.	*	-	&	%	+	;	(	)
0	/	,	_	\$	~	=	?	0	
#	#	>	<	{	}	[	]	"	`



### **User Tip: Special characters in passwords**

Some passwords may contain special characters that the handset cannot produce. The special characters listed above are the only ones available in the handset. If your password contains other special characters, you will need to change it to include only those available in the handset.

### **To enter text in a special language:**

Press the **Encoding** softkey to display a shortcut menu of the available language options:

- **ASCII** Regular text
- **Latin** To add accented characters, for example é.
- **Katakana** Japanese characters
- **Unicode** Stores characters as double bites
- **Cyrillic** Russian

Press a key one or more times to enter the character you want.

### **To delete text already entered:**

- Press ► or ◀ to position the cursor to the right of the character you want to delete, and press the << softkey.



### **User Tip: Overwrite and delete**

When the contents of a cell are highlighted in yellow, a key entry will delete the entire field. Use the Nav keys to move the cursor and preserve existing content.

## ***Locking and Unlocking the Keypad***

To avoid making inadvertent calls, you can lock your keypad so that key presses are not recognized. You must unlock the keypad before you can make calls. Check with your system administrator if this feature is not available and for information on the timeout value. By default, Keypad lock is on with a timeout value of 0, which means it will lock as soon as it is enabled.



### Settings: Emergency calling options while the keypad is locked

If configured in your facility, you could have one of these options available for making an emergency call while the keypad is locked:

- A New Call softkey opens an Authorized Call menu with up to five numbers listed that can be dialed by scrolling to select and pressing OK or by pressing the corresponding keypad number.
- The PTT button on the left side of the handset can be configured to make an emergency call. Press it once to test this functionality. If configured for emergency dial, a popup will explain that if you press the key twice within 2 seconds, an emergency call will be placed.

### To lock the keypad:

- 1 Press the **Features** softkey.



- 2 Press the **2** key or scroll to **2 Keypad Lock**, and press the **Yes** softkey. Once you lock the keypad, all the keys become frozen except for an Unlock softkey, which replaces the Features softkey.

### To unlock the keypad:

- 1 Press the **Unlock** softkey.
- 2 When prompted, press the **Yes** softkey.

Any incoming call, chat or broadcast will automatically unlock a locked keypad and restore normal keypad operation as long as a call cell remains open. If you do not answer the call, the keypad immediately locks upon termination of the ring period.

## Using the Headsets and Speakerphone

The Speaker softkey gives you access to the following audio options:

- **Speakerphone** You can direct audio through the speakerphone on the back of the handset. Use the volume buttons on the left side of the handset to adjust the volume.
- **Receiver** The receiver speaker is the default speaker you use when you hold the handset to your ear. If another option is in use, return to the Receiver by selecting Receiver from the Speaker softkey menu.
- **Headset** You can route audio to a headset by plugging a headset into the headset jack on the right side of the handset. The headset jack accepts a four-conductor 2.5mm TRS plug. Note that the headset jack will not function when the handset is docked in the Dual Charger (DCA39).
- **Bluetooth** If the system administrator enables Bluetooth capability, the Bluetooth option will display in the Settings menu. You must pair and connect Bluetooth devices before you can hear audio through the headset.

### Audio Path Priorities

The handset automatically chooses the highest-priority audio path, which can be overridden by the user. The following audio paths are listed in order of highest priority:

- Speakerphone Dock microphone and speaker.
- Bluetooth headset.
- Wired headset,
- Phone microphone and speaker.

### To override the audio path priorities and select an audio path:

- 1 From the home screen, press the Speaker softkey. (While in a call, press the “Features” softkey.)
- 2 Highlight the desired audio path.
- 3 Press OK to select it.

## Hearing Aid Compatibility

Radio frequency can interfere with some hearing aids. Your handset has a hearing aid compatibility mode that adjusts the frequency response for users who have hearing aids equipped with telecoil inductive pickups. Acoustic pickup hearing aids will not respond to this adjustment.

To view the current status of the Hearing Aid Compatibility feature and to enable or disable this feature, navigate to **Settings > Basic Settings > Hearing Aid Compatibility**.

# Chapter 4: Using Telephony Applications

The handset enables multiple ways of making calls and several options for handling incoming calls.

## Making Calls

There are several ways to make a call. When you hear a dial tone, and a call starts ringing, the handset is in the active mode. Once a call starts ringing, the Session Manager opens and the ringing icon will display at the left side of the call cell. You may abort the call by pressing the **End** key.

### Making an Emergency Call



#### **Warning: Power failure may prevent call functionality**

Your handset may not function in the event of a power failure as it relies on the greater computer network to transmit calls. You will have a red “X” over the signal bars if the wireless system is down. You will have a registration failure icon if the handset cannot make or receive calls, but there may be a time delay between the system failure and the appearance of the registration failure icon. Check with your system administrator to see if the wireless telephony system is protected from power outages.

Emergency calls can be programmed by the system administrator. Check to see which of these features is available.



### Settings: Emergency calling options while the keypad is locked

If configured in your facility, you could have one of these options available for making an emergency call while the keypad is locked:

- A Speed Dial key. Press Features > Speed Dial and select the emergency number.
- A New Call softkey opens an Authorized Call menu with up to five numbers listed that can be dialed by scrolling to select and pressing OK or by pressing the corresponding keypad number.
- The PTT button on the left side of the handset can be configured to make an emergency call. Press it once to test this functionality. If configured for emergency dial, a popup will explain that if you press the key twice within 2 seconds, an emergency call will be placed.

#### Use the Speed Dial option:

If the keypad is locked, this option is replaced by a New Call softkey which lists up to five emergency numbers that can be dialed.

- 1 Press the **Features** softkey.
- 2 Press **3** or scroll to the **Speed Dial** option and press **OK**.
- 3 Scroll to the emergency number and press **OK**.

#### Use the PTT Talk button:

The PTT Talk button may be reprogrammed to Emergency Dial. Note locking the keypad does not disable this functionality.

- 1 Test to see what function is performed by the PTT button. Press the button once. If the Emergency Dial popup appears, you can use the PTT button to make an emergency call. If the PTT Channel list appears, use the first option for emergency calls.
- 2 Make an emergency call by pressing the PTT Talk button twice within two seconds.

### Multiple Call Methods

You can use your handset to start a call in several ways. You can enter a number into the Dialer, call a contact you have entered and saved to your contact directory, or you can call the contact of a sent, received, or missed call that is automatically stored in a call list.

#### To call by entering a number:

- Press any number on the keypad to open the Dialer. The Dialer is the screen that displays when you begin entering a phone number. Dial the complete number and press **Start** (the green button). For complete instructions on how to use the Dialer, see [Using the Dialer](#).

### To call a contact in your contact directory:

- 1 Scroll to the Contacts/Call Lists icon on the Home screen and press **OK**.
- 2 Select Contact Directory and press **OK** or press **1**. Your contact directory list opens.
- 3 Scroll to the contact you wish to call and press the **Start** key.

### To call from a call list:

- 1 Scroll to the Contacts/Call Lists icon on the Home screen and press **OK**.
- 2 Highlight Call Lists and Press **OK** or press **3**. Your call list opens.
- 3 Scroll to the contact you wish to call and press the **Start** key. For more information, see [Using Call Lists](#).

### To call from the speed dial list:

- To place a speed dial call from the Home screen press the **Favorites** softkey. This opens a list of your speed dial contacts.



You can select a name from the speed dial menu or use the keypad to press a speed-dial index number. The call is placed immediately.

### To call a URL or SIP IP address:

- 1 Press any number key on the keypad to open the Dialer. Note that URL addresses can be letter or number characters.  
The Dial mode softkey displays.
- 2 Press the **Dial mode** softkey, select **URL**, and press **OK**.  
The Dialer displays an *Enter URL* field with the prefix *sip:* A list of recently-dialed or received URLs/IP addresses will display.
- 3 Select one of the displayed cells or enter the URL or SIP address you want to dial. The IP address of another 84-Series handset can be used as in SIP: 192.168.2.224.



#### 4 Press Start.



#### User Tip: Aborting a call

To abort an outgoing call while it is ringing, press the **End** key.

## Using the Dialer

The Dialer is the screen that opens when you start to dial a number. The Dialer has several built-in features that make dialing more convenient. This section also shows you several ways to open the Dialer.

### Using the Autocomplete Feature

Sent, received, and missed calls, as well as contacts you have saved to the handset, are stored in the handset's memory. The Autocomplete feature matches numbers you dial with contacts stored on the handset. If a number you begin to dial matches a number stored on the handset, the Autocomplete feature displays a list of possible matches.

If the name or number of the person you are trying to call displays on this list, highlight the cell by scrolling to it and place the call by doing one of these:

- Press **Start**.
- Press the **OK** key to pop the highlighted number into the entry window, and press **Start**.

If you are in an active call and placing a second or third call, the Autocomplete cells replace the other session cells until the new call begins to ring.

### Numeric Dialing

This is your usual dialing a number. It can be an external phone number or a short extension. The numbers you need to enter depend upon the dial plan used in your facility. Contact your system administrator for complete information.

### Dialing to a URL

When you select URL dialing from the Dial mode softkey, the prefix *sip:* is displayed at the start of the number. Enter the IP address after this prefix. The address could be a number somewhere on the Internet, or it could belong to one of your contacts, or it could be a recently received call. If the address belongs to a contact, or the handset has recently received a call from the address, Autocomplete will filter the cells so you can select it.

### Dialing Contact Names and IM Names

The Dial Mode softkey allows you to enter letters, special characters, and supported language characters that may be required for entering a name.

To dial a name, press **Start** and then press the **Dial Mode** softkey and select the **Name** option. Start entering the letters of the name you wish to call. The autocomplete feature will populate the list with names from your Contact Directory and names from the sent, received and missed call lists. Continue to enter the name or scroll to the name you wish to call and press **Start**.

## Opening the Dialer from the Home Screen

You can open the Dialer from the Home screen using one of the following procedures:

- **On-Hook Dialing** Press a number key (0-9) to start dialing, and the Dialer displays the number in the dial cell. You can place the call when you finish entering the numbers or, if the Autocomplete feature matches the number you are dialing to a stored number, select the matching number and press **Start** to place the call. You can enable or disable On-Hook Dialing (also referred to as *predialing*) from the Home screen by navigating to **Settings > Basic Settings > Preferences > On-Hook Dialing**.
- **Press the Start Key** Press the **Start** key to open the Dialer and listen for a dial tone. You can enter the number manually or select the number from the Autocomplete list as you begin to dial.
- **Select a Line** Press the **Features** softkey, select **Lines** from the menu, and choose a line you wish to use. The Dialer opens and you hear a dial tone. You can enter the number manually or select the number from the Autocomplete list as you begin to dial.
- **Select an Audio Path** Press the **Speaker** softkey and select an audio path from the menu. The Dialer opens and you hear a dial tone. You can enter the number manually or select the number from the Autocomplete list as you begin to dial.

## Opening the Dialer from the Session Screen

If you want to place a call during an active call, you can open the Dialer. When you begin to dial the new number, the Autocomplete cells will replace the session cells of active calls until the new call begins to ring. Open the Dialer during active calls using one of the following ways:

- **On-Hook** If On-Hook dialing is enabled, press the **Hold** softkey and then press a number key (0-9) to start dialing. The Dialer displays the number in the dial cell. You can place the call when you finish entering the numbers or, if the Autocomplete feature matches the number you are dialing to a stored number, select the matching number and press **Start** to place the call. You can enable or disable On-Hook dialing from the Home screen by navigating to **Settings > Basic Settings > Preferences > On-Hook Dialing**.
- **Press the Start key** Pressing the **Start** key places the active call on hold and opens the Dialer. You can listen for a dial tone. Enter the number manually or select a number from the Autocomplete list as you begin to dial.

## Managing Calls

This section shows you how to manage incoming calls. The handset can alert you of incoming calls using one of many different ringtones. Ringtones are played through the handset speaker unless you have silenced the handset speaker. If you are wearing a headset, you will hear an in-ear notification instead of a speaker alert.



### User Tip: Adjusting the ringer volume

While the handset is alerting you of an incoming call, you can increase or decrease the ringer volume using the volume buttons. The handset will use this new ringer volume setting until you log off or power cycle the handset (turn the handset off and then on again).

Much of this chapter refers to handset icons that will become familiar as you use the handset. The icons differ depending on the type of session you are in, but all of the icons display in the Session Manager. The following table gives you an overview of the session icons.

### Session Icons

Icons display on the left side of the call cell to indicate the status of that call. The number indicates which line the call is using.

Table 4: Session Icons.

<i>Icon</i>	<i>Description</i>
	Incoming call alert
	Active call
	Call on hold
	Conference call
	Conference leg
	PTT/Page receive
	PTT/Page transmit
	PTT/Page idle
	PTT/Page hold
	IM Presence indicator

## Answering Incoming Calls

You can answer an incoming call in several ways. You can press the Start key to answer an incoming call with the handset. You can press the Speaker softkey and select a different audio path. Or, you can enable the Multi Key Answer mode, which enables you to answer a call by pressing any keypad key (0-9, \*, #).

### To answer any incoming call:

- Press the **Start** key.

### To answer incoming calls using Multi Key Answer:

- If Multi Key Answer is enabled, you can press any keypad key (0-9, \*, #) to answer an incoming call. Enable (or disable) Multi Key Answer by navigating to **Settings > Basic Settings > Preferences > Multi Key Answer**.

## Managing Incoming Calls

There are several ways to manage an incoming call – you can answer it, end it, reject it, silence the call alert, send it to voicemail (if enabled by your system admin), forward it, or divert it. This section explains each of these options.

When you have an incoming call, a screen displays the call information.



### To answer a call:

- The easiest way to answer a call is to press the **Start** key.

### To answer an incoming call when in an active call:

- 1 While in an active call, press the **Ignore** softkey to open the Session Manager.
- 2 Press the **Hold** softkey to place the current call on hold and highlight the incoming call cell.
- 3 Press **Start** to answer the incoming call.

**To answer an incoming call by ending the current call:**

- 1 While in an active call, press the **Ignore** softkey to open the Session Manager.
- 2 Press **End** to end the current call.
- 3 Press the **Start** key to answer the incoming call.

**To end an active call:**

- Press **End** to end or hang up an active call.

**To reject an incoming call:**

- Press **End**. The ended call will be sent to voicemail if set up in your facility. You can also forward calls to another number. To set up automatic call forwarding, see [Editing Contacts](#).

**To silence the call alert:**

- Press the **Ignore** softkey to silence the ring. The call will display in the Session Manager until it stops ringing. You can have unanswered calls automatically forwarded to voicemail. To set up call forwarding, see [Editing Contacts](#).

**To send an incoming call immediately to voicemail:**

- Press **End**. If voicemail is set up in your facility, the ended call will be sent immediately to voicemail. See [Accessing Voicemail](#).

**To forward an incoming call to another number:**

- Press the **Forward** softkey. You can have incoming calls automatically forwarded to voicemail. To set up call forwarding, , see [Editing Contacts](#).

**To divert an incoming call:**

- You can divert calls from specified contacts to another number. See [Editing Contacts](#).

## *Managing Active Calls*

When you are in an active telephony call, the Session Manager displays each call in a separate cell, as shown next.

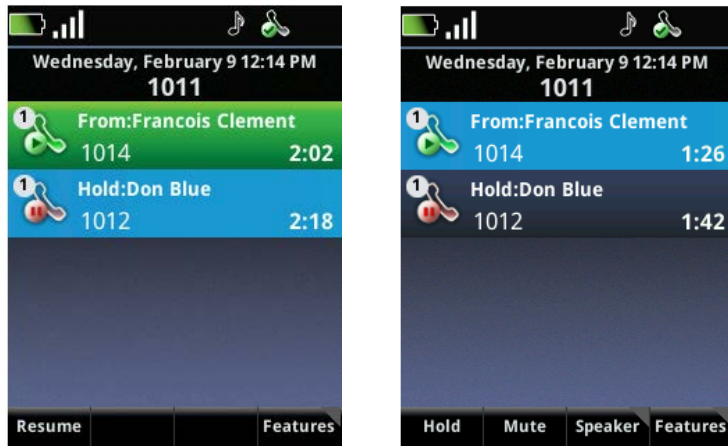

An active call has a light blue field when it is highlighted. An active call has a green field when another session cell is highlighted. Softkey presses affect highlighted cells. In the above example, you can see how the softkeys change when you highlight an active call.

When you are in an active call, the *Active call* icon displays in the Session Manager beside the active call cell and one of the softkeys displayed is the *Hold* softkey.

#### To place an active call on hold:

- Press the **Hold** softkey to place an active call on hold. When you place a call on hold, the *Call on hold* icon displays in the Session Manager beside the active call cell and the *Resume* softkey will be displayed.

#### To resume a call on hold to active status:

- Press the **Resume** softkey or the **OK** key to resume a held call to active status.
  - If you have more than one call on hold, use the ▲ and ▼ keys to highlight one of them, then press the **Resume** softkey or **OK** to make it an active call.

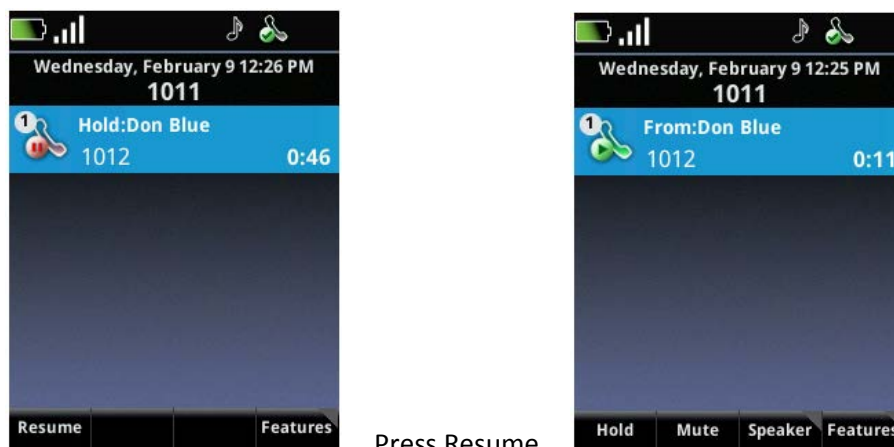

**To mute a call:**

- To mute yourself in the call, press the **Mute** softkey. A Mute icon displays in the status bar. Now you can still hear the other party, but that person can't hear you. Press **UnMute** to resume audio flow.

**To activate the speakerphone:**

- To activate the speakerphone, press the **Speaker** softkey and select the **Speakerphone** option.

## Transferring Calls

A transfer connects two parties as you exit the conversation. Your handset can perform two types of transfers:

- **Blind** A blind transfer exits the call while the second party is ringing, before the two other parties are connected.
- **Consultative** In a consultative transfer, you can speak to either of the two other parties before making the transfer.

**To perform a blind transfer:**

While in an active call, or with the call on hold:

- 1 Press the **Features** softkey and select **Blind Transfer**.

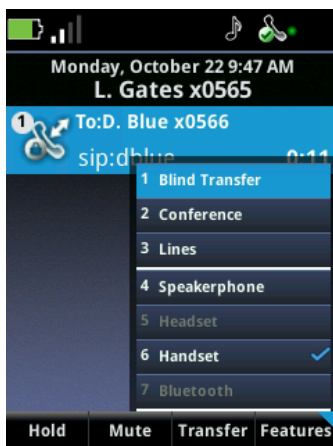

You will hear a dial tone and the Dialer will open.

- 2 Dial the number of the target party. If the Autocomplete feature matches the number you are dialing to a stored number, select the matching number and press **Start** or **OK** to place the call. For more information about the Autocomplete feature, see [Using the Dialer](#).
- 3 Once you dial a call, the transfer is complete and you are returned to the Home screen whether or not the other party answers the call. If there are other active sessions, you will be returned to the Session Manager.

**To perform a consultative transfer:**

- 1 While in an active call or with a call on hold highlighted in the Session Manager, press the **Transfer** softkey.
- 2 Dial the number of the target party. If the Autocomplete feature matches the number you are dialing to a stored number, select the matching number and press **Start** to place the call. For more information about the Autocomplete feature, see [Using the Dialer](#).
- 3 When the target party answers, explain that you are going to transfer the call.
- 4 Press the **Transfer** softkey to complete the transfer.
- 5 You are returned to the Home screen or, if other calls are active, to the Session Manager.

## Setting up Conference Calls

You can set up a conference call so that you and two other parties can converse at once.

**To set up a conference call:**

- 1 While in an active call or with the call on hold highlighted in the Session Manager, press the **Features** softkey and select **Conference**.
- 2 Use any method to place a call to the target party.
- 3 When the target party answers, explain that you are going to set up a conference call.
- 4 Press the **Conference** softkey. When all three participants are connected to the conference call, the Session Manager will look like this:



- 5 To exit the call, ensure the conference cell is highlighted (light blue) and press **End**. After exiting, you are returned to the Home screen or, if other calls are active, to the Session Manager.





**User Tip: How many conference call participants can you have?**

The Spectralink 84-Series handsets support a maximum number of three participants in a conference call.

## Managing Conference Calls

Once you have set up a conference call, you can manage the conference call in several ways.

### To mute your microphone during a conference call:

- 1 During a conference call, in the Session Manager, highlight the **Active: Conference** call cell.
- 2 Press the **Mute** softkey. When you press the **Mute** softkey, only your microphone is muted.

### To put your handset on hold:

- 1 During a conference call, in the Session Manager, highlight the **Active: Conference** call cell.
- 2 Press the **Hold** softkey. Note: If your call server has music on hold enabled, placing the conference call on hold will allow the music to be heard by the other conference participants.

### To resume conferencing:

- 1 During a conference call, in the Session Manager, highlight the **Active: Conference** call cell.
- 2 Press the **Resume** softkey.

### To manage conference call participants:

- To remove a participant from the conference, in the Session Manager, highlight the participant's call cell and press the **Remove** softkey.



**User Tip: Ending a participant's call**

Note that if you press the End key while a conference participant's cell is selected, you will end that participant's connection to the conference call.

- To mute a participant, in the Session Manager, highlight the participant's call cell and press the **FarMute** softkey.

- To place a participant on hold, in the Session Manager, highlight the participant's call cell and press the **Hold** softkey. To add the participant back to the conference call, highlight the participant's call cell, and press the **Resume** softkey.



**To exit a conference call:**

- To exit a conference call, in the Session Manager, highlight the **Active: Conference** call cell and press **End**. The other parties remain connected.

**To split conference calls into two calls on hold**

- 1 During a conference call, in the Session Manager, highlight the **Active: Conference** call cell.
- 2 Press the **Features** softkey and select **Split**.

The conference ends and each participant is split into an individual call cell and put on hold.

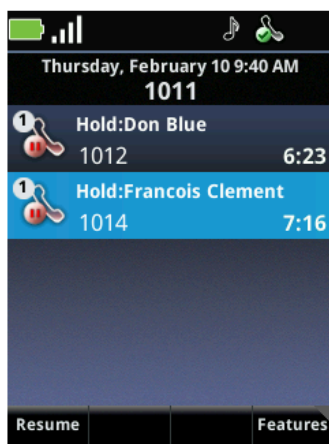
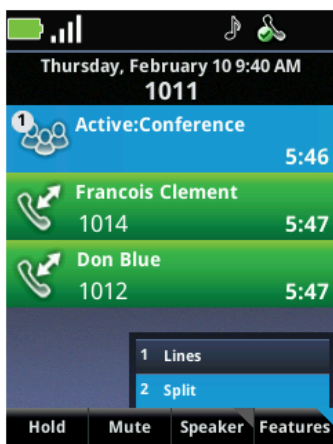

## Forwarding Calls

You can forward calls manually or automatically. When you have an incoming call, you can manually forward it to another number, or you can set up automatic forwarding criteria in the Settings menu.



### User Tip: Call forwarding

Automatic call forwarding works only as long as your handset is registered and turned on. If you turn off your handset or move out of range for an extended period of time, calls to your handset are neither received nor forwarded. Depending on your organization's Private Branch Exchange (PBX), the caller might hear unending ring tones or a recorded message such as "The party you have called is not available."

### To manually forward an incoming call:

- 1 When the handset alerts you to an incoming call, select the **Forward** softkey.

The Forward-to-Dial screen displays the last number that a call was forwarded to (either manually or automatically). If you would like to forward the call to a different number, enter the target number as you would through the Dialer. Be quick about this sequence as you only have the ring period to accomplish the forward.

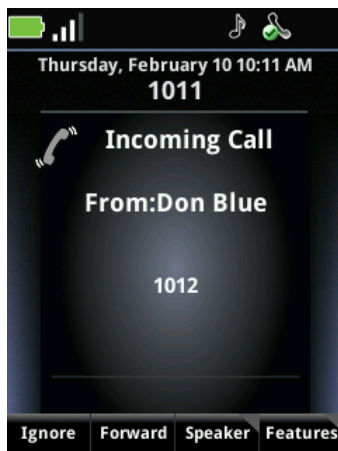

- 2 When the forwarding number displays, press **Forward**.

The incoming call is forwarded to the other party and you are disconnected.

### To enable automatic call forwarding:

- From the Home screen, navigate to **Settings > Feature Settings > Forward**.

Depending on the type of server installed at your facility, you will see one of these screens:

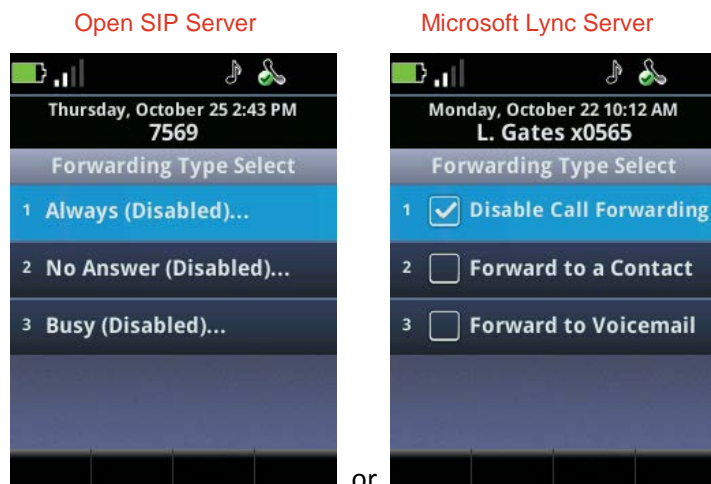

### *Open SIP Server*

Forwarding is handled locally by the handset. Options allow you to set when the forwarding occurs and what number is called.

- 1 If your handset is set up with a single line, the *Forwarding Type Select* screen displays, enabling you to select the forwarding type you want.
- 2 If you have multiple lines, select **Line**. The *Line Select* screen displays. Highlight the line you wish to enable with call forwarding, and press **OK**.
- 3 You can enable the following call forwarding options:
  - o **Always** To forward all incoming calls
  - o **No Answer** To forward all unanswered incoming calls
  - o **Busy** To forward incoming calls when you're in an active call

Enable one of the forwarding options and press the **OK** key.

- 4 Depending on your selection, do one of the following:
  - o If you selected **Always**, enter the forwarding number.
  - o If you selected **No Answer**, enter a forwarding number and then select **Forward After Rings**, and enter how many rings should be played before forwarding the call (one ring is about 6 seconds). A value of 2 is recommended.
  - o If you selected **Busy**, enter a forwarding number for calls that come in when you're in an active session. Contact your system administrator for more information about when the handset "knows" it is busy.

### *Microsoft Lync Server*

When the server handles the forwarding task, different options are presented. For Microsoft Lync, you can select forward to contact or forward to voicemail. Select the option and enter the data accordingly.



### User Tip: Forwarding calls to a URL

You can also enter a forwarding URL or IP address. For more information on using a URL or IP address, see [Dialing to a URL](#).

- 1 Press the **Enable** softkey, if presented, to confirm call forwarding.
- 2 Press **Home** to return to the Home screen.

### To disable Call Forwarding:

- 1 Perform one of the following actions:
  - o If you have a single line, choose **Settings > Feature Settings > Forward**.
  - o If you have multiple lines, select **Settings > Feature Settings > Forward > Line** to display the *Line Select* screen and choose the line you wish to disable call forwarding for.
- 2 If you've selected a line, or if your handset is set up with a single line, the Forwarding Type Select screen displays, enabling you to select the forwarding type you want. Highlight the Enabled forwarding type and press the **Disable** softkey.
- 3 Press **Home** to return to the Home screen.

## Enabling and Disabling Do Not Disturb (DND)

Do Not Disturb (DND) is an optional feature that your system administrator must enable. Ask your system administrator if DND is enabled on your network.

By default, the DND feature, when enabled, applies to all lines on your handset. The system administrator can enable your handset to apply DND on a line-by-line basis. This section explains how to enable and disable the DND feature for all lines and for single lines. For more information, contact your system administrator.

While DND is enabled, calls you receive are logged in your Missed Calls list. If you have also chosen to forward your calls to another number, calls will be sent to the forwarding number.

### Enabling and Disabling DND on All Lines

The DND feature, when set up, applies by default to all lines on your handset.

#### Enabling DND on all lines

- 1 From the Home screen, navigate to **Settings > Feature Settings > Do Not Disturb** and press **OK**.
- 2 Press the **Enable** softkey. DND is now enabled and the DND icon displays on the Status Bar.

## Disabling DND on all lines

- 1 From the Home screen, navigate to **Settings > Feature Settings > Do Not Disturb** and press **OK**.
- 2 Press the **Disable** softkey. DND is now disabled and the DND icon does not display on the Status Bar.

## Enabling and Disabling DND for Individual Lines

If your handset is set up with multiple lines and the system administrator has enabled your handset to apply DND to individual lines, follow these steps to enable or disable DND on one or more lines.

### Enabling DND on an individual line when DND for an individual line is enabled:

- 1 From the Home screen, navigate to **Settings > Feature Settings > Do Not Disturb**. When you select the DND feature, the *Line Select* screen displays.
- 2 Highlight the line you want to enable with DND and press **OK**.
- 3 Press the **Enable** softkey.  
The DND icon now displays on the Line bar in the Line Select screen.

### Enabling and Disabling DND on all lines when individual line DND is enabled:

- Once you enable one line with DND, the **Set All** and **Clear All** softkeys display. Press one of these to enable or disable DND for all lines.

## Using the Speed Dial List

Each time you add a contact to your Contact Directory, that contact is automatically assigned the next available speed dial index number and added to your speed dial list. You can use the speed dial list for quick dialing of frequently used numbers. You can dial contacts from the *Favorites* menu or from the speed dial list.



### Note: Understanding the Favorites list

Favorites are sorted in ascending order of the speed dial index number. There is not a one to one correlation between the Favorites number and the speed dial index number. If you want to change the order in the Favorites list, you must change the speed dial index numbers according to the sort order you desire. For example, if you want Joe to be number 1 in your Favorites list, you must assign him the lowest speed dial index number in use.

**To dial from the Favorites menu:**

- 1 From the Home screen, press the **Favorites** softkey. The contacts that display on this menu are the contacts at the top of your speed dial list, as shown next:



- 2 Scroll to a contact and press **Start** or press the contact index number, for example '1' on the keypad.

**To dial from the speed dial list:**

- 1 From the Home screen, press the **Features** softkey and select **Speed Dial**.

A list of speed dial contacts displays. Scroll through the list to view all speed dial contacts, as shown next.



- 2 Scroll to a contact and press **Start** or press the index number, for example '1' on the keypad would place a call to Don Blue.

### To add a speed dial contact:

A speed dial number can be assigned to any name in the contact directory. To add a new name that is not in the contact directory to the speed dial list, you must first add the name to the contact directory. Assign the speed dial number when you add the name.

- 1 Open the Contacts / Call Lists icon on the Home screen, and choose Contact Directory.  
Your contact directory opens.
- 2 Choose a contact and press the Edit softkey, Change option.  
The Edit Contact screen displays.
- 3 Scroll to Speed Dial Index and enter an unused speed-dial index number for that contact.
- 4 Press the Save softkey.

## Accessing Voicemail

If you have voicemail enabled, your handset will display the voicemail icon in the Status Bar and the LED will flash when you have a new unheard voicemail. The icon displays the current number of saved voicemail messages.



### User Tip: How to get a voicemail account

Voicemail is an optional feature. See your system administrator to set up a voicemail account.

### To access your voicemail:

- 1 Navigate to Messages > Voicemail.
- 2 If you have multiple lines:
  - a Choose **Line**. The Line Select screen displays.
  - b Highlight a line and press **OK**.  
The Messages screen displays and Voicemail is highlighted.
- 3 Press **OK** to select Voicemail.
- 4 Press the **Connect** softkey to access your mail, and follow the visual prompts on the screen.
- 5 If you want to delete voicemail messages, press the **Clear** softkey.
- 6 Press **Home** to return to the Home screen.



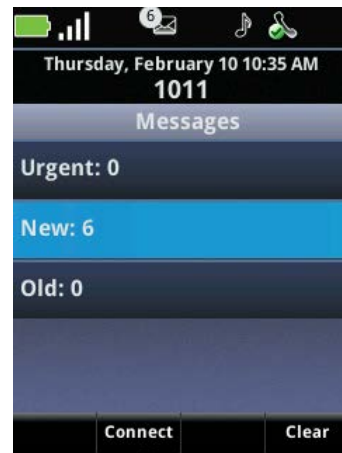
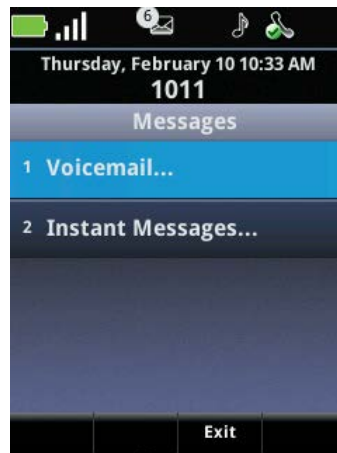
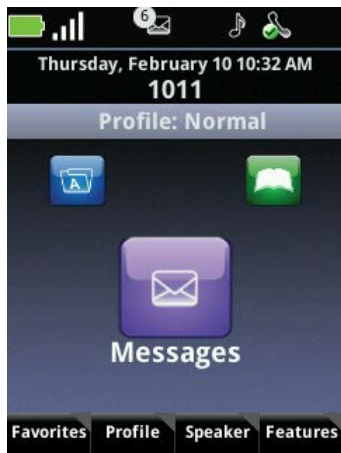

# Chapter 5: Push-to-Talk (PTT) and Paging

The Push-to-Talk (PTT) and Paging features enable you to broadcast a call to as many people as have subscribed to a PTT channel or Paging group. PTT is a two-way radio feature that opens a channel for ongoing two-way communication that uses the Talk button on the left side of the handset. Multiple channels can be open at the same time. Paging is a one way feature that opens a call cell but does not support a response or multiple page cells. It is an option on the Feature softkey. Your system administrator enables these features and determines the best way to deploy these features in your facility. Contact your system administrator if you need help with these features.



## Note: When to use Paging

The Paging feature is normally used only in environments where Polycom desksets are deployed and broadcasts need to reach both Spectralink wireless telephones and Polycom wired desksets. Paging is not normally otherwise deployed.

Manage both features in the Settings menu. Navigate to **Settings > Basic Settings > Preferences > Paging/PTT Configuration** to view the configuration options.

## Using the Push-to-Talk Feature

Spectralink 84-Series handsets can operate in a group broadcast mode called Push-to-Talk (PTT). With PTT, the administrator enables channels and users are subscribed to some or all of these channels to receive and send PTT broadcasts. In PTT mode, the handsets behave like walkie-talkies: your handset transmits audio over a built-in speakerphone and recipients can respond to your message. Your system administrator defines which PTT channels are available for subscription. By default, subscriptions to Channels 1, 24, and 25 are enabled. Contact your system administrator for more information.

This section shows you how to send and receive PTT broadcasts, and how to configure PTT. If the system administrator has disabled PTT, the PTT options will not display when you open the Settings icon from the Home screen.

There are three PTT channel types:

- **Normal Channels** PTT Channels 1 to 23 can be used as normal channels by any subscribed handset user. The administrator can create a label, comprised of up to 15 characters, for Channels 1 to 23 to help users identify PTT Channels. The default label for Channel 1 is ALL.

Normal Channels are allocated to various groups of users and recipients. Examples include channel 2 for the maintenance group, channel 3 for Hospital Admitting, channel 4 for the IT Helpdesk.

- **Priority Channel** Users subscribed to the Priority Channel will receive transmissions on the Priority Channel unless Do Not Disturb is enabled or an Emergency page is already playing. The Priority Channel plays transmissions at the current audio level. The default Priority Channel is 24.
- **Emergency Channel** Every handset will receive transmissions on the Emergency channel even if the handset is in an active call or if Do Not Disturb is enabled. Emergency transmissions play out on the speaker at the highest audio level. The audio level will return to normal for subsequent non-emergency transmissions. The default Emergency Channel is 25.

## Sending PTT Broadcasts

Press and release the **Talk** button to display the *PTT Channels List*, which displays channels in this order: the default Channel, the most recent channel you used, (if enabled) Channel 25 (the default Emergency Channel), and Channel 24 (the default Priority Channel) after which all channels are listed in numerical order.

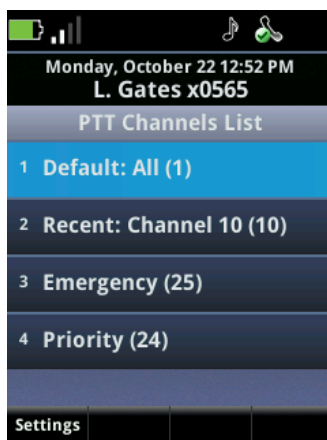

### To send a PTT broadcast:

- To broadcast on the default channel from standby mode, press and hold the **Talk** button. Hold the handset microphone approximately two inches from your mouth and speak. A Call cell opens in the Session Manager with a blue call icon.

### To transmit on a different PTT channel:

If there is an active PTT session, you must end it before changing the channel.

- From the **Home** screen, press and release the **Talk** button. Use the ▲ and ▼ keys to highlight a channel. Press and hold the **Talk** button to transmit on the highlighted channel.

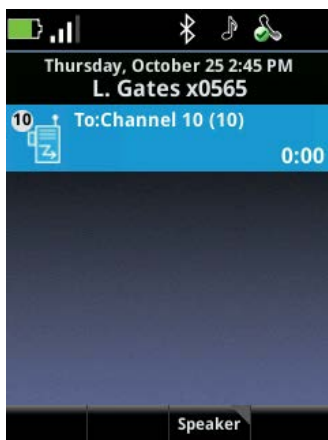

When you release the *Talk* button, the handset enters a ten-second wait period during which the channel is open to receive or send additional broadcasts. If no activity occurs within the wait period, the cell is closed. A waiting cell displays an orange call icon.

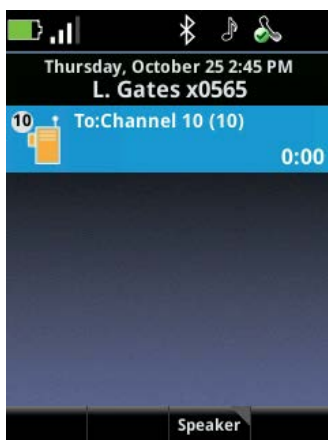

The wait period keeps the channel open and gives any handset subscribed to that channel time to join the conversation. To open a different channel or to send a new broadcast within the wait period, end the wait period on the current channel by pressing the **End** key.

## Receiving PTT Transmissions

Your handset will receive PTT transmissions differently depending on the priority of the PTT Channel, whether you are on an active call, or whether you have enabled or disabled your handset to receive PTT transmissions during an active call.



### PTT Channel Priority

The handset will alert you to PTT transmissions from Normal Channels, the Priority Channel, and the Emergency Channel. If you enable Do Not Disturb, you will not receive PTT transmissions from the Normal or Priority Channels. You will receive transmissions on the Emergency Channel even if Do Not Disturb is enabled.

### Receiving PTT Broadcasts

The handset will receive PTT broadcasts differently depending on whether or not you are in an active call.

#### To answer a PTT broadcast:

- Press and hold the **Talk** button during the ten-second wait period.

#### To end a wait period:

- Press **End**.

#### To transmit on a different PTT channel:

If there is an active PTT session, you must end it before changing the channel.

- From the Home screen, press and release the **Talk** button. Use the **▲** and **▼** keys to highlight a channel. Press and hold the **Talk** button to transmit on the highlighted channel.

#### To end one PTT broadcast and start another one:

- 1 Press the **End** key to exit a current PTT broadcast.
- 2 Press and release the **Talk** button and highlight a channel from the *PTT Channels List*.
- 3 Press and hold the **Talk** button to begin transmitting on the highlighted channel.

#### To answer a telephone call during a PTT broadcast:

- Press the **Start** key to mute a PTT transmission and answer the telephone call.

**To start a telephone call during a PTT broadcast:**

- 1 Press the **Start** key. The PTT transmission is put on hold.
- 2 Dial the number and press **Start**.

**To transmit on the priority channel:**

- 1 Press and release the **Talk** button.
- 2 Select the priority channel from the *PTT Channels List*. The default is Channel 24.
- 3 Press and hold **Talk**, and deliver your PTT message.

**To transmit on the emergency channel:**

- 1 Press and release the **Talk** button.
- 2 Select the emergency channel from the *PTT Channels List*. The default is Channel 25.
- 3 Press and hold **Talk**, and deliver your PTT message.

**To end an active PTT broadcast:**

- Press the **End** key to exit the PTT broadcast.

**To change the PTT volume:**

- Press the Volume up or Volume down buttons on the side of the handset.

Setting up the Accept While Busy Feature

In order to receive PTT broadcasts while you are in an active call, enable the *Accept While Busy* feature. When *Accept While Busy* is enabled, PTT broadcast and the active telephone call audio will play concurrently: you will be able to hear the audio of both the telephone call and the PTT broadcast through the handset speaker. The party on the other end of the telephone call cannot hear the PTT broadcast unless that party is local and has also enabled *Accept While Busy*.

If *Accept While Busy* is disabled, PTT broadcasts received while you are in an active call are placed on hold. If you wish, you can select the PTT broadcast and listen to it which puts the telephony call on hold.

**To enable and disable the Accept While Busy feature:**

- 1 Navigate to **Settings > Basic Settings > Preferences > Paging/PTT Configuration > PTT Push To Talk**.
- 2 Highlight and select **Accept While Busy**.
- 3 Enable or disable the *Accept While Busy* feature.

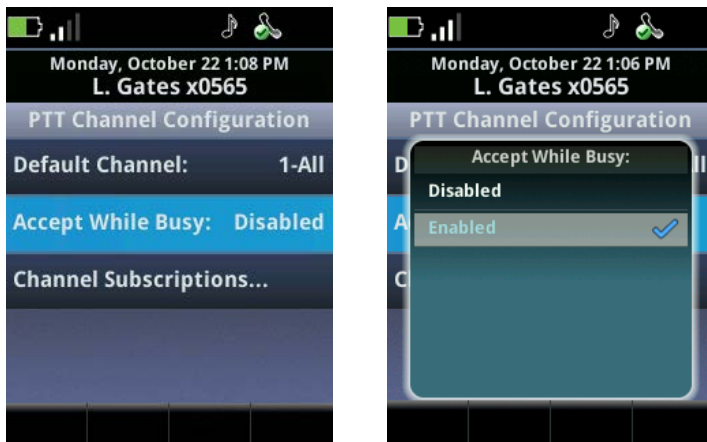

- 4 Press the **Home** key to exit.

#### To play PTT broadcasts when Accept While Busy is disabled:

- Select the PTT cell in the Session Manager and press the **Start** key to play the PTT broadcast. This puts the active call on hold.

### Configuring PTT

There are several ways to configure PTT. You can change the PTT default channel, subscribe or unsubscribe to channels that the system administrator has enabled, and customize incoming PTT alerts.

#### Changing the Default PTT Channel

The default PTT channel is the one that is transmitted on when you press and hold the Talk button. Press and release the Talk button to display all the channels. You can select a different channel from this list. The default channel can be changed to any available channel.

#### To change the default PTT channel:

- 1 Navigate to Settings > Basic Settings > Preferences > Paging/PTT Configuration > PTT Push to Talk.
- 2 Select Default Channel.
- 3 Select the new default channel number and press the **OK** softkey.
- 4 Press **Home** or **End** to exit.

#### Subscribing and Unsubscribing to Channels

You can subscribe or unsubscribe to any channel that the system administrator has enabled. Enabled channels will display in the *PTT Channels List*.

**To subscribe or unsubscribe to PTT channels:**

- 1 Navigate to **Settings > Basic Settings > Preferences > Paging/PTT Configuration > PTT Push To Talk.**

The *PTT Channel Configuration* screen displays.

- 2 Highlight and select **Channel Subscriptions.**

The *Channel Subscriptions* screen displays.

- 3 Select a channel.

- 4 Enable your subscription to that channel by choosing **Yes** or disable your subscription to that channel by choosing **No**.

- 5 Press the **Home** key to exit.

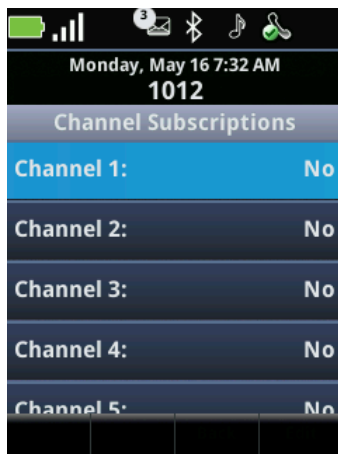
**Customizing PTT Alerts**

When you press the **Talk** button to send or receive a PTT transmission, your handset emits a PTT alert sound. You can customize this PTT alerting sound in any notification profile.

**To set a custom PTT alert for start and end transmissions:**

- 1 Navigate to **Settings > Basic Settings > Notification Profiles > [Profile] > Alerts.**

A list of alerts is displayed.

- 2 Highlight **PTT Start of Transmission** and press **OK**.

OR

Highlight **PTT End of Transmission** and press **OK**.

- 3 Highlight **Alert Tone** and press **OK**.

A list of alert tones is displayed.

- 4 Highlight an alert tone and press **OK**. You can preview alert tones by pressing the Play softkey.



To enhance the alerting of a PTT broadcast, you can enable PTT vibrate. When you enable PTT vibrate, the handset will vibrate three times whenever a PTT broadcast is received, whether the handset is in standby or in a call. The vibration does not replace any PTT tone pattern already set.

#### To enable vibration:

- Select **Vibrate** and Enable/Disable.



#### User Tip: PTT vibrate

To set the handset for PTT vibrate only, enable the vibrate option and set the alert tone pattern to Silent Ring.

## Using the Paging Feature

Spectralink 84-Series handsets can operate in a group broadcast mode called Paging. You can use the Paging feature to make a page to a page group. A page is a one-way transmission played over the handset's speakerphone. A page group is a defined group of page recipients that have subscribed to that group. Your system administrator defines which page groups are available for subscription. By default, subscriptions to groups 1, 24, and 25 are enabled. Contact your system administrator for more information.

There are three paging group types:

- **Normal pages** Page Groups 1 to 23 can be used as normal page groups by any subscribed handset user. The administrator can create a label, comprised of up to 15 characters, for Groups 1 to 23 to help users identify the page group. The default label for Group 1 is *ALL*.
- **Priority pages** Pages from this group are received by all handsets unless Do Not Disturb is enabled or an Emergency page is already playing. Priority pages are played at the current audio level. The default priority page group is 24.
- **Emergency pages** Every handset will receive Emergency pages even if the handset is in an active call or if Do Not Disturb is enabled. Emergency pages play out on the speaker at the highest audio level. The audio level will return to normal for subsequent non-emergency pages. The default Emergency Page Group is 25.

### Sending a Page

When you send a page, the page displays in a call cell on the handset, indicating the page sender and paging group. If you are sending a page, press *End* to end the transmission to the whole page group. If you are a page recipient, press *End* to end a page transmission on your handset.

## To send a page:

- 1 To send a page, press the **Features** softkey, and select **Paging**.  
The Paging Groups List displays, shown next:

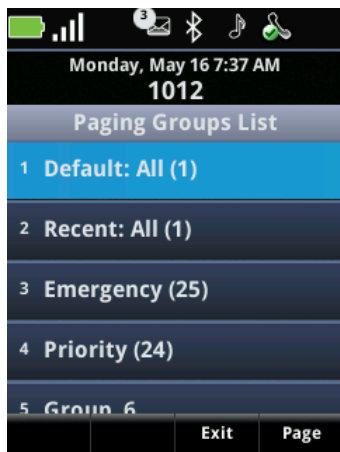

- 2 Highlight the Paging Group you wish to page.
- 3 Press **OK** or press the **Page** softkey to start the page.  
The page displays as a call cell, shown next:



- 4 When the preamble period ends and the page starts, start speaking your message.
- 5 When you are finished speaking your page, press the **End** key. If you are the sender, this ends your page transmission. If you are the recipient, pressing the **End** key ends the page only to you.



### User Tip: Calling while paging

If you press the Start key while you are sending a page, the page ends and the Dialer opens.

### Change the audio option while sending a page:

- Change the audio option while you are sending a page by pressing the **Speaker** softkey and selecting a different option.

## Receiving a Page

Your handset will receive pages differently depending on the priority of the page group, whether you are on an active call, or whether you have enabled or disabled your handset to receive pages during an active call.

### Page Group Priority

The handset will alert you to pages from Normal page groups, the Priority page group, and the Emergency page group. If you enable Do Not Disturb, you will not receive pages from the Normal or Priority page groups. You will receive pages on the Emergency page group even if Do Not Disturb is enabled.

### Receiving Pages

The handset will receive pages differently depending on whether or not you are in an active call.

### To receive pages when you are not in an active call:

If you receive a page and you are not in an active call, the page displays on your screen no matter what the paging group is. You can do the following:

- Hold the page and resume a held page.
- Press the **End** key to stop receiving the page. This ends the page at your handset only.
- Place a new call by opening the dialer.

### Setting up the Accept While Busy Feature

In order to receive pages while you are in an active call, enable the *Accept While Busy* feature. When Accept While Busy is enabled, pages will interrupt active telephone calls and you will be able to hear the audio of both the telephone call and the page. The party on the other end of the telephone call cannot hear the page unless that party has also enabled Accept While Busy.

If Accept While Busy is disabled, Pages received while you are in an active call are placed on hold. To play the Page, you can either place the active call on hold or end the active call.

### To receive pages while you are in an active call:

- 1 Navigate to **Settings > Basic Settings > Preferences > Paging/PTT Configuration > Group Paging**.
- 2 Highlight and select **Accept While Busy**.
- 3 Enable or disable the Accept While Busy feature.

- o If you have enabled your handset to receive pages while in an active call, the page will display in a second call cell as an active page. You will hear both the original call and the page. Press the **End** key to end the page.
- o If you have disabled your handset from receiving pages while you are in an active call, the page will display in a second call cell as a page on hold. Highlight the page on hold and press the **Resume** softkey to play the page. Press the **End** key to end the page



### User Tip: Priority or Emergency pages

If you have disabled your handset from receiving pages while you are in an active call, and you receive a Priority or Emergency page while in an active call, the page will display in a second call cell as an active call. You will hear both the original call and the page audio. Highlight the Page cell and press the **End** key to end the page.

## Paging Configuration

There are several ways to change the paging configuration. You can change the default paging group, and subscribe/unsubscribe to paging groups.

### Changing the Default Paging Group

By default, Group 1 is the default page group but your system administrator may set a different default group. If necessary, you can change the default group.

#### To change the default paging group:

- 1 Navigate to **Settings > Basic Settings > Preferences > Paging/PTT Configuration > Group Paging**.  
The *Group Paging Configuration* screen displays and *Default Group* is highlighted.
- 2 Press the **Ok** key. A text entry box displays.
- 3 Type the number of the new default paging group.
- 4 Press the **Ok** softkey.

### Changing Your Subscription to a Page Group

In order to receive a page from a particular group, you must subscribe to that group. By default, you are subscribed to groups 1, 24, and 25. Contact your system administrator for information about who is in each group.

#### To subscribe or unsubscribe to a page group:

- 1 Navigate to **Settings > Basic Settings > Preferences > Paging/PTT Configuration > Group Paging**.

The *Group Paging Configuration* screen displays.

**2** Highlight and select **Group Subscriptions**.

The *Group Subscriptions* screen displays.

**3** Select a group. Enable your subscription to that channel by choosing **Yes** or disable your subscription to that channel by choosing **No**.

**4** Press the **Home** key to exit

**To adjust the volume of non-Emergency group pages:**

- Use the side buttons to adjust the volume during a non-Emergency group page.



**User Tip: Emergency page volume**

You cannot adjust the volume of Emergency group pages using the handset volume control buttons. Setting the Emergency page volume is an administrator function. By default, Emergency pages are played at the highest volume level.

# Chapter 6: Using the Contact Directory

You can open your Contact Directory from the *Contacts/Call Lists* icon on the Home screen. The Contact Directory enables you to store up to 9999 contacts. By default, contacts are listed alphabetically. You can use the Contact Directory to search, dial, add, edit, and delete specific contacts in your directory. To view the Contact directory, navigate to the **Contacts/Call Lists** icon on the Home screen and select **Contact Directory**.

You can add contacts manually, from the missed, received, and placed call lists, or from the IM History list. You may also add contacts from the Corporate Directory. See [Searching and Saving with the Corporate Directory](#).

## Editing Contacts

To edit contacts in your Contact Directory, you will need to navigate to a specific contact.

### To edit a contact:

- 1 Navigate to Home > Contacts/Call Lists > Contact Directory.  
The Contact Directory list of contacts displays.
- 2 Highlight a specific contact and press the **Edit** softkey. The popup menu presents **Add**, **Change** or **Delete** options. Select **Change**.

The following table shows you the fields you can edit for each contact in your contact directory.

Table 5: Contact Directory Fields

<b>Field Name</b>	<b>Description</b>
<b>First Name</b> <b>Last Name</b>	Enter the first and last name of the contact. Each field supports a maximum of 32 characters. You can search for a contact by first or last name. Note that although contacts are listed alphabetically, contact labels (such as a nickname) display before and take priority over first and last name.
<b>Contact</b>	Enter the phone number of a contact. This could be an extension number within your facility, or an IP address or phone number outside your facility. The phone number must be unique, and must not already exist in the directory. The handset will not save entries already in use. This field supports a maximum of 128 characters.

<b>Field Name</b>	<b>Description</b>
<b>Speed Dial Index</b>	<p>Contacts are automatically assigned the next available Speed Dial Index number. You may edit the Index number after the contact has been added.</p> <p>When editing the Speed Dial Index number, you may assign it an unused value between 1 and 9999. If you assign it a value that is already in use, the message <b>Speed dial index already exists</b> displays. If you enter an invalid speed dial index number (for example, 0 or 00), the message <b>Speed dial index is invalid</b> displays.</p>
<b>Label</b>	Use a label to further identify a contact. Note that although contacts are listed alphabetically, contact labels (such as a nickname) display before and take priority over first and last name. This field supports a maximum of 32 characters.
<b>Ring Type</b>	Choose a ring identifier from the drop-down list to specify a unique ring tone for this contact.
<b>Divert Contact</b>	If you want calls from this contact to be sent to a third party, enter the number of the third party here. Calls will be sent to this number if you enable Auto Divert. The Divert Contact field supports a maximum of 32 characters.
<b>Auto Reject</b>	If you enable Auto Reject, calls from this contact will not ring on your handset. Your system administrator determines how rejected calls are handled (for example, rejected calls may go to your voicemail system). Calls that are rejected from a contact display in the Missed Calls list.
<b>Auto Divert</b>	If you set the Auto Divert field to enabled, each time the contact calls, the call will be directed to a third party specified in the Divert Contact field.
<b>IM Name</b>	Enter an Instant Messaging (IM) identifier for this contact. See <a href="#">Understanding IM Contact Names</a> for additional information about the entry requirements for this field.

## Managing Your Contacts

This section explains how to add, search, edit, and delete contacts, and how to reject and divert calls.

### To add contacts manually:

- 1 Navigate to the **Contacts/Call Lists** icon on the Home screen and press **OK**.
- 2 Highlight **Contact Directory** and press **OK**.

Existing contacts in the Contact Directory will display in alphabetical order. If you have created instant messaging (IM) contacts, each contact that has an IM name entered in the Contact Directory shows a presence icon indicating their IM status.

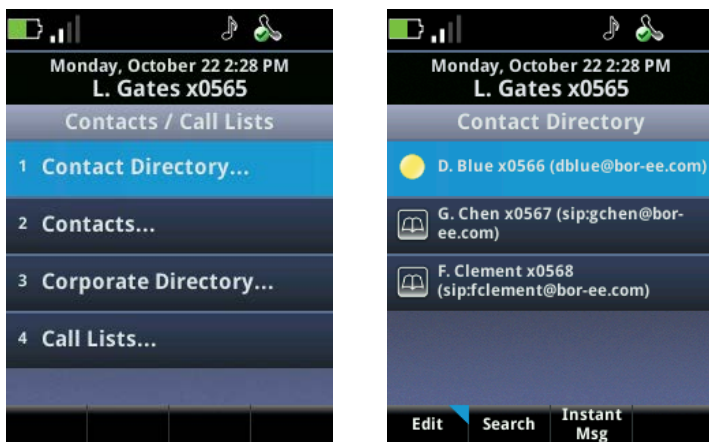

- 3 Press the **Edit** softkey, Add option.

An *Add to Contact Directory* screen displays:

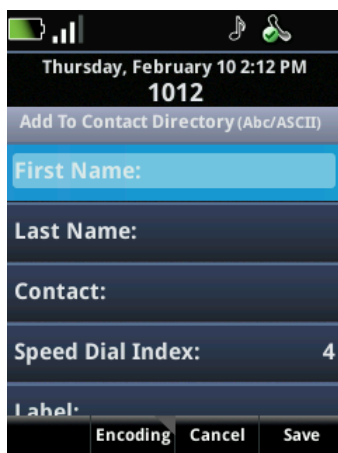

- 4 Add contact information about the new contact. Use the softkeys for entry assistance.
- 5 When finished, press the **Save** softkey.
- 6 Press the **Home** key to return to the Home screen.

**To add a contact from the Missed, Received or Placed Call Directory:**

- 1 Navigate to the Contacts/Call Lists icon on the Home screen and press **OK**.
- 2 Highlight **Call Lists** and press **OK**.

A list of missed, received, and placed calls displays.



- 3 Highlight the contact and press **OK**.  
The call information displays.
- 4 Press the **Save** softkey. The contact information is entered to the Contact Directory.
- 5 Press the **Home** key to return to the Home screen.

**To search for a directory contact:**

- 1 Navigate to the Contacts/Call Lists icon on the Home screen and press **OK**.
- 2 Highlight **Contact Directory** and press **OK**.
- 3 Press the **Search** softkey, enter the first few characters of the contact's first or last name, and press the **Search** softkey again.

**To delete a directory contact:**

- 1 Navigate to the Contacts/Call Lists icon on the Home screen and press **OK**.
- 4 Highlight **Contact Directory** and press **OK**.
- 5 Highlight the contact you wish to delete and press the **Delete** softkey.

**To enable or disable Auto Reject:**

- 1 Go to the Contacts/Call Lists icon on the Home screen and press **OK**.
- 2 Highlight and select **Contact Directory**.  
The Contact Directory list of contacts displays.
- 3 Highlight a specific contact and press the **Edit** softkey, Change option.
- 4 Highlight and enable or disable **Auto Reject**.

**To enable Auto Divert:**

- 1 Go to the Contacts/Call Lists icon on the Home screen and press **OK**.
- 2 Highlight and select **Contact Directory**.  
The Contact Directory list of contacts displays.
- 3 Highlight a specific contact and press the **Edit** softkey, Change option.
- 4 Highlight **Auto Divert**, press **OK**, and choose **Enabled**.
- 5 Highlight **Divert Contact**, enter the number of a third-party contact, and press **OK** or the **Save** softkey.

## *Using Call Lists*

The handset captures information about calls you have missed, received, and placed. You can set your call list to display all types of calls or one type of call. The All Calls, Missed Calls,

Received Calls, and Placed Calls lists enable you to view call details, save the contact information to the Contact Directory, delete calls, and call an entry on the list.

Navigate to **Home > Contacts / Call Lists > Call Lists**.

#### To set the type of call list:

- Press the **Type** softkey, highlight the type of calls you wish to view on the call list, and press **OK**.

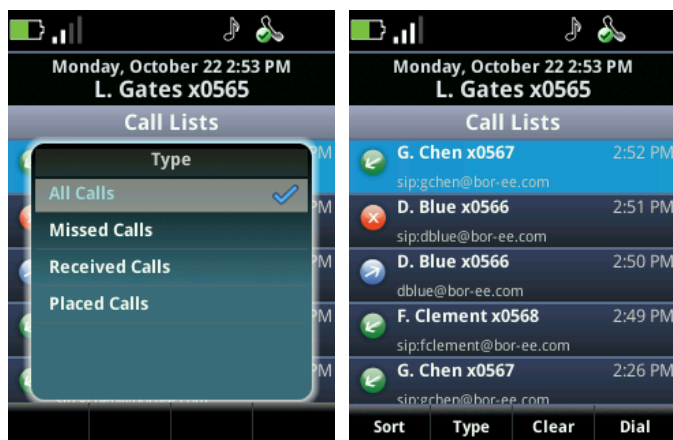

#### To view call details:

- Select the call you wish to view and press **OK** to view contact, time, name, and duration.



#### To save contact information to the Contact Directory:

- Select the call and press the Save softkey.

#### To delete calls from the Call List:

- Select an individual call and press the Delete softkey.
- Delete all calls by opening the list and pressing the Clear softkey.

### To dial an entry on the Call List:

- You can call from the Call List by selecting the call and pressing the Dial softkey or by selecting the call and pressing the Dial softkey.

## *Searching and Saving with the Corporate Directory*

Your system administrator can enable access to your organization's Corporate Directory that resides on the call server. You can search for contacts in the Corporate Directory, view contact information, call a contact, and add a contact to your Contact Directory.

### Searching the Corporate Directory

Your system administrator can set up a Corporate Directory that you can use to search for contacts in your organization. You can open the Corporate Directory from the Contacts/Call Lists icon on the Home screen.

The administrator may set up a Contact Directory list of contacts, or you can perform a quick search or an advanced search. A quick search enables you to search contacts by last name. If you make an advanced search, you can search the Corporate Directory using any combination of first name, last name, phone number, address, and title. Search options will vary by facility.

### To search for a contact in the Corporate Directory:

- 1 Navigate to the Contacts/Call Lists icon on the Home screen and press **OK**.
- 2 Highlight and select Corporate Directory and press **OK**.
- 3 Do one of the following:
  - To perform a quick search, enter the first few characters of the contact's last name, and then press the **Submit** softkey. The screen displays a list of contacts, starting with any successful matches.
  - To perform an advanced search, press the **AdvFind** softkey. Enter your search criteria in the Advanced Find field, and press the **Submit** softkey. Successful matches are displayed in a list.
- 4 To erase your search criteria and enter new criteria, press the **Clear** softkey.

### Saving Corporate Directory Search Results

You can set your handset to save the last Corporate Directory search results. When you open the Corporate Directory with Save Search Results enabled, the results of your last search or the last person you selected will display. If you don't enable your handset to save search results, a blank search screen will display each time you open the Corporate Directory.

**To enable your handset to save Corporate Directory search results:**

- 1** Navigate to **Settings > Basic Settings > Preferences > Corporate Directory > View Persistency**.
- 2** Scroll to **Enabled**, and press **OK**. Your handset will now save corporate directory search results in the Corporate Directory search screen.
- 3** Press the **Home** key.

# Chapter 7: Instant Messaging

Your system administrator sets up Instant Messaging (IM) using Microsoft® Office Communications or Microsoft Lync®. If IM is available, *My Status* will display in the *Profile* softkey menu on the Home screen. You can set your IM status or “presence”, and enter an IM name for each of your contacts.

You can initiate IM chats from the Contact Directory, your Contacts list or from the IM History list. Only one IM session can be active at a time. An incoming IM message opens a pop-up window and active chats display in the Session Manager. You may put an IM session on hold for up to five minutes after which the session is closed.

You can view your IM History list by selecting the Messages icon on the Home screen. Highlight and select **Instant Messages** to view IM chat history. Press the View softkey to view the chat history or initiate a new chat. Press the Contacts softkey to go to the Contacts list.

## Understanding IM Contact Names

The default IM contact name is actually a shortened form of the IM address that the server recognizes in the form of sip:ImUserName@CompanyServerDomain. When the ImUserName is, for instance, Joe54, and Joe is also in your company, you can enter Joe54 in the IM name field and the rest of the address is appended to the IM name when the chat is initiated. In this example, Joe’s email address might be Joe54@widgets.com.

When you add a contact to your IM contacts from the Corporate Directory or from the IM History list, you will see the full IM address saved in the IM Name field. If you share the same domain name with a contact, you do not have to enter the full domain name of that contact. If your IM contact doesn’t share your domain name, include that contact’s domain name using this format: sip:ImUserName@OtherDomain. (If the sip: prefix is missing, the handset will add it automatically.)

To communicate using IM, you will need to add the Last Name, Contact, and IM Name of the contact in the Contact Directory. The easiest way to get IM names is by adding contacts from the Corporate Directory or from the IM history list. Contacts that are added from the Corporate Directory may also have an IM name as part of their information. The required fields are automatically populated when a contact is saved from the IM history list, which presumes that the contact placed an IM chat with you first and therefore already has an IM name. See [Editing Contacts](#) for more information about entering and editing data in the contact fields.



### User Tip: How to get IM names into your Contacts

The easiest way to get IM names may be to get them from the Corporate Directory. Check with your system administrator and see [Saving Corporate Directory Search Results](#) for more information.

## Understanding IM Status Icons

When a contact has an IM name, the IM icon will display to the left of the name in the Directory to indicate availability.

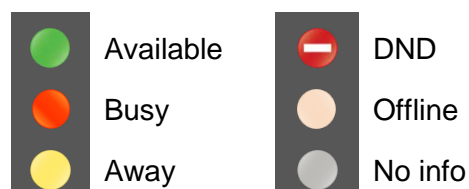

If there is an unread IM from a contact, the unread message icon will display next to the contact name in the history list:



When you are using IM, you need to set your status so that your IM contacts know your availability.

### To set your IM status:

- 1 From the **Home screen**, select the **Profile softkey**.
- 2 **Select My Status** from the menu to display the options in the My Status screen. Choose the status you wish to display.

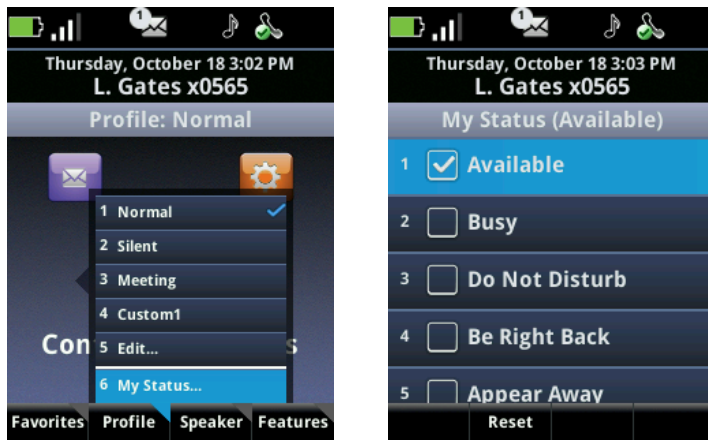

## Managing Your IM Contacts

### To display your IM contacts:

- Select the Contacts / Call Lists icon on the Home screen, and choose **Contacts**.
- OR
- Select the Messages icon on the Home screen, and **Instant Messages** to see your IM History list.
- Press the **Contacts** softkey to open your IM contacts.

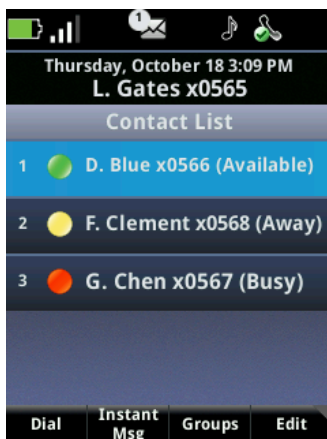

From this screen you can call a contact, send an IM, view in Groups and edit IM contacts.

### To view, add or delete IM contacts:

- Press the **Edit** softkey to display information about the contact, add a new IM contact or delete the selected contact.

### To call an IM contact:

- Select the contact and press the Dial softkey. Note that the Dial softkey will not display if no telephony information is stored.

### To view groups:

- Groups are set up and managed on the Microsoft Client that resides on an associated computer. You can view/call/IM a group member but you cannot edit the Groups.

## Initiating an Instant Messaging Session

This section shows you how to initiate an instant messaging session, understand the chat window, manage instant message sessions, and read and manage stored messages.

You can initiate an instant message in several ways:

### Message Center:

- Select the **Messages** icon on the Home screen, and choose **Instant Messages** to open a list of your recent chat contacts. Select the contact you wish to open a chat with and press **OK** to open a chat window for that contact.

### An incoming IM call:

- Accept the call by pressing **OK** or **Start**.

### Contact Directory:

- 1 Open the Contact Directory by selecting the **Contacts/Call Lists** icon on the Home screen, and choosing **Contact Directory**.
- 2 Select your intended recipient from the list. Only those names with a presence icon have IM names stored.
- 4 Press the **Instant Msg** softkey to open a new chat window.

### IM Contacts List

- Open the IM Contacts list by selecting the *Contacts/Call Lists* icon on the Home screen, and choosing **Contacts**.
- Select a contact and press the **Instant Msg** softkey to open a new chat window.

## Understanding the Chat Window

The IM chat window is divided into two sections. The top section contains the history of chats with the contact and the bottom section is the text entry field for your new message. Navigate within the history field by pressing the ▲ and ▼ keys. Navigate within the text entry field by pressing the ◀ and ▶ keys. Press the << softkey to backspace and delete text you have entered.



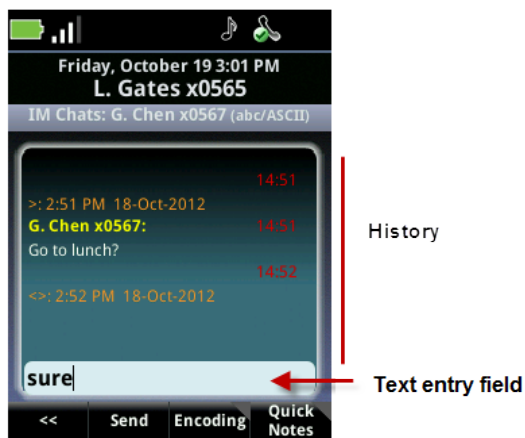

When a new IM chat window opens, you can type a new message. The default entry mode is alphabetic. Use the *Encoding* softkey for entering numbers and other characters. Use the **Quick Notes** softkey to enter preprogrammed messages. A message can be up to 128 characters in length. Once you have finished typing your message, press **OK** to send.

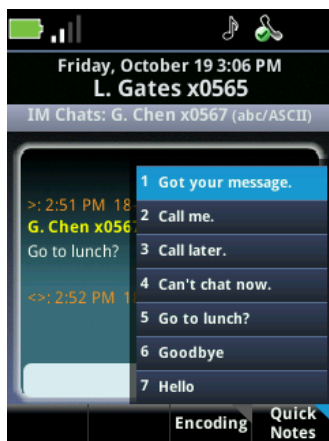

Quick Notes are programmed by your system administrator. The Quick Notes shown here are for illustration purposes only. Contact your system administrator for Quick Notes support.

## Managing Instant Message Sessions

There are several ways to manage IM sessions.

When you receive an incoming IM chat, an IM pop-up window displays, shown next.

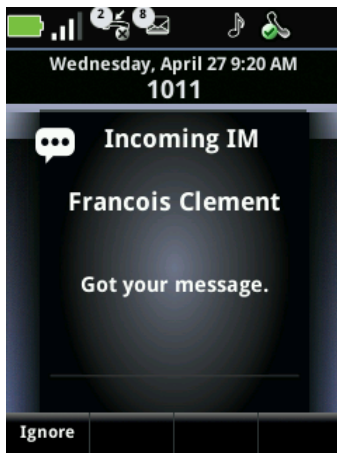

### To respond to an IM call:

- Press the Dial key or OK key to open the IM chat window.

### To ignore an IM call:

- Press the **Ignore** softkey to close the IM pop-up. The IM session is added to the session list and to the IM History list as an unread entry.

### To end an IM call without responding:

- Press the **End** key to close the IM pop-up and add the IM session to the IM history list as an unread entry. The IM session is not placed on hold and will not display in the Session Manager.

### To allow an IM pop-up to expire:

- If you take no action during an IM pop-up announcement, the pop-up announcement will terminate after 20 seconds and the alerting IM session will display in the Session Manager as a held session.

### To end an IM session:

- Press the **End** key.
  - When you end an IM chat while the IM chat window is active, the IM chat window closes, and the session is stored in the IM history List.
  - When you end an IM chat while the IM chat cell is highlighted and on hold or alerting, the cell is closed and the chat is stored in the IM history List.

### To exit an IM session without ending it:

Do one of the following:

- Press the **Home** key to place the chat on hold and display the Home screen.

- Press the **Back** key to place the chat on hold and display the Session Manager. If you entered the IM chat from the IM history list, the IM history list will display, not the Session Manager.
- Press the **Start** key to place the chat on hold in the Session Manager and display the Dialer.

#### **To open an IM chat window during an existing non-IM call:**

- Press the Home key and navigate to Contacts/Call Lists > Contacts and locate the IM contact you want to chat. Press the **Instant Msg** key to put any existing non-IM call on hold and open an IM Chat window.



#### **User Tip: One chat at a time**

Only one IM Chat can be active at any given time. If you have a chat on hold in the Session Manager and use the Dialer to start a new IM chat session, the old session will be terminated. Any unfinished IM message will be discarded and the session will be appended to the IM History. A new chat window will open for the new chat.



#### **User Tip: Chats interrupting chats go to history list**

An incoming IM message that arrives while another chat is active is announced by a tone. It will be appended to the IM History List as an unread message and the unread count status icon is incremented.



#### **Note: Instant Messaging conferences**

Instant Messaging conferences are not supported. If another party sends you an invitation to an Instant Messaging Conference, the invitation will be rejected without notice to you as the party being invited.

## *Reading and Managing Stored Messages*

IM history is stored by contact under Messages > Instant Messages. The History list displays a list of contacts you have had IM sessions with since the last time the handset was turned on, starting with the most recent.



#### **User Tip: When IM chats are cleared**

When you turn your handset off, the IM history list is cleared. Only IM chats that you have made during the current handset power cycle are displayed in the IM history list.

**To view your IM chat history:**

- 1 Select the **Messages** icon on the Home screen, and choose **Instant Messages**.
- 2 Highlight the cell of a contact you wish to view and press the **View** softkey.

An IM chat window opens with the top window displaying all chats with that contact since the handset was turned on.

**To resume an IM session:**

- Highlight the cell of the contact you wish to chat with and press **OK**.

An IM chat window opens.

**To delete IM contact history:**

- To delete an IM contact history from the IM history list, highlight the contact's cell and press the **Contacts** softkey. Press the **Edit** softkey, Delete option.

# Chapter 8: Using the Calendar

The Calendar is an optional feature set up by the system administrator as part of an implementation of the Exchange Server Integration (ESI). If administrators have not implemented the Exchange server in your facility, the Calendar will not function. If your administrator has implemented the Exchange server, select the **Applications** icon on the Home screen and select **Calendar** from the menu.

The Calendar displays the Day view with your next appointment highlighted by default. The Day view lists your appointments for that day. View the Month by pressing the Month softkey. Days with appointments are identified with a yellow dot. When you select a day, the Day view opens and displays appointments that you have scheduled for that day. In the Day view, select an appointment to view the appointment details.

The clock time and date are configurable in the Settings menu.



## User Tip: Log in to use the Calendar

The Exchange Server Integration requires login credentials in order to use the Calendar application. See [Logging In and Signing In](#) for more information.

### Day View

The Day view opens as the default view and when you select a day in the Month view.

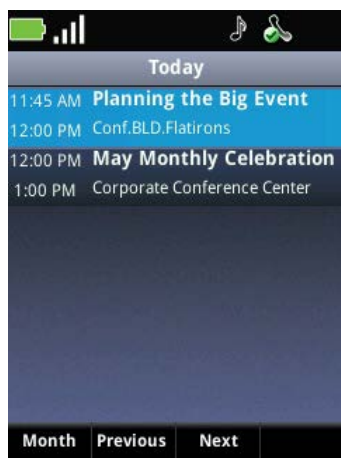

- To view the details of a meeting, highlight it and press **OK** to open the Details view.
- Use the navigation keys to scroll to meetings that are not visible on the screen.
- Press the *Previous* and *Next* softkeys to scroll to other days. Press the *Month* softkey to display the Month view.

### Details View

When you are in the Day view, highlight and select a meeting to view the details.

The Details View lists the following meeting information:

- Meeting name/Subject
- Meeting Date
- Meeting Start Time
- Meeting End Time
- Meeting Location
- Meeting Organizer Name
- Required Attendees
- Meeting Description

A blue scroll bar on the right side of the screen indicates further meeting information. Use the navigation keys to scroll to meeting information that is not visible on the screen.

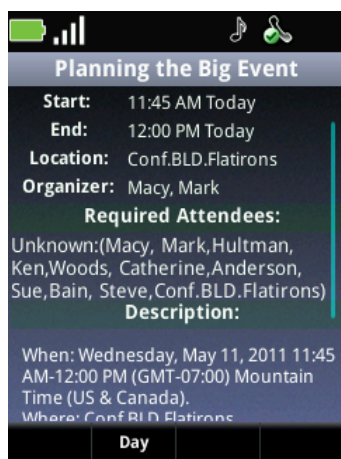

- Press the **Day** softkey to return to the Day view.

### Notification Pop-up

Enable/disable meeting reminders by navigating to **Home > Settings > Basic Settings > Preferences > Calendar Settings** and selecting the **Reminder** option. It is enabled by default. If meeting Reminders are enabled, a Reminder will display 15 minutes before the scheduled meeting start time.



When a Reminder displays, you can press one of the following softkeys:

- **Detail** Open the meeting details
- **Snooze** Remind you again in a few minutes
- **Dismiss** Cancel the reminder

### Month View

To open the Calendar, select the **Applications** icon on the Home screen and select **Calendar**. The Month view, shown next, opens with the current date highlighted.



- Yellow dots indicate one or more meetings on that day.
- Use the navigation keys to scroll to a day and press **OK** to select the Day view for that day.
- Press the *Previous* and *Next* softkeys to scroll to other months. Press the **Exit** softkey to return to the Home screen.

# Chapter 9: Pairing and Connecting a Bluetooth Headset

This section shows you how to pair and connect your Bluetooth headset.



## **Note: Bluetooth compatibility**

Your 84-Series handset has been tested for compatibility with Bluetooth v2.1 headsets. However, Spectralink does not recommend using your headset while the 2.4 GHz band is enabled. In this case, the Bluetooth and WLAN network with both use the same 2.4GHz frequency range. Bluetooth technology and 802.11b/g/n technology are not compatible. Bluetooth device behavior may also vary slightly between phone models. The following instructions are intended as a guide, and may not specifically apply to your Bluetooth device. You can usually find instructions on the Bluetooth headset manufacturer's Web site.



## **User Tip: Pairing a Bluetooth device**

To avoid conflicts with other devices, pair your Bluetooth device in an area that is free of other Bluetooth activity.



## **Caution: Out of range conditions**

If the Bluetooth headset moves out of range of the handset and loses its connection, it may beep a warning. When it moves back into range, the Bluetooth headset may or may not reconnect with the handset. This behavior varies with Bluetooth headset model.

## **Pairing Versus Connecting**

You can have up to four Bluetooth headset paired with the handset at any one time. Pairing establishes a relationship between a headset and the handset. This relationship is maintained through power cycles unless the headset is removed from the list of paired headsets. To make or receive a call using a paired headset, you'll need to establish a headset connection. Only one Bluetooth headset can be connected to the handset at any time. To switch to a different paired headset, you'll need to first disconnect your current headset and then connect to the new one.



## Turning On and Managing the Bluetooth User Feature Options

Once the handset is administratively enabled for Bluetooth, you can access the user options to enable or disable Bluetooth and manage the feature for personal use.

### To enable Bluetooth on your handset:

- 1 Turn on the handset. Navigate to **Settings > Basic Settings > Bluetooth Settings**. The following screen displays:



- 2 Select **Bluetooth Radio** and turn Bluetooth on. When Bluetooth is turned on, the Bluetooth icon (  ) displays in the Status Bar.

### To Add, Pair and Connect a Bluetooth headset:

- 1 Place the Bluetooth headset in discovery mode by holding down the answer/end button on the headset.

The indicator light will flash blue for several seconds before glowing a solid blue color. See the manufacturer's instructions for pairing if you have any difficulty with this step.

- 2 Select **Manage BT Headsets**. A list displaying your paired headsets displays. When the list is populated, the icon color indicates headset status:

- **Red icon** Indicates the listed headset is identified but not paired.



- **White icon** Indicates that the headset is paired.



- **White icon with a headset** Indicates that the headset is paired and connected.

1  Motorola H700

- 3 If your headset is not on the list under *Manage BT Headsets*, you can scan for unpaired headsets by pressing the **Scan** softkey.

All the nearby devices in discovery mode will be added to the list. The message *Place device in discoverable mode* reminds you to put your headset in discovery mode if you haven't done that yet.

When scanning for headsets to pair with, the handset ignores other incompatible Bluetooth devices such as printers, or laptops. The handset alternates its scanning cycle every 12-seconds—12 seconds on, then 12 seconds off. Note that certain headset models are designed with a discovery mode time-out period, which may require that you reactivate discovery mode for the headset to establish a successful pairing. Certain newer-model headsets may pair as soon as they're discovered by the handset and added by the user, while some legacy headsets require the user to enter a headset PIN number—usually 0000 by default. Once paired, the handset will remember the headset even if the handset or headset is turned off and on.

Each new unpaired headset added to the list has a red icon.

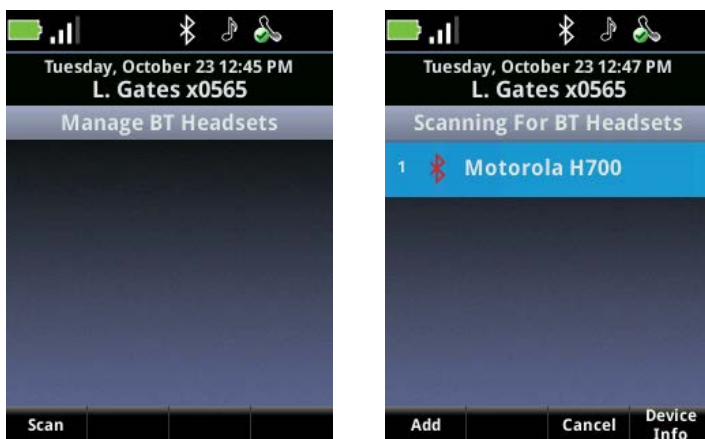

- 4 Locate your headset in the list and press the **Add** softkey to begin the acquire procedure. Once the handset has acquired the headset, the **Manage BT Headsets** screen appears with the headset displayed. The white icon indicates that it is paired but not connected.

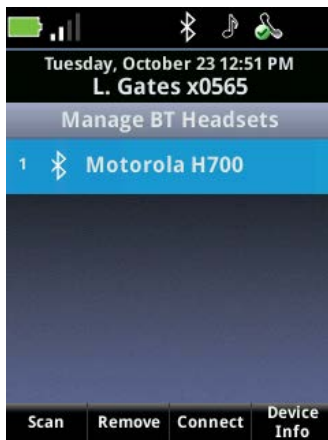

- 5 In order to use the headset, you must connect it. Press the **Connect** softkey. If you are using a legacy headset, you may be prompted for a password: 0000.

Once it is connected it will display on the list with the headset icon. The headset icon will also display in the Status Bar.

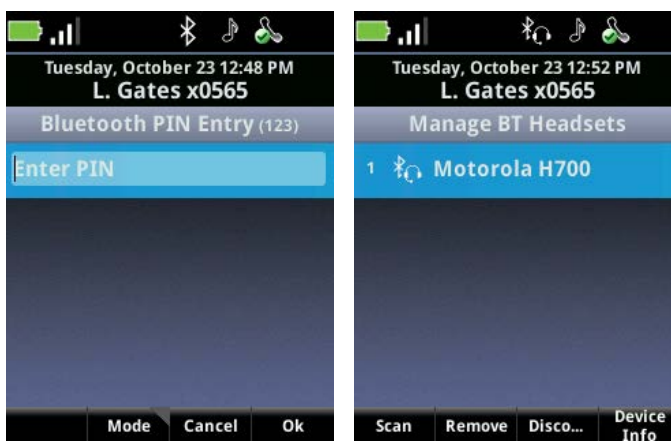

- o To turn off the headset, press the **Disconnect** softkey.
- o To remove the headset from the list, press the **Remove** softkey.

#### Changing the audio option while using a Bluetooth headset:

- If you press the Speaker softkey while using a Bluetooth headset, you get a shortcut menu that enables you to redirect audio through a different audio path.
- If you turn off the Bluetooth headset without ending an active call, the audio will be routed to the next active audio option.

#### Setting Bluetooth volume:

- Use the volume adjustment buttons on the headset to increase or decrease call volume.

## **Receiving Push-To-Talk Calls**

When you receive a Push-to-talk (PTT) call, the audio is automatically routed through the handset speaker and not through the headset you are currently using.

If you wish, you can use the Speaker softkey (or, if you're in a handset call, the Features softkey) during a PTT call to change the audio path of the PTT call to your Bluetooth headset.

# Chapter 10: Using the Barcode Reader (8450/8452/8453 only)

Barcode technology enables you to encode and decode information stored in a variety of visual patterns. You can use the barcode reader to input data in the following ways:

- Input scanned data into a Web application running on the handset, such as an application input field.
- Input scanned data into an application running on a PC using the Spectralink® Quick Barcode Connector (QBC) program.

Currently, the Spectralink 8450 handset supports a wide range of one-dimensional (1D) and stacked 1D barcode types, including the Code 128 barcode symbology, which can contain up to 70 numerals and/or characters. The Spectralink 8452/8453 handset supports both 1D and a wide range of two-dimensional (2D) barcode types. Two-dimensional barcode symbologies typically encode more data, which may be contained in a smaller barcode label, as compared with 1D barcode symbologies.

1D example (Code 128 symbology) for 8450, 8452 and 8453



2D example (QR Code symbology) for 8452 and 8453 only



## Caution: The barcode reader LED

The LED light is not a laser but is very bright. Do not stare at it or shine it into the eyes.

## General Operating Instructions

The barcode reader, shown next, is located at the top rear of the handset. Scanning range for the 8450 is 4 to 12 inches. The 8452/8453 has a slightly larger reader and an operable range of 1 to 18 inches.

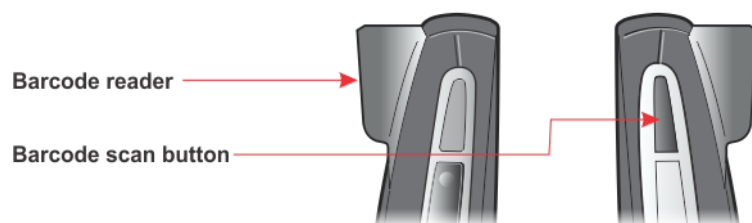

### Scanning with the barcode reader:

- 1 Hold the handset so that the barcode reader is pointing to the item you want to scan. A perpendicular angle is best but the reader can be rotated and will still work.
- 2 Press the scan button.

The red light comes on. Orient the red light so that it shines across the entire barcode symbol. The red light stays on until you hear a beep that indicates the read is successful and then the light turns off.



#### **Note: The delay period**

When the backlight is off, the scanner is in a low power state. When you press the scan button, the backlight comes on first and about ½ second later the scan light comes on. Adjust this delay by changing the backlight timeout settings on the **Home > Settings > Basic Settings** menu.

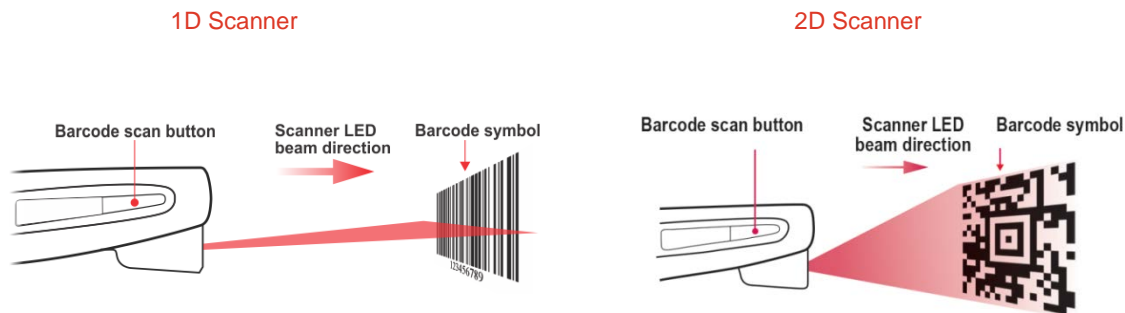

- 3 When a beep sounds to indicate a successful scan and the red light turns off, release the scan button. If you wish, you can change the barcode reader sound.



#### **User Tip: How long does it take to scan a barcode?**

The larger the barcode, the more data it contains. 2D barcodes can be very large and contain a lot of information. It can take several seconds to read a very large barcode. Always wait for the beep that indicates that the scan is complete before letting go of the scan button.



#### **Note: Cleaning the scanner window**

The 8452/8453 scanner has a larger window than the 8450 and is more prone to being smudged by fingerprints. If you have trouble scanning, clean the scanner window using a monitor wipe or a glass cleaner sprayed onto a soft cloth. Do not spray the scanner window directly. When first using the bar code scanner, ensure that the shipping plastic is removed. The shipping plastic covers the bar code lens and must be removed by its small tab before use, for reliable operation.

## *Handset Barcode Applications*

You can use the barcode reader with two types of software applications that you can install on your handset. You can open a browser application and enter information with the barcode reader to an input field in the browser. You may also have a custom application installed on the handset that accepts scanned data but does not use input fields. Your administrator will let you know if you have either of these types of applications configured on your handset.

### **Scanning to an Input Field**

You can use the barcode reader to enter information into a Web-based application that you open from the Applications icon on the Home screen.

### **To enter barcode data into a browser input field:**

- 1 Navigate to **Home > Application** and open the application.
- 2 As needed, use the Nav keys to position the cursor at the input field.
- 3 Point to the barcode and press the scan button to enter input data.
- 4 Complete any further instructions required by the specific application.

### Scanning to an Application Prompt

Some applications accept scanned barcode data without requiring the user to position the cursor. In this type of application, the entry field may not be shown on the handset screen. In this case, the application will prompt you with specific instructions.

### **To scan a barcode in response to an Application Prompt:**

- 1 Navigate to **Home > Application** and open the application.
- 2 Point to the barcode you want to scan and press the scan button.
- 3 Complete any further instructions required by the specific application.

## *Sending Barcode Data to PC Applications using QBC*

The Quick Barcode Connector (QBC) enables you to capture barcode patterns and transfer the data to an application running on one or more host computers. You can think of the system as a wireless barcode scanner connected to one or more host computers.

Your system administrator will install QBC on one or more computers. Depending on how your administrator sets up the environment, the handsets can transfer data to one computer only (one-to-one mode), or to any computer in a group of computers (many-to-many mode).

In one-to-one mode, the Spectralink QBC application is installed on one computer. When a handset captures barcode data, the data automatically transfers to the application on that computer.

In many-to-many mode, the Spectralink QBC application is installed on a group of computers so that a handset can transfer barcode data to any computer in that group. Although you can connect a handset to any computer in the group, you can connect a handset to only one computer at a time and you can connect only one handset to a computer at a time.

Check with your system administrator to find out which QBC modes are used in your facility.

The QBC application icon in the computer's system tray indicates the connection status. If your handset is not connected to the Spectralink QBC application, the application icon displays a red X. If the handset is connected, the icon displays a green arrow, as shown next.





### Barcode Scanning in One-to-One Mode

If you are scanning to a PC application in one-to-one mode, your handset will automatically connect to your computer.

#### To scan a barcode in one-to-one mode:

- 1 Open the application on the PC.
- 2 Ensure that your cursor is in the correct position in the application you're using to enter incoming data.
- 3 Scan the barcode(s) you want to enter into the PC application.

### Barcode Scanning in Many-to-Many Mode

To enter barcode data in many-to-many mode, you must first connect your handset to a computer.



#### User Tip: Many to many status icon

While your Spectralink 8450/8452/8453 handset is set to many-to-many mode and connected to a computer, the following status icon is displayed:



#### To enter barcode data in many-to-many mode:

- 1 If you haven't already done so, on the computer, launch Spectralink QBC by choosing **Start > Programs > Spectralink > Quick Barcode Connector > Start Quick Barcode Connector**.  
The application launches quietly and runs in the background. You can confirm that the Spectralink QBC is running by checking for the icon in the status bar of your 8450/8452/8453 handset.
- 2 Move the cursor on the host computer to one of the barcode hotspots, typically a corner of the display.  
The application barcode will display temporarily.



### User Tip: Displaying the barcode

If you cannot see the barcode display due to interference from other applications running on the host computer, right-click the Spectralink QBC icon in the system tray and choose **Show Barcode** from the pop-up menu. While you have *Show Barcode* selected, Spectralink QBC will persistently display the barcode pattern identifying the host computer until you select **Hide Barcode** from the pop-up menu.

- 3 Use your 8450/8452/8453 handset to scan the barcode on the computer monitor. This connects your handset to the computer.

When your handset has scanned and decoded the barcode pattern and connected to the Spectralink QBC application running on the computer, the following will happen:

- The handset will emit a confirmation tone to notify you that it is connected.
- The Spectralink QBC status icon on the handset will appear on the right side of the status icon row.
- The Spectralink QBC status icon on the computer will display in the system tray.
- The computer will display a 'Connected' balloon and a notification sound (if enabled).

The barcode pattern displays the message *Connection* when you move the pointer to the hotspot, as shown next. (If there is no connection between the handset and the host computer, the message *No Connection* displays on the barcode.)



Once you are connected, you are ready to scan data into the computer application.

- 4 Start the application and ensure that your cursor is in the correct position in the application you're using to capture the incoming data.
- 5 Scan the barcode(s) you want to enter into the target computer application.

### Disconnecting from the computer

The handset automatically disconnects from the computer when it has been inactive for a while or when a second handset connects to the computer.

# Chapter 11: Personal Alarms

Workers can be at risk during security breaches or if personal incidents require immediate attention. Spectralink 8441 and 8453 handsets offer personal monitoring and duress call functionality, including “man down” alarms, “running” alarms and duress calls to an emergency number. Contact your system administrator about this feature.

Personal Alarm features can be coupled with a security alarm application program. Contact your system administrator about this feature.

Duress call alarms can also be deployed within the functionality of the 8440 and 8452 models. The emergency dial feature can be programmed to sound a local alarm through the built-in speakerphone when an emergency call is dialed. Coupled with a security alarm application, this duress alarm can be used to identify the handset, the user and the location of the alarming handset.



## Warning

The reliability of the Spectralink Personal Alarms application depends on the functionality and reliability of the greater infrastructure – the wireless LAN, the LAN, the call server, the central provisioning server, the server hosting location services, the central security system and its servers, the correct configuration of the Spectralink 84-Series handsets, correct installation and central provisioning server(s), and thorough training of personnel.



## Note: Emergency call functionality

The ability to make an emergency call can be configured on every Spectralink 84-Series handset model and is not unique to Spectralink Personal Alarms which are offered only on the 8441 and 8453 models. Spectralink Personal Alarms can be configured to automatically generate an emergency call when a Running/Tilt/Still alarm is triggered. Contact your system administrator if you have any questions about how emergency calls are triggered.

Four conditions of alerting can be activated and each is configurable to the requirements of the facility. If any of the running/tilt/still conditions occur, the handset will first warn the user about an impending alarm and if the user does not cancel the warning within a configurable number of seconds the handset will start to alarm.

	8440	8441	8452	8453
Duress	X	X	X	X
Running		X		X
Still		X		X
Tilt		X		X

- Duress – should the user press the emergency button on the left side of the handset, a call is placed to an emergency number. A call can also be placed automatically if a running/tilt/still alarm is initiated,
- “Running” – the handset detects shaking in case a user runs for a configurable number of seconds,
- Tilt – the handset is tilted (not vertical) for a configurable number of seconds (aka “man down”),
- Still – the handset remains unmoved for a configurable number of seconds, potentially indicating the user is no longer moving.



**Caution: Contact your system administrator for training on Personal Alarms**

All users need to know what the result will be if an alarm is activated, either intentionally or unintentionally. The user cannot permanently disable Spectralink Personal Alarms or turn the feature on and off.

The Spectralink Personal Alarms icon on the status bar indicates that the Spectralink Personal Alarms functionality is active. Colors and shapes signify its status:



= Spectralink Personal Alarms monitoring active



= Spectralink Personal Alarms alarm triggered



= Spectralink Personal Alarms temporarily suspended (if configured)

No icon = handset in charger (or the feature has been disabled by the administrator)



**Note: Personal alarm icon for the 8440/8450/8452 handsets**

The Spectralink 8440/8450/8452 models display the red icon during an Emergency Call until the alarm is cleared. No other icon is displayed.

## Suspending the Personal Alarm Monitor

If configured, the user can suspend Spectralink Personal Alarms running/tilt/still sensing mechanism for a period of time by selecting the **Suspend monitor** option on the Features menu. The user may restart Spectralink Personal Alarms before the time elapses by selecting the **Resume monitor** option. The Duress button functionality is not suspended.

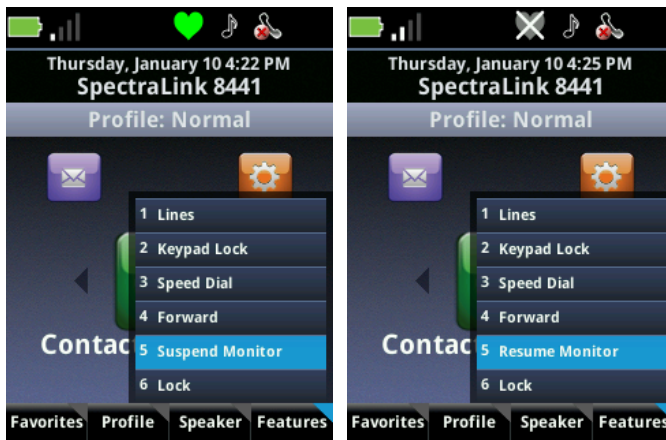

## The Warning State

If a running/tilt/still event has been detected, the handset goes into a “warning” state in which it presents a warning window and sounds the alert and/or vibrates. The user can cancel an impending alarm during the warning state by pressing the **Cancel** softkey and the alert audio will turn off and an alarm will not be sent to any configured security application and the handset resumes monitoring.



## The Alarm State

If the user does not cancel during the running/tilt/still warning state, the handset goes into the alarm state. The alarm sounds and the alarm window appears. If configured, an XML alarm event is generated and sent to a security application, and an emergency call is placed.



When you are in an alarm state, the alerting ring tone or vibration can be turned off by selecting the **Silence alarm** option on the Features softkey menu. Only the audio/vibration is stopped. The alarm state will continue until cleared. The flashing LED continues until the alarm state is cleared.

Once an alarm state is reached, the user cannot retract the alarm but can cancel the alarming state and return the handset to the monitoring state by selecting the **Clear alarms** option on the Features menu. Clear alarm returns the handset to the monitoring state and sends an xml notification of the end of the alarm. If an emergency call has been placed as well, the call must be terminated as would any call.

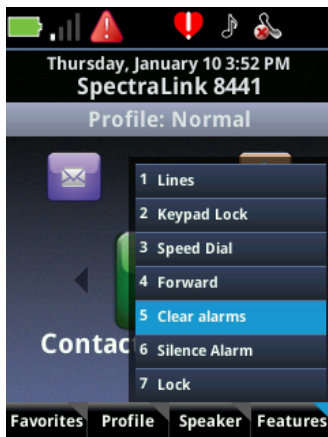

## Emergency Dial

If the Duress alarm is activated, a similar process occurs as for running/tilt/still alarms except there is no warning state and an emergency call is placed when the button is pressed twice within two seconds or with one long press. An emergency call preempts any existing active call. The emergency call is ended by pressing the END key or by the far end hanging up. The handset remains in the alarm state until manually cleared by the user.



### Personal Alarm Monitor State during Charging

New alarm detection is inactive when the handset is connected to a charger – USB, Dual Charger or Speakerphone Dock. No icon displays during the inactive state. Once the handset is removed from the charger, monitoring begins and the icon turns green.

Alarms must be manually cleared. They cannot be cleared by placing the handset into a charger.

## Chapter 12: Applications

The Applications icon on the Home screen may be populated with Web applications or custom applications for your facility. If your facility uses custom applications, see your system administrator to find out what they are and how to use them. See your administrator if you see the message *No configured applications please see your system administrator*.

When you activate an Application, a cell is opened in the session manager. You can make and receive calls, putting the application on hold, and then activate the application once again by selecting it in the session manager.

### Web Applications

Certain applications point directly to a website. You can browse the site and enter information into fields using the keypad. Other applications emulate website functionality. Use the following tips to navigate both types of applications. See your system administrator if you have any questions.

#### Navigating a website

Use the ▲ and ▼ navigation keys to scroll up and down.

Use the ◀ and ▶ navigation keys to tab through navigable fields or links. An orange box lets you know that a navigable field or link is selected.

Press the *OK* key to activate a link.

#### Entering text

Use the ◀ and ▶ navigation keys to tab in and out of a text box. Once you start entering text, the ◀ and ▶ keys navigate within the text you are entering.

Use the *Mode* softkey to change text entry characters. Press the *Edit/Cancel* softkey to return to the tab functions.

Press the *OK* key to confirm the text you have entered.

#### Softkeys

When you are in a Web-style application, softkeys perform expected functions. The Home softkey jumps to the home page for that application, if one has been defined. The Back softkey goes to the previous application, the Refresh softkey refreshes the screen, and Quit ends the session.



If you are using a custom application, other softkeys may allow you to do different functions. See your system administrator if you have any questions about the custom applications on your handset.

## Custom Applications

If programmed, certain custom applications use Open Application Interface (OAI) navigation icons.

A custom application call is identified in the display title with a row of icons just below.

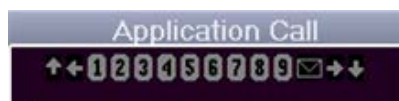

	OAI arrows 'on'
	OAI arrows 'off'
	OAI line numbers 'on'
	OAI line numbers 'off'
	OAI Message Waiting 'on' and 'off'

### The Open Application Interface

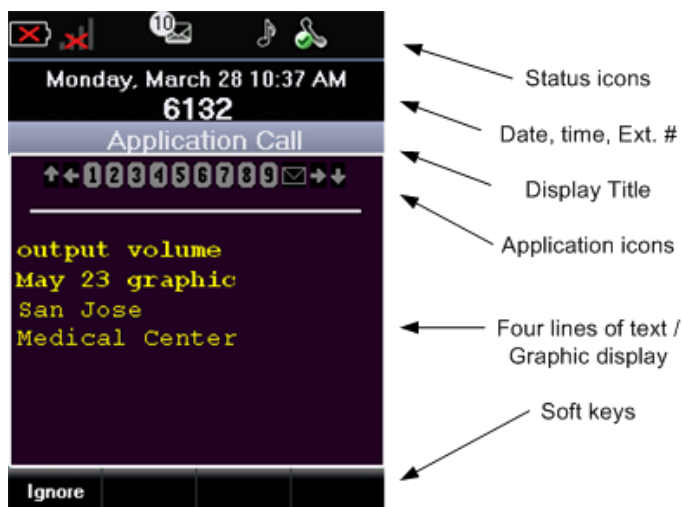

See your system administrator if you have any questions about custom applications.

# Chapter 13: Customizing your Handset

Notification Profiles are the various types of handset alerts and settings associated with those alerts. There are four types of Notification Profiles: Normal, Silent, Meeting, and Custom1. Notification Profiles have default settings that you can customize. You may also edit the Profile labels.

## To set the current profile:

- Press the **Profile** softkey from the Home screen and select a Profile.



## Customizing a Profile

### To open a Notification Profile for customizing:

- 1 Open the Notification Profile you wish to edit.
    - Navigate to **Home > Settings > Basic Settings > Notification Profiles**.
    - OR
    - From the Home screen, press the **Profiles** softkey and choose Edit.
- You can see the four types of Notification Profiles.

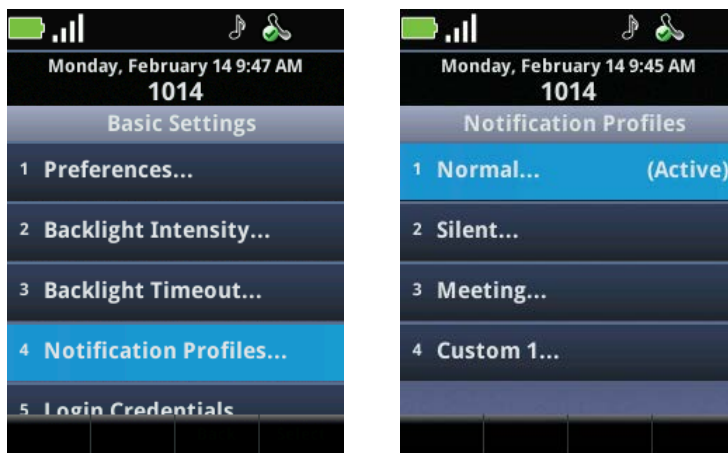

- 2 Select the Notification Profile you wish to edit and press **OK**.
- 3 You can edit the label, the tone volume, the ringing characteristics and alerts for each profile. If you change one characteristic on one profile, it will not affect the other profiles.

**To change the ring pattern and vibration mode of telephone calls:**

- 1 Select the type of profile you wish to edit and select Ringing. The Ringing option sets the ring pattern and vibrate mode, not the volume. If you want to set the volume, select Tone Volume.

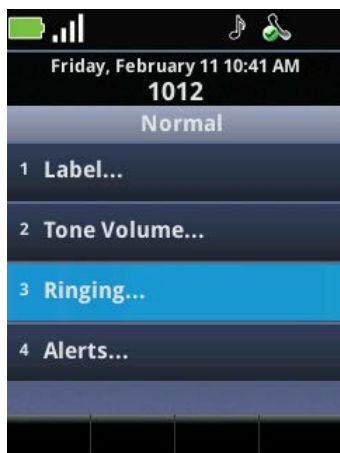

- 2 Select Calls, and choose Ring Pattern or Vibration.

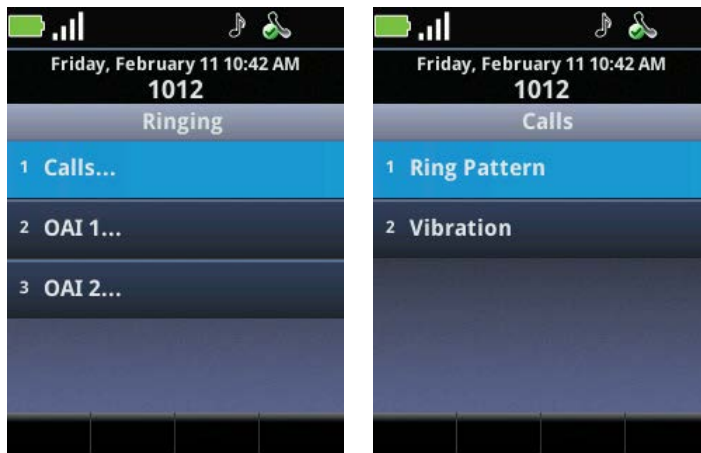

- 3 Change the ring pattern or the vibration mode. Experiment with the options until you find a combination that suits you.

### Setting Unique Ring Tones for Contacts

When setting up or editing contacts in the Contact Directory, you can specify a ring pattern for each contact during the entry procedure. See [Editing Contacts](#).

### Change the Alerting Characteristics

You can change the alerting characteristic of each alert type.

#### To customize alert types:

- 1 Navigate to Home > Settings > Basic Settings > Notification Profiles > [Profile] > Alerts. A list of alert types displays.
- 2 Scroll to an alert type and press **OK**.
- 3 Select **Alert Tone** to view and choose from a list of alert tones or select **Vibration** to enable or disable the vibrate option.

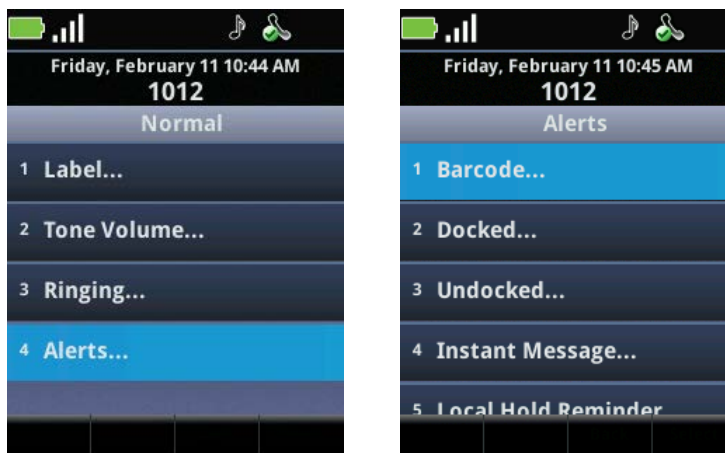

## Changing the Ring Settings for OAI Applications

You can change the message alerts for non-telephony applications.

### To change ring for OAI applications:

- 1 Navigate to Settings > Basic Settings > Notification Profiles > [Profile] > Ringing.
- 2 On the Ringing screen, select **OAI 1** or **OAI 2** (Open Application Interface).



- 3 Select **Ring Pattern** to view and choose from a list of ring patterns or select **Vibration** to view and choose from a list of vibrate options.

## Customizing the Handset Display and Other Preferences

You can adjust the text that displays on the screen in the Preferences menu. Each of the options listed next is available in the Preferences menu.

### To open the Preferences menu:

- From the Home screen, navigate to **Settings > Basic Settings > Preferences**. Scroll to view all the options.

### Language

The **Language** option allows you to change the language of menu options and other text that displays on the handset.

### Time & Date

Select the **Time and Date** option on the Preference menu to get to the Time and Date screen. You can choose the Clock Date, Clock Time, Clock Order, or you can disable/enable the time and date display.

## Headset Ringing

The **Headset Ringing** option enables the handset to remember that it has a headset plugged into it. You may enable or disable this option. If you enable it, you do not need to select the Headset option from the Speaker softkey menu every time you plug in a headset. Enable this option if you use a headset most of the time.

## Corporate Directory (if enabled)

You use the Corporate Directory option when you want to display entries in the corporate directory chronologically instead of alphabetically. See [Searching the Corporate Directory](#).

## Background

The Background option enables you to change the background characteristics of the display. Options are customized by facility.

## Auto Answer

When the handset is in the Auto Answer Mode, an incoming call will be answered automatically after the first ring. When you select this option, you are given the option to auto answer SIP calls and mute the microphone for auto answered calls.

## On-Hook Dialing

With the On-Hook dialing option, you can enable or disable the ability to dial a call before getting a dial tone, also called pre-dialing. If disabled, you must press **Start** before dialing a number.

## Multi Key Answer

The Multi Key Answer option enables you to answer incoming calls by pressing any keypad key. It is disabled by default.

## Presence (if IM is available)

The Idle Timeout sets the number of minutes that an inactive chat cell will stay open. You can set the timeout for IM chats for both office hours and off hours. Office hours and off hours are defined by the system administrator.

## Paging/PTT Configuration

You can configure PTT to a different default channel, you can allow PTT broadcasts to override an active call, and you can subscribe or unsubscribe to channels that the system administrator has enabled. For more information on configuring PTT, see [Using the Push-to-Talk Feature](#).

## Calendar Settings (if available)

Enable or disable meeting reminders.

## Adjusting the Backlight

The handset's backlight helps you to see the screen. You can adjust the backlight for different lighting conditions. Note that when the handset has been idle for a period of time, the backlight will turn off and the handset will go into power-saving mode.

You can make backlight adjustments on the Basic Settings menu. From the Home screen, navigate to **Settings > Basic Settings**. Scroll to view the options.

### To change the backlight timeout:

- Navigate to **Settings > Basic Settings > Backlight Timeout** to change the amount of time that elapses after a period of inactivity before the backlight turns off or to disable it completely.

The backlight LCD turns on when you press any key or when incoming activity occurs, and will turn off after a selected period of either 5, 10, 15, 30, 40, 50 or 60 seconds of inactivity. You can also disable the backlight completely with this option.

### To change the backlight intensity:

- Navigate to **Settings > Basic Settings > Backlight Intensity** to get to the Backlight Intensity screen. Here you can adjust the Backlight On intensity to High Medium or Low, and the Maximum Intensity.



#### User Tip: Backlight intensity

When you modify the Maximum Intensity, you are modifying the entire Backlight intensity scale. For example, if you decrease the Maximum Intensity, the low, medium, and high values for Backlight On intensity also decrease.

# Chapter 14: Chargers and Battery Packs

Your handset is powered by a removable Battery Pack that you will need to fully charge before first using the handset and then recharge periodically. You may charge the Battery Pack while it is removed from or while attached to your handset. Some facilities provide chargers to all users while other facilities maintain a bin of charged Battery Packs. Ask your system administrator how your facility charges Battery Packs.

## Charging the Battery Pack

You must fully charge your handset's Battery Pack before you use it for the first time. Depending on the type of charger you use, this might take several hours.



### Caution: Battery compatibility

Only use Spectralink 84-Series Battery Packs with Spectralink 84-Series handsets. Check the label on the Battery Pack and ensure the model number is RS657 for the Standard Capacity Battery Pack or RS658 for the Extended Capacity Battery Pack.



### Warning: Shock risk

Risk of electric shock. Do not expose charger or battery to liquid, vapor, or rain.

The Battery Pack icon at the upper left corner of the Status Bar of your handset is completely green when it is fully charged. When the handset is in a charging device and charging, the Battery Pack icon has a lightning bolt symbol through it. When the background of this icon turns green, the Battery Pack is fully charged.

 Fully Charged Battery Pack, handset not in charger

 Battery Pack charging, handset in charger

 Battery Pack fully charged, handset in charger

## Charger Options

Three types of Chargers are available. Contact your system administrator if you need assistance with any of these options. The Dual Charger will charge the handset and a spare Battery Pack. The USB charger charges a single handset through the USB port on the right side of the handset. The Quad Charger can charge up to four Battery Packs at a time. The 12-Bay



Charger is an assembly of three Quad Chargers and can charge up to 12 Battery Packs at the same time. Any Battery Pack for the Spectralink 84-Series handset can be charged in any Spectralink 84-Series Charger.



**Caution: Battery compatibility**

Only use Spectralink 84-Series Chargers with Spectralink 84-Series handsets. Check the label on the Charger and ensure the model number shown on the label is the same number this document gives for the Charger models.

**Using the Dual Charger**

The Dual Charger is designed to charge the Battery Pack while keeping the handset operational. You can charge one Battery Pack by placing the handset in the front charging bay, and charge a second Battery Pack in the rear charging slot. When both slots are occupied, the front charging bay has charging priority. The battery status icon on the handset indicates the charging status of the Battery Packs. When the handset is fully charged or removed, the rear Battery Pack will begin charging.

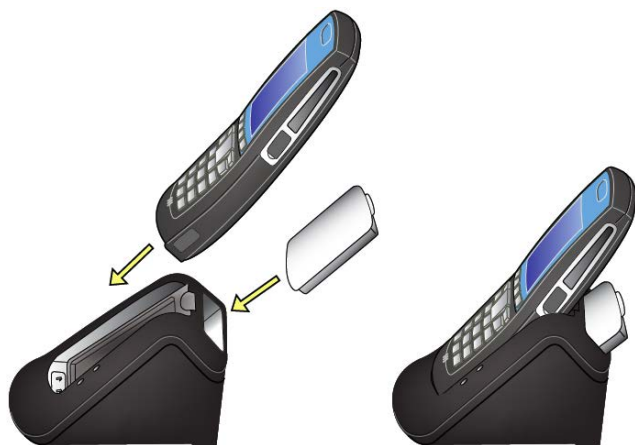

- Place the handset in the front slot, facing forward. Battery Packs drop into the rear charging slot.

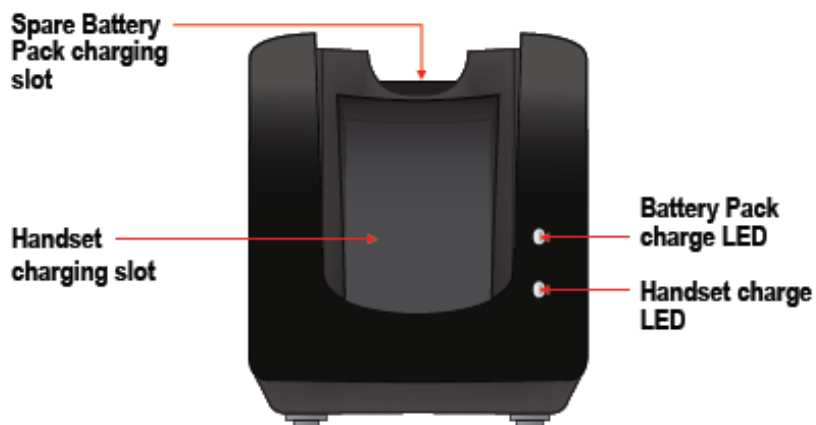

The Dual charger has two LEDs. The top LED indicates the charging status of the Battery Pack in the rear bay. The bottom LED indicates whether or not the handset is properly seated in the front charging bay. The battery status icon on the handset indicates the charging status of the Battery Packs.

Table 7: Dual Charger LED Indicators.

<i>LED Indication</i>	<i>Battery Pack charge LED</i>	<i>Handset charge LED</i>
Blinking	Charging	n/a
Solid green	Fully charged	Properly seated
Off	Not properly seated or empty	Not properly seated or empty



#### **User Tip: Faster charging times**

If you are trying to charge a Battery Pack in the rear slot, do not store the handset in the front charging bay. This will slow the charging cycle of the rear charging slot.

## **Using the USB Charger**

The USB Charger (SA106B-05), shown next, plugs into the USB port on the side of the handset, and the transformer plugs into a 110v outlet. Plug the charger into a wall socket. Carefully open the hinged cover on the right side of the handset, close to the bottom, and plug in the USB cable. The charging icons will display as described for the Dual Charger.



### Using the Quad Charger

The Quad Charger is used in facilities where other types of chargers are not efficient. It can charge four Battery Packs simultaneously and can be mounted on a horizontal or vertical surface. The Battery Pack snaps into the charging slot. The LED above the occupied bay indicates the charging status of the Battery Pack in the bay. The LED will display as described for the Dual Charger.



The Battery Pack snaps into the charging slot. The LED just above the charging slot indicates the charging status of the Battery Pack. The following table lists the LED indications and charger status.

### Using the 12-Bay Charger

The 12-Bay Charger is an assembly of three Quad Chargers and is used in high-volume mobile environments. It is usually mounted on a wall in an accessible area. The LEDs above the charging bays display as described for the Dual Charger.



## About Battery Packs

Two types of Battery Packs are available: Standard and Extended. The Standard lithium ion rechargeable handset Battery Pack gives you approximately eight hours of talk time or 80 hours of standby time. Standby time occurs when the handset is on but not in an active call. The Extended model gives you approximately 12 hours of talk time and 120 hours of standby time. Charging times vary according to the type of charger you are using.

Table 8: Battery Pack Talk and Standby Times

Type	Talk Time	Standby Time	Charging Time*
Standard (RS657)	8 hours	80 hours	3.5 hours typical*
Extended (RS658)	12 hours	120 hours	5 hours typical*

\* Using the Quad Charger or 12-Bay Charger



### User Tip: Fastest charging

The Quad Charger/12-Bay Chargers are the fastest. If you use the handset while it is in the Dual or USB Charger, charging time will be prolonged.



### User Tip: How to determine type of battery

The Battery Pack type is printed on the label. Remove the Battery Pack and view the label to determine the type of Battery Pack you have been issued.



### Warning: Explosion risk

WARNING: THERE IS A RISK OF EXPLOSION IF YOU REPLACE THE BATTERY PACK WITH AN INCORRECT TYPE. ONLY USE POLYCOM MODEL RS657 OR RS658 BATTERY PACKS WITH SPECTRALINK 84-SERIES HANDSETS. DISPOSE OF USED BATTERIES BY RETURNING THEM TO THE DISTRIBUTOR OR PRODUCER WHO SUPPLIED THEM.

## Indications of Low Battery

The Battery Pack icon in the status row on the handset's screen indicates the amount of charge remaining.

The handset will sound warning tones and display the Battery Low message when there are fewer than two minutes of talk time remaining. When the handset is in Standby mode, the message *Battery Low* and a series of chirps indicate a critically low Battery Pack charge. The handset will not work until the Battery Pack is charged.

### *Battery Pack Removal and Replacement*

To remove the Battery Pack from the handset, press up on the Battery Pack removal latch on the back of the handset. The Battery Pack releases outward.

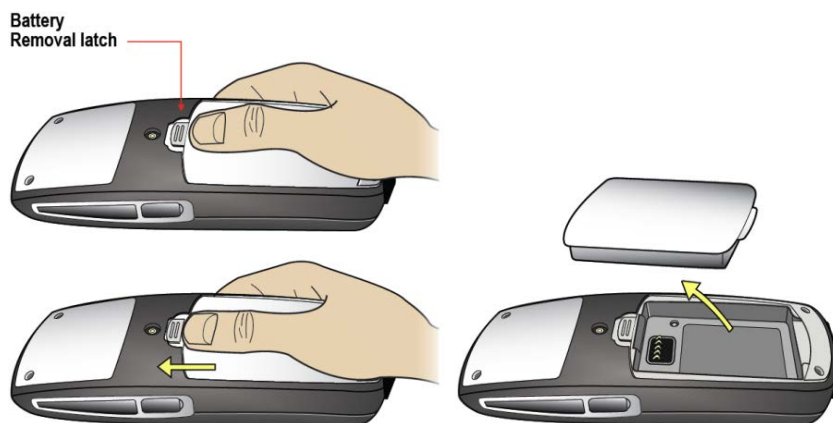

To replace the battery Pack, slide the tab of the Battery Pack into the bottom slot as shown below. Gently push the top of the Battery Pack until it snaps into place. You should not have to force it against the handset.

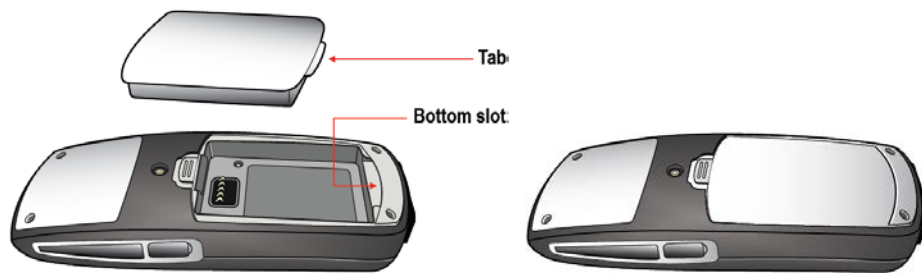

## Battery Safety Notices



### **Warning: Handle batteries with care**

All batteries can cause property damage and/or bodily injury, such as burns, if a conductive material such as jewelry, keys, or beaded chains touches exposed terminals. The conductive material may complete an electrical circuit (short circuit) and become quite hot. Exercise care in handling any charged battery, particularly when placing it inside a pocket, purse, or other container with metal objects.



### **Warning: Proper battery disposal**

**WARNING**– The battery used in this device may present a risk of fire or chemical burn if mistreated. Do not disassemble, heat above 45°C, or incinerate. Replace battery with Spectralink model RS657 or RS658 only. Use of another battery may present a risk of fire or explosion.

## Notes on Battery Packs

- Battery Pack life will vary depending on your handset's model and its features and system infrastructure.
- Ensure that you fully charge the Battery Pack the first few times, as the Battery Pack becomes most efficient after the first few charge cycles.
- If multiple Battery Packs are supplied with your handset, Spectralink recommends that each be fully charged upon receipt to prolong battery life. Battery Packs will slowly lose charge if unused. To maintain battery potential, charge unused Battery Packs occasionally or alternate Battery Pack use.
- After a length of time, Battery Packs will lose the ability to maintain a charge and to perform at maximum capacity and will need to be replaced. This is normal for all batteries.
- If your Battery Pack requires replacement, contact your system administrator.

- Overnight charging is best done while the handset is turned off.
- If the handset does not charge, clean the Battery Pack, the charger, and the handset contacts with an alcohol swab.
- When the handset is properly seated, the backlight comes on briefly and the handset beeps to indicate that charging has begun.
- Any battery that exhibits swelling, cracking, or other abnormality should be disposed of promptly and properly.
- Dispose of any used battery promptly. Keep away from children. Do not disassemble and do not dispose of in fire.
- The handset is not designed for and will not function properly with third party batteries.

# Appendix A: Cleaning and Drying the Handset



## User Tip: Proper cleaning solutions

The Spectralink 84-Series handsets have been tested for resistance to cleaning chemicals per IEC 60068-2-74 (1999). Exposure of the Spectralink 84-Series handsets to Lysol® or diluted bleach poses little risk of functional or cosmetic damage.

- Avoid dropping the handset or knocking it against hard surfaces. Carry the handset in a holster or carrying case to protect it.
- There are no serviceable parts in the handset or chargers. You should not open the handset case nor disassemble the chargers. Doing so will void your warranty.
- Turn off the handset and unplug the chargers before you clean them. Never immerse the handset or charger in liquid. Clean the exterior surfaces, including the charging contacts, with a cloth that has been slightly moistened with water. Take care not to exert undue pressure on charger electrical contacts while wiping.
- Spectralink recommends the use of a silicone cover to prolong the life of your handset, especially when it is dropped regularly or cleaned frequently with the disinfectants prescribed below.
- Wiping the handset surface with a water-dampened cloth or paper towel will remove most films or residues. If the soiling is too stubborn for plain water, a mild detergent solution, Lysol, isopropyl alcohol, or diluted bleach may be used.
- Pre-treated cloths and towelettes, like those used for eyeglasses or cameras, may be used to clean the handset; however, avoid using those containing lanolin or aloe as these will leave a slippery residue.
- When cleaning with disinfectants, do not rub the keypad characters vigorously. Doing so will degrade the handset's keys and make them illegible.
- Do not directly spray or immerse the handset in a disinfectant or cleaning agent. Spray the disinfectant on a soft cloth or paper towel, then wipe the handset's surface to dry it.
- The following products should NOT be used on the Spectralink wireless handset:



- Do not use cleaning products containing quaternary ammonium compounds<sup>2</sup>, such as CaviWipes™, CaviWipes™ XL, Cavicide® or Sani-Wipes®, Sani-Cloth, Super Sani-Cloth® and Sani-Cloth® Plus. Quaternary ammonium compounds have been laboratory tested and proven to damage the handset plastics.
- Do not use furniture polishes, waxes, or plasticizer-based cleaners (ArmorAll®, etc.)
- Do not use lanolin, aloe, glycerin, or other skin care products
- Do not apply any solvent such as acetone, mineral spirits, etc.
- Should the headset connector become dirty, you may experience a scratchy or intermittent signal. To clean the connector, dip the non-padded end of either a wooden or paper handled cotton swab in isopropyl alcohol. Gently insert in the connector and twist, repeating several times. If available, blow compressed air into the connector to clear debris.
- Keep the headset jack covered when not in use.
- Using a carrying case may help protect the surfaces and help prevent liquids (rain, etc.) from entering into the interior of the handset. This product is not waterproof, and exposing the unit to liquids may result in permanent damage to the unit.
- If your wireless handset interior gets wet, do not try to accelerate drying with the use of an oven or a dryer as this will damage the wireless handset and void the warranty. Instead, do the following:
  - 1 Immediately power off the wireless handset.
  - 2 Remove Battery Pack from wireless handset.
  - 3 Shake excess liquid from the wireless handset.
  - 4 Place the wireless handset and Battery Pack in an area that is at room temperature and has good airflow.
  - 5 Let the wireless handset and Battery Pack dry for 72 hours before reconnecting the Battery Pack and/or powering on the wireless handset.

If the wireless handset does not work after following the steps listed above, contact your dealer for servicing information.

---

<sup>2</sup> Quaternary ammonium compounds are also known as C12-18-alkyl [(ethylphenyl) methyl] dimethyl, chlorides and Benzyl-C12-18-alkyldimethyl ammonium chlorides. Review the Materials Safety Data Sheet for your specific product to verify the chemical composition.

# Appendix B: Settings Menu

The User Settings menu contains all the options you need to customize your handset settings for optimum use. Navigate to this menu from the Home screen Settings icon. Use the tables shown next as a quick reference to find the option you need.

## Basic Settings and Preferences

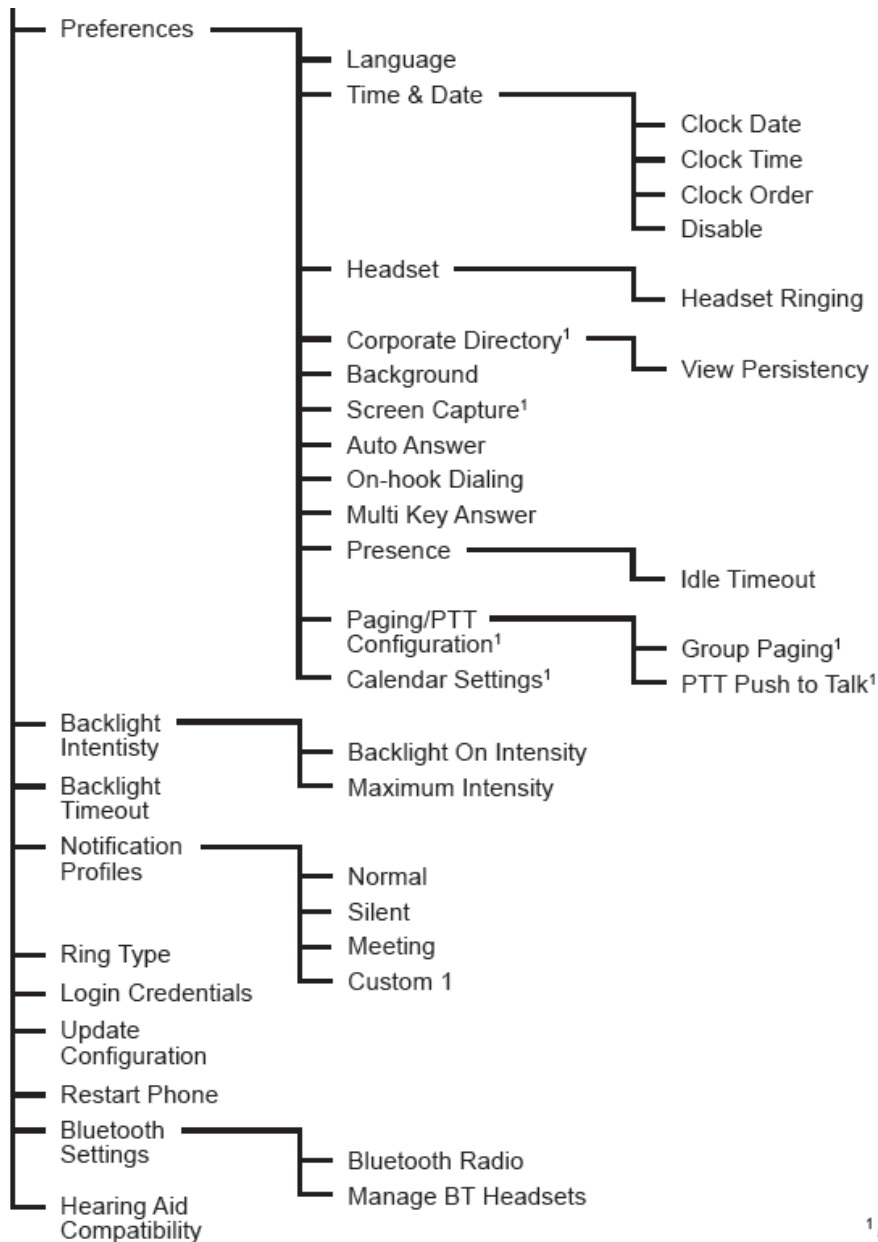

## Advanced Settings

The Advanced Settings menu is used by the system administrator to set system parameters. It is accessible only by a password. Contact your system administrator if you need access to this menu.

## Feature Settings

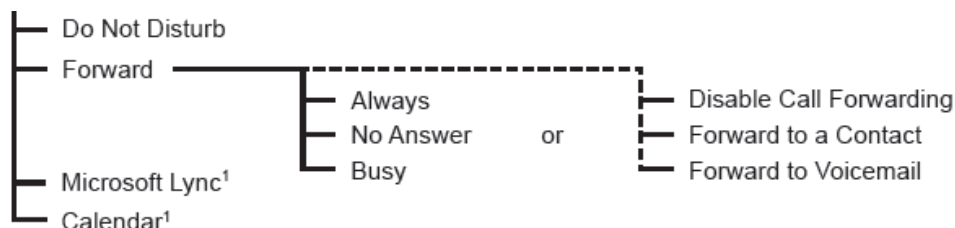

## Status

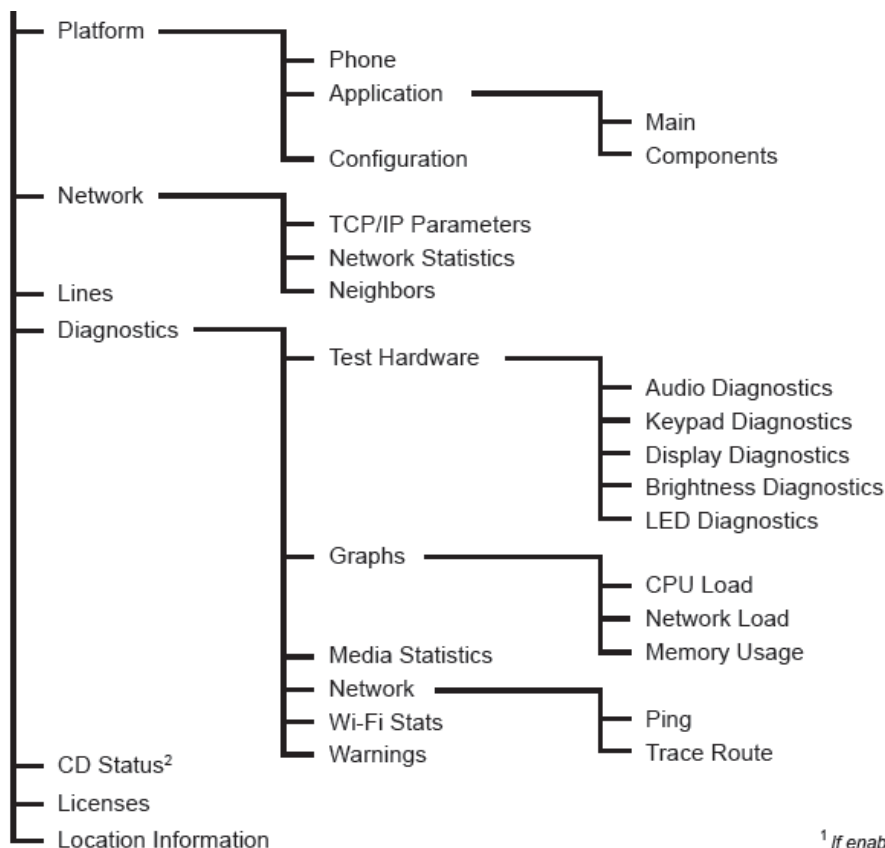

<sup>1</sup> If enabled.

<sup>2</sup> If enabled and license available.

# Appendix C: Safety Information



## Caution: Product compatibility

Each Spectralink family of products only works with other members of the same family. If you have any questions about product compatibility, contact your system administrator.

### Spectralink 84-Series

Use only 84-Series products with other 84-Series products as identified by the model number located on the label of the product.

Spectralink 8453 Wireless Handset	8453
Spectralink 8452 Wireless Handset	8452
Spectralink 8450 Wireless Handset	8450
Spectralink 8441 Wireless Handset	8441
Spectralink 8440 Wireless Handset	8440
Speakerphone Dock	8410
USB Charger	SA106B-05
Dual Charger	DCA39
Quad Charger	DCA40
12-Bay Multi-Charger	S0001
Standard Capacity Battery Pack	RS657
Extended Capacity Battery Pack	RS658

### Spectralink 80-Series

Use only 80-Series products with other 80-Series products as identified by the model number located on the label of the product.

Spectralink 8020 Wireless Handset	802X
Spectralink 8030 Wireless Handset	803X
Desktop Charger	PCS1850
Dual Charger	PCD1850
Quad Charger	PCQ1850
Standard Battery Pack	PBP0850
Extended Battery Pack	PBP1300
UltraExtended Battery Pack	PBP1850

## Industry Canada Notice

Under Industry Canada regulations, this radio transmitter may only operate using an antenna of a type and maximum (or lesser) gain approved for the transmitter by Industry Canada. To reduce potential radio interference to other users, the antenna type and its gain should not exceed the equivalent isotropically radiated power (EIRP) necessary for successful communication.

This device complies with Industry Canada license-exempt RSS standard(s). Operation is subject to the following two conditions: (1) this device may not cause interference, and (2) this device must accept any interference, including interference that may cause undesired operation of the device.

## Chargers and Battery Packs

- Chargers operate in a 50° to 85° F (10° to 30° C) environment. Do not expose them to freezing temperatures or direct sunlight.
- Do not place anything in the charger other than the handset or single Battery Pack as appropriate to avoid bending the contacts. Bent contacts can keep the Battery Pack from charging.
- Only use Spectralink 84-Series Battery Packs with Spectralink 84-Series Chargers.
- Never use a non-Spectralink charging unit as it could damage the Battery Pack.
- Use only the original plug-in power adapter for the chargers.
- Contact your service representative for assistance if you have a faulty Battery Pack or a problem with your charger.
- Any battery that exhibits swelling, cracking or other abnormality should be disposed of promptly and properly.



**Warning: Do not...**

Do not immerse the Battery Pack in water or throw it into a fire.



**Warning: Do not...**

Do not throw away the Battery Pack with your domestic waste. Return used Battery Packs to your supplier or servicing agent.



**Warning: Do not...**

All batteries can cause property damage and/or bodily injury, such as burns, if a conductive material such as jewelry, keys, or beaded chains touches exposed terminals. The conductive material may complete an electrical circuit (short circuit) and become quite hot. Exercise care in handling any charged battery, particularly when placing it inside a pocket, purse, or other container with metal objects.

## Wireless Telephones

Please read the following text carefully for important safety information.



**Warning: Magnetic earpiece**

The earpiece may retain magnetic objects.



**Caution: Authority to operate this equipment**

Changes or modifications to this equipment that are not approved by Spectralink may cause this equipment to fail to comply with part 15 of the FCC rules, voiding the user's authority to operate this equipment.



**Caution: Not user serviceable**

Spectralink products contain no user-serviceable parts inside. Refer servicing to qualified service personnel.



**Warning: Medical equipment interference**

Spectralink recommends that standard acceptance procedures be followed prior to operating this equipment in proximity of life-support systems.

### Operational Warnings

Certain operational environments are potentially hazardous. Please read the following text carefully to ensure that you understand the handset's operating conditions.

### *Potentially Explosive Atmospheres*

Do not take your handset into any area with a potentially explosive atmosphere. Do not remove, install, or charge batteries in such areas. Sparks in a potentially explosive atmosphere can cause an explosion or fire resulting in bodily injury or even death.



#### **Warning: Explosive Atmospheres**

Avoid areas with potentially explosive atmospheres include fueling areas such as lower decks on boats, fuel, or chemical transfer or storage facilities, areas where the air contains chemicals or particles such as grain, dust, or metal powders, and any other area where you would normally be advised to turn off your vehicle engine. Areas with potentially explosive atmospheres are often marked with signs, but not always.

## *Electromagnetic Interference and Compatibility*

Nearly every electronic device is susceptible to electromagnetic interference (EMI) if inadequately shielded, designed, or otherwise configured for electromagnetic compatibility.

### **Facilities**

To avoid electromagnetic interference and/or compatibility conflicts, turn off your handset in any facility where posted notices instruct you to do so. Hospitals or health care facilities may be using equipment that is sensitive to external radio frequency (RF) energy.

### **Pacemakers**

The Health Industry Manufacturers Association recommends that you maintain a minimum separation of 6 inches (15 cm) between a handheld, wireless-radio product and a pacemaker. These recommendations are consistent with the independent research by, and recommendations of, Wireless Technology Research. Persons with pacemakers should:

- ALWAYS keep the handset more than 6 inches (15 cm) from their pacemaker when the handset is turned on
- Not carry the handset in a breast pocket
- Use the ear opposite the pacemaker to minimize the potential for interference
- Turn the handset off immediately if you have any reason to suspect that interference is taking place

## Other Medical Devices

If you use any other personal medical device, consult the manufacturer of your device to determine if it is adequately shielded from external RF energy. Your physician may be able to assist you in obtaining this information.

## Use While Driving

Campus installations and warehouse facilities that use vehicles such as forklifts or golf carts should abide by these guidelines when using wireless telephones:

- Give full attention to driving and to the road, aisle, or path
- Use hands-free operation, if available
- Pull off the road, aisle, or path and park before making or answering a call

## For Vehicles Equipped with an Airbag

Do not place a portable device in the area over the airbag or in the airbag deployment area. An airbag inflates with great force. If you place the handset in the airbag deployment area, and the airbag inflates, the airbag may propel the handset at high speed and cause serious injury to occupants of the vehicle.

## FCC Statement

This device complies with part 15 of the United States FCC Rules. Operation is subject to the following two conditions: (1) This device may not cause harmful interference, and (2) this device must accept any interference received, including interference that may cause undesired operation.

## *Specific Absorption Rate (SAR) Information: Spectralink 84-Series Wireless Telephones*

Your wireless handset is a low power radio transmitter and receiver. When it is on, it receives and sends out 802.11a/b/g/n radio frequency (RF) signals. In August 1996, the Federal Communications Commission (FCC) adopted radio frequency (RF) exposure guidelines with safety levels for hand-held wireless handsets. Those guidelines are consistent with the safety standards previously set by both U.S. and international standards bodies:

- ANSI C95.1 (1992) American National Standards Institute
- NCRP - Report 86 (1986) National Council on Radiation Protection and Measurements
- ICNIRP (1996) International Commission on Non-Ionizing Radiation Protection
- DHWC - Safety Code 6 Department of Health and Welfare Canada

These standards were developed by independent scientific organizations through periodic and thorough evaluation of scientific studies. The standards include a substantial safety margin



designed to assure the safety of all persons, regardless of age and health. The exposure standard for wireless mobile handsets employs a unit of measurement known as the Specific Absorption Rate, or SAR. The SAR limit set by the FCC is 1.6W/kg.



**Note: SAR limits**

In the United States and Canada, the SAR limit for mobile handsets used by the public is 1.6 watts/kg (W/kg) averaged over one gram of tissue. The standard incorporates a substantial margin of safety to give additional protection for the public and to account for any variations in measurements.

The FCC conducts tests for SAR using standard operating positions specified by the FCC with the handset transmitting at its highest certified power level in all tested frequency bands. Although the SAR is determined at the highest certified power level, the actual SAR level of the handset while operating can be well below the maximum value. This is because the handset is designed to operate at multiple power levels so that it uses only the power required to reach the network. Before a handset model is available for sale to the public, the FCC must test and certify it to ensure that handsets do not exceed the limit established by the government-adopted requirement for safe exposure. The tests are performed in positions and locations (at the ear and worn on the body) as required by the FCC for each model. While there may be differences between the SAR levels of various handsets and at various positions, they all meet the government requirement for safe exposure.

The FCC has granted an Equipment Authorization for this model handset with all reported SAR levels evaluated in compliance with the FCC RF emission guidelines.

SAR information on this model handset is on file with the FCC. You can find it under the Display Grant section at <http://www.fcc.gov/oet/ea> after searching on the FCC ID number found on the handset label inside the battery compartment. Additional information on Specific Absorption Rates (SAR) can be found on the Cellular Telecommunications Industry Association (CTIA) Website at <http://www.ctia.org>.

**CE:**

0.060 W/kg Body Tissue

0.066 W/kg Head Tissue

**FCC:**

0.161 W/kg Body Tissue

0.203 W/kg Head Tissue

### **Handset operation normal position**

To position the antenna properly, hold the handset as you would any other telephone, with the earpiece to your ear and speak into the microphone.