

Application manual

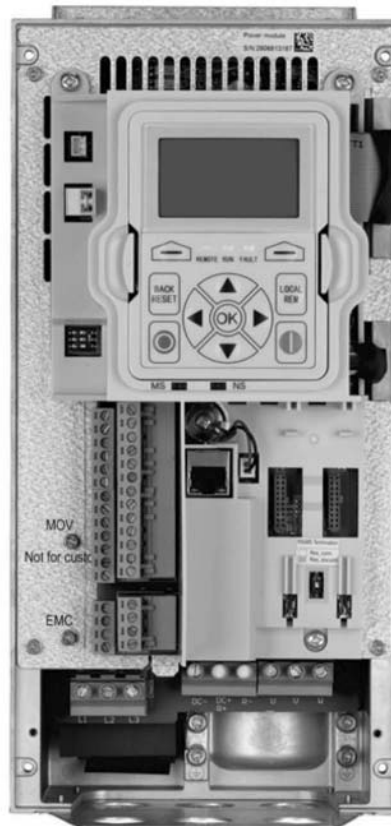

Disclaimer of warranties and limitation of liability

The information, recommendations, descriptions, and safety notations in this document are based on Eaton's experience and judgment and may not cover all contingencies. If further information is required, an Eaton sales office should be consulted. Sale of the product shown in this literature is subject to the terms and conditions outlined in appropriate Eaton selling policies or other contractual agreement between Eaton and the purchaser.

THERE ARE NO UNDERSTANDINGS, AGREEMENTS, WARRANTIES, EXPRESSED OR IMPLIED, INCLUDING WARRANTIES OF FITNESS FOR A PARTICULAR PURPOSE OR MERCHANTABILITY, OTHER THAN THOSE SPECIFICALLY SET OUT IN ANY EXISTING CONTRACT BETWEEN THE PARTIES. ANY SUCH CONTRACT STATES THE ENTIRE OBLIGATION OF EATON. THE CONTENTS OF THIS DOCUMENT SHALL NOT BECOME PART OF OR MODIFY ANY CONTRACT BETWEEN THE PARTIES.

In no event will Eaton be responsible to the purchaser or user in contract, in tort (including negligence), strict liability, or otherwise for any special, indirect, incidental, or consequential damage or loss whatsoever, including but not limited to damage or loss of use of equipment, plant or power system, cost of capital, loss of power, additional expenses in the use of existing power facilities, or claims against the purchaser or user by its customers resulting from the use of the information, recommendations, and descriptions contained herein. The information contained in this manual is subject to change without notice.

Cover Photo: Eaton PowerXL® Series Drives

Support services

Support services

The goal of Eaton is to ensure your greatest possible satisfaction with the operation of our products. We are dedicated to providing fast, friendly, and accurate assistance. That is why we offer you so many ways to get the support you need. Whether it is by phone, fax, or email, you can access Eaton's support information 24 hours a day, seven days a week.

Our wide range of services is listed below.

You should contact your local distributor for product pricing, availability, ordering, expediting, and repairs.

Website

Use the Eaton Website to find product information. You can also find information on local distributors or Eaton's sales offices.

Website address

www.eaton.com/drives

EatonCare customer support center

Call the EatonCare Support Center if you need assistance with placing an order, stock availability or proof of shipment, expediting an existing order, emergency shipments, product price information, returns other than warranty returns, and information on local distributors or sales offices.

Voice: 877-ETN-CARE (386-2273) (8:00 a.m.–6:00 p.m. EST)
After-Hours Emergency: 800-543-7038
(6:00 p.m.–8:00 a.m. EST)

Drives technical resource center

Voice: 877-ETN-CARE (386-2273) option 2, option 6
(8:00 a.m.–5:00 p.m. Central Time U.S. [UTC –6])
email: TRCDrives@Eaton.com

For customers in europe, contact

Phone: +49 (0) 228 6 02-3640
Hotline: +49 (0) 180 5 223822
email: AfterSalesEGBonn@Eaton.com
www.eaton.com/moeller/aftersales

Table of contents

SAFETY

Before commencing the installation	xiii
Definitions and symbols	xiv
Hazardous high voltage	xiv
Warnings and cautions	xiv
Important safety information.	xv

CHAPTER 1—powerXL DG1 series overview

How to use this manual	23
Receiving and inspection	23
Real time clock battery activation	23
Rating label	24
Carton labels (U.S. and Europe)	24
Catalog number system	25
Power ratings and product selection	26

Chapter 2—Keypad overview

Keypad buttons	32
LED lights	34
LCD display	34

Chapter 3—Menu overview

Main menu page	37
Menu navigation	37
Menu structure	38
T—Favorite	49

Chapter 4—Startup

Startup wizard page.	50
Startup wizard	51
Application macro mini-wizard.	52
PID Mini-wizard	52

Chapter 5—Standard application

Introduction	53
I/O Controls	53
Force open/force close selection	54
DIGIN Selection	54
Option board digIN selection.	54
Timer channel selection.	54
Force open/force close selection	54
Control I/O configuration	55
Standard application—parameters list.	57

Table of Contents, continued

Chapter 6 – Multi-Pump and fan control application	
Introduction	80
I/O Controls	80
Control examples	82
Control I/O Configuration.	91
Pump and fan application—Parameters list.	93
Chapter 7—Multi-pid application	
Introduction	123
I/O Controls	123
Multi-PID application—Parameters list	127
Chapter 8 – Multi-Purpose application	
Introduction	161
Multi-Purpose application—parameters list.	165
Appendix A – Description of parameters	
Application level.	202
Appendix B – Fault Log	
Fault codes and descriptions.	302
Appendix C – Recommend Cyber security information	
Recommended Secure Hardening Guidelines	307

List of figures

Figure 1. RTC battery connection	23
Figure 2. Rating label	24
Figure 3. Catalog numbering system	25
Figure 4. Keypad and display	31
Figure 5. General view of LCD	34
Figure 6. Welcome page	34
Figure 7. Upgrade page	35
Figure 8. Auto backup page	35
Figure 9. Main menu	35
Figure 10. Parent node page	35
Figure 11. Parameter page	36
Figure 12. Parameter page from favorite menu	36
Figure 13. Fault page	36
Figure 14. Main Menu Page	37
Figure 15. Main menu navigation	37
Figure 16. M—Monitor	39
Figure 17. Active Faults	40
Figure 18. Pop-up active faults	41
Figure 19. Fault history	42
Figure 20. Parameter menu overview	43
Figure 21. Parameter sets	44
Figure 22. Down from keypad	45
Figure 23. Parameters comparison	46
Figure 24. Password	47
Figure 25. Edit parameter value	48
Figure 26. Parameter locked	49
Figure 27. Example of Two-Pump Autochange, Main Diagram	82
Figure 28. Two-Pump Autochange System Principal Control Diagram	83
Figure 29. Example of Three-Pump Autochange, Main Diagram	84
Figure 30. Three-Pump Autochange System Principal Control Diagram	84
Figure 31. Example of the Function of the PFC Application with Three Auxiliary Drives	85
Figure 32. Multi Pump Control Curve	86
Figure 33. Multi-Drive/Multi-Pump Layout	86
Figure 34. PowerXL Drives with 10 V Supply with a 0–10 V Transducer	87
Figure 35. PowerXL Drives with 10 V Supply with a 4–20 mA Transducer	88
Figure 36. PowerXL Drives with Ext Supply with a 4–20 mA Transducer	89
Figure 37. Bandwidth Feedback	90
Figure 38. PID Controller Flowchart	124
Figure 39. Acceleration and deceleration time	202
Figure 40. Motor parameters from ratings plate	203
Figure 41. With and without reference scaling	206
Figure 42. AI1 2wire-current	207

List of figures, continued

Figure 43. AI1 3wire-current	207
Figure 44. AI1 4wire-current	207
Figure 45. AI1 reference potentiometer 10V	207
Figure 46. Analog input AI scaling	208
Figure 47. AI1 signal filtering	208
Figure 48. AI1 No signal inversion	209
Figure 49. AI1 Signal Inversion	209
Figure 50. Example of joystick hysteresis	210
Figure 51. Example of sleep limit function	211
Figure 52. A/2 2wire-current	212
Figure 53. AI2 3wire-current	212
Figure 54. AI2 4wire-current	212
Figure 55. AI2 pot ref.	212
Figure 56. AI2 differential voltage	213
Figure 57. AI2 Filter time	213
Figure 58. AI2 No signal inversion	214
Figure 59. AI2 Signal inversion	214
Figure 60. Example of joystick hysteresis	215
Figure 61. Example of sleep limit function	215
Figure 62. Start forward/start reverse	216
Figure 63. Start, stop and reverse	217
Figure 64. Start pulse/stop pulse	218
Figure 65. Activation of fixed frequencies	221
Figure 66. Start forward/start reverse	227
Figure 67. Start, stop and reverse	227
Figure 68. Start pulse/stop pulse	228
Figure 69. Analog output filtering.	232
Figure 70. Analog output scaling	232
Figure 71. Analog output invert.	233
Figure 72. AO2 Filter Time	234
Figure 73. Analog output scalling.	234
Figure 74. Analog output invert	235
Figure 75. Supervision function	237
Figure 76. Supervision function	238
Figure 77. External brake control	238
Figure 78. Acceleration/Deceleration (S-shaped)	244
Figure 79. Acceleration/Deceleration (S-shaped)	245
Figure 80. Example of skip frequency area setting	246
Figure 81. Ramp speed scaling between skip frequencies	246
Figure 82. Linear and squared change of motor voltage	248
Figure 83. Programmable V/Hz curve.	249
Figure 84. Speed control F1	251
Figure 85. Motor thermal current it curve	255

List of figures, continued

Figure 86. Motor temperature calculation	256
Figure 87. Stall characteristics settings.	256
Figure 88. Stall time count	257
Figure 89. Setting of minimum load.	257
Figure 90. Underload time counter function	258
Figure 91. Auto restart fail (try number >2.)	259
Figure 92. Setting up PID application	267
Figure 93. DC-Braking time when stop mode = coasting	275
Figure 94. DC-Braking time when stop mode = ramp.	275

List of tables

Table 1. Common abbreviations	23
Table 2. Type/IP20	26
Table 3. Type 1/IP21	26
Table 4. Type 12/IP54	26
Table 5. Type/IP20	27
Table 6. Type 1/IP21	27
Table 7. Type 12/IP54.	28
Table 8. Type 0/IP00	28
Table 9. Type 1/IP21	29
Table 10. Type 12/IP54.	29
Table 11. Type 0/IP00.	30
Table 12. Keypad buttons	32
Table 13. LED state indicators	34
Table 14. Soft keys	35
Table 15. Keypad menus.	38
Table 16. Startup Wizard Instructions	51
Table 17. Multi-Pump and fan control	52
Table 18. PID Mini-Wizard values	52
Table 19. I/O connection	55
Table 20. Drive communication ports.	56
Table 21. Monitor—M	57
Table 22. Operate mode—O.	59
Table 23. Basic parameters—P1.	60
Table 24. Analog input—P2.	61
Table 25. Digital input—P3	62
Table 26. Analog output—P4	64
Table 27. Digital output—P5	66
Table 28. Drive control—P7	68
Table 29. Motor control—P8	70

List of tables, continued

Table 30. Protections—P9	71
Table 31. Preset speed—P12	74
Table 32. Brake—P14	74
Table 33. FB Process Data Input Sel—P20.1	74
Table 34. FB Process Data Output Sel—P20.2	75
Table 35. Basic Setting— P20.3.1	75
Table 36. Modbus RTU— P20.3.2	75
Table 37. BACnet MS/TP— P20.3.3	53
Table 38. Ethernet IP—P20.4	76
Table 39. Modbus TCP—P20.5	76
Table 40. Basic setting—P21.1	77
Table 41. Version Info—P21.2	79
Table 42. Application Info—P21.3	79
Table 43. User Info—P21.4	79
Table 44. Multi-Pump and fan application default I/O connection	91
Table 45. Drive communication ports	92
Table 46. Monitor—M	93
Table 47. Operate mode—O	95
Table 48. Basic parameters—P1	96
Table 49. Analog input—P2	97
Table 50. Digital input—P3	98
Table 51. Analog output—P4	100
Table 52. Digital output—P5	101
Table 53. Drive control—P7	103
Table 54. Motor control—P8	104
Table 55. Protections—P9	104
Table 56. PID controller 1—P10	107
Table 57. Preset speed—P12	110
Table 58. Brake—P14	110
Table 59. Fire mode—P15	111
Table 60. Second motor parameter—P16	111
Table 61. Bypass—P17	111
Table 62. Basic settings—P18.1	112
Table 63. Operation mode P18.2.1	112
Table 64. Multi Pump status P18.2.2	113
Table 65. Network status P18.2.3	113
Table 66. Last fault code P18.3.1	114
Table 67. Output frequency P18.3.2	114
Table 68. Motor voltage P18.3.3	114
Table 69. Motor current P18.3.4	114
Table 70. Motor torque P18.3.5	114
Table 71. Motor power P18.3.6	114

List of tables, continued

Table 72. Motor speed P18.3.7	115
Table 73. Motor run time P18.3.8	115
Table 74. Multi-Pump single drive - P18.4.	115
Table 75. Multi-Pump multi drive - P18.5	115
Table 76. Protections - P18.6	116
Table 77. Real time clock—P19	116
Table 78. FB Process Data Input Sel—P20.1	117
Table 79. FB Process Data Output Sel—P20.2	117
Table 80. Basic Setting— P20.3.1	118
Table 81. Modbus RTU—P20.3.2	118
Table 82. BACnet MS/TP—P20.3.3.	118
Table 83. Ethernet IP—P20.4	119
Table 84. Modbus TCP—P20.5	119
Table 85. Basic setting—P21.1.	120
Table 86. Version info—P21.2	121
Table 87. Application info—P21.3	122
Table 88. User info—P21.4	122
Table 89. Multi-PID Application Default I/O Configuration	125
Table 90. Drive Communication Ports	126
Table 91. Monitor—M	127
Table 92. Operate Mode—O.	129
Table 93. Basic Parameters—P1.	130
Table 94. Analog Input—P2	131
Table 95. Digital Input—P3	132
Table 96. Analog Output—P4	135
Table 97. Digital Output—P5.	136
Table 98. Drive Control—P7	138
Table 99. Motor Control—P8	139
Table 100. Protections—P9.	140
Table 101. PID Controller 1—P10	142
Table 102. PID Controller 2—P11	145
Table 103. Preset Speed—P12	147
Table 104. Brake—P14	148
Table 105. Fire Mode—P15.	148
Table 106. Second Motor Parameter—P16.	148
Table 107. Bypass—P17	149
Table 108. Basic Settings - P18.1	149
Table 109. Operation Mode P18.2.1	150
Table 110. Multi Pump Status P18.2.2	150
Table 111. Network Status P18.2.3	151
Table 112. Last Fault Code P18.3.1.	151
Table 113. Output Frequency P18.3.2.	151

List of tables, continued

Table 114. Motor Voltage P18.3.3	151
Table 115. Motor Current P18.3.4	152
Table 116. Motor Torque P18.3.5	152
Table 117. Motor Power P18.3.6	152
Table 118. Motor Speed P18.3.7	152
Table 119. Motor Run Time P18.3.8	152
Table 120. Multi-Pump Single Drive - P18.4	153
Table 121. Multi-Pump Multi Drive - P18.5	153
Table 122. Protections—P18.6	153
Table 123. Real Time Clock—P19	154
Table 124. FB Process Data Input Sel—P20.1	155
Table 125. FB Process Data Output Sel—P20.2	155
Table 126. Basic Setting— P20.3.1	156
Table 127. Modbus RTU— P20.3.2	156
Table 128. BACnet MS/TP— P20.3.3	157
Table 129. Table 118. Ethernet IP—P20.4	157
Table 130. Modbus TCP—P20.5	157
Table 131. Basic Setting—P21.1	158
Table 132. Version Info—P21.2	159
Table 133. Application Info—P21.3	159
Table 134. User Info—P21.4	160
Table 135. Multi-Purpose application default I/O configuration	163
Table 136. Drive communication ports	164
Table 137. Monitor—M	165
Table 138. Operate mode—O	167
Table 139. Basic parameters—P1	168
Table 140. Analog input—P2	169
Table 141. Digital input—P3	170
Table 142. Analog output—P4	173
Table 143. Digital output—P5	174
Table 144. Logic function—P6	177
Table 145. Drive control—P7	178
Table 146. Motor control—P8	179
Table 147. Protections—P9	181
Table 148. PID Controller 1—P10	184
Table 149. PID Controller 2—P11	187
Table 150. Preset speed—P12	189
Table 151. Torque control—P13	190
Table 152. Brake—P14	190
Table 153. Fire Mode—P15	191
Table 154. Second motor parameter—P16	191
Table 155. Bypass—P17	191

List of tables, continued

Table 156. Basic settings—P18.1	192
Table 157. Operation mode—P18.2.1	192
Table 158. Multi pump status—P18.2.2	193
Table 159. Network status—P18.2.3	193
Table 160. Last fault code—P18.3.1	193
Table 161. Output frequency—P18.3.2	194
Table 162. Motor voltage—P18.3.3	194
Table 163. Motor current—P18.3.4	194
Table 164. Motor torque—P18.3.5	194
Table 165. Motor power—P18.3.6	194
Table 166. Motor Speed—P18.3.7	194
Table 167. Motor run Time—P18.3.8	195
Table 168. Multi-pump single drive—P18.4	195
Table 169. Multi-Pump multi drive—P18.5	195
Table 170. Protections—P18.6	195
Table 171. Real time clock—P19	196
Table 172. FB Process Data Input Sel—P20.1	197
Table 173. FB Process Data Output Sel—P20.2	197
Table 174. Basic Setting— P20.3.1	198
Table 175. Modbus RTU— P20.3.2	198
Table 176. BACnet MS/TP— P20.3.3	198
Table 177. Ethernet IP—P20.4	199
Table 178. Modbus TCP—P20.5	199
Table 179. Basic setting—P21.1	199
Table 180. Version info—P21.2	201
Table 181. Application info—P21.3	201
Table 182. User info—P21.4	201
Table 183. Active Faults	302
Table 184. History faults	302

Safety



WARNING!
DANGEROUS ELECTRICAL VOLTAGE!

Before commencing the installation

- Disconnect the power supply of the device
- Ensure that devices cannot be accidentally restarted
- Verify isolation from the supply
- Earth and short circuit the device
- Cover or enclose any adjacent live components
- Only suitably qualified personnel in accordance with EN 50110-1/-2 (VDE 0105 Part 100) may work on this device/system
- Before installation and before touching the device ensure that you are free of electrostatic charge
- The functional earth (FE, PES) must be connected to the protective earth (PE) or the potential equalization. The system installer is responsible for implementing this connection
- Connecting cables and signal lines should be installed so that inductive or capacitive interference does not impair the automation functions
- Install automation devices and related operating elements in such a way that they are well protected against unintentional operation
- Suitable safety hardware and software measures should be implemented for the I/O interface so that an open circuit on the signal side does not result in undefined states in the automation devices
- Ensure a reliable electrical isolation of the extra-low voltage of the 24 V supply. Only use power supply units complying with IEC 60364-4-41 (VDE 0100 Part 410) or HD384.4.41 S2
- Deviations of the input voltage from the rated value must not exceed the tolerance limits given in the specifications, otherwise this may cause malfunction and dangerous operation
- Emergency stop devices complying with IEC/EN 60204-1 must be effective in all operating modes of the automation devices. Unlatching the emergency-stop devices must not cause a restart
- Devices that are designed for mounting in housings or control cabinets must only be operated and controlled after they have been installed and with the housing closed. Desktop or portable units must only be operated and controlled in enclosed housings
- Measures should be taken to ensure the proper restart of programs interrupted after a voltage dip or failure. This should not cause dangerous operating states even for a short time. If necessary, emergency-stop devices should be implemented
- Wherever faults in the automation system may cause injury or material damage, external measures must be implemented to ensure a safe operating state in the event of a fault or malfunction (for example, by means of separate limit switches, mechanical interlocks, and so on)
- Depending on their degree of protection, adjustable frequency drives may contain live bright metal parts, moving or rotating components, or hot surfaces during and immediately after operation
- Removal of the required covers, improper installation, or incorrect operation of motor or adjustable frequency drive may cause the failure of the device and may lead to serious injury or damage
- The applicable national accident prevention and safety regulations apply to all work carried out on live adjustable frequency drives
- The electrical installation must be carried out in accordance with the relevant regulations (for example, with regard to cable cross sections, fuses, PE)
- Transport, installation, commissioning, and maintenance work must be carried out only by qualified personnel (IEC 60364, HD 384 and national occupational safety regulations)
- Installations containing adjustable frequency drives must be provided with additional monitoring and protective devices in accordance with the applicable safety regulations. Modifications to the adjustable frequency drives using the operating software are permitted
- All covers and doors must be kept closed during operation
- To reduce hazards for people or equipment, the user must include in the machine design measures that restrict the consequences of a malfunction or failure of the drive (increased motor speed or sudden standstill of motor). These measures include:
 - Other independent devices for monitoring safety-related variables (speed, travel, end positions, and so on)
 - Electrical or non-electrical system-wide measures (electrical or mechanical interlocks)
- Never touch live parts or cable connections of the adjustable frequency drive after it has been disconnected from the power supply. Due to the charge in the capacitors, these parts may still be live after disconnection. Fit appropriate warning signs

Definitions and symbols

WARNING

This symbol indicates high voltage. It calls your attention to items or operations that could be dangerous to you and other persons operating this equipment. Read the message and follow the instructions carefully. This symbol is the “Safety Alert Symbol”. It occurs with either of two signal words: CAUTION or WARNING, as described below.

WARNING

Indicates a potentially hazardous situation which, if not avoided, can result in serious injury or death.

CAUTION

Indicates a potentially hazardous situation which, if not avoided, can result in minor to moderate injury, or serious damage to the product. The situation described in the CAUTION may, if not avoided, lead to serious results. Important safety measures are described in CAUTION (as well as WARNING).

Hazardous high voltage

WARNING

Motor control equipment and electronic controllers are connected to hazardous line voltages. When servicing drives and electronic controllers, there may be exposed components with housings or protrusions at or above line potential. Extreme care should be taken to protect against shock.

Stand on an insulating pad and make it a habit to use only one hand when checking components. Always work with another person in case an emergency occurs. Disconnect power before checking controllers or performing maintenance. Be sure equipment is properly grounded. Wear safety glasses whenever working on electronic controllers or rotating machinery.

Warnings and cautions

This manual contains clearly marked cautions and warnings which are intended for your personal safety and to avoid any unintentional damage to the product or connected appliances. Please read the information included in cautions and warnings carefully.

WARNING

The relay outputs and other I/O-terminals may have a dangerous control voltage present even when PowerXL DG1 is disconnected from mains.

WARNING

Be sure not to plug the Ethernet IP cable to the terminal under the keypad! This might harm your personal computer.

WARNING

Be sure not to plug the Modbus TCP cable to the terminal under the keypad! This might harm your personal computer.

CAUTION

Remove external control signal before resetting the fault to prevent unintentional restart of the drive.

Important safety information

Hazardous high voltage

 **WARNING**

The components of the power unit of PowerXL Series are live when the AC drive is connected to mains potential. Coming into contact with this voltage is extremely dangerous and may cause death or severe injury.

 **WARNING**

The motor terminals U, V, W and the brake resistor terminals are live when PowerXL Series is connected to mains, even if the motor is not running.

 **WARNING**

After disconnecting the AC drive from the mains, wait until the indicators on the keypad go out (if no keypad is attached see the indicators on the cover). Wait 5 more minutes before doing any work on the connections of PowerXL Series. Do not open the cover before this time has expired. After expiration of this time, use a measuring equipment to absolutely ensure that no voltage is present. Always ensure absence of voltage before starting any electrical work!

 **WARNING**

The control I/O-terminals are isolated from the mains potential. However, the relay outputs and other I/O-terminals may have a dangerous control voltage present even when PowerXL DG1 is disconnected from mains.

 **WARNING**

Before connecting the AC drive to mains, confirm that the front and cable covers of PowerXL DG1 are closed.

 **WARNING**

During a ramp stop (see the Application Manual), the motor is still generating voltage to the drive. Therefore, do not touch the components of the AC drive before the motor has completely stopped. Wait until the indicators on the keypad go out (if no keypad is attached see the indicators on the cover). Wait additional 5 minutes before starting any work on the drive.

Important warnings

 **WARNING**

PowerXL Series AC drive is meant for fixed installations only.

 **WARNING**

Do not perform any measurements when the AC drive is connected to the mains.

 **WARNING**

The ground leakage current of PowerXL Series AC drives exceeds 3.5 mA AC. According to standard EN61800-5-1, a reinforced protective ground connection must be ensured.

 **WARNING**

If the AC drive is used as a part of a machine, the machine manufacturer is responsible for providing the machine with a supply disconnecting device (EN 60204-1).

 **WARNING**

Only spare parts delivered by Eaton can be used.

 **WARNING**

At power-up, power brake or fault reset the motor will start immediately if the start signal is active, unless the pulse control for Start/Stop logic has been selected. Furthermore, the I/O functionalistic (including start inputs) may change if parameters, applications or software are changed. Disconnect, therefore, the motor if an unexpected start can cause danger.

 **WARNING**

The motor starts automatically after automatic fault reset if the auto restart function is activated. See the Application Manual for more detailed information.

 **WARNING**

Prior to measurements on the motor or the motor cable, disconnect the motor cable from the AC drive.

 **WARNING**

Do not touch the components on the circuit boards. Static voltage discharge may damage the components.

 **WARNING**

Check that the EMC level of the AC drive corresponds to the requirements of your supply network.

Additional cautions

CAUTION

The PowerXL DG1 AC drive must always be grounded with an grounding conductor connected to the grounding terminal marked with. The ground leakage current of PowerXL DG1 exceeds 3.5 mA AC. According to EN61800-5-1, one or more of the following conditions for the associated protective circuit shall be satisfied:

- a) The protective conductor shall have a cross-sectional area of at least 10 mm² Cu or 16 mm² Al, through its total run
- b) Where the protective conductor has a cross-sectional area of less than 10 mm² Cu or 16 mm² Al, a second protective conductor of at least the same cross-sectional area shall be provided up to a point where the protective conductor has a cross-sectional area not less than 10 mm² Cu or 16 mm² Al
- c) Automatic disconnection of the supply in case of loss of continuity of the protective conductor. The cross-sectional area of every protective grounding conductor that does not form part of the supply cable or cable enclosure shall, in any case, be not less than:
 - 2.5mm² if mechanical protection is provided or
 - 4 mm² if mechanical protection is not provided.

The ground fault protection inside the AC drive protects only the drive itself against ground faults in the motor or the motor cable. It is not intended for personal safety. The ground fault protection inside the AC drive protects only the drive itself against ground faults in the motor or the motor cable. It is not intended for personal safety. Due to the high capacitive currents present in the AC drive, fault current protective switches may not function properly.

Do not perform any voltage withstand tests on any part of PowerXL Series. There is a certain procedure according to which the tests shall be performed. Ignoring this procedure may result in damaged product.

Sécurité



AVERTISSEMENT ! TENSION ÉLECTRIQUE DANGEREUSE !

Avant de commencer l'installation

- Débrancher l'alimentation de l'appareil
- S'assurer que les dispositifs ne peuvent pas être accidentellement redémarrés
- Vérifier l'isolement de l'alimentation
- Mettre l'appareil à la terre et le protéger contre les courts-circuits
- Couvrir ou enfermer tout composant sous tension adjacent
- Seul le personnel qualifié conformément à la norme EN 50110-1/-2 (VDE 0105 Partie 100) peut travailler sur cet appareil/ce système
- Avant l'installation et avant de toucher l'appareil, s'assurer de ne porter aucune charge électrostatique
- La terre fonctionnelle (FE, PSE) doit être raccordée à la terre de protection (PE) ou la compensation de potentiel. L'installateur du système a la responsabilité d'assurer cette connexion
- Les câbles de connexion et les lignes de signal doivent être installés de façon à ce que les interférences capacitatives ou inductives ne compromettent pas les fonctions d'automatisation
- Installer les appareils d'automatisation et les éléments de fonctionnement associés de manière à ce qu'ils soient bien protégés contre tout fonctionnement accidentel
- Des dispositifs de sécurité matériels et logiciels appropriés doivent être utilisés en rapport avec l'interface des E/S afin qu'un circuit ouvert sur le côté signal ne résulte pas en états indéfinis dans les dispositifs d'automatisation
- Assurer une isolation électrique fiable sur le côté tension extra basse de l'alimentation 24 V. Utiliser uniquement des blocs d'alimentation conformes à la norme CEI 60364-4-41 (VDE 0100, partie 410) ou HD384.4.41 S2
- Les écarts entre la tension d'entrée et la tension nominale ne doivent pas dépasser les limites de tolérance indiquées dans les spécifications, au risque de provoquer un mauvais fonctionnement et une utilisation dangereuse du système
- Les dispositifs d'arrêt d'urgence conformes à la norme CEI/EN 60204-1 doivent être efficace dans tous les modes de fonctionnement des dispositifs d'automatisation. Le déverrouillage des dispositifs d'arrêt d'urgence ne doit pas entraîner un redémarrage
- Les dispositifs conçus pour un montage dans des boîtiers ou armoires de commande ne doivent être utilisés et contrôlés qu'après avoir été installés et avec le boîtier fermé. Les unités de bureau ou portatives ne doivent être utilisées et contrôlées que dans leurs boîtiers fermés
- Des mesures doivent être prises pour assurer un bon redémarrage des programmes interrompus après une chute ou une panne de tension. Ceci ne doit pas causer des états de fonctionnement dangereux, même pour un court laps de temps. Si nécessaire, des dispositifs d'arrêt d'urgence doivent être utilisés
- Quand des défaillances du système d'automatisation peuvent entraîner des blessures ou des dommages matériels, des mesures externes doivent être appliquées pour assurer un état de fonctionnement sans danger en cas de panne ou de mauvais fonctionnement (par exemple au moyen de disjoncteurs séparés, de verrouillages mécaniques, etc.)
- En fonction de leur degré de protection, les entraînements à fréquence variable peuvent contenir des pièces métalliques sous tension, des composants rotatifs ou en mouvement et des surfaces brûlantes, pendant le fonctionnement et immédiatement après l'arrêt
- Le retrait des protections requises, une installation incorrecte ou un mauvais fonctionnement du moteur ou de l'entraînement à fréquence variable peuvent causer la défaillance de l'appareil et entraîner des blessures graves et des dommages importants
- La réglementation nationale applicable en matière de sécurité et de prévention des accidents s'applique à tous les travaux effectués sur les entraînements à fréquence variable sous tension
- L'installation électrique doit être effectuée conformément aux réglementations applicables (par exemple, en ce qui concerne les sections transversales des câbles, les fusibles, la mise à la terre de protection)
- Le transport, l'installation, la mise en service et les travaux de maintenance doivent être effectués uniquement par un personnel qualifié (IEC 60364, HD 384 et règles de sécurité du travail)
- Les installations contenant des entraînements à fréquence variable doivent être équipées de dispositifs de surveillance et de protection, conformément aux réglementations applicables en matière de sécurité. Les modifications des entraînements à fréquence variable réalisées à l'aide du logiciel d'exploitation sont autorisées
- Toutes les protections et les portes doivent être maintenues fermées pendant le fonctionnement

- Pour réduire les risques d'accidents et de dommages matériels, l'utilisateur doit inclure dans la conception de la machine des mesures limitant les conséquences de panne ou de mauvais fonctionnement de l'entraînement (augmentation de la vitesse ou arrêt soudain du moteur). Ces mesures comprennent :

- Autres dispositifs indépendants de surveillance des variables en rapport avec la sécurité (vitesse, voyages, positions d'extrémité, etc.)
- Mesures électriques ou non électriques appliquées à l'ensemble du système (verrouillages électriques ou mécaniques)
- Ne jamais toucher les pièces sous tension ni les connexions des câbles de l'entraînement à fréquence variable après leur déconnexion de l'alimentation. En raison de la charge dans les condensateurs, ces pièces peuvent être encore sous tension après la déconnexion. Installer les panneaux d'avertissement appropriés

Lire ce manuel en entier et s'assurer de bien comprendre les procédures avant de tenter d'installer, de configurer, d'utiliser et d'effectuer tout travail d'entretien sur cet entraînement à fréquence variable DG1.

Définitions et symboles

AVERTISSEMENT

Ce symbole indique une haute tension. Il attire l'attention sur les éléments ou les opérations qui pourraient être dangereux pour les personnes utilisant cet équipement. Lire attentivement le message et suivre attentivement les instructions.



Ce symbole est le « symbole d'alerte de sécurité ». Il accompagne les deux termes d'avertissement suivants : MISE EN GARDE ou AVERTISSEMENT, comme décrit ci-dessous.

AVERTISSEMENT

Indique une situation potentiellement dangereuse qui, si elle n'est pas évitée, peut entraîner des blessures graves ou la mort.

MISE EN GARDE

Indique une situation potentiellement dangereuse qui, si elle n'est pas évitée, peut entraîner des blessures légères à modérées et d'importants dégâts matériels. La situation décrite dans la MISE EN GARDE peut, si elle n'est pas évitée, entraîner des conséquences graves. Des mesures de sécurité importantes sont décrites dans les MISES EN GARDE (ainsi que dans les AVERTISSEMENTS).

Haute tension dangereuse

AVERTISSEMENT

L'équipement de contrôle du moteur et les contrôleurs électroniques sont branchés sur des tensions secteur dangereuses. Lors de l'entretien des entraînements et des contrôleurs électroniques, il peut y avoir des composants exposés avec des boîtiers ou des protubérances au niveau du potentiel du réseau ou au-dessus. Toutes les précautions doivent être prises pour se protéger contre les chocs électriques.

- Se tenir sur un tapis isolant et prendre l'habitude de n'utiliser qu'une seule main pour vérifier les composants
- Toujours travailler avec une autre personne lorsqu'une situation d'urgence se produit
- Débrancher l'alimentation avant de vérifier les contrôleurs ou d'effectuer des travaux d'entretien
- S'assurer que l'équipement est correctement relié à la terre
- Porter des lunettes de sécurité lors des travaux sur les contrôleurs électroniques ou les machines rotatives

AVERTISSEMENT

Les composants de la section d'alimentation de l'entraînement restent sous tension après la coupure de la tension d'alimentation. Après la déconnexion de l'alimentation, attendre au moins cinq minutes avant de retirer le couvercle pour permettre la décharge des condensateurs du circuit intermédiaire.

Prêter attention aux avertissements signalant des dangers !



DANGER
5 MIN

AVERTISSEMENT

Risque de choc électrique – risque de blessures !
Effectuer le câblage uniquement si l'unité n'est plus sous tension.

AVERTISSEMENT

Ne pas effectuer de modifications sur l'entraînement CA lorsqu'il est connecté à l'alimentation secteur.

Avertissements et mises en garde

AVERTISSEMENT

S'assurer de mettre l'appareil à la terre en suivant les instructions de ce manuel. Les unités non mises à la terre peuvent causer des chocs électriques et des incendies.

AVERTISSEMENT

Cet équipement ne doit être installé, réglé et entretenu que par un personnel d'entretien électrique qualifié connaissant la construction et le fonctionnement de ce type d'équipement, ainsi que les risques encourus. Le non-respect de cette précaution peut entraîner la mort ou des blessures graves.

AVERTISSEMENT

Les composants à l'intérieur de l'entraînement sont sous tension lorsque l'entraînement est branché à l'alimentation. Le contact avec cette tension est extrêmement dangereux et peut causer la mort ou des blessures graves.

AVERTISSEMENT

Les bornes de phase (L1, L2, L3), les bornes du moteur (U, V, W) et les bornes de résistance de liaison CC/frein (DC-, DC+/R+, R-) sont sous tension lorsque l'entraînement est branché à l'alimentation, même si le moteur ne tourne pas. Le contact avec cette tension est extrêmement dangereux et peut causer la mort ou des blessures graves.

AVERTISSEMENT

Même si les bornes E/S de commande sont isolées de la tension secteur, les sorties de relais et les autres bornes E/S peuvent présenter une tension dangereuse même lorsque l'entraînement est débranché. Le contact avec cette tension est extrêmement dangereux et peut causer la mort ou des blessures graves.

AVERTISSEMENT

Cet équipement a un grand courant de fuite capacitif pendant le fonctionnement, ce qui peut mettre les pièces du boîtier à un niveau supérieur au potentiel de terre. Une mise à la terre appropriée, telle que décrite dans ce manuel, est nécessaire. Le non-respect de cette précaution peut entraîner la mort ou des blessures graves.

AVERTISSEMENT

Avant de mettre l'entraînement sous tension, s'assurer que les protections avant et des câbles sont fermées et attachées pour empêcher l'exposition à d'éventuelles défaillances électriques. Le non-respect de cette précaution peut entraîner la mort ou des blessures graves.

AVERTISSEMENT

Un dispositif de protection/déconnexion en amont doit être fourni, tel que requis par le code électrique national (NEC®). Le non-respect de cette précaution peut entraîner la mort ou des blessures graves.

AVERTISSEMENT

Cet entraînement peut causer un courant CC dans le conducteur de mise à la terre de protection. Lorsqu'un dispositif de protection ou de surveillance à courant résiduel est utilisé pour la protection en cas de contact direct ou indirect, seul un dispositif de type B est autorisé sur le côté alimentation de ce produit.

AVERTISSEMENT

Ne travailler sur le câblage qu'après que l'entraînement a été correctement monté et attaché.

AVERTISSEMENT

Avant d'ouvrir les couvercles de l'entraînement :

- Débrancher toute l'alimentation allant à l'entraînement, y compris l'alimentation de commande externe pouvant être présente
- Attendre un minimum de cinq minutes après l'extinction de tous les voyants du clavier. Cela permet aux condensateurs de bus CC de se décharger
- Une tension dangereuse peut rester dans les condensateurs de bus CC même si l'alimentation a été coupée. Confirmer que les condensateurs sont entièrement déchargés en mesurant la tension à l'aide d'un multimètre réglé pour mesurer la tension CC

Le non-respect de cette précaution peut entraîner la mort ou des blessures graves.

AVERTISSEMENT

L'ouverture du dispositif de protection du circuit de dérivation peut indiquer que le courant de défaut a été interrompu. Pour réduire le risque d'incendie ou de choc électrique, les pièces porteuses de courant et les autres composants du contrôleur doivent être examinés et remplacés s'ils sont endommagés. Si l'élément de courant d'un relais de surcharge a grillé, le relais de surcharge doit être intégralement remplacé.

AVERTISSEMENT

Le fonctionnement de cet équipement nécessite le respect des instructions d'installation et de fonctionnement détaillées fournies dans le manuel d'installation/de fonctionnement destiné à être utilisé avec ce produit. Ces informations sont fournies sur le CD-ROM, la disquette ou tout autre périphérique de stockage inclus dans l'emballage contenant ce dispositif. Ce support doit être conservé avec cet appareil à tout moment. Une copie papier de ces informations peut être commandée auprès du service de documentation Eaton.

AVERTISSEMENT

Avant de procéder à l'entretien de l'entraînement :

- **Débrancher toute l'alimentation allant à l'entraînement, y compris l'alimentation de commande externe pouvant être présente**
- **Placer une étiquette « NE PAS UTILISER » sur le dispositif de déconnexion**
- **Verrouiller le dispositif de déconnexion en position ouverte**

Le non-respect de ces instructions peut entraîner la mort ou des blessures graves.

AVERTISSEMENT

Les sorties de l'entraînement (U, V, W) ne doivent pas être connectées à la tension d'entrée ni à l'alimentation secteur, car ceci pourrait gravement endommager l'appareil et causer un incendie.

AVERTISSEMENT

Le dissipateur de chaleur et/ou le boîtier externe peuvent atteindre une température élevée.

Prêter attention aux avertissements signalant des dangers !



Surface brûlante – Risque de brûlure. NE PAS TOUCHER !

MISE EN GARDE

Toute modification électrique ou mécanique de cet entraînement sans consentement écrit préalable d'Eaton annule toutes les garanties, peut entraîner un danger pour la sécurité et annuler l'homologation UL®.

MISE EN GARDE

Installer cet entraînement sur une matière résistante aux flammes, telle qu'une plaque d'acier, pour réduire les risques d'incendie.

MISE EN GARDE

Installer cet entraînement sur une surface perpendiculaire capable de supporter le poids de l'entraînement et non soumise à des vibrations afin de diminuer les risques de chute et de dommage de l'entraînement, ainsi que les risques de blessures.

MISE EN GARDE

Empêcher la pénétration de corps étrangers, tels que morceaux de fils et copeaux métalliques, dans le boîtier de l'entraînement, car ceci pourrait provoquer la formation d'un arc électrique et un incendie.

MISE EN GARDE

Installer cet entraînement dans une pièce bien aérée non soumise à des températures extrêmes, à une forte humidité ou à la condensation. Éviter les endroits directement exposés au soleil ou présentant de fortes concentrations de poussières, des gaz corrosifs, des gaz explosifs, des gaz inflammables, ou des vapeurs de liquide de meulage, etc. Une installation inadéquate peut entraîner un risque d'incendie.

MISE EN GARDE

Lors de la sélection de la section transversale des câbles, prendre en compte la chute de tension dans des conditions de charge. La prise en compte d'autres paramètres relève de la responsabilité de l'utilisateur.

Il relève de la responsabilité de l'utilisateur de respecter toutes les normes électriques nationales et internationales en vigueur concernant la mise à la terre de protection de l'ensemble de l'équipement.

MISE EN GARDE

Les spécifications minimum relatives aux sections transversales des conducteurs de terre de protection indiquées dans ce manuel doivent être respectées.

Le courant de fuite de cet équipement dépasse 3,5 mA (CA). La taille minimum du conducteur de la mise à la terre de protection doit être conforme aux exigences de la norme EN 61800-5-1 et/ou aux réglementations de sécurité locales.

MISE EN GARDE

Les courants de fuite de ce convertisseur de fréquence sont supérieures à 3,5 mA (CA). Conformément à la norme CEI/EN 61800-5-1, un conducteur de mise à la terre de l'équipement supplémentaire possédant la même superficie de coupe transversale que le conducteur de mise à la terre de protection d'origine doit être branché, ou la section transversale du conducteur de mise à la terre de l'équipement doit être d'au moins 10 mm² Cu. Seul un conducteur en cuivre doit être utilisé avec cet entraînement.

MISE EN GARDE

Les entrées anti-rebond ne sont pas permises dans le schéma du circuit de sécurité. Des disjoncteurs de courant résiduel (RCD) ne peuvent être installés qu'entre le réseau de courant alternatif et l'entraînement.

MISE EN GARDE

Les entrées anti-rebond ne sont pas permises dans le schéma du circuit de sécurité. Si plusieurs moteurs sont connectés à un entraînement, des contacteurs doivent être conçus pour les moteurs individuels conformément à la catégorie d'utilisation AC-3.

Sélectionner du contacteur du moteur en fonction du courant de fonctionnement nominal du moteur à connecter.

MISE EN GARDE

Les entrées anti-rebond ne sont pas permises dans le schéma du circuit de sécurité. Une commutation entre l'entraînement et l'alimentation d'entrée doit avoir lieu dans un état sans tension.

MISE EN GARDE

Les entrées anti-rebond ne sont pas permises dans le schéma du circuit de sécurité. Risque d'incendie !

Utiliser uniquement des câbles, des interrupteurs de protection et des contacteurs indiquant le courant nominal permis.

MISE EN GARDE

Avant de connecter l'entraînement à l'alimentation secteur CA, s'assurer que les réglages de la classe de protection CEM sont correctement effectués selon les instructions de ce manuel.

- Si l'entraînement doit être utilisé dans un réseau de distribution flottant, retirer les vis au niveau des VOM et CEM. Voir « Installation dans un réseau à une phase connectée à la terre (corner-grounded) » et « Installation dans un réseau IT »
- Débrancher le filtre CEM interne lors de l'installation de l'entraînement sur un réseau IT (système d'alimentation non mis à la terre ou système d'alimentation électrique mis à la terre haute résistance [plus de 30 ohms]) pour ne pas que le système soit connecté au potentiel de terre via les condensateurs du filtre CEM. Ceci peut être une cause de dangers ou endommager l'entraînement
- Débrancher le filtre CEM interne lors de l'installation de l'entraînement sur un système TN à une phase connectée à la terre pour ne pas endommager l'entraînement

Note: Lorsque le filtre CEM interne est débranché, l'entraînement peut ne pas être conforme aux normes de compatibilité électromagnétique.

- Ne pas tenter d'installer ou de retirer les vis des VOM et CEM lorsque l'alimentation est appliquée aux bornes d'entrée de l'entraînement

Sécurité du moteur et de l'équipement

MISE EN GARDE

n'effectuer aucun test de résistance de tension ou au mégohmmètre sur toute partie de l'entraînement ou de ses composants. Un test inadéquat peut entraîner des dommages.

MISE EN GARDE

Avant tout test ou mesure du moteur ou du câble du moteur, débrancher le câble du moteur au niveau des bornes de sortie de l'entraînement (U, V, W) pour éviter d'endommager ce dernier lors des tests.

MISE EN GARDE

Ne toucher aucun composant sur les cartes de circuit. Les décharges d'électricité statique peuvent endommager les composants.

MISE EN GARDE

Avant de mettre le moteur en marche, vérifier qu'il est correctement monté et aligné avec l'équipement entraîné. S'assurer que le démarrage du moteur ne risque pas de provoquer des blessures ou d'endommager l'équipement connecté au moteur.

MISE EN GARDE

Régler la vitesse maximale du moteur (fréquence) dans l'entraînement conformément aux exigences du moteur et de l'équipement qui lui est connecté. Des réglages de fréquence maximum incorrects peuvent endommager le moteur ou l'équipement et causer des blessures.

MISE EN GARDE

Avant d'inverser le sens de rotation du moteur, veiller à ce que cela ne risque pas de provoquer des blessures ou des dommages matériels.

MISE EN GARDE

S'assurer qu'aucun condensateur de correction de puissance n'est connecté à la sortie de l'entraînement ou aux bornes du moteur pour éviter un mauvais fonctionnement de l'entraînement et des dommages potentiels.

MISE EN GARDE

S'assurer que les bornes de sortie de l'entraînement (U, V, W) ne sont pas connectées à l'alimentation secteur, ce qui pourrait causer de graves dommages à l'entraînement.

 MISE EN GARDE

Lorsque les bornes de commande de deux ou plusieurs unités d'entraînement sont raccordées en parallèle, la tension auxiliaire de ces connexions de commande doit être fournie par une source unique, qui peut être soit l'une des unités, soit une alimentation externe.

 MISE EN GARDE

L'entraînement démarre automatiquement après une interruption de la tension d'entrée si la commande de démarrage externe est active.

 MISE EN GARDE

Ne pas commander le moteur avec le dispositif de déconnexion ; à la place, utiliser les touches de marche et d'arrêt du tableau de contrôle ou les commandes du tableau des E/S de l'entraînement. Le nombre de cycles de charge maximum permis des condensateurs CC (c'est-à-dire les mises sous tension par application de puissance) est de cinq en dix minutes.

 MISE EN GARDE

Fonctionnement incorrect de l'entraînement :

- Si l'entraînement n'est pas mis en marche pendant une longue période, la performance de ses condensateurs électrolytiques sera réduite
- S'il est arrêté pour une période prolongée, le mettre en marche au moins tous les six mois pendant au moins 5 heures pour restaurer la performance des condensateurs, puis vérifier son fonctionnement. Il est recommandé de ne pas brancher l'entraînement directement sur la tension secteur. La tension doit être augmentée progressivement en utilisant une source CA réglable

Le non-respect de ces instructions peut entraîner des blessures ou des dégâts matériels.

Pour plus d'informations techniques, contacter l'usine ou le représentant commercial Eaton local.

Chapter 1—PowerXL series overview

This chapter describes the purpose and contents of this manual, the receiving inspection recommendations and the PowerXL Series Open Drive catalog numbering system.

How to use this manual

The purpose of this manual is to provide you with information necessary to install, set and customize parameters, start up, troubleshoot and maintain the Eaton PowerXL Series variable frequency drive (VFD). To provide for safe installation and operation of the equipment, read the safety guidelines at the beginning of this manual and follow the procedures outlined in the following chapters before connecting power to the PowerXL Series VFD. Keep this operating manual handy and distribute to all users, technicians and maintenance personnel for reference.

Receiving and inspection

The PowerXL Series VFD has met a stringent series of factory quality requirements before shipment. It is possible that packaging or equipment damage may have occurred during shipment. After receiving your PowerXL Series VFD, please check for the following:

Check to make sure that the package includes the Instruction Leaflet Quick Start Guide, and accessory packet. The accessory packet includes:

- Rubber grommets
- Control cable grounding clamps
- Additional grounding screw

Inspect the unit to ensure it was not damaged during shipment.

Make sure that the part number indicated on the nameplate corresponds with the catalog number on your order.

If shipping damage has occurred, please contact and file a claim with the carrier involved immediately.

If the delivery does not correspond to your order, please contact your Eaton Electrical representative.

Note: Do not destroy the packing. The template printed on the protective cardboard can be used for marking the mounting points of the PowerXL VFD on the wall or in a cabinet.

Real time clock battery activation

To activate the real time clock (RTC) functionality in the PowerXL Series VFD, the RTC battery (already mounted in the drive) must be connected to the control board.

Simply remove the primary drive cover, locate the RTC battery directly below the keypad, and connect the white 2-wire connector to the receptacle on the control board.

Figure 1. RTC battery connection



Table 1. Common abbreviations

Abbreviation	Definition
CT	Constant torque with high overload rating (150%)
VT	Variable torque with low overload rating (110%)
I _H	High overload current (150%)
I _L	Low overload current (110%)
VFD	Variable Frequency Drive
RTC	Real Time Clock

Rating label

Figure 2. Rating label

EATON
Powering Business Worldwide

Type: DG1-34038FB-C21C
 Style No.: 9702-3005-XX
 Article No.: 9702-3004-XX
 PowerXL™ DG1 VFD Factory ID: I

CT/VT		Input	Output
18.5KW/ 22KW	U(V~)	380-440 3Ø	0-Vin 3Ø
	F(Hz)	50/60 Hz	0-400 Hz
	I(A)	42.6	38/46
25HP/ 30HP	U(V~)	440-500 3Ø	0-Vin 3Ø
	F(Hz)	50/60 Hz	0-400 Hz
	I(A)	42.6	34/40

Enclosure Rating TYPE1 / IP21

User installation manual: MN040002EN
 Serial No.: XXXXXXXXXX

Contains EAN Code: EAN: 4015081721450
 Contains NAED Code: NAED: 786685878928

Contains SN, PN, Type, Date:

20 UL CERTIFIED SAFETY US-CA E134360 CE EAC E1296

Field installed conductors must be copper rated at 75°C
 XXXXXX www.eaton.com Made in China

Date Code: 20131118

Carton labels (U.S. and Europe)

Same as rating label shown above.

Catalog number system

Figure 3. Catalog numbering system

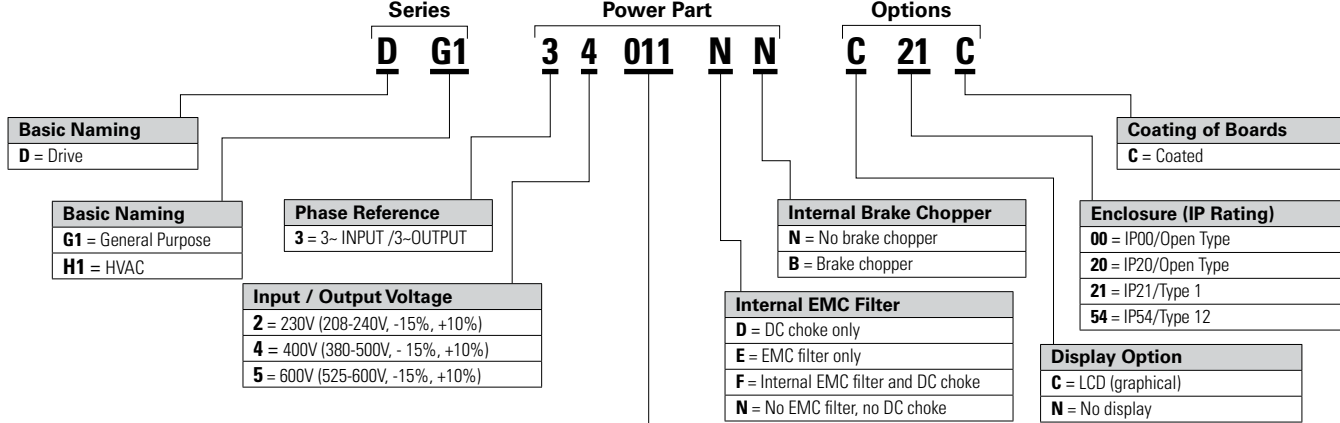

DG1 - Output Current Rating (CT)		
208-240V	380-500V	525-600V
3D7 =3.7 A, 0.55 kW, 0.75 hp	2D2 =2.2 A, 0.75 kW, 1 hp	3D3 =3.3 A, 1.5 kW, 2 hp
4D8 =4.8 A, 0.75 kW, 1 hp	3D3 =3.3 A, 1.1 kW, 1.5 hp	4D5 =4.5 A, 2.2 kW, 3 hp
6D6 =6.6 A, 1.1 kW, 1.5 hp	4D3 =4.3 A, 1.5 kW, 2 hp	7D5 =7.5 A, 3.7 kW, 5 hp
7D8 =7.8 A, 1.5 kW, 2 hp	5D6 =5.6 A, 2.2 kW, 3 hp	010 =10 A, 5.5 kW, 7.5 hp
011 =11 A, 2.2 kW, 3 hp	7D6 =7.6 A, 3 kW, 5 hp	013 =13.5 A, 7.5 kW, 10 hp
012 =12.5 A, 3 kW, 5 hp (VT)	9D0 =9 A, 4 kW, 7.5 hp (VT)	018 =18 A, 11 kW, 15 hp
017 =17.5 A, 3.7 kW, 5 hp	012 =12 A, 5.5 kW, 7.5 hp	022 =22 A, 15 kW, 20 hp
025 =25 A, 5.5 kW, 7.5 hp	016 =16 A, 7.5 kW, 10 hp	027 =27 A, 18.5 kW, 25 hp
031 =31 A, 7.5 kW, 10 hp	023 =23 A, 11 kW, 15 hp	034 =34 A, 22 kW, 30 hp
048 =48 A, 11 kW, 15 hp	031 =31 A, 15 kW, 20 hp	041 =41 A, 30 kW, 40 hp
061 =61 A, 15 kW, 20 hp	038 =38 A, 18.5 kW, 25 hp	052 =52 A, 37 kW, 50 hp
075 =75 A, 18.5 kW, 25 hp	046 =46 A, 22 kW, 30 hp	062 =62 A, 45 kW, 60 hp
088 =88 A, 22 kW, 30 hp	061 =61 A, 30 kW, 40 hp	080 =80 A, 55 kW, 75 hp
114 =114 A, 30 kW, 40 hp	072 =72 A, 37 kW, 50 hp	100 =100 A, 75 kW, 100 hp
143 =143 A, 37 kW, 50 hp	087 =87 A, 45 kW, 60 hp	125 =125 A, 90 kW, 125 hp
170 =170 A, 45 kW, 60 hp	105 =105 A, 55 kW, 75 hp	144 =144 A, 110 kW, 150 hp
211 =211 A, 55 kW, 75 hp	140 =140 A, 75 kW, 100 hp	208 =208 A, 132 kW, 200 hp
248 =248 A, 75 kW, 100 hp	170 =170 A, 90 kW, 125 hp	200 = 208 A, 200 kW, 200 hp
	205 =205 A, 110 kW, 150 hp	261 = 261 A, 250 kW, 250 hp
	245 =245 A, 132 kW, 200 hp	325 = 325 A, 315 kW, 300 hp
	310 = 310 A, 160 kW, 250 hp	385 = 385 A, 355 kW, 300 hp
	385 = 385 A, 200 kW, 300 hp	416 = 416 A, 400 kW, 400 hp
	460 = 460 A, 250 kW, 350 hp	460 = 460 A, 450 kW, 450 hp
	520 = 520 A, 250 kW, 450 hp	520 = 520 A, 500 kW, 500 hp
	590 = 590 A, 315 kW, 500 hp	590 = 590 A, 560 kW, 600 hp
	650 = 650 A, 355 kW, 500 hp	650 = 650 A, 630 kW, 650 hp
	730 = 730 A, 400 kW, 600 hp	820 = 820 A, 800 kW, 800 hp (VT)
	820 = 820 A, 450 kW, 700 hp	
	920 = 920 A, 500 kW, 800 hp	
	1K0 = 1180 A, 630 kW, 1000 hp (VT)	

Power ratings and product selection

PowerXL Series drives—208-230 Volt

Table 2. Type/IP20

Frame size	Constant torque (CT)/high overload (I_H)			Variable torque (VT)/low overload (I_L)			DG1 Catalog number
	230 V, 50 Hz kW rating	230 V, 60 Hz hp	Current A	230 V, 50 Hz kW rating	230 V, 60 Hz hp	Current A	
FR0	0.55	0.75	3.7	0.75	1	4.8	DG1-323D7EB-C20C
	0.75	1	4.8	1.1	1.5	6.6	DG1-324D8EB-C20C
	1.1	1.5	6.6	1.5	2	7.8	DG1-326D6EB-C20C

Table 3. Type 1/IP21

Frame size	Constant torque (CT)/high overload (I_H)			Variable torque (VT)/low overload (I_L)			Catalog number
	230 V, 50 Hz kW rating	230 V, 60 Hz hp	Current A	230 V, 50 Hz kW rating	230 V, 60 Hz hp	Current A	
FR1	0.55	0.75	3.7	0.75	1	4.8	DG1-323D7FB-C21C
	0.75	1	4.8	1.1	1.5	6.6	DG1-324D8FB-C21C
	1.1	1.5	6.6	1.5	2	7.8	DG1-326D6FB-C21C
	1.5	2	7.8	2.2	3	11	DG1-327D8FB-C21C
	2.2	3	11	3	—	12.5	DG1-32011FB-C21C
FR2	3	—	12.5	3.7	5	17.5	DG1-32012FB-C21C
	3.7	5	17.5	5.5	7.5	25	DG1-32017FB-C21C
	5.5	7.5	25	7.5	10	31	DG1-32025FB-C21C
FR3	7.5	10	31	11	15	48	DG1-32031FB-C21C
	11	15	48	15	20	61	DG1-32048FB-C21C
FR4	15	20	61	18.5	25	75	DG1-32061FN-C21C
	18.5	25	75	22	30	88	DG1-32075FN-C21C
	22	30	88	30	40	114	DG1-32088FN-C21C
FR5	30	40	114	37	50	143	DG1-32114FN-C21C
	37	50	143	45	60	170	DG1-32143FN-C21C
	45	60	170	55	75	211	DG1-32170FN-C21C
FR6	55	75	211	75	100	261	DG1-32211FN-C21C
	75	100	248	90	125	312	DG1-32248FN-C21C

Table 4. Type 12/IP54

Frame size	Constant torque (CT)/high overload (I_H)			Variable torque (VT)/low overload (I_L)			Catalog number
	230 V, 50 Hz kW rating	230 V, 60 Hz hp	Current A	230 V, 50 Hz kW rating	230 V, 60 Hz hp	Current A	
FR1	0.55	0.75	3.7	0.75	1	4.8	DG1-323D7FB-C54C
	0.75	1	4.8	1.1	1.5	6.6	DG1-324D8FB-C54C
	1.1	1.5	6.6	1.5	2	7.8	DG1-326D6FB-C54C
	1.5	2	7.8	2.2	3	11	DG1-327D8FB-C54C
	2.2	3	11	3	—	12.5	DG1-32011FB-C54C
FR2	3	—	12.5	3.7	5	17.5	DG1-32012FB-C54C
	3.7	5	17.5	5.5	7.5	25	DG1-32017FB-C54C
	5.5	7.5	25	7.5	10	31	DG1-32025FB-C54C
FR3	7.5	10	31	11	15	48	DG1-32031FB-C54C
	11	15	48	15	20	61	DG1-32048FB-C54C
FR4	15	20	61	18.5	25	75	DG1-32061FN-C54C
	18.5	25	75	22	30	88	DG1-32075FN-C54C
	22	30	88	30	40	114	DG1-32088FN-C54C
FR5	30	40	114	37	50	143	DG1-32114FN-C54C
	37	50	143	45	60	170	DG1-32143FN-C54C
	45	60	170	55	75	211	DG1-32170FN-C54C
FR6	55	75	211	75	100	261	DG1-32211FN-C54C
	75	100	248	90	125	312	DG1-32248FN-C54C

Note:

PowerXL Series drives—380-500 Volt

Table 5. Type/IP20

Frame size	Constant torque (CT)/high overload (I_H)			Variable torque (VT)/low overload (I_L)			DG1 Catalog number
	400 V, 50 Hz kW rating	460 V, 60 Hz hp	Current A	400 V, 50 Hz kW rating	460 V, 60 Hz hp	Current A	
FR0	0.75	1	2.2	1.1	1.5	3.3	DG1-342D2EB-C20C
	1.1	1.5	3.3	1.5	2	4.6	DG1-343D3EB-C20C
	1.5	2	4.3	2.2	3	5.6	DG1-344D3EB-C20C
	2.2	3	5.6	3	5	7.6	DG1-345D6EB-C20C

Table 6. Type 1/IP21

Frame size	Constant torque (CT)/high overload (I_H)			Variable torque (VT)/low overload (I_L)			Catalog number
	400 V, 50 Hz kW rating	460 V, 60 Hz hp	Current A	400 V, 50 Hz kW rating	460 V, 60 Hz hp	Current A	
FR1	0.75	1	2.2	1.1	1.5	3.3	DG1-342D2FB-C21C
	1.1	1.5	3.3	1.5	2	4.3	DG1-343D3FB-C21C
	1.5	2	4.3	2.2	3	5.6	DG1-344D3FB-C21C
	2.2	3	5.6	3	5	7.6	DG1-345D6FB-C21C
	3	5	7.6	4	–	9	DG1-347D6FB-C21C
	4	–	9	5.5	7.5	12	DG1-349D0FB-C21C
FR2	5.5	7.5	12	7.5	10	16	DG1-34012FB-C21C
	7.5	10	16	11	15	23	DG1-34016FB-C21C
	11	15	23	15	20	31	DG1-34023FB-C21C
FR3	15	20	31	18.5	25	38	DG1-34031FB-C21C
	18.5	25	38	22	30	46	DG1-34038FB-C21C
	22	30	46	30	40	61	DG1-34046FB-C21C
FR4	30	40	61	37	50	72	DG1-34061FN-C21C
	37	50	72	45	60	87	DG1-34072FN-C21C
	45	60	87	55	75	105	DG1-34087FN-C21C
FR5	55	75	105	75	100	140	DG1-34105FN-C21C
	75	100	140	90	125	170	DG1-34140FN-C21C
	90	125	170	110	150	205	DG1-34170FN-C21C
FR6	110	150	205	132	200	261	DG1-34205FN-C21C
	150	200	245	160	250	310	DG1-34245FN-C21C

Table 7. Type 12/IP54

Frame size	Constant torque (CT)/high overload (I _H)			Variable torque (VT)/low overload (I _L)			Catalog number
	400 V, 50 Hz kW rating	460 V, 60 Hz hp	Current A	400 V, 50 Hz kW rating	460 V, 60 Hz hp	Current A	
FR1	0.75	1	2.2	1.1	1.5	3.3	DG1-342D2FB-C54C
	1.1	1.5	3.3	1.5	2	4.3	DG1-343D3FB-C54C
	1.5	2	4.3	2.2	3	5.6	DG1-344D3FB-C54C
	2.2	3	5.6	3	5	7.6	DG1-345D6FB-C54C
	3	5	7.6	4	–	9	DG1-347D6FB-C54C
	4	–	9	5.5	7.5	12	DG1-349D0FB-C54C
FR2	5.5	7.5	12	7.5	10	16	DG1-34012FB-C54C
	7.5	10	16	11	15	23	DG1-34016FB-C54C
	11	15	23	15	20	31	DG1-34023FB-C54C
FR3	15	20	31	18.5	25	38	DG1-34031FB-C54C
	18.5	25	38	22	30	46	DG1-34038FB-C54C
	22	30	46	30	40	61	DG1-34046FB-C54C
FR4	30	40	61	37	50	72	DG1-34061FN-C54C
	37	50	72	45	60	87	DG1-34072FN-C54C
	45	60	87	55	75	105	DG1-34087FN-C54C
FR5	55	75	105	75	100	140	DG1-34105FN-C54C
	75	100	140	90	125	170	DG1-34140FN-C54C
	90	125	170	110	150	205	DG1-34170FN-C54C
FR6	110	150	205	132	200	261	DG1-34205FN-C54C
	150	200	245	160	250	310	DG1-34245FN-C54C

PowerXL Series drives—380, 500 Volt

Table 8. Type 0/IP00

Frame size	Constant torque (CT)/high overload (I _H)			Variable torque (VT)/low overload (I _L)			Catalog number
	400 V, 50 Hz kW rating	480 V, 60 Hz hp	Current A	400 V, 50 Hz kW rating	480 V, 60 Hz hp	Current A	
FR7	160	250	311	200	300	385	DG1-34310FN-C00C
	200	300	385	250	350	460	DG1-34385FN-C00C
	250	350	460	250	450	520	DG1-34460FN-C00C
	250	450	520	315	500	590	DG1-34520FN-C00C
FR8	315	500	590	355	500	650	DG1-34590FN-C00C
	355	500	650	400	600	730	DG1-34650FN-C00C
	400	600	730	450	700	820	DG1-34730FN-C00C
	450	700	820	500	800	920	DG1-34820FN-C00C
	500	800	920	560	900	1040	DG1-34920FN-C00C
	500	800	920	630	1000	1180	DG1-341K0FN-C00C

Note:

PowerXL Series Drives—600 volt^①

Table 9. Type 1/IP21

Frame size	Constant torque (CT)/high overload (I_H)			Variable torque (VT)/low overload (I_L)			Catalog number
	600 V, 60 Hz kW rating	600 V, 60 Hz hp	Current A	600 V, 60 Hz kW rating	600 V, 60 Hz hp	Current A	
FR1	1.5	2	3.3	2.2	3	4.5	DG1-353D3FB-C21C
	2.2	3	4.5	3.7	5	7.5	DG1-354D5FB-C21C
	3.7	5	7.5	5.5	7.5	10	DG1-357D5FB-C21C
FR2	5.5	7.5	10	7.5	10	13.5	DG1-35010FB-C21C
	7.5	10	13.5	11	15	18	DG1-35013FB-C21C
	11	15	18	15	20	22	DG1-35018FB-C21C
FR3	15	20	22	18.5	25	27	DG1-35022FB-C21C
	18.5	25	27	22	30	34	DG1-35027FB-C21C
	22	30	34	30	40	41	DG1-35034FB-C21C
FR4	30	40	41	37	50	52	DG1-35041FN-C21C
	37	50	52	45	60	62	DG1-35052FN-C21C
	45	60	62	55	75	80	DG1-35062FN-C21C
FR5	55	75	80	75	100	100	DG1-35080FN-C21C
	75	100	100	90	125	125	DG1-35100FN-C21C
	90	125	125	110	150	144	DG1-35125FN-C21C
FR6	110	150	144	150	200	208	DG1-35144FN-C21C
	150	200	208	187	250	250	DG1-35208FN-C21C

Table 10. Type 12/IP54

Frame size	Constant torque (CT)/high overload (I_H)			Variable torque (VT)/low overload (I_L)			Catalog number
	600 V, 60 Hz kW rating	600 V, 60 Hz hp	Current A	600 V, 60 Hz kW rating	600 V, 60 Hz hp	Current A	
FR1	1.5	2	3.3	2.2	3	4.5	DG1-353D3FB-C54C
	2.2	3	4.5	3.7	5	7.5	DG1-354D5FB-C54C
	3.7	5	7.5	5.5	7.5	10	DG1-357D5FB-C54C
FR2	5.5	7.5	10	7.5	10	13.5	DG1-35010FB-C54C
	7.5	10	13.5	11	15	18	DG1-35013FB-C54C
	11	15	18	15	20	22	DG1-35018FB-C54C
FR3	15	20	22	18.5	25	27	DG1-35022FB-C54C
	18.5	25	27	22	30	34	DG1-35027FB-C54C
	22	30	34	30	40	41	DG1-35034FB-C54C
FR4	30	40	41	37	50	52	DG1-35041FN-C54C
	37	50	52	45	60	62	DG1-35052FN-C54C
	45	60	62	55	75	80	DG1-35062FN-C54C
FR5	55	75	80	75	100	100	DG1-35080FN-C54C
	75	100	100	90	125	125	DG1-35100FN-C54C
	90	125	125	110	150	144	DG1-35125FN-C54C
FR6	110	150	144	150	200	208	DG1-35144FN-C54C
	150	200	208	187	250	250	DG1-35208FN-C54C

PowerXL Series drives—525—600 Volt

Table 11. Type 0/IP00

Frame size	Constant torque (CT)/high overload (I _H)			Variable torque (VT)/low overload (I _L)			Catalog number
	600 V, 50 Hz kW rating	600 V, 60 Hz hp	Current A	600 V, 50 Hz kW rating	600 V, 60 Hz hp	Current A	
FR7	187	250	261	224	300	325	DG1-35261FN-C00C
	224	300	325	298	400	385	DG1-35325FN-C00C
	224	300	385	336	450	416	DG1-35385FN-C00C
FR8	298	400	416	336	450	460	DG1-35416FN-C00C
	336	450	460	373	500	520	DG1-35460FN-C00C
	373	500	520	448	600	590	DG1-35520FN-C00C
	448	600	590	485	650	650	DG1-35590FN-C00C
	485	650	650	522	700	750	DG1-35650FN-C00C
	485	650	650	597	800	820	DG1-35820FN-C00C

Note:

Chapter 2—Keypad overview

The keypad is the interface between the drive and the user. It features an LCD display, 3 LED lights and 11 buttons. With the control keypad, it is possible to control the speed of a motor, to supervise the state of the equipment and to set the frequency converter's parameters. See **Figure 4**.

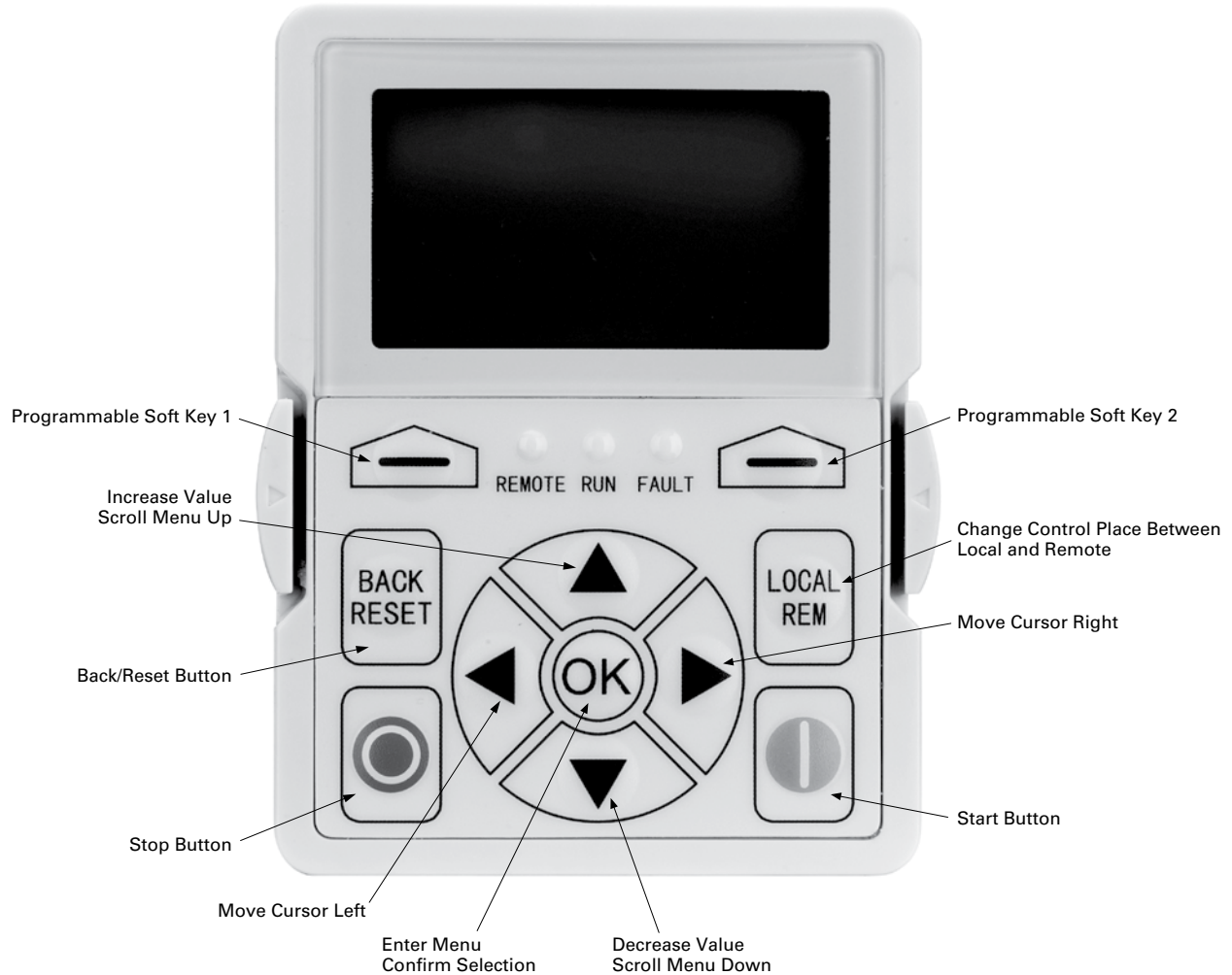

Figure 4. Keypad and display





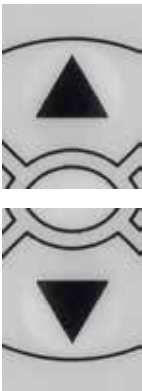

Keypad buttons

Buttons description



Table 12. Keypad buttons

Icon	Button	Description
	Soft key 1, Soft key 2	<p>Soft key 1, soft key 2: The functions of these two buttons shall be the following:</p> <ul style="list-style-type: none"> • Forward/Reverse, this shall change motor's run direction. • Menu, this shall return to main menu. • Details, this shall display the details of the fault. • Bypass, this shall make drive go into bypass. • Jog, this shall activate jog. Jog can enabled via press OK Key and Soft2 Key(When the Soft2Key is Jog) and disabled via release any one of the two keys. • Favorite, this shall add this parameter to the Favorite menu. • Delete, this shall delete this parameter from the Favorite menu.
	Back/Reset	<p>Back/Reset: This button has three integrated functions. The button operates as backward button during normal mode. In edit mode, it is used as cancel operate. It is also used to reset faults when faults occur.</p> <ul style="list-style-type: none"> • Backs up one step. • Cancels Modify in edit mode. • Resets the active faults (all the active faults shall be reset by pressing this button more than 2 seconds in any page). • Hold Stop and Back Reset for 5 seconds to return drive to factory default • At Main Menu page by hitting Back/Reset takes to Default Page.
	Local/Remote	<p>Local/Remote: Switches between LOCAL and REMOTE control for start and speed reference. The control locations corresponding to local and remote shall be selected within an application.</p>
	Up Down	<p>Up and down arrows:</p> <ul style="list-style-type: none"> • Move either up or down a menu list to select the desired menu item. • Editing a parameter bit by bit, while the active digit is scrolled. • Increase/decrease the reference value of the selected parameter. • In parameter comparison mode, scroll through the parameters of which current value is different from comparison parameter value. • In parameter page when in read mode, move to the previous or next brother parameter of this parameter.

	Left	<p>Left arrow:</p> <ul style="list-style-type: none"> • Navigation button, movement to left when editing a parameter digit by digit. • Backs up one step. • At Main Menu page by hitting Back/Reset takes to Default Page.
	Right	<p>Right arrow:</p> <ul style="list-style-type: none"> • Enter parameter group mode. • Enter parameter mode from group mode. • Enter parameter whole edit mode when this parameter can be written. • Enter parameter bit by bit edit mode from whole edit mode. • Navigation button, movement to right when editing a parameter bit by bit.
	OK	<p>OK:</p> <ul style="list-style-type: none"> • Will clear all the fault history if pressed for more than 5 seconds (including 5 seconds) in any page. • This button is used in the parameter edit mode to save the parameter setting. • To confirm the start-up list at the end of the Start-Up Wizard. • To confirm the comparison item in parameters comparison mode. <p>The following is the same with Right key:</p> <ul style="list-style-type: none"> • Enter parameter whole edit mode when this parameter can be written. • Enter parameter group mode. • Enter parameter mode from group mode.
	Stop	<p>Stop:</p> <p>This button operates as the motor stop button for normal operation. The default is for this button to always be active. It can be changed in parameter P7.5 to only when "Keypad" is selected as the control source.</p> <ul style="list-style-type: none"> • Motor stop from the keypad.
	Start	<p>Start:</p> <p>This button operates as motor start button for normal operation when the "Keypad" is selected as the active control source. When Keypad is the reference place after hitting the start button, it will jump directly to the Keypad Ref Screen.</p>

LED lights

Table 13. LED state indicators

Indicator	Description
 Run	Run: Indicates that the VFD is running and controlling the load in Drive or Bypass. Blinks when a stop command has been given but the drive is still ramping down.
 Fault	Fault: Turn on when there is one or more active drive fault(s).
 Remote	Local/Remote: Local: If the local control place is selected, the light will be off. Remote: If the remote control place is selected, the light will be on.

LCD display

The keypad LCD indicates the status of the motor and the drive and any faults in motor or drive functions. On the LCD, the user sees information about the current location in the menu structure and the item displayed.

Overview

Five lines shall be displayed in the screen. General view is as following in **Figure 5**.

Figure 5. General view of LCD

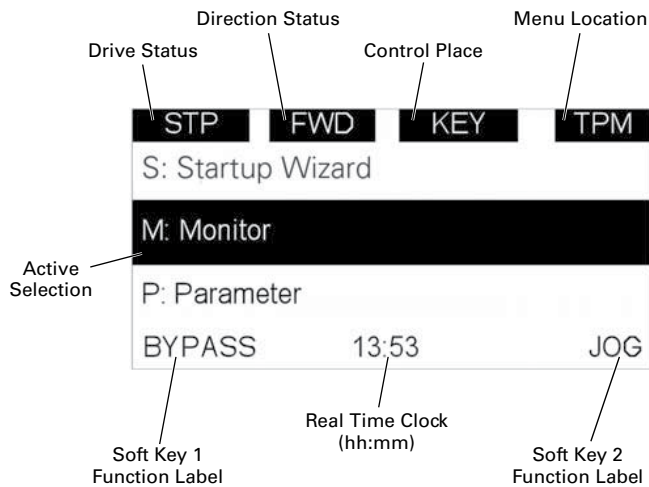

The lines definition is as below:

The first line is State line, shows:

- **RUN/STP/NRD/FIM/TFM**—If motor is running, the run state shall display “RUN”; otherwise the state display “STP.” “RUN” blinks when the stop command is sent but the drive is decelerating. “NRD” is displayed if the drive is not ready or does not have a signal “FIM” is displayed to indicate it is in Fire Mode and the drive is in a Run state. “TFM” is displayed when in the Fire Mode Test Mode and the drive is in a Run State.
- **FWD/REV/JOG**—If the motor running direction is clockwise, display “FWD”; otherwise display “REV” “Jog” if the drive is in Jog mode the status indication will occur.
- **KEY/I/O/BPS/RBP/BUS/OFF**—If it is in bypass currently, display “BPS”; when run command is given it will got to “RBP” otherwise, if the current control source is I/O terminal, display “I/O.” If it is keypad, then display “KEY”; otherwise display “BUS.” if HOA enabled and switch to OFF, it shall show OFF.
- **PAR/MON/FLT/OPE/QSW/FAV/TPM/MS1/SL1/SL2/SL3/SL4/BUx**.—If the current page is parameter menu, display “PAR”; If monitor menu, then display “MON”; If fault menu, then display “FLT”; If operation menu, then display “OPE”; If quick start wizard, then display “QSW”; If optional card menu, then display “BOA”; If favorite menu, then display “FAV”; If main menu, then display “TPM” when doing the Multi-drive Pump and Fan mode, the drive mode will be defined with MS- Master and SL being a slave drive. The 1 through 4 will indicate the number in the series it is. “BUx” indicates the drive being a backup drive when in the redundant drive system.

The second line is Code line, shows the menu code.

The third line is Name line, shows the menu name or parameters name.

The fourth line is Value line, shows the submenu name or parameters value.

The fifth line is Soft key line, the functions of Soft key 1 and Soft key 2 are changeable, and the real time is in the middle.

Welcome page

LCD shall show the welcome page when power on. See **Figure 6**.

Figure 6. Welcome page



Upgrade page

After welcome page, keypad will check whether there is different keypad firmware version in MCU's serial flash. If yes, then ask user whether to upgrade the keypad.

Figure 7. Upgrade page

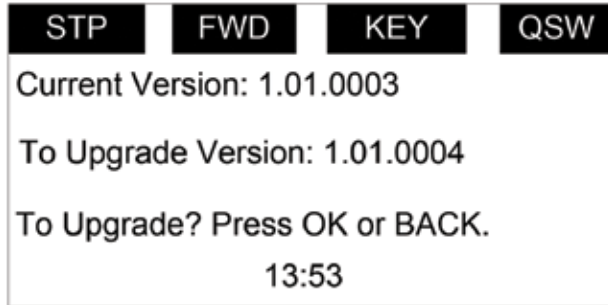

Auto backup page

If keypad is plugged into a new drive, then auto backup page will be shown to notice the user whether to do the upload/download.

Figure 8. Auto backup page

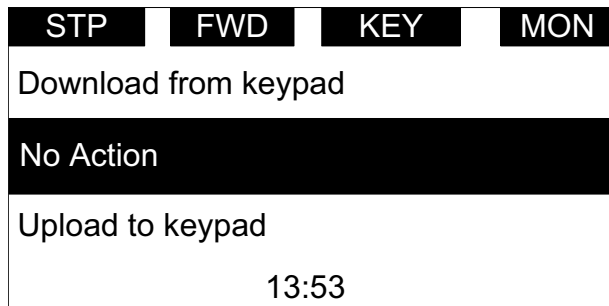

Soft key description

There are two soft key buttons. They have different definitions under different pages.

Table 14. Soft keys

Keypad Display page	Default Soft key 1	Default Soft key 2
Main menu page	Null or bypass	Jog*
Group node page	Reverse or forward*	Menu
Parameter node page	Null or favorite	Menu
Favorite page	Delete	Menu
Fault page	Detail	Menu

***Note:** if P21.1.18 or P21.1.19 is set to hidden it will hide this value.

1. In the main menu (root node), "JOG" shall be shown on the right. If bypass is enabled, then "BYPASS" shall be shown on the left. Otherwise, it will not be shown. See **Figure 9**

Figure 9. Main menu



2. For the parameter group, the two soft keys "REVERSE/FORWARD" and "MENU" shall be shown. See **Figure 10**

Figure 10. Parent node page

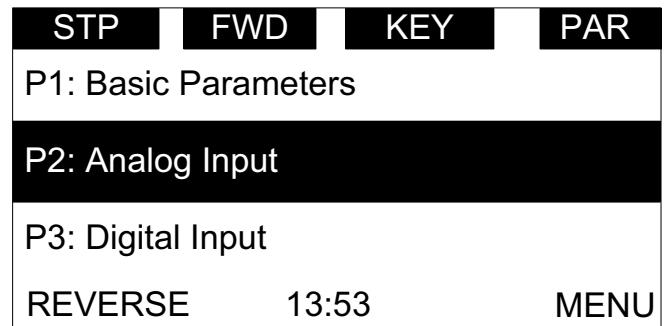

Chapter 2—Keypad overview

- For the parameter menu, if this parameter hasn't been added into the favorite list, two soft keys "FAVORITE" and "MENU" shall be shown. If it has been added into the favorite list, only one soft key "MENU" is shown in the right

Figure 11. Parameter page

STP	FWD	KEY	PAR
P2.3.1			
AI2 Mode			
0 - 20mA			
FAVORITE		13:53	MENU

- If one parameter has been added to the favorite list, it shall appear in the favorite menu. Then when you enter into the favorite menu, two soft keys "DELETE" and "MENU" shall be shown, and "DELETE" means you can delete the selected parameter from favorite list. See **Figure 12**

Figure 12. Parameter page from favorite menu

STP	FWD	KEY	PAR
P2.3.1: AI2 Mode			
M2: Reference Frequency			
M3: Motor Speed			
DELETE		13:53	MENU

- For the fault group, two soft keys "DETAIL" and "MENU" shall be shown. See **Figure 13**. For more information, see **Page 16**

Figure 13. Fault page

STP	FWD	KEY	FLT
F1.2: Fault			
Over Voltage			
2012-4-8 12:30:45			
DETAIL		13:53	MENU

Chapter 3—Menu overview

Main menu page

The data on the keypad are arranged in menus and sub-menus. The first menu level consists of M, P, F, B, T, O and S, and it is called the Main Menu.

Figure 14. Main menu page



Menu navigation

This section provides basic instruction on navigating each section in the menu structure.

Figure 15. Main menu navigation

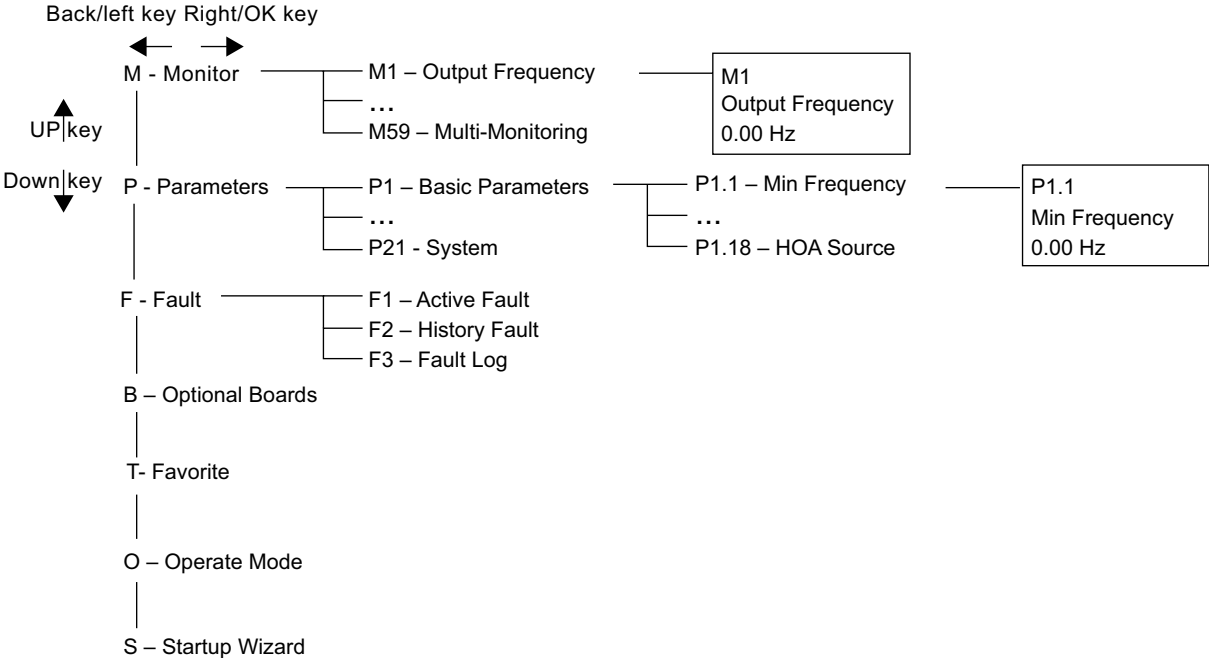

Menu structure

Table 15. Keypad menus

Item	Description		Item	Description	Item	Description
Monitor	M1—Output Frequency	M31—PID1 Feedback	Parameters	P1—Basic Parameters	Fault	F1—Active Fault
	M2—Freq Reference	M32—PID1 Error Value		P2—Analog Input		F2—History Fault
	M3—Motor Speed	M33—PID1 Output		P3—Digital Input		F3—Fault Log
	M5—Motor Torque	M35—PID2 Set Point		P5—Digital Output	Optional Boards	Bx—SlotA/SlotB
	M6—Motor Power	M36—PID2 Feedback		P6—Logic Function		Favorite
	M7—Motor Voltage	M37—PID2 Error Value		P7—Drive Control	Operate Mode	O1—Output Frequency
	M8—DC-link Voltage	M38—PID2 Output		P8—Motor Control		O2—Freq Reference
	M9—Unit Temperature	M39—PID2 Status		P9—Protections		O3—Motor Speed
	M10—Motor Temperature	M40—Running Motors		P10—PID Controller1		O4—Motor Current
	M11—Torque Reference	M41—PT100 Temp		P11—PID Controller2		O5—Motor Torque
	M12—Analog Input 1	M42—Last Active Fault		P12—Preset Speed		O6—Motor Power
	M13—Analog Input 2	M43—RTC Battery Status		P13—Torque Control		O7—Motor Voltage
	M14—Analog Output 1	M44—Instance Motor Power		P14—Brake		O8—DC-Link Voltage
	M15—Analog Output 2	M45—Energy Savings		P15—Fire Mode		O9—Unit Temperature
	M16—DI1, DI2, DI3	M46—Control Board DIDO Status		P16—Second Motor Para		O10—Motor Temperature
	M17—DI4, DI5, DI6	M47—SlotA DIDO Status		P17—Bypass		R11—Keypad Torque Ref
	M18—DI7, DI8	M48—SlotB DIDO Status		P18—Pump Parameters		R12—Keypad Reference
	M19—DO1, Virtual RO1, Virtual RO2	M49—Application Status Word		P19—Real Time Clock		R13—PID1 Keypad Setpoint 1
	M20—RO1, RO2, RO3	M50—Standard Status Word		P20—Communication		R14—PID1 Keypad Setpoint 2
	M21—TC1, TC2, TC3	M51—Output		P21—System	Startup Wizard	S—Startup Wizard
	M22—Interval 1	M52—Reference				
	M23—Interval 2	M53—Total MWh Count				
	M24—Interval 3	M54—Total Power Day Count				
	M25—Interval 4	M55—Total Power Hr Count				
	M26—Interval 5	M56—Trip MWh Count				
	M27—Timer 1	M57—Trip Power Day Count				
	M28—Timer 2	M58—Trip Power Hr Count				
	M29—Timer 3	M59—Multi-Monitoring				
	M30—PID1 Set Point					

Note: Will vary depending on application selected.

M—Monitor

In monitor page, user shall not be able to edit the parameters except multi-monitor parameter. Multi-monitor parameters allow for displaying 3 monitor values on display. The three values can be changed to any of the listed values.

The navigation for monitor is as **Figure 16**.

Figure 16. M—Monitor

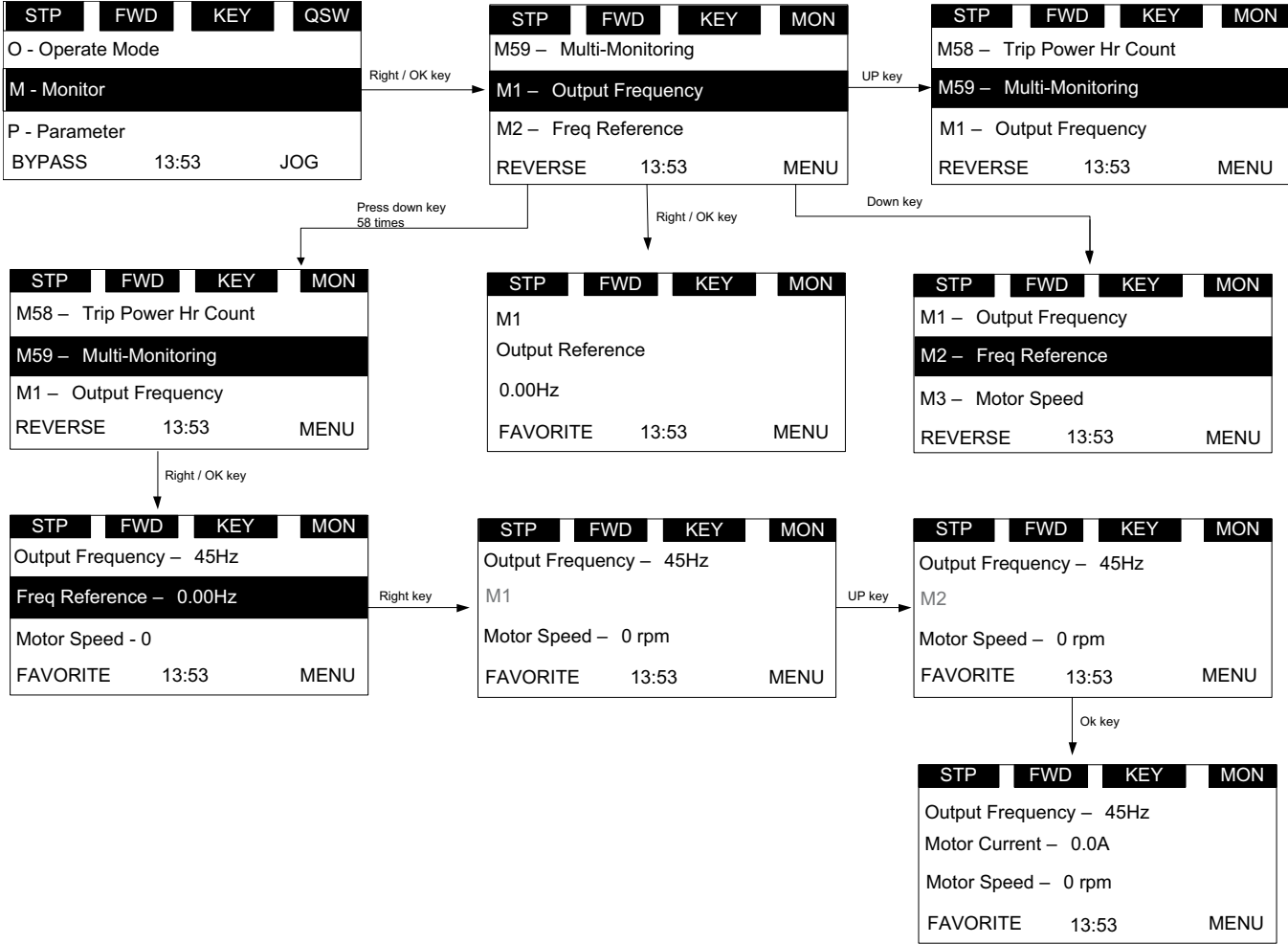

Chapter 3—Menu overview

F—Fault

There are four fault pages. The first one is F1 active faults; the second one will pop-up automatically when fault occurs; the third one is F2 fault history, and the fourth one is the fault log page

If there is no active fault/history fault, then “No fault” shall be shown.

Active fault

The navigation for active faults is as **Figure 17**.

After the DETAIL soft key is pressed, the following detail information about the fault shall be shown: fault code, type, power day count, power hour count, frequency, current, voltage, power, torque, DC voltage, unit temperature, run status, direction, warning, zero speed, Mwh count, at reference.

Figure 17. Active faults

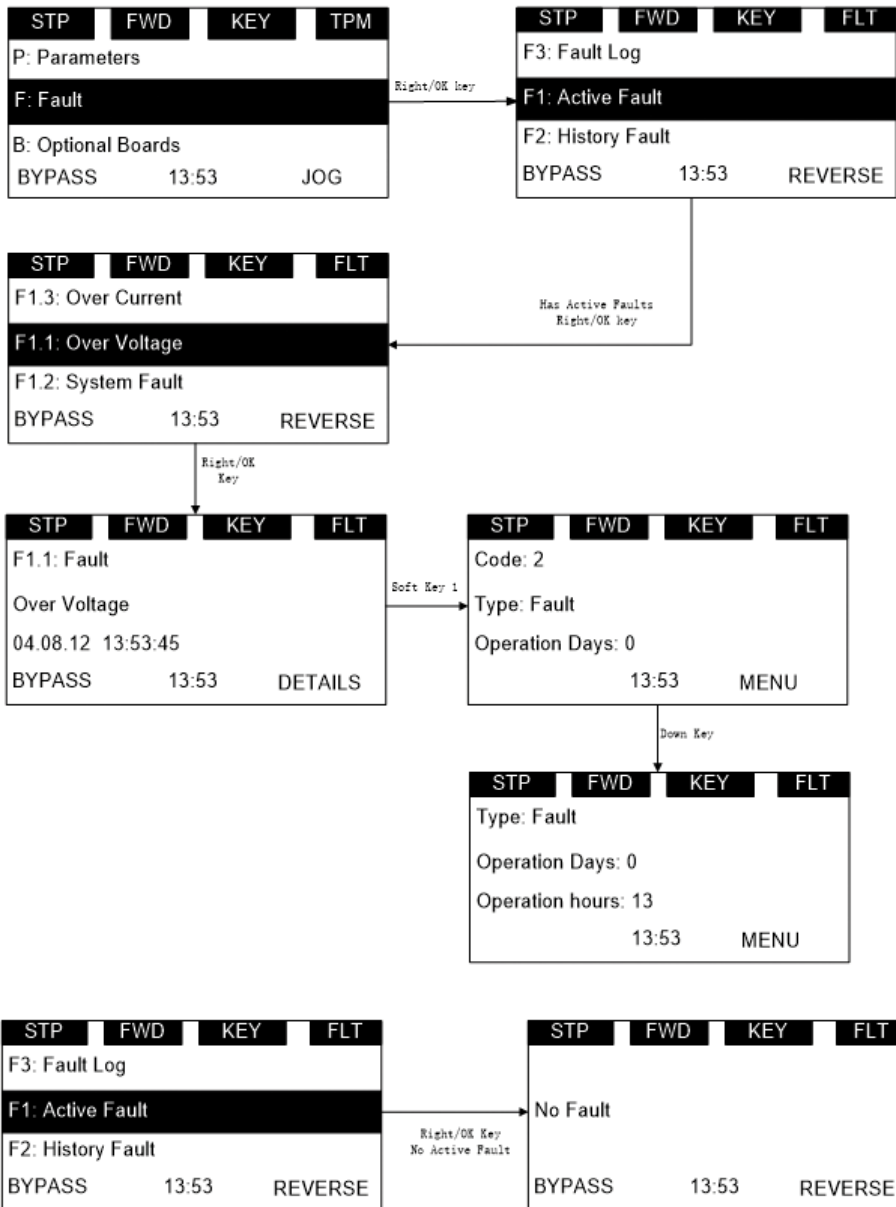

Pop-up fault

The navigation for the pop-up active fault is as **Figure 18**.

Figure 18. Pop-up active faults

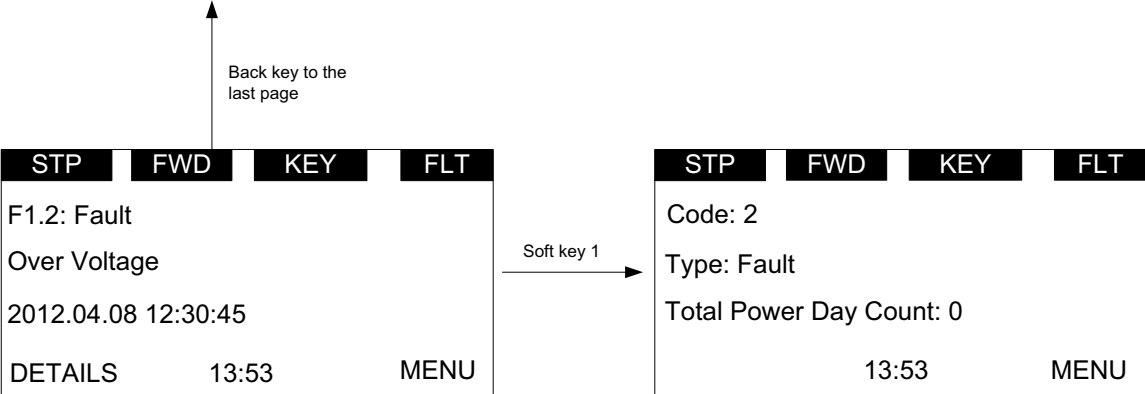

The latest active fault page shall pop up when there is a new active fault, the pop-up fault page is the same as the active fault page.

Pressing the back/reset key less than 2 seconds shall back to the last page user is watching.

Pressing the back/reset key more than 2 seconds shall reset all active faults when all the active fault condition is not satisfied.

User shall be able to navigate all the active faults by up/down key.

The page for active faults and pop-up faults are the same, except one: the response to the "Back" key. In active faults page, if the Back key is pressed, it returns to the last level menu. In pop-up faults page, it returns to the last page.

Chapter 3—Menu overview

Fault history

The navigation for fault history is as **Figure 19**.

In any page, OK button is used to clear all the active faults and fault history by pressing more than 5s without password.

Figure 19. Fault history

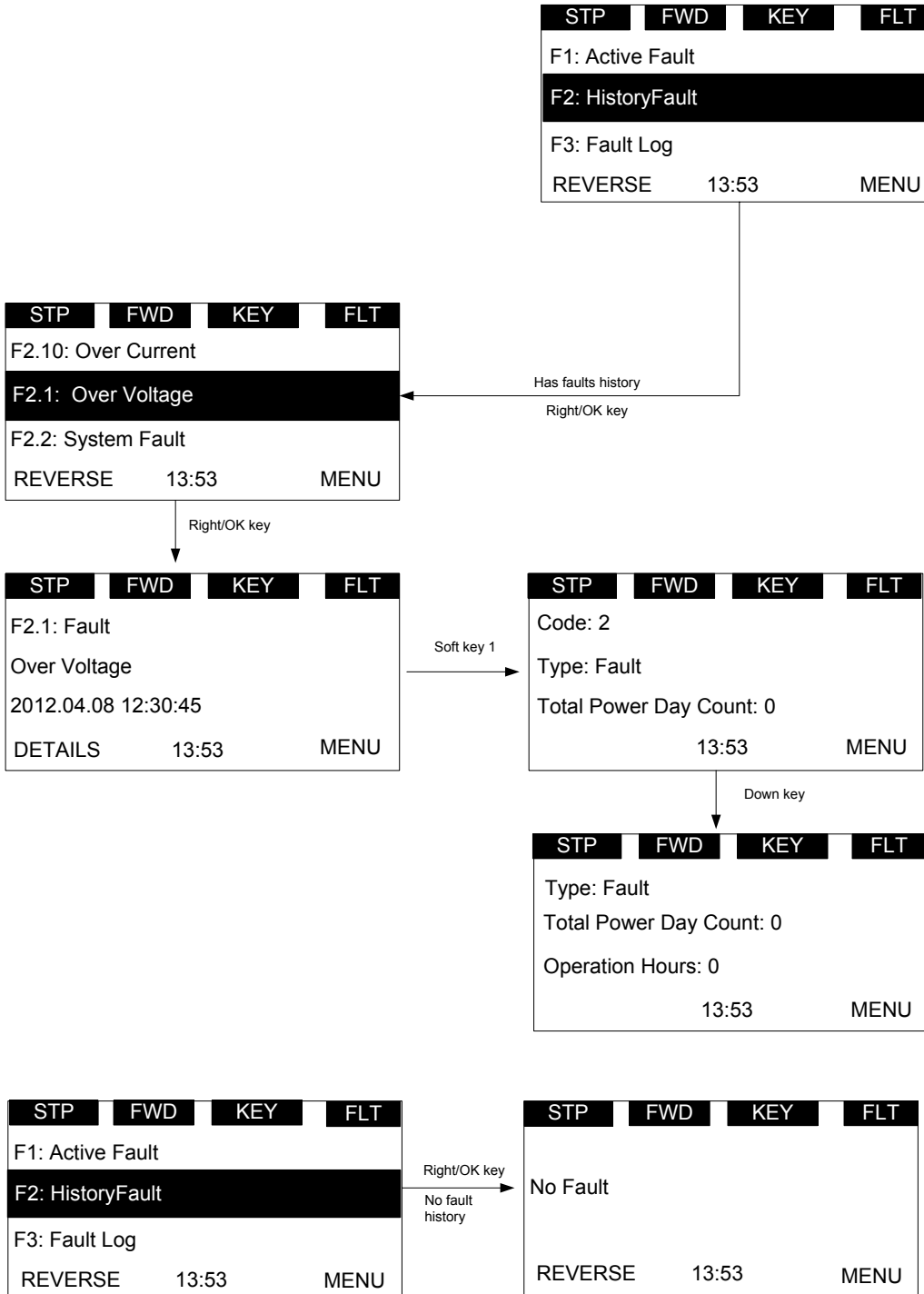

Fault Log

The Fault Log will store the last 50 faults in it with 1 being the most recent and 50 being the oldest. Only the fault code, name and time stamp are stored with these faults.

P—Parameter

The navigation for the parameter menu is shown in **Figure 20**.

In parameter page, the parameter code shall be shown in the second line (such as P1.1).

will not have any effect, which means that the value can't be edited.

In parameter page, the parameter name shall be shown in the third line (such as Min Frequency).

In parameter page, the value of parameter and unit shall be shown in the fourth line (0.00 Hz).

If the parameter is read and write, then pressing the right key shall make the parameter value flash, which means that the value can be edited.

If the parameter is read only, then pressing the right key

Figure 20. Parameter menu overview

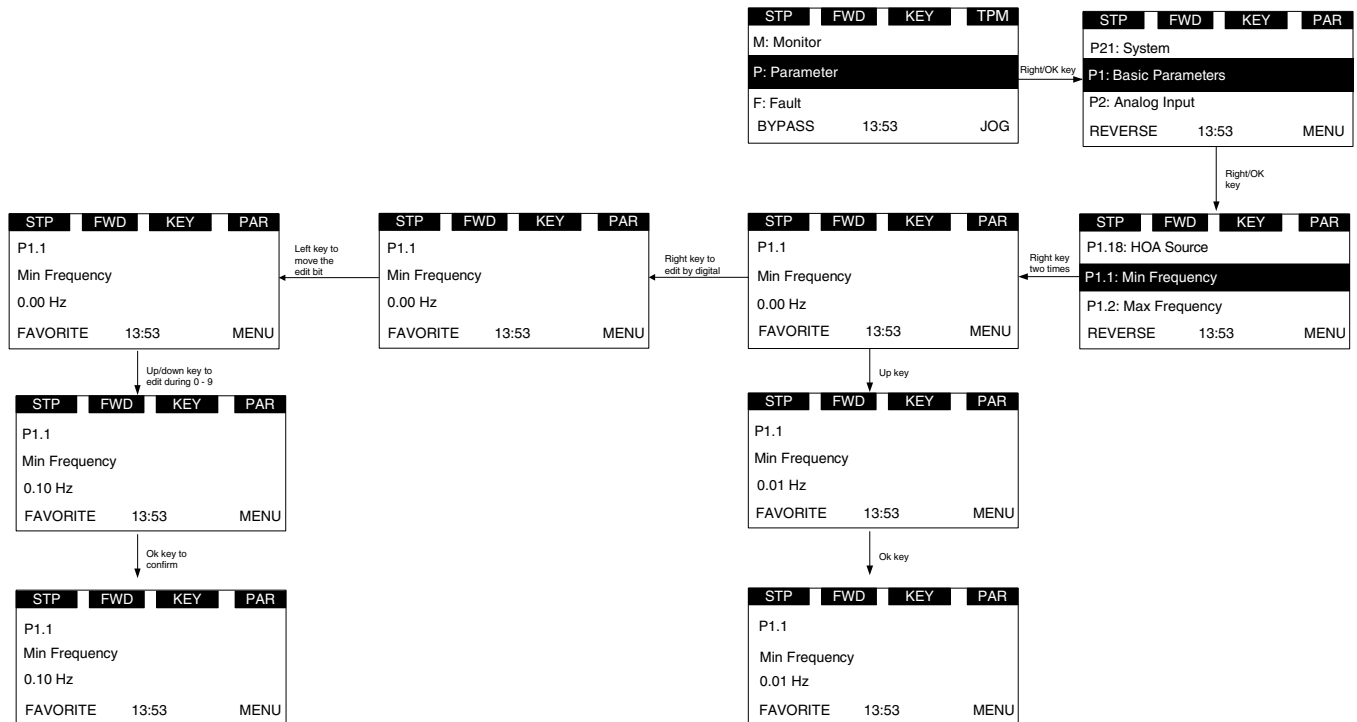

There are several special pages:

1. P21.1.3 Parameter Sets. See **Figure 21**.

User shall be able to load or store parameters. The options are as follows: Reload Defaults, Reload Set 1, Reload Set 2, Store Set 1, Store Set 2, Reset, Reload Defaults VM. The special points are:

- During this operation, “waiting...” shall flash, which means it is in process
- When it is finished, “OK” shall be shown
- Drive shall restart after default parameters are loaded
- “Reload Defaults VM” is for the sales stand. Do not use on a fully functioning drive

Figure 21. Parameter sets

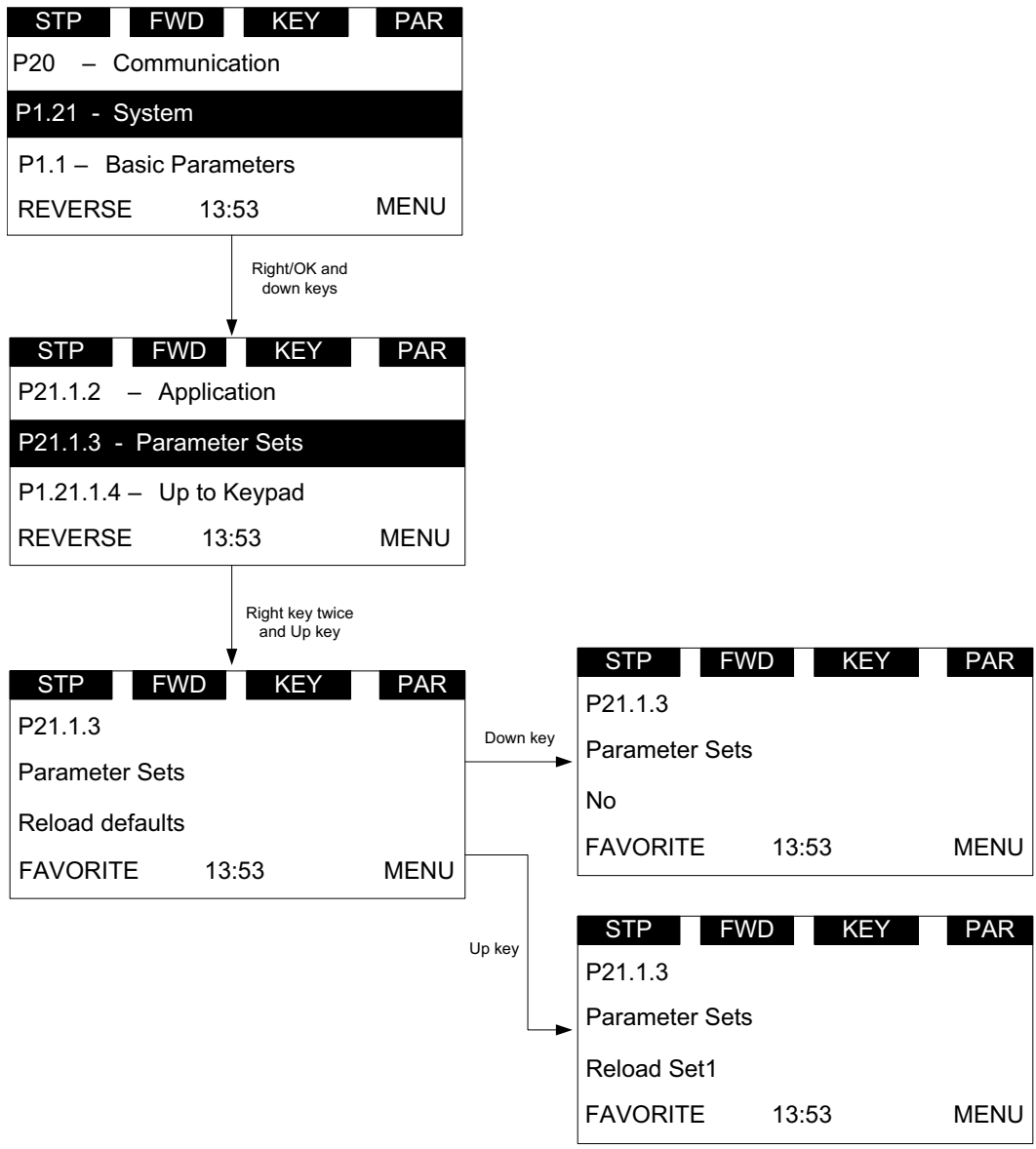

2. P21.1.4 Up to keypad and P21.1.5 Down from keypad

During this operation, “waiting...” shall flash, which means it is in process. When it is finished, “OK” shall be shown.

This stores the parameters to keypad for transferring. Down from keypad is to download parameters from keypad to drive. Up to keypad takes the parameters from the drive and loads them to the keypad.

Figure 22. Down from keypad

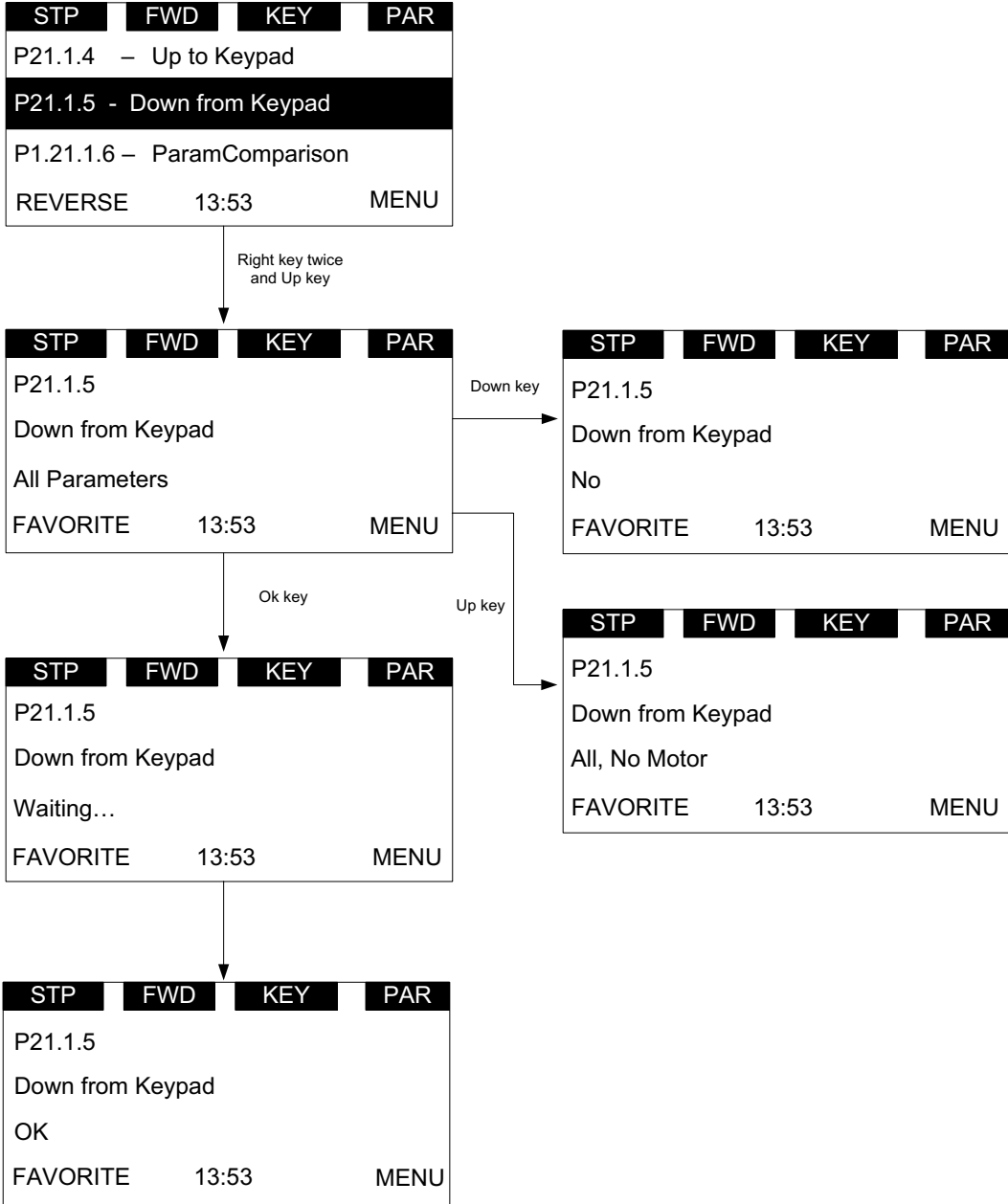

Chapter 3—Menu overview

3. P21.1.6 Parameters Comparison

After the operation, the number of different parameter will be shown. Then press the right key; the first different parameter shall be shown.

The parameter name shall be shown in the second line, and the value which is from keypad/default/set1/set2 shall be shown in the third line, the current value shall be shown in the fourth line.

If the user wants to modify the current value, user shall be able to enter the edit mode by right key.

User shall be able to browse all the different parameters by up/down key.

During this operation, “waiting...” shall flash, which means it is in process.

When it is finished, “OK” shall be shown. See **Figure 23**.

Figure 23. Parameters comparison

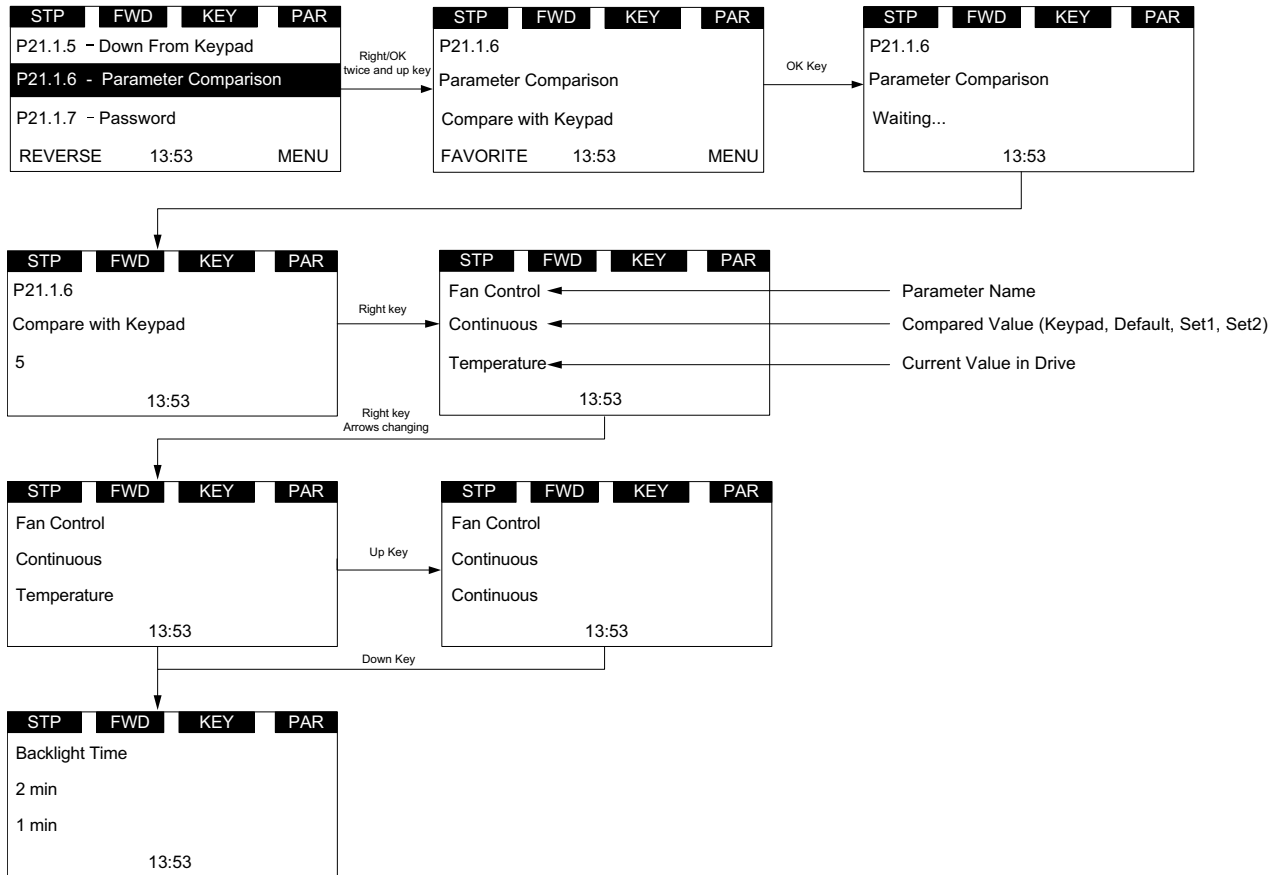

4. P21.1.7 Password

Password protects the parameters' security. Zero means not used, otherwise in use. If password is in use, user can still see the values of parameters, but needs to enter the password before editing. User must enter current password before changing the password.

0000 shall mean that the password is not used, the password is 0000 by default.

The password range shall be 0001–9999, the setting of password and checking of password are as Figure 4-21.

Enter the password setting page. If the password is 0000, then the “Not use” shall be shown. If the password is not 0000, then the “in use” shall be shown.

If the password is in use, and user inputs the wrong password, then the “failed” shall be shown.

After “failed” is shown 3 seconds, the page shall return to the parameter read page.

If the password is in use, and user inputs the right password, then the value shall flash, which indicates that it can be edited.

Figure 24. Password

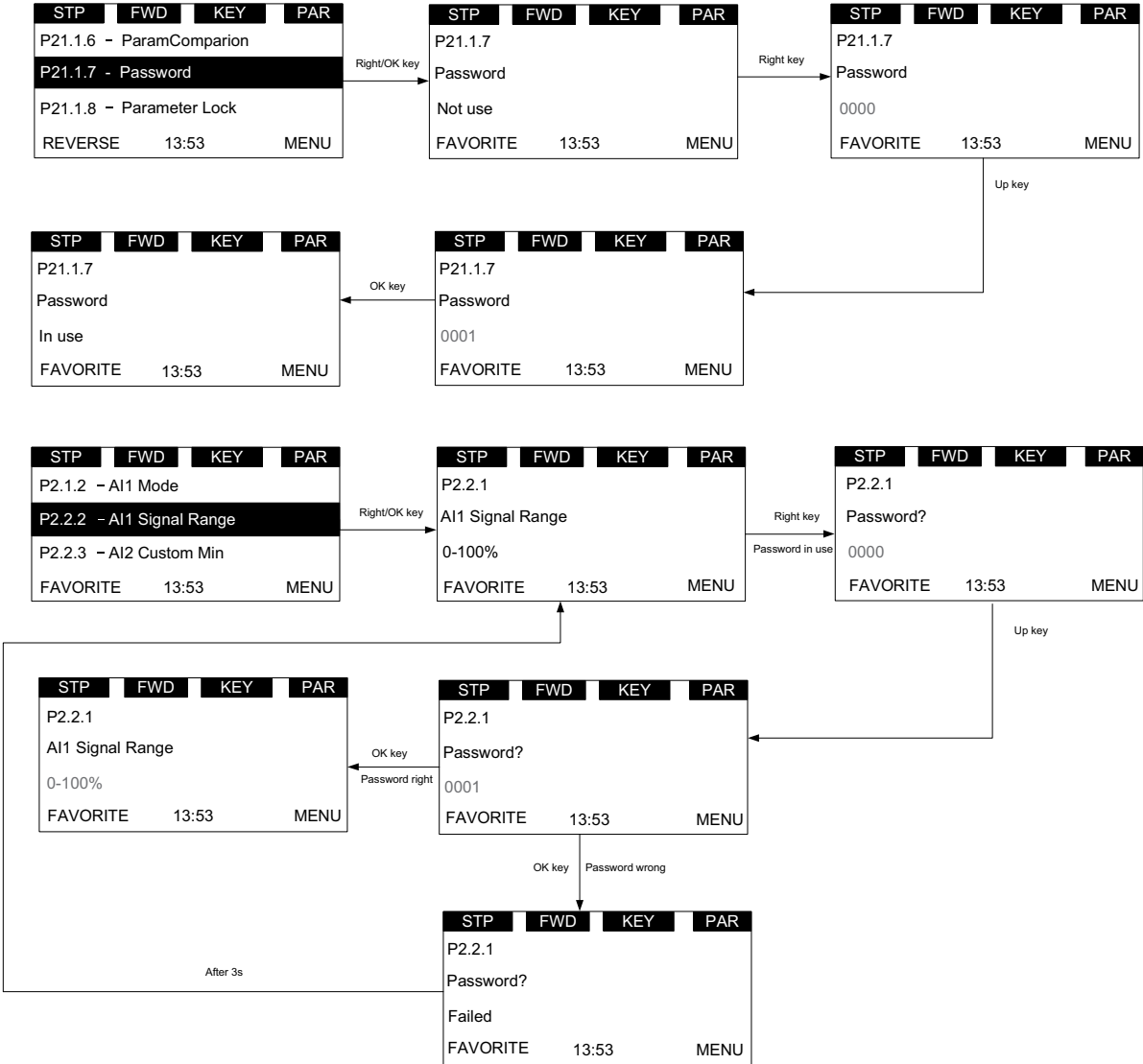

Value edit

This topic shows the methods to edit value, and what will happen to edit value when password is in use and parameter lock is enabled.

We have three methods to edit value: edit by key press-hold, edit bit by bit, edit click by click.

For details, please see **Figure 25**. For the editable parameter, press “Right” key once to enter the read mode (just read the value of this parameter), press “Right” key again to enter the edit mode (user can modify the value of this parameter), press “Right” key again to enter the bit-by-bit edit mode.

User shall use Left/Right key to change the current editable bit. When editing one number, it increases/decreases circularly, for example, pressing Up key can change to 9 from 0.

Figure 25. Edit parameter value

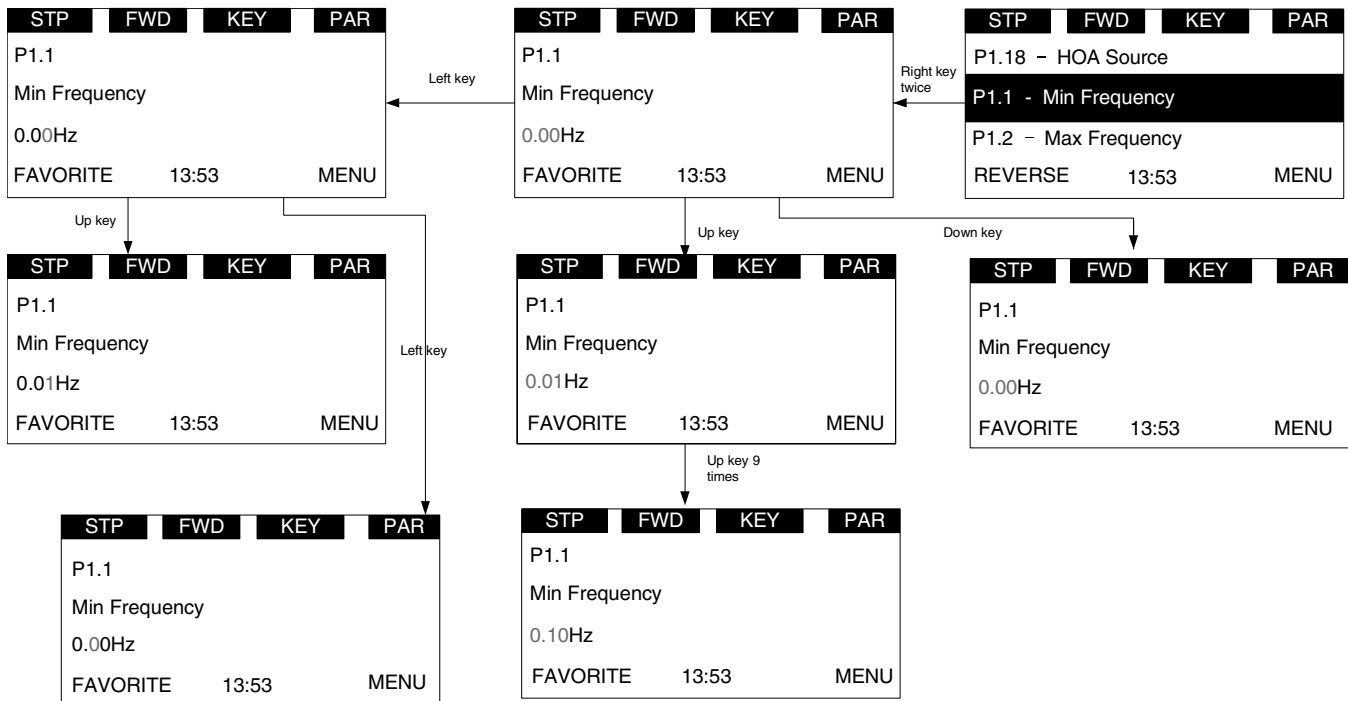

1. If password is in use, password shall be needed to check before edit parameter value.
2. If no action in 1min, the password shall need to be checked again.
3. If Parameter locked is enabled, *Locked* shall be shown if user tries to edit the parameter.

Figure 26. Parameter locked

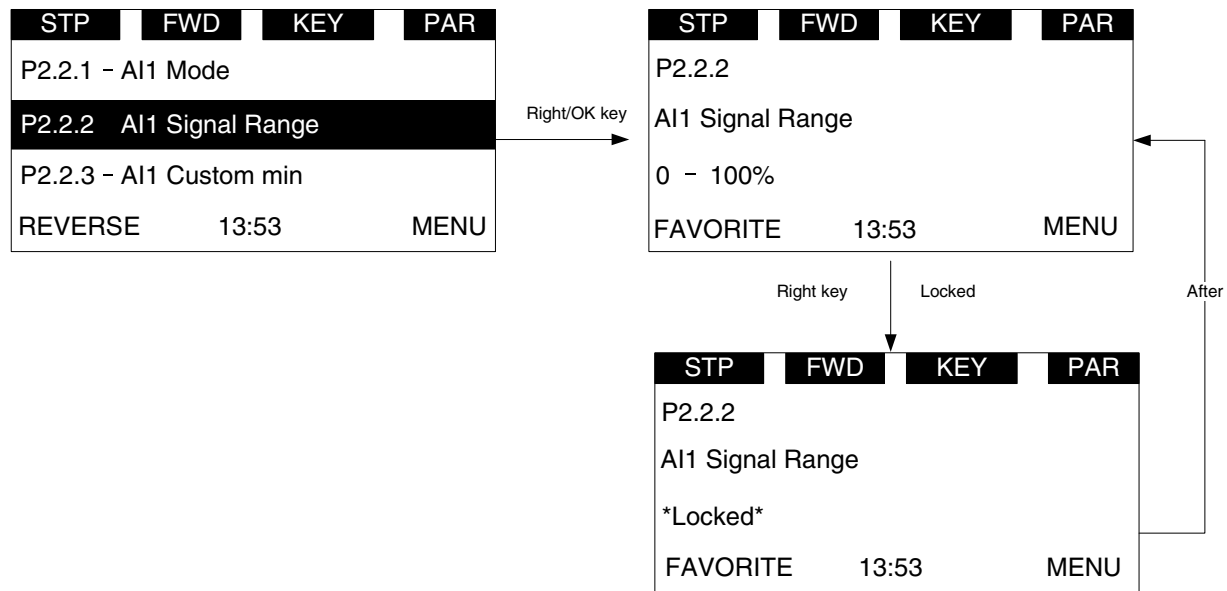

T—Favorite

Favorites collect the user's favorite parameters. User can add one parameter into favorite list by "FAVORITE" soft key, and can delete it from favorite list by "DELETE" soft key.

If a parameter has not been added into the favorite list, the soft keys "FAVORITE" will be shown in parameter page (see **Figure 11** on **Page 12**). If it has been added into the favorite list, the soft key "FAVORITE" will not be shown.

If a parameter has been added to the favorite list, it shall appear in the favorite menu. Then when you enter into the favorite menu, the soft keys "DELETE" will be shown. This allows you to remove the selected parameter from favorite list (see **Figure 12** on **Page 12**).

After one parameter is removed from favorite list, the next parameter in the favorite list will be selected by default.

Chapter 4—Startup

Startup wizard page

The Startup Wizard is a sub-menu of main menu. Once user enters into this menu, the Startup Wizard will begin.

In the Startup Wizard, you will be prompted for essential information needed by the drive so that it can start controlling your motor. During this process, you can also select the application that best suits your needs.

If user changes the Application, the drive and keypad will reset.

Startup wizard

In the *Startup Wizard*, you will be prompted for essential information needed by the drive so that it can start controlling your process. In the Wizard, you will need the following keypad buttons:



Up/Down buttons.
Use these to change value.



OK button.
Confirm selection with this button, and enter into next question.



Back/Reset button.
If this button was pressed at the first question, the Startup Wizard will be cancelled.
If this button is pressed in any step on the Startup Wizard, the Startup Wizard will be cancelled.

Once you have connected power to your Eaton PowerXL frequency converter, and the Startup Wizard is enabled, follow these instructions to easily set up your drive.

Table 16. Startup wizard instructions

Item	Description	
1	Startup Wizard	Press OK?
2	Application	0 = Standard 1 = Multi-Pump 2 = Multi-PID 3 = Multi-Purpose
3	Language	0 = English 1 = 中文 2 = Deutsch
4	Real Time Clock	yy.mm.dd hh:mm:ss
5	Daylight Saving	0 = Off 1 = EU 2 = US
6	Min Frequency	Min: 0.00Hz Max: Max Frequency
7	Max Frequency	Min: Min Frequency Max: 400.00Hz
8	Motor Nom Current	Min: DriveNomCurrCT*1/10 Max: DriveNomCurrCT*2
9	Current Limit	Min: Ih*1/10 Max: Ih*2
10	Motor Nom Speed	Min: 300 Max: 20000

Table 16. Startup wizard instructions, continued

Item	Description	
11	Motor PF	Min: 0.30 Max: 1.0
12	Motor Nom Volt	Min: 180 V Max: 690 V
13	Motor Nom Freq	Min: 30.00 Hz Max: 400.00 Hz
14	Accel Time 1	Min: 0.1 s Max: 3000.0 s
15	Decel Time 1	Min: 0.1 s Max: 3000.0 s
16	Local Control Place	0 = Keypad 1 = I/O terminal Start 1 2 = I/O Terminal Start 2 3 = Fieldbus
17	Local Reference	0 = AI1 1 = AI2 2 = Slot A: AI1 3 = Slot B: AI1 4 = AI1 Joystick 5 = AI2 Joystick 6 = Keypad 7 = Fieldbus Ref 8 = Motor Pot 9 = Max Frequency 10 = AI1 + AI2 11 = AI1 - AI2 12 = AI2 - AI1 13 = AI1 * AI2 14 = AI1 or AI2 15 = MIN(AI1,AI2) 16 = MAX(AI1,AI2) 17 = PID1 Control Output 18 = PID2 Control Output
18	Remote 1 Control Place	0 = Keypad 1 = I/O terminal Start 1 2 = I/O Terminal Start 2 3 = Fieldbus
19	Remote 1 Reference	0 = AI1 1 = AI2 2 = Slot A: AI1 3 = Slot B: AI1 4 = AI1 Joystick 5 = AI2 Joystick 6 = Keypad 7 = Fieldbus Ref 8 = Motor Pot 9 = Max Frequency 10 = AI1 + AI2 11 = AI1 - AI2 12 = AI2 - AI1 13 = AI1 * AI2 14 = AI1 or AI2 15 = MIN(AI1,AI2) 16 = MAX(AI1,AI2) 17 = PID1 Control Output 18 = PID2 Control Output

Now the Startup Wizard is done. It will not show again at the next power up. If you want to reset it, please select it from the main menu ("Startup Wizard").

Application macro Mini-Wizard

Multi-Pump and fan control Mini-Wizard

Table 17. Multi-Pump and fan control

Item	Description	
20	PID 1 Process Unit	Select Units
21	PID1 Process Unit Min	Min: -99999.99 Max: PID1 Process Unit Max
22	PID1 Process Unit Max	Min: Process Unit Min Max: 99999.99
23	PID 1 Set Point 1 Source	Select Function
24	PID 1 Keypad Set Point 1	Min: PID 1 Process Unit Min Max: PID 1 Process Unit Max
25	PID 1 Feedback 1 Source	Select Input
26	PID 1 Feedback 1 Min	Min: -200% Max: 200%
27	PID 1 Feedback 1 Max	Min: -200% Max: 200%
28	Number of Pumps	Min: 1 Max: 5
29	PID Bandwidth	Min: 0% Max: 100%
30	Add/Remove Delay	Min: 0 s Max: 3600 s
31	Interlock Enable	0 = Disabled 1 = Enabled

PID Mini-Wizard

The PID Mini-Wizard is activated in the Quick Setup menu. This Wizard assumes that you are going to use the PID controller in the “one feedback/one setpoint” mode. The control place will be I/O A and the default process unit “%”. The PID Mini-Wizard asks for the following values to be set:

Table 18. PID Mini-Wizard values

Item	Description	
20	PID 1 Process Unit	Select Units
21	PID1 Process Unit Min	Min: -99999.99 Max: PID1 Process Unit Max
22	PID1 Process Unit Max	Min: PID1 Process Unit Min Max: 99999.99
23	PID 1 Set Point 1 Source	Select Function
24	PID 1 Keypad Set Point 1	Min: PID 1 Process Unit Min Max: PID 1 Process Unit Max
25	PID 1 Feedback 1 Source	Select Input
26	PID 1 Feedback 1 Min	Min: -200% Max: 200%
27	PID 1 Feedback 1 Max	Min: -200% Max: 200%

Chapter 5—Standard application

Introduction

The Standard Application is typically used in basic motor control scenarios where multiple pump control, PID loops, or advanced control loops are not required. It provides the ability for the user to define its local and remote control and reference signals. In addition there is the ability to scale the analog input and output signals to be read based off the desired motor response. There are also 8 digital inputs, 3 relay outputs, and 1 digital output that can be programmed to allow for control schemes that require the drive to have certain functions. It provides full customization on the motor control sequence with the ability to be in frequency or speed control mode, and tuning of the V/Hz curve can be selected. Drive/Motor protections can be customized to defined actions for added user control. Below is a list of other features that are available in the Standard Application.

Standard Application includes functions:

- Selectable digital input function
- Selectable digital output function
- Reference filter, scaling, inversion, offset and range
- Output signal filter, scaling, inversion, offset and range
- Selectable analog output function
- Programmable start/stop and reverse signal logic
- Two independent set of Acceleration/Deceleration ramps
- S curves
- Skip frequency
- Start source (Local/Remote control function)
- Reference source
- Flying start
- Jog
- Volts per Hertz control
- Real time clock function—RTC time display
- Drive temperature limit supervision
- Output frequency 1 limit supervision
- Output frequency 2 limit supervision
- Torque limit supervision
- Reference frequency limit supervision
- Power limit supervision
- Analog input limit supervision
- Auto restart
- Power loss ride through
- Trend buffer
- Programmable switching frequency
- Multi-Preset speeds
- Emergency stop
- Line start lockout
- Fan control
- DC brake
- Flux brake
- Dynamic brake
- Motor current limit supervision

I/O controls

- “Terminal To Function” (TTF) Programming

The design behind the programming of the digital inputs in the DG1 drive is to use “Terminal To Function” programming, which is composed of multiple functions that get assigned a digital input to that function. The parameters in the drive are set up with specific functions and by defining the digital input and slot in some cases, depending on which options are available. For use of the drives control board inputs, they will be referred to as DigIN:1 through DigIN:8. When additional option cards are used, they will be defined as DigIN:X:IOY:Z. The X indicates the slot that the card is being installed in, which will be either A or B. The IOY determines the type of card it is, which would be IO1 or IO5. The Z indicates which input is being used on that available option card.

- “Function To Terminal” (FTT) Programming

The design behind the programming of the relay outputs and digital output in the DG1 drive is to use “Function To Terminal” programming. It is composed of a terminal, be it a relay output or a digital output, that is assigned a parameter. Within that parameter, it has different functions that can be set.

Chapter 5—Standard application

The parameters of the Standard Application are explained on **Page 150** of this manual, “Description of Parameters.” The explanations are arranged according to the parameter number.

For the DI function, we use Terminal programming method to function (TTF), where there is a fixed input that gets programmed to a list of functions. This allows for multiple inputs to be used for different functions. Connecting a certain input with a certain parameter function is done by give a parameter an appropriate value. The value is formed by the location of the input, either being on the standard control board or an external option board and the slot it is located in.

Force open/force close selection

The Force Open Selection would make the selected function always off. Essentially this is a virtual switch that is always open.

The Force Close Selection would make the selected function always on. Essentially this is a virtual switch that is always closed.

These options are assigned to a function if we want to force a state without using a hardware input.

Example:

If we set Run Enable to Force Closed the drive is always enabled. If we set the same function to Force Open the drive would never be Enabled. If a Digital input is to be used to activate this Run Enable the function should be assigned to a hardware input(See below for DIGIN Selections).

DIGIN selection

This allows Assignment of a hardware digital input to a function, this is set in a format of DigIN:X where X is one of the 8 Digital inputs on the Main control board.

Example:

If we set Run Enable to DigIN:6 the drive will be enabled when digital input 6 (Terminal 8) is closed, and would not be enabled when digital input 6 (Terminal 8) is open.

Option board digIN selection

This allows Assignment of a hardware digital input on an option card to a function, this is set in a format of DigIN:Y:IO1:X where Y is the slot the option card is inserted on the Main control board and X is the Input on the Board and IO1 is the type of option board used.

Example:

If we set Run Enable to DigIN:A:IO5:6 the drive will be enabled when digital input 6 is closed on the IO5 option card which is inserted in Slot A, and would not be enabled when digital input 6 on the option card is open.

Timer channel selection

A Time Channel is a virtual path to link the digital output of a timer function to a digital input function. To utilize this feature a timer or interval would need to be assigned to a time channel 1 through 3, and the input function to be controlled would need to be assigned to the same time channel.

Example:

If we set Run Enable to DigIN:TimeChannel1 the drive will be enabled when the timer assigned to Time Channel 1 is active or High, and would not be enabled when the Time Channel is inactive or Low.

Control I/O configuration

- Run 240 Vac and 24 Vdc control wiring in separate conduit
- Communication wire to be shielded

Table 19. I/O connection

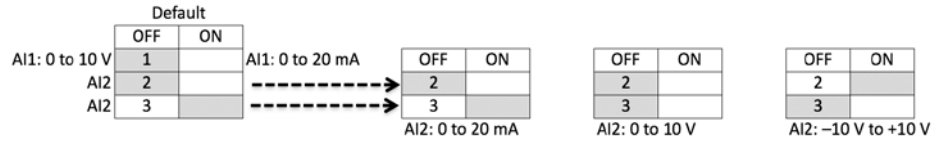

External Wiring	Pin	Signal Name	Signal	Default Setting	Description
	1	+10 V	Ref. Output Voltage	—	10 Vdc Supply Source
	2	AI1+ⓐ	Analog Input 1	0–10 V	Voltage Speed Reference (Programmable to 4 mA to 20 mA)
	3	AI1–	Analog Input 1 Ground	—	Analog Input 1 Common (Ground)
	4	AI2+ⓐ	Analog Input 2	4 mA to 20 mA	Current Speed Reference (Programmable to 0–10 V)
	5	AI2–	Analog Input 2 Ground	—	Analog Input 2 Common (Ground)
	6	GND	I/O Signal Ground	—	I/O Ground for Reference and Control
	7	DIN5	Digital Input 5	Preset Speed B0	Sets frequency output to Preset Speed 1
	8	DIN6	Digital Input 6	Preset Speed B1	Sets frequency output to Preset Speed 2
	9	DIN7	Digital Input 7	Not used (TI–)	Input forces VFD output to shut off
	10	DIN8	Digital Input 8	Force Remote (TI+)	Input takes VFD from Local to Remote
	11	CMB	DI5 to DI8 Common	Grounded	Allows source input
	12	GND	I/O Signal Ground	—	I/O Ground for Reference and Control
	13	24 V	+24 Vdc Output	—	Control voltage output (100 mA max.)
	14	DO1	Digital Output 1	Ready	Shows the drive is ready to run
	15	24 Vo	+24 Vdc Output	—	Control voltage output (100 mA max.)
	16	GND	I/O Signal Ground	—	I/O Ground for Reference and Control
	17	AO1+	Analog Output 1	Output Frequency	Shows Output frequency to motor 0–60 Hz (4 mA to 20 mA)
	18	AO2+	Analog Output 2	Motor Current	Shows Motor current of motor 0–FLA (4 mA to 20 mA)
	19	24 Vi	+24 Vdc Input	—	External control voltage input
	20	DIN1	Digital Input 1	Run Forward	Input starts drive in forward direction (start enable)
	21	DIN2	Digital Input 2	Run Reverse	Input starts drive in reverse direction (start enable)
	22	DIN3	Digital Input 3	External Fault	Input causes drive to fault
	23	DIN4	Digital Input 4	Fault Reset	Input resets active faults
	24	CMA	DI1 to DI4 Common	Grounded	Allows source input
	25	A/+	RS-485 Signal A	—	Fieldbus Communication (Modbus, BACnet)
	26	B/-	RS-485 Signal B	—	Fieldbus Communication (Modbus, BACnet)
	27	R3NO	Relay 3 Normally Open	At Speed	Relay output 3 shows VFD is at Ref. Frequency
	28	R1NC	Relay 1 Normally Closed	Run	Relay output 1 shows VFD is in a run state
	29	R1CM	Relay 1 Common		
	30	R1NO	Relay 1 Normally Open		
	31	R3CM	Relay 3 Common	At Speed	Relay output 3 shows VFD is at Ref. Frequency
	32	R2NC	Relay 2 Normally Closed	Fault	Relay output 2 shows VFD is in a fault state
	33	R2CM	Relay 2 Common		
	34	R2NO	Relay 2 Normally Open		

Notes: The above wiring demonstrates a SINK configuration. It is important that CMA and CMB are wired to ground (as shown by dashed line). If a SOURCE configuration is desired, wire 24 V to CMA and CMB and close the inputs to ground. When using the +10 V for AI1, it is important to wire AI1— to ground (as shown by dashed line). If using +10 V for AI1 or AI2, terminals 3, 5, and 6 need to be jumpered together.
 ⓐ AI1+ and AI2+ Support 10K potentiometer.

Table 20. Drive communication ports

Port	Communication
RJ45 Keypad Port	
Upload/Download Parameters	USB to RJ45
Remote Mount Keypad	Ethernet
Upgrade Drive Firmware	USB to RJ45
RJ45 Ethernet Port	
Upload/Download Parameters	Ethernet
Ethernet IP Communications	Ethernet
Modbus TCP Communications	Ethernet
RS-485 Serial Port ①	
Upload/Download Parameters	Two-Wire Twisted Pair
Upgrade Drive Firmware	Two-Wire Twisted Pair
Modbus RTU Communications	Two-Wire Twisted Pair
BACnet MS/TP Communications	Two-Wire Twisted Pair

① Shielded wire recommended.

Standard application—parameters list

On the next pages you will find the lists of parameters within the respective parameter groups. The parameter descriptions are given on **Page 150**, “Description of Parameters.” The descriptions are arranged according to the parameter number.

Column explanations:

Code = Location indication on the keypad; shows the operator the present parameter number

Parameter = Name of parameter

Min = Minimum value of parameter

Max = Maximum value of parameter

Unit = Unit of parameter value; given if available

Default = Value preset by factory

ID = ID number of the parameter

Table 21. Monitor—M

Code	Parameter	Min.	Max.	Unit	Default	ID	Note
M1	Output Frequency			Hz	0.00	1	
M2	Freq Reference			Hz	0.00	24	
M3	Motor Speed			rpm	0	2	
M4	Motor Current			A	0.0	3	
M5	Motor Torque			%	0.0	4	
M6	Motor Power			%	0.0	5	
M7	Motor Voltage			V	0.0	6	
M8	DC-link Voltage			V	0	7	
M9	Unit Temperature			°C	0.0	8	
M10	Motor Temperature			%	0.0	9	
M12	Analog Input 1			Varies	0.00	10	
M13	Analog Input 2			Varies	0.00	11	
M14	Analog Output 1			Varies	0.00	25	
M15	Analog Output 2			Varies	0.00	575	
M16	DI1, DI2, DI3				0	12	
M17	DI4, DI5, DI6				0	13	
M18	DI7, DI8				0	576	
M19	DO1, Virtual RO1, Virtual RO2				0	14	
M20	RO1, RO2, RO3				0	557	
M41	PT100 Temperature			°C	1000.0	27	
M42	Last Active Fault				0	28	See Fault Codes on Page 223 in Appendix B
M43	RTC Battery Status					583	0 = Not Installed 1 = Installed 2 = Change Battery 3 = Over Voltage
M44	Instant Motor Power			kW	0.000	1686	
M45	Energy Savings			Varies	0	2120	

Table 21. Monitor—M, continued

Code	Parameter	Min.	Max.	Unit	Default	ID	Note
M46	Control board DIDO Status				0	2209	Bit 0 = DIN1 Status Bit 1 = DIN2 Status Bit 2 = DIN3 Status Bit 3 = DIN4 Status Bit 4 = DIN5 Status Bit 5 = DIN6 Status Bit 6 = DIN7 Status Bit 7 = DIN8 Status Bit 8 = DO1 Status Bit 9 = RO1 Status Bit 10 = RO2 Status Bit 11 = RO3 Status Bit 12 = Slot A with Board Bit 13 = Slot B with Board Bit 14 -15 = Not used
M47	SlotA DIDO Status				0	2210	Bit 0 = IO1_DIN1 Status Bit 1 = IO1_DIN2 Status Bit 2 = IO1_DIN3 Status Bit 3 = IO1_DO1 Status Bit 4 = IO1_DO2 Status Bit 5 = IO1_DO3 Status Bite 6 = IO3_RO1 Status Bit 7 = IO3_RO2 Status Bit 8 = IO3_RO3 Status Bit 9 = IO5_AC1 Status Bit 10 = IO5_AC2 Status Bit 11 = IO5_AC3 Status Bit 12 = IO5_AC4 Status Bit 13 = IO5_AC5 Status Bit 14 = IO5_AC6 Status Bit 15 = Not Used
M48	SlotB DIDO Status				0	2211	Bit 0 = IO1_DIN1 Status Bit 1 = IO1_DIN2 Status Bit 2 = IO1_DIN3 Status Bit 3 = IO1_DO1 Status Bit 4 = IO1_DO2 Status Bit 5 = IO1_DO3 Status Bite 6 = IO3_RO1 Status Bit 7 = IO3_RO2 Status Bit 8 = IO3_RO3 Status Bit 9 = IO5_AC1 Status Bit 10 = IO5_AC2 Status Bit 11 = IO5_AC3 Status Bit 12 = IO5_AC4 Status Bit 13 = IO5_AC5 Status Bit 14 = IO5_AC6 Status Bit 15 = Not Used

Table 21. Monitor—M, continued

Code	Parameter	Min.	Max.	Unit	Default	ID	Note
M49	App Status Word				0	29	Bit 0 = MC Ready Bit 1 = MC_Run Bit 2 = MC_Fault Bit 3 = FB_Ref_Active Bit 4 = MC_Stopping Bit 5 = MC_Reverse Bit 6 = MC_Warning/AR-Fault Bit 7 = MC_ZeroSpeed Bit 8 = I/O Control Indicate Bit 9 = Panel Control Indicator Bit 10 = Panel Fieldbus Indicator Bit 11 = MC_DC_Brake Bit 12 = RunEnable Bit 13 = Run Bypass Bit 14 = Ext Brake Control Bit 15 = Bypass Mode
M50	Standard Status Word				0	2414	Bit 0 = P20.1.9 (default = Ready) Bit 1 = P20.1.10 (default = Run) Bit 2 = P20.1.11 (default = Fault) Bit 3 = P20.1.12 (default = Fault Invert) Bit 4 = P20.1.13 (default = Warning) Bit 5 = P20.1.14 (default = Reversed) Bit 6 = P20.1.15 (default = At Speed) Bit 7 = P20.1.16 (default = Zero Frequency) Bit 8 - 15 = Not Used
M51	Output				0	2445	
M52	Reference				0	2447	
M53	Total MWh Count				Varies	601	
M54	Total Power Day Count				Varies	603	
M55	Total Power Hr Count				Varies	606	
M56	Trip MWh Count				Varies	604	
M57	Trip Power Day Count				Varies	636	
M58	Trip Power Hr Count				Varies	637	
M59	Multi-Monitoring				1, 2, 3	30	

Table 22. Operate mode—O

Code	Parameter	Min.	Max.	Unit	Default	ID	Note
O1	Output Frequency			Hz	0.00	1	
O2	Freq Reference			Hz	0.00	24	
O3	Motor Speed			rpm	0	2	
O4	Motor Current			A	0.0	3	
O5	Motor Torque			%	0.0	4	
O6	Motor Power			%	0.0	5	
O7	Motor Voltage			V	0.0	6	
O8	DC-link Voltage			V	0	7	
O9	Unit Temperature			°C	0.0	8	
O10	Motor Temperature			%	0.0	9	
R12 ②	Keypad Reference	Par. P1.1	Par. P1.2	Hz	0.00	141	

Notes: ① Parameter value can only be changed after the drive has stopped.

② Parameter value will be set to be default when changing macros.

Chapter 5—Standard application

Table 23. Basic parameters—P1

Code	Parameter	Min.	Max.	Unit	Default	ID	Note
P1.1 ①②	Min Frequency	0.00	See Para ID 102	Hz	0.00	101	
P1.2 ①②③	Max Frequency	See Para ID 101	400.00/320.00	Hz	60.00	102	
P1.3 ②	Accel Time 1	0.1	3000.0	s	3.0	103	
P1.4 ②	Decel Time 1	0.1	3000.0	s	3.0	104	
P1.5 ①	Motor Nom Current	Drive Nom CT*1/10	Drive Nom CT*2	A	Drive Nom CT	486	
P1.6 ①③	Motor Nom Speed	300	20000/19200	rpm	Motor Nom Speed	489	
P1.7 ①	Motor PF	0.30	1.00		0.85	490	
P1.8 ①	Motor Nom Voltage	180	690	V	Motor Nom Voltage	487	
P1.9 ①③	Motor Nom Frequency	8.00	400.00/320.00	Hz	Motor Nom Freq	488	
P1.10 ②	Power Up Local Remote Select				0	1685	0 = Hold Last 1 = Local Control 2 = Remote Control
P1.11 ②	Remote1 Control Place				0	135	0 = I/O Terminal Start 1 1 = Fieldbus 2 = I/O Terminal Start 2 3 = Keypad
P1.12 ②	Local Control Place				0	1695	0 = Keypad 1 = I/O Terminal Start 1 2 = I/O Terminal Start 2 3 = Fieldbus
P1.13 ②	Bumpless Enable				0	2462	0 = Disabled 1 = Enabled
P1.14 ①②	Local Reference				6	136	0 = AI1 1 = AI2 2 = Slot A: AI1 3 = Slot B: AI1 4 = AI1 Joystick 5 = AI2 Joystick 6 = Keypad 7 = Fieldbus Ref 9 = Max Frequency 10 = AI1 + AI2 11 = AI1–AI2 12 = AI2–AI1 13 = AI1 * AI2 14 = AI1 or AI2 15 = Min (AI1, AI2) 16 = MAX(AI1,AI2)
P1.15 ①②	Remote1 Reference				1	137	See Para ID 136
P1.16 ①	Reverse Enable				1	1679	0 = Disabled 1 = Enabled
P1.17 ②	Run Delay Time	0	32500	s	0	2423	
P1.18 ②	HOA Source	0	2		0	2465	0 = Disable 1 = I/O Terminal 2 = Keypad

Notes: ① Parameter value can only be changed after the drive has stopped.
 ② Parameter value will be set to be default when changing macros.
 ③ DG1 Frame 1-6/DG1 Frame 7-8.

Table 24. Analog input—P2

Code	Parameter	Min.	Max.	Unit	Default	ID	Note
P2.1.1	AI Ref Scale Min Value	0.00	See Para ID 145	Hz	0	144	
P2.1.2	AI Ref Scale Max Value	See Para ID 144	400.00	Hz	0	145	
P2.2.1 ②	AI1 Mode	0	1		1	222	0 = 0–20 mA 1 = 0–10 V
P2.2.2 ②	AI1 Signal Range	0	2		0	175	0 = 0–100% / 0–20 mA / 0–10 V 1 = 20–100% / 4–20 mA / 2–10 V 2 = Customized
P2.2.3 ②	AI1 Custom Min	0.00	See Para ID 177	%	0.00	176	
P2.2.4 ②	AI1 Custom Max	See Para ID 176	100.00	%	100.00	177	
P2.2.5 ②	AI1 Filter Time	0.00	10.00	s	0.10	174	
P2.2.6 ②	AI1 Signal Invert	0	1		0.00	181	0 = Not Inverted 1 = Inverted
P2.2.7 ②	AI1 Joystick Hyst	0.00	20.00	%	0.00	178	
P2.2.8 ②	AI1 Sleep Limit	0.00	100.00	%	0.00	179	
P2.2.9 ②	AI1 Sleep Delay	0.00	320.00	s	0.00	180	
P2.2.10 ②	AI1 Joystick Offset	–50.00	50.00	%	0.00	133	
P2.3.1 ②	AI2 Mode	0	2		1	223	0 = 0–20 mA 1 = 0–10 V 2 = –10 to +10 V
P2.3.2 ②	AI2 Signal Range	0	2		0	183	0 = 0–100% / 0–20 mA / 0–10 V 1 = 20–100% / 4–20 mA / 2–10 V 2 = Customized
P2.3.3 ②	AI2 Custom Min	0.00	See Para ID 185	%	0.00	184	
P2.3.4 ②	AI2 Custom Max	See Para ID 184	100.00	%	100.00	185	
P2.3.5 ②	AI2 Filter Time	0.00	10.00	s	0.10	182	
P2.3.6 ②	AI2 Signal Invert	0	1		0.00	189	"0 = Not Inverted 1 = Inverted"
P2.3.7 ②	AI2 Joystick Hyst	0.00	20.00	%	0.00	186	
P2.3.8 ②	AI2 Sleep Limit	0.00	100.00	%	0.00	187	
P2.3.9 ②	AI2 Sleep Delay	0.00	320.00	s	0.00	188	
P2.3.10 ②	AI2 Joystick Offset	–50.00	50.00	%	0.00	134	
P2.4.1 ②	Fine Tuning Input	0	5		0	2484	0 = Not Used 1 = AI1 2 = AI2 3 = Slot A: AI1 4 = Slot A: AI1 5 = Fieldbus
P2.4.2 ②	Fine Tuning Min	0.00	100.00	%	0.00	2485	
P2.4.3 ②	Fine Tuning Max	0.00	100.00	%	0.00	2486	

Notes: ① Parameter value can only be changed after the drive has stopped.

② Parameter value will be set to be default when changing macros.

Chapter 5—Standard application

Table 25. Digital input—P3

Code	Parameter	Min.	Max.	Unit	Default	ID	Note
P3.1 ①②	IO Terminal 1Start/Stop Logic				0	143	0 = Forward–Reverse 1 = Start–Reverse 2 = Start–Enable 3 = Start Pulse–Stop Pulse
P3.2 ②⑤	IO Terminal 1Start Signal 1				2	190	0 = DigIN:ForceOpen 1 = DigIN:ForceClose 2 = DigIN: 1 3 = DigIN: 2 4 = DigIN: 3 5 = DigIN: 4 6 = DigIN: 5 7 = DigIN: 6 8 = DigIN: 7 9 = DigIN: 8 10 = DigIN: A: IO1: 1 11 = DigIN: A: IO1: 2 12 = DigIN: A: IO1: 3 13 = DigIN: A: IO5: 1 14 = DigIN: A: IO5: 2 15 = DigIN: A: IO5: 3 16 = DigIN: A: IO5: 4 17 = DigIN: A: IO5: 5 18 = DigIN: A: IO5: 6 19 = DigIN: B: IO1: 1 20 = DigIN: B: IO1: 2 21 = DigIN: B: IO1: 3 22 = DigIN: B: IO5: 1 23 = DigIN: B: IO5: 2 24 = DigIN: B: IO5: 3 25 = DigIN: B: IO5: 4 26 = DigIN: B: IO5: 5 27 = DigIN: B: IO5: 6 28 = Time Channel 1 29 = Time Channel 2 30 = Time Channel 3 31 = RO1 Function 32 = RO2 Function 33 = RO3 Function 34 = Virtual RO1 Function 35 = Virtual RO2 Function
P3.3 ②⑤	IO Terminal 1Start Signal 2				3	191	See Para ID 190
P3.4 ①②	Thermistor Input Select				0	881	0 = Digital Input 1 = Thermistor Input
P3.5 ②③	Reverse				0	198	See Para ID 190
P3.6 ②③	Ext. Fault 1 NO				4	192	See Para ID 190
P3.7 ②③	Ext. Fault 1 NC				1	193	See Para ID 190
P3.8 ②④	Fault Reset				5	200	See Para ID 190

- Notes:**
- ① Parameter value can only be changed after the drive has stopped.
 - ② Parameter value will be set to be default when changing macros.
 - ③ Input function is Level sensed
 - ④ Input function is edge sensed
 - ⑤ Input function is edge sensed when using StartP/StopP start logic Para ID 143 and 2206

Table 25. Digital input—P3, continued

Code	Parameter	Min.	Max.	Unit	Default	ID	Note
P3.9 ②③	Run Enable				1	194	See Para ID 190
P3.10 ②③	Preset Speed B0				6	205	See Para ID 190
P3.11 ②③	Preset Speed B1				7	206	See Para ID 190
P3.12 ②③	Preset Speed B2				0	207	See Para ID 190
P3.15 ②③	Accel/Decel Time Set				0	195	See Para ID 190
P3.16 ②③	Accel/Decel Prohibit				0	201	See Para ID 190
P3.17 ②④	No Access To Param				0	215	See Para ID 190
P3.21 ②③	Remote Control				9	196	See Para ID 190
P3.22 ②③	Local Control				0	197	See Para ID 190
P3.23 ②③	Remote1/2 Select				0	209	See Para ID 190
P3.26 ②③	DC Brake Enable				0	202	See Para ID 190
P3.32 ②③	Jog Enable				0	199	See Para ID 190
P3.36 ②③	AI Ref Source Select				0	208	See Para ID 190
P3.42 ②③	Emergency Stop				1	747	See Para ID 190
P3.45 ①②	IO Terminal 2 Start Stop Logic				0	2206	See Para ID 143
P3.46 ②⑤	IO Terminal 2 Start Signal 1				2	2207	See Para ID 190
P3.47 ②⑤	IO Terminal 2 Start Signal 2				3	2208	See Para ID 190
P3.48 ②③	Ext. Fault 2 NO				0	2293	See Para ID 190
P3.49 ②③	Ext. Fault 2 NC				1	2294	See Para ID 190
P3.50 ②③	Ext. Fault 3 NO				0	2295	See Para ID 190
P3.51 ②③	Ext. Fault 3 NC				1	2296	See Para ID 190
P3.52 ②	Ext. Fault 1 Text				0	2297	0 = External Fault 1 = Vibration Cut out 2 = High Motor temp 3 = Low Pressure 4 = High Pressure 5 = Low Water 6 = Damper Interlock 7 = Run Enable 8 = Freeze Stat Trip 9 = Smoke Detect 10 = Seal Leakage 11 = Rod Breakage
P3.53 ②	Ext. Fault 2 Text				1	2298	0 = External Fault 1 = Vibration Cut out 2 = High Motor temp 3 = Low Pressure 4 = High Pressure 5 = Low Water 6 = Damper Interlock 7 = Run Enable 8 = Freeze Stat Trip 9 = Smoke Detect 10 = Seal Leakage 11 = Rod Breakage

Notes: ① Parameter value can only be changed after the drive has stopped.
 ② Parameter value will be set to be default when changing macros.
 ③ Input function is Level sensed
 ④ Input function is edge sensed
 ⑤ Input function is edge sensed when using StartP/StopP start logic See Para ID 143 and 2206

Table 25. Digital input—P3, continued

Code	Parameter	Min.	Max.	Unit	Default	ID	Note
P3.54 ②	Ext. Fault 3 Text				2	2299	0 = External Fault 1 = Vibration Cut out 2 = High Motor temp 3 = Low Pressure 4 = High Pressure 5 = Low Water 6 = Damper Interlock 7 = Run Enable 8 = Freeze Stat Trip 9 = Smoke Detect 10 = Seal Leakage 11 = Rod Breakage
P3.55 ②④	Parameter Set1/2 Sel				0	2312	See Para ID 190
P3.56 ②④	Deragging Enable				0	2394	See Para ID 190
P3.57 ②③	Off Control				0	2395	See Para ID 190

Table 26. Analog output—P4

Code	Parameter	Min.	Max.	Unit	Default	ID	Note
P4.1 ②	A01 Mode				0	227	0 = 0–20 mA 1 = 0–10 V
P4.2 ②	A01 Function				1	146	0 = Not Used 1 = Output Frequency 2 = Freq Reference 3 = Motor Speed 4 = Motor Current 5 = Motor Torque (0–Nom) 6 = Motor Power 7 = Motor Voltage 8 = DC-Bus Voltage 19 = AI1 20 = AI2 21 = Output Freq (–2 to +2N) 22 = Motor Torque (–2 to +2N) 23 = Motor Power (–2 to +2N) 24 = PT100 Temperature 25 = FB Data Input 1 26 = FB Data Input 2 27 = FB Data Input 3 28 = FB Data Input 4 29 = FB Data Input 5 30 = FB Data Input 6 31 = FB Data Input 7 32 = FB Data Input 8 33 = SlotA PT100 Temp Channel 1 34 = SlotA PT100 Temp Channel 2

- Notes:** ① Parameter value can only be changed after the drive has stopped.
 ② Parameter value will be set to be default when changing macros.
 ③ Input function is Level sensed
 ④ Input function is edge sensed
 ⑤ Input function is edge sensed when using StartP/StopP start logic See Para ID 143 and 2206

Table 26. Analog output—P4, continued

Code	Parameter	Min.	Max.	Unit	Default	ID	Note
							35 = SlotA PT100 Temp Channel 3 36 = SlotB PT100 Temp Channel 1 37 = SlotB PT100 Temp Channel 2 38 = SlotB PT100 Temp Channel 3 39 = User Defined Output 40 = Motor Current(-2 to +2N)
P4.3 ②	A01 Minimum				1	149	0 = 0 V / 0 mA 1 = 2 V / 4 mA
P4.4 ②	A01 Filter Time	0.00	10.00	s	1.00	147	
P4.5 ②	A01 Scale	10	1000	%	100	150	
P4.6 ②	A01 Inversion				0	148	0 = Not Inverted 1 = Inverted
P4.7 ②	A01 Offset	-100.00	100.00	%	0.00	173	
P4.8 ②	A02 Mode				0	228	See Para ID 227
P4.9 ②	A02 Function				4	229	See Para ID 146
P4.10 ②	A02 Minimum				1	232	See Para ID 149
P4.11 ②	A02 Filter Time	0.00	10.00	s	1.00	230	
P4.12 ②	A02 Scale	10	1000	%	100	233	
P4.13 ②	A02 Inversion				0	231	See Para ID 148
P4.14 ②	A02 Offset	-100.00	100.00	%	0.00	234	

- Notes:** ① Parameter value can only be changed after the drive has stopped.
 ② Parameter value will be set to be default when changing macros.
 ③ Input function is Level sensed
 ④ Input function is edge sensed
 ⑤ Input function is edge sensed when using StartP/StopP start logic P3.1 and P3.45

Table 27. Digital output—P5

Code	Parameter	Min.	Min.	Unit	Default	ID	Note
P5.1 ①	D01 Function				1	151	0 = Not Used 1 = Ready 2 = Run 3 = Fault 4 = Fault Invert 5 = Warning 6 = Reversed 7 = At Speed 8 = Zero Frequency 9 = Freq Limit 1 Superv 10 = Freq Limit 2 Superv 13 = Overheat Fault 14 = Overcurrent Regular 15 = Overvoltage Regular 16 = Undervoltage Regular 17 = 4 mA Ref Fault/Warning 20 = Torq Limit Superv 21 = Ref Limit Superv 22 = Control from I/O 23 = Un-Requested Rotation Direction 24 = Thermistor Fault Output 27 = Ext Fault/Warning 28 = Remote Control 29 = Jog Speed Select 30 = Motor Therm Protection 31 = FB Digital Input 1 32 = FB Digital Input 2 33 = FB Digital Input 3 34 = FB Digital Input 4 36 = TC1 Status 37 = TC2 Status 38 = TC3 Status 39 = In E-Stop 40 = Power Limit Superv 41 = Temp Limit Superv 42 = Analog Input Superv 51 = Motor Current 1 Supv 52 = Motor Current 2 Supv 53 = Second AI Limit Supv 54 = DC Charge Switch Close 55 = Preheat Active 56 = Cold Weather Active ② 58 = 2 th Stage Ramp Frequency Active 59 = STO Fault 60 = Run Bypass/Drive 61 = Bypass Overload
P5.2 ①	R01 Function				2	152	See Para ID 151
P5.3 ①	R02 Function				3	153	See Para ID 151
P5.4 ①	R03 Function				7	538	See Para ID 151
P5.5 ①	Virtual R01 Function				0	2463	See Para ID 151
P5.6 ①	Virtual R02 Function				0	2464	See Para ID 151

Notes: ① Parameter value can only be changed after the drive has stopped.
 ② Parameter value will be set to be default when changing macros.
 ③ Function is not available in FR7 and FR8 of DG1 drives.

Table 27. Digital output—P5, continued

Code	Parameter	Min.	Max.	Unit	Default	ID	Note
P5.7 ②	Freq Limit 1 Supv				0	154	0 = No Limit 1 = Low Limit Superv 2 = High Limit Superv
P5.8 ②	Freq Limit 1 Supv Val	0.00	See Para ID 102	Hz	0.00	155	
P5.9 ②	Freq Limit 2 Supv				0	157	0 = No Limit 1 = Low Limit Superv 2 = High Limit Superv
P5.10 ②	Freq Limit 2 Supv Val	0.00	See Para ID 102	Hz	0.00	158	
P5.11 ②	Torque Limit Supv				0	159	0 = No Limit 1 = Low Limit Superv 2 = High Limit Superv
P5.12 ②	Torque Limit Supv Val	-1000.0	1000.0	%	100.0	160	
P5.13 ②	Ref Limit Supv				0	161	0 = No Limit 1 = Low Limit Superv 2 = High Limit Superv
P5.14 ②	Ref Limit Supv Val	0.00	See Para ID 102	Hz	0.00	162	
P5.17 ②	Temp Limit Supv				0	165	See Para ID 161
P5.18 ②	Temp Limit Supv Val	-10.0	75.0	°C	40.0	166	
P5.19 ②	Power Limit Supv				0	167	See Para ID 161
P5.20 ②	Power Limit Supv Val	0.0	200.0	%	0.0	168	
P5.21 ②	AI Supv Select				0	170	0 = AI1 1 = AI2
P5.22 ②	AI Limit Supv				0	171	See Para ID 161
P5.23 ②	AI Limit Supv Val	0.00	100.00	%	0.00	172	
P5.32 ②	R01 On Delay	0	320	s	0	2112	
P5.33 ②	R01 Off Delay	0	320	s	0	2113	
P5.34 ②	R02 On Delay	0	320	s	0	2114	
P5.35 ②	R02 Off Delay	0	320	s	0	2115	
P5.36 ②	R03 On Delay	0	320	s	0	2116	
P5.37 ②	R03 Off Delay	0	320	s	0	2117	
P5.38 ②	R03 Reverse				0	2118	0 = No 1 = Yes
P5.39 ②	Motor Current 1 Supv				0	2189	0 = No Limit 1 = Low Limit Superv 2 = High Limit Superv
P5.40 ②	Motor Current 1 Supv Value	0	DriveNomCurrCT*2	A	DriveNomCurrCT	2190	
P5.41 ②	Motor Current 2 Supv				0	2191	0 = No Limit 1 = Low Limit Superv 2 = High Limit Superv
P5.42 ②	Motor Current 2 Supv Value	0	DriveNomCurrCT*2	A	DriveNomCurrCT	2192	
P5.43 ②	Second AI Supv Select				0	2193	0 = AI1 1 = AI2
P5.44 ②	Second AI Limit Supv				0	2194	See Para ID 161

Notes: ① Parameter value can only be changed after the drive has stopped.
② Parameter value will be set to be default when changing macros.

Table 27. Digital output—P5, continued

Code	Parameter	Min.	Max.	Unit	Default	ID	Note
P5.45 ②	Second AI Limit Supv Val	0	100	%	0	2195	
P5.46 ②	Motor Current 1 Supv Hyst	0.1	1	A	0.1	2196	
P5.47 ②	Motor Current 2 Supv Hyst	0.1	1	A	0.1	2197	
P5.48 ②	AI Supv Hyst	1	10	%	1	2198	
P5.49 ②	Second AI Supv Hyst	1	10	%	1	2199	
P5.50 ②	Freq Limit 1 Supv Hyst	0.1	1	Hz	0.1	2200	
P5.51 ②	Freq Limit 2 Supv Hyst	0.1	1	Hz	0.1	2201	
P5.52 ②	Torque Limit Supv Hyst	1	5	%	1	2202	
P5.53 ②	Ref Limit Supv Hyst	0.1	1	Hz	0.1	2203	
P5.54 ②	Temp Limit Supv Hyst	1	10	?	1	2204	
P5.55 ②	Power Limit Supv Hyst	0.1	10	%	0.1	2205	

Table 28. Drive control—P7

Code	Parameter	Min.	Min.	Unit	Default	ID	Note
P7.1 ②	Remote 2 Control Place				1	138	See Para ID 135
P7.2 ①②	Remote 2 Reference				7	139	See Para ID 136
P7.3 ②	Keypad Reference	See Para ID 101	See Para ID 102	Hz	0.00	141	
P7.4 ②	Keypad Direction				0	116	0 = Forward 1 = Reverse
P7.5 ②	Keypad Stop				1	114	0 = Enabled-Keypad Operation 1 = Always Enabled
P7.6 ②	Jog Reference	See Para ID 101	See Para ID 102	Hz	0.00	117	
P7.9 ②	Start Mode				0	252	0 = Ramp 1 = Flying Start
P7.10 ②	Stop Mode				1	253	0 = Coasting 1 = Ramp
P7.11 ②	Ramp 1 Shape	0.0	10.0	s	0.0	247	
P7.12 ②	Ramp 2 Shape	0.0	10.0	s	0.0	248	
P7.13 ②	Accel Time 2	0.1	3000.0	s	10.0	249	
P7.14 ②	Decel Time 2	0.1	3000.0	s	10.0	250	
P7.15 ②	Skip F1 Low Limit	0.00	See Para ID 257	Hz	0.00	256	
P7.16 ②③	Skip F1 High Limit	See Para ID 256	400.00/320.00	Hz	0.00	257	
P7.17 ②	Skip F2 Low Limit	0.00	See Para ID 259	Hz	0.00	258	
P7.18 ②③	Skip F2 High Limit	See Para ID 258	400.00/320.00	Hz	0.00	259	
P7.19 ②	Skip F3 Low Limit	0.00	See Para ID 260	Hz	0.00	260	
P7.20 ②③	Skip F3 High Limit	See Para ID 260	400.00/320.00	Hz	0.00	261	
P7.21 ②	Prohibit Accel/Decel Ramp	0.1	10.0		1.0	264	
P7.22 ②④	Power Loss Function				0	267	0 = Disabled 1 = Enabled
P7.23 ②④	Power Loss Time	0.3	5.0	s	2.0	268	

Notes: ① Parameter value can only be changed after the drive has stopped.
 ② Parameter value will be set to be default when changing macros.
 ③ Function is not available in FR7 and FR8 of DG1 drives.
 ④ DG1 Frame 1-6/DG1 Frame 7-8.

Table 28. Drive control—P7, continued

Code	Parameter	Min.	Max.	Unit	Default	ID	Note
P7.24 ②	Currency				\$	2122	0 = \$ 1 = GBP 2 = Eur 3 = JPY 4 = Rs 5 = R\$ 6 = Fr 7 = Kr
P7.25 ②	Energy Cost			Varies	0	2123	
P7.26 ②	Data Type				0	2124	0 = Cumulative 1 = Daily Avg 2 = Weekly Avg 3 = Monthly Avg 4 = Yearly Avg
P7.27 ②	Energy Savings Reset				0	2125	0 = No Action 1 = Reset
P7.28 ②	2th Stage Ramp Frequency	See Para ID 101	See Para ID 102	Hz	30	2444	
P7.29 ②	Change Phase Sequence Motor	0	1		0	2515	0 = Change Disable 1 = Change Enable

Notes: ① Parameter value can only be changed after the drive has stopped.
 ② Parameter value will be set to be default when changing macros.

Chapter 5—Standard application

Table 29. Motor control—P8

Code	Parameter	Min.	Min.	Unit	Default	ID	Note
P8.1 ①②	Motor Control Mode				0	287	0 = Freq Control 1 = Speed Control
P8.2 ①	Current Limit	Drive Nom CT*1/10	Drive Nom CT*2	A	Drive Nom VT	107	
P8.3 ①②	V/Hz Optimization				0	109	0 = Disabled 1 = Enabled
P8.4 ①②	V/Hz Ratio				0	108	0 = Linear 1 = Squared 2 = Programmable 3 = Linear + Flux Optimization
P8.5 ①②③	Field Weakening Point	8.00	400.00/320.00	Hz	60.00	289	
P8.6 ①②	Voltage at FWP	10.00	200.00	%	100.00	290	
P8.7 ①②	V/Hz Mid Frequency	0.00	See Para ID 289	Hz	V/Hz Midpoint Freq	291	
P8.8 ①②	V/Hz Mid Voltage	0.00	100.00	%	100.00	292	
P8.9 ①②	Zero Frequency Voltage	0.00	40.00	%	0.00	293	
P8.10 ②	Switching Frequency	Min Switching Freq	Max Switching Freq	kHz	Default Switching Freq CT	288	
P8.11 ②	Sine Filter Enable				0	1665	0 = Disabled 1 = Enabled
P8.12 ①②	Overvoltage Control				1	294	0 = Disabled 1 = Enabled
P8.14 ②⑦	Identification				0	299	0 = No Action 1 = Identification Only Stator Resistor 2 = Identification with Run 3 = Identification No Run
P8.17 ②③	Frequency Ramp Out FilterTime Constant	0	3000	ms	0	1585	
P8.39 ②	Start Boost Rise Time	-1	32000	s	0	1622	
P8.45 ②⑦	Torque Memory Start	-300.00	300.0	%	0.0	1632	
P8.50 ①⑦	Stator Resistor	0.001	65.535	ohm	0.033	771	
P8.52 ①⑦	Leak Inductance	0.001	65.535	mh	0.128	773	

- Notes:**
- ① Parameter value can only be changed after the drive has stopped.
 - ② Parameter value will be set to be default when changing macros.
 - ③ Function is not available in FR7 and FR8 of DG1 drives.
 - ⑦ Function is only available in FR7 and FR8 of DG1 drives.
 - ⑧ DG1 Frame 1-6/DG1 Frame 7-8.

Table 30. Protections—P9

Code	Parameter	Min.	Min.	Unit	Default	ID	Note
P9.1 ①②	4 mA Input Fault				0	306	0 = No Action 1 = Warning 2 = Warning: Previous Freq 3 = Warning: Preset Freq 4 = Fault 5 = Fault, Coast
P9.2 ①②	4 mA Fault Frequency	0.00	See Para ID 102	Hz	0.00	331	
P9.3 ①②	External Fault				2	307	See Para ID 313
P9.4 ①②	Input Phase Fault				2	332	0 = No Action 1 = Warning ④ 2 = Fault 3 = Fault, Coast ④
P9.5 ①②	Uvoltage Fault Response				2	330	See Para ID 313
P9.6 ①②	Output Phase Fault				2	308	See Para ID 313
P9.7 ①②	Ground Fault				2	309	See Para ID 313
P9.8 ①②	Motor Thermal Protection				2	310	See Para ID 313
P9.9 ②⑧	Motor Thermal F0 Current	0.0/5.0	150.0	%	40.0/60.0	311	
P9.10 ②⑧	Motor Thermal Time	1	200	min	45/78	312	
P9.11 ①②	Stall Protection				0	313	0 = No Action 1 = Warning 2 = Fault 3 = Fault, Coast
P9.12 ②	Stall Current Limit	0.1	Active Motor Nom I*2	A	Active Motor Nom I*13/10	314	
P9.13 ②	Stall Time Limit	1.0	120.0	s	15.0	315	
P9.14 ②	Stall Frequency Limit	1.00	See Para ID 102	Hz	25.00	316	
P9.15 ①②	Underload Protection				0	317	See Para ID 313
P9.16 ②	Underload Fnom Torque	10.0	150.0	%	50.0	318	
P9.17 ②	Underload F0 Torque	5.0	150.0	%	10.0	319	
P9.18 ②	Underload Time Limit	2.00	600.00	s	20.00	320	
P9.19 ①②	Thermistor Fault Response				2	333	See Para ID 313

Notes: ① Parameter value can only be changed after the drive has stopped.
 ② Parameter value will be set to be default when changing macros.
 ③ Function is not available in FR7 and FR8 of DG1 drives.
 ④ DG1 Frame 1-6/DG1 Frame 7-8.

Chapter 5—Standard application

Table 30. Protections—P9, continued

Code	Parameter	Min.	Min.	Unit	Default	ID	Note
P9.20 ②	Line Start Lockout				2	750	0 = Disabled, No Change 1 = Enable, No Change 2 = Disabled, Changed 3 = Enable, Changed
P9.21 ①②	Fieldbus Fault Response				2	334	0=No Action 1=Warning 2=Fault 3=Fault, Coast 4=Warning, Coast
P9.22 ①②	OPTCard Fault Response				2	335	See Para ID 313
P9.23 ①②	Unit Under Temp Prot				2	1564	See Para ID 313
P9.24 ②	Wait Time	1.00	300.00	s	1.00	321	
P9.25 ②	Trail Time	0.00	600.00	s	30.00	322	
P9.26 ②	Start Function				0	323	0 = Flying Start 1 = Ramp
P9.27 ②	Undervoltage Attempts	0	10		1	324	
P9.28 ②	Overvoltage Attempts	0	10		1	325	
P9.29 ②	Overcurrent Attempts	0	3		1	326	
P9.30 ②	4 mA Fault Attempts	0	10		1	327	
P9.31 ②	Motor Temp Fault Attempts	0	10		1	329	
P9.32 ②	External Fault Attempts	0	10		0	328	
P9.33 ②	Underload Attempts	0	10		1	336	
P9.34 ①②	RTC Fault				1	955	See Para ID 313
P9.36 ①②	Replace Battery Fault Response				1	1256	See Para ID 313
P9.37 ①②	Replace Fan Fault Response				1	1257	See Para ID 313
P9.38 ①②	IP Address Conflicion Resp				1	1678	See Para ID 313
P9.39 ②④	Cold Weather Mode				0	2126	0 = Disable 1 = Enable

- Notes:** ① Parameter value can only be changed after the drive has stopped.
 ② Parameter value will be set to be default when changing macros.
 ③ Function is not available in FR7 and FR8 of DG1 drives.
 ④ DG1 Frame 1-6/DG1 Frame 7-8.

Table 30. Protections—P9, continued

Code	Parameter	Min.	Min.	Unit	Default	ID	Note
P9.40 ②④	Cold Weather Voltage Level	0	20	%	2	2127	
P9.41②④	Cold Weather Time Out	0	10	min	3	2128	
P9.44 ②④	Ground Fault Limit	0	30	%	15	2158	
P9.45 ①②	Keypad Comm Fault Response				2	2157	See Para ID 313
P9.46 ②	Preheat Mode				0	2159	0 = Disabled 1 = Enabled
P9.47 ②	Preheat Temp Source				31	2160	0 = DigIN: NormallyOpen 1 = DigIN: NormallyClosed 2 = DigIN: 1 3 = DigIN: 2 4 = DigIN: 3 5 = DigIN: 4 6 = DigIN: 5 7 = DigIN: 6 8 = DigIN: 7 9 = DigIN: 8 10 = DigIN: A: IO1: 1 11 = DigIN: A: IO1: 2 12 = DigIN: A: IO1: 3 13 = DigIN: A: IO5: 1 14 = DigIN: A: IO5: 2 15 = DigIN: A: IO5: 3 16 = DigIN: A: IO5: 4 17 = DigIN: A: IO5: 5 18 = DigIN: A: IO5: 6 19 = DigIN: B: IO1: 1 20 = DigIN: B: IO1: 2 21 = DigIN: B: IO1: 3 22 = DigIN: B: IO5: 1 23 = DigIN: B: IO5: 2 24 = DigIN: B: IO5: 3 25 = DigIN: B: IO5: 4 26 = DigIN: B: IO5: 5 27 = DigIN: B: IO5: 6 28 = Time Channel 1 29 = Time Channel 2 30 = Time Channel 3 31 = Drive Temperature 32 = Slot A PT100 Temp Channel 1 33 = Slot A PT100 Temp Channel 2 34 = Slot A PT100 Temp Channel 3 35 = Slot A Max PT100 Temp 36 = Slot B PT100 Temp Channel 1 37 = Slot B PT100 Temp Channel 2 38 = Slot B PT100 Temp Channel 3 39 = Slot B Max PT100 Temp 40 = Slot A and Slot B Max PT100 Temp

Notes: ① Parameter value can only be changed after the drive has stopped.
② Parameter value will be set to be default when changing macros.

Table 30. Protections—P9, continued

Code	Parameter	Min.	Max.	Unit	Default	ID	Note
P9.48 ②	Preheat Enter Temp	0.0	19.9	°C	10.0	2161	
P9.49 ②	Preheat Quit Temp	20.0	40.0	°C	20.0	2162	
P9.50 ②	Preheat Output Voltage/ Preheat Output Current	0.0/0	20.0/50	%	2.0/20	2163	
P9.56 ②	STO Fault Response				2	2429	0 = No Action 1 = Warning 2 = Fault
P9.57 ②	Fault Reset Start	0	1		0	2483	0 = Start/Stop After Fault Reset 1 = Restart After Fault Reset

Table 31. Preset speed—P12

Code	Parameter	Min.	Max.	Unit	Default	ID	Note
P12.1 ②	Preset Speed 1	0.00	See Para ID 102	Hz	5.00	105	
P12.2 ②	Preset Speed 2	0.00	See Para ID 102	Hz	10.00	106	
P12.3 ②	Preset Speed 3	0.00	See Para ID 102	Hz	15.00	118	
P12.4 ②	Preset Speed 4	0.00	See Para ID 102	Hz	20.00	119	
P12.5 ②	Preset Speed 5	0.00	See Para ID 102	Hz	25.00	120	
P12.6 ②	Preset Speed 6	0.00	See Para ID 102	Hz	30.00	121	
P12.7 ②	Preset Speed 7	0.00	See Para ID 102	Hz	35.00	122	

Table 32. Brake—P14

Code	Parameter	Min.	Max.	Unit	Default	ID	Note
P14.1 ①②③	DC-Brake Current	Drive Nom CT*15/100/0.0	Drive Nom CT*15/10/Drive Nom VT*2	A	Drive Nom CT*1/2 Drive Nom VT*1/2	254	
P14.2 ①②	Start DC-Brake Time	0.00	600.00	s	0.00	263	
P14.3 ①②	Stop DC-Brake Frequency	0.10	10.00	Hz	1.50	262	
P14.4 ①②	Stop DC-Brake Time	0.00	600.00	s	0.00	255	
P14.5 ①②	Brake Chopper Define				0	251	0 = Disabled 1 = B(Run) T(Rdy) 2 = External 3 = B(Rdy) T(Rdy) 4 = B(Run) T(No)
P14.6 ①②	Flux Brake				0	266	0 = Off 1 = On
P14.7 ①②	Flux Brake Current	Active Motor Nom I*1/10	See Para ID 107	A	Active Motor Nom I*1/2	265	

Communication P20

Table 33. FB Process Data Input Sel—P20.1

Code	Parameter	Min.	Max.	Unit	Default	ID	Note
P20.1.1	FB Process Data Input 1 Sel				2541	2533	
P20.1.2	FB Process Data Input 2 Sel				2542	2534	
P20.1.3	FB Process Data Input 3 Sel				2550	2535	
P20.1.4	FB Process Data Input 4 Sel				103	2536	
P20.1.5	FB Process Data Input 5 Sel				104	2537	
P20.1.6	FB Process Data Input 6 Sel				107	2538	
P20.1.7	FB Process Data Input 7 Sel				0	2539	
P20.1.8	FB Process Data Input 8 Sel				0	2540	

Notes: ① Parameter value can only be changed after the drive has stopped.
 ② Parameter value will be set to be default when changing macros.
 ③ DG1 Frame 1-6/DG1 Frame 7-8.

Table 34. FB Process Data Output Sel—P20.2

Code	Parameter	Min.	Max.	Unit	Default	ID	Note
P20.2.1	FB Process Data Output 1 Sel				1	1556	
P20.2.2	FB Process Data Output 2 Sel				2	1557	
P20.2.3	FB Process Data Output 3 Sel				3	1558	
P20.2.4	FB Process Data Output 4 Sel				4	1559	
P20.2.5	FB Process Data Output 5 Sel				5	1560	
P20.2.6	FB Process Data Output 6 Sel				6	1561	
P20.2.7	FB Process Data Output 7 Sel				7	1562	
P20.2.8	FB Process Data Output 8 Sel				28	1563	
P20.2.9	Standard Status Word Bit0 Function Select				1	2415	See Para ID 151
P20.2.10	Standard Status Word Bit1 Function Select				1	2416	See Para ID 151
P20.2.11	Standard Status Word Bit2 Function Select				1	2417	See Para ID 151
P20.2.12	Standard Status Word Bit3 Function Select				1	2418	See Para ID 151
P20.2.13	Standard Status Word Bit4 Function Select				1	2419	See Para ID 151
P20.2.14	Standard Status Word Bit5 Function Select				1	2420	See Para ID 151
P20.2.15	Standard Status Word Bit6 Function Select				1	2421	See Para ID 151
P20.2.16	Standard Status Word Bit7 Function Select				1	2422	See Para ID 151

RS485 Bus P20.3**Table 35. Basic Setting— P20.3.1**

Code	Parameter	Min.	Max.	Unit	Default	ID	Note
P20.3.1.1	RS485 Comm Set				0	586	0 = Modbus RTU 1 = BACnet MS/TP 2 = SWD

Table 36. Modbus RTU— P20.3.2

Code	Parameter	Min.	Max.	Unit	Default	ID	Note
P20.3.2.1	Slave Address	1	247		1	587	
P20.3.2.2	Baud Rate				1	584	0 = 9600 1 = 19200 2 = 38400 3 = 57600 4 = 115200
P20.3.2.3	Parity Type				2	585	0 = None 1 = Odd 2 = Even
P20.3.2.4	Modbus RTU Protocol Status				0	588	0 = Initial 1 = Stopped 2 = Operational 3 = Faulted
P20.3.2.5	Slave Busy				0	589	0 = Not Busy 1 = Busy
P20.3.2.6	Parity Error				0	590	
P20.3.2.7	Slave Fault				0	591	
P20.3.2.8	Last Fault Response				0	592	
P20.3.2.9	Comm Timeout Modbus RTU			ms	10000	593	
P20.3.2.10	Modbus RTU Fault Response	0	1		0	2516	0 = In Fieldbus Control 1 = In All Control

- Notes:**
- ① Parameter value can only be changed after the drive has stopped.
 - ② Parameter value will be set to be default when changing macros.
 - ③ Function is not available in FR7 and FR8 of DG1 drives.

Table 37. BACnet MS/TP— P20.3.3

Code	Parameter	Min.	Max.	Unit	Default	ID	Note
P20.3.3.1	MSTP Baud Rate				2	594	0 = 9600 1 = 19200 2 = 38400 3 = 78600 4 = 115200
P20.3.3.2	MSTP MS/TP Device Address	0	127		1	595	
P20.3.3.3	MSTP Instance Number	0	4194302		varies	596	
P20.3.3.4	MSTP Comm Timeout MSTP			ms	10000	598	
P20.3.3.5	MSTP Protocol Status				0	599	0 = Stopped 1 = Operational 2 = Faulted
P20.3.3.6	MSTP Fault Code				0	600	0 = None 1 = Sole Master
P20.3.3.7	MSTP Fault Response	0	1		0	2526	0 = In Fieldbus Control 1 = In All Control

Table 38. Ethernet IP— P20.4

Code	Parameter	Min.	Max.	Unit	Default	ID	Note
P20.4.1	IP Address Mode				1	1500	0 = Static IP 1 = DHCP with AutoIP"
P20.4.2	Active IP Address					1507	
P20.4.3	Active Subnet Mask					1509	
P20.4.4	Active Default Gateway					1511	
P20.4.5	MAC Address					1513	
P20.4.6	Static IP Address				192.168.1.254	1501	
P20.4.7	Static Subnet Mask				255.255.255.0	1503	
P20.4.8	Static Default Gateway				192.168.1.1	1505	
P20.4.9	Ethernet IP Protocol Status					608	0 = Stopped 1 = Operational 2 = Faulted
P20.4.10	EIP Fault Response	0	1		0	2518	0 = In Fieldbus Control 1 = In All Control

Table 39. Modbus TCP— P20.5

Code	Parameter	Min.	Max.	Unit	Default	ID	Note
P20.5.1	Connection Limit				5	609	
P20.5.2	Modbus TCP Unit ID				1	610	
P20.5.3	Comm Timeout Modbus TCP			ms	10000	611	
P20.5.4	Modbus TCP Protocol Status				0	612	0 = Stopped 1 = Operational 2 = Faulted
P20.5.5	Slave Busy				0	613	0 = Not Busy 1 = Busy
P20.5.6	Parity Error				0	614	
P20.5.7	Slave Failure				0	615	
P20.5.8	Last Fault Response				0	616	
P20.5.9	Modbus TCP Fault Response	0	1		0	2517	0 = In Fieldbus Control 1 = In All Control

Notes: ① Parameter value can only be changed after the drive has stopped.
 ② Parameter value will be set to be default when changing macros.

Table 40. Basic setting—P21.1

Code	Parameter	Min.	Max.	Unit	Default	ID	Note
P21.1.1	Language				0	340	0 = English 1 = Depends upon Language Pack 2 = Depends upon Language Pack
P21.1.2 ①	Application				0	142	0 = Standard 1 = Multi-Pump 2 = Multi-PID 3 = Multi-Purpose
P21.1.3	Parameter Sets				0	619	0 = No 1 = Reload Defaults 2 = Reload Set 1 3 = Reload Set 2 4 = Store Set 1 5 = Store Set 2 6 = Reset 7 = Reload Defaults VM
P21.1.4	Up To Keypad				0	620	0 = No 1 = Yes
P21.1.5	Down From Keypad				0	621	0 = No 1 = All Parameters 2 = All, No Motor 3 = App Parameters
P21.1.6	Parameter Comparison				0	623	0 = No 1 = Compare with Keypad 2 = Compare with Default 3 = Compare with Set 1 4 = Compare with Set 2
P21.1.7	Password	0	9999		0	624	
P21.1.8	Parameter Lock				0	625	0 = Change Enable 1 = Change Disable
P21.1.9	Multimonitor Set				0	627	See Para ID 625
P21.1.10	Default Page				0	628	0 = None 1 = Main Menu 2 = Multi-Monitor 3 = Favorite Menu 4 = Keypad Reference
P21.1.11	Timeout Time	0	65535	s	30	629	
P21.1.12	Contrast Adjust	5	18		12	630	
P21.1.13	Backlight Time	1	65535	min	10	631	
P21.1.14	Fan Control				2	632	0 = Continuous 1 = Temperature 2 = Run Follow ② 3 = Calculate Temp ②
P21.1.15	HMI ACK Timeout	200	5000	ms	200	633	
P21.1.16	HMI Retry Number	1	10		5	634	
P21.1.17	Startup Wizard	0	1		1	626	0 = No 1 = Yes
P21.1.18	Jog Soft Key Hidden	0	1		0	2412	0 = Disable 1 = Enable
P21.1.19	Reverse Softkey Hidden	0	1		0	2413	0 = Disable 1 = Enable

Notes: ① Parameter value can only be changed after the drive has stopped.

② Parameter value will be set to be default when changing macros.

Chapter 5—Standard application

Table 40. Basic setting—P21.1 , continued

Code	Parameter	Min.	Max.	Unit	Default	ID	Note
P21.1.20	Output Display Unit				45	2424	0 = % 1 = 1/min 2 = rpm 3 = ppm 4 = pps 5 = l/s 6 = l/min 7 = l/h 8 = kg/s 9 = kg/min 10 = kg/h 11 = m ³ /s 12 = m ³ /min 13 = m ³ /h 14 = m/s 15 = mbar 16 = bar 17 = Pa 18 = kPa 19 = mVs 20 = kW 21 = deg C 22 = GPM 23 = gal/s 24 = gal/min 25 = gal/h 26 = lb/s 27 = lb/min 28 = lb/h 29 = CFM 30 = ft ³ /s 31 = ft ³ /min 32 = ft ³ /h 33 = ft/s 34 = in wg 35 = ft wg 36 = PSI 37 = lb/in ² 38 = HP 39 = deg F 40 = PA 41 = WC 42 = HG 43 = ft 44 = m 45 = Hz
P21.1.21	Output Display Unit Min	-60000.00	See Para ID 2425	varies	0.00	2460	
P21.1.22	Output Display Unit Max	See Para ID 2460	60000.00	varies	60	2425	

Table 41. Version Info—P21.2

Code	Parameter	Min.	Max.	Unit	Default	ID	Note
P21.2.1	Keypad Software Version					640	
P21.2.2	Motor Control Software Version					642	
P21.2.3	Application Software Version				App Firmware	644	
P21.2.4	Software Bundle Version				App bundle rev	1714	

Table 42. Application Info—P21.3

Code	Parameter	Min.	Max.	Unit	Default	ID	Note
P21.3.1	Brake Chopper					646	0 = No 1 = Yes
P21.3.2	Brake Resistor Status					647	See Para ID 646
P21.3.3	Serial Number					648	

Table 43. User Info—P21.4

Code	Parameter	Min.	Max.	Unit	Default	ID	Note
P21.4.1	Real Time Clock				0.0.0.1:1:13	566	
P21.4.2	Daylight Saving				0	582	0 = Off 1 = EU 2 = US
P21.4.3	Total MWh Count			Mwh		601	
P21.4.4	Total Power Day Count					603	
P21.4.5	Total Power Hr Count					606	
P21.4.6	Trip MWh Count			Mwh		604	
P21.4.7	Clear Trip MWh Count				0	635	0 = Not Reset 1 = Reset
P21.4.8	Trip Power Day Count					636	
P21.4.9	Trip Power Hr Count					637	
P21.4.10	Clear Trip Power Count				0	639	See Para ID 635

Chapter 6 — Multi-Pump and fan control application

Introduction

The Multi-Pump and Fan Control Application is designed to be used in applications where multiple pumps or fan systems are used to maintain a desired flow rate, pressure, or temperature value. It gives the ability to use a single PID loop to control one drive and have auxiliary motors connected via drives or contactors start and stop based off the desired process. It also gives the ability to use a single PID loop and operate using a multi-master/lead-lag scheme using up to 5 drives. It also provides the ability to auto-change between the multiple motors to keep run times equal. Controlwise it allows for 2 control and reference place selections with 8 digital inputs and 2 analog inputs that are programmable. For monitoring the system and turning on aux motors, there are 3 programmable relay outputs, 1 digital output, and 2 sets of analog outputs that are programmable. The application allows for full customization of the motor control scheme with frequency or speed control along with customizing the V/Hz curve. Drive/Motor protections can be customized to defined actions. Below is a list of other features in addition to the Standard Application features that are available in the Multi-Pump and Fan Control Application.

Select the Multi-Pump and Fan Application in menu **P21.1.2**.

Multi-Pump and Fan includes all the functions in Standard Application and Additional functions:

- Damper control
- Fire mode
- Smoke purge mode
- Interlock for motors
- Multi-Pump control
- Auto change function
- Bypass
- Real time clock function—Timer
- Real time clock function—Interval
- PM setback
- Two independent set of motor Parameter
- PID
- Multi-Master/Lead-Lag

Note: When Fire mode is enabled, this causes the drive to ignore any fault and run till its death. Warranty will be none valid in the case this is enabled and the drive causes issues to the system.

I/O controls

- “Terminal To Function” (TTF) Programming

The design behind the programming of the digital inputs in the DG1 drive is to use “Terminal To Function” programming, which is composed of multiple functions that get assigned a digital input to that function. The parameters in the drive are set up with specific functions and by defining the digital input and slot in some cases, depending on which options are available. For use of the drives control board inputs, they will be referred to as DigIN:1 through DigIN:8. When additional option cards are used, they will be defined as DigIN:X:IOY:Z. The X indicates the slot that the card is being installed in, which will be either A or B. The IOY determines the type of card it is, which would be IO1 or IO5. The Z indicates which input is being used on that available option card.

- “Function To Terminal” (FTT) Programming

The design behind the programming of the relay outputs and digital output in the DG1 drive is to use “Function To Terminal” programming. It is composed of a terminal, be it a relay output or a digital output, that is assigned a parameter. Within that parameter, it has different functions that can be set.

The parameters of the Multi-Pump and Fan Control Application are explained on **Page 150** of this manual, “Description of Parameters.” The explanations are arranged according to the parameter

For the DI function, we use Terminal programming method to function (TTF), where there is a fixed input that gets programmed to a list of functions. This allows for multiple inputs to be used for different functions. Connecting a certain input with a certain parameter function is done by give a parameter an appropriate value. The value is formed by the location of the input, either being on the standard control board or an external option board and the slot it is located in.

Force open/force close selection

The Force Open Selection would make the selected function always off. Essentially this is a virtual switch that is always open.

The Force Close Selection would make the selected function always on. Essentially this is a virtual switch that is always closed.

These options are assigned to a function if we want to force a state without using a hardware input.

Example:

If we set Run Enable to Force Closed the drive is always enabled. If we set the same function to Force Open the drive would never be Enabled. If a Digital input is to be used to activate this Run Enable the function should be assigned to a hardware input(See below for DIGIN Selections).

DIGIN selection

This allows Assignment of a hardware digital input to a function, this is set in a format of DigIN:X where X is one of the 8 Digital inputs on the Main control board.

Example:

If we set Run Enable to DigIN:6 the drive will be enabled when digital input 6 (Terminal 8) is closed, and would not be enabled when digital input 6 (Terminal 8) is open.

Option board DigIN selection

This allows Assignment of a hardware digital input on an option card to a function, this is set in a format of DigIN:Y:IO1:X where Y is the slot the option card is inserted on the Main control board and X is the Input on the Board and IO1 is the type of option board used.

Example:

If we set Run Enable to DigIN:A:IO5:6 the drive will be enabled when digital input 6 is closed on the IO5 option card which is inserted in Slot A, and would not be enabled when digital input 6 on the option card is open.

Timer channel selection

A Time Channel is a virtual path to link the digital output of a timer function to a digital input function. To utilize this feature a timer or interval would need to be assigned to a time channel 1 through 3, and the input function to be controlled would need to be assigned to the same time channel.

Example:

If we set Run Enable to DigIN:TimeChannel1 the drive will be enabled when the timer assigned to Time Channel 1 is active or High, and would not be enabled when the Time Channel is inactive or Low.

Control examples

Single Drive

Figure 27. Example of Two-Pump autochange, main diagram

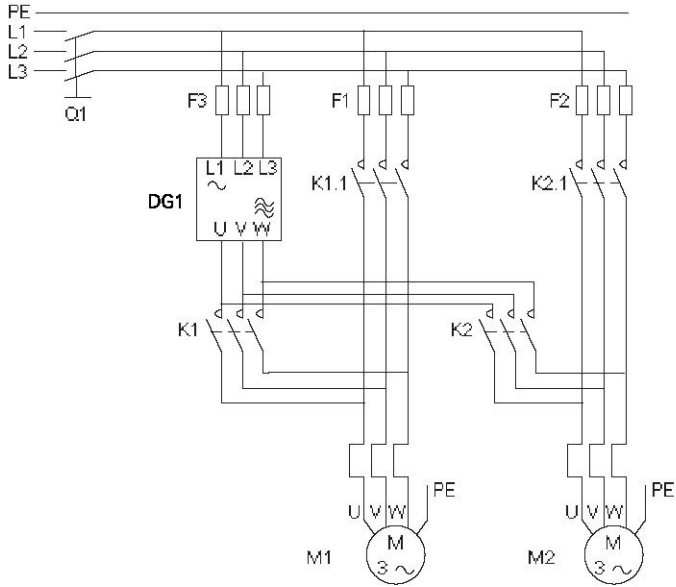

Figure 28. Two-Pump autochange system principal control diagram

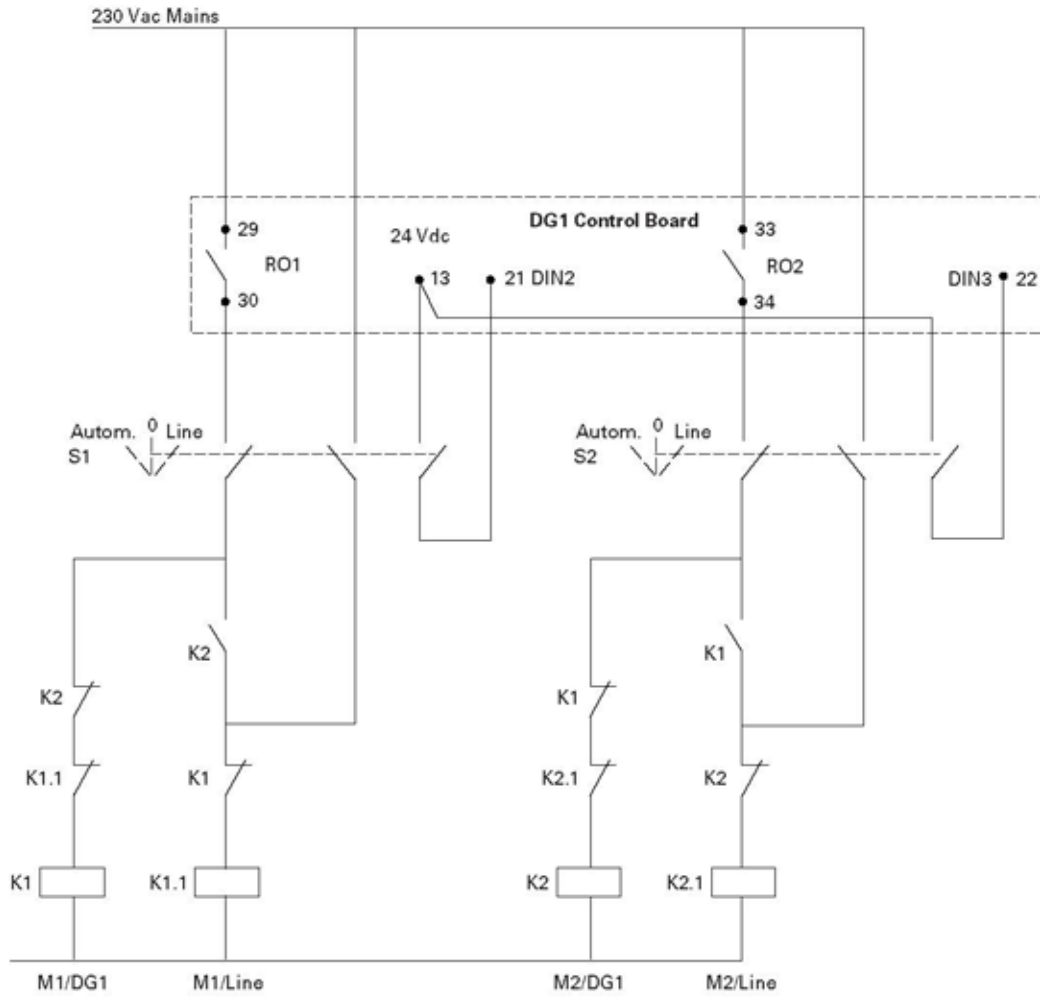

Figure 29. Example of Three-Pump autochange, main diagram

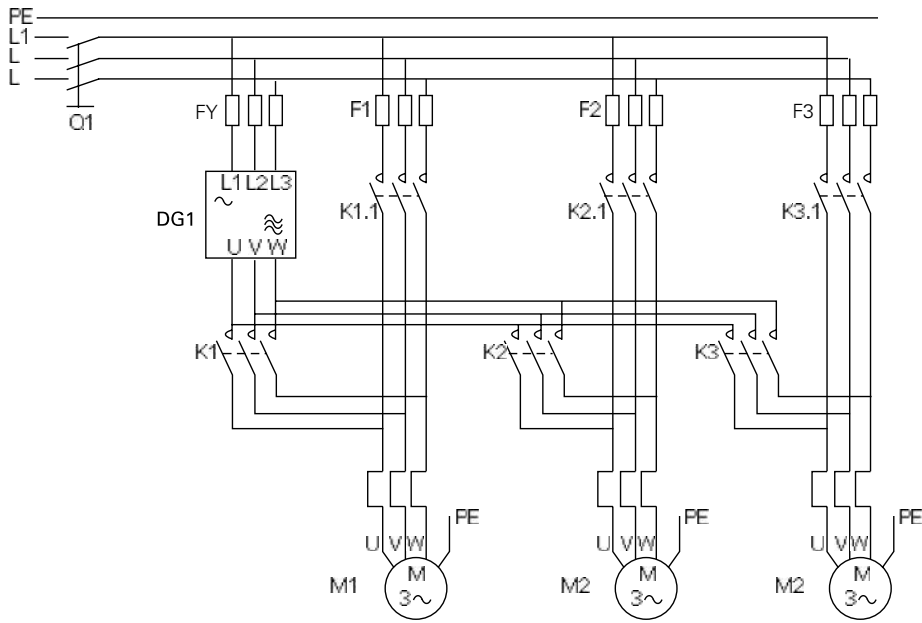

Figure 30. Three-Pump autochange system principal control diagram

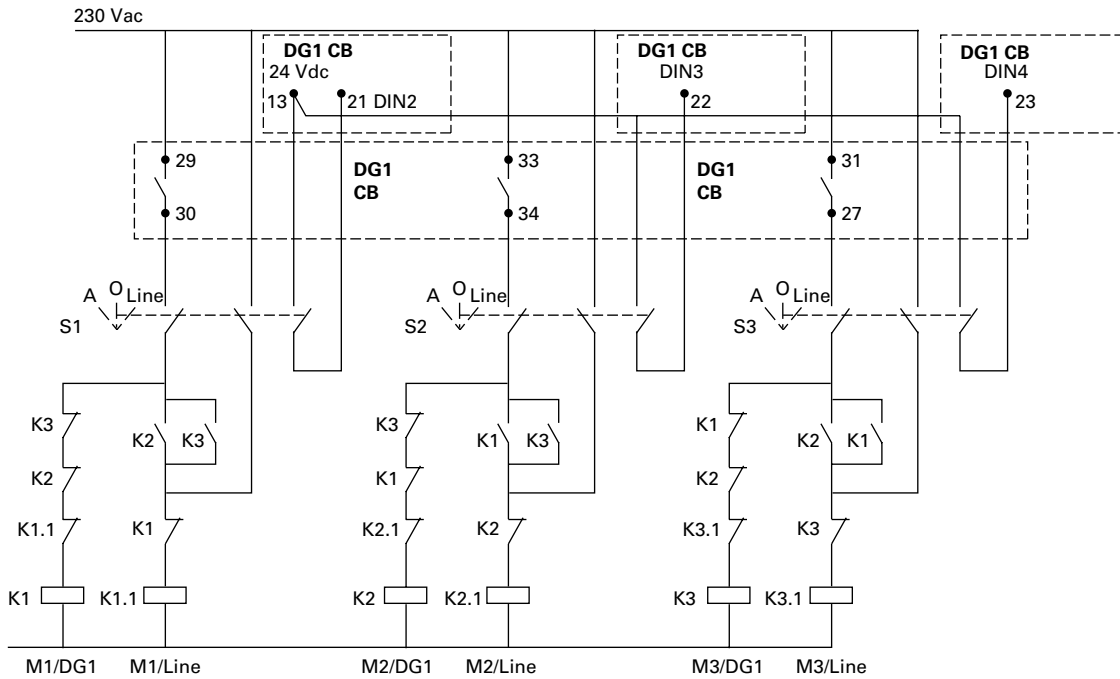

Figure 31. Example of the function of the PFC application with three auxiliary drives

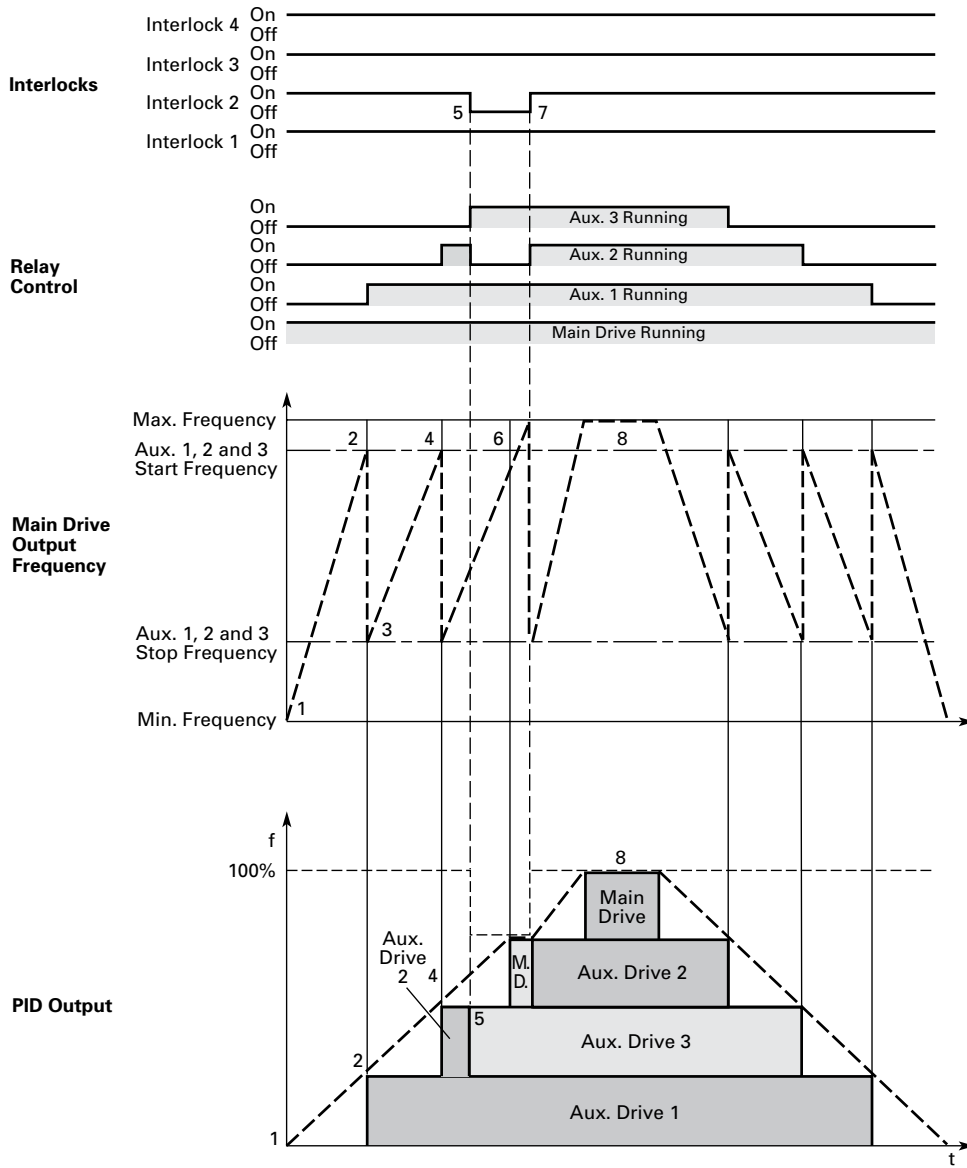

Figure 32. Multi Pump control curve

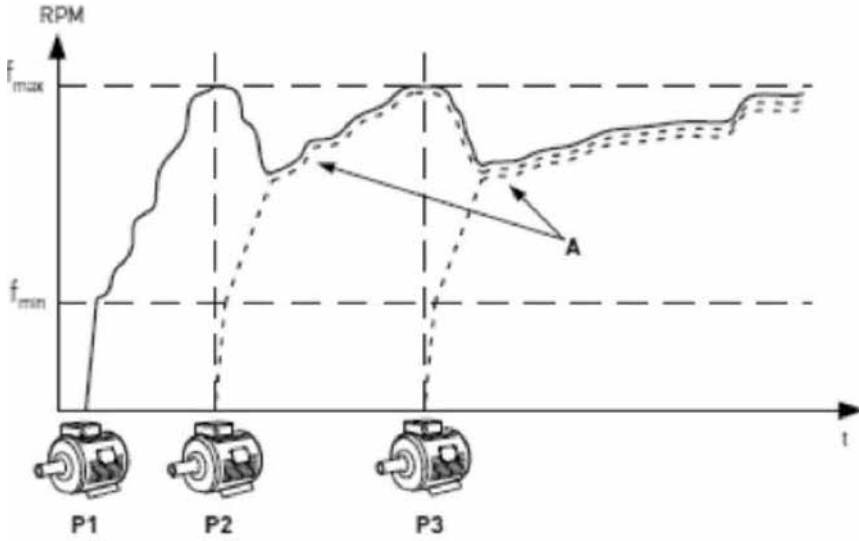

Figure 33. Multi-Drive/Multi-Pump layout

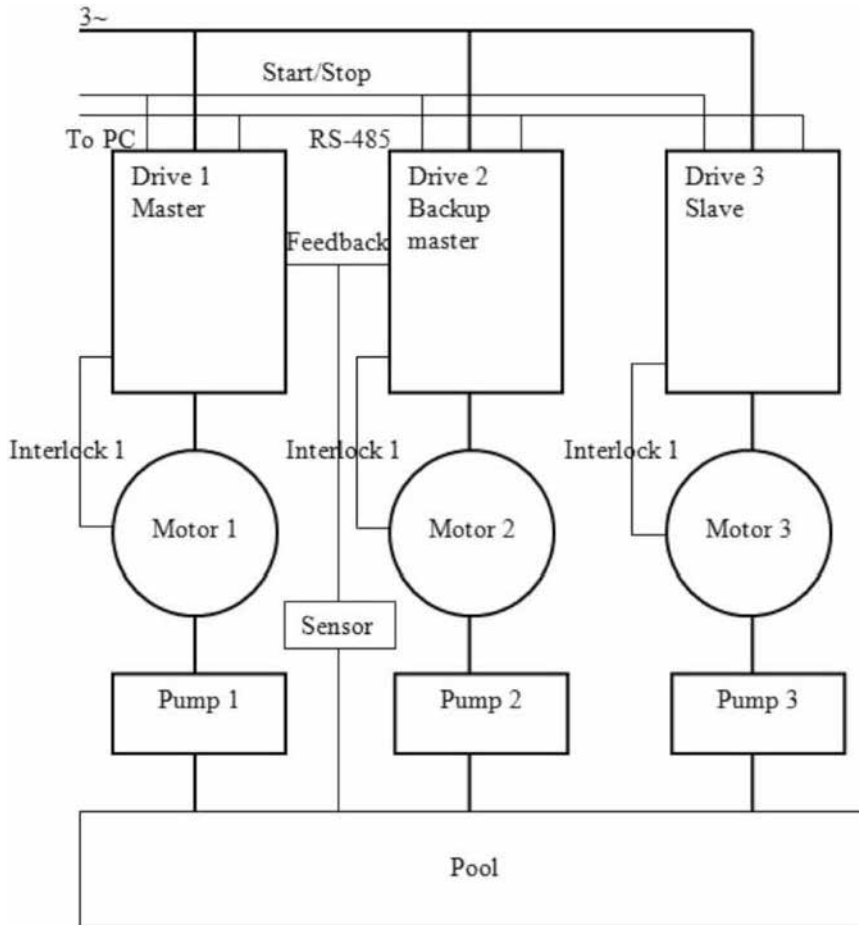

Figure 34. PowerXL drives with 10 V supply with a 0–10 V transducer

Note

- 10V+/24V Supplies along with grounds for each Master should be connected for the Reference/Setpoint And Start signal if using I/O. (There could be up to 1-5 Masters, anything not considered a master could be a slave with a max of 4 slaves)
- The feedback is wired to each Master, since it is a voltage signal they are connected in parallel
- Check the Analog input jumpers to be sure they match signal.

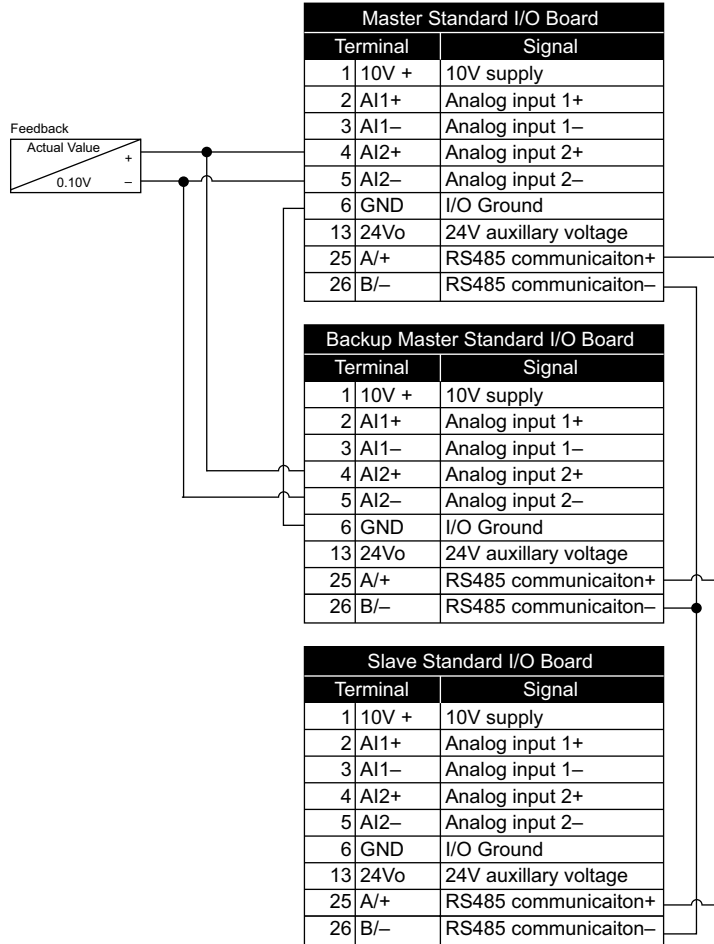

Figure 35. PowerXL drives with 24 V supply with a 4–20 mA transducer

Note
 - 10V+/24V Supplies along with Grounds for each Master should be connected for the Reference/Setpoint And Start signal if using I/O. (There could be up to 1- 5 Masters, anything not considered a master could be a slave with a max of 4 slaves)
 -The feedback is wired to each Master, since it is a voltage signal they are connected in parallel.
 -Check the Analog input jumpers to be sure they match signal.

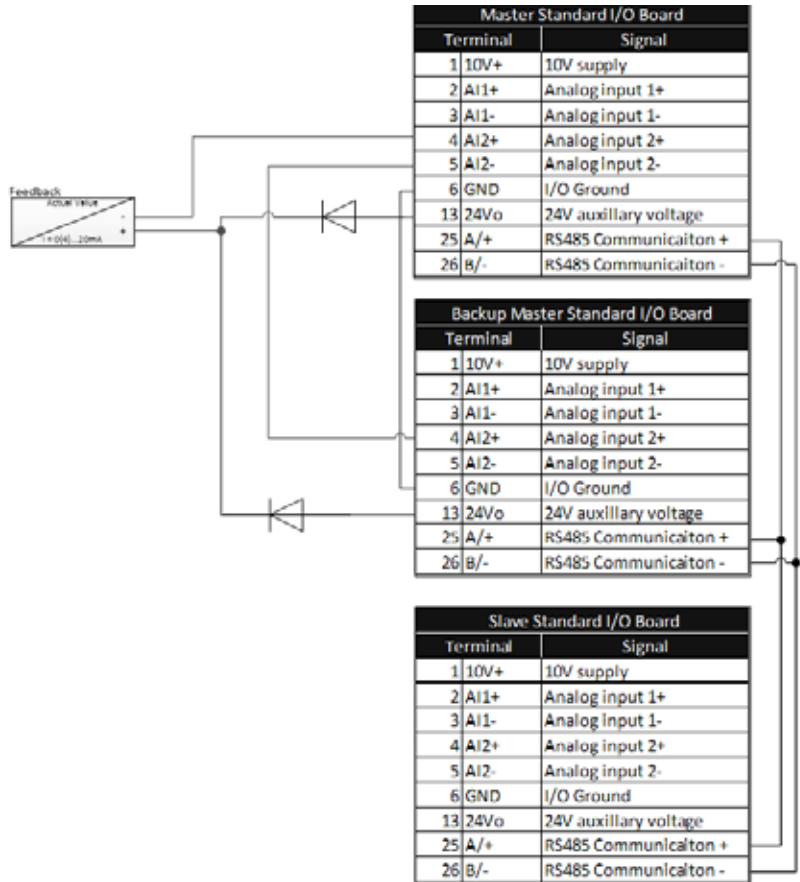

Figure 36. PowerXL drives with Ext supply with a 4–20 mA transducer

Note
 - 10V+/24V Supplies along with Grounds for each Master should be connected for the Reference/Setpoint And Start signal if using I/O. (There could be up to 1- 5 Masters, anything not considered a master could be a slave with a max of 4 slaves)
 -The feedback is wired to each Master, since it is a voltage signal they are connected in parallel.
 -Check the Analog input jumpers to be sure they match signal.

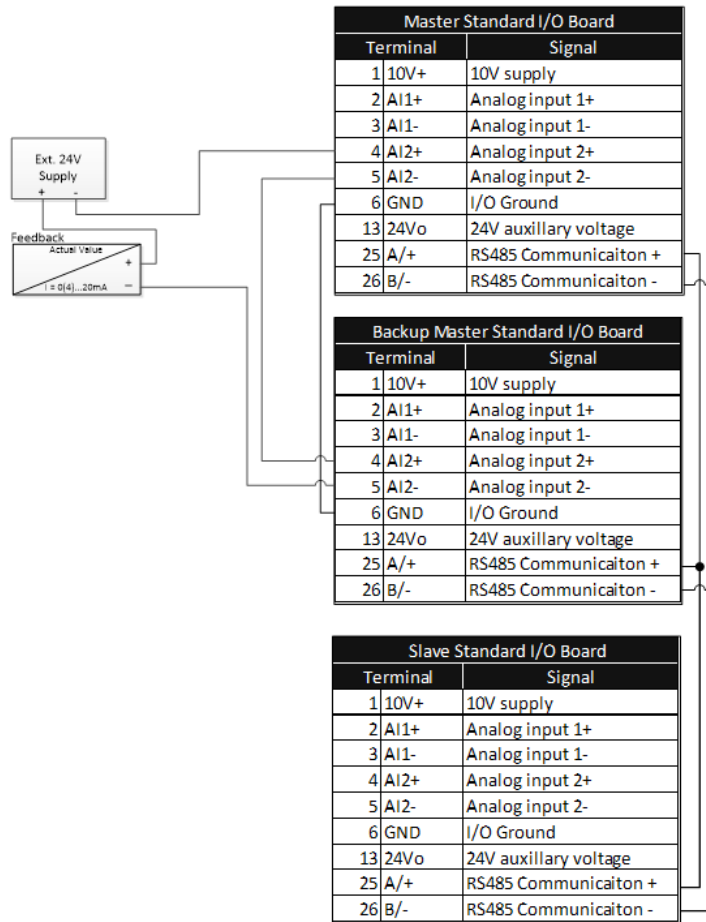
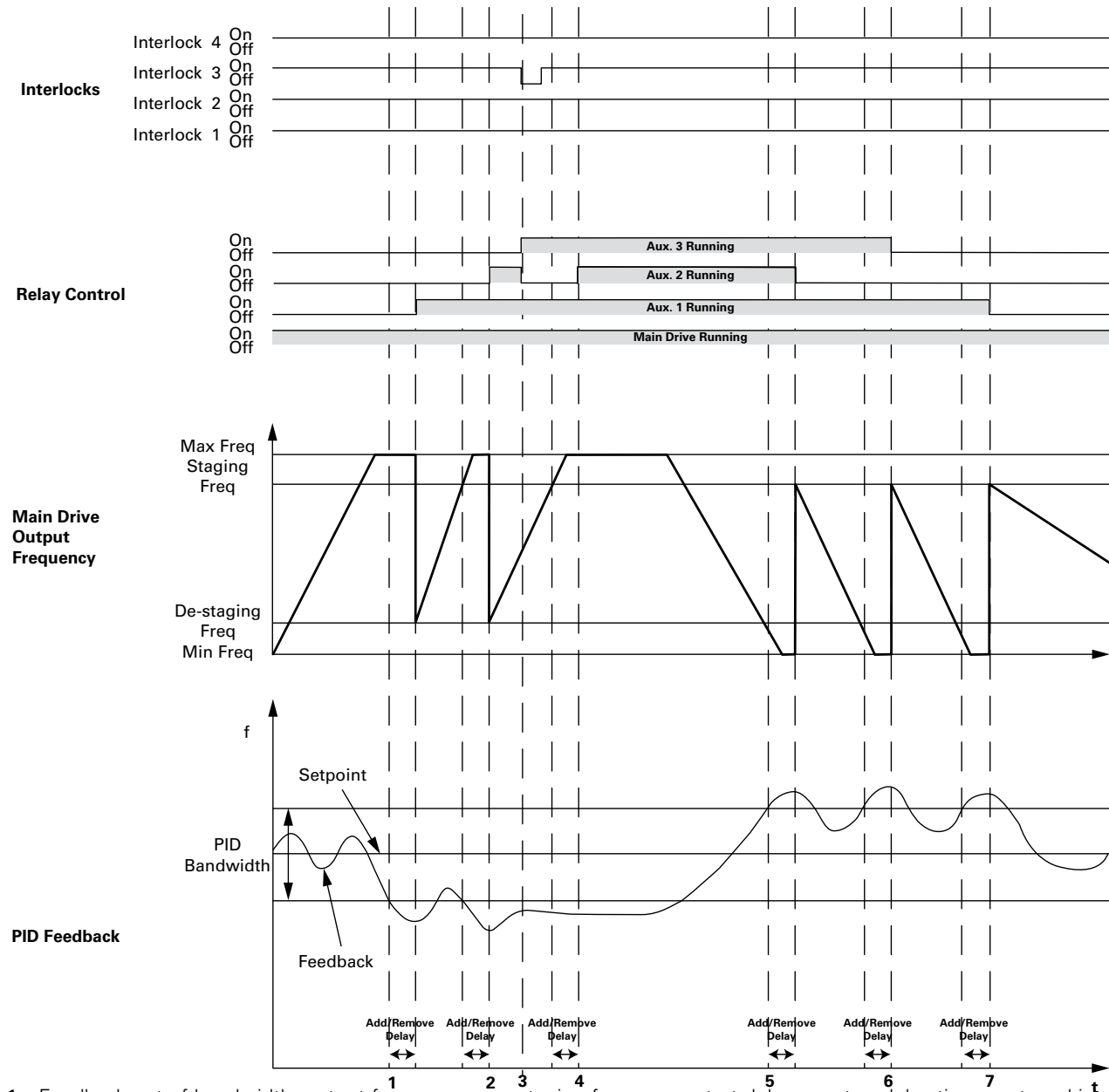

Figure 37. Bandwidth feedback



1. Feedback out of bandwidth, output frequency over staging frequency, start delay counter; delay times out, and interlock 2 is ok, add aux 1 motor by closing its corresponding relay.
2. As above, add aux 2 motor.
3. Aux 2's interlock lost, add aux 3 as backup immediately.
4. Add aux 2 motor again since its interlock resumed.
5. Feedback out of bandwidth, output frequency below de-staging frequency, start delay counter; delay times out, remove aux 2 motor first because it's the last one which been added.
6. As above, remove aux 3 motor.
7. As above, remove aux 1 motor.

Control I/O configuration

- Run 240 Vac and 24 Vdc control wiring in separate conduit
- Communication wire to be shielded

Table 44. Multi-Pump and fan application default I/O connection

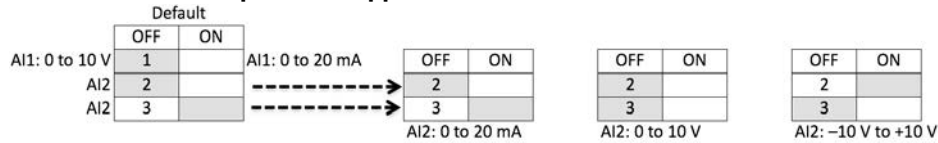

External Wiring	Pin	Signal Name	Signal	Default Setting	Description
	1	+10 V	Ref. Output Voltage	—	10 Vdc Supply Source
	2	AI1+Ⓢ	Analog Input 1	0–10 V	Voltage Speed Reference (Programmable to 4 mA to 20 mA)
	3	AI1–	Analog Input 1 Ground	—	Analog Input 1 Common (Ground)
	4	AI2+Ⓢ	Analog Input 2	4 mA to 20 mA	Current Speed Reference (Programmable to 0–10 V)
	5	AI2–	Analog Input 2 Ground	—	Analog Input 2 Common (Ground)
	6	GND	I/O Signal Ground	—	I/O Ground for Reference and Control
	7	DIN5	Digital Input 5	Preset Speed B0	Sets frequency output to Preset Speed 1
	8	DIN6	Digital Input 6	Preset Speed B1	Sets frequency output to Preset Speed 2
	9	DIN7	Digital Input 7	Not Used (TI–)	Input forces VFD output to shut off
	10	DIN8	Digital Input 8	Force Remote (TI+)	Input takes VFD from Local to Remote
	11	CMB	DI5 to DI8 Common	Grounded	Allows source input
	12	GND	I/O Signal Ground	—	I/O Ground for Reference and Control
	13	24 V	+24 Vdc Output	—	Control voltage output (100 mA max.)
	14	DO1	Digital Output 1	Ready	Shows the drive is ready to run
	15	24 Vo	+24 Vdc Output	—	Control voltage output (100 mA max.)
	16	GND	I/O Signal Ground	—	I/O Ground for Reference and Control
	17	AO1+	Analog Output 1	Output Frequency	Shows Output frequency to motor 0–60 Hz (4 mA to 20 mA)
	18	AO2+	Analog Output 2	Motor Current	Shows Motor current of motor 0–FLA (4 mA to 20 mA)
	19	24 Vi	+24 Vdc Input	—	External control voltage input
	20	DIN1	Digital Input 1	Run Forward	Input starts drive in forward direction (start enable)
	21	DIN2	Digital Input 2	Run Reverse	Input starts drive in reverse direction (start enable)
	22	DIN3	Digital Input 3	External Fault	Input causes drive to fault
	23	DIN4	Digital Input 4	Fault Reset	Input resets active faults
	24	CMA	DI1 to DI4 Common	Grounded	Allows source input
	25	A/+	RS-485 Signal A	—	Fieldbus Communication (Modbus, BACnet)
	26	B/-	RS-485 Signal B	—	Fieldbus Communication (Modbus, BACnet)
	27	R3NO	Relay 3 Normally Open	At Speed	Relay output 3 shows VFD is at Ref. Frequency
	28	R1NC	Relay 1 Normally Closed	Run	Relay output 1 shows VFD is in a run state
	29	R1CM	Relay 1 Common	—	—
	30	R1NO	Relay 1 Normally Open	—	—
	31	R3CM	Relay 3 Common	At Speed	Relay output 3 shows VFD is at Ref. Frequency
	32	R2NC	Relay 2 Normally Closed	Fault	Relay output 2 shows VFD is in a fault state
	33	R2CM	Relay 2 Common	—	—
	34	R2NO	Relay 2 Normally Open	—	—

Note: The above wiring demonstrates a SINK configuration. It is important that CMA and CMB are wired to ground (as shown by dashed line). If a SOURCE configuration is desired, wire 24 V to CMA and CMB and close the inputs to ground. When using the +10 V for AI1, it is important to wire AI1–to ground (as shown by dashed line). If using +10 V for AI1 or AI2, terminals 3, 5, and 6 need to be jumpered together.
 Ⓢ AI1+ and AI2+ Support 10K potentiometer.

Table 45. Drive communication ports

Port	Communication
RJ45 Keypad Port	
Upload/Download Parameters	USB to RJ45
Remote Mount Keypad	Ethernet
Upgrade Drive Firmware	USB to RJ45
RJ45 Ethernet Port	
Upload/Download Parameters	Ethernet
Ethernet IP Communications	Ethernet
Modbus TCP Communications	Ethernet
RS-485 Serial Port^①	
Upload/Download Parameters	Two-Wire Twisted Pair
Upgrade Drive Firmware	Two-Wire Twisted Pair
Modbus RTU Communications	Two-Wire Twisted Pair
BACnet MS/TP Communications	Two-Wire Twisted Pair
SmartWire-DT Communications	Two-Wire Shielded Cable

① Shielded wire recommended.

Note: ① Parameter value can only be changed after the drive has stopped.
 ② Parameter value will be set to be default when changing macros.

Pump and fan application—parameters list

On the next pages you will find the lists of parameters within the respective parameter groups. The parameter descriptions are given on **Page 150**, “Description of Parameters.” The descriptions are arranged according to the parameter number.

Column explanations:

Code = Location indication on the keypad; shows the operator the present parameter number

Parameter = Name of parameter

Min = Minimum value of parameter

Max = Maximum value of parameter

Unit = Unit of parameter value; given if available

Default = Value preset by factory

ID = ID number of the parameter

Table 46. Monitor—M

Code	Parameter	Min.	Max.	Unit	Default	ID	Note
M1	Output Frequency			Hz	0.00	1	
M2	Freq Reference			Hz	0.00	24	
M3	Motor Speed			rpm	0	2	
M4	Motor Current			A	0.0	3	
M5	Motor Torque			%	0.0	4	
M6	Motor Power			%	0.0	5	
M7	Motor Voltage			V	0.0	6	
M8	DC-link Voltage			V	0	7	
M9	Unit Temperature			°C	0.0	8	
M10	Motor Temperature			%	0.0	9	
M12	Analog Input 1			Varies	0.00	10	
M13	Analog Input 2			Varies	0.00	11	
M14	Analog Output 1			Varies	0.00	25	
M15	Analog Output 2			Varies	0.00	575	
M16	DI1, DI2, DI3				0	12	
M17	DI4, DI5, DI6				0	13	
M18	DI7, DI8				0	576	
M19	DO1, Virtual RO1, Virtual RO2				0	14	
M20	RO1, RO2, RO3				0	557	
M21	TC1, TC2, TC3				0	558	
M22	Interval 1				0	559	0 = Inactive 1 = Active
M23	Interval 2				0	560	See Para ID 559
M24	Interval 3				0	561	See Para ID 559
M25	Interval 4				0	562	See Para ID 559
M26	Interval 5				0	563	See Para ID 559
M27	Timer 1			s	0	569	
M28	Timer 2			s	0	571	
M29	Timer 3			s	0	573	
M30	PID1 Set Point			Varies	0.00	16	
M31	PID1 Feedback			Varies	0.00	18	
M32	PID1 Error Value			Varies	0.00	20	
M33	PID1 Output			%	0.00	22	
M34	PID1 Status				0	23	0 = Stopped 1 = Running 2 = Sleep Mode
M40	Running Motors				0	26	

Note: ① Parameter value can only be changed after the drive has stopped.

② Parameter value will be set to be default when changing macros.

Chapter 6 — Multi-Pump and fan control application

Table 46. Monitor—M, Continued

Code	Parameter	Min.	Max.	Unit	Default	ID	Note
M41	PT100 Temperature			°C	1000.0	27	
M42	Last Active Fault				0	28	See Fault Codes on Page 246 in Appendix B
M43	RTC Battery Status					583	0 = Not Installed 1 = Installed 2 = Change Battery 3 = Over Voltage
M44	Instant Motor Power			kW	0.000	1686	
M45	Energy Savings			Varies		2120	
M46	Control board DIDO Status				0	2209	Bit 0 = DIN1 Status Bit 1 = DIN2 Status Bit 2 = DIN3 Status Bit 3 = DIN4 Status Bit 4 = DIN5 Status Bit 5 = DIN6 Status Bit 6 = DIN7 Status Bit 7 = DIN8 Status Bit 8 = DO1 Status Bit 9 = RO1 Status Bit 10 = RO2 Status Bit 11 = RO3 Status Bit 12 = Slot A with Board Bit 13 = Slot B with Board Bit 14 -15 = Not used
M47	SlotA DIDO Status				0	2210	Bit 0 = IO1_DIN1 Status Bit 1 = IO1_DIN2 Status Bit 2 = IO1_DIN3 Status Bit 3 = IO1_DO1 Status Bit 4 = IO1_DO2 Status Bit 5 = IO1_DO3 Status Bit 6 = IO3_RO1 Status Bit 7 = IO3_RO2 Status Bit 8 = IO3_RO3 Status Bit 9 = IO5_AC1 Status Bit 10 = IO5_AC2 Status Bit 11 = IO5_AC3 Status Bit 12 = IO5_AC4 Status Bit 13 = IO5_AC5 Status Bit 14 = IO5_AC6 Status Bit 15 = Not Used
M48	SlotB DIDO Status				0	2211	Bit 0 = IO1_DIN1 Status Bit 1 = IO1_DIN2 Status Bit 2 = IO1_DIN3 Status Bit 3 = IO1_DO1 Status Bit 4 = IO1_DO2 Status Bit 5 = IO1_DO3 Status Bit 6 = IO3_RO1 Status Bit 7 = IO3_RO2 Status Bit 8 = IO3_RO3 Status Bit 9 = IO5_AC1 Status Bit 10 = IO5_AC2 Status Bit 11 = IO5_AC3 Status Bit 12 = IO5_AC4 Status Bit 13 = IO5_AC5 Status Bit 14 = IO5_AC6 Status Bit 15 = Not Used

Note: ① Parameter value can only be changed after the drive has stopped.
② Parameter value will be set to be default when changing macros.

Table 46. Monitor—M, Continued

Code	Parameter	Min.	Max.	Unit	Default	ID	Note
M49	App Status Word				0	29	Bit 0 = MC Ready Bit 1 = MC_Run Bit 2 = MC_Fault Bit 3 = FB_Ref_Active Bit 4 = MC_Stopping Bit 5 = MC_Reverse Bit 6 = MC_Warning/AR-Fault Bit 7 = MC_ZeroSpeed Bit 8 = I/O Control Indicate Bit 9 = Panel Control Indicator Bit 10 = Panel Fieldbus Indicator Bit 11 = MC_DC_Brake Bit 12 = RunEnable Bit 13 = Run Bypass Bit 14 = Ext Brake Control Bit 15 = Bypass Mode
M50	Standard Status Word				0	2414	Bit 0 = P20.1.9 (default = Ready) Bit 1 = P20.1.10 (default = Run) Bit 2 = P20.1.11 (default = Fault) Bit 3 = P20.1.12 (default = Fault Invert) Bit 4 = P20.1.13 (default = Warning) Bit 5 = P20.1.14 (default = Reversed) Bit 6 = P20.1.15 (default = At Speed) Bit 7 = P20.1.16 (default = Zero Frequency) Bit 8 - 15 = Not Used
M51	Output				0	2445	
M52	Reference				0	2447	
M53	Total MWh Count				Varies	601	
M54	Total Power Day Count				Varies	603	
M55	Total Power Hr Count				Varies	606	
M56	Trip MWh Count				Varies	604	
M57	Trip Power Day Count				Varies	636	
M58	Trip Power Hr Count				Varies	637	
M59	Multi-Monitoring				1,2,3	30	

Table 47. Operate mode—O

Code	Parameter	Min.	Max.	Unit	Default	ID	Note
O1	Output Frequency			Hz	0.00	1	
O2	Freq Reference			Hz	0.00	24	
O3	Motor Speed			rpm	0	2	
O4	Motor Current			A	0.0	3	
O5	Motor Torque			%	0.0	4	
O6	Motor Power			%	0.0	5	
O7	Motor Voltage			V	0.0	6	
O8	DC-link Voltage			V	0	7	
O9	Unit Temperature			°C	0.0	8	
O10	Motor Temperature			%	0.0	9	
R12 ②	Keypad Reference	See Para ID 101	See Para ID 102	Hz	0.00	141	
R13 ②	PID1 Keypad Set Point 1	See Para ID 1298	See Para ID 1300	Varies	0	1307	
R14 ②	PID1 Keypad Set Point 2	See Para ID 1298	See Para ID 1300	Varies	0	1309	

Note: ① Parameter value can only be changed after the drive has stopped.
 ② Parameter value will be set to be default when changing macros.

Chapter 6 — Multi-Pump and fan control application

Table 48. Basic parameters—P1

Code	Parameter	Min.	Max.	Unit	Default	ID	Note
P1.1 ①②	Min Frequency	0.00	See Para ID 102	Hz	0.00	101	
P1.2 ①②③	Max Frequency	See Para ID 101	400.00/320.00	Hz	60.00	102	
P1.3 ②	Accel Time 1	0.1	3000.0	s	3.0	103	
P1.4 ②	Decel Time 1	0.1	3000.0	s	3.0	104	
P1.5 ①	Motor Nom Current	Drive Nom CT*1/10	Drive Nom CT*2	A	Drive Nom CT	486	
P1.6 ①③	Motor Nom Speed	300	20000/19200	rpm	Motor Nom Speed	489	
P1.7 ①	Motor PF	0.30	1.00		0.85	490	
P1.8 ①	Motor Nom Voltage	180	690	V	Motor Nom Volt	487	
P1.9 ①③	Motor Nom Frequency	8.00	400.00/320.00	Hz	Motor Nom Freq	488	
P1.10 ②	Power Up Local Remote Select				0	1685	0 = Hold Last 1 = Local Control 2 = Remote Control
P1.11 ②	Remote1 Control Place				0	135	0 = I/O Terminal Start 1 1 = Fieldbus 2 = I/O Terminal Start 2 3 = Keypad
P1.12	Local Control Place				0	1695	0 = Keypad 1 = I/O Terminal Start 1 2 = I/O Terminal Start 2 3 = Fieldbus
P1.13 ②	Bumpless Enable				0	2462	0 = Disabled 1 = Enabled
P1.14 ①②	Local Reference				6	136	0 = AI1 1 = AI2 2 = Slot A: AI1 3 = Slot B: AI1 4 = AI1 Joystick 5 = AI2 Joystick 6 = Keypad 7 = Fieldbus Ref 9 = Max Frequency 10 = AI1 + AI2 11 = AI1–AI2 12 = AI2–AI1 13 = AI1 * AI2 14 = AI1 or AI2 15 = Min (AI1, AI2) 16 = MAX(AI1, AI2) 17 = PID1 Control Output 18 = PID2 Control Output
P1.15 ①②	Remote1 Reference				1	137	See Para ID 136
P1.16 ①	Reverse Enable				1	1679	0 = Disabled 1 = Enabled
P1.17 ②	Run Delay Time	0	32500	s	0	2423	
P1.18 ②	HOA Source	0	2		0	2465	0 = Disable 1 = I/O Terminal 2 = Keypad

- Note:**
- ① Parameter value can only be changed after the drive has stopped.
 - ② Parameter value will be set to be default when changing macros.
 - ③ Input function is Level sensed
 - ④ Input function is edge sensed
 - ⑤ Input function is edge sensed when using StartP/StopP start logic See Para ID 143 and 2206
 - ⑧ DG1 Frame 1-6/DG1 Frame 7-8

Table 49. Analog input—P2

Code	Parameter	Min.	Max.	Unit	Default	ID	Note
P2.1.1	AI Ref Scale Min Value	0.00	See Para ID 145	Hz	0	144	
P2.1.2	AI Ref Scale Max Value	See Para ID 144	400.00	Hz	0	145	
P2.2.1 ②	AI1 Mode	0	1		1	222	0 = 0–20 mA 1 = 0–10 V
P2.2.2 ②	AI1 Signal Range	0	2		0	175	0 = 0–100% / 0–20 mA / 0–10 V 1 = 20–100% / 4–20 mA / 2–10 V 2 = Customized
P2.2.3 ②	AI1 Custom Min	0.00	See Para ID 177	%	0.00	176	
P2.2.4 ②	AI1 Custom Max	See Para ID 176	100.00	%	100.00	177	
P2.2.5 ②	AI1 Filter Time	0.00	10.00	s	0.10	174	
P2.2.6 ②	AI1 Signal Invert	0	1		0.00	181	0 = Not Inverted 1 = Inverted
P2.2.7 ②	AI1 Joystick Hyst	0.00	20.00	%	0.00	178	
P2.2.8 ②	AI1 Sleep Limit	0.00	100.00	%	0.00	179	
P2.2.9 ②	AI1 Sleep Delay	0.00	320.00	s	0.00	180	
P2.2.10 ②	AI1 Joystick Offset	–50.00	50.00	%	0.00	133	
P2.3.1 ②	AI2 Mode	0	2		1	223	0 = 0–20 mA 1 = 0–10 V 2 = –10 to +10 V
P2.3.2 ②	AI2 Signal Range	0	2		0	183	0 = 0–100% / 0–20 mA / 0–10 V 1 = 20–100% / 4–20 mA / 2–10 V 2 = Customized
P2.3.3 ②	AI2 Custom Min	0.00	See Para ID 185	%	0.00	184	
P2.3.4 ②	AI2 Custom Max	See Para ID 184	100.00	%	100.00	185	
P2.3.5 ②	AI2 Filter Time	0.00	10.00	s	0.10	182	
P2.3.6 ②	AI2 Signal Invert	0	1		0.00	189	0 = Not Inverted 1 = Inverted
P2.3.7 ②	AI2 Joystick Hyst	0.00	20.00	%	0.00	186	
P2.3.8 ②	AI2 Sleep Limit	0.00	100.00	%	0.00	184	
P2.3.9 ②	AI2 Sleep Delay	0.00	320.00	s	0.00	188	
P2.3.10 ②	AI2 Joystick Offset	–50.00	50.00	%	0.00	134	
P2.4.1 ②	Fine Tuning Input	0	5		0	2484	0 = Not Used 1 = AI1 2 = AI2 3 = Slot A: AI1 4 = Slot A: AI1 5 = Fieldbus
P2.4.2 ②	Fine Tuning Min	0.00	100.00	%	0.00	2485	
P2.4.3 ②	Fine Tuning Max	0.00	100.00	%	0.00	2486	

- Note:**
- ① Parameter value can only be changed after the drive has stopped.
 - ② Parameter value will be set to be default when changing macros.
 - ③ Input function is Level sensed
 - ④ Input function is edge sensed
 - ⑤ Input function is edge sensed when using StartP/StopP start logic See Para ID 143 and 2206

Chapter 6 — Multi-Pump and fan control application

Table 50. Digital input—P3

Code	Parameter	Min.	Max.	Unit	Default	ID	Note
P3.1 ①②	IO Terminal 1Start/Stop Logic				0	143	0 = Forward–Reverse 1 = Start–Reverse 2 = Start–Enable 3 = Start Pulse–Stop Pulse
P3.2 ②⑤	IO Terminal 1Start Signal 1				2	190	0 = DigIN:ForceOpen 1 = DigIN:ForceClose 2 = DigIN: 1 3 = DigIN: 2 4 = DigIN: 3 5 = DigIN: 4 6 = DigIN: 5 7 = DigIN: 6 8 = DigIN: 7 9 = DigIN: 8 10 = DigIN: A: IO1: 1 11 = DigIN: A: IO1: 2 12 = DigIN: A: IO1: 3 13 = DigIN: A: IO5: 1 14 = DigIN: A: IO5: 2 15 = DigIN: A: IO5: 3 16 = DigIN: A: IO5: 4 17 = DigIN: A: IO5: 5 18 = DigIN: A: IO5: 6 19 = DigIN: B: IO1: 1 20 = DigIN: B: IO1: 2 21 = DigIN: B: IO1: 3 22 = DigIN: B: IO5: 1 23 = DigIN: B: IO5: 2 24 = DigIN: B: IO5: 3 25 = DigIN: B: IO5: 4 26 = DigIN: B: IO5: 5 27 = DigIN: B: IO5: 6 28 = Time Channel 1 29 = Time Channel 2 30 = Time Channel 3 31 = RO1 Function 32 = RO2 Function 33 = RO3 Function 34 = Virtual RO1 Function 35 = Virtual RO2 Function
P3.3 ②⑤	IO Terminal 1Start Signal 2				3	191	See Para ID 190
P3.4 ①②	Thermistor Input Select				0	881	0 = Digital Input 1 = Thermistor Input
P3.5 ②③	Reverse				0	198	See Para ID 190
P3.6 ②③	Ext. Fault 1 NO				4	192	See Para ID 190
P3.7 ②③	Ext. Fault 1 NC				1	193	See Para ID 190
P3.8 ②④	Fault Reset				5	200	See Para ID 190
P3.9 ②③	Run Enable				1	194	See Para ID 190
P3.10 ②③	Preset Speed B0				6	205	See Para ID 190
P3.11 ②③	Preset Speed B1				7	206	See Para ID 190
P3.12 ②③	Preset Speed B2				0	207	See Para ID 190
P3.13 ②③	PID1 Control Enable				1	550	See Para ID 190
P3.15 ②③	Accel/Decel Time Set				0	195	See Para ID 190
P3.16 ②③	Accel/Decel Prohibit				0	201	See Para ID 190
P3.17 ②④	No Access To Param				0	215	See Para ID 190
P3.21 ②③	Remote Control				9	196	See Para ID 190
P3.22 ②③	Local Control				0	197	See Para ID 190

- Note:** ① Parameter value can only be changed after the drive has stopped.
 ② Parameter value will be set to be default when changing macros.
 ③ Input function is Level sensed
 ④ Input function is edge sensed
 ⑤ Input function is edge sensed when using StartP/StopP start logic See Para ID 143 and 2206

Table 50. Digital input—P3, continued

Code	Parameter	Min.	Max.	Unit	Default	ID	Note
P3.23 ②③	Remote1/2 Select				0	209	See Para ID 190
P3.24 ②③	Second Motor Para Select				0	217	See Para ID 190
P3.25 ②④	Bypass Start				0	218	See Para ID 190
P3.26 ②③	DC Brake Enable				0	202	See Para ID 190
P3.27 ②③	Smoke Mode				0	219	See Para ID 190
P3.28 ②③	Fire Mode				0	220	See Para ID 190
P3.29 ②③	Fire Mode Ref Select				0	221	See Para ID 190
P3.30 ②③	PID1 Set Point Select				0	351	See Para ID 190
P3.32 ②③	Jog Enable				0	199	See Para ID 190
P3.33 ②④	Start Timer 1				0	224	See Para ID 190
P3.34 ②④	Start Timer 2				0	225	See Para ID 190
P3.35 ②④	Start Timer 3				0	226	See Para ID 190
P3.36 ②③	AI Ref Source Select				0	208	See Para ID 190
P3.37 ②③	Motor Interlock 1				0	210	See Para ID 190
P3.38 ②③	Motor Interlock 2				0	211	See Para ID 190
P3.39 ②③	Motor Interlock 3				0	212	See Para ID 190
P3.40 ②③	Motor Interlock 4				0	213	See Para ID 190
P3.41 ②③	Motor Interlock 5					214	See Para ID 190
P3.42 ②③	Emergency Stop				1	747	See Para ID 190
P3.43 ②③	Bypass Overload				0	1246	See Para ID 190
P3.44 ②④	Fire Mode Reverse				0	2118	See Para ID 190
P3.45 ①②	IO Terminal 2 Start Stop Logic				0	2206	See Para ID 190
P3.46 ②⑤	IO Terminal 2 Start Signal 1				2	2207	See Para ID 190
P3.47 ②⑤	IO Terminal 2 Start Signal 2				3	2208	See Para ID 190
P3.48 ②③	Ext. Fault 2 NO				0	2293	See Para ID 190
P3.49 ②③	Ext. Fault 2 NC				1	2294	See Para ID 190
P3.50 ②③	Ext. Fault 3 NO				0	2295	See Para ID 190
P3.51 ②③	Ext. Fault 3 NC				1	2296	See Para ID 190
P3.52 ②	Ext. Fault 1 Text				0	2297	0 = External Fault 1 = Vibration Cut out 2 = High Motor temp 3 = Low Pressure 4 = High Pressure 5 = Low Water 6 = Damper Interlock 7 = Run Enable 8 = Freeze Stat Trip 9 = Smoke Detect 10 = Seal Leakage 11 = Rod Breakage
P3.53 ②	Ext. Fault 2 Text				1	2298	0 = External Fault 1 = Vibration Cut out 2 = High Motor temp 3 = Low Pressure 4 = High Pressure 5 = Low Water 6 = Damper Interlock 7 = Run Enable 8 = Freeze Stat Trip 9 = Smoke Detect 10 = Seal Leakage 11 = Rod Breakage

Note: ① Parameter value can only be changed after the drive has stopped.
 ② Parameter value will be set to be default when changing macros.
 ⑥ Function is not available in FR7 and FR8 of DG1 drives.

Chapter 6 — Multi-Pump and fan control application

Table 50. Digital input—P3, continued

Code	Parameter	Min.	Max.	Unit	Default	ID	Note
P3.54 ②	Ext. Fault 3 Text				2	2299	0 = External Fault 1 = Vibration Cut out 2 = High Motor temp 3 = Low Pressure 4 = High Pressure 5 = Low Water 6 = Damper Interlock 7 = Run Enable 8 = Freeze Stat Trip 9 = Smoke Detect 10 = Seal Leakage 11 = Rod Breakage
P3.55 ②④	Parameter Set1/2 Sel				0	2312	See Para ID 190
P3.56 ②④	Deragging Enable				0	2394	See Para ID 190
P3.57 ②③	Off Control				0	2395	See Para ID 190

Table 51. Analog output—P4

Code	Parameter	Min.	Max.	Unit	Default	ID	Note
P4.1 ②	AO1 Mode				0	227	0 = 0–20 mA 1 = 0–10 V
P4.2 ②	AO1 Function				1	146	0 = Not Used 1 = Output Frequency 2 = Freq Reference 3 = Motor Speed 4 = Motor Current 5 = Motor Torque (0–Nom) 6 = Motor Power 7 = Motor Voltage 8 = DC-Bus Voltage 9 = PID1 Setpoint 10 = PID1 Feedback 1 11 = PID1 Feedback 2 12 = PID1 Control Error Value 13 = PID1 Control Output 19 = AI1 20 = AI2 21 = Output Freq (–2 to +2N) 22 = Motor Torque (–2 to +2N) 23 = Motor Power (–2 to +2N) 24 = PT100 Temperature 25 = FB Data Input 1 26 = FB Data Input 2 27 = FB Data Input 3 28 = FB Data Input 4 29 = FB Data Input 5 30 = FB Data Input 6 31 = FB Data Input 7 32 = FB Data Input 8 33 = SlotA PT100 Temp Channel 1 34 = SlotA PT100 Temp Channel 2 35 = SlotA PT100 Temp Channel 3 36 = SlotB PT100 Temp Channel 1 37 = SlotB PT100 Temp Channel 2 38 = SlotB PT100 Temp Channel 3 39 = User Defined Output 40 = Motor Current(–2 to +2N)
P4.3 ②	AO1 Minimum				1	149	0 = 0 V / 0 mA 1 = 2 V / 4 mA
P4.4 ②	AO1 Filter Time	0.00	10.00	s	1.00	147	
P4.5 ②	AO1 Scale	10	1000	%	100	150	
P4.6 ②	AO1 Inversion				0	148	0 = Not Inverted 1 = Inverted
P4.7 ②	AO1 Offset	–100.00	100.00	%	0.00	173	

Note: ① Parameter value can only be changed after the drive has stopped.

② Parameter value will be set to be default when changing macros.

Table 51. Analog output—P4 , continued

Code	Parameter	Min.	Max.	Unit	Default	ID	Note
P4.8 ②	A02 Mode				0	228	See Para ID 227
P4.9 ②	A02 Function				4	229	See Para ID 146
P4.10 ②	A02 Minimum				1	232	See Para ID 149
P4.11 ②	A02 Filter Time	0.00	10.00	s	1.00	230	
P4.12 ②	A02 Scale	10	1000	%	100	233	
P4.13 ②	A02 Inversion				0	231	See Para ID 148
P4.14 ②	A02 Offset	-100.00	100.00	%	0.00	234	

Table 52. Digital output—P5

Code	Parameter	Min.	Max.	Unit	Default	ID	Note
P5.1 ②	D01 Function				1	151	0 = Not Used 1 = Ready 2 = Run 3 = Fault 4 = Fault Invert 5 = Warning 6 = Reversed 7 = At Speed 8 = Zero Frequency 9 = Freq Limit 1 Superv 10 = Freq Limit 2 Superv 11 = PID1 Superv 13 = Overheat Fault 14 = Overcurrent Regular 15 = Overvoltage Regular 16 = Undervoltage Regular 17 = 4 mA Ref Fault/Warning 20 = Torq Limit Superv 21 = Ref Limit Superv 22 = Control from I/O 23 = Un-Requested Rotation Direction 24 = Thermistor Fault Output 25 = Fire Mode 26 = In Bypass Mode 27 = Ext Fault/Warning 28 = Remote Control 29 = Jog Speed Select 30 = Motor Therm Protection 31 = FB Digital Input 1 32 = FB Digital Input 2 33 = FB Digital Input 3 34 = FB Digital Input 4 35 = Damper Control 36 = TC1 Status 37 = TC2 Status 38 = TC3 Status 39 = In E-Stop 40 = Power Limit Superv 41 = Temp Limit Superv 42 = Analog Input Superv 43 = Motor 1 Control 44 = Motor 2 Control 45 = Motor 3 Control 46 = Motor 4 Control 47 = Motor 5 Control 49 = PID1 Sleep 51 = Motor Current 1 Supv 52 = Motor Current 2 Supv 53 = Second AI Limit Supv 54 = DC Charge Switch Close 55 = Preheat Active 56 = Cold Weather Active ⑥ 57 = Pre-Charge Active 58 = 2th Stage Ramp Frequency Active 59 = STO Fault 60 = Run Bypass/Drive 61 = Bypass Overload

Note: ① Parameter value can only be changed after the drive has stopped.

② Parameter value will be set to be default when changing macros.

⑥ Function is not available in FR7 and FR8 of DG1 drives.

Chapter 6 — Multi-Pump and fan control application

Table 52. Digital output—P5, continued

Code	Parameter	Min.	Max.	Unit	Default	ID	Note
P5.2 ②	RO1 Function				2	152	See Para ID 151
P5.3 ②	RO2 Function				3	153	See Para ID 151
P5.4 ②	RO3 Function				7	538	See Para ID 151
P5.5 ②	Virtual RO1 Function				0	2463	See Para ID 151
P5.6 ②	Virtual RO2 Function				0	2464	See Para ID 151
P5.7 ②	Freq Limit 1 Supv				0	154	0 = No Limit 1 = Low Limit Superv 2 = High Limit Superv
P5.8 ②	Freq Limit 1 Supv Val	0.00	See Para ID 102	Hz	0.00	155	
P5.9 ②	Freq Limit 2 Supv				0	157	0 = No Limit 1 = Low Limit Superv 2 = High Limit Superv
P5.10 ②	Freq Limit 2 Supv Val	0.00	See Para ID 102	Hz	0.00	158	
P5.11 ②	Torque Limit Supv				0	159	0 = No Limit 1 = Low Limit Superv 2 = High Limit Superv
P5.12 ②	Torque Limit Supv Val	-1000.0	1000.0	%	100.0	160	
P5.13 ②	Ref Limit Supv				0	161	0 = No Limit 1 = Low Limit Superv 2 = High Limit Superv
P5.14 ②	Ref Limit Supv Val	0.00	See Para ID 102	Hz	0.00	162	
P5.17 ②	Temp Limit Supv				0	165	See Para ID 161
P5.18 ②	Temp Limit Supv Val	-10.0	75.0	°C	40.0	166	
P5.19 ②	Power Limit Supv				0	167	See Para ID 161
P5.20 ②	Power Limit Supv Val	0.0	200.0	%	0.0	168	
P5.21 ②	AI Supv Select				0	170	0 = AI1 1 = AI2
P5.22 ②	AI Limit Supv				0	171	See Para ID 161
P5.23 ②	AI Limit Supv Val	0.00	100.00	%	0.00	172	
P5.24 ②	PID1 Superv Enable				0	1346	0 = Disabled 1 = Enabled
P5.25 ②	PID1 Superv Upper Limit	See Para ID 1298	See Para ID 1300	Varies	0.00	1347	
P5.26 ②	PID1 Superv Lower Limit	See Para ID 1298	See Para ID 1300	Varies	0.00	1349	
P5.27 ②	PID1 Superv Delay	0	3000	s	0	1351	
P5.32 ②	RO1 On Delay	0	320	s	0	2112	
P5.33 ②	RO1 Off Delay	0	320	s	0	2113	
P5.34 ②	RO2 On Delay	0	320	s	0	2114	
P5.35 ②	RO2 Off Delay	0	320	s	0	2115	
P5.36 ②	RO3 On Delay	0	320	s	0	2116	
P5.37 ②	RO3 Off Delay	0	320	s	0	2117	
P5.38 ②	RO3 Reverse				0	2118	0 = No 1 = Yes
P5.39 ②	Motor Current 1 Supv				0	2189	0 = No Limit 1 = Low Limit Superv 2 = High Limit Superv
P5.40 ②	Motor Current 1 Supv Value	0	DriveNomCurrCT*2	A	DriveNomCurrCT	2190	
P5.41 ②	Motor Current 2 Supv				0	2191	0 = No Limit 1 = Low Limit Superv 2 = High Limit Superv
P5.42 ②	Motor Current 2 Supv Value	0	DriveNomCurrCT*2	A	DriveNomCurrCT	2192	
P5.43 ②	Second AI Supv Select				0	2193	0 = AI1 1 = AI2

Note: ① Parameter value can only be changed after the drive has stopped.
② Parameter value will be set to be default when changing macros.

Table 52. Digital output—P5, continued

Code	Parameter	Min.	Max.	Unit	Default	ID	Note
P5.44 ②	Second AI Limit Supv				0	2194	See Para ID 161
P5.45 ②	Second AI Limit Supv Val	0	100	%	0	2195	
P5.46 ②	Motor Current 1 Supv Hyst	0.1	1	A	0.1	2196	
P5.47 ②	Motor Current 2 Supv Hyst	0.1	1	A	0.1	2197	
P5.48 ②	AI Supv Hyst	1	10	%	1	2198	
P5.49 ②	Second AI Supv Hyst	1	10	%	1	2199	
P5.50 ②	Freq Limit 1 Supv Hyst	0.1	1	Hz	0.1	2200	
P5.51 ②	Freq Limit 2 Supv Hyst	0.1	1	Hz	0.1	2201	
P5.52 ②	Torque Limit Supv Hyst	1	5	%	1	2202	
P5.53 ②	Ref Limit Supv Hyst	0.1	1	Hz	0.1	2203	
P5.54 ②	Temp Limit Supv Hyst	1	10	deg C	1	2204	
P5.55 ②	Power Limit Supv Hyst	0.1	10	%	0.1	2205	

Table 53. Drive control—P7

Code	Parameter	Min.	Max.	Unit	Default	ID	Note
P7.1 ②	Remote 2 Control Place				1	138	See Para ID 135
P7.2 ①②	Remote 2 Reference				7	139	See Para ID 136
P7.3 ②	Keypad Reference	See Para ID 101	See Para ID 102	Hz	0.00	141	
P7.4 ②	Keypad Direction				0	116	0 = Forward 1 = Reverse
P7.5 ②	Keypad Stop				1	114	0 = Enabled-Keypad Operation 1 = Always Enabled
P7.6 ②	Jog Reference	See Para ID 101	See Para ID 102	Hz	0.00	117	
P7.9 ②	Start Mode				0	252	0 = Ramp 1 = Flying Start
P7.10 ②	Stop Mode				1	253	0 = Coasting 1 = Ramp
P7.11 ②	Ramp 1 Shape	0.0	10.0	s	0.0	247	
P7.12 ②	Ramp 2 Shape	0.0	10.0	s	0.0	248	
P7.13 ②	Accel Time 2	0.1	3000.0	s	10.0	249	
P7.14 ②	Decel Time 2	0.1	3000.0	s	10.0	250	
P7.15 ②	Skip F1 Low Limit	0.00	See Para ID 257	Hz	0.00	256	
P7.16 ②⑧	Skip F1 High Limit	See Para ID 256	400.00/320.00	Hz	0.00	257	
P7.17 ②	Skip F2 Low Limit	0.00	See Para ID 259	Hz	0.00	258	
P7.18 ②⑧	Skip F2 High Limit	See Para ID 258	400.00/320.00	Hz	0.00	259	
P7.19 ②	Skip F3 Low Limit	0.00	See Para ID 261	Hz	0.00	260	
P7.20 ②⑧	Skip F3 High Limit	See Para ID 260	400.00/320.00	Hz	0.00	261	
P7.21 ②	Prohibit Accel/Decel Ramp	0.1	10.0		1.0	264	
P7.22 ②④	Power Loss Function				0	267	0 = Disabled 1 = Enabled
P7.23 ②④	Power Loss Time	0.3	5.0	s	2.0	268	
P7.24 ②	Currency				\$	2122	0 = \$ 1 = GBP 2 = Eur 3 = JPY 4 = Rs 5 = R\$ 6 = Fr 7 = Kr
P7.25 ②	Energy Cost				0	2123	

Note: ① Parameter value can only be changed after the drive has stopped.
 ② Parameter value will be set to be default when changing macros.
 ④ Function is not available in FR7 and FR8 of DG1 drives.
 ⑧ DG1 Frame 1-6/DG1 Frame 7-8

Chapter 6 — Multi-Pump and fan control application

Table 53. Protections—P9, continued

Code	Parameter	Min.	Max.	Unit	Default	ID	Note
P7.26 ②	Data Type				0	2124	0 = Cumulative 1 = Daily Avg 2 = Weekly Avg 3 = Monthly Avg 4 = Yearly Avg
P7.27 ②	Energy Savings Reset				0	2125	0 = No Action 1 = Reset
P7.28 ②	2th Stage Ramp Frequency	See Para ID 101	See Para ID 102	Hz	30	2444	
P7.29 ②	Change Phase Sequence Motor	0	1	0	0	2515	0 = Change Disable 1 = Change Enable

Table 54. Motor control—P8

Code	Parameter	Min.	Max.	Unit	Default	ID	Note
P8.1 ①②	Motor Control Mode				0	287	0 = Freq Control 1 = Speed Control
P8.2 ①	Current Limit	Drive Nom CT*1/10	Drive Nom CT*2	A	Drive Nom VT	107	
P8.3 ①②	V/Hz Optimization				0	109	0 = Disabled 1 = Enabled
P8.4 ①②	V/Hz Ratio				0	108	0 = Linear 1 = Squared 2 = Programmable 3 = Linear + Flux Optimization
P8.5 ①②⑥	Field Weakening Point	8.00	400.00/320.00	Hz	60.00	289	
P8.6 ①②	Voltage at FWP	10.00	200.00	%	100.00	290	
P8.7 ①②	V/Hz Mid Frequency	0.00	See Para ID 289	Hz	V/Hz Curve Midpoint Freq	291	
P8.8 ①②	V/Hz Mid Voltage	0.00	100.00	%	100.00	292	
P8.9 ①②	Zero Frequency Voltage	0.00	40.00	%	0.00	293	
P8.10 ②	Switching Frequency	Min Switch Freq	Max Switch Freq	kHz	Default Switching Freq CT	288	
P8.11 ②	Sine Filter Enable				0	1665	0 = Disabled 1 = Enabled
P8.12 ①②	Overvoltage Control				1	294	0 = Disabled 1 = Enabled
P8.14 ②⑦	Identification				0	299	0 = No Action 1 = Identification Only Stator Resistor 2 = Identification with Run 3 = Identification No Run
P8.17 ②⑥	Frequency Ramp Out FilterTime Constant	0	3000	ms	0	1585	
P8.39 ②	Start Boost Rise Time	0	32000	s	0	1622	
P8.45 ②⑦	Torque Memory Start	-300.0	300.0	%	0.0	1632	
P8.50 ①⑦	Stator Resistor	0.001	65.535	ohm	0.033	771	
P8.52 ①⑦	Leak Inductance	0.001	65.535	mh	0.128	773	

Table 55. Protections—P9

Code	Parameter	Min.	Max.	Unit	Default	ID	Note
P9.1 ①②	4 mA Input Fault				0	306	0 = No Action 1 = Warning 2 = Warning: Previous Freq 3 = Warning: Preset Freq 4 = Fault 5 = Fault, Coast
P9.2 ①②	4 mA Fault Frequency	0.00	See Para ID 102	Hz	0.00	331	
P9.3 ①②	External Fault				2	307	See Para ID 313

- Note:** ① Parameter value can only be changed after the drive has stopped.
 ② Parameter value will be set to be default when changing macros.
 ⑥ Function is not available in FR7 and FR8 of DG1 drives.
 ⑦ Function is only available in FR7 and FR8 of DG1 drives.
 ⑧ DG1 Frame 1-6/DG1 Frame 7-8

Table 55. Protections—P9, continued

Code	Parameter	Min.	Max.	Unit	Default	ID	Note
P9.4 ①②	Input Phase Fault				2	332	0 = No Action 1 = Warning(6) 2 = Fault 3 = Fault, Coast(6)
P9.5 ①②	Uvoltage Fault Response				2	330	See Para ID 313
P9.6 ①②	Output Phase Fault				2	308	See Para ID 313
P9.7 ①②	Ground Fault				2	309	See Para ID 313
P9.8 ①②	Motor Thermal Protection				2	310	See Para ID 313
P9.9 ②⑥	Motor Thermal F0 Current	0.0/5.0	150.0	%	40.0/60.0	311	
P9.10 ②⑥	Motor Thermal Time	1	200	min	45/78	312	
P9.11 ①②	Stall Protection				0	313	0 = No Action 1 = Warning 2 = Fault 3 = Fault, Coast
P9.12 ②	Stall Current Limit	0.1	Active Motor Nom I*2	A	Active Motor Nom I*13/10	314	
P9.13 ②	Stall Time Limit	1.0	120.0	s	15.0	315	
P9.14 ②	Stall Frequency Limit	1.00	See Para ID 102	Hz	25.00	316	
P9.15 ①②	Underload Protection				0	317	See Para ID 313
P9.16 ②	Underload Fnom Torque	10.0	150.0	%	50.0	318	
P9.17 ②	Underload F0 Torque	5.0	150.0	%	10.0	319	
P9.18 ②	Underload Time Limit	2.00	600.00	s	20.00	320	
P9.19 ①②	Thermistor Fault Response				2	333	See Para ID 313
P9.20 ②	Line Start Lockout				2	750	0 = Disabled, No Change 1 = Enable, No Change 2 = Disabled, Changed 3 = Enable, Changed
P9.21 ①②	Fieldbus Fault Response				2	334	See Para ID 313
P9.22 ①②	OPTCard Fault Response				2	335	See Para ID 313
P9.23 ①②	Unit Under Temp Prot				2	1564	See Para ID 313
P9.24 ②	Wait Time	1.00	300.00	s	1.00	321	
P9.25 ②	Trail Time	0.00	600.00	s	30.00	322	
P9.26 ②	Start Function				0	323	0 = Flying Start 1 = Ramp
P9.27 ②	Undervoltage Attempts	0	10		1	324	
P9.28 ②	Overvoltage Attempts	0	10		1	325	
P9.29 ②	Overcurrent Attempts	0	3		1	326	
P9.30 ②	4 mA Fault Attempts	0	10		1	327	
P9.31 ②	Motor Temp Fault Attempts	0	10		1	329	
P9.32 ②	External Fault Attempts	0	10		0	328	
P9.33 ②	Underload Attempts	0	10		1	336	
P9.34 ①②	RTC Fault				1	955	See Para ID 313
P9.35 ①②	PT100 Fault Response				2	337	See Para ID 313
P9.36 ①②	Replace Battery Fault Response				1	1256	See Para ID 313
P9.37 ①②	Replace Fan Fault Response				1	1257	See Para ID 313
P9.38 ①②	IP Address Confliction Resp				1	1678	See Para ID 313
P9.39 ②⑥	Cold Weather Mode				0	2126	0 = Disable 1 = Enable
P9.40 ②⑥	Cold Weather Voltage Level	0	20	%	2	2127	
P9.41 ②⑥	Cold Weather Time Out	0	10	min	3	2128	

Note: ① Parameter value can only be changed after the drive has stopped.
 ② Parameter value will be set to be default when changing macros.
 ⑥ Function is not available in FR7 and FR8 of DG1 drives.
 ⑦ Function is only available in FR7 and FR8 of DG1 drives.
 ⑧ DG1 Frame 1-6/DG1 Frame 7-8

Chapter 6 — Multi-Pump and fan control application

Table 55. Protections—P9, continued

Code	Parameter	Min.	Max.	Unit	Default	ID	Note
P9.44 ②⑥	Ground Fault Limit	0	30	%	15	2158	
P9.45 ①②	Keypad Comm Fault Response				2	2157	See Para ID 313
P9.46 ②	Preheat Mode				0	2159	0 = Disabled 1 = Enabled
P9.47 ②	Preheat Temp Source				31	2160	0 = DigIN: NormallyOpen 1 = DigIN: NormallyClosed 2 = DigIN: 1 3 = DigIN: 2 4 = DigIN: 3 5 = DigIN: 4 6 = DigIN: 5 7 = DigIN: 6 8 = DigIN: 7 9 = DigIN: 8 10 = DigIN: A: IO1: 1 11 = DigIN: A: IO1: 2 12 = DigIN: A: IO1: 3 13 = DigIN: A: IO5: 1 14 = DigIN: A: IO5: 2 15 = DigIN: A: IO5: 3 16 = DigIN: A: IO5: 4 17 = DigIN: A: IO5: 5 18 = DigIN: A: IO5: 6 19 = DigIN: B: IO1: 1 20 = DigIN: B: IO1: 2 21 = DigIN: B: IO1: 3 22 = DigIN: B: IO5: 1 23 = DigIN: B: IO5: 2 24 = DigIN: B: IO5: 3 25 = DigIN: B: IO5: 4 26 = DigIN: B: IO5: 5 27 = DigIN: B: IO5: 6 28 = Time Channel 1 29 = Time Channel 2 30 = Time Channel 3 31 = Drive Temperature 32 = Slot A PT100 Temp Channel 1 33 = Slot A PT100 Temp Channel 2 34 = Slot A PT100 Temp Channel 3 35 = Slot A Max PT100 Temp 36 = Slot B PT100 Temp Channel 1 37 = Slot B PT100 Temp Channel 2 38 = Slot B PT100 Temp Channel 3 39 = Slot B Max PT100 Temp 40 = Slot A and Slot B Max PT100 Temp
P9.48 ②	Preheat Enter Temp	0.0	19.9	°C	10.0	2161	
P9.49 ②	Preheat Quit Temp	20.0	40.0	°C	20.0	2162	
P9.50 ②⑧	Preheat Output Voltage Preheat Output Current	0.0/0	20.0/50	%	2.0/20	2163	
P9.51 ②	PID Feedback AI loss Response				0	2401	0 = No Action 1 = Warning 2 = Fault 3 = Warning: Preset Frequency 4 = Warning: Analog ->Net
P9.52 ②	PID Feedback AI Loss Pre Freq	0.00	400.00	Hz	0.00	2402	
P9.53 ②	PID Feedback AI Loss Pipe Fill Level	0.0	1000.0	A	0.0	2403	
P9.54 ②	PID Feedback AI Loss Prefreq Timeout	0	6000	s	0	2404	

Note: ① Parameter value can only be changed after the drive has stopped.
 ② Parameter value will be set to be default when changing macros.
 ⑧ DG1 Frame 1-6/DG1 Frame 7-8

Table 55. Protections—P9, continued

Code	Parameter	Min.	Max.	Unit	Default	ID	Note
P9.55 ②	PID Feedback AI Loss Attempts	0	10		1	2405	
P9.56 ②	STO Fault Response				2	2429	0 = No Action 1 = Warning 2 = Fault
P9.57 ②	Fault Reset Start	0	1		0	2483	0 = Start/Stop After Fault Reset 1 = Restart After Fault Reset

Table 56. PID controller 1—P10

Code	Parameter	Min.	Max.	Unit	Default	ID	Note
P10.1 ②	PID1 Control Gain	0.00	200.00	%	100.00	1294	
P10.2 ②	PID1 Control ITime	0.00	600.00	s	1.00	1295	
P10.3 ②	PID1 Control DTime	0.00	100.00	s	0.00	1296	
P10.4 ①②	PID1 Process Unit				0	1297	0 = % 1 = 1/min 2 = rpm 3 = ppm 4 = pps 5 = l/s 6 = l/min 7 = l/h 8 = kg/s 9 = kg/min 10 = kg/h 11 = m ³ /s 12 = m ³ /min 13 = m ³ /h 14 = m/s 15 = mbar 16 = bar 17 = Pa 18 = kPa 19 = mVS 20 = kW 21 = °C 22 = GPM 23 = gal/s 24 = gal/min 25 = gal/h 26 = lb/s 27 = lb/min 28 = lb/h 29 = CFM 30 = ft ³ /s 31 = ft ³ /min 32 = ft ³ /h 33 = ft/s 34 = in wg 35 = ft wg 36 = PSI 37 = lb/in ² 38 = HP 39 = °F 40 = PA 41 = WC 42 = HG 43 = ft 44 = m
P10.5 ②	PID1 Process Unit Min	-99999.99	99999.99	Varies	0.00	1298	
P10.6 ②	PID1 Process Unit Max	-99999.99	99999.99	Varies	100.00	1300	
P10.7 ②	PID1 Process Unit Decimal	0	4		2	1302	
P10.8 ①②	PID1 Error Inversion				0	1303	0 = Not Inverted 1 = Inverted
P10.9 ②	PID1 Dead Band	0.00	99999.99	Varies	0.00	1304	

Note: ① Parameter value can only be changed after the drive has stopped.
 ② Parameter value will be set to be default when changing macros.

Chapter 6 — Multi-Pump and fan control application

Table 56. PID controller 1—P10, continued

Code	Parameter	Min.	Max.	Unit	Default	ID	Note
P10.10 ②	PID1 Dead Band Delay	0.00	320.00	s	0.00	1306	
P10.11 ②	PID1 Keypad Set Point 1	See Para ID 1298	See Para ID 1300	Varies	0.00	1307	
P10.12 ②	PID1 Keypad Set Point 2	See Para ID 1298	See Para ID 1300	Varies	0.00	1309	
P10.13 ②	PID1 Ramp Time	0.00	300.00	s	0.00	1311	
P10.14 ①②	PID1 Set Point 1 Source				1	1312	0 = Not Used 1 = PID1 Keypad Set Point 1 2 = PID1 Keypad Set Point 2 3 = AI1 4 = AI2 5 = Slot A: AI1 6 = Slot B: AI1 7 = FB Data Input 1 8 = FB Data Input 2 9 = FB Data Input 3 10 = FB Data Input 4 11 = FB Data Input 5 12 = FB Data Input 6 13 = FB Data Input 7 14 = FB Data Input 8 16 = Multi Drive Network 17=FB PID1 Set Point 1 18=FB PID1 Set Point 2
P10.15 ②	PID1 Set Point 1 Min	-200.00	200.00	%	0.00	1313	
P10.16 ②	PID1 Set Point 1 Max	-200.00	200.00	%	100.00	1314	
P10.17 ①②	PID1 Set Point 1 Sleep Enable				0	1315	0 = Disabled 1 = Enabled
P10.18	PID1 Setpoint 1 Sleep Unit				0	2396	0 = Ouptut Frequency 1 = Motor Speed 2 = Motor Current 3 = PID1 Feedabck
P10.19 ②	PID1 Setpoint 1 Sleep Level	See Para ID 1298	See Para ID 1300	varies	0.00	2450	
P10.20 ②	PID1 Set Point 1 Sleep Delay	0	3000	s	0	1317	
P10.21 ②	PID1 Set Point 1 Wake Up Level	-99999.99	99999.99	varies	0.00	1318	
P10.22 ②	PID1 Set Point 1 Boost	-2.0	2.0		1.0	1320	
P10.23 ①②	PID1 Set Point 2 Source				2	1321	See Para ID 1312
P10.24 ②	PID1 Set Point 2 Min	-200.00	200.00	%	0.00	1322	
P10.25 ②	PID1 Set Point 2 Max	-200.00	200.00	%	100.00	1323	
P10.26 ①②	PID1 Set Point 2 Sleep Enable				0	1324	0 = Disabled 1 = Enabled
P10.27	PID1 Setpoint 2 Sleep Unit				0	2397	0 = Ouptut Frequency 1 = Motor Speed 2 = Motor Current 3 = PID1 Feedabck
P10.28 ②	PID1 Setpoint 2 Sleep Level	See Para ID 1298	See Para ID 1300	varies	0.00	2452	
P10.29②	PID1 Set Point 2 Sleep Delay	0	3000	s	0	1326	
P10.30 ②	PID1 Set Point 2 Wake Up Level	-99999.99	99999.99	varies	0.00	1327	
P10.31 ②	PID1 Set Point 2 Boost	-2.0	2.0		1.0	1329	
P10.32 ①②	PID1 Feedback Function				0	1330	0 = Source 1 1 = SQRT(Source 1) 2 = SQRT(Source 1-Source 2) 3=SQRT(Source 1)+SQRT(Source 2) 4 = Source 1 + Source 2 5 = Source 1-Source 2 6 = MIN(Source 1,Source 2) 7 = MAX(Source 1,Source 2) 8 = MEAN(Source1,Source2)
P10.33 ②	PID1 Feedback Gain	-1000.0	1000.0	%	100.0	1331	

Note: ① Parameter value can only be changed after the drive has stopped.
② Parameter value will be set to be default when changing macros.

Table 56. PID controller 1—P10, continued

Code	Parameter	Min.	Max.	Unit	Default	ID	Note
P10.34 ①②	PID1 Feedback 1 Source				1	1332	0 = Not Used 1 = AI1 2 = AI2 3 = Slot A: AI1 4 = Slot B: AI1 5 = FB Data Input 1 6 = FB Data Input 2 7 = FB Data Input 3 8 = FB Data Input 4 9 = FB Data Input 5 10 = FB Data Input 6 11 = FB Data Input 7 12 = FB Data Input 8 13 = PT100 Temperature 15 = SlotA PT100 Temp Channel 1 16 = SlotA PT100 Temp Channel 2 17 = SlotA PT100 Temp Channel 3 18 = SlotB PT100 Temp Channel 1 19 = SlotB PT100 Temp Channel 2 20 = SlotB PT100 Temp Channel 3 21=FB PID1 Feedback 1 22=FB PID1 Feedback 2
P10.35 ②	PID1 Feedback 1 Min	-200.00	200.00	%	0.00	1333	
P10.36 ②	PID1 Feedback 1 Max	-200.00	200.00	%	100.00	1334	
P10.37 ①②	PID1 Feedback 2 Source				0	1335	See Para ID 1332
P10.38 ②	PID1 Feedback 2 Min	-200.00	200.00	%	0.00	1336	
P10.39 ②	PID1 Feedback 2 Max	-200.00	200.00	%	100.00	1337	
P10.40 ①②	PID1 Feedforward Func				0	1338	0 = Source 1 1 = SQRT(Source 1) 2 = SQRT(Source 1-Source 2) 3=SQRT(Source 1)+SQRT(Source 2) 4 = Source 1 + Source 2 5 = Source 1-Source 2 6 = MIN(Source 1,Source 2) 7 = MAX(Source 1,Source 2) 8 = MEAN(Source1,Source2)
P10.41 ②	PID1 Feedforward Gain	-1000.0	1000.0	%	100.0	1339	
P10.42 ①②	PID1 Feedforward 1 Source				0	1340	0 = Not Used 1 = AI1 2 = AI2 3 = Slot A: AI1 4 = Slot B: AI1 5 = FB Data Input 1 6 = FB Data Input 2 7 = FB Data Input 3 8 = FB Data Input 4 9 = FB Data Input 5 10 = FB Data Input 6 11 = FB Data Input 7 12 = FB Data Input 8 13 = PT100 Temperature 15 = SlotA PT100 Temp Channel 1 16 = SlotA PT100 Temp Channel 2 17 = SlotA PT100 Temp Channel 3 18 = SlotB PT100 Temp Channel 1 19 = SlotB PT100 Temp Channel 2 20 = SlotB PT100 Temp Channel 3 21=FB PID1 Feedforward 1 22=FB PID1 Feedforward 2
P10.43 ②	PID1 Feedforward 1 Min	-200.00	200.00	%	0.00	1341	
P10.44 ②	PID1 Feedforward 1 Max	-200.00	200.00	%	100.00	1342	
P10.45 ①②	PID1 Feedforward 2 Source				0	1343	See Para ID 1340
P10.46 ②	PID1 Feedforward 2 Min	-200.00	200.00	%	0.00	1344	
P10.47 ②	PID1 Feedforward 2 Max	-200.00	200.00	%	100.00	1345	
P10.48 ②	PID1 Set Point 1 Comp Enable				0	1352	0 = Disabled 1 = Enabled
P10.49 ②	PID1 Set Point 1 Comp Max	-200.00	200.00	%	0.00	1353	

Note: ① Parameter value can only be changed after the drive has stopped.
② Parameter value will be set to be default when changing macros.

Chapter 6 — Multi-Pump and fan control application

Table 56. PID controller 1—P10, continued

Code	Parameter	Min.	Max.	Unit	Default	ID	Note
P10.50 ②	PID1 Set Point 2 Comp Enable				0	1354	0 = Disabled 1 = Enabled
P10.51 ②	PID1 Set Point 2 Comp Max	-200.00	200.00	%	0.00	1355	
P10.52 ②	PID1 Wake Up Action	0	3		0	2466	0 = Below Wake Up Level 1 = Above Wake Up Level 2 = Below Wake Up Level(PID ref.) -Wake up when below wakeup level % set in Para ID 1318 or 1327 from PID Setpoint. 3 = Above Wake Up Level(PID ref.) -Wake up when above wakeup level % set in Para ID 1318 or 1327 from PID Setpoint.
P10.53	FB PID1 Set Point 1	P10.5	P10.6	varies	0.00	2542	
P10.54	FB PID1 Set Point 2	P10.5	P10.6	varies	0.00	2544	
P10.55	FB PID1 Feedback 1			varies	0.00	2550	
P10.56	FB PID1 Feedback 2			varies	0.00	2551	
P10.57	FB PID1 Feedforward 1			varies	0.00	2554	
P10.58	FB PID1 Feedforward 2			varies	0.00	2555	

Table 57. Preset speed—P12

Code	Parameter	Min.	Max.	Unit	Default	ID	Note
P12.1 ②	Preset Speed 1	0.00	See Para ID 102	Hz	5.00	105	
P12.2 ②	Preset Speed 2	0.00	See Para ID 102	Hz	10.00	106	
P12.3 ②	Preset Speed 3	0.00	See Para ID 102	Hz	15.00	118	
P12.4 ②	Preset Speed 4	0.00	See Para ID 102	Hz	20.00	119	
P12.5 ②	Preset Speed 5	0.00	See Para ID 102	Hz	25.00	120	
P12.6 ②	Preset Speed 6	0.00	See Para ID 102	Hz	30.00	121	
P12.7 ②	Preset Speed 7	0.00	See Para ID 102	Hz	35.00	122	

Table 58. Brake—P14

Code	Parameter	Min.	Max.	Unit	Default	ID	Note
P14.1 ①②③	DC-Brake Current	Drive Nom CT*15/100/0.0	Drive Nom CT*15/10/Drive Nom VT*2	A	Drive Nom CT*1/2 /Drive Nom VT*1/2	254	
P14.2 ①②	Start DC-Brake Time	0.00	600.00	s	0.00	263	
P14.3 ①②	Stop DC-Brake Frequency	0.10	10.00	Hz	1.50	262	
P14.4 ①②	Stop DC-Brake Time	0.00	600.00	s	0.00	255	
P14.5 ①②	Brake Chopper Define				0	251	0 = Disabled 1 = B(Run) T(Rdy) 2 = External 3 = B(Rdy) T(Rdy) 4 = B(Run) T(No)
P14.6 ①②	Flux Brake				0	266	0 = Off 1 = On
P14.7 ①②	Flux Brake Current	Active Motor Nom I*1/10	See Para ID 107	A	Active Motor Nom I*1/2	265	

Note: ① Parameter value can only be changed after the drive has stopped.
 ② Parameter value will be set to be default when changing macros.
 ③ DG1 Frame 1-6/DG1 Frame 7-8

Table 59. Fire mode—P15

Code	Parameter	Min.	Max.	Unit	Default	ID	Note
P15.1 ①②	Fire Mode Function				0	535	0 = Closing Contact 1 = Opening Contact
P15.2 ①②	Fire Mode Ref Select Function				0	536	0 = Fire mode Min Frequency 1 = Fire Mode Ref 2 = Fieldbus Ref 3 = AI1 4 = AI2 5 = AI1+AI2 6 = PID1 Control Output 7 = PID2 Control Output
P15.3 ②	Fire Mode Min Frequency	See Para ID 101	See Para ID 102	Hz	15.00	537	
P15.4 ②	Fire Mode Freq Ref 1	0.0	100.0	%	75.0	565	
P15.5 ②	Fire Mode Freq Ref 2	0.0	100.0	%	100.0	564	
P15.6 ①②	Smoke Purge Frequency	0.0	100.0	%	50.0	554	
P15.7 ②	Fire Mode Test Enable				0	2443	0 = Disable 1 = Enable

Table 60. Second motor parameter—P16

Code	Parameter	Min.	Max.	Unit	Default	ID	Note
P16.1 ①	Motor Nom Current 2	Drive Nom CT*1/10	Drive Nom CT*1/10	A	Drive Nom CT	577	
P16.2 ①⑧	Motor Nom Speed 2	300	20000/19200	rpm	2nd Motor Nom Speed	578	
P16.3 ①	Motor PF 2	0.30	1.00		0.85	579	
P16.4 ①	Motor Nom Volt 2	180	690	V	2nd Motor Nom V	580	
P16.5 ①⑧	Motor Nom Freq 2	8.00	400.00/ 320.00	Hz	2nd Motor Nom Freq	581	
P16.6 ①⑦	Stator Resistor 2	0.001	65.535	ohm	0.033	1419	
P16.7 ①⑥	Rotor Resistor 2	0.001	65.535	ohm	0.034	1420	
P16.8 ①⑦	Leak Inductance 2	0.001	65.535	mh	0.128	1421	
P16.9 ①⑥	Mutual Inductance 2	0.01	655.35	mh	3.44	1422	
P16.10 ①⑦⑧	Excitation Current 2	0.1/0.0	Drive Nom Curr CT*2	A	0.1/0.0	1423	

Table 61. Bypass—P17

Basic Settings

Code	Parameter	Min.	Max.	Unit	Default	ID	Note
P17.1.1 ①②	Bypass Enable				0	1418	0 = Disabled 1 = Enabled
P17.1.2 ①②	Bypass Start Delay	1	32765	s	5	544	
P17.1.3 ①②	Auto Bypass				0	542	0 = Disabled 1 = Enabled
P17.1.4 ①②	Auto Bypass Delay	0	32765	s	10	543	
P17.1.5 ①②	Overcurrent Bypass Enable				0	547	0 = Disabled 1 = Enabled
P17.1.6 ①②	IGBT Fault Bypass Enable				0	546	0 = Disabled 1 = Enabled
P17.1.7 ①②	4 mA Fault Bypass Enable				0	548	0 = Disabled 1 = Enabled
P17.1.8 ①②	Undervoltage Bypass Enable				0	545	0 = Disabled 1 = Enabled
P17.1.9 ①②	Overvoltage Bypass Enable				0	549	0 = Disabled 1 = Enabled

Note: ① Parameter value can only be changed after the drive has stopped.
 ② Parameter value will be set to be default when changing macros.
 ③ Function is not available in FR7 and FR8 of DG1 drives.
 ⑦ Function is only available in FR7 and FR8 of DG1 drives.
 ⑧ DG1 Frame 1-6/DG1 Frame 7-8

Chapter 6 — Multi-Pump and fan control application

Table 61. Bypass—P17, continued

Code	Parameter	Min.	Max.	Unit	Default	ID	Note
P17.2.1 ②	Redundant Drive Enable	0	1		0	2476	0 = Disabled 1 = Enabled
P17.2.2 ②	Drive ID	0	5		0	2278	
P17.2.3 ②	Redundant Run Time Enable	0	1		0	2477	0 = Disabled 1 = Enabled
P17.2.4 ②	Redundant Run Time Reset	0	1		0	2478	0 = Not Reset 1 = Reset
P17.2.5 ②	Redundant RunTime Limit	0.0	300000.0	h	0.0	2479	

Table 62. Basic settings—P18.1

Code	Parameter	Min.	Max.	Unit	Default	ID	Note
P18.1.1 ②	Multi-Pump Mode				0	2279	0 = Disable 1 = Single Drive Control 2 = Multi Drive Network
P18.1.2 ②	Drive ID	0	5		0.00	2278	
P18.1.3 ②	PID Bandwidth	0	100	Varies	10	343	
P18.1.4 ②	Staging Frequency	See Para ID 101	400		See Para ID 102	2315	
P18.1.5 ②	De-Staging Frequency	0	See Para ID 102		See Para ID 101	2316	
P18.1.6 ②	Add/Remove Delay	0	3600	s	10	344	
P18.1.7 ②	Interlock Enable				0	350	0 = Disable 1 = Enable
P18.1.8 ②	Damper Start				0	483	0 = Normal 1 = Interlock Start 2 = Interlock Tout 3 = Interlock Delay
P18.1.9 ②	Damper Time Out	1	32500	s	5	484	
P18.1.10 ②	Damper Delay	1	32500	s	5	485	
P18.1.11 ②	Derag Cycles	0	10		3	2468	0 = Off 1 = Start 2 = Stop 3 = Start and Stop 4 = Digital Input;
P18.1.12 ②	Derag at Start/Stop	0	4		0	2469	
P18.1.13 ②	Deragging Run Time	0	3600	s	0	2470	
P18.1.14 ②	Derag Speed	See Para ID 101	See Para ID 102	Hz	5	2471	
P18.1.15 ②	Derag Off Delay	1	600	s	10	2472	

Multi-Pump com status P18.2

Table 63. Operation mode P18.2.1

Code	Parameter	Min.	Max.	Unit	Default	ID	Note
P18.2.1.1	Drive 1				0	2218	0 = Offline 1 = Slave Drive 2 = Master Drive
P18.2.1.2	Drive 2				0	2230	0 = Offline 1 = Slave Drive 2 = Master Drive
P18.2.1.3	Drive 3				0	2242	0 = Offline 1 = Slave Drive 2 = Master Drive
P18.2.1.4	Drive 4				0	2254	0 = Offline 1 = Slave Drive 2 = Master Drive
P18.2.1.5	Drive 5				0	2266	0 = Offline 1 = Slave Drive 2 = Master Drive

Note: ① Parameter value can only be changed after the drive has stopped.

② Parameter value will be set to be default when changing macros.

Table 64. Multi Pump status P18.2.2

Code	Parameter	Min.	Max.	Unit	Default	ID	Note
P18.2.2.1	Drive 1				0	2219	0 = Stopped 1 = Sleep 2 = Regulating 3 = Wait for CMD 4 = Following 5 = Unknown
P18.2.2.2	Drive 2				0	2231	0 = Stopped 1 = Sleep 2 = Regulating 3 = Wait for CMD 4 = Following 5 = Unknown
P18.2.2.3	Drive 3				0	2243	0 = Stopped 1 = Sleep 2 = Regulating 3 = Wait for CMD 4 = Following 5 = Unknown
P18.2.2.4	Drive 4				0	2245	0 = Stopped 1 = Sleep 2 = Regulating 3 = Wait for CMD 4 = Following 5 = Unknown
P18.2.2.5	Drive 5				0	2267	0 = Stopped 1 = Sleep 2 = Regulating 3 = Wait for CMD 4 = Following 5 = Unknown

Table 65. Network status P18.2.3

Code	Parameter	Min.	Max.	Unit	Default	ID	Note
P18.2.3.1	Drive 1				0	2220	0 = Disconnected 1 = Fault 2 = Pump Lost 3 = Need Alternation 4 = No Error
P18.2.3.2	Drive 2				0	2232	0 = Disconnected 1 = Fault 2 = Pump Lost 3 = Need Alternation 4 = No Error
P18.2.3.3	Drive 3				0	2244	0 = Disconnected 1 = Fault 2 = Pump Lost 3 = Need Alternation 4 = No Error
P18.2.3.4	Drive 4				0	2246	0 = Disconnected 1 = Fault 2 = Pump Lost 3 = Need Alternation 4 = No Error
P18.2.3.5	Drive 5				0	2268	0 = Disconnected 1 = Fault 2 = Pump Lost 3 = Need Alternation 4 = No Error

Note: ① Parameter value can only be changed after the drive has stopped.
 ② Parameter value will be set to be default when changing macros.

Multi-Pump measurement P18.3

Table 66. Last fault code P18.3.1

Code	Parameter	Min.	Max.	Unit	Default	ID	Note
P18.3.1.1	Drive 1				0	2221	
P18.3.1.2	Drive 2				0	2233	
P18.3.1.3	Drive 3				0	2245	
P18.3.1.4	Drive 4				0	2257	
P18.3.1.5	Drive 5				0	2269	

Table 67. Output frequency P18.3.2

Code	Parameter	Min.	Max.	Unit	Default	ID	Note
P18.3.2.1	Drive 1			Hz	0	2222	
P18.3.2.2	Drive 2			Hz	0	2234	
P18.3.2.3	Drive 3			Hz	0	2246	
P18.3.2.4	Drive 4			Hz	0	2258	
P18.3.2.5	Drive 5			Hz	0	2270	

Table 68. Motor voltage P18.3.3

Code	Parameter	Min.	Max.	Unit	Default	ID	Note
P18.3.3.1	Drive 1			V	0	2223	
P18.3.3.2	Drive 2			V	0	2235	
P18.3.3.3	Drive 3			V	0	2247	
P18.3.3.4	Drive 4			V	0	2259	
P18.3.3.5	Drive 5			V	0	2271	

Table 69. Motor current P18.3.4

Code	Parameter	Min.	Max.	Unit	Default	ID	Note
P18.3.4.1	Drive 1			A	0	2224	
P18.3.4.2	Drive 2			A	0	2236	
P18.3.4.3	Drive 3			A	0	2248	
P18.3.4.4	Drive 4			A	0	2260	
P18.3.4.5	Drive 5			A	0	2272	

Table 70. Motor torque P18.3.5

Code	Parameter	Min.	Max.	Unit	Default	ID	Note
P18.3.5.1	Drive 1			%	0	2225	
P18.3.5.2	Drive 2			%	0	2237	
P18.3.5.3	Drive 3			%	0	2249	
P18.3.5.4	Drive 4			%	0	2261	
P18.3.5.5	Drive 5			%	0	2273	

Table 71. Motor power P18.3.6

Code	Parameter	Min.	Max.	Unit	Default	ID	Note
P18.3.6.1	Drive 1			%	0	2226	
P18.3.6.2	Drive 2			%	0	2238	
P18.3.6.3	Drive 3			%	0	2250	
P18.3.6.4	Drive 4			%	0	2262	
P18.3.6.5	Drive 5			%	0	2274	

Note: ① Parameter value can only be changed after the drive has stopped.
 ② Parameter value will be set to be default when changing macros.

Table 72. Motor speed P18.3.7

Code	Parameter	Min.	Max.	Unit	Default	ID	Note
P18.3.7.1	Drive 1			RPM	0	2227	
P18.3.7.2	Drive 2			RPM	0	2239	
P18.3.7.3	Drive 3			RPM	0	2251	
P18.3.7.4	Drive 4			RPM	0	2263	
P18.3.7.5	Drive 5			RPM	0	2275	

Table 73. Motor run time P18.3.8

Code	Parameter	Min.	Max.	Unit	Default	ID	Note
P18.3.8.1	Drive 1			h	0	2228	
P18.3.8.2	Drive 2			h	0	2240	
P18.3.8.3	Drive 3			h	0	2252	
P18.3.8.4	Drive 4			h	0	2264	
P18.3.8.5	Drive 5			h	0	2276	

Table 74. Multi-Pump single drive - P18.4

Code	Parameter	Min.	Max.	Unit	Default	ID	Note
P18.4.1 ②	Number of Pumps	1	5		1	342	
P18.4.2 ②	Include Frequency Converter				1	346	0 = Disable 1 = Enable
P18.4.3 ②	Auto-Change Enable				0	345	0 = Disable 1 = Enable
P18.4.4 ②	Auto-Change Interval	0	3000	h	48	347	
P18.4.5 ②	Auto-Change Freq Limit	See Para ID 101	See Para ID 102	Hz	25	349	
P18.4.6 ②	Auto-Change Pump Limit	0	5		1	348	
P18.4.7 ②	Pipe Fill Aux Pump Select				0	2441	0=Disabled 1=Aux Motor 1 2=Aux Motor 2 3=Aux Motor 3 4=Aux Motor 4
P18.4.8 ②	Pipe Fill Aux Pump Run Time	0.0	3600.0	min	0.0	2442	
P18.4.9 ②	Pipe Fill Aux Pump Operation				0	2443	0 = Automatic 1 = Stop
P18.4.10 ②	Pipe Fill Aux Pump Delay	0.0	600.0	min	2.0	2444	

Table 75. Multi-Pump multi drive - P18.5

Code	Parameter	Min.	Max.	Unit	Default	ID	Note
P18.5.1 ②	Number of Drives	1	5		1	2451	
P18.5.2 ②	Regulation Source				0	2284	0 = Network 1 = PID Controller 1
P18.5.3 ②	Recovery Method				0	2285	0 = Automatic 1 = Stop
P18.5.4 ②	Callback Source				0	2286	0 = No Action 1 = Safe Torque Off
P18.5.5 ②	Add/Remove Drive Selection				0	2311	0 = Drive ID 1 = Run Time
P18.5.6 ②	Run Time Enable				0	2280	0 = Disable 1 = Enable
P18.5.7 ②	Run Time Limit	0	300000	h	0	2281	
P18.5.8 ②	Run Time Reset				0.0	2283	0 = No Action 1 = Reset
P18.5.9 ②	Master Drive Mode	0	2		0	2473	0 = Follow PID 1 = Fixed Speed 2 = Turn Off
P18.5.10 ②	Master Fixed Speed	See Para ID 101	See Para ID 102	Hz	50.00	2474	
P18.5.11 ②	Master Fixed Speed Delay	0	1000	s	5	2475	

Note: ① Parameter value can only be changed after the drive has stopped.

② Parameter value will be set to be default when changing macros.

Chapter 6 — Multi-Pump and fan control application

Table 76. Protections - P18.6

Code	Parameter	Min.	Max.	Unit	Default	ID	Note
P18.6.1 ②	Pipe Fill Loss Detection Method				0	2406	0 = Motor Current 1 = Motor Power 2 = Motor Torque
P18.6.2 ②	Pipe Fill Loss Level	0.0	1000.0	%	0.0	2407	
P18.6.3 ②	Pipe Fill Loss Time	0	600	s	0	2408	
P18.6.4 ②	Pipe Fill Loss Frequency	0.00	See Para ID 102	Hz	0.00	2409	
P18.6.5 ②	Pipe Fill Loss Response				0	2410	0 = No Action 1 = Warning 2 = Fault
P18.6.6 ②	Pipe Fill Loss Attempts	0	10		1	2411	
P18.6.7 ②	Prime Pump Enable				0	2430	See Para ID 190
P18.6.8 ②	Prime Pump Level	0.00	6000.00	%	0.00	2431	
P18.6.9 ②	Prime Pump Frequency	See Para ID 101	See Para ID 102	Hz	0.00	2433	
P18.6.10 ②	Prime Pump Delay Time	0.0	3600.0	min	0.0	2434	
P18.6.11 ②	Prime Pump Loss of Prime Level	0.0	1000.0	%	0.0	2435	
P18.6.12 ②	Prime Pump Level 2	0.00	6000.00	%	0.00	2436	
P18.6.13 ②	Prime Pump Frequency 2	See Para ID 101	See Para ID 102	Hz	0.00	2438	
P18.6.14 ②	Prime Pump Delay Time 2	0.0	3600.0	min	0.0	2439	
P18.6.15 ②	Prime Pump Loss of Prime Level 2	0.0	1000.0	%	0.0	2440	

Table 77. Real time clock—P19

Code	Parameter	Min.	Max.	Unit	Default	ID	Note
P19.1 ②	Interval 1 On Time				0,0,0	491	
P19.2 ②	Interval 1 Off Time				0,0,0	493	
P19.3 ②	Interval 1 From Day				0	517	0 = Sunday 1 = Monday 2 = Tuesday 3 = Wednesday 4 = Thursday 5 = Friday 6 = Saturday
P19.4 ②	Interval 1 To Day				0	518	See Para ID 517
P19.5 ②	Interval 1 Channel				0	519	0 = Not Used 1 = Time Channel 1 2 = Time Channel 2 3 = Time Channel 3
P19.6 ②	Interval 2 On Time				0,0,0	495	
P19.7 ②	Interval 2 Off Time				0,0,0	497	
P19.8 ②	Interval 2 From Day				0	520	See Para ID 517
P19.9 ②	Interval 2 To Day				0	521	See Para ID 517
P19.10 ②	Interval 2 Channel				0	522	See Para ID 519
P19.11 ②	Interval 3 On Time				0,0,0	499	
P19.12 ②	Interval 3 Off Time				0,0,0	501	
P19.13 ②	Interval 3 From Day				0	523	See Para ID 517
P19.14 ②	Interval 3 To Day				0	524	See Para ID 517
P19.15 ②	Interval 3 Channel				0	525	See Para ID 519
P19.16 ②	Interval 4 On Time				0,0,0	503	
P19.17 ②	Interval 4 Off Time				0,0,0	505	
P19.18 ②	Interval 4 From Day				0	526	See Para ID 517
P19.19 ②	Interval 4 To Day				0	527	See Para ID 517
P19.20 ②	Interval 4 Channel				0	528	See Para ID 519
P19.21 ②	Interval 5 On Time				0,0,0	507	

Note: ① Parameter value can only be changed after the drive has stopped.

② Parameter value will be set to be default when changing macros.

Table 77. Real time clock—P19, continued

Code	Parameter	Min.	Max.	Unit	Default	ID	Note
P19.22 ②	Interval 5 Off Time				0,0,0	509	
P19.23 ②	Interval 5 From Day				0	529	See Para ID 517
P19.24 ②	Interval 5 To Day				0	530	See Para ID 517
P19.25 ②	Interval 5 Channel				0	531	See Para ID 519
P19.26 ②	Timer 1 Duration	0	72000	s	0	511	
P19.27 ②	Timer 1 Channel				0	532	0 = Not Used 1 = Time Channel 1 2 = Time Channel 2 3 = Time Channel 3
P19.28 ②	Timer 2 Duration	0	72000	s	0	513	
P19.29 ②	Timer 2 Channel				0	533	See Para ID 532
P19.30 ②	Timer 3 Duration	0	72000	s	0	515	
P19.31 ②	Timer 3 Channel				0	534	See Para ID 532
P19.32 ②	Interval 1 Setting	0	1		0	2487	0 = Weekly 1 = Daily
P19.33 ②	Interval 2 Setting	0	1		0	2488	0 = Weekly 1 = Daily
P19.34 ②	Interval 3 Setting	0	1		0	2489	0 = Weekly 1 = Daily
P19.35 ②	Interval 4 Setting	0	1		0	2490	0 = Weekly 1 = Daily
P19.36 ②	Interval 5 Setting	0	1		0	2491	0 = Weekly 1 = Daily

Communication P20**Table 78. FB Process Data Input Sel—P20.1**

Code	Parameter	Min.	Max.	Unit	Default	ID	Note
P20.1.1	FB Process Data Input 1 Sel				2541	2533	
P20.1.2	FB Process Data Input 2 Sel				2542	2534	
P20.1.3	FB Process Data Input 3 Sel				2550	2535	
P20.1.4	FB Process Data Input 4 Sel				103	2536	
P20.1.5	FB Process Data Input 5 Sel				104	2537	
P20.1.6	FB Process Data Input 6 Sel				107	2538	
P20.1.7	FB Process Data Input 7 Sel				0	2539	
P20.1.8	FB Process Data Input 8 Sel				0	2540	

Table 79. FB Process Data Output Sel—P20.2

Code	Parameter	Min.	Max.	Unit	Default	ID	Note
P20.2.1	FB Process Data Output 1 Sel				1	1556	
P20.2.2	FB Process Data Output 2 Sel				2	1557	
P20.2.3	FB Process Data Output 3 Sel				3	1558	
P20.2.4	FB Process Data Output 4 Sel				4	1559	
P20.2.5	FB Process Data Output 5 Sel				5	1560	
P20.2.6	FB Process Data Output 6 Sel				6	1561	
P20.2.7	FB Process Data Output 7 Sel				7	1562	
P20.2.8	FB Process Data Output 8 Sel				28	1563	
P20.2.9	Standard Status Word Bit0 Function Select				1	2415	See Para ID 151
P20.2.10	Standard Status Word Bit1 Function Select				1	2416	See Para ID 151

Note: ① Parameter value can only be changed after the drive has stopped.

② Parameter value will be set to be default when changing macros.

Chapter 6 — Multi-Pump and fan control application

Table 79. FB Process Data Output Sel—P20.2, continued

Code	Parameter	Min.	Max.	Unit	Default	ID	Note
P20.2.11	Standard Status Word Bit2 Function Select				1	2417	See Para ID 151
P20.2.12	Standard Status Word Bit3 Function Select				1	2418	See Para ID 151
P20.2.13	Standard Status Word Bit4 Function Select				1	2419	See Para ID 151
P20.2.14	Standard Status Word Bit5 Function Select				1	2420	See Para ID 151
P20.2.15	Standard Status Word Bit6 Function Select				1	2421	See Para ID 151
P20.2.16	Standard Status Word Bit7 Function Select				1	2422	See Para ID 151

RS485 Bus P20.3

Table 80. Basic Setting— P20.3.1

Code	Parameter	Min.	Max.	Unit	Default	ID	Note
P20.3.1.1	RS485 Comm Set				0	586	0 = Modbus RTU 1 = BACnet MS/TP 2 = SWD

Table 81. Modbus RTU—P20.3.2

Code	Parameter	Min.	Max.	Unit	Default	ID	Note
P20.3.2.1	Slave Address	1	247		1	587	
P20.3.2.2	Baud Rate				1	584	0 = 9600 1 = 19200 2 = 38400 3 = 57600 4 = 115200
P20.3.2.3	Parity Type				2	585	0 = None 1 = Odd 2 = Even
P20.3.2.4	Modbus RTU Protocol Status				0	588	0 = Initial 1 = Stopped 2 = Operational 3 = Faulted
P20.3.2.5	Slave Busy				0	589	0 = Not Busy 1 = Busy
P20.3.2.6	Parity Error				0	590	
P20.3.2.7	Slave Fault				0	591	
P20.3.2.8	Last Fault Response				0	592	
P20.3.2.9	Comm Timeout Modbus RTU			ms	10000	593	
P20.3.2.10	Modbus RTU Fault Response	0	1		0	2516	0 = In Fieldbus Control 1 = In All Control

Table 82. BACnet MS/TP—P20.3.3

Code	Parameter	Min.	Max.	Unit	Default	ID	Note
P20.3.3.1	MSTP Baud Rate				2	594	0 = 9600 1 = 19200 2 = 38400 3 = 78600 4 = 115200
P20.3.3.2	MSTP MS/TP Device Address	0	127		1	595	
P20.3.3.3	MSTP Instance Number	0	4194302		varies	596	
P20.3.3.4	MSTP Comm Timeout MSTP			ms	10000	598	
P20.3.3.5	MSTP Protocol Status				0	599	0 = Stopped 1 = Operational 2 = Faulted
P20.3.3.6	MSTP Fault Code				0	600	0 = None 1 = Sole Master
P20.3.3.7	MSTP Fault Response	0	1		0	2526	0 = In Fieldbus Control 1 = In All Control

Note: ① Parameter value can only be changed after the drive has stopped.
② Parameter value will be set to be default when changing macros.

Table 83. Ethernet IP—P20.4

Code	Parameter	Min.	Max.	Unit	Default	ID	Note
P20.4.1	IP Address Mode				1	1500	0 = Static IP 1 = DHCP with AutoIP
P20.4.2	Active IP Address					1507	
P20.4.3	Active Subnet Mask					1509	
P20.4.4	Active Default Gateway					1511	
P20.4.5	MAC Address					1513	
P20.4.6	Static IP Address				192.168.1.254	1501	
P20.4.7	Static Subnet Mask				255.255.255.0	1503	
P20.4.8	Static Default Gateway				192.168.1.1	1505	
P20.4.9	Ethernet IP Protocol Status					608	0 = Stopped 1 = Operational 2 = Faulted
P20.4.10	EIP Fault Response	0	1		0	2518	0 = In Fieldbus Control 1 = In All Control
P20.3.11	Modbus TCP Unit ID				1	610	
P20.3.12	Comm Timeout Modbus TCP			ms	10000	611	
P20.3.13	Modbus TCP Protocol Status				0	612	0 = Stopped 1 = Operational 2 = Faulted
P20.3.14	Slave Busy				0	613	0 = Not Busy 1 = Busy
P20.3.15	Modbus TCP Parity Error				0	614	
P20.3.16	Slave Failure				0	615	
P20.3.17	Last Fault Response				0	616	
P20.3.18	Modbus TCP Fault Response	0	1		0	2517	0 = In Fieldbus Control 1 = in all Control
P20.3.19	EIP Fault Response	0	1		0	2518	0 = In Fieldbus Control 1 = in all Control

Table 84. Modbus TCP—P20.5

Code	Parameter	Min.	Max.	Unit	Default	ID	Note
P20.5.1	Connection Limit				5	609	
P20.5.2	Modbus TCP Unit ID				1	610	
P20.5.3	Comm Timeout Modbus TCP			ms	10000	611	
P20.5.4	Modbus TCP Protocol Status				0	612	0 = Stopped 1 = Operational 2 = Faulted
P20.5.5	Slave Busy				0	613	0 = Not Busy 1 = Busy
P20.5.6	Parity Error				0	614	
P20.5.7	Slave Failure				0	615	
P20.5.8	Last Fault Response				0	616	
P20.5.9	Modbus TCP Fault Response	0	1		0	2517	0 = In Fieldbus Control 1 = In All Control

Note: ① Parameter value can only be changed after the drive has stopped.
 ② Parameter value will be set to be default when changing macros.

Chapter 6 — Multi-Pump and fan control application

Table 85. Basic setting—P21.1

Code	Parameter	Min.	Max.	Unit	Default	ID	Note
P21.1.1	Language				0	340	0 = English 1 = Depends upon Language Pack 2 = Depends upon Language Pack
P21.1.2 ①	Application				0	142	0 = Standard 1 = Multi-Pump 2 = Multi-PID 3 = Multi-Purpose
P21.1.3	Parameter Sets				0	619	0 = No 1 = Reload Defaults 2 = Reload Set 1 3 = Reload Set 2 4 = Store Set 1 5 = Store Set 2 6 = Reset 7 = Reload Defaults VM
P21.1.4	Up To Keypad				0	620	0 = No 1 = Yes
P21.1.5	Down From Keypad				0	621	0 = No 1 = All Parameters 2 = All, No Motor 3 = App Parameters
P21.1.6	Parameter Comparison				0	623	0 = No 1 = Compare with Keypad 2 = Compare with Default 3 = Compare with Set 1 4 = Compare with Set 2
P21.1.7	Password	0	9999		0	624	
P21.1.8	Parameter Lock				0	625	0 = Change Enable 1 = Change Disable
P21.1.9	Multimonitor Set				0	627	See Para ID 625
P21.1.10	Default Page				0	628	0 = None 1 = Main Menu 2 = Multi-Monitor 3 = Favorite Menu 4 = Keypad Reference
P21.1.11	Timeout Time	0	65535	s	30	629	
P21.1.12	Contrast Adjust	5	18		12	630	
P21.1.13	Backlight Time	1	65535	min	10	631	
P21.1.14	Fan Control				2	632	0 = Continuous 1 = Temperature 2 = Run Follow ② 3 = Calculate Temp ④
P21.1.15	HMI ACK Timeout	200	5000	ms	200	633	
P21.1.16	HMI Retry Number	1	10		5	634	
P21.1.17	Startup Wizard	0	1		1	626	0 = No 1 = Yes
P21.1.18	Jog Soft Key Hidden	0	1		0	2412	0 = Disable 1 = Enable
P21.1.19	Reverse Softkey Hidden	0	1		0	2413	0 = Disable 1 = Enable

Table 85. Basic setting—P21.1, continued

Code	Parameter	Min.	Max.	Unit	Default	ID	Note
P21.1.20	Output Display Unit				45	2424	0 = % 1 = 1/min 2 = rpm 3 = ppm 4 = pps 5 = l/s 6 = l/min 7 = l/h 8 = kg/s 9 = kg/min 10 = kg/h 11 = m ³ /s 12 = m ³ /min 13 = m ³ /h 14 = m/s 15 = mbar 16 = bar 17 = Pa 18 = kPa 19 = mVs 20 = kW 21 = deg C 22 = GPM 23 = gal/s 24 = gal/min 25 = gal/h 26 = lb/s 27 = lb/min 28 = lb/h 29 = CFM 30 = ft ³ /s 31 = ft ³ /min 32 = ft ³ /h 33 = ft/s 34 = in wg 35 = ft wg 36 = PSI 37 = lb/in ² 38 = HP 39 = deg F 40 = PA 41 = WC 42 = HG 43 = ft 44 = m 45 = Hz
P21.1.21	Output Display Unit Min	-60000.00	See Para ID 2425	varies	0.00	2460	
P21.1.22	Output Display Unit Max	See Para ID 2460	60000.00	varies	60	2425	

Table 86. Version info—P21.2

Code	Parameter	Min.	Max.	Unit	Default	ID	Note
P21.2.1	Keypad Software Version					640	
P21.2.2	Motor Control Software Version					642	
P21.2.3	Application Software Version				App Firmware	644	
P21.2.4	Software Bundle Version				App bundle rev	1714	

Chapter 6 — Multi-Pump and fan control application

Table 87. Application info—P21.3

Code	Parameter	Min.	Max.	Unit	Default	ID	Note
P21.3.1	Brake Chopper					646	0 = No 1 = Yes
P21.3.2	Brake Resistor Status					647	See Para ID 646
P21.3.3	Serial Number					648	

Table 88. User info—P21.4

Code	Parameter	Min.	Max.	Unit	Default	ID	Note
P21.4.1	Real Time Clock				0.0.0.1:1:13	566	
P21.4.2	Daylight Saving				0	582	0 = Off 1 = EU 2 = US
P21.4.3	Total MWh Count			Mwh		601	
P21.4.4	Total Power Day Count					603	
P21.4.5	Total Power Hr Count					606	
P21.4.6	Trip MWh Count			Mwh		604	
P21.4.7	Clear Trip MWh Count				0	635	0 = Not Reset 1 = Reset
P21.4.8	Trip Power Day Count					636	
P21.4.9	Trip Power Hr Count					637	
P21.4.10	Clear Trip Power Count				0	639	See Para ID 635

Chapter 7—Multi-PID Application

Introduction

The Multi-PID Application is designed to be used with up to 2 PID Control applications determined by the use of a digital input; it is typically used with pumps and fans to maintain a desired set-point. With PID, the frequency converter is given a set reference from a keypad, analog inputs, or fieldbus data-in. It also uses an analog probe that measures flow, temperature, and pressure in the system referred to as feedback. The frequency converter takes the feedback signal and compares it to the set point. From there based off the Gain, Integral time, and Derivative time, it corrects the speed of the motor to meet the set point value and maintain it; no additional components. Drive controlwise it provides the ability to have 2 control and reference locations with 8 digital inputs, 2 analog inputs, 3 relay outputs, 1 digital output, and 2 analog outputs that are programmable. Motor control is customizable to frequency or speed control, and the V/Hz curve can be programmable. Drive/Motor protection selections can be programmable to defined actions. Below is a list of additional features available in addition to the Standard and Multi-Pump and Fan Application features that are available in the Multi-PID Application.

Multi-PID Application includes all the functions in Multi-Pump and Fan Application, and Additional functions:

- The Second PID control

I/O Controls

- “Terminal To Function” (TTF) Programming

The design behind the programming of the digital inputs in the DG1 drive is to use “Terminal To Function” programming, which is composed of multiple functions that get assigned a digital input to that function. The parameters in the drive are set up with specific functions and by defining the digital input and slot in some cases, depending on which options are available. For use of the drives control board inputs, they will be referred to as DigIN:1 through DigIN:8. When additional option cards are used, they will be defined as DigIN:X:IOY:Z. The X indicates the slot that the card is being installed in, which will be either A or B. The IOY determines the type of card it is, which would be IO1 or IO5. The Z indicates which input is being used on that available option card.

- “Function To Terminal” (FTT) Programming

The design behind the programming of the relay outputs and digital output in the DG1 drive is to use “Function To Terminal” programming. It is composed of a terminal, be it a relay output or a digital output, that is assigned a parameter. Within that parameter, it has different functions that can be set.

The parameters of the Multi-PID Application are explained on **Page 150** of this manual, “Description of Parameters.” The explanations are arranged according to the parameter number.

Force Open/Force Close Selection

The Force Open Selection would make the selected function always off. Essentially this is a virtual switch that is always open.

The Force Close Selection would make the selected function always on. Essentially this is a virtual switch that is always closed.

These options are assigned to a function if we want to force a state without using a hardware input.

Example:

If we set Run Enable to Force Closed the drive is always enabled. If we set the same function to Force Open the drive would never be Enabled. If a Digital input is to be used to activate this Run Enable the function should be assigned to a hardware input(See below for DIGIN Selections).

DIGIN Selection

This allows Assignment of a hardware digital input to a function, this is set in a format of DigIN:X where X is one of the 8 Digital inputs on the Main control board.

Example:

If we set Run Enable to DigIN:6 the drive will be enabled when digital input 6 (Terminal 8) is closed, and would not be enabled when digital input 6 (Terminal 8) is open.

Option Board DigIN Selection

This allows Assignment of a hardware digital input on an option card to a function, this is set in a format of DigIN:Y:IO1:X where Y is the slot the option card is inserted on the Main control board and X is the Input on the Board and IO1 is the type of option board used.

Example:

If we set Run Enable to DigIN:A:IO5:6 the drive will be enabled when digital input 6 is closed on the IO5 option card which is inserted in Slot A, and would not be enabled when digital input 6 on the option card is open.

Timer Channel Selection

A Time Channel is a virtual path to link the digital output of a timer function to a digital input function. To utilize this feature a timer or interval would need to be assigned to a time channel 1 through 3, and the input function to be controlled would need to be assigned to the same time channel.

Example:

If we set Run Enable to DigIN:TimeChannel1 the drive will be enabled when the timer assigned to Time Channel 1 is active or High, and would not be enabled when the Time Channel is inactive or Low.

Figure 38. PID Controller Flowchart

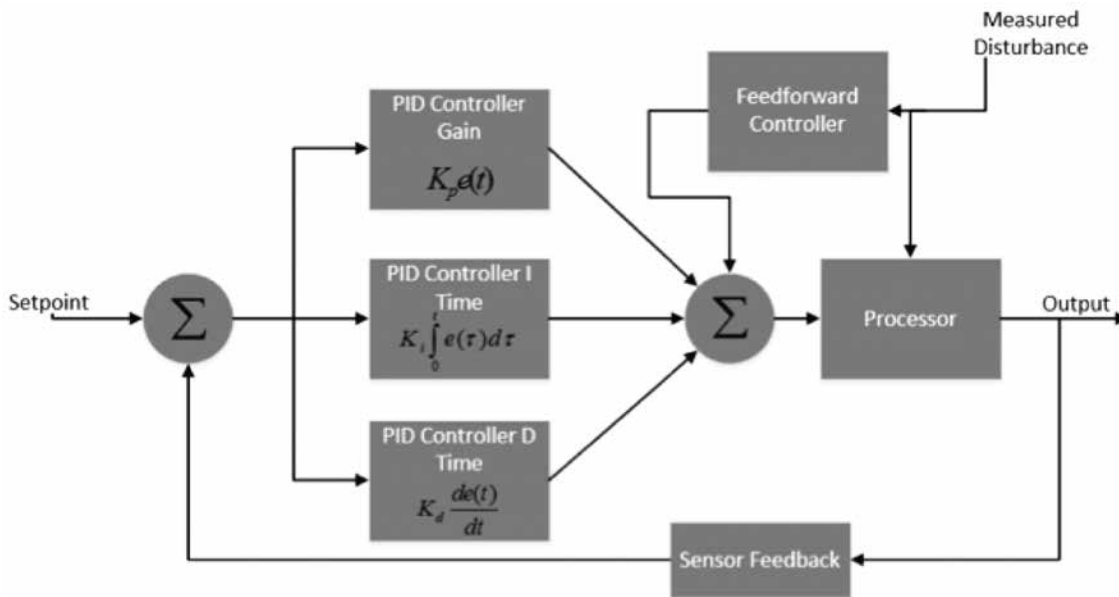

Control I/O Configuration

- Run 240 Vac and 24 Vdc control wiring in separate conduit
- Communication wire to be shielded

Table 89. Multi-PID Application Default I/O Configuration

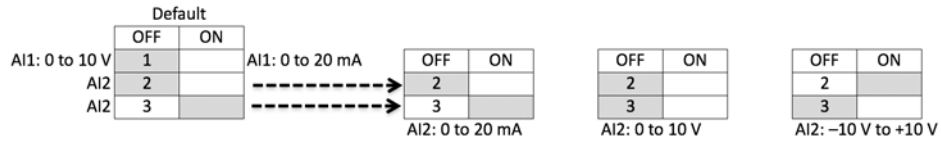

External Wiring	Pin	Signal Name	Signal	Default Setting	Description
	1	+10 V	Ref. Output Voltage	—	10 Vdc Supply Source
	2	AI1+Ⓞ	Analog Input 1	0–10 V	Voltage Speed Reference (Programmable to 4 mA to 20 mA)
	3	AI1–	Analog Input 1 Ground	—	Analog Input 1 Common (Ground)
	4	AI2+Ⓞ	Analog Input 2	4 mA to 20 mA	Current Speed Reference (Programmable to 0–10 V)
	5	AI2–	Analog Input 2 Ground	—	Analog Input 2 Common (Ground)
	6	GND	I/O Signal Ground	—	I/O Ground for Reference and Control
	7	DIN5	Digital Input 5	Preset Speed B0	Sets frequency output to Preset Speed 1
	8	DIN6	Digital Input 6	Preset Speed B1	Sets frequency output to Preset Speed 2
	9	DIN7	Digital Input 7	Not Used (TI–)	Input forces VFD output to shut off
	10	DIN8	Digital Input 8	Force Remote (TI+)	Input takes VFD from Local to Remote
	11	CMB	DI5 to DI8 Common	Grounded	Allows source input
	12	GND	I/O Signal Ground	—	I/O Ground for Reference and Control
	13	24 V	+24 Vdc Output	—	Control voltage output (100 mA max.)
	14	DO1	Digital Output 1	Ready	Shows the drive is ready to run
	15	24 Vo	+24 Vdc Output	—	Control voltage output (100 mA max.)
	16	GND	I/O Signal Ground	—	I/O Ground for Reference and Control
	17	AO1+	Analog Output 1	Output Frequency	Shows Output frequency to motor 0–60 Hz (4 mA to 20 mA)
	18	AO2+	Analog Output 2	Motor Current	Shows Motor current of motor 0–FLA (4 mA to 20 mA)
	19	24 Vi	+24 Vdc Input	—	External control voltage input
	20	DIN1	Digital Input 1	Run Forward	Input starts drive in forward direction (start enable)
	21	DIN2	Digital Input 2	Run Reverse	Input starts drive in reverse direction (start enable)
	22	DIN3	Digital Input 3	External Fault	Input causes drive to fault
	23	DIN4	Digital Input 4	Fault Reset	Input resets active faults
	24	CMA	DI1 to DI4 Common	Grounded	Allows source input
	25	A/+	RS-485 Signal A	—	Fieldbus Communication (Modbus, BACnet)
	26	B/-	RS-485 Signal B	—	Fieldbus Communication (Modbus, BACnet)
	27	R3NO	Relay 3 Normally Open	At Speed	Relay output 3 shows VFD is at Ref. Frequency
	28	R1NC	Relay 1 Normally Closed	Run	Relay output 1 shows VFD is in a run state
	29	R1CM	Relay 1 Common		
	30	R1NO	Relay 1 Normally Open		
	31	R3CM	Relay 3 Common	At Speed	Relay output 3 shows VFD is at Ref. Frequency
	32	R2NC	Relay 2 Normally Closed	Fault	Relay output 2 shows VFD is in a fault state
	33	R2CM	Relay 2 Common		
	34	R2NO	Relay 2 Normally Open		

Notes: The above wiring demonstrates a SINK configuration. It is important that CMA and CMB are wired to ground (as shown by dashed line). If a SOURCE configuration is desired, wire 24 V to CMA and CMB and close the inputs to ground. When using the +10 V for AI1, it is important to wire AI1– to ground (as shown by dashed line). If using +10 V for AI1 or AI2, terminals 3, 5, and 6 need to be jumpered together.
 ① AI1+ and AI2+ Support 10K potentiometer.

Table 90. Drive Communication Ports

Port	Communication
RJ45 Keypad Port	
Upload/Download Parameters	USB to RJ45
Remote Mount Keypad	Ethernet
Upgrade Drive Firmware	USB to RJ45
RJ45 Ethernet Port	
Upload/Download Parameters	Ethernet
Ethernet IP Communications	Ethernet
Modbus TCP Communications	Ethernet
RS-485 Serial Port^①	
Upload/Download Parameters	Two-Wire Twisted Pair
Upgrade Drive Firmware	Two-Wire Twisted Pair
Modbus RTU Communications	Two-Wire Twisted Pair
BACnet MS/TP Communications	Two-Wire Twisted Pair

^① Shielded wire recommended.

Multi-PID Application—Parameters List

On the next pages you will find the lists of parameters within the respective parameter groups. The parameter descriptions are given on **Page 150**, “Description of Parameters.” The descriptions are arranged according to the parameter number.

Column explanations:

Code = Location indication on the keypad; shows the operator the present parameter number

Parameter = Name of parameter

Min = Minimum value of parameter

Max = Maximum value of parameter

Unit = Unit of parameter value; given if available

Default = Value preset by factory

ID = ID number of the parameter

Table 91. Monitor—M

Code	Parameter	Min.	Max.	Unit	Default	ID	Note
M1	Output Frequency			Hz	0.00	1	
M2	Freq Reference			Hz	0.00	24	
M3	Motor Speed			rpm	0	2	
M4	Motor Current			A	0.0	3	
M5	Motor Torque			%	0.0	4	
M6	Motor Power			%	0.0	5	
M7	Motor Voltage			V	0.0	6	
M8	DC-link Voltage			V	0	7	
M9	Unit Temperature			°C	0.0	8	
M10	Motor Temperature			%	0.0	9	
M12	Analog Input 1			Varies	0.00	10	
M13	Analog Input 2			Varies	0.00	11	
M14	Analog Output 1			Varies	0.00	25	
M15	Analog Output 2			Varies	0.00	575	
M16	DI1, DI2, DI3				0	12	
M17	DI4, DI5, DI6				0	13	
M18	DI7, DI8				0	576	
M19	DO1, Virtual RO1, Virtual RO2				0	14	
M20	RO1, RO2, RO3				0	557	
M21	TC1, TC2, TC3				0	558	
M22	Interval 1				0	559	0 = Inactive 1 = Active
M23	Interval 2				0	560	See Para ID 559
M24	Interval 3				0	561	See Para ID 559
M25	Interval 4				0	562	See Para ID 559
M26	Interval 5				0	563	See Para ID 559
M27	Timer 1			s	0	569	
M28	Timer 2			s	0	571	
M29	Timer 3			s	0	573	
M30	PID1 Set Point			Varies	0.00	16	
M31	PID1 Feedback			Varies	0.00	18	
M32	PID1 Error Value			Varies	0.00	20	
M33	PID1 Output			%	0.00	22	
M34	PID1 Status				0	23	0 = Stopped 1 = Running 2 = Sleep Mode

Table 91. Monitor—M, continued

Code	Parameter	Min.	Max.	Unit	Default	ID	Note
M35	PID2 Set Point			Varies	0.00	32	
M36	PID2 Feedback			Varies	0.00	34	
M37	PID2 Error Value			Varies	0.00	36	
M38	PID2 Output			%	0.00	38	
M39	PID2 Status				0	39	See Para ID 23
M40	Running Motors				0	26	
M41	PT100 Temperature			°C	1000.0	27	
M42	Last Active Fault				0	28	See Fault Codes on Page 223 in Appendix B
M43	RTC Battery Status					583	0 = Not Installed 1 = Installed 2 = Change Battery 3 = Over Voltage
M44	Instant Motor Power			kW	0.000	1686	
M45	Energy Savings			Varies		2120	
M46	Control board DIDO Status				0	2209	Bit 0 = DIN1 Status Bit 1 = DIN2 Status Bit 2 = DIN3 Status Bit 3 = DIN4 Status Bit 4 = DIN5 Status Bit 5 = DIN6 Status Bit 6 = DIN7 Status Bit 7 = DIN8 Status Bit 8 = DO1 Status Bit 9 = RO1 Status Bit 10 = RO2 Status Bit 11 = RO3 Status Bit 12 = Slot A with Board Bit 13 = Slot B with Board Bit 14 -15 = Not used
M47	SlotA DIDO Status				0	2210	Bit 0 = IO1_DIN1 Status Bit 1 = IO1_DIN2 Status Bit 2 = IO1_DIN3 Status Bit 3 = IO1_DO1 Status Bit 4 = IO1_DO2 Status Bit 5 = IO1_DO3 Status Bit 6 = IO3_RO1 Status Bit 7 = IO3_RO2 Status Bit 8 = IO3_RO3 Status Bit 9 = IO5_AC1 Status Bit 10 = IO5_AC2 Status Bit 11 = IO5_AC3 Status Bit 12 = IO5_AC4 Status Bit 13 = IO5_AC5 Status Bit 14 = IO5_AC6 Status Bit 15 = Not Used
M48	SlotB DIDO Status				0	2211	Bit 0 = IO1_DIN1 Status Bit 1 = IO1_DIN2 Status Bit 2 = IO1_DIN3 Status Bit 3 = IO1_DO1 Status Bit 4 = IO1_DO2 Status Bit 5 = IO1_DO3 Status Bit 6 = IO3_RO1 Status Bit 7 = IO3_RO2 Status Bit 8 = IO3_RO3 Status Bit 9 = IO5_AC1 Status Bit 10 = IO5_AC2 Status Bit 11 = IO5_AC3 Status Bit 12 = IO5_AC4 Status Bit 13 = IO5_AC5 Status Bit 14 = IO5_AC6 Status Bit 15 = Not Used

Notes: ① Parameter value can only be changed after the drive has stopped.
 ② Parameter value will be set to be default when changing macros.

Table 91. Monitor—M, continued

Code	Parameter	Min.	Max.	Unit	Default	ID	Note
M49	App Status Word				0	29	Bit 0 = MC Ready Bit 1 = MC_Run Bit 2 = MC_Fault Bit 3 = FB_Ref_Active Bit 4 = MC_Stopping Bit 5 = MC_Reverse Bit 6 = MC_Warning/AR-Fault Bit 7 = MC_ZeroSpeed Bit 8 = I/O Control Indicate Bit 9 = Panel Control Indicator Bit 10 = Panel Fieldbus Indicator Bit 11 = MC_DC_Brake Bit 12 = RunEnable Bit 13 = Run Bypass Bit 14 = Ext Brake Control Bit 15 = Bypass Mode
M50	Standard Status Word				0	2414	Bit 0 = P20.1.9 (default = Ready) Bit 1 = P20.1.10 (default = Run) Bit 2 = P20.1.11 (default = Fault) Bit 3 = P20.1.12 (default = Fault Invert) Bit 4 = P20.1.13 (default = Warning) Bit 5 = P20.1.14 (default = Reversed) Bit 6 = P20.1.15 (default = At Speed) Bit 7 = P20.1.16 (default = Zero Frequency) Bit 8 - 15 = Not Used
M51	Output				0	2445	
M52	Reference				0	2447	
M53	Total MWh Count				Varies	601	
M54	Total Power Day Count				Varies	603	
M55	Total Power Hr Count				Varies	606	
M56	Trip MWh Count				Varies	604	
M57	Trip Power Day Count				Varies	636	
M58	Trip Power Hr Count				Varies	637	
M59	Multi-Monitoring				1,2,3	30	

Table 92. Operate Mode—O

Code	Parameter	Min.	Max.	Unit	Default	ID	Note
O1	Output Frequency			Hz	0.00	1	
O2	Freq Reference			Hz	0.00	24	
O3	Motor Speed			rpm	0	2	
O4	Motor Current			A	0.0	3	
O5	Motor Torque			%	0.0	4	
O6	Motor Power			%	0.0	5	
O7	Motor Voltage			V	0.0	6	
O8	DC-link Voltage			V	0	7	
O9	Unit Temperature			°C	0.0	8	
O10	Motor Temperature			%	0.0	9	
R12 ②	Keypad Reference	See Para ID 101	See Para ID 102	Hz	0.00	141	
R13 ②	PID1 Keypad Set Point 1	See Para ID 1298	See Para ID 1300	Varies	0	1307	
R14 ②	PID1 Keypad Set Point 2	See Para ID 1298	See Para ID 1300	Varies	0	1309	

Notes: ① Parameter value can only be changed after the drive has stopped.
 ② Parameter value will be set to be default when changing macros.

Chapter 7—Multi-PID Application

Table 93. Basic Parameters—P1

Code	Parameter	Min.	Max.	Unit	Default	ID	Note
P1.1 ①②	Min Frequency	0.00	See Para ID 102	Hz	0.00	101	
P1.2 ①②③	Max Frequency	See Para ID 101	400.00/320.00	Hz	60.0	102	
P1.3 ②	Accel Time 1	0.1	3000.0	s	3.0	103	
P1.4 ②	Decel Time 1	0.1	3000.0	s	3.0	104	
P1.5 ①	Motor Nom Current	Drive Nom CT*1/10	Drive Nom CT*2	A	Drive Nom CT	486	
P1.6 ①③	Motor Nom Speed	300	20000/19200	rpm	Motor Nom Speed	489	
P1.7 ①	Motor PF	0.30	1.00		0.85	490	
P1.8 ①	Motor Nom Voltage	180	690	V	Motor Nom Volt	487	
P1.9 ①③	Motor Nom Frequency	8.00	400.00/320.00	Hz	Motor Nom Freq	488	
P1.10 ②	Power Up Local Remote Select				0	1685	0 = Hold Last 1 = Local Control 2 = Remote Control
P1.11 ②	Remote1 Control Place				0	135	0 = I/O Terminal Start 1 1 = Fieldbus 2 = I/O Terminal Start 2 3 = Keypad
P1.12	Local Control Place				0	1695	0 = Keypad 1 = I/O Terminal Start 1 2 = I/O Terminal Start 2 3 = Fieldbus
P1.13 ②	Bumpless Enable				0	2462	0 = Disabled 1 = Enabled
P1.14 ①②	Local Reference				6	136	0 = AI1 1 = AI2 2 = Slot A: AI1 3 = Slot B: AI1 4 = AI1 Joystick 5 = AI2 Joystick 6 = Keypad 7 = Fieldbus Ref 9 = Max Frequency 10 = AI1 + AI2 11 = AI1–AI2 12 = AI2–AI1 13 = AI1 * AI2 14 = AI1 or AI2 15 = Min (AI1, AI2) 16 = MAX(AI1, AI2) 17 = PID1 Control Output 18 = PID2 Control Output
P1.15 ①②	Remote1 Reference				1	137	See Para ID 136
P1.16 ①	Reverse Enable				1	1679	0 = Disabled 1 = Enabled
P1.17 ②	Run Delay Time	0	32500	s	0	2423	
P1.18 ②	HOA Source	0	2		0	2465	0 = Disable 1 = I/O Terminal 2 = Keypad

Notes: ① Parameter value can only be changed after the drive has stopped.
 ② Parameter value will be set to be default when changing macros.
 ③ DG1 Frame 1-6/DG1 Frame 7-8

Table 94. Analog Input—P2

Code	Parameter	Min.	Max.	Unit	Default	ID	Note
P2.1.1	AI Ref Scale Min Value	0.00	See Para ID 145	Hz	0	144	
P2.1.2	AI Ref Scale Max Value	See Para ID 144	400.00	Hz	0	145	
P2.2.1 ②	AI1 Mode	0	1		1	222	0 = 0–20 mA 1 = 0–10 V
P2.2.2 ②	AI1 Signal Range	0	2		0	175	0 = 0–100% / 0–20 mA / 0–10 V 1 = 20–100% / 4–20 mA / 2–10 V 2 = Customized
P2.2.3 ②	AI1 Custom Min	0.00	See Para ID 177	%	0.00	176	
P2.2.4 ②	AI1 Custom Max	See Para ID 176	100.00	%	100.00	177	
P2.2.5 ②	AI1 Filter Time	0.00	10.00	s	0.10	174	
P2.2.6 ②	AI1 Signal Invert	0	1		0.00	181	0 = Not Inverted 1 = Inverted
P2.2.7 ②	AI1 Joystick Hyst	0.00	20.00	%	0.00	178	
P2.2.8 ②	AI1 Sleep Limit	0.00	100.00	%	0.00	179	
P2.2.9 ②	AI1 Sleep Delay	0.00	320.00	s	0.00	180	
P2.2.10 ②	AI1 Joystick Offset	–50.00	50.00	%	0.00	133	
P2.3.1 ②	AI2 Mode	0	2		1	223	0 = 0–20 mA 1 = 0–10 V 2 = –10 to +10 V
P2.3.2 ②	AI2 Signal Range	0	2		0	183	0 = 0–100% / 0–20 mA / 0–10 V 1 = 20–100% / 4–20 mA / 2–10 V 2 = Customized
P2.3.3 ②	AI2 Custom Min	0.00	See Para ID 185	%	0.00	184	
P2.3.4 ②	AI2 Custom Max	See Para ID 184	100.00	%	100.00	185	
P2.3.5 ②	AI2 Filter Time	0.00	10.00	s	0.10	182	
P2.3.6 ②	AI2 Signal Invert	0	1		0.00	189	0 = Not Inverted 1 = Inverted
P2.3.7 ②	AI2 Joystick Hyst	0.00	20.00	%	0.00	186	
P2.3.8 ②	AI2 Sleep Limit	0.00	100.00	%	0.00	184	
P2.3.9 ②	AI2 Sleep Delay	0.00	320.00	s	0.00	188	
P2.3.10 ②	AI2 Joystick Offset	–50.00	50.00	%	0.00	134	
P2.4.1 ②	Fine Tuning Input	0	5		0	2484	0 = Not Used 1 = AI1 2 = AI2 3 = Slot A: AI1 4 = Slot A: AI1 5 = Fieldbus
P2.4.2 ②	Fine Tuning Min	0.00	100.00	%	0.00	2485	
P2.4.3 ②	Fine Tuning Max	0.00	100.00	%	0.00	2486	

Notes: ① Parameter value can only be changed after the drive has stopped.

② Parameter value will be set to be default when changing macros.

Chapter 7—Multi-PID Application

Table 95. Digital Input—P3

Code	Parameter	Min.	Max.	Unit	Default	ID	Note
P3.1 ①②	IO Terminal 1 Start/Stop Logic				0	143	0 = Forward–Reverse 1 = Start–Reverse 2 = Start–Enable 3 = Start Pulse–Stop Pulse
P3.2 ②③	IO Terminal 1 Start Signal 1				2	190	0 = DigIN:ForceOpen 1 = DigIN:ForceClose 2 = DigIN: 1 3 = DigIN: 2 4 = DigIN: 3 5 = DigIN: 4 6 = DigIN: 5 7 = DigIN: 6 8 = DigIN: 7 9 = DigIN: 8 10 = DigIN: A: IO1: 1 11 = DigIN: A: IO1: 2 12 = DigIN: A: IO1: 3 13 = DigIN: A: IO5: 1 14 = DigIN: A: IO5: 2 15 = DigIN: A: IO5: 3 16 = DigIN: A: IO5: 4 17 = DigIN: A: IO5: 5 18 = DigIN: A: IO5: 6 19 = DigIN: B: IO1: 1 20 = DigIN: B: IO1: 2 21 = DigIN: B: IO1: 3 22 = DigIN: B: IO5: 1 23 = DigIN: B: IO5: 2 24 = DigIN: B: IO5: 3 25 = DigIN: B: IO5: 4 26 = DigIN: B: IO5: 5 27 = DigIN: B: IO5: 6 28 = Time Channel 1 29 = Time Channel 2 30 = Time Channel 3 31 = RO1 Function 32 = RO2 Function 33 = RO3 Function 34 = Virtual RO1 Function 35 = Virtual RO2 Function
P3.3 ②⑤	IO Terminal 1 Start Signal 2				3	191	See Para ID 190
P3.4 ①②	Thermistor Input Select				0	881	0 = Digital Input 1 = Thermistor Input
P3.5 ②③	Reverse				0	198	See Para ID 190
P3.6 ②③	Ext. Fault 1 NO				4	192	See Para ID 190
P3.7 ②③	Ext. Fault 1 NC				1	193	See Para ID 190
P3.8 ②④	Fault Reset				5	200	See Para ID 190
P3.9 ②③	Run Enable				1	194	See Para ID 190
P3.10 ②③	Preset Speed B0				6	205	See Para ID 190
P3.11 ②③	Preset Speed B1				7	206	See Para ID 190
P3.12 ②③	Preset Speed B2				0	207	See Para ID 190
P3.13 ②③	PID1 Control Enable				1	550	See Para ID 190
P3.14 ②③	PID2 Control Enable				1	553	See Para ID 190
P3.15 ②③	Accel/Decel Time Set				0	195	See Para ID 190
P3.16 ②③	Accel/Decel Prohibit				0	201	See Para ID 190
P3.17 ②④	No Access To Param				0	215	See Para ID 190
P3.21 ②③	Remote Control				9	196	See Para ID 190

- Notes:**
- ① Parameter value can only be changed after the drive has stopped.
 - ② Parameter value will be set to be default when changing macros.
 - ③ Input function is Level sensed
 - ④ Input function is edge sensed
 - ⑤ Input function is edge sensed when using StartP/StopP start logic See Para ID 143 and 2206

Table 95. Digital Input—P3, continued

Code	Parameter	Min.	Max.	Unit	Default	ID	Note
P3.22 ②③	Local Control				0	197	See Para ID 190
P3.23 ②③	Remote1/2 Select				0	209	See Para ID 190
P3.24 ②③	Second Motor Para Select				0	217	See Para ID 190
P3.25 ②④	Bypass Start				0	218	See Para ID 190
P3.26 ②③	DC Brake Enable				0	202	See Para ID 190
P3.27 ②③	Smoke Mode				0	219	See Para ID 190
P3.28 ②③	Fire Mode				0	220	See Para ID 190
P3.29 ②③	Fire Mode Ref Select				0	221	See Para ID 190
P3.30 ②③	PID1 Set Point Select				0	351	See Para ID 190
P3.31 ②③	PID2 Set Point Select				0	352	See Para ID 190
P3.32 ②③	Jog Enable				0	199	See Para ID 190
P3.33 ②④	Start Timer 1				0	224	See Para ID 190
P3.34 ②④	Start Timer 2				0	225	See Para ID 190
P3.35 ②④	Start Timer 3				0	226	See Para ID 190
P3.36 ②③	AI Ref Source Select				0	208	See Para ID 190
P3.37 ②③	Motor Interlock 1				0	210	See Para ID 190
P3.38 ②③	Motor Interlock 2				0	211	See Para ID 190
P3.39 ②③	Motor Interlock 3				0	212	See Para ID 190
P3.40 ②③	Motor Interlock 4				0	213	See Para ID 190
P3.41 ②③	Motor Interlock 5				0	214	See Para ID 190
P3.42 ②③	Emergency Stop				1	747	See Para ID 190
P3.43 ②③	Bypass Overload				0	1246	See Para ID 190
P3.44 ②④	Fire Mode Reverse				0	2119	See Para ID 190
P3.45 ①②	IO Terminal 2 Start Stop Logic				0	2206	See Para ID 143
P3.46 ②⑤	IO Terminal 2 Start Signal 1				2	2207	See Para ID 190
P3.47 ②⑤	IO Terminal 2 Start Signal 2				3	2208	See Para ID 190
P3.48 ②③	Ext. Fault 2 NO				0	2293	See Para ID 190
P3.49 ②③	Ext. Fault 2 NC				1	2294	See Para ID 190
P3.50 ②③	Ext. Fault 3 NO				0	2295	See Para ID 190
P3.51 ②③	Ext. Fault 3 NC				1	2296	See Para ID 190
P3.52 ②	Ext. Fault 1 Text				0	2297	0 = External Fault 1 = Vibration Cut out 2 = High Motor temp 3 = Low Pressure 4 = High Pressure 5 = Low Water 6 = Damper Interlock 7 = Run Enable 8 = Freeze Stat Trip 9 = Smoke Detect 10 = Seal Leakage 11 = Rod Breakage

- Notes:**
- ① Parameter value can only be changed after the drive has stopped.
 - ② Parameter value will be set to be default when changing macros.
 - ③ Input function is Level sensed
 - ④ Input function is edge sensed
 - ⑤ Input function is edge sensed when using StartP/StopP start logic See Para ID 143 and 2206

Chapter 7—Multi-PID Application

Table 95. Digital Input—P3, continued

Code	Parameter	Min.	Max.	Unit	Default	ID	Note
P3.53 ②	Ext. Fault 2 Text				1	2298	0 = External Fault 1 = Vibration Cut out 2 = High Motor temp 3 = Low Pressure 4 = High Pressure 5 = Low Water 6 = Damper Interlock 7 = Run Enable 8 = Freeze Stat Trip 9 = Smoke Detect 10 = Seal Leakage 11 = Rod Breakage
P3.54 ②	Ext. Fault 3 Text				2	2299	0 = External Fault 1 = Vibration Cut out 2 = High Motor temp 3 = Low Pressure 4 = High Pressure 5 = Low Water 6 = Damper Interlock 7 = Run Enable 8 = Freeze Stat Trip 9 = Smoke Detect 10 = Seal Leakage 11 = Rod Breakage
P3.55 ②④	Parameter Set1/2 Sel				0	2312	See Para ID 190
P3.56 ②④	Deragging Enable				0	2394	See Para ID 190
P3.57 ②③	Off Control				0	2395	See Para ID 190

- Notes:**
- ① Parameter value can only be changed after the drive has stopped.
 - ② Parameter value will be set to be default when changing macros.
 - ③ Input function is Level sensed
 - ④ Input function is edge sensed
 - ⑤ Input function is edge sensed when using StartP/StopP start logic See Para ID 143 and 2206

Table 96. Analog Output—P4

Code	Parameter	Min.	Max.	Unit	Default	ID	Note
P4.1 ①	A01 Mode				0	227	0 = 0–20 mA 1 = 0–10 V
P4.2 ②	A01 Function				1	146	0 = Not Used 1 = Output Frequency 2 = Freq Reference 3 = Motor Speed 4 = Motor Current 5 = Motor Torque (0–Nom) 6 = Motor Power 7 = Motor Voltage 8 = DC-Bus Voltage 9 = PID1 Setpoint 10 = PID1 Feedback 1 11 = PID1 Feedback 2 12 = PID1 Control Error Value 13 = PID1 Control Output 14 = PID2 Setpoint 15 = PID2 Feedback 1 16 = PID2 Feedback 2 17 = PID2 Control Error Value 18 = PID2 Control Output 19 = AI1 20 = AI2 21 = Output Freq (–2 to +2N) 22 = Motor Torque (–2 to +2N) 23 = Motor Power (–2 to +2N) 24 = PT100 Temperature 25 = FB Data Input 1 26 = FB Data Input 2 27 = FB Data Input 3 28 = FB Data Input 4 29 = FB Data Input 5 30 = FB Data Input 6 31 = FB Data Input 7 32 = FB Data Input 8 33 = SlotA PT100 Temp Channel 1 34 = SlotA PT100 Temp Channel 2 35 = SlotA PT100 Temp Channel 3 36 = SlotB PT100 Temp Channel 1 37 = SlotB PT100 Temp Channel 2 38 = SlotB PT100 Temp Channel 3 39 = User Defined Output 40 = Motor Current(–2 to +2N)
P4.3 ②	A01 Minimum				1	149	0 = 0 V / 0 mA 1 = 2 V / 4 mA
P4.4 ②	A01 Filter Time	0.00	10.00	s	1.00	147	
P4.5 ②	A01 Scale	10	1000	%	100	150	
P4.6 ②	A01 Inversion				0	148	0 = Not Inverted 1 = Inverted
P4.7 ②	A01 Offset	–100.00	100.00	%	0.00	173	
P4.8 ②	A02 Mode				0	228	See Para ID 227
P4.9 ②	A02 Function				4	229	See Para ID 146
P4.10 ②	A02 Minimum				1	232	See Para ID 149
P4.11 ②	A02 Filter Time	0.00	10.00	s	1.00	230	
P4.12 ②	A02 Scale	10	1000	%	100	233	
P4.13 ②	A02 Inversion				0	231	See Para ID 148
P4.14 ②	A02 Offset	–100.00	100.00	%	0.00	234	

Notes: ① Parameter value can only be changed after the drive has stopped.

② Parameter value will be set to be default when changing macros.

Table 97. Digital Output—P5

Code	Parameter	Min.	Max.	Unit	Default	ID	Note
P5.1 ②	DO1 Function				1	151	0 = Not Used 1 = Ready 2 = Run 3 = Fault 4 = Fault Invert 5 = Warning 6 = Reversed 7 = At Speed 8 = Zero Frequency 9 = Freq Limit 1 Superv 10 = Freq Limit 2 Superv 11 = PID1 Superv 12 = PID2 Superv 13 = Overheat Fault 14 = Overcurrent Regular 15 = Overvoltage Regular 16 = Undervoltage Regular 17 = 4 mA Ref Fault/Warning 20 = Torq Limit Superv 21 = Ref Limit Superv 22 = Control from I/O 23 = Un-Requested Rotation Direction 24 = Thermistor Fault Output 25 = Fire Mode 26 = In Bypass Mode 27 = Ext Fault/Warning 28 = Remote Control 29 = Jog Speed Select 30 = Motor Therm Protection 31 = FB Digital Input 1 32 = FB Digital Input 2 33 = FB Digital Input 3 34 = FB Digital Input 4 35 = Damper Control 36 = TC1 Status 37 = TC2 Status 38 = TC3 Status 39 = In E-Stop 40 = Power Limit Superv 41 = Temp Limit Superv 42 = Analog Input Superv 43 = Motor 1 Control 44 = Motor 2 Control 45 = Motor 3 Control 46 = Motor 4 Control 47 = Motor 5 Control 48 = Logic Fulfilled 49 = PID1 Sleep 50 = PID2 Sleep 51 = Motor Current 1 Supv 52 = Motor Current 2 Supv 53 = Second AI Limit Supv 54 = DC Charge Switch Close 55 = Preheat Active 56 = Cold Weather Active ③ 57 = Pre-Charge Active 58 = 2th Stage Ramp Frequency Active 59 = STO Fault 60 = Run Bypass/Drive 61 = Bypass Overload
P5.2 ②	RO1 Function				2	152	See Para ID 151
P5.3 ②	RO2 Function				3	153	See Para ID 151
P5.4 ②	RO3 Function				7	538	See Para ID 151
P5.5 ②	Virtual RO1 Function				0	2463	See Para ID 151
P5.6 ②	Virtual RO2 Function				0	2464	See Para ID 151

Notes: ① Parameter value can only be changed after the drive has stopped.
 ② Parameter value will be set to be default when changing macros.
 ③ Function is not available in FR7 and FR8 of DG1 drives.

Table 97. Digital Output—P5, continued

Code	Parameter	Min.	Max.	Unit	Default	ID	Note
P5.7 ②	Freq Limit 1 Supv				0	154	0 = No Limit 1 = Low Limit Superv 2 = High Limit Superv
P5.8 ②	Freq Limit 1 Supv Val	0.00	See Para ID 102	Hz	0.00	155	
P5.9 ②	Freq Limit 2 Supv				0	157	0 = No Limit 1 = Low Limit Superv 2 = High Limit Superv
P5.10 ②	Freq Limit 2 Supv Val	0.00	See Para ID 102	Hz	0.00	158	
P5.11 ②	Torque Limit Supv				0	159	0 = No Limit 1 = Low Limit Superv 2 = High Limit Superv
P5.12 ②	Torque Limit Supv Val	-1000.0	1000.0	%	100.0	160	
P5.13 ②	Ref Limit Supv				0	161	0 = No Limit 1 = Low Limit Superv 2 = High Limit Superv
P5.14 ②	Ref Limit Supv Val	0.00	See Para ID 102	Hz	0.00	162	
P5.17 ②	Temp Limit Supv				0	165	See Para ID 161
P5.18 ②	Temp Limit Supv Val	-10.0	75.0	°C	40.0	166	
P5.19 ②	Power Limit Supv				0	167	See Para ID 161
P5.20 ②	Power Limit Supv Val	0.0	200.0	%	0.0	168	
P5.21 ②	AI Supv Select				0	170	0 = AI1 1 = AI2
P5.22 ②	AI Limit Supv				0	171	See Para ID 161
P5.23 ②	AI Limit Supv Val	0.00	100.00	%	0.00	172	
P5.24 ②	PID1 Superv Enable				0	1346	0 = Disabled 1 = Enabled
P5.25 ②	PID1 Superv Upper Limit	See Para ID 1298	See Para ID 1300	Varies	0.00	1347	
P5.26 ②	PID1 Superv Lower Limit	See Para ID 1298	See Para ID 1300	Varies	0.00	1349	
P5.27 ②	PID1 Superv Delay	0	3000	s	0	1351	
P5.28 ②	PID2 Superv Enable				0	1408	0 = Disabled 1 = Enabled
P5.29 ②	PID2 Superv Upper Limit	See Para ID 1360	See Para ID 1362	Varies	0.00	1409	
P5.30 ②	PID2 Superv Lower Limit	See Para ID 1360	See Para ID 1362	Varies	0.00	1411	
P5.31 ②	PID2 Superv Delay	0	3000	s	0	1413	
P5.32 ②	RO1 On Delay	0	320	s	0	2112	
P5.33 ②	RO1 Off Delay	0	320	s	0	2113	
P5.34 ②	RO2 On Delay	0	320	s	0	2114	
P5.35 ②	RO2 Off Delay	0	320	s	0	2115	
P5.36 ②	RO3 On Delay	0	320	s	0	2116	
P5.37 ②	RO3 Off Delay	0	320	s	0	2117	
P5.38 ②	RO3 Reverse				0	2118	0 = No 1 = Yes
P5.39 ②	Motor Current 1 Supv				0	2189	0 = No Limit 1 = Low Limit Superv 2 = High Limit Superv
P5.40 ②	Motor Current 1 Supv Value	0	Drive Nominal Current CT*2	A	Drive Nominal Current CT*2	2190	

Notes: ① Parameter value can only be changed after the drive has stopped.
 ② Parameter value will be set to be default when changing macros.

Chapter 7—Multi-PID Application

Table 97. Digital Output—P5, continued

Code	Parameter	Min.	Max.	Unit	Default	ID	Note
P5.41 ②	Motor Current 2 Supv				0	2191	0 = No Limit 1 = Low Limit Superv 2 = High Limit Superv
P5.42 ②	Motor Current 2 Supv Value	0	Drive Nominal Current CT*2	A	Drive Nominal Current CT*2	2192	
P5.43 ②	Second AI Supv Select				0	2193	0 = AI1 1 = AI2
P5.44 ②	Second AI Limit Supv				0	2194	See Para ID 161
P5.45 ②	Second AI Limit Supv Val	0	100	%	0	2195	
P5.46 ②	Motor Current 1 Supv Hyst	0.1	1	A	0.1	2196	
P5.47 ②	Motor Current 2 Supv Hyst	0.1	1	A	0.1	2197	
P5.48 ②	AI Supv Hyst	1	10	%	1	2198	
P5.49 ②	Second AI Supv Hyst	1	10	%	1	2199	
P5.50 ②	Freq Limit 1 Supv Hyst	0.1	1	Hz	0.1	2200	
P5.51 ②	Freq Limit 2 Supv Hyst	0.1	1	Hz	0.1	2201	
P5.52 ②	Torque Limit Supv Hyst	1	5	%	1	2202	
P5.53 ②	Ref Limit Supv Hyst	0.1	1	Hz	0.1	2203	
P5.54 ②	Temp Limit Supv Hyst	1	10	°C	1	2204	
P5.55 ②	Power Limit Supv Hyst	0.1	10	%	0.1	2205	

Table 98. Drive Control—P7

Code	Parameter	Min.	Max.	Unit	Default	ID	Note
P7.1 ②	Remote 2 Control Place				1	138	See Para ID 135
P7.2 ①②	Remote 2 Reference				7	139	See Para ID 136
P7.3 ②	Keypad Reference	See Para ID 101	See Para ID 102	Hz	0.00	141	
P7.4 ②	Keypad Direction				0	116	0 = Forward 1 = Reverse
P7.5 ②	Keypad Stop				1	114	0 = Enabled-Keypad Operation 1 = Always Enabled
P7.6 ②	Jog Reference	See Para ID 101	See Para ID 102	Hz	0.00	117	
P7.9 ②	Start Mode				0	252	0 = Ramp 1 = Flying Start
P7.10 ②	Stop Mode				1	253	0 = Coasting 1 = Ramp
P7.11 ②	Ramp 1 Shape	0.0	10.0	s	0.0	247	
P7.12 ②	Ramp 2 Shape	0.0	10.0	s	0.0	248	
P7.13 ②	Accel Time 2	0.1	3000.0	s	10.0	249	
P7.14 ②	Decel Time 2	0.1	3000.0	s	10.0	250	
P7.15 ②	Skip F1 Low Limit	0.00	See Para ID 257	Hz	0.00	256	
P7.16 ②③	Skip F1 High Limit	See Para ID 256	400.00/320.00	Hz	0.00	257	
P7.17 ②	Skip F2 Low Limit	0.00	See Para ID 259	Hz	0.00	258	
P7.18 ②③	Skip F2 High Limit	See Para ID 258	400.00/320.00	Hz	0.00	259	
P7.19 ②	Skip F3 Low Limit	0.00	See Para ID 261	Hz	0.00	260	
P7.20 ②③	Skip F3 High Limit	See Para ID 260	400.00/320.00	Hz	0.00	261	
P7.21 ②	Prohibit Accel/Decel Ramp	0.1	10.0		1.0	264	

Notes: ① Parameter value can only be changed after the drive has stopped.
 ② Parameter value will be set to be default when changing macros.
 ③ DG1 Frame 1-6/DG1 Frame 7-8

Table 98. Drive Control—P7, continued

Code	Parameter	Min.	Max.	Unit	Default	ID	Note
P7.22 ②⑥	Power Loss Function				0	267	0 = Disabled 1 = Enabled
P7.23 ②⑥	Power Loss Time	0.3	5.0	s	2.0	268	
P7.24 ②	Currency				\$	2122	0 = \$ 1 = GBP 2 = Eur 3 = JPY 4 = Rs 5 = R\$ 6 = Fr 7 = Kr
P7.25	Energy Cost				0	2123	
P7.26	Data Type				0	2124	0 = Cumulative 1 = Daily Avg 2 = Weekly Avg 3 = Monthly Avg 4 = Yearly Avg
P7.27 ②	Energy Savings Reset				0	2125	0 = No Action 1 = Reset
P7.28 ②	2th Stage Ramp Frequency	See Para ID 101	See Para ID 102	Hz	30	2444	
P7.29 ②	Change Phase Sequence Motor	0	1		0	2515	0 = Change Disable 1 = Change Enable

Table 99. Motor Control—P8

Code	Parameter	Min.	Max.	Unit	Default	ID	Note
P8.1 ①②	Motor Control Mode				0	287	0 = Freq Control 1 = Speed Control
P8.2 ①	Current Limit	Drive Nom CT*1/10	Drive Nom CT*2	A	Drive Nom CT	107	
P8.3 ①②	V/Hz Optimization				0	109	0 = Disabled 1 = Enabled
P8.4 ①②	V/Hz Ratio				0	108	0 = Linear 1 = Squared 2 = Programmable 3 = Linear + Flux Optimization
P8.5 ①②③	Field Weakening Point	8.00	400.00/320.00	Hz	60.00	289	
P8.6 ①②	Voltage at FWP	10.00	200.00	%	100.00	290	
P8.7 ①②	V/Hz Mid Frequency	0.00	See Para ID 289	Hz	V/Hz Curve Midpoint Freq	291	
P8.8 ①②	V/Hz Mid Voltage	0.00	100.00	%	100.00	292	
P8.9 ①②	Zero Frequency Voltage	0.00	40.00	%	0.00	293	
P8.10 ②	Switching Frequency	Min Switching Freq	Max Switching Freq	kHz	Default Switching Freq CT	288	
P8.11 ②	Sine Filter Enable				0	1665	0 = Disabled 1 = Enabled
P8.12 ①②	Overvoltage Control				1	294	0 = Disabled 1 = Enabled
P8.14 ②⑦	Identification				0	299	0 = No Action 1 = Identification Only Stator Resistor 2 = Identification with Run 3 = Identification No Run
P8.17 ②⑥	Frequency Ramp Out FilterTime Constant	0	3000	ms	0	1585	
P8.39 ②	Start Boost Rise Time	0	32000	s	0	1622	
P8.45 ②⑦	Torque Memory Start	-300.0	300.0	%	0.0	1632	
P8.50 ①⑦	Stator Resistor	0.001	65.535	ohm	0.033	771	
P8.52 ①⑦	Leak Inductance	0.001	65.535	mh	0.128	773	

Notes: ① Parameter value can only be changed after the drive has stopped.
 ② Parameter value will be set to be default when changing macros.
 ③ Function is not available in FR7 and FR8 of DG1 drives.
 ④ Function is only available in FR7 and FR8 of DG1 drives.
 ⑤ DG1 Frame 1-6/DG1 Frame 7-8

Chapter 7—Multi-PID Application

Table 100. Protections—P9

Code	Parameter	Min.	Max.	Unit	Default	ID	Note
P9.1 ①②	4 mA Input Fault				0	306	0 = No Action 1 = Warning 2 = Warning: Previous Freq 3 = Warning: Preset Freq 4 = Fault 5 = Fault, Coast
P9.2 ①②	4 mA Fault Frequency	0.00	See Para ID 102	Hz	0.00	331	
P9.3 ①②	External Fault				2	307	See Para ID 313
P9.4 ①②	Input Phase Fault				2	332	0 = No Action 1 = Warning(6) 2 = Fault 3 = Fault, Coast(6)
P9.5 ①②	Uvoltage Fault Response				2	330	See Para ID 313
P9.6 ①②	Output Phase Fault				2	308	See Para ID 313
P9.7 ①②	Ground Fault				2	309	See Para ID 313
P9.8 ①②	Motor Thermal Protection				2	310	See Para ID 313
P9.9 ②③	Motor Thermal F0 Current	0.0/5.0	150.0	%	40.0/60.0	311	
P9.10 ②③	Motor Thermal Time	1	200	min	45/78	312	
P9.11 ①②	Stall Protection				0	313	0 = No Action 1 = Warning 2 = Fault 3 = Fault, Coast
P9.12 ②	Stall Current Limit	0.1	Active Motor Nom I*2	A	Active Motor Nom I*13/10	314	
P9.13 ②	Stall Time Limit	1.0	120.0	s	15.0	315	
P9.14 ②	Stall Frequency Limit	1.00	See Para ID 102	Hz	25.00	316	
P9.15 ①②	Underload Protection				0	317	See Para ID 313
P9.16 ②	Underload Fnom Torque	10.0	150.0	%	50.0	318	
P9.17 ②	Underload F0 Torque	5.0	150.0	%	10.0	319	
P9.18 ②	Underload Time Limit	2.00	600.00	s	20.00	320	
P9.19 ①②	Thermistor Fault Response				2	333	See Para ID 313
P9.20 ②	Line Start Lockout				2	750	0 = Disabled, No Change 1 = Enable, No Change 2 = Disabled, Changed 3 = Enable, Changed
P9.21 ①②	Fieldbus Fault Response				2	334	See Para ID 313
P9.22 ①②	OPTCard Fault Response				2	335	See Para ID 313
P9.23 ①②	Unit Under Temp Prot				2	1564	See Para ID 313
P9.24 ②	Wait Time	1.00	300.00	s	1.00	321	
P9.25 ②	Trail Time	0.00	600.00	s	30.00	322	
P9.26 ②	Start Function				0	323	0 = Flying Start 1 = Ramp
P9.27 ②	Undervoltage Attempts	0	10		1	324	
P9.28 ②	Overvoltage Attempts	0	10		1	325	
P9.29 ②	Overcurrent Attempts	0	3		1	326	
P9.30 ②	4 mA Fault Attempts	0	10		1	327	
P9.31 ②	Motor Temp Fault Attempts	0	10		1	329	
P9.32 ②	External Fault Attempts	0	10		0	328	
P9.33 ②	Underload Attempts	0	10		1	336	
P9.34 ①②	RTC Fault				1	955	See Para ID 313

Notes: ① Parameter value can only be changed after the drive has stopped.

② Parameter value will be set to be default when changing macros.

③ DG1 Frame 1-6/DG1 Frame 7-8

Table 100. Protections—P9, continued

Code	Parameter	Min.	Max.	Unit	Default	ID	Note
P9.35 ①②	PT100 Fault Response				2	337	See Para ID 313
P9.36 ①②	Replace Battery Fault Response				1	1256	See Para ID 313
P9.37 ①②	Replace Fan Fault Response				1	1257	See Para ID 313
P9.38 ①②	IP Address Confliction Resp				1	1678	See Para ID 313
P9.39 ②④	Cold Weather Mode				0	2126	0 = Disable 1 = Enable
P9.40 ②④	Cold Weather Voltage Level	0	20	%	2	2127	
P9.41 ②④	Cold Weather Time Out	0	10	min	3	2128	
P9.44 ②④	Ground Fault Limit	0	30	%	15	2158	
P9.45 ①②	Keypad Comm Fault Response				2	2157	See Para ID 313
P9.46 ②	Preheat Mode				0	2159	0 = Disabled 1 = Enabled
P9.47 ②	Preheat Temp Source				31	2160	0 = DigIN: NormallyOpen 1 = DigIN: NormallyClosed 2 = DigIN: 1 3 = DigIN: 2 4 = DigIN: 3 5 = DigIN: 4 6 = DigIN: 5 7 = DigIN: 6 8 = DigIN: 7 9 = DigIN: 8 10 = DigIN: A: IO1: 1 11 = DigIN: A: IO1: 2 12 = DigIN: A: IO1: 3 13 = DigIN: A: IO5: 1 14 = DigIN: A: IO5: 2 15 = DigIN: A: IO5: 3 16 = DigIN: A: IO5: 4 17 = DigIN: A: IO5: 5 18 = DigIN: A: IO5: 6 19 = DigIN: B: IO1: 1 20 = DigIN: B: IO1: 2 21 = DigIN: B: IO1: 3 22 = DigIN: B: IO5: 1 23 = DigIN: B: IO5: 2 24 = DigIN: B: IO5: 3 25 = DigIN: B: IO5: 4 26 = DigIN: B: IO5: 5 27 = DigIN: B: IO5: 6 28 = Time Channel 1 29 = Time Channel 2 30 = Time Channel 3 31 = Drive Temperature 32 = Slot A PT100 Temp Channel 1 33 = Slot A PT100 Temp Channel 2 34 = Slot A PT100 Temp Channel 3 35 = Slot A Max PT100 Temp 36 = Slot B PT100 Temp Channel 1 37 = Slot B PT100 Temp Channel 2 38 = Slot B PT100 Temp Channel 3 39 = Slot B Max PT100 Temp 40 = Slot A and Slot B Max PT100 Temp
P9.48 ②	Preheat Enter Temp	0.0	19.9	°C	10.0	2161	
P9.49 ②	Preheat Quit Temp	20.0	40.0	°C	20.0	2162	
P9.50 ②⑧	Preheat Output Voltage / Preheat Output Current	0.0/0	20.0/50	%	2.0/20	2163	
P9.51	PID Feedback AI loss Response				0	2401	0 = No Action 1 = Warning 2 = Fault 3 = Warning: Preset Frequency 4 = Warning: Analog ->Net
P9.52 ②	PID Feedback AI Loss Pre Freq	0.00	400.00	Hz	0.00	2402	

Notes: ① Parameter value can only be changed after the drive has stopped.
 ② Parameter value will be set to be default when changing macros.
 ⑧ Function is not available in FR7 and FR8 of DG1 drives.

Chapter 7—Multi-PID Application

Table 100. Protections—P9, continued

Code	Parameter	Min.	Max.	Unit	Default	ID	Note
P9.53 ②	PID Feedback AI Loss Pipe Fill Level	0.0	1000.0	A	0.0	2403	
P9.54 ②	PID Feedback AI Loss PreFreq Timeout	0	6000	s	0	2404	
P9.55 ②	PID Feedback AI Loss Attempts	0	10		1	2405	
P9.56 ②	STO Fault Response				2	2429	0 = No Action 1 = Warning 2 = Fault
P9.57 ②	Fault Reset Start	0	1		0	2483	0 = Start/Stop After Fault Reset 1 = Restart After Fault Reset

Table 101. PID Controller 1—P10

Code	Parameter	Min.	Max.	Unit	Default	ID	Note
P10.1 ②	PID1 Control Gain	0.00	200.00	%	100.00	1294	
P10.2 ②	PID1 Control ITime	0.00	600.00	s	1.00	1295	
P10.3 ②	PID1 Control DTime	0.00	100.00	s	0.00	1296	
P10.4 ①②	PID1 Process Unit				0	1297	0 = % 1 = 1/min 2 = rpm 3 = ppm 4 = pps 5 = l/s 6 = l/min 7 = l/h 8 = kg/s 9 = kg/min 10 = kg/h 11 = m ³ /s 12 = m ³ /min 13 = m ³ /h 14 = m/s 15 = mbar 16 = bar 17 = Pa 18 = kPa 19 = mVS 20 = kW 21 = °C 22 = GPM 23 = gal/s 24 = gal/min 25 = gal/h 26 = lb/s 27 = lb/min 28 = lb/h 29 = CFM 30 = ft ³ /s 31 = ft ³ /min 32 = ft ³ /h 33 = ft/s 34 = in wg 35 = ft wg 36 = PSI 37 = lb/in ² 38 = HP 39 = °F 40 = PA 41 = WC 42 = HG 43 = ft 44 = m
P10.5 ②	PID1 Process Unit Min	-99999.99	99999.99	Varies	0.00	1298	
P10.6 ②	PID1 Process Unit Max	-99999.99	99999.99	Varies	100.00	1300	
P10.7 ②	PID1 Process Unit Decimal	0	4		2	1302	
P10.8 ①②	PID1 Error Inversion				0	1303	0 = Not Inverted 1 = Inverted

Notes: ① Parameter value can only be changed after the drive has stopped.

② Parameter value will be set to be default when changing macros.

Table 101. PID Controller 1—P10, continued

Code	Parameter	Min.	Max.	Unit	Default	ID	Note
P10.9 ②	PID1 Dead Band	0.00	99999.99	Varies	0.00	1304	
P10.10 ②	PID1 Dead Band Delay	0.00	320.00	s	0.00	1306	
P10.11 ②	PID1 Keypad Set Point 1	See Para ID 1298	See Para ID 1300	Varies	0.00	1307	
P10.12 ②	PID1 Keypad Set Point 2	See Para ID 1298	See Para ID 1300	Varies	0.00	1309	
P10.13 ②	PID1 Ramp Time	0.00	300.00	s	0.00	1311	
P10.14 ①②	PID1 Set Point 1 Source				1	1312	0 = Not Used 1 = PID1 Keypad Set Point 1 2 = PID1 Keypad Set Point 2 3 = AI1 4 = AI2 5 = Slot A: AI1 6 = Slot B: AI1 7 = FB Data Input 1 8 = FB Data Input 2 9 = FB Data Input 3 10 = FB Data Input 4 11 = FB Data Input 5 12 = FB Data Input 6 13 = FB Data Input 7 14 = FB Data Input 8 16 = Multi Drive Network 17=FB PID1 Set Point 1 18=FB PID1 Set Point 2
P10.15 ②	PID1 Set Point 1 Min	-200.00	200.00	%	0.00	1313	
P10.16 ②	PID1 Set Point 1 Max	-200.00	200.00	%	100.00	1314	
P10.17 ①②	PID1 Set Point 1 Sleep Enable				0	1315	0 = Disabled 1 = Enabled
P10.18 ②	PID1 Setpoint 1 Sleep Unit				0	2396	0 = Ouptut Frequency 1 = Motor Speed 2 = Motor Current 3 = PID1 Feedabck
P10.19 ②	PID1 Setpoint 1 Sleep Level	See Para ID 1298	See Para ID 1300	varies	0.00	2450	
P10.20 ②	PID1 Set Point 1 Sleep Delay	0	3000	s	0	1317	
P10.21 ②	PID1 Set Point 1 Wake Up Level	-99999.99	99999.99	varies	0.00	1318	
P10.22 ②	PID1 Set Point 1 Boost	-2.0	2.0		1.0	1320	
P10.23 ①②	PID1 Set Point 2 Source				2	1321	See Para ID 1312
P10.24 ②	PID1 Set Point 2 Min	-200.00	200.00	%	0.00	1322	
P10.25 ②	PID1 Set Point 2 Max	-200.00	200.00	%	100.00	1323	
P10.26 ①②	PID1 Set Point 2 Sleep Enable				0	1324	0 = Disabled 1 = Enabled
P10.27 ②	PID1 Setpoint 2 Sleep Unit				0	2397	0 = Ouptut Frequency 1 = Motor Speed 2 = Motor Current 3 = PID1 Feedabck
P10.28 ②	PID1 Setpoint 2 Sleep Level	See Para ID 1298	See Para ID 1300	varies	0.00	2452	
P10.29 ②	PID1 Set Point 2 Sleep Delay	0	3000	s	0	1326	
P10.30 ②	PID1 Set Point 2 Wake Up Level	-99999.99	99999.99	varies	0.00	1327	
P10.31 ②	PID1 Set Point 2 Boost	-2.0	2.0		1.0	1329	
P10.32 ①②	PID1 Feedback Function				0	1330	0 = Source 1 1 = SQRT(Source 1) 2 = SQRT(Source 1-Source 2) 3 = SQRT(Source 1) + SQRT(Source 2) 4 = Source 1 + Source 2 5 = Source 1-Source 2 6 = MIN(Source 1,Source 2) 7 = MAX(Source 1,Source 2) 8 = MEAN(Source1,Source2)
P10.33 ②	PID1 Feedback Gain	-1000.0	1000.0	%	100.0	1331	

Notes: ① Parameter value can only be changed after the drive has stopped.

② Parameter value will be set to be default when changing macros.

Chapter 7—Multi-PID Application

Table 101. PID Controller 1—P10, continued

Code	Parameter	Min.	Max.	Unit	Default	ID	Note
P10.34 ①②	PID1 Feedback 1 Source				1	1332	0 = Not Used 1 = AI1 2 = AI2 3 = Slot A: AI1 4 = Slot B: AI1 5 = FB Data Input 1 6 = FB Data Input 2 7 = FB Data Input 3 8 = FB Data Input 4 9 = FB Data Input 5 10 = FB Data Input 6 11 = FB Data Input 7 12 = FB Data Input 8 13 = PT100 Temperature 15 = SlotA PT100 Temp Channel 1 16 = SlotA PT100 Temp Channel 2 17 = SlotA PT100 Temp Channel 3 18 = SlotB PT100 Temp Channel 1 19 = SlotB PT100 Temp Channel 2 20 = SlotB PT100 Temp Channel 3 21=FB PID1 Feedback 1 22=FB PID1 Feedback 2
P10.35 ②	PID1 Feedback 1 Min	-200.00	200.00	%	0.00	1333	
P10.36 ②	PID1 Feedback 1 Max	-200.00	200.00	%	100.00	1334	
P10.37 ①②	PID1 Feedback 2 Source				0	1335	See Para ID 1332
P10.38 ②	PID1 Feedback 2 Min	-200.00	200.00	%	0.00	1336	
P10.39 ②	PID1 Feedback 2 Max	-200.00	200.00	%	100.00	1337	
P10.40 ①②	PID1 Feedforward Func				0	1338	0 = Source 1 1 = SQRT(Source 1) 2 = SQRT(Source 1-Source 2) 3 = SQRT(Source 1) + SQRT(Source 2) 4 = Source 1 + Source 2 5 = Source 1-Source 2 6 = MIN(Source 1,Source 2) 7 = MAX(Source 1,Source 2) 8 = MEAN(Source1,Source2)
P10.41 ②	PID1 Feedforward Gain	-1000.0	1000.0	%	100.0	1339	
P10.42 ①②	PID1 Feedforward 1 Source				0	1340	0 = Not Used 1 = AI1 2 = AI2 3 = Slot A: AI1 4 = Slot B: AI1 5 = FB Data Input 1 6 = FB Data Input 2 7 = FB Data Input 3 8 = FB Data Input 4 9 = FB Data Input 5 10 = FB Data Input 6 11 = FB Data Input 7 12 = FB Data Input 8 13 = PT100 Temperature 15 = SlotA PT100 Temp Channel 1 16 = SlotA PT100 Temp Channel 2 17 = SlotA PT100 Temp Channel 3 18 = SlotB PT100 Temp Channel 1 19 = SlotB PT100 Temp Channel 2 20 = SlotB PT100 Temp Channel 3 21=FB PID1 Feedforward 1 22=FB PID1 Feedforward 2
P10.43 ②	PID1 Feedforward 1 Min	-200.00	200.00	%	0.00	1341	
P10.44 ②	PID1 Feedforward 1 Max	-200.00	200.00	%	100.00	1342	
P10.45 ①②	PID1 Feedforward 2 Source				0	1343	See Para ID 1340
P10.46 ②	PID1 Feedforward 2 Min	-200.00	200.00	%	0.00	1344	

Notes: ① Parameter value can only be changed after the drive has stopped.
② Parameter value will be set to be default when changing macros.

Table 101. PID Controller 1—P10, continued

Code	Parameter	Min.	Max.	Unit	Default	ID	Note
P10.47 ②	PID1 Feedforward 2 Max	-200.00	200.00	%	100.00	1345	
P10.48 ②	PID1 Set Point 1 Comp Enable				0	1352	0 = Disabled 1 = Enabled
P10.49 ②	PID1 Set Point 1 Comp Max	-200.00	200.00	%	0.00	1353	
P10.50 ②	PID1 Set Point 2 Comp Enable				0	1354	0 = Disabled 1 = Enabled
P10.51 ②	PID1 Set Point 2 Comp Max	-200.00	200.00	%	0.00	1355	
P10.52 ②	PID1 Wake Up Action	0	3		0	2466	0 = Below Wake Up Level 1 = Above Wake Up Level 2 = Below Wake Up Level(PID ref.) -Wake up when below wakeup level % set in Para ID 1318 or 1327 from PID Setpoint. 3 = Above Wake Up Level(PID ref.) -Wake up when above wakeup level % set in Para ID 1318 or 1327 from PID Setpoint.
P10.53	FB PID1 Set Point 1	P10.5	P10.6	varies	0.00	2542	
P10.54	FB PID1 Set Point 2	P10.5	P10.6	varies	0.00	2544	
P10.55	FB PID1 Feedback 1			varies	0.00	2550	
P10.56	FB PID1 Feedback 2			varies	0.00	2551	
P10.57	FB PID1 Feedforward 1			varies	0.00	2554	
P10.58	FB PID1 Feedforward 2			varies	0.00	2555	

Table 102. PID Controller 2—P11

Code	Parameter	Min.	Max.	Unit	Default	ID	Note
P11.1 ②	PID2 Control Gain	0.00	200.00	%	100.00	1356	
P11.2 ②	PID2 Control I Time	0.00	600.00	s	1.00	1357	
P11.3 ②	PID2 Control D Time	0.00	100.00	s	0.00	1358	
P11.4 ①②	PID2 Process Unit				0	1359	See Para ID 1297
P11.5 ②	PID2 Process Unit Min	-99999.99	99999.99	Varies	0.00	1360	
P11.6 ②	PID2 Process Unit Max	-99999.99	99999.99	Varies	100.00	1362	
P11.7 ②	PID2 Process Unit Decimal	0	4		2	1364	
P11.8 ①②	PID2 Error Inversion				0	1365	0 = Not Inverted 1 = Inverted
P11.9 ②	PID2 Dead Band	0.00	99999.99	Varies	0.00	1366	
P11.10 ②	PID2 Dead Band Delay	0.00	320.00	s	0.00	1368	
P11.11 ②	PID2 Keypad Set Point 1	See Para ID 1360	See Para ID 1362	Varies	0.00	1369	
P11.12 ②	PID2 Keypad Set Point 2	See Para ID 1360	See Para ID 1362	Varies	0.00	1371	
P11.13 ②	PID2 Ramp Time	0.00	300.00	s	0.00	1373	
P11.14 ①②	PID2 Set Point 1 Source				1	1374	0=Not Used 1=PID2 Keypad Set Point 1 2=PID2 Keypad Set Point 2 3=A11 4=A12 5=Slot A: A11 6=Slot B: A11 7=FB Process Data Input 1 8=FB Process Data Input 2 9=FB Process Data Input 3 10=FB Process Data Input 4 11=FB Process Data Input 5 12=FB Process Data Input 6 13=FB Process Data Input 7 14=FB Process Data Input 8 15=PID1 Output 16=Multi Drive Network 17=FB PID2 Set Point 1 18=FB PID2 Set Point 2
P11.15 ②	PID2 Set Point 1 Min	-200.00	200.00	%	0.00	1375	
P11.16 ②	PID2 Set Point 1 Max	-200.00	200.00	%	100.00	1376	
P11.17 ①②	PID2 Set Point 1 Sleep Enable				0	1377	0 = Disabled 1 = Enabled

Notes: ① Parameter value can only be changed after the drive has stopped.

② Parameter value will be set to be default when changing macros.

Chapter 7—Multi-PID Application

Table 102. PID Controller 2—P11, continued

Code	Parameter	Min.	Max.	Unit	Default	ID	Note
P11.18 ②	PID2 Setpoint 1 Sleep Unit				0	2398	0 = Ouptut Frequency 1 = Motor Speed 2 = Motor Current 3 = PID1 Feedabck
P11.19 ②	PID2 Setpoint 1 Sleep Level	See Para ID 1360	See Para ID 1362	varies	0.00	2454	
P11.20 ②	PID2 Set Point 1 Sleep Delay	0	3000	s	0	1379	
P11.21 ②	PID2 Set Point 1 WakeUp Level	-99999.99	99999.99	varies	0.00	1380	
P11.22 ②	PID2 Set Point 1 Boost	-2.0	2.0		1.0	1382	
P11.23 ①②	PID2 Set Point 2 Source				2	1383	See Para ID 1374
P11.24 ②	PID2 Set Point 2 Min	-200.00	200.00	%	0.00	1384	
P11.25 ②	PID2 Set Point 2 Max	-200.00	200.00	%	100.00	1385	
P11.26 ①②	PID2 Set Point 2 Sleep Enable				0	1386	0 = Disabled 1 = Enabled
P11.27 ②	PID2 Setpoint 2 Sleep Unit				0	2399	0 = Ouptut Frequency 1 = Motor Speed 2 = Motor Current 3 = PID1 Feedabck
P11.28 ②	PID2 Setpoint 2 Sleep Level	See Para ID 1360	See Para ID 1362	varies	0.00	2456	
P11.29 ②	PID2 Set Point 2 Sleep Delay	0	3000	s	0	1388	
P11.30 ②	PID2 Set Point 2 WakeUp Level	-99999.99	99999.99	varies	0.00	1389	
P11.31 ②	PID2 Set Point 2 Boost	-2.0	2.0		1.0	1391	
P11.32 ①②	PID2 Feedback Func				0	1392	See Para ID 1330
P11.33 ②	PID2 Feedback Gain	-1000.0	1000.0	%	100.0	1393	
P11.34 ①②	PID2 Feedback 1 Source				1	1394	0=Not Used 1=A11 2=A12 3=Slot A: A11 4=Slot B: A11 5=FB Process Data Input 1 6=FB Process Data Input 2 7=FB Process Data Input 3 8=FB Process Data Input 4 9=FB Process Data Input 5 10=FB Process Data Input 6 11=FB Process Data Input 7 12=FB Process Data Input 8 13=PT100 Temperture 14=PID1 Output 15=SlotA PT100 Temp Channel 1 16=SlotA PT100 Temp Channel 2 17=SlotA PT100 Temp Channel 3 18=SlotB PT100 Temp Channel 1 19=SlotB PT100 Temp Channel 2 20=SlotB PT100 Temp Channel 3 21=FB PID2 Feedback 1 22=FB PID2 Feedback 2
P11.35 ②	PID2 Feedback 1 Min	-200.00	200.00	%	0.00	1395	
P11.36 ②	PID2 Feedback 1 Max	-200.00	200.00	%	100.00	1396	
P11.37 ①②	PID2 Feedback 2 Source				0	1397	See Para ID 1394
P11.38 ②	PID2 Feedback 2 Min	-200.00	200.00	%	0.00	1398	
P11.39 ②	PID2 Feedback 2 Max	-200.00	200.00	%	100.00	1399	
P11.40 ①②	PID2 Feedforward Func				0	1400	See Para ID 1338
P11.41 ②	PID2 Feedforward Gain	-1000.0	1000.0	%	100.0	1401	

Notes: ① Parameter value can only be changed after the drive has stopped.
② Parameter value will be set to be default when changing macros.

Table 102. PID Controller 2—P11, continued

Code	Parameter	Min.	Max.	Unit	Default	ID	Note
P11.42 ①②	PID2 Feedforward 1 Source				0	1402	0=Not Used 1=A11 2=A12 3=Slot A: A11 4=Slot B: A11 5=FB Process Data Input 1 6=FB Process Data Input 2 7=FB Process Data Input 3 8=FB Process Data Input 4 9=FB Process Data Input 5 10=FB Process Data Input 6 11=FB Process Data Input 7 12=FB Process Data Input 8 13=PT100 Temperature 14=PID1 Output 15=SlotA PT100 Temp Channel 1 16=SlotA PT100 Temp Channel 2 17=SlotA PT100 Temp Channel 3 18=SlotB PT100 Temp Channel 1 19=SlotB PT100 Temp Channel 2 20=SlotB PT100 Temp Channel 3 21=FB PID2 Feedforward 1 22=FB PID2 Feedforward 2
P11.43 ②	PID2 Feedforward 1 Min	-200.00	200.00	%	0.00	1403	
P11.44 ②	PID2 Feedforward 1 Max	-200.00	200.00	%	100.00	1404	
P11.45 ①②	PID2 Feedforward 2 Source				0	1405	See Para ID 1402
P11.46 ②	PID2 Feedforward 2 Min	-200.00	200.00	%	0.00	1406	
P11.47 ②	PID2 Feedforward 2 Max	-200.00	200.00	%	100.00	1407	
P11.48 ②	PID2 Set Point1 Comp Enable				0	1414	0 = Disabled 1 = Enabled
P11.49 ②	PID2 Set Point1 Comp Max	-200.00	200.00	%	0.00	1415	
P11.50 ②	PID2 Set Point 2 Comp Enable				0	1416	0 = Disabled 1 = Enabled
P11.51 ②	PID2 Set Point 2 Comp Max	-200.00	200.00	%	0.00	1417	
P11.52 ②	PID2 Wake Up Action	0	3		0	2467	0 = Below Wake Up Level 1 = Above Wake Up Level 2 = Below Wake Up Level(PID ref.) -Wake up when below wakeup level % set in Para ID 1380 or 1389 from PID Setpoint. 3 = Above Wake Up Level(PID ref.) -Wake up when above wakeup level % set in Para ID 1380 or 1389 from PID Setpoint.
P11.53	FB PID2 Set Point 1	P11.5	P11.6	varies	0.00	2546	
P11.54	FB PID2 Set Point 2	P11.5	P11.6	varies	0.00	2548	
P11.55	FB PID2 Feedback 1			varies	0.00	2552	
P11.56	FB PID2 Feedback 2			varies	0.00	2553	
P11.57	FB PID2 Feedforward 1			varies	0.00	2556	
P11.58	FB PID2 Feedforward 2			varies	0.00	2557	

Table 103. Preset Speed—P12

Code	Parameter	Min.	Max.	Unit	Default	ID	Note
P12.1 ②	Preset Speed 1	0.00	See Para ID 102	Hz	5.00	105	
P12.2 ②	Preset Speed 2	0.00	See Para ID 102	Hz	10.00	106	
P12.3 ②	Preset Speed 3	0.00	See Para ID 102	Hz	15.00	118	
P12.4 ②	Preset Speed 4	0.00	See Para ID 102	Hz	20.00	119	
P12.5 ②	Preset Speed 5	0.00	See Para ID 102	Hz	25.00	120	
P12.6 ②	Preset Speed 6	0.00	See Para ID 102	Hz	30.00	121	
P12.7 ②	Preset Speed 7	0.00	See Para ID 102	Hz	35.00	122	

Notes: ① Parameter value can only be changed after the drive has stopped.

② Parameter value will be set to be default when changing macros.

Chapter 7—Multi-PID Application

Table 104. Brake—P14

Code	Parameter	Min.	Max.	Unit	Default	ID	Note
P14.1 ①②⑧	DC-Brake Current	Drive Nom CT*15/100/0.0	Drive Nom CT*15/10/Drive Nom VT*2	A	Drive Nom CT*1/2 / Drive Nom VT*1/2	254	
P14.2 ①②	Start DC-Brake Time	0.00	600.00	s	0.00	263	
P14.3 ①②	Stop DC-Brake Frequency	0.10	10.00	Hz	1.50	262	
P14.4 ①②	Stop DC-Brake Time	0.00	600.00	s	0.00	255	
P14.5 ①②	Brake Chopper Define				0	251	0 = Disabled 1 = B(Run) T(Rdy) 2 = External 3 = B(Rdy) T(Rdy) 4 = B(Run) T(No)
P14.6 ①②	Flux Brake				0	266	0 = Off 1 = On
P14.7 ①②	Flux Brake Current	Active Motor Nom I*1/10	See Para ID 107	A	Active Motor Nom I*1/2	265	

Table 105. Fire Mode—P15

Code	Parameter	Min.	Max.	Unit	Default	ID	Note
P15.1 ①②	Fire Mode Function				0	535	0 = Closing Contact 1 = Opening Contact
P15.2 ①②	Fire Mode Ref Select Function				0	536	0 = Fire Mode Min Frequency 1 = Fire Mode Reference 2 = Fieldbus Reference 3 = AI1 4 = AI2 5 = AI1+AI2 6 = PID1 Control Output 7 = PID2 Control Output
P15.3 ②	Fire Mode Min Frequency	See Para ID 101	See Para ID 102	Hz	15.00	537	
P15.4 ②	Fire Mode Freq Ref 1	0.0	100.0	%	75.0	565	
P15.5 ②	Fire Mode Freq Ref 2	0.0	100.0	%	100.0	564	
P15.6 ①②	Smoke Purge Frequency	0.0	100.0	%	50.0	554	
P15.7 ②	Fire Mode Test Enable				0	2443	0 = Disable 1 = Enable

Table 106. Second Motor Parameter—P16

Code	Parameter	Min.	Max.	Unit	Default	ID	Note
P16.1 ①	Motor Nom Current 2	Drive Nom CT*1/10	Drive Nom CT*2	A	Drive Nom CT	577	
P16.2 ①	Motor Nom Speed 2	300	20000	rpm	2nd Motor Nom Speed	578	
P16.3 ①	Motor PF 2	0.30	1.00		0.85	579	
P16.4 ①	Motor Nom Volt 2	180	690	V	2nd Motor Nom Volt	580	
P16.5 ①	Motor Nom Freq 2	8.00	400.00	Hz	2nd Motor Nom Freq	581	
P16.6 ①⑦	Stator Resistor 2	0.001	65.535	ohm	0.033	1419	
P16.7 ①⑥	Rotor Resistor 2	0.001	65.535	ohm	0.034	1420	
P16.8 ①⑦	Leak Inductance 2	0.001	65.535	mh	0.128	1421	
P16.9 ①⑥	Mutual Inductance 2	0.01	655.35	mh	3.44	1422	
P16.10 ①⑦⑧	Excitation Current 2	0.1/0.0	Drive Nom Curr CT*2	A	0.1/0.0	1423	

- Notes:**
- ① Parameter value can only be changed after the drive has stopped.
 - ② Parameter value will be set to be default when changing macros.
 - ③ Function is not available in FR7 and FR8 of DG1 drives.
 - ④ Function is only available in FR7 and FR8 of DG1 drives.
 - ⑤ DG1 Frame 1-6/DG1 Frame 7-8.

Table 107. Bypass—P17**Basic Settings**

Code	Parameter	Min.	Max.	Unit	Default	ID	Note
P17.1.1 ①②	Bypass Enable				0	1418	0 = Disabled 1 = Enabled
P17.1.2 ①②	Bypass Start Delay	1	32765	s	5	544	
P17.1.3 ①②	Auto Bypass				0	542	0 = Disabled 1 = Enabled
P17.1.4 ①②	Auto Bypass Delay	0	32765	s	10	543	
P17.1.5 ①②	Overcurrent Bypass Enable				0	547	0 = Disabled 1 = Enabled
P17.1.6 ①②	IGBT Fault Bypass Enable				0	546	0 = Disabled 1 = Enabled
P17.1.7 ①②	4 mA Fault Bypass Enable				0	548	0 = Disabled 1 = Enabled
P17.1.8 ①②	Undervoltage Bypass Enable				0	545	0 = Disabled 1 = Enabled
P17.1.9 ①②	Overvoltage Bypass Enable				0	549	0 = Disabled 1 = Enabled
P17.2.1 ②	Redundant Drive Enable	0	1		0	2476	0 = Disabled 1 = Enabled
P17.2.2 ②	Drive ID	0	5		0	2278	
P17.2.3 ②	Redundant Run Time Enable	0	1		0	2477	0 = Disabled 1 = Enabled
P17.2.4 ②	Redundant Run Time Reset	0	1		0	2478	0 = Not Reset 1 = Reset
P17.2.5 ②	Redundant RunTime Limit	0.0	300000.0	h	0.0	2479	

Table 108. Basic Settings - P18.1

Code	Parameter	Min.	Max.	Unit	Default	ID	Note
P18.1.1 ②	Multi-Pump Mode				0	2279	0 = Disable 1 = Single Drive Control 2 = Multi Drive Network
P18.1.2 ②	Drive ID	0	5		0.00	2278	
P18.1.3 ②	PID Bandwidth	0	100	Varies	10	343	
P18.1.4 ②	Staging Frequency	See Para ID 101	400		See Para ID 102	2315	
P18.1.5 ②	De-Staging Frequency	0	See Para ID 102		See Para ID 101	2316	
P18.1.6 ②	Add/Remove Delay	0	3600	s	10	344	
P18.1.7 ②	Interlock Enable				0	350	0 = Disable 1 = Single Drive Control 2 = Multi Drive Network
P18.1.8 ②	Damper Start				0	483	0 = Normal 1 = Interlock Start 2 = Interlock Tout 3 = Interlock Delay
P18.1.9 ②	Damper Time Out	1	32500	s	5	484	
P18.1.10 ②	Damper Delay	1	32500	s	5	485	
P18.1.11 ②	Derag Cycles	0	10		3	2468	0 = Off 1 = Start 2 = Stop 3 = Start and Stop 4 = Digital Input
P18.1.12 ②	Derag at Start/Stop	0	4		0	2469	
P18.1.13 ②	Deragging Run Time	0	3600	s	0	2470	
P18.1.14 ②	Derag Speed	See Para ID 101	See Para ID 102	Hz	5	2471	
P18.1.15 ②	Derag Off Delay	1	600	s	10	2472	

Notes: ① Parameter value can only be changed after the drive has stopped.
 ② Parameter value will be set to be default when changing macros.
 ③ Function is not available in FR7 and FR8 of DG1 drives.
 ④ Function is only available in FR7 and FR8 of DG1 drives.
 ⑤ DG1 Frame 1-6/DG1 Frame 7-8.

Multi-Pump Com Status P18.2

Table 109. Operation Mode P18.2.1

Code	Parameter	Min.	Max.	Unit	Default	ID	Note
P18.2.1.1	Drive 1				0	2218	0 = Offline 1 = Slave Drive 2 = Master Drive
P18.2.1.2	Drive 2				0	2230	0 = Offline 1 = Slave Drive 2 = Master Drive
P18.2.1.3	Drive 3				0	2242	0 = Offline 1 = Slave Drive 2 = Master Drive
P18.2.1.4	Drive 4				0	2254	0 = Offline 1 = Slave Drive 2 = Master Drive
P18.2.1.5	Drive 5				0	2266	0 = Offline 1 = Slave Drive 2 = Master Drive

Table 110. Multi Pump Status P18.2.2

Code	Parameter	Min.	Max.	Unit	Default	ID	Note
P18.2.2.1	Drive 1				0	2219	0 = Stopped 1 = Sleep 2 = Regulating 3 = Wait for CMD 4 = Following 5 = Unknown
P18.2.2.2	Drive 2				0	2231	0 = Stopped 1 = Sleep 2 = Regulating 3 = Wait for CMD 4 = Following 5 = Unknown
P18.2.2.3	Drive 3				0	2243	0 = Stopped 1 = Sleep 2 = Regulating 3 = Wait for CMD 4 = Following 5 = Unknown
P18.2.2.4	Drive 4				0	2245	0 = Stopped 1 = Sleep 2 = Regulating 3 = Wait for CMD 4 = Following 5 = Unknown
P18.2.2.5	Drive 5				0	2267	0 = Stopped 1 = Sleep 2 = Regulating 3 = Wait for CMD 4 = Following 5 = Unknown

Notes: ① Parameter value can only be changed after the drive has stopped.
 ② Parameter value will be set to be default when changing macros.

Table 111. Network Status P18.2.3

Code	Parameter	Min.	Max.	Unit	Default	ID	Note
P18.2.3.1	Drive 1				0	2220	0 = Disconnected 1 = Fault 2 = Pump Lost 3 = Need Alternation 4 = No Error
P18.2.3.2	Drive 2				0	2232	0 = Disconnected 1 = Fault 2 = Pump Lost 3 = Need Alternation 4 = No Error
P18.2.3.3	Drive 3				0	2244	0 = Disconnected 1 = Fault 2 = Pump Lost 3 = Need Alternation 4 = No Error
P18.2.3.4	Drive 4				0	2246	0 = Disconnected 1 = Fault 2 = Pump Lost 3 = Need Alternation 4 = No Error
P18.2.3.5	Drive 5				0	2268	0 = Disconnected 1 = Fault 2 = Pump Lost 3 = Need Alternation 4 = No Error

Multi-Pump Measurement P18.3**Table 112. Last Fault Code P18.3.1**

Code	Parameter	Min.	Max.	Unit	Default	ID	Note
P18.3.1.1	Drive 1				0	2221	
P18.3.1.2	Drive 2				0	2233	
P18.3.1.3	Drive 3				0	2245	
P18.3.1.4	Drive 4				0	2257	
P18.3.1.5	Drive 5				0	2269	

Table 113. Output Frequency P18.3.2

Code	Parameter	Min.	Max.	Unit	Default	ID	Note
P18.3.2.1	Drive 1			Hz	0	2222	
P18.3.2.2	Drive 2			Hz	0	2234	
P18.3.2.3	Drive 3			Hz	0	2246	
P18.3.2.4	Drive 4			Hz	0	2258	
P18.3.2.5	Drive 5			Hz	0	2270	

Table 114. Motor Voltage P18.3.3

Code	Parameter	Min.	Max.	Unit	Default	ID	Note
P18.3.3.1	Drive 1			V	0	2223	
P18.3.3.2	Drive 2			V	0	2235	
P18.3.3.3	Drive 3			V	0	2247	
P18.3.3.4	Drive 4			V	0	2259	
P18.3.3.5	Drive 5			V	0	2271	

Notes: ① Parameter value can only be changed after the drive has stopped.
 ② Parameter value will be set to be default when changing macros.

Table 115. Motor Current P18.3.4

Code	Parameter	Min.	Max.	Unit	Default	ID	Note
P18.3.4.1	Drive 1			A	0	2224	
P18.3.4.2	Drive 2			A	0	2236	
P18.3.4.3	Drive 3			A	0	2248	
P18.3.4.4	Drive 4			A	0	2260	
P18.3.4.5	Drive 5			A	0	2272	

Table 116. Motor Torque P18.3.5

Code	Parameter	Min.	Max.	Unit	Default	ID	Note
P18.3.5.1	Drive 1			%	0	2225	
P18.3.5.2	Drive 2			%	0	2237	
P18.3.5.3	Drive 3			%	0	2249	
P18.3.5.4	Drive 4			%	0	2261	
P18.3.5.5	Drive 5			%	0	2273	

Table 117. Motor Power P18.3.6

Code	Parameter	Min.	Max.	Unit	Default	ID	Note
P18.3.6.1	Drive 1			%	0	2226	
P18.3.6.2	Drive 2			%	0	2238	
P18.3.6.3	Drive 3			%	0	2250	
P18.3.6.4	Drive 4			%	0	2262	
P18.3.6.5	Drive 5			%	0	2274	

Table 118. Motor Speed P18.3.7

Code	Parameter	Min.	Max.	Unit	Default	ID	Note
P18.3.7.1	Drive 1			RPM	0	2227	
P18.3.7.2	Drive 2			RPM	0	2239	
P18.3.7.3	Drive 3			RPM	0	2251	
P18.3.7.4	Drive 4			RPM	0	2263	
P18.3.7.5	Drive 5			RPM	0	2275	

Table 119. Motor Run Time P18.3.8

Code	Parameter	Min.	Max.	Unit	Default	ID	Note
P18.3.8.1	Drive 1			h	0	2228	
P18.3.8.2	Drive 2			h	0	2240	
P18.3.8.3	Drive 3			h	0	2252	
P18.3.8.4	Drive 4			h	0	2264	
P18.3.8.5	Drive 5			h	0	2276	

Notes: ① Parameter value can only be changed after the drive has stopped.
 ② Parameter value will be set to be default when changing macros.

Table 120. Multi-Pump Single Drive - P18.4

Code	Parameter	Min.	Max.	Unit	Default	ID	Note
P18.4.1 ②	Number of Pumps	1	5		1	342	
P18.4.2 ②	Include Frequency Converter				1	346	0 = Disable 1 = Enable
P18.4.3 ②	Auto-Change Enable				0	345	0 = Disable 1 = Enable
P18.4.4 ②	Auto-Change Interval	0	3000	h	48	347	
P18.4.5 ②	Auto-Change Freq Limit	See Para ID 101	See Para ID 102	Hz	25	349	
P18.4.6 ②	Auto-Change Pump Limit	0	5		1	348	
P18.4.7 ②	Pipe Fill Aux Pump Select				0	2441	0=Disabled 1=Aux Motor 1 2=Aux Motor 2 3=Aux Motor 3 4=Aux Motor 4
P18.4.8 ②	Pipe Fill Aux Pump Run Time	0.0	3600.0	min	0.0	2442	
P18.4.9 ②	Pipe Fill Aux Pump Operation				0	2443	0 = Automatic 1 = Stop
P18.4.10 ②	Pipe Fill Aux Pump Delay	0.0	600.0	min	2.0	2444	

Table 121. Multi-Pump Multi Drive - P18.5

Code	Parameter	Min.	Max.	Unit	Default	ID	Note
P18.5.1 ②	Number of Drives	1	5		1	2451	
P18.5.2 ②	Regulation Source				0	2284	0 = Network 1 = PID Controller 1
P18.5.3 ②	Recovery Method				0	2285	0 = Automatic 1 = Stop
P18.5.4 ②	Callback Source				0	2286	0 = No Action 1 = Safe Torque Off
P18.5.5 ②	Add/Remove Drive Selection				0	2311	0 = Drive ID 1 = Run Time
P18.5.6 ②	Run Time Enable				0	2280	0 = Disable 1 = Enable
P18.5.7 ②	Run Time Limit	0	300000	h	0	2281	
P18.5.8 ②	Run Time Reset				0.0	2283	0 = No Action 1 = Reset
P18.5.9 ②	Master Drive Mode	0	2		0	2473	0 = Follow PID 1 = Fixed Speed 2 = Turn Off
P18.5.10 ②	Master Fixed Speed	See Para ID 101	See Para ID 102	Hz	50.00	2474	
P18.5.11 ②	Master Fixed Speed Delay	0	1000	s	5	2475	

Table 122. Protections—P18.6

Code	Parameter	Min.	Max.	Unit	Default	ID	Note
P18.6.1 ②	Pipe Fill Loss Detection Method				0	2406	0 = Motor Current 1 = Motor Power 2 = Motor Torque
P18.6.2 ②	Pipe Fill Loss Level	0.0	1000.0	varies based off Para ID2406	0.0	2407	
P18.6.3 ②	Pipe Fill Loss Time	0	600	s	0	2408	
P18.6.4 ②	Pipe Fill Loss Frequency	0.00	See Para ID 102	Hz	0.00	2409	
P18.6.5 ②	Pipe Fill Loss Response				0	2410	0 = No Action 1 = Warning 2 = Fault
P18.6.6 ②	Pipe Fill Loss Attempts	0	10		1	24011	
P18.6.7 ②	Prime Pump Enable				0	2430	See Para ID 190

Notes: ① Parameter value can only be changed after the drive has stopped.

② Parameter value will be set to be default when changing macros.

Chapter 7—Multi-PID Application

Table 122. Protections—P18.6, continued

P18.6.8 ②	Prime Pump Level	0.00	6000.00	%	0.00	2431
P18.6.9 ②	Prime Pump Frequency	See Para ID 101	See Para ID 102	Hz	0.00	2433
P18.6.10 ②	Prime Pump Delay Time	0.0	3600.0	min	0.0	2434
P18.6.11 ②	Prime Pump Loss of Prime Level	0.0	1000.0	%	0.0	2435
P18.6.12 ②	Prime Pump Level 2	0.00	6000.00	%	0.00	2436
P18.6.13 ②	Prime Pump Frequency 2	See Para ID 101	See Para ID 102	Hz	0.00	2438
P18.6.14 ②	Prime Pumpe Delay Time 2	0.0	3600.0	min	0.0	2439
P18.6.15 ②	Prime Pumpe Loss of Prime Level 2	0.0	1000.0	%	0.0	2440

Table 123. Real Time Clock—P19

Code	Parameter	Min.	Max.	Unit	Default	ID	Note
P19.1 ②	Interval 1 On Time				0,0,0	491	
P19.2 ②	Interval 1 Off Time				0,0,0	493	
P19.3 ②	Interval 1 From Day				0	517	0 = Sunday 1 = Monday 2 = Tuesday 3 = Wednesday 4 = Thursday 5 = Friday 6 = Saturday
P19.4 ②	Interval 1 To Day				0	518	See Para ID 517
P19.5 ②	Interval 1 Channel				0	519	0 = Not Used 1 = Time Channel 1 2 = Time Channel 2 3 = Time Channel 3
P19.6 ②	Interval 2 On Time				0,0,0	495	
P19.7 ②	Interval 2 Off Time				0,0,0	497	
P19.8 ②	Interval 2 From Day				0	520	See Para ID 517
P19.9 ②	Interval 2 To Day				0	521	See Para ID 517
P19.10 ②	Interval 2 Channel				0	522	See Para ID 519
P19.11 ②	Interval 3 On Time				0,0,0	499	
P19.12 ②	Interval 3 Off Time				0,0,0	501	
P19.13 ②	Interval 3 From Day				0	523	See Para ID 517
P19.14 ②	Interval 3 To Day				0	524	See Para ID 517
P19.15 ②	Interval 3 Channel				0	525	See Para ID 519
P19.16 ②	Interval 4 On Time				0,0,0	503	
P19.17 ②	Interval 4 Off Time				0,0,0	505	
P19.18 ②	Interval 4 From Day				0	526	See Para ID 517
P19.19 ②	Interval 4 To Day				0	527	See Para ID 517
P19.20 ②	Interval 4 Channel				0	528	See Para ID 519
P19.21 ②	Interval 5 On Time				0,0,0	507	
P19.22 ②	Interval 5 Off Time				0,0,0	509	
P19.23 ②	Interval 5 From Day				0	529	See Para ID 517
P19.24 ②	Interval 5 To Day				0	530	See Para ID 517
P19.25 ②	Interval 5 Channel				0	531	See Para ID 519
P19.26 ②	Timer 1 Duration	0	72000	s	0	511	

Notes: ① Parameter value can only be changed after the drive has stopped.
② Parameter value will be set to be default when changing macros.

Table 123. Real Time Clock—P19, continued

Code	Parameter	Min.	Max.	Unit	Default	ID	Note
P19.27 ②	Timer 1 Channel				0	532	0 = Not Used 1 = Time Channel 1 2 = Time Channel 2 3 = Time Channel 3
P19.28 ②	Timer 2 Duration	0	72000	s	0	513	
P19.29 ②	Timer 2 Channel				0	533	See Para ID 532
P19.30 ②	Timer 3 Duration	0	72000	s	0	515	
P19.31 ②	Timer 3 Channel				0	534	See Para ID 532
P19.32 ②	Interval 1 Setting	0	1		0	2487	0 = Weekly 1 = Daily
P19.33 ②	Interval 2 Setting	0	1		0	2488	0 = Weekly 1 = Daily
P19.34 ②	Interval 3 Setting	0	1		0	2489	0 = Weekly 1 = Daily
P19.35 ②	Interval 4 Setting	0	1		0	2490	0 = Weekly 1 = Daily
P19.36 ②	Interval 5 Setting	0	1		0	2491	0 = Weekly 1 = Daily

Communication P20**Table 124. FB Process Data Input Sel—P20.1**

Code	Parameter	Min.	Max.	Unit	Default	ID	Note
P20.1.1	FB Process Data Input 1 Sel				2541	2533	
P20.1.2	FB Process Data Input 2 Sel				2542	2534	
P20.1.3	FB Process Data Input 3 Sel				2550	2535	
P20.1.4	FB Process Data Input 4 Sel				103	2536	
P20.1.5	FB Process Data Input 5 Sel				104	2537	
P20.1.6	FB Process Data Input 6 Sel				107	2538	
P20.1.7	FB Process Data Input 7 Sel				0	2539	
P20.1.8	FB Process Data Input 8 Sel				0	2540	

Table 125. FB Process Data Output Sel—P20.2

Code	Parameter	Min.	Max.	Unit	Default	ID	Note
P20.2.1	FB Process Data Output 1 Sel				1	1556	
P20.2.2	FB Process Data Output 2 Sel				2	1557	
P20.2.3	FB Process Data Output 3 Sel				3	1558	
P20.2.4	FB Process Data Output 4 Sel				4	1559	
P20.2.5	FB Process Data Output 5 Sel				5	1560	
P20.2.6	FB Process Data Output 6 Sel				6	1561	
P20.2.7	FB Process Data Output 7 Sel				7	1562	

Notes: ① Parameter value can only be changed after the drive has stopped.
 ② Parameter value will be set to be default when changing macros.

Chapter 7—Multi-PID Application

Table 125. FB Process Data Output Sel—P20.2, continued

Code	Parameter	Min.	Max.	Unit	Default	ID	Note
P20.2.8	FB Process Data Output 8 Sel				28	1563	
P20.2.9	Standard Status Word Bit0 Function Select				1	2415	See Para ID 151
P20.2.10	Standard Status Word Bit1 Function Select				1	2416	See Para ID 151
P20.2.11	Standard Status Word Bit2 Function Select				1	2417	See Para ID 151
P20.2.12	Standard Status Word Bit3 Function Select				1	2418	See Para ID 151
P20.2.13	Standard Status Word Bit4 Function Select				1	2419	See Para ID 151
P20.2.14	Standard Status Word Bit5 Function Select				1	2420	See Para ID 151
P20.2.15	Standard Status Word Bit6 Function Select				1	2421	See Para ID 151
P20.2.16	Standard Status Word Bit7 Function Select				1	2422	See Para ID 151

RS485 Bus P20.3

Table 126. Basic Setting— P20.3.1

Code	Parameter	Min.	Max.	Unit	Default	ID	Note
P20.3.1.1	RS485 Comm Set				0	586	0 = Modbus RTU 1 = BACnet MS/TP 2 = SWD

Table 127. Modbus RTU— P20.3.2

Code	Parameter	Min.	Max.	Unit	Default	ID	Note
P20.3.2.1	Slave Address	1	247		1	587	
P20.3.2.2	Baud Rate				1	584	0 = 9600 1 = 19200 2 = 38400 3 = 57600 4 = 115200
P20.3.2.3	Parity Type				2	585	0 = None 1 = Odd 2 = Even
P20.3.2.4	Modbus RTU Protocol Status				0	588	0 = Initial 1 = Stopped 2 = Operational 3 = Faulted
P20.3.2.5	Slave Busy				0	589	0 = Not Busy 1 = Busy
P20.3.2.6	Parity Error				0	590	
P20.3.2.7	Slave Fault				0	591	
P20.3.2.8	Last Fault Response				0	592	
P20.3.2.9	Comm Timeout Modbus RTU			ms	10000	593	
P20.3.2.10	Modbus RTU Fault Response	0	1		0	2516	0 = In Fieldbus Control 1 = In All Control

Notes: ① Parameter value can only be changed after the drive has stopped.
② Parameter value will be set to be default when changing macros.

Table 128. BACnet MS/TP— P20.3.3

Code	Parameter	Min.	Max.	Unit	Default	ID	Note
P20.3.3.1	MSTP Baud Rate				2	594	0 = 9600 1 = 19200 2 = 38400 3 = 78600 4 = 115200
P20.3.3.2	MSTP MS/TP Device Address	0	127		1	595	
P20.3.3.3	MSTP Instance Number	0	4194302		varies	596	
P20.3.3.4	MSTP Comm Timeout MSTP			ms	10000	598	
P20.3.3.5	MSTP Protocol Status				0	599	0 = Stopped 1 = Operational 2 = Faulted
P20.3.3.6	MSTP Fault Code				0	600	0 = None 1 = Sole Master
P20.3.3.7	MSTP Fault Response	0	1		0	2526	0 = In Fieldbus Control 1 = In All Control

Table 129. Table 118. Ethernet IP—P20.4

Code	Parameter	Min.	Max.	Unit	Default	ID	Note
P20.4.1	IP Address Mode				1	1500	0 = Static IP 1 = DHCP with AutoIP
P20.4.2	Active IP Address					1507	
P20.4.3	Active Subnet Mask					1509	
P20.4.4	Active Default Gateway					1511	
P20.4.5	MAC Address					1513	
P20.4.6	Static IP Address				192.168.1.254	1501	
P20.4.7	Static Subnet Mask				255.255.255.0	1503	
P20.4.8	Static Default Gateway				192.168.1.1	1505	

Table 130. Modbus TCP— P20.5

Code	Parameter	Min.	Max.	Unit	Default	ID	Note
P20.5.1	Connection Limit				5	609	
P20.5.2	Modbus TCP Unit ID				1	610	
P20.5.3	Comm Timeout Modbus TCP			ms	10000	611	
P20.5.4	Modbus TCP Protocol Status				0	612	0 = Stopped 1 = Operational 2 = Faulted
P20.5.5	Slave Busy				0	613	0 = Not Busy 1 = Busy
P20.5.6	Parity Error				0	614	
P20.5.7	Slave Failure				0	615	
P20.5.8	Last Fault Response				0	616	
P20.5.9	Modbus TCP Fault Response	0	1		0	2517	0 = In Fieldbus Control 1 = In All Control

Notes: ① Parameter value can only be changed after the drive has stopped.
 ② Parameter value will be set to be default when changing macros.

Chapter 7—Multi-PID Application

Table 131. Basic Setting—P21.1

Code	Parameter	Min.	Max.	Unit	Default	ID	Note
P21.1.1	Language				0	340	0 = English 1 = Depends upon Language Pack 2 = Depends upon Language Pack
P21.1.2 ①	Application				0	142	0 = Standard 1 = Multi-Pump 2 = Multi-PID 3 = Multi-Purpose
P21.1.3	Parameter Sets				0	619	0 = No 1 = Reload Defaults 2 = Reload Set 1 3 = Reload Set 2 4 = Store Set 1 5 = Store Set 2 6 = Reset 7 = Reload Defaults VM
P21.1.4	Up To Keypad				0	620	0 = No 1 = Yes
P21.1.5	Down From Keypad				0	621	0 = No 1 = All Parameters 2 = All, No Motor 3 = App Parameters
P21.1.6	Parameter Comparison				0	623	0 = No 1 = Compare with Keypad 2 = Compare with Default 3 = Compare with Set 1 4 = Compare with Set 2
P21.1.7	Password	0	9999		0	624	
P21.1.8	Parameter Lock				0	625	0 = Change Enable 1 = Change Disable
P21.1.9	Multimonitor Set				0	627	See Para ID 625
P21.1.10	Default Page				0	628	0 = None 1 = Main Menu 2 = Multi-Monitor 3 = Favorite Menu 4 = Keypad Reference
P21.1.11	Timeout Time	0	65535	s	30	629	
P21.1.12	Contrast Adjust	5	18		12	630	
P21.1.13	Backlight Time	1	65535	min	10	631	
P21.1.14	Fan Control				2	632	0 = Continuous 1 = Temperature 2 = Run Follow ② 3 = Calculate Temp ②
P21.1.15	HMI ACK Timeout	200	5000	ms	200	633	
P21.1.16	HMI Retry Number	1	10		5	634	
P21.1.17	Startup Wizard	0	1		1	626	0 = No 1 = Yes
P21.1.18	Jog Soft Key Hidden	0	1		0	2412	0 = Disable 1 = Enable
P21.1.19	Reverse Softkey Hidden	0	1		0	2413	0 = Disable 1 = Enable

Notes: ① Parameter value can only be changed after the drive has stopped.
② Parameter value will be set to be default when changing macros.

Table 131. Basic Setting—P21.1, continued

Code	Parameter	Min.	Max.	Unit	Default	ID	Note
P21.1.20	Output Display Unit				45	2424	0 = % 1 = 1/min 2 = rpm 3 = ppm 4 = pps 5 = l/s 6 = l/min 7 = l/h 8 = kg/s 9 = kg/min 10 = kg/h 11 = m ³ /s 12 = m ³ /min 13 = m ³ /h 14 = m/s 15 = mbar 16 = bar 17 = Pa 18 = kPa 19 = mVs 20 = kW 21 = deg C 22 = GPM 23 = gal/s 24 = gal/min 25 = gal/h 26 = lb/s 27 = lb/min 28 = lb/h 29 = CFM 30 = ft ³ /s 31 = ft ³ /min 32 = ft ³ /h 33 = ft/s 34 = in wg 35 = ft wg 36 = PSI 37 = lb/in ² 38 = HP 39 = deg F 40 = PA 41 = WC 42 = HG 43 = ft 44 = m 45 = Hz
P21.1.21	Output Display Unit Min	-60000.00	See Para ID 2425	varies	0.00	2460	
P21.1.22	Output Display Unit Max	See Para ID 2460	60000.00	varies	60	2425	

Table 132. Version Info—P21.2

Code	Parameter	Min.	Max.	Unit	Default	ID	Note
P21.2.1	Keypad Software Version					640	
P21.2.2	Motor Control Software Version					642	
P21.2.3	Application Software Version				App Firmware	644	
P21.2.4	Software Bundle Version				App bundle rev	1714	

Table 133. Application Info—P21.3

Code	Parameter	Min.	Max.	Unit	Default	ID	Note
P21.3.1	Brake Chopper					646	0 = No 1 = Yes
P21.3.2	Brake Resistor Status					647	See Para ID 646
P21.3.3	Serial Number					648	

Chapter 7—Multi-PID Application

Table 134. User Info—P21.4

Code	Parameter	Min.	Max.	Unit	Default	ID	Note
P21.4.1	Real Time Clock				0:0.0.1:1:13	566	
P21.4.2	Daylight Saving				0	582	0 = Off 1 = EU 2 = US
P21.4.3	Total MWh Count			Mwh		601	
P21.4.4	Total Power Day Count					603	
P21.4.5	Total Power Hr Count					606	
P21.4.6	Trip MWh Count			Mwh		604	
P21.4.7	Clear Trip MWh Count				0	635	0 = Not Reset 1 = Reset
P21.4.8	Trip Power Day Count					636	
P21.4.9	Trip Power Hr Count					637	
P21.4.10	Clear Trip Power Count				0	639	See Para ID 635

Chapter 8—Multi-Purpose application

Introduction

The Multi-Purpose Application is designed for a large set of applications with the ability to have advanced motor control systems. It takes the same functions provided in the Standard, Multi-Pump and Fan, and Multi-PID applications and adds in some additional control techniques. The application is designed with 2 control places that use 8 digital inputs, 2 analog inputs, 3 relay outputs, 1 digital output, and 2 analog outputs that are programmable. Motor controlwise it provides the ability to do frequency and speed control and adds Open Loop Speed Control as well as Torque Control. For tuning the V/Hz curve, it has the ability to go out and ID the motor characteristic and enters those specific measurements into its parameters for better control. Drive/Motor protections are programmable for desired actions depending on the application. Below is a list of additional features available in addition to the Standard, Multi-Pump and Fan, and Multi-PID Application features that are available in the Multi-Purpose Application.

- Motor potentiometer reference control
- External Brake control
- Droop function with multiple loads
- Motor Identification
- Motor Control modes
- I/O Controls
 - “Terminal To Function” (TTF) Programming

The design behind the programming of the digital inputs in the DG1 drive is to use “Terminal To Function” programming. It is composed of multiple functions that get assigned a digital input to that function, the parameters in the drive are set up with specific functions and by defining the Digital input and slot in some cases depending on the what options are available. For use of the drives control board inputs they will be referred to as DigIN:1 through DigIN:8. When additional option cards are used, they will be defined as DigIN:X:IOY:Z. The X indicates the slot that the card is being installed in which will be either A or B, then the IOY determines the type of card it is, which would be IO1 or IO5, and the Z would indicate which input is being used on that available option card.

- “Function To Terminal” (FTT) Programming

The design behind the programming of the relay outputs and digital output in the DG1 drive is to use “Function To Terminal” programming. It is composed of a terminal be it a relay output or a digital output that is assigned a parameter. Within that parameter, it has different functions that can be set.

The parameters of the Multi-Purpose Application are explained on **Page 150** of this manual, “Description of Parameters.” The explanations are arranged according to the parameter number.

For the DI function, we use Terminal programming method to function (TTF), where there is a fixed input that gets programmed to a list of functions. This allows for multiple inputs to be used for different functions. Connecting a certain input with a certain parameter function is done by give a parameter an appropriate value. The value is formed by the location of the input, either being on the standard control board or an external option board and the slot it is located in.

Force Open/Force close selection

The Force Open Selection would make the selected function always off. Essentially this is a virtual switch that is always open.

The Force Close Selection would make the selected function always on. Essentially this is a virtual switch that is always closed.

These options are assigned to a function if we want to force a state without using a hardware input.

Example:

If we set Run Enable to Force Closed the drive is always enabled. If we set the same function to Force Open the drive would never be Enabled. If a Digital input is to be used to activate this Run Enable the function should be assigned to a hardware input(See below for DIGIN Selections).

DIGIN selection

This allows Assignment of a hardware digital input to a function, this is set in a format of DigIN:X where X is one of the 8 Digital inputs on the Main control board.

Example:

If we set Run Enable to DigIN:6 the drive will be enabled when digital input 6 (Terminal 8) is closed, and would not be enabled when digital input 6 (Terminal 8) is open.

Option board DigIN selection

This allows Assignment of a hardware digital input on an option card to a function, this is set in a format of DigIN:Y:IO1:X where Y is the slot the option card is inserted on the Main control board and X is the Input on the Board and IO1 is the type of option board used.

Example:

If we set Run Enable to DigIN:A:IO5:6 the drive will be enabled when digital input 6 is closed on the IO5 option card which is inserted in Slot A, and would not be enabled when digital input 6 on the option card is open.

Timer channel selection

A Time Channel is a virtual path to link the digital output of a timer function to a digital input function. To utilize this feature a timer or interval would need to be assigned to a time channel 1 through 3, and the input function to be controlled would need to be assigned to the same time channel.

Example:

If we set Run Enable to DigIN:TimeChannel1 the drive will be enabled when the timer assigned to Time Channel 1 is active or High, and would not be enabled when the Time Channel is inactive or Low.

Control I/O configuration

- Run 240 Vac and 24 Vdc control wiring in separate conduit
- Communication wire to be shielded

Table 135. Multi-Purpose application default I/O configuration

Default

OFF		ON	
AI1	1		
AI2	2		
AI2	3		

AI1: 0 to 10 V

AI1: 0 to 20 mA

OFF		ON	
	2		
	3		

AI2: 0 to 20 mA

OFF		ON	
	2		
	3		

AI2: 0 to 10 V

OFF		ON	
	2		
	3		

AI2: -10 V to +10 V

External wiring	Pin	Signal name	Signal	Default setting	Description
	1	+10 V	Ref. Output Voltage	—	10 Vdc Supply Source
	2	AI1+⊕	Analog Input 1	0–10 V	Voltage Speed Reference (Programmable to 4 mA to 20 mA)
	3	AI1–	Analog Input 1 Ground	—	Analog Input 1 Common (Ground)
	4	AI2+⊕	Analog Input 2	4 mA to 20 mA	Current Speed Reference (Programmable to 0–10 V)
	5	AI2–	Analog Input 2 Ground	—	Analog Input 2 Common (Ground)
	6	GND	I/O Signal Ground	—	I/O Ground for Reference and Control
	7	DIN5	Digital Input 5	Preset Speed B0	Sets frequency output to Preset Speed 1
	8	DIN6	Digital Input 6	Preset Speed B1	Sets frequency output to Preset Speed 2
	9	DIN7	Digital Input 7	Not Used (TI–)	Input forces VFD output to shut off
	10	DIN8	Digital Input 8	Force Remote (TI+)	Input takes VFD from Local to Remote
	11	CMB	DI5 to DI8 Common	Grounded	Allows source input
	12	GND	I/O Signal Ground	—	I/O Ground for Reference and Control
	13	24 V	+24 Vdc Output	—	Control voltage output (100 mA max.)
	14	DO1	Digital Output 1	Ready	Shows the drive is ready to run
	15	24 Vo	+24 Vdc Output	—	Control voltage output (100 mA max.)
	16	GND	I/O Signal Ground	—	I/O Ground for Reference and Control
	17	AO1+	Analog Output 1	Output Frequency	Shows Output frequency to motor 0–60 Hz (4 mA to 20 mA)
	18	AO2+	Analog Output 2	Motor Current	Shows Motor current of motor 0–FLA (4 mA to 20 mA)
	19	24 Vi	+24 Vdc Input	—	External control voltage input
	20	DIN1	Digital Input 1	Run Forward	Input starts drive in forward direction (start enable)
	21	DIN2	Digital Input 2	Run Reverse	Input starts drive in reverse direction (start enable)
	22	DIN3	Digital Input 3	External Fault	Input causes drive to fault
	23	DIN4	Digital Input 4	Fault Reset	Input resets active faults
	24	CMA	DI1 to DI4 Common	Grounded	Allows source input
	25	A/+	RS-485 Signal A	—	Fieldbus Communication (Modbus, BACnet)
	26	B/-	RS-485 Signal B	—	Fieldbus Communication (Modbus, BACnet)
	27	R3NO	Relay 3 Normally Open	At Speed	Relay output 3 shows VFD is at Ref. Frequency
	28	R1NC	Relay 1 Normally Closed	Run	Relay output 1 shows VFD is in a run state
	29	R1CM	Relay 1 Common		
	30	R1NO	Relay 1 Normally Open		
	31	R3CM	Relay 3 Common	At Speed	Relay output 3 shows VFD is at Ref. Frequency
	32	R2NC	Relay 2 Normally Closed	Fault	Relay output 2 shows VFD is in a fault state
	33	R2CM	Relay 2 Common		
	34	R2NO	Relay 2 Normally Open		

Notes: The above wiring demonstrates a SINK configuration. It is important that CMA and CMB are wired to ground (as shown by dashed line). If a SOURCE configuration is desired, wire 24 V to CMA and CMB and close the inputs to ground. When using the +10 V for AI1, it is important to wire AI1— to ground (as shown by dashed line). If using +10 V for AI1 or AI2, terminals 3, 5, and 6 need to be jumpered together.

⊕ AI1+ and AI2+ Support 10K potentiometer.

Table 136. Drive communication ports

Port	Communication
RJ45 Keypad Port	
Upload/Download Parameters	USB to RJ45
Remote Mount Keypad	Ethernet
Upgrade Drive Firmware	USB to RJ45
RJ45 Ethernet Port	
Upload/Download Parameters	Ethernet
Ethernet IP Communications	Ethernet
Modbus TCP Communications	Ethernet
RS-485 Serial Port ①	
Upload/Download Parameters	Two-Wire Twisted Pair
Upgrade Drive Firmware	Two-Wire Twisted Pair
Modbus RTU Communications	Two-Wire Twisted Pair
BACnet MS/TP Communications	Two-Wire Twisted Pair

① Shielded wire recommended.

Multi-Purpose application—parameters list

On the next pages you will find the lists of parameters within the respective parameter groups. The parameter descriptions are given on **Page 150**, “Description of Parameters.” The descriptions are arranged according to the parameter number.

Column explanations:

Code = Location indication on the keypad; shows the operator the present parameter number

Parameter = Name of parameter

Min = Minimum value of parameter

Max = Maximum value of parameter

Unit = Unit of parameter value; given if available

Default = Value preset by factory

ID = ID number of the parameter

Table 137. Monitor—M

Code	Parameter	Min.	Max.	Unit	Default	ID	Note
M1	Output Frequency			Hz	0.00	1	
M2	Freq Reference			Hz	0.00	24	
M3	Motor Speed			rpm	0	2	
M4	Motor Current			A	0.0	3	
M5	Motor Torque			%	0.0	4	
M6	Motor Power			%	0.0	5	
M7	Motor Voltage			V	0.0	6	
M8	DC-link Voltage			V	0	7	
M9	Unit Temperature			°C	0.0	8	
M10	Motor Temperature			%	0.0	9	
M11	Torque Reference			%	0.0	15	
M12	Analog Input 1			Varies	0.00	10	
M13	Analog Input 2			Varies	0.00	11	
M14	Analog Output 1			Varies	0.00	25	
M15	Analog Output 2			Varies	0.00	575	
M16	DI1, DI2, DI3				0	12	
M17	DI4, DI5, DI6				0	13	
M18	DI7, DI8				0	576	
M19	DO1, Virtual RO1, Virtual RO2				0	14	
M20	RO1, RO2, RO3				0	557	
M21	TC1, TC2, TC3				0	558	
M22	Interval 1				0	559	0 = Inactive 1 = Active
M23	Interval 2				0	560	See Para ID 559
M24	Interval 3				0	561	See Para ID 559
M25	Interval 4				0	562	See Para ID 559
M26	Interval 5				0	563	See Para ID 559
M27	Timer 1			s	0	569	
M28	Timer 2			s	0	571	
M29	Timer 3			s	0	573	
M30	PID1 Set Point			Varies	0.00	16	
M31	PID1 Feedback			Varies	0.00	18	
M32	PID1 Error Value			Varies	0.00	20	
M33	PID1 Output			%	0.00	22	

Table 137. Monitor—M, continued

Code	Parameter	Min.	Max.	Unit	Default	ID	Note
M34	PID1 Status				0	23	0 = Stopped 1 = Running 2 = Sleep Mode
M35	PID2 Set Point			Varies	0.00	32	
M36	PID2 Feedback			Varies	0.00	34	
M37	PID2 Error Value			Varies	0.00	36	
M38	PID2 Output			%	0.00	38	
M39	PID2 Status				0	39	See Para ID 23
M40	Running Motors				0	26	
M41	PT100 Temperature			°C	1000.0	27	
M42	Last Active Fault				0	28	See Fault Codes on Page 223 in Appendix B
M43	RTC Battery Status					583	0 = Not Installed 1 = Installed 2 = Change Battery 3 = Over Voltage
M44	Instant Motor Power			kW	0.000	1686	
M45	Energy Savings			Varies		2120	
M46	Control board DIDO Status				0	2209	Bit 0 = DIN1 Status Bit 1 = DIN2 Status Bit 2 = DIN3 Status Bit 3 = DIN4 Status Bit 4 = DIN5 Status Bit 5 = DIN6 Status Bit 6 = DIN7 Status Bit 7 = DIN8 Status Bit 8 = DO1 Status Bit 9 = RO1 Status Bit 10 = RO2 Status Bit 11 = RO3 Status Bit 12 = Slot A with Board Bit 13 = Slot B with Board Bit 14 -15 = Not used
M47	SlotA DIDO Status				0	2210	Bit 0 = IO1_DIN1 Status Bit 1 = IO1_DIN2 Status Bit 2 = IO1_DIN3 Status Bit 3 = IO1_DO1 Status Bit 4 = IO1_DO2 Status Bit 5 = IO1_DO3 Status Bit 6 = IO3_RO1 Status Bit 7 = IO3_RO2 Status Bit 8 = IO3_RO3 Status Bit 9 = IO5_AC1 Status Bit 10 = IO5_AC2 Status Bit 11 = IO5_AC3 Status Bit 12 = IO5_AC4 Status Bit 13 = IO5_AC5 Status Bit 14 = IO5_AC6 Status Bit 15 = Not Used
M48	SlotB DIDO Status				0	2211	Bit 0 = IO1_DIN1 Status Bit 1 = IO1_DIN2 Status Bit 2 = IO1_DIN3 Status Bit 3 = IO1_DO1 Status Bit 4 = IO1_DO2 Status Bit 5 = IO1_DO3 Status Bit 6 = IO3_RO1 Status Bit 7 = IO3_RO2 Status Bit 8 = IO3_RO3 Status Bit 9 = IO5_AC1 Status Bit 10 = IO5_AC2 Status Bit 11 = IO5_AC3 Status Bit 12 = IO5_AC4 Status Bit 13 = IO5_AC5 Status Bit 14 = IO5_AC6 Status Bit 15 = Not Used

Table 137. Monitor—M, continued

Code	Parameter	Min.	Max.	Unit	Default	ID	Note
M49	App Status Word				0	29	Bit 0 = MC Ready Bit 1 = MC_Run Bit 2 = MC_Fault Bit 3 = FB_Ref_Active Bit 4 = MC_Stopping Bit 5 = MC_Reverse Bit 6 = MC_Warning/AR-Fault Bit 7 = MC_ZeroSpeed Bit 8 = I/O Control Indicate Bit 9 = Panel Control Indicator Bit 10 = Panel Fieldbus Indicator Bit 11 = MC_DC_Brake Bit 12 = RunEnable Bit 13 = Run Bypass Bit 14 = Ext Brake Control Bit 15 = Bypass Mode
M50	Standard Status Word				0	2414	Bit 0 = P20.1.9 (default = Ready) Bit 1 = P20.1.10 (default = Run) Bit 2 = P20.1.11 (default = Fault) Bit 3 = P20.1.12 (default = Fault Invert) Bit 4 = P20.1.13 (default = Warning) Bit 5 = P20.1.14 (default = Reversed) Bit 6 = P20.1.15 (default = At Speed) Bit 7 = P20.1.16 (default = Zero Frequency) Bit 8 - 15 = Not Used
M51	Output				0	2445	
M52	Reference				0	2447	
M53	Total MWh Count				Varies	601	
M54	Total Power Day Count				Varies	603	
M55	Total Power Hr Count				Varies	606	
M56	Trip MWh Count				Varies	604	
M57	Trip Power Day Count				Varies	636	
M58	Trip Power Hr Count				Varies	637	
M59	Multi-Monitoring				1, 2, 3	30	

Table 138. Operate mode—O

Code	Parameter	Min.	Max.	Unit	Default	ID	Note
O1	Output Frequency			Hz	0.00	1	
O2	Freq Reference			Hz	0.00	24	
O3	Motor Speed			rpm	0	2	
O4	Motor Current			A	0.0	3	
O5	Motor Torque			%	0.0	4	
O6	Motor Power			%	0.0	5	
O7	Motor Voltage			V	0.0	6	
O8	DC-link Voltage			V	0	7	
O9	Unit Temperature			°C	0.0	8	
O10	Motor Temperature			%	0.0	9	
R11	Keypad Torque Ref	-300.0	300.0	%	0.0	782	
R12 ②	Keypad Reference	See Para ID 101	See Para ID 102	Hz	0.00	141	
R13 ②	PID1 Keypad Set Point 1	See Para ID 1298	See Para ID 1300	Varies	0	1307	
R14 ②	PID1 Keypad Set Point 2	See Para ID 1298	See Para ID 1300	Varies	0	1309	

Notes: ① Parameter value can only be changed after the drive has stopped.
 ② Parameter value will be set to be default when changing macros.

Chapter 8—Multi-Purpose application

Table 139. Basic parameters—P1

Code	Parameter	Min.	Max.	Unit	Default	ID	Note
P1.1 ①②	Min Frequency	0.00	See Para ID 102	Hz	0.00	101	
P1.2 ①②③	Max Frequency	See Para ID 101	400.00/320.00	Hz	60.00	102	
P1.3 ②	Accel Time 1	0.1	3000.0	s	3.0	103	
P1.4 ②	Decel Time 1	0.1	3000.0	s	3.0	104	
P1.5 ①	Motor Nom Current	Drive Nom CT*1/10	Drive Nom CT*2	A	Drive Nom CT	486	
P1.6 ①③	Motor Nom Speed	300	20000/19200	rpm	Motor Nom Speed	489	
P1.7 ①	Motor PF	0.30	1.00		0.85	490	
P1.8 ①	Motor Nom Voltage	180	690	V	Motor Nom Volt	487	
P1.9 ①③	Motor Nom Frequency	8.00	400.00/320.00	Hz	Motor Nom Freq	488	
P1.10 ②	Power Up Local Remote Select				0	1685	0 = Hold Last 1 = Local Control 2 = Remote Control
P1.11 ②	Remote1 Control Place				0	135	0 = I/O Terminal Start 1 1 = Fieldbus 2 = I/O Terminal Start 2 3 = Keypad
P1.12	Local Control Place				0	1695	0 = Keypad 1 = I/O Terminal Start 1 2 = I/O Terminal Start 2 3 = Fieldbus
P1.13 ②	Bumpless Enable				0	2462	0 = Disabled 1 = Enabled
P1.14 ①②	Local Reference				6	136	0 = AI1 1 = AI2 2 = Slot A: AI1 3 = Slot B: AI1 4 = AI1 Joystick 5 = AI2 Joystick 6 = Keypad 7 = Fieldbus Ref 8 = Motor Pot 9 = Max Frequency 10 = AI1 + AI2 11 = AI1–AI2 12 = AI2–AI1 13 = AI1 * AI2 14 = AI1 or AI2 15 = Min (AI1, AI2) 16 = MAX(AI1,AI2) 17 = PID1 Control Output 18 = PID2 Control Output
P1.15 ①②	Remote1 Reference				1	137	See Para ID 136
P1.16 ①	Reverse Enable				1	1679	0 = Disabled 1 = Enabled
P1.17 ②	Run Delay Time	0	32500	s	0	2423	
P1.18 ②	HOA Source	0	2		0	2465	0 = Disable 1 = I/O Terminal 2 = Keypad

Notes: ① Parameter value can only be changed after the drive has stopped.
 ② Parameter value will be set to be default when changing macros.
 ③ DG1 Frame 1-6/DG1 Frame 7-8

Table 140. Analog input—P2

Code	Parameter	Min.	Max.	Unit	Default	ID	Note
P2.1.1	AI Ref Scale Min Value	0.00	See Para ID 145	Hz	0	144	
P2.1.2	AI Ref Scale Max Value	See Para ID 144	400.00	Hz	0	145	
P2.2.1 ②	AI1 Mode	0	1		1	222	0 = 0–20 mA 1 = 0–10 V
P2.2.2 ②	AI1 Signal Range	0	2		0	175	0 = 0–100% / 0–20 mA / 0–10 V 1 = 20–100% / 4–20 mA / 2–10 V 2 = Customized
P2.2.3 ②	AI1 Custom Min	0.00	See Para ID 177	%	0.00	176	
P2.2.4 ②	AI1 Custom Max	See Para ID 176	100.00	%	100.00	177	
P2.2.5 ②	AI1 Filter Time	0.00	10.00	s	0.10	174	
P2.2.6 ②	AI1 Signal Invert	0	1		0.00	181	0 = Not Inverted 1 = Inverted
P2.2.7 ②	AI1 Joystick Hyst	0.00	20.00	%	0.00	178	
P2.2.8 ②	AI1 Sleep Limit	0.00	100.00	%	0.00	179	
P2.2.9 ②	AI1 Sleep Delay	0.00	320.00	s	0.00	180	
P2.2.10 ②	AI1 Joystick Offset	–50.00	50.00	%	0.00	133	
P2.3.1 ②	AI2 Mode	0	2		1	223	0 = 0–20 mA 1 = 0–10 V 2 = –10 to +10 V
P2.3.2 ②	AI2 Signal Range	0	2		0	183	0 = 0–100% / 0–20 mA / 0–10 V 1 = 20–100% / 4–20 mA / 2–10 V 2 = Customized
P2.3.3 ②	AI2 Custom Min	0.00	See Para ID 185	%	0.00	184	
P2.3.4 ②	AI2 Custom Max	See Para ID 184	100.00	%	100.00	185	
P2.3.5 ②	AI2 Filter Time	0.00	10.00	s	0.10	182	
P2.3.6 ②	AI2 Signal Invert	0	1		0.00	189	0 = Not Inverted 1 = Inverted
P2.3.7 ②	AI2 Joystick Hyst	0.00	20.00	%	0.00	186	
P2.3.8 ②	AI2 Sleep Limit	0.00	100.00	%	0.00	184	
P2.3.9 ②	AI2 Sleep Delay	0.00	320.00	s	0.00	188	
P2.3.10 ②	AI2 Joystick Offset	–50.00	50.00	%	0.00	134	
P2.4.1 ②	Fine Tuning Input	0	5		0	2484	0 = Not Used 1 = AI1 2 = AI2 3 = Slot A: AI1 4 = Slot A: AI2 5 = Fieldbus
P2.4.2 ②	Fine Tuning Min	0.00	100.00	%	0.00	2485	
P2.4.3 ②	Fine Tuning Max	0.00	100.00	%	0.00	2486	

Notes: ① Parameter value can only be changed after the drive has stopped.
 ② Parameter value will be set to be default when changing macros.

Chapter 8—Multi-Purpose application

Table 141. Digital input—P3

Code	Parameter	Min.	Max.	Unit	Default	ID	Note
P3.1 ①②	IO Terminal 1 Start/Stop Logic				0	143	0 = Forward–Reverse 1 = Start–Reverse 2 = Start–Enable 3 = Start Pulse–Stop Pulse
P3.2 ②⑤	IO Terminal 1 Start Signal 1				2	190	0 = DigIN:ForceOpen 1 = DigIN:ForceClose 2 = DigIN: 1 3 = DigIN: 2 4 = DigIN: 3 5 = DigIN: 4 6 = DigIN: 5 7 = DigIN: 6 8 = DigIN: 7 9 = DigIN: 8 10 = DigIN: A: IO1: 1 11 = DigIN: A: IO1: 2 12 = DigIN: A: IO1: 3 13 = DigIN: A: IO5: 1 14 = DigIN: A: IO5: 2 15 = DigIN: A: IO5: 3 16 = DigIN: A: IO5: 4 17 = DigIN: A: IO5: 5 18 = DigIN: A: IO5: 6 19 = DigIN: B: IO1: 1 20 = DigIN: B: IO1: 2 21 = DigIN: B: IO1: 3 22 = DigIN: B: IO5: 1 23 = DigIN: B: IO5: 2 24 = DigIN: B: IO5: 3 25 = DigIN: B: IO5: 4 26 = DigIN: B: IO5: 5 27 = DigIN: B: IO5: 6 28 = Time Channel 1 29 = Time Channel 2 30 = Time Channel 3 31 = RO1 Function 32 = RO2 Function 33 = RO3 Function 34 = Virtual RO1 Function 35 = Virtual RO2 Function
P3.3 ②⑤	IO Terminal 1 Start Signal 2				3	191	See Para ID 190
P3.4 ①②	Thermistor Input Select				0	881	0 = Digital Input 1 = Thermistor Input
P3.5 ②③	Reverse				0	198	See Para ID 190
P3.6 ②③	Ext. Fault 1 NO				4	192	See Para ID 190
P3.7 ②③	Ext. Fault 1 NC				1	193	See Para ID 190
P3.8 ②④	Fault Reset				5	200	See Para ID 190
P3.9 ②③	Run Enable				1	194	See Para ID 190
P3.10 ②③	Preset Speed B0				6	205	See Para ID 190
P3.11 ②③	Preset Speed B1				7	206	See Para ID 190
P3.12 ②③	Preset Speed B2				0	207	See Para ID 190
P3.13 ②③	PID1 Control Enable				1	550	See Para ID 190
P3.14 ②③	PID2 Control Enable				1	553	See Para ID 190
P3.15 ②③	Accel/Decel Time Set				0	195	See Para ID 190
P3.16 ②③	Accel/Decel Prohibit				0	201	See Para ID 190
P3.17 ②④	No Access To Param				0	215	See Para ID 190
P3.18 ②③	Accel Pot Value				0	203	See Para ID 190

Note: ① Parameter value can only be changed after the drive has stopped.

② Parameter value will be set to be default when changing macros.

③ Input function is Level sensed

④ Input function is edge sensed

⑤ Input function is edge sensed when using StartP/StopP start logic See Para ID 143 and 2206

Table 141. Digital input—P3, continued

Code	Parameter	Min.	Max.	Unit	Default	ID	Note
P3.19 ②③	Decel Pot Value				0	204	See Para ID 190
P3.20 ②③	Reset Pot Zero				0	216	See Para ID 190
P3.21 ②③	Remote Control				9	196	See Para ID 190
P3.22 ②③	Local Control				0	197	See Para ID 190
P3.23 ②③	Remote1/2 Select				0	209	See Para ID 190
P3.24 ②③	Second Motor Para Select				0	217	See Para ID 190
P3.25 ②④	Bypass Start				0	218	See Para ID 190
P3.26 ②③	DC Brake Enable				0	202	See Para ID 190
P3.27 ②③	Smoke Mode				0	219	See Para ID 190
P3.28 ②③	Fire Mode				0	220	See Para ID 190
P3.29 ②③	Fire Mode Ref Select				0	221	See Para ID 190
P3.30 ②③	PID1 Set Point Select				0	351	See Para ID 190
P3.31 ②③	PID2 Set Point Select				0	352	See Para ID 190
P3.32 ②③	Jog Enable				0	199	See Para ID 190
P3.33 ②④	Start Timer 1				0	224	See Para ID 190
P3.34 ②④	Start Timer 2				0	225	See Para ID 190
P3.35 ②④	Start Timer 3				0	226	See Para ID 190
P3.36 ②③	AI Ref Source Select				0	208	See Para ID 190
P3.37 ②③	Motor Interlock 1				0	210	See Para ID 190
P3.38 ②③	Motor Interlock 2				0	211	See Para ID 190
P3.39 ②③	Motor Interlock 3				0	212	See Para ID 190
P3.40 ②③	Motor Interlock 4				0	213	See Para ID 190
P3.41 ②③	Motor Interlock 5				0	214	See Para ID 190
P3.42 ②③	Emergency Stop				1	747	See Para ID 190
P3.43 ②③	Bypass Overload				0	1246	See Para ID 190
P3.44 ②④	Fire Mode Reverse				0	2119	See Para ID 190
P3.45 ①②	IO Terminal 2 Start Stop Logic				0	2206	See Para ID 143
P3.46 ②⑤	IO Terminal 2 Start Signal 1				2	2207	See Para ID 190
P3.47 ②⑤	IO Terminal 2 Start Signal 2				3	2208	See Para ID 190
P3.48 ②③	Ext. Fault 2 NO				0	2293	See Para ID 190
P3.49 ②③	Ext. Fault 2 NC				1	2294	See Para ID 190
P3.50 ②③	Ext. Fault 3 NO				0	2295	See Para ID 190
P3.51 ②③	Ext. Fault 3 NC				1	2296	See Para ID 190

Note: ① Parameter value can only be changed after the drive has stopped.
 ② Parameter value will be set to be default when changing macros.
 ③ Input function is Level sensed.
 ④ Input function is edge sensed.
 ⑤ Input function is edge sensed when using StartP/StopP start logic See Para ID 143 and 2206

Chapter 8—Multi-Purpose application

Table 141. Digital input—P3, continued

Code	Parameter	Min.	Max.	Unit	Default	ID	Note
P3.52 ②	Ext. Fault 1 Text				0	2297	0 = External Fault 1 = Vibration Cut out 2 = High Motor temp 3 = Low Pressure 4 = High Pressure 5 = Low Water 6 = Damper Interlock 7 = Run Enable 8 = Freeze Stat Trip 9 = Smoke Detect 10 = Seal Leakage 11 = Rod Breakage
P3.53 ②	Ext. Fault 2 Text				1	2298	0 = External Fault 1 = Vibration Cut out 2 = High Motor temp 3 = Low Pressure 4 = High Pressure 5 = Low Water 6 = Damper Interlock 7 = Run Enable 8 = Freeze Stat Trip 9 = Smoke Detect 10 = Seal Leakage 11 = Rod Breakage
P3.54 ②	Ext. Fault 3 Text				2	2299	0 = External Fault 1 = Vibration Cut out 2 = High Motor temp 3 = Low Pressure 4 = High Pressure 5 = Low Water 6 = Damper Interlock 7 = Run Enable 8 = Freeze Stat Trip 9 = Smoke Detect 10 = Seal Leakage 11 = Rod Breakage
P3.55 ②④	Parameter Set1/2 Sel				0	2312	See Para ID 190
P3.56 ②④	Deragging Enable				0	2394	See Para ID 190
P3.57 ②	Off Control				0	2395	See Para ID 190

- Note:** ① Parameter value can only be changed after the drive has stopped.
 ② Parameter value will be set to be default when changing macros.
 ③ Input function is Level sensed.
 ④ Input function is edge sensed.
 ⑤ Input function is edge sensed when using StartP/StopP start logic See Para ID 143 and 2206

Table 142. Analog output—P4

Code	Parameter	Min.	Max.	Unit	Default	ID	Note
P4.1 ①	A01 Mode				0	227	0 = 0–20 mA 1 = 0–10 V
P4.2 ②	A01 Function				1	146	0 = Not Used 1 = Output Frequency 2 = Freq Reference 3 = Motor Speed 4 = Motor Current 5 = Motor Torque (0–Nom) 6 = Motor Power 7 = Motor Voltage 8 = DC-Bus Voltage 9 = PID1 Setpoint 10 = PID1 Feedback 1 11 = PID1 Feedback 2 12 = PID1 Control Error Value 13 = PID1 Control Output 14 = PID2 Setpoint 15 = PID2 Feedback 1 16 = PID2 Feedback 2 17 = PID2 Control Error Value 18 = PID2 Control Output 19 = AI1 20 = AI2 21 = Output Freq (–2 to +2N) 22 = Motor Torque (–2 to +2N) 23 = Motor Power (–2 to +2N) 24 = PT100 Temperature 25 = FB Data Input 1 26 = FB Data Input 2 27 = FB Data Input 3 28 = FB Data Input 4 29 = FB Data Input 5 30 = FB Data Input 6 31 = FB Data Input 7 32 = FB Data Input 8 33 = SlotA PT100 Temp Channel 1 34 = SlotA PT100 Temp Channel 2 35 = SlotA PT100 Temp Channel 3 36 = SlotB PT100 Temp Channel 1 37 = SlotB PT100 Temp Channel 2 38 = SlotB PT100 Temp Channel 3 39 = User Defined Output 40 = Motor Current(–2 to +2N)
P4.3 ②	A01 Minimum				1	149	0 = 0 V / 0 mA 1 = 2 V / 4 mA
P4.4 ②	A01 Filter Time	0.00	10.00	s	1.00	147	
P4.5 ②	A01 Scale	10	1000	%	100	150	
P4.6 ②	A01 Inversion				0	148	0 = Not inverted 1 = Inverted
P4.7 ②	A01 Offset	–100.00	100.00	%	0.00	173	
P4.8 ②	A02 Mode				0	228	See Para ID 227
P4.9 ②	A02 Function				1	229	See Para ID 146
P4.10 ②	A02 Minimum				1	232	See Para ID 149
P4.11 ②	A02 Filter Time	0.00	10.00	s	1.00	230	
P4.12 ②	A02 Scale	10	1000	%	100	233	
P4.13 ②	A02 Inversion				0	231	See Para ID 148
P4.14 ②	A02 Offset	–100.00	100.00	%	0.00	234	

Notes: ① Parameter value can only be changed after the drive has stopped.
② Parameter value will be set to be default when changing macros.

Table 143. Digital output—P5

Code	Parameter	Min.	Max.	Unit	Default	ID	Note
P5.1 ②	DO1 Function				1	151	0 = Not Used 1 = Ready 2 = Run 3 = Fault 4 = Fault Invert 5 = Warning 6 = Reversed 7 = At Speed 8 = Zero Frequency 9 = Freq Limit 1 Superv 10 = Freq Limit 2 Superv 11 = PID1 Superv 12 = PID2 Superv 13 = Overheat Fault 14 = Overcurrent Regular 15 = Overvoltage Regular 16 = Undervoltage Regular 17 = 4 mA Ref Fault/Warning 18 = Ext Brake Control 19 = Ext Brake Inverted 20 = Torq Limit Superv 21 = Ref Limit Superv 22 = Control from I/O 23 = Un-Requested Rotation Direction 24 = Thermistor Fault Output 25 = Fire Mode 26 = In Bypass Mode 27 = Ext Fault/Warning 28 = Remote Control 29 = Jog Speed Select 30 = Motor Therm Protection 31 = FB Digital Input 1 32 = FB Digital Input 2 33 = FB Digital Input 3 34 = FB Digital Input 4 35 = Damper Control 36 = TC1 Status 37 = TC2 Status 38 = TC3 Status 39 = In E-Stop 40 = Power Limit Superv 41 = Temp Limit Superv 42 = Analog Input Superv 43 = Motor 1 Control 44 = Motor 2 Control 45 = Motor 3 Control 46 = Motor 4 Control 47 = Motor 5 Control 48 = Logic Fulfilled 49 = PID1 Sleep 50 = PID2 Sleep 51 = Motor Current 1 Supv 52 = Motor Current 2 Supv 53 = Second AI Limit Supv 54 = DC Charge Switch Close 55 = Preheat Active 56 = Cold Weather Active ③ 57 = Pre-Charge Active 58 = 2th Stage Ramp Frequency Active 59 = STO Fault 60 = Run Bypass/Drive 61 = Bypass Overload
P5.2 ②	RO1 Function				2	152	See Para ID 151
P5.3 ②	RO2 Function				3	153	See Para ID 151
P5.4 ②	RO3 Function				7	538	See Para ID 151
P5.5 ②	Virtual RO1 Function				0	2463	See Para ID 151
P5.6 ②	Virtual RO2 Function				0	2464	See Para ID 151

Notes: ① Parameter value can only be changed after the drive has stopped.
 ② Parameter value will be set to be default when changing macros.
 ③ Function is not available in FR7 and FR8 of DG1 drives.

Table 143. Digital output—P5, continued

Code	Parameter	Min.	Max.	Unit	Default	ID	Note
P5.7 ②	Freq Limit 1 Supv				0	154	0 = No Limit 1 = Low Limit Superv 2 = High Limit Superv 3 = Brake-on Control
P5.8 ②	Freq Limit 1 Supv Val	0.00	See Para ID 102	Hz	0.00	155	
P5.9 ②	Freq Limit 2 Supv				0	157	0 = No Limit 1 = Low Limit Superv 2 = High Limit Superv 3 = Brake-off Control 4 = Brake-on/off Control
P5.10 ②	Freq Limit 2 Supv Val	0.00	See Para ID 102	Hz	0.00	158	
P5.11 ②	Torque Limit Supv				0	159	0 = No Limit 1 = Low Limit Superv 2 = High Limit Superv 3 = Brake-off Control
P5.12 ②	Torque Limit Supv Val	-1000.0	1000.0	%	100.0	160	
P5.13 ②	Ref Limit Supv				0	161	0 = No Limit 1 = Low Limit Superv 2 = High Limit Superv
P5.14 ②	Ref Limit Supv Val	0.00	See Para ID 102	Hz	0.00	162	
P5.15 ②	Ext Brake Off Delay	0.0	100.0	s	0.5	163	
P5.16 ②	Ext Brake On Delay	0.0	100.0	s	1.5	164	
P5.17 ②	Temp Limit Supv				0	165	See Para ID 161
P5.18 ②	Temp Limit Supv Val	-10.0	75.0	°C	40.0	166	
P5.19 ②	Power Limit Supv				0	167	See Para ID 161
P5.20 ②	Power Limit Supv Val	0.0	200.0	%	0.0	168	
P5.21 ②	AI Supv Select				0	170	0 = AI1 1 = AI2
P5.22 ②	AI Limit Supv				0	171	See Para ID 161
P5.23 ②	AI Limit Supv Val	0.00	100.00	%	0.00	172	
P5.24 ②	PID1 Superv Enable				0	1346	0 = Disabled 1 = Enabled
P5.25 ②	PID1 Superv Upper Limit	See Para ID 1298	See Para ID 1300	Varies	0.00	1347	
P5.26 ②	PID1 Superv Lower Limit	See Para ID 1298	See Para ID 1300	Varies	0.00	1349	
P5.27 ②	PID1 Superv Delay	0	3000	s	0	1351	
P5.28 ②	PID2 Superv Enable				0	1408	0 = Disabled 1 = Enabled
P5.29 ②	PID2 Superv Upper Limit	See Para ID 1360	See Para ID 1362	Varies	0.00	1409	
P5.30 ②	PID2 Superv Lower Limit	See Para ID 1360	See Para ID 1362	Varies	0.00	1411	
P5.31 ②	PID2 Superv Delay	0	3000	s	0	1413	
P5.32 ②	RO1 On Delay	0	320	s	0	2112	
P5.33 ②	RO1 Off Delay	0	320	s	0	2113	
P5.34 ②	RO2 On Delay	0	320	s	0	2114	
P5.35 ②	RO2 Off Delay	0	320	s	0	2115	
P5.36 ②	RO3 On Delay	0	320	s	0	2116	
P5.37 ②	RO3 Off Delay	0	320	s	0	2117	
P5.38 ②	RO3 Reverse				0	2118	0 = No 1 = Yes
P5.39 ②	Motor Current 1 Supv				0	2189	0 = No Limit 1 = Low Limit Superv 2 = High Limit Superv 3 = Brake Off Control

Notes: ① Parameter value can only be changed after the drive has stopped.
 ② Parameter value will be set to be default when changing macros.

Chapter 8—Multi-Purpose application

Table 143. Digital output—P5, continued

Code	Parameter	Min.	Max.	Unit	Default	ID	Note
P5.40 ②	Motor Current 1 Supv Value	0	DCI_uwDrive NomCurrCT*2	A	DCI_uwDrive NomCurrCT	2190	
P5.41 ②	Motor Current 2 Supv				0	2191	0 = No Limit 1 = Low Limit Superv 2 = High Limit Superv 3 = Brake Off Control
P5.42 ②	Motor Current 2 Supv Value	0	DCI_uwDrive NomCurrCT*2	A	DCI_uwDrive NomCurrCT	2192	
P5.43 ②	Second AI Supv Select				0	2193	0 = AI1 1 = AI2
P5.44 ②	Second AI Limit Supv				0	2194	See Para ID 161
P5.45 ②	Second AI Limit Supv Val	0	100	%	0	2195	
P5.46 ②	Motor Current 1 Supv Hyst	0.1	1	A	0.1	2196	
P5.47 ②	Motor Current 2 Supv Hyst	0.1	1	A	0.1	2197	
P5.48 ②	AI Supv Hyst	1	10	%	1	2198	
P5.49 ②	Second AI Supv Hyst	1	10	%	1	2199	
P5.50 ②	Freq Limit 1 Supv Hyst	0.1	1	Hz	0.1	2200	
P5.51 ②	Freq Limit 2 Supv Hyst	0.1	1	Hz	0.1	2201	
P5.52 ②	Torque Limit Supv Hyst	1	5	%	1	2202	
P5.53 ②	Ref Limit Supv Hyst	0.1	1	Hz	0.1	2203	
P5.54 ②	Temp Limit Supv Hyst	1	10	?	1	2204	
P5.55 ②	Power Limit Supv Hyst	0.1	10	%	0.1	2205	

Notes: ① Parameter value can only be changed after the drive has stopped.
 ② Parameter value will be set to be default when changing macros.

Table 144. Logic function—P6

Code	Parameter	Min.	Max.	Unit	Default	ID	Note
P6.1 ②	Logic Function Select				0	751	0 = AND 1 = OR 2 = XOR
P6.2 ②	Logic Operation Input A				0	752	0 = Not Used 1 = Ready 2 = Run 3 = Fault 6 = Reversed 7 = Warning 8 = Zero Frequency 9 = Control from I/O 15 = Ext Brake Control 16 = In Bypass Mode 17 = At Speed 18 = Remote Control 19 = Freq Limit 1 Superv 20 = Freq Limit 2 Superv 22 = PID1 Superv 23 = PID2 Superv 24 = Overheat Fault 28 = 4 mA Ref Fault/Warning 29 = Overcurrent Regular 30 = Overvoltage Regular 31 = Undervoltage Regular 32 = Torq Limit Superv 33 = Ref Limit Superv 34 = Un-Requested Rotation Direction 35 = Thermal Fault/Warning 36 = Bypass Enable 37 = Jog Speed Select 38 = Motor Therm Protection 39 = FB Digital Input 1 40 = FB Digital Input 2 41 = FB Digital Input 3 42 = FB Digital Input 4 43 = Damper Control 44 = TC1 Status 45 = TC2 Status 46 = TC3 Status 47 = In E-Stop 48 = Power Limit Superv 49 = Temp Limit Superv 50 = Analog Input Superv 51 = Motor 1 Control 52 = Motor 2 Control 53 = Motor 3 Control 54 = Motor 4 Control 55 = Motor 5 Control 56 = Logic Fulfilled

Notes: ① Parameter value can only be changed after the drive has stopped.
② Parameter value will be set to be default when changing macros.

Table 144. Logic function—P6, continued

Code	Parameter	Min.	Max.	Unit	Default	ID	Note
P6.3 ②	Logic Operation Input B				0	753	0 = Not Used 1 = Ready 2 = Run 3 = Fault 6 = Reversed 7 = Warning 8 = Zero Frequency 9 = Control from I/O 15 = Ext Brake Control 16 = In Bypass Mode 17 = At Speed 18 = Remote Control 19 = Freq Limit 1 Superv 20 = Freq Limit 2 Superv 22 = PID1 Superv 23 = PID2 Superv 24 = Overheat Fault 28 = 4 mA Ref Fault/Warning 29 = Overcurrent Regular 30 = Overvoltage Regular 31 = Undervoltage Regular 32 = Torq Limit Superv 33 = Ref Limit Superv 34 = Un-Requested Rotation Direction 35 = Thermal Fault/Warning 36 = Bypass Enable 37 = Jog Speed Select 38 = Motor Therm Protection 39 = FB Digital Input 1 40 = FB Digital Input 2 41 = FB Digital Input 3 42 = FB Digital Input 4 43 = Damper Control 44 = TC1 Status 45 = TC2 Status 46 = TC3 Status 47 = In E-Stop 48 = Power Limit Superv 49 = Temp Limit Superv 50 = Analog Input Superv 51 = Motor 1 Control 52 = Motor 2 Control 53 = Motor 3 Control 54 = Motor 4 Control 55 = Motor 5 Control 56 = Logic Fulfilled

Table 145. Drive control—P7

Code	Parameter	Min.	Max.	Unit	Default	ID	Note
P7.1 ②	Remote 2 Control Place				1	138	See Para ID 135
P7.2 ①②	Remote 2 Reference				7	139	See Para ID 136
P7.3 ②	Keypad Reference	See Para ID 101	See Para ID 102	Hz	0.00	141	
P7.4 ②	Keypad Direction				0	116	0 = Forward 1 = Reverse
P7.5 ②	Keypad Stop				1	114	0 = Enabled-Keypad Operation 1 = Always Enabled
P7.6 ②	Jog Reference	See Para ID 101	See Para ID 102	Hz	0.00	117	
P7.7 ②	Motor Pot Ramp Time	0.1	2000.0	Hz/s	10.0	156	
P7.8 ②	Motor Pot Ref Reset				0	169	0 = No Reset 1 = Reset: Stop + Power Down 2 = Reset: Power Down
P7.9 ②	Start Mode				0	252	0 = Ramp 1 = Flying Start
P7.10 ②	Stop Mode				1	253	0 = Coasting 1 = Ramp

Notes: ① Parameter value can only be changed after the drive has stopped.
 ② Parameter value will be set to be default when changing macros.

Table 145. Drive control—P7, continued

Code	Parameter	Min.	Max.	Unit	Default	ID	Note
P7.11 ②	Ramp 1 Shape	0.0	10.0	s	0.0	247	
P7.12 ②	Ramp 2 Shape	0.0	10.0	s	0.0	248	
P7.13 ②	Accel Time 2	0.1	3000.0	s	10.0	249	
P7.14 ②	Decel Time 2	0.1	3000.0	s	10.0	250	
P7.15 ②	Skip F1 Low Limit	0.00	See Para ID 257	Hz	0.00	256	
P7.16 ②③	Skip F1 High Limit	See Para ID 256	400.00/320.00	Hz	0.00	257	
P7.17 ②	Skip F2 Low Limit	0.00	See Para ID 259	Hz	0.00	258	
P7.18 ②③	Skip F2 High Limit	See Para ID 258	400.00/320.00	Hz	0.00	259	
P7.19 ②	Skip F3 Low Limit	0.00	See Para ID 261	Hz	0.00	260	
P7.20 ②③	Skip F3 High Limit	See Para ID 260	400.00/320.00	Hz	0.00	261	
P7.21 ②	Prohibit Accel/Decel Ramp	0.1	10.0		1.0	264	
P7.22 ②④	Power Loss Function				0	267	0 = Disabled 1 = Enabled
P7.23 ②④	Power Loss Time	0.3	5.0	s	2.0	268	
P7.24 ②	Currency				\$	2122	0 = \$ 1 = GBP 2 = Eur 3 = JPY 4 = Rs 5 = R\$ 6 = Fr 7 = Kr
P7.25 ②	Energy Cost				0	2123	
P7.26 ②	Data Type				0	2124	0 = Cumulative 1 = Daily Avg 2 = Weekly 3 = Monthly Avg 4 = Yearly Avg
P7.27 ②	Energy Savings Reset				0	2125	0 = No Action 1 = Reset
P7.28 ②	2th Stage Ramp Frequency	See Para ID 101	See Para ID 102	Hz	30	2444	
P7.29 ②	Change Phase Sequence Motor	0	1		0	2515	0 = Change Disable 1 = Change Enable

Table 146. Motor control—P8

Code	Parameter	Min.	Max.	Unit	Default	ID	Note
P8.1 ①②	Motor Control Mode				0	287	0 = Freq Control 1 = Speed Control 2 = Torque Control ② 5 = Open Loop Speed Control 6 = Open Loop Torque Control
P8.2 ①	Current Limit	Drive Nom CT*1/10	Drive Nom CT*2	A	Drive Nom VT	107	
P8.3 ①②	V/Hz Optimization				0	109	0 = Disabled 1 = Enabled
P8.4 ①②	V/Hz Ratio				0	108	0 = Linear 1 = Squared 2 = Programmable 3 = Linear + Flux Optimization
P8.5 ①②	Field Weakening Point	8.00	400.00	Hz	60.00	289	
P8.6 ①②	Voltage at FWP	10.00	200.00	%	100.00	290	
P8.7 ①②	V/Hz Mid Frequency	0.00	See Para ID 289	Hz	V/Hz Curve Midpoint Freq	291	
P8.8 ①②	V/Hz Mid Voltage	0.00	100.00	%	100.00	292	
P8.9 ①②	Zero Frequency Voltage	0.00	40.00	%	0.00	293	
P8.10 ②	Switching Frequency	Min Switching Freq	Max Switching Freq	kHz	Default Switching Freq CT	288	

Notes: ① Parameter value can only be changed after the drive has stopped.
 ② Parameter value will be set to be default when changing macros.
 ③ Function is not available in FR7 and FR8 of DG1 drives.
 ④ Function is only available in FR7 and FR8 of DG1 drives.
 ⑤ DG1 Frame 1-6/DG1 Frame 7-8.

Chapter 8—Multi-Purpose application

Table 146. Motor control—P8, continued

Code	Parameter	Min.	Max.	Unit	Default	ID	Note
P8.11 ②	Sine Filter Enable				0	1665	0 = Disabled 1 = Enabled
P8.12 ①②	Overtoltage Control				1	294	0 = Disabled 1 = Enabled
P8.13 ②③	Load Drooping	0.00	100.00/20.00	%	0.00	298	
P8.14 ②	Identification				0	299	0 = No Action 1 = Identification Only Stator Resistor 2 = Identification with Run 3 = Identification No Run
P8.15 ①②③	Neg Frequency Limit	-400.00/-320.00	See Para ID 1576	Hz	-400.00/-320.00	1574	
P8.16 ①②③	Pos Frequency Limit	See Para ID 1574	400.00/320.00	Hz	400.00/320.00	1576	
P8.17 ②④	Frequency Ramp Out FilterTime Constant	0	3000	ms	0	1585	
P8.18 ②③	Speed Error Filter Time Constant	0	3000/1000	ms	0	1591	
P8.19 ②④	Speed Error Band Stop Frequency	0.00	320.00	Hz	0.00	1592	
P8.20 ②③	Speed Control Kp	0.0	1000.0	%	varies/20.0	1593	
P8.21 ②③	Speed Control Ti	0.0	3200.0	ms	varies/20.0	1594	
P8.22 ②④	Speed Control Kp At Field Weakening	0.0	1000.0	%	100.0	1595	
P8.23 ②④	Speed Control Kp Below F0	0.0	1000.0	%	0.0	1596	
P8.24 ②④	Speed Control F0	0.00	See Para ID 1598	Hz	0.00	1597	
P8.25 ②④	Speed Control F1	See Para ID 1597	See Para ID 289	Hz	0.00	1598	
P8.26 ②④	Speed Control Kp Below T0	0.0	1000.0	%	0.0	1599	
P8.27 ②④	Speed Control T0	0.0	100.0	%	0.0	1600	
P8.28 ②④	Speed Control Kp Filter Time Constant	0	3000	ms	0	1601	
P8.29 ②	Motoring Torque Limit	0.0	300.0	%	300.0	1602	
P8.30 ②	Generator Torque Limit	0.0	300.0	%	300.0	1603	
P8.31 ②	Torque Limit Forward	0.0	300.0	%	300.0	1604	
P8.32 ②	Torque Limit Reverse	0.0	300.0	%	300.0	1605	
P8.33 ②	Motoring Power Limit	0.0	300.0	%	300.0	1607	
P8.34 ②	Generator Power Limit	0.0	300.0	%	300.0	1608	
P8.35 ②④	Acc Compensation Time Constant	0.0	1000.0	%	0.0	1611	
P8.36 ②④	Acc Compensation Filter Time Constant	0	3000	ms	0	1612	
P8.37 ②	Flux Reference	0.0	500.0	%	100.0	1620	
P8.38 ②④	Stop State Magnetization	0.0	100.0	%	100.0	1621	
P8.39 ②④	Start Boost Rise Time	0	32000	s	0	1622	
P8.40 ②④	Flux Current Ramp Time	0	32000	ms	200	1623	
P8.41 ②④	Zero Speed Start Time	0	32000	ms	100	1624	
P8.42 ②④	Zero Speed Stop Time	0	32000	ms	100	1625	
P8.43 ②	Droop Control Filter Time Constant	0	3000	ms	0	1630	
P8.44 ②	Startup Torque Selection				0	1631	0 = Not Used 1 = TorqueMemory 2 = TorqueReference 3 = StartupTorqueFWD/REV
P8.45 ②	Torque Memory Start	-300.0	300.0	%	0.0	1632	
P8.46 ②	Startup Torque Forward	-300.0	300.0	%	0.0	1633	
P8.47 ②	Startup Torque Reverse	-300.0	300.0	%	0.0	1634	
P8.48 ②	Startup Torque Actual			%		1635	

Notes: ① Parameter value can only be changed after the drive has stopped.
 ② Parameter value will be set to be default when changing macros.
 ③ Function is not available in FR7 and FR8 of DG1 drives.
 ④ DG1 Frame 1-6/DG1 Frame 7-8.

Table 146. Motor control—P8, continued

Code	Parameter	Min.	Max.	Unit	Default	ID	Note
P8.49 ②	Startup Torque Time	0	10000	ms	50	1667	
P8.50 ①	Stator Resistor	0.001	65.535	ohm	0.033	771	
P8.51 ①⑥	Rotor Resistor	0.001	65.535	ohm	0.034	772	
P8.52 ①	Leak Inductance	0.001	65.535	mh	0.128	773	
P8.53 ①⑥	Mutual Inductance	0.01	655.35	mh	3.44	774	
P8.54 ①⑧	Excitation Current	0.1/0.0	Drive Nom CT*2	A	0.1/0.0	775	
P8.55 ①②⑦	Advanced Open Loop Options				16384	58	B0 = Calculate stator resistance on start B1 = reserved B2 = reserved B3 = Limit Frequency polarity B4 = reserved B5 = reserved B6 = reserved B7 = reserved B8 = Voltage based current limit B9 = Limit voltage polarity B10 = reserved B11 = reserved B12 = reserved B13 = DC Brake at Start B14 = Ramp anti-windup B15 = reserved
P8.56 ①②⑦	Torque Stability Gain	0.0	500.0	%	50.0	63	
P8.57 ①②⑦	Torque Stability FWP Gain	0.0	500.0	%	50.0	64	
P8.58 ①②⑦	Torque Stability Dampening Time	0.0005	1.0000	s	0.0050	62	

Table 147. Protections—P9

Code	Parameter	Min.	Max.	Unit	Default	ID	Note
P9.1 ①②	4 mA Input Fault				0	306	0 = No Action 1 = Warning 2 = Warning: Previous Freq 3 = Warning: Preset Freq 4 = Fault 5 = Fault, Coast
P9.2 ①②	4 mA Fault Frequency	0.00	See Para ID 102	Hz	0.00	331	
P9.3 ①②	External Fault				2	307	See Para ID 313
P9.4 ①②	Input Phase Fault				2	332	0 = No Action 1 = Warning(6) 2 = Fault 3 = Fault, Coast(6)
P9.5 ①②	Uvoltage Fault Response				2	330	See Para ID 313
P9.6 ①②	Output Phase Fault				2	308	See Para ID 313
P9.7 ①②	Ground Fault				2	309	See Para ID 313
P9.8 ①②	Motor Thermal Protection				2	310	See Para ID 313
P9.9 ②⑧	Motor Thermal FO Current	0.0/ 5.0	150.0	%	40.0/60.0	311	
P9.10 ②⑧	Motor Thermal Time	1	200	min	45/78	312	
P9.11 ①②	Stall Protection				0	313	0 = No Action 1 = Warning 2 = Fault 3 = Fault, Coast
P9.12 ②	Stall Current Limit	0.1	Active Motor Nom I*2	A	Active Motor Nom I*13/10	314	
P9.13 ②	Stall Time Limit	1.0	120.0	s	15.0	315	
P9.14 ②	Stall Frequency Limit	1.00	See Para ID 102	Hz	25.00	316	
P9.15 ①②	Underload Protection				0	317	See Para ID 313
P9.16 ②	Underload Fnom Torque	10.0	150.0	%	50.0	318	

Notes: ① Parameter value can only be changed after the drive has stopped.
 ② Parameter value will be set to be default when changing macros.
 ③ Function is not available in FR7 and FR8 of DG1 drives.
 ④ Function is only available in FR7 and FR8 of DG1 drives.
 ⑤ DG1 Frame 1-6/DG1 Frame 7-8.

Chapter 8—Multi-Purpose application

Table 147. Protections—P9, continued

Code	Parameter	Min.	Max.	Unit	Default	ID	Note
P9.17 ②	Underload FO Torque	5.0	150.0	%	10.0	319	
P9.18 ②	Underload Time Limit	2.00	600.00	s	20.00	320	
P9.19 ①②	Thermistor Fault Response				2	333	See Para ID 313
P9.20 ②	Line Start Lockout				2	750	0 = Disabled, No Change 1 = Enable, No Change 2 = Disabled, Changed 3 = Enable, Changed
P9.21 ①②	Fieldbus Fault Response				2	334	See Para ID 313
P9.22 ①②	OPTCard Fault Response				2	335	See Para ID 313
P9.23 ①②	Unit Under Temp Prot				2	1564	See Para ID 313
P9.24 ②	Wait Time	1.00	300.00	s	1.00	321	
P9.25 ②	Trail Time	0.00	600.00	s	30.00	322	
P9.26 ②	Start Function				0	323	0 = Flying Start 1 = Ramp
P9.27 ②	Undervoltage Attempts	0	10		1	324	
P9.28 ②	Overvoltage Attempts	0	10		1	325	
P9.29 ②	Overcurrent Attempts	0	3		1	326	
P9.30 ②	4 mA Fault Attempts	0	10		1	327	
P9.31 ②	Motor Temp Fault Attempts	0	10		1	329	
P9.32 ②	External Fault Attempts	0	10		0	328	
P9.33 ②	Underload Attempts	0	10		1	336	
P9.34 ①②	RTC Fault				1	955	See Para ID 313
P9.35 ①②	PT100 Fault Response				2	337	See Para ID 313
P9.36 ①②	Replace Battery Fault Response				1	1256	See Para ID 313
P9.37 ①②	Replace Fan Fault Response				1	1257	See Para ID 313
P9.38 ①②	IP Address Conflicion Resp				1	1678	See Para ID 313
P9.39 ②⑥	Cold Weather Mode				0	2126	0 = Disable 1 = Enable
P9.40 ②⑥	Cold Weather Voltage Level	0	20	%	2	2127	
P9.41 ②⑥	Cold Weather Time Out	0	10	min	3	2128	
P9.44 ②⑥	Ground Fault Limit	0	30	%	15	2158	

Notes: ① Parameter value can only be changed after the drive has stopped.
 ② Parameter value will be set to be default when changing macros.
 ⑥ Function is not available in FR7 and FR8 of DG1 drives.

Table 147. Protections—P9, continued

Code	Parameter	Min.	Max.	Unit	Default	ID	Note
P9.45 ①②	Keypad Comm Fault Response				2	2157	See Para ID 313
P9.46 ②	Preheat Mode				0	2159	0 = Disabled 1 = Enabled
P9.47 ②	Preheat Temp Source				31	2160	0 = DigIN: NormallyOpen 1 = DigIN: NormallyClosed 2 = DigIN: 1 3 = DigIN: 2 4 = DigIN: 3 5 = DigIN: 4 6 = DigIN: 5 7 = DigIN: 6 8 = DigIN: 7 9 = DigIN: 8 10 = DigIN: A: IO1: 1 11 = DigIN: A: IO1: 2 12 = DigIN: A: IO1: 3 13 = DigIN: A: IO5: 1 14 = DigIN: A: IO5: 2 15 = DigIN: A: IO5: 3 16 = DigIN: A: IO5: 4 17 = DigIN: A: IO5: 5 18 = DigIN: A: IO5: 6 19 = DigIN: B: IO1: 1 20 = DigIN: B: IO1: 2 21 = DigIN: B: IO1: 3 22 = DigIN: B: IO5: 1 23 = DigIN: B: IO5: 2 24 = DigIN: B: IO5: 3 25 = DigIN: B: IO5: 4 26 = DigIN: B: IO5: 5 27 = DigIN: B: IO5: 6 28 = Time Channel 1 29 = Time Channel 2 30 = Time Channel 3 31 = Drive Temperature 32 = Slot A PT100 Temp Channel 1 33 = Slot A PT100 Temp Channel 2 34 = Slot A PT100 Temp Channel 3 35 = Slot A Max PT100 Temp 36 = Slot B PT100 Temp Channel 1 37 = Slot B PT100 Temp Channel 2 38 = Slot B PT100 Temp Channel 3 39 = Slot B Max PT100 Temp 40 = Slot A and Slot B Max PT100 Temp
P9.48 ②	Preheat Enter Temp	0.0	19.9	°C	10.0	2161	
P9.49 ②	Preheat Quit Temp	20.0	40.0	°C	20.0	2162	
P9.50 ②	Preheat Output Voltage / Preheat Output Current	0.0/0	20.0/50	%	2.0/20	2163	
P9.51 ②	PID Feedback AI loss Response				0	2401	0 = No Action 1 = Warning 2 = Fault 3 = Warning: Preset Frequency 4 = Warning: Analog ->Net
P9.52 ②	PID Feedback AI Loss Pre Freq	0.00	400.00	Hz	0.00	2402	
P9.53 ②	PID Feedback AI Loss Pipe Fill Level	0.0	1000.0	A	0.0	2403	
P9.54 ②	PID Feedback AI Loss PreFreq Timeout	0	6000	s	0	2404	
P9.55 ②	PID Feedback AI Loss Attemps	0	10		1	2405	
P9.56 ②	STO Fault Response				2	2429	0 = No Action 1 = Warning 2 = Fault
P9.57 ②	Fault Reset Start	0	1		0	2483	0 = Start/Stop After Fault Reset 1 = Restart After Fault Reset

Notes: ① Parameter value can only be changed after the drive has stopped.
 ② Parameter value will be set to be default when changing macros.
 ③ DG1 Frame 1-6/DG1 Frame 7-8.

Chapter 8—Multi-Purpose application

Table 148. PID Controller 1—P10

Code	Parameter	Min.	Max.	Unit	Default	ID	Note
P10.1 ②	PID1 Control Gain	0.00	200.00	%	100.00	1294	
P10.2 ②	PID1 Control ITime	0.00	600.00	s	1.00	1295	
P10.3 ②	PID1 Control DTime	0.00	100.00	s	0.00	1296	
P10.4 ①②	PID1 Process Unit				0	1297	0 = % 1 = 1/min 2 = rpm 3 = ppm 4 = pps 5 = l/s 6 = l/min 7 = l/h 8 = kg/s 9 = kg/min 10 = kg/h 11 = m ³ /s 12 = m ³ /min 13 = m ³ /h 14 = m/s 15 = mbar 16 = bar 17 = Pa 18 = kPa 19 = mVS 20 = kW 21 = °C 22 = GPM 23 = gal/s 24 = gal/min 25 = gal/h 26 = lb/s 27 = lb/min 28 = lb/h 29 = CFM 30 = ft ³ /s 31 = ft ³ /min 32 = ft ³ /h 33 = ft/s 34 = in wg 35 = ft wg 36 = PSI 37 = lb/in ² 38 = HP 39 = °F 40 = PA 41 = VWC 42 = HG 43 = ft 44 = m
P10.5 ②	PID1 Process Unit Min	-99999.99	99999.99	Varies	0.00	1298	
P10.6 ②	PID1 Process Unit Max	-99999.99	99999.99	Varies	100.00	1300	
P10.7 ②	PID1 Process Unit Decimal	0	4		2	1302	
P10.8 ①②	PID1 Error Inversion				0	1303	0 = Not Inverted 1 = Inverted
P10.9 ②	PID1 Dead Band	0.00	99999.99	Varies	0.00	1304	
P10.10 ②	PID1 Dead Band Delay	0.00	320.00	s	0.00	1306	
P10.11 ②	PID1 Keypad Set Point 1	See Para ID 1298	See Para ID 1300	Varies	0.00	1307	
P10.12 ②	PID1 Keypad Set Point 2	See Para ID 1298	See Para ID 1300	Varies	0.00	1309	
P10.13 ②	PID1 Ramp Time	0.00	300.00	s	0.00	1311	

Notes: ① Parameter value can only be changed after the drive has stopped.

② Parameter value will be set to be default when changing macros.

Table 148. PID Controller 1—P10, continued

Code	Parameter	Min.	Max.	Unit	Default	ID	Note
P10.14 ①②	PID1 Set Point 1 Source				1	1312	0 = Not Used 1 = PID1 Keypad Set Point 1 2 = PID1 Keypad Set Point 2 3 = AI1 4 = AI2 5 = Slot A: AI1 6 = Slot B: AI1 7 = FB Data Input 1 8 = FB Data Input 2 9 = FB Data Input 3 10 = FB Data Input 4 11 = FB Data Input 5 12 = FB Data Input 6 13 = FB Data Input 7 14 = FB Data Input 8 16 = Multi Drive Network 17=FB PID1 Set Point 1 18=FB PID1 Set Point 2
P10.15 ②	PID1 Set Point 1 Min	-200.00	200.00	%	0.00	1313	
P10.16 ②	PID1 Set Point 1 Max	-200.00	200.00	%	100.00	1314	
P10.17 ①②	PID1 Set Point 1 Sleep Enable				0	1315	0 = Disabled 1 = Enabled
P10.18 ②	PID1 Setpoint 1 Sleep Unit				0	2396	0 = Ouput Frequency 1 = Motor Speed 2 = Motor Current 3 = PID1 Feedabck
P10.19 ②	PID1 Setpoint 1 Sleep Level	See Para ID 1298	See Para ID 1300	varies	0.00	2450	
P10.20 ②	PID1 Set Point 1 Sleep Delay	0	3000	s	0	1317	
P10.21 ②	PID1 Set Point 1 Wake Up Level	-99999.99	99999.99	varies	0.00	1318	
P10.22 ②	PID1 Set Point 1 Boost	-2.0	2.0		1.0	1320	
P10.23 ①②	PID1 Set Point 2 Source				2	1321	See Para ID 1312
P10.24 ②	PID1 Set Point 2 Min	-200.00	200.00	%	0.00	1322	
P10.25 ②	PID1 Set Point 2 Max	-200.00	200.00	%	100.00	1323	
P10.26 ①②	PID1 Set Point 2 Sleep Enable				0	1324	0 = Disabled 1 = Enabled
P10.27 ②	PID1 Setpoint 2 Sleep Unit				0	2397	0 = Ouput Frequency 1 = Motor Speed 2 = Motor Current 3 = PID1 Feedabck
P10.28 ②	PID1 Setpoint 2 Sleep Level	See Para ID 1298	See Para ID 1300	varies	0.00	2452	
P10.29 ②	PID1 Set Point 2 Sleep Delay	0	3000	s	0	1326	
P10.30 ②	PID1 Set Point 2 Wake Up Level	-99999.99	99999.99	varies	0.00	1327	
P10.31 ②	PID1 Set Point 2 Boost	-2.0	2.0		1.0	1329	
P10.32 ①②	PID1 Feedback Function				0	1330	0 = Source 1 1 = SQRT(Source 1) 2 = SQRT(Source 1–Source 2) 3 = SQRT(Source 1) + SQRT(Source 2) 4 = Source 1 + Source 2 5 = Source 1–Source 2 6 = MIN(Source 1,Source 2) 7 = MAX(Source 1,Source 2) 8 = MEAN(Source1,Source2)
P10.33 ②	PID1 Feedback Gain	-1000.0	1000.0	%	100.0	1331	

Notes: ① Parameter value can only be changed after the drive has stopped.

② Parameter value will be set to be default when changing macros.

Chapter 8—Multi-Purpose application

Table 148. PID Controller 1 — P10 continued

Code	Parameter	Min.	Max.	Unit	Default	ID	Note
P10.34 ①②	PID1 Feedback 1 Source				1	1332	0 = Not Used 1 = AI1 2 = AI2 3 = Slot A: AI1 4 = Slot B: AI1 5 = FB Data Input 1 6 = FB Data Input 2 7 = FB Data Input 3 8 = FB Data Input 4 9 = FB Data Input 5 10 = FB Data Input 6 11 = FB Data Input 7 12 = FB Data Input 8 13 = PT100 Temperature 15 = SlotA PT100 Temp Channel 1 16 = SlotA PT100 Temp Channel 2 17 = SlotA PT100 Temp Channel 3 18 = SlotB PT100 Temp Channel 1 19 = SlotB PT100 Temp Channel 2 20 = SlotB PT100 Temp Channel 3 21=FB PID1 Feedback 1 22=FB PID1 Feedback 2
P10.35 ②	PID1 Feedback 1 Min	-200.00	200.00	%	0.00	1333	
P10.36 ②	PID1 Feedback 1 Max	-200.00	200.00	%	100.00	1334	
P10.37 ①②	PID1 Feedback 2 Source				0	1335	See Para ID 1332
P10.38 ②	PID1 Feedback 2 Min	-200.00	200.00	%	0.00	1336	
P10.39 ②	PID1 Feedback 2 Max	-200.00	200.00	%	100.00	1337	
P10.40 ①②	PID1 Feedforward Func				0	1338	0 = Source 1 1 = SQRT(Source 1) 2 = SQRT(Source 1–Source 2) 3 = SQRT(Source 1) + SQRT(Source 2) 4 = Source 1 + Source 2 5 = Source 1–Source 2 6 = MIN(Source 1,Source 2) 7 = MAX(Source 1,Source 2) 8 = MEAN(Source1,Source2)
P10.41 ②	PID1 Feedforward Gain	-1000.0	1000.0	%	100.0	1339	
P10.42 ①②	PID1 Feedforward 1 Source				0	1340	0 = Not Used 1 = AI1 2 = AI2 3 = Slot A: AI1 4 = Slot B: AI1 5 = FB Data Input 1 6 = FB Data Input 2 7 = FB Data Input 3 8 = FB Data Input 4 9 = FB Data Input 5 10 = FB Data Input 6 11 = FB Data Input 7 12 = FB Data Input 8 13 = PT100 Temperature 15 = SlotA PT100 Temp Channel 1 16 = SlotA PT100 Temp Channel 2 17 = SlotA PT100 Temp Channel 3 18 = SlotB PT100 Temp Channel 1 19 = SlotB PT100 Temp Channel 2 20 = SlotB PT100 Temp Channel 3 21=FB PID1 Feedforward 1 22=FB PID1 Feedforward 2
P10.43 ②	PID1 Feedforward 1 Min	-200.00	200.00	%	0.00	1341	
P10.44 ②	PID1 Feedforward 1 Max	-200.00	200.00	%	100.00	1342	
P10.45 ①②	PID1 Feedforward 2 Source				0	1343	See Para ID 1340
P10.46 ②	PID1 Feedforward 2 Min	-200.00	200.00	%	0.00	1344	
P10.47 ②	PID1 Feedforward 2 Max	-200.00	200.00	%	100.00	1345	
P10.48 ②	PID1 Set Point 1 Comp Enable				0	1352	0 = Disabled 1 = Enabled

Notes: ① Parameter value can only be changed after the drive has stopped.
② Parameter value will be set to be default when changing macros.

Table 148. PID Controller 1—P10 continued

Code	Parameter	Min.	Max.	Unit	Default	ID	Note
P10.49 ②	PID1 Set Point 1 Comp Max	-200.00	200.00	%	0.00	1353	
P10.50 ②	PID1 Set Point 2 Comp Enable				0	1354	0 = Disabled 1 = Enabled
P10.51 ②	PID1 Set Point 2 Comp Max	-200.00	200.00	%	0.00	1355	
P10.52 ②	PID1 Wake Up Action	0	3		0	2466	0 = Below Wake Up Level 1 = Above Wake Up Level 2 = Below Wake Up Level(PID ref.) -Wake up when below wakeup level % set in Para ID 1318 or 1327 from PID Setpoint. 3 = Above Wake Up Level(PID ref.) -Wake up when above wakeup level % set in Para ID 1318 or 1327 from PID Setpoint.
P10.53	FB PID1 Set Point 1	P10.5	P10.6	varies	0.00	2542	
P10.54	FB PID1 Set Point 2	P10.5	P10.6	varies	0.00	2544	
P10.55	FB PID1 Feedback 1			varies	0.00	2550	
P10.56	FB PID1 Feedback 2			varies	0.00	2551	
P10.57	FB PID1 Feedforward 1			varies	0.00	2554	
P10.58	FB PID1 Feedforward 2			varies	0.00	2555	

Table 149. PID Controller 2—P11

Code	Parameter	Min.	Max.	Unit	Default	ID	Note
P11.1 ②	PID2 Control Gain	0.00	200.00	%	100.00	1356	
P11.2 ②	PID2 Control I Time	0.00	600.00	s	1.00	1357	
P11.3 ②	PID2 Control D Time	0.00	100.00	s	0.00	1358	
P11.4 ①②	PID2 Process Unit				0	1359	See Para ID 1297
P11.5 ②	PID2 Process Unit Min	-99999.99	99999.99	Varies	0.00	1360	
P11.6 ②	PID2 Process Unit Max	-99999.99	99999.99	Varies	100.00	1362	
P11.7 ②	PID2 Process Unit Decimal	0	4		2	1364	
P11.8 ①②	PID2 Error Inversion				0	1365	0 = Not Inverted 1 = Inverted
P11.9 ②	PID2 Dead Band	0.00	99999.99	Varies	0.00	1366	
P11.10 ②	PID2 Dead Band Delay	0.00	320.00	s	0.00	1368	
P11.11 ②	PID2 Keypad Set Point 1	See Para ID 1360	See Para ID 1362	Varies	0.00	1369	
P11.12 ②	PID2 Keypad Set Point 2	See Para ID 1360	See Para ID 1362	Varies	0.00	1371	
P11.13 ②	PID2 Ramp Time	0.00	300.00	s	0.00	1373	
P11.14 ①②	PID2 Set Point 1 Source				1	1374	0=Not Used 1=PID2 Keypad Set Point 1 2=PID2 Keypad Set Point 2 3=A11 4=A12 5=Slot A: A11 6=Slot B: A11 7=FB Process Data Input 1 8=FB Process Data Input 2 9=FB Process Data Input 3 10=FB Process Data Input 4 11=FB Process Data Input 5 12=FB Process Data Input 6 13=FB Process Data Input 7 14=FB Process Data Input 8 15=PID1 Output 16=Multi Drive Network 17=FB PID2 Set Point 1 18=FB PID2 Set Point 2
P11.15 ②	PID2 Set Point 1 Min	-200.00	200.00	%	0.00	1375	
P11.16 ②	PID2 Set Point 1 Max	-200.00	200.00	%	100.00	1376	

Notes: ① Parameter value can only be changed after the drive has stopped.
② Parameter value will be set to be default when changing macros.

Chapter 8—Multi-Purpose application

Table 149. PID Controller 2—P11 continued

Code	Parameter	Min.	Max.	Unit	Default	ID	Note
P11.17 ①②	PID2 Set Point 1 Sleep Enable				0	1377	0 = Disabled 1 = Enabled
P11.18 ②	PID2 Setpoint 1 Sleep Unit				0	2398	0 = Ouptut Frequency 1 = Motor Speed 2 = Motor Current 3 = PID1 Feedabck
P11.19 ②	PID2 Setpoint 1 Sleep Level	See Para ID 1360	See Para ID 1362	varies	0.00	2454	
P11.20 ②	PID2 Set Point 1 Sleep Delay	0	3000	s	0	1379	
P11.21 ②	PID2 Set Point 1 WakeUp Level	-99999.99	-99999.99	varies	0.00	1380	
P11.22 ②	PID2 Set Point 1 Boost	-2.0	2.0		1.0	1382	
P11.23 ①②	PID2 Set Point 2 Source				2	1383	See Para ID 1374
P11.24 ②	PID2 Set Point 2 Min	-200.00	200.00	%	0.00	1384	
P11.25 ②	PID2 Set Point 2 Max	-200.00	200.00	%	100.00	1385	
P11.26 ①②	PID2 Set Point 2 Sleep Enable				0	1386	0 = Disabled 1 = Enabled
P11.27 ②	PID2 Setpoint 2 Sleep Unit				0	2399	0 = Ouptut Frequency 1 = Motor Speed 2 = Motor Current 3 = PID1 Feedabck
P11.28 ②	PID2 Setpoint 2 Sleep Level	See Para ID 1360	See Para ID 1362	varies	0.00	2456	
P11.29 ②	PID2 Set Point 2 Sleep Delay	0	3000	s	0	1388	
P11.30 ②	PID2 Set Point 2 WakeUp Level	-99999.99	-99999.99	varies	0.00	1389	
P11.31 ②	PID2 Set Point 2 Boost	-2.0	2.0		1.0	1391	
P11.32 ①②	PID2 Feedback Func				0	1392	See Para ID 1330
P11.33 ②	PID2 Feedback Gain	-1000.0	1000.0	%	100.0	1393	
P11.34 ①②	PID2 Feedback 1 Source				1	1394	0=Not Used 1=A11 2=A12 3=Slot A: A11 4=Slot B: A11 5=FB Process Data Input 1 6=FB Process Data Input 2 7=FB Process Data Input 3 8=FB Process Data Input 4 9=FB Process Data Input 5 10=FB Process Data Input 6 11=FB Process Data Input 7 12=FB Process Data Input 8 13=PT100 Temperture 14=PID1 Output 15=SlotA PT100 Temp Channel 1 16=SlotA PT100 Temp Channel 2 17=SlotA PT100 Temp Channel 3 18=SlotB PT100 Temp Channel 1 19=SlotB PT100 Temp Channel 2 20=SlotB PT100 Temp Channel 3 21=FB PID2 Feedback 1 22=FB PID2 Feedback 2
P11.35 ②	PID2 Feedback 1 Min	-200.00	200.00	%	0.00	1395	
P11.36 ②	PID2 Feedback 1 Max	-200.00	200.00	%	100.00	1396	
P11.37 ①②	PID2 Feedback 2 Source				0	1397	See Para ID 1394
P11.38 ②	PID2 Feedback 2 Min	-200.00	200.00	%	0.00	1398	
P11.39 ②	PID2 Feedback 2 Max	-200.00	200.00	%	100.00	1399	
P11.40 ①②	PID2 Feedforward Func				0	1400	See Para ID 1338
P11.41 ②	PID2 Feedforward Gain	-1000.0	1000.0	%	100.0	1401	

Notes: ① Parameter value can only be changed after the drive has stopped.

② Parameter value will be set to be default when changing macros.

Table 149. PID Controller 2—P11 continued

Code	Parameter	Min.	Max.	Unit	Default	ID	Note
P11.42 ①②	PID2 Feedforward 1 Source				0	1402	0=Not Used 1=A11 2=A12 3=Slot A: A11 4=Slot B: A11 5=FB Process Data Input 1 6=FB Process Data Input 2 7=FB Process Data Input 3 8=FB Process Data Input 4 9=FB Process Data Input 5 10=FB Process Data Input 6 11=FB Process Data Input 7 12=FB Process Data Input 8 13=PT100 Temperture 14=PID1 Output 15=SlotA PT100 Temp Channel 1 16=SlotA PT100 Temp Channel 2 17=SlotA PT100 Temp Channel 3 18=SlotB PT100 Temp Channel 1 19=SlotB PT100 Temp Channel 2 20=SlotB PT100 Temp Channel 3 21=FB PID2 Feedforward 1 22=FB PID2 Feedforward 2
P11.43 ②	PID2 Feedforward 1 Min	-200.00	200.00	%	0.00	1403	
P11.44 ②	PID2 Feedforward 1 Max	-200.00	200.00	%	100.00	1404	
P11.45 ①②	PID2 Feedforward 2 Source				0	1405	See Para ID 1402
P11.46 ②	PID2 Feedforward 2 Min	-200.00	200.00	%	0.00	1406	
P11.47 ②	PID2 Feedforward 2 Max	-200.00	200.00	%	100.00	1407	
P11.48 ②	PID2 Set Point1 Comp Enable				0	1414	0 = Disabled 1 = Enabled
P11.49 ②	PID2 Set Point1 Comp Max	-200.00	200.00	%	0.00	1415	
P11.50 ②	PID2 Set Point 2 Comp Enable				0	1416	0 = Disabled 1 = Enabled
P11.51 ②	PID2 Set Point 2 Comp Max	-200.00	200.00	%	0.00	1417	
P11.52 ②	PID2 Wake Up Action	0	3		0	2467	0 = Below Wake Up Level 1 = Above Wake Up Level 2 = Below Wake Up Level(PID ref.) -Wake up when below wakeup level % set in Para ID 1380 or 1389 from PID Setpoint. 3 = Above Wake Up Level(PID ref.) -Wake up when below wakeup level % set in Para ID 1380 or 1389 from PID Setpoint.
P11.53	FB PID2 Set Point 1	P11.5	P11.6	varies	0.00	2546	
P11.54	FB PID2 Set Point 2	P11.5	P11.6	varies	0.00	2548	
P11.55	FB PID2 Feedback 1			varies	0.00	2552	
P11.56	FB PID2 Feedback 2			varies	0.00	2553	
P11.57	FB PID2 Feedforward 1			varies	0.00	2556	
P11.58	FB PID2 Feedforward 2			varies	0.00	2557	

Table 150. Preset speed—P12

Code	Parameter	Min.	Max.	Unit	Default	ID	Note
P12.1 ②	Preset Speed 1	0.00	See Para ID 102	Hz	5.00	105	
P12.2 ②	Preset Speed 2	0.00	See Para ID 102	Hz	10.00	106	
P12.3 ②	Preset Speed 3	0.00	See Para ID 102	Hz	15.00	118	
P12.4 ②	Preset Speed 4	0.00	See Para ID 102	Hz	20.00	119	
P12.5 ②	Preset Speed 5	0.00	See Para ID 102	Hz	25.00	120	
P12.6 ②	Preset Speed 6	0.00	See Para ID 102	Hz	30.00	121	
P12.7 ②	Preset Speed 7	0.00	See Para ID 102	Hz	35.00	122	

Notes: ① Parameter value can only be changed after the drive has stopped.
② Parameter value will be set to be default when changing macros.

Chapter 8—Multi-Purpose application

Table 151. Torque control—P13

Code	Parameter	Min.	Max.	Unit	Default	ID	Note
P13.1 ②	Torque Limit	0.0	400.0	%	400.0	295	
P13.2 ②	Torque Ref Select				0	303	0 = Not Used 1 = AI1 2 = AI2 3 = Slot A: AI1 4 = Slot B: AI1 5 = AI1 Joystick 6 = AI2 Joystick 7 = Keypad Torque Ref 8 = FB Data Input 1 9 = PID1 Control Output 10 = PID2 Control Output 11 = FB Torque Ref
P13.3 ②	Keypad Torque Ref	-300.0	300.0	%	0.0	782	
P13.4 ②	Torque Ref Max	-300.0	300.0	%	100.0	304	
P13.5 ②	Torque Ref Min	-300.0	300.0	%	0.0	305	
P13.6 ②	Speed Limiter Mode				0	1666	0 = NegFreqMax...PosFreqMax 1 = - FreqRampOut ... + FreqRampOut 2 = NegFreqMax... FreqRampOut(MIN) 3 = FreqRampOut... PosFreqMax (MAX) ⑥ 4 = FreqRampOut + -WindowPos/NegWidth ⑥ 5 = 0...FreqRampOut (pos or neg direction) ⑥ 6 = FreqRamp + -WindowPos/ Neg/PosOff/NegOff ⑥
P13.7 ②⑥	Window Pos Width	0.00	50.00	Hz	2.00	1636	
P13.8 ②⑥	Window Neg Width	0.00	50.00	Hz	2.00	1637	
P13.9 ②⑥	Window Pos Off Limit	0.00	See Para ID 1636	Hz	0.00	1638	
P13.10 ②⑥	WindowNeg Off Limit	0.00	See Para ID 1637	Hz	0.00	1639	
P13.11 ②	Torque Reference Filter TC	0	32000	ms	0	1640	
P13.12 ②⑥	Pull Out Torque	0	1000.0	%	250.0	1606	
P13.13 ②	Stop State Magnetization Time	0	32000	s	0	1684	
P13.14	FB Torque Ref	-300	300			2541	
P13.15 ①②⑦	Torque Control(2) Min Frequency	0.00	P1.2	Hz	3.00	300	
P13.16 ①②⑦	Torque Control(2) P-gain	0.00	500.00		0.01	301	
P13.17 ①②⑦	Torque Control(2) I-gain	0.00	1000.00		2.00	302	
P13.18 ①②⑦	Torque Control(6) P-gain	0.0	500.0	%	0.6	60	
P13.19 ①②⑦	Torque Control(6) I-gain	0.0	1000.0	%	5.0	61	

Table 152. Brake—P14

Code	Parameter	Min.	Max.	Unit	Default	ID	Note
P14.1 ①②⑧	DC-Brake Current	Drive Nom CT*15/100/0.0	Drive Nom CT*15/10 /Drive Nom VT*2	A	Drive Nom CT*1/2 / Drive Nom VT*1/2	254	
P14.2 ①②	Start DC-Brake Time	0.00	600.00	s	0.00	263	
P14.3 ①②	Stop DC-Brake Frequency	0.10	10.00	Hz	1.50	262	
P14.4 ①②	Stop DC-Brake Time	0.00	600.00	s	0.00	255	
P14.5 ①②	Brake Chopper Define				0	251	0 = Disabled 1 = B(Run) T(Rdy) 2 = External 3 = B(Rdy) T(Rdy) 4 = B(Run) T(No)

Notes: ① Parameter value can only be changed after the drive has stopped.
 ② Parameter value will be set to be default when changing macros.
 ③ Function is not available in FR7 and FR8 of DG1 drives.
 ④ Function is only available in FR7 and FR8 of DG1 drives.
 ⑤ DG1 Frame 1-6/DG1 Frame 7-8.

Table 152. Brake—P14 continued

Code	Parameter	Min.	Max.	Unit	Default	ID	Note
P14.6 ①②	Flux Brake				0	266	0 = Off 1 = On
P14.7 ①②	Flux Brake Current	Active Motor Nom I*1/10	See Para ID 107	A	Active Motor Nom I*1/2	265	

Table 153. Fire Mode—P15

Code	Parameter	Min.	Max.	Unit	Default	ID	Note
P15.1 ①②	Fire Mode Function				0	535	0 = Closing Contact 1 = Opening Contact
P15.2 ①②	Fire Mode Ref Select Function				0	536	0 = Fire Mode Min Frequency 1 = Fire Mode Reference 2 = Fieldbus Reference 3 = AI1 4 = AI2 5 = AI1+AI2 6 = PID1 Control Output 7=PID2 Control Output
P15.3 ②	Fire Mode Min Frequency	See Para ID 101	See Para ID 102	Hz	15.00	537	
P15.4 ②	Fire Mode Freq Ref 1	0.0	100.0	%	75.0	565	
P15.5 ②	Fire Mode Freq Ref 2	0.0	100.0	%	100.0	564	
P15.6 ①②	Smoke Purge Frequency	0.0	100.0	%	50.0	554	
P15.7 ②	Fire Mode Test Enable				0	2443	0 = Disable 1 = Enable

Table 154. Second motor parameter—P16

Code	Parameter	Min.	Max.	Unit	Default	ID	Note
P16.1 ①	Motor Nom Current 2	Drive Nom CT*1/10	Drive Nom CT*2	A	Drive Nom CT	577	
P16.2 ①⑥	Motor Nom Speed 2	300	20000/19200	rpm	2nd Motor Nom Speed	578	
P16.3 ①	Motor PF 2	0.30	1.00		0.85	579	
P16.4 ①	Motor Nom Volt 2	180	690	V	2nd Motor Nom Volt	580	
P16.5 ①⑧	Motor Nom Freq 2	8.00	400.00/320.00	Hz	2nd Motor Nom Freq	581	
P16.6 ①	Stator Resistor 2	0.001	65.535	ohm	0.033	1419	
P16.7 ①⑥	Rotor Resistor 2	0.001	65.535	ohm	0.034	1420	
P16.8 ①	Leak Inductance 2	0.001	65.535	mh	0.128	1421	
P16.9 ①⑥	Mutual Inductance 2	0.01	655.35	mh	3.44	1422	
P16.10 ①⑧	Excitation Current 2	0.1/0.0	Drive Nom CT*2	A	0.1/0.0	1423	

Table 155. Bypass—P17**Basic Settings**

Code	Parameter	Min.	Max.	Unit	Default	ID	Note
P17.1.1 ①②	Bypass Enable				0	1418	0 = Disabled 1 = Enabled
P17.1.2 ①②	Bypass Start Delay	1	32765	s	5	544	
P17.1.3 ①②	Auto Bypass				0	542	0 = Disabled 1 = Enabled
P17.1.4 ①②	Auto Bypass Delay	0	32765	s	10	543	
P17.1.5 ①②	Overcurrent Bypass Enable				0	547	0 = Disabled 1 = Enabled
P17.1.6 ①②	IGBT Fault Bypass Enable				0	546	0 = Disabled 1 = Enabled
P17.1.7 ①②	4 mA Fault Bypass Enable				0	548	0 = Disabled 1 = Enabled

Notes: ① Parameter value can only be changed after the drive has stopped.
 ② Parameter value will be set to be default when changing macros.
 ③ Function is not available in FR7 and FR8 of DG1 drives.
 ④ Function is only available in FR7 and FR8 of DG1 drives.
 ⑤ DG1 Frame 1-6/DG1 Frame 7-8.

Chapter 8—Multi-Purpose application

Table 155 Bypass—P17, continued

Code	Parameter	Min.	Max.	Unit	Default	ID	Note
P17.1.8 ①②	Undervoltage Bypass Enable				0	545	0 = Disabled 1 = Enabled
P17.1.9 ①②	Overvoltage Bypass Enable				0	549	0 = Disabled 1 = Enabled
P17.2.1 ②	Redundant Drive Enable	0	1		0	2476	0 = Disabled 1 = Enabled
P17.2.2 ②	Drive ID	0	5		0	2278	
P17.2.3 ②	Redundant Run Time Enable	0	1		0	2477	0 = Disabled 1 = Enabled
P17.2.4 ②	Redundant Run Time Reset	0	1		0	2478	0 = Not Reset 1 = Reset
P17.2.5 ②	Redundant RunTime Limit	0.0	300000.0	h	0.0	2479	

Table 156. Basic settings—P18.1

Code	Parameter	Min	Max	Unit	Default	ID	Note
P18.1.1 ②	Multi-Pump Mode				0	2279	0 = Disable 1 = Single Drive Control 2 = Multi Drive Network
P18.1.2 ②	Drive ID	0	5		0.00	2278	
P18.1.3 ②	PID Bandwidth	0	100	Varies	10	343	
P18.1.4 ②	Staging Frequency	See Para ID 101	400		See Para ID 102	2315	
P18.1.5 ②	De-Staging Frequency	0	See Para ID 102		See Para ID 101	2316	
P18.1.6 ②	Add/Remove Delay	0	3600	s	10	344	
P18.1.7 ②	Interlock Enable				0	350	0 = Disable 1 = Enable
P18.1.8 ②	Damper Start				0	483	0 = Normal 1 = Interlock Start 2 = Interlock Tout 3 = Interlock Delay
P18.1.9 ②	Damper Time Out	1	32500	s	5	484	
P18.1.10	Damper Delay	1	32500	s	5	485	
P18.1.11 ②	Derag Cycles	0	10		3	2468	0 = Off 1 = Start 2 = Stop 3 = Start and Stop 4 = Digital Input;
P18.1.12 ②	Derag at Start/Stop	0	4		0	2469	
P18.1.13 ②	Deragging Run Time	0	3600	s	0	2470	
P18.1.14 ②	Derag Speed	See Para ID 101	See Para ID 102	Hz	5	2471	
P18.1.15 ②	Derag Off Delay	1	600	s	10	2472	

Multi-Pump Com Status P18.2

Table 157. Operation mode—P18.2.1

Code	Parameter	Min	Max	Unit	Default	ID	Note
P18.2.1.1	Drive 1				0	2218	0 = Offline 1 = Slave Drive 2 = Master Drive
P18.2.1.2	Drive 2				0	2230	0 = Offline 1 = Slave Drive 2 = Master Drive
P18.2.1.3	Drive 3				0	2242	0 = Offline 1 = Slave Drive 2 = Master Drive
P18.2.1.4	Drive 4				0	2254	0 = Offline 1 = Slave Drive 2 = Master Drive
P18.2.1.5	Drive 5				0	2266	0 = Offline 1 = Slave Drive 2 = Master Drive

Notes: ① Parameter value can only be changed after the drive has stopped.
② Parameter value will be set to be default when changing macros.

Table 158. Multi pump status—P18.2.2

Code	Parameter	Min	Max	Unit	Default	ID	Note
P18.2.2.1	Drive 1				0	2219	0 = Stopped 1 = Sleep 2 = Regulating 3 = Wait for CMD 4 = Following 5 = Unknown
P18.2.2.2	Drive 2				0	2231	0 = Stopped 1 = Sleep 2 = Regulating 3 = Wait for CMD 4 = Following 5 = Unknown
P18.2.2.3	Drive 3				0	2243	0 = Stopped 1 = Sleep 2 = Regulating 3 = Wait for CMD 4 = Following 5 = Unknown
P18.2.2.4	Drive 4				0	2245	0 = Stopped 1 = Sleep 2 = Regulating 3 = Wait for CMD 4 = Following 5 = Unknown
P18.2.2.5	Drive 5				0	2267	0 = Stopped 1 = Sleep 2 = Regulating 3 = Wait for CMD 4 = Following 5 = Unknown

Table 159. Network status—P18.2.3

Code	Parameter	Min	Max	Unit	Default	ID	Note
P18.2.3.1	Drive 1				0	2220	0 = Disconnected 1 = Fault 2 = Pump Lost 3 = Need Alternation 4 = No Error
P18.2.3.2	Drive 2				0	2232	0 = Disconnected 1 = Fault 2 = Pump Lost 3 = Need Alternation 4 = No Error
P18.2.3.3	Drive 3				0	2244	0 = Disconnected 1 = Fault 2 = Pump Lost 3 = Need Alternation 4 = No Error
P18.2.3.4	Drive 4				0	2246	0 = Disconnected 1 = Fault 2 = Pump Lost 3 = Need Alternation 4 = No Error
P18.2.3.5	Drive 5				0	2268	0 = Disconnected 1 = Fault 2 = Pump Lost 3 = Need Alternation 4 = No Error

Multi-Pump Measurement P18.3**Table 160. Last fault code—P18.3.1**

Code	Parameter	Min	Max	Unit	Default	ID	Note
P18.3.1.1	Drive 1				0	2221	
P18.3.1.2	Drive 2				0	2233	

Notes: ① Parameter value can only be changed after the drive has stopped.
 ② Parameter value will be set to be default when changing macros.

Table 160. Network status—P18.2.3, continued

Code	Parameter	Min	Max	Unit	Default	ID	Note
P18.3.1.3	Drive 3				0	2245	
P18.3.1.4	Drive 4				0	2257	
P18.3.1.5	Drive 5				0	2269	

Table 161. Output frequency—P18.3.2

Code	Parameter	Min	Max	Unit	Default	ID	Note
P18.3.2.1	Drive 1			Hz	0	2222	
P18.3.2.2	Drive 2			Hz	0	2234	
P18.3.2.3	Drive 3			Hz	0	2246	
P18.3.2.4	Drive 4			Hz	0	2258	
P18.3.2.5	Drive 5			Hz	0	2270	

Table 162. Motor voltage—P18.3.3

Code	Parameter	Min	Max	Unit	Default	ID	Note
P18.3.3.1	Drive 1			V	0	2223	
P18.3.3.2	Drive 2			V	0	2235	
P18.3.3.3	Drive 3			V	0	2247	
P18.3.3.4	Drive 4			V	0	2259	
P18.3.3.5	Drive 5			V	0	2271	

Table 163. Motor current—P18.3.4

Code	Parameter	Min	Max	Unit	Default	ID	Note
P18.3.4.1	Drive 1			A	0	2224	
P18.3.4.2	Drive 2			A	0	2236	
P18.3.4.3	Drive 3			A	0	2248	
P18.3.4.4	Drive 4			A	0	2260	
P18.3.4.5	Drive 5			A	0	2272	

Table 164. Motor torque—P18.3.5

Code	Parameter	Min	Max	Unit	Default	ID	Note
P18.3.5.1	Drive 1			%	0	2225	
P18.3.5.2	Drive 2			%	0	2237	
P18.3.5.3	Drive 3			%	0	2249	
P18.3.5.4	Drive 4			%	0	2261	
P18.3.5.5	Drive 5			%	0	2273	

Table 165. Motor power—P18.3.6

Code	Parameter	Min	Max	Unit	Default	ID	Note
P18.3.6.1	Drive 1			%	0	2226	
P18.3.6.2	Drive 2			%	0	2238	
P18.3.6.3	Drive 3			%	0	2250	
P18.3.6.4	Drive 4			%	0	2262	
P18.3.6.5	Drive 5			%	0	2274	

Table 166. Motor Speed—P18.3.7

Code	Parameter	Min	Max	Unit	Default	ID	Note
P18.3.7.1	Drive 1			RPM	0	2227	
P18.3.7.2	Drive 2			RPM	0	2239	
P18.3.7.3	Drive 3			RPM	0	2251	
P18.3.7.4	Drive 4			RPM	0	2263	
P18.3.7.5	Drive 5			RPM	0	2275	

Notes: ① Parameter value can only be changed after the drive has stopped.
 ② Parameter value will be set to be default when changing macros.

Table 167. Motor run Time—P18.3.8

Code	Parameter	Min	Max	Unit	Default	ID	Note
P18.3.8.1	Drive 1			h	0	2228	
P18.3.8.2	Drive 2			h	0	2240	
P18.3.8.3	Drive 3			h	0	2252	
P18.3.8.4	Drive 4			h	0	2264	
P18.3.8.5	Drive 5			h	0	2276	

Table 168. Multi-pump single drive—P18.4

Code	Parameter	Min	Max	Unit	Default	ID	Note
P18.4.1 ②	Number of Pumps	1	5		1	342	
P18.4.2 ②	Include Frequency Converter				1	346	0 = Disable 1 = Enable
P18.4.3 ②	Auto-Change Enable				0	345	0 = Disable 1 = Enable
P18.4.4 ②	Auto-Change Interval	0	3000	h	48	347	
P18.4.5 ②	Auto-Change Freq Limit	See Para ID 101	See Para ID 102	Hz	25	349	
P18.4.6 ②	Auto-Change Pump Limit	0	5		1	348	
P18.4.7 ②	Pipe Fill Aux Pump Select				0	2441	0=Disabled 1=Aux Motor 1 2=Aux Motor 2 3=Aux Motor 3 4=Aux Motor 4
P18.4.8 ②	Pipe Fill Aux Pump Run Time	0.0	3600.0	min	0.0	2442	
P18.4.9 ②	Pipe Fill Aux Pump Operation				0	2443	0 = Automatic 1 = Stop
P18.4.10 ②	Pipe Fill Aux Pump Delay	0.0	600.0	min	2.0	2444	

Table 169. Multi-Pump multi drive—P18.5

Code	Parameter	Min	Max	Unit	Default	ID	Note
P18.5.1 ②	Number of Drives	1	5		1	2451	
P18.5.2 ②	Regulation Source				0	2284	0 = Network 1 = PID Controller 1
P18.5.3 ②	Recovery Method				0	2285	0 = Automatic 1 = Stop
P18.5.4 ②	Callback Source				0	2286	0 = No Action 1 = Safe Torque Off
P18.5.5 ②	Add/Remove Drive Selection				0	2311	0 = Drive ID 1 = Run Time
P18.5.6 ②	Run Time Enable				0	2280	0 = Disable 1 = Enable
P18.5.7 ②	Run Time Limit	0	300000	h	0	2281	
P18.5.8 ②	Run Time Reset				0.0	2283	0 = No Action 1 = Reset
P18.5.9 ②	Master Drive Mode	0	2		0	2473	0 = Follow PID 1 = Fixed Speed 2 = Turn Off
P18.5.10 ②	Master Fixed Speed	See Para ID 101	See Para ID 102	Hz	50.00	2474	
P18.5.11 ②	Master Fixed Speed Delay	0	1000	s	5	2475	

Table 170. Protections—P18.6

Code	Parameter	Min	Max	Unit	Default	ID	Note
P18.6.1 ②	Pipe Fill Loss Detection Method				0	2406	0 = Motor Current 1 = Motor Power 2 = Motor Torque
P18.6.2 ②	Pipe Fill Loss Level	0.0	1000.0	%	0.0	2407	

Notes: ① Parameter value can only be changed after the drive has stopped.
 ② Parameter value will be set to be default when changing macros.

Chapter 8—Multi-Purpose application

Table 170. Multi-Pump multi drive—P18.5, continued

Code	Parameter	Min	Max	Unit	Default	ID	Note
P18.6.3 ②	Pipe Fill Loss Time	0	600	s	0	2408	
P18.6.4 ②	Pipe Fill Loss Frequency	0.00	See Para ID 102	Hz	0.00	2409	
P18.6.5 ②	Pipe Fill Loss Response				0	2410	0 = No Action 1 = Warning 2 = Fault
P18.6.6 ②	Pipe Fill Loss Attempts	0	10		1	2411	
P18.6.7 ②	Prime Pump Enable				0	2430	See Para ID 190
P18.6.8 ②	Prime Pump Level	0.00	6000.00	%	0.00	2431	
P18.6.9 ②	Prime Pump Frequency	See Para ID 101	See Para ID 102	Hz	0.00	2433	
P18.6.10 ②	Prime Pump Delay Time	0.0	3600.0	min	0.0	2434	
P18.6.11 ②	Prime Pump Loss of Prime Level	0.0	1000.0	%	0.0	2435	
P18.6.12 ②	Prime Pump Level 2	0.00	6000.00	%	0.00	2436	
P18.6.13 ②	Prime Pump Frequency 2	See Para ID 101	See Para ID 102	Hz	0.00	2438	
P18.6.14 ②	Prime Pumpe Delay Time 2	0.0	3600.0	min	0.0	2439	
P18.6.15 ②	Prime Pumpe Loss of Prime Level 2	0.0	1000.0	%	0.0	2440	

Table 171. Real time clock—P19

Code	Parameter	Min.	Max.	Unit	Default	ID	Note
P19.1 ②	Interval 1 On Time				0,0,0	491	
P19.2 ②	Interval 1 Off Time				0,0,0	493	
P19.3 ②	Interval 1 From Day				0	517	0 = Sunday 1 = Monday 2 = Tuesday 3 = Wednesday 4 = Thursday 5 = Friday 6 = Saturday
P19.4 ②	Interval 1 To Day				0	518	See Para ID 517
P19.5 ②	Interval 1 Channel				0	519	0 = Not Used 1 = Time Channel 1 2 = Time Channel 2 3 = Time Channel 3
P19.6 ②	Interval 2 On Time				0,0,0	495	
P19.7 ②	Interval 2 Off Time				0,0,0	497	
P19.8 ②	Interval 2 From Day				0	520	See Para ID 517
P19.9 ②	Interval 2 To Day				0	521	See Para ID 517
P19.10 ②	Interval 2 Channel				0	522	See Para ID 519
P19.11 ②	Interval 3 On Time				0,0,0	499	
P19.12 ②	Interval 3 Off Time				0,0,0	501	
P19.13 ②	Interval 3 From Day				0	523	See Para ID 517
P19.14 ②	Interval 3 To Day				0	524	See Para ID 517
P19.15 ②	Interval 3 Channel				0	525	See Para ID 519
P19.16 ②	Interval 4 On Time				0,0,0	503	
P19.17 ②	Interval 4 Off Time				0,0,0	505	
P19.18 ②	Interval 4 From Day				0	526	See Para ID 517
P19.19 ②	Interval 4 To Day				0	527	See Para ID 517
P19.20 ②	Interval 4 Channel				0	528	See Para ID 519
P19.21 ②	Interval 5 On Time				0,0,0	507	
P19.22 ②	Interval 5 Off Time				0,0,0	509	
P19.23 ②	Interval 5 From Day				0	529	See Para ID 517
P19.24 ②	Interval 5 To Day				0	530	See Para ID 517
P19.25 ②	Interval 5 Channel				0	531	See Para ID 519
P19.26 ②	Timer 1 Duration	0	72000	s	0	511	

Notes: ① Parameter value can only be changed after the drive has stopped.
② Parameter value will be set to be default when changing macros.

Table 171. Real time clock—P19, continued

Code	Parameter	Min.	Max.	Unit	Default	ID	Note
P19.27 ②	Timer 1 Channel				0	532	0 = Not Used 1 = Time Channel 1 2 = Time Channel 2 3 = Time Channel 3
P19.28 ②	Timer 2 Duration	0	72000	s	0	513	
P19.29 ②	Timer 2 Channel				0	533	See Para ID 532
P19.30 ②	Timer 3 Duration	0	72000	s	0	515	
P19.31 ②	Timer 3 Channel				0	534	See Para ID 532
P19.32 ②	Interval 1 Setting	0	1		0	2487	0 = Weekly 1 = Daily
P19.33 ②	Interval 2 Setting	0	1		0	2488	0 = Weekly 1 = Daily
P19.34 ②	Interval 3 Setting	0	1		0	2489	0 = Weekly 1 = Daily
P19.35 ②	Interval 4 Setting	0	1		0	2490	0 = Weekly 1 = Daily
P19.36 ②	Interval 5 Setting	0	1		0	2491	0 = Weekly 1 = Daily

Communication P20**Table 172. FB Process Data Input Sel—P20.1**

Code	Parameter	Min.	Max.	Unit	Default	ID	Note
P20.1.1	FB Process Data Input 1 Sel				2541	2533	
P20.1.2	FB Process Data Input 2 Sel				2542	2534	
P20.1.3	FB Process Data Input 3 Sel				2550	2535	
P20.1.4	FB Process Data Input 4 Sel				103	2536	
P20.1.5	FB Process Data Input 5 Sel				104	2537	
P20.1.6	FB Process Data Input 6 Sel				107	2538	
P20.1.7	FB Process Data Input 7 Sel				0	2539	
P20.1.8	FB Process Data Input 8 Sel				0	2540	

Table 173. FB Process Data Output Sel—P20.2

Code	Parameter	Min.	Max.	Unit	Default	ID	Note
P20.2.1	FB Process Data Output 1 Sel				1	1556	
P20.2.2	FB Process Data Output 2 Sel				2	1557	
P20.2.3	FB Process Data Output 3 Sel				3	1558	
P20.2.4	FB Process Data Output 4 Sel				4	1559	
P20.2.5	FB Process Data Output 5 Sel				5	1560	
P20.2.6	FB Process Data Output 6 Sel				6	1561	
P20.2.7	FB Process Data Output 7 Sel				7	1562	
P20.2.8	FB Process Data Output 8 Sel				28	1563	
P20.2.9	Standard Status Word Bit0 Function Select				1	2415	See Para ID 151
P20.2.10	Standard Status Word Bit1 Function Select				1	2416	See Para ID 151
P20.2.11	Standard Status Word Bit2 Function Select				1	2417	See Para ID 151
P20.2.12	Standard Status Word Bit3 Function Select				1	2418	See Para ID 151
P20.2.13	Standard Status Word Bit4 Function Select				1	2419	See Para ID 151

Notes: ① Parameter value can only be changed after the drive has stopped.
 ② Parameter value will be set to be default when changing macros.

Chapter 8—Multi-Purpose application

Table 173. FB Process Data Output Sel—P20.2, continued

P20.2.14	Standard Status Word Bit5 Function Select	1			2420	See Para ID 151
P20.2.15	Standard Status Word Bit6 Function Select	1			2421	See Para ID 151
P20.2.16	Standard Status Word Bit7 Function Select	1			2422	See Para ID 151

RS485 Bus P20.3

Table 174. Basic Setting— P20.3.1

Code	Parameter	Min.	Max.	Unit	Default	ID	Note
P20.3.1.1	RS485 Comm Set				0	586	0 = Modbus RTU 1 = BACnet MS/TP 2 = SWD

Table 175. Modbus RTU— P20.3.2

Code	Parameter	Min.	Max.	Unit	Default	ID	Note
P20.3.2.1	Slave Address	1	247		1	587	
P20.3.2.2	Baud Rate				1	584	0 = 9600 1 = 19200 2 = 38400 3 = 57600 4 = 115200
P20.3.2.3	Parity Type				2	585	0 = None 1 = Odd 2 = Even
P20.3.2.4	Modbus RTU Protocol Status				0	588	0 = Initial 1 = Stopped 2 = Operational 3 = Faulted
P20.3.2.5	Slave Busy				0	589	0 = Not Busy 1 = Busy
P20.3.2.6	Parity Error				0	590	
P20.3.2.7	Slave Fault				0	591	
P20.3.2.8	Last Fault Response				0	592	
P20.3.2.9	Comm Timeout Modbus RTU			ms	10000	593	
P20.3.2.10	Modbus RTU Fault Response	0	1		0	2516	0 = In Fieldbus Control 1 = In All Control

Table 176. BACnet MS/TP— P20.3.3

Code	Parameter	Min.	Max.	Unit	Default	ID	Note
P20.3.3.1	MSTP Baud Rate				2	594	0 = 9600 1 = 19200 2 = 38400 3 = 78600 4 = 115200
P20.3.3.2	MSTP MS/TP Device Address	0	127		1	595	
P20.3.3.3	MSTP Instance Number	0	4194302		varies	596	
P20.3.3.4	MSTP Comm Timeout MSTP			ms	10000	598	
P20.3.3.5	MSTP Protocol Status				0	599	0 = Stopped 1 = Operational 2 = Faulted
P20.3.3.6	MSTP Fault Code				0	600	0 = None 1 = Sole Master
P20.3.3.7	MSTP Fault Response	0	1		0	2526	0 = In Fieldbus Control 1 = In All Control

Notes: ① Parameter value can only be changed after the drive has stopped.
② Parameter value will be set to be default when changing macros.

Table 177. Ethernet IP—P20.4

Code	Parameter	Min.	Max.	Unit	Default	ID	Note
P20.4.1	IP Address Mode				1	1500	"0 = Static IP 1 = DHCP with AutoIP"
P20.4.2	Active IP Address					1507	
P20.4.3	Active Subnet Mask					1509	
P20.4.4	Active Default Gateway					1511	
P20.4.5	MAC Address					1513	
P20.4.6	Static IP Address				192.168.1.254	1501	
P20.4.7	Static Subnet Mask				255.255.255.0	1503	
P20.4.8	Static Default Gateway				192.168.1.1	1505	
P20.4.9	Ethernet IP Protocol Status					608	0 = Stopped 1 = Operational 2 = Faulted
P20.4.10	EIP Fault Response	0	1		0	2518	0 = In Fieldbus Control 1 = In All Control

Table 178. Modbus TCP—P20.5

Code	Parameter	Min.	Max.	Unit	Default	ID	Note
P20.5.1	Connection Limit				5	609	
P20.5.2	Modbus TCP Unit ID				1	610	
P20.5.3	Comm Timeout Modbus TCP			ms	10000	611	
P20.5.4	Modbus TCP Protocol Status				0	612	0 = Stopped 1 = Operational 2 = Faulted
P20.5.5	Slave Busy				0	613	0 = Not Busy 1 = Busy
P20.5.6	Parity Error				0	614	
P20.5.7	Slave Failure				0	615	
P20.5.8	Last Fault Response				0	616	
P20.5.9	Modbus TCP Fault Response	0	1		0	2517	0 = In Fieldbus Control 1 = In All Control

Table 179. Basic setting—P21.1

Code	Parameter	Min.	Max.	Unit	Default	ID	Note
P21.1.1	Language				0	340	0 = English 1 = Depends upon Language Pack 2 = Depends upon Language Pack
P21.1.2.1	Application				0	142	0 = Standard 1 = Multi-Pump 2 = Multi-PID 3 = Multi-Purpose
P21.1.3	Parameter Sets				0	619	0 = No 1 = Reload Defaults 2 = Reload Set 1 3 = Reload Set 2 4 = Store Set 1 5 = Store Set 2 6 = Reset 7 = Reload Defaults VM
P21.1.4	Up To Keypad				0	620	0 = No 1 = Yes
P21.1.5	Down From Keypad				0	621	0 = No 1 = All Parameters 2 = All, No Motor 3 = App Parameters
P21.1.6	Parameter Comparison				0	623	0 = No 1 = Compare with Keypad 2 = Compare with Default 3 = Compare with Set 1 4 = Compare with Set 2

Notes: ① Parameter value can only be changed after the drive has stopped.
 ② Parameter value will be set to be default when changing macros.

Chapter 8—Multi-Purpose application

Table 179. Basic setting—P21.1, continued

Code	Parameter	Min.	Max.	Unit	Default	ID	Note
P21.1.7	Password	0	9999		0	624	
P21.1.8	Parameter Lock				0	625	0 = Change Enable 1 = Change Disable
P21.1.9	Multimonitor Set				0	627	See Para ID 625
P21.1.10	Default Page				0	628	0 = None 1 = Main Menu 2 = Multi-Monitor 3 = Favorite Menu 4 = Keypad Reference
P21.1.11	Timeout Time	0	65535	s	30	629	
P21.1.12	Contrast Adjust	5	18		12	630	
P21.1.13	Backlight Time	1	65535	min	10	631	
P21.1.14	Fan Control				2	632	0 = Continuous 1 = Temperature 2 = Run Follow [Ⓞ] 3 = Calculate Temp [Ⓞ]
P21.1.15	HMI ACK Timeout	200	5000	ms	200	633	
P21.1.16	HMI Retry Number	1	10		5	634	
P21.1.17	Startup Wizard	0	1		1	626	0 = No 1 = Yes
P21.1.18	Jog Soft Key Hidden	0	1		0	2412	0 = Disable 1 = Enable
P21.1.19	Reverse Softkey Hidden	0	1		0	2413	0 = Disable 1 = Enable
P21.1.20	Output Display Unit				45	2424	0 = % 1 = 1/min 2 = rpm 3 = ppm 4 = pps 5 = l/s 6 = l/min 7 = l/h 8 = kg/s 9 = kg/min 10 = kg/h 11 = m ³ /s 12 = m ³ /min 13 = m ³ /h 14 = m/s 15 = mbar 16 = bar 17 = Pa 18 = kPa 19 = mVs 20 = kW 21 = deg C 22 = GPM 23 = gal/s 24 = gal/min 25 = gal/h 26 = lb/s 27 = lb/min 28 = lb/h 29 = CFM 30 = ft ³ /s 31 = ft ³ /min 32 = ft ³ /h 33 = ft/s 34 = in wg 35 = ft wg 36 = PSI 37 = lb/in ² 38 = HP 39 = deg F 40 = PA 41 = WC 42 = HG 43 = ft 44 = m 45 = Hz

Notes: [Ⓞ] Parameter value can only be changed after the drive has stopped.
[Ⓞ] Parameter value will be set to be default when changing macros.

Table 179. Basic setting—P21.1, continued

Code	Parameter	Min.	Max.	Unit	Default	ID	Note
P21.1.21	Output Display Unit Min	-60000.00	See Para ID 24275	varies	0.00	2460	
P21.1.22	Output Display Unit Max	See Para ID 2460	60000.00	varies	60	2425	

Table 180. Version info—P21.2

Code	Parameter	Min.	Max.	Unit	Default	ID	Note
P21.2.1	Keypad Software Version					640	
P21.2.2	Motor Control Software Version					642	
P21.2.3	Application Software Version				App Firmware	644	
P21.2.4	Software Bundle Version				App bundle rev	1714	

Table 181. Application info—P21.3

Code	Parameter	Min.	Max.	Unit	Default	ID	Note
P21.3.1	Brake Chopper					646	0 = No 1 = Yes
P21.3.2	Brake Resister Status					647	See Para ID 646
P21.3.3	Serial Number					648	

Table 182. User info—P21.4

Code	Parameter	Min.	Max.	Unit	Default	ID	Note
P21.4.1	Real Time Clock				0.0.0.1:1:13	566	
P21.4.2	Daylight Saving				0	582	0 = Off 1 = EU 2 = US
P21.4.3	Total MWh Count			Mwh		601	
P21.4.4	Total Power Day Count					603	
P21.4.5	Total Power Hr Count					606	
P21.4.6	Trip MWh Count			Mwh		604	
P21.4.7	Clear Trip MWh Count				0	635	0 = Not Reset 1 = Reset
P21.4.8	Trip Power Day Count					636	
P21.4.9	Trip Power Hr Count					637	
P21.4.10	Clear Trip Power Count				0	639	See Para ID 635

Notes: ① Parameter value can only be changed after the drive has stopped.
 ② Parameter value will be set to be default when changing macros.

Appendix A—Description of parameters

On the following pages you will find the parameter descriptions arranged according to the parameter number.

Some parameter names are followed by a number code indicating the applications in which the parameter is included. See the list of applications below. The parameter numbers under which the parameter appears in different applications are also given.

Application level

- 1 Standard Application
- 2 Multi-Pump and Fan Application
- 3 Multi-PID Application
- 4 Multi-Purpose Application

Code	Modbus ID	Parameter	Application	RO/RW
P1.1	101	Min frequency Sets the lower limit for the frequency of the motor. This will limit other frequency parameter settings; Preset Speeds, Jog Speed, 4mA Fault preset speed, Fire Mode speed, and brake speed settings.	1, 2, 3, 4	RW
P1.2	102	Max frequency Sets the upper limit for the frequency of the motor. This will limit other frequency parameter settings; Preset Speeds, Jog Speed, 4mA Fault preset speed, Fire Mode speed, and brake speed settings.	1, 2, 3, 4	RW
P1.3	103	Accel time 1 Use this parameter to set the acceleration ramp time 1 in seconds.	1, 2, 3, 4	RW
P1.4	104	Decel time 1 Use this parameter to set the deceleration ramp time 1 in seconds.	1, 2, 3, 4	RW

Figure 39. Acceleration and deceleration time

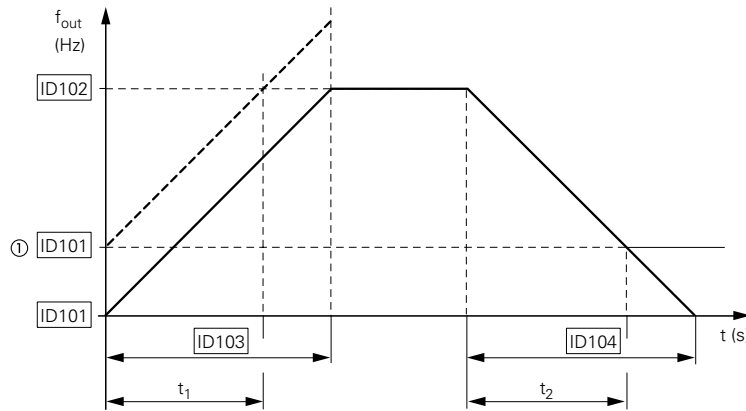

The values for the acceleration time t_1 and the deceleration time t_2 are calculated as follows:

$$t_1 = \frac{(ID102 - ID101) \times ID103}{ID102} \quad t_2 = \frac{(ID102 - ID101) \times ID104}{ID102}$$

The defined acceleration (ID103) and deceleration times ID104 apply for all changes to the frequency setpoint value.

If the start-release (FWD, REV) is switched off, the output frequency (f_{out}) is immediately set to zero. The motor runs down uncontrolled.

If a controlled run-down is requested (with value from ID104), stop mode should be set to ramp.

- ① When setting a minimum output frequency (ID104 greater than 0 Hz), the acceleration and deceleration time of the drive is reduced to t_1 or t_2 .

Code	Modbus ID	Parameter	Application	RO/RW
P1.5	486	Motor Nom Current Use this parameter to set the Motor rated current.	1, 2, 3, 4	RW

Figure 40. Motor parameters from ratings plate

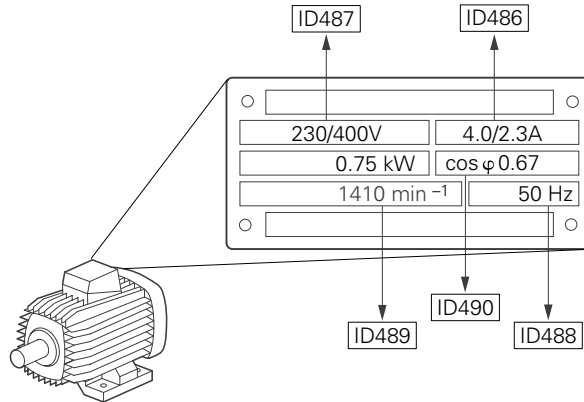

P1.6	489	Motor nom speed Use this parameter to set the Motor Rated Speed.	1, 2, 3, 4	RW
P1.7	490	Motor PF Use this parameter to set the Power factor cos phi of the motor.	1, 2, 3, 4	RW
P1.8	487	Motor nom voltage Use this parameter to set the motor rated voltage.	1, 2, 3, 4	RW
P1.9	488	Motor nom frequency The rated frequency of the motor. This is the frequency at which "Motor Nom Voltage" is applied to the motor. Below this frequency, the applied motor voltage will be reduced. Above this frequency the voltage remains limited to "Motor Nom Voltage"	1, 2, 3, 4	RW
P1.10	1685	Power up local remote select Selects the control place location on power up. By default it will hold the last state that the drive was in when power was removed. Otherwise by setting to "Local" or "Remote" it would default back to that control place when power is reapplied. 0 = Hold Last 1 = Local Control 2 = Remote Control	1, 2, 3, 4	RW
P1.11	135	Remote1 control place Selects where the drive will look for the start command in the "Remote 1" location. • I/O terminal Start 1 and 2 would be from the Digital hardwired inputs assigned via the input group • Fieldbus would be from a communication bus. • Keypad would be from the Start/Stop buttons on the keypad.	1, 2, 3, 4	RW
P1.12	1695	Local control place Selects where the drive will look for the start command in the "Remote 1" location. • I/O terminal Start 1 and 2 would be from the Digital hardwired inputs assigned via the input group • Fieldbus would be from a communication bus. • Keypad would be from the Start/Stop buttons on the keypad.	1, 2, 3, 4	RW
P1.13	2462	Bumpless enable Use this parameter for switching from local to remote mode, change reference only if changed in new source after switching, thus enabling use of ramps. Upon transition stopping can be performed via Keypad Stop, Enable input, ExtFault, or E-Stop.	1,2,3,4	RW
P1.14	136	Local reference This parameter determines the reference for "Local" control mode.	1, 2, 3, 4	RW

Appendix A—Description of parameters

Code	Modbus ID	Parameter	Application				RO/RW
			Standard	Multi-Pump and Fan	Multi-PID	Multi-Purpose	
Application—Selection			Standard	Multi-Pump and Fan	Multi-PID	Multi-Purpose	
0		AI1—Control Terminals 2 and 3, defined as a voltage or current signal input based on S1 DIP switch setting. Parameter settings done in Analog input group.	■	■	■	■	
1		AI2—Control Terminals 4 and 5, defined as a current or voltage signal input based on S2 and S3 DIP switch setting. Parameter settings done in Analog input group.	■	■	■	■	
2		Slot A: AI1—Comes from the slot A DXG-EXT-1AI2AO board, defined as a voltage or current signal based off on board DIP switch. See Option card Manual for more details.	■	■	■	■	
3		Slot B: AI1—Comes from the slot B DXG-EXT-1AI2AO board, defined as a voltage or current signal based off on board DIP switch. See Option card Manual for more details.	■	■	■	■	
4		AI1 joystick—Control Terminals 2 and 3, defined as a voltage or current signal input based on S1 DIP switch setting. Parameter settings done in Analog input group.	■	■	■	■	
5		AI2 joystick—Control Terminals 4 and 5, defined as a current or voltage signal input based on S2 and S3 DIP switch setting. Parameter settings done in Analog input group.	■	■	■	■	
6		Keypad— Keypad Up and down buttons change keypad reference parameter Para ID 141.	■	■	■	■	
7		Fieldbus Ref—Speed reference word used to define speed. Check Communication Manual for more details.	■	■	■	■	
8		Motor Pot—Digital input assigned for increasing and decreasing speed, see digital input group for motor pot input settings and drive control group to define ramp rate and reset condition.	—	—	—	■	
9		Max Frequency—Run at the Para ID 102 Max Frequency level.	■	■	■	■	
10		AI1+AI2— Sum of the AI1 and AI2 signals. See Option 0 and 1 for input details.	■	■	■	■	
11		AI1–AI2— AI1 signal value minus AI2 signal value. See Option 0 and 1 for input details.	■	■	■	■	
12		AI2–AI1— AI2 signal value minus AI1 signal value. See Option 0 and 1 for input details.	■	■	■	■	
13		AI1*AI2— AI1 signal value multiplied by AI2 signal value. See Option 0 and 1 for input details.	■	■	■	■	
14		AI1 or AI2—AI1 signal value or AI2 signal value. See Digital input group to assign select input signal. See Option 0 and 1 for input details.	■	■	■	■	
15		Min (AI1, AI2)—Minimum of AI1 signal value or AI2 signal value. See Option 0 and 1 for input details.	■	■	■	■	
16		Max (AI1, AI2)—Maximum of AI1 signal value or AI2 signal value. See Option 0 and 1 for input details.	■	■	■	■	
17		PID1 Control—PID controller 1 output , see PID group for setup.	—	■	■	■	
18		PID2 control—PID controller 2 output. see PID group for setup.	■	■	■	■	
P1.15	137	Remote1 Ref This parameter determines the reference for "Remote" control mode.			1, 2, 3, 4		RW

Code	Modbus ID	Parameter	Application				RO/RW
			Standard	Multi-Pump and Fan	Multi-PID	Multi-Purpose	
Application—Selection							
0		AI1—Control Terminals 2 and 3, defined as a voltage or current signal input based on S1 DIP switch setting. Parameter settings done in Analog input group.	■	■	■	■	
1		AI2—Control Terminals 4 and 5, defined as a current or voltage signal input based on S2 and S3 DIP switch setting. Parameter settings done in Analog input group.	■	■	■	■	
2		Slot A: AI1—Comes from the slot A DXG-EXT-1AI2AO board, defined as a voltage or current signal based off on board DIP switch. See Option card Manual for more details.	■	■	■	■	
3		Slot B: AI1—Comes from the slot B DXG-EXT-1AI2AO board, defined as a voltage or current signal based off on board DIP switch. See Option card Manual for more details.	■	■	■	■	
4		AI1 joystick—Control Terminals 2 and 3, defined as a voltage or current signal input based on S1 DIP switch setting. Parameter settings done in Analog input group.	■	■	■	■	
5		AI2 joystick—Control Terminals 4 and 5, defined as a current or voltage signal input based on S2 and S3 DIP switch setting. Parameter settings done in Analog input group.	■	■	■	■	
6		Keypad— Keypad Up and down buttons change keypad reference parameter Para ID 141.	■	■	■	■	
7		Fieldbus Ref—Speed reference word used to define speed. Check Communication Manual for more details.	■	■	■	■	
8		Motor Pot—Digital input assigned for increasing and decreasing speed, see digital input group for motor pot input settings and drive control group to define ramp rate and reset condition.	—	—	—	■	
9		Max Frequency—Run at the Para ID 102 Max Frequency level.	■	■	■	■	
10		AI1+AI2— Sum of the AI1 and AI2 signals. See Option 0 and 1 for input details.	■	■	■	■	
11		AI1–AI2— AI1 signal value minus AI2 signal value. See Option 0 and 1 for input details.	■	■	■	■	
12		AI2 signal value minus AI1 signal value. See Option 0 and 1 for input details.	■	■	■	■	
13		AI1*AI2— AI1 signal value multiplied by AI2 signal value. See Option 0 and 1 for input details.	■	■	■	■	
14		AI1 or AI2—AI1 signal value or AI2 signal value. See Digital input group to assign select input signal. See Option 0 and 1 for input details.	■	■	■	■	
15		Min (AI1, AI2)—Minimum of AI1 signal value or AI2 signal value. See Option 0 and 1 for input details.	■	■	■	■	
16		Max (AI1, AI2)—Maximum of AI1 signal value or AI2 signal value. See Option 0 and 1 for input details.	■	■	■	■	
17		PID1 Control—PID controller 1 output , see PID group for setup.	—	■	■	■	
18		PID2 control—PID controller 2 output. see PID group for setup.	■	■	■	■	
P1.16	1679	Reverse enable Use this parameter to enables or disables the reverse motor direction.			1, 2, 3, 4		RW
P1.17	2423	Run delay time Run Delay time parameter sets the time required for the drive to wait before another run command can be received. During this time the run signal is given it is ignored until the time has expired upon which it will then start, in keypad, I/O, or fieldbus Control Modes.			1,2,3,4		RW

Appendix A—Description of parameters

Code	Modbus ID	Parameter	Application	RO/RW
P1.18	2465	HOA Source Use this parameter to enables the HOA control function. If enabled it selects the desired location for switching between Hand, Off, and Auto control locations. 0 - Disabled - Off is disable and the standard Loc/Rem is used. 1 - HOA Source: I/O Terminal - Drive is looking for control source selection via I/O terminals. Have to use the HOA On/Off digital input along with Force Hand or Remote to function. 2 - HOA Source: Keypad - Keypad Loc/Rem button will function as the switch between Hand/Off/Auto.	1,2,3,4	RW
P2.1.1	144	AI Ref Scale Min Value Min Frequency when min of Analog References is applied. With values set at 0 scaling will follow the minimum frequency value parameter Para ID 101.	1,2,3,4	RW
P2.1.2	145	AI Ref Scale Max Value Max Frequency when max of Analog Reference is applied. With values set at 0 scaling will follow the maximum frequency value parameter Para ID 102.	1, 2, 3, 4	RW

Figure 41. With and without reference scaling

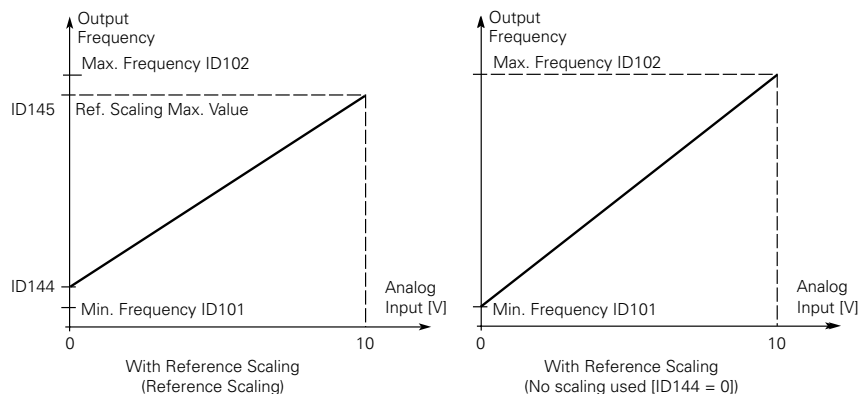

Code	Modbus ID	Parameter	Application	RO/RW
P2.2.1	222	AI1 Mode	1, 2, 3, 4	RW

Defines the analog input 1 source mode for current or voltage, also need to set DIP switches on control board SW1.
 0 = 0-20mA - current loop with an external supply the ground jumper is not required.

Figure 42. AI1 2wire-current

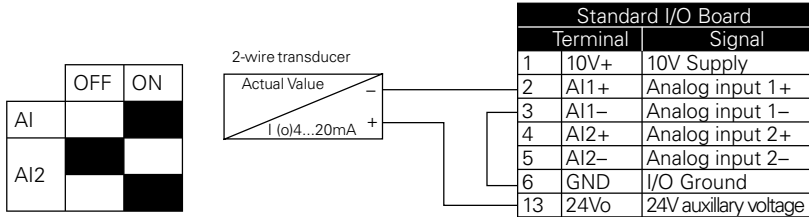

Figure 43. AI1 3wire-current

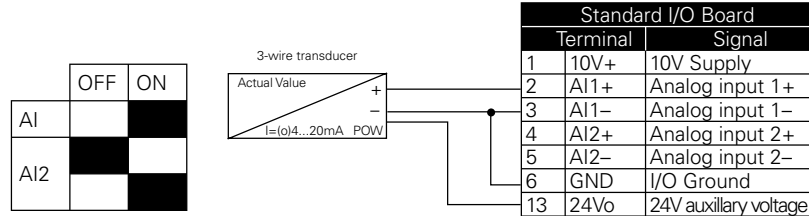
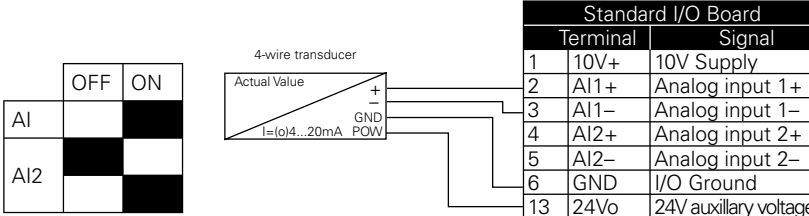
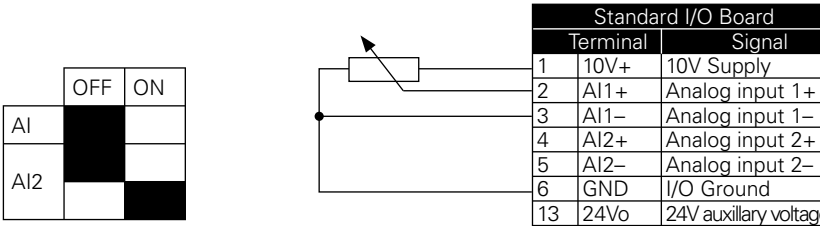

Figure 44. AI1 4wire-current



1 = 0-10V - If using the 10V supply on Terminal 1 of the drive, it will require a ground jumper from Terminal 6 to the AI- input terminal 3.

Figure 45. AI1 reference potentiometer 10V



Appendix A—Description of parameters

Code	Modbus ID	Parameter	Application	RO/RW
P2.2.2	175	AI1 Signal Range	1, 2, 3, 4	RW

Configures the Analog input 1 signal source scaling.
 0 = 0-100%/0-20mA/0-10V - 0-100% is equal to 0 to 10V, 0-20mA.
 1 = 20-100%/4-20mA/2-10V - 20-100% is equal to 2 to 10V, 4-20mA.
 2 = "Customized," see parameter Para ID 176 and 177, this defines the customized signal range.

Figure 46. Analog input AI scaling

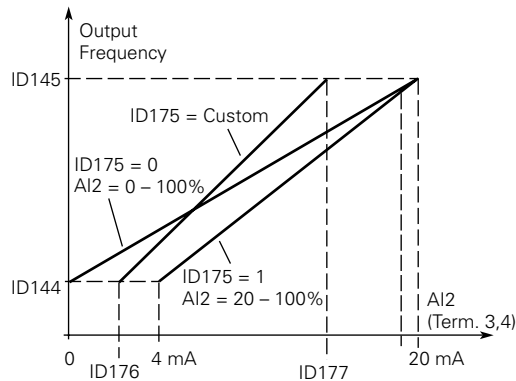

P2.2.3	176	AI1 Custom Min	1,2,3,4	RW
--------	-----	-----------------------	---------	----

Defines the custom minimum range of the analog input scale when the signal range is set for custom.
 AI1 Custom Min ≤ AI1 Custom Max.

P2.2.4	177	AI1 Custom Max	1,2,3,4	RW
--------	-----	-----------------------	---------	----

Defines the custom maximum range of the analog input scale when the signal range is set for custom.
 AI1 Custom Min ≤ AI1 Custom Max.

P2.2.5	174	AI1 filter time	1, 2, 3, 4	RW
--------	-----	------------------------	------------	----

When this parameter is given a value greater than 0, the function that filters out disturbances from the incoming analog signal is activated.

A long filtering time makes the regulation response slower.

Figure 47. AI1 signal filtering

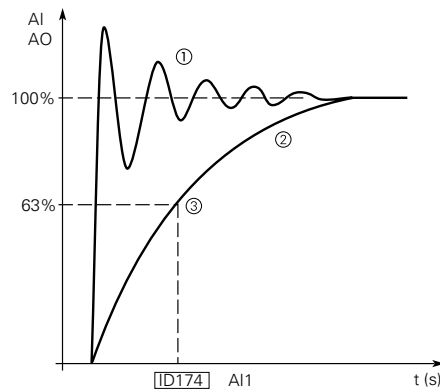

- Notes:**
- ① Analog signal with faults (unfiltered).
 - ② Filtered analog signal.
 - ③ Filter time constant at 63% of the set value.

Code	Modbus ID	Parameter	Application	RO/RW
P2.2.6	181	AI1 signal invert	1, 2, 3, 4	RW

This parameter is used to invert the logic of the analog input.
 0 No Inversion = no inversion of analog Vin signal takes place. 0V/0(4)mA = min frequency, 10V/20mA = max frequency
 1 Inverted = inversion of analog signal takes place. 0V/0(4)mA = max frequency, 10V/20mA = min frequency.

Figure 48. AI1 No signal inversion

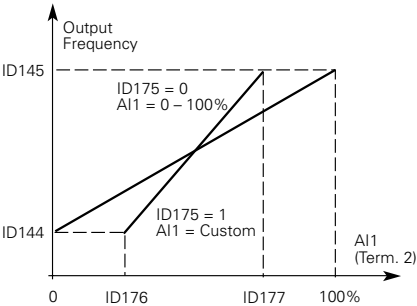
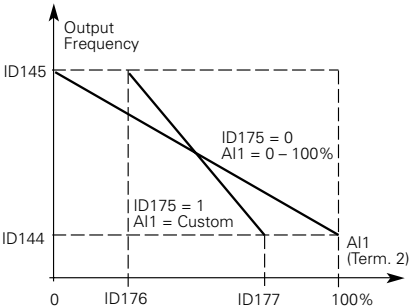

Figure 49. AI1 Signal Inversion



Maximum AI1 signal = minimum set speed.
 Minimum AI1 signal = maximum set speed.

Appendix A—Description of parameters

Code	Modbus ID	Parameter	Application	RO/RW
P2.2.7	178	A11 joystick hyst	1, 2, 3, 4	RW

This parameter is used to set the analog joystick control hysteresis around the 0 speed reference. To ignore values around the 0 speed reference, set the value greater than 0%, this will cause a +/- dead band around the low analog reference. With an analog signal at 0 +/- this value the reference will stay at 0 Hz or min speed.

Figure 50. Example of joystick hysteresis

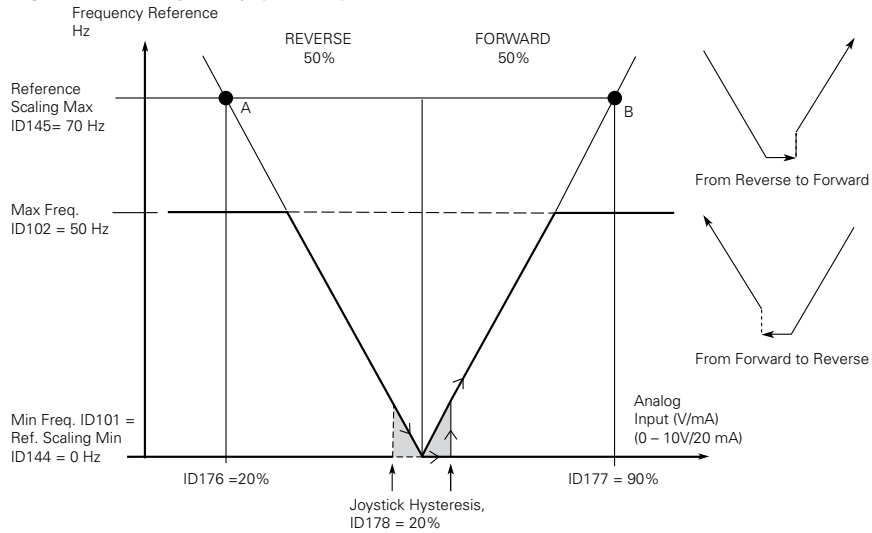

Code	Modbus ID	Parameter	Application	RO/RW
------	-----------	-----------	-------------	-------

P2.2..8	179	A11 Sleep Limit This parameter defines the sleep frequency level in the joystick control mode. The output of the drive turns off if the joystick reference stays below the sleep limit for longer than the sleep delay time parameter Para ID 180.	1, 2, 3, 4	RW
----------------	------------	--	-------------------	----

Figure 51. Example of sleep limit function

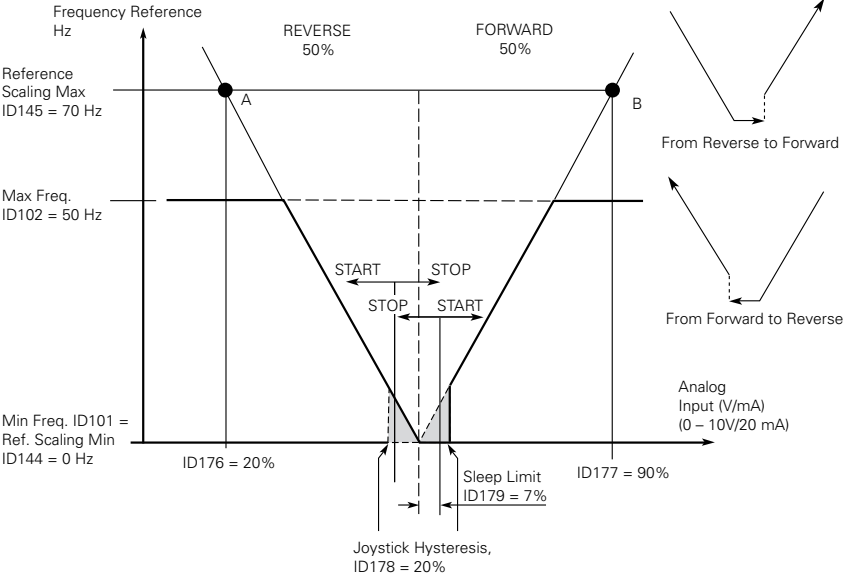

P2.2.9	180	A11 sleep delay This parameter defines the joystick sleep delay time. If the joystick reference is below the sleep limit level for the time defined the output of the drive will shutoff and be in sleep mode. Sleep function is disabled when this value is set to 0.	1, 2, 3, 4	RW
P2.2.10	133	A11 joystick offset This parameter defines the mid point of the analog joystick control. By moving the offset in a positive or negative direction will cause the min frequency crossing point to be move between +/-50% of the analog input scale.	1, 2, 3, 4	RW

Appendix A—Description of parameters

Code	Modbus ID	Parameter	Application	RO/RW
P2.3.1	223	AI2 mode	1, 2, 3, 4	RW

Defines the analog input 2 source mode for current or voltage, also need to set DIP switches on control board SW2 and 3.

0 = 0-20mA - current loop with an external supply the ground jumper is not required.

Figure 52. AI2 2wire-current

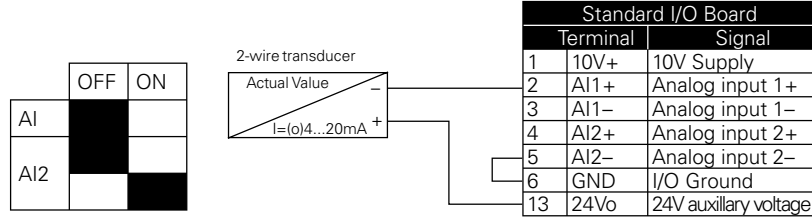

Figure 53. AI2 3wire-current

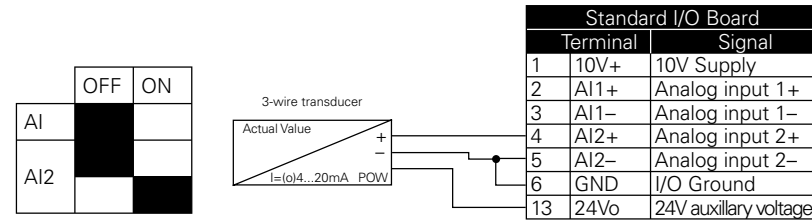
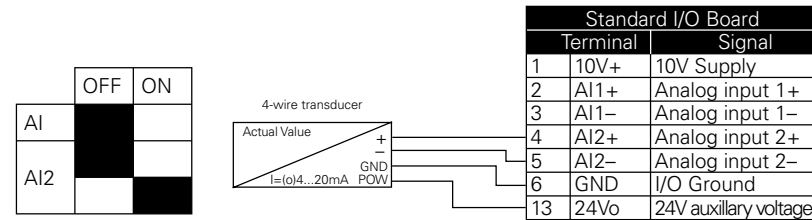
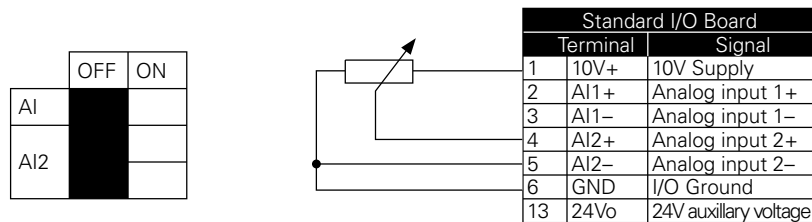

Figure 54. AI2 4wire-current



1 = 0-10V - If using the 10V supply on Terminal 1 of the drive, it will require a ground jumper from Terminal 6 to the AI- input terminal 3.

Figure 55. AI2 pot ref



Code **Modbus ID** **Parameter** **Application** **RO/RW**

2 = -10V to +10Vdc - Voltage loop with a +10 and a -10 volt differential supply.

Figure 56. AI2 differential voltage

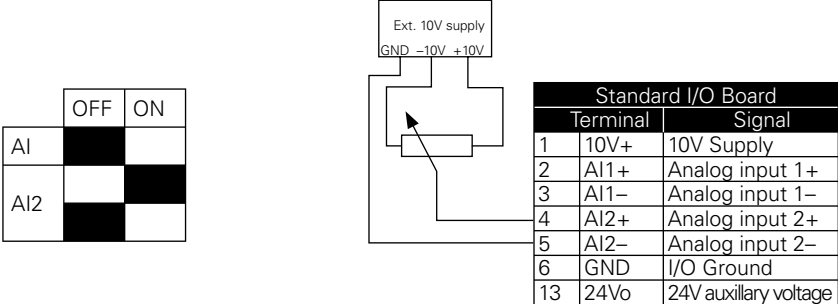

P2.3.2	183	AI2 signal range Configures the Analog input 2 signal source scaling. 0 = 0-100%/0-20mA/0-10V - 0-100% is equal to 0 to 10V, 0-20mA 1 = 20-100%/4-20mA/2-10V - 20-100% is equal to 2 to 10V, 4-20mA. 2 = "Customized," see parameter Para ID 184 and 185, this defines the customized signal range.	1, 2, 3, 4	RW
P2.3.3	184	AI2 custom min Defines the custom min range of the analog input scale when the signal range is set for custom. AI2Custom Min <= AI2 Custom Max.	1, 2, 3, 4	RW
P2.3.4	185	AI2 custom max Defines the custom max range of the analog input scale when the signal range is set for custom. AI2 Custom Min <= AI2 Custom Max.	1, 2, 3, 4	RW
P2.3.5	182	AI2 filter time When this parameter is given a value greater than 0, the function that filters out disturbances from the incoming analog signal is activated. A long filtering time makes the regulation response slower.	1, 2, 3, 4	RW

Figure 57. AI2 Filter time

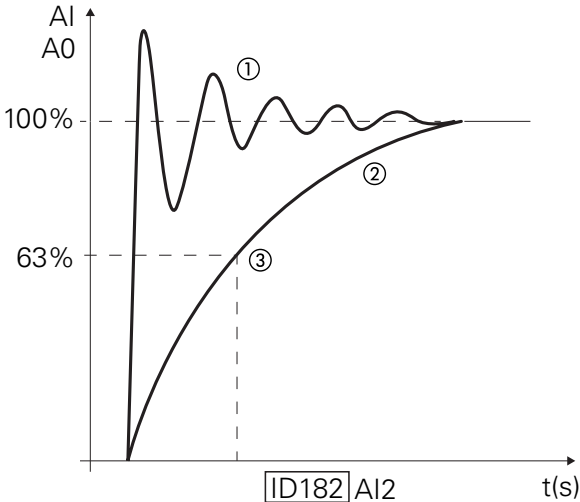

Notes: ① Analog signal with faults (unfiltered)
 ② Filtered analog signal.
 ③ Filter time constant at 63% of the set value.

P2.3.6	189	AI2 signal invert This parameter is used to invert the logic of the analog input. 0 No Inversion = no inversion of analog Vin signal takes place. 0V/0(4)mA = min frequency, 10V/20mA = max frequency 1 Inverted = inversion of analog signal takes place. 0V/0(4)mA = max frequency, 10V/20mA = min frequency.	1, 2, 3, 4	RW
---------------	------------	---	-------------------	----

Appendix A—Description of parameters

Code	Modbus ID	Parameter	Application	RO/RW
------	-----------	-----------	-------------	-------

Figure 58. AI2 No signal inversion

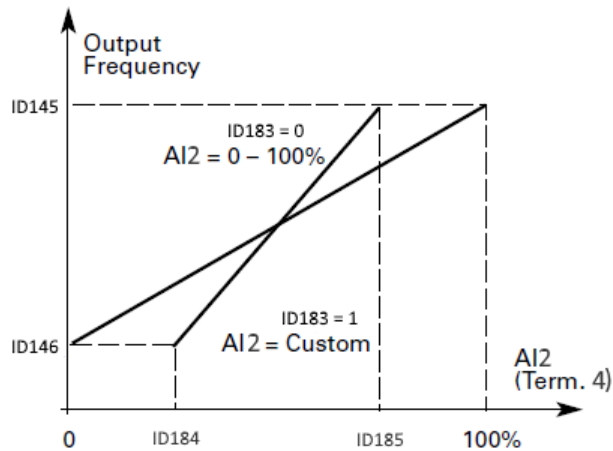
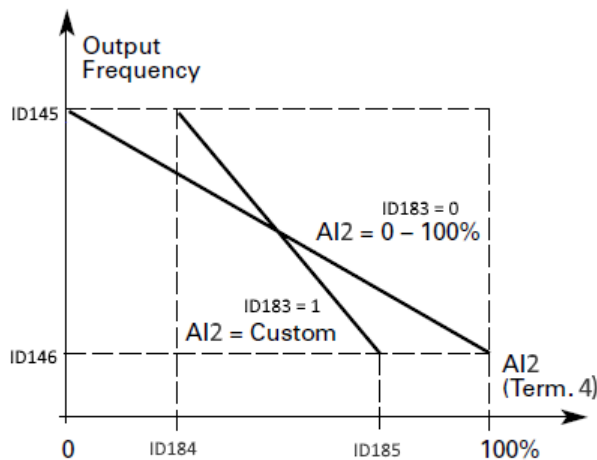

Figure 59. AI2 Signal inversion



Maximum AI2 signal = minimum set speed.

Minimum AI2 signal = maximum set speed.

P2.3.7	186	AI2 joystick hyst	1, 2, 3, 4	RW
--------	-----	-------------------	------------	----

This parameter is used to set the analog joystick control hysteresis around the 0 speed reference. To ignore values around the 0 speed reference, set the value greater than 0%, this will cause a +/- dead band around the low analog reference. With an analog signal at 0+/- this value the reference will stay at 0Hz or min speed.

Code	Modbus ID	Parameter	Application	RO/RW
------	-----------	-----------	-------------	-------

Figure 60. Example of joystick hysteresis

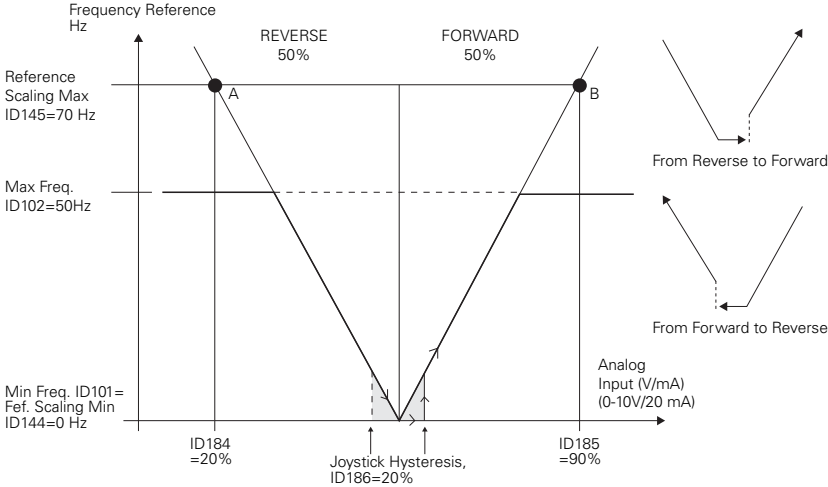

P2.3.8	187	AI2 sleep limit	1, 2, 3, 4	RW
---------------	------------	------------------------	-------------------	-----------

This parameter defines the sleep frequency level in the joystick control mode. The output of the drive turns off if the joystick reference stays below the sleep limit for longer than the sleep delay time parameter Para ID 188.

Figure 61. Example of sleep limit function

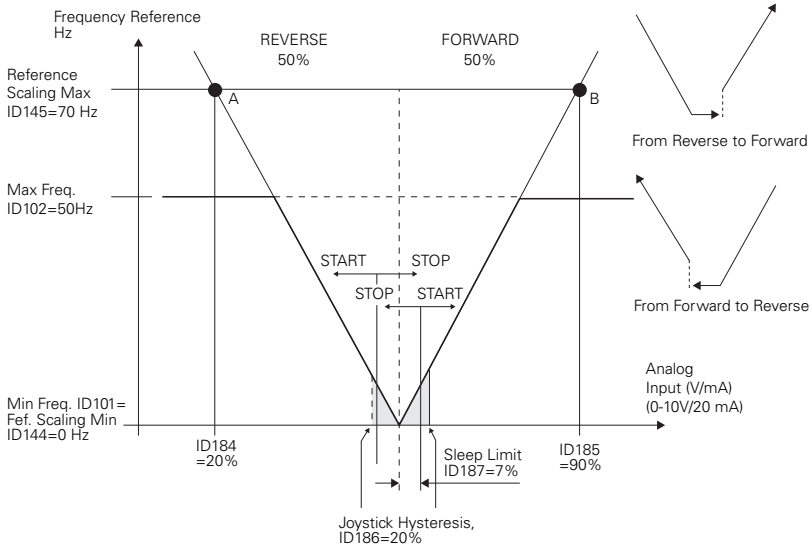

P2.3.9	188	AI2 sleep delay	1, 2, 3, 4	RW
---------------	------------	------------------------	-------------------	-----------

This parameter defines the joystick sleep delay time. If the joystick reference is below the sleep limit level for the time defined the output of the drive will shutoff and be in sleep mode. Sleep function is disabled when this value is set to 0.

P2.3.10	134	AI2 joystick offset	1, 2, 3, 4	RW
----------------	------------	----------------------------	-------------------	-----------

This parameter defines the mid point of the analog joystick control. By moving the offset in a positive or negative direction will cause the min frequency crossing point to be move between +/-50% of the analog input scale.

P2.4.1	2484	Fine Tuning Input	1, 2, 3, 4	RW
---------------	-------------	--------------------------	-------------------	-----------

Selects the Analog input used for Fine adjustment tuning of a referenc signal.
 0 - Not Used
 1 - Analog Input 1
 2 - Analog Input 2
 3 = Slot A: AI1
 4 = Slot A: AI1
 5 = Fieldbus

Appendix A—Description of parameters

Code	Modbus ID	Parameter	Application	RO/RW
P2.4.2	2485	Fine Tuning Min Use this parameter to set the percentage that is subtracted from the main reference when adjust input is at minimum.	1, 2, 3, 4	RW
P2.4.3	2486	Fine Tuning Max Use this parameter to set the percentage that is added from the main reference when adjust input is at maximum.		
P3.1	143	IO Terminal 1 start/stop logic This parameter defines the start and stop of the drive with the digital signals. 0 = Forward - Reverse - Modbus ID 190: DI closed contact = start forward Para ID 191: DI closed contact = start reverse - This would be considered 2 wire control with either a contact used on the Start FWD or Start REV commands. Contacts Open the motor stops.		

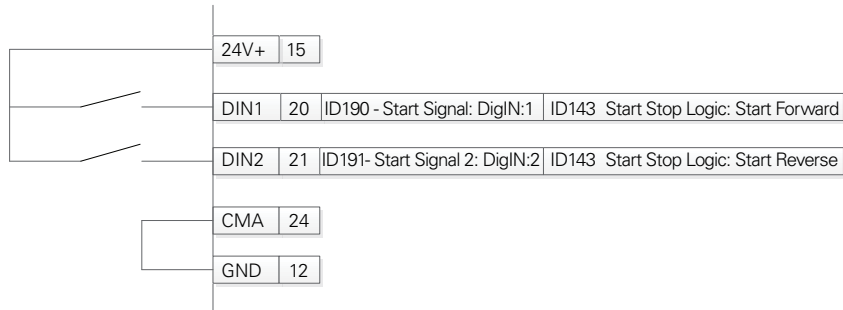
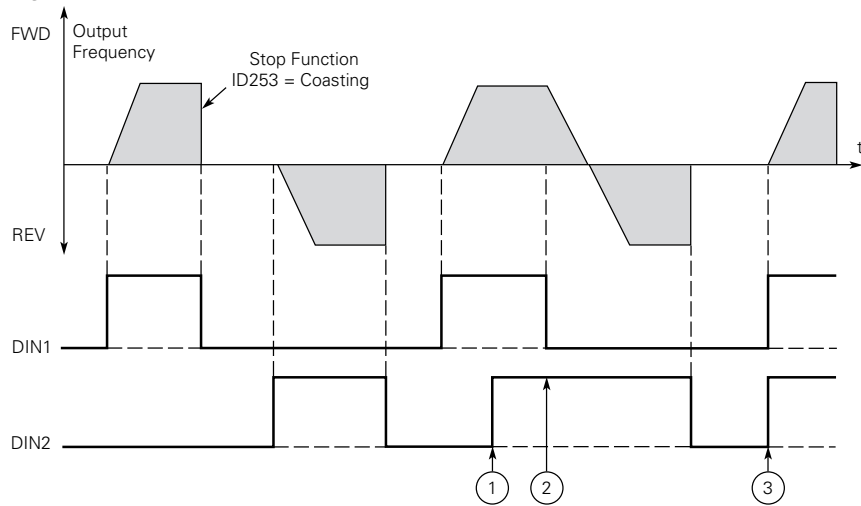

Figure 62. Start forward/start reverse



- Notes:**
- ① The first selected direction has the highest priority.
 - ② When the DIN1 contact opens the direction of rotation starts to change.
 - ③ If Start forward (DIN1) and Start reverse (DIN2) signals are active simultaneously the Start forward signal (DIN1) has priority.

Code	Modbus ID	Parameter	Application	RO/RW
		1 = Start - Reverse - Modbus ID 190: DI closed contact = start /open contact = stop Para ID 191: DI closed contact = reverse / open contact = forward - This would be considered 2 wire control with a contact on start/stop, contact open it stops and direction on 2nd start signal.	1, 2, 3, 4	RW

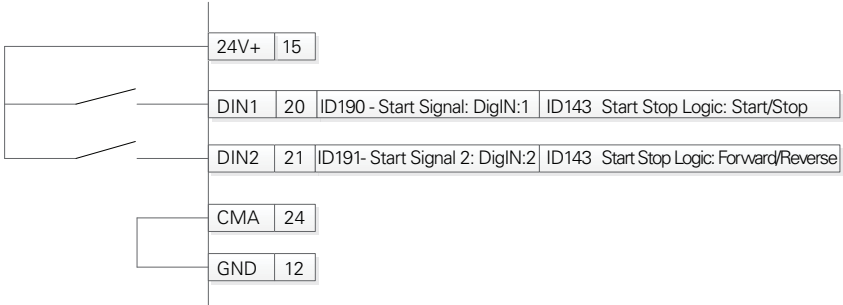
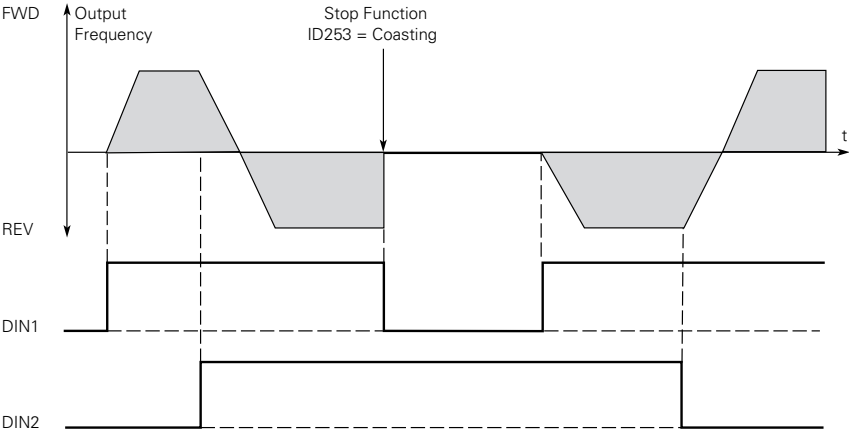
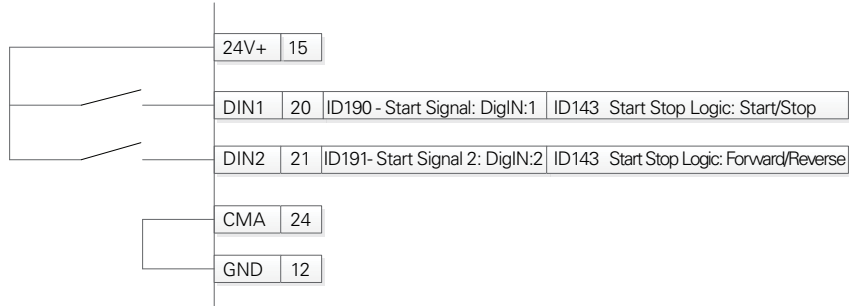

Figure 63. Start, stop and reverse



Appendix A—Description of parameters

Code	Modbus ID	Parameter	Application	RO/RW
P3.1	143	2 = Start - Enable - Para ID 190: DI closed contact = start / open contact = stop Para ID 191: DI closed contact = start enabled / open contact = start disabled and drive stopped if running Motor direction keeps forward - This would be considered 3 wire control with Start signal 2 required to be closed to enable Start on Start signal 1.	1, 2, 3, 4	RW



3 = Three-wire connection (pulse control): Para ID 190: DI changes from open to closed = start pulse
 Para ID 191: DI changes from closed to open = stop pulse Para ID 198: DI closed contact = reverse/ open contact = forward - This would be considered 3 wire control with Start Signal 1 being the Start Pulse and Start Signal 2 being the NC Stop.

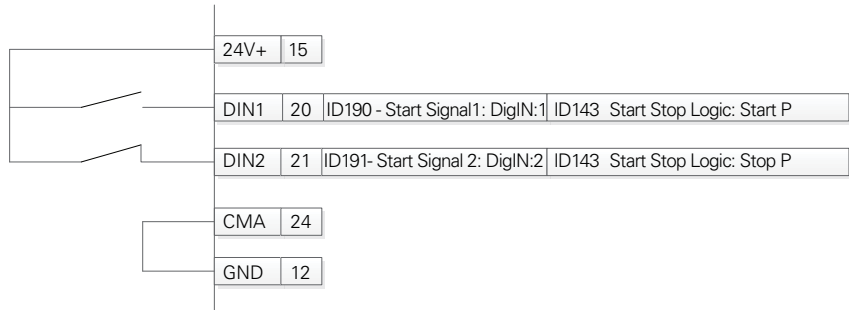
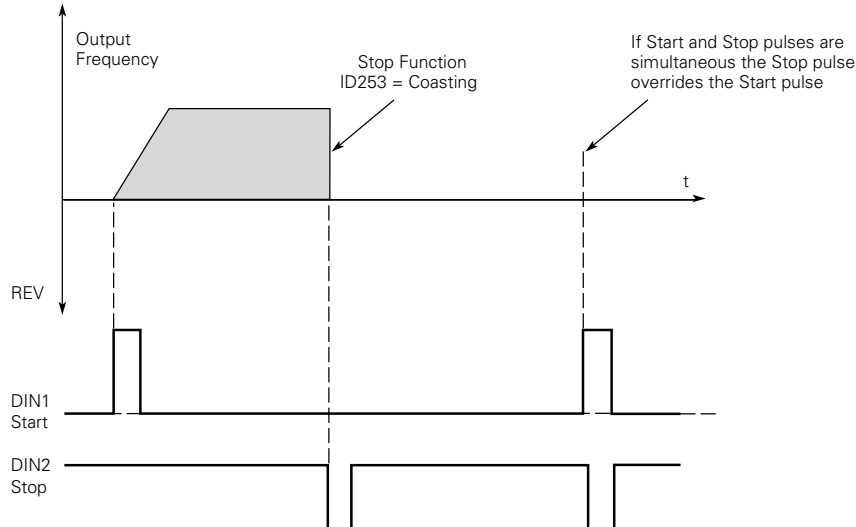

Figure 64. Start pulse/stop pulse



Code	Modbus ID	Parameter	Application	RO/RW
P3.2	190	IO Terminal 1 Start Signal 1 Signal selection 1 for the start/stop logic listed in parameter Para ID 143. This parameter would correspond to the function listed for DIN1. When the parameter is set to DigiN: 1 it references DIN1 on the control board, selecting different DIGIN values will assign it to a different input on the control board or option card. When set to Normally Open this function would be always tied low or 0 when using I/O terminal 1 as the control place. When value is set to Normally Closed this will cause the function to be always on and activate the output if I/O Terminal 1 is the current control place. Can be set to DigiN:X indicates on board terminal inputs, DigiN:A:IOX:X indicates optional board inputs in A slot, DigiN:B:IOX:X indicates optional board inputs in B slot, or Timer Channel X	1, 2, 3, 4	RW
P3.3	191	IO Terminal 1 Start Signal 2 Signal selection 2 for the start/stop logic listed in parameter Para ID 143. This parameter would correspond to the function listed for DIN2. When the parameter is set to DigiN: 2 it references DIN2 on the control board, selecting different DIGIN values will assign it to a different input on the control board or option card. When set to Normally Open this function would be always tied low or 0 when using I/O terminal 1 as the control place. When value is set to Normally Closed this will cause the function to be always on and activate the output if I/O Terminal 1 is the current control place. Can be set to DigiN:X indicates on board terminal inputs, DigiN:A:IOX:X indicates optional board inputs in A slot, DigiN:B:IOX:X indicates optional board inputs in B slot, or Timer Channel X	1, 2, 3, 4	RW
P3.4	881	Thermistor input sel This parameter defines DIN7, and DIN8 is digital input or thermistor input. When this parameter is enabled it switches DIN7 and DIN8 to a thermistor input that triggers at 4.7k ohm.	1, 2, 3, 4	RW
P3.5	198	Reverse Use this parameter for switching the direction of the motor to reverse when using 3 wire start/stop logic parameter in Para ID 143 = 3. Can be set to DigiN:X indicates on board terminal inputs, DigiN:A:IOX:X indicates optional board inputs in A slot, DigiN:B:IOX:X indicates optional board inputs in B slot, or Timer Channel X Contact Open = Forward direction. Contact Close = Reverse direction.	1, 2, 3, 4	RW
P3.6	192	Ext. Fault 1 NO Use this parameter for setting external input causing drive to fault. This function is defined as NO so the function activates on a closed contact. If this function is assigned to Normally Open - the function is always off so the drive will not fault, when set to Normally Closed the function will be active and fault all the time. The additional settings allow assigning them to an input to control the function. Different Settings DigiN:X indicates on board terminal inputs, DigiN:A:IOX:X indicates optional board inputs in A slot, DigiN:B:IOX:X indicates optional board inputs in B slot, or Timer Channel X. The description on the fault can be changed in parameter Para ID 2297. RO X Function allows for having an input turn on without having to hard wire it to the physical relay output. Closed contact = external fault. Open contact = no external fault.	1, 2, 3, 4	RW
P3.7	193	Ext. Fault 1 NC Use this parameter for setting external input causing drive to fault. This function is defined as NC so the function activates on a open contact. If this function is assigned to Normally Closed - the function is always on so the drive will not fault, when set to Normally Open the function will be active and fault all the time. The additional settings allow assigning them to an input to control the function. Different Settings DigiN:X indicates on board terminal inputs, DigiN:A:IOX:X indicates optional board inputs in A slot, DigiN:B:IOX:X indicates optional board inputs in B slot, or Timer Channel X. The description on the fault can be changed in parameter Para ID 2297. RO X Function allows for having an input turn on without having to hard wire it to the physical relay output. Closed contact = no external fault. Open contact = external fault.	1, 2, 3, 4	RW
P3.8	200	Fault Reset Use this parameter for setting external fault reset input. This function is looking for a rising edge to reset a fault. If this function is set for Normally Open, the drive will not do a reset via the control terminals. When set for Normally Closed, the fault condition will always be trying to reset on the rising edge. When it is tied to an input on the control board or option card the function would be set to DIGIN: and the input desired. Can be set to DigiN:X indicates on board terminal inputs, DigiN:A:IOX:X indicates optional board inputs in A slot, DigiN:B:IOX:X indicates optional board inputs in B slot, or Timer Channel X. RO X Function allows for having an input turn on without having to hard wire it to the physical relay output. DI change from open contact to closed contact: reset fault.	1, 2, 3, 4	RW

Appendix A—Description of parameters

Code	Modbus ID	Parameter	Application	RO/RW
P3.9	194	<p>Run Enable</p> <p>Use this parameter for setting external safety start input that is required along with start command for frequency converter to turn on output. When using this command if the function is set for Normally Open, the drive will see this as a open input and not allow the drive to run due to no Ready. The default state being Normally Closed indicates that the drive is in a Ready condition and will accept the start command. When assigned to one of the DIGIN or Time channels it requires the input to be high to activate output. Can be set to DigilN:X indicates on board terminal inputs, DigilN:A:IOX:X indicates optional board inputs in A slot, DigilN:B:IOX:X indicates optional board inputs in B slot, or Timer Channel X. RO X Function allows for having an input turn on without having to hard wire it to the physical relay output.</p> <p>Closed contact = Start of motor enabled Open contact = Start of motor disabled</p>	1, 2, 3, 4	RW
P3.10	205	<p>Preset speed B0</p> <p>Use this parameter selecting the of the digital input for an external speed setpoint desired. Validating 3 digital inputs will allow for 7 preset speeds to be obtained. When switching between inputs it will follow the acceleration and deceleration time. When all the inputs are set to Normally Open none of the preset speeds will be enabled and the output will follow the control place reference command. If the function is set for Normally Closed the drive will follow the preset speed assigned to the inputs enabled. When assigned to one of the DIGIN on the control board or an installed option card it is looking for a high input to enable that preset. Can be set to DigilN:X indicates on board terminal inputs, DigilN:A:IOX:X indicates optional board inputs in A slot, DigilN:B:IOX:X indicates optional board inputs in B slot, or Timer Channel X. RO X Function allows for having an input turn on without having to hard wire it to the physical relay output.</p>	1, 2, 3, 4	RW
P3.11	206	<p>Preset speed B1</p> <p>Use this parameter selecting the of the digital input for an external speed setpoint desired. Validating 3 digital inputs will allow for 7 preset speeds to be obtained. When switching between inputs it will follow the acceleration and deceleration time. When all the inputs are set to Normally Open none of the preset speeds will be enabled and the output will follow the control place reference command. If the function is set for Normally Closed the drive will follow the preset speed assigned to the inputs enabled. When assigned to one of the DIGIN on the control board or an installed option card it is looking for a high input to enable that preset. Can be set to DigilN:X indicates on board terminal inputs, DigilN:A:IOX:X indicates optional board inputs in A slot, DigilN:B:IOX:X indicates optional board inputs in B slot, or Timer Channel X. RO X Function allows for having an input turn on without having to hard wire it to the physical relay output.</p>	1, 2, 3, 4	RW

Code	Modbus ID	Parameter	Application	RO/RW
------	-----------	-----------	-------------	-------

P3.12 207 Preset Speed B2 1, 2, 3, 4 RW

Use this parameter selecting the of the digital input for an external speed setpoint desired. Validating 3 digital inputs will allow for 7 preset speeds to be obtained. When switching between inputs it will follow the acceleration and deceleration time. When all the inputs are set to Normally Open none of the preset speeds will be enabled and the output will follow the control place reference command. If the function is set for Normally Closed the drive will follow the preset speed assigned to the inputs enabled. When assigned to one of the DIGIN on the control board or an installed option card it is looking for a high input to enable that preset. Can be set to DigilN:X indicates on board terminal inputs, DigilN:A:IOX:X indicates optional board inputs in A slot, DigilN:B:IOX:X indicates optional board inputs in B slot, or Timer Channel X. RO X Function allows for having an input turn on without having to hard wire it to the physical relay output.

Figure 65. Activation of fixed frequencies

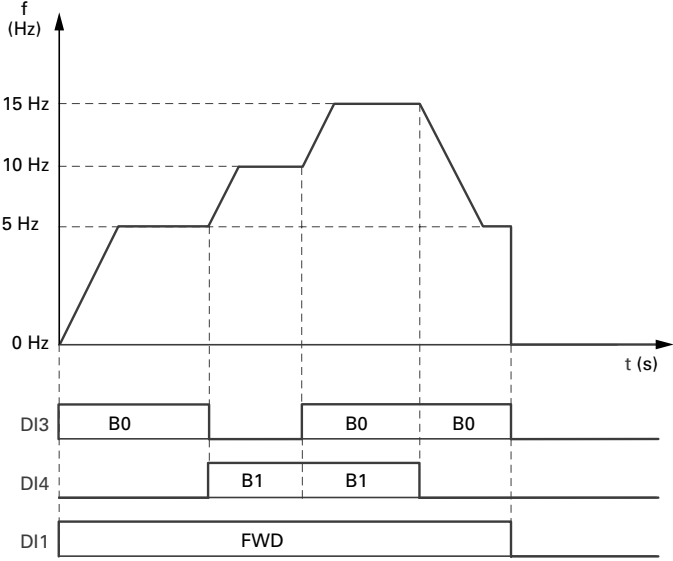

Fixed frequency

Input (Binary)			Fixed frequency
B0	B1	B2	(Factory setting)
X	—	—	Preset Speed 1, ID105 = 5 Hz
—	X	—	Preset Speed 2, ID106 = 10 Hz
X	X	—	Preset Speed 3, ID118 = 15 Hz
—	—	X	Preset Speed 4, ID119 = 20 Hz
X	—	X	Preset Speed 5, ID120 = 25 Hz
—	X	X	Preset Speed 6, ID121 = 30 Hz
X	X	X	Preset Speed 7, ID122 = 35 Hz

Note: When inputs are all 0 drive will follow control place reference command.

Code	Modbus ID	Parameter	Application	RO/RW
------	-----------	-----------	-------------	-------

P3.13 550 PID1 Control Enable 2, 3, 4 RW

Use this parameter for selecting the digital input for turn on or off the PID1 controller. If the input is not enabled when starting the drive with PID1 Controller set as the reference the drive output will not start. Can be set to DigilN:X indicates on board terminal inputs, DigilN:A:IOX:X indicates optional board inputs in A slot, DigilN:B:IOX:X indicates optional board inputs in B slot, or Timer Channel X. RO X Function allows for having an input turn on without having to hard wire it to the physical relay output.

Contact Close: Enables PID 1 control mode.

Code	Modbus ID	Parameter	Application	RO/RW
------	-----------	-----------	-------------	-------

P3.14 553 PID2 Control Enable 3, 4 RW

Use this parameter for selecting the digital input for turn on or off the PID2 controller. If the input is not enabled when starting the drive with PID1 Controller set as the reference the drive output will not start. Can be set to DigilN:X indicates on board terminal inputs, DigilN:A:IOX:X indicates optional board inputs in A slot, DigilN:B:IOX:X indicates optional board inputs in B slot, or Timer Channel X. RO X Function allows for having an input turn on without having to hard wire it to the physical relay output.

Contact Close: Enables PID 2 control mode.

Appendix A—Description of parameters

Code	Modbus ID	Parameter	Application	RO/RW
P3.15	195	<p>Accel/decel time set</p> <p>Use this parameter for selecting the external digital input used to select between accel/decel time 1 and accel/decel time 2. When this function is set for Normally Open the Accel/Decel time set will follow time 1 always, when set for Normally Closed it will follow the 2nd Accel/Decel time always. Assigning it to an input will allow for the input to control this. Can be set to DigiIN:X indicates on board terminal inputs, DigiIN:A:IOX:X indicates optional board inputs in A slot, DigiIN:B:IOX:X indicates optional board inputs in B slot, or Timer Channel X. RO X Function allows for having an input turn on without having to hard wire it to the physical relay output.</p> <p>Closed contact = 2nd set of acc/dec time applied. Open contact = 1st set of acc/dec time applied.</p>	1, 2, 3, 4	RW
P3.16	201	<p>Accel/decel prohibit</p> <p>Use this parameter for selecting an external input used to disables the ability to change speed, even if the reference signal changes if this input is enabled the output stays at the value it was at before the input was enabled. When this functions is set for Normally Open the Accel/Decel will be allowed via the desired control source, when is set for Normally Closed the drive will prohibit changing of speed from any control source. Can be set to DigiIN:X indicates on board terminal inputs, DigiIN:A:IOX:X indicates optional board inputs in A slot, DigiIN:B:IOX:X indicates optional board inputs in B slot, or Timer Channel X. RO X Function allows for having an input turn on without having to hard wire it to the physical relay output.</p> <p>Closed contact: drive output frequency cannot rise or fall, it keeps on current output.</p>	1, 2, 3, 4	RW
P3.17	215	<p>No access to param</p> <p>Use this parameter selecting an external input for locking out the ability to change parameters when this input is enabled, this can be used with the password protection. When this function is set for Normally Open it will allow for changing of parameters, if it is set for Normally Closed it prevents any changes to parameters. If a input is desired to control this DIGIN X can be used. Can be set to DigiIN:X indicates on board terminal inputs, DigiIN:A:IOX:X indicates optional board inputs in A slot, DigiIN:B:IOX:X indicates optional board inputs in B slot, or Timer Channel X. RO X Function allows for having an input turn on without having to hard wire it to the physical relay output.</p> <p>Closed contact: all writable parameters cannot be edited.</p>	1, 2, 3, 4	RW
P3.18	203	<p>Accel pot value</p> <p>Use this parameter selecting an external input for use when Motor Potentiometer is set for a reference, when this input is enabled it will increase reference value till contact opens. When this function is set for Normally Open it will not cause the Motor Pot reference to increase, when this is set for Normally Closed it will cause the Motor pot reference to increase till it reaches max frequency. Can be set to DigiIN:X indicates on board terminal inputs, DigiIN:A:IOX:X indicates optional board inputs in A slot, DigiIN:B:IOX:X indicates optional board inputs in B slot, or Timer Channel X. RO X Function allows for having an input turn on without having to hard wire it to the physical relay output.</p> <p>Closed contact: Potentiometer value keeps on rising.</p>	4	RW
P3.19	204	<p>Decel pot value</p> <p>Use this parameter selecting an external input for use when Motor Potentiometer is set for a reference, when this input is enabled it decrease reference value till contact opens. When this function is set for Normally Open it will not cause the Motor Pot reference to decrease, when this is set for Normally Closed it will cause the Motor pot reference to decrease till the min frequency is reached. Can be set to DigiIN:X indicates on board terminal inputs, DigiIN:A:IOX:X indicates optional board inputs in A slot, DigiIN:B:IOX:X indicates optional board inputs in B slot, or Timer Channel X. RO X Function allows for having an input turn on without having to hard wire it to the physical relay output.</p> <p>Closed contact: Potentiometer value keeps on falling.</p>	4	RW
P3.20	216	<p>Reset pot zero</p> <p>Use this parameter selecting an external input for use for setting Motor Potentiometer reference value to zero when using the Motor Potentiometer as a Reference signal when contact closes. When this is set for Normally Open it will not cause the Motor Pot reference to not reset to 0 speed, when this is set for Normally Closed it will cause the Motor pot reference to reset to 0 speed and stay there till the opens. Can be set to DigiIN:X indicates on board terminal inputs, DigiIN:A:IOX:X indicates optional board inputs in A slot, DigiIN:B:IOX:X indicates optional board inputs in B slot, or Timer Channel X. RO X Function allows for having an input turn on without having to hard wire it to the physical relay output.</p> <p>Closed contact: Potentiometer value reset to zero.</p>	4	RW
P3.21	196	<p>Remote control</p> <p>Use this parameter selecting an external input for use when desiring to use the remote control location. When this function is set for Normally Open the drive will not go into the remote control unless the keypad input is pressed. When set for Normally Closed the drive will always be in the remote location no matter the keypad loc/rem is pressed. Can be set to DigiIN:X indicates on board terminal inputs, DigiIN:A:IOX:X indicates optional board inputs in A slot, DigiIN:B:IOX:X indicates optional board inputs in B slot, or Timer Channel X. RO X Function allows for having an input turn on without having to hard wire it to the physical relay output.</p> <p>Closed Contact: force to remote control.</p>	1, 2, 3, 4	RW

Code	Modbus ID	Parameter	Application	RO/RW
P3.22	197	<p>Local control</p> <p>Use this parameter selecting an external input for use when desiring to use the local control location. When this function is set for Normally Open the drive will not go into the local control place unless the keypad Loc/Rem button is used. When it is set for Normally Closed it will always be in the local control location no matter if the keypad loc/rem button is pressed. Can be set to DigilN:X indicates on board terminal inputs, DigilN:A:IOX:X indicates optional board inputs in A slot, DigilN:B:IOX:X indicates optional board inputs in B slot, or Timer Channel X. RO X Function allows for having an input turn on without having to hard wire it to the physical relay output.</p> <p>Closed contact: force to local control.</p>	1, 2, 3, 4	RW
P3.23	209	<p>Remote1/2 select</p> <p>Use this parameter selecting an external input for use when desiring to use the remote2 control location. This switches control and reference locations. When this function is set for Normally Open the drive will not go into the Remote 2 control place and will stay in Remote 1. When it is set for Normally Closed the drive will always be in the Remote 2 Control Place. When a DIGIN is used it will allow cycling between the 2 based off high/low state. Can be set to DigilN:X indicates on board terminal inputs, DigilN:A:IOX:X indicates optional board inputs in A slot, DigilN:B:IOX:X indicates optional board inputs in B slot, or Timer Channel X. RO X Function allows for having an input turn on without having to hard wire it to the physical relay output.</p> <p>Closed contact: remote2 is selected as control source.</p> <p>Open contact: remote1 is selected as control.</p>	1, 2, 3, 4	RW
P3.24	217	<p>Second motor para select</p> <p>Use this parameter selecting an external input for use of switching between motor parameter set 1(P1 Group) and set 2 (P16 Group). When this function is set for Normally pen the drive will follow the first set of motor parameters and when the input is set for Normally Closed it will used the Second Motor Parameter set. If an input is used the function will follow the logic of the input being high/low. Can be set to DigilN:X indicates on board terminal inputs, DigilN:A:IOX:X indicates optional board inputs in A slot, DigilN:B:IOX:X indicates optional board inputs in B slot, or Timer Channel X. RO X Function allows for having an input turn on without having to hard wire it to the physical relay output.</p> <p>Closed contact: the 2nd motor parameters is applied.</p>	2, 3, 4	RW
P3.25	218	<p>Bypass start</p> <p>Use this parameter for selecting an external input for switching between bypass and drive modes. When this input is enabled the Bypass output contactor is enabled, when disabled this relay opens and puts drive in normal mode. When the input is enabled on the rising edge the bypass output contactor function is enabled in the output functions on the drive. When this fault is set for Normally Open/Normally Closed the drive will not activate the bypass relay output function due to the drive looking for a rising edge trigger. Can be set to DigilN:X indicates on board terminal inputs, DigilN:A:IOX:X indicates optional board inputs in A slot, DigilN:B:IOX:X indicates optional board inputs in B slot, or Timer Channel X. RO X Function allows for having an input turn on without having to hard wire it to the physical relay output.</p> <p>Closed contact: switch to bypass.</p> <p>Open contact: switch to drive.</p>	2, 3, 4	RW
P3.26	202	<p>DC brake enable</p> <p>Use this parameter for selecting an external input for enabling DC brake on a closed contact. When enabled this will cause the drive inject DC voltage into the motor to assist in bring it to a stop. When this function is set for Normally Open the drive will not activate the DC brake function. When Normally Closed is used the drive will always have the DC brake function activated. Can be set to DigilN:X indicates on board terminal inputs, DigilN:A:IOX:X indicates optional board inputs in A slot, DigilN:B:IOX:X indicates optional board inputs in B slot, or Timer Channel X. RO X Function allows for having an input turn on without having to hard wire it to the physical relay output.</p> <p>Closed contact: DC brake function is enable.</p>	1, 2, 3, 4	RW
P3.27	219	<p>Smoke mode</p> <p>Use this parameter for selecting an external input for enabling the smoke purge preset speed to be enabled. When this function is set for Normally Open the drive will not activate the Smoke Mode frequency. When Normally Closed is used the drive will always run at the Smoke Purge Frequency. Can be set to DigilN:X indicates on board terminal inputs, DigilN:A:IOX:X indicates optional board inputs in A slot, DigilN:B:IOX:X indicates optional board inputs in B slot, or Timer Channel X. RO X Function allows for having an input turn on without having to hard wire it to the physical relay output.</p> <p>Closed contact: drive is in smoke purge mode.</p>	2, 3, 4	RW

Appendix A—Description of parameters

Code	Modbus ID	Parameter	Application	RO/RW
P3.28	220	<p>Fire mode</p> <p>Use this parameter for selecting an external input for enabling the drive fire mode feature where faults will be ignored and preset speeds are given for reference commands to the drive, the reference are selectable in the P15 Group. When this function is set for Normally Open or Normally Closed it will depend on the setting in the Fire Mode parameter group, if the function activates on an open contact and this is set for Normally Open it will always be in the Fire Mode, if Normally Closed is used then the function will always be off. Vice versa will occur if Fire Mode is active on an Closed contact. Can be set to DigiIN:X indicates on board terminal inputs, DigiIN:A:IOX:X indicates optional board inputs in A slot, DigiIN:B:IOX:X indicates optional board inputs in B slot, or Timer Channel X. RO X Function allows for having an input turn on without having to hard wire it to the physical relay output.</p> <p>Closed contact: drive is in fire mode. Ignores all the faults.</p> <p>Note: when Fire mode is enabled, this causes the drive to ignore all faults except hardware overcurrent, STO, saturation fault. Warranty will be non valid in the case this is enabled and the drive causes issues to the system.</p>	2, 3, 4	RW
P3.29	221	<p>Fire mode ref select</p> <p>Use this parameter for selecting an external input for switching between fire mode speed reference 1 and reference 2 which is set via P15.4 and P15.5. When this function is set for Normally Open and the drive is in Fire Mode it will follow Fire Mode Ref 1, if the function is set for Normally Closed it will follow Fire Mode Ref 2. Can be set to DigiIN:X indicates on board terminal inputs, DigiIN:A:IOX:X indicates optional board inputs in A slot, DigiIN:B:IOX:X indicates optional board inputs in B slot, or Timer Channel X. RO X Function allows for having an input turn on without having to hard wire it to the physical relay output.</p> <p>Closed contact: drive output reference frequency selection 2</p>	2, 3, 4	RW
P3.30	351	<p>PID1 set point sel</p> <p>Use this parameter for selecting an external input for selecting between Set point 1 and Set point 2 when in the PID control mode, depending on the PID Controller you are using this will all for multiple set points. When this function is set for Normally Open and the drive is in PID mode, it will use the first PID Set Point Reference. When the function is set for Normally Close the 1st PID Set Point will be active. Can be set to DigiIN:X indicates on board terminal inputs, DigiIN:A:IOX:X indicates optional board inputs in A slot, DigiIN:B:IOX:X indicates optional board inputs in B slot, or Timer Channel X. RO X Function allows for having an input turn on without having to hard wire it to the physical relay output.</p> <p>Closed contact: setpoint2 is selected for PID1. Open contact:setpoint1 is selected for PID1.</p>	2, 3, 4	RW
P3.31	352	<p>PID2 set point sel</p> <p>Use this parameter for selecting an external input for selecting between Set point 1 and Set point 2 when in the PID control mode, depending on the PID Controller you are using this will all for multiple set points. When this function is set for Normally Open and the drive is in PID mode, it will use the first PID Set Point Reference. When the function is set for Normally Close the 2nd PID Set Point will be active. Can be set to DigiIN:X indicates on board terminal inputs, DigiIN:A:IOX:X indicates optional board inputs in A slot, DigiIN:B:IOX:X indicates optional board inputs in B slot, or Timer Channel X. RO X Function allows for having an input turn on without having to hard wire it to the physical relay output.</p> <p>Closed contact: setpoint2 is selected for PID2. Open contact:setpoint1 is selected for PID2.</p>	3, 4	RW
P3.32	199	<p>Jog enable</p> <p>Use this parameter for selecting an external input for enabling the jog frequency reference and starts the drive to slowly advance the system. When this function is set for Normally Open the drive will not follow the jog enable speed. If the function is set for Normally Close then the output will be activated and run at the Jog Frequency. Can be set to DigiIN:X indicates on board terminal inputs, DigiIN:A:IOX:X indicates optional board inputs in A slot, DigiIN:B:IOX:X indicates optional board inputs in B slot, or Timer Channel X. RO X Function allows for having an input turn on without having to hard wire it to the physical relay output.</p> <p>Closed contact: drive is under jog mode.</p>	1, 2, 3, 4	RW
P3.33	224	<p>Start timer 1</p> <p>Use this parameter for selecting an external input for enabling the timer functions to begin counting. When this function is set for Normally Open the drive will not start the Timer sequence. If the function is set for Normally Close the Timer function will start. When assigned to an input the input active will start the timer. Can be set to DigiIN:X indicates on board terminal inputs, DigiIN:A:IOX:X indicates optional board inputs in A slot, DigiIN:B:IOX:X indicates optional board inputs in B slot, or Timer Channel X. RO X Function allows for having an input turn on without having to hard wire it to the physical relay output.</p> <p>Closed contact: Timer1,Timer2 or Timer3 will be started.</p>	2, 3, 4	RW

Code	Modbus ID	Parameter	Application	RO/RW
P3.34	225	<p>Start timer 2</p> <p>Use this parameter for selecting an external input for enabling the timer functions to begin counting. When this function is set for Normally Open the drive will not start the Timer sequence. If the function is set for Normally Close the Timer function will start. When assigned to an input the input active will start the timer. Can be set to DigiIN:X indicates on board terminal inputs, DigiIN:A:IOX:X indicates optional board inputs in A slot, DigiIN:B:IOX:X indicates optional board inputs in B slot, or Timer Channel X. RO X Function allows for having an input turn on without having to hard wire it to the physical relay output.</p> <p>Closed contact: Timer1,Timer2 or Timer3 will be started.</p>	2, 3, 4	RW
P3.35	226	<p>Start timer 3</p> <p>Use this parameter for selecting an external input for enabling the timer functions to begin counting. When this function is set for Normally Open the drive will not start the Timer sequence. If the function is set for Normally Close the Timer function will start. When assigned to an input the input active will start the timer. Can be set to DigiIN:X indicates on board terminal inputs, DigiIN:A:IOX:X indicates optional board inputs in A slot, DigiIN:B:IOX:X indicates optional board inputs in B slot, or Timer Channel X. RO X Function allows for having an input turn on without having to hard wire it to the physical relay output.</p> <p>Closed contact: Timer1,Timer2 or Timer3 will be started.</p>	2, 3, 4	RW
P3.36	208	<p>AI ref source select</p> <p>Use this parameter for selecting an external input for switching between AI1 and AI2 reference signals that are located on the control board. When this function is set for Normally Open the drive will follow the AI1 input. If the function is set for Normally Close the AI2 input would then be active. Can be set to DigiIN:X indicates on board terminal inputs, DigiIN:A:IOX:X indicates optional board inputs in A slot, DigiIN:B:IOX:X indicates optional board inputs in B slot, or Timer Channel X. RO X Function allows for having an input turn on without having to hard wire it to the physical relay output.</p> <p>Closed contact: AI2 is selected for reference source.</p> <p>Open contact: AI1 is selected for reference source.</p>	1, 2, 3, 4	RW
P3.37	210	<p>Motor interlock 1</p> <p>Use this parameter for selecting an external input for verifying aux motors are connected to allow them to run, if inputs are disabled drive will see this as a motor not connected an skip over the motor in the booster/auto-change sequence. When this function is set for Normally Open the drive will not see a motor interlock enabled when doing multi-pump and fan. If the function is set for Normally Close the drive will initialize that motors are connected to allow running. These are ideally tied to aux contacts on the output contactor to the motor. Can be set to DigiIN:X indicates on board terminal inputs, DigiIN:A:IOX:X indicates optional board inputs in A slot, DigiIN:B:IOX:X indicates optional board inputs in B slot, or Timer Channel X. RO X Function allows for having an input turn on without having to hard wire it to the physical relay output.</p> <p>Closed contact: motor interlock signal activated.</p> <p>Open contact: motor interlock signal inactivated.</p>	2, 3, 4	RW
P3.38	211	<p>Motor interlock 2</p> <p>Use this parameter for selecting an external input for verifying aux motors are connected to allow them to run, if inputs are disabled drive will see this as a motor not connected an skip over the motor in the booster/auto-change sequence. When this function is set for Normally Open the drive will not see a motor interlock enabled when doing multi-pump and fan. If the function is set for Normally Close the drive will initialize that motors are connected to allow running. These are ideally tied to aux contacts on the output contactor to the motor. Can be set to DigiIN:X indicates on board terminal inputs, DigiIN:A:IOX:X indicates optional board inputs in A slot, DigiIN:B:IOX:X indicates optional board inputs in B slot, or Timer Channel X. RO X Function allows for having an input turn on without having to hard wire it to the physical relay output.</p> <p>Closed contact: motor interlock signal activated.</p> <p>Open contact: motor interlock signal inactivated.</p>	2, 3, 4	RW
P3.39	212	<p>Motor interlock 3</p> <p>Use this parameter for selecting an external input for verifying aux motors are connected to allow them to run, if inputs are disabled drive will see this as a motor not connected an skip over the motor in the booster/auto-change sequence. When this function is set for Normally Open the drive will not see a motor interlock enabled when doing multi-pump and fan. If the function is set for Normally Close the drive will initialize that motors are connected to allow running. These are ideally tied to aux contacts on the output contactor to the motor. Can be set to DigiIN:X indicates on board terminal inputs, DigiIN:A:IOX:X indicates optional board inputs in A slot, DigiIN:B:IOX:X indicates optional board inputs in B slot, or Timer Channel X. RO X Function allows for having an input turn on without having to hard wire it to the physical relay output.</p> <p>Closed contact: motor interlock signal activated.</p> <p>Open contact: motor interlock signal inactivated.</p>	2, 3, 4	RW

Appendix A—Description of parameters

Code	Modbus ID	Parameter	Application	RO/RW
P3.40	213	<p>Motor interlock 4</p> <p>Use this parameter for selecting an external input for verifying aux motors are connected to allow them to run, if inputs are disabled drive will see this as a motor not connected and skip over the motor in the booster/auto-change sequence. When this function is set for Normally Open the drive will not see a motor interlock enabled when doing multi-pump and fan. If the function is set for Normally Close the drive will initialize that motors are connected to allow running. These are ideally tied to aux contacts on the output contactor to the motor. Can be set to DigilN:X indicates on board terminal inputs, DigilN:A:IOX:X indicates optional board inputs in A slot, DigilN:B:IOX:X indicates optional board inputs in B slot, or Timer Channel X. RO X Function allows for having an input turn on without having to hard wire it to the physical relay output.</p> <p>Closed contact: motor interlock signal activated. Open contact: motor interlock signal inactivated.</p>	2, 3, 4	RW
P3.41	214	<p>Motor interlock 5</p> <p>Use this parameter for selecting an external input for verifying aux motors are connected to allow them to run, if inputs are disabled drive will see this as a motor not connected and skip over the motor in the booster/auto-change sequence. When this function is set for Normally Open the drive will not see a motor interlock enabled when doing multi-pump and fan. If the function is set for Normally Close the drive will initialize that motors are connected to allow running. These are ideally tied to aux contacts on the output contactor to the motor. When this function is set for Normally Open the drive will not see a motor interlock enabled when doing multi-pump and fan. If the function is set for Normally Close the drive will initialize that motors are connected to allow running. These are ideally tied to aux contacts on the output contactor to the motor. Can be set to DigilN:X indicates on board terminal inputs, DigilN:A:IOX:X indicates optional board inputs in A slot, DigilN:B:IOX:X indicates optional board inputs in B slot, or Timer Channel X. RO X Function allows for having an input turn on without having to hard wire it to the physical relay output.</p> <p>Closed contact: motor interlock signal activated. Open contact: motor interlock signal inactivated.</p>	2, 3, 4	RW
P3.42	747	<p>Emergency stop</p> <p>Use this parameter for selecting an external input for disabling the frequency converter from running the motor. Once this function is open the drive will stop on E-stop fault, when input closes drive will return to run with no reset required. If the function is set for Normally Open it will cause the drive to always have this function active. When set to Normally Closed the function will not be active and allow operation of the drive. Can be set to DigilN:X indicates on board terminal inputs, DigilN:A:IOX:X indicates optional board inputs in A slot, DigilN:B:IOX:X indicates optional board inputs in B slot, or Timer Channel X. RO X Function allows for having an input turn on without having to hard wire it to the physical relay output. This input will automatically reset once the input is closed</p> <p>Contact Open: Disables the ability for the motor to Run Contact Close: Enables the ability for the motor to Run</p>	1, 2, 3, 4	RW
P3.43	1246	<p>BypassOverLoad</p> <p>Function faults frequency converter when using an overload block input. The relay would be fed into this input to fault the drive. When the function is set for Normally Open the drive will not go into the fault state, if it is set for Normally Closed the drive will go into this fault state and stay even if reset is applied. Input needs to be low to allow operation. Different settings: DigilN:X indicates on board terminal inputs, DigilN:A:IOX:X indicates optional board inputs in A slot, DigilN:B:IOX:X indicates optional board inputs in B slot, or Timer Channel X. RO X Function allows for having an input turn on without having to hard wire it to the physical relay output.</p> <p>Closed contact: motor is over load in bypass. Use TTF method to realize the above functions.</p>	2, 3, 4	RW
P3.44	2119	<p>Fire Mode Direction Invert</p> <p>Use this parameter for selecting an external input for enabling the motor to run in reverse when in fire mode input is enabled. when the function is set for Normally Open and not in Fire mode the drive will run as normal, when the function is set for Normally Closed and the Fire Mode input is enabled the motor will spin in the counter clockwise direction. DigilN:X indicates on-board terminal inputs, DigilN:A:IOX:X indicates optional board inputs in A slot and DigilN:B:IOX:X indicates optional board inputs in B slot or Timer Channel X. RO X Function allows for having an input turn on without having to hard wire it to the physical relay output.</p>	2, 3, 4	RW
P3.45	2206	<p>IO Terminal 2 Start Stop Logic</p> <p>For the DI function, we use Terminal programming method to function (TTF), where there is a fixed input or output to define a certain function for.</p>	1, 2, 3, 4	RW

Code	Modbus ID	Parameter	Application	RO/RW
------	-----------	-----------	-------------	-------

0 = Forward-Reverse - Para ID 2207: DI closed contact = start forward Para ID 2208: DI closed contact = start reverse. This would be considered 2 wire control with either a contact used on the Start FWD or Start REV commands. Contacts Open the motor stops.

Figure 66. Start forward/start reverse

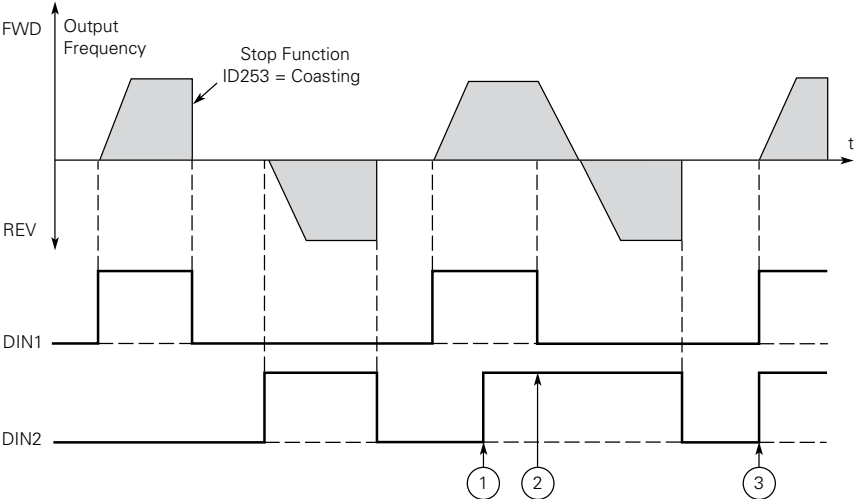

1 = Start-Reverse - Para ID 2207: DI closed contact = start /open contact = stop Para ID 2208: DI closed contact = reverse / open contact = forward - This would be considered 2 wire control with a contact on start/stop, contact open it stops and direction on 2nd start signal.

- NOTES:**
- ① The first selected direction has the highest priority.
 - ② When the DIN1 contact opens the direction of rotation starts to change.
 - ③ If Start forward (DIN1) and Start reverse (DIN2) signals are active simultaneously the Start forward signal (DIN1) has priority.

Figure 67. Start, stop and reverse

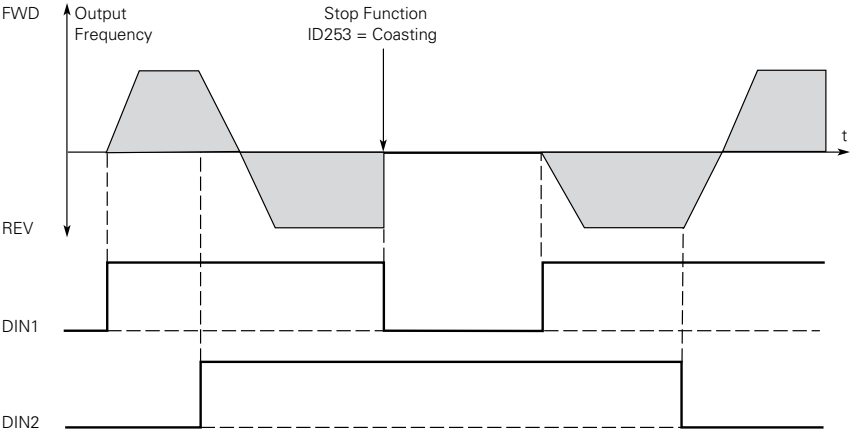

2 = Start-Enable Para ID 2207: DI closed contact = start / open contact = stop Para ID 2208: DI closed contact = start enabled / open contact = start disabled and drive stopped if running Motor direction keeps forward - This would be considered 3 wire control with Start signal 2 required to be closed to enable Start on Start signal 1.

3 = StartP-StopP Three-wire connection (pulse control): Para ID 2207: DI changes from open to closed = start pulse Para ID 2208: DI changes from closed to open = stop pulse Para ID 198: DI closed contact = reverse/ open contact = forward - This would be considered 3 wire control with Start Signal 1 being the Start Pulse and Start Signal 2 being the NC Stop.

Appendix A—Description of parameters

Code	Modbus ID	Parameter	Application	RO/RW
Figure 68. Start pulse/stop pulse				
P3.46	2207	IO Terminal 2 Start Signal 1	1, 2, 3, 4	RW
<p>The 2nd Signal selection 1 for the start/stop logic listed in parameter Para ID 2206. When the parameter is set to DigiIN: 1 it references DIN1 on the control board, selecting different DigiIN values will assign it to a different input on the control board or option card. When set to Normally Open this function would be always tied low or 0 when using I/O terminal 1 as the control place. When value is set to Normally Closed this will cause the function to be always on and activate the output if I/O Terminal 1 is the current control place. Can be set to DigiIN:X indicates on board terminal inputs, DigiIN:A:IOX:X indicates optional board inputs in A slot, DigiIN:B:IOX:X indicates optional board inputs in B slot, or Timer Channel X</p>				
P3.47	2208	IO Terminal 2 Start Signal 2	1, 2, 3, 4	RW
<p>The 2nd Signal selection 2 for the start/stop logic listed in parameter Para ID 2206. When the parameter is set to DigiIN: 2 it references DIN2 on the control board, selecting different DigiIN values will assign it to a different input on the control board or option card. When set to Normally Open this function would be always tied low or 0 when using I/O terminal 1 as the control place. When value is set to Normally Closed this will cause the function to be always on and activate the output if I/O Terminal 1 is the current control place. Can be set to DigiIN:X indicates on board terminal inputs, DigiIN:A:IOX:X indicates optional board inputs in A slot, DigiIN:B:IOX:X indicates optional board inputs in B slot, or Timer Channel X</p>				
P3.48	2293	Ext. Fault 2 NO	1, 2, 3, 4	RW
<p>Use this parameter for setting external input causing drive to fault. This function is defined as NO so the function activates on a closed contact. If this function is assigned to Normally Open - the function is always off so the drive will not fault, when set to Normally Closed the function will be active and fault all the time. The additional settings allow assigning them to an input to control the function. Can be set to DigiIN:X indicates on board terminal inputs, DigiIN:A:IOX:X indicates optional board inputs in A slot, DigiIN:B:IOX:X indicates optional board inputs in B slot, or Timer Channel X. RO X Function allows for having an input turn on without having to hard wire it to the physical relay output. The description on the fault can be changed in parameter Para ID 2298.</p> <p>Closed contact = external fault. Open contact = no external fault.</p>				
P3.49	2294	Ext. Fault 2 NC	1, 2, 3, 4	RW
<p>Use this parameter for setting external input causing drive to fault. This function is defined as NC so the function activates on a open contact. If this function is assigned to Normally Closed - the function is always on so the drive will not fault, when set to Normally Open the function will be active and fault all the time. The additional settings allow assigning them to an input to control the function. Can be set to DigiIN:X indicates on board terminal inputs, DigiIN:A:IOX:X indicates optional board inputs in A slot, DigiIN:B:IOX:X indicates optional board inputs in B slot, or Timer Channel X. RO X Function allows for having an input turn on without having to hard wire it to the physical relay output. The description on the fault can be changed in parameter Para ID 2298.</p> <p>Closed contact = no external fault. Open contact = external fault.</p>				

Code	Modbus ID	Parameter	Application	RO/RW
P3.50	2295	<p>Ext. Fault 3 NO</p> <p>Use this parameter for setting external input causing drive to fault. This function is defined as NO so the function activates on a closed contact. If this function is assigned to Normally Open - the function is always off so the drive will not fault, when set to Normally Closed the function will be active and fault all the time. The additional settings allow assigning them to an input to control the function. Can be set to DigiIN:X indicates on board terminal inputs, DigiIN:A:IOX:X indicates optional board inputs in A slot, DigiIN:B:IOX:X indicates optional board inputs in B slot, or Timer Channel X. RO X Function allows for having an input turn on without having to hard wire it to the physical relay output. The description on the fault can be changed in parameter Para ID 2299.</p> <p>Closed contact = external fault. Open contact = no external fault.</p>	1, 2, 3, 4	RW
P3.51	2296	<p>Ext. Fault 3 NC</p> <p>Use this parameter for setting external input causing drive to fault. This function is defined as NC so the function activates on a open contact. If this function is assigned to Normally Closed - the function is always on so the drive will not fault, when set to Normally Open the function will be active and fault all the time. The additional settings allow assigning them to an input to control the function. Can be set to DigiIN:X indicates on board terminal inputs, DigiIN:A:IOX:X indicates optional board inputs in A slot, DigiIN:B:IOX:X indicates optional board inputs in B slot, or Timer Channel X. RO X Function allows for having an input turn on without having to hard wire it to the physical relay output. The description on the fault can be changed in parameter Para ID 2299.</p> <p>Closed contact = no external fault. Open contact = external fault.</p>	1, 2, 3, 4	RW
P3.52	2297	<p>Ext. Fault 1 Text</p> <p>This parameter allows for the text to be changed when using external Fault 1 NO or NC.</p> <p>0 = External Fault 1 = Vibration Cut Out 2 = High Motor Temp 3 = Low Pressure 4 = High Pressure 5 = Low Water 6 = Damper Interlock 7 = Run Enable 8 = Freeze Stat Trip 9 = Smoke Detect 10 = Seal Leakage 11 = Rod Breakage</p>	1, 2, 3, 4	RW
P3.53	2298	<p>This parameter allows for the text to be changed when using external Fault 1 NO or NC.</p> <p>0 = External Fault 1 = Vibration Cut Out 2 = High Motor Temp 3 = Low Pressure 4 = High Pressure 5 = Low Water 6 = Damper Interlock 7 = Run Enable 8 = Freeze Stat Trip 9 = Smoke Detect 10 = Seal Leakage 11 = Rod Breakage</p>		

Appendix A—Description of parameters

Code	Modbus ID	Parameter	Application	RO/RW
P3.54	2299	<p>Ext. Fault 3 Text</p> <p>This parameter allows for the text to be changed when using external Fault 1 NO or NC.</p> <p>0 = External Fault 1 = Vibration Cut Out 2 = High Motor Temp 3 = Low Pressure 4 = High Pressure 5 = Low Water 6 = Damper Interlock 7 = Run Enable 8 = Freeze Stat Trip 9 = Smoke Detect 10 = Seal Leakage 11 = Rod Breakage</p>	1, 2, 3, 4	RW
P3.55	2312	<p>Parameter Set1/Set 2</p> <p>Use this parameter for setting external input for selecting between the stored parameter set1 or set2, this requires saving parameters to the stored sets via P21.1.3. When the function is set for Normally Open the drive will use the standard Parameter Set 1 in the keypad, if the function is set for Normally Closed the drive will follow Parameter Set 2 setting when stored to the keypad. DigiIN:A:IOX:X indicates optional board inputs in A slot, DigiIN:B:IOX:X indicates optional board inputs in B slot, or Timer Channel X. RO X Function allows for having an input turn on without having to hard wire it to the physical relay output.</p>	1, 2, 3, 4	RW
P3.56	2394	<p>Deragging enable</p> <p>Use this parameter for setting external input for enabling the Derag function is off an input. If the function is set for Normally Open the Deragging function will not be activated, if he function is set for Normally Closed then the Derag Function will always be active. Can be set to DigiIN: X indicates on board terminal inputs, DigiIN:A:IOX:X indicates option boards in A slot, DigiIN:B:IOX:X indicates optional board in B slot, or Timer Channel X. RO X function allows for having an input turn on without having to hard wire it to the physical relay output.</p>	1,2,3,4	RW
P3.57	2395	<p>Off control</p> <p>Use this parameter for setting external input for disabling any control signal when the input is the off/ open position, when closed drive will follow the desired control signal. If the function is set for Normally Open this will cause the drive to operate, if the function i set for Normally Closed then the drive will e in the off location and not allow operation. Can be set to DigiIN: X indicates on board terminal inputs, DigiIN:A:IOX:X indicates option boards in A slot, DigiIN:B:IOX:X indicates optional board in B slot, or Timer Channel X. RO X function allows for having an input turn on without having to hard wire it to the physical relay output.</p>	1,2,3,4	RW
P4.1	227	<p>A01 mode</p> <p>Use this parameter to select the analog output mode for A01 to be current or voltage. There are internal relays to perform the switching of the signal between mA or V.</p>	1, 2, 3, 4	RW
P4.2	146	<p>A01 function</p> <p>Use this parameter to select the function or signal that is connected to the terminal A01 terminal 22. Scaling will very based on the signal selected.</p>	1, 2, 3, 4	RW

Code	Modbus ID	Parameter	Application RO/RW			
Application—Function			Standard	Multi-Pump and Fan	Multi-PID	Multi-Purpose
0		Not used—no function	■	■	■	■
1		O/P Frequency—frequency output to motor (0–Fmax)	■	■	■	■
2		Frequency Ref—reference frequency (Fmin–Fmax)	■	■	■	■
3		Motor Speed—motor speed (0–Motor Nominal Speed)	■	■	■	■
4		Motor Current—output motor current (0–Imotor)	■	■	■	■
5		Motor Torque—motor torque (0–Tmotor)	■	■	■	■
6		Motor Power—calculated motor power (0–Pmotor)	■	■	■	■
7		Motor Voltage—output motor voltage (0–Unmotor)	■	■	■	■
8		DC Bus Voltage—DC bus voltage level (0–1000 V)	■	■	■	■
9		PID1 Setpoint—PID setpoint value (setpoint min–setpoint max)	—	■	■	■
10		PID1 Feedback1—PID actual value 1 (feedback1 min–feedback1 max)	—	■	■	■
11		PID1 Feedback2—PID actual 2 value (feedback2 min–feedback2 max)	—	■	—	—
12		PID1 Control Error Value—PID error value	—	■	—	—
13		PID1 Control O/P—PID controller output	—	■	—	—
14		PID2 Setpoint—PID setpoint value (setpoint min–setpoint max)	—	—	■	■
15		PID2 Feedback1—PID actual value 1 (feedback1 min–feedback1 max)	—	—	■	■
16		PID2 Feedback2—PID actual 2 value (feedback2 min–feedback2 max)	—	—	■	■
17		PID2 Control Error Value—PID error value	—	—	■	■
18		PID2 Control O/P—PID controller output	—	—	■	■
19		AI1—Analog input 1	■	■	■	■
20		AI2—Analog input 2	■	■	■	■
21		O/P Frequency—Output frequency (–2 to +2x nominal frequency)	■	■	■	■
22		Motor Torque—Motor output torque (–2 to +2x Tmotor)	■	■	■	■
23		Motor Power—Motor calculated power (–2 to +2x Pmotor)	■	■	■	■
24		PT100 Temp—Thermistor input temperature	■	■	■	■
33		SlotA PT100 Temp Channel 1	■	■	■	■
34		SlotA PT100 Temp Channel 2	■	■	■	■
35		SlotA PT100 Temp Channel 3	■	■	■	■
36		SlotB PT100 Temp Channel 1	■	■	■	■
37		SlotB PT100 Temp Channel 2	■	■	■	■
38		SlotB PT100 Temp Channel 3	■	■	■	■
39		User Defined Output	■	■	■	■
40		Motor Current(–2 to +2N)	■	■	■	■
P4.3	149	A01 minimum Use this parameter to define the signal minimum range setting to be either 0 mA or 4 mA (A01 mode = 0–20 mA); 0V or 2V (A01 mode = 0–10V). 0 = Set minimum value to 0V/0 mA. 1 = Set minimum value to 2V/4 mA.			1, 2, 3, 4	RW

Appendix A—Description of parameters

Code	Modbus ID	Parameter	Application	RO/RW
P4.4	147	A01 Filter Time	1, 2, 3, 4	RW

Use this parameter to define the filtering time for the analog output signal, with a higher number the more filtering time is added on the output signal. Setting this parameter value to 0.00 will deactivate filtering.

Figure 69. Analog output filtering

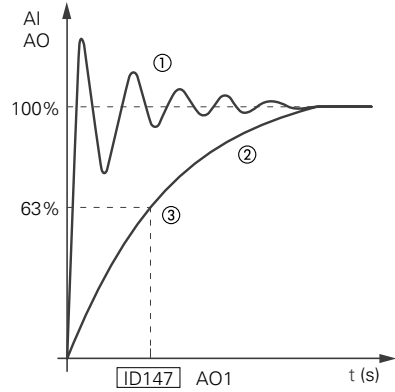

Notes

- ① Analog signal with faults (unfiltered).
- ② Filtered analog signal.
- ③ Filter time constant at 63% of the set value.

P4.5	150	A01 Scale	1, 2, 3, 4	RW
------	-----	------------------	------------	----

This parameter will scale the analog output function from 10% to 1000%, in adjusting this value it will either extend or shrink the scale on the analog signal from 0-10V/0-20mA or 2-10V/4-20mA.

Figure 70. Analog output scaling

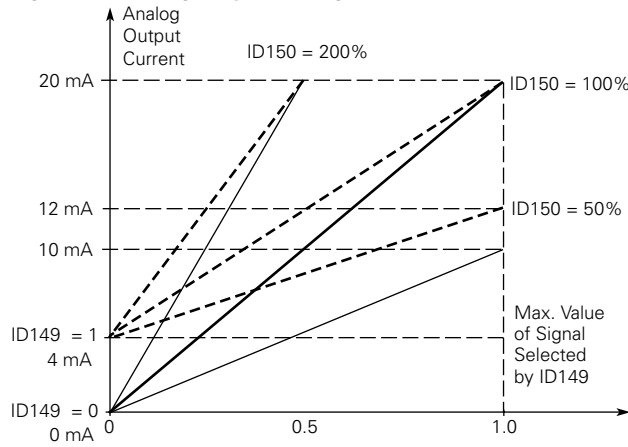

Code	Modbus ID	Parameter	Application	RO/RW
P4.6	148	<p>A01 inversion</p> <p>Use this parameter to invert the analog output signal, normally 0V/0mA/2V/4mA = 0% and 10V/20mA = 100%, when inverted 0V/0mA/2V/4mA = 100% and 10V/20mA = 0%:</p> <p>Maximum output signal = Minimum set value. Minimum output signal = Maximum set value.</p> <p>Figure 71. Analog output invert</p>	1, 2, 3, 4	RW
P4.7	375	<p>A01 Offset</p> <p>This parameter is used to add a offset of -100.0 to 100.0% to the analog output minimum value to add in an additional offset scale factor.</p>	1, 2, 3, 4	RW
P4.8	228	<p>A02 Mode</p> <p>Use this parameter to select the analog output mode for A02 as current or voltage. There are internal relays to perform the switching of the signal between mA or V.</p>	1, 2, 3, 4	RW
P4.9	229	<p>A02 Function</p> <p>Use this parameter to select the function or signal that is connected to the terminal A02 terminal 24. Scaling will vary based on the signal selected. See ID 146 for options.</p>	1, 2, 3, 4	RW
P4.10	232	<p>A02 Minimum</p> <p>Use this parameter to define the signal minimum to be either 0 mA (A01 mode = 0–20 mA); 0V or 2V (A01 mode = 0–10V).</p> <p>0<tab>Set minimum value to 0V/0 mA. 1<tab>Set minimum value to 2V/4 mA.</p>	1, 2, 3, 4	RW

Appendix A—Description of parameters

Code	Modbus ID	Parameter	Application	RO/RW
P4.11	230	AO2 Filter Time	1, 2, 3, 4	RW

Use this parameter to define the filtering time for the analog output signal, with a higher number the more filtering time is added on the output signal. Setting this parameter value to 0.00 will deactivate filtering.

Figure 72. AO2 Filter Time

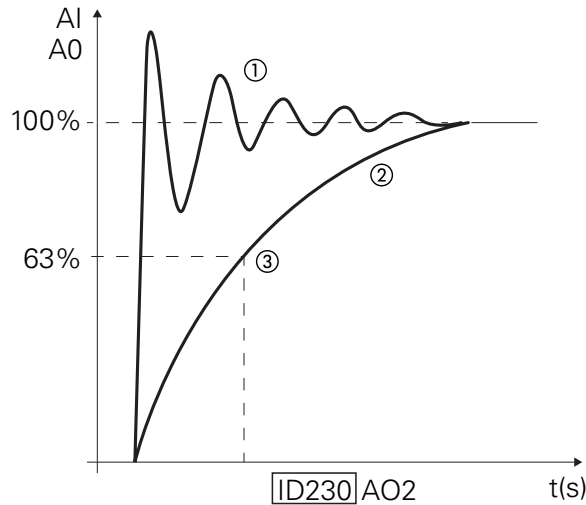

Notes: ① Analog signal with faults (unfiltered)
 ② Filtered analog signal.
 ③ Filter time constant at 63% of the set value.

P4.12	233	AO2 Scale	1, 2, 3, 4	RW
-------	-----	------------------	------------	----

This parameter will scale the analog output function from 10% to 1000%, in adjusting this value it will either extend or shrink the scale on the analog signal from 0-10V/0-20mA or 2-10V/4-20mA.

Figure 73. Analog output scaling

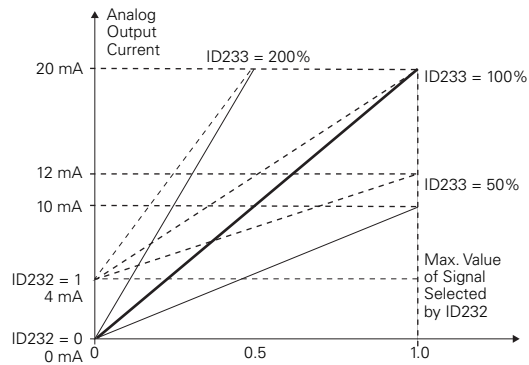

P4.13	231	AO2 Inversion	1, 2, 3, 4	RW
-------	-----	----------------------	------------	----

Use this parameter to invert the analog output signal, normally 0V/0mA/2V/4mA = 0% and 10V/20mA = 100%, when inverted 0V/0mA/2V/4mA = 100% and 10V/20mA = 0%:

Maximum output signal = Minimum set value.

Minimum output signal = Maximum set value.

Code	Modbus ID	Parameter	Application	RO/RW
P4.14	234	AO2 Offset	1, 2, 3, 4	RW

This parameter is used to add a offset of -100.0 to 100.0% to the analog output minimum value to add in an additional offset scale factor.

Figure 74. Analog output invert

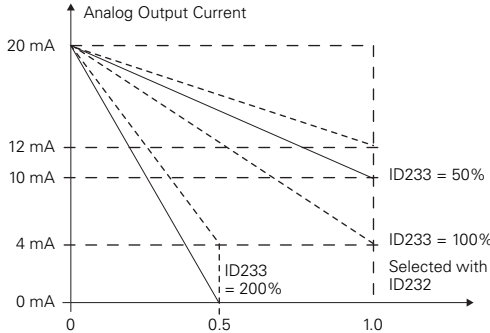

P5.1	151	DO1 Function Use this parameter to select signal to show the digital output.	1, 2, 3, 4	RW
P5.2	152	RO1 Function Use this parameter to select signal to show the digital output.	1, 2, 3, 4	RW
P5.3	153	RO2 Function Use this parameter to select signal to show the digital output.	1, 2, 3, 4	RW
P5.4	538	RO3 Function Use this parameter to select signal to show the digital output.	1, 2, 3, 4	RW

Appendix A—Description of parameters

Code	Modbus ID	Parameter	Application				RO/RW
Application		Function	Standard	Multi-Pump and Fan	Multi-PID	Multi-Purpose	
0 = Not used		Not operational	■	■	■	■	
1 = Ready		Frequency converter is ready for operations	■	■	■	■	
2 = Run		Frequency converter is running motor	■	■	■	■	
3 = Fault		A fault trip has occurred	■	■	■	■	
4 = Fault inverted		A fault trip has not occurred	■	■	■	■	
5 = Warning		Warning exists in frequency converter	■	■	■	■	
6 = Reverse		Reverse command has been activated	■	■	■	■	
7 = At speed		Output frequency has reached reference	■	■	■	■	
8 = Zero frequency		Motor output is at zero frequency	■	■	■	■	
9 = Frequency Limit1 supervision		Frequency limit1 achieved	■	■	■	■	
10 = Frequency Limit2 supervision		Frequency limit2 achieved	■	■	■	■	
11 = PID1 supervision		PID1 controller level achieved	—	■	—	—	
12 = PID2 supervision		PID2 controller level achieved	—	—	■	■	
13 = Over heat warning		Drive over heat has occurred	■	■	■	■	
14 = Over current regular		Over current controller activated	■	■	■	■	
15 = Over voltage regular		Over voltage controller activated	■	■	■	■	
16 = Under voltage regular		Under voltage controller activated	■	■	■	■	
17 = 4 mA fault		4 mA reference fault occurred	■	■	■	■	
18 = External brake		External brake activated	—	—	—	■	
19 = External brake inverted		External brake control inverted	—	—	—	■	
20 = Torque limit supervision		Torque limit value achieved	■	■	■	■	
21 = Reference limit supervision		Reference limit achieved	■	■	■	■	
22 = Control from IO		Control place I/O is activated	■	■	■	■	
23 = Unrequired rotation direction		Active direction is different than reference direction	■	■	■	■	
24 = Thermal fault		Thermal fault has occurred	■	■	■	■	
25 = Fire mode		Fire mode is activated	—	■	■	■	
26 = Bypass running		Bypass mode is activated	—	■	■	■	
27 = External fault		External fault has occurred	■	■	■	■	
28 = Remote control		Remote control place is activated	■	■	■	■	
29 = Jog speed		Drive is in jog mode	■	■	■	■	
30 = Motor thermal protection		Motor calculated temperature fault activated	■	■	■	■	
31 = Fieldbus input1		Controlled by FB control word	■	■	■	■	
32 = Fieldbus input2		Controlled by FB control word	■	■	■	■	
33 = Fieldbus input3		Controlled by FB control word	■	■	■	■	
34 = Fieldbus input4		Controlled by FB control word	■	■	■	■	
35 = Damper control		Damper control input is activated	—	■	■	■	
36 = Timer1 status		Timer1 activated	■	■	■	■	
37 = Timer2 status		Timer2 activated	■	■	■	■	
38 = Timer3 status		Timer3 activated	■	■	■	■	
39 = Emergency stop		Emergency stop input activated, drive faulted	■	■	■	■	
40 = Power limit supervision		Power limit value achieved	■	■	■	■	
41 = Temperature limit supervision		Temperature limit value achieved	■	■	■	■	
42 = Analog input supervision		Analog limit value achieved	■	■	■	■	
43 = Motor1 control		Auxiliary motor1 activated	—	■	■	■	
44 = Motor2 control		Auxiliary motor2 activated	—	■	■	■	
45 = Motor3 control		Auxiliary motor3 activated	—	■	■	■	
46 = Motor4 control		Auxiliary motor4 activated	—	■	■	■	
47 = Motor5 control		Auxiliary motor5 activated	—	■	■	■	
48 = Logic fulfilled		Logic function is activated	—	—	—	■	
49 = PID1 sleep		PID1 controller sleep mode active	—	■	—	■	
50 = PID2 sleep		PID2 controller sleep mode active	—	—	■	■	
51 = Motor Current 1 Supv		Motor current supervision value active	■	■	■	■	
52 = Motor Current 2 Supv		Motor current supervision value active	■	■	■	■	
53 = Second AI Limit Supv		Analog input supervision active	■	■	■	■	
54 = DC Charge Switch Close		DC bus is charged	■	■	■	■	
55 = Preheat Active		Preheat Control mode is activated	■	■	■	■	
56 = Cold Weather Active		Cold Weather mode is activated	■	■	■	■	
57 = Pre-Charge Active		Pump Precharge has been completed	—	■	■	■	
58 = 2th Stage Ramp Frequency Active		Indicates the Frequency is above the 2th Ramp	■	■	■	■	
59 = STO Fault Output		Frequency level to switch to 2nd accel/decel time.	■	■	■	■	
60 = Run Bypass/Drive		Run indication for bypass or drive mode.	—	■	■	■	
61 = Bypass Overload		Bypass Overload fault input is enabled.	—	■	■	■	

Notes: © Function is not available in FR7 and FR8 of drives.

Code	Modbus ID	Parameter	Application	RO/RW									
P5.5	2463	Virtual R01 function Use this parameter to select the function of output relay VO1. This relay is a internal relay that can be used to tie to internal functions in the drive. The functions are the same with the standard hardware relays.	1,2,3,4	RW									
P5.6	2464	Virtual R02 function Use this parameter to select the function of output relay VO2. This relay is a internal relay that can be used to tie to internal functions in the drive. The functions are the same with the standard hardware relays.	1,2,3,4	RW									
P5.7	154	Freq Limit 1 Supv Use this parameter to select how the frequency converter supervision controller functions as either a high or low limit based off the set supervision value. It can also be used to enabled an external brake control relay. 0 = No supervision 1 = Low limit supervision 2 = High limit supervision 3 = Brake-on control (Application 4 only)	1, 2, 3, 4	RW									
P5.8	155	Freq limit 1 supv val. Use this parameter to select the frequency value supervised by Para ID 154. If the output frequency goes under/over the set limit, this function generates a warning message via the digital output DO1 or relay outputs RO1 or RO2 or RO3 .	1, 2, 3, 4	RW									
<p>Figure 75. Supervision function</p> <p>Example:</p> <table border="1"> <tr> <td>21</td> <td>RO1</td> <td></td> </tr> <tr> <td>22</td> <td>RO1</td> <td></td> </tr> <tr> <td>23</td> <td>RO1</td> <td></td> </tr> </table>					21	RO1		22	RO1		23	RO1	
21	RO1												
22	RO1												
23	RO1												
P5.9	157	Freq limit 2 supv Use this parameter to select how the frequency converter supervision controller functions as either a high or low limit based off the set supervision value. It can also be used to enabled/disabled an external brake control relay. 0<tab>No limit 1 = Low limit supervision 2 = High limit supervision 3 = Brake-off control (Application 4 only) 4 = Brake-on/off control (Application 4 only)	1, 2, 3, 4	RW									
P5.10	158	Freq Limit 2 supv val. Use this parameter to select the frequency value supervised by Para ID 157. If the output frequency goes under/over the set limit, this function generates a warning message via the digital output DO1 or relay outputs RO1 or RO2 or RO3.	1, 2, 3, 4	RW									

Appendix A—Description of parameters

Code	Modbus ID	Parameter	Application	RO/RW
P5.11	159	<p>Torque limit supv</p> <p>Use this parameter to select how the frequency converter functions upon the torque limit supervision value being met as a high or low limit. It can also control a mechanical brake to disable once torque is built up with the motor (Torque proofing).</p> <p>0 = No limit 1 = Low limit supervision 2 = High limit supervision 3 = Brake-off control (Application 4 only)</p> <p>Figure 76. Supervision function</p>	1, 2, 3, 4	RW
P5.12	160	<p>Torque limit supv val.</p> <p>Use this parameter to select the torque value to be supervised by Para ID 159.</p> <p>If the output frequency goes under/over the set limit, this function generates a warning message via the digital output DO1 or via the relay outputs RO1 or RO2 or RO3.</p>	1, 2, 3, 4	RW
P5.13	161	<p>Ref limit supv</p> <p>Use this parameter to select how the frequency converter functions upon the reference supervision value being a high or low limit.</p> <p>0 = No supervision 1 = Low limit supervision 2 = High limit supervision</p>	1, 2, 3, 4	RW
P5.14	162	<p>Ref limit supv val</p> <p>Use this parameter to select the frequency value to be supervised by Para ID 161.</p> <p>If the output frequency goes under/over the set limit, this function generates a warning message via the digital output DO1 or via the relay outputs RO1 or RO2 or RO3.</p>	1, 2, 3, 4	RW
P5.15	163	<p>Ext brake off delay</p>	4	RW
P5.16	164	<p>Ext brake on delay</p> <p>Use this parameter to select the time delay after the external brake logic is met before the relay output function disables the ext brake output function.</p> <p>The brake control signal can be programmed via digital output DO1 or via one of the relay outputs RO1, RO2 and RO3.</p> <p>Figure 77. External brake control</p> <p>a) Start/Stop Logic Selection, Para ID 143 = 0, 1 or 2</p> <p>b) Start/Stop Logic Selection, Para ID 143 = 3</p>	4	RW

Code	Modbus ID	Parameter	Application	RO/RW
------	-----------	-----------	-------------	-------

When using the brake control the following table is used to demonstrate the control functions. Brake on delay should be set longer than the ramp time in order to avoid damaging the brake.

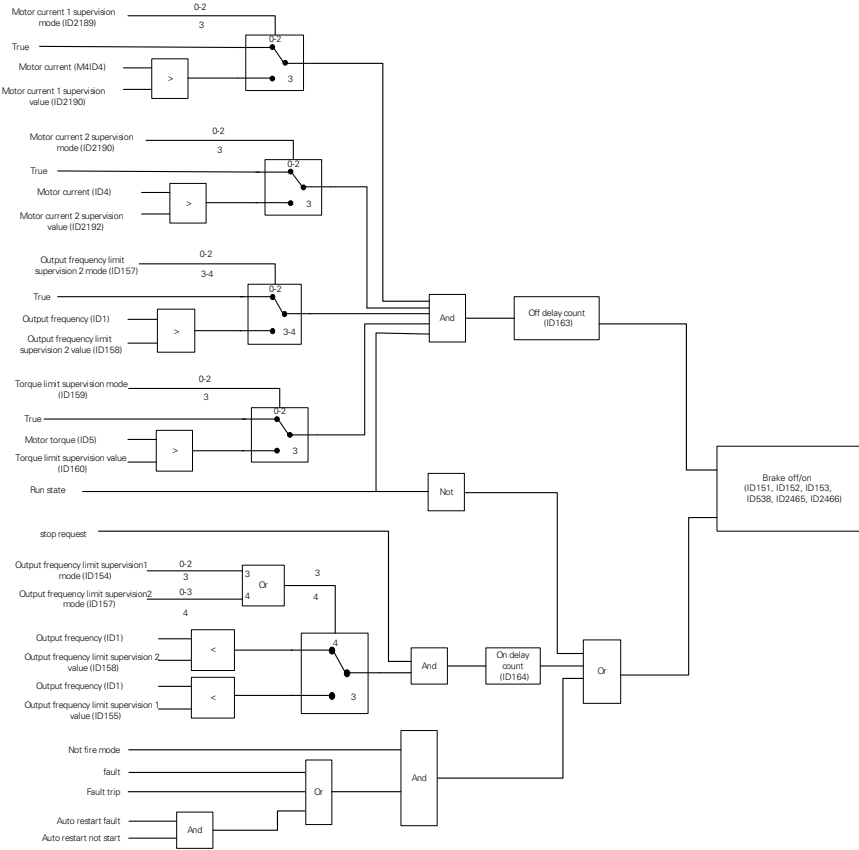

P5.17	165	Temp limit supv Use this parameter to select how the frequency converter functions upon the value setting based off the Drive Temperature. 0 = No supervision 1 = Low limit supervision 2 = High limit supervision	1, 2, 3, 4	RW
P5.18	166	Temp limit supv val Use this parameter to select the temperature value to be supervised by Para ID 165 If the temperature of the frequency converter unit falls below or exceeds the set limit, this function generates a warning message via the digital output DO1 or via a relay output RO1, RO2 or RO3.	1, 2, 3, 4	RW
P5.19	167	Power limit supv Use this parameter to select how the frequency converter functions based off the power monitor upon the limit value setting 0 = No supervision 1 = Low limit supervision 2 = High limit supervision	1, 2, 3, 4	RW
P5.20	168	Power limit supv val Use this parameter to select the power value to be supervised by Para ID 167 If the calculated power value falls below or exceeds the set limit, this function generates a warning message via the digital output DO1 or via a relay output RO1, RO2 or RO3..	1, 2, 3, 4	RW

Appendix A—Description of parameters

Code	Modbus ID	Parameter	Application	RO/RW
P5.21	170	AI supv select Use this parameter to select an analog signal to use for the analog input supervision 0 = Analog reference from AI1 (terminals 2 and 3, e.g., potentiometer) 1 = Analog reference from AI2 (terminals 4 and 5, e.g., transducer)	1, 2, 3, 4	RW
P5.22	171	AI limit supv Use this parameter to select how the frequency converter functions based off the analog input limit value setting 0 = No supervision 1 = Low limit supervision 2 = High limit supervision	1, 2, 3, 4	RW
P5.23	172	AI limit supv val Use this parameter to select the analog input value to be supervised by Para ID 171. If the value of the selected analog input goes under/over the set limit, this function generates a warning message via the digital output DO1 or via a relay output RO1, RO2 or RO3.	1, 2, 3, 4	RW
P5.24	1346	PID1 superv enable Use this parameter to select enabling of the upper and lower limits around the reference are set. When the actual value goes above or below these, a counter starts counting up toward the Delay. When the actual value is within the allowed area, the same counter counts down instead. After the delay time it will turn on an relay output value.	2, 3, 4	RW
P5.25	1347	PID1 superv upper limit Use this parameter to set the upper PID feedback supervision limit level.	2, 3, 4	RW
P5.26	1349	PID1 superv lower limit Use this parameter to set the lower PID feedback supervision limit level.	2, 3, 4	RW
P5.27	1351	PID1 superv delay Use this parameter to set the delay time after which the PID feedback goes above or below the limit settings to provide status to relay output function.	2, 3, 4	RW
P5.28	1408	PID2 superv enable Use this parameter to select enabling of the upper and lower limits around the reference are set. When the actual value goes above or below these, a counter starts counting up toward the Delay. When the actual value is within the allowed area, the same counter counts down instead. After the delay time it will turn on an relay output value.	3, 4	RW
P5.29	1409	PID2 superv upper limit Use this parameter to set the upper PID feedback supervision limit level.	3, 4	RW
P5.30	1411	PID2 superv lower limit Use this parameter to set the lower PID feedback supervision limit level.	3, 4	RW
P5.31	1413	PID2 superv delay Use this parameter to set the delay time after which the PID feedback goes above or below the limit settings to provide status to relay output function.	3, 4	RW
P5.32	2112	RO1 on delay Use this parameter to set the delay time for RO1 relay to transition from logic 0 to 1 state.	1, 2, 3, 4	RW
P5.33	2113	RO1 off delay Use this parameter to set the delay time for RO1 relay to transition from logic 1 to 0 state.	1, 2, 3, 4	RW
P5.34	2114	RO2 on delay Use this parameter to set the delay time for RO2 relay to transition from logic 0 to 1 state.	1, 2, 3, 4	RW
P5.35	2115	RO2 off delay Use this parameter to set the delay time for RO2 relay to transition from logic 1 to 0 state.	1, 2, 3, 4	RW
P5.36	2116	RO3 on delay Use this parameter to set the delay time for RO3 relay to transition from logic 0 to 1 state.	1, 2, 3, 4	RW
P5.37	2117	RO3 off delay Use this parameter to set the delay time for RO3 relay to transition from logic 1 to 0 state.	1, 2, 3, 4	RW
P5.38	2118	RO3 Invert Use this parameter to invert the output logic of RO3 to be normally closed. Instead of normally open. Power off state of relay will be Normally Open. 1 = Not Inverted 2 = Inverted	1, 2, 3, 4	RW

Code	Modbus ID	Parameter	Application	RO/RW
P5.39	2189	Motor current 1 supv Use this parameter to select how the frequency converter functions based off the motor current supervision. The drive monitors the active motor current and based of this supervision will enable itself based off the supervision value. 0 = No supervision 1 = Low limit supervision 2 = High limit supervision 3 = Brake Off Control (Application 4 only)	1, 2, 3, 4	RW
P5.40	2190	Motor current 1 supv value Use this parameter to select the current level used for the supervision setting. If the value of the selected analog input goes under/over the defined value, this function generates a warning message through the digital output or the relay output.	1, 2, 3, 4	RW
P5.41	2191	Motor current 2 supv Use this parameter to select how the frequency converter functions based off the motor current supervision. The drive monitors the active motor current and will enable itself based off the supervision value. 0 = No supervision 1 = Low limit supervision 2 = High limit supervision 3 = Brake Off Control (Application 4 only)	1, 2, 3, 4	RW
P5.42	2192	Motor current 2 supv value Use this parameter to select the current level used for the supervision setting. If the value of the selected analog input goes under/over the defined value, this function generates a warning message through the digital output or the relay output.	1, 2, 3, 4	RW
P5.43	2193	Second AI supv select Use this parameter to select an analog signal to use for the analog input supervision 0 = Analog reference from AI1 (terminals 2 and 3, e.g., potentiometer) 1 = Analog reference from AI2 (terminals 4 and 5, e.g., transducer)	1, 2, 3, 4	RW
P5.44	2194	Second AI limit supv Use this parameter to select how the frequency converter functions based off the analog input limit value setting 0 = No supervision 1 = Low limit supervision 2 = High limit supervision	1, 2, 3, 4	RW
P5.45	2195	Second AI limit supv val Use this parameter to select the analog input value to be supervised by Para ID 2194. If the value of the selected analog input goes under/over the set limit, this function generates a warning message via the digital output DO1 or via a relay output RO1, RO2 or RO3.	1, 2, 3, 4	RW
P5.46	2196	Motor current 1 supv hyst Use this parameter to define the hysteresis value between when the motor current 1 supervision enables and disables itself. This value is in reference from distance away form the defined limit value.	1, 2, 3, 4	RW
P5.47	2197	Motor current 2 supv hyst Use this parameter to define the hysteresis value between when the motor current 2 supervision enables and disables itself. This value is in reference from distance away form the defined limit value.	1, 2, 3, 4	RW
P5.48	2198	AI supv hysteresis Use this parameter to define the hysteresis value between when the AI supervision enables and disables itself. This value is in reference from distance away form the defined limit value.	1, 2, 3, 4	RW
P5.49	2199	Second AI supv hysteresis Use this parameter to define the hysteresis value between when the AI supervision enables and disables itself. This value is in reference from distance away form the defined limit value.	1, 2, 3, 4	RW
P5.50	2200	Frequency limit 1 supv hysteresis Use this parameter to define the hysteresis value between when the Output Frequency supervision enables and disables itself. This value is in reference from distance away form the defined limit value.	1, 2, 3, 4	RW
P5.51	2201	Frequency limit 2 supv hysteresis Use this parameter to define the hysteresis value between when the Output Frequency supervision enables and disables itself. This value is in reference from distance away form the defined limit value.	1, 2, 3, 4	RW

Appendix A—Description of parameters

Code	Modbus ID	Parameter	Application	RO/RW
P5.52	2202	Torque limit supv hysteresis Use this parameter to define the hysteresis value between when the Torque supervision enables and disables itself. This value is in reference from distance away form the defined limit value.	1, 2, 3, 4	RW
P5.53	2203	Ref limit supv hysteresis Use this parameter to define the hysteresis value between when the Reference limit supervision enables and disables itself. This value is in reference from distance away form the defined limit value.	1, 2, 3, 4	RW
P5.54	2204	Temp limit supv hysteresis Use this parameter to define the hysteresis value between when the Temp limit supervision enables and disables itself. This value is in reference from distance away form the defined limit value.	1, 2, 3, 4	RW
P5.55	2205	Power limit supv hysteresis Use this parameter to define the hysteresis value between when the Power limit supervision enables and disables itself. This value is in reference from distance away form the defined limit value.	1, 2, 3, 4	RW
P6.1	751	Logic function select Use this parameter to define the logical math function used with the Logic A and B input functions. The value can be And - indicating both being active then enable the logic, OR - if one or both inputs are active then it will enabled the logic, XOR - if any one of the inputs are active the logic is enabled, if both logic's are the same state it disables the logic. The result (LOG) can then be assigned to the digital outputs DO, R01, R02 and R03. The type of operation is defined in parameter ID751: 0 = AND 1 = OR 2 = XOR	4	RW
P6.2	752	Logic operation input A Use this parameter to define the logic function that is assigned to the logic A input.	4	RW
P6.3	753	Logic operation input B Use this parameter to define the logic function that is assigned to the logic B input.	4	RW
P7.1	138	Remote 2 control place Selects where the drive will look for the start command in the "Remote 2" location. Using the Remote 1/2 select digital input will select between control place 1 and 2. - I/O terminal Start 1 and 2 would be from the Digital hardwired inputs assigned via the input group - Fieldbus would be from a communication bus. - Keypad would be from the Start/Stop buttons on the keypad.	1, 2, 3, 4	RW

Code	Modbus ID	Parameter	Application	RO/RW		
P7.2	139	Remote 2 reference Use this parameter to select what frequency reference source to look at when in the Remote 2 control mode.	1, 2, 3, 4	RW		
Application—Selection						
			Standard	Multi-Pump and Fan	Multi-PID	Multi-Purpose
0		AI1 - Control Terminals 2 and 3, defined as a voltage or current signal input based on S1 DIP switch setting. Parameter settings done in Analog input group.	■	■	■	■
1		AI2 - Control Terminals 4 and 5, defined as a current or voltage signal input based on S2 and S3 DIP switch setting. Parameter settings done in Analog input group.	■	■	■	■
2		Slot A: AI1 - Comes from the slot A DXG-EXT-1AI2AO board, defined as a voltage or current signal based off on board DIP switch. See Option card Manual for more details.	■	■	■	■
3		AI1 - Comes from the slot B DXG-EXT-1AI2AO board, defined as a voltage or current signal based off on board DIP switch. See Option card Manual for more details.	■	■	■	■
4		AI1 Joystick - Control Terminals 2 and 3, defined as a voltage or current signal input based on S1 DIP switch setting. Parameter settings done in Analog input group.	■	■	■	■
5		AI2 Joystick - Control Terminals 4 and 5, defined as a current or voltage signal input based on S2 and S3 DIP switch setting. Parameter settings done in Analog input group.	■	■	■	■
6		Keypad - Keypad Up and down buttons change keypad reference parameter Para ID 141.	■	■	■	■
7		Fieldbus Ref - Speed reference word used to define speed. Check Communication Manual for more details.	■	■	■	■
8		Motor Pot - Digital input assigned for increasing and decreasing speed, see digital input group for motor pot input settings and drive control group to define ramp rate and reset condition.	—	—	—	■
9		Max Frequency - Run at the Para ID 102 Max Frequency level.	■	■	■	■
10		AI1 + AI2 - Sum of the AI1 and AI2 signals. See Option 0 and 1 for input details.	■	■	■	■
11		AI1 - AI2 - AI1 signal value minus AI2 signal value. See Option 0 and 1 for input details.	■	■	■	■
12		AI2 - AI1 - AI2 signal value minus AI1 signal value. See Option 0 and 1 for input details.	■	■	■	■
13		AI1 * AI2 - AI1 signal value multiplied by AI2 signal value. See Option 0 and 1 for input details.	■	■	■	■
14		AI1 or AI2 - AI1 signal value or AI2 signal value. See Digital input group to assign select input signal. See Option 0 and 1 for input details.	■	■	■	■
15		Min(AI1,AI2) - Minimum of AI1 signal value or AI2 signal value. See Option 0 and 1 for input details.	■	■	■	■
16		Max(AI1,AI2) - Maximum of AI1 signal value or AI2 signal value. See Option 0 and 1 for input details.	■	■	■	■
17		PID1 Control Output - PID controller 1 output , see PID group for setup.	—	■	■	■
18		PID2 Control Output - PID controller 2 output. see PID group for setup..	—	—	■	■
P7.3	141	Keypad reference Use this parameter to modify the frequency reference on the keypad.			1, 2, 3, 4	RW
P7.4	116	Keypad direction Use this parameter to set the rotation direction of the motor when in the keypad control place. 0 = Forward: The rotation of the motor is forward or clockwise direction . 1 = Reverse: The rotation of the motor is reversed or counter clockwise direction.			1, 2, 3, 4	RW
P7.5	114	Keypad stop Use this parameter to make the STOP button a “hot-spot” that always stops the drive regardless of the selected control place, set the value of this parameter to “Always Enabled”. “Enable - Keypad Operation” activates the stop button only in keypad mode or the local control place.			1, 2, 3, 4	RW
P7.6	117	Jog reference Use this parameter to set the jogging speed set point, this speed is selected with the digital input programmed for Jogging speed. When enabled the drive starts and ramps to this speed, input removed drive stops. This parameter’s value is automatically limited between minimum and maximum frequency.			1, 2, 3, 4	RW
P7.7	156	Motor pot ramp time Use this parameter to set the rate of change for the motor potentiometer reference value when it is increased or decreased. The value is defined as Hz/second.			4	RW

Appendix A—Description of parameters

Code	Modbus ID	Parameter	Application	RO/RW
P7.8	169	<p>Motor pot ref reset</p> <p>Use this parameter to select how Defines how the motor pot reference signal is handled on shutting down the frequency converter output or powering down the frequency converter.</p> <p>0 = No reset - reference stays at last setting</p> <p>1 = Memory reset in stop and power down - reference resets to 0 when drive is stopped or the power is cycled to the drive</p> <p>2 = Memory reset in power down - reference resets to 0 when drive is powered down only</p>	4	RW
P7.9	252	<p>Start mode</p> <p>Use this parameter to define the start function.</p> <p>Ramp</p> <p>0 = The frequency converter starts from 0 Hz and accelerates to the set reference frequency within the set acceleration time. (Load inertia or starting friction may cause prolonged acceleration times.)</p> <p>Flying start</p> <p>1 = The frequency converter is able to start into a running motor by applying a small voltage to motor to search for the frequency corresponding to the speed the motor is running at. Searching starts from the maximum frequency toward the actual frequency until the correct value is detected. Thereafter, the output frequency will be increased/decreased to the set reference value according to the set acceleration/deceleration parameters.</p> <p>Use this mode if the motor is coasting when the start command is given, with the flying start</p>	1, 2, 3, 4	RW
P7.10	253	<p>Stop mode</p> <p>Use this parameter to define the stop function.</p> <p>Coasting</p> <p>0 = The motor coasts to a halt without any control from the frequency converter, after the Stop command, output of drive shuts off. The Motor slows based off the inertia loss.</p> <p>Ramp</p> <p>1 = After the Stop command, the speed of the motor is decelerated according to the set deceleration parameters. If the regenerated energy is high and a faster deceleration is required, it may be necessary to use an external braking resistor for faster deceleration.</p> <p>Enabled Normal stop: Ramp/ Run</p> <p>Disable stop: coasting</p>	1, 2, 3, 4	RW
P7.11	247	<p>Ramp 1 shape</p> <p>Use this parameter to make the beginning and end of the acceleration and deceleration ramps can be smoother. Setting a value of 0.0 gives a linear ramp shape that causes acceleration and deceleration to react immediately to the changes in the reference signal.</p> <p>Setting a value from 0.1 to 10 seconds for this parameter produces an S-shaped acceleration/ deceleration at the start and stop of the slope.</p>	1, 2, 3, 4	RW

Figure 78. Acceleration/Deceleration (S-shaped)

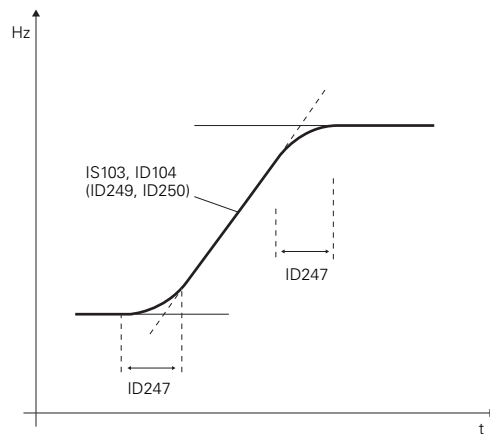

Code	Modbus ID	Parameter	Application	RO/RW
P7.12	248	<p>Ramp 2 shape</p> <p>The start and end of the acceleration and deceleration ramps can be smoothed with these parameters. Setting a value of 0.0 gives a linear ramp shape that causes acceleration and deceleration to react immediately to the changes in the reference signal.</p> <p>Setting a value from 0.1 to 10 seconds for this parameter produces an S-shaped acceleration/ deceleration at the start and stop of the slope.</p> <p>Figure 79. Acceleration/Deceleration (S-shaped)</p>	1, 2, 3, 4	RW
P7.13	249	<p>Accel time 2</p> <p>Use this parameter to set the time required for the output frequency to accelerate from the zero frequency to the set maximum frequency. These parameters provide the possibility to set two different acceleration/deceleration time sets for one application. The active set can be selected with the programmable digital input.</p>	1, 2, 3, 4	RW
P7.14	250	<p>Decel time 2</p> <p>Use this parameter to set the time required for the output frequency to accelerate from the zero frequency to the set maximum frequency. These parameters provide the possibility to set two different acceleration/deceleration time sets for one application. The active set can be selected with the programmable digital input.</p>	1, 2, 3, 4	RW
P7.15	256	<p>Skip F1 low lim</p> <p>Use this parameter to set frequency limits to prevent the drive from operating in, the frequency converter will skip the set frequencies, ramp time will be the same. In some systems it may be necessary to avoid certain frequencies because of mechanical resonance problems.</p>	1, 2, 3, 4	RW
P7.16	257	<p>Skip F1 high lim</p> <p>Use this parameter to set frequency limits to prevent the drive from operating in, the frequency converter will skip the set frequencies, ramp time will be the same. In some systems it may be necessary to avoid certain frequencies because of mechanical resonance problems.</p>	1, 2, 3, 4	RW
P7.17	258	<p>Skip F2 low lim</p> <p>Use this parameter to set frequency limits to prevent the drive from operating in, the frequency converter will skip the set frequencies, ramp time will be the same. In some systems it may be necessary to avoid certain frequencies because of mechanical resonance problems.</p>	1, 2, 3, 4	RW
P7.18	259	<p>Skip F2 high lim</p> <p>Use this parameter to set frequency limits to prevent the drive from operating in, the frequency converter will skip the set frequencies, ramp time will be the same. In some systems it may be necessary to avoid certain frequencies because of mechanical resonance problems.</p>	1, 2, 3, 4	RW
P7.19	260	<p>Skip F3 low lim</p> <p>Use this parameter to set frequency limits to prevent the drive from operating in, the frequency converter will skip the set frequencies, ramp time will be the same. In some systems it may be necessary to avoid certain frequencies because of mechanical resonance problems.</p>	1, 2, 3, 4	RW

Appendix A—Description of parameters

Code	Modbus ID	Parameter	Application	RO/RW
P7.20	261	Skip F3 high lim	1, 2, 3, 4	RW

Use this parameter to set frequency limits to prevent the drive from operating in, the frequency converter will skip the set frequencies, ramp time will be the same. In some systems it may be necessary to avoid certain frequencies because of mechanical resonance problems.

Figure 80. Example of skip frequency area setting

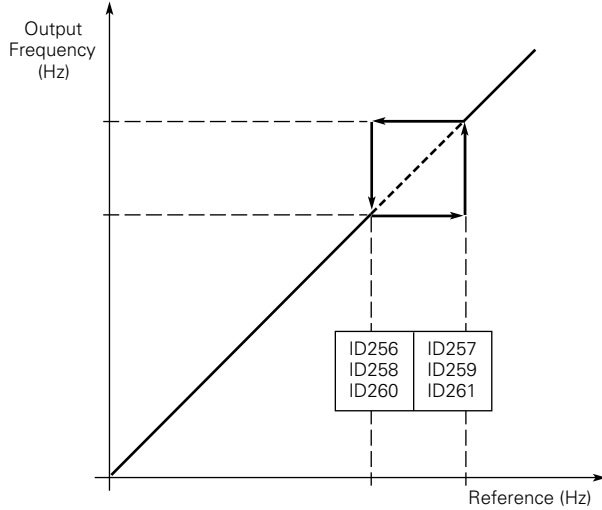

P7.21	264	Skip Range Ramp Factor	1, 2, 3, 4	RW
-------	-----	-------------------------------	------------	----

Use this parameter to set the multiplier used for acceleration/deceleration time when the output frequency is between the selected prohibit frequency range limits. The ramping speed (selected acceleration/deceleration time 1 or 2) is multiplied with this factor. e.g., value 0.1 makes the acceleration time 10 times shorter than outside the prohibit frequency range limits.

Figure 81. Ramp speed scaling between skip frequencies

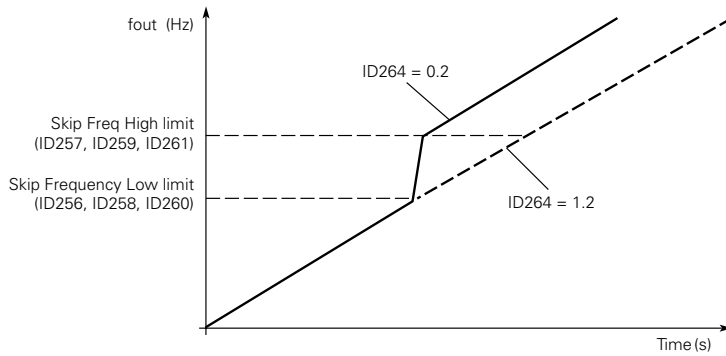

Code	Modbus ID	Parameter	Application	RO/RW
P7.22	267	<p>Power loss function</p> <p>Use this parameter to enable or disable the power loss ride thru function. When enabled the drive will stop the output voltage to the motor allowing motor to coast down but PWM active to feed power back into drive to keep the drive powered up as long as it can before power is lost. The drive will accept restart and safely control the motor in the time set without cycling the run command if input voltage returns. This mode is engaged at the following levels - 230V - 156.8Vdc, 480V - 303Vdc, and 575 - 426.65Vdc. Not available in FR7 and FR8.</p> <p>1 = Enable power loss function 0 = Disable power loss function</p>		
P7.23	268	<p>Power loss time</p> <p>Use this parameter to set the allowable power loss max time before the drive will not auto restart when power is reestablished and run command active. If AC input voltage recovers before this time expires, drive shall continue to operate. Not available in FR7 and FR8.</p>	1, 2, 3, 4	RW
P7.24	2122	<p>Currency</p>	1, 2, 3, 4	RW
P7.25	2123	<p>Energy Cost</p> <p>Use this parameter to set the local energy cost per kW, with this value the drive will use it in the energy savings calculation.</p>	1, 2, 3, 4	RW
P7.26	2124	<p>Data Type</p> <p>Use this parameter to select the format to view Energy Savings in. The drive takes four recordings in an hour and then calculates the average based off this setting. The savings is compared to what it would cost to run a across the line starter in the same load.</p> <p>0 = Cumulative 1 = Daily Avg 2 = Weekly Avg 3 = Monthly Avg 4 = Yearly Avg</p>	1, 2, 3, 4	RW
P7.27	2125	<p>Energy savings reset</p> <p>Use this parameter to reset the Energy Savings calculation value.</p>	1, 2, 3, 4	RW
P7.28	2444	<p>2th stage ramp frequency</p> <p>Use this parameter to define the frequency level where the drive enables the 2th Stage Ramp Frequency output function. This then can be used for other inputs or devices to signal a frequency level.</p>	1,2,3,4	RW
P7.29	2515	<p>Change Phase Sequence Moto</p> <p>Use this parameter allows for swapping the motor phase output from u, v, w to u, w, v. This does not affect the forward/reverse selection. Can be used in fan and pump applications where motor rotation was incorrect and not able to swap motor leads.</p>	1,2,3,4	RW
P8.1	287	<p>Motor Ctrl mode</p> <p>Use this parameter to set the drive control mode.</p> <p>0 = Frequency control: Motor is controlled by giving a frequency reference to it. Voltage reference is calculated from scalar U/f ratio according to preprogrammed curve. (Output frequency resolution = 0.01 Hz). The frequency reference can be from I/O terminal, keypad or communication bus.</p> <p>1 = Speed control: Motor is controlled by giving a frequency reference to it with slip compensation. Voltage reference is calculated from scalar U/f ratio according to preprogrammed curve. (Output frequency resolution = 0.01 Hz). The speed reference can be from I/O terminal, keypad or communication bus (accuracy ±0.5%).</p> <p>2 = Torque Control Mode: Motor is controlled given a torque reference with slip compensation enabled. (Output frequency resolution = 0.01 Hz) The torque reference can be from I/O terminal, keypad or communication bus (accuracy ±0.5%). Only available in FR7 and FR8.</p> <p>5 = Speed Control (Open Loop): Similar to the standard Speed Control mode, but it internally calculates for the amount of slip feedback from the motor. Requires running a motor Identification to perform the calculations.</p> <p>6 = Torque control (Open loop): Motor is controlled based off a torque reference given to the drive and then based on the motor load the drive will maintain that torque level. Requires running a motor Identification to perform the calculations.</p> <p>Note: Option 0/1 is V/Hz mode, Options 5/6 are Vector control modes.</p>	1, 2, 3, 4	RW
P8.2	107	<p>Current limit</p> <p>This parameter determines the maximum motor current allowed from the frequency converter. When the motor current hits this level it goes into the current controller and tries to limit the output frequency to drop the current. This is not a fault trip limit.</p>	1, 2, 3, 4	RW

Appendix A—Description of parameters

Code	Modbus ID	Parameter	Application	RO/RW
P8.3	109	V/Hz optimization Automatic torque boost Use this parameter to enable an increase in voltage to the motor change automatically, this allows the motor to produce sufficient torque to start and run at low frequencies because of high starting torque processes. The voltage increase depends on the motor type and power. When enabled this has an effect on the linear V/Hz curve. Best results can be obtained from doing a motor identification and run the programmable V/Hz curve. <i>Example:</i> What changes are required to start the load from 0 Hz? First set the motor nominal values (Basic Parameter group). Option 1: Activate the Automatic torque boost. Option 2: Programmable V/Hz curve. To obtain the required torque, the zero point voltage and midpoint voltage/frequency (in parameter Motor Control group) need to be set, so that the motor can draw enough current at the low frequencies. First set parameter Para ID108 to Programmable V/Hz curve (value 2). Increase the zero point voltage Para ID293 to get enough current at zero speed. Then set the midpoint voltage Para ID292 to 100% and the midpoint frequency Para ID291 to value Para ID292/100%*Para ID488. Note: In high torque—low speed applications—it is likely that the motor will overheat. If the motor has to run a prolonged time under these conditions, special attention must be paid to cooling the motor. Use external cooling for the motor if the temperature tends to rise too high.	1, 2, 3, 4	RW
P8.4	108	V/Hz Ratio Use this parameter to set the type of V/Hz curve to use between the zero frequency and the field weakening point. Linear 0 = The voltage of the motor changes linearly with the frequency in the constant flux area from 0 Hz to the field weakening point where the nominal voltage is supplied to the motor. A linear V/Hz ratio should be used in constant torque applications. This default setting should be used if there is no special need for another setting. Squared 1 = The voltage of the motor changes following a squared curve form with the frequency in the area from 0 Hz to the field weakening point where the nominal voltage is supplied to the motor. The motor runs under magnetized below the field weakening point and produces less torque and electromechanical noise. A squared V/Hz ratio can be used in applications where the torque demand of the load is proportional to the square of the speed, e.g., in centrifugal fans and pumps.	1, 2, 3, 4	RW

Figure 82. Linear and squared change of motor voltage

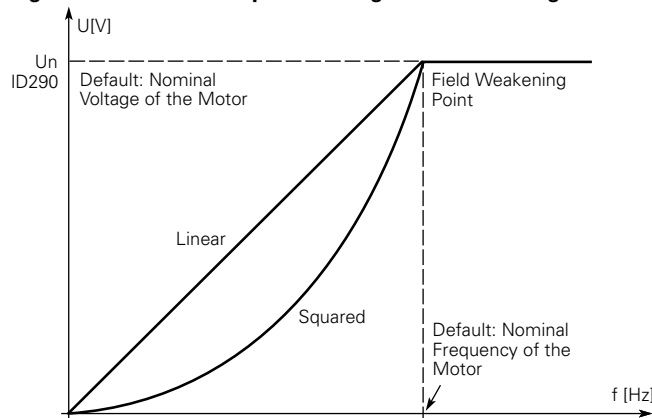

Programmable V/Hz curve

2 = The V/Hz curve can be programmed with three different points. These points are the 0 frequency voltage, midpoint and weakening point. A programmable V/Hz curve can be used if the other settings do not satisfy the needs of the application. When running the Motor Identification this parameter gets set by default along with the values below for the V/Hz curve along with the resistance information of the motor.

Code	Modbus ID	Parameter	Application	RO/RW
------	-----------	-----------	-------------	-------

Figure 83. Programmable V/Hz curve

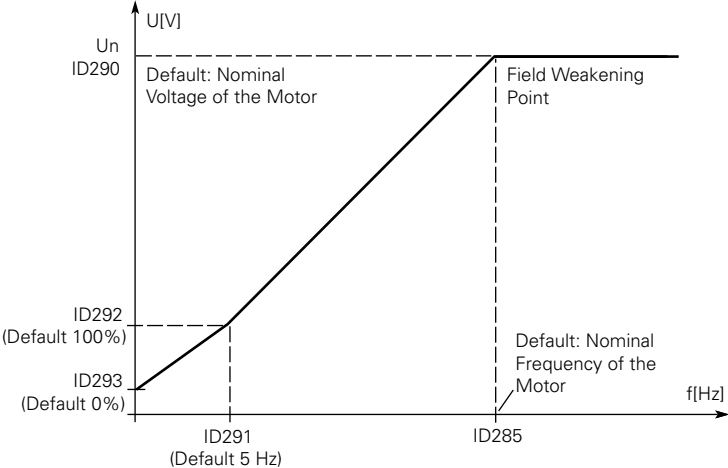

Manual motor tuning - in multi-purpose app

- Setting the Motor Magnetizing current:
 - Run the Motor at 2/3 of the motor nominal frequency as the frequency reference.
 - Read the Motor current in the Monitor Menu or via the InControl PC tool.
 - Set the current as the Motor Excitation Current(Para ID775)
- Set the V/Hz optimization parameter (Para ID108) to value 2 “Programmable V/Hz curve”.
- Run the Motor with zero frequency reference and increase the motor zero point voltage (Para ID293) until the motor current is approximately same as the motor Excitation Current. If the Motor is in a low frequency area for only short periods, 65% of the motor nominal current is possible.
- Set the Midpoint Voltage (Para ID292) to $1.4142 \cdot (\text{Para ID293})$ and midpoint frequency(Para ID291) to value $\text{Para ID291}/100\% \cdot \text{Para ID488}$.
- If required, activate the speed control or V/Hz Optimization (Torque Boost).
- If required, activate the speed control and V/Hz Optimization (Torque Boost).

Linear with flux optimization

3 = The frequency converter starts to search for the minimum motor current in order to save energy, lower the disturbance level and the noise. This function can be used in applications with constant motor load, such as fans, pumps, etc

P8.5	289	Field weakening point Use this parameter to set the frequency at which the output voltage reaches the field weakening point. This value is usually determined by the motor nameplate value or if motor specs were supplied it can be further adjusted.	1, 2, 3, 4	RW
P8.6	290	Voltage at FWP Use this parameter to set the voltage at the field weakening point as a percentage of the motor nominal voltage. Above the frequency at the field weakening point, the output voltage remains at the set maximum value. Below the frequency at the field weakening point, the output voltage depends on the setting of the V/Hz curve parameters.	1, 2, 3, 4	RW
P8.7	291	V/Hz mid freq Use this parameter if the programmable V/Hz curve has been selected, it defines the midpoint frequency of the curve. This value can be set anywhere between 0 and the FWP, to either have a different V/Hz ramp or if set to the FWP it will provide the max voltage all the way up the curve.	1, 2, 3, 4	RW
P8.8	292	V/Hz mid volt Use this parameter if programmable V/Hz curve has been selected, it defines the mid point voltage of the curve. This value can be set anywhere between zero frequency Volt and the FWP voltage, this can either have a different ramp above and below this point or allow for max voltage.	1, 2, 3, 4	RW
P8.9	293	Zero frequency volt Use this parameter if programmable V/Hz curve has been selected, it defines the zero frequency voltage of the curve. When putting this value above 0% additional voltage is given, in some cases by putting this value to high it can cause the motor to be oversaturated.	1, 2, 3, 4	RW

Appendix A—Description of parameters

Code	Modbus ID	Parameter	Application	RO/RW
P8.10	288	<p>Switching frequency</p> <p>This parameter sets the frequency that the PWM wave rides on, higher switching frequency will be cleaner the output sine wave, lower switching frequency will be a choppy sine wave.</p> <p>Motor noise can be minimized using a high switching frequency but the amount of heat dissipation increases. Increasing the switching frequency reduces the capacity of the frequency converter unit.</p> <p>For protection against thermal overload, the switching frequency automatically is reduce in the fact that the ambient temperature is high as well as high load currents.</p> <p>Note: See Installation Manual for the values listed for the individual frame size switching frequency ranges. It also provides de-rating tables required for sizing.</p>	1, 2, 3, 4	RW
P8.11	1665	<p>Sine filter enable</p> <p>This parameter is used when a sine filter is connected to the output motor leads, the parameter is used to lock in the thermal management controls to not decrease the Switching frequency.</p>	1, 2, 3, 4	RW
P8.12	294	<p>Overvoltage control</p> <p>This parameters allow the overvoltage controllers to be switched out of operation. This may be useful, for example, if the main supply voltage varies more than -15% to +10% and the application will not tolerate this overvoltage. In this case, the regulator controls the output frequency taking the supply fluctuations into account.</p> <p>0 = Controller switched off 1 = Controller switched on</p>	1, 2, 3, 4	RW
P8.13	298	<p>Load drooping</p> <p>This parameter is used to enable speed drop as a function of the load, used to share loads between mechanically coupled motors. This parameter corresponds to the nominal torque of the motor.</p> <p>Example: If load drooping is set to 10% for a motor that has a nominal frequency of 50Hz and is nominally loaded (100% of torque) the output frequency is allowed to decrease 5Hz from the frequency reference. The function is used for e.g. when balanced load is needed for mechanically connected motors.</p>	4	RW
P8.14	299	<p>Identification</p> <p>With this parameter, the drive will identify the motor and adjust tuning parameters to improve starting torque and open loop current control on an unloaded motor. Upon this operation it will be active then set back to 0. When a run command is seen the message on the keypad will indicate "Motor Identification" is being performed and when completed will show "Motor ID Completed". If there is an issue with the Motor Identification a fault message will be displayed. Once completed this will set the V/Hz curve up to correspond to the resistance values obtained for optimized control of the motor.</p> <p>0 = Not Action 1 = Identification only stator resistor 2 = Identification with run Note: Identification with Run must be performed on an unloaded motor shaft for accurate results. 3 = Identification no run - Motor is supplied with current and voltage but at zero frequency. In FR7 and FR8 this is the same as selecting option 1.</p> <p>Note: Identification with Run must be performed on an unloaded motor shaft for accurate results. This is available in all applications on Frame 7 and 8.</p>	4/1,2,3,4	RW
P8.15	1574	<p>Neg frequency limit</p> <p>Frequency limit in the reverse direction in Open Loop Speed Control mode.</p>	4	RW
P8.16	1576	<p>Pos frequency limit</p> <p>Frequency limit in the forward direction in Open Loop Speed Control mode.</p>	4	RW
P8.17	1585	<p>Frequency ramp out filter time constant</p> <p>Filter time used with the internal Ramp output generator for Open Loop Speed Control mode. Not available in FR7 and FR8.</p>	1, 2, 3, 4	RW
P8.18	1591	<p>Speed error filter time constant</p> <p>Filter time constant for speed reference vs actual speed difference calculation.</p>	4	RW
P8.19	1592	<p>Speed error band stop frequency</p> <p>Speed error Band Stop Frequency. Not available in FR7 and FR8.</p>	4	RW
P8.20	1593	<p>Speed control Kp</p> <p>Proportional Gain Kp of Motor Speed Control loop. Gain Value of 100% means that the nominal torque reference is produced at the speed controller output fro a frequency error of 1Hz.</p>	4	RW
P8.21	1594	<p>Speed control Ti</p> <p>Integral time Ti of the Motor Speed Control loop.</p>	4	RW
P8.22	1595	<p>Speed control Kp at field weakening</p> <p>The relative gain of the speed controller in the Field weakening area as a percentage of the Speed Control Gain (See Para ID1593). See image in Para ID1598. Not available in FR7 and FR8.</p>	4	RW

Code	Modbus ID	Parameter	Application	RO/RW
P8.23	1596	Speed control Kp below F0 The relative gain of the speed controller as a percentage of the Speed Control Gain (See Para ID1593) when the speed is below the defined level of Speed Control F0 frequency (see Para ID1597). See Image in Para ID1598. Not available in FR7 and FR8.	4	RW
P8.24	1597	Speed control F0 Speed Level in Hz below the speed controller gain is equal to the Speed Control Gain Below F0 (See Para ID1596). See image in Para ID1598. Not available in FR7 and FR8.	4	RW
P8.25	1598	Speed control F1 The Speed level in Hz above the speed controller Gain is equal to the Speed Control Gain (See Para ID1593). From the speed defined by the F0 (See Para ID1597) setting to the speed defined by the F1 setting, the speed controller gain changes linearly from the F0 gain to the Speed Gain Kp. Not available in FR7 and FR8.	4	RW

Figure 84. Speed control F1

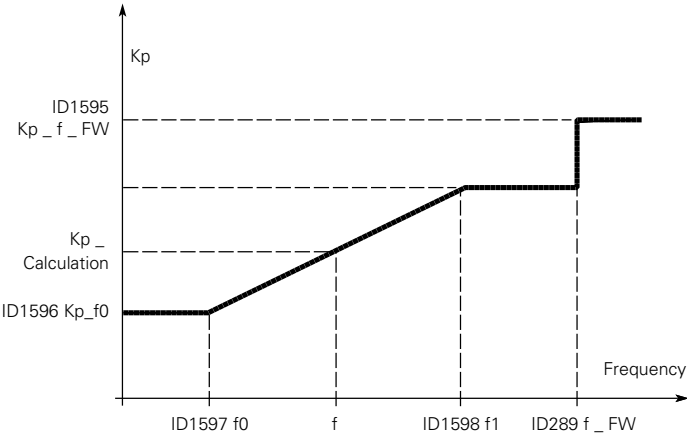

P8.26	1599	Speed control Kp below T0 The relative gain of the speed controller as a percentage of the Speed Control Gain (See Para ID1593) when torque reference or speed control output is less than the value of Speed Control T0 (See Para ID1600). This parameter is normally used to stabilize the speed controller for a drive system with gear backlash. Not available in FR7 and FR8.v	4	RW
P8.27	1600	Speed control T0 The level of torque reference below which the speed controller gain is changed from the Speed Control Gain (See Para ID1593) to Speed Control T0. This is a percentage of nominal Torque. Not available in FR7 and FR8.	4	RW
P8.28	1601	Speed control Kp filter time constant Filter time constant for the speed controller gain. Not available in FR7 and FR8.	4	RW
P8.29	1602	Motor torque limit This parameter sets the maximum torque limit of the motoring side.	4	RW
P8.30	1603	Generator torque limit This parameter sets the maximum torque limit of the generating side.	4	RW
P8.31	1604	Torque limit forward This parameter sets the maximum torque limit of the drive in the forward direction.	4	RW
P8.32	1605	Torque limit reverse This parameter sets the maximum torque limit of the drive in the reverse direction.	4	RW
P8.33	1607	Motor power limit This parameter sets the masimum power limit of the motoring side.	4	RW
P8.34	1608	Generator power limit This parameter sets the maximum power limit of the generating side.	4	RW
P8.35	1611	Acc compensation time constant Torque Compensation during acceleration to overcome mass of inertia. It improves speed response and is defined as acceleration time to nominal speed with nominal torque. Not available in FR7 and FR8.	4	RW

Appendix A—Description of parameters

Code	Modbus ID	Parameter	Application	RO/RW
P8.36	1612	Acc compensation filter time constant The Filter time for the Acceleration Compensation time Constant (See Para ID1611). Used to remove any disturbances in the inertia feedback seen by the controller. Not available in FR7 and FR8.	4	RW
P8.37	1620	Flux reference This parameter defines the amount of flux that is output to the motor at any frequency or speed level.	4	RW
P8.38	1621	Stop state magnetization This parameter defines the % of magnetizing current based off the nominal current the drive will output in a stop state. This value is obtained during motor identification or auto tuning. Not available in FR7 and FR8.	4	RW
P8.39	1622	Start boost rise time Acceleration time used with auto torque boost. Limits the amount of time the boost is enabled. Not available in FR7 and FR8.	1, 2, 3, 4	RW
P8.40	1623	Flux current ramp time Defines the amount of time required for the Flux Current to build up in the motor. Not available in FR7 and FR8.	4	RW
P8.41	1624	Zero speed start time After giving the start command the drive will remain at 0 speed for the time defined by this parameter. The speed will then be released to follow the set frequency/speed reference after this time has elapsed from the instant where the command is given. Not available in FR7 and FR8.	4	RW
P8.42	1625	Zero speed stop time The drive will remain at zero speed with controllers active for the time defined by this parameter after reaching the zero speed when a stop command is given. This parameter has no effect if the selected stop function is coasting. The zero speed time starts when the ramp time is expected to reach zero speed. Not available in FR7 and FR8.	4	RW
P8.43	1630	Droop control filter time constant Filter time when using droop control	4	RW
P8.44	1631	Start torque selection Selects where the start up torque reference is coming from there are 3 options depending on the desired reference response on startup; either Start Memory (See Para ID1632), Torque Reference, and Start Torque FWD/REV (See Para ID1633 or See Para ID1634). This reference is only active when a start command is given from there it will follow the desired torque reference location.	4	RW
P8.45	1632	Start memory start This starting torque reference comes from the Para ID1635 Actual Torque. On start it will use the measure actual torque value stored to memory and then use that value the next time a start is required. This is available in all applications on Frame 7 and 8.	4/1,2,3,4	RW
P8.46	1633	Start torque forward Defines the amount of Starting torque reference applied on startup in the forward direction when selected in Para ID1631.	4	RW
P8.47	1634	Start Torque Reverse Defines the amount of Starting torque reference applied on startup in the reverse direction when selected in Para ID1631.	4	RW
P8.48	1635	Start Torque Actual This parameter is the Actual starting torque	4	RO
P8.49	1667	Startup Torque Time This time is used to define the amount of time the Start Torque value assigned in Para ID1631 will be applied for before the normal torque reference is used.	4	RW
P8.50	771	Stator Resistor Stator resistance of the motor, this value is the stator winding resistance of the windings in the motor. Value is measured when performing Identification (See Para ID299). This is available in all applications on Frame 7 and 8.	4/1,2,3,4	RW
P8.51	772	Rotor Resistor Rotor resistance of the motor, this value is the rotor resistance of the motor. Value is measured when performing Identification (See Para ID299). Not available in FR7 and FR8.	4	RW
P8.52	773	Leak Inductance Inductance of the Motor (Stator + Rotor), this value is the amount of magnetic inductance that does not link to a winding in the motor. Value is measured when performing Identification (See Para ID299). This is available in all applications on Frame 7 and 8.	4/1,2,3,4	RW

Code	Modbus ID	Parameter	Application	RO/RW
P8.53	774	Mutual Inductance Main Inductance of the motor, this value is the amount of inductance between 2 sets of windings in the motor. Value is measured when performing Identification (See Para ID299). Not available in FR7 and FR8.	4	RW
P8.54	775	Excitation Current Magnetizing Current of the motor, this value is the amount of electrical current required to generate a rotating magnetic field in the motor. Value is measured when performing Identification (See Para ID299).	4	RW
P8.55	58	Advanced Open Loop Options “Use this parameter to set the options of the advanced sensorless control. The parameter has a checkbox selection of values. B0 = Stator Resistance Identification - identify the stator resistance during the start magnetisation. The bit B0 enables stator resistance identification at each start. It cannot be used when a start is made to a rotating motor. It is recommended when a start is always made from standstill. The temperature has an effect on the stator resistance value. A correct resistance value is necessary for the advanced sensorless control, especially at low frequencies. The temperature effect is mitigated, when instead of using a value that was identified in the first identification run, the resistance is identified at each start. When you set the bit to 1, the stator resistance is identified during the start magnetisation. B1 - B2 = Reserved B3 = Limit Frequency Polarity -When this option is selected the frequency is limited based on sign of frequency reference. With positive frequency reference the output frequency is always limited to positive value, and vice versa. This makes the control system more robust toward parameter errors, especially when induction motor is used, but can only be used if nature of process allows it: • No speed reversal with high or moderate load are required. • No high impact loads at low frequencies that could “pull” the shaft to opposite direction. • No operation at generator side. B4 - B7 = Reserved B8 = Voltage based Current limit - Bit B8 activates a function that reduces the risk of the control system getting stuck in the current limit at low frequencies by limiting the motor voltage. This could occur because of errors in the parameter settings. The function is active only when the output frequency is less than 1.0 Hz. Use the bit B8 only if the nature of the process allows it, because otherwise it can lead to loss of performance due to limited voltage. Bit B8 can be used if there is no need to run against current or torque limit or handle high loads at low frequencies in normal operation. An example of a situation when the bit should not be used is operation against a locked rotor. B9 = Limit Voltage Polarity - When this option is activated the voltage vector calculation is limited based on sign of output frequency. This makes the control system more robust against parameter errors, but can only be used if nature of process allows it: • No speed reversal with high or moderate load are required. • No high impact loads at low frequencies that could “pull” the shaft to opposite direction. • No operation at generator side. Note: It is recommended to use this option together with “Limit frequency polarity” B10 - B12 = Reserved B13 = DC Brake At Start - This selection allows modifications to the start magnetizing phase and allows dc brake at start functionality when in open loop control modes. During a normal start magnetization phase, the drive first builds up the flux in the motor as fast as possible by outputting DC Brake Current value, once the motor flux has built up. The drive transitions and outputs the Excitation Current value for the remainder of the Start DC Brake Time. When the DC Brake at Start is enabled, the drive will maintain DC Brake Current for the majority of the Start DC Brake Time and will only reduce the current to the Excitation level just prior to attempting to start the motor. B14 = Ramp Anti-windup - Use the ramp anti-windup control. The bit B14 defines the reaction of the ramp output during the limit control functions. By default, the limit controls have no effect on the ramp output. This causes the motor to accelerate with maximum torque (against the current limit) to the speed reference when the limit control deactivates. By activating bit B14, the ramp output follows the actual frequency/speed with a defined gap. Thus, when the limit control deactivates, the motor accelerates to the speed reference with the defined ramp time. The default value of the gap frequency is 3.0 Hz. B15 = Reserved”	4	RW
P8.56	63	Torque Stability Gain Use this parameter to set the gain of the torque stabilator in an open loop control operation.	4	RW
P8.57	64	Torque Stability FWP Gain “Use this parameter to set the gain of the torque stabilator at field weakening point in an open loop control operation. The torque stabiliser stabilises the possible oscillations in the estimated torque. Two gains are used. TorqStabGainFWP is a constant gain at all the output frequencies. TorqStabGain changes linearly between the zero frequency and the field weakening point frequency. The full gain is at 0 Hz and the gain is zero at the field weakening point. The figure shows the gains as a function of output frequency.”	4	RW
P8.58	62	Torque Stability Dampening Time Use this parameter to set the damping time constant of the torque stabiliser.	4	RW

Appendix A—Description of parameters

Code	Modbus ID	Parameter	Application	RO/RW
P9.1	306	<p>4 mA Input Fault</p> <p>Use this parameter to set the device reaction after occurring of “4-20mA fault”. This fault could be device dependent. The information can also be programmed into digital output DO1 or relay outputs RO1 and RO2.</p> <p>0 = No response 1 = Warning 2 = Warning, the frequency from 10 seconds back is set as reference 3 = Warning, the Preset Frequency Para ID331 is set as reference 4 = Fault, stop mode after fault according to standard stop mode. 5 = Fault, stop mode after fault always by coasting</p>	1, 2, 3, 4	RW
P9.2	331	<p>4 mA Fault Freq</p> <p>Use this parameter to set the preset frequency for the 4-20mA fault condition. See Para ID306 = 3.</p>	1, 2, 3, 4	RW
P9.3	307	<p>External Fault</p> <p>Use this parameter to set the device reaction after occurring of “External Fault”. This failure could be device dependent. The status information can also be programmed into digital output DO1 and into relay outputs RO1 and RO2.</p> <p>0 = No response 1 = Warning - Note not available in FR7 and FR8 2 = Fault, stop mode after fault according to standard stop mode 3 = Fault, stop mode after fault always by coasting -Note not available in FR7 and FR8</p>	1, 2, 3, 4	RW
P9.4	332	<p>Input Phase Fault</p> <p>Use this parameter to set the device reaction to a “Phase Loss” fault condition. This failure could be device dependent.</p> <p>0 = No response 1 = Warning Note: not available in FR7 and FR8 2 = Fault, stop mode after fault according to standard stop mode 3 = Fault, stop mode after fault always by coasting Note: not available in FR7 and FR8</p>	1, 2, 3, 4	RW
P9.5	330	<p>Undervoltage Fault Resp</p> <p>Use this parameter to set the device reaction to a “UnderVoltage Mains” fault condition. This failure could be device dependent.</p> <p>0 = No response 1 = Warning 2 = Fault, stop mode after fault according to standard stop mode 3 = Fault, stop mode after fault always by coasting</p>	1, 2, 3, 4	RW
P9.6	308	<p>OutputPhaseFault</p> <p>Use this parameter to set the device reaction to a “Phase Loss Output” condition. This failure could be device dependent.</p> <p>0 = No response 1 = Warning 2 = Fault, stop mode after fault according to standard stop mode 3 = Fault, stop mode after fault always by coasting</p>	1, 2, 3, 4	RW
P9.7	309	<p>Ground Fault</p> <p>Use this parameter to set the device reaction to a “Ground Fault U-V-W” fault condition. This failure could be device dependent. The level of fault occurs is based off the total drive current and the Para ID2158.</p> <p>0 = No response 1 = Warning 2 = Fault, stop mode after fault according to standard stop mode 3 = Fault, stop mode after fault always by coasting</p>	1, 2, 3, 4	RW

Code	Modbus ID	Parameter	Application	RO/RW
P9.8	310	Motor Therm Prot Use this parameter to set the device reaction to a “Overtemperature Motor” fault condition. This failure could be device dependent. Deactivating this protection, i.e., setting parameter to 0, will reset the thermal stage of the motor to 0%. 0 = No response 1 = Warning 2 = Fault, stop mode after fault according to standard stop mode 3 = Fault, stop mode after fault always by coasting	1, 2, 3, 4	RW

P9.9	311	Motor Therm F0 Current This parameter sets minimal current at speed zero without thermal overload. The default value is set assuming that there is no external fan cooling the motor. If an external fan is used, this parameter can be set to 90% (or even higher). Note: The value is set as a percentage of the motor nameplate data, Para ID486 (nominal current of the motor), not the drive’s nominal output current. The motor’s nominal current is the current that the motor can withstand in direct on-line use without being overheated. If you change the parameter Nominal current of motor, this parameter is automatically restored to the default value. Setting this parameter does not affect the maximum output current of the drive, which is determined by Param ID1679 alone.	1, 2, 3, 4	RW
------	-----	--	------------	----

Figure 85. Motor thermal current it curve

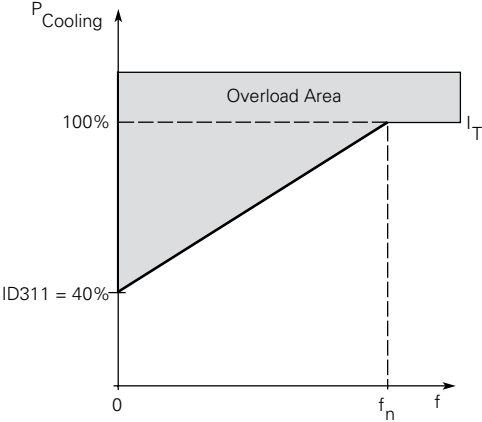

Appendix A—Description of parameters

Code	Modbus ID	Parameter	Application	RO/RW
P9.10	312	Motor Thermal Time	1, 2, 3, 4	RW

This parameter is used to set the time constant of the motor to rise to 63% of thermal load. The motor thermal time is specific to the motor design and it varies between different motor manufacturers.

If the motor's t6-time (t6 is the time in seconds the motor can safely operate at six times the rated current) is known (given by the motor manufacturer) the time constant parameter can be set based on it. As a rule of thumb, the motor thermal time constant in minutes is equal to 2xt6. If the drive is in stop stage, the time constant is internally increased to three times the set parameter value. The cooling in the stop stage is based on convection and the time constant is increased.

Figure 86. Motor temperature calculation

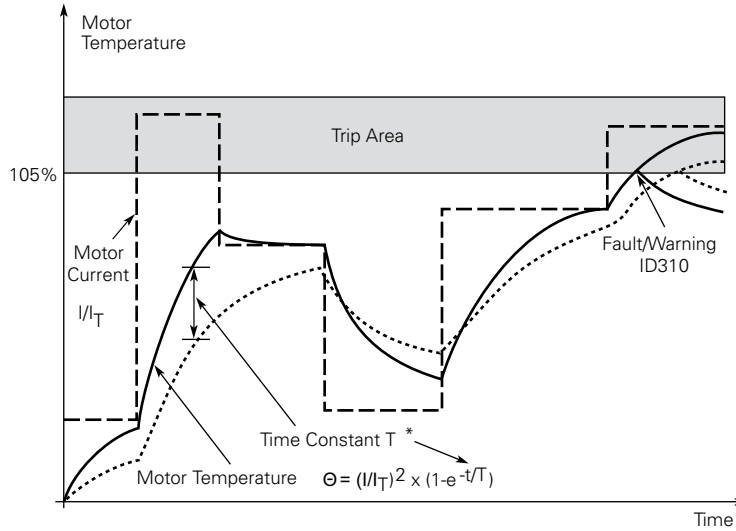

P9.11	313	Stall protection	1, 2, 3, 4	RW
-------	-----	-------------------------	------------	----

Use this parameter to set the device reaction after a "Motor Stalled" condition has occurred. This is customer selectable based off of current level, frequency level and time.

- 0 = No Action
- 1 = Warning
- 2 = Fault
- 3 = Fault, Coast

P9.12	314	Stall current limit	1, 2, 3, 4	RW
-------	-----	----------------------------	------------	----

This parameter is used to set the current level when above the unit will stall. For a stall stage to occur, the current must have exceeded this limit. The software does not allow entering a greater value than $I_n \cdot \text{Motor}^2$. If nominal motor current is changed, this parameter is automatically restored to the default value (IL).

Figure 87. Stall characteristics settings



Code	Modbus ID	Parameter	Application	RO/RW
P9.13	315	Stall time limit This parameter is used to set the time limit before a stall error occurs. The stall time is counted by an internal up/down counter based off the current being above the limit setting. If the stall time counter value goes above this limit the protection will cause a trip (see Para ID313).	1, 2, 3, 4	RW

Figure 88. Stall time count

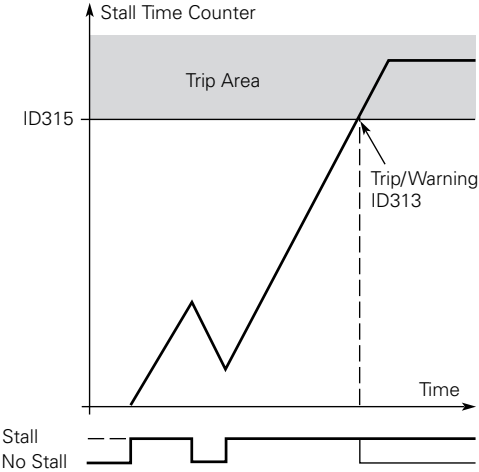

P9.14	316	Stall frequency limit This parameter is used to set the frequency level where below it a stall condition and is above the current limit for the stall time to occur.	1, 2, 3, 4	RW
P9.15	317	Underload Protection This parameter is used to set the device reaction to an "UnderLoad Motor" condition. Deactivating the protection by setting the parameter to 0 will reset the underload time counter to zero. 0 = No response 1 = Warning 2 = Fault, stop mode after fault according to standard stop mode 3 = Fault, stop mode after fault always by coasting	1, 2, 3, 4	RW

P9.16	318	Underload from torque This parameter gives the value for the minimum torque allowed when the output frequency is at or above the field weakening point. If you change Para ID486, nominal motor current, this parameter is automatically restored to the default value.	1, 2, 3, 4	RW
-------	-----	--	------------	----

Figure 89. Setting of minimum load

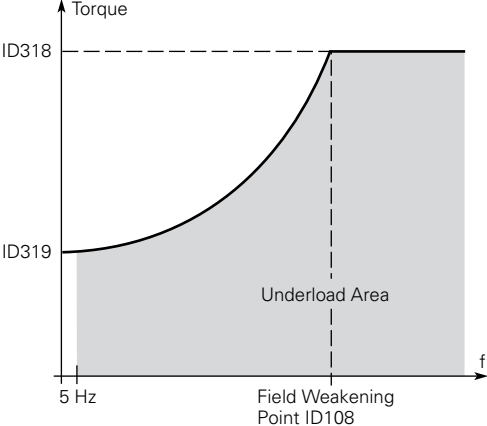

Appendix A—Description of parameters

Code	Modbus ID	Parameter	Application	RO/RW
P9.17	319	Underload F0 torque This parameter gives value for the minimum torque allowed at zero frequency. If you change the value of Para ID486, nominal motor current, this parameter is automatically restored to the default value.	1, 2, 3, 4	RW
P9.18	320	Underload Time Limit This is the maximum time allowed in an underload condition. An internal up/down counter counts the accumulated underload time. If the underload counter value goes above this limit, the protection will cause a trip according to Para ID317. If the drive is stopped, the underload counter is reset to zero.	1, 2, 3, 4	RW
Figure 90. Underload time counter function				
P9.19	333	Thermistor fault response This parameter is used to define the device reaction after a “Thermistor Fault Motor” condition occurs. This failure could be device dependent. 0 = No response 1 = Warning 2 = Fault, stop mode after fault according to standard stop mode. 3 = Fault, stop mode after fault always by coasting	1, 2, 3, 4	RW
P9.20	750	Line Start Lockout This parameter determines the response of frequency converter going to a run state cycle with I/O run command is still active as the control place. 0 = Respond to I/O run command when power is applied. If in another control place and switched to I/O control do not respond. (Run Command has to be cycled) 1 = Do not respond to I/O run command when power is applied. If in another control place and switched to I/O control do not respond (Run Command has to be cycled) 2 = Respond to I/O commands when power is applied. If in another control place and switched to I/O control the drive will respond to a maintained Run Command. 3 = Do Not respond to I/O commands when power is applied. If in another control place and switched to I/O control the drive will respond to a maintained Run Command.	1, 2, 3, 4	RW
P9.21	334	Fieldbus fault response This parameter used to set the reaction after a “Network COM Fault” condition occurs. This failure could be device dependent. 0 = No response 1 = Warning 2 = Fault, stop mode after fault according to standard stop mode. 3 = Fault, stop mode after fault always by coasting	1, 2, 3, 4	RW
P9.22	335	OPTCard fault response This parameter used to set the reaction after a “Link to Option Card” condition occurs. This failure could be device dependent. 0 = No response 1 = Warning 2 = Fault, stop mode after fault according to standard stop mode. 3 = Fault, stop mode after fault always by coasting	1, 2, 3, 4	RW

Code	Modbus ID	Parameter	Application	RO/RW
P9.23	1564	Unit under temp prot This parameter used to set the reaction when a "Undertemperature Device" condition occurs. This failure could be device dependent. 0 = No response 1 = Warning 2 = Fault, stop mode after fault according to standard stop mode. 3 = Fault, stop mode	1, 2, 3, 4	RW

P9.24	321	AR Wait time This parameter defines the time before the frequency converter tries to automatically restart the motor after a specific fault condition has been received. Auto Restart faults listed Para ID324 to Para ID336.	1, 2, 3, 4	RW
-------	-----	---	------------	----

P9.25	322	AR Trial time This parameter sets the amount of time after the Wait time that the drive uses the restart tries to attempt to restart the fault, after this time has run out without resetting the alarm drive will fault.	1, 2, 3, 4	RW
-------	-----	---	------------	----

Figure 91. Auto restart fail (try number >2.)

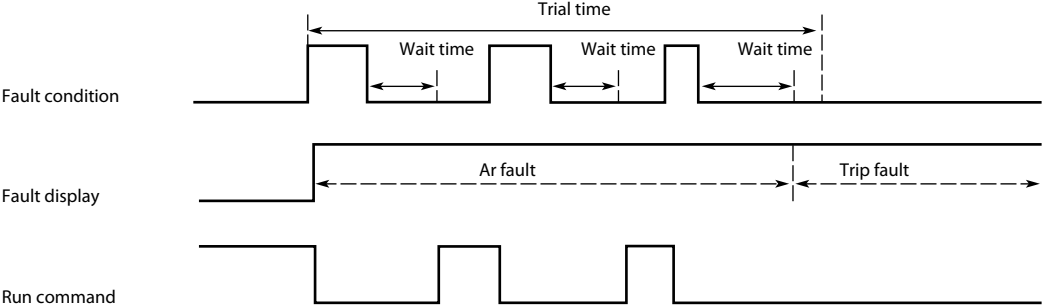

Fig5. Auto restart fail (try number >2.)

Para ID324 to Para ID336 determine the maximum number of automatic restarts during the trial time set by Para ID322. The time count starts from the first auto restart. If the number of faults occurring during the trial time exceeds the values of Para ID324 to Para ID336 the fault state becomes active. Otherwise the fault is cleared after the trial time has elapsed and the next fault starts the trial time count again.

If a single fault remains during the trial time, a fault state is true.

P9.26	323	AR Start function This parameter defines the way the device handles the start operation after a fault occurs. The parameter defines the start mode upon a auto restart condition: 0 = Start with ramp 1 = Flying start 2 = Start according to the standard start mode	1, 2, 3, 4	RW
-------	-----	--	------------	----

Appendix A—Description of parameters

Code	Modbus ID	Parameter	Application	RO/RW
P9.27	324	<p>Undervoltage attempts</p> <p>This parameter determines the number of allowed restart-attempts after “DC-Undervotlag” condition has occurred.</p> <p>0 = No automatic restart</p> <p>>0 = Number of automatic restarts after under voltage fault. The fault is reset and the drive is started automatically after the DC-link voltage has returned to the normal level.</p>	1, 2, 3, 4	RW
P9.28	325	<p>Overvoltage attempts</p> <p>This parameter determines the number of allowed restart-attempts after “DC-Overvoltage” condition has occurred.</p> <p>0 = No automatic restart after overvoltage fault trip</p> <p>>0 = Number of automatic restarts after overvoltage fault trip. The fault is reset and the drive is started automatically after the DC-link voltage has returned to the normal level.</p>	1, 2, 3, 4	RW
P9.29	326	<p>Overcurrent attempts</p> <p>This parameter determines the number of allowed restart-attempts after “Overcurrent” condition has occurred.</p> <p>Note: An IGBT temperature fault, Saturation Fault and Overcurrent Faults are included as part of this fault.</p> <p>0 = No automatic restart after overcurrent fault trip</p> <p>>0 = Number of automatic restarts after an overcurrent trip, saturation trip or IGBT temperature fault.</p>	1, 2, 3, 4	RW
P9.30	327	<p>4 mA fault attempts</p> <p>This parameter determines the number of allowed restart-attempts after “4-20mA fault” condition has occurred.</p> <p>0 = No automatic restart after reference fault trip</p> <p>>0 = Number of automatic restarts after the analog current signal (4–20 mA) has returned to the normal level (>4 mA)</p>	1, 2, 3, 4	RW
P9.31	329	<p>Motor temp fault attempts</p> <p>This parameter determines the number of allowed restart-attempts after “Thermistorfault Motor” condition has occurred.</p> <p>0 = No automatic restart after Motor temperature fault trip</p> <p>>0 = Number of automatic restarts after the motor temperature has returned to its normal level</p>	1, 2, 3, 4	RW
P9.32	328	<p>External fault attempts</p> <p>This parameter determines the number of allowed restart-attempts after “External Fault” condition has occurred.</p> <p>0 = No automatic restart after External fault trip</p> <p>>0 = Number of automatic restarts after External fault trip</p>	1, 2, 3, 4	RW
P9.33	336	<p>Underload attempts</p> <p>This parameter determines the number of allowed restart-attempts after “Underload Motor” condition has occurred.</p> <p>0 = No automatic restart after an Underload fault trip</p> <p>>0 = Number of automatic restarts after an Underload fault trip</p>	1, 2, 3, 4	RW
P9.34	955	<p>RTC fault</p> <p>This parameter sets the device reaction after a “Realtime Clock Fault” condition has occurred. This condition could be possible device dependent.</p> <p>0 = No response</p> <p>1 = Warning</p> <p>2 = Fault, stop mode after fault according to standard stop mode</p> <p>3 = Fault, stop mode after fault always by coasting</p>	1, 2, 3, 4	RW
P9.35	337	<p>PT100 fault response</p> <p>This parameter sets the device reaction after a “PT100 Fault” condition has occurred. This condition could be possible device dependent.</p> <p>0 = No response</p> <p>1 = Warning</p> <p>2 = Fault, stop mode after fault according to standard stop mode</p> <p>3 = Fault, stop mode after fault always by coasting</p>	1, 2, 3, 4	RW

Code	Modbus ID	Parameter	Application	RO/RW
P9.36	1256	Replace battery fault response This parameter sets the device reaction after a “Replace Battery” condition has occurred, when the battery falls below 2V level. This condition could be possible device dependent. 0 = No response 1 = Warning 2 = Fault, stop mode after fault according to standard stop mode 3 = Fault, stop mode after fault always by coasting	1, 2, 3, 4	RW
P9.37	1257	Replace fan fault response This parameter sets the device reaction after a “Replace Device Fan” condition has occurred, when the fan run time counter expires. This condition could be possible device dependent. 0 = No response 1 = Warning 2 = Fault, stop mode after fault according to standard stop mode 3 = Fault, stop mode after fault always by coasting	1, 2, 3, 4	RW
P9.38	1678	IP address conflict response This parameter sets the device reaction after a “IP Conflict” condition has occurred, when the ip address is duplicated on the network. This condition could be possible device dependent. 0 = No response 1 = Warning 2 = Fault, stop mode after fault according to standard stop mode 3 = Fault, stop mode after fault always by coasting	1, 2, 3, 4	RW
P9.39	2126	Cold weather mode This parameter allows for enabling a cold weather function that allows the frequency converter’s under temp limit to drop from –10°C to –30°C drive. This then enables a warmup feature when the frequency converter is between –30°C and –20°C. The motor, when given a run command, will turn on for the Cold Weather Timeout (See Par ID 2128) and output the Cold Weather Voltage (See Par ID 2127) at 0.5 Hz to allow the motor to warm up. If it does not warm up above –20°C, after that the time frequency converter will fault on Under temp fault. If the frequency converter does go above –20°C, output will begin to follow reference. Not available in FR7 and FR8. 0 = Disable 1 = Enable	1, 2, 3, 4	RW
P9.40	2127	Cold weather voltage level This parameter allows for setting the % of the motor voltage that is output to the motor when in the cold weather warmup period. Not available in FR7 and FR8.	1, 2, 3, 4	RW
P9.41	2128	Cold Weather Time Out This parameter allows for selecting the time limit that the frequency converter will run in the warm up period. Not available in FR7 and FR8.	1, 2, 3, 4	RW
P9.42	2129	Cold weather password This password allows access to override the under temperature fault protection, this parameter is seen by pressing the left and right soft keys on the keypad. Password should be set to 32866, this value gets reset on cycle of power. Not available in FR7 and FR8.	1, 2, 3, 4	RW
P9.43	2130	Drive under temperature fault override With the password set to the correct value this parameter is enabled and will give the ability to override the under temp fault. This function gets reset when power is cycled. Not available in FR7 and FR8.	1, 2, 3, 4	RW
P9.44	2158	Ground fault limit This parameter sets the level of the ground fault protection, this protection is based off the amount of leakage current that is seen to ground on the output of the drive. Not available in FR7 and FR8.	1, 2, 3, 4	RW
P9.45	2157	Keypad comm fault response This parameter determines the device reaction after a “Keypad Fault” condition. This condition could be possible device dependent. 0 = No Action 1 = Warning 2 = Fault, stop mode after fault according to standard stop mode 3 = Fault, stop mode after fault always by coasting	1, 2, 3, 4	RW

Appendix A—Description of parameters

Code	Modbus ID	Parameter	Application	RO/RW
P9.46	2159	<p>Preheat mode</p> <p>This parameter defines the location for enabling or disabling the preheat function where this is used in the case depending on where the temperature is being read from the drive will turn on the output to allow current to flow to the motor if the temperature of the drive or PT100 sensor drops, this is typically used when the motor is not running.</p> <p>0 = Disable 1 = Enable</p>	1, 2, 3, 4	RW
P9.47	2160	<p>Preheat temp source</p> <p>This parameter selects the source of where the temperature is coming from to enable the preheat function, it can be enabled from a digital input or automatically via internal/external temperature sensors.</p> <p>0 = DigIN: NormallyOpen 1 = DigIN: NormallyClosed 2 = DigIN: 1 3 = DigIN: 2 4 = DigIN: 3 5 = DigIN: 4 6 = DigIN: 5 7 = DigIN: 6 8 = DigIN: 7 9 = DigIN: 8 10 = DigIN: A: IO1: 1 11 = DigIN: A: IO1: 2 12 = DigIN: A: IO1: 3 13 = DigIN: A: IO5: 1 14 = DigIN: A: IO5: 2 15 = DigIN: A: IO5: 3 16 = DigIN: A: IO5: 4 17 = DigIN: A: IO5: 5 18 = DigIN: A: IO5: 6 19 = DigIN: B: IO1: 1 20 = DigIN: B: IO1: 2 21 = DigIN: B: IO1: 3 22 = DigIN: B: IO5: 1 23 = DigIN: B: IO5: 2 24 = DigIN: B: IO5: 3 25 = DigIN: B: IO5: 4 26 = DigIN: B: IO5: 5 27 = DigIN: B: IO5: 6 28 = Time Channel 1 29 = Time Channel 2 30 = Time Channel 3 31 = Drive Temperature 32 = SlotA PT100 Temp Channel 1 33 = Slot A PT100 Temp Channel 2 34 = SlotA PT100 Temp Channel 3 35 = SlotA Max PT100 Temp 36 = SlotB PT100 Temp Channel 1 37 = SlotB PT100 Temp Channel 2 38 = SlotB PT100 Temp Channel 3 39 = SlotB Max PT100 Temp 40 = Slot A and SlotB Max PT100 Temp</p>	1, 2, 3, 4	RW
P9.48	2161	<p>Preheat enter temp</p> <p>This parameter is used to set the temperature level when the preheat is enabled if using one of the internal or external temperature mode settings in Para ID2160.</p>	1, 2, 3, 4	RW
P9.49	2162	<p>Preheat quit temp</p> <p>This parameter is used to set the temperature level when the preheat is disabled if using one of the internal or external temperature mode settings in Para ID2160.</p>	1, 2, 3, 4	RW
P9.50	2163	<p>Preheat output voltage Preheat Output Current</p> <p>This parameter is used to set the voltage level output to the motor when the drive is in the Preheat operation mode. This is a percentage of the motor nameplate voltage.</p>	1, 2, 3, 4	RW

Code	Modbus ID	Parameter	Application	RO/RW
P9.51	2401	PID feedback AI loss response This parameter defines the reaction after occurring of a "PID Feedback Loss" condition. This condition could be possible device dependent. 0 = No Action 1 = Warning 2 = Fault 3 = Warning: Preset Frequency (See Para ID2402) 4 = Warning: Analog -> Net	2,3,4	RW
P9.52	2402	PID feedback AI loss pre freq This parameter defines the frequency the device will run at if the response method is set for option 3. See Para ID2401	2,3,4	RW
P9.53	2403	PID feedback AI pipe fill loss This parameter sets the current level when below to indicate a possible loss of feedback signal. If the current drops below this level for the timeout time set in Para ID2403 the drive will respond via the setting in Para ID2401.	2,3,4	RW
P9.54	2404	PID feedback AI loss PreFreq timeout This parameter sets the time to run in this preset mode when a feedback is lost. For example Para ID2401 is set to 3 or 4, when the Feedback signal is lost, the drive will run at the frequency in Para ID2402 for the time set here, after this time the drive will fault out on "Feedback Loss". The Time is disabled when set to 0sec.	2,3,4	RW
P9.55	2405	PID feedback AI loss attempts This parameter is used to define the number of allowed restart attempts after a "PID Feedback Loss" condition has occurred.	2,3,4	RW
P9.56	2429	STO fault response This parameter is used to set the reaction of the device after a "Safe Torque Off" condition is seen. This condition could be possible device dependent. No Action = Drive will stop no indication shown, n reset required, have to cycle start command. Fault = drive will indicate fault/Require Reset to start again, Warning = drive indicate warning/if STO clears drive will run without Reset.	1,2,3,4	RW
P9.57	2483	Fault Reset Start This parameter is used to defines how the drive would start after a Fault Reset is given if the run command is still present to the device. 0 - Start/Stop After Fault Reset - run command has to be cycled to restart after fault reset. 1 - Restart After Fault Reset - run command is still active after fault the drive will restart without resending command.	1,2,3,4	RW
P10.1	1294	PID1 control gain This parameter is used to defines the proportional gain of the PID Controller. It adjust the slope of the speed increase according to the initial of the load. If this value is set to 100% a change of 10% in the error value causes the controller output to change 10%.	2, 3, 4	RW
P10.2	1295	PID1 control ITime This parameter is used to defines the integration time constant of the PID Controller. Over the time the integral time contributes to the deviation between the reference and the feedback signal. If this value is set to 1.00 sec, a change of 10% in the error value causes the controller output to change by 10.00%/s. With value set to 0.0, frequency converter operates as PD controller.	2, 3, 4	RW
P10.3	1296	PID1 Control DTime This parameter is used to defines the derivation time constant of the PID Controller. This value will adjust the rate of change on the feedback signal. If this value is set to 1.00 sec, a change of %10 in error value during 1.00 sec causes the control output to change by %10.00. If value is set to 0.0, frequency converter operates as PI controller	2, 3, 4	RW
P10.4	1297	PID1 process unit This parameter is used to defines the unit type for PID controller. This will change the Feedback and Setpoint variables to show the desired unit of measure.	2, 3, 4	RW
P10.5	1298	PID1 process unit min This parameter is used to defines the minimum process unit value for the PID controller.	2, 3, 4	RW
P10.6	1300	PID1 process unit max This parameter is used to defines the maximum process unit value for the PID controller.	2, 3, 4	RW
P10.7	1302	PID1 process unit decimal This parameter is used to defines the amount of decimal places used in the value for the PID Controller setpoint.	2, 3, 4	RW
P10.8	1303	PID1 error inversion This parameter defines the way the process value output reacts to the feedback signal. 0 = Normal, If feedback is less than set-point, PID controller output increases. 1 = Inverted, If feedback is less than set-point, PID controller output decreases.	2, 3, 4	RW

Appendix A—Description of parameters

Code	Modbus ID	Parameter	Application	RO/RW
P10.9	1304	PID1 dead band This parameter sets the PID Dead band around the set point in process units. This is a band where no actions occur to the output of the PID controller, to prevent oscillation or repeated activation/deactivation of controller.	2, 3, 4	RW
P10.10	1306	PID1 dead band delay This parameter sets the delay time, if the PID process value goes out of the Dead Band area for the desired time delay at that point the controller will re-initialize and try to level out again.	2, 3, 4	RW
P10.11	1307	PID1 keypad set point 1 This parameter sets the Keypad PID Reference value set point 1.	2, 3, 4	RW
P10.12	1309	PID1 keypad set point 2 This parameter sets the Keypad PID Reference value set point 2.	2, 3, 4	RW
P10.13	1311	PID1 ramp time This parameter defines the rising and falling ramp times for changes in the process value setpoint. The ramp time corresponds to the time it takes to change the setpoint value from minimum to the maximum, if the value is 0 no ramps are used.	2, 3, 4	RW
P10.14	1312	PID1 set point 1 source Use this parameter to define the source of the PID set point value. This can either be an internal preset value, keypad set point, analog signal or Fieldbus message.	2, 3, 4	RW
P10.15	1313	PID1 set point 1 min Use this parameter to set the minimum value for the set point 1 source.	2, 3, 4	RW
P10.16	1314	PID1 set point 1 max Use this parameter to set the maximum value for the set point 1 source.	2, 3, 4	RW
P10.17	1315	PID1 set point 1 sleep enable Use this parameter to enable PID Set Point Sleep mode function. When enabled this function will disable the output when the frequency drops below the sleep frequency for the sleep delay time. The output re-engages when feedback rises above the wakeup level. When the function is disabled the drive will run at the minimum or maximum defined speed.	2, 3, 4	RW
P10.18	2397	PID1 setpoint 1 sleep unit Use this parameter to define the variable used when going into the sleep mode. 0 = Output Frequency 1 = Motor Speed 2 = Motor Current 3 = PID1 Feedback	2,3,4	RW
P10.19	2450	PID1 setpoint 1 sleep level Use this parameter to set the level of which the unit value is used to look at to go into the sleep mode. When the unit drops below or goes above this level for the sleep delay time it will put the drive into the sleep mode.	2,3,4	RW
P10.20	1317	PID1 set point 1 sleep delay Use this parameter sets the minimum time after the variable drops below the Sleep level for this amount of time that the output will shutoff.	2, 3, 4	RW
P10.21	1318	PID1 set point 1 wake-up level Use this parameter to set the level for the drive wakes up from the sleep mode condition. This level is variable based off the wake up action selection.	2, 3, 4	RW
P10.22	1320	PID1 set point 1 boost Use this parameter to set the value the set point can be boosted when going into sleep mode. This is an additive variable that will add to the setpoint before drive output goes to sleep to prevent premature cycling.	2, 3, 4	RW
P10.23	1321	PID1 set point 2 source Use this parameter to define the source of the PID set point value. This can either be an internal preset value, keypad set point, analog signal or Fieldbus message.	2, 3, 4	RW
P10.24	1322	PID1 set point 2 min Use this parameter to set the minimum value for the set point 2 source.	2, 3, 4	RW
P10.25	1323	PID1 set point 2 max Use this parameter to set the maximum value for the set point 2 source.	2, 3, 4	RW
P10.26	1324	PID1 set point 2 sleep enable Use this parameter to enable PID Set Point Sleep mode function. When enabled this function will disable the output when the frequency drops below the sleep frequency for the sleep delay time. The output re-engages when feedback rises above the wakeup level. When the function is disabled the drive will run at the minimum or maximum defined speed.	2, 3, 4	RW

Code	Modbus ID	Parameter	Application	RO/RW
P10.27	2397	PID1 setpoint 2 sleep unit Use this paramter to define the variable used when going into the sleep mode. 0 = Output Frequency 1 = Motor Speed 2 = Motor Current 3 = PID1 Feedback	2,3,4	RW
P10.28	2452	PID1 setpoint 2 sleep level Use this parameter to seet the level of which the unit value is used to look at to go into the sleep mode. When the unit drops below or goes above this level for the sleep delay time it will put the drive into the sleep mode.	2,3,4	RW
P10.29	1326	PID1 set point 2 sleep delay Use this parameter sets the minimum time after the variable drops below the Sleep level for this amount of time that the output will shutoff.	2, 3, 4	RW
P10.30	1327	PID1 set point 2 wake-up level Use this paramter to set the level for the drive wakes up form the sleep mode condition. This level is variable based off the wake up action selection.	2, 3, 4	RW
P10.31	1329	PID1 set point 2 boost Use this parameter to set the value the set point can be boosted when going into sleep mode. This is an additive variable that will add to the setpoint before drive output goes to sleep to prevent premature cycling.	2, 3, 4	RW
P10.32	1330	PID1 feedback function Use this paramter to select if the feedback value is taken form a single signal or a combination of two signals. The mathematical functions can be selected that is used when two feedback signals are combined.	2, 3, 4	RW
P10.33	1331	PID1 feedback gain Use this parameter to set the gain associated with feedback signal from the measuring signals defined in the feedback function.	2, 3, 4	RW
P10.34	1332	PID1 feedback 1 source Use this paramter is used to select where feedback signal is being fed into the drive. This signal could be defined as analog inputs or fieldbus data value.	2, 3, 4	RW
P10.35	1333	PID1 feedback 1 min Use this parameter to set the minimum unit value for the feedback signal.	2, 3, 4	RW
P10.36	1334	PID1 feedback 1 max Use this parameter to set the maximum unit value for the feedback signal.	2, 3, 4	RW
P10.37	1335	PID1 feedback 2 source Use this paramter is used to select where feedback signal is being fed into the drive. This signal could be defined as analog inputs or fieldbus data value.	2, 3, 4	RW
P10.38	1336	PID1 feedback 2 min Use this parameter to set the minimum unit value for the feedback signal.	2, 3, 4	RW
P10.39	1337	PID1 feedback 2 max Use this parameter to set the maximum unit value for the feedback signal.	2, 3, 4	RW
P10.40	1338	PID1 feedforward func Use this paramter to select if the feedforward value is taken form a single signal or a combination of two signals. The mathematical functions can be selected that is used when two feedback signals are combined.	2, 3, 4	RW
P10.41	1339	PID1 feedforward gain Use this parameter to set the gain associated with feedforward signal from the measuring signals defined in the feedback function.	2, 3, 4	RW
P10.42	1340	PID1 feedforward 1 source Use this parameter is used to select where feedforward signal is being fed into the drive. This signal could be defined as analog inputs or fieldbus data value.	2, 3, 4	RW
P10.43	1341	PID1 feedforward 1 min Use this parameter to set the minimum unit value for the feedforward signal.	2, 3, 4	RW
P10.44	1342	PID1 feedforward 1 max Use this parameter to set the maximum unit value for the feedforward signal.	2, 3, 4	RW
P10.45	1343	PID1 feedforward 2 source Use this parameter is used to select where feedforward signal is being fed into the drive. This signal could be defined as analog inputs or fieldbus data value.	2, 3, 4	RW

Appendix A—Description of parameters

Code	Modbus ID	Parameter	Application	RO/RW
P10.46	1344	PID1 feedforward 2 min Use this parameter to set the minimum unit value for the feedforward signal.	2, 3, 4	RW
P10.47	1345	PID1 feedforward 2 max Use this parameter to set the maximum unit value for the feedforward signal.	2, 3, 4	RW
P10.48	1352	PID1 set point 1 comp enable Use this parameter to enable pressure loss compensation for set point 1 signal value. This is used in pump systems to compensate the pressure loss that occurs at the end of the pipe line due to the liquid flow.	2, 3, 4	RW
P10.49	1353	PID1 set point 1 comp max Use this parameter to set the maximum compensation for the PID setpoint value that is applied to the output frequency of the drive is at its maximum frequency level. This value is added to the actual setpoint value as a function of the output frequency. Set Point Compensation = comp max * (output freq - min freq) / (max freq - min freq).	2, 3, 4	RW
P10.50	1354	PID1 set point 2 comp enable Use this parameter to enable pressure loss compensation for set point 2 signal value. This is used in pump systems to compensate the pressure loss that occurs at the end of the pipe line due to the liquid flow.	2, 3, 4	RW

Code	Modbus ID	Parameter	Application	RO/RW
------	-----------	-----------	-------------	-------

P10.51 1355 PID1 set point 2 comp max 2, 3, 4 RW
 Use this paramter to set the maximum compensation for the PID setpoint value that is applied to the output frequency of the drive is at its maximum frequency level. This value is added to the actual setpoint value as a function of the output frequency.
 Set Point Compensation = comp max * (output freq–min freq)/(max freq–min freq).

Procedure for setting up PID application:

Initially set PID Gain(Para ID1294) to 0.0% and set the PID I Time (Para ID1295) to 20 sec. Start the frequency converter and verify if the set point is reached quickly while maintaining stable operation of the system. If not increase the PID Gain (Para ID1294) until the drive speed oscillates constantly. After this occurs reduce the PID Gain (Para ID1294) slightly to reduce the oscillation. From here take the value found for PID Gain (Para ID1294) to 0.5 times that value and reduce the PID I time (Para ID1295) until the feedback signal oscillates again. Increase the PID I time (Para ID1295) until the oscillation stops, with that value take it times 1.2 and use that value for the PID I time (Para ID1295). If signal noise is seen at high frequency increase the filter time value to filter the signal. If further tuning is required refer to the table showing what is effected.

Figure 92. Setting up PID application

Response	Rise time	Overshoot	Settling time	Steady state error
Increase PID Gain	Decrease Rise	Increases Overshoot	Not Affected	Decreases Error
Increase PID1 Time	Decrease Rise	Increases Overshoot	Increases Setting	Eliminates Error
Increase PID0 Time	Not Affected	Decreases Overshoot	Decreases Settling	Not Affected

Rise Time—the time required for the output to rise 90% of the desired level for the first time.
 Overshoot—the difference between the peak level and the steady state level. Settling Time—time required for the system to converge to its steady state.
 Steady State Error—the difference between the steady state level and the desired output level.

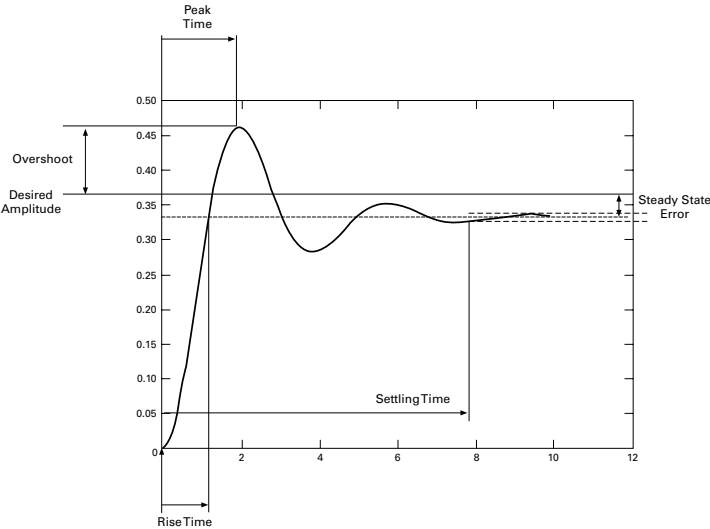

P10.52 2466 PID1 Wake Up Action 2,3,4 RW
 Use this parameter to define the wakeup function action. This defines if a static absolute value is used above or below the level setting or a relative value that changes based off the set point value.
 0 - Wakeup when below wakeup level (Absolute Level)
 1 - Wakeup when above wakeup level (Absolute Level)
 2 - Wakeup when below wakeup level % from PID set point (Relative setpoint)
 3 - Wakeup when above wakeup level % from PID set point (Relative setpoint)

P10.53 2542 FB PID1 Set Point 1 2, 3, 4 RO
 PID Set point value from Network. Can be assigned to PID Set Point Source

P10.54 2544 FB PID1 Set Point 2 2, 3, 4 RO
 PID Set point value from Network. Can be assigned to PID Set Point Source

P10.55 2550 FB PID1 Feedback 1 2, 3, 4 RO
 PID Feedback value from Network. Can be assigned to PID Feedback Source

P10.56 2551 FB PID1 Feedback 2 2, 3, 4 RO
 PID Feedback value from Network. Can be assigned to PID Feedback Source

P10.57 2554 FB PID1 Feedforward 1 2, 3, 4 RO
 PID Feedforward value from Network. Can be assigned to PID Feedforward Source

Appendix A—Description of parameters

Code	Modbus ID	Parameter	Application	RO/RW
P10.58	2555	FB PID1 Feedforward 2 PID Feedforward value from Network. Can be assigned to PID Feedforward Source	2, 3, 4	RO
P11.1	1356	PID2 control gain This parameter is used to defines the proportional gain of the PID Controller. It adjust the slope of the speed increase according to the initial of the load. If this value is set to 100% a change of 10% in the error value causes the controller output to change 10%.	3, 4	RW
P11.2	1357	PID2 control itime This parameter is used to defines the integration time constant of the PID Controller. Over the time the integral time contributes to the deviation between the reference and the feedback signal. If this value is set to 1.00 sec, a change of 10% in the error value causes the controller output to change by 10.00%/s. With value set to 0.0, frequency converter operates as PD controller.	3, 4	RW
P11.3	1358	PID2 control dtime This parameter is used to defines the derivation time constant of the PID Controller. This value will adjust the rate of change on the feedback signal. If this value is set to 1.00 sec, a change of %10 in error value during 1.00 sec causes the control output to change by %10.00. If value is set to 0.0, frequency converter operates as PI controller	3, 4	RW
P11.4	1359	PID2 process unit This parameter is used to defines the unit type for PID controller. This will change the Feedback and Setpoint variables to show the desired unit of measure.	3, 4	RW
P11.5	1360	PID2 process unit min This parameter is used to defines the minimum process unit value for the PID controller.	3, 4	RW
P11.6	1362	PID2 process unit max This parameter is used to defines the maximum process unit value for the PID controller.	3, 4	RW
P11.7	1364	PID2 process unit decimal This parameter is used to defines the amount of decimal places used in the value for the PID Controller setpoint.	3, 4	RW
P11.8	1365	PID2 error inversion This parameter defines the way the process value output reacts to the feedback signal. 0 = Normal, If feedback is less than set-point, PID controller output increases. 1 = Inverted, If feedback is less than set-point, PID controller output decreases.	3, 4	RW
P11.9	1366	PID2 dead band This parameter sets the PID Dead band around the set point in process units. This is a band where no actions occur to the ouput of the PID controller, to prevent oscillation or repeated activation/deactivation of controller.	3, 4	RW
P11.10	1368	PID2 dead band delay This parameter sets the delay time, if the PID process value goes out of the Dead Band area for the desired time delay at that point the controller will re-initialize and try to level out again.	3, 4	RW
P11.11	1369	PID2 keypad set point 1 This parameter sets the Keypad PID Reference value set point 1.	3, 4	RW
P11.12	1371	PID2 keypad set point 2 This parameter sets the Keypad PID Reference value set point 2.	3, 4	RW
P11.13	1373	PID2 ramp time This parameter defines the rising and falling ramp times for changes in the process value setpoint. The ramp time corresponds to the time it takes to change the setpoint vlaue from minimum to the maximum, if the value is 0 no ramps are used.	3, 4	RW
P11.14	1374	PID2 set point 1 source Use this parameter to define the source of the PID set point value. This can either be an internal preset value, keypad set point, analog signal or Fieldbus message.	3, 4	RW
P11.15	1375	PID2 set point 1 min Use this parmaeter to set the minimum value for the set point 1 source.	3, 4	RW
P11.16	1376	PID2 set point 1 max Use this parameter to set the maximum value for the set point 1 source.	3, 4	RW
P11.17	1377	PID2 set point 1 sleep enable Use this parameter to enable PID Set Point Sleep mode function. When enabled this function will disable the output when the frequency drops below the sleep frequency for the sleep delay time. The output re engages when feedback rises above the wakeup level. When the function is disabled the drive will run at the minimum or maximum defined speed.	3, 4	RW

Code	Modbus ID	Parameter	Application	RO/RW
P11.18	2398	PID2 setpoint 1 sleep unit Use this paramter to define the variable used when going into the sleep mode. 0 = Output Frequency 1 = Motor Speed 2 = Motor Current 3 = PID1 Feedback	2,3,4	RW
P11.19	2454	PID2 setpoint 1 sleep level Use this parameter to seet the level of which the unit value is used to look at to go into the sleep mode. When the unit drops below or goes above this level for the sleep delay time it will put the drive into the sleep mode.	2,3,4	RW
P11.20	1379	PID2 set point 1 sleep delay Use this parameter sets the minimum time after the variable drops below the Sleep level for this amount of time that the output will shutoff.	3, 4	RW
P11.21	1380	PID2 set point 1 wake-up level Use this parameter to set the level for the drive wakes up form the sleep mode condition. This level is variable based off the wake up action selection.	3, 4	RW
P11.22	1382	PID2 set point 1 boost Use this parameter to set the value the set point can be boosted when going into sleep mode. This is an additive variable that will add to the setpoint before drive output goes to sleep to prevent premature cycling.	3, 4	RW
P11.23	1383	PID2 set point 2 source Use this parameter to define the source of the PID set point value. This can either be an internal preset value, keypad set point, analog signal or Fieldbus message.	3, 4	RW
P11.24	1384	PID2 set point 2 min Use this parameter to set the minimum value for the set point 2 source.	3, 4	RW
P11.25	1385	PID2 set point 2 max Use this parameter to set the maximum value for the set point 2 source.	3, 4	RW
P11.26	1386	PID2 set point 2 sleep enable Use this parameter to enable PID Set Point Sleep mode function. When enabled this function will disable the output when the frequency drops below the sleep frequency for the sleep delay time. The output re engages when feedback rises above the wakeup level. When the function is disabled the drive will run at the minimum or maximum defined speed.	3, 4	RW
P11.27	2399	PID2 setpoint 2 sleep unit Use this parameter to define the variable used when going into the sleep mode. 0 = Output Frequency 1 = Motor Speed 2 = Motor Current 3 = PID1 Feedback	2,3,4	RW
P11.28	2456	PID2 setpoint 2 sleep level Use this parameter to set the level of which the unit value is used to look at to go into the sleep mode. When the unit drops below or goes above this level for the sleep delay time it will put the drive into the sleep mode.	2,3,4	RW
P11.29	1388	PID2 Set point 2 sleep delay Use this parameter sets the minimum time after the variable drops below the Sleep level for this amount of time that the output will shutoff.	3, 4	RW
P11.30	1389	PID2 set point 2 wake-up level Use this parameter to set the level for the drive wakes up form the sleep mode condition. This level is variable based off the wake up action selection.	3, 4	RW
P11.31	1391	PID2 set point 2 boost Use this parameter to set the value the set point can be boosted when going into sleep mode. This is an additive variable that will add to the setpoint before drive output goes to sleep to prevent premature cycling.	3, 4	RW
P11.32	1392	PID2 feedback func Use this paramter to select if the feedback value is taken form a single signal or a combination of two signals. The mathematical functions can be selected that is used when two feedback signals are combined.	3, 4	RW
P11.33	1393	PID2 feedback gain Use this parameter to set the gain associated with feedback signal from the measuring signals defined in the feedback function.	3, 4	RW

Appendix A—Description of parameters

Code	Modbus ID	Parameter	Application	RO/RW
P11.34	1394	PID2 feedback 1 source Use this parameter is used to select where feedback signal is being fed into the drive. This signal could be defined as analog inputs or fieldbus data value.	3, 4	RW
P11.35	1395	PID2 feedback 1 min Use this parameter to set the minimum unit value for the feedback signal.	3, 4	RW
P11.36	1396	PID2 feedback 1 max Use this parameter to set the maximum unit value for the feedback signal.	3, 4	RW
P11.37	1397	PID2 feedback 2 source Use this parameter is used to select where feedback signal is being fed into the drive. This signal could be defined as analog inputs or fieldbus data value.	3, 4	RW
P11.38	1398	PID2 feedback 2 min Use this parameter to set the minimum unit value for the feedback signal.	3, 4	RW
P11.39	1399	PID2 feedback 2 max Use this parameter to set the maximum unit value for the feedback signal.	3, 4	RW
P11.40	1400	PID2 feedforward func Use this parameter to select if the feedforward value is taken form a single signal or a combination of two signals. The mathematical functions can be selected that is used when two feedback signals are combined.	3, 4	RW
P11.41	1401	PID2 feedforward gain Use this parameter to set the gain associated with feedforward signal from the measuring signals defined in the feedback function.	3, 4	RW
P11.42	1402	PID2 feedforward 1 source Use this parameter is used to select where feedforward signal is being fed into the drive. This signal could be defined as analog inputs or fieldbus data value.	3, 4	RW
P11.43	1403	PID2 feedforward 1 min Use this parameter to set the minimum unit value for the feedforward signal.	3, 4	RW
P11.44	1404	PID2 feedforward 1 max Use this parameter to set the maximum unit value for the feedforward signal.	3, 4	RW
P11.45	1405	PID2 feedforward 2 source Use this paramter is used to select where feedforward signal is being fed into the drive. This signal could be defined as analog inputs or fieldbus data value.	3, 4	RW
P11.46	1406	PID2 feedforward 2 min Use this parameter to set the minimum unit value for the feedforward signal.	3, 4	RW
P11.47	1407	PID2 feedforward 2 max Use this parameter to set the maximum unit value for the feedforward signal.	3, 4	RW
P11.48	1414	PID2 set point 1 comp enable Use this parameter to enables pressure loss compensation for set point 1 signal value. This is used in pump systems to compensate the pressure loss that occurs at the end of the pipe line due to the liquid flow.	3, 4	RW
P11.49	1415	PID2 set point 1 comp max Use this paramter to set the maximum compensation for the PID setpoint value that is applied to the output frequency of the drive is at its maximum frequency level. This value is added to the actual setpoint value as a function of the output frequency. Set Point Compensation = comp max * (output freq–min freq)/(max freq–min freq).	3, 4	RW
P11.50	1416	PID2 set point 2 comp enable Use this parameter to enables pressure loss compensation for set point 2 signal value. This is used in pump systems to compensate the pressure loss that occurs at the end of the pipe line due to the liquid flow.	3, 4	RW
P11.51	1417	PID2 set point 2 comp max Use this parameter to set the maximum compensation for the PID setpoint value that is applied to the output frequency of the drive is at its maximum frequency level. This value is added to the actual setpoint value as a function of the output frequency. Set Point Compensation = comp max * (output freq–min freq)/(max freq–min freq).	3, 4	RW

Code	Modbus ID	Parameter	Application	RO/RW
------	-----------	-----------	-------------	-------

P11.52 **2467**

PID2 Wake Up Action

Use this parameter to define the wakeup function action. This defines if a static absolute value is used above or below the level setting or a relative value that changes based off the set point value.
 0 - Wakeup when below wakeup level (Absolute Level)
 1 - Wakeup when above wakeup level (Absolute Level)
 2 - Wakeup when below wakeup level % from PID set point (Relative setpoint)
 3 - Wakeup when above wakeup level % from PID set point (Relative setpoint)

Response	Rise time	Overshoot	Settling time	Steady state error
Increase PID Gain	Decrease Rise	Increases Overshoot	Not Affected	Decreases Error
Increase PID1 Time	Decrease Rise	Increases Overshoot	Increases Setting	Eliminates Error
Increase PID0 Time	Not Affected	Decreases Overshoot	Decreases Setting	Not Affected

Rise Time—the time required for the output to rise 90% of the desired level for the first time.
 Overshoot—the difference between the peak level and the steady state level. Settling Time—time required for the system to converge to its steady state.
 Steady State Error—the difference between the steady state level and the desired output level.

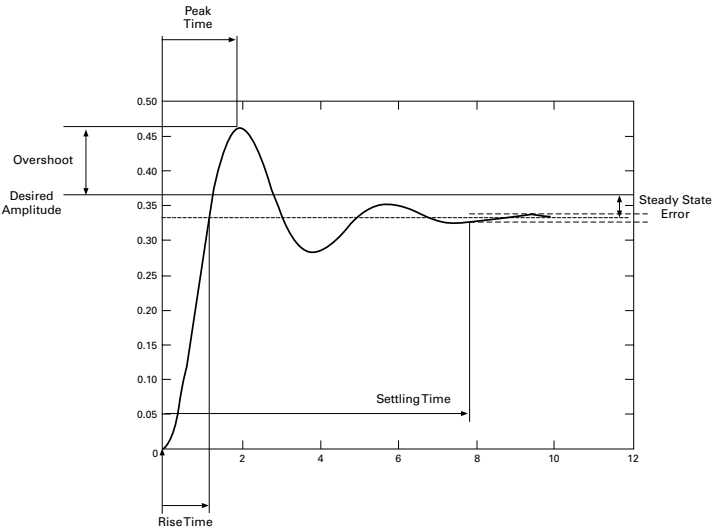

Procedure for setting up PID Application.
 Initially set PID Gain (Para ID1356) to 0.0% and set the PID I Time (Para ID1357) to 20 sec. Start the frequency converter and verify if the set point is reached quickly while maintaining stable operation of the system. If not increase the PID Gain (Para ID1356) until the drive speed oscillates constantly. After this occurs reduce the PID Gain (Para ID1356) slightly to reduce the oscillation. From here take the value found for PID Gain (Para ID1356) to 0.5 times that value and reduce the PID I time (Para ID1357) until the feedback signal oscillates again. Increase the PID I time (Para ID1357) until the oscillation stops, with that value take it times 1.2 and use that value for the PID I time (Para ID1357). If signal noise is seen at high frequency increase the filter time value to filter the signal. If further tuning is required refer to the table showing what is effected.

P11.53	2546	FB PID2 Set Point 1 PID Set point value from Network. Can be assigned to PID Set Point Source	3, 4	RO
P11.54	2548	FB PID2 Set Point 2 PID Set point value from Network. Can be assigned to PID Set Point Source	3, 4	RO
P11.55	2552	FB PID2 Feedback 1 PID Feedback value from Network. Can be assigned to PID Feedback Source	3, 4	RO
P11.56	2553	FB PID2 Feedback 2 PID Feedback value from Network. Can be assigned to PID Feedback Source	3, 4	RO
P11.57	2556	FB PID2 Feedforward 1 PID Feedforward value from Network. Can be assigned to PID Feedforward Source	3, 4	RO
P11.58	2557	FB PID2 Feedforward 2 PID Feedforward value from Network. Can be assigned to PID Feedforward Source	3, 4	RO
P12.1	105	Preset speed 1 Use this parameter to set the Preset Frequency 1.	1, 2, 3, 4	RW

Appendix A—Description of parameters

Code	Modbus ID	Parameter	Application	RO/RW
P12.2	106	Preset speed 2 Use this parameter to set the Preset Frequency 2.	1, 2, 3, 4	RW
P12.3	118	Preset speed 3 Use this parameter to set the Preset Frequency 3.	1, 2, 3, 4	RW
P12.4	119	Preset speed 4 Use this parameter to set the Preset Frequency 4.	1, 2, 3, 4	RW
P12.5	120	Preset speed 5 Use this parameter to set the Preset Frequency 5.	1, 2, 3, 4	RW
P12.6	121	Preset speed 6 Use this parameter to set the Preset Frequency 6.	1, 2, 3, 4	RW
P12.7	122	Preset speed 7 Use this parameter to set the Preset Frequency 7.	1, 2, 3, 4	RW
P13.1	295	Torque limit Use this parameter to set the torque limit control limit between 0.0–400.0% when in open loop torque control.	4	RW
P13.2	303	Torque ref sel Use this parameter to set the source for torque reference when in the open loop torque control mode. 0 = Not used 1 = AI1 2 = AI2 3 = SlotA:AI1 4 = SlotB:AI1 5 = AI1 joystick 6 = AI2 joystick 7 = Keypad Torque Ref 8 = FB Process Input 1 9 = PID1 Control Output 10 = PID2 Control Output 11 = FB Torque Ref	4	RW
P13.3	782	Keypad torque ref Use this parameter to set the Keypad Torque speed reference when keypad is selected as the torque reference.	4	RW
P13.4	304	Torque ref max Use this parameter to set the maximum torque reference value, this is scaled between –300.0 to 300.0%.	4	RW
P13.5	305	Torque ref min Use this parameter to set the minimum torque reference value, this is scaled between –300.0 to 300.0%.	4	RW

Code	Modbus ID	Parameter	Application	RO/RW
P13.6	1666	<p>Torque control freq max</p> <p>Use this parameter to set the Speed limit control which the frequency converter operates in when in open loop torque control mode.</p> <p>0 = NegFreqMax...PosFreqMax The speed range, inside which a torque control can take place, is bounded by the parameter ID 1574 "Neg Frequency Limit" and 1576 "Pos Frequency Limit".</p> <ul style="list-style-type: none"> • Para ID 1574 is effective in reverse direction • Para ID 1574 is effective in forward direction <p>1 = - FreqRampOut ...+ FreqRampOut Torque control is performed between standstill and the speed, which corresponds to the speed reference at the output of the ramp. The sense of rotation is not of importance. In case the speed of the torque controlled drive corresponds to the speed reference at the output of the ramp, the drive runs speed controlled instead of torque controlled. When the speed drops, a commutation back to torque control takes place automatically.</p> <p>2 = NegFreqMax...FreqRampout(MIN) In forward direction torque control is performed between standstill and the speed, which corresponds to the speed reference at the output of the ramp. In case the speed of the torque controlled drive corresponds to the speed reference at the output of the ramp, the drive runs speed controlled instead of torque controlled. When the speed drops, a commutation back to torque control takes place automatically. In reverse direction torque control is possible up to the speed defined with Para ID 1574.</p> <p>3 = FreqRampOut...PosFreqMax(MAX) In reverse direction torque control is performed between standstill and the speed, which corresponds to the speed reference at the output of the ramp. In case the speed of the torque controlled drive corresponds to the speed reference at the output of the ramp, the drive runs speed controlled instead of torque controlled. When the speed drops, a commutation back to torque control takes place automatically. In forward direction torque control is possible up to the speed defined with Para ID 1576.</p> <p>4 = FreqRampOut+WindowPos/NegWidth When the speed of the torque controlled drive is inside the tolerance band around the speed reference at the output of the ramp, torque control is performed. The permissible deviation is bounded above by Para ID 1636 "Window Pos Width" and below by Para ID 1637 "Window Neg Width". In case the red dashed line is reached, the drive runs speed controlled. When the speed comes back into the tolerance band a commutation back to torque control takes place automatically. The maximum possible speed is defined by the parameter ID 1574 and ID 1576.</p> <p>5 = 0...FreqRampOut(pos or neg direction) In both directions torque control is performed between standstill and the speed, which corresponds to the speed reference at the output of the ramp. In case the speed of the torque controlled drive corresponds to the speed reference at the output of the ramp, the drive runs speed controlled instead of torque controlled. When the speed drops, a commutation back to torque control takes place automatically.</p> <p>6 = FreqRamp+WindowPos/Neg/PosOff/NegOff When the speed of the torque controlled drive is inside the tolerance band around the speed reference at the output of the ramp, torque control is performed. The permissible deviation is bounded above by Para ID 1636 "Window Pos Width" and below by Para ID 1637 "Window Neg Width". In case the red dashed line is reached, the drive runs speed controlled. When the speed comes back into the tolerance band a commutation back to torque control takes place automatically. Thereby a hysteresis is effective (green shaded area). When deviating in the upper direction, the speed must undercut the threshold defined with Para ID 1638 "Window Pos Off Limit" first, before it changes back to torque control. The same is true for deviations in the lower direction, where the threshold for reactivating torque control is defined with Para ID 1639 "Window Neg Off Limit". The hysteresis prevents, that a drive which operates close to the red dashed line commutes between torque control and speed control permanently, which can lead to oscillations inside the application. The maximum possible speed is defined by the parameters ID 1574 and ID 1576.</p> <p>Options 2 through 6 are not available in the FR7 and FR8 drives.</p>	4	RW
P13.7	1636	<p>Window pos width</p> <p>Use this parameter to set the positive window width value when the window option is selected in the Speed limiter mode selection. Not available in the FR7 and FR8 drives.</p>	4	RW
P13.8	1637	<p>Window neg width</p> <p>Use this parameter to set the negative window width value when the window option is selected in the Speed limiter mode selection. Not available in the FR7 and FR8 drives.</p>	4	RW
P13.9	1638	<p>Window pos off limit</p> <p>Use this parameter to set the positive off window width value when the window option is selected in the Speed limiter mode selection. Not available in the FR7 and FR8 drives.</p>	4	RW
P13.10	1639	<p>Window neg off limit</p> <p>Use this parameter to set the negative off window width value when the window option is selected in the Speed limiter mode selection. Not available in the FR7 and FR8 drives.</p>	4	RW

Appendix A—Description of parameters

Code	Modbus ID	Parameter	Application	RO/RW
P13.11	1640	Torque reference filter TC Use this parameter to set the torque reference filter time for set torque reference source.	4	RW
P13.12	1606	Pull out torque Use this parameter to set the amount of torque required for start up torque level in percentage. Not available in the FR7 and FR8 drives.	4	RW
P13.13	1684	Stop state magnetization time Use this parameter to set the stop-Magnetization time at the stopping of the load in the open-loop torque control mode.	4	RW
P13.14	2541	FB Torque Ref Use this parameter to view the Torque reference from fieldbus.	4	RO
P13.15	300	Torque Control(2) Min Frequency "Use this parameter to set the output frequency limit below which the drive operates in the frequency control mode. Active when Motor Control mode is set to Torque Control. This parameter is only active in the FR7 and FR8 drives."	4	RW
P13.16	301	Torque Control(2) P-gain "Use this parameter to set the P gain for the torque controller in the open loop control mode. The P Gain value 1.0 causes a 1 Hz change in the output frequency when the torque error is 1% of the motor nominal torque. Active when Motor Control mode is set to Torque Control. This parameter is only active in the FR7 and FR8 drives."	4	RW
P13.17	302	Torque Control(2) I-gain "Use this parameter to set the I gain for the torque controller in the open loop control mode. The I Gain value 1.0 causes the integration to reach 1.0 Hz in 1 second when the torque error is 1% of the motor nominal torque. Active when Motor Control mode is set to Torque Control. This parameter is only active in the FR7 and FR8 drives."	4	RW
P13.18	60	Torque Control(6) P-gain "Use this parameter to set the P gain for the torque controller in the sensorless control mode. The P Gain value 1.0 causes a 1 Hz change in the output frequency when the torque error is 1% of the motor nominal torque. Active when Motor Control mode is set Open Loop Torque Control. This parameter is always active in Open Loop Torque Control. This parameter is only active in the FR7 and FR8 drives."	4	RW
P13.19	61	Torque Control(6) I-gain "Use this parameter to set the I gain for the torque controller in the sensorless control mode. The I Gain value 1.0 causes the integration to reach 1.0 Hz in 1 second when the torque error is 1% of the motor nominal torque. Active when Motor Control mode is set Open Loop Torque Control. This parameter is always active in Open Loop Torque Control. This parameter is only active in the FR7 and FR8 drives."	4	RW
P14.1	254	DC-brake current Use this parameter to set the amount of DC current as an amp value that is injected into the motor during DC braking.	1, 2, 3, 4	RW
P14.2	263	Start DC-Brake time Use this parameter to set the length of time the DC-brake is activated when the start command is given.	1, 2, 3, 4	RW
P14.3	262	Stop DC-Brake frequency Use this parameter to set the frequency level in hz at which DC braking starts during the deceleration phase.	1, 2, 3, 4	RW

Code	Modbus ID	Parameter	Application	RO/RW
P14.4	255	Stop DC-Brake time	1, 2, 3, 4	RW

Use this parameter to set the length of DC braking at stop.
 0.0 = DC-brake is not used
 >0.0 = DC-brake is in use and its function depends on the Stop function. The DC-braking time is determined with this parameter.
 Para ID 253 = 1; Stop function = Ramp:
 After the stop command, the motor coasts to a stop without control of the frequency converter.
 With DC-injection, the motor can be electrically stopped in the shortest possible time, without using an optional external braking resistor.
 The braking time is scaled according to the frequency when the DC-braking starts. If the frequency is \geq the nominal frequency of the motor, the set value of parameter ID 255 determines the braking time. When the frequency is $\leq 10\%$ of the nominal, the braking time is 10% of the set value of Para ID 255.

Figure 93. DC-Braking time when stop mode = coasting

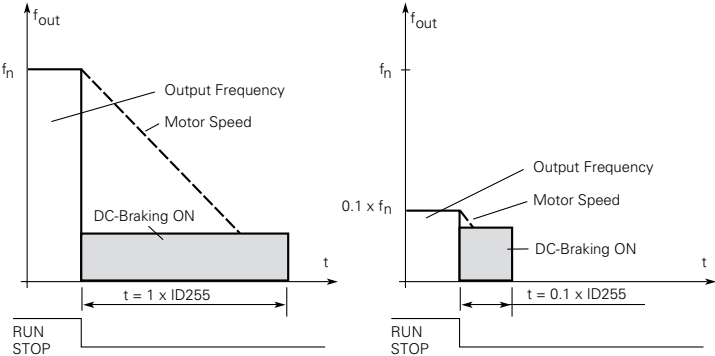

Para ID 253 = 1; Stop function = Ramp:
 After the Stop command, the speed of the motor is reduced according to the set deceleration parameters, as fast as possible, to the speed defined with Para ID 262, where the DC-braking starts.
 The braking time is defined with Para ID 262. If high inertia exists, it is recommended to use an external braking resistor for faster deceleration.

Figure 94. DC-Braking time when stop mode = ramp

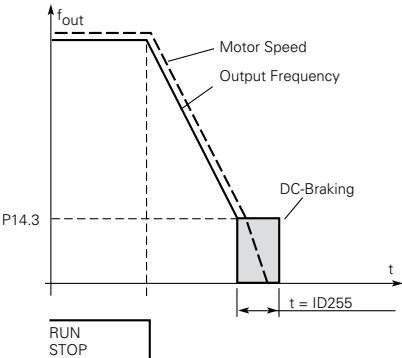

P14.5	251	Brake chopper Define	1, 2, 3, 4	RW
-------	-----	-----------------------------	------------	----

Use this parameter to enable/disable the internal brake chopper logic if a brake chopper is installed. When the frequency converter is decelerating the motor, the inertia of the motor and the load is fed into an external brake resistor. This enables the frequency converter to decelerate the load with a torque equal to that of acceleration (provided that the correct brake resistor has been selected).
 0 = No brake chopper used
 1 = Brake chopper in use and tested when running. Can be tested also in READY state. In the FR7 and FR8 drives this test is not performed when in the ready state.
 2 = External brake chopper (no testing)
 3 = Used and tested in READY state and when running
 4 = Used when running (no testing)

Appendix A—Description of parameters

Code	Modbus ID	Parameter	Application	RO/RW
P14.6	266	<p>Flux Brake</p> <p>Use this parameter to enable the flux braking, the frequency is reduced and the flux in the motor is increased, which in turn increases the motor's capability to brake. Unlike DC braking, the motor speed remains controlled during braking.</p> <p>The flux braking can be set ON or OFF.</p> <p>0 = Flux braking OFF</p> <p>1 = Flux braking ON</p> <p>Note: Flux braking converts the energy into heat in the motor, and should be used intermittently to avoid motor damage.</p>	1, 2, 3, 4	RW
P14.7	519	<p>Flux brake current</p> <p>Use this parameter to set the level of current In amps for the flux braking is enabled.</p>	1, 2, 3, 4	RW
P15.1	535	<p>Fire mode function</p> <p>Use this parameter to control whether the fire mode function is determined by a contact closure or contact opening on the desired digital input selections.</p> <p>0 = Closing contact initiates fire mode function</p> <p>1 = Opening contact initiates fire mode function</p> <p>Note: when Fire mode is enabled, this causes the drive to ignore any fault and run till its death. Warranty will be non valid in the case this is enabled and the drive causes issues to the system.</p>	2, 3, 4	RW
P15.2	536	<p>Fire Mode Ref Select Function</p> <p>Use this parameter allows for setting the reference location for when the firemode is enabled.</p> <p>0 = Fire Mode Min Frequency (see Para ID 537)</p> <p>1 = Fire Mode Ref - follows Para ID 565 and ID 564 with the use of an digital input to select the active speed.</p> <p>2 = Fieldbus Ref - Reference from fieldbus process in</p> <p>3 = AI1 - Analog input 1</p> <p>4 = AI2 - Analog input 2</p> <p>5 = AI1 + AI2 - Analog input 1 added to Analog input 2</p> <p>6 = PID1 Control Output - follows the PID control algorithm settings</p> <p>7 = PID2 Control Output - follows the PID control algorithm settings</p>	2, 3, 4	RW
P15.3	537	<p>Fire mode min frequency</p> <p>Use this parameter sets the minimum output frequency for fire mode, when reference selection is the min frequency.</p>	2, 3, 4	RW
P15.4	565	<p>Fire mode freq ref 1</p> <p>Use this parameter to set the fire mode frequency reference 1 when the ref selection mode is used.</p>	2, 3, 4	RW
P15.5	564	<p>Fire mode freq ref 2</p> <p>Use this parameter to set the fire mode frequency reference 2 when the ref selection mode is used.</p>	2, 3, 4	RW
P15.6	554	<p>Smoke purge frequency</p> <p>Use this parameter to set the frequency level in hz used when the input for smoke purge is enabled.</p>	2, 3, 4	RW
P15.7	2443	<p>Fire mode test enable</p> <p>Use this parameter to allows for testing the Fire Mode feature, with the parameter set to Enable and Fire Mode input enabled, the drive will run at the Fire Mode speed desired but all faults are still enabled.</p>	2, 3, 4	RW
P16.1	557	<p>Motor nom current 2</p> <p>Use this parameter to set the second motor set name plate Current. Selected based off of a digital input.</p>	2, 3, 4	RW
P16.2	578	<p>Motor nom speed 2</p> <p>Use this parameter to set the second motor set name plate RPM. Selected based off of a digital input.</p>	2, 3, 4	RW
P16.3	579	<p>Motor PF 2</p> <p>Use this parameter to set the second motor set name plate Power Factor. Selected based off of a digital input.</p>	2, 3, 4	RW
P16.4	580	<p>Motor nom voltage 2</p> <p>Use this parameter to set the second motor set name plate Voltage. Selected based off of a digital input.</p>	2, 3, 4	RW
P16.5	581	<p>Motor nom freq 2</p> <p>Use this parameter to set the second motor set name plate Frequency. Selected based off of a digital input.</p>	2, 3, 4	RW
P16.6	1419	<p>Stator resistor 2</p> <p>Use this parameter to set the second set of motor stator resistor real values for 2nd motor set. Available in All applications for FR7 and FR8.</p>	4/2,3,4	RW

Code	Modbus ID	Parameter	Application	RO/RW
P16.7	1420	Rotor resistor 2 Use this parameter to set the second set of motor rotor resistor real value for 2 nd motor set. Not available in FR7 and FR8 drives.	4	RW
P16.8	1421	Leak inductance 2 Use this parameter to set the second set of motor leakage inductance real value for 2 nd motor set.	4 / 2,3,4	RW
P16.9	1422	Mutual inductance 2 Use this parameter to set the second set of motor mutual inductance real value for 2 nd motor set. Not available in FR7 and FR8 drives.	4	RW
P16.10	1423	Excitation current 2 Use this parameter to set the second set of motor no-load current real value for 2 nd motor set. Available in All applications for FR7 and FR8.	4 / 2,3,4	RW
P17.1.1	1418	Bypass enable Use this parameter to enable the bypass functionality in the drive to have a soft key or input to force bypass.	2, 3, 4	RW
P17.1.2	544	Bypass start delay Use this parameter to set a time delay between when the Bypass Signal is applied via I/O, Fieldbus or keypad, to when the motor starts and once bypass is removed the time to switch back to drive.	2, 3, 4	RW
P17.1.3	542	Auto bypass Use this parameter to enable whether an automatic switch to bypass will occur based on the selected faults below. 0 = Auto Bypass disabled 1 = Auto Bypass enabled	2, 3, 4	RW
P17.1.4	543	Auto bypass delay Use this parameter to set the time delay before an automatic switch to bypass.	2, 3, 4	RW
P17.1.5	547	Overcurrent bypass enable Use this parameter to enable an automatic switch to bypass when an overcurrent fault occurs. 0 = Disable Auto bypass on overcurrent fault 1 = Enable Auto bypass on overcurrent fault	2, 3, 4	RW
P17.1.6	546	IGBT FLT bypass enable Use this parameter to enable an automatic switch to bypass when an IGBT fault occurs. 0 = Disable Auto bypass on IGBT fault 1 = Enable Auto bypass on IGBT fault	2, 3, 4	RW
P17.1.7	548	4 mA FLT bypass enable Use this parameter to enable an automatic switch to bypass when a loss of reference fault occurs. 0 = Disable Auto bypass on loss of reference fault 1 = Enable Auto bypass on loss of reference fault	2, 3, 4	RW
P17.1.8	545	Undervoltage bypass enable Use this parameter to an automatic switch to bypass when an under voltage fault occurs. 0 = Disable Auto bypass on under voltage fault 1 = Enable Auto bypass on under voltage fault	2, 3, 4	RW
P17.1.9	549	Overvoltage bypass enable This parameter specifies whether an automatic switch to bypass when an overvoltage fault occurs. 0 = Disable Auto bypass on overvoltage fault 1 = Enable Auto bypass on overvoltage fault	2,3,4	RW
P17.2.1	2476	Redundant Drive Enabl Use this parameter to enable the Redundant drive setup where multiple drives can be connected via Para communications to start if the main drive fails or runtime settings below expires.	2,3,4	RW
P17.2.2	2278	Drive ID Use this parameter to set the drive address when using multi drive redundant mode, based off this id the drive enables in the desired sequence and can be monitored at this drive ID value in the monitor screen.	2,3,4	RW
P17.2.3	2477	Redundant Run Time Enable Use this parameter to enables the Run time limit for the Redundant drive mode so that drives will be cycled based off the Run time limit value.	2,3,4	RW

Appendix A—Description of parameters

Code	Modbus ID	Parameter	Application	RO/RW
P17.2.4	2478	Redundant Run Time Reset Use this parameter to manually Reset the Redundant Drive Run timer.	2,3,4	RW
P17.2.5	2479	Redundant Run Time Limit Use this parameter to set the time limit for Run time of the drive when enabled for the Redundant drive scheme.	2,3,4	RW
P18.1.1	2279	Multi-pump mode Use this a parameter to set the drive mode for Multi-pump configuration. 0 = Disabled - standard drive mode. 1 = Single Drive - single drive for main motor, contactors used on other motors 2 = Multi Drive - multi-follower sequence with multiple drives.	2,3,4	RW
P18.1.2	2278	Drive ID Use this parameter to set the drive address when using multi drive pump mode, based off this id the drive enables in the desired sequence and can be monitored at this drive ID value in the monitor screen.	2,3,4	RW
P18.1.3	343	PID bandwidth Use this parameter to set the bandwidth around the PID setpoint that would prevent for staging in or out a pump or drive in the single and multi-drive pump modes.	2,3,4	RW
P18.1.4	2315	Staging frequency Use this parameter to set the frequency level at which if the master drive goes above this frequency it will look to stage in the next aux motor either across the line or via another drive to provide the required reference level for the system.	2,3,4	RW
P18.1.5	2316	De-Staging frequency Use this parameter to set the frequency level at which if the master drive goes below this frequency it then looks to drop out the next aux motor. This would indicate the system is able to maintain the reference level without the current running pumps.	2,3,4	RW
P18.1.6	344	Add/Remove delay Use this parameter to set the time delay on staging or destaging of pumps or drives after the staging or destaging frequency is reached.	2,3,4	RW
P18.1.7	350	Interlock enable Use this parameter to enable the drive to look at the digital input interlocks to indicate which motor is available for running in the system. If the motor interlock input is off the system will skip this motor or drive in the sequence.	2,3,4	RW
P18.1.8	483	Damper start Use this parameter to set the start mode condition to include an external damper circuit. 0 = Start—standard start 1 = Interlocked Start—To use this, a relay output, R01–R03, needs to be programmed for selections 35 “Damper Control,” and a digital input DIN must be programmed for selection “RunEn/INTLK.” The relay output is used to energize an element of the driven system, such as a damper, seal water solenoid, or a pre-lube pump. Upon a return acknowledgement contact closure to the programmed digital input, the frequency converter will start. 2 = Interlock Time Start—This functions the same as the Interlocked Start, except that if the return acknowledgement contact is not received within the Interlock Timeout, a “prevent-up start” fault is displayed in keypad and the start sequence will need to be restarted. 3 = Delay Start—This start is similar to the Interlocked Start, except that a return contact is not used. After the “Delay Time” following the relay output closure, the frequency converter starts.	2,3,4	RW
P18.1.9	484	Damper time out Use this parameter to set the timeout time used for an Interlocked Time Start, if the time is expired before getting a feedback, the start sequence must be restarted if no acknowledgment contact is received.	2,3,4	RW
P18.1.10	485	Damper delay Use this parameter to set the delay time following a the Delay Start start mode selection, once the time has expired the drive will being to ramp the output.	2,3,4	RW
P18.1.11	2468	Derag Cycles Use this parameter to set the number of cycles in the forward/Reverse direction the drive will perform based on the derage at start/stop setting.	2,3,4	RW
P18.1.12	2469	Derag at Start/Stop Use this parameter to set how the derag function will become activated; start, stop, both or based off the digital input function.	2,3,4	RW
P18.1.13	2470	Deragging Run Time Use this parameter to set the length of time the drive will run at the Derag speed in the forward and reverse direction during the derage cycle.	2,3,4	RW

Code	Modbus ID	Parameter	Application	RO/RW
P18.1.14	2471	<p>Derag Speed</p> <p>Use this parameter to set the frequency the drive will run at in the forward/reverse direction when in the Derag cycle.</p>	2,3,4	RW
P18.1.15	2472	<p>Derag Off Delay</p> <p>Use this parameter to set the length of time the drive will run at the 0Hz level between transitioning from the forward direction and the reverse direction in the derag cycle.</p>	2,3,4	RW
P18.2.1.1	2218	<p>Drive 1</p> <p>This parameter gives the status of Drive 1 when doing the Multi-Pump mode with multiple drives connected via Modbus together to run individual motors. 0 = Offline - when in single drive mode or slave drive which lost master in multi drive mode 1 = Slave Drive - Operates as an auxiliary drive in multi-drive mode 2 = Master Drive - Operates as the regulating drive of the multi-drive mode</p>	2,3,4	RO
P18.2.1.2	2230	<p>Drive 2</p> <p>This parameter gives the status of Drive 2 when doing the Multi-Pump mode with multiple drives connected via Modbus together to run individual motors. 0 = Offline - when in single drive mode or slave drive which lost master in multi drive mode 1 = Slave Drive - Operates as an auxiliary drive in multi-drive mode 2 = Master Drive - Operates as the regulating drive of the multi-drive mode</p>	2,3,4	RO
P18.2.1.3	2242	<p>Drive 3</p> <p>This parameter gives the status of Drive 3 when doing the Multi-Pump mode with multiple drives connected via Modbus together to run individual motors. 0 = Offline - when in single drive mode or slave drive which lost master in multi drive mode 1 = Slave Drive - Operates as an auxiliary drive in multi-drive mode 2 = Master Drive - Operates as the regulating drive of the multi-drive mode</p>	2,3,4	RO
P18.2.1.4	2254	<p>Drive 4</p> <p>This parameter gives the status of Drive 4 when doing the Multi-Pump mode with multiple drives connected via Modbus together to run individual motors. 0 = Offline - when in single drive mode or slave drive which lost master in multi drive mode 1 = Slave Drive - Operates as an auxiliary drive in multi-drive mode 2 = Master Drive - Operates as the regulating drive of the multi-drive mode</p>	2,3,4	RO
P18.2.1.5	2266	<p>Drive 5</p> <p>This parameter gives the status of Drive 5 when doing the Multi-Pump mode with multiple drives connected via Modbus together to run individual motors. 0 = Offline - when in single drive mode or slave drive which lost master in multi drive mode 1 = Slave Drive - Operates as an auxiliary drive in multi-drive mode 2 = Master Drive - Operates as the regulating drive of the multi-drive mode</p>	2,3,4	RO
P18.2.2.1	2219	<p>Drive 1</p> <p>This parameter gives the status of Drive 1 in terms of the Multi-pump level when doing the Multi-Pump mode with multiple drives connected via Modbus together to run individual motors. 0 = Stopped—For master or single drive that is stopped 1 = Sleep—For master or single drive that is asleep 2 = Regulating—For master or single drive which is running 3 = Wait for CMD—For slave drive which is stopped 4 = Following—For slave drive which is running 5 = Unknown—status for disconnected drives showing on the other drives menu</p>	2,3,4	RO
P18.2.2.2	2231	<p>Drive 2</p> <p>This parameter gives the status of Drive 2 in terms of the Multi-pump level when doing the Multi-Pump mode with multiple drives connected via Modbus together to run individual motors. 0 = Stopped—For master or single drive that is stopped 1 = Sleep—For master or single drive that is asleep 2 = Regulating—For master or single drive which is running 3 = Wait for CMD—For slave drive which is stopped 4 = Following—For slave drive which is running 5 = Unknown—status for disconnected drives showing on the other drives menu</p>	2,3,4	RO

Appendix A—Description of parameters

Code	Modbus ID	Parameter	Application	RO/RW
P18.2.2.3	2243	Drive 3 This parameter gives the status of Drive 3 in terms of the Multi-pump level when doing the Multi-Pump mode with multiple drives connected via Modbus together to run individual motors. 0 = Stopped—For master or single drive that is stopped 1 = Sleep—For master or single drive that is asleep 2 = Regulating—For master or single drive which is running 3 = Wait for CMD—For slave drive which is stopped 4 = Following—For slave drive which is running 5 = Unknown—status for disconnected drives showing on the other drives menu	2,3,4	RO
P18.2.2.4	2245	Drive 4 This parameter gives the status of Drive 4 in terms of the Multi-pump level when doing the Multi-Pump mode with multiple drives connected via Modbus together to run individual motors. 0 = Stopped—For master or single drive that is stopped 1 = Sleep—For master or single drive that is asleep 2 = Regulating—For master or single drive which is running 3 = Wait for CMD—For slave drive which is stopped 4 = Following—For slave drive which is running 5 = Unknown—status for disconnected drives showing on the other drives menu	2,3,4	RO
P18.2.2.5	2267	Drive 5 This parameter gives the status of Drive 5 in terms of the Multi-pump level when doing the Multi-Pump mode with multiple drives connected via Modbus together to run individual motors. 0 = Stopped—For master or single drive that is stopped 1 = Sleep—For master or single drive that is asleep 2 = Regulating—For master or single drive which is running 3 = Wait for CMD—For slave drive which is stopped 4 = Following—For slave drive which is running 5 = Unknown—status for disconnected drives showing on the other drives menu	2,3,4	RO
P18.2.3.1	2220	Drive 1 This parameter gives the status of Drive 1 in terms of the Network Status when doing the Multi-Pump mode with multiple drives connected via Modbus together to run individual motors. 0 = Disconnected—for disconnected slave drive, single drive or MPFC is disabled 1 = Fault—for drives that suffer fault 2 = Pump Lost—for drives that lose interlock signal 3 = Need Alternation—for drives that run time is over limit 4 = No Error	2,3,4	RO
P18.2.3.2	2232	Drive 2 This parameter gives the status of Drive 2 in terms of the Network Status when doing the Multi-Pump mode with multiple drives connected via Modbus together to run individual motors. 0 = Disconnected—for disconnected slave drive, single drive or MPFC is disabled 1 = Fault—for drives that suffer fault 2 = Pump Lost—for drives that lose interlock signal 3 = Need Alternation—for drives that run time is over limit 4 = No Error	2,3,4	RO
P18.2.3.3	2244	Drive 3 This parameter gives the status of Drive 3 in terms of the Network Status when doing the Multi-Pump mode with multiple drives connected via Modbus together to run individual motors. 0 = Disconnected—for disconnected slave drive, single drive or MPFC is disabled 1 = Fault—for drives that suffer fault 2 = Pump Lost—for drives that lose interlock signal 3 = Need Alternation—for drives that run time is over limit 4 = No Error	2,3,4	RO
P18.2.3.4	2246	Drive 4 This parameter gives the status of Drive 4 in terms of the Network Status when doing the Multi-Pump mode with multiple drives connected via Modbus together to run individual motors. 0 = Disconnected—for disconnected slave drive, single drive or MPFC is disabled 1 = Fault—for drives that suffer fault 2 = Pump Lost—for drives that lose interlock signal 3 = Need Alternation—for drives that run time is over limit 4 = No Error	2,3,4	RO
P18.2.3.5	2268	Drive 5 This parameter gives the status of Drive 5 in terms of the Network Status when doing the Multi-Pump mode with multiple drives connected via Modbus together to run individual motors. 0 = Disconnected—for disconnected slave drive, single drive or MPFC is disabled 1 = Fault—for drives that suffer fault 2 = Pump Lost—for drives that lose interlock signal 3 = Need Alternation—for drives that run time is over limit 4 = No Error	2,3,4	RO

Code	Modbus ID	Parameter	Application	RO/RW
P18.3.1.1	2221	Drive 1 This parameter gives the status of Drive 1 in terms of the Latest Fault Code when doing the Multi-Pump mode with multiple drives connected via Modbus together to run individual motors. This will be seen from the Master drive.	2,3,4	RO
P18.3.1.2	2233	Drive 2 This parameter gives the status of Drive 2 in terms of the Latest Fault Code when doing the Multi-Pump mode with multiple drives connected via Modbus together to run individual motors. This will be seen from the Master drive.	2,3,4	RO
P18.3.1.3	2245	Drive 3 This parameter gives the status of Drive 3 in terms of the Latest Fault Code when doing the Multi-Pump mode with multiple drives connected via Modbus together to run individual motors. This will be seen from the Master drive.	2,3,4	RO
P18.3.1.4	2257	Drive 4 This parameter gives the status of Drive 4 in terms of the Latest Fault Code when doing the Multi-Pump mode with multiple drives connected via Modbus together to run individual motors. This will be seen from the Master drive.	2,3,4	RO
P18.3.1.5	2269	Drive 5 This parameter gives the status of Drive 5 in terms of the Latest Fault Code when doing the Multi-Pump mode with multiple drives connected via Modbus together to run individual motors. This will be seen from the Master drive.	2,3,4	RO
P18.3.2.1	2222	Drive 1 This parameter gives the status of Drive 1 in terms of the Output Frequency when doing the Multi-Pump mode with multiple drives connected via Modbus together to run individual motors. This will be seen from the Master drive.	2,3,4	RO
P18.3.2.2	2234	Drive 2 This parameter gives the status of Drive 2 in terms of the Output Frequency when doing the Multi-Pump mode with multiple drives connected via Modbus together to run individual motors. This will be seen from the Master drive.	2,3,4	RO
P18.3.2.3	2246	Drive 3 This parameter gives the status of Drive 3 in terms of the Output Frequency when doing the Multi-Pump mode with multiple drives connected via Modbus together to run individual motors. This will be seen from the Master drive.	2,3,4	RO
P18.3.2.4	2258	Drive 4 This parameter gives the status of Drive 4 in terms of the Output Frequency when doing the Multi-Pump mode with multiple drives connected via Modbus together to run individual motors. This will be seen from the Master drive.	2,3,4	RO
P18.3.2.5	2270	Drive 5 This parameter gives the status of Drive 5 in terms of the Output Frequency when doing the Multi-Pump mode with multiple drives connected via Modbus together to run individual motors. This will be seen from the Master drive.	2,3,4	RO
P18.3.3.1	2223	Drive 1 This parameter gives the status of Drive 1 in terms of the Motor Voltage when doing the Multi-Pump mode with multiple drives connected via Modbus together to run individual motors. This will be seen from the Master drive.	2,3,4	RO
P18.3.3.2	2235	Drive 2 This parameter gives the status of Drive 2 in terms of the Motor Voltage when doing the Multi-Pump mode with multiple drives connected via Modbus together to run individual motors. This will be seen from the Master drive.	2,3,4	RO
P18.3.3.3	2247	Drive 3 This parameter gives the status of Drive 3 in terms of the Motor Voltage when doing the Multi-Pump mode with multiple drive connected via Modbus together to run individual motors. This will be seen from the Master drive.	2,3,4	RO
P18.3.3.4	2259	Drive 4 This parameter gives the status of Drive 4 in terms of the Motor Voltage when doing the Multi-Pump mode with multiple drives connected via Modbus together to run individual motors. This will be seen from the Master drive.	2,3,4	RO
P18.3.3.5	2271	Drive 5 This parameter gives the status of Drive 5 in terms of the Motor Voltage when doing the Multi-Pump mode with multiple drives connected via Modbus together to run individual motors. This will be seen from the Master drive.	2,3,4	RO

Appendix A—Description of parameters

Code	Modbus ID	Parameter	Application	RO/RW
P18.3.4.1	2224	Drive 1 This parameter gives the status of Drive 1 in terms of the Motor Current when doing the Multi-Pump mode with multiple drives connected via Modbus together to run individual motors. This will be seen from the Master drive.	2,3,4	RO
P18.3.4.2	2236	Drive 2 This parameter gives the status of Drive 2 in terms of the Motor Current when doing the Multi-Pump mode with multiple drives connected via Modbus together to run individual motors. This will be seen from the Master drive.	2,3,4	RO
P18.3.4.3	2248	Drive 3 This parameter gives the status of Drive 3 in terms of the Motor Current when doing the Multi-Pump mode with multiple drives connected via Modbus together to run individual motors. This will be seen from the Master drive.	2,3,4	RO
P18.3.4.4	2260	Drive 4 This parameter gives the status of Drive 4 in terms of the Motor Current when doing the Multi-Pump mode with multiple drives connected via Modbus together to run individual motors. This will be seen from the Master drive.	2,3,4	RO
P18.3.4.5	2272	Drive 5 This parameter gives the status of Drive 5 in terms of the Motor Current when doing the Multi-Pump mode with multiple drives connected via Modbus together to run individual motors. This will be seen from the Master drive.	2,3,4	RO
P18.3.5.1	2225	Drive 1 This parameter gives the status of Drive 1 in terms of the Motor Torque when doing the Multi-Pump mode with multiple drives connected via Modbus together to run individual motors. This will be seen from the Master drive.	2,3,4	RO
P18.3.5.2	2237	Drive 2 This parameter gives the status of Drive 2 in terms of the Motor Torque when doing the Multi-Pump mode with multiple drives connected via Modbus together to run individual motors. This will be seen from the Master drive.	2,3,4	RO
P18.3.5.3	2249	Drive 3 This parameter gives the status of Drive 3 in terms of the Motor Torque when doing the Multi-Pump mode with multiple drives connected via Modbus together to run individual motors. This will be seen from the Master drive.	2,3,4	RO
P18.3.5.4	2261	Drive 4 This parameter gives the status of Drive 4 in terms of the Motor Torque when doing the Multi-Pump mode with multiple drives connected via Modbus together to run individual motors. This will be seen from the Master drive.	2,3,4	RO
P18.3.5.5	2273	Drive 5 This parameter gives the status of Drive 5 in terms of the Motor Torque when doing the Multi-Pump mode with multiple drives connected via Modbus together to run individual motors. This will be seen from the Master drive.	2,3,4	RO
P18.3.6.1	2226	Drive 1 This parameter gives the status of Drive 1 in terms of the Motor Power when doing the Multi-Pump mode with multiple drives connected via Modbus together to run individual motors. This will be seen from the Master drive.	2,3,4	RO
P18.3.6.2	2238	Drive 2 This parameter gives the status of Drive 2 in terms of the Motor Power when doing the Multi-Pump mode with multiple drives connected via Modbus together to run individual motors. This will be seen from the Master drive.	2,3,4	RO
P18.3.6.3	2250	Drive 3 This parameter gives the status of Drive 3 in terms of the Motor Power when doing the Multi-Pump mode with multiple drive drives connected via Modbus together to run individual motors. This will be seen from the Master drive.	2,3,4	RO
P18.3.6.4	2262	Drive 4 This parameter gives the status of Drive 4 in terms of the Motor Power when doing the Multi-Pump mode with multiple drives connected via Modbus together to run individual motors. This will be seen from the Master drive.	2,3,4	RO
P18.3.6.5	2274	Drive 5 This parameter gives the status of Drive 5 in terms of the Motor Power when doing the Multi-Pump mode with multiple drives connected via Modbus together to run individual motors. This will be seen from the Master drive.	2,3,4	RO

Code	Modbus ID	Parameter	Application	RO/RW
P18.3.7.1	2227	Drive 1 This parameter gives the status of Drive 1 in terms of the Motor Speed when doing the Multi-Pump mode with multiple drives connected via Modbus together to run individual motors. This will be seen from the Master drive.	2,3,4	RO
P18.3.7.2	2239	Drive 2 This parameter gives the status of Drive 2 in terms of the Motor Speed when doing the Multi-Pump mode with multiple drives connected via Modbus together to run individual motors. This will be seen from the Master drive.	2,3,4	RO
P18.3.7.3	2251	Drive 3 This parameter gives the status of Drive 3 in terms of the Motor Speed when doing the Multi-Pump mode with multiple drives connected via Modbus together to run individual motors. This will be seen from the Master drive.	2,3,4	RO
P18.3.7.4	2263	Drive 4 This parameter gives the status of Drive 4 in terms of the Motor Speed when doing the Multi-Pump mode with multiple drives connected via Modbus together to run individual motors. This will be seen from the Master drive.	2,3,4	RO
P18.3.7.5	2275	Drive 5 This parameter gives the status of Drive 5 in terms of the Motor Speed when doing the Multi-Pump mode with multiple drives connected via Modbus together to run individual motors. This will be seen from the Master drive.	2,3,4	RO
P18.3.8.1	2228	Drive 1 This parameter gives the status of Drive 1 in terms of the Motor Run Time when doing the Multi-Pump mode with multiple drives connected via Modbus together to run individual motors. This will be seen from the Master drive.	2,3,4	RO
P18.3.8.2	2240	Drive 2 This parameter gives the status of Drive 2 in terms of the Motor Run Time when doing the Multi-Pump mode with multiple drives connected via Modbus together to run individual motors. This will be seen from the Master drive.	2,3,4	RO
P18.3.8.3	2252	Drive 3 This parameter gives the status of Drive 3 in terms of the Motor Run Time when doing the Multi-Pump mode with multiple drives connected via Modbus together to run individual motors. This will be seen from the Master drive.	2,3,4	RO
P18.3.8.4	2264	Drive 4 This parameter gives the status of Drive 4 in terms of the Motor Run Time when doing the Multi-Pump mode with multiple drives connected via Modbus together to run individual motors. This will be seen from the Master drive.	2,3,4	RO
P18.3.8.5	2276	Drive 5 This parameter gives the status of Drive 5 in terms of the Motor Run Time when doing the Multi-Pump mode with multiple drives connected via Modbus together to run individual motors. This will be seen from the Master drive.	2,3,4	RO
P18.4.1	342	Number of Pumps Use this parameter to set the Total number of auxiliary motors/pumps to be used with the Multi-Pump System. When in single drive mode, this functions as the amount of motors on a single drive.	2,3,4	RW
P18.4.2	346	Include frequency converter Use this parameter to include the motor/pump connected to frequency converter into the auto change sequence with the aux contact blocks.	2,3,4	RW
P18.4.3	345	Auto-Change enable Use this parameter to enable the Auto-change function to rotate the starting order/priority of the motors in the system to get equal run time on all the motors.	2,3,4	RW
P18.4.4	347	Auto-Change interval Use this parameter to set the time for alternating the motors, upon expiring the staging sequence will cycle if the frequency limit and pump limit levels are met.	2,3,4	RW
P18.4.5	349	Auto-Change freq limit Use this parameter to set the frequency level for the auto-change to be accomplished after the auto-change interval has elapsed.	2,3,4	RW
P18.4.6	348	Auto-Change pump limit Use this parameter to set the number of pumps that can be active to allow for a alternation of the lead pump. If the number of active pumps is greater when the time interval expires and the drive waits to pumps are destage to change.	2,3,4	RW

Appendix A—Description of parameters

Code	Modbus ID	Parameter	Application	RO/RW
P18.4.7	2441	Pipe fill aux pump select Defines the aux pump to perform the pipe fill process. 0 = Disabled 1 = Aux motor 1 2 = Aux Motor 2 3 = Aux Motor 3 4 = Aux Motor 4	2,3,4	RW
P18.4.8	2442	Pipe fill aux pump run time Defines the time the aux pump run time is set to.	2,3,4	RW
P18.4.9	2443	Pipe fill aux pump operation Defines the operation mode of the aux pump operation when disabling. Either follow an automatic transition into scheme or stop. 0 = Automatic 1 = Stop	2,3,4	RW
P18.4.10	2444	Pipe fill aux pump delay Defines the delay time in enabling of the aux pump from enabling.	2,3,4	RW
P18.5.1	2451	Number of drives This defines the number of drives active when doing the Multi-Drive Pump and fan scheme. By default there will be always 1 drive active at 1 time by setting value to above 1 it allows to bring in additional drives to maintain the system.	2,3,4	RW
P18.5.2	2284	Regulation source Use this parameter to define which drive will be considered a master or slave in the system. 0 = Network - Follower 1 = PID Controller 1 - Master	2,3,4	RW
P18.5.3	2285	Recovery method Use this parameter to set the operation of the slave drive if communication to the master is lost. Slave drive can continue run if it set to be "Automatic", however slave drive will stop immediately if it is set to be "Stop". 0 = Automatic 1 = Stop	2,3,4	RW
P18.5.4	2286	Callback source Use this parameter to allow the slave drives to send the safety contact information back to the master. If slave drive has a callback source as Safe Torque Off, when it suffers STO fault, master drive will answer this callback and shutdown whole system. When set to No action that slave will just stop and the system will continue to run. 0 = No Action 1 = Safe Torque Off	2,3,4	RW
P18.5.5	2311	Add/Remove drive selection Use this parameter to define the operation of adding and removing drives to the system and alternating masters. By default, MPFC system will add/remove pump according to their drive ID, from small to large; If it is based off run time then it will use the length of run to add the drive that has shortest running time and remove the drive has longest running time first. 0 = Drive ID 1 = Run Time	2,3,4	RW
P18.5.6	2280	Run time enable Use this parameter to enable the run time counter on the drive to be used with add/remove sequence or alternation. 0 = Disable 1 = Enable	2,3,5	RW
P18.5.7	2281	Run time limit Use this parameter to assign the run time limit required for alternation the system. Once the run time expires an alarm will be shown on the drive and will alternate if able to another slave or Master position.	2,3,6	RW
P18.5.8	2283	Run time reset Use this parameter to manually reset the run time counter.	2,3,7	RW
P18.5.9	2473	Master Drive Mode Use this parameter to define how the master will maintain its frequency as slave units are brought in to the system. 0 = Follow PID - Regulate the output based off the PID controller 1 = Fixed Speed - Run at a Fixed speed 2 = Turn Off - disable the pump output	2,3,4	RW

Code	Modbus ID	Parameter	Application	RO/RW
P18.5.10	2474	Master Fixed Speed Use this parameter to set the frequency level that is used when the master is desired to run at a fixed speed when slaves are brought in.	2,3,4	RW
P18.5.11	2475	Master Fixed Speed Delay Defines the delay time before the master drive begins running at the fixed speed or turns off if the Master Mode is set for Fixed Speed or Turn Off.	2,3,4	RW
P18.6.1	2406	Pipe fill loss detection method Defines the value for looking at a loss of prime 0 = Motor Current 1 = Motor Power (%) 2 = Motor Torque (%)	2,3,4	RW
P18.6.2	2407	Pipe fill loss level Use this parameter to select the level at which to look at a condition of Loss of Prime. When the measured value defined in the Detection Method drops below this level for the Prime Loss Time and is above the Prime Loss Frequency level, the drive will respond based off the	2,3,4	RW
P18.6.3	2408	Pipe fill loss time Use this parameter to set the delay time before a "Loss of Prime" condition will occur based of the Detection Method and Prime Loss Level.	2,3,4	RW
P18.6.4	2409	Pipe fill loss frequency Use this parameter to set the frequency point at which the drive needs to be above to enabled the "Loss of Prime" feature. When set to 0 Hz protection is disabled.	2,3,4	RW
P18.6.5	2410	Pipe fill loss response Use this parameter to set the response method when a "Pipe Fill Fault" fault condition. Possibilities device dependent	2,3,4	RW
P18.6.6	2411	Pipe fill loss attempts Use this parameter to set the number of allowed restart-attempts after "Pipe Fill Fault" occurred.	2, 3, 4	RW
P18.6.7	2430	Prime pump enable Use this parameter to enable or disabled the Prime Pump(Pre Charge) function to allow for pre filling a system before going into PID control mode.	2, 3, 4	RW
P18.6.8	2431	Prime pump level Use this parameter to set the level at which the Prime Pump(Pre Charge) function will drop out, If the feedback level raise above this value Prime Pump(Pre Charge) becomes deactivated, if the level is not reach it will switch after the delay time.	2, 3, 4	RW
P18.6.9	2433	Prime pump frequency Use this parameter to set the Frequency at which the Prime Pump(Pre Charge) function will operate when enabled.	2, 3, 4	RW
P18.6.10	2434	Prime pump delay time Use this parameter to set the time that the drive will run the Prime Pump(Pre Charge) function on start up. When set to "0 Hz" this function is not enabled. When set to "0 Hz" this function is not enabled.	2, 3, 4	RW
P18.6.11	2435	Prime pump loss of prime level Use this parameter to set the limit to indicate a loss of Prime in pump. If the measured current drops below the determined value for the value assigned in the Prime Loss of Time setting the drive will display a Pre-charge Loss of Prime.	2, 3, 4	RW
P18.6.12	2436	Prime pump level 2 Use this parameter to set the level at which the Prime Pump(Pre Charge) function will drop out, If the feedback level raise above this value Prime Pump(Pre Charge) becomes deactivated, if the level is not reach it will switch after the delay time.	2, 3, 4	RW
P18.6.13	2438	Prime pump frequency 2 Use this parameter to set the Frequency at which the Prime Pump(Pre Charge) function will operate when enabled.	2, 3, 4	RW
P18.6.14	2439	Prime pump delay time 2 Use this parameter to set the time that the drive will run the Prime Pump(Pre Charge) function on start up. When set to "0 Hz" this function is not enabled. When set to "0 Hz" this function is not enabled.	2, 3, 4	RW
P18.6.15	2440	Prime pump loss of prime level 2 Use this parameter to set the limit to indicate a loss of Prime in pump. If the measured current drops below the determined value for the value assigned in the Prime Loss of Time setting the drive will display a Pre-charge Loss of Prime.	2, 3, 4	RW
P19.1	491	Interval 1 on time Use this parameter to set the on time for Interval function. It uses 24-hour format. Use to specify a time of day for a desired function to be disabled.	2, 3, 4	RW

Appendix A—Description of parameters

Code	Modbus ID	Parameter	Application	RO/RW
P19.2	493	Interval 1 off time Use this parameter to set the off time for Interval function. It uses 24-hour format. Use to specify a time of day for a desired function to be disabled.	2, 3, 4	RW
P19.3	517	Interval 1 from day Use this parameter to set the day of week for Interval function to start on. 0 = Sunday 1 = Monday 2 = Tuesday 3 = Wednesday 4 = Thursday 5 = Friday 6 = Saturday	2, 3, 4	RW
P19.4	518	Interval 1 to day Use this parameter to set the day of week for Interval function to stop on. 0 = Sunday 1 = Monday 2 = Tuesday 3 = Wednesday 4 = Thursday 5 = Friday 6 = Saturday	2, 3, 4	RW
P19.5	519	Interval 1 channel Use this parameter to assign the interval to a select time channel to store the interval time. 0 = Not used 1 = Time channel 1 2 = Time channel 2 3 = Time channel 3	2, 3, 4	RW
P19.6	495	Interval 2 on time Use this parameter to set the on time for Interval function. It uses 24-hour format. Use to specify a time of day for a desired function to be disabled.	2, 3, 4	RW
P19.7	497	Interval 2 off time Use this parameter to set the off time for Interval function. It uses 24-hour format. Use to specify a time of day for a desired function to be disabled.	2, 3, 4	RW
P19.8	520	Interval 2 from day Use this parameter to set the day of week for Interval function to start on. 0 = Sunday 1 = Monday 2 = Tuesday 3 = Wednesday 4 = Thursday 5 = Friday 6 = Saturday	2, 3, 4	RW
P19.9	521	Interval 2 to day Use this parameter to set the day of week for Interval function to stop on. 0 = Sunday 1 = Monday 2 = Tuesday 3 = Wednesday 4 = Thursday 5 = Friday 6 = Saturday	2, 3, 4	RW
P19.10	522	Interval 2 channel Use this parameter to assign the interval to a select time channel to store the interval time. 0 = Not used 1 = Time channel 1 2 = Time channel 2 3 = Time channel 3	2, 3, 4	RW

Code	Modbus ID	Parameter	Application	RO/RW
P19.11	499	Interval 3 on time Use this parameter to set the on time for Interval function. It uses 24-hour format. Use to specify a time of day for a desired function to be disabled.	2, 3, 4	RW
P19.12	501	Interval 3 off time Use this parameter to set the off time for Interval function. It uses 24-hour format. Use to specify a time of day for a desired function to be disabled.	2, 3, 4	RW
P19.13	523	Interval 3 from day Use this parameter to set the day of week for Interval function to start on. 0 = Sunday 1 = Monday 2 = Tuesday 3 = Wednesday 4 = Thursday 5 = Friday 6 = Saturday	2, 3, 4	RW
P19.14	524	Interval 3 to day Use this parameter to set the day of week for Interval function to stop on. 0 = Sunday 1 = Monday 2 = Tuesday 3 = Wednesday 4 = Thursday 5 = Friday 6 = Saturday	2, 3, 4	RW
P19.15	525	Interval 3 channel Use this parameter to assign the interval to a select time channel to store the interval time. 0 = Not used 1 = Time channel 1 2 = Time channel 2 3 = Time channel 3	2, 3, 4	RW
P19.16	503	Interval 4 on time Use this parameter to set the on time for Interval function. It uses 24-hour format. Use to specify a time of day for a desired function to be disabled.	2, 3, 4	RW
P19.17	505	Interval 4 off time Use this parameter to set the off time for Interval function. It uses 24-hour format. Use to specify a time of day for a desired function to be disabled.	2, 3, 4	RW
P19.18	526	Interval 4 from day Use this parameter to set the day of week for Interval function to start on. 0 = Sunday 1 = Monday 2 = Tuesday 3 = Wednesday 4 = Thursday 5 = Friday 6 = Saturday	2, 3, 4	RW
P19.19	527	Interval 4 to day Use this parameter to set the day of week for Interval function to stop on. 0 = Sunday 1 = Monday 2 = Tuesday 3 = Wednesday 4 = Thursday 5 = Friday 6 = Saturday	2, 3, 4	RW
P19.20	528	Interval 4 channel Use this parameter to assign the interval to a select time channel to store the interval time. 0 = Not used 1 = Time channel 1 2 = Time channel 2 3 = Time channel 3	2, 3, 4	RW
P19.21	507	Interval 5 on time Use this parameter to set the on time for Interval function. It uses 24-hour format. Use to specify a time of day for a desired function to be disabled.	2, 3, 4	RW

Appendix A—Description of parameters

Code	Modbus ID	Parameter	Application	RO/RW
P19.22	509	Interval 5 off time Use this parameter to set the off time for Interval function. It uses 24-hour format. Use to specify a time of day for a desired function to be disabled.	2, 3, 4	RW
P19.23	529	Interval 5 from day Use this parameter to set the day of week for Interval function to start on. 0 = Sunday 1 = Monday 2 = Tuesday 3 = Wednesday 4 = Thursday 5 = Friday 6 = Saturday	2, 3, 4	RW
P19.24	530	Interval 5 to day Use this parameter to set the day of week for Interval function to stop on. 0 = Sunday 1 = Monday 2 = Tuesday 3 = Wednesday 4 = Thursday 5 = Friday 6 = Saturday	2, 3, 4	RW
P19.25	531	Interval 5 channel Use this parameter to assign the interval to a select time channel to store the interval time. 0 = Not used 1 = Time channel 1 2 = Time channel 2 3 = Time channel 3	2, 3, 4	RW
P19.26	511	Timer 1 duration Use this parameter to set the duration of time the timer will run when activated. (Activated by DI)	2, 3, 4	RW
P19.27	532	Timer 1 channel Use this parameter to assign the interval to a select time channel to store the timer channel. 0 = Not used 1 = Time channel 1 2 = Time channel 2 3 = Time channel 3	2, 3, 4	RW
P19.28	513	Timer 2 duration Use this parameter to set the duration of time the timer will run when activated. (Activated by DI)	2, 3, 4	RW
P19.29	533	Timer 2 channel Use this parameter to assign the interval to a select time channel to store the timer channel. 0 = Not used 1 = Time channel 1 2 = Time channel 2 3 = Time channel 3	2, 3, 4	RW
P19.30	515	Timer 3 duration Use this parameter to set the duration of time the timer will run when activated. (Activated by DI)	2, 3, 4	RW
P19.31	534	Timer 3 channel Use this parameter to assign the interval to a select time channel to store the timer channel. 0 = Not used 1 = Time channel 1 2 = Time channel 2 3 = Time channel 3	2, 3, 4	RW
P19.32	2487	Interval 1 Setting Use this parameter with the Interval time setting for interval 1 to set the desired time frame for the selection; to be Weekly or Daily. 0 - Weekly - would setup the timer for the week long. Drive starts on the on day/time and runs to the stop day and time. 1 - Daily - would setup the timer for the defined day. Drive starts on time and stops on that day off time, for the listed days in the sequence	2, 3, 4	RW

Code	Modbus ID	Parameter	Application	RO/RW
P19.33	2488	Interval 2 Setting Use this parameter with the Interval time setting for interval 2 to set the desired time frame for the selection; to be Weekly or Daily. 0 - Weekly - would setup the timer for the week long. Drive starts on the on day/time and runs to the stop day and time. 1 - Daily - would setup the timer for the defined day. Drive starts on time and stops on that day off time, for the listed days in the sequence	2, 3, 4	RW
P19.34	2489	Interval 3 Setting Use this parameter with the Interval time setting for interval 3 to set the desired time frame for the selection; to be Weekly or Daily. 0 - Weekly - would setup the timer for the week long. Drive starts on the on day/time and runs to the stop day and time. 1 - Daily - would setup the timer for the defined day. Drive starts on time and stops on that day off time, for the listed days in the sequence	2, 3, 4	RW
P19.35	2490	Interval 4 Setting Use this parameter with the Interval time setting for interval 4 to set the desired time frame for the selection; to be Weekly or Daily. 0 - Weekly - would setup the timer for the week long. Drive starts on the on day/time and runs to the stop day and time. 1 - Daily - would setup the timer for the defined day. Drive starts on time and stops on that day off time, for the listed days in the sequence	2, 3, 4	RW
P19.36	2491	Interval 5 Setting Use this parameter with the Interval time setting for interval 5 to set the desired time frame for the selection; to be Weekly or Daily. 0 - Weekly - would setup the timer for the week long. Drive starts on the on day/time and runs to the stop day and time. 1 - Daily - would setup the timer for the defined day. Drive starts on time and stops on that day off time, for the listed days in the sequence	2, 3, 4	RW
P20.1.1	2533	FB process data input 1 sel Use this parameter to assign the Fieldbus Data Input Selections, parameter/monitor Para ID's can be assigned to these registers and then written over the desired Fieldbus Network Word for Process Data. see Communication Manual MN040010EN for more details.	1, 2, 3, 4	RW
P20.1.2	2534	FB process data input 2 sel Use this parameter to assign the Fieldbus Data Input Selections, parameter/monitor Para ID's can be assigned to these registers and then written over the desired Fieldbus Network Word for Process Data. see Communication Manual MN040010EN for more details.	1, 2, 3, 4	RW
P20.1.3	2535	FB Process Data Input 3 Sel Use this parameter to assign the Fieldbus Data Input Selections, parameter/monitor Para ID's can be assigned to these registers and then written over the desired Fieldbus Network Word for Process Data. see Communication Manual MN040010EN for more details.	1, 2, 3, 4	RW
P20.1.4	2536	FB Process Data Input 4 Sel Use this parameter to assign the Fieldbus Data Input Selections, parameter/monitor Para ID's can be assigned to these registers and then written over the desired Fieldbus Network Word for Process Data. see Communication Manual MN040010EN for more details.	1, 2, 3, 4	RW
P20.1.5	2537	FB Process Data Input 5 Sel Use this parameter to assign the Fieldbus Data Input Selections, parameter/monitor Para ID's can be assigned to these registers and then written over the desired Fieldbus Network Word for Process Data. see Communication Manual MN040010EN for more details.	1, 2, 3, 4	RW
P20.1.6	2538	FB Process Data Input 6 Sel Use this parameter to assign the Fieldbus Data Input Selections, parameter/monitor Para ID's can be assigned to these registers and then written over the desired Fieldbus Network Word for Process Data. see Communication Manual MN040010EN for more details.	1, 2, 3, 4	RW
P20.1.7	2539	FB Process Data Input 7 Sel Use this parameter to assign the Fieldbus Data Input Selections, parameter/monitor Para ID's can be assigned to these registers and then written over the desired Fieldbus Network Word for Process Data. see Communication Manual MN040010EN for more details.	1, 2, 3, 4	RW
P20.1.8	2540	FB Process Data Input 8 Sel Use this parameter to assign the Fieldbus Data Input Selections, parameter/monitor Para ID's can be assigned to these registers and then written over the desired Fieldbus Network Word for Process Data. see Communication Manual MN040010EN for more details.	1, 2, 3, 4	RW

Appendix A—Description of parameters

Code	Modbus ID	Parameter	Application	RO/RW
P20.2.1	1556	FB Process Data Output 1 Sel Use this parameter to accessing the Fieldbus Data Output Selections, parameter/monitor ID's can be assigned to these registers and then read over the desired Fieldbus Network Word for Process Data. Default Values for Process Data Out in Fieldbus(build table for below values) Process Data Out1 - Output Frequency = ID 1 Process Data Out2 - Motor Speed = ID 2 Process Data Out3 - Motor Current = ID 3 Process Data Out4 - Motor Torque = ID 4 Process Data Out5 - Motor Power = ID 5 Process Data Out6 - Motor Voltage = ID 6 Process Data Out7 - DC Link Voltage = ID 7 Process Data Out8 - Active Fault Code = ID 28 see Communication Manual MN040010EN for more details.	1,2,3,4	RW
P20.2.2	1557	FB Process Data Output 2 Sel Use this parameter to accessing the Fieldbus Data Output Selections, parameter/monitor ID's can be assigned to these registers and then read over the desired Fieldbus Network Word for Process Data. Default Values for Process Data Out in Fieldbus(build table for below values) Process Data Out1 - Output Frequency = ID 1 Process Data Out2 - Motor Speed = ID 2 Process Data Out3 - Motor Current = ID 3 Process Data Out4 - Motor Torque = ID 4 Process Data Out5 - Motor Power = ID 5 Process Data Out6 - Motor Voltage = ID 6 Process Data Out7 - DC Link Voltage = ID 7 Process Data Out8 - Active Fault Code = ID 28 see Communication Manual MN040010EN for more details.	1,2,3,4	RW
P20.2.3	1558	FB Process Data Output 3 Sel Use this parameter to accessing the Fieldbus Data Output Selections, parameter/monitor ID's can be assigned to these registers and then read over the desired Fieldbus Network Word for Process Data. Default Values for Process Data Out in Fieldbus(build table for below values) Process Data Out1 - Output Frequency = ID 1 Process Data Out2 - Motor Speed = ID 2 Process Data Out3 - Motor Current = ID 3 Process Data Out4 - Motor Torque = ID 4 Process Data Out5 - Motor Power = ID 5 Process Data Out6 - Motor Voltage = ID 6 Process Data Out7 - DC Link Voltage = ID 7 Process Data Out8 - Active Fault Code = ID 28 see Communication Manual MN040010EN for more details.	1,2,3,4	RW
P20.2.4	1559	FB Process Data Output 4 Sel Use this parameter to accessing the Fieldbus Data Output Selections, parameter/monitor ID's can be assigned to these registers and then read over the desired Fieldbus Network Word for Process Data. Default Values for Process Data Out in Fieldbus(build table for below values) Process Data Out1 - Output Frequency = ID 1 Process Data Out2 - Motor Speed = ID 2 Process Data Out3 - Motor Current = ID 3 Process Data Out4 - Motor Torque = ID 4 Process Data Out5 - Motor Power = ID 5 Process Data Out6 - Motor Voltage = ID 6 Process Data Out7 - DC Link Voltage = ID 7 Process Data Out8 - Active Fault Code = ID 28 see Communication Manual MN040010EN for more details.	1,2,3,4	RW
P20.2.5	1560	FB Process Data Output 5 Sel Use this parameter to accessing the Fieldbus Data Output Selections, parameter/monitor ID's can be assigned to these registers and then read over the desired Fieldbus Network Word for Process Data. Default Values for Process Data Out in Fieldbus(build table for below values) Process Data Out1 - Output Frequency = ID 1 Process Data Out2 - Motor Speed = ID 2 Process Data Out3 - Motor Current = ID 3 Process Data Out4 - Motor Torque = ID 4 Process Data Out5 - Motor Power = ID 5 Process Data Out6 - Motor Voltage = ID 6 Process Data Out7 - DC Link Voltage = ID 7 Process Data Out8 - Active Fault Code = ID 28 see Communication Manual MN040010EN for more details.	1,2,3,4	RW

Code	Modbus ID	Parameter	Application	RO/RW
P20.2.6	1561	FB Process Data Output 6 Sel Use this parameter to accessing the Fieldbus Data Output Selections, parameter/monitor ID's can be assigned to these registers and then read over the desired Fieldbus Network Word for Process Data. Default Values for Process Data Out in Fieldbus(build table for below values) Process Data Out1 - Output Frequency = ID 1 Process Data Out2 - Motor Speed = ID 2 Process Data Out3 - Motor Current = ID 3 Process Data Out4 - Motor Torque = ID 4 Process Data Out5 - Motor Power = ID 5 Process Data Out6 - Motor Voltage = ID 6 Process Data Out7 - DC Link Voltage = ID 7 Process Data Out8 - Active Fault Code = ID 28 see Communication Manual MN040010EN for more details.	1,2,3,4	RW
P20.2.7	1562	FB Process Data Output 7 Sel Use this parameter to accessing the Fieldbus Data Output Selections, parameter/monitor ID's can be assigned to these registers and then read over the desired Fieldbus Network Word for Process Data. Default Values for Process Data Out in Fieldbus(build table for below values) Process Data Out1 - Output Frequency = ID 1 Process Data Out2 - Motor Speed = ID 2 Process Data Out3 - Motor Current = ID 3 Process Data Out4 - Motor Torque = ID 4 Process Data Out5 - Motor Power = ID 5 Process Data Out6 - Motor Voltage = ID 6 Process Data Out7 - DC Link Voltage = ID 7 Process Data Out8 - Active Fault Code = ID 28 see Communication Manual MN040010EN for more details.	1,2,3,4	RW
P20.2.8	1563	FB Process Data Output 8 Sel Use this parameter to accessing the Fieldbus Data Output Selections, parameter/monitor ID's can be assigned to these registers and then read over the desired Fieldbus Network Word for Process Data. Default Values for Process Data Out in Fieldbus(build table for below values) Process Data Out1 - Output Frequency = ID 1 Process Data Out2 - Motor Speed = ID 2 Process Data Out3 - Motor Current = ID 3 Process Data Out4 - Motor Torque = ID 4 Process Data Out5 - Motor Power = ID 5 Process Data Out6 - Motor Voltage = ID 6 Process Data Out7 - DC Link Voltage = ID 7 Process Data Out8 - Active Fault Code = ID 28 see Communication Manual MN040010EN for more details.	1,2,3,4	RW
P20.2.9	2415	Standard Status Word Bit0 Function Select Use this parameter to select status indication of this bit0 to be read over the communication Standard Status Word.	1, 2, 3, 4	RW
P20.2.10	2416	Standard Status Word Bit1 Function Select Use this parameter to select status indication of this bit1 to be read over the communication Standard Status Word.	1, 2, 3, 4	RW
P20.2.11	2417	Standard Status Word Bit2 Function Select Use this parameter to select status indication of this bit2 to be read over the communication Standard Status Word.	1, 2, 3, 4	RW
P20.2.12	2418	Standard Status Word Bit3 Function Select Use this parameter to select status indication of this bit3 to be read over the communication Standard Status Word.	1, 2, 3, 4	RW
P20.2.13	2419	Standard Status Word Bit4 Function Select Use this parameter to select status indication of this bit4 to be read over the communication Standard Status Word.	1, 2, 3, 4	RO
P20.2.14	2420	Standard Status Word Bit5 Function Select Use this parameter to select status indication of this bit5 to be read over the communication Standard Status Word.	1, 2, 3, 4	RO
P20.2.15	2421	Standard Status Word Bit6 Function Select Use this parameter to select status indication of this bit6 to be read over the communication Standard Status Word.	1, 2, 3, 4	RO
P20.2.16	2422	Standard Status Word Bit7 Function Select Use this parameter to select status indication of this bit7 to be read over the communication Standard Status Word.	1, 2, 3, 4	RO

Appendix A—Description of parameters

Code	Modbus ID	Parameter	Application	RO/RW
P20.3.1.1	586	RS485 Comm Set This parameter to select the communication protocol for RS-485 terminals. 0 = Modbus RTU 1 = BACnet MS/TP 2 = Smartwire DT	1, 2, 3, 4	RW
P20.3.2.1	587	Slave Address Use this parameter set the slave address for RS-485 communication.	1, 2, 3, 4	RW
P20.3.2.2	584	Baud Rate Use this parameter set communication speed for RS-485 communication.	1, 2, 3, 4	RW
P20.3.2.3	585	Parity Type Use this parameter set parity type for RS-485 communication.	1, 2, 3, 4	RW
P20.3.2.4	588	Modbus RTU Protocol Status Use this parameter to show the protocol status for RS-485 communication. 0 = Initial 1 = Stopped 2 = Operational 3 = Faulted	1, 2, 3, 4	RW
P20.3.2.5	589	Slave Busy Use this parameter to indicate the status of the Slave device on the network.	1, 2, 3, 4	RO
P20.3.2.6	590	Parity Error Use this parameter to see the amount of Parity Errors seen on the RS-485 network.	1, 2, 3, 4	RO
P20.3.2.7	591	Slave Fault Use this parameter to see the Error response given when slave receives message without communication error, but can't handle it.	1, 2, 3, 4	RO
P20.3.2.8	592	Last Fault Response Use this parameter to show the last active fault for viewing over communications.	1,2,3,4	RW
P20.3.2.9	593	Comm Timeout Modbus RTU Use this parameter to set the time it waits before a communication fault occurs over Modbus RTU if a message isn't received.	1, 2, 3, 4	RW
P20.3.2.10	2516	Modbus RTU Fault Response Use this parameter to set the the Fieldbus Fault condition for Modbus RTU Communication. 0 = Only in Fieldbus Control Mode - when Fieldbus is the control place and Fieldbus fault is active drive will fault on loss of coms, if not in Fieldbus Control place will not fault. 1 = In all Control Modes - no matter the control place setting if communication is lost Fieldbus fault response will occur.	1, 2, 3, 4	RW
P20.3.3.1	594	MSTP Baud Rate Use this parameter to set the communication speed over BACnet.	1, 2, 3, 4	RW
P20.3.3.2	595	MSTP MS/TP Device Address Use this parameter to set the BACnet Address that the drive will be located at on Instance node.	1, 2, 3, 4	RW
P20.3.3.3	596	MSTP Instance Number Use this parameter to set the the BACnet Instance value.	1, 2, 3, 4	RW
P20.3.3.4	598	MSTP Comm Timeout MSTP Use this parameter to set the time it waits before a communication fault occurs over BACnet.	1, 2, 3, 4	RW
P20.3.3.5	599	MSTP Protocol Status Use this parameter to see the status of the BACnet Protocol.	1, 2, 3, 4	RO
P20.3.3.6	600	MSTP Fault Code Use this parameter to see the status of the BACnet Protocol faults 0 = None 1 = Sole Master 2 = Duplicate MAC ID 3 = Baud rate fault	1, 2, 3, 4	RO
P20.3.3.7	2526	MSTP Fault Response Use this parameter to set the Fieldbus Fault condition for Modbus RTU and BACnet Communication. 0 = Only in Fieldbus Control Mode - when fieldbus is the control place and Fieldbus fault is active drive will fault on loss of coms, if not in Fieldbus Control place will not fault. 1 = In all Control Modes - no matter the control place setting if communication is lost Fieldbus fault response will occur.	1, 2, 3, 4	RO

Code	Modbus ID	Parameter	Application	RO/RW
P20.4.1	1500	IP Address Mode Use this parameter to set the IP address configuration mode for EIP/Modbus TCP. 0 = DHCP with AutoIP 1 = Static IP	1, 2, 3, 4	RW
P20.4.2	1507	Active IP Address Use this parameter to see the current used IP address.	1, 2, 3, 4	RO
P20.4.3	1509	Active Subnet Mask Use this parameter to see the current used subnet mask.	1, 2, 3, 4	RO
P20.4.4	1511	Active Default Gateway Use this parameter to see the current used default gateway.	1, 2, 3, 4	RO
P20.4.5	1513	MAC Address Use this parameter to see the 48 bit hardware address.	1, 2, 3, 4	RO
P20.4.6	1501	Static IP Address Use this parameter to set the static IP address.	1, 2, 3, 4	RW
P20.4.7	1503	Static Subnet Mask Use this parameter to set the static subnet mask.	1, 2, 3, 4	RW
P20.4.8	1505	Static Default Gateway Use this parameter to set the static gateway ip address.	1, 2, 3, 4	RW
P20.4.9	608	Ethernet IP Protocol Status This parameter shows the status of the Ethernet Protocol is active or not. 0 = Stopped 1 = Operational 2 = Faulted	1,2,3,4	RO
P20.4.10	2518	EIP Fault Response Use this parameter to set the Fieldbus Fault condition for Ethernet IP Communication. 0 = Only in Fieldbus Control Mode - when fieldbus is the control place and Fieldbus fault is active drive will fault on loss of coms, if not in Fieldbus Control place will not fault. 1 = In all Control Modes - no matter the control place setting if communication is lost Fieldbus fault response will occur.	1,2,3,4	RW
P20.5.1	609	Connection Limit Use this parameter to set the maximum number of connections allowed to the frequency converter.	1,2,3,4	RW
P20.5.2	610	Modbus TCP Unit ID Use this parameter to set the unit identifier value for Modbus TCP.	1,2,3,4	RW
P20.5.3	611	Comm Timeout Modbus TCP Use this parameter to set the time it waits before a communication fault occurs over Ethernet.	1,2,3,4	RW
P20.5.4	612	Modbus TCP Protocol Status Use this parameter to show the Modbus TCP Protocol is active or not. 0 = Stopped 1 = Operational 2 = Faulted	1,2,3,4	RO
P20.5.5	613	Slave Busy Use this parameter to show the status of the Slave device on the network.	1,2,3,4	RO
P20.5.6	614	Parity Error Use this parameter to show amount of Parity Errors seen on the RS-485 network.	1,2,3,4	RO
P20.5.7	615	Slave Failure Use this parameter to see the status of the frequency converter not able to process message.	1,2,3,4	RO
P20.5.8	616	Last Fault Response Use this parameter to show the last active fault for viewing over communications.	1,2,3,4	RO
P20.5.9	2517	Modbus TCP Fault Response Use this parameter to set the Fieldbus Fault condition for Modbus TCP Communication. 0 = Only in Fieldbus Control Mode - when fieldbus is the control place and Fieldbus fault is active drive will fault on loss of coms, if not in Fieldbus Control place will not fault. 1 = In all Control Modes - no matter the control place setting if communication is lost Fieldbus fault response will occur.	1,2,3,4	RW
P21.1.1	340	Language Use this parameter to allow to control the frequency converter through the keypad in the language of your choice.	1, 2, 3, 4	RW

Appendix A—Description of parameters

Code	Modbus ID	Parameter	Application	RO/RW
P21.1.2	142	Application Use this parameter to set the active application marco to use.	1, 2, 3, 4	RW
P21.1.3	619	Parameter sets Use this parameter to reload the factory default parameter values, and to store and load two customized parameter sets. 0 = No 1 = Reload Defaults 2 = Reload Set #1 3 = Reload Set #2 4 = Store Set #1 5 = Store Set #2 6=Reset 7=Reload Defaults VM - only used with the sales demo stand.	1, 2, 3, 4	RW
P21.1.4	620	Up to keypad Use this parameter to enable uploading all parameter to the keypad. 0 = No 1 = Yes (All parameters)	1, 2, 3, 4	RW
P21.1.5	621	Down from keypad Use this parameter to enable downloading parameter from the keypad. 0 = No 1 = All parameters 2 = All Parameter, No Motor 3 = App Parameter	1, 2, 3, 4	RW
P21.1.6	623	Param comparison Use this parameter to initiate a Parameter Comparison function, you can compare the actual parameter values to the values of your customized parameter sets and those loaded to the control keypad. The actual parameter values are first compared to those of the customized parameter Set1. If no differences are detected, a "0" is displayed on the lowermost line of the keypad. If any of the parameter values differ from those of the Set1 parameters, the number of the deviations is displayed together. By pressing the right arrow button once again you will see both the actual value and the value it was compared to. In this display, the value on the Description line (in the middle) is the default value, and the one on the value line (lowermost line) is the edited value. You can also edit the actual value by pushing the Right Arrow button. Actual values can also be compared to Set2, Factory Settings and Keypad Set values.	1, 2, 3, 4	RW
P21.1.7	624	Password Use this parameter to setup a password to protected against unauthorized changes. When the password function is enabled, the user will be prompted to enter a password before application changes, parameter value changes, or password changes. By default, the password function is not in use. If you want to activate the password, change the value of this parameter to any number between 1 and 9999. To deactivate the password, reset the parameter value to 0.	1, 2, 3, 4	RW
P21.1.8	625	Parameter lock Use this parameter to prevent user from changing parameters. User has to come to thie parameter to allow changing. When the parameter lock is activated the text "locked" will appear on the display if you try to edit a parameter value. Note: This function does not prevent unauthorized editing of parameter values.	1, 2, 3, 4	RW
P21.1.9	627	Multimonitor set Use this parameter lock in the values set for the mult-monitor page and not allow changing unless re enabled.	1, 2, 3, 4	RW
P21.1.10	628	Default page This parameter sets the view to which the display automatically moves as the Timeout Time expires or when the keypad power is switched on. If the Default Page value is 0, the function is not activated, i.e., the last displayed page remains on the keypad display.	1, 2, 3, 4	RW
P21.1.11	629	Timeout time Use this parameter to set the time after which the keypad display returns to the Default Page, if no keypad keys are pressed. Note: Note: If the Default Page value is 0 the Timeout Time setting has no effect.	1, 2, 3, 4	RW

Code	Modbus ID	Parameter	Application	RO/RW
P21.1.12	630	Contrast adjust Use this parameter to adjust the display by changing the contrast.	1, 2, 3, 4	RW
P21.1.13	631	Backlight time Use this parameter to set the time to illuminate the display.	1, 2, 3, 4	RW
P21.1.14	632	Fan control This function allows you to control the drives cooling fan. You can set the fan to run: 0 = Continuous—fan runs continuously. 1 = Temperature—based on the temperature of the unit. The fan is switched on automatically when the heat sink temperature reaches 60°C. The fan receives a stop command when the heat sink temperature falls to 55°C. The fan runs for about a minute after receiving the stop command or switching on the power, as well as after changing the value from “Continuous” to “Temperature.” 2 = Run Follow—after power up, the fan is stopped until the run command is given and then fan runs continuously. This is mainly made for common DC-bus systems to prevent cooling fans to load charging resistors on power up moment. This selection is not supported by FR7 and FR8 drives 3 = Calculated IGBT Temp—starting of cooling fan is based on calculated IGBT temperature. When IGBT temp = 40°C, fan starts and when temp falls down to 30°C, fan stops. This selection is not supported by FR7 and FR8 drives Note: The fan runs continuously, regardless of this setting, when the frequency converter is in RUN state.	1, 2, 3, 4	RW
P21.1.15	633	Keypad ACK timeout This function allows the user to change the timeout of the Keypad acknowledgement time. This is the communication performed between the control module and the keypad. This would be adjusted when using long communication cables between drive and a keypad to delay message timeouts. Example: Transfer delay between the frequency converter and the PC = 600 ms I The value of HMI Acknowledge Timeout is set to 1200 ms (2 x 600, sending delay + receiving delay) I The corresponding setting shall be entered in the [Misc]-part of the file I It must also be considered that intervals shorter than the HMI Acknowledge Timeout time cannot be used in frequency converter drive monitoring.	1, 2, 3, 4	RW
P21.1.16	634	Keypad Retry Number With this parameter you can set the number of times the drive will try to receive acknowledgement when it has not been received within the acknowledgement time (HMI Acknowledge Timeout) or if the received acknowledgement is faulty.	1, 2, 3, 4	RW
P21.1.17	626	Startup wizard The Startup Wizard facilitates commissioning the PowerXL Series drive. If selected Enable, the Startup Wizard prompts operator for the language and application desired, RTC time clock and then advances through the start-up parameter list/Application Mini wizard in keypad. After completion it allows the user to go to the Main menu or default page and this parameter is set to Disabled. The Startup Wizard is always enabled for the initial power up of the PowerXL Series vfd. By setting this parameter to Disable without going through the Startup Wizard it will disable it from being active on Start up. If user goes into Start Up Wizard after completion or defaults drive the Startup wizard will be Enabled. 0 = Enabled 1 = Disabled	1,2,3,4	RW
P21.1.18	2412	Jog soft key hidden Use this parameter to hidd the jog function from the soft key buttons. 0 = Disable 1 = Enable	1,2,3,4	RW
P21.1.19	2413	Reverse softkey hidden Use this parameter to hide the Reverse fuction from the soft key buttons. 0 = Disable 1 = Enable	1,2,3,4	RW

Appendix A—Description of parameters

Code	Modbus ID	Parameter	Application	RO/RW
P21.1.20	2424	<p>Output display unit</p> <p>This parameter allows for selecting a desired unit and scaled output to be viewed in the monitor menu as user output and reference display. Value is scaled based on the max value setting the min and max value.</p> <p>0 = % 1 = 1/min 2 = rpm 3 = ppm 4 = pps 5 = l/s 6 = l/min 7 = l/h 8 = kg/s 9 = kg/min 10 = kg/h 11 = m³/s 12 = m³/min 13 = m³/h 14 = m/s 15 = mbar 16 = bar 17 = Pa 18 = kPa 19 = mVs 20 = kW 21 = deg C 22 = GPM 23 = gal/s 24 = gal/min 25 = gal/h 26 = lb/s 27 = lb/min 28 = lb/h 29 = CFM 30 = ft³/s 31 = ft³/min 32 = ft³/h 33 = ft/s 34 = in wg 35 = ft wg 36 = PSI 37 = lb/in² 38 = HP 39 = deg F 40 = PA 41 = WC 42 = HG 43 = ft 44 = m 45 = Hz 46 = Strokes/min</p>	1,2,3,4	RW
P21.1.21	2460	<p>Output display unit min</p> <p>Use this parameter to set the minimum scaled value when changing the display unit to a value other than the default Hz.</p>	1, 2, 3, 4	RW
P21.1.22	2425	<p>Output display unit max</p> <p>Use this parameter to set the maximum scaled value when changing the display unit to a value other than the default Hz.</p>	1,2,3,4	RW
P21.2.1	640	<p>Keypad software version</p> <p>Keypad firmware Version</p>	1, 2, 3, 4	RO
P21.2.2	642	<p>Motor control software version</p> <p>DSP/Motor Control Software Version</p>	1, 2, 3, 4	RO
P21.2.3	644	<p>Application software version</p> <p>MCU/Application Software Version</p>	1, 2, 3, 4	RO

Code	Modbus ID	Parameter	Application	RO/RW
P21.2.4	1714	Software Bundle Version Software bundle version number, this encompasses the keypad software, Motor control software and application software.	1,2,3,4	RO
P21.3.1	646	Brake chopper This parameter is used to provide a status to indicate if the unit has a brake chopper installed in it.	1, 2, 3, 4	RO
P21.3.2	647	Brake resistor The Hardware information - indication of the Brake Resistor status being connected or disconnect.	1, 2, 3, 4	RO
P21.3.3	648	Serial number Serial Number of the drive.	1, 2, 3, 4	RO
P21.4.1	566	Real time clock This parameter provides the ability to see and adjust the time clock settings in the drive. Formatted in MM.DD.YY, HH:MM:SS.	1, 2, 3, 4	RW
P21.4.2	582	Daylight saving This parameter provides the ability to see and adjust the daylight saving time rule. 0 = Off 1 = EU 2 = US	1, 2, 3, 4	RW
P21.4.3	601	Total MWh count Energy Consumption MWh Meter (not resettable).	1, 2, 3, 4	RO
P21.4.4	603	Total power day count Total Time Power is on, Days count (not resettable).	1, 2, 3, 4	RO
P21.4.5	606	Total power Hr count Total Time Power is on, Hours count (not resettable).	1, 2, 3, 4	RO
P21.4.6	604	Trip MWh count Energy Consumption MWh Meter (resettable).	1, 2, 3, 4	RW
P21.4.7	635	Clear trip MWh Count This parameter will reset the Trip MWh count.	1, 2, 3, 4	RW
P21.4.8	636	Trip power day count Time Power is on, Days count (resettable).	1, 2, 3, 4	RW
P21.4.9	637	Trip power Hr count Time Power is on, Hours count (resettable).	1, 2, 3, 4	RW
P21.4.10	639	Clear trip power count This parameter will reset the Trip Power on Day and Hr count.	1, 2, 3, 4	RW
M1	1	Output frequency Instantaneous output frequency going to the motor in Hz.	1, 2, 3, 4	RO
M2	24	Frequency reference Instantaneous frequency reference value in Hz.	1, 2, 3, 4	RO
M3	2	Motor speed Calculated motor speed in rpms based off the motor parameters entered and the V/Hz curve when running.	1, 2, 3, 4	RO
M4	3	Motor current Measured Instantaneous output motor current.	1, 2, 3, 4	RO
M5	4	Motor torque Calculated instantaneous Motor-Torque in Percentage of total Motor Torque.	1, 2, 3, 4	RO
M6	5	Motor power Calculated instantaneous motor power in Percentage of total Motor Power.	1, 2, 3, 4	RO
M7	6	Motor voltage Measured instantaneous output voltage in AC to the motor.	1, 2, 3, 4	RO
M8	7	DC link voltage Measured Instantaneous DC link Voltage	1, 2, 3, 4	RO
M9	8	Unit temperature Measured instantaneous device temperature in °C.	1, 2, 3, 4	RO

Appendix A—Description of parameters

Code	Modbus ID	Parameter	Application	RO/RW
M10	9	Motor temperature Calculated motor temperature value in Percentage. Value is based off motor name plate data and the drive status information take when power up and a calculation performed while motor is active.	1, 2, 3, 4	RO
M11	15	Torque reference Torque reference in percentage when in open loop torque control mode.	4	RO
M12	10	Analog input 1 Analog input 1 measured value, units will depend on analog mode setting of voltage or current.	1, 2, 3, 4	RO
M13	11	Analog input 2 Analog input 2 measured value, units will depend on analog mode setting of voltage or current.	1, 2, 3, 4	RO
M14	25	Analog output 1 Analog Output 1 measured value supplied from the drive, units will depend on analog mode setting of voltage or current.	1, 2, 3, 4	RO
M15	575	Analog output 2 Analog Output 2 measured value supplied from the drive, units will depend on analog mode setting of voltage or current.	1, 2, 3, 4	RO
M16	12	DI1, DI2, DI3 Digital Input status for digital input 1, 2 and 3. IO Terminals 20, 21, 22.	1, 2, 3, 4	RO
M17	13	DI4, DI5, DI6 Digital Input status for digital input 4, 5 and 6. IO Terminals 23, 7, 8.	1, 2, 3, 4	RO
M18	576	DI7, DI8 Digital Input status for digital input 7 and 8. IO Terminals 9 and 10.	1, 2, 3, 4	RO
M19	14	DO1, virtual RO1, virtual RO2 Digital Output status and Firmware Virtual Relay status. The Virtual RO1 and Virtual RO2 status are of internal relays in the control board not for external use, allows for turning on functions internal to the drive without the use of hardwire connections.	1, 2, 3, 4	RO
M20	557	RO1, RO2, RO3 Relay output status for RO1, RO2 and RO3. IO Terminals 27 through 34.	1, 2, 3, 4	RO
M21	558	TC1, TC2, TC3 Timer channel status of channel 1, 2 and 3. Timer channels are used within the RTC parameter group settings.	2, 3, 4	RO
M22	559	Interval Time interval 1 status. See the RTC parameters for checking Interval 1 setup, when setting is met the status will go indicated on and when not met it will be off.	1, 2, 3, 4	RO
M23	560	Interval 2 Time interval 2 status. See the RTC parameters for checking Interval 2 setup, when setting is met the status will go indicated on and when not met it will be off.	2, 3, 4	RO
M24	561	Interval 3 Time interval 3 status. See the RTC parameters for checking Interval 3 setup, when setting is met the status will go indicated on and when not met it will be off.	2, 3, 4	RO
M25	562	Interval 4 Time interval 4 status. See the RTC parameters for checking Interval 4 setup, when setting is met the status will go indicated on and when not met it will be off.	2, 3, 4	RO
M26	563	Interval 5 Time interval 5 status. See the RTC parameters for checking Interval 5 setup, when setting is met the status will go indicated on and when not met it will be off.	2, 3, 4	RO
M27	569	Timer 1 Timer 1 value in seconds, value counts up to set timer value. See the RTC parameter group for defined Timer value.	2, 3, 4	RO
M28	571	Timer 2 Timer 2 value in seconds, value counts up to set timer value. See the RTC parameter group for defined Timer value.	2, 3, 4	RO
M29	573	Timer 3 Timer 3 value in seconds, value counts up to set timer value. See the RTC parameter group for defined Timer value.	2, 3, 4	RO
M30	16	PID1 Set Point PI(D) Controller 1 setpoint reference value, units will vary based on PI(D) Controller 1 units setting.	2, 3, 4	RO

Code	Modbus ID	Parameter	Application	RO/RW
M31	18	PID1 feedback PI(D) Controller 1 actual value feedback, units will vary based on the PI(D) Controller 1 unit setting.	2, 3, 4	RO
M32	20	PID1 error value PI(D) Controller 1 Error or difference from between the reference and feedback, units will vary based on the PI(D) Controller 1 unit setting.	2, 3, 4	RO
M33	22	PID1 output PI(D) Controller 1 output value in percentage.	2, 3, 4	RO
M34	23	PID1 status PI(D) Controller 1 status indication, indicates if drive is stopped, running in PID mode, or in PID sleep mode.	2, 3, 4	RO
M35	32	PID2 set point PI(D) Controller 2 setpoint reference value, units will vary based on PI(D) Controller 2 units setting.	3, 4	RO
M36	34	PID2 feedback PI(D) Controller 2 actual value feedback, units will vary based on the PI(D) Controller 2 unit setting.	3, 4	RO
M37	36	PID2 error value PI(D) Controller 2 Error or difference from between the reference and feedback, units will vary based on the PI(D) Controller 2 unit setting.	3, 4	RO
M38	38	PID2 output PI(D) Controller output value in percentage.	3, 4	RO
M39	39	PID2 status PI(D) Controller 2 status indication, indicates if drive is stopped, running in PID mode, or in PID sleep mode.	3, 4	RO
M40	26	Running motors Number of auxiliary motors currently running when operating in single or multi-drive pump mode. Max value depends on the number of aux motors assigned in Pump Configuration setup.	2, 3, 4	RO
M41	27	PT100 temperature Maximum PT100 thermistor temperature value in °C.	1, 2, 3, 4	RO
M42	28	Last active fault Active Fault code value. See fault codes for description of the value shown here.	1, 2, 3, 4	RO
M43	583	RTC battery status Real time clock battery status.	1, 2, 3, 4	RO
M44	1686	Instant motor power Measured Instantaneous motor power, units in kW.	1, 2, 3, 4	RO
M45	2119	Energy savings Displays the Energy savings of the drive compared to an across the line starter based off the defined motor name plate values.	1, 2, 3, 4	RO
M46	2209	Control board DIDO status Control Board DIDO Status provides the status of inputs and outputs on the control board. It is looking at DIN1 - Terminal 20, DIN2 - Terminal 21, DIN3 - Terminal 22, DIN4 - Terminal 23, DIN5 - Terminal 7, DIN6 - Terminal 8, DIN7 - Terminal 9, DIN8 - Terminal 10, DO1 - Terminal 14, RO1 - Terminal 28-29, RO2 - Terminal 32-34, RO3 - Terminal 27 and 31. Along with the onboard I/O being monitored it also provides status info if there are boards in the A or B expander Board slots. Bit 0 = DIN1 Status Bit 1 = DIN2 Status Bit 2 = DIN3 Status Bit 3 = DIN4 Status Bit 4 = DIN5 Status Bit 5 = DIN6 Status Bit 6 = DIN7 Status Bit 7 = DIN8 Status Bit 8 = DO1 Status Bit 9 = RO1 Status Bit 10 = RO2 Status Bit 11 = RO3 Status Bit 12 = Slot A with Board Bit 13 = Slot B with Board Bit 14 -15 = Not used	1,2,3,4	RO

Appendix A—Description of parameters

Code	Modbus ID	Parameter	Application	RO/RW
M47	2210	<p>SlotA DIDO status</p> <p>SlotA DIDO Status will give the input and output status of a board inserted in the A expander board slot. Depending on the board inserted different bits will become active if the I/O is enabled.</p> <p>Bit 0 = IO1_DIN1 Status Bit 1 = IO1_DIN2 Status Bit 2 = IO1_DIN3 Status Bit 3 = IO1_DO1 Status Bit 4 = IO1_DO2 Status Bit 5 = IO1_DO3 Status Bit 6 = IO3_RO1 Status Bit 7 = IO3_RO2 Status Bit 8 = IO3_RO3 Status Bit 9 = IO5_AC1 Status Bit 10 = IO5_AC2 Status Bit 11 = IO5_AC3 Status Bit 12 = IO5_AC4 Status Bit 13 = IO5_AC5 Status Bit 14 = IO5_AC6 Status Bit 15 = Not Used</p>	1,2,3,4	RO
M48	2211	<p>SlotB DIDO status</p> <p>SlotB DIDO Status will give the input and output status of a board inserted in the B expander board slot. Depending on the board inserted different bits will become active if the I/O is enabled.</p> <p>Bit 0 = IO1_DIN1 Status Bit 1 = IO1_DIN2 Status Bit 2 = IO1_DIN3 Status Bit 3 = IO1_DO1 Status Bit 4 = IO1_DO2 Status Bit 5 = IO1_DO3 Status Bit 6 = IO3_RO1 Status Bit 7 = IO3_RO2 Status Bit 8 = IO3_RO3 Status Bit 9 = IO5_AC1 Status Bit 10 = IO5_AC2 Status Bit 11 = IO5_AC3 Status Bit 12 = IO5_AC4 Status Bit 13 = IO5_AC5 Status Bit 14 = IO5_AC6 Status Bit 15 = Not Used</p>	1,2,3,4	RO
M49	29	<p>App status word</p> <p>Application Status word will provide additional status indication of the health of the drive.</p> <p>Bit 0 = MC Ready Bit 1 = MC_Run Bit 2 = MC_Fault Bit 3 = FB_Ref_Active Bit 4 = MC_Stopping Bit 5 = MC_Reverse Bit 6 = MC_Warning/AR-Fault Bit 7 = MC_ZeroSpeed Bit 8 = I/O Control Indicate Bit 9 = Panel Control Indicator Bit 10 = Panel Fieldbus Indicator Bit 11 = MC_DC_Brake Bit 12 = RunEnable Bit 13 Motor Regulator Status not Zero Bit 14 = Ext Brake Control Bit 15 = Bypass Mode</p>	1,2,3,4	RO

Code	Modbus ID	Parameter	Application	RO/RW
M50	2414	<p>Standard status word</p> <p>Standard Status Word is defined based of the parameter setting in the Fieldbus Process Data Output group, define the first 8 bits of this status word. The options for these bits are based off the standard Relay functions.</p> <p>Bit 0 = parameter Para ID 2415 (default = Ready) Bit 1 = parameter Para ID 2416 (default = Run) Bit 2 = parameter Para ID 2417 (default = Fault) Bit 3 = parameter Para ID 2418 (default = Fault Invert) Bit 4 = parameter Para ID 2419 (default = Warning) Bit 5 = parameter Para ID 2420 (default = Reversed) Bit 6 = parameter Para ID 2421 (default = At Speed) Bit 7 = parameter Para ID 2422 (default = Zero Frequency) Bit 8 - 15 = Not Used</p>	1,2,3,4	RO
M51	2445	<p>Output</p> <p>User defined output value that can be seen in a specific desired unit and scale factor based on the output frequency. This value will be displayed in the format selected by parameter Para ID 2426 with a scale value from parameter Para ID 2462 and 2427.</p>	1,2,3,4	RO
M52	2447	<p>Reference</p> <p>User defined reference value that can be seen in the desired unit and scale factor based on the frequency reference. This value will be displayed in the format selected by parameter Para ID 2426 with a scale value from parameter Para ID 2462 and 2427.</p>	1,2,3,4	RO
M53	601	<p>Total MWh Count</p> <p>Energy Consumption MWH Meter (not resettable)</p>	1,2,3,4	RO
M54	603	<p>Total Power Day Count</p> <p>Total Time Power is on, Days count (not resettable)</p>	1,2,3,4	RO
M55	606	<p>Total Power Hr Count</p> <p>Total time Power is on, Hr Count (not resettable)</p>	1,2,3,4	RO
M56	604	<p>Trip MWh Count</p> <p>Energy Consumption MWH Meter(resettable)</p>	1,2,3,4	RO
M57	636	<p>Trip Power Day Count</p> <p>Total Time Power is On, Days count (resettable)</p>	1,2,3,4	RO
M58	637	<p>Trip Power Hr Count</p> <p>Total time Power is on, Hr Count (resettable)</p>	1,2,3,4	RO
M59	30	<p>Multi-monitoring</p> <p>Displays any 3 monitoring values in a single screen. The values are selectable via the keypad menu. by going to the Multi-Monitor page and seeing 3 lines of Monitoring values, Up and Down keys can be used to select the row and then hitting the left arrow key will allow for editing the value then by going up and down.</p>	1,2,3,4	RO

Appendix B—Fault Log

Under this menu, you can find Active faults, History faults and Fault codes.

Table 183. Active Faults

Menu	Function	Note
Active Faults	When a fault/faults appear(s), the display with the name and fault time of the fault will be pop. Press DETAIL to see the fault data. The Active Faults submenu shows the list of faults. Select the fault and push DETAIL to see the fault data.	The fault remains active until it is cleared with the Reset button (push for 2s) or with a reset signal from the I/O terminal or Fieldbus. The memory of active faults can store the maximum of 10 faults in the order of appearance.

Table 184. History faults

Menu	Function	Note
History Faults	10 latest faults are stored in the Fault history, Select the fault and push DETAIL to see the fault data.	The history fault will be stored until it is cleared with the OK button (push for 5s). The memory of active faults can store the maximum of 10 faults in the order of appearance.

Fault codes and descriptions

Configurable 1 = The fault type of this fault is configurable, fault type can be configured as
0 = No Action; 1 = Warning; 2 = Fault; 3= Fault, Coast

Fault code	Fault name	Fault type	Default fault type	Possible cause	Remedy	Realization
1	Over Current	Fault		AC drive has detected too high a current (>4*I _H) in the motor cable: <ul style="list-style-type: none"> • Sudden heavy load increase • Short circuit in motor cables • Unsuitable motor 	<ul style="list-style-type: none"> • Check loading • Check motor • Check cables and connections • Make identification run • Check ramp times 	DSP
2	Over Voltage	Fault		The DC-link voltage has exceeded the limits defined: <ul style="list-style-type: none"> • Too short a deceleration time • Brake chopper is disabled • High overvoltage spikes in supply • Start/Stop sequence too fast 	<ul style="list-style-type: none"> • Make deceleration time longer • Use brake chopper or brake resistor (available as options) • Activate overvoltage controller • Check input voltage 	DSP
3	Earth Fault	Configurable	Fault	Current measurement has detected that the sum of motor phase current is not zero: <ul style="list-style-type: none"> • Insulation failure in cables or motor 	Check motor cables and motor	DSP
5	Charging Switch	Fault		The charging switch is open, when the START command has been given: <ul style="list-style-type: none"> • Faulty operation • Component failure 	<ul style="list-style-type: none"> • Reset the fault and restart • Should the fault re-occur, contact the distributor near to you 	DSP
9	UnderVoltage	Configurable	Fault	DC link voltage is under the voltage limits defined: <ul style="list-style-type: none"> • Most probable cause: Too low a supply voltage • AC drive internal fault • Defect input fuse • External charge switch not closed Note: Note: This fault is activated only if the drive is in Run state.	In case of temporary supply voltage break reset the fault and restart the AC drive Check the supply voltage. If it is adequate, an internal failure has occurred. Contact the distributor near you	DSP
10	Input Phase Superv	Configurable	Fault	Input line phase is missing	Check supply voltage, fuses and cable	DSP
11	Output Phase Superv	Configurable	Fault	Current measurement has detected that there is no current in one motor phase	Check motor cable and motor	DSP

Fault code	Fault name	Fault type	Default fault type	Possible cause	Remedy	Realization
12	Brake Chopper Superv	Fault		<ul style="list-style-type: none"> No brake resistor installed Brake resistor is broken Brake chopper failure 	Check brake resistor and cabling. If these are OK, the chopper is faulty. Contact the distributor near you	DSP
13	Drive UnderTemp	Configurable	Warning	Too low temperature measured in power Unit's heat sink or board. Heat sink temperature is under -10°C		DSP
14	Drive OverTemp	Fault		Too high temperature measured in power Unit's heat sink or board. Heat sink temperature is over 90°C	<ul style="list-style-type: none"> Check the correct amount and flow of cooling air Check the heat sink for dust Check the ambient temperature Make sure that the switching frequency is not too high in relation to ambient temperature and motor load 	DSP
15	Motor Stalled	Configurable	No Action	Motor is stalled	Check motor and load	DSP
16	Motor Over Temp	Configurable	No Action	Motor is too hot, based on either the drive's estimate or on temperature feedback	Decrease motor load. If no motor overload exists, check the temperature model parameters	DSP
17	Motor Under Load	Configurable	No Action	Condition defined by parameter P1.9.15~P1.9.17 have been valid longer than the time defined by P1.9.18	Check load	DSP
18	IP Address Conflict	Configurable	Warning	IP setting issue.	Check settings for IP address, verify no duplicates are on the network.	MCU
19	Power Board EEPROM Fault	Fault		Power board eeprom fault, memory lost in eeprom.	Cycle power to drive. Try updating software, if issue continues contact Distributor near you.	MCU
20	FRAM Fault	Fault		FRAM data error in FRAM memory.	Cycle power to drive. Try updating software, if issue continues contact a Distributor near you.	MCU
21	S-Flash Fault	warning		Serial flash error, serial flash memory failed.	Cycle power to drive. Try updating software, if issue continues contact a Distributor near you.	MCU
25	MCU WatchDog Fault	Fault		Watchdog register overflows in MCU	Cycle power to drive. Try updating software, if issue continues contact a Distributor near you.	MCU
26	Start-up Prevent	Fault		The time when Interlock signal activates is over setting time.	Stop drive and resend start command.	MCU
29	Thermistor Fault	Configurable	Fault	Option board or control board thermistor resistor larger than 4.7K	Thermistor open or short, over temperature	MCU
32	Fan Cooling	Fault		Fan is damaged or stalled.	Check fan and fan connected wires, verify 24Vdc is supplied to fan.	DSP
36	Compatibility Fault	Fault		The control board isn't match with the power board.	Cycle power to drive. Try updating software, if issue continues contact a Distributor near you.	MCU
37	Device Change	Warning		Power board or option card change.	Alarm will reset	MCU
38	Device Added	Warning		Power board or option board added.	Device is ready for use Old parameter settings will be used	MCU
39	Device Removed	Fault		Optional board removed from slot, or power board removed from control board.	Device no longer available in drive.	MCU
40	Device Unknown	Fault			"Check eeprom connection. Check board connection on slot A/B Power cycle to drive."	MCU
41	IGBT Over Temp	Fault		IGBT temperature is too high.	<ul style="list-style-type: none"> Check output loading Check motor size Decrease switching frequency 	DSP
50	AI < 4mA (4to20mA)	Configurable	No Action	Loss in analog input signal, dropped below 4mA.	Verify analog input current reference value on either AI1 or AI2, check cabling.	MCU

Appendix B—Fault Log

Fault code	Fault name	Fault type	Default fault type	Possible cause	Remedy	Realization
51	External Fault	Configurable	Fault	Digital input is activated for external fault input. • The real time isn't normal	check digital input settings and verify input level, could be an external device causing fault.	MCU
56	PT100 Fault	Configurable	Fault	Temperature is beyond the limit of sensing capacity of PT100	Pt100 short, open or over temperature, check PT100 temperature probe.	MCU
57	Motor ID fault	Fault		The Motor parameters Identification running was not completed successfully	Check motor size Verify the input and output wiring is connected properly.	DSP
58	Current Measure Fault	Fault		Current measurement is out of range	Restart the drive again. Should the fault re-occur, contact the distributor near to you	DSP
59	Power Wiring Error	Fault		power wiring connected to output of drive.	Verify power input wiring is connected to L1, L2 and L3 terminals and they are properly torqued.	DSP
60	Control Board OverTemp	Fault		Control board is over +85 degrees or under -30 degrees	Check NTC resistor Check control board temperature	MCU
61	Internal Control Supply	Fault		+24V port voltage is over 27V or under 17V	Check voltage range of +24V on terminals 12 to 13. If voltage is out of range contact distributor near you.	MCU
62	Speed Search Fault	Fault		Speed searching failed when performing flying start.	Check motor parameters' setting and motor connections.	DSP
64	Replace Battery	Configurable	Warning	RTC Battery voltage is too low.	Check the RTC battery voltage, contact distributor near you for replacement battery.	MCU
65	Replace Fan	Configurable	Warning	Fan life is less than 2 months	Check the fan, clean out any contamination, contact distributor near you for replacement fan.	MCU
66	Safe Torque Off	Fault		STO Triggered, STO input is open.	Reset STO Trigger and verify wiring. Reset fault after input is enabled.	DSP
67	Current Limit Control	Warning		The output current has reached the current limit value	Check the load Set the acceleration time longer	DSP
68	Over Voltage Control	Warning		The DC link voltage has reached its voltage limit value	Check the input voltage Set the acceleration/deceleration time longer	DSP
69	System Fault	Fault		thermistor spi communication error.	Check thermistor chip.	MCU
70	System Fault	Fault		MCU send wrong parameters to DSP.	Restart the drive again. Should the fault re-occur, contact the distributor near to you.	DSP
72	Power Board EEPROM Fault	Fault		Power board eeprom fault, memory lost in eeprom when initial drive.	Cycle power to drive. Try updating software, if issue continues contact Distributor near you.	MCU
73	FRAM Fault	Fault		fram chip is broken.	Contact Distributor near you.	MCU
74	FRAM Fault	Fault		crc check fault when access fram data.	Try recovery factory default setting if issue continues contact Distributor near you.	MCU
75	Power Board EEPROM Fault	Fault		eeprom chipor I2c circuit is broken.	Contact Distributor near you.	MCU
76	Power Board EEPROM Fault	Fault		crc check fault when access eeprom data.	Try recovery factory default setting if issue continues contact Distributor near you.	MCU
77	S-Flash Fault	warning		external serial flash chip is broken.	contact Distributor near you.	MCU
80	Fieldbus Fault	Configurable	Fault	Loss of communication with BACnet MSTP, and the fieldbus reference is the remote reference OR the fieldbus control place is the remote control place.	Check BACnet MSTP communication wiring. Verify drive parameter are set correctly. Check master programming to verify proper addressing.	MCU
82	Bypass Overload	Fault		Over load when motor is in bypass mode	Check motor connection situation	MCU

Fault code	Fault name	Fault type	Default fault type	Possible cause	Remedy	Realization
83	Fieldbus Fault	Configurable	Fault	Loss of communication with Modbus RTU, and the fieldbus reference is the remote reference OR the fieldbus control place is the remote control place.	Check RS485 communication wiring. Verify drive parameter are set correctly. Check master programming to verify proper addressing.	MCU
84	Fieldbus Fault	Configurable	Fault	Loss of communication with Modbus TCP, and the fieldbus reference is the remote reference OR the fieldbus control place is the remote control place.	Check Ethernet communication wiring. Verify drive parameter are set correctly. Check master programming to verify proper addressing.	MCU
85	Fieldbus Fault	Configurable	Fault	Loss of communication with BACnet, and The fieldbus reference is the remote reference OR The fieldbus control place is the remote control place ,and The fault protection is not "NO action"	Check RS485 communication wiring. Verify drive parameter are set correctly. Check BACnet master configuration programming to verify proper addressing.	MCU
86	Fieldbus Fault	Configurable	Fault	Loss of communication with Ethernet IP, and The fieldbus reference is the remote reference OR The fieldbus control place is the remote control place ,and The fault protection is not "NO action"	Check Ethernet communication wiring. Verify drive parameter are set correctly. Check EIP master configuration programming to verify proper addressing.	MCU
87	Fieldbus Fault	Configurable	Fault	Loss of communication with Profibus/Canopen/Devicenet master on Slot A, and The fieldbus reference is the remote reference OR The fieldbus control place is the remote control place ,and The fault protection is not "NO action"	Check Profibus/Canopen/Devicenet communication wiring. Verify drive parameter are set correctly. Check Profibus/Canopen/Devicenet master configuration programming to verify proper addressing.	MCU
88	Fieldbus Fault	Configurable	Fault	Loss of communication with Profibus/Canopen/Devicenet master on Slot B, and The fieldbus reference is the remote reference OR The fieldbus control place is the remote control place ,and The fault protection is not "NO action"	Check Profibus/Canopen/Devicenet communication wiring. Verify drive parameter are set correctly. Check Profibus/Canopen/Devicenet master configuration programming to verify proper addressing.	MCU
89	Under Voltage Stop	Fault		"The DC link voltage has reached the Drive under voltage stop limit value."	Check the input voltage.	DSP
90	Drive Under Temp	Warning/Fault		<ul style="list-style-type: none"> • Cold weather mode is not enabled, and unit temperature is less than -10 degree. • Cold weather mode is enabled and Under Temp Fault Override is not set, unit temperature is less than -30 degree. • Cold weather mode is enabled and Under Temp Fault Override is not set, unit temperature is -20~ -30 degree. The temp <-20 degree when cold weather start time out." 	"If unit temp -20 ~ -10 degree, start motor in cold weather mode. If unit temp <-20 degree, Warm up unit above -20deg C for proper operation using cold weather mode. If still < -20 degree when cold weather mode time out, try higher output voltage in cold weather mode."	DSP
91	Option Card Fault	Configurable	Fault	External supply on the DeviceNet communication connector is not present.	Check voltage and wiring of power supply of the DeviceNet communication.	MCU
92	External Fault 2	Configurable	Fault	Digital input is activated for external fault input.	check digital input settings and verify input level, could be an external device causing fault.	MCU

Appendix B—Fault Log

Fault code	Fault name	Fault type	Default fault type	Possible cause	Remedy	Realization
93	External Fault 3	Configurable	Fault	Digital input is activated for external fault input.	check digital input settings and verify input level, could be an external device causing fault.	MCU
103	Drive OverTemp Warning	Warning		drive is 10 degrees away from trip point of 90 deg C.	Check the drive degree	DSP
104	Compatibility Fault	Warning		DSP firmware is not compatible with MCB firmware	Check the DSP firmware revision	MCU
105	Compatibility Fault	Warning		Keypad firmware is not compatible with MCB firmware	Check the keypad firmware revision	MCU
106	Compatibility Fault	Warning		IO1 card firmware is not compatible with MCB firmware	Check the IO1 card firmware revision	MCU
107	Compatibility Fault	Warning		IO2 card firmware is not compatible with MCB firmware	Check the IO2 card firmware revision	MCU
108	Compatibility Fault	Warning		IO3 card firmware is not compatible with MCB firmware	Check the IO3 card firmware revision	MCU
109	Compatibility Fault	Warning		IO4 card firmware is not compatible with MCB firmware	Check the IO4 card firmware revision	MCU
110	Compatibility Fault	Warning		IO5 card firmware is not compatible with MCB firmware	Check the IO5 card firmware revision	MCU
111	Compatibility Fault	Warning		Profibus card firmware is not compatible with MCB firmware	Check the Profibus card firmware revision	MCU

Appendix C—PowerXL Recommended Secure Hardening Guidelines

Introduction

This section “secure configuration” or “hardening” guidelines provide information to the users to securely deploy and maintain this product to adequately minimize the cybersecurity risks to their system.

Eaton is committed to minimizing the Cybersecurity risk in its products and deploys cybersecurity best practices and latest cybersecurity technologies in its products and solutions; making them more secure, reliable and competitive for our customers. Eaton also offers Cybersecurity Best Practices whitepapers to its customers that can be referenced at www.eaton.com/cybersecurity

PowerXL - SECURE CONFIGURATION GUIDELINES

Category	Description
Asset identification and Inventory	<p>Keeping track of all the devices in the system is a pre-requisite for effective management of Cybersecurity of a system. Ensure you maintain an inventory of all the components in your system in a manner in which you uniquely identify each component. To facilitate this PowerXL Series VFD supports the following identifying information - manufacturer, type, serial number, f/w version number, and location.</p> <p>Customers/users can read following information from product label</p> <ul style="list-style-type: none"> • Model Number • Serial Number • Device Name <p>Information specific to communication protocols is available form parameter menu as below</p> <ul style="list-style-type: none"> • IP Address Mode • Active IP Address • MAC Address <p>See application manual for these parameter locations.</p>
Restrict Physical access	<p>Industrial Control Protocols don't offer cryptographic protections at protocol level leaving them exposed to Cybersecurity risk. Physical security is an important layer of defense in such cases. PowerXL Series VFD is designed with the consideration that it would be deployed and operated in a physically secure location.</p> <ul style="list-style-type: none"> • Eaton suggests that physical access to cabinets and/or enclosures containing PowerXL Series VFD and the associated system should be restricted, monitored and logged at all times. • Physical access to the communication lines should be restricted to prevent any attempts of wiretapping, sabotage. It's a best practice to use metal conduits for the communication lines running between one cabinet to another cabinet. • Attacker with unauthorized physical access to the device could cause serious disruption of the device functionality. A combination of physical access controls to the location should be used, such as locks, card readers, and/or guards etc. • PowerXL Series VFD supports the following physical access ports, <ul style="list-style-type: none"> • RJ45 connector for removable keypad as well as Modbus RTU communications • RJ45 for EtherNet IP/Modbus TCP communications • Terminal block for Modbus RTU and other Digital IOs <p>Eaton suggests access to above physical ports need to be restricted.</p>

Appendix C—Recommended Secure Hardening Guidelines

Category	Description
Restrict Logical access to PowerXL Series Drive	<p>It is extremely important to securely configure the logical access mechanisms provided in PowerXL Series VFD to safeguard the device from unauthorized access. PowerXL Series VFD provides various types of administrative, operational, configuration privilege levels. Eaton recommends that the available access control mechanisms be used properly to ensure that access to the system is restricted to legitimate users only. And, such users are restricted to only the privilege levels necessary to complete their job roles/functions.</p> <p>Eaton recommends below best practices to be followed to ensure adequate cybersecurity of the setup/system</p> <ul style="list-style-type: none">• Default credentials are changed upon first login. PowerXL Series VFD should not be commissioned for production with Default credentials, it's a serious Cybersecurity flaw as the default credentials are published in the manuals. Restrict administrative privileges - Threat actors are increasingly focused on gaining control of legitimate credentials, especially those associated with highly privileged accounts. Limit privileges to only those needed for a user's duties. Make sure that the password used in the device is only available to authorized users like Configuring Engineers and not shared among all operational users.• Perform periodic account maintenance to make sure that password is changed whenever there is personnel change.• Change passwords and other system access credentials as appropriate• PowerXL Series VFD is provided with data/access protection mechanism on keypad, follow below steps to utilize it <p>PowerXL Series VFD provides four levels of data protection for users to ensure the security:</p> <ol style="list-style-type: none">1. Lock parameters on keypad. User can lock the parameters through DI or disable change, in which way all the parameters cannot be edited.2. Lock parameters while motor running. Motor control parameters can only be modified when motor is in stop mode. In which way to enhance the motor security. The parameters are listed in the application manual.3. Through Power Xpert inControl tool, facility to hide parameters on keypad is available. User can hide the parameters he/she thinks are significant for himself/herself. Such as IP address and so on.4. Password on keypad.<ul style="list-style-type: none">• 0000 means no password, which is the default.• Password range is 0001 – 9999.• With password, user can monitor parameters value but need enter password if he/she wants to edit parameters.• User needs to re-enter the password if there is no key operation in 1 min after enter the password.• User needs to enter the old password if he/she wants to change to a new one.
Restrict Network Access	<p>PowerXL Series VFD provides network access to facilitate communication with other devices in the systems and configuration. But this capability could open up a big security hole if it's not configured securely.</p> <p>Eaton recommends segmentation of networks into logical enclaves and restrict the communication to host-to-host paths. This helps protect sensitive information and critical services and limits damage from network perimeter breaches. At a minimum, a utility Industrial Control Systems network should be segmented into a three-tiered architecture (as recommended by NIST SP800-82[R3]) for better security control.</p> <p>Deploy adequate network protection devices like Firewalls, Intrusion Detection / Protection devices,</p> <p>Below are the protocols and their port details available on PowerXL Series VFD. Use below information for configuring the firewalls.</p> <p>PowerXL Series VFD provides below communication protocols –</p> <ul style="list-style-type: none">• EtherNet IP protocols on RJ45 connector – enabled by default on port 44818 and 2222• Modbus TCP protocol on RJ45 connector – enabled by default on port 502• Modbus RTU on RS485 physical layer – enabled by default• BACnet MS/TP on RS485 physical layer – disabled by default, when this is enabled, Modbus RTU is disabled. <p>All the protocols have dedicated menu structure, and details are described in User's Manual for how to activate or configure them.</p> <ul style="list-style-type: none">• Eaton has published detailed information about various Network level protection strategies in Eaton Cybersecurity Considerations for Electrical Distribution Systems [R1].

Category	Description
Logging and Event Management	<p>Best Practices</p> <ul style="list-style-type: none"> • PowerXL Series VFD provides parameters change log and fault log functions for user, to help diagnose the drive <ol style="list-style-type: none"> 1. Parameters change log: <ul style="list-style-type: none"> • PowerXL Series VFD will log the parameter information in FRAM when the parameter changes. The max number of 66 items can be logged. New log will rewrite the old one. User cannot clear this fault information. 2. Fault log: <ul style="list-style-type: none"> • PowerXL Series VFD will log the drive information in FRAM when fault occurs. The max number of 10 items can be logged. New log will rewrite the old one. User can clear the history fault by pressing OK key more than 5 Sec. • PowerXL Series VFD will log the fault information in FRAM when fault occurs. The max number of 50 items can be logged. New log will rewrite the old one. User cannot clear this fault information.
Secure Maintenance	<p>Best Practices</p> <p>Apply Firmware updates and patches regularly</p> <p>Due to rapidly increasing Cyber Threats in Industrial Control Systems, Eaton implements a comprehensive patch and update process for its products. Users are encouraged to maintain a consistent process to promptly monitor for fresh firmware updates and apply the update whenever required.</p> <ul style="list-style-type: none"> • The latest firmware can be acquired from the www.eaton.com/drives website. There will be separate link for PowerXL Series VFD FR0 to FR6 and PowerXL Series VFD FR7 & FR8 • Users can also sign up on our website to get emails when new material is released to the site if desired. • Using the PC Tool or verifying on the keypad the current version of firmware can be verified. • For additional information or technical support on Eaton's Variable frequency drive products contact us at TRCDrives@eaton.com or by phone at 800-386-2273 for US customers. For European customers contact us at AfterSalesEGBonn@eaton.com or by phone at +49 (0) 228602-3640 <p>Eaton also has a robust vulnerability response process. In the event of any security vulnerability getting discovered in its products, Eaton patches the vulnerability and releases information bulletin through its cybersecurity website - http://www.eaton.com/cybersecurity and patches through www.eaton.com/drives.</p>

References

- [R1] Cybersecurity Considerations for Electrical Distribution Systems (WP152002EN):
http://www.eaton.com/ecm/groups/public/@pub/@eaton/@corp/documents/content/pct_1603172.pdf
- [R2] Cybersecurity Best Practices Checklist Reminder (WP910003EN):
http://www.cooperindustries.com/content/dam/public/powersystems/resources/library/1100_EAS/WP910003EN.pdf



Eaton
1000 Eaton Boulevard
Cleveland, OH 44122
United States
Eaton.com

© 2018 Eaton
All Rights Reserved
Printed in USA
Publication No.
MN040004EN1 / CSSC-1801-5058
April 2018

Eaton is a registered trademark.

All trademarks are property
of their respective owners.