



MXCW

Microflex[®] Complete Wireless

Complete user guide for the MXCW system. Includes installation instructions, specifications, best practices, and troubleshooting.
Version: 10.3 (2021-A)

Table of Contents

MXCW Microflex® Complete Wireless	4	Requirement Checklist	23
General Description	4	Mount the Access Point Transceiver	24
Features	4	Mount the Networked Charging Station	31
Getting Started	5	System Set Up	32
Set Up the System Access Point (MXCWAPT)	5	Maximum System Size	33
Set Up Wireless Conference Units (MXCW640)	6	Wireless Device Network	33
Perform a Soundcheck	6	Connecting Devices for the First Time	33
Access Point Transceiver (MXCWAPT)	7	Restricting New Device Connections	34
Access Point Menu	10	Custom Network SSID Labels	35
Conference Unit (MXCW640)	12	Separating Networks for Multiple Systems	35
Gooseneck Microphone (MXC416, MXC420, MXC425, MXC406/MS)	13	Web Applications for Monitoring and Control	37
Using the Conference Units	14	Opening the Device Web Application	37
Customize Welcome Screen	16	Web Browser Requirements	39
Conference Unit Buttons	16	Using DNS to Open Web Application	39
Rechargeable Battery (SB930)	17	Web Application Views	39
Important Tips for Care and Storage of Shure Rechargeable Batteries	18	Using a Passphrase	40
Networked Charging Station (MXCWNCS)	18	Wireless and RF Management	40
Powering On the Device	20	Wireless Operating Distance	41
Monitoring Battery Charge	20	Reliable Bandwidth Allocation	42
Icons for Charging Batteries	20	Selecting or Excluding Specific Wireless Channels	42
Charge Status LEDs	20	Interference Detection and Avoidance	43
Average Charging Times	21	Tips to Improve Wireless System Performance	43
Charging Batteries with USB	21	Setting the Access Point Country and Region (MX-CWAPT-B and MXCWAPT-W only)	43
Battery Statistics	22	Setting Up Participants	44
Storing Batteries	23	Participant Roles	44
Installation	23	Configuring Conference Units for Remote Callers	45
Additional Equipment	23	Speak Priority for Remote Callers	45
		Changing the Participant Role	46
		Identifying a Device from the Software	46
		Customizing the Devices Page	47

Assigning Names and Seat Numbers	48	Using the Web Application with a Wireless Connection	64
Retain Seat Information	49	IP Ports and Protocols	65
NFC Card Functionality	49	AES67	66
Speak Priority	49	System Maintenance and Troubleshooting	66
Active Speaker Interruption	49	Troubleshooting	67
Microphone Activation Style	50	Resetting Devices	67
Setting the Number of Active Speakers	50	Export Log Files	68
Prevent Speak Button Conflicts	51	Firmware	68
Audio Setup and Channel Routing	51	Firmware Updates	68
MXCW Routing Descriptions	52	Update Firmware for Conference Units	69
MXCW Wireless Audio	53	Firmware Versioning	69
The Floor Mix	54	Using a Third-Party Control System	69
Analog Connections	54	Specifications	69
Connecting Analog Devices	55	System	69
Automatic Gain Control (AGC)	56	MXCWAPT	70
Adding Other Sources to the Floor Mix	56	MXCW640	73
Language Interpretation	60	MXCWNCS	79
Set Up Interpretation Channels	60	SB930	80
Conference Unit Interpretation Channels	60	Accessories	81
Digital Audio Networking	61	Optional Accessories	81
Dante Network Audio	61	Access Point Model Variations	81
Switch Recommendations for Dante Networking	62	Networked Charging Station Model Variations	82
QoS (Quality of Service) Settings	62	Important Product Information	82
Dante Network Audio Encryption	62	Safety Information	82
Networking	63	Information to the user	84
Networking Best Practices	63	Certifications	85
Device IP Settings	63	Trademarks	88
Configuring IP Settings	63	Contact Customer Support	88
Manually Assigning Static IP Address	64		
Setting Latency	64		

MXCW Microflex[®] Complete Wireless

General Description

The Shure Microflex[®] Complete Wireless (MXCW) system is a conferencing solution that provides a steady, reliable audio experience for up to 125 conference units. MXCW overcomes cable limitations for off-site meetings, flexible meeting rooms, or historic buildings where drilling holes in furniture is impractical. The system features automatic RF interference detection and avoidance technology, encrypted digital wireless transmission, and digital audio networking using Dante[™].

The MXCW access point has multiple mounting options for discreet communication between wireless conference units and the digital audio network, and works within the 2.4 GHz and 5 GHz frequency bands. Use the access point web application for system setup, and to monitor and control conference units. Conference units have configurable roles for meeting participants, and can be routed to the floor audio or an interpretation channel. Each wireless conference unit is powered by a smart lithium-ion rechargeable battery whose remaining charge can be checked remotely by a technician. The MXCW networked charging station charges and stores up to 10 Shure rechargeable batteries that can be monitored through its own web application.



Features

RF Efficiency	Sound quality is consistent with one speaker or several, and up to 125 units are supported with just one access point transceiver and one RF channel.
Automatic Frequency Coordination	The system automatically scans the available spectrum and selects clean transmission channels for best performance. Setting up the system is as easy as setting up a wireless router.
Interference Avoidance	While in use, the system automatically moves away from unexpected interference. Channel adjustment protects against disruption to the audio.
Encryption	Standard AES-128 encryption of audio and data keeps meeting content private.
Bi-Directional Wireless	Provides return channels for interpretation audio to conference units and enables real-time remote control of conference unit settings.

Getting Started

Set Up the System Access Point (MXCWAPT)

1. Connect the access point to a Power over Ethernet (PoE) source to turn on the device.

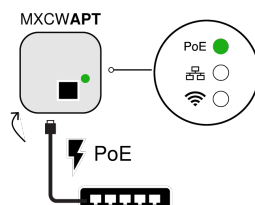

2. If prompted, select the operating region on the menu for RF coordination (some model variations).

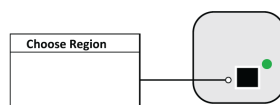

3. Open the web application in a browser and set an Admin passphrase.

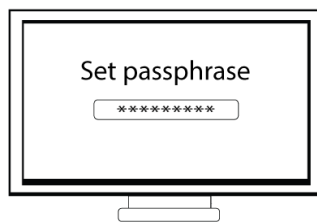

4. Wait while the access point scans the area for the best available channel.



5. Once the channel is selected, the default wireless network (00) is ready for the MXCW microphones.

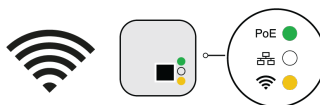

Set Up Wireless Conference Units (MXCW640)

1. Insert a fully charged Shure SB930 rechargeable battery and connect the MXC400 series microphone.

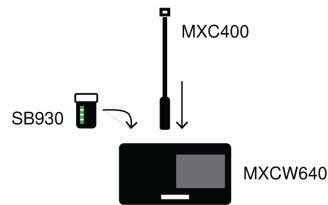

2. Press and hold the power button on the bottom of the device until the screen powers on.

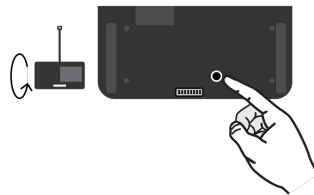

3. Wait while the microphone device searches for the default access point network (00).

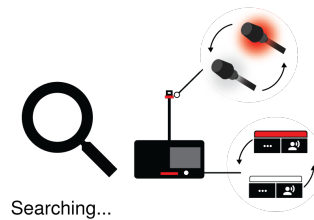

4. The devices are ready when the LEDs briefly flash green and the touchscreen displays the home-screen.

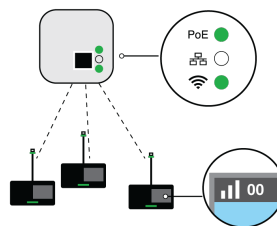

Perform a Soundcheck

1. Press the  speak button on one of the devices to activate the microphone.

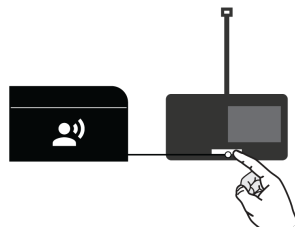

2. Speak into the microphone to check the audio.

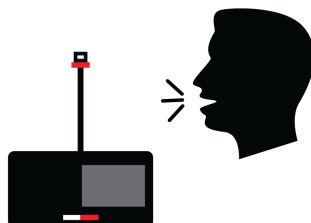

3. Listen to the sound check on the loudspeakers or headphone output.

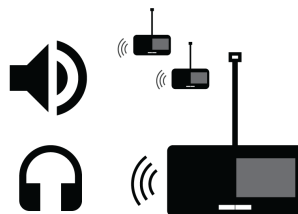

Access Point Transceiver (MXCWAPT)

The access point transceiver is the hub of the audio signal flow and manages the RF stability of each microphone in the group. The access point performs the following functions:

- Receives and decrypts wireless audio signals from microphones in the group
- Delivers and receives digital and analog audio signals via Dante and XLR
- Hosts an embedded web server that provides access to the control software used to manage the system
- Sends and receives control information (such as gain adjustment and link settings) between the components, control software and 3rd party controllers
- Transmits an encrypted audio signal to the microphone's headphone output for listening to translated audio or other external sources.

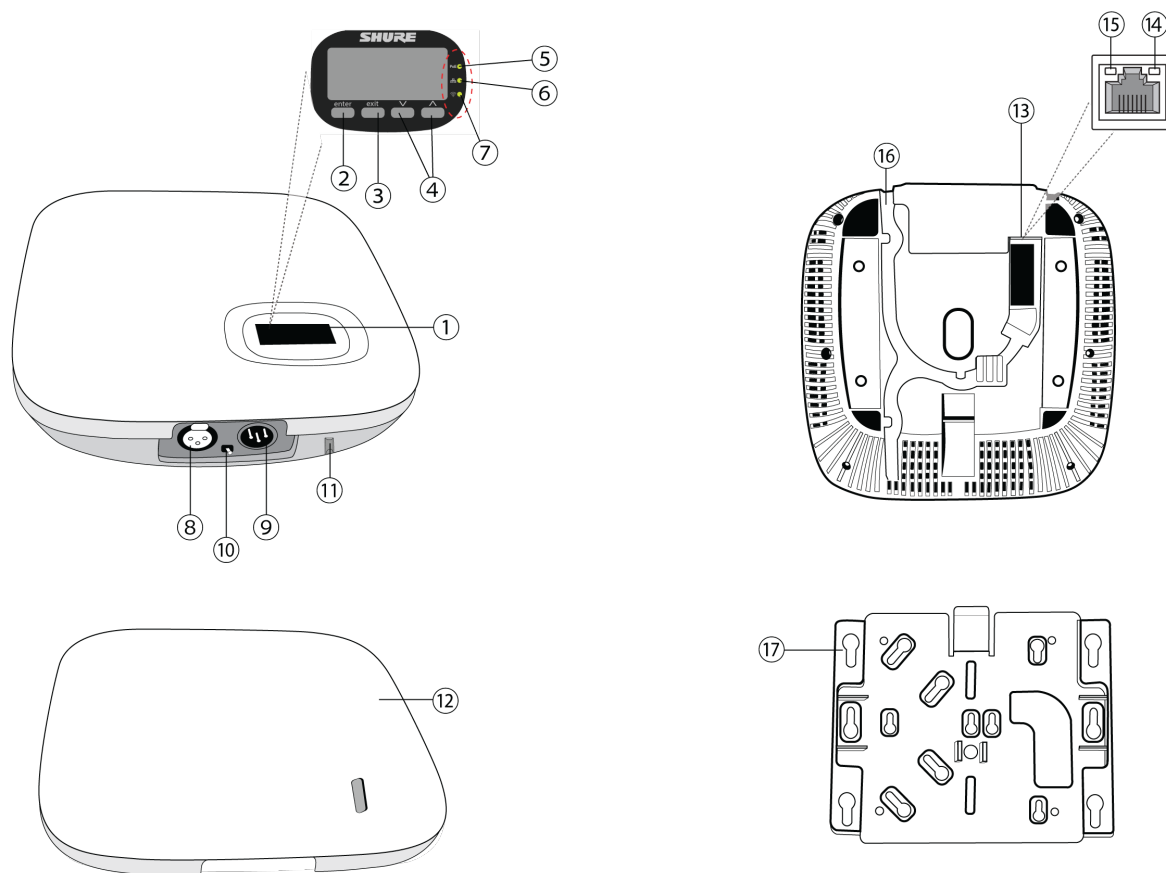

① Display

Shows menu screens and settings.

② Enter Button

Enter a menu or save settings.

③ Exit Button



Return to previous menu screens or cancel setting changes.

④ Arrow Buttons



Scroll to a menu item or make a change to a setting.

⑤ Power LED



Icon	LED Color	Description
PoE	Off	Powered off (disconnected from network or PoE not present on port)
	Green	Unit is receiving power
	Green (flashing)	A system reset is in progress

Icon	LED Color	Description
	Amber (flashing)	A network reset is in progress
	Green (flashing) +  RF LED green (flashing) +  Network Audio LED green (flashing)	Simultaneous LEDs: Device identify from the software is in progress Alternating LEDs: Firmware update is in progress

⑥ Network Audio LED

Icon	LED Color	Description
	Off	No Dante channels are routed (receive or transmit). Dante Controller software displays no marks for these channels.
	Green	All connected Dante network audio channels are functional (receiving digital audio as expected). Dante Controller software displays green check marks for these channels.
	Amber	One or more connected (receiving) Dante network audio channels are experiencing a subscription error, or unresolved (transmitting device is off, disconnected, renamed or has incorrect network setting). Dante Controller software displays yellow triangle marks for these channels.
	Amber (flashing)	A network reset is in progress
	Green (flashing) +  RF LED green (flashing) + PoE Power LED green (flashing)	Simultaneous LEDs: Device identify from the software is in progress Alternating LEDs: Firmware update is in progress

⑦ Wireless Audio LED

Icon	LED Color	Description
	Off	No connection or set to RF mute
	Green	Wireless channel secured and RF/wireless audio connected for 1 or more devices
	Amber	Wireless channel selection in progress
	Green/ red (flashing)	Detecting wireless interference
	Green (flashing) + PoE Power LED green (flashing) +  Network Audio LED green (flashing)	Simultaneous LEDs: Device identify from the software is in progress Alternating LEDs: Firmware update is in progress

⑧ Analog XLR Audio Input

Connect an external output.

⑨ Analog XLR Audio Output

Connect to an external input.

⑩ Ground Lift Switch

Lifts the ground from pin 1 of the XLR connector and the sleeve of the ¼" Audio Output to minimize ground-related noise that can occur when connecting the XLR Audio Output or Input to a third-party device. The ON position of the switch is labeled **lift**.

⑪ Reset Button (recessed)

Press and hold the reset button for 10 seconds to reset the MXCW system to factory default settings.

⑫ Access Point Cover

Paint to match the surrounding decor and snap onto the front plate of the device.

The LCD menu and navigation buttons are inaccessible with the cover.

⑬ Ethernet Port

Connect a Cat5e (or higher) cable to a PoE source and the network.

⑭ Ethernet Status LED (Green)

- Off = no network link
- On = network link established
- Flashing = network link active

⑮ Ethernet Link Speed LED (Amber)

- Off = 10/100 Mbps
- On = 1 Gbps (required for digital audio routing)

⑯ Cable Routing Path

Provides a path for the Ethernet cable to enable a flush-mount.

⑰ Mounting Bracket

Allows for optional mounting to a wall, ceiling, or mic stand.

Access Point Menu

Use the access point menu to monitor and adjust system settings without a computer.

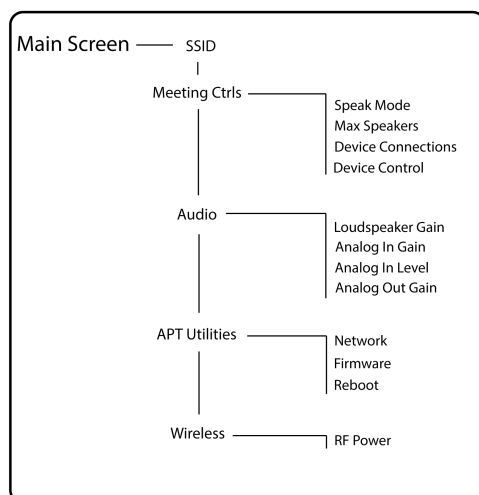

SSID

Select an access point network ID for easy recognition and control of connected conference units. The default SSID is 00.

Meeting Ctrls

Speak Mode	Select a mode to determine how microphones are activated for participants.
Max Speakers	Change the maximum number of delegates and the total speakers. Total speakers includes the number of chairmen.
Device Connections	Determine the access of additional conference units connecting and registering to the network audio.
Device Control	Reboot or power off all connected devices.

Audio

Loudspeaker Gain	Adjust the loudspeaker gain from a range of -30 dB to 6 dB, or select enter to mute.
Analog In Gain	Adjust the input gain from a range of -30 dB to 10 dB, or select enter to mute.
Analog In Level	Select line or aux level.
Analog Out Gain	Adjust the output gain from a range of -30 dB to 10 dB, or select enter to mute.

APT Utilities

Network	Shure Control displays the IP address, Subnet, Gateway, and MAC address of the access point, while Audio Network shows this information for Dante. Set the IP address for each network interface to automatic for an assigned IP address, or manual to edit the IP address.
Firmware	Display the access point firmware version and serial number.
Reboot	The unit performs a power cycle.

Wireless

RF Power	Select the RF coverage level of the access point, or turn it off.
-----------------	---

Conference Unit (MXCW640)

MXCW conference units facilitate communication between participants in group meetings and conferences. The multifunctional units enable participants to speak and be heard with clarity, even in large multilingual events, by combining a gooseneck microphone, loudspeaker, headphone jack, and user controls. For advanced meeting tasks, MXCW microphone units include features for voting, managing speakers, and more.

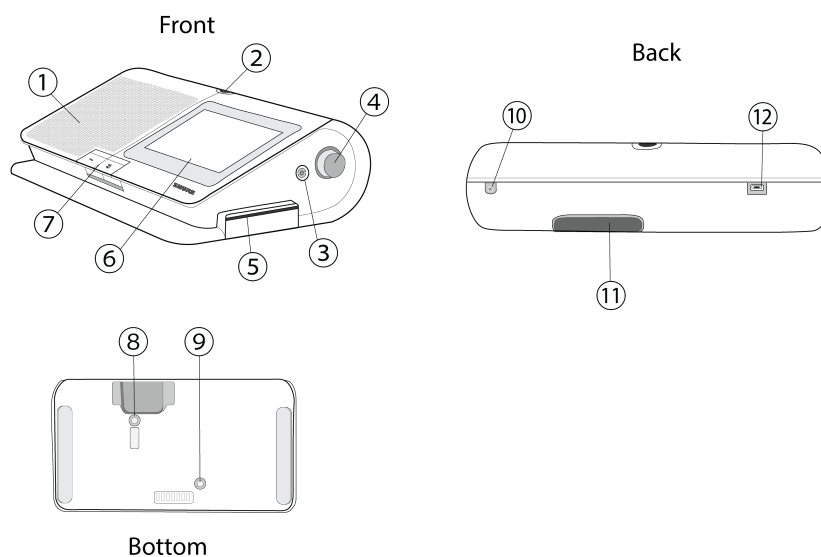

① Loudspeaker

Provides a clear audio signal of the floor mix.

② Microphone Connector

Lockable 10-pin microphone connector for MXC gooseneck microphones.

③ Headphone Output

Two TRRS 3.5 mm ports on each side of the unit allow participants to listen to an interpretation channel or the floor audio over headphones.

④ Volume Control

Two knobs on each side increase and decrease audio playback volume for headphones.

⑤ NFC Card Slot

Insert an NFC card to provide participant identification.

⑥ Touchscreen

View and select menu options on the display.

⑦ Microphone Buttons

Press to control the microphone. The buttons are customizable and function differently depending on the participant role and meeting setup. See **Using the Conference Units** for more details.

⑧ Power Button

Press and hold to power the unit on or off. The button LEDs on the front of the unit light up red when it is powered on.

⑨ Battery Status Button

Press to check the remaining charge of the battery in the unit.

⑩ TRRS Port

Enables a remote caller to listen and be heard over the floor mix when a cell phone is connected.

⑪ Battery Slot

Insert an SB930 rechargeable battery to power on the unit.

⑫ USB Micro-B Connector

Connect a USB Micro-B cable to charge the battery in the conference unit.

Gooseneck Microphone (MXC416, MXC420, MXC425, MXC406/MS)

MXC-series gooseneck microphones deliver excellent audio performance with a frequency response specifically tailored for speech.

- Commshield® Technology eliminates RF noise
- Single and Dualflex gooseneck options provide flexible positioning
- Locking 10-pin modular connector
- Built-in LED status indicator (LED ring)
- Compatible with the Microflex series cardioid, supercardioid, and omnidirectional cartridges
- Available in 16 inch (40 cm), 20 inch (50 cm), and 25 in (63 cm) lengths, as well as the MXC406/MS mini-shotgun microphone

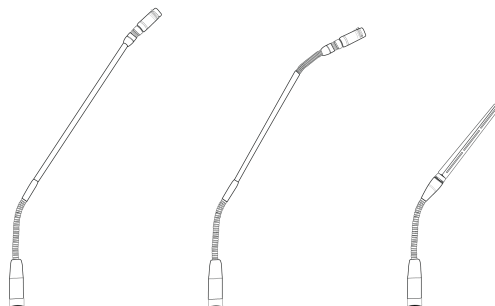

Securing the Microphone to the Conference Unit

1. Insert the microphone into the microphone connector.
2. Insert the hex wrench into the hole next to the microphone on the conference unit and turn counterclockwise.

Using the Conference Units

Once a unit has powered on, tap the touchscreen to access the home screen, or insert a pre-programmed NFC card if available.

Use the navigation pane to move between menus for different options and information on the MXCW640.

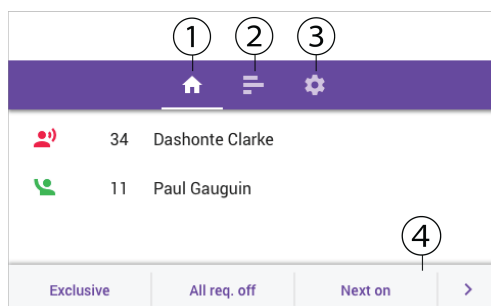

1. Home screen
2. Voting menu (chairman only)
3. Settings menu
4. Chairman control buttons (chairman only)

Home Screen

The home screen displays a combined speaker and request list. Chairmen can control participant microphones from this screen.

To hide the request list from conference unit screens:

1. Open the access point web application.
2. Click the  wrench icon to open global device settings.
3. Deselect the request list box under the screen content settings.

Voting Menu

The chairman sets up and monitors voting sessions in the voting menu.

Choose 1 of the 6 voting configurations: 2-button, 2-button secret, 3-button, 3-button secret, 5-button, or 5-button secret. A voting screen automatically displays on all conference units when a voting session is started by the chairman. Participants with voting rights can cast their vote using the touchscreen.

The results of the latest non-secret voting session displays after a vote has finished. Chairmen can choose to share secret voting results by pressing Share after the session. Results are not available or displayed for canceled voting sessions.

Note: Results may not always add up to 100 percent due to decimal rounding.

Settings Menu

Access the settings menu by tapping on the  gear icon in the navigation pane. From this screen you can view the battery status, hide the status bar, change the brightness, and change the screen language.

Technician Menu

Additional conference unit information and settings are in the technician menu. To access the menu:

1. Tap the  gear icon to enter the settings menu.
2. While at the top of the settings page, hold down on both volume control knobs and tap on the right side of the touchscreen.

From this menu you can access 4 different screens to perform the following actions:

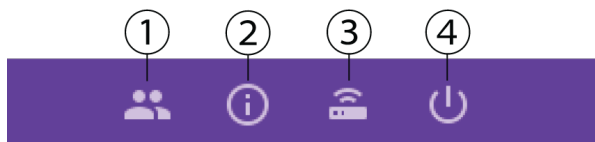

①

- Assign a participant role
- Change the left-button functionality

②

- Display the firmware version of the conference unit and connected access point
- Factory reset the device
- Reboot the device

③

- Display the connected access point SSID
- Disconnect from the access point

④

- Change the startup mode
- Power off the device

Conference Unit Startup Mode

Set the startup mode to determine how MXCW conference units connect to the access point after powering on.

Access the technician menu and choose one of the following startup modes:

Last Connected (default)	Automatically selects the network it was last connected to before powering down. New or factory default devices use this setting to access the SSID 00 by default.
List	Manually choose from a prepopulated list of networks. To update the list with custom names, rename the SSID labels in the web application and push the list to the registered wireless devices.
Scan	The device scans for available access point networks and ranks them with strongest signal at top, and weakest at the bottom. Manually select the network from the list.

Tip: When choosing the network manually, the list indicates the last connected access point with a clock icon.

Customize Welcome Screen

You can upload a custom start-up image to connected MXCW640 devices.

Go to Meeting Controls > Custom welcome screen and upload your image. The image must be 480 by 272 pixels in .png format.

Conference Unit Buttons

Both hardware buttons on the conference unit are customizable, and you can change the left-button functionality depending on the participant role.

To change the left-button functionality:

1. Access the technician menu.
2. Assign a role to the conference unit.
3. Select the function for the left button of the conference unit.

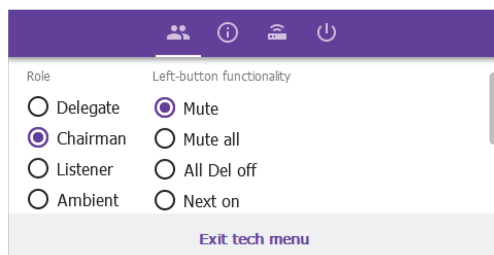

Left Button Icons							
Right Button Icons							

Note: Go to Accessories to view which buttons can be ordered.

	Name	Description	LED Status
--	------	-------------	------------

Right-Button Functionality	Speak	Press to be placed on the speak or request list.	Solid red: The microphone is on. Solid green: The participant is placed in the request queue. Flashing green: The request to speak has been denied.
Left-Button Functionality	Mute	Press and hold to mute the microphone without removing the right to speak.	Solid blue
	Mute all (chairman only)	Press and hold to mute all active speakers without removing the right to speak.	Solid blue
	All Del off (chairman only)	Turn off all delegate microphones.	Solid blue
	Next on (chairman only)	Turn on the first microphone in the request list.	Solid blue
	Exclusive (chairman only)	Press and hold to mute all delegate microphones and activate the chairman microphone only.	Solid red
	Speak (dual delegate only)	Press to be placed on the speak or request list.	Solid red: The microphone is on. Solid green: The participant is placed in the request queue. Flashing green: The request to speak has been denied.

Rechargeable Battery (SB930)

The SB930 is a smart, lithium-ion rechargeable battery that powers the MXCW640 conference unit. An integrated battery level indicator allows you to quickly check the battery status.

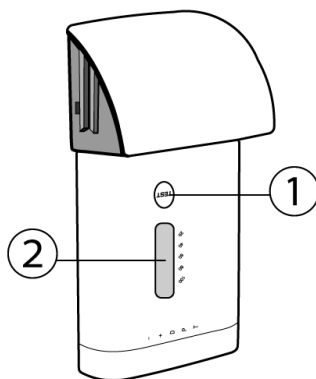

① Battery Status Button

Press the button to check the remaining charge of the battery in the unit.

② LED Status Indicator

Shows battery state when battery status button is pressed.

Important Tips for Care and Storage of Shure Rechargeable Batteries

Proper care and storage of Shure batteries results in reliable performance and ensures a long lifetime.

- Always store batteries and transmitters at room temperature
- Ideally, batteries should be charged to approximately 40% of capacity for long-term storage
- Periodically clean the battery contacts with alcohol to maintain ideal contact
- During storage, check batteries every 6 months and recharge to 40% of capacity as needed

Networked Charging Station (MXCWNCs)

The MXCW networked charging station (MXCWNCs) provides charging and storage for up to ten SB930 rechargeable batteries. Installation options include mounting in a rack, to a wall, or on a table surface.

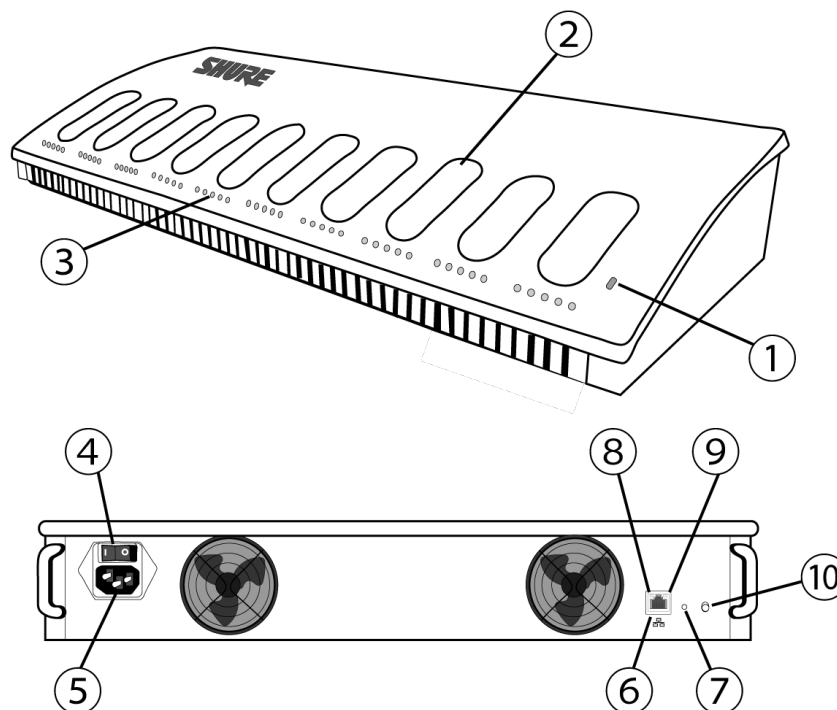

① Status LED

Indicator		Description
Color	Status	
Off	Off	Powered off

Indicator		Description
Color	Status	
Green	Solid	Powered on
	Flashing	Factory default reset in progress
Amber	Solid	Storage mode enabled
	Flashing	Network reset in progress

② Charging Slots

For charging and storing SB930 batteries.

③ Charging Status LEDs

Each charging slot has 5 LEDs that illuminate to show the battery's charge level:

LED	% Battery Charge
1	Flashing: <10% Solid: >10%
2	>25%
3	>50%
4	>75%
5	>95%

Charging error details are available in the web application and the full online system guide at pubs.shure.com

④ Power Button

Flip the switch to turn the unit on or off.

⑤ Power Input

Connect to the included power supply.

⑥ Ethernet Port

Connect to an Ethernet network to enable remote monitoring from the web application.

⑦ Reset Button

Press and hold to reset the device to default settings. The length of the button press determines the type of reset:

- **Network reset:** Press and hold for 4 seconds to reset any network settings and refresh the network connection.
- **Factory default settings:** Press and hold for 8 seconds to reset the device to factory default settings.

⑧ Ethernet Link Speed LED (Amber)

- Off = 10 Mbps
- On = 100 Mbps

⑨ Ethernet Status LED (Green)

- Off = No network link
- On = Network link established
- Flashing = Network link active

⑩ Storage Mode Button

Press to preserve battery health for batteries being stored for an extended period of time.

Powering On the Device

1. Connect the device to a power source using the supplied power cable.
2. Flip the power switch to turn on the device.





Monitoring Battery Charge

The MXCW power management system combines intelligent, rechargeable technology with a variety of monitoring options for the SB930 batteries.

In Use	<ul style="list-style-type: none"> • View remaining battery runtime on in-use microphones from the touchscreen or under the Devicestab in the MXCW system web application. The remaining time is displayed in hours:minutes. • Check the battery LEDs by pressing the battery status button on the bottom of the conference unit.
Charging	<ul style="list-style-type: none"> • View the charging status from the charging station web application. • Monitor the LEDs on the charger.

Icons for Charging Batteries

The following icons appear in the MXCWAPT web application to indicate battery status:

-  : Battery charge ≤ 30 minutes
-  : Battery charge ≤ 1 hour
-  : Battery minutes are being calculated
-  : Battery is being charged by USB
-  (flashing): USB cable has insufficient power

Charge Status LEDs

Each charging slot has a row of LEDs that illuminate to indicate the status of the battery. See the networked charging station web application for more details.

LED Segment	LED State	Description
1	Green (flashing)	<10% battery charge
	Green	>10% battery charge
	Red (flashing)	Invalid battery Recovery failed Charge failed Check battery Check charger Battery read error
	Red	Battery cold Battery hot
	Green + Amber (alternate flashing)	In recovery
2	Green	>25% battery charge
3	Green	>50% battery charge
4	Green	>75% battery charge Battery warm. See web application for details.
5	Green	<95% battery charge

Average Charging Times

Time Charging	Operating Runtime	Capacity
30 minutes	1 hour	10%
1.5 hours	5 hours	50%
4 hours	>11 hours	100%

*based on battery with 100% health

Charging Batteries with USB

Use the USB port on the conference unit to charge the battery during operation. This can be especially useful for long meetings or when backup batteries are not available. The battery status appears as a lightning bolt on the touchscreen when plugged into USB.

When a battery is being charged while the unit is turned off, the charging status shows on the touchscreen. If the battery is fully charged, the conference unit powers off after 10 minutes.

Average Charging Times Using USB

MXCW640 Power Status	Time Charging	Capacity
On	8 hours	100%
Off	6 hours : 30 minutes	100%

USB Cable Requirements

Use a micro USB cable that can supply at least 2 amps of power to the conference unit.

If an insufficient power supply is plugged in while the conference unit is powered on, the battery status alternates between the status and a warning symbol. If the unit is powered off, the touchscreen shows it is not charging due to an insufficient power supply. The conference unit powers off again after 10 minutes.

Battery Statistics

The charging station web application provides detailed information for each battery in the charger. Sort battery statistics by selecting one of the following statistics from the dropdown:

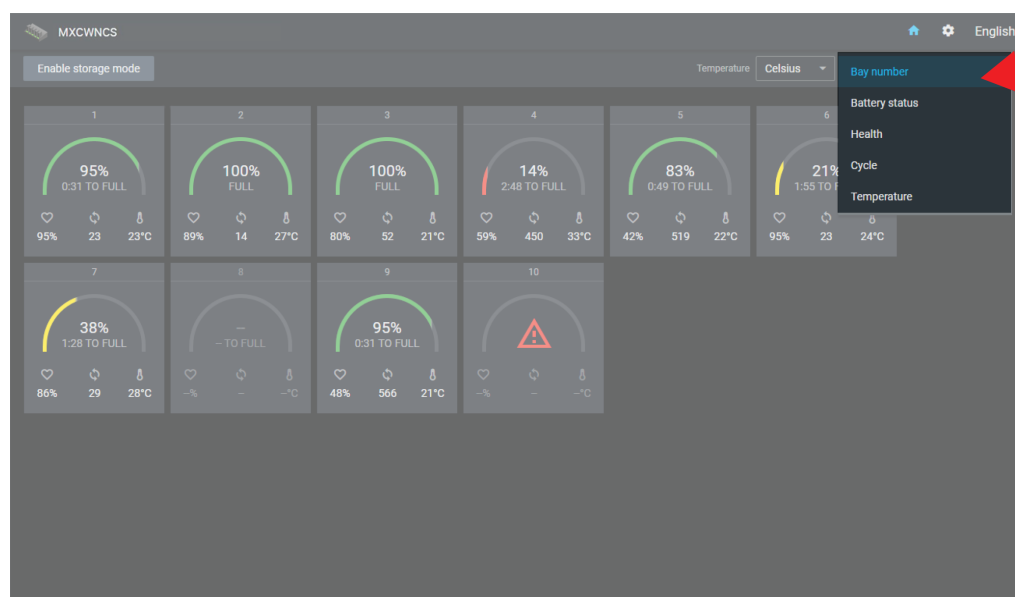

Bay number

Displays the order of the batteries based on which slot they are placed in.

Battery status

Displays charge as a percentage of the total battery capacity. Also shows time remaining to full charge.

Health

Displays health of selected battery as a percentage of the charge capacity of a **new** battery. Charge capacity (battery life when fully charged) will decline as a result of repeated charge cycles, age, or storage conditions.

Cycle

Displays total number of times that the battery has undergone one full count of discharge and charge. Recharging after discharging halfway counts as one half of a cycle. Recharging after discharging a quarter of the way counts as one quarter of a cycle.

Temperature

Displays battery temperature.

Storing Batteries

Use the MXCW charging station to store batteries for long periods of time (weeks and months). Storage mode protects batteries by storing them at a safe charge level that preserves battery health over time. When you are ready to use the batteries again, simply turn off storage mode and wait for the batteries to fully charge.

1. Insert batteries in the charging station.
2. Place the charger in storage mode:
 - **From the hardware:** Press and hold the Storage mode button for 5 seconds.
 - **From the software:** Open the charger web application to the home page and turn on storage mode.

Installation

Additional Equipment

Network Cables	Use shielded Cat5e (or higher) Ethernet cables, limiting cable runs to 100 meters maximum between network devices.
Audio Cables	Use balanced XLR cables for analog input/output from the access point.
Gigabit DHCP Router (systems with >1 APT)	<p>A DHCP router is recommended to connect multiple access points in the same installation. Ensure that it meets the following requirements:</p> <ul style="list-style-type: none"> • Gigabit ports • Provides Class 0 PoE with at least 6.5W (for powering the MXCW access point) • Quality of Service (QoS) with 4 queues • Diffserv (DSCP) QoS, with strict priority • If the router features Energy Efficient Ethernet (or Green Ethernet), ensure it is disabled from the ports dedicated for the MXCW system. • Recommended: A managed switch to provide detailed information about the operation of each network link: port speed, error counters, bandwidth used, etc.

Requirement Checklist

Make sure your equipment meets these requirements before installing the system:

- Use shielded Cat 5e or higher Ethernet cables.
- Use Gigabit networking equipment between network audio devices.
- Limiting cable runs to ≤ 100 m between devices.
- Same firmware version* for all devices in your system
- Ensure MXCW components and the PC are on the same network and set to the same subnet.

Tip: Keep the system upgraded to the latest available firmware version to ensure proper system compatibility and take advantage of new features. See **Firmware** for more information.

Mount the Access Point Transceiver

The directional antennas of the access point send and receive the RF signal in a cardioid pattern with the greatest sensitivity toward the face of the device. Always aim this side toward the microphone coverage area.

Select a Location for the Access Point

The access point is typically mounted to a ceiling or wall near the microphone coverage area.

Use the following best-practices when selecting a location for the device:

- Direct the face of the access point toward the intended microphone coverage area.
- Position the access point so there is nothing obstructing a line of sight to the microphones.
- Keep the device away from large metal objects.
- Keep at least eight feet between access points.
- Mount with the reset button accessible, as it may be useful for troubleshooting.

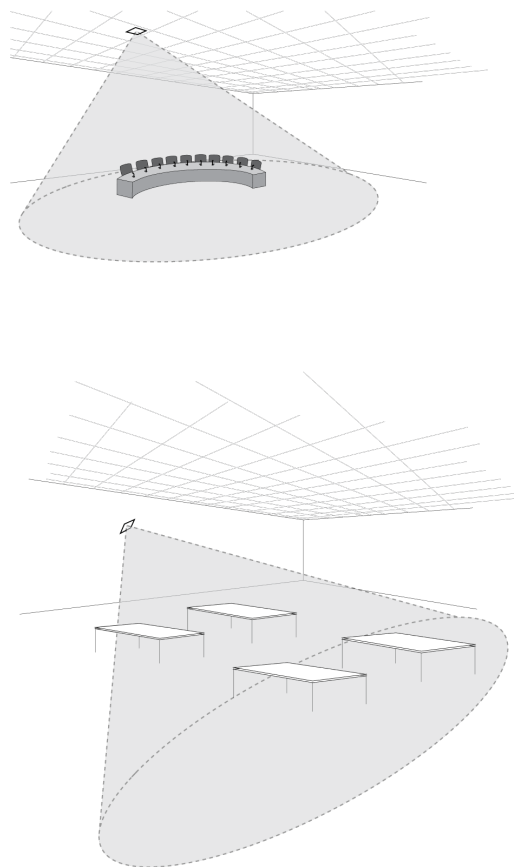

Important: Always perform a "walk around" test to verify coverage before using a wireless system during a speech or performance. Experiment with placement to find the optimum location. If necessary, mark "trouble spots" and ask presenters or performers to avoid those areas.

External Cover for Painting

The access point is supplied with an external cover that can be painted to match the decor of the installation. After it has been painted and dried, it snaps onto the front plate of the device.



Securing to a Wall or Ceiling

Required Equipment

- Two #8 screws at appropriate length*

*Screw Length = Surface thickness + thread engagement (4.75 mm max.) + thickness of flat washer + the thickness of the split lock washer

General Installation Steps

1. Use the mounting plate as a template and mark the location for the holes.
2. Drill the holes into the mounting surface.
3. Secure mounting plate to the surface.

CAUTION: Do not over-tighten screws, as this could cause permanent damage to the charging station

4. Connect of the Ethernet cable to the access point using the cable route path.
5. Position the access point over the keyway slots of the mounting plate and slide it down into the locked position.

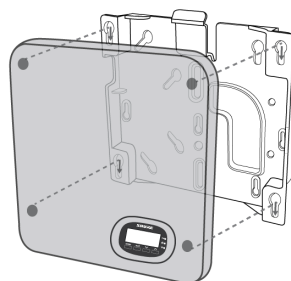
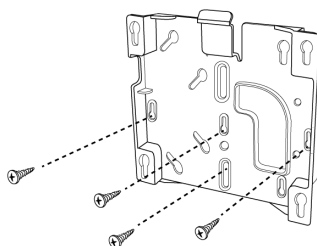

Mounting at an Electrical Box

1. Feed the Ethernet cable through the electrical box.



2. Mount the bracket to the electrical box using #6-32 screws (not included).

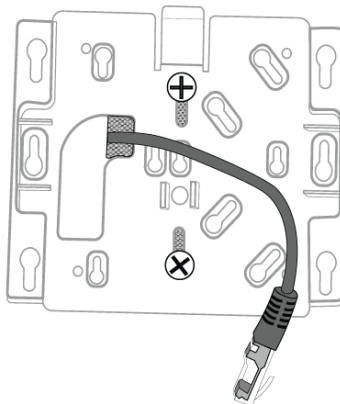

3. Connect the Ethernet cable to the MXCWAPT and mount the MXCWAPT to the bracket.



Mounting in Drywall

1. Hold the bracket up to the wall and mark the location for the screws.

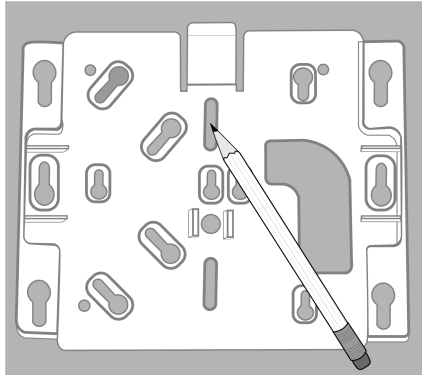

2. Drill holes and install drywall anchors into the drywall.

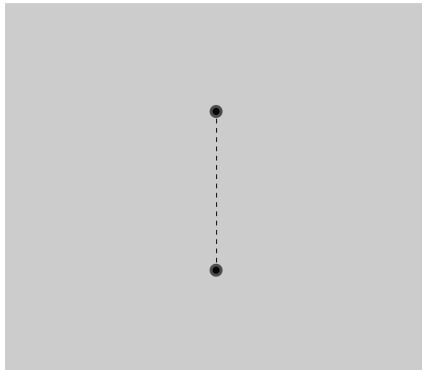

3. Mount the bracket to the drywall anchors using #8 screws (not included).

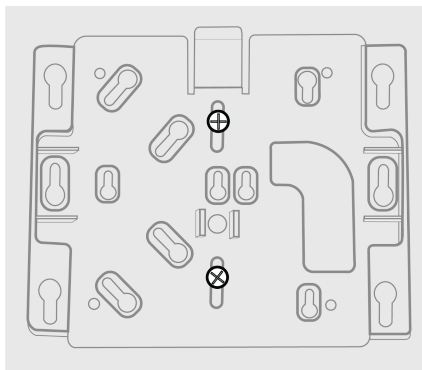

4. Connect the Ethernet cable to the MXCWAPT and mount the MXCWAPT to the bracket. Using the channels in the back of the MXCWAPT, the Ethernet cable can be routed out the top or bottom.



Mounting on Wood Paneling

1. Hold the bracket up to the wall and mark the location of the screws.

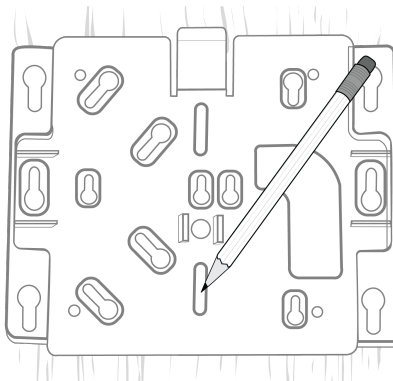

2. Drill 3/32" pilot holes.

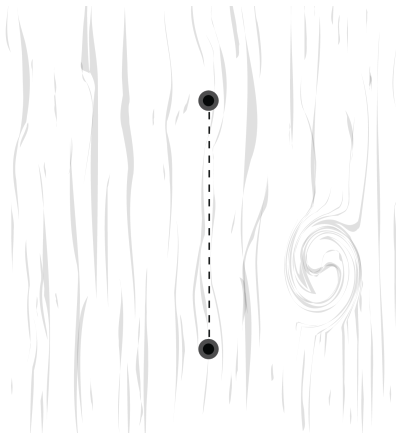

3. Mount the bracket to the wall using #8 screws (not included).

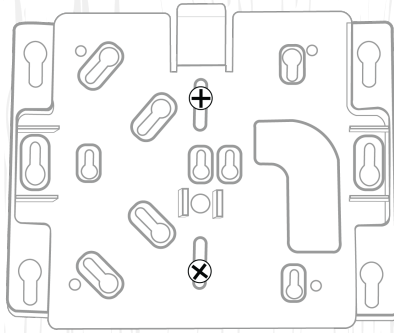

4. Connect the Ethernet cable to the MXCWAPT and mount the MXCWAPT to the bracket. Using the channels in the back of the MXCWAPT, the Ethernet cable can be routed out the top or bottom.



Mounting to Ceiling Tile

Important: Make certain to use large fender washers or a large metal plate on the back side of the ceiling tile to support the weight of the access point.

1. Use the mounting bracket to mark the location of two screw holes and the cable entrance on the ceiling tile.
2. Drill two small holes for #6 screws into the ceiling tile to attach the mounting bracket.
3. Drill or cut a larger opening for the cable. Attach the mounting bracket to the ceiling tile.

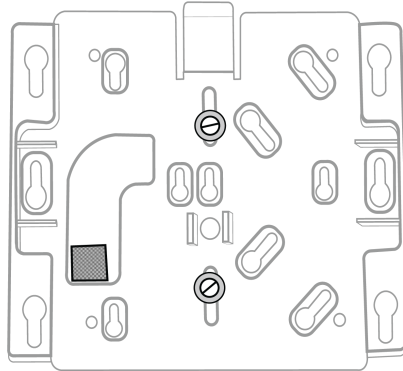

Front side of ceiling tile

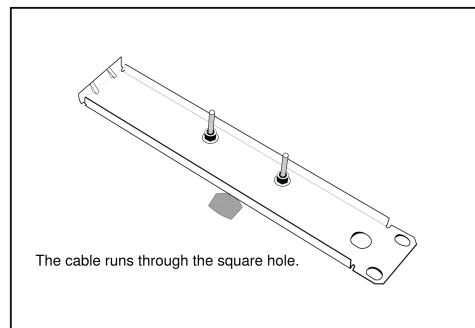

Back side of ceiling tile with fender washers or metal plate.

Use lock nuts or blue Loctite on standard nuts to make certain the nuts do not loosen with any vibration.

4. Run the cable through the hole, attach it to the APT and attach the APT to the mounting bracket.



Mounting on a Tripod

Use an adapter to bolt the mounting plate to a mic stand or tripod. If a bolt is needed to secure the plate and the adapter, take note of the bolt size and purchase the corresponding bolt from a local hardware store.

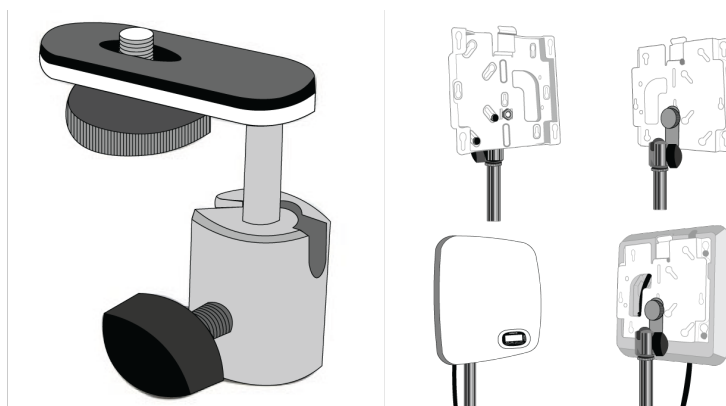

Mount the Networked Charging Station

How to Use Screws for Secure Installation

The screws for attaching the mounting brackets to the charger are provided. Screws for securing the charger to another surface must be purchased at a hardware store.

Important: The top of the screw must extend **exactly** 9/64 (0.149) inches (3.78 mm) above the surface (about 4 ½ threads).

- Use the screws that best fit the thickness of the surface.
- Use at least 3 screws to secure the mounting brackets to the charger.
- Use at least 3 screws on each side to secure the mounting brackets to the rack or wall.

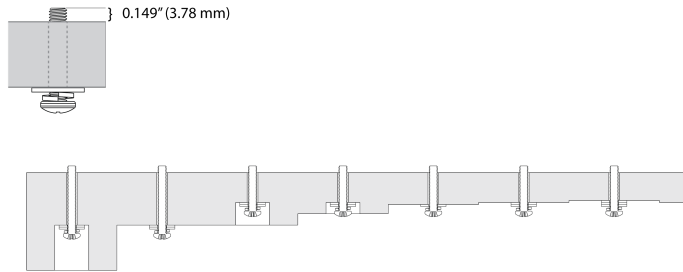

Installing the Networked Charging Station

1. Screw the mounting brackets to each side of the charging station.



Bottom of Networked Charging Station

2. Leave room for cabling to the charging station.
3. Attach the mounting bracket to the rack or wall using the appropriate screws for your surface.

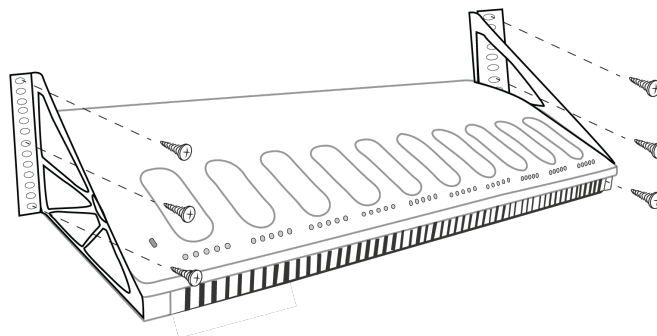

Note: Use 3 screws on each side of the mounting bracket when installing the charger.

Best Practices for Rack Installation

- Ambient temperature of the rack should not exceed specified operating temperature range of the device.
- Keep fan inlet and air vents clear from obstruction and provide adequate space for airflow within the rack.
- When possible, provide 1 RU of empty space between each device.

System Set Up

Maximum System Size

Connect up to 125 MXCW wireless conference units to a single access point. Connected devices operate as a self-contained, encrypted audio system for speaking, listening, and contributing to the meeting.

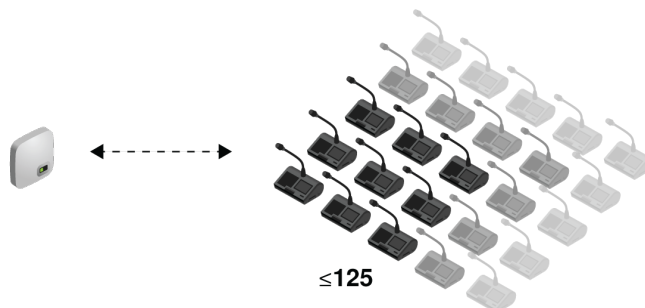

Wireless Device Network

Setting up wireless MXCW devices is similar to connecting your computer to a wireless network. The MXCW access point acts as the wireless router, broadcasting a network SSID to the wireless devices in range.

The access point includes several customizable network SSIDs that allow you to label MXCW networks for easy recognition and control according to the installation or application. A default network (SSID 00) ensures that new or reset devices automatically connect after powering on.

To add a microphone, simply connect it to the right network.

Connecting Devices for the First Time

MXCW wireless devices automatically connect and register after power up. The default network **SSID 00** ensures new or factory reset devices connect automatically to the access point in range.

To connect to an access point network:

1. Power on the access point. Wait for it to automatically select the best available wireless channel for operation. When the channel is secured, the access point will broadcast its network (SSID 00) to the wireless MXCW devices.
2. Power on the MXCW conference unit. The device automatically scans for the default network.



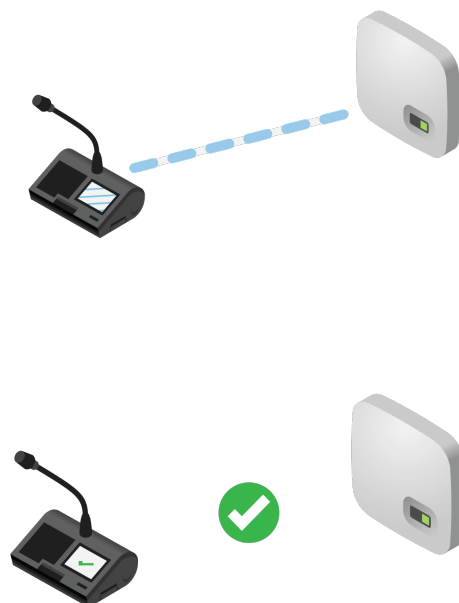

3. The default access point network (SSID 00) is selected and the devices are ready for use.



4. Add additional microphones until all participants are covered or the system is full.

Restricting New Device Connections

The devices tab in the web application shows which conference units are connected to the SSID network by separating them into 3 groups: **online**, **offline**, or **unregistered**. By default, conference units automatically register once they are connected.

You can add or remove devices from registration. Select a device, open  more options, and press Deregister to move a device to the unregistered group. Select a device from the unregistered group, then open  more options and press Register to register a unit.

To determine **additional** device connections, select one of the following options from the dropdown on the Devices tab:

- Open (default): New devices will automatically connect and register.
- Restricted: New devices will connect to the SSID network, but will be on the unregistered list until registered manually.
- Private: No new devices can connect or register to the audio system.

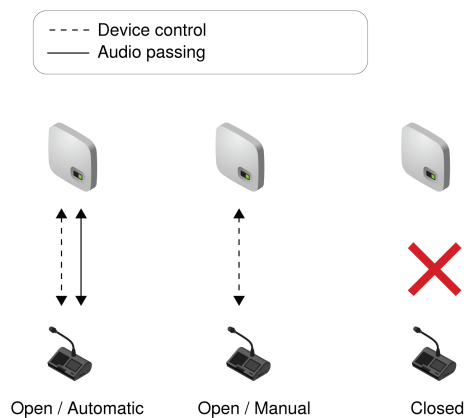

Custom Network SSID Labels

It is recommended to change to a custom wireless network after getting up and running on the default network:

- **Recognizable:** Provide distinct names for your installation. Useful names correlate to a room or common use of the system (examples: SSID=Training or SSID=3NW)
- **Security:** Custom SSIDs are less likely to inadvertently connect unwanted wireless microphones.
- **Automatic Updates:** All connected devices automatically update to match the new network label.

To customize the network SSID label:

1. Go to  Settings > SSIDs.
2. Select an SSID and rename it. Choose names (up to 32 characters) that make sense for your installation or use case.

Note: The default SSID 00 is not editable.

3. (Optional) Press Push to devices to update the static SSID list on all devices connected to this access point. The device startup mode must be set to static list.

Resolving Identical Label Conflicts

If multiple access points share the same SSID and are in range of the devices, the system resolves the conflict by choosing one of the following:

- Last connected access point based on its unique MAC address
- Or if none are recognized, the access point with the strongest RF signal

Separating Networks for Multiple Systems

To create separate microphone systems, use multiple access points and set each one to a different SSID. Then connect the conference units to the corresponding network to set up the independent systems.

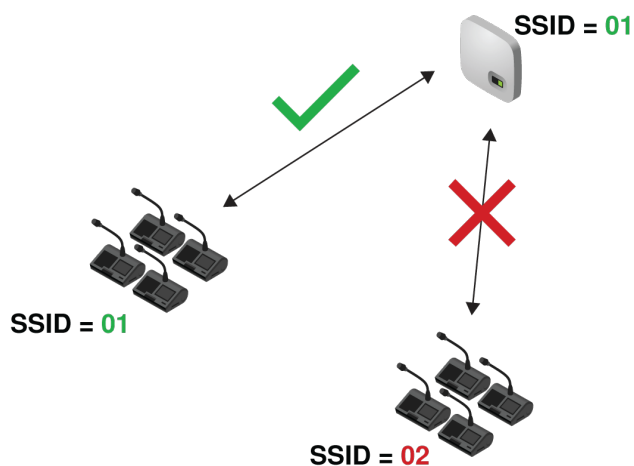

Multiple networks are useful for installations with adjacent meetings or divisible rooms that can be reconfigured depending on the size and needs of the event.

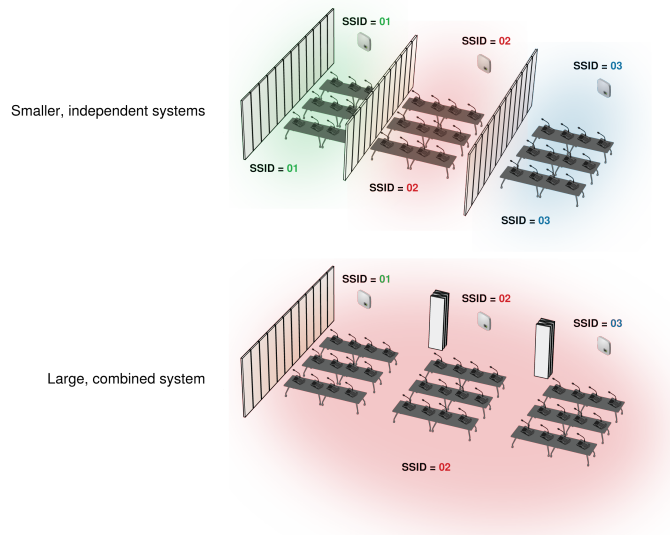

Divisible Room with Multiple System Options

Use different SSIDs to separate conference units into independent systems for smaller events. When the room opens up to support more participants, simply set all conference units to the same access point network to create a large system.

First, set an access point to a different SSID:

1. Open the MXCW web application and go to Settings > SSIDs.
2. (Optional) Rename one of the SSIDs network for easy identification, for example: *Room C*
3. Select that network and press Set to confirm the setting.

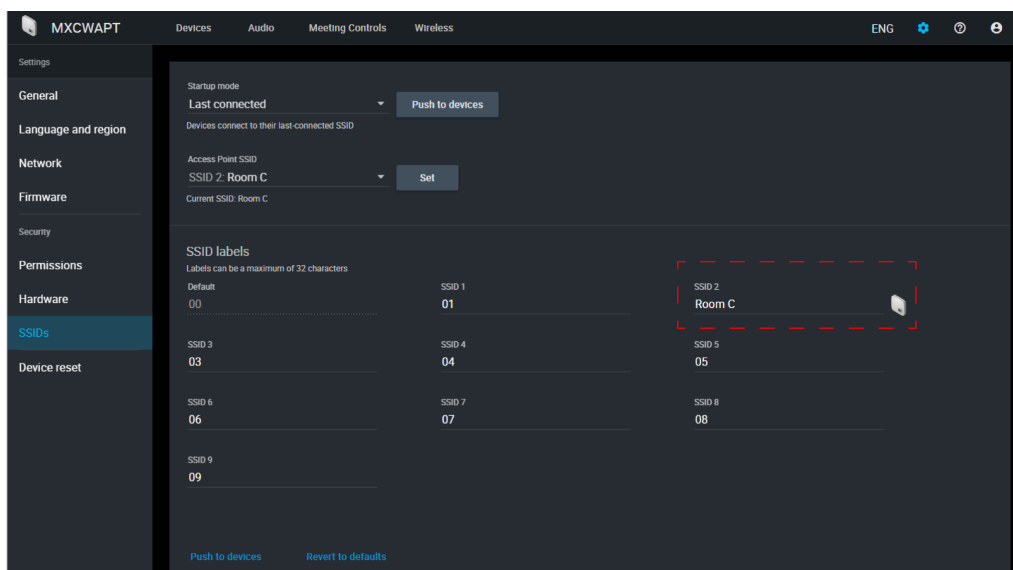

All connected microphones automatically update to the new network.

To update any other devices:

1. Open the technician menu on the MXCW640 by tapping the gear icon. While at the top of the page, hold down the volume control knobs and tap the right side of the screen.

2. Go to the  wireless tab.
3. Depending on the Startup mode set on the unit, either scan for a network or view options in the list.
4. Choose an access point network and press Connect .

To combine rooms again, simply change the conference units back to the original network to create the larger system.

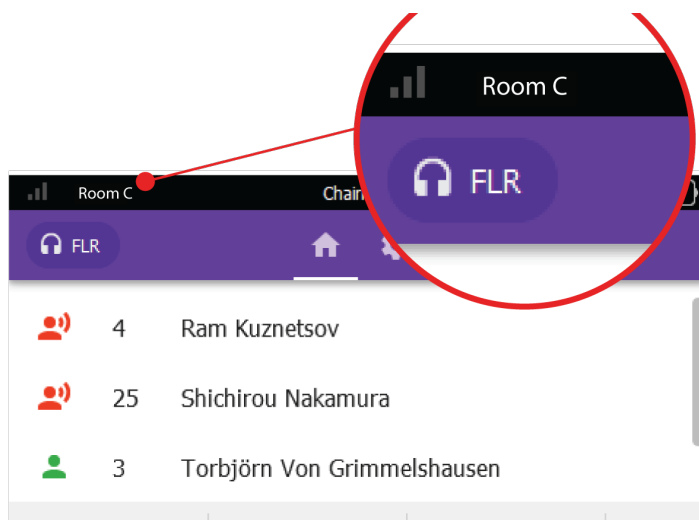

Connected Network Name

The device displays the connected network from the toolbar.

Web Applications for Monitoring and Control

Web applications provide convenient, remote access to configure, monitor, and control the system. The application is hosted in the device on an embedded webserver and can be accessed using the device IP address or DNS name.

MXCW Web Applications

Application	Host device	Features
MXCW system and meeting control	Access point (MXCWAPT)	Full configuration and control of the MXCW system, devices, participants, and live meetings.
Charging batteries	Charging station (MX-CWNCS)	Monitor battery charge and statistics.

Opening the Device Web Application

1. Connect the computer to the device network.

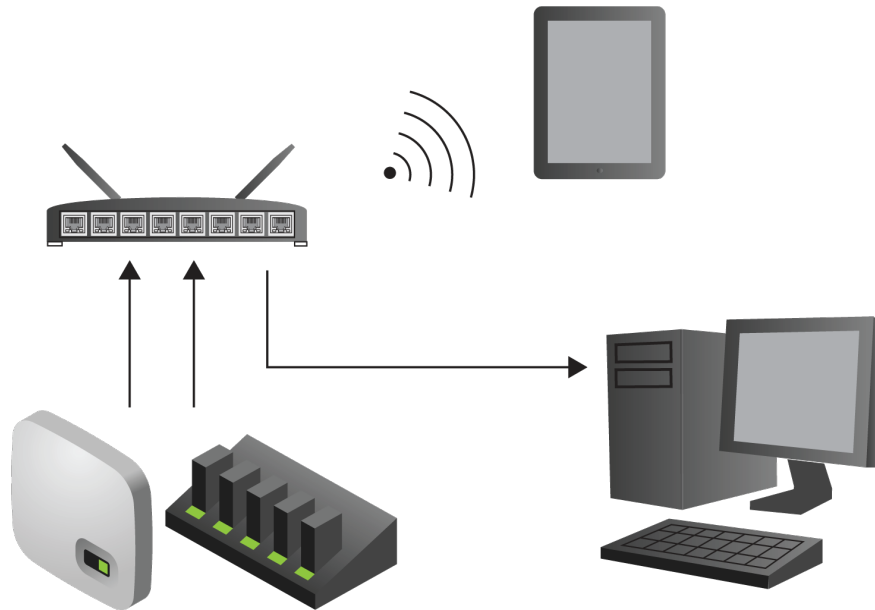

- Open the [Shure Web Device Discovery](#) application. The application lists Shure devices on the network that provide computer control.



- Find the device you want to open:

Application	Device host
MXCW system setup, control, and monitoring	MXCWAPT
Batteries currently charging	MXCWNCS

Model	Name	DNS name	IP Address	Network Audio	Web
SCM820-DAN	SCM820-Room1	SCM820-DAN-ffe656.local	169.254.100.125	Dante	Yes
MXWNCS8	MXWNCS8-5bae	MXWNCS8-415bae.local	169.254.182.153		No
MXWAPT8	MXWAPT8-e797	MXWAPT8-ffe797.local	169.254.253.30	Dante	Yes
MXWAPT4	MXWAPT4-6e1b	MXWAPT4-406e1b.local	169.254.191.228	Dante	Yes
MXWANI8	MXWANI8-0bae	MXWANI8-f80bae.local	169.254.142.143	Dante	Yes
MXCWAPT	MXCWAPT-a64ee5	MXCWAPT-a64ee5.local	169.254.125.44	Dante	Yes
MXCWNCS	MXCWNCS-bb2ff5	MXCWAPT-a64ee5.local	169.254.125.44	Dante	Yes

4. Double-click the row or right-click to copy the IP address or DNS name to paste into a browser.

Tip: Bookmark the DNS name to bypass the Web Device Discovery application.

Web Browser Requirements

Web applications are supported by the following browsers:

- Google Chrome
- Safari
- Internet Explorer

Using DNS to Open Web Application

You can bypass the Web Device Discovery application by entering the device DNS name into an internet browser. The DNS name is derived from the model of the unit (MXCWAPT or MXCWNCS), in combination with the last three bytes (six digits) of the MAC address, and ending in .local.

Format Example: If the MAC address of a unit is 00:0E:DD:AA:BB:CC, then the link is written as follows:

- **MXCWAPT:** <http://MXCWAPT-aabbcc.local>
- **MXCWNCS:** <http://MXCWNCS-aabbcc.local>

Web Application Views

The access point web application has dedicated views for specific meeting management tasks.

Open the web application and sign in to the desired view. To have access to all views, sign in as the administrator and select one of the additional views from the  user dropdown.

Admin View

This view is for meeting setup and configuration. Use this view to manage **Devices**, **Audio**, **Meeting Controls**, and **Wireless** settings.

To access this view, do one of the following:

- Sign in as **Admin**
- Enter the IP address of the access point, followed by /admin

(example: <http://192.168.11.137/admin>).

Chairman View

Use the **Main** tab for microphone control and managing speakers and speak requests during the meeting.

Use the **Voting** tab to select the voting configuration, view and share the last voting results, and remove certain participants from a voting session.

To access this view, do one of the following:

- Sign in as **Chairman**
- Select it from the administrator page
- Enter the IP address of the access point, followed by /chairman

(example: <http://192.168.11.137/chairman>).

Display View

Display view shows the speaker list, request list, and voting results to meeting participants. Use this view to share a screen with the entire meeting space.

To access this view, do one of the following:

- Sign in to **Display**
- Select it from the administrator or chairman page
- Enter the IP address of the access point, followed by /display

(example: <http://192.168.11.137/display>).

Tip: Put the page in full-screen mode during the meeting:

- PC: F11
- Mac: ctrl + cmd + f

Using a Passphrase

The access point web application must have an Admin passphrase created when an access point is powered on for the first time, or after a factory reset. The passphrase may be changed or removed after the system setup is complete.

To change or remove a passphrase, open the  Settings menu in **Admin view** and select the Permissions tab.

Note: Anyone can access the web application from a computer or mobile device connected to the network when a passphrase is not enabled.

Wireless and RF Management

Microflex Complete Wireless provides automatic, encrypted wireless transmission for up to 125 conference units at a time. The access point scans and selects the best operating channel across the wireless 2.4 GHz and 5 GHz frequency bands, including DFS channels.

Wireless Operating Distance

The RF power level determines the operating distance between the access point and conference units. Set the RF power level according to the size of the microphone installation.

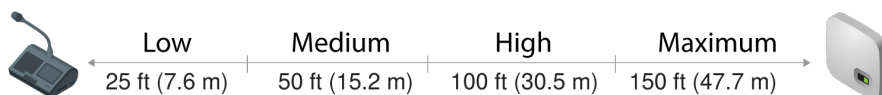

Variable Operating Distance

Setting RF Power

Select the RF power from the web application by going to **Wireless > RF power**.

RF Coverage from the Access Point

Setting	Transmitter Power (mW)	Coverage Distance from APT	Typical Application
Maximum (default)	25	150 ft (45.7 m)	Ballroom and auditorium spaces
High	13	100 ft (30.5 m)	Large meeting spaces and lecture halls
Medium	5	50 ft (15.2 m)	Conference, training and multipurpose rooms
Low	1	25 ft (7.6 m)	Small video-conference rooms and boardrooms
Mute	0	0 ft (0 m)	Long meeting breaks or access point not in use

Note: Maximum transmitter power varies by region.

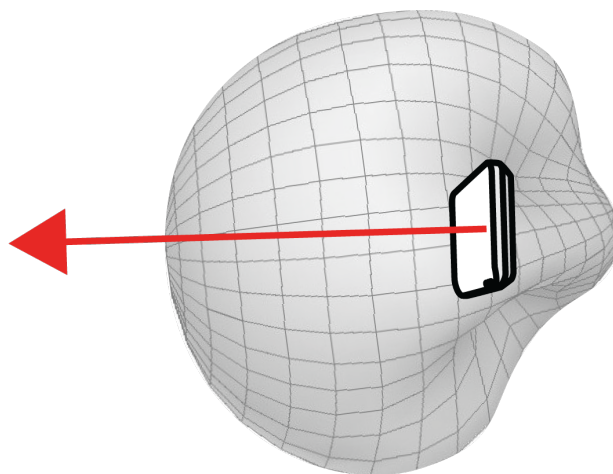

Cardioid RF Pattern

The access point RF pattern is cardioid, picking up equally from the sides to the front cover of the unit.

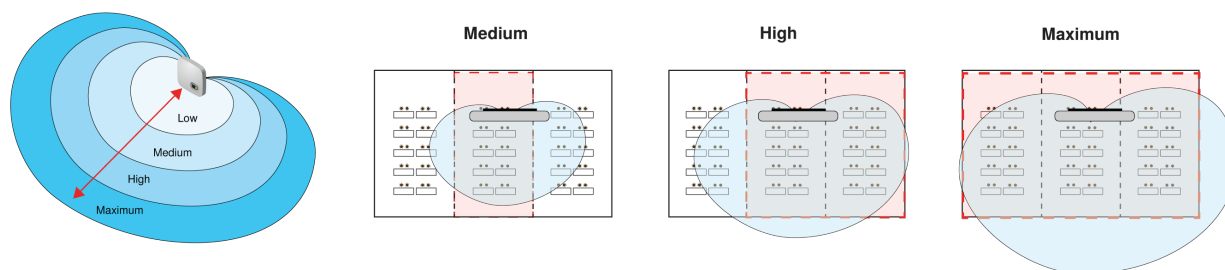

Room Combining Example

Increase RF power levels to cover larger combined rooms.

Reliable Bandwidth Allocation

MXCW easily scales from 2 to 125 microphone units without any change in the audio performance. The bandwidth is strategically divided, allocating the uplink channels only for active speakers, while preserving traffic for continuous downlink monitoring channels.

Selecting or Excluding Specific Wireless Channels

You can avoid specific wireless channels by deselecting them from the web application. The MXCW system scans all channels in the 2.4 and 5 GHz spectrum and chooses the cleanest one for operation. After deselecting specific channels, MXCW will no longer scan and operate in those frequencies. At least one non-DFS channel must be selected at all times.

To exclude specific wireless channels:

1. Go to the Wireless tab.
2. Press Select wireless channels .
3. Deselect the channels you do not want to use.
4. Press Apply to save your changes.

Interference Detection and Avoidance

The access point has a built-in spectrum analyzer that continuously scans the wireless environment and ranks the best channels for operation. MXCW commonly operates in a specific block of 5 GHz channels that require **Dynamic Frequency Selection (DFS)** or **Doppler weather radar Dynamic Frequency Selection (DDFS)**. These channels reserve priority for weather, aviation, and military devices.

To avoid interference from priority devices, DFS channels are scanned for 1 minute and DDFS channels are scanned for 10 minutes before the channels are available for use. If interference is detected, the access point changes to a verified backup channel with minimal disruption to the audio performance. Channels with detected interference are unavailable for 30 minutes. After 30 minutes, the system will resume scanning and verifying the channel for use.

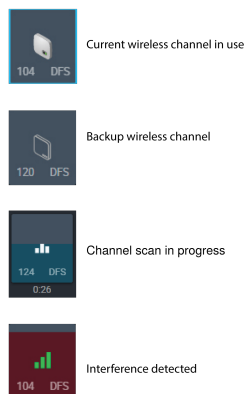

Tips to Improve Wireless System Performance

If you encounter interference or dropouts, try the following suggestions:

1. Check the installation of access point:
 - Ensure a clear line of sight between access point and the conference units.
 - Mount the access point near or above the microphone units
 - Make sure people do not block the line of sight between receiver and transmitter.
2. Check that other wireless systems are not causing interference:
 - Ensure at least 3 meters (10 feet) between access point and wireless routers, computers, or other active 2.4 GHz or 5 GHz sources.
 - Turn on typical wireless devices prior to the event so the MXCW system has time to select a clean channel.
 - Avoid heavy wireless traffic activities on nearby networks such as downloading large files or viewing a movie.
3. Additional tips:
 - Make sure the access point is using all available channels (reselect any channels that were manually deselected from the web application)
 - During sound check, mark trouble spots and position participants away from those areas.
 - Move access point and microphones away from metal or other dense materials.

Setting the Access Point Country and Region (MXCWAPT-B and MXCWAPT-W only)

For the MXCWAPT-B and global MXCWAPT-W model variations, the country and region **must** be set when the unit is powered on for the first time, or after a factory reset. Use the web application or the LCD menu to set the operating location for compliance with local regulations and to get the most reliable scans.

The MXCWAPT-B access point needs to be set to Canada or Mexico. The MXCWAPT-W access point needs to be set to one of the following countries and regions:

Regions	Countries
APAC (Asia Pacific)	Australia, China, Hong Kong, India, Indonesia, Malaysia, New Zealand, Pakistan, Philippines, Singapore, South Korea, Taiwan, Thailand, Vietnam
Africa	Egypt, Ethiopia, Kenya, Morocco, Nigeria, South Africa
Americas	Argentina, Brazil, Chile, Colombia, Costa Rica, Dominican Republic, El Salvador, Guatemala, Jamaica, Panama, Peru, Uruguay, Venezuela
EME	Austria*, Belgium*, Bulgaria*, Croatia*, Cyprus*, Czech Republic*, Denmark*, Estonia*, Finland*, France*, Germany*, Greece*, Hungary*, Iceland*, Ireland*, Italy*, Latvia*, Liechtenstein*, Lithuania*, Luxemburg*, Malta*, Netherlands*, Norway*, Oman, Poland*, Portugal*, Qatar, Romania*, Russia, Saudi Arabia, Slovakia*, Slovenia*, Spain*, Sweden*, Switzerland*, Turkey, UAE, United Kingdom*

* part of the European Union/EFTA listing in the web application and LCD menu.

Changing the Country and Region

Use the web application to change the country and region after the initial setup:

1. Go to web application > Language and region and select a new country or region.
2. Press Apply to save your changes.

Note: After a change is applied, the access point will reboot and all connected devices will not be able to pass audio during this time. Refresh the browser for the web application after the access point has rebooted.

Setting Up Participants

Participant Roles

The system facilitates meetings in part by adjusting features and permissions based on the role assigned to each participant device. Participant roles affect:

- **Speaker limitations:** The chairman can speak at any time, while delegates may need to wait their turn.
- **Speak priority:** Participants can interrupt another active speaker depending on rank.
- **Hardware controls:** Button functions depend on the role of the speaker.

For example, since the chairman is responsible for the meeting, additional controls and permissions are granted to perform additional tasks and to speak at any time without waiting in line. Others are listeners and have minimal speaking permissions.

The following is a summary of the roles in the system:

Role	Brief description	Details
Chairman	Moderator or leader of the event	The chairman is a participant with additional permissions for controlling delegate microphones, accessing meeting controls, and overriding delegate speakers at any time.

Role	Brief description	Details
Delegate	Typical participant	Delegates represent the majority of participants in a meeting. Depending on the microphone operation, delegates may need to wait in the request queue until it is their turn to speak.
Listener	No microphone required	Participants use the device only to listen to the floor mix (using the loudspeaker) or to an interpretation channel (using headphones). There are no speaking permissions in this role, but a chairman can turn on this microphone manually.
Ambient	Improves audio mix	This role is for spare, utility devices to add natural room ambient noise to the floor mix to aid during pauses in speech or brief breaks between agenda items when no other participants are on the speaker list. There are no listening or speaking permissions in this role. Go to Meetings Controls > Advanced > Enable - ambient microphones.
Remote Caller	Delegates can remotely participate in events	Connect a cell phone to a conference unit configured to the remote caller role. A remote caller occupies any of the 8 unassigned microphone slots, and remains on the speak list during the event.
Dual Delegate	Two delegates share one conference unit	Both the left and right buttons are configured as speak buttons, one for each participant. The speaker list shows both delegates as individual speakers, but only one uplink channel is being used by the shared microphone. Both delegates can cast votes.

Configuring Conference Units for Remote Callers

1. Change a conference unit to the remote caller role in the technician menu or web application.
2. Call the remote participant on a mobile device.
3. Connect the mobile device to the TRRS jack on the back of the conference unit.

To allow conference units to automatically change to the remote caller role when connecting a mobile device, go to Meeting Controls > Basic and select Auto-sense remote caller role cable.

Speak Priority for Remote Callers

When a mobile device is connected to the conference unit, the remote caller will hear 1 of 3 tones that indicate their connection and speak priority:

- 3 short ascending tones: Connected to the event and remains on the speak list.
- 3 short descending tones: Connected and listening to the event, but no speaking permissions
- 2 short repeating tones: Conference unit lost connectivity to the access point

Note: If the conference unit loses power, no tones are sent to the remote caller.

When a microphone slot becomes available, a remote caller can be added to the speak list by unplugging the cable from the conference unit and plugging it in again.

Changing the Participant Role

From the MXCW web application:

1. Go to the Devices tab.
2. Find and select the participant (or seat) in the list.
3. Select the role to expand the dropdown and view additional roles.
4. Select the role for that participant. The device reprograms with the corresponding controls and permissions.

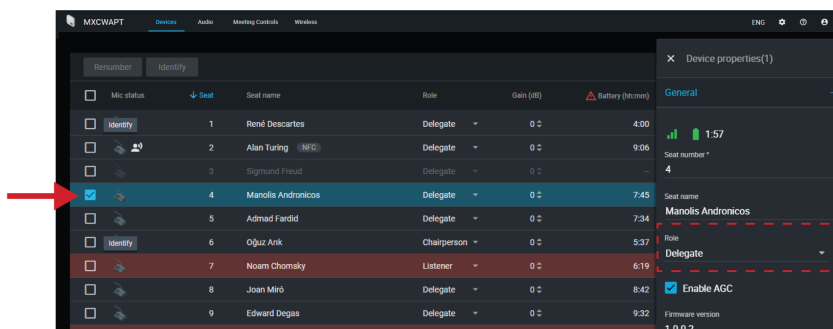

Tip: To update multiple participants at once: select them and change the role from the side properties panel.

From the device technician menu:

1. Enter the technician menu on the conference unit.



2. From the  role tab, select a new role.

Identifying a Device from the Software

Before making changes in the software, confirm you are interacting with the correct hardware.

1. Go to the Devices tab.
2. Click the desired device's icon. The device beeps or flashes to confirm your selection.

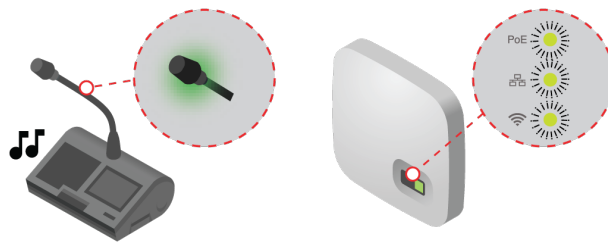
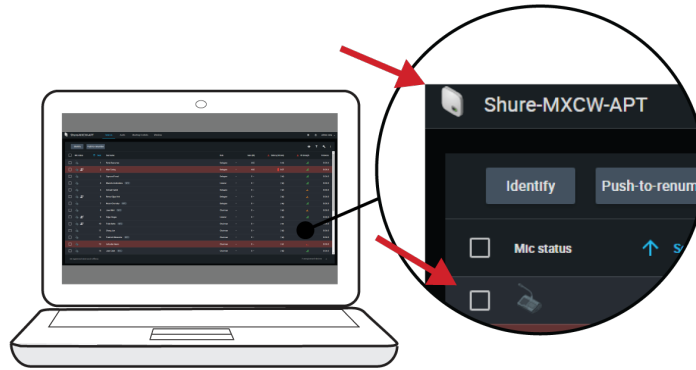

Note: Click the  wrench icon to change the device identification indicator.

3. Select the icon again to stop identifying or wait until it times out (30 seconds).





Identify the Hardware

Customizing the Devices Page

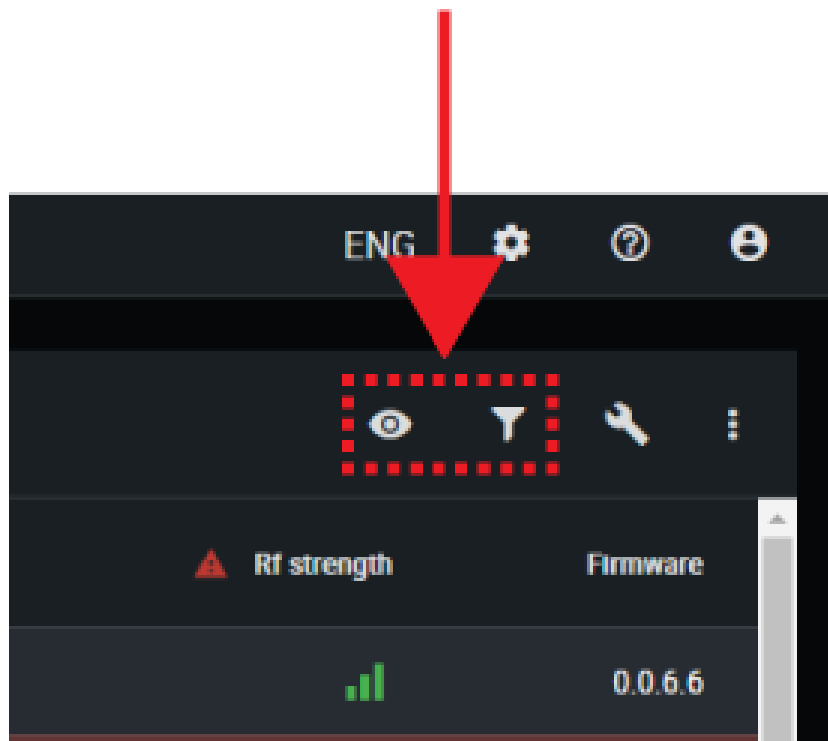
Choose which information you want to see from the Devices tab. Edit the  filter and  visible columns to remove fields that are not useful to your workflow.



 Visible columns	<p>Determine which columns display in the devices table:</p> <ul style="list-style-type: none"> • Seat number • Seat name • Role • Battery • RF strength • Speak priority • Audio groups • Left-button functionality • Firmware version • Serial number • Mic gain • Low-pass filter (9 kHz) • High-pass filter (150 Hz)
 Filter	<p>Only allow devices with these attributes to display in the devices table:</p> <ul style="list-style-type: none"> • Role • Speak priority • Audio groups • Left-button functionality • Firmware version

To return to default settings, open  more options and select Reset.

Assigning Names and Seat Numbers

The chairman and meeting operators will need to refer to the participants by either name, seat number, or both. The proper assignment of names and seat numbers is critical to ensure the continuity of the discussion.

When setting up the installation for the first time, each microphone unit appears with its default name and an automatically assigned seat number according to the order they were powered on. Use the Devices tab to match wireless devices to the anticipated seating chart.

Note: Devices already display the participant's name if an NFC card is inserted. See **NFC Card Functionality** for more details.



1. Draw a seating chart, or diagram, that represents the room. Number each seat that requires a microphone. Add participant names to the seating chart.
2. Provide seat names by clicking the seat name field and writing the new name for each unit.

<input type="checkbox"/> Mic status	↑ Seat	Seat name	Role
<input type="checkbox"/>	1	John Smith	Delegate
<input type="checkbox"/>	2	Seat 2	Delegate

3. Reorder seats to match the actual seat numbers in the room or on your seating chart:
 - To move a single seat, click in the seat field for that row and enter the new number. If another seat already exists in that number, it will exchange positions with the other seat.

- To move multiple seats, click  more options > Push-to-renumber. Enable this mode to rearrange seats by pressing each device's speak buttons in the preferred order. This will remap devices according to the order the buttons are pressed.

Retain Seat Information

Device settings, such as seat name and seat number, are saved during a power cycle by default. To stop saving seat information click the  save icon > Disable. Click the  save icon > Retain to start saving seat information again.

NFC Card Functionality

Use the free Shure NFC Card Programming application (available on www.shure.com) to program NFC identification cards with the names of meeting participants.

The NFC Card Programming application is designed to work with ACOS3 dual interface or contactless cards, such as the MX-CDualCard. Use the ACR1252U USB card programmer (www.acs.com.hk) to write participant names to the identification cards.

To allow NFC functionality for conference units:

1. Go to Meeting Controls > Advanced > Enable NFC.
2. Insert an NFC card into the conference unit so participants are identified by their name.

Note: NFC cards are not supported with dual delegate conference units.

Speak Priority

When speaker interruption is enabled, participants can override each other in the speaker list based on their speak priority and their role.

Manually adjust the speak priority of each participant to meet the needs of your meeting.

Example speak priority settings:

Multiple Chairmen	<ul style="list-style-type: none"> • Set the highest-ranking chairman to 5 • Set the rest of the chairmen to 4
High-Ranking Delegates	<ul style="list-style-type: none"> • Leave the normal delegates at 1 (default) • Set the high-ranking delegates to 2

Adjusting Speak Priority

To adjust the speak priority without changing the participant's role:

1. Open the web application to the Devices tab.
2. Select the participant in the table to open the properties panel.
3. Expand the additional properties and adjust the speak priority for that participant.

Active Speaker Interruption

When interruption is allowed, a participant that turns on their microphone will override the last person in the speaker list. The different modes determine the behavior of microphone activation when the speaker list is full.

To change the interruption mode:



1. Go to Meeting Controls > Advanced > Active speaker interruption
2. Select a mode:

- Not allowed
- Higher speak priority allowed (default)
- Equal or higher speak priority allowed

See **Speak Priority** for information on adjusting individual participants' priority.

Microphone Activation Style

The speak mode determines the way the participants use their microphones in a group setting. Several factors may affect the meeting requirements and the manner in which the meeting is run: room size, number of participants, formality of the event, and amount of technical support on staff. The speak mode addresses these factors with presets to control the microphone behavior.

Mode	Description	How it Works
Automatic (default)	Press to speak 	Speak button turns on participant microphone. There is no request queue: when the speaker list is full, the mic does not turn on.
FIFO (First in, first out)	Automatic request queue 	Speak button adds participant to a queue system. Once the speaker list is full, participants are placed into a chronological request queue. The next microphone in queue turns on automatically once a space is open in the speaker list.
Manual	Managed request queue 	Speak button adds the participant to a request queue that is managed by the chairman or operator.

Note: Speak priority may affect the list. A new speaker with higher priority may automatically override the earliest activated microphone if that speaker has a lower priority. See **Speak Priority** for more details.

Changing the Speak Mode

The speak mode is a system setting that applies to all conference units registered with the access point.

Use one of the following methods to change the speak mode:

- Web application: Meeting Controls > Basic > Speak mode

Note: Chairmen can also change speak mode from the chairman view.

- Access point LCD menu: Meeting Ctrl's > Speak mode

Setting the Number of Active Speakers

The MXCW system allows up to 8 active speakers. Once the speaker list is full, participants must wait until their turn to speak. If they attempt to speak before their turn, their microphone LED ring flashes momentarily and then turns off as a reminder.

To set the number of speakers:

1. Go to Meeting Controls > Basic.

2. Use the plus sign (+) and minus sign (-) to change the number of speakers.
 - **Total:** Total number of active delegate and chairman devices. This is the absolute maximum number of people that can address the floor at the same time.
 - **Delegate:** Number of delegate microphones that can be open at the same time (excludes the chairman).
 - **Maximum Requests:** Total number of participants that can be in the request queue. This is only available in Manual and FIFO mode.

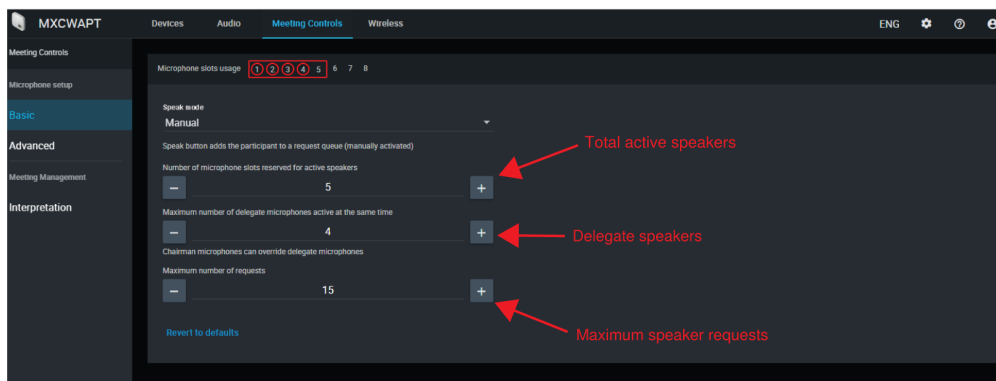

Best Practices for Setting Active Speakers

- Add an extra participant to the total number of speakers to allow a chairman to speak at any time.
- When using First In, First Out (FIFO) mode, set the maximum number of speakers to 1 so the participants must wait to speak until another has finished.
- Keep a microphone slot available for a remote caller.

Prevent Speak Button Conflicts

To prevent conflicts of a participant and an administrator or chairman attempting to perform the same action on a unit:

1. Go to Meeting Controls > Advanced > Microphone off permissions.
2. Select Prevent double-press of Speak button.
3. Set the amount of time (in seconds) for a conference unit to register a second press.
4. Optional: Allow a delegate to cancel the administrator or chairman's speak button press by holding the speak button down for an assigned duration between 1 - 120 seconds.

Changing Participant Microphone Off Permissions

To allow only the administrator or the chairman to turn off participant microphones:

1. Go to Meeting Controls > Advanced > Microphone off permissions.
2. Select Only admin/chairman can turn off participant microphones.

Audio Setup and Channel Routing

The MXCW system supports wireless, analog, and Dante™ network channels for a wide range of applications and installations. Use the web application to customize the audio system for your meeting.

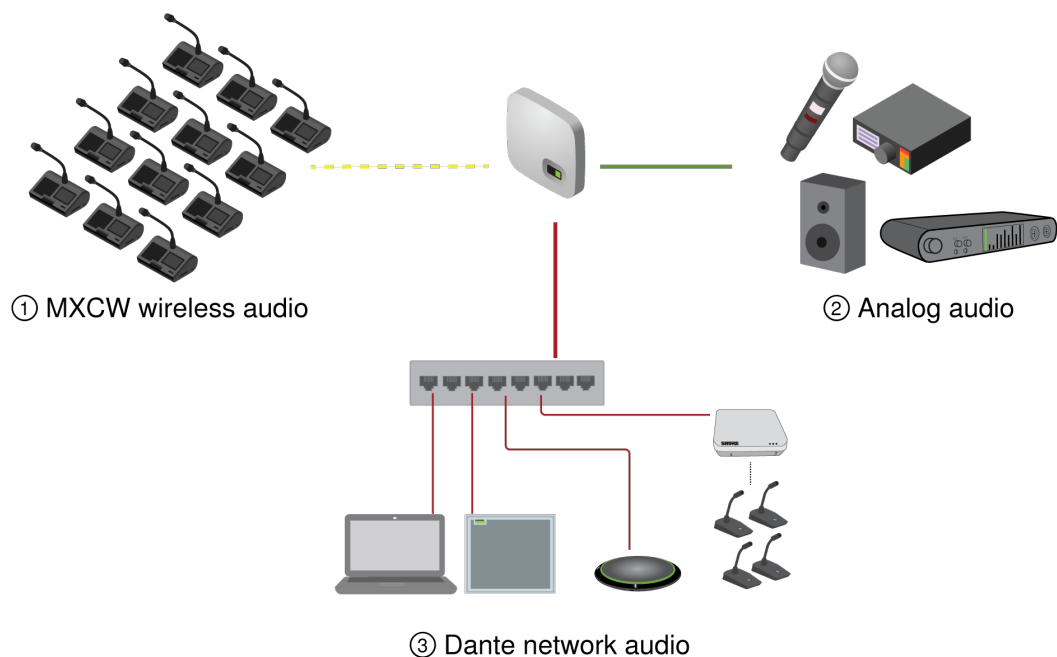

MXCW Audio Channels

① MXCW Wireless Network	Encrypted wireless audio between the access point and conference units: <ul style="list-style-type: none"> • 8 uplink channels for active speakers • 9 downlink listening channels (1 floor mix + 8 interpretation channels)
② Analog audio	XLR connectors on the access point: <ul style="list-style-type: none"> • 1 input channel • 1 output channel
③ Dante network audio	Digital audio channels over the Ethernet network: <ul style="list-style-type: none"> • 10 input channels • 10 output channels

Once the audio signal is added to the MXCW system, an internal matrix mixer routes audio signals between inputs and outputs, for simple and flexible routing:

- Send the floor mix to multiple outputs for recording, broadcasting, and a spillover listening room.
- Add an external sound source to the floor mix, such as a bodypack microphone for presenters.
- Record each active microphone on a separate audio channel for official record keeping.

MXCW Routing Descriptions

Reference the table for a variety of MXCW routing options.

MXCW Audio Routing Description

Route	Description	Available channels	Web application path
Input channels	<p>Monitor and adjust the signal at each input channel:</p> <p>Audio signal Volume and mute AGC and EQ</p>	<p>1 Analog input 10 Dante inputs</p>	web application > Audio > Inputs
Group mixes	<p>1 or more source(s) for each mix group:</p> <p>Seat numbers Input channels</p>	<p>Floor mix 8 group mixes</p>	web application > Audio > Group mixes
Output channels	<p>Select source for each output channel:</p> <p>Floor or group mix Microphone slot Input channels</p>	<p>1 Analog output 10 Dante outputs</p>	web application > Audio > Outputs

MXCW Wireless Audio

Encrypted wireless audio between the access point and conference units:

Speaking Channels (Up-link)

8 uplink channels are provided for active speakers. As participants turn on their microphones, they are added to these channels. Depending on your event, you may want to lower the limit of speakers or add a chairman role to certain participants.

See **Setting Up Participants** for more information.

Up to 8 Speakers

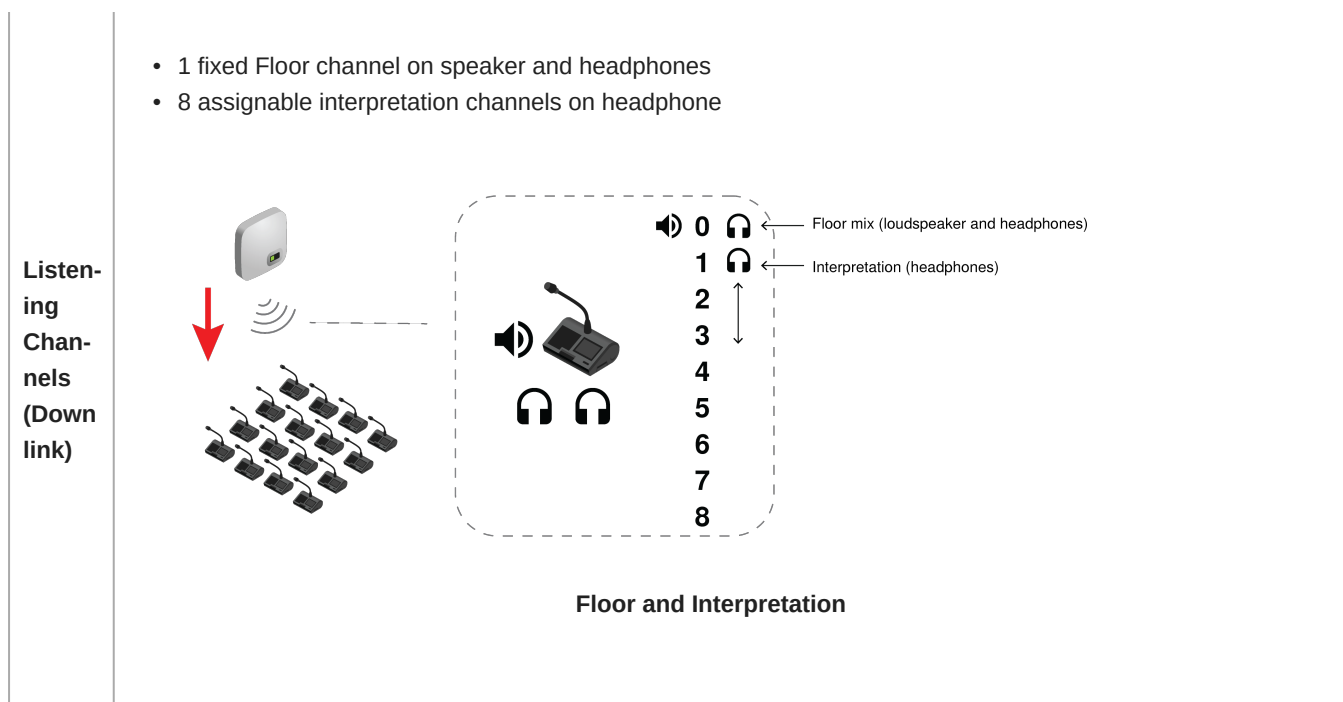

The Floor Mix

Whenever a microphone is turned on, the audio is routed to the floor mix by default. The floor mix combines all active speakers and sends that signal to the other participant units for listening.

Listen to the floor mix on the unit loudspeaker or the headphone channel.

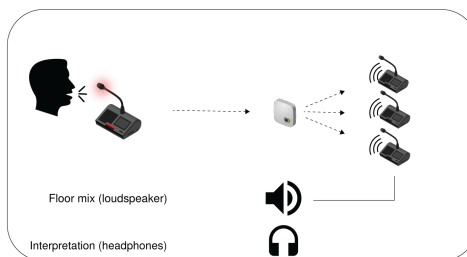

- **Loudspeakers:** The floor mix is **always** the source for the loudspeakers
- **Headphones:** The floor mix is also available on a headphone channel (Ch. 0)

Monitoring Active Microphones

Use the MXCW system web application to monitor and adjust the microphone slots for audio contributing to the floor mix. Go to [Audio > Active microphones](#).

Analog Connections

Easily connect additional equipment using the XLR analog connectors on the MXCW access point. Common applications include adding a Q&A or presenter microphone, sending audio out to a broadcast feed, or connecting to a teleconferencing system.

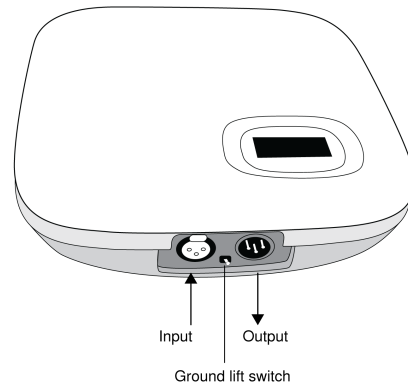

Access Point Analog Connectors

Remove the cover to access the analog connectors

Connecting Analog Devices

1. Connect a line-level audio device:
 - XLR input from a mixer or wireless receiver (default route to floor mix)
 - XLR output to a recording, loudspeaker, or teleconferencing system (default source is floor mix)
2. Perform a sound check using normal speech levels with the rest of the MXCW microphones. For best results:
 - Always leave AGC enabled to make sure the signals blends naturally with other MXCW sources
 - Use the equalization filters to reduce unwanted sounds like HVAC.

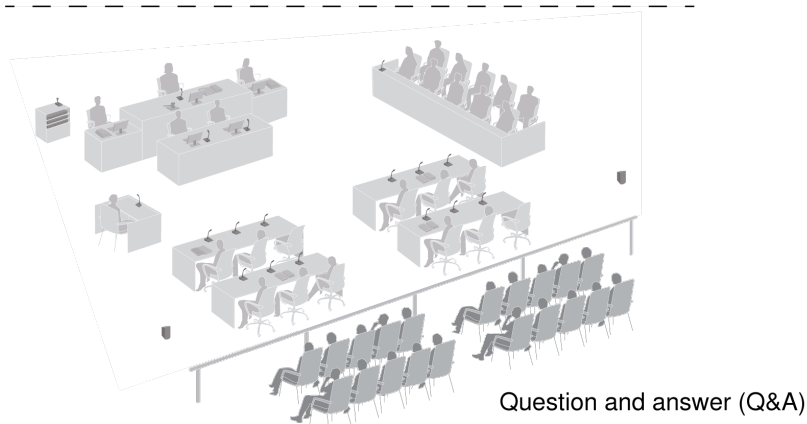
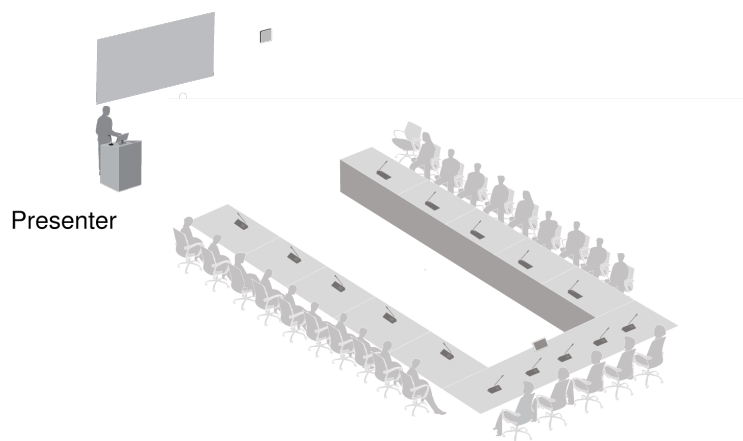

Analog Input Example

Automatic Gain Control (AGC)

Automatic gain control adjusts channel levels to ensure consistent volume for all speakers, in all scenarios. For quieter voices, it increases gain; for louder voices, it attenuates the signal.

For best performance, it is recommended that AGC be enabled for all inputs. This means that all level adjustments will be made automatically by AGC and manual control of input levels using channel faders is inhibited.

If necessary, it is possible to override AGC functionality on a channel-by-channel basis. This may be accomplished by disabling the channel's AGC and then manually adjusting input level with the corresponding channel fader.

Enable or disable AGC in one of the following ways:

- Go to Audio > Active microphones and click the AGC button.
- Select the desired devices from the Devices tab and check the Enable AGC box.
- For analog and Dante inputs, go to Audio > Inputs and click the AGC button.

Adding Other Sources to the Floor Mix

Add other audio sources to blend with the floor mix of MXCW wireless microphones.

- 1 XLR analog input on the access point is automatically routed to the floor
- 10 Dante digital network channels are selectable for routing

1. Connect the audio source to the system:

- Analog input: Connect an audio source to the XLR input on the access point.

Tip: Flip the ground lift switch if a buzzing or humming sound occurs because of a ground loop.

- Digital audio: Route audio to one of the MXCW Dante channels using Dante Controller software.

2. Ensure the sources are selected on the floor group.

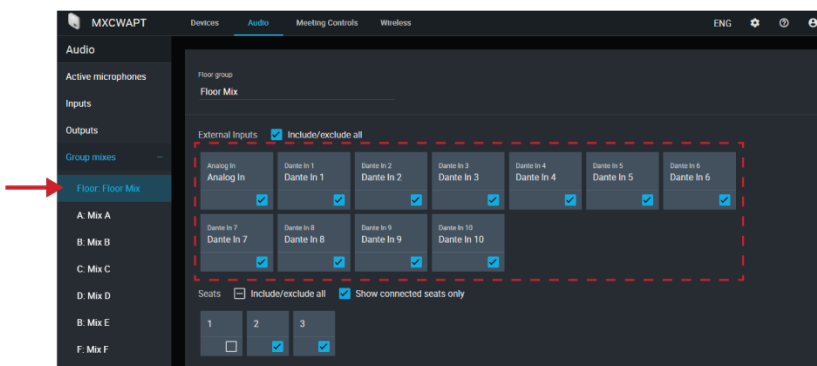

3. If necessary, adjust the volume level or EQ to match the other input levels from Audio > Inputs.

Tip: Always use AGC on each channel for automatic, continuous volume optimization.

Removing a Microphone from the Floor

By default, the audio from any active microphone is routed to the floor mix. However, you can remove a conference unit from the floor mix if you do not want it to go to the loudspeakers.

For example, a chairman's conference unit can be recorded but kept private (taken out of the floor mix). Remove it from the floor mix and route it to another group that is connected to a recording system for archival purposes.

1. Go to Audio > Group mixes > Floor.
2. Find the seat you want to remove and deselect it.

Tip: Select Show connected seats only to filter out unoccupied seats.

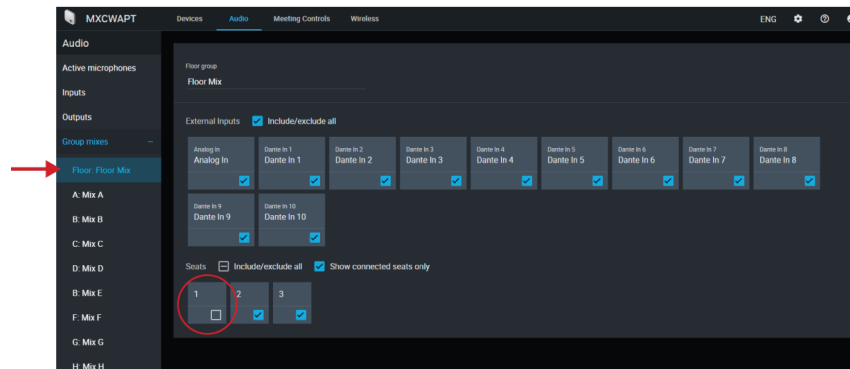

3. Route the audio from that seat to another group. Open the desired group and select the seat.

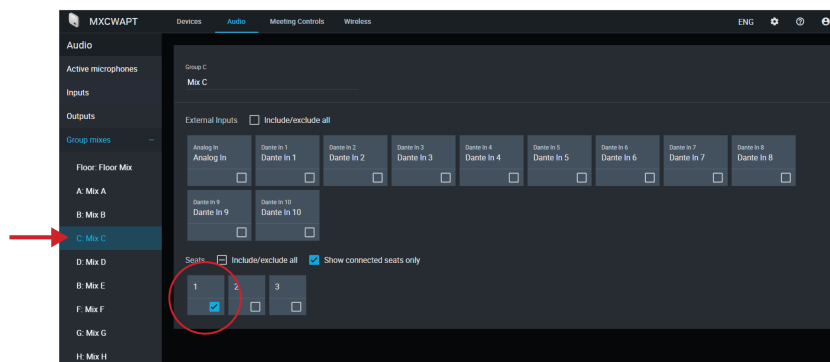

4. Select that group as the source for the output channel.

4a. Press Select source

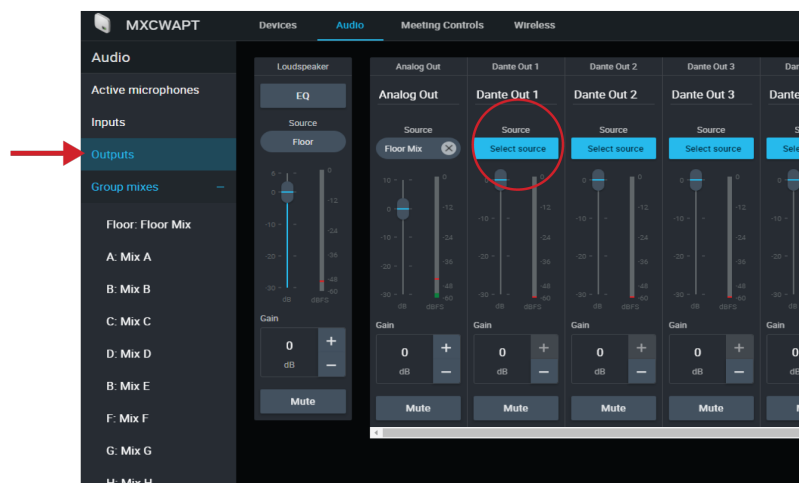

4b. Choose the group mix that the seat is routed to.

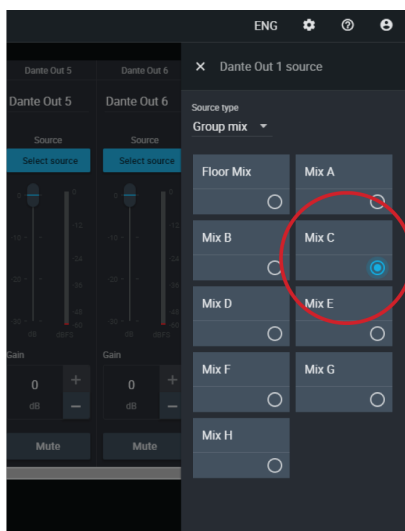

This group (with the seat that was removed from the floor mix) is now routed to the output channel and ready for recording, broadcasting, or another application.

Isolating Participants on Separate Output Channels

8 or Fewer Active Speakers

Assign each participant to their own group mix to record them individually on predetermined channels.

1. Open the first group mix (A). Select the first seat. For easy reference, rename the group according that seat.

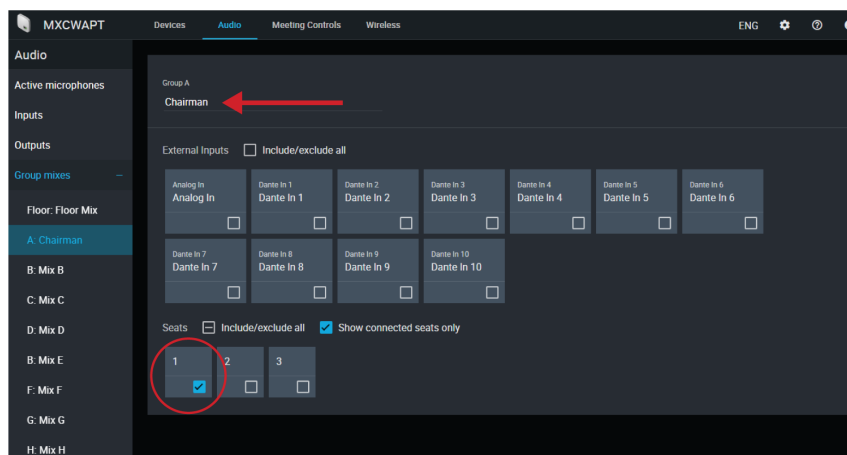

2. Repeat for the rest of the group mixes (B - H).
3. Open the Outputs tab.
4. For the first Dante output channel, select Mix A for the input source.



5. Repeat for the rest of the outputs.

More than 8 Active Speakers

To record more than 8 active speakers at a time, route the 8 microphone slots (instead of seats routed to mixes) to the output channels.

Keep in mind that the channels will not be permanently assigned to certain participants. The wireless 8 microphone slots 'fill up' starting with slot 1 and increasing with more active microphones. (Slot 1 is always filled whenever a microphone is active.) Therefore this method allows clean recordings, but the labeling will not follow the participants by seat.

1. Set the number of active microphones and delegate microphones to 8 (maximum).
2. Open the Outputs tab.
3. For the first Dante output channel, select Microphone slot 1 for the input source.

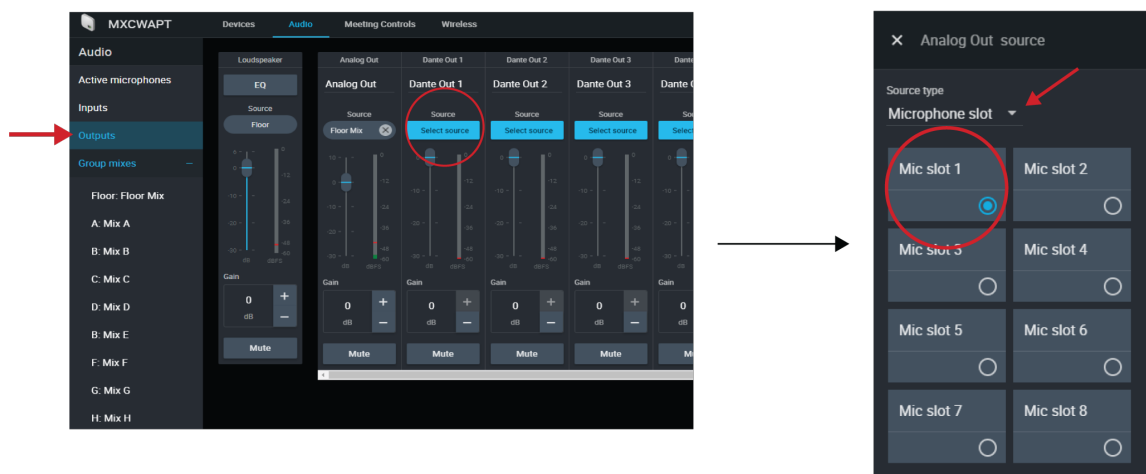

4. Repeat for the remaining microphone slots.

Emergency Audio Signal

To prepare for an emergency, connect an Emergency Evacuation Message (EEM) audio signal to the analog XLR input or one of the 10 Dante input channels. The system will detect when the EEM signal is present and distribute it to the loudspeakers and all output connections.

1. Go to Audio > Inputs.
2. Open the emergency audio dropdown menu and connect the EEM signal to a Dante channel (example: Dante input 1) or the XLR connector on the access point.

Note: Audio returns to normal after being below the threshold for 5 seconds.

Language Interpretation

There are 8 audio channels available for language interpretation. In multilingual meetings, participants speak their native language into the microphone and listen to the interpretation on headphones. Conference units configured to the remote caller role also have access to interpretation channels.

Set Up Interpretation Channels

Use the access point web application to set up interpretation channels for conference units.

1. Go to Audio > Interpretation.
2. Select the desired language from the dropdown menu.
3. Press Assign Source and choose from the available analog input or 10 Dante inputs.
4. Click the channel slider to turn the interpretation channel on.
5. Repeat the above steps to create up to 8 interpretation channels.

Conference Unit Interpretation Channels

Conference units include a headphone and remote caller output for listening to interpreter channels or other participants on the floor channel. Each participant chooses their channel from the conference unit touchscreen.

Participants select one of the channels to listen to their language during a multilingual event. The audio source comes from the analog input or one of the Dante inputs.

The floor channel is used by interpreters to provide simultaneous interpretation of the discussion. This channel is also selectable by other participants to listen to the floor channel on headphones or in the remote call.

To select headphone channels:

1. Connect headphones to a headphone jack on one of the sides of the conference unit.
2. Press the  headphone icon on the touchscreen and select a channel from the list.
3. Adjust the volume of the headphones using the control knobs on the unit.

To select remote caller channels:

1. Connect a mobile device to the TRRS jack on the back of the conference unit.
2. Press the  phone icon on the touchscreen and select a channel from the list.

Digital Audio Networking

Dante™ digital audio is carried over standard Ethernet and operates using standard Internet Protocols. Dante provides low latency, tight clock synchronization, and high Quality-of-Service (QoS) to provide reliable audio transport to a variety of Dante devices. Dante audio can coexist safely on the same network as IT and control data, or can be configured to use a dedicated network.

Dante Network Audio

Connect your Dante audio network to the MXCW system.

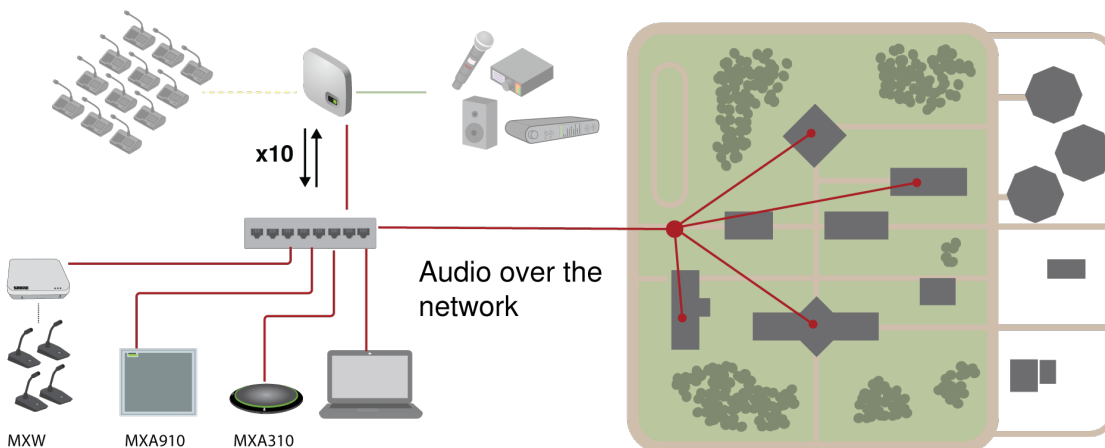

Connect a network of devices

10 input channels, useful for:

- Dante-enabled microphones, such as Microflex® Advance™ Ceiling and Table Arrays
- Output from an automatic mixer or room system
- Videoconferencing signal of far-end audio

10 output channels, useful for:

- Recording system for archiving
- Live-streaming events

- Videoconferencing feed of near-end audio

Routing Dante Channels

Use the free Dante Controller software by Audinate® to route Dante channels in and out of the MXCW system.

Switch Recommendations for Dante Networking

In addition to the basic networking requirements, Dante audio networks should use a Gigabit network switch or router with the following features:

- Gigabit ports
- Quality of Service (QoS) with 4 queues
- Diffserv (DSCP) QoS, with strict priority
- Recommended: A managed switch to provide detailed information about the operation of each network link (port speed, error counters, bandwidth used)

QoS (Quality of Service) Settings

QoS settings assign priorities to specific data packets on the network, ensuring reliable audio delivery on larger networks with heavy traffic. This feature is available on most managed network switches. Although not required, assigning QoS settings is recommended.

Note: Coordinate changes with the network administrator to avoid disrupting service.

To assign QoS values, open the switch interface and use the following table to assign Dante-associated queue values.

- Assign the highest possible value (shown as 4 in this example) for time-critical PTP events
- Use descending priority values for each remaining packet.

Dante QoS Priority Values

Priority	Usage	DSCP Label	Hex	Decimal	Binary
High (4)	Time-critical PTP events	CS7	0x38	56	111000
Medium (3)	Audio, PTP	EF	0x2E	46	101110
Low (2)	(reserved)	CS1	0x08	8	001000
None (1)	Other traffic	BestEffort	0x00	0	000000

Note: Switch management may vary by manufacturer and switch type. Consult the manufacturer's product guide for specific configuration details.

For more information on Dante requirements and networking, visit www.audinate.com.

Networking Terminology

PTP (Precision Time Protocol): Used to synchronize clocks on the network

DSCP (Differentiated Services Code Point): Standardized identification method for data used in layer 3 QoS prioritization

Dante Network Audio Encryption

Audio is encrypted with the Advanced Encryption Standard (AES-256), as specified by the US Government National Institute of Standards and Technology (NIST) publication FIPS-197.

To activate encryption:

1. Open the Settings menu and select Encryption.
2. Click Enable Encryption.

Important for encryption to work:

- Encryption must be universally enabled or disabled on all connected Shure devices.
- AES67 must be disabled in Dante Controller to turn encryption on or off.

Networking

Networking Best Practices

Use the following best practices when setting up a network to ensure reliable communication:

- Always use a "star" network topology by connecting each component directly to the switch or router.
- Connect all Shure networked devices to the **same network** and set to the **same subnet**. This applies to all devices that audio signals must be routed between (managed through Dante Controller). It is also required in order to open the web application for a device.
- Devices on separate networks require an audio processor or conferencing software to carry audio between them.
- Use only 1 DHCP server per network. Disable DHCP addressing on additional servers.
- Power on the switch and DHCP server prior to MXCW equipment.
- To expand the network, use multiple Ethernet switches in a star topology.
- All devices must be at the same firmware revision level.

Device IP Settings

Configure IP

Sets IP mode of the selected network interface:

- **Auto (DHCP):** For automatic assignment of IP addresses.
- **Manual (Static):** For Static IP addresses.

IP Settings

View and edit the IP Address, Subnet Mask, and Gateway for each network interface.

MAC Address

The network interface's unique identification.

Configuring IP Settings

IP configurations are managed through the web application or the access point LCD screen. By default, they are set to Automatic (DHCP) mode. DHCP mode enables the devices to accept IP settings from a DHCP server, or automatically fall back to Link-Local settings when no DHCP is available. IP addresses may also be manually set.

To configure the IP properties in the web application:

1. Open the web application.
2. Go to Settings and select Network.
3. Select Automatic or Manual. If Automatic is used, addresses will be automatically assigned. See **Manually Assigning Static IP Address** for Manual setup.

Manually Assigning Static IP Address

To manually assign IP addresses:

1. Open the web application.
2. Go to the Settings tab and select Network.
3. Select Manual as the IP configuration.
4. Enter the IP address, Subnet mask, and Gateway address.
5. Click Apply when finished.

Setting Latency

Latency is the amount of time for a signal to travel across the system to the outputs of a device. To account for variances in latency time between devices and channels, Dante has a predetermined selection of latency settings. When the same setting is selected, it ensures that all Dante devices on the network are in sync.

These latency values should be used as a starting point. To determine the exact latency to use for your setup, deploy the set-up, send Dante audio between your devices, and measure the actual latency in your system using Audinate's Dante Controller software. Then round up to the nearest latency setting available, and use that one.

Use Audinate's Dante Controller software to change latency settings.

Latency Recommendations

Latency Setting	Maximum Number of Switches
0.25 ms	3
0.5 ms (default)	5
1 ms	10
2 ms	10+

Using the Web Application with a Wireless Connection

When operating the web application with a wireless connection, it's important to set up the wireless router properly for best performance. The system employs several standard-based protocols that rely on multicast. The wireless connection treats broadcast and multicast packets differently than general packets for backward compatibility reasons. In some cases, the wireless router will limit the multicast packet transmission rate to a value that is too slow for web application to properly operate.

Wireless routers typically support 802.11b, 802.11a/g, and/or 802.11n standards. By default, many wireless routers are configured to allow older 802.11b devices to operate over the network. In this configuration, these routers will automatically limit the multicast data rates (or sometimes referred to as 'basic rate', or 'management rate') to 1-2Mbps.

Note: A wireless connection can only be used for the control software. Network audio cannot be transmitted over a wireless connection.

Tip: For larger wireless microphone configurations, it's recommended to increase the multicast transmission rate to provide adequate bandwidth.

Important: For best performance, use a wireless router that does not limit the multicast rate to 1-2 Mbps.

Shure recommends the following wireless router brands:

- Cisco
- Linksys
- Apple

IP Ports and Protocols

Shure Control

Port	TCP/UDP	Protocol	Description	Factory Default
21	tcp	FTP	Required for firmware updates (otherwise closed)	Closed
22	tcp	SSH	Secure Shell Interface	Closed
23	tcp	Telnet	Not supported	Closed
68	udp	DHCP	Dynamic Host Configuration Protocol	Open
80*	tcp	HTTP	Required to launch embedded web server	Open
443	tcp	HTTPS	Not supported	Closed
161	tcp	SNMP	Not supported	Closed
162	tcp	SNMP	Not supported	Closed
2202	tcp	ASCII	Required for 3rd party control strings	Open
5353	udp	mDNS [†]	Required for device discovery	Open
5568	udp	SDT [†]	Required for inter-device communication	Open
8023	tcp	Telnet	Debug console interface	Closed
8180	tcp	HTML	Required for web application	Open
8427	udp	Multicast SLP [†]	Required for inter-device communication	Open
64000	tcp	Telnet	Required for Shure firmware update	Open

Dante Audio & Controller

Port	TCP/UDP	Protocol	Description
162	udp	SNMP	Used by Dante
[319-320]*	udp	PTP [†]	Dante clocking
2203	udp	Custom	Required for packet bridge
4321, 14336-14600	udp	Dante	Dante audio
[4440, 4444, 4455]*	udp	Dante	Dante audio routing
5353	udp	mDNS [†]	Used by Dante

Port	TCP/UDP	Protocol	Description
[8700-8706, 8800]*	udp	Dante	Dante Control and Monitoring
8751	udp	Dante	Dante Controller
16000-65536	udp	Dante	Used by Dante

*These ports must be open on the PC or control system to access the device through a firewall.

†These protocols require multicast. Ensure multicast has been correctly configured for your network.

AES67

AES67 is a networked audio standard that enables communication between hardware components which use different IP audio technologies. This Shure device supports AES67 for increased compatibility within networked systems for live sound, integrated installations, and broadcast applications.

The following information is critical when transmitting or receiving AES67 signals:

- Update Dante Controller software to the newest available version to ensure the AES67 configuration tab appears.
- Before turning encryption on or off in the Shure device's web application, you must disable AES67 in Dante Controller.
- AES67 cannot operate when the transmit and receive devices both support Dante.

Shure Device Supports:	Device 2 Supports:	AES67 Compatibility
Dante and AES67	Dante and AES67	No. Must use Dante.
Dante and AES67	AES67 without Dante. Any other audio networking protocol is acceptable.	Yes

Separate Dante and AES67 flows can operate simultaneously. The total number of flows is determined by the maximum flow limit of the device.

Sending Audio from a Shure Device

All AES67 configuration is managed in Dante Controller software. For more information, refer to the Dante Controller user guide.

1. Open the Shure transmitting device in Dante Controller.
2. Enable AES67.
3. Reboot the Shure device.
4. Create AES67 flows according to the instructions in the [Dante Controller user guide](#).

Receiving Audio from a Device Using a Different Audio Network Protocol

Third-party devices: When the hardware supports SAP, flows are identified in the routing software that the device uses. Otherwise, to receive an AES67 flow, the AES67 session ID and IP address are required.

Shure devices: The transmitting device must support SAP. In Dante Controller, a transmit device (appears as an IP address) can be routed like any other Dante device.

System Maintenance and Troubleshooting

Troubleshooting

Basic System Check

Check your system for the following basic hardware and connections:

- Devices are receiving power and are turned on
- Cables are connected
- Devices are on the same network

Wireless Interference

Select more wireless channels	If any wireless channels are deselected, add them back to the wireless scan in the web application: <code>Wireless > Select wireless channels</code> .
Adjust RF power	<ul style="list-style-type: none"> • Lower the RF power in the web application: <code>Wireless > RF power</code>. • This improves signal-to-noise ratio but does not eliminate the interference. Go to the web application: <code>Wireless > RF power</code>.
Relocate the MXCW access point	Move the access point to another point in the room. See Installation for more details.

Resetting Devices



Shure devices are designed to work together right out of the box. Prior to a new installation, or during troubleshooting, it may be useful to reset devices to ensure system compatibility.

The system provides 2 reset levels to choose from:





- **Network reset:** Clears only network settings and provides a fresh network connection.
- **System reset:** Clears all device and system settings to reset the device to default factory settings.

From the Hardware

Access Point	<p>Press and hold the recessed reset button.</p> <ul style="list-style-type: none"> • Network reset: Press and hold for 5 seconds to reset any network settings and refresh network connection. • System reset: Press and hold for 10 seconds to reset the device to default factory settings. <p>See Access Point Transceiver (MXCWAPT) for more details on LED behaviors during a reset.</p>
---------------------	---

Conference Units	<ol style="list-style-type: none"> 1. Access the technician menu by tapping the  gear icon. While at the top of the settings page, hold down the volume control knobs and tap the right side of the screen. 2. Go to the  information screen and tap Factory reset.
Networked Charging Station	<p>Press and hold the recessed reset button.</p> <ul style="list-style-type: none"> • Network reset: Press and hold for 4 seconds to reset any network settings and refresh network connection. • System reset: Press and hold for 8 seconds to reset the device to default factory settings.

From the Software

Access Point	 <p>Go to  Settings > Device reset . Select Reboot device or Restore factory defaults.</p>
Conference Units	<p>Go to Devices and select a device. From the device properties panel, open</p>  <p>more options and select Factory reset.</p>
Networked Charging Station	 <p>Go to  Settings > Device reset . Select Reboot device or Restore factory defaults.</p>

Export Log Files

Log files provide important device and network activity information. Go to  Settings and click Download APT logs to send the log files to Shure Systems Support for troubleshooting.

Firmware

Firmware Updates

Firmware is embedded software in each component that controls functionality. Periodically, new versions of firmware are developed to incorporate additional features and enhancements. You can install firmware using Shure Update Utility.

Download Shure Update Utility at [shure.com](https://www.shure.com).

Update Firmware for Conference Units

1. Upload MXCWAPT and MXCW640 firmware updates to the MXCWAPT using the Shure Update Utility tool.
2. Go to the web application >  Settings > Firmware.
3. Select the desired conference units.

Note: A minimum of 20 minutes of battery charge is required for firmware updates.

4. Click Update.

Firmware Versioning

When updating firmware, update all hardware to the same firmware version to ensure consistent operation.

The firmware of all devices has the form of MAJOR.MINOR.PATCH (e.g., 1.2.14). At a minimum, all devices on the network, must have the same MAJOR and MINOR firmware version numbers (e.g., 1.2.x).

Using a Third-Party Control System

The access point and networked charging station connect to external control systems such as AMX or Crestron via the Ethernet. These devices receive logic commands over the network. Many parameters controlled through the web application can be controlled through a third party control system, using the appropriate command string. Use only one controller per system to avoid messaging conflicts. For a comprehensive list of command strings, visit pubs.shure.com.

- Connection: Ethernet (TCP/IP; select "Client" in the AMX/Crestron program)
- Port: 2202

Specifications

System

Latency

Microphone Input to Speaker/Headphone Output	16 ms
Microphone Input to Analog Output	9.2 ms
Analog Input to Speaker/Headphone Output	7.7 ms

Frequency Response

Headphone Output	100 Hz -20 kHz (+0.5 dB/-3 dB)
Speaker Output	220 Hz -15 kHz (±10 dB)

Total Harmonic Distortion

Headphone Output	0.06%, typical
Speaker Output	1%, typical

Dynamic Range

Headphone Output	100 dB (A-weighted), 97 dB (Unweighted), typical
Speaker Output (unweighted), typical	94 dB (A-weighted), 91 dB (Unweighted), typical

Digital Signal Processing

24-bit , 48 kHz

Audio Polarity

Positive pressure on MXCW640 microphone diaphragm produces positive voltage on pin 2 of MXCWAPT XLR output

Working Range

8 m (Low), 15 m (Medium), 30 m (High), 45 m (Maximum)

Security

AES Encryption (Dante and 802.11 a, g)

MXCWAPT

Analog Input

Maximum Input Level

Line	24.9 dBV
Aux	10.3 dBV

Frequency Response

Line	22 Hz - 20 kHz (+0.5 dB/-3 dB)
Aux	22 Hz - 20 kHz (+0.5 dB/-3 dB)

Total Harmonic Distortion

Line	0.03%, typical
Aux	0.02%, typical

Dynamic Range

Line	115 dB (A-weighted), 113 dB (Unweighted), typical
Aux	112 dB (A-weighted), 110 dB (Unweighted), typical

Preamplifier Equivalent Input Noise (EIN)

Line	-92 dBV (A-weighted), typical
Aux	-104 dBV (A-weighted), typical

Input Impedance

Line	10 k Ω
-------------	---------------

Aux	12 k Ω
------------	---------------

Configuration

Balanced

Type

3-pin femal XLR

Pin Assignments

Standard XLR Pinout

1=ground, 2=audio +, 3=audio -

GND Lift

Left	Pin 1=GND Connected
Right	Pin 1=GND Disconnected

Analog Output

Maximum Output Level

4.3 dBV

Frequency Response

1 Hz - 20 kHz (+0.5 dB/-3 dB)

Total Harmonic Distortion

0.01%, typical

Dynamic Range

100 dB (A-weighted), 97 dB (Unweighted), typical

Load Impedance

>600 Ω , typical

Type

3-pin male XLR

Pin Assignments

Standard XLR Pinout

1=ground, 2=audio +, 3=audio -

GND Lift

Left	Pin 1=GND Connected
Right	Pin 1=GND Disconnected

RF

WLAN Standard

IEEE 802.11 a, g

Frequency Bands

2.4 GHz ISM , 5 GHz UNII

Sensitivity

-80 dBm at 10% PER

Output Power

1 mW (Low), 5 mW (Medium), 13 mW (High), 25 mW (Maximum)

Antenna Type

Proprietary Internal Bi-level Dual-band (PIFA), patent pending

Power

Supply Type

Power over Ethernet (PoE) 802.2 af, Class 0 PD

Supply Voltage

37-57 V

Power Consumption

12 .95 W maximum , 6.5 W typical

Network

Interface

Gigabit Ethernet , Dante digital audio

Link Speed

10/100/1000Mbps

Network Addressing Capability

DHCP or Manual IP address

Cable Length

100 m maximum

Cable Type

Cat 5e or higher

Connector Type

RJ45

Display

Type

Monochrome FFSTN LCD

Display Size

1.84 x .074 in. (46.7 x 18.8 mm)

Display Resolution

152 x 78 (78 ppi)

Mechanical

Dimensions

47.8 x 242.5 x 241.8 mm (1.88 x 9.55 x 9.52 in.)

Weight

1.15 kg

Housing

Molded Plastic , Die-casted Aluminum

Mounting Type

Ceiling bracket or wall

Environmental

Operating Temperature Range

-7°C (19.4°F) to 49°C (120.2°F)

Storage Temperature

-29°C (-20.2°F) to 60°C (140°F)

Relative Humidity

<95%

MXCW640

Microphone Input

Nominal Input Level

-60 dBV

Maximum Input Level

-1.5 dBV

Frequency Response

20 Hz - 20 kHz (+0.5 dB/-3 dB)

Total Harmonic Distortion

0.04% , typical

Dynamic Range

112 dB A-weighted, 110 dB Unweighted, typical

Preamplifier Equivalent Input Noise (EIN)

-117 dBV A-weighted, typical

Input Impedance

26 k Ω

Configuration

Unbalanced

Type

Multipin Female Gooseneck Socket

Pin Assignments

Proprietary Shure Pinout

Remote Caller Input

Maximum Input Level

1.6 dBV

Frequency Response

30 Hz - 20 kHz (+0.5 dB/-3 dB)

Total Harmonic Distortion

0.07%, typical

Dynamic Range

95 dB A-weighted , 93 dB Unweighted, typical

Preamplifier Equivalent Input Noise (EIN)

-106 dBV A-weighted, typical

Input Impedance

3.5 Ω

Configuration

Unbalanced

Type

TRRS 3.5 mm female socket

Pin Assignments

CTIA/AHJ Standard Pinout

Tip= Left side earpiece, Ring 1= Right side earpiece, Ring2= Ground, Sleeve= Microphone

Headset Microphone Input

Maximum Input Level

-5.5 dBV

Frequency Response

20 Hz - 20 kHz (+0.5 dB/-3 dB)

Total Harmonic Distortion

0.07%, typical

Dynamic Range

94 dB A-weighted, 92 dB Unweighted, typical

Input Impedance

2.2 k Ω

Configuration

Unbalanced

Type

TRRS 3.5 mm female socket

Pin Assignments

CTIA/AHJ Standard Pinout

Tip= Left side earpiece, Ring 1= Right side earpiece, Ring2= Ground, Sleeve= Microphone

Speaker Output

Nominal Output Level

72 dB SPL at 0.5 m

Maximum Output Level

89 dB SPL at 0.5 m

Frequency Response

220 Hz - 15 kHz (± 10 dB)

Total Harmonic Distortion

1%, typical

Dynamic Range

94 dB A-weighted, 91 dB Unweighted, typical

Headphone Output

Maximum Output Level

2.1 dBV

Frequency Response

100 Hz - 20 kHz (+0.5 dB/-3 dB)

Total Harmonic Distortion

0.04%, typical

Dynamic Range

101 dB A-weighted, 99 dB Unweighted, typical

Load Impedance

>8 Ω , typical

Configuration

Dual mono

Type

TRRS 3.5 mm female socket

Pin Assignments

CTIA/AHJ Standard Pinout

Tip= Left side earpiece, Ring 1= Right side earpiece, Ring2= Ground, Sleeve= Microphone

Remote Caller Output

Maximum Output Level

-29.1 dBV

Frequency Response

4 Hz - 20 kHz (+0.5 dB/-3 dB)

Total Harmonic Distortion

0.07%, typical

Dynamic Range

87 dB A-weighted, 77 dB Unweighted, typical

Output Impedance

2 k Ω

Type

TRRS 3.5 mm female socket

Pin Assignments

CTIA/AHJ Standard Pinout

Tip= Left side earpiece, Ring 1= Right side earpiece, Ring2= Ground, Sleeve= Microphone

RF

WLAN Standard

IEEE 802.11 a, g

Frequency Bands

2.4 GHz ISM, 5 GHz UNII

Sensitivity

-75 dBm at 10% PER

Output Power

1 mW (Low), 3 mW (Medium), 6 mW (High), 10 mW (Maximum)

Antenna Type

Proprietary Internal Bi-level Dual-band (PIFA), patent pending

NFC

Carrier Frequency Range

13.56 MHz

Transmission Protocols

ISO/IEC 14443

Antenna Type

Internal NFC Loop Antenna

Power

Battery Type

Shure SB930 , Lithium-Ion

Battery Connector

Proprietary blade

Battery Voltage

3 - 4.2 V

Nominal Capacity

35 Wh

Power Consumption

3 W, typical

Operating Time

> 11 hours, typical

Charge Time

6 hours : 30 minutes	typical when powered off
8 hours	typical when powered on

USB

Input Voltage Range

4.5 - 5.25 V

Power Consumption

10 W maximum

Recommended Cable

28 AWG/1 P + 22 AWG/2 C, <1.5 m

Display

Type

Color TFT LCD with Capacitive Touchscreen

Display Size

4.3 in. (109.2 mm)

Display Resolution

480 x 272 (128 ppi)

Mechanical

Dimensions

70.2 x 148 x 257.5 mm (2.8 x 5.8 x 10.1 in.)

Weight

1.21 kg with battery , 1.025 kg without battery

Housing

Molded Plastic , Die-casted Aluminum

Mounting Type

M4 hexagon bolt

Temperature Range

Operating Temperature Range

0 °C (-32 °F) to 35 °C (95 °F)

Charging Temperature Range

0 °C (32 °F) to 33 °C (91.4 °F)

Storage Temperature Range

-20 °C (4 °F) to 50 °C (122 °F)

Relative Humidity

>95%

MXCWNC5

Battery Type

Shure SB930 Rechargeable Li-Ion

Battery Connector

Proprietary blade

Charge Time

50% = 1.5 hours ; 100% = 4 hours

Charge Current

3.6 A

Power Requirements

Input	100 to 240 V AC , 50/60 Hz , 2 A maximum
Output	4.2 V DC maximum , 160W maximum

Network Connections

RJ45 (Ethernet)

Other Connections

IEC (power)

Network Addressing Capability

DHCP or Manual IP address

Network Interface

10/100 Mbps Ethernet

Cable Length

100 m maximum

Cable Requirements

Cat 5e or higher

Housing

Molded Plastic , steel

Mounting Type

Tabletop , rack , or wall

Dimensions

72.4 mm x 438.9 mm x 193.5 mm (2.9 in. x 17.3 in. x 7.6 in.)

Weight

2825 g

Operating Temperature Range

-20 °C (-4 °F) to 35 °C (95 °F)

Discharging Temperature Range

-20 °C (-4 °F) to 35 °C (95 °F)

Charging Temperature Range

0 °C (32 °F) to 35 °C (95 °F)

Storage Temperature Range

-29 °C (20.2 °F) to 60 °C (140 °F)

Relative Humidity

<95%

SB930

SB930

Battery Type

Rechargeable Li-Ion

Nominal Voltage

3.6 V

Output Voltage

3.0 V to 4.2 V

Nominal Capacity

35 Wh

Charge Voltage

4.2 V

Charge Current

3.6 A

Dimensions

31 mm x 65 mm x 101.5 mm (1.2 in. x 2.56 in. x 4 in.), H x W x D

Weight

184 g

Housing

Molded Plastic

Discharging Temperature Range

-20 °C (- 4 °F) to 60 °C (140 °F)

Charging Temperature Range

0 °C (32 °F) to 45 °C (113 °F)

Storage Temperature Range

-20 °C (- 4 °F) to 50 °C (122 °F)

Relative Humidity

<95%

Accessories

Mini-shotgun gooseneck microphone for MXC and MXCW	MXC406/MS
Cardioid gooseneck microphone for MXC and MXCW	MXC416/C
Dualflex, cardioid gooseneck microphone for MXC and MXCW	MXC416DF/C
Cardioid gooseneck microphone for MXC and MXCW	MXC420/C
Dualflex, cardioid gooseneck microphone for MXC and MXCW	MXC420DF/C
Cardioid gooseneck microphone for MXC and MXCW	MXC425/C
Dualflex, cardioid gooseneck microphone for MXC and MXCW	MXC425DF/C

Optional Accessories

Dual-Card for MXC, MXCW, and DCS; Quantity 10	MXCDUALCARD-10PK
Chairman button set for MXCW640; Includes 1 of each: All Delegates Off, Mute All, Next On	MXCW-ACC-CM
A and B buttons for MXCW640; Quantity 10 each	MXCW-ACC-A/B
Mute button for MXCW640; Quantity 10	MXCW-ACC-M
Reply button for MXCW640; Quantity 10	MXCW-ACC-RPY

Access Point Model Variations

Region	Model
United States	MXCWAPT-A
North America	MXCWAPT-B
Japan	MXCWAPT-JP
Israel	MXCWAPT-IL
World-wide	MXCWAPT-W

Networked Charging Station Model Variations

All include power cable unless otherwise noted.

Region	Model
United States	MXCWNCS-US
Argentina	MXCWNCS-AR
Brazil	MXCWNCS-BR
Europe	MXCWNCS-E
United Kingdom	MXCWNCS-UK
Japan	MXCWNCS-J
China	MXCWNCS-CHN
Korea	MXCWNCS-K
Taiwan	MXCWNCS-TW
Australia	MXCWNCS-AZ
India	MXCWNCS-IN

Important Product Information

Safety Information

IMPORTANT SAFETY INSTRUCTIONS

1. READ these instructions.
2. KEEP these instructions.
3. HEED all warnings.
4. FOLLOW all instructions.
5. DO NOT use this apparatus near water.

6. CLEAN ONLY with dry cloth.
7. DO NOT block any ventilation openings. Allow sufficient distances for adequate ventilation and install in accordance with the manufacturer’s instructions.
8. DO NOT install near any heat sources such as open flames, radiators, heat registers, stoves, or other apparatus (including amplifiers) that produce heat. Do not place any open flame sources on the product.
9. DO NOT defeat the safety purpose of the polarized or grounding type plug. A polarized plug has two blades with one wider than the other. A grounding type plug has two blades and a third grounding prong. The wider blade or the third prong are provided for your safety. If the provided plug does not fit into your outlet, consult an electrician for replacement of the obsolete outlet.
10. PROTECT the power cord from being walked on or pinched, particularly at plugs, convenience receptacles, and the point where they exit from the apparatus.
11. ONLY USE attachments/accessories specified by the manufacturer.
12. USE only with a cart, stand, tripod, bracket, or table specified by the manufacturer, or sold with the apparatus. When a cart is used, use caution when moving the cart/apparatus combination to avoid injury from tip-over.



13. UNPLUG this apparatus during lightning storms or when unused for long periods of time.
14. REFER all servicing to qualified service personnel. Servicing is required when the apparatus has been damaged in any way, such as power supply cord or plug is damaged, liquid has been spilled or objects have fallen into the apparatus, the apparatus has been exposed to rain or moisture, does not operate normally, or has been dropped.
15. DO NOT expose the apparatus to dripping and splashing. DO NOT put objects filled with liquids, such as vases, on the apparatus.
16. The MAINS plug or an appliance coupler shall remain readily operable.
17. The airborne noise of the Apparatus does not exceed 70dB (A).
18. Apparatus with CLASS I construction shall be connected to a MAINS socket outlet with a protective earthing connection.
19. To reduce the risk of fire or electric shock, do not expose this apparatus to rain or moisture.
20. Do not attempt to modify this product. Doing so could result in personal injury and/or product failure.
21. Operate this product within its specified operating temperature range.

	This symbol indicates that dangerous voltage constituting a risk of electric shock is present within this unit.
	This symbol indicates that there are important operating and maintenance instructions in the literature accompanying this unit.

WARNING: Voltages in this equipment are hazardous to life. No user-serviceable parts inside. Refer all servicing to qualified service personnel. The safety certifications do not apply when the operating voltage is changed from the factory setting.

SAFETY PRECAUTIONS

The possible results of incorrect use are marked by one of the two symbols—"WARNING" and "CAUTION"—depending on the imminence of the danger and the severity of the damage.

	WARNING: Ignoring these warnings may cause severe injury or death as a result of incorrect operation.
--	--



CAUTION: Ignoring these cautions may cause moderate injury or property damage as a result of incorrect operation.

WARNING

LISTENING TO AUDIO AT EXCESSIVE VOLUMES CAN CAUSE PERMANENT HEARING DAMAGE. USE AS LOW A VOLUME AS POSSIBLE. Over exposure to excessive sound levels can damage your ears resulting in permanent noise-induced hearing loss (NIHL). Please use the following guidelines established by the Occupational Safety Health Administration (OSHA) on maximum time exposure to sound pressure levels before hearing damage occurs.

90 dB SPL at 8 hours	95 dB SPL at 4 hours	100 dB SPL at 2 hours	105 dB SPL at 1 hour
110 dB SPL at ½ hour	115 dB SPL at 15 minutes	120 dB SPL Avoid or damage may occur	

Note: Use this product only with an agency approved power supply which meets local regulatory requirements (e.g., UL, CSA, VDE, CCC, INMETRO).

WARNING

- Battery packs may explode or release toxic materials. Risk of fire or burns. Do not open, crush, modify, disassemble, heat above 140°F (60°C), or incinerate.
- Follow instructions from manufacturer
- Only use Shure charger to recharge Shure rechargeable batteries
- **WARNING:** Danger of explosion if battery incorrectly replaced. Replace only with same or equivalent type.
- Never put batteries in mouth. If swallowed, contact your physician or local poison control center
- Do not short circuit; may cause burns or catch fire
- Do not charge or use battery packs other than Shure rechargeable batteries
- Dispose of battery packs properly. Check with local vendor for proper disposal of used battery packs.
- Batteries (battery pack or batteries installed) shall not be exposed to excessive heat such as sunshine, fire or the like
- Do not immerse the battery in liquid such as water, beverages, or other fluids.
- Do not attach or insert battery with polarity reversed.
- Keep away from small children.
- Do not use abnormal batteries.
- Pack the battery securely for transport.

Warning: Before charging, make sure the product is at room temperature, between 0 to 45°C (32 to 113°F).

1. 經審驗合格之射頻電信終端設備，非經許可，公司、商號或使用者均不得擅自變更頻率、加大功率或變更原設計之特性及功能。
2. 射頻電信終端設備之使用不得影響飛航安全及干擾合法通信；經發現有干擾現象時，應立即停用，並改善至無干擾時方得繼續使用。所謂合法通信，係指依電信法規定作業之無線電信。
3. 輸入、製造射頻電信終端設備之公司、商號或其使用者違反本辦法規定，擅自使用或變更無線電頻率、電功率者，除依電信法規定處罰外，國家通訊傳播委員會並得撤銷其審驗合格證明。
4. 減少電磁波影響，請妥適使用

Information to the user

This device complies with part 15 of the FCC Rules. Operation is subject to the following two conditions:

1. This device may not cause harmful interference.
2. This device must accept any interference received, including interference that may cause undesired operation.

Note: This equipment has been tested and found to comply with the limits for a Class B digital device, pursuant to part 15 of the FCC Rules. These limits are designed to provide reasonable protection against harmful interference in a residential installation. This equipment generates uses and can radiate radio frequency energy and, if not installed and used in accordance with the instructions, may cause harmful interference to radio communications. However, there is no guarantee that interference will not occur in a particular installation. If this equipment does cause harmful interference to radio or television reception, which can be determined by turning the equipment off and on, the user is encouraged to try to correct the interference by one or more of the following measures:

- Reorient or relocate the receiving antenna.
- Increase the separation between the equipment and the receiver.
- Connect the equipment to an outlet on a circuit different from that to which the receiver is connected.
- Consult the dealer or an experienced radio/TV technician for help.

The equipment is intended to be used in professional audio applications.

Changes or modifications not expressly approved by Shure Incorporated could void your authority to operate this equipment.

Note: This device is not intended to be connected directly to a public internet network.

This equipment is for indoor use only.

Installation personnel: This product is designed for specific application and needs to be installed by qualified personnel with RF and related rule knowledge. The general user shall not attempt to install, or to change the settings.

Certifications

EMC conformance to Environment E2: Commercial and Light Industrial. Testing is based on the use of supplied and recommended cable types. The use of other than shielded (screened) cable types may degrade EMC performance.

This device complies with part 15 of the FCC Rules. Operation is subject to the following two conditions: (1) This device may not cause harmful interference, and (2) this device must accept any interference received, including interference that may cause undesired operation.

This equipment complies with FCC radiation exposure limits set forth for an uncontrolled environment. This equipment should be installed and operated with minimum distance 20 cm between the radiator & your body.

This Class B digital apparatus complies with Canadian ICES-003. Cet appareil numérique de la classe B est conforme à la norme NMB-003 du Canada.

This device contains licence-exempt transmitter(s)/receiver(s) that comply with Innovation, Science and Economic Development Canada's licence-exempt RSS(s). Operation is subject to the following two conditions:

1. This device may not cause interference.
2. This device must accept any interference, including interference that may cause undesired operation of the device.

L'émetteur/récepteur exempt de licence contenu dans le présent appareil est conforme aux CNR d'Innovation, Sciences et Développement économique Canada applicables aux appareils radio exempts de licence. L'exploitation est autorisée aux deux conditions suivantes :

1. L'appareil ne doit pas produire de brouillage;

2. L'appareil doit accepter tout brouillage radioélectrique subi, même si le brouillage est susceptible d'en compromettre le fonctionnement.

La operación de este equipo está sujeta a las siguientes dos condiciones: (1) es posible que este equipo o dispositivo no cause interferencia perjudicial y (2) este equipo o dispositivo debe aceptar cualquier interferencia, incluyendo la que pueda causar su operación no deseada.

日本の電波法および電気通信事業法準拠。本デバイスは日本の電波法および電気通信事業法に基づく認証を受けています。本デバイスを改造しないでください（改造すると認証番号は無効になります）。

本製品が 5GHz 帯で使用するチャンネルは、下記の W52、W53、W56 の 3 タイプです。

タイプ	チャンネル番号	周波数
W52	36	5,180 MHz
	40	5,200 MHz
	44	5,220 MHz
	48	5,240 MHz
W53	52	5,260 MHz
	56	5,280 MHz
	60	5,300 MHz
	64	5,320 MHz
W56	100	5,500 MHz
	104	5,520 MHz
	108	5,540 MHz
	112	5,560 MHz
	116	5,580 MHz
	120	5,600 MHz
	124	5,620 MHz
	128	5,640 MHz
	132	5,660 MHz
	136	5,680 MHz
	140	5,700 MHz

W52 と W53 の帯域の電波は屋内でのみ使用可能です。

運用に際しての注意

この機器の使用周波数帯では、電子レンジ等の産業・科学・医療用機器のほか工場の製造ライン等で使用されている移動体識別用の構内無線局（免許を要する無線局）及び特定小電力無線局（免許を要しない無線局）並びにアマチュア無線局（免許を要する無線局）が運用されています。

- この機器を使用する前に、近くで移動体識別用の構内無線局及び特定小電力無線局並びにアマチュア無線局が運用されていないことを確認して下さい。

2. 万一、この機器から移動体識別用の構内無線局に対して有害な電波干渉の事例が発生した場合には、速やかに使用周波数を変更するか又は電波の発射を停止した上、下記連絡先にご連絡頂き、混信回避のための処置等（例えば、パーティションの設置など）についてご相談して下さい。
3. その他、この機器から移動体識別用の特定小電力無線局あるいはアマチュア無線局に対して有害な電波干渉の事例が発生した場合など何かお困りのことが起きたときは、保証書に記載の販売代理店または購入店へお問い合わせください。代理店および販売店情報は Shure 日本語ウェブサイト <http://www.shure.co.jp> でもご覧いただけます。

現品表示記号について

2.4 OF 40

現品表示記号は、以下のことを表しています。この無線機器は 2.4GHz 帯の電波を使用し、変調方式は「DS-SS」方式および「FH-SS」方式、想定干渉距離は 40m です。2,400MHz ~ 2,483.5MHz の全帯域を使用し、移動体識別装置の帯域を回避することはできません。

EAC Clarification: This product meets Russian compliance regulations as well as EAC marking requirements.



Este equipamento não tem direito à proteção contra interferência prejudicial e não pode causar interferência em sistemas devidamente autorizados.

 R-C-SHU-MXCWAPT-W
 商号名: Shure Incorporated
 機器種の略称: Access Point Transceiver
 型番名: MXCWAPT-W
 제조업체명/제조국명: Shure Incorporated / China
 제조년월: 별도표기
 정격: 37 - 57Vdc, 350mA
 서비스센터: 삼성전자 유영회사 02-734-0653
 * 해당 무선기기는 전파혼신 가능성이 있으므로, 인명 안전과 관련된 서비스는 할 수 없습니다.*

 R-C-SHU-MXCW640
 商号名: Shure Incorporated
 機器種の略称: Conference Unit
 型番명: MXCW640
 제조업체명/제조국명: Shure Incorporated / China
 제조년월: 별도표기
 정격 Input Battery: 3.6Vdc, 1A; Input USB: 5Vdc, 1A
 서비스센터: 삼성전자 유영회사 02-734-0653
 * 해당 무선기기는 전파혼신 가능성이 있으므로, 인명 안전과 관련된 서비스는 할 수 없습니다.*
 안전확인신고번호: XV100012-18005A
 모델명: SP930
 제품명: Rechargeable Li-ion Battery
 정격: 3.6Vdc, 9500mAh
 제조업체명/제조국명: National Power Corporation / US
 A/S 연락처: 삼성전자 유영회사 02-734-0653

 R-R-SHU-MXCWNCS
 HU10XXXXXXX
 商号名: Shure Incorporated
 機器種の略称: Networked Charging Station
 型番명: MXCWNCS
 제조업체명/제조국명: Shure Incorporated / China
 제조년월: 별도표기
 정격: Input: 100-240V~, 50/60Hz, 2.0A MAX; Output: 4.2Vdc; MAX: 160W MAX
 서비스센터: 삼성전자 유영회사 02-734-0653
 * 해당 무선기기는 전파혼신 가능성이 있으므로, 인명 안전과 관련된 서비스는 할 수 없습니다.*

Environmentally friendly disposal



Old electrical appliances must not be disposed of together with the residual waste, but have to be disposed of separately. The disposal at the communal collecting point via private persons is for free. The owner of old appliances is responsible to bring the appliances to these collecting points or to similar collection points. With this little personal effort, you contribute to recycle valuable raw materials and the treatment of toxic substances.

Hereby, Shure Incorporated declares that the radio equipment is in compliance with Directive 2014/53/EU. The full text of the EU declaration of conformity is available at the following internet address: <http://www.shure.com/europe/compliance>

Authorized European representative:

Shure Europe GmbH

Headquarters Europe, Middle East & Africa

Department: EMEA Approval

Jakob-Dieffenbacher-Str. 12

75031 Eppingen, Germany

Phone: +49-7262-92 49 0

Fax: +49-7262-92 49 11 4

Email: EMEAsupport@shure.de

Note: See the label located on the bottom side of the charger enclosure for the FCC marking, the CE marking, the RCM marking, and the electrical ratings.

Trademarks

Audinate®, the Audinate logo and Dante are trademarks of Audinate Pty Ltd.

Contact Customer Support

Didn't find what you need? [Contact our customer support](#) to get help.