



UniFi[®] LED

Network-Managed
LED Panel Powered by AC

Model: ULED-AC

QUICK START GUIDE

Introduction

Thank you for purchasing the Ubiquiti Networks® UniFi® LED Panel. This Quick Start Guide is designed to guide you through installation and includes warranty terms.

Package Contents

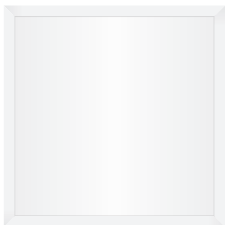

UniFi LED Panel



Quick Start Guide

System Requirements

- Network switch (for wired configuration), or access point (for wireless configuration)
- UniFi LED mobile app software
 - Mobile device: iOS 10 or Android 5.0
- UniFi LED Controller software
 - Computer: UniFi Application Server 0.5.0, Ubuntu 16.04 LTS (Xenial Xerus) 64-bit or Debian 9 64-bit
 - Web browser: Google Chrome (Other browsers may have limited functionality.)
- UniFi Dimmer Switch, model UDIM-AC or UDIM-AT

Installation Requirements

- Phillips screwdriver
- Wire stripper/cutter
- Needle-nose pliers (Optional)



IMPORTANT: The ULED-AC is to be installed by a qualified electrician in accordance with local electrical codes and regulations.



IMPORTANT : Le ULED-AC doit être installé par un électricien qualifié conformément aux codes électriques locaux et des règlements.



WARNING: TO AVOID FIRE, SHOCK OR DEATH, turn off power at the circuit breaker or fuse before installing.



AVERTISSEMENT : POUR ÉVITER TOUT RISQUE D'INCENDIE, D'ÉLECTROCUTION OU DE DÉCÈS; coupez le courant au niveau du disjoncteur ou du coupe-circuit ou fusible avant l'installation.

Network Topology Requirements

Network topology requirements are as follows:

- DHCP-enabled network (for the UniFi LED Panel to obtain an IP address)
- Network switch (for wired configuration), or access point (for wireless configuration)
- For UniFi Dimmer Switch only:
A UniFi Dimmer Switch connected to the same Layer 2 network as the UniFi LED Panel
- For LED Controller software:
A UniFi Application Server running the UniFi LED Controller software and connected to the same Layer 2 network as the UniFi LED Panel
- For UniFi LED app only:
A UniFi AP connected to the same Layer 2 network as the UniFi LED Panel

Connection Options

A UniFi LED Panel can use either a wired connection or a wireless connection. A wired connection to a switch allows immediate detection and control by the LED Controller, but if a panel is in a location where Ethernet cabling is not a reasonable option, then the panel can connect via Wi-Fi to a UniFi AP.

Control Options

You can control the UniFi LED Panel's state (on/off) and brightness. There are three ways to control the Panel:

UniFi Dimmer Switch A user in the immediate vicinity controls the UniFi LED Panel using the UniFi Dimmer Switch.

UniFi LED App over Layer 2 Network A local user runs the app to connect to a UniFi AP on the same Layer 2 network as the UniFi LED Panel.

UniFi LED Controller over Layer 2 Network A local user runs the LED Controller software on the same Layer 2 network as the UniFi LED Panel.

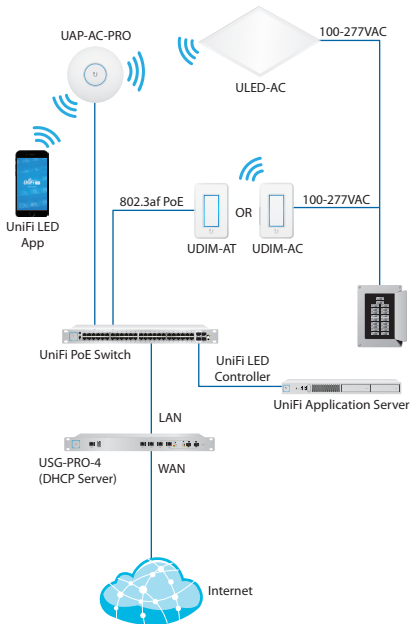

Sample Network Diagram - Wireless Topology

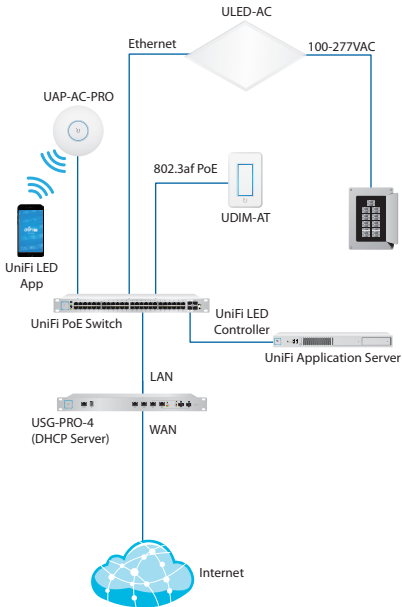

Sample Network Diagram - Wired Topology

Daisy-Chain Configuration

For installations using multiple UniFi LED Panels in a wired configuration, we recommend using a daisy chain topology, as illustrated in the following diagram.

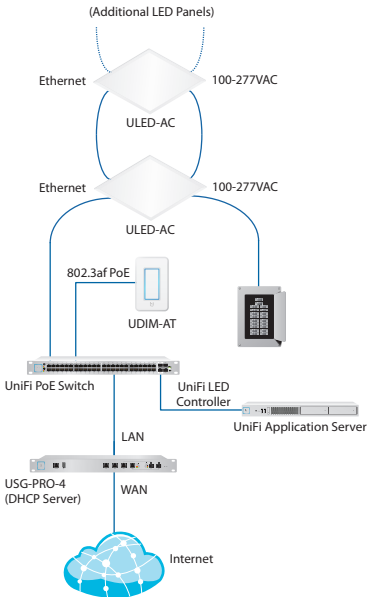

Daisy Chain Topology - Sample Network Diagram

Hardware Overview

LED



State	Status
Flashing White	Initializing.
Steady White	System ready.
Steady Blue	Adopted by LED Controller.
Alternating White/Blue	Firmware upgrade is taking place.

Ports

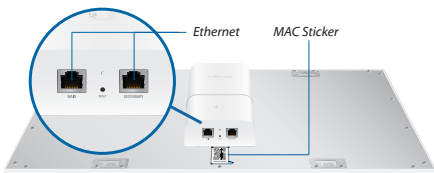

Ethernet Use these 10/100 Ethernet ports to connect to the LAN or to daisy-chain with other UniFi LED Panels.

MAC Sticker Used to scan the MAC address. For details, refer to **“Quick Setup”**.

Button

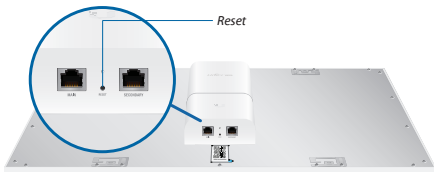

Reset The *Reset* button serves two functions:

- **Restart** Press and release the *Reset* button quickly.
- **Restore to Factory Default Settings** Press and hold the *Reset* button for more than five seconds.

Terminal Block

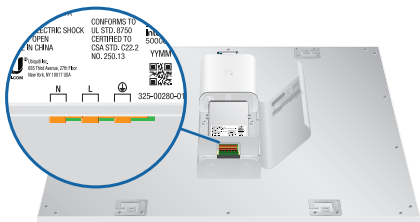

N L ⊕ Connections for AC power: *N* (Neutral), *L* (Live), and ⊕ (Earth ground). Each has two connectors, used to connect to the power source, and optionally to connect to another UniFi LED Panel (daisy-chain configuration).

Installation

To install and configure the UniFi LED Panel:

1. Lift the panel and seat it in an opening in the ceiling grid.

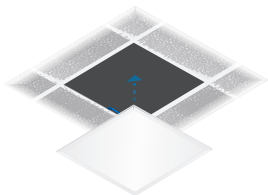

2. If the panel will use Wi-Fi to connect to the network, go to step 3. If the panel will use a wired connection to the network, connect an Ethernet cable to the *Main* port.

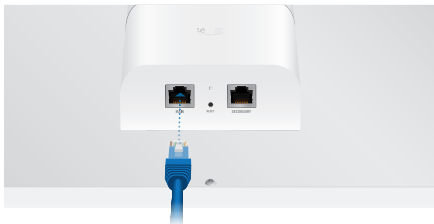

3. Remove the screw from the cover of the *Junction Box* and open the cover.

4. Remove a knockout from the *Junction Box* and feed the power cable through the knockout into the *Junction Box*.

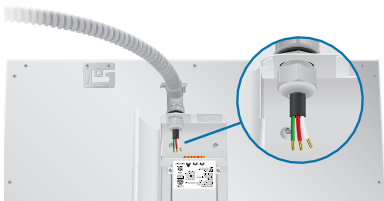

5. Connect each of the cable's wires to the appropriate *Terminal Block* connector as follows:

- Connect the Neutral (white) wire to **N**.
- Connect the Live (red) wire to **L**.
- Connect the Earth ground (green) wire to \oplus .



Note: To connect a wire, push it into the *Terminal Block* connector until it is securely held. To release a wire, push the button next to it.



Note: We recommend using UL-certified 14 AWG single-core copper wire.

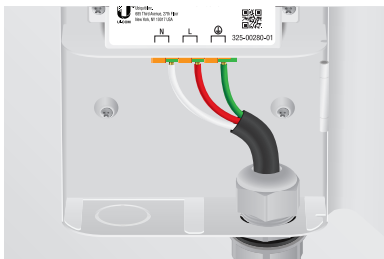

Daisy Chain Configuration (Optional)

For each additional panel in the chain:

1. Make the following changes to the UniFi LED Panel which is currently the **last panel** in the chain:
 - a. If the new panel will use a wired connection to the network, connect an Ethernet cable to the *Secondary* port of the current last UniFi LED Panel.

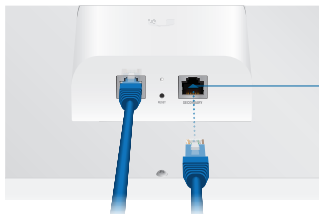

*Secondary
Port of
current last
ULED-AC in
the chain*

- b. Connect a stripped power cable to the *Terminal Block* on the UniFi LED Panel: Neutral (white) to **N**, Live (red) to **L**, and Earth ground (green) to \oplus .

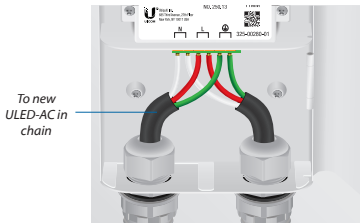

*To new
ULED-AC in
chain*

2. Connect the new panel as described in steps 2-5 of **"Installation"**.

Configuring the UniFi LED Panel

Follow the instructions for the software you wish to use:

UniFi LED App

1. Install the UniFi LED app on your smartphone or mobile device. The app is available from the App Store® or Google Play™ Store.



2. Enable Bluetooth on your mobile device.
3. Launch the app.



4. If the UniFi LED Panel has a wired connection, it will be automatically detected and shown on the UniFi LED app. If the UniFi LED Panel will be connected wirelessly, follow the on-screen instructions to locate and connect it to your wireless network.

UniFi LED Controller Software

1. Install the latest version of the UniFi LED Controller software on a computer on the same Layer 2 network as the UniFi LED Panel:
 - **Ubuntu users** Download the software from: www.ubnt.com/download/unifi-led
 - **UAS users** Install the software using the UniFi Application Server (UAS) management console.
2. Launch a web browser and go to: <https://localhost:20443>

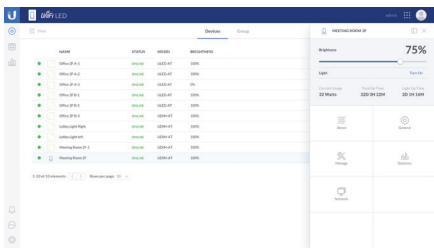

3. The UniFi LED Controller will appear, allowing you to configure the UniFi LED Panel and customize other settings.

For additional details on the UniFi LED Controller, refer to the documentation available at:

www.ubnt.com/download/unifi-led



640-00340-09

Quick Setup

This section describes the Quick Setup procedure for installations with large numbers of UniFi LED Panels and Dimmer Switches. The Quick Setup requires using the UniFi LED app along with a *QR Code Log* that you create. Each UniFi LED Panel or Dimmer Switch has a removable *MAC Sticker* on its reverse side; this has a QR code used to scan the device's MAC address. The Quick Setup consists of these steps:

- Create the *QR Code Log*
- Install the LED Panels and Dimmer Switches
- Scan the QR codes

Create the QR Code Log

1. Download the *QR Code Log* template at:
ubnt.link/QR-Code-Log
2. Print out as many copies as needed (each sheet can log up to 16 LED Panels and 3 Dimmer Switches).

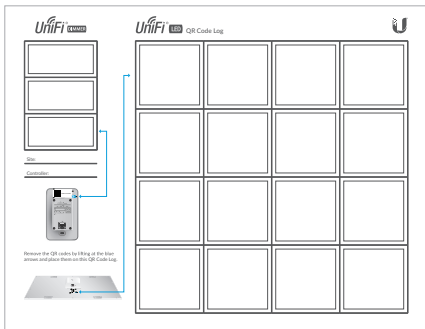

3. Fill in the *Site* (such as "1st Floor Meeting Room") and *Controller* (such as "UniFi LED Controller") on each sheet.

Install the LED Panels and Dimmer Switches

For each UniFi LED Panel or Dimmer Switch:

1. Remove the *MAC Sticker* from the back of the device by carefully peeling back and pulling the blue tab.



OR



2. Place the sticker on the *QR Code Log* sheet that matches the device's location.

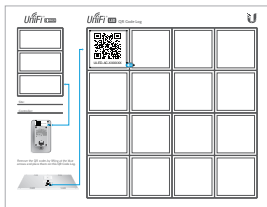

OR

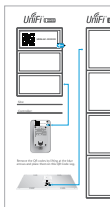

3. Install the device as described in the *Installation* section of the device's Quick Start Guide.

Scan the QR Codes

1. On your mobile device, open the UniFi LED app.
2. Go to the *More* screen. Tap **Quick Setup**.

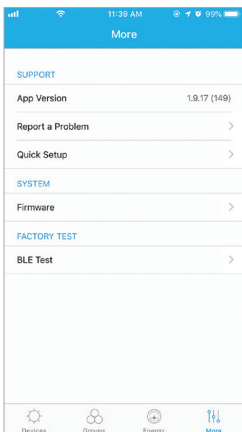

3. Follow the instructions as the UniFi LED app guides you through the process of adding devices by scanning the QR codes on the *QR Code Log* sheet(s).



Note: Instead of scanning the QR codes, you can also use the UniFi LED app's *Locate* function to identify and assign individual LED Panels to their groups; however, this is best suited for smaller installations.

Specifications

ULED-AC	
Dimensions	602 x 602 x 56.7 mm (23.7 x 23.7 x 2.23")
Weight	5.3 kg (11.68 lb)
Networking Interface	802.11 b/g/n (2.4 GHz Only) 10/100 Ethernet Port
Wireless Security	WEP, WPA/WPA2 Personal
Connectivity	Wi-Fi 802.11 b/g/n, Bluetooth LE 4.1
Buttons	Reset
LEDs	Status
Power Method	AC Input
Supported Voltage Range	100-277VAC 50/60 Hz
Max. Power Consumption	34W
Mounting	Standard T-Grid
Operating Temperature	0 to 40° C (32 to 104° F)
Certifications	FCC, IC, DLC, MET
DLC Listed	Yes

Lighting	
Initial Delivered Luminance (Typical)	3400 lm
Efficacy	100 lm/W
CCT	4,000 K
L80	> 50,000 hrs
CRI	> 80
Beam Angle	114°
Brightness Control	10-100% Dimming
Environment	Indoor Dry Location

Safety Notices

1. Read, follow, and keep these instructions.
2. Heed all warnings.
3. Only use attachments/accessories specified by the manufacturer.



WARNING: Do not use this product in location that can be submerged by water.



WARNING: Avoid using this product during an electrical storm. There may be a remote risk of electric shock from lightning.



WARNING: The ULED-AC is to be installed by a qualified electrician in accordance with local electrical codes and regulations.



AVERTISSEMENT : Le ULED-AC doit être installé par un électricien qualifié conformément aux codes électriques locaux et des règlements.



WARNING: TO AVOID FIRE, SHOCK OR DEATH, turn off power at the circuit breaker or fuse before installing.



AVERTISSEMENT : POUR ÉVITER TOUT RISQUE D'INCENDIE, D'ÉLECTROCUTION OU DE DÉCÈS; coupez le courant au niveau du disjoncteur ou du coupe-circuit ou fusible avant l'installation.

Electrical Safety Information

1. Compliance is required with respect to voltage, frequency, and current requirements indicated on the manufacturer's label. Connection to a different power source than those specified may result in improper operation, damage to the equipment or pose a fire hazard if the limitations are not followed.
2. There are no operator serviceable parts inside this equipment. Service should be provided only by a qualified service technician.

UniFi LED Panel AC Limited Warranty

This limited warranty is provided by Ubiquiti Networks, Inc. ("UBIQUITI") for the UniFi LED Panel AC (the "LED Product") only. All other UBIQUITI products are covered under the limited warranty found at: ubnt.com/support/warranty. It is UBIQUITI'S policy to offer a limited product warranty to end users of the LED Product (the "customer" or "you") only on LED Products purchased from an authorized UBIQUITI distributor or reseller and only accompanied by a Return Materials Authorization ("RMA") as further described below. Unfortunately, there are some websites and dealers who claim to be authorized UBIQUITI resellers but are not. LED Products sold on these websites or from these dealers

do not carry a warranty from UBIQUITI. When you purchase products from an unauthorized website or dealer, you are taking a risk because these products may be counterfeit, used, defective, or may not be designed for use in your country. Please protect yourself and your LED Product by ensuring that you only purchase UBIQUITI products from an authorized reseller. If you have any questions about authorized distributors or resellers, please visit our website at:

<https://www.ubnt.com/distributors/>

THIS LIMITED WARRANTY CONTAINS A DISPUTE RESOLUTION AND ARBITRATION PROVISION, INCLUDING A CLASS ACTION WAIVER THAT AFFECTS YOUR RIGHTS UNDER THIS LIMITED WARRANTY AND WITH RESPECT TO DISPUTES YOU MAY HAVE WITH UBIQUITI. YOU MAY OPT OUT OF ARBITRATION AND THE CLASS ACTION WAIVER AS PROVIDED BELOW.

Limited Product Warranty

UBIQUITI warrants that the LED Product shall be free from defects in material and workmanship for a period of five (5) years from the date of shipment by UBIQUITI under normal use and operation. UBIQUITI'S sole and exclusive obligation and liability under the foregoing warranty shall be for UBIQUITI, at its discretion, to replace any LED Product with a new or refurbished version of the LED Product that fails to conform to the above warranty during the above warranty period. Such obligation shall be the sole remedy under this warranty and UBIQUITI'S exclusive obligation and the full extent of its liability. The expense of removal and reinstallation of any LED Product, including labor costs, is not included in this warranty. The warranty period of any replaced LED Product shall not extend beyond its original term. This warranty does not cover any software applications or programs, non-UBIQUITI products or non-UBIQUITI peripherals. All products and parts that are replaced become the property of UBIQUITI.

Warranty Conditions

The above warranty does not apply if the LED Product:

- (I) has been modified and/or altered, or an addition made thereto, except by UBIQUITI, or UBIQUITI'S authorized representatives, or as approved by UBIQUITI in writing;
- (II) has been painted, rebranded or physically modified in any way;
- (III) has been damaged due to errors or defects in cabling;
- (IV) has been damaged due to use with non-UBIQUITI products;
- (V) has been damaged due to power surges, improper power supply, electrical current fluctuations, corrosive environment installations, induced vibration, harmonic oscillations or resonance associated with movement of air currents around the LED Product;
- (VI) has been damaged due to natural disaster, including but not limited to lightning, flood, tornado, earthquake, heavy rain or hurricane;
- (VII) has been subjected to misuse, abuse, improper handling, alterations, modifications or repairs by reseller, customer or third parties, negligence, abnormal physical, electromagnetic or electrical stress, including lightning strikes, or accident;
- (VIII) has been damaged or impaired as a result of using third party hardware, software or firmware;

- (IX) has no original Ubiquiti MAC label, or is missing any other original Ubiquiti label(s), or is manufactured by and carries the brand of a third party that is not UBIQUITI;
- (X) has not been installed, operated or maintained in accordance with normal practice and in conformity with recommendations and published specifications of UBIQUITI;
- (XI) has not been properly installed and used at all times in accordance, and in all material respects, with the applicable Product Quick Start Guide and, if applicable, the applicable Product User Guide or Datasheet;
- (XII) is a UBIQUITI radio product and has not been professionally installed;
- (XIII) or the customer has not followed local country regulations, including operation within legal frequency channels, output power Dynamic Frequency Selection requirements; or
- (XIV) has not been received by UBIQUITI within 90 days of issuance of the RMA.

Returns and Product Replacement

No LED Products will be accepted for replacement without obtaining an RMA number from UBIQUITI during the warranty period. Any returned LED Products must be received at UBIQUITI'S facility freight prepaid in accordance with the RMA process of UBIQUITI prior to replacement of any returned LED Products. LED Products returned without an RMA number and without a valid proof of purchase will not be processed and will be subject to disposal.

Customers may obtain an RMA number at rma.ubnt.com by submitting the required information: name, contact information, shipping information, date and proof of purchase of the LED Product (we may request a copy of the actual invoice as proof of purchase), problem description, MAC address of LED Product, and troubleshooting actions taken so far. If UBIQUITI determines in its sole discretion that any of the aforementioned information is false or incorrect or does not correspond to the LED Products received, LED Products will not be replaced and will be subject to disposal or returned with a customer-provided shipping account number. By submitting an RMA Request, you confirm your acceptance of all terms in this product warranty.

A replacement LED Product may be returned to you as the LED Product was configured when originally purchased. You are responsible for all back-up, recovery and reinstallation of other software or data.

For customers outside of the United States, the following conditions must also be met or the RMA request will not be accepted or fulfilled:

- You must use your own shipping account when sending the LED Product;
- The commercial invoice must declare "return for repair" and "no commercial value"; and
- You must pay for all applicable duties and customs charges for shipment of a LED Product to and from UBIQUITI.

You are responsible for compliance with your country's customs laws and regulations for shipment of a LED Product to and from UBIQUITI.

Disclaimer

EXCEPT FOR ANY EXPRESS WARRANTIES PROVIDED HEREIN, UBIQUITI, ITS AFFILIATES, AND ITS AND THEIR THIRD PARTY DATA, SERVICE, SOFTWARE AND HARDWARE PROVIDERS HEREBY DISCLAIM AND MAKE NO OTHER REPRESENTATION OR WARRANTY OF ANY KIND, EXPRESS, IMPLIED OR STATUTORY, INCLUDING, BUT NOT LIMITED TO, REPRESENTATIONS, GUARANTEES, OR WARRANTIES OF MERCHANTABILITY, ACCURACY, QUALITY OF SERVICE OR RESULTS, AVAILABILITY, SATISFACTORY QUALITY, LACK OF VIRUSES, QUIET ENJOYMENT, FITNESS FOR A PARTICULAR PURPOSE AND USE, NON-INFRINGEMENT AND ANY WARRANTIES ARISING FROM ANY COURSE OF DEALING, USAGE OR TRADE PRACTICE IN CONNECTION WITH SUCH PRODUCTS AND SERVICES. CUSTOMER ACKNOWLEDGES THAT NEITHER UBIQUITI NOR ITS THIRD PARTY PROVIDERS CONTROL CUSTOMER'S EQUIPMENT OR THE TRANSFER OF DATA OVER COMMUNICATIONS FACILITIES, INCLUDING THE INTERNET, AND THAT THE PRODUCTS AND SERVICES MAY BE SUBJECT TO LIMITATIONS, INTERRUPTIONS, DELAYS, CANCELLATIONS AND OTHER PROBLEMS INHERENT IN THE USE OF COMMUNICATIONS FACILITIES. UBIQUITI, ITS AFFILIATES AND ITS AND THEIR THIRD PARTY PROVIDERS ARE NOT RESPONSIBLE FOR ANY INTERRUPTIONS, DELAYS, CANCELLATIONS, DELIVERY FAILURES, DATA LOSS, LOSS OF PROFITS, LOSS OF USE, CONTENT CORRUPTION, PACKET LOSS, OR OTHER DAMAGE RESULTING FROM ANY OF THE FOREGOING INCLUDING ACTS OF GOD. In addition, UBIQUITI does not warrant that the operation of the Products will be error-free or that operation will be uninterrupted. In no event shall UBIQUITI be responsible for damages or claims of any nature or description relating to system performance, including coverage, customer's selection of products (including the Products) for customer's application and/or failure of products (including the Products) to meet government or regulatory requirements. No UBIQUITI employee, agent, or reseller can make any verbal or written modification, extension, or addition to this warranty.

Limitation of Liability

EXCEPT TO THE EXTENT PROHIBITED BY LOCAL LAW, IN NO EVENT WILL UBIQUITI OR ITS SUBSIDIARIES, AFFILIATES OR SUPPLIERS BE LIABLE FOR DIRECT, SPECIAL, INCIDENTAL, CONSEQUENTIAL OR OTHER DAMAGES (INCLUDING LOST PROFIT, LOST DATA, LOSS OF USE, OR DOWNTIME COSTS), ARISING OUT OF THE USE, INABILITY TO USE, OR THE RESULTS OF USE OF THE PRODUCT, WHETHER BASED IN WARRANTY, CONTRACT, TORT OR OTHER LEGAL THEORY, AND WHETHER OR NOT ADVISED OF THE POSSIBILITY OF SUCH DAMAGES. ALL DISPUTES WITH UBIQUITI ARISING IN ANY WAY FROM THIS LIMITED WARRANTY OR FROM THE SALE, CONDITION OR PERFORMANCE OF THE PRODUCTS SHALL BE RESOLVED EXCLUSIVELY THROUGH FINAL AND BINDING ARBITRATION AS SET FORTH IN THE APPLICABLE PRODUCT QUICK START GUIDE AND, IF APPLICABLE, THE APPLICABLE PRODUCT USER GUIDE, AND NOT BY A COURT OR JURY.

Dispute Resolution

Arbitration is a form of private dispute resolution in which persons having a dispute agree to waive their right to file a lawsuit to proceed in court and to a jury trial, and instead agree to present their dispute to a neutral third party (arbitrator) for binding decision. You have the right to opt-out of this provision which means that you retain your right to file a lawsuit; to do so, you must read

carefully and follow the directions under the paragraph listed How to Opt Out of Mandatory Arbitration. Unless you Opt Out of the Mandatory Arbitration, you will be understood to have agreed to the mandatory arbitration and to the provisions provided below.

- a. **Mandatory Arbitration.** Please read this carefully. It affects your rights. YOU AND ANY COMPANY AND ITS RESPECTIVE CORPORATE PARENTS, SUBSIDIARIES, AFFILIATES, PREDECESSORS IN INTEREST, SUCCESSORS, PERMITTED ASSIGNS, AND ANY OTHER PARTIES ON WHOSE BEHALF YOU ARE ACCESSING THE SERVICE OR USING THE LED PRODUCT AGREE TO ARBITRATION (EXCEPT FOR MATTERS THAT MAY BE TAKEN TO SMALL CLAIMS COURT), AS THE EXCLUSIVE FORM OF DISPUTE RESOLUTION EXCEPT AS PROVIDED FOR BELOW, FOR ANY AND ALL DISPUTES, AS DEFINED BELOW. THE TERM “**DISPUTE**” MEANS ANY DISPUTE, CLAIM OR CONTROVERSY NOW OR IN THE FUTURE BETWEEN YOU AND UBIQUITI WHETHER BASED IN CONTRACT, STATUTE, REGULATION, ORDINANCE, TORT (INCLUDING, BUT NOT LIMITED TO, FRAUD, MISREPRESENTATION, FRAUDULENT INDUCEMENT, OR NEGLIGENCE), OR ANY OTHER LEGAL OR EQUITABLE THEORY, AND INCLUDING THE VALIDITY, ENFORCEABILITY OR SCOPE OF THIS PROVISION (WITH THE EXCEPTION OF THE ENFORCEABILITY OF THE CLASS ACTION WAIVER CLAUSE BELOW) ARISING OUT OF OR RELATING TO YOUR PURCHASE, OWNERSHIP AND/OR USE OF THE LED PRODUCT AND/OR THE SERVICE ACCOMPANYING THE LED PRODUCT. FOR EACH LED PRODUCT PURCHASED THIS MANDATORY ARBITRATION PROVISION WOULD APPLY UNLESS YOU CHOOSE TO OPT-OUT AS DISCUSSED ABOVE. THE TERM “LED PRODUCT” INCLUDES THE PHYSICAL PRODUCT PURCHASED AND ANY SOFTWARE NECESSARY TO OPERATE THAT PRODUCT. “Dispute” is to be given the broadest possible meaning that will be enforced. Arbitration is more informal than a lawsuit in court. Arbitration uses a neutral, third-person arbitrator instead of a judge or jury, allows for more limited discovery than in court, and is subject to very limited review by courts. Arbitrators can award the same damages and relief that a court can award. Please visit <http://www.iccwbo.org> for more information.
- b. **How to Opt Out of Mandatory Arbitration.** Notwithstanding the above, you or UBIQUITI may choose to file a lawsuit in court rather than resolving your Dispute with UBIQUITI by arbitration. You may opt-out of mandatory arbitration if (a) the Dispute qualifies for small claims court (there are monetary limitations for small claims court), or (b) YOU OPT OUT OF THESE ARBITRATION PROCEDURES WITHIN 30 DAYS FROM THE DATE THAT YOU PURCHASE OR OTHERWISE ACQUIRE THE LED PRODUCT (the “**Opt-Out Deadline**”). In order to opt out of mandatory arbitration, you need to (I) mail written notification to Ubiquiti Networks, Inc., Legal Department, 685 Third Avenue, 27th Floor, New York, New York 10017; or (II) email written notification to legal@ubnt.com. In either case, your written notification must include: (1) your name, (2) your address, (3) a copy of your receipt or other proof of purchase, showing the date of purchase, and (4) a clear statement that you do not wish to resolve disputes with UBIQUITI through arbitration. Your decision to opt-out of this provision will have no adverse effect on your relationship with UBIQUITI. Any opt-out request received after the Opt-Out Deadline will not be valid and you **must** pursue your Dispute in arbitration or, if the dispute qualifies, in small claims court.
- c. **Pre-Arbitration Claim Resolution:** For all Disputes, whether pursued in court or in mandatory arbitration, you must first give UBIQUITI written notification

and forty-five (45) days to resolve the Dispute. The written notification shall include the information listed above in the preceding paragraph (b) items (1)-(3) plus (4) a written description of your Dispute and (5) a written description of the relief you seek. It is to be sent to the address listed at (l) in the above paragraph. If UBIQUITI does not resolve the dispute within forty-five (45) days you may pursue your dispute in arbitration. You may pursue your dispute in a court only under the circumstances described above in the Opt Out provision.

d. Arbitration Process.

- i. Commencing Arbitration. A party who intends to seek arbitration must first send to the other, by a reputable courier with a tracking mechanism, a written notice of intent to arbitrate (a "**Notice**"), or, in the absence of a mailing address provided by you to UBIQUITI, then UBIQUITI can send to you by any other method available to UBIQUITI for sending such notice, including via e-mail. The Notice to UBIQUITI should be addressed to Ubiquiti Networks, Inc., 685 Third Avenue, 27th Floor, New York, New York 10017, Attn: Legal Department (the "**Arbitration Notice Address**"). The Notice shall include the information listed above in the preceding paragraph (b) items (1)-(3) plus (4) a written description of your Dispute and (5) a written description of the relief you seek (the "**Demand**"). THE ARBITRATION WILL BE ADMINISTERED BY THE INTERNATIONAL CENTER FOR DISPUTE RESOLUTION ("**ICDR**") IN ACCORDANCE WITH THE INTERNATIONAL ARBITRATION RULES (THE "**Rules**"), AS MODIFIED HEREIN. The Rules are available at <https://www.icdr.org>. Except as otherwise set forth herein, if you are required to pay a filing fee to commence arbitration against UBIQUITI, then UBIQUITI will, within ten (10) business days of receipt of your confirmed payment reimburse you for the amount of your confirmed payment of the filing fee that exceeds the amount of any fees you would be required to pay if the Demand were filed in federal court in the Southern District of New York upon UBIQUITI'S receipt of Notice at the Arbitration Notice Address that you have commenced arbitration along with a receipt evidencing payment of the filing fee.
- ii. Arbitration Proceeding. The arbitration will be conducted in English and a translator may be utilized at the expense of the party requiring the translation services. A single independent and impartial arbitrator with his or her primary place of business in New York, New York will be appointed pursuant to the Rules. You and UBIQUITI agree to the following rules, which are intended to streamline the dispute resolution process and reduce the costs and burdens on the parties: (a) subject to the Rules, the arbitration shall be conducted online via videoconference, telephonically and/or be solely based on written submissions- rather than requiring the personal appearance of the parties- with the specific manner to be mutually agreed upon in writing by the parties and (b) any judgment on the award rendered by the arbitrator may be entered in any court of competent jurisdiction.
- iii. No Class Actions. YOU AND UBIQUITI AGREE THAT YOU AND UBIQUITI MAY BRING CLAIMS AGAINST THE OTHER ONLY IN

YOUR OR ITS INDIVIDUAL CAPACITY AND NOT AS A PLAINTIFF OR CLASS MEMBER IN ANY PURPORTED CLASS OR REPRESENTATIVE PROCEEDING. FURTHER, YOU AGREE THAT THE ARBITRATOR MAY NOT CONSOLIDATE PROCEEDINGS OF MORE THAN ONE PERSON'S CLAIMS, AND MAY NOT OTHERWISE PRESIDE OVER ANY FORM OF A REPRESENTATIVE OR CLASS PROCEEDING, AND THAT IF THIS SPECIFIC PROVISIO IS FOUND TO BE UNENFORCEABLE, THEN THE ENTIRETY OF THIS MANDATORY ARBITRATION SECTION WILL BE NULL AND VOID. IF YOU CHOOSE TO PURSUE YOUR DISPUTE IN COURT BY OPTING OUT OF THIS PROVISION, AS SPECIFIED ABOVE, THIS CLASS ACTION WAIVER WILL NOT APPLY TO YOU. NEITHER YOU, NOR ANY OTHER USER OF THE LED PRODUCT OR SERVICES CAN BE A CLASS REPRESENTATIVE, CLASS MEMBER, OR OTHERWISE PARTICIPATE IN A CLASS, CONSOLIDATED, OR REPRESENTATIVE PROCEEDING WITHOUT HAVING COMPLIED WITH THE OPT-OUT REQUIREMENTS ABOVE.

- iv. Decision of the Arbitrator. Barring extraordinary circumstances, the arbitrator will issue his or her decision within one-hundred and twenty (120) days from the date the arbitrator is appointed. The arbitrator may extend this time limit for an additional thirty (30) days in the interests of justice upon written notice by the arbitrator to You and UBIQUITI at least twenty-one (21) days prior to the last date to issue his or her decision. Failure to adhere to this time limit shall not constitute a basis for challenging the arbitration award. All arbitration proceedings will be closed to the public and confidential, and all records relating thereto will be permanently sealed, except as necessary to obtain court confirmation of the arbitration award. The award of the arbitrator will be in writing and will include a statement setting forth the reasons for the disposition of any claim. The arbitrator will apply the laws of the State of New York in conducting the arbitration. You acknowledge that these terms and your use of the product or service evidences a transaction involving interstate commerce. The United States Federal Arbitration Act will govern the interpretation, enforcement, and proceedings pursuant to the Mandatory Arbitration clause in this QSG.
 - v. Arbitration Award. The arbitrator may award on an individual basis any relief that would be available pursuant to applicable law, and will not have the power to award relief to, against, or for the benefit of any person who is not a party to the proceeding. Such award will be final and binding on the parties, except for any right of appeal provided by the Federal Arbitration Act, and may be entered in any court having competent jurisdiction over the parties for purposes of enforcement.
- e. Equitable Relief; Punitive Damages.
- i. You acknowledge that, in the event UBIQUITI or a third party breaches the Mandatory Arbitration clause in this limited warranty, the damage or harm, if any, caused to you will not entitle you to seek injunctive or other equitable relief against UBIQUITI, and your only remedy will be for monetary damages, subject to the limitations of liability set forth in this limited warranty.

- ii. You and UBIQUITI agree that the arbitrator is not authorized to award punitive or other damages not measured by the prevailing party's actual damages, subject to the limitations of liability set forth in this limited warranty.
- f. **Claims.** You and UBIQUITI agree that, notwithstanding any other rights the party may have under law or equity, any cause of action arising out of or related to this limited warranty, the LED Product, or the service, excluding a claim for indemnification, must commence within **one (1) year** after the cause of action accrues. Otherwise, such cause of action is permanently barred.
- g. **Jury Waiver.** You understand and agree that by failing to opt out to this provision you and UBIQUITI are each waiving the right to a jury trial or a trial before a judge in public court. In the absence of this provision, you and UBIQUITI might otherwise have had a right or opportunity to bring Disputes in court, before a judge or jury and/or to participate or be represented in a case filed in court by others (including class actions). Except as otherwise provided herein, those rights are waived.
- h. **Enforceability.** If only paragraph (d)(iii) of this Dispute Resolution section or the entirety of this Dispute Resolution section is found to be unenforceable, then the entirety of this Dispute Resolution section will be null and void and, in such case, the parties agree that the exclusive jurisdiction and venue described in the Governing Law section of this limited warranty will govern any action arising out of or related to this this limited warranty, the LED Product, or the service.
- i. **Governing Law; Jurisdiction.** This limited warranty shall in all respects be governed by and interpreted under the laws of the State of New York (without regard to the conflicts of laws provisions thereof or the UN Convention on the International Sale of Goods). The parties agree that any judicial proceeding to resolve claims relating to these Terms or the Services will be brought in the courts of New York, county and city of Manhattan, or the U.S. District Court for the Southern District of New York, subject to the mandatory arbitration provisions in this limited warranty. Both you and UBIQUITI consent to venue and personal jurisdiction in such courts; provided, however, that UBIQUITI reserves the right to institute proceedings against you in the courts having jurisdiction in the places where you reside, do business, have assets, or in any jurisdiction where a harm to UBIQUITI is occurring or has occurred. In any action or proceeding to enforce rights under this limited warranty, the prevailing party will be entitled to recover costs and attorney's fees. Notwithstanding anything herein (including the mandatory arbitration provision above), in the event you infringe or misappropriate any of UBIQUITI'S intellectual property rights, UBIQUITI is entitled to seek any permanent or temporary remedies (including, without limitation, compensation for damages, ceasing of infringement act, injunctive reliefs) against You in accordance with the applicable laws of your resident country or the jurisdiction where such infringing act has transpired.

Note

Some countries, states and provinces do not allow exclusions or limitations of implied warranties or conditions or of limitation of liability for incidental or consequential damages, so the above exclusion may not apply to you.

You may have other rights that vary from country to country, state to state, or province to province. EXCEPT TO THE EXTENT ALLOWED BY LOCAL LAW, THESE WARRANTY TERMS DO NOT EXCLUDE, RESTRICT OR MODIFY, AND ARE IN ADDITION TO, THE MANDATORY STATUTORY RIGHTS YOU MAY HAVE. FOR A FULL UNDERSTANDING OF YOUR RIGHTS YOU SHOULD CONSULT THE LAWS OF YOUR STATE, PROVINCE, OR COUNTRY. The United Nations Convention on Contracts for the International Sale of Goods shall not apply to any transactions regarding the sale of the LED Products.

Compliance

FCC

Changes or modifications not expressly approved by the party responsible for compliance could void the user's authority to operate the equipment.

This device complies with Part 15 of the FCC Rules. Operation is subject to the following two conditions.

1. This device may not cause harmful interference, and
2. This device must accept any interference received, including interference that may cause undesired operation.

This equipment has been tested and found to comply with the limits for a Class B digital device, pursuant to Part 15 of the FCC Rules. These limits are designed to provide reasonable protection against harmful interference in a residential installation. This equipment generates, uses, and can radiate radio frequency energy and, if not installed and used in accordance with the instructions, may cause harmful interference to radio communications. However, there is no guarantee that interference will not occur in a particular installation. If this equipment does cause harmful interference to radio or television reception, which can be determined by turning the equipment off and on, the user is encouraged to try to correct the interference by one or more of the following measures:

- Reorient or relocate the receiving antenna.
- Increase the separation between the equipment and receiver.
- Connect the equipment into an outlet on a circuit different from that to which the receiver is connected.
- Consult the dealer or an experienced radio/TV technician for help.

This radio transmitter FCC ID: SWX-ULEDAC has been approved by FCC.

ISED Canada

CAN ICES-3(B)/NMB-3(B)

This device complies with ISED Canada licence-exempt RSS standard(s). Operation is subject to the following two conditions:

1. This device may not cause interference, and
2. This device must accept any interference, including interference that may cause undesired operation of the device.

This radio transmitter (IC: 6545A-ULEDAC) has been approved by ISED Canada.

CAN ICES-3(B)/NMB-3(B)

Le présent appareil est conforme aux CNR d'ISDE Canada applicables aux appareils radio exempts de licence. L'exploitation est autorisée aux deux conditions suivantes :

1. l'appareil ne doit pas produire de brouillage;
2. l'appareil doit accepter tout brouillage radioélectrique subi, même si le brouillage est susceptible d'en compromettre le fonctionnement.

Le présent émetteur radio (IC : 6545A-ULEDAC) a été approuvé par ISDE Canada.

IMPORTANT NOTE:

Radiation Exposure Statement:

- This equipment complies with FCC and IC radiation exposure limits set forth for an uncontrolled environment.
- This equipment should be installed and operated with minimum distance 20 cm between the radiator & your body.
- This transmitter must not be co-located or operating in conjunction with any other antenna or transmitter.

AVIS IMPORTANT :

Déclaration sur l'exposition aux rayonnements

- Cet équipement est conforme aux limites prévues par la FCC et IC pour l'exposition aux rayonnements dans un environnement non contrôlé.
- Lors de l'installation et de la mise en fonctionnement de l'équipement, assurez-vous qu'il y ait une distance minimale de 20 cm entre l'élément rayonnant et vous.
- Cet émetteur ne doit être installé à proximité d'aucune autre antenne ni d'aucun autre émetteur, et ne doit être utilisé conjointement à aucun autre de ces appareils.

Online Resources

Website www.ubnt.com
Support help.ubnt.com
Community community.ubnt.com
Downloads downloads.ubnt.com

Ubiquiti Networks, Inc.
685 Third Avenue, 27th Floor
New York, NY 10017
USA



©2019 Ubiquiti Networks, Inc. All rights reserved. Ubiquiti, Ubiquiti Networks, the Ubiquiti U logo, the Ubiquiti beam logo, and UniFi are trademarks or registered trademarks of Ubiquiti Networks, Inc. in the United States and in other countries. Apple and the Apple logo are trademarks of Apple Inc., registered in the U.S. and other countries. App Store is a service mark of Apple Inc. Android, Google, Google Play, the Google Play logo and other marks are trademarks of Google LLC. All other trademarks are the property of their respective owners.