



Model 680

Microplate Reader

Instruction Manual

Catalog Numbers	168-1000
	168-1001
	168-1002
	168-1003



Warranty Statement

This warranty may vary outside of the continental United States. Contact your local Bio-Rad office for exact terms of your warranty.

Bio-Rad Laboratories warrants to the customer that the Model 680 Microplate Reader (catalog number 168-1000, 168-1001, 168-1002, and 168-1003) will be free from defects in material and workmanship, and will meet all performance specification for period of one year from the date of shipment. This warranty covers all parts and labor.

In the event that the instrument must be returned to the factory for repair under warranty, the instrument must be packed for return in original packaging.

Bio-Rad shall not be liable for any incidental, special, or consequential loss, damage, or expense directly or indirectly arising from the use of the Model 680 Microplate Reader. Bio-Rad makes no warranty whatsoever in regard to products or parts furnished by third parties, such being subject to the warranty of their respective manufacturers. Service under this warranty shall be requested by contacting your nearest Bio-Rad office.

The following items are considered Customer-installable consumables: thermal printer paper and light bulbs. These parts are not covered by this warranty. All customer-installed parts are warranted only to be free from defects in workmanship.

This warranty does not extend to any instrument or parts thereof that have been subject to misuse, neglect, or accident, or that have been modified by anyone other than Bio-Rad or that have been used in violation of Bio-Rad instructions.

The foregoing obligation are in lieu of all other obligations and liabilities including negligence and all warranties, of merchantability, fitness for a particular purpose or otherwise, expressed or implied in fact or by law, and state Bio-Rad's entire and exclusive liability and buyer's exclusive remedy for any claims or damages in connection with the furnishing of goods or parts, their design, suitability for use, installation or operation. Bio-Rad will in no event be liable for any special, incidental or consequential damages whatsoever, and Bio-Rad's liability under no circumstances will exceed the contract price for the goods for which liability is claimed.

Regulatory Notices

Electro Magnetic Compatibility:

This instrument is designed to meet the Class-A emissions and immunity levels of the EN61326 product family standard for the CE mark. This rating requires that it only be used in a laboratory environment.

Note: This instrument has been tested and found to comply with the limits for a Class A digital device, pursuant to Part 15 of the FCC rules. These limits are designed to provide reasonable protection against harmful interference when the equipment is operated in a commercial environment. This equipment generates, uses, and can radiate radio frequency energy and, if not installed and used in accordance with the instruction manual, may cause harmful interference to radio communications. Operation of equipment in a residential area is likely to cause harmful interference in which case the user will be required to correct the interference at his/her own expense.

Safety:

This instrument is designed to meet EN61010-1 requirements for the CE mark, which are internationally accepted safety standards for electrical equipment for measurement, control and laboratory use. EN61010-1 applies to equipment which is used under the following conditions;

- Indoor use

- Altitude up to 2,000 m

- MAINS supply voltage fluctuations up to $\pm 10\%$

This instrument has been tested, and its compliance has been confirmed under the following environmental conditions;

- Overvoltage category II

- Pollution degree 2

If the instrument is used in a manner not specified in this manual, the protection provided by the instrument may be impaired. This instrument should not be modified or altered in any way. Alteration of this instrument will result in the following:

- Void the manufacture's warranty.

- Void regulatory compliance.

- Create a potential safety hazard.

Protective Ground: This instrument has detachable, three-wire power cord for connection to both the power source and protective ground. The protective ground contact is connected to the accessible metal parts of the instrument. To prevent electrical shock, always use a power source outlet that has a properly grounded protective-ground contact.

Table of Contents

Section 1.....Introduction	1
1.1 Description and accessories for Model 680 Microplate Reader	2
Section 2.....Product Description	3
2.1 Contents of Shipping Carton	3
2.2 External Features.....	4
2.3 Membrane Keypad	5
Section 3.....Instrument Set-up.....	6
3.1 Initial Start-up.....	6
Section 4.....Operation	7
4.1 Instrument Overview	7
4.2 Functions Overview.....	10
4.2.1 Calculations	10
4.2.2 Security password	10
4.2.3 Memory Back-up.....	10
4.2.4 Limits.....	11
4.2.5 Reports.....	11
4.2.6 RS-232C Interface.....	16
4.2.7 Printer	17
4.3 Detailed Operation	18
4.3.1. Initial Start-up	18
4.3.2. Configuring the system	19
4.3.3. Printing Reports and Protocol information.....	21
4.3.4. Memory Recall operation.....	22
4.3.5. Editing Kinetic protocol	23
4.3.6. Checkmark value setting (by Administrator only).....	25
4.3.7. Editing End Point Protocol	26
4.3.8. Cutoff setting procedure	27
4.3.9. Standard setting procedure.....	31
4.3.10. Mode setting procedure	34
4.3.11. Plate Map setting procedure	36
4.4 Quick Guide – Reading a plate	39
4.5 Language choice.....	40
Section 5.....Instrument service by the user.....	42
5.1 Installing Interference Filters	42
5.2 Changing the Lamp	42
Section 6.....Troubleshooting and Error Messages.....	43
Section 7.....Specifications	45
7.1 Instrument Specifications	45
7.2 Interface Specifications.....	47
7.3 Command Language for Model 680 Microplate Reader	48
7.3.1 Command Language for Remote control mode	48
7.3.2 Error Codes	63

Section 1. Introduction

The Model 680 Microplate Reader is an eight-channel, vertical pathlength photometer that measures the absorbance of the contents in the wells of a 96-well microtitration plates. It can perform single or dual wavelength measurements and can report absorbance values to three decimal places.

The Model 680 reader can be programmed by entering commands through the membrane keypad to define plate reading and data analysis parameters as testing protocols and select report types. Hard copy reports can be produced by an optional on-board thermal printer or external printer.

The Model 680 reader can also be controlled by the Windows' based Microplate Manager software (catalog number 170-9520) program, through its built-in RS232C serial interface device. Microplate Manager software program provides a complete, user-friendly package for protocol programming as well as data analysis, for all absorbance microplate readers from Bio-Rad Laboratories.

1.1 Description and accessories for Model 680 Microplate Reader

Catalog Number	Description
168-1000	Model 680 microplate reader
168-1001	Model 680 microplate reader with temperature control
168-1002	Model 680 microplate reader with internal printer
168-1003	Model 680 microplate reader with temperature control and internal printer
168-1011	405 nm filter
168-1013	415 nm filter
168-1020	450 nm filter
168-1028	490 nm filter
168-1038	540 nm filter
168-1040	550 nm filter
168-1044	570 nm filter
168-1049	595 nm filter
168-1056	630 nm filter
168-1061	655 nm filter
168-1080	750 nm filter
168-1005	Serial PC Cable
168-1006	Replacement lamp for Model 680 microplate reader
168-1007	Printer paper, 2 rolls

Custom filters between 400 and 750 nm may be ordered, corresponding catalog numbers can be found on www.bio-rad.com, or you can order by specifying the wavelength and the model number of the reader.

Section 2. Product Description

2.1 Contents of Shipping Carton

The shipping carton contains the following items:

- Model 680 Microplate Reader, with 415nm, 450nm, 490nm and 655nm interference filters installed on the filter wheel.
- Power cord
- Serial PC Cable
- Spare fuse
- Dust cover
- Instruction manual
- Warranty card
- One roll of thermal printer paper (for units equipped with internal printer)

Inspect the exterior of the instrument for any signs of shipping damage. Contact your local Bio-Rad representative if any of these items are damaged or missing.

2.2 External Features

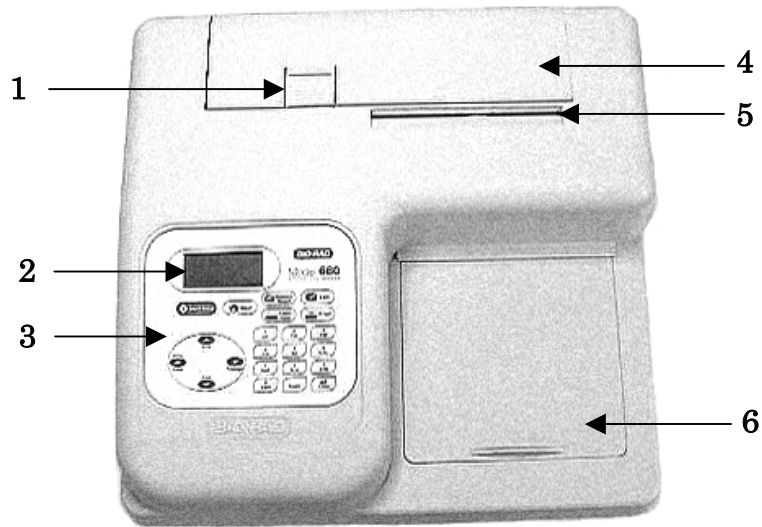

- | | |
|---------------------------------|---|
| 1. Release latch for rear cover | 4. Rear cover |
| 2. Liquid crystal display (LCD) | 5. Printer slot (when optional built-in printer is installed) |
| 3. Membrane keypad | 6. Reading chamber door |

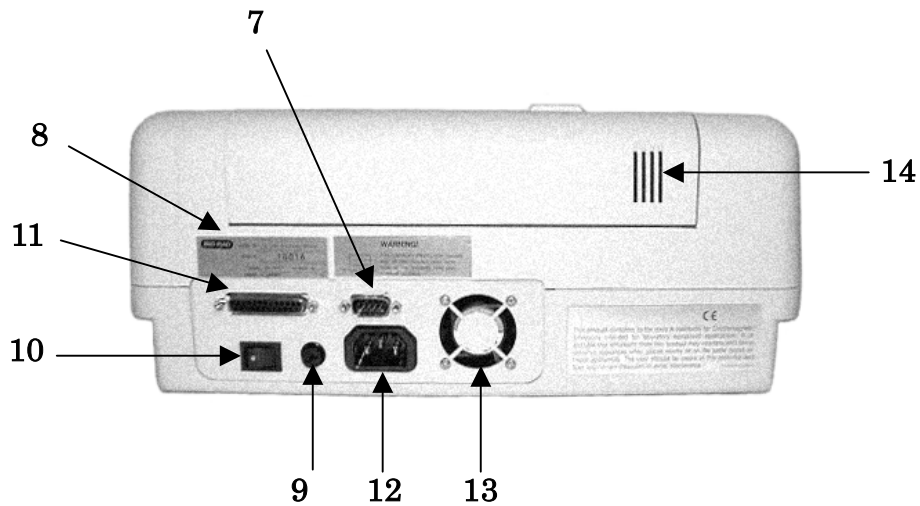

- | | |
|-----------------------------|---|
| 7. RS-232C serial interface | 11. Printer port (only when optional built-in printer is not installed) |
| 8. Serial number Label | 12. Power cord receptacle |
| 9. Fuse | 13. Cooling Fan |
| 10. Power switch | 14. Cooling Vents |

2.3 Membrane Keypad

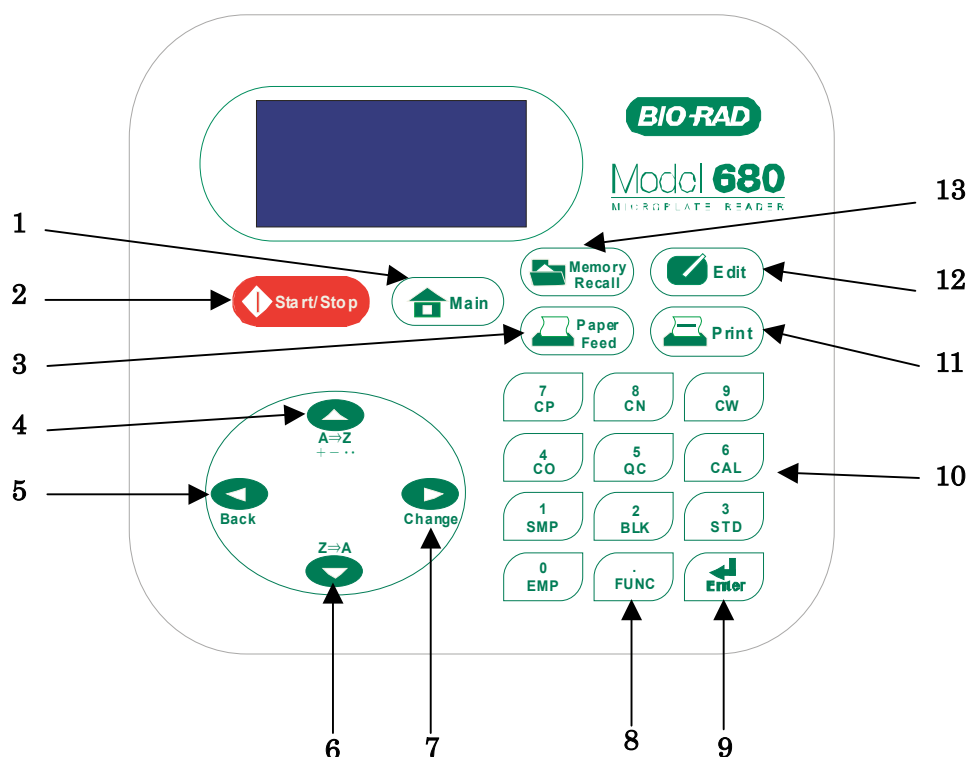

- | | |
|--------------------------|--|
| 1. Main | Returns to MAIN SCREEN. |
| 2. Start/Stop | Initiates plate reading using current active protocol.
Stops plate reading and printing. |
| 3. Paper Feed | Advances paper strip in internal printer. |
| 4. Up Arrow | Moves the cursor upward. Selects the alphabet or the symbol. |
| 5. Left Arrow | Returns to the previous screen. Moves the cursor to the left. |
| 6. Down Arrow | Moves the cursor downward. Selects the alphabet or the symbol. |
| 7. Right Arrow | Moves the cursor to the right. Changes or selects the value and type. |
| 8. Dot/Function | Inputs the dot. Changes the input mode. |
| 9. Enter | Completes or seals a field entry. |
| 10. Ten Keys | Inputs numbers or well type in plate mapping.
0 / EMP : Empty 5 / QC : QC control
1 / SMP : Sample 6 / CAL : Calibrator
2 / BLK : Blank 7 / CP : Positive Control
3 / STD : Standard 8 / CN : Negative Control
4 / CO : Cutoff control 9 / CW : Weak Positive Control |
| 11. Print | Prints out the plate data and protocol information. |
| 12. Edit | Enter the Edit Menu, and set up the instrument. |
| 13. Memory Recall | Read out protocol and plate data. |

Section 3. Instrument Set-up

3.1 Initial Start-up

- 1 Place the instrument on a clean, sturdy table or bench. It is important to keep the instrument in a clean, relatively dust free environment to ensure optimal performance.
- 2 Connect the power cord to the back of the instrument. Before connecting the instrument to the main electrical supply, check that the AC voltage is appropriate for the instrument.
- 3 Turn on the power switch on the rear panel. The LCD will display the version number of the on-board firmware. After about three seconds, the instrument will perform an initial self-diagnosis that requires about fifteen seconds. The Login Screen will now be displayed for you to choose your user level (administrator or common user), and enter the password (Initial password: 00000). Please allow three minutes for the instrument to warm up (reach thermal equilibrium) before reading plates.
- 4 Install the printer paper (if the optional internal printer is installed). The thermal printer paper is treated on one side only and must be properly installed for the printer to function. The side of the paper that faces out from the roll is the treated side.
 - a. Open the rear cover of the instrument.
 - b. Tear off a small piece at the beginning of a new roll at an angle to form a point.
 - c. Place the roll of paper in the small pan-like holder positioned below the printer. The roll should be positioned so that it will feed from the bottom.
 - d. While pressing the PAPER FEED key, feed the pointed end of the paper into the paper feed slot in the underside of the printer until the printer grabs the paper and feeds it through the slot in the top of the instrument.
 - e. Securely close the rear compartment.

Section 4. Operation

4.1 Instrument Overview

The Model 680 Microplate Reader has built-in software that allows the user to set the plate reading and data analysis conditions as a protocol data, read a microplate under the defined reading conditions, and get the printout reports from the internal or external printer. The software communicates through the 4-line, 20-character LCD and is controlled through the instrument's membrane keypad.

The display shows the current mode of the on-board software. The software has three different protocol types: End-point analysis, Kinetic analysis, and the Checkmark validation protocols. The user presses the Memory Recall key to select analysis mode passing through the choice of the protocol or the collected data.

Operation flow when End point protocol selected

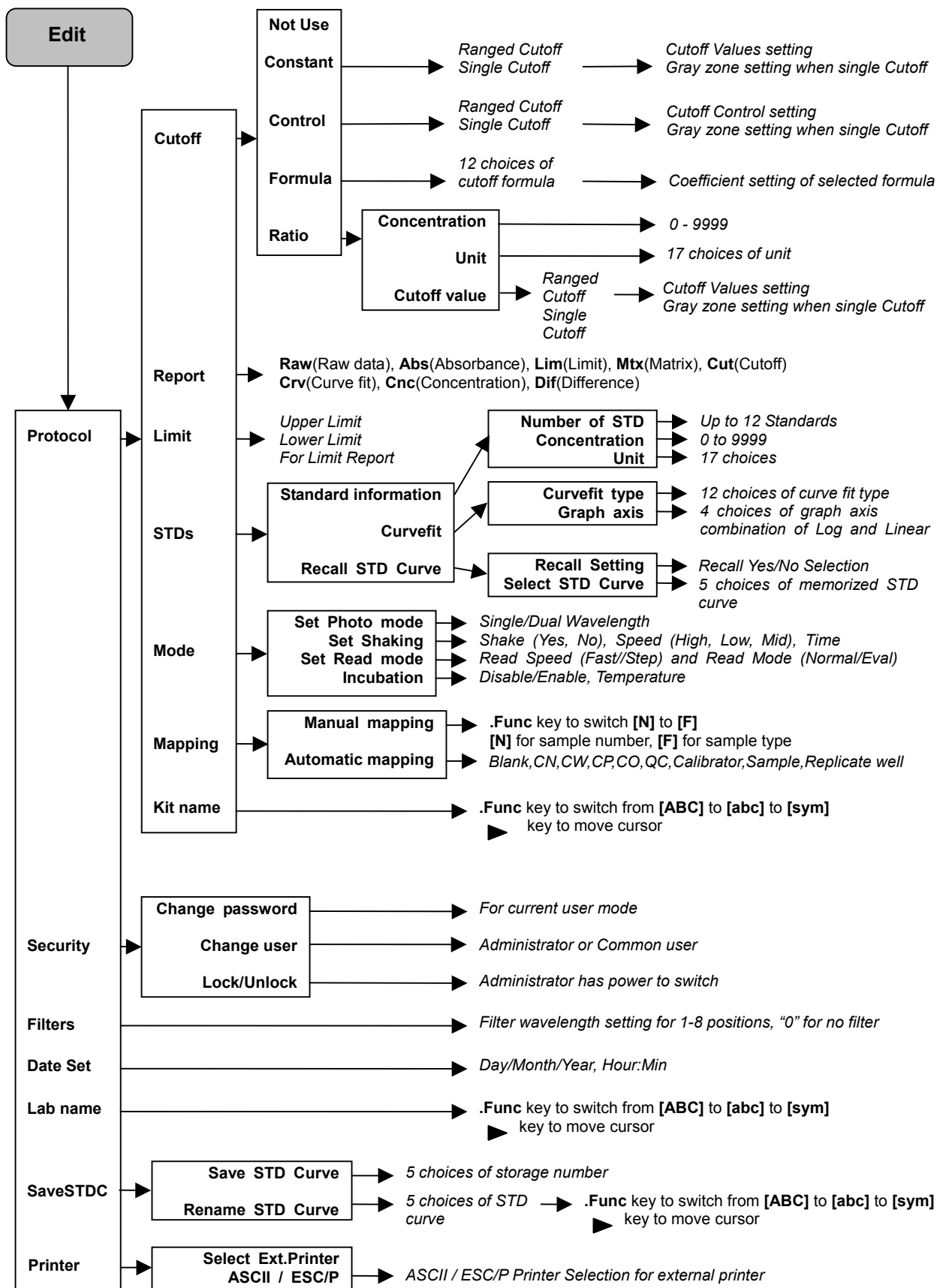

Box for menu *Italic* for program pages

Operation flow when Kinetic protocol selected

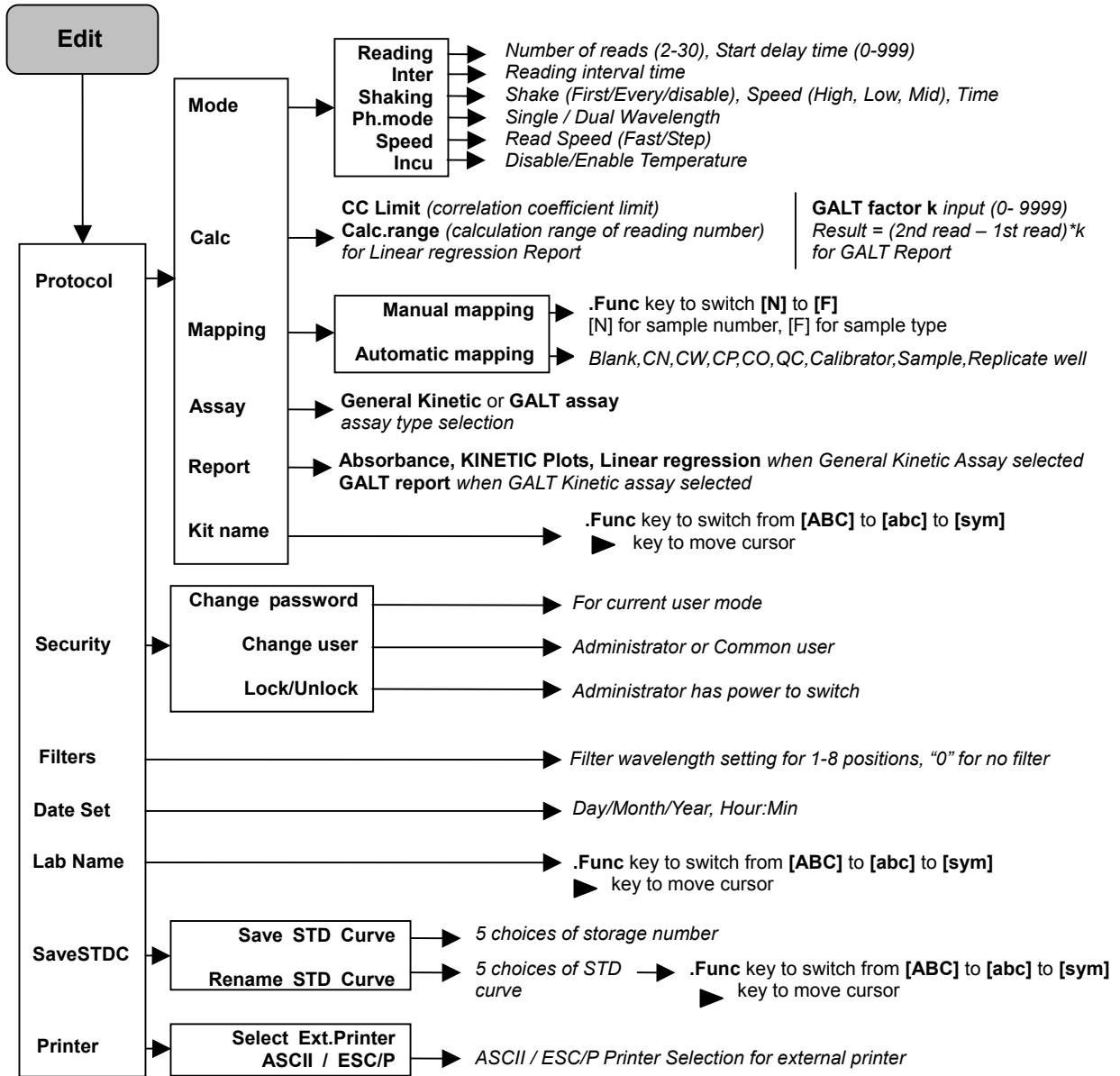

Special Buttons

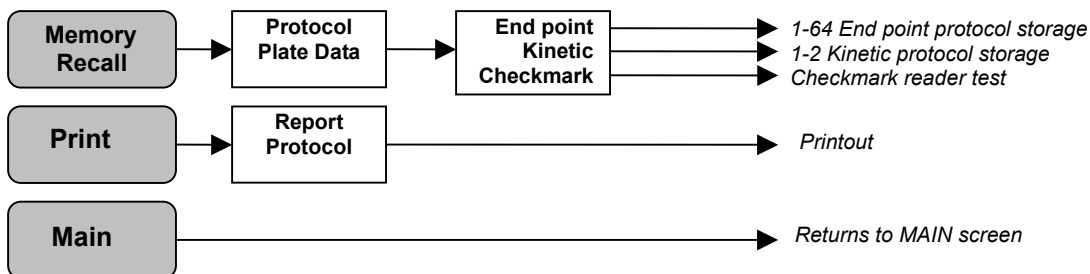

Bold for menu *Italic* for program pages

4.2 Functions Overview

4.2.1 Calculations

The Microplate Reader uses Beer's Law to calculate the absorbance value of each well. Beer's Law states that absorbance is equal to the log₁₀ of the ratio of the baseline measurement intensity (I₀) to the sample measurement intensity (I).

Beer's Law

$$\text{Absorbance} = \text{Log}_{10} (I_0/I)$$

Before measuring the plate, the reader takes a reading for all eight photodiode channels. These values are recorded as the baseline measurement (I₀) values for each channel, respectively. The reader then records the sample measurement (I) value for each well, and calculates the absorbance using these values. Channel-to-channel error is significantly reduced because the I₀ value for a given channel is used only in determining the absorbance of the wells of that channel.

4.2.2 Security password

The Model 680 Microplate Reader requires user login with password. This security feature helps to prevent any unwarranted modifications to the analysis conditions/protocols and data stored in the instrument, and identifies operator on reports. The reader has two user settings, the Administrator and the Common user. Each user level has its own security password.

4.2.3 Memory Back-up

The battery back-up provides memory even after the reader is turned off.

The following information will be saved in the memory until new reading parameters are set by the user or a new plate is read by the instrument. Note that if a run is aborted before it is finished, all the previous plate reading data remain in memory and none of the data from the aborted reading is stored.

1. 10 latest plate reading result for End-point protocol
2. 2 latest sets of Kinetic plate reading result (Max 30 series of readings for each Kinetic)
3. 64 End-point Protocol settings and 2 Kinetic Protocol settings
4. A set of Checkmark reference data and one latest set of Checkmark reading result
5. 5 set of Standard curve data for the storage of standard curves and graphs
6. 8 wavelength values for filters
7. Laboratory name
8. Two security passwords (for the Administrator and the Common user)
9. External printer type (ASCII or ESC/P type)

In addition to the battery back-up memory, the instrument has a small amount of non-volatile memory to keep the system information after the battery is dead. The Serial Number is stored

in this memory.

The first time the instrument is turned on, or after a battery failure, the following default information will be held in the memory.

1. Both of Administrator and Common user security password are set to "00000".
2. Laboratory name is "Bio-Rad Laboratories".
3. All wavelength values of the filters are set to "---" nm.
4. The date and time of the calendar chip are set to 1 day, 1 month, 00 year, 0 hour and 0 minute.
5. None of plate reading data is available.
6. End-point protocol is chosen and the protocol number is set to #1.
7. None of Standard curve data for the storage of standard curves and graphs is available.
8. External printer type is set to ASCII type.

4.2.4 Limits

The Microplate Reader displays absorbance readings with absolute values as 3.500. Out-of-range absorbance values, i.e. those with absolute values greater than 3.500, are displayed as either "*.****" or "-*.****". For example, if the absorbance is 4.500, then the display will read "*.****", and if the absorbance is -4.500, the display will read "-*.****".

4.2.5 Reports

The Microplate Reader can generate nine types of reports for End-point protocol: Raw data, Absorbance, Limit, Matrix, Cutoff, Curve fit, Concentration, Difference, and TeSeE Screening report. And four types of Kinetic protocol can be generated by the reader: Absorbance, Kinetic Plots, Linear regression, and GALT report.

Reports of End-point Protocol

(1) Raw data report

The Raw data report is the uncorrected absorbance values (without blank subtraction). In single-wavelength mode, the reported value is the measured absorbance. In dual-wavelength mode, the reported value is the difference between the uncorrected readings taken with the measurement filter and with the reference filter.

(2) Absorbance report

The Absorbance report is the blank-corrected absorbance values. The mean absorbance value of all of the wells designated as assay blanks is calculated and then subtracted from all 96 values of the raw data set to produce the Absorbance report.

$$\text{Abs} = \text{Raw} - \text{Blank mean}$$

Blank mean = X/n

S.D. = $\sqrt{\{X^2 - n*(Blank\ mean)^2\}/\{n-1\}}$

Where:

S.D. = Standard deviation

X = Sum total of the raw absorbance for each blank

X² = Sum total of the squared raw absorbance for each blank

n = Number of blanks

(3) **Limit report**

The Limit report provides a qualitative YES/NO report. Wells with blank-subtracted absorbance values between the upper and lower limits are represented with an asterisk (*), wells with absorbance values below the lower limit by minus signs (-), and wells with absorbance values greater than the upper limit by positive signs (+).

(4) **Matrix report**

The Matrix report provides a qualitative report of the relative magnitude of the absorbance values on the plate. The absorbance range defined by the upper and lower limits is divided into 10 equal partitions, numbered 0 through 9. The blank-subtracted absorbance value of each well is classified according to the partition of the matrix to which it corresponds, and is reported as a signal digit. Wells with absorbance values greater than the upper limit are reported by plus signs (+), and wells with absorbance values less than the lower limit by minus signs (-).

(5) **Cutoff report**

The Cutoff report provides a qualitative report of the relative magnitude of the absorbance values or converted concentrations on the plate.

Four types of cutoff report are supported as listed below.

a. Cutoff Constant Ranged Cutoff Constant

The user inputs Positive and Negative values to be used as the cutoff.

For units designated "Abs", if the absorbance of a well is within the positive and negative cutoff values, the well is scored "*". If the absorbance of a well is greater than the positive value, the well is scored "+", and if the absorbance of a well is below the negative value, the well is scored "-".

For units not designated "Abs", the absorbance value of each well is converted to the concentration value using the curve fit constants of the curve fit report. If the concentration of a well is within the positive and negative cutoff values, the well is scored "*". If the concentration of a well is greater than the positive value, the well is scored "+", and if the concentration of a well is below the negative value, the well is scored "-".

Single Cutoff Constant

The user inputs Positive and Gray zone values to be used as the cutoff.

For units designated "Abs", if the absorbance of a well is within the gray zone value of the positive cutoff value, the well is scored "*". If the absorbance of a well is more than the gray zone value and greater than the positive value, the well is scored "+", and if the absorbance of a well is more than the gray zone value below the positive value, the well is scored "-".

$$\begin{aligned} \text{Upper cutoff absorbance} &= \text{Positive absorbance} + ((\text{Gray zone}/100) * \text{Positive absorbance}) \\ \text{Lower cutoff absorbance} &= \text{Positive absorbance} - ((\text{Gray zone}/100) * \text{Positive absorbance}) \end{aligned}$$

For units not designated "Abs", the absorbance value of each well is converted to the concentration value using the curve fit constants of the curve fit report. If the concentration of a well is within the gray zone value of the positive cutoff value, the well is scored "*". If the concentration of a well is more than the gray zone value greater than the positive value, the well is scored "+", and if the concentration of a well is more than the gray zone value below the positive value, the well is scored "-".

$$\begin{aligned} \text{Upper cutoff conc.} &= \text{Conc. of positive controls} + ((\text{Gray zone}/100) * \text{Conc. of positive controls}) \\ \text{Lower cutoff conc.} &= \text{Conc. of positive controls} - ((\text{Gray zone}/100) * \text{Conc. of positive controls}) \end{aligned}$$

b. Cutoff Control

Ranged Cutoff Control

The mean absorbance values of the Positive and Negative wells defined in the plate map are used for the cutoff.

The absorbance range of the Positive and Negative is divided into 10 equal partitions, numbered 0 through 9. The absorbance value of each well is classified according to the partition of the matrix to which it corresponds, and is reported as a signal digit. Wells with absorbance values greater than the Positive are reported by plus signs (+), and wells with absorbance values less than the Negative by minus signs (-).

Single Cutoff Control

The mean absorbance value of the Negative wells that defined in the plate map and the gray zone value that is entered by the user are used to the cutoff. The upper and lower cutoff values are:

$$\begin{aligned} \text{Upper cutoff absorbance} &= \text{Mean of negative controls} + ((\text{Gray zone}/100) * \text{Mean of negative controls}) \\ \text{Lower cutoff absorbance} &= \text{Mean of negative controls} - ((\text{Gray zone}/100) * \text{Mean of negative controls}) \end{aligned}$$

The absorbance range of the upper and lower cutoff is divided into 10 equal partitions, numbered 0 through 9. The absorbance value of each well is classified according to the partition of the matrix to which it corresponds, and is reported as a signal digit. Wells with absorbance values greater than the upper cutoff are reported by plus signs (+), and wells with absorbance values less than the lower cutoff by minus signs (-).

c. Cutoff Formula

The mean absorbance values of the Positive and Negative wells defined in the plate map are used for the cutoff formula calculation.

The 12 types of formula supported are:

- | | |
|----------------|----------------------------|
| i. $k * CNx$ | vii. $k + CNx$ |
| ii. $k * CPx$ | viii. $k + CPx$ |
| iii. $k * COx$ | ix. $k + COx$ |
| iv. CNx / k | x. $k * CNx + CPx$ |
| v. CPx / k | xi. $(CNx + CPx) / k$ |
| vi. COx / k | xii. $k1 * CNx + k2 * CPx$ |

The result absorbance value of the formula calculation and the gray zone value that is entered by the user are used for the cutoff. The upper and lower cutoff values are:

$$\text{Upper cutoff absorbance} = \text{Result of a Formula} + ((\text{Gray zone}/100) * \text{Result of a Formula})$$

$$\text{Lower cutoff absorbance} = \text{Result of a Formula} - ((\text{Gray zone}/100) * \text{Result of a Formula})$$

The absorbance range of the upper and lower cutoff is divided into 10 equal partitions, numbered 0 through 9. The absorbance value of each well is classified according to the partition of the matrix to which it corresponds and is reported as a signal digit. Wells with absorbance values greater than the upper cutoff are reported by plus signs (+), and wells with absorbance values less than the lower cutoff by minus signs (-).

d. Cutoff Ratio

The mean absorbance value of the Calibrator wells defined in the plate map and the concentration value entered by the user are used for the cutoff ratio. Before the cutoff, the absorbance value of each well is converted into the concentration value. The ratio of Concentration/Absorbance of Calibrator is applied to the conversion. Then, the cutoff is done with the defined Positive and Negative or the defined Positive and Gray zone values.

Ranged Cutoff Control

The concentration range of the Positive and Negative is divided into 10 equal partitions, numbered 0 through 9. The concentration value of each well is classified according to the partition of the matrix to which it corresponds, and is reported as a signal digit. Wells with concentration greater than the Positive are reported by plus signs (+), and wells with concentration less than the Negative by minus signs (-).

Single Cutoff Control

The concentration value of the Negative and the gray zone value entered by the user are used for the cutoff. The upper and lower cutoff values are:

$$\text{Upper cutoff concentration} = \text{Positive} + ((\text{Gray zone}/100) * \text{Positive})$$

$$\text{Lower cutoff concentration} = \text{Positive} - ((\text{Gray zone}/100) * \text{Positive})$$

The concentration range of the upper and lower cutoff is divided into 10 equal partitions, numbered 0 through 9. The concentration value of each well is classified according to the partition of the matrix to which it corresponds, and is reported as a signal digit. Wells with concentrations greater than the upper cutoff are reported by plus signs (+), and wells with concentrations less than the lower cutoff by minus signs (-).

(6) Curve fit report

The Curve fit report provides a regression analysis based on the absorbance values of a series of standards. There are ten types of curve fits supported with the onboard software on Model 680 microplate readers:

- i. 5P Logistic Rodbard
- ii. 4P Logistic Rodbard
- iii. 5P Logistic Cook-Wilkenson
- iv. 4P Logistic Cook-Wilkenson
- v. 5P Exponential
- vi. Sigmoid Logistic
- vii. Linear regression
- viii. Quadratic regression
- ix. Cubic spline
- x. Point To Point regression

The onboard software calculates the best fit of the defined curve between each set of two consecutive data points in the standard curve of absorbance vs. concentration. And then it generates the report with the coefficients of regression, the correlation coefficient, and the standard error.

For readers with the optional internal printer or with an external ESC/P printer which accepts ESC/P code, a graph of the standard curve may be generated when selected in the report parameter.

(7) Concentration report

In case of the curve fit, the Concentration report also provides the regression analysis. After the calculation of the curve fit, it calculates the concentrations values of the samples, and generates the report.

In case of the cutoff constant with the unit not designated "Abs" and in case of the cutoff ratio, the reader generates the list of concentration of each well.

(8) Difference report

The Difference report is the subtraction report between the neighboring columns or row.

(9) TeSeE Screening report

Analysis of the TeSeE screening assay results can be done with two pre-programmed protocols: "TeSeE" protocol is stored in Endpoint Protocol position #5 and "TeSeE eq" is stored in Endpoint Protocol position #6 as factory default setting. Both protocols are locked.

TeSeE screening report is generated only if these protocols are selected as current active protocol. Plate is first validated according to negative and positive controls validation criteria; samples are then compared to the calculated cut-off.

Criteria for plate validation are set as follow:

- Criteria #1: Individual Negative Control must be < 0.150
Number of valid Negative Control must be ≥ 3
- Criteria #2: Individual Negative Control must be $< 1.400 * \text{Negative Control average}$
Number of valid Negative Control must be ≥ 2
- Criteria #3: Positive Control average must be ≥ 1.000

Cutoff is calculated as follow:

TeSeE:

$$\text{Positive cutoff} = \text{Negative Control average} + 0.210$$

Negative cutoff = (Negative Control average + 0.210) * 0.900

TeSeE eq:

Positive cutoff = Negative Control average + 0.210

Negative cutoff = Negative Control average + 0.090

Samples are interpreted as follow:

“POS”:
Positive when sample OD >= Positive cutoff

“NEG”:
Negative when sample OD < Negative cutoff

“???”:
Gray zone: NEG cutoff =< sample OD < POS cutoff

Reports of Kinetic Protocol

(1) Absorbance report

The Kinetic Absorbance report is the series of absorbance data in the kinetic sequence.

(2) Kinetic Plots

The Kinetic plots are the absorbance plots of each well in the plate. It is available for readers with the optional internal printer or with an external ESC/P printer which accepts ESC/P code.

(3) Linear Regression report

The Linear Regression report provides the calculation of Kinetic reaction rate for each well using the linear regression.

(4) GALT report

The GALT report calculates the following formula for each well between two readings of a plate.

$$\text{GALT} = (R2 - R1) * k$$

Where: R1 = Absorbance value of 1st reading

R2 = Absorbance value of 2nd reading

k = GALT factor

4.2.6 RS-232C Interface

The Model 680 Microplate Reader has a built-in bi-directional RS-232C interface (9 pin D-sub connector, Bio-Rad catalog number: 168-1005). This allows external computers to control the instrument. When an external computer is in control of the microplate reader, the printer and the membrane keys, except for the "Start/Stop" key, are automatically deactivated and the LCD display as below.

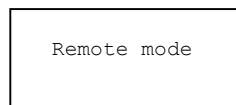

The reader will remain in remote control mode until it receives "RL" command from the host computer or until the "Start/Stop" key on the microplate reader is pressed.

4.2.7 Printer

The Model 680 Microplate Reader has a built-in printer interface connector (25 pin D-sub) or an optional factory built-in printer.

The printer interface connector allows the user to connect an external printer for the printout of reports or protocol. This external printer interface is based upon Centronics interface standards.

Two types of printer, ASCII type and ESC/P type, are allowable to connect. The ASCII type printer can only accept ASCII character based codes which does not include any graphic codes. Next, the ESC/P type printer can accept ESC/P codes which include graphic codes.

The optional factory built-in internal printer and the external ESC/P type printer can generate all types of report including graphs and kinetic plots.

4.3 Detailed Operation

4.3.1. Initial Start-up

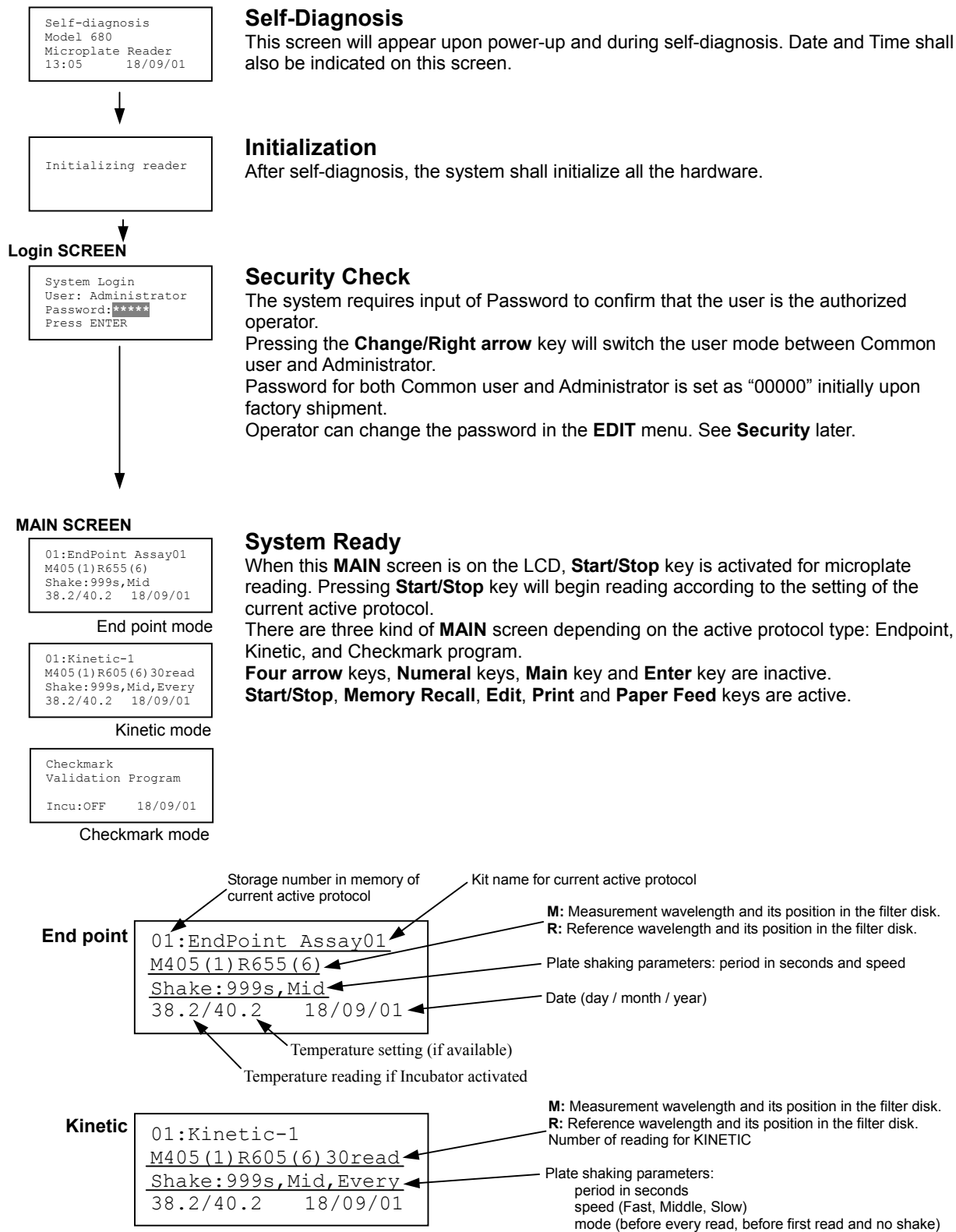

4.3.2. Configuring the system

Note: To return to the previous screen, use the **back/left** arrow key.

Edit Menu

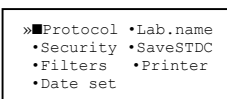

Edit Menu

This menu can be accessed by pressing the **Edit** key in the **MAIN SCREEN**.

Security Menu

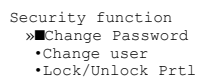

Security Setting

Select “**Security**” in **Edit Menu** screen above, and press **Enter**. Then **Security Menu** shall be on the screen.

Change Password

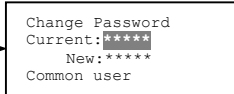

Change Password

Select “**Change Password**” in the **Security Menu**.

Enter the current Password then move the cursor to the 3rd line and enter a new password. Press **Enter** to complete the field entry. The system will return to the previous **Security Menu**.

Change user

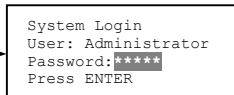

Change user mode

Select “**Change user**” in the **Security Menu**.

Select a desired user mode by pressing the **Right** Arrow key. Enter the appropriate Password for the selected user mode. Press **Enter** to complete the field entry. The system will return to the previous **Security Menu**.

Lock/Unlock

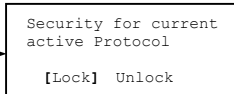

Lock/Unlock Protocol

Select “**Lock/Unlock Prtl**” in the **Security Menu**. Move the selected mark “[]” to the desired position: Lock or Unlock using the **Right** Arrow key. Press **Enter** to complete the field entry.

The system will return to the previous **Security Menu**.

If “**Lock**” is selected, the current active protocol will be protected against modification made by a Common user. If “**Unlock**” is selected, the current active protocol can be modified by any user mode.

NOTE: Only the Administrator has authority to lock and unlock the Checkmark Protocol.

```

Filter
1:400nm 5:650nm
2:450nm 6:...nm
3:475nm 7:...nm
4:650nm 8:...nm

```

Filter setting

Move the cursor to the desired position and using the **Up**, **Down**, and **Right** arrow keys. Enter the filter wavelength on the selected position using the number keys.

If the selected position of the filter disk is empty, enter three "...".

Press **Enter** to complete the field entry. The system will return to the previous **Edit Menu** screen.

```

Date set
Day/Month/Year
16 / 05 / 01
Hour: Minutes
18 : 55

```

Calendar setting

Move the cursor to the desirable position for date or time input by using the **Up**, **Down**, and **Right** arrow keys. Enter the present date or time using number keys.

Press **Enter** to complete the field entry. The system will return to the previous **Edit Menu** screen.

```

Lab. name
Enter Lab. name
Bio Rad Laboratories
↑ [ABC]

```

Lab. name setting

Use the **Up** and **Down** arrow keys to select from "A" to "Z" and symbol.

Use the **Number** keys for numeric input.

Right arrow key to move the cursor to the right.

Left arrow key to slip out of the screen and it returns to the **Edit Menu** screen.

Pressing **./FUNC** key will change the character mode: Upper case alphabet, Lower case alphabet, and symbol. Current character mode is indicated on the lower right corner of the LCD.

```

Save STDC
Save STD Curve
> Save STD Curve
Rename STD Curve

```

Save STDC setting

Select "Save STDC" in Edit Menu screen above, and press **Enter**. Then Save STD Curve Menu shall be appeared on the screen.

Move the cursor to the desired position by using the **Up** and **Down** arrow keys.

Save STD Curve

```

Select STD storage #
> 1:12/03/04 15:00
2:***** *****
3:15/03/04 10:30

```

Save STD Curve

To save a STD Curve, you should select the storage number between #1 and #5. The **Up** and **Down** arrow keys are used to move the cursor to the desired storage number. And press **Enter** to complete the selection.

After the storage number selection, "Are you sure?" message is appeared. Select "Yes" or "No" and press **Enter**. In case of "Yes", the reader saves the STD Curve and returns to the **Edit Menu** screen.

```

Save STD Curve:
#1:16/03/04 11:25
Are you sure?
> Yes No

```

If the curve fit calculation has not done or it has not finished successfully, an error message will be appeared and saving STD Curve will be invalidated.

```

STD curve does not
exist yet.
Press any key

```

Rename STD Curve

```

Select for renaming
> 1:16/03/04 11:25
2:***** *****
3:15/03/04 10:30

```

Rename STD Curve

To change a name of STD Curve, you should select the storage number between #1 and #5. The **Up** and **Down** arrow keys are used to move the cursor to the desired storage number. And press **Enter** to complete the selection.

Use the **Up** and **Down** arrow keys to select from "A" to "Z" and symbol. Use the **Number** keys for numeric input.

Right arrow key to move the cursor to the right.

Left arrow key to slip out of the screen and it returns to the **Edit Menu** screen.

Pressing **./FUNC** key will change the character mode: Upper case alphabet, Lower case alphabet, and symbol. Current character mode is indicated on the lower right corner of the LCD.

```

#1:16/03/04 11:25
>STD Curve #1 <
[ABC]

```

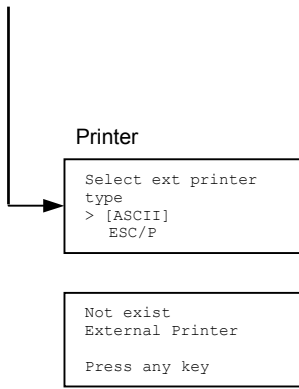
External Printer setting

Select "Printer" in Edit Menu screen above, and press **Enter**.

Then, Select ext printer type menu shall be appeared on the screen.

The **Up** and **Down** arrow keys are used to move the cursor to the desired printer; "**ASCII**" type or "**ESC/P**" type. Pressing **Enter** accepts the setting and the reader returns to the **Edit Menu** screen.

"**ASCII**" type :Text printer

"**ESC/P**" type :Graphic printer

If the external printer is not connected, an error message, "**Not exist External Printer**" will be appeared.

The reader will be returned to the **Edit Menu** screen by pressing any key.

4.3.3. Printing Reports and Protocol information

PRINT MENU

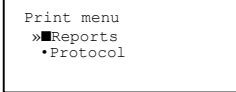

Print Menu

This menu screen can be accessed by pressing the **Print** key in the **MAIN** screen.

Printing Reports

Select "**Reports**" and press **Enter** to print the current active plate data report.

Printing Protocol information

Select "**Protocol**" and press **Enter** to print all parameter setting in the current active Protocol.

Stop printing

Pressing **Start/Stop** key during printing will stop the print job immediately.

When printing is completed, the system will automatically return to the **MAIN** screen.

4.3.4. Memory Recall operation

MEMORY RECALL MENU

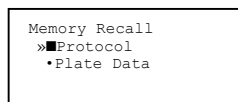

Memory Recall Menu

This menu screen can be accessed by pressing the **Memory Recall** key in the **MAIN** screen.

Protocol type menu

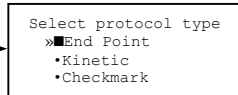

Changing current active protocol

Select **"Protocol"** in **Memory Recall** menu above, and press **Enter**. The **Select Protocol type** menu will appear on the screen.

Select a protocol using the **Up** and **Down** arrow keys. Press **Enter** to complete the selection.

End Point

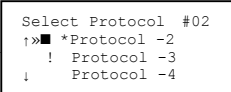

Selecting protocol

Move the cursor to the position of the desired protocol and press **Enter** to complete the selection.

"*" indicates the currently activated protocol, and **"!"** indicates a security locked protocol.

Kinetic

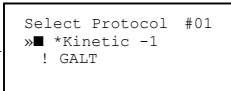

Checkmark

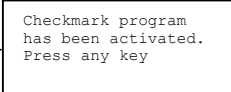

There is no protocol selection with **"Checkmark"**.

When a protocol is selected, the system will then automatically return to the **MAIN** screen.

Data type menu

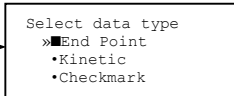

Changing current active plate data

Select **"Plate Data"** using the **Memory Recall** button and press **Enter**. The **Data type** menu will appear.

Use the **Up** and **Down** arrow keys to select a plate data type. Press **Enter** to complete the selection.

End Point

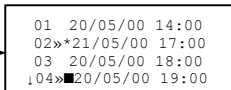

Selecting plate data

Move the cursor to the position of the desired plate data and press **Enter** to complete the selection.

"*" indicates the currently activated plate data.

Kinetic

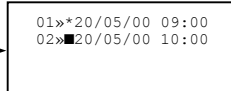

Checkmark

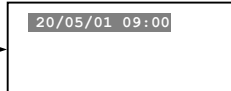

There is only one storage for **"Checkmark"** data.

When a plate data is selected, the system will then automatically return to the **MAIN** screen.

4.3.5. Editing Kinetic protocol

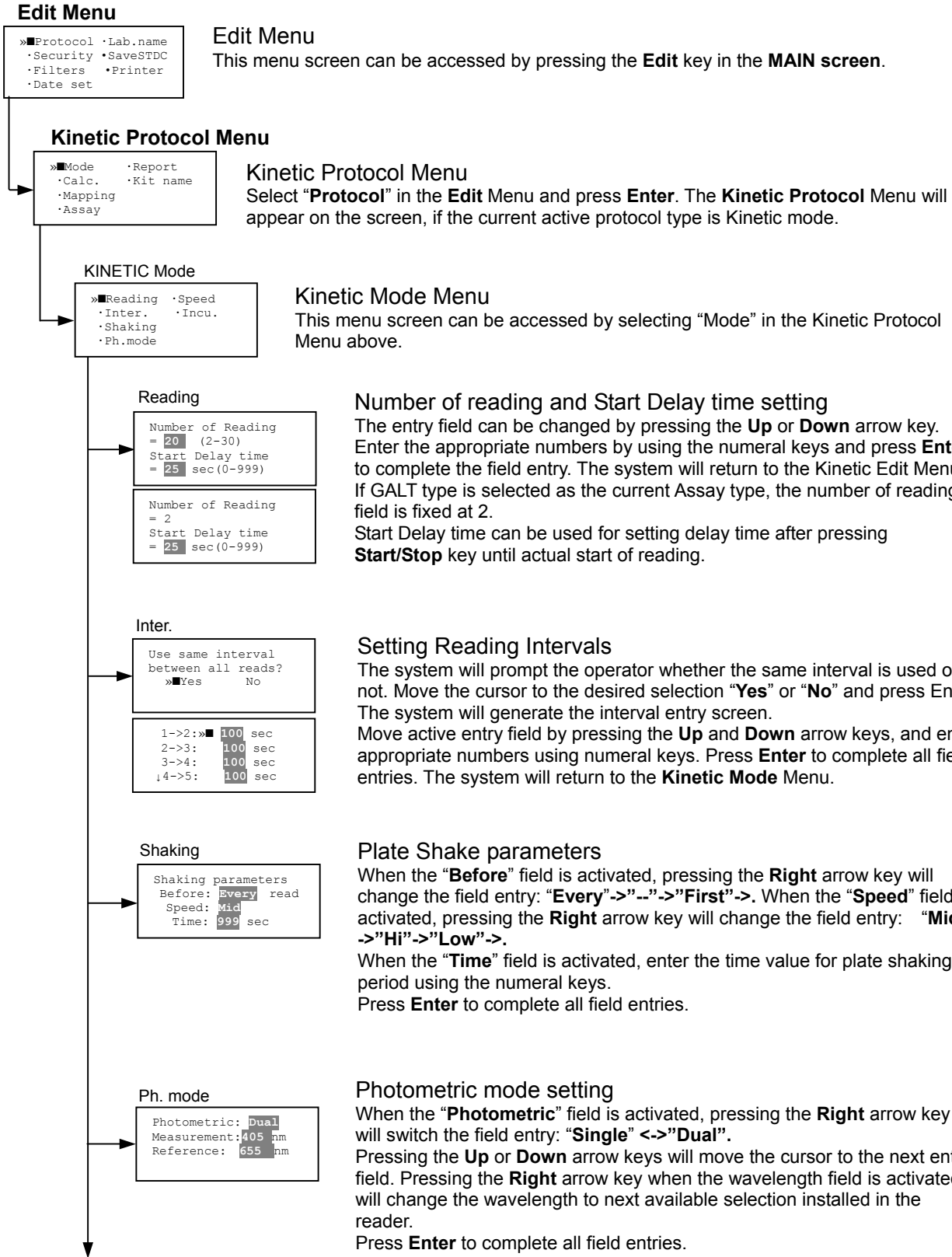

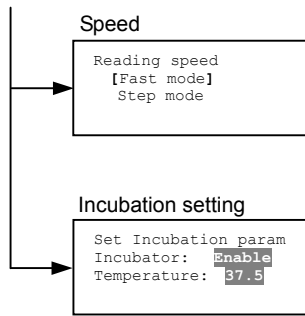

Selecting Reading Speed

Pressing the **Up** or **Down** arrow keys will switch the selection. Press **Enter** to complete the selection.

Incubator parameter setting

When the “**Incubator**” field is activated, pressing the **Right** arrow key will switch the field entry: “**Enable**” <-> “**Disable**”.

Pressing the **Up** or **Down** arrow keys will move the cursor to the next entry field. When the Temperature field is activated enter the temperature value using the numeral keys. Press **Enter** to complete all field entries.

This setting is available only when the Incubator is installed in the system.

Kinetic Protocol Menu

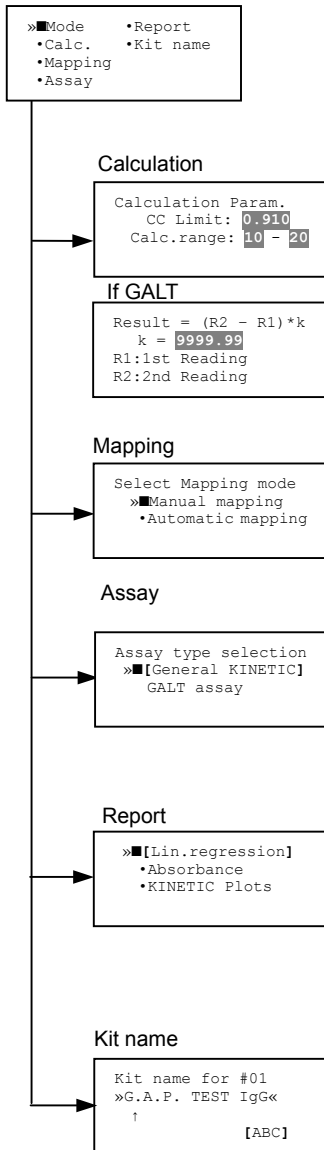

Calculation Parameter setting

When the “**CC Limit**” field is activated, pressing the numeral key will enter the desired numbers. Press **Enter** to complete all field entries.

If the GALT Reports is activated, pressing the numeral keys will enter the desired numbers. Press **Enter** to complete all field entries.

Plate Mapping

See **Plate Map setting procedure**.

Selecting Kinetic Assay type

Move the cursor to the desired Assay type by pressing the **Up** or **Down** arrow keys. Press **Enter** to complete the selection.

The item with mark “**[]**” is the currently selected item.

GALT assay: $\text{Result} = \text{factor} \times (\text{2nd Read} - \text{1st Read})$

Selecting report type

Move the cursor to the desired report type by pressing the **Up** or **Down** arrow keys. Pressing the **Right** arrow key will select or deselect the item.

Press **Enter** to complete the selection.

Note: When GALT assay is selected “**GALT report**” shall be the only one option on this screen.

Kit name setting

Use the **Up** and **Down** arrow keys to select alphabet from “A” to “Z” and space. Use the **Number** keys for numeric input.

Right arrow key to move the cursor to the right.

Left arrow key to slip out of the screen and it returns to the **Protocol Menu** screen.

Pressing “**./FUNC**” key will change the character mode: Upper case alphabet -> Lower case alphabet -> symbol. Current character mode is indicated on the lower right corner of the LCD.

4.3.6. Checkmark value setting (by Administrator only)

Edit Menu

```

»■Protocol  •Lab.name
•Security  •SaveSTDC
•Filters   •Printer
•Date set
    
```

Edit Menu

This menu screen can be accessed by pressing the **Edit** key in the **MAIN** screen.

Checkmark Protocol Menu

```

»■Serial #/Report
•Linearity ref.
•Max.CV%
•Filter Check ref.
    
```

Checkmark Protocol Menu

Select "**Protocol**" in the **Edit** Menu and press **Enter**. The **Checkmark Protocol** Menu will appear on the screen, if the current active protocol type is Checkmark mode.

Serial #/Report

```

»■Serial #: 0000
Rep.type: Simple
    
```

Serial number and Report type setting

Pressing the **Up** and **Down** arrow keys will move the cursor and change the field entry.

When "**Serial #**" field is active, enter the serial number that will be shown in the data sheet of the Checkmark plate using the numeral keys.

When the "**Rep. type**" field is active, pressing the **Right** arrow key will switch the report type between "**Simple**" and "**Full**".

Linearity reference

```

405nm  S1:0.158
Linearity S2:0.309
reference S3:1.401
         S4:2.109
    
```

Linearity reference value setting

Pressing the **Up** or **Down** arrow keys will move the field entry from S1 to S4. Pressing the **Right** arrow key will change the wavelength:

405nm->450nm->492nm->540nm->620nm->690nm

Use the **numeral** keys for the reference value setting.

Pressing **Enter** will complete all field entries at all wavelength.

Max. CV%

```

Max.CV%  »■S1:1.5%
Linearity S2:0.5%
reference S3:0.2%
         S4:0.2%
    
```

Max. CV% setting

Pressing the **Up** or **Down** arrow keys will move the field entry from S1 to S4.

Use the **numeral** keys for the Max. CV% setting. Pressing **Enter** will complete all field entries.

Filter check reference

```

Filter max  min
405:1.875  0.329
450:1.167  0.954
↓ 492:0.596 0.103
    
```

Filter check reference value setting

Initial screen shall be the reference entries for 405nm to 492nm and pressing the **Down** arrow key at the bottom of the screen entries will scroll to the next page for 540nm to 690nm. Pressing the **Up**, **Down** and **Right** arrow keys will move the field entry.

Use the **numeral** keys for the filter check reference value setting. Pressing **Enter** will complete all field entries.

```

Filter max  min
↑ 540:1.875  0.329
620:1.167  0.954
690:0.596  0.103
    
```

4.3.7. Editing End Point Protocol

Edit Menu

```

»■Protocol •Lab.name
•Security •SaveSTDC
•Filters •Printer
•Date set
    
```

Edit Menu

This menu screen can be accessed by pressing the **Edit** key in the **MAIN** screen.

End Point Protocol Menu

```

»■Cutoff •Mode
•Report •Mapping
•Limit •Kit name
•STDs
    
```

End Point Protocol Menu

Select "**Protocol**" in **Edit Menu** screen above and press **Enter**. The **End point Protocol** Menu will appear on the screen, if the current active protocol type is End point mode.

Cutoff

```

»■[Not use] •Ratio
•Constant
•Contrl
•Formula
    
```

See **Cutoff** setting procedure

Report

```

»[Raw] •Mtx •Cnc
•Abs •Cut •Dif
•Lim •Crv
    
```

If "Dif" selected

```

[Raw] •Mtx •Cnc
•Abs •Cut [Dif]
•Lim •Crv
»row, odd-even
    
```

Report type setting

Use the **Up** and **Down** Arrow key to move the cursor, and press the **Right** Arrow key to select or deselect the report type. Selected report type is marked as "[]". Press **Enter** to complete the selection.

Limit

```

Upper Limit= 2.000
Lower Limit= 0.000
input range: 0-3.500
Upper > Lower
    
```

Limit value setting

Use the **Up** and **Down** Arrow key to move the cursor, and enter the OD value using the **numeral** keys. The OD value range is 0.000 - 3.500. Press **Enter** to complete the selection.

STDs

```

Standard menu
»■STD information
•Curvefit
•Recall STD Curve
    
```

See **Standard** setting procedure

Mode

```

»■Set photo mode
•Set shaking
•Set read mode
•Incubation
    
```

See **Mode** setting procedure

Mapping

```

Select mapping mode
»■Manual mapping
•Automatic mapping
    
```

See **Plate Map** setting procedure

Kit name

```

Kit name for #01
»G.A.P. TEST IgG«
↑
[ABC]
    
```

See **Kit name** setting in **Editing Kinetic Protocol**

4.3.8. Cutoff setting procedure

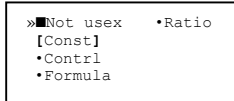

Cutoff setting Menu

This menu is entered by choosing "Cutoff" in the End Point Protocol Menu. It is used to set the cutoff type. The cutoff type marked with "[]" is the current selection. The **Up** and **Down** arrow key moves the cursor to the desired item in the menu list. When the desired parameters have been selected, press **Enter** twice to accept the selection and to resume to the next screen.

"Not use" means that the reader does not generate the cutoff report.

4 types of cutoff are supported as below.

1. Cutoff Constant
2. Cutoff Control
3. Cutoff Formula
4. Cutoff Ratio

a. Cutoff Constant setting

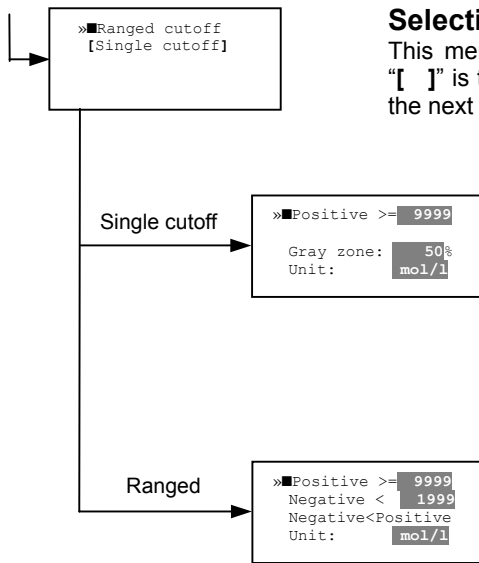

Selection of Single/Ranged Cutoff Constant

This menu selects Single or Ranged cutoff type. The cutoff type marked with "[]" is the current selection. The **Enter** key seals the selection and resumes to the next setting screen.

Single Cutoff Constant

The **Numerical** keys and the **Decimal point** key are used to enter the positive and gray zone values. The **Right** arrow key is used to select the unit. The **Up** and **Down** arrow key moves the cursor to the desired parameter of the single cutoff. The **Enter** key sets all values and selection of the cutoff constant and returns to the previous screen.

Ranged Cutoff Constant

The **Numerical** keys and the **Decimal point** key are used to enter the positive and negative values. The **Right** arrow key is used to select the unit. The **Up** and **Down** arrow key moves the cursor to the desired ranged cutoff parameters. The **Enter** key sets all values and selection of the cutoff constant and returns to the previous screen.

NOTE:

Two available Cutoff constant are "Absorbance" and "Concentration". If "Abs" is chosen, the Absorbance cutoff will be done with the cutoff constant parameters defined and the absorbance report is generated. For other units defined in the curve fit setting, the Concentration value using the curve fit and then cutoff is done with the cutoff constant parameters defined and the concentration value of each well. It is necessary to set the curve fit parameters.

b. Cutoff Control setting

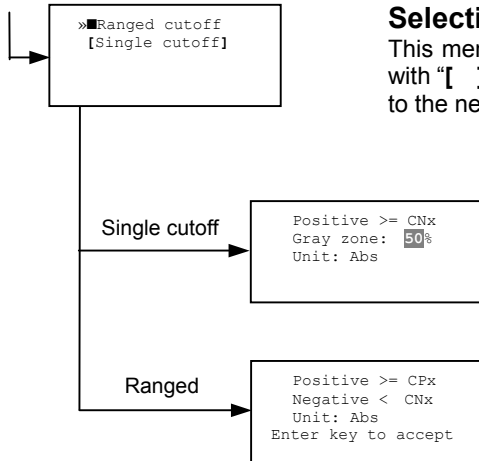

Selection of Single/Ranged Cutoff Control

This menu screen selects Single or Ranged cutoff type. The cutoff type marked with "[]" is the current selection. The **Enter** key seals the selection and resumes to the next setting screen.

Single Cutoff Control

The **Numerical** keys are used to enter the gray zone value. The unit is fixed to "Abs". The **Enter** key sets the value of the cutoff control and returns to the previous screen.

Ranged Cutoff Control

There is no parameter to set for the ranged cutoff control. The **Enter** key returns to the previous screen.

NOTE:

The "CNx" means the mean absorbance value of Negative control wells and the "CPx" means the mean absorbance value of Positive control wells. These wells are defined in the plate map setting. The cutoff is done with the Positive and Negative value to the absorbance value of each well.

c. Cutoff Formula setting

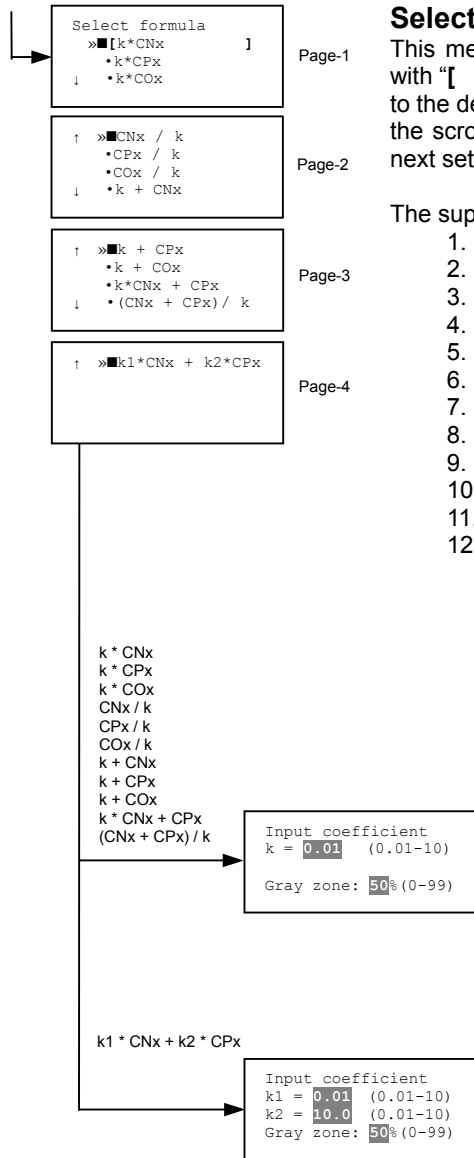

Selection of Formula

This menu screen selects a formula for cutoff calculation. The formula marked with "[]" is the current selection. The **Up** and **Down** arrow key moves the cursor to the desired type of the formula. The movement of the cursor also accompanies the scroll of this screen. The **Enter** key seals the selection and resumes to the next setting screen.

The supported formula types are:

1. $k * CNx$
2. $k * CPx$
3. $k * COx$
4. CNx / k
5. CPx / k
6. COx / k
7. $k + CNx$
8. $k + CPx$
9. $k + COx$
10. $k * CNx + CPx$
11. $(CNx + CPx) / k$
12. $k1 * CNx + k2 * CPx$

Coefficient for Cutoff Formula #1 to #11

The **Numerical** keys and the **Decimal point** key are used to enter the coefficient "k" and gray zone values. The **Up** and **Down** arrow key moves the cursor to the desired parameter of the cutoff formula. The **Enter** key sets all values of the cutoff formula and returns to the previous screen.

Coefficient for Cutoff Formula #12

The **Numerical** keys and the **Decimal point** key are used to enter the coefficient "k1" and "k2" and gray zone values. The **Up** and **Down** arrow key moves the cursor to the desired cutoff formula. The **Enter** key sets the all values of the cutoff formula and returns to the previous screen.

NOTE:

The "CNx" means the mean absorbance value of Negative control wells, the "CPx" is the mean absorbance value of Positive control wells and the "COx" is the mean absorbance value of Cutoff control wells. These wells are defined on the plate map setting. The cutoff value is calculated using the defined formula with the defined values and coefficients.

d. Cutoff Ratio setting

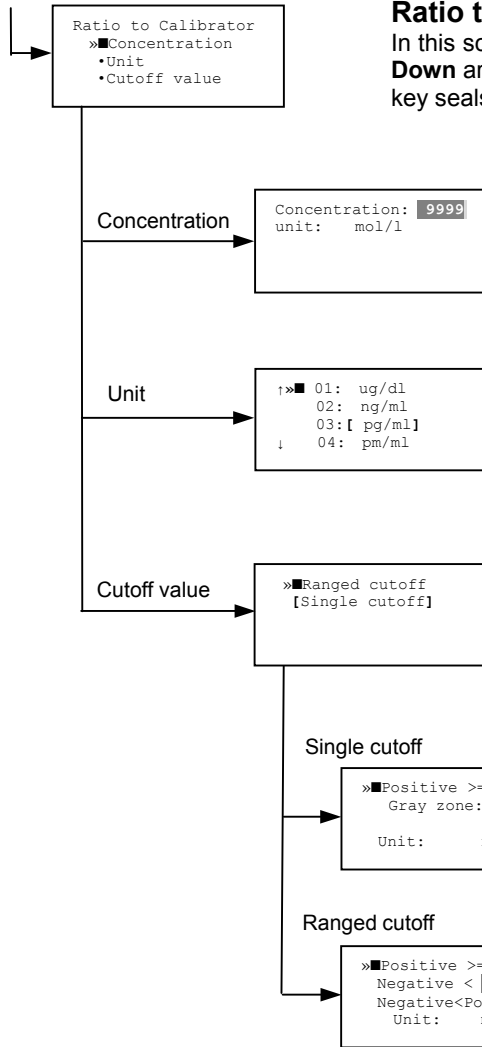

Ratio to Calibrator

In this screen, there are three items for setting the ratio to calibrator. The **Up** and **Down** arrow key moves the cursor to the desired item in the menu list. The **Enter** key seals the selection and resumes to the next setting screen.

Concentration of Calibrator

The **Numerical** keys and the **Decimal point** key are used to enter the calibrator concentration value. The **Enter** key sets the value and returns to the previous screen.

Unit of Calibrator

17 units are supported, as for the standard's unit. The unit marked with "[]" is the current selection.

The setting procedure is the same as the unit selection of Standards.

Cutoff value setting

This menu screen selects Single or Ranged cutoff type. The cutoff type marked with "[]" is the current selection. The **Enter** key seals the selection and resumes to the next setting screen

Single Cutoff Control

The **Numerical** keys are used to enter the Positive cutoff concentration value and gray zone value. The **Enter** key sets these cutoff ratio values and returns to the previous screen.

Ranged Cutoff Control

The **Numerical** keys are used to input the Positive and the Negative cutoff concentration value. The **Enter** key sets these cutoff ratio and returns to the previous screen.

NOTE:

The calibrator concentration value is used to convert the absorbance value of each well into concentration value. The ratio of Concentration/Absorbance of Calibrator well is applied to the conversion. The cutoff is done with the defined Positive and Negative values to the converted concentration value of each well.

4.3.9. Standard setting procedure

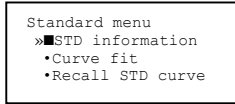

Standard curve setting Menu

This menu screen is entered by choosing "STDs" in the End Point Protocol Menu screen. It is used to set the concentration data and the curve fit type for a standard curve or to recall a memorized standard curve.

The **Up** and **Down** arrow key moves the cursor to the desired item in the menu list. The **Enter** key seals the selection and resumes to the next setting screen.

a. STD information setting

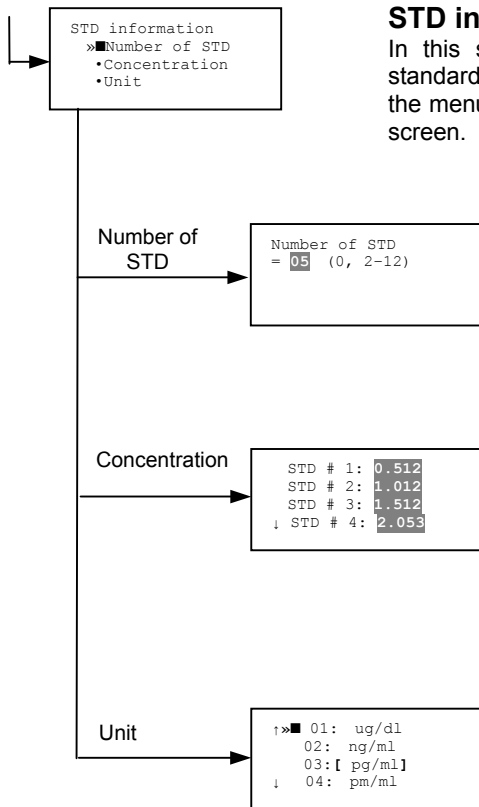

STD information

In this screen, there are three items for setting the concentration data of standards. The **Up** and **Down** arrow key moves the cursor to the desired item in the menu list. The **Enter** key seals the selection and resumes to the next setting screen.

Number of Standards

The **Numerical** keys are used to enter the number of Standards. 0 means that the curve fit report is not used. The **Enter** key sets the number and returns to the previous screen.

The maximum number of standards is 12.

Concentration

The **Numerical** keys and the **Decimal point** key are used to enter the concentration values of Standards. The **Up** and **Down** arrow key moves the cursor to the desired position. The movement of the cursor also accompanies the scroll of this screen. The **Enter** key sets all values of the concentration of standards and returns to the previous screen.

Unit

17 units are supported as below. The unit marked with "[]" is the current selection. The **Up** and **Down** arrow key moves the cursor to the desired unit type. The movement of the cursor also accompanies the scroll of this screen. Press **Enter** twice to select the unit type and to return to the previous screen.

The supported types of unit are:

- | | |
|------------|------------|
| 1. mol/l | 11. pg/ml |
| 2. m mol/l | 12. U/ml |
| 3. u mol/l | 13. IU/ml |
| 4. n mol/l | 14. uIU/ml |
| 5. p mol/l | 15. mIU/ml |
| 6. mg/l | 16. EU |
| 7. ng/l | 17. Arbit. |
| 8. pg/l | |
| 9. ug/dl | |
| 10. ng/ml | |

b. Curve fit setting

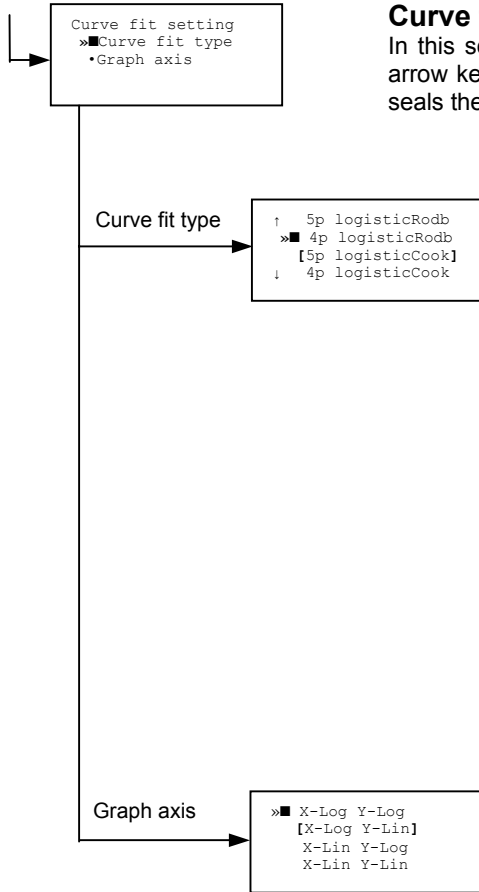

Curve fit

In this screen, there are two items for setting the curve fit. The **Up** and **Down** arrow key moves the cursor to the desired item in the menu list. The **Enter** key seals the selection and resumes to the next setting screen.

Curve fit type

10 types of curve fit are supported as below. The curve fit type marked with "[]" is the current selection. The **Up** and **Down** arrow key moves the cursor to the desired curve fit type. The movement of the cursor also accompanies the scroll of this screen. Press **Enter** twice to select the unit type and to return to the previous screen.

The supported curve fit types are:

1. 5P Logistic Rodbard
2. 4P Logistic Rodbard
3. 5P Logistic Cook-Wilkenson
4. 4P Logistic Cook-Wilkenson
5. 5P Exponential
6. Sigmoid Logistic
7. Linear regression
8. Quadratic regression
9. Cubic spline
10. Point To Point regression

Graph axis

4 types of graph are supported as below. The curve fit type marked with "[]" is the current selection. The **Up** and **Down** arrow key moves the cursor to the desired graph type. Press **Enter** twice to select the unit type and to return to the previous screen.

The supported graph types are:

1. Log - Log
2. Log - Linear
3. Linear - Log
4. Linear - Linear

c. Recall STD curve setting

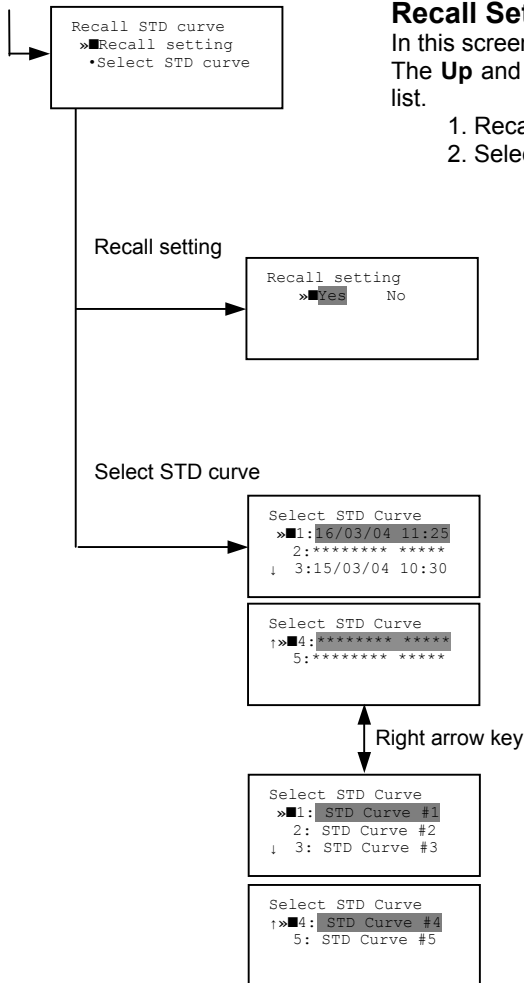

Recall Setting of Standard Curve

In this screen, there are two items for setting the Recall STD curve as below. The **Up** and **Down** arrow key moves the cursor to the desired item in the menu list.

1. Recall setting (Yes/No)
2. Selecting the storage number of standard curves (1 -> 5)

Recall setting

Move the cursor to the desired position using the **Up**, **Down** or **Right** arrow keys. **Enter** key accepts the setting and returns to the Standard menu screen.

- Yes: Recalling of the standard curve is active.
- No: Recalling of the standard curve is inactive.

Storage number selection

Five memories are selectable. The vacant memory which is marked with asterisks on the date and time field is also selectable. But it is necessary to save any standard curve before using its protocol.

Move the cursor to the desired position using the **Up** and **Down** keys.

This setting screen consists of two parts. The **Right** arrow key is used to switch the indication field between the date and time to the standard curve name.

Move the cursor to the desired position using the **Up** and **Down** keys. **Enter** key accepts the storage number and returns to the Standard menu screen.

NOTE:

If the recall of standard curve is active (the recall setting is "Yes"), the Standard information setting and the Curve fit setting will be invalidated and there setting screens will not open.

4.3.10. Mode setting procedure

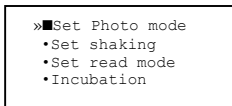

Mode setting Menu

This menu screen is entered by choosing the "Mode" in the End Point Protocol Menu screen or the Kinetic Protocol Menu screen. It is used to set the plate reading conditions. The **Up** and **Down** arrow key moves the cursor to the desired item in the menu list. The **Enter** key seals the selection and resumes to the next setting screen.

a. Set Photo mode

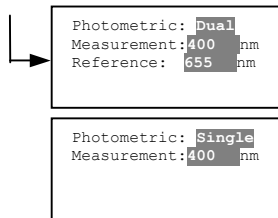
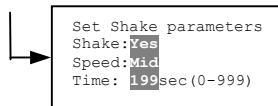

Photo mode

In this screen, the user chooses Single or Dual wavelength measurement and assigns the measurement and reference (for dual wavelength measurement) filters. The assignment of the reference filter appears for dual wavelength measurement.

The **Up** and **Down** arrow key moves the cursor to the desired parameter. The **Right** arrow key chooses Single/Dual wavelength measurement or selects filter number that is installed on the "Filters" of Edit Menu screen. The **Enter** key seals the selection and returns to the previous screen.

b. Set shaking



Shaking

In this screen, the user selects/deselects shaking function, sets the shaking strength and enters the shaking time. A shaking time of 0s indicates no shaking. The maximum shaking time is 999 seconds.

The **Up** and **Down** arrow key moves the cursor to the desired parameters. The **Right** arrow key toggles between Yes/No (Select/Deselect) shaking or selects strength: Low/Middle/High. The **Numerical** keys are used to enter the shaking time. The **Enter** key seals the selection and returns to the previous screen.

c. Set read mode

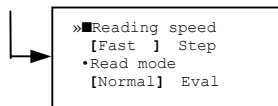

Read mode

In this screen, the user chooses Fast or Step reading and also chooses Normal or Evaluation mode.

The "[]" indicates the current selection. The **Up** and **Down** arrow key moves the cursor to the desired parameters. The **Right** arrow key chooses Fast/Step speed or chooses Normal/Eval mode. The **Enter** key seals the selection and returns to the previous screen.

The followings are the description of each read mode parameter.

Reading speed

Fast reading: 6 sec/single wavelength reading, 10 sec/dual wavelength reading

Step reading: 15 sec/single wavelength reading, 30 sec/dual wavelength reading

Reading mode

Normal mode: Plate reading once

Evaluation mode: Four plate readings per one of measurement are performed and the average data of their plate readings is generated as a plate data.

d. Incubation

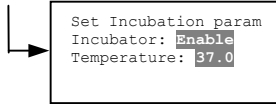

Incubation

In this screen, the user switches on/off the Incubator and sets the incubation temperature. The temperature setting range is from 25.0 to 45.0 degrees.

The **Up** and **Down** arrow key moves the cursor to the desired parameter. The **Right** arrow key chooses "Enable" or "Disable" (ON/OFF) of Incubator. The **Numerical** keys and the **Decimal point** key are used to input the incubation temperature. The **Enter** key seals the selection and returns to the previous screen.

NOTE:

The Incubator is optional. If the incubator is not installed and the "Incubation" menu is chosen, a warning message will appear on the screen.

4.3.11. Plate Map setting procedure

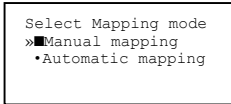

Select Mapping mode Menu

This menu screen is entered by choosing the "Mapping" in the End Point Protocol Menu screen or the Kinetic Protocol Menu screen. It is used to set the plate format (plate mapping). The **Up** and **Down** arrow key moves the cursor next to the desired item of menu list. The **Enter** key seals the selection and changes this screen to the next setting screen.

a. Manual Mapping

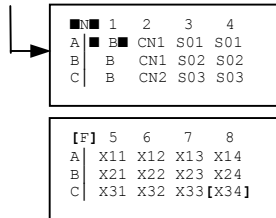

Manual Mapping

In this screen, the user can set the plate format manually. 10 well types as below are available to set.

Well type:

The supported well types are:

Well type	Indication on LCD
1. Blank:	B
2. Sample:	X00...X99
3. Standard:	S01...S99
4. In-kit Control: Positive Control	CP0...CP9
5. Weak Positive Control	CW0...CW9
6. Negative Control	CN0...CN9
7. Cutoff Control	CO0...CO9
8. Calibrator	CL0...CL9
9. QC Control:	QC0...QC9
10. Empty well:	-

The key assignments of well type are:

- "0/EMP" --- Empty well
- "1/SMP" --- Sample well
- "2/BLK" --- Blank well
- "3/STD" --- Standard well
- "4/CO" --- Cutoff Control well
- "5/QC" --- QC well
- "6/CAL" --- Calibrator well
- "7/CP" --- Positive Control well
- "8/CN" --- Negative Control well
- "9/CW" --- Weak Positive Control well

Two edit modes in plate mapping:

There are two editing modes, or the well type input mode and the well number input mode. The current input mode is displayed at the upper left corner of the screen. In case of the well type input mode, the mode sign is "[F]". And in case of the well number input mode, it is "■N■".

The cursor that encloses the editing position of well has two types of enclosures depending on the mode. For example, "[S01]" accepts the well type keys that be assigned to the numerical keys and "■S01■" accepts the numerical input.

The mode is easily changed with the **Decimal point** key.

Key functions:

The **Up**, **Down**, **Right** and **Left** arrow key moves the cursor to the desired well. The movement of the cursor also accompanies the scroll of this screen. The **Left** arrow key will return the screen to the preceding screen, or the "select Mapping mode Menu", only if the cursor is on the column #1. At this time, the selection screen appears (See the left figure).

The **Decimal point** key changes the input mode.

The **Numerical** keys have two functions that one is used to input the number and another is used to select a well type.

The **Enter** key checks the consistency between the edited plate map and other parameters, memorizes the plate map into the protocol and changes this screen back to the preceding screen. If it finds any inconsistency, a warning message will be appeared on the screen.

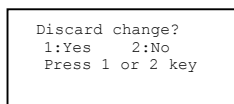

Acceptable range of number for each well type:

1. Blank and Empty wells are not acceptable for any number.
2. Sample and Standard wells: 00 - 99
3. Standard wells: 01 - 99
4. Control and Calibrator wells: 0 - 9

b. Automatic mapping

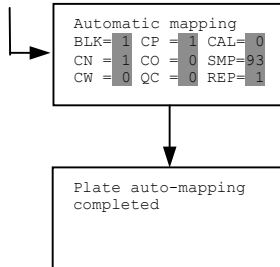

Automatic mapping

In this screen, the user can input each number of the well types for a plate map. These defined numbers are used to set a plate map automatically.

Well type:

9 well types are available to set the number as below.

1. BLK : Blank (0->10)
2. CN : Control CN (0->9)
3. CW : Control CW (0->9)
4. CP : Control CP (0->9)
5. CO : Control CO (0->9)
6. QC : Control QC (0->9)
7. CAL : Calibrator (0->9)
8. SMP : Sample (0->96)
9. REP : Replicate well (1->4)

It is possible to define the number of Blanks, Samples, Calibrators and Controls. But it does not include the number of Standards because of the Standard is defined at the Standard setting menu.

The number of replicate wells is also included. It is used for replicating each well type individually.

Key functions:

The **Up**, **Down**, **Right** and **Left** arrow keys are used to move the cursor to the next position. The **Numerical** keys are used to input the mapping parameters. The **Enter** key accepts the mapping parameters and it sets a plate map automatically using these parameters.

During the execution of the plate mapping, "Plate auto-mapping completed" message is appeared on the screen. After that it returns automatically to the previous **Protocol Menu** screen.

```
Discard change?
1:Yes 2:No
Press 1 or 2 key
```

If the **Left** arrow key is pressed at the left end position of the cursor, the left figure will appear on the screen. If the user chooses "Yes", the system will return to the previous **Protocol Menu** screen. If the user chooses "No", the system will stay in this setting screen.

Placing order and placing direction of plate mapping:

Placing order:

The placing order of Blanks, Standards, Samples, Calibrators and Controls are fixed as follows. The numbering for Standards, Samples, Calibrators and Controls is started at 1.

1. Blank
2. Standard 1 ->12 ---- **NOTE**
3. Control CN 1->9
4. Control CW 1->9
5. Control CP 1->9
6. Control CO 1->9
7. Control QC 1->9
8. Calibrator 1->9
9. Sample 1->96
10. Empty well

NOTE: Only if the "Cutoff Control", the "Value by Formula" or the "Ratio to Calibrator" is selected for the Cutoff, the plate mapping will skip the placing arrangement for Standards.

Placing direction:

The placing direction of the mapping is limited to the column direction as below.

Column direction: A1 -> H1, A2 -> H2, -----, A12 -> H12

Warning: The total
Of mapped wells has
Exceeded 96.
Press any key

Warning and Error of Automatic Mapping:

Warning screen:

If the total number of mapping wells exceeds 96 wells, a warning message in the left figure will appear on the screen. The calculation of the total number of mapping wells is as below:

$$(Blanks+Standards+CNs+CWs+CPs+COs+QCs+Calibrators+Sample)*Replicates$$

The plate mapping is executed normally and the exceeded part is invalidated.

Entered value is
Out of range
BLK: 0 - 10
Press any key

Error screen:

If one or more mapping parameters are over the input range, an error message in the left figure will appear on the screen.

On the third line of the LCD, the name of the parameter which has been out of range and its input range will appear.

Example: "BLK: 0 - 10"

In case of more than one error, the first parameter of errors is indicated. By pressing nay key it returns to the automatic mapping screen.

Example of automatic mapping:

An example of automatic mapping is as below.

1. Conditions of each parameter

Blank = 1

Standard = 8

Control CN = 2, CW = 0, CP = 2, CO = 0, QC = 0

Calibrator = 1

Sample = 32

Replicate number = 2

2. Plate mapping data

	1	2	3	4	5	6	7	8	9	10	11	12
A	B	S4	S8	CP2	X3	X7	X11	X15	X19	X23	X27	X31
B	B	S4	S8	CP2	X3	X7	X11	X15	X19	X23	X27	X31
C	S1	S5	CN1	CL1	X4	X8	X12	X16	X20	X24	X28	X32
D	S1	S5	CN1	CL1	X4	X8	X12	X16	X20	X24	X28	X32
E	S2	S6	CN2	X1	X5	X9	X13	X17	X21	X25	X29	E
F	S2	S6	CN2	X1	X5	X9	X13	X17	X21	X25	X29	E
G	S3	S7	CP1	X2	X6	X10	X14	X18	X22	X26	X30	E
H	S3	S7	CP1	X2	X6	X10	X14	X18	X22	X26	X30	E

4.4 Quick Guide – Reading a plate

1. Turn on the instrument. Allow about 15 seconds for the self-diagnosis. Allow the instrument to warm up for about three minutes prior to reading a plate.
2. Upon power up, the login screen will appear. Enter the login password (initial password: 00000), press Enter.
3. Program a protocol for your assay. See [section 4.3.5](#) for editing a Kinetic protocol, or [section 4.3.7](#) for editing an End point protocol. Make sure filters installed correlate with information entered in reader firmware.
4. Select the protocol of choice, if programmed. See the [Memory Recall \(section 4.3.4\)](#) for detailed operation.
5. Review or print parameters set in the protocol. See [section 4.3.7 Editing End Point Protocol](#) for details.
 - (a) Verify settings on Cutoff, Report, Limit, STDs, Mode, Mapping, and kit name parameters are as desired.
 - (b) Protocol setting can be printed see [section 4.3.3 Printing Reports and Protocol information](#).
 - (c) All reports other than the Raw data report requires plate mapping. Set the plate map with instructions as in [section 4.3.11 Plate Map setting procedure](#).
 - (d) The Matrix and Limit reports require assignment of upper and lower limits. See [section 4.3.7, Editing End Point Protocol Limit setting window](#) to set the upper and lower limits.
 - (e) The Cutoff report requires definition of the cutoff setting. Refer to [section 4.3.8 for cutoff setting procedure](#).
 - (f) The Curve fit and Concentration reports require that standard concentration and locations be defined. Refer to [section 4.3.9 for details to define the standards and the curve fit parameters](#).
 - (g) Set general reading mode (single or dual wavelength reading, plate shaking, read mode, and incubation) following instructions in [section 4.3.10 Mode setting procedure](#).

After warm-up is complete:

6. Press “Main” key, the main screen will appear on the LCD.
7. Carefully place the microplate in the reading chamber. Close the reading chamber door and press the “Start/Stop” key to read.

4.5 Language choice

The Model 680 Microplate Reader has two versions, English and Chinese, in the on-board software. And it allows the user to choose between English and Chinese.

1. Language choice screen

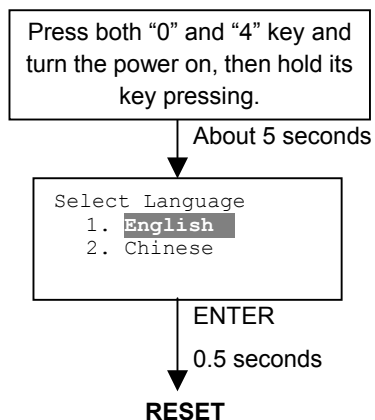

If both "0" key and "4" key are pressed at the same time and the power is turned on and then held for about 5 seconds, the reader will enter into the language choice mode. And the language choice screen is only shown in English.

Up and down arrow key are used to select a language. The enter key is used to determine it.

When the Enter key is pressed, the reader resets automatically. And then the reader restarts itself with the selected language.

If the selected language is difference from the previous language, the reader will clear all of memories and will be set to the initial condition. At that time the battery error screen appears, but it is not an actual error.

NOTE:

The details of the initial condition are described at the memory back-up section. See [section 4.2.3](#) for Memory Back-up.

2. Deference between English and Chinese version

There are some functionality differences between the English and the Chinese version as below.

- (1). On-board storage of standard curves and graphs
The Chinese version does not support the on-board storage of standard curves and graphs. Therefore, saving and recalling of a standard curve is not available for Chinese version.
- (2). Automatic mapping function for the plate mapping
The Chinese version has the function of automatic mapping, but it is an old style. It does not allow the user to input each number of the well types for a plate map.
- (3). Cutoff formula
The Chinese version supports only five types of the cutoff formula. The supported formulas for Chinese version are as follows.
 - i. $K * CNx$
 - ii. $K + CNx$
 - iii. $K * CNx + CPx$
 - iv. $(CNx + CPx) / K$
 - v. $K1 * CNx + K2 * CPx$
- (4). TeSeE Screening Report
The Chinese version does not support TeSeE and TeSeE eq screening report. Endpoint Protocol #5 and Endpoint Protocol #6 for Chinese version is worked as a normal endpoint protocol. The UTSE command and DTSE command in Command Language does not function in Chinese version.

(5). Retrieval function for plate data

The Chinese version does not support this feature. The URPD (Upload Raw Plate Data) and DRPD (Download Raw Plate Data) command in Command Language does not function in Chinese version.

(6). Serial number input/output

The Chinese version does not support Serial number input/output. It means that the serial number does not appear in the head line of each printout report.

Section 5. Instrument service by the user



Caution: Electrical shock hazardous! Always disconnect the instrument from the AC power source before opening the service compartment.



Caution: The lamp and the lamp cover may be very HOT! Use caution and allow the lamp to cool before attempting service.

5.1 Installing Interference Filters

1. With the power off, open the rear cover of the instrument by pressing the release latch located on the top left portion of the cover.
2. The filter wheel is located on the left side of the instrument. Note that the filter wheel has eight filter positions.
3. Rotate the filter wheel to the desired filter. Grasp the top of filter frame and pull up to remove the filter.
4. Insert the new filter into the desired filter position.
5. Ensure that the new filter is added to the filter list as follows: Main menu->Edit->Filters.



5.2 Changing the Lamp

1. With the power off, open the rear cover of the instrument by pressing the release latch located on the top left portion of the cover.
2. Remove the two screws on the black plastic cover and carefully remove the plastic cover.
3. Remove the screw on the metal cover. Lift the cover up and away from the instrument. This will allow the lamp to be pulled free from the lamp housing.
4. Holding the ceramic base in one hand and the lamp housing in the other, carefully pull the lamp free of the base.
5. Carefully insert the new lamp firmly in the ceramic base. Apply even pressure when inserting the lamp so that the bulb does not become misaligned in the reflector housing. Be extremely careful not to touch the front glass of the lamp during installation.
6. Position the new lamp into the housing so that the plastic guides hold the flange of the lamp.
7. Carefully place the metal cover over the lamp. Tighten the screw.
8. Replace the plastic cover and tighten the screws.
9. Close the rear cover.

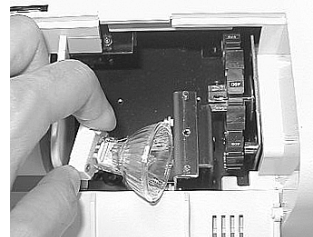

Section 6. Troubleshooting and Error Messages

The Model 680 Microplate Reader constantly monitors several functions and will display appropriate error message on the LCD when errors are encountered.

1. LCD appears blank on power up.
 - a. Power switch is not turned on. Turn on power switch on the rear panel.
 - b. Unit is not plugged into AC outlet or power code is not attached to the instrument. Check power cord connections at outlet and on the rear panel of the instrument.
 - c. The AC outlet is non-functional. Check circuit breakers or fuses.
 - d. Instrument has blown a fuse. Check the fuse on the rear panel of the instrument, and replace if necessary. Replace only with the same type fuse. If the instrument continues to blow fuses, discontinue use and contact your Bio-Rad service representative immediately.
2. Instrument displays "Light bulb error" message indicating that the bulb is burned out.
 - a. Lamp is not emitting light. Replace the lamp as described in Section 5.2
 - b. Lamp is emitting light. Check the alignment of the lamp in the housing. Align or replace the lamp if necessary.
3. Printer will not print on command.
 - a. Printer paper is not installed properly. Verify that the paper is properly installed. Refer to Section 3.1 for details.
4. Plate carriage jams during reading, and "Carrier home sensor open status error", "Carrier home sensor closed status error", "Carrier jammed error before reading", or "Carrier jammed error after reading" is displayed.
 - a. Plate is not seated in carriage properly. Press the STOP button immediately. Position the plate carefully in the carriage, making certain that it is properly seated.
5. LCD displays "Filter missing". Install a filter in the empty position. See Section 5.1. Select the installed filter by pressing Edit key.
6. LCD displays "Filter disk jammed", indicating that the filter wheel is not turning freely. Turn off the instrument, and inspect the filter wheel. Turn by hand to verify that the wheel is moving freely. Make sure that all the filters are properly installed and firmly seated. Contact your Bio-Rad representative if the filter wheel is jammed or if the problem persists.

- | | | |
|-----|---|---|
| 7. | LCD displays "Filter not installed". | Enter the Edit Menu by pressing Edit key, and set up the filters. |
| 8. | Wells have color, but absorbance values seem low. | |
| | a. | Incorrect filter used for measurement and /or reference wavelength. Check wavelength used in analysis. Read plate in single wavelength mode at all wavelength to verify that the proper filter was used. The measurement wavelength should produce the highest absorbance. |
| | b. | The best measurement wavelength filter for the substrate in use has not been installed in the filter wheel. Check references for the substrate you are using, or determine the best measurement wavelength by analyzing the substrate product on a scanning spectrophotometer. Custom filters are available from 400 to 750 nm. |
| | c. | The filters have been switched in the wheel. Check that the filters are installed in the correct position. |
| 9. | "Printer error" displayed. | Check for paper jam. Install the printer paper correctly. |
| 10. | "Battery error" displayed. | The internal battery is almost dead. Contact your local Bio-Rad service center or local representative. |
| 11. | "memory error" ,
"calendar error" ,
"LCD hardware error" ,
"Incubator error" ,
"Light level error between channel" ,
"D/A conversion error" ,
"A/D conversion error"
is displayed. | Contact your local Bio-Rad service center or local representative if these problems persist. |

Section 7. Specifications

7.1 Instrument Specifications

Operating panel	Membrane pad with 4 arrow keys, 7 function keys and 11 numeral keys	
Display	4 lines x 20 alphabet characters LCD	
Computer interface	Bi-directional RS232C serial communication port, 9 pin D-sub plug	
External printer port (Only when the internal printer option is not installed)	Centronics interface with ASCII character code 25 pin D-sub receptacle 80 characters output per line	
Report types	Raw, Absorbance, Matrix, Limit, Cutoff, Concentration, curve fit, difference, Kinetic Report	
Applicable plates	96 well microtiter plate of Polystyrene "flat", "U", "V" bottom rigid type (Plate Footprint: 127 x 85mm(standard size)) 8 and 12 well strip plate Maximum plate height: 16 mm	
Mixing	3 speeds(Low, Mid, High) Programmable time period: 0 - 999 seconds	
Data storage	Latest 10 data plates for end-point, latest 2 data plates of 30 readings for kinetic readings, protocol data and calendar/clock function shall be kept in memory by a lithium battery even when the power is off. Average lifetime of the battery shall be 5 years.	
Warm-up time	3 minutes	
Photometric Methods	Single and dual wavelength	
Photo detectors	8 silicon photodiodes for measurement and 1 silicon photodiode for reference	
Light source	Tungsten halogen lamp 20W with 3000 hours average lifetime	
Spectral range	400nm to 750nm	
Interference filters	Wavelength tolerance: $\pm 3.0\text{nm}$, Band width: 10nm typically	
Filter capacity	8 filters	
Standard filters	450, 415, 490, 655nm	
Optional filters	405, 540, 550, 570, 595, 630, 750nm	
Reading speed	Fast Reading	6 second with single wavelength reading 10 second with dual wavelength reading
	Standard Reading	15 second with single wavelength reading 30 second with dual wavelength reading
Indication range	0.000 to 3.5 OD	
Resolution	0.001 OD	

Accuracy	±1.0% or 0.010 OD from 0 to 3.0 OD at 490nm	
Linearity	±1.0% from 0 to 2.0 OD, ±2.0% from 0 to 3.0 OD	
Reproducibility	1.0% or 0.005 OD from 0 to 2.0 OD, 1.5% from 2.0 to 3.0 OD	
Inter-channel variation	1.5% or 0.005 OD from 0 to 3.0 OD	
Stability and Drift	0.010 OD at OD=1 with single wavelength reading	
Incubator (Factory option)	Temperature set point	25°C to 45°C, 0.1°C step Set point must be 5°C above ambient.
	Set point accuracy	Less than ±0.5°C when set point =37°C at RT=25°C
	Well to well uniformity	Less than 0.7°C when set point =37°C at RT=25°C
	Warm-up time	Less than 5 minutes when set point =37°C at RT=25°C
Internal Printer (Factory option, external printer port is not available when this option is installed)	Thermal printer, Paper Width 112mm	
Line Voltage	Universal input: 100 - 240 VAC, 50/60Hz	
Power consumption	100 VA max.	
Dimensions	340(W) x 330(D) x 152(H) mm	
Weight	5.5 kg	
Operating Environment	5°C to 35°C 0 to 95% relative humidity without condensation	
Storage Temperature	-20°C to 50°C 0 to 95% relative humidity without condensation	

7.2 Interface Specifications

The following specification describes the syntax and language required for computer control of the reader.

1. SIGNALS

TXD: transmit data
RXD: receive data
DTR: data terminal ready
DSR: data set ready
CTS: clear to send
RTS: request to send

2. TRANSMISSION

Baud rate: 9600
Data width: 8
Stop width: 1
Parity: None

3. DATA

All data must be transmitted in ASCII.

The READER command interpreter must be "case blind" (no distinction between upper or lower case ASCII characters).

The first two characters of the command can distinguish all READER commands from each other.

4. SIGNAL ASSIGNMENT

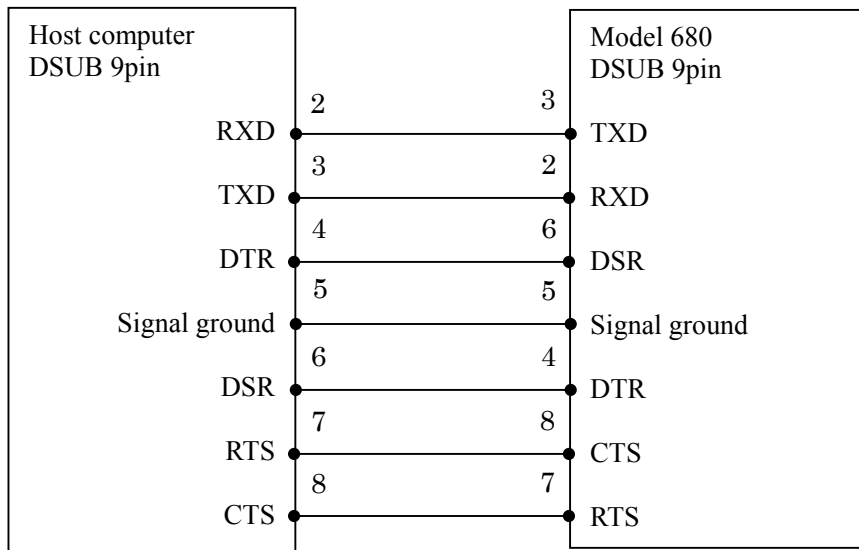

7.3 Command Language for Model 680 Microplate Reader

7.3.1 Command Language for Remote control mode

1-1. Syntax

SYNTAX:

Command: <device name><space><command>[<space><command args.>...]<cr>

<device name>: "EIA.READER" – Model680 reader

Response: <response header><space><error code>[<space><response data>...]<cr>
<response header>: "ERE"

1-2. Commands

1-2-1. ID (Get Instrument ID)

<command>: "ID"

Request device ID

<arguments>: None

<response>: "ERE"<space><error code><space><id><cr>

<id>: "Model 680"

1-2-2. AQ (Go to remote control mode)

<command>: "AQ"

Acquire remote control of the device and lock front panel key pad.

<arguments>: none

<response>: "ERE"<space><error code><cr>

NOTE: Until the reader receives the "AQ" command, the reader will not accept any other command by responding error code of "8073"-Device not in remote mode. Once the reader received the "AQ" command, the reader will turn into remote mode and lock all keys on front panel except for START/STOP for release.

1-2-3. RL (Release remote control mode)

<command>: "RL"

Release remote control of the device and lock front panel key pad.

<arguments>: no arguments

<response>: "ERE"<space><error code><cr>

1-2-4. RS (Reset device)

<command>: "RS"

Reset device to power up configuration local mode

<arguments>: none

<response>: "ERE"<space><error code><cr>

1-2-5. MR (Maintenance report)

<command>: "MR"

Transmit maintenance report

<arguments>: none

<response>: "ERE"<space><error code><cr><mrecords><cr>

<mrecords>: maintenance records;

"On/Off:" <#on/off><cr>:number of times the reader was turned on.

"Hours :" <#hours><cr>:number of hours the reader was on.

"Plates:" <#plates><cr>:number of plates read.

Note: <#on/off>, <#hours> and <#plates> are 4 ASCII encoded decimal values. This information is kept in battery backup RAM

1-2-6 RM (Reset maintenance report)

<command>: **"RM"**
Reset maintenance report values.
<arguments>: none
<response>: "ERE"<space><error code><cr>

1-2-7. ISTATUS (Get incubator status)

<command>: **"ISTATUS"**
Request incubator status from reader.
<arguments>: none
<response>: "ERE"<space><error code><space><inc status><cr>
<inc status>: <incubator exist status><space><on/off><space><setting temperature value>
<space><sensor temperature value>
incubator exist status: "0":The reader don't have incubator / "1":The reader have incubator.
on/off - Incubator ON/OFF status, "0": incubator OFF / "1": incubator ON
setting & sensor temperature value:
(Temperature is 3 bytes ASCII encoded decimal value and floating point. ex: "37.0")

1-2-8. INCU (Set Incubator)

<command>: **"INCU"**
Incubator ON/OFF control; Benchmark Compatible Format
<arguments>: <on/off>
<cmd args>: on/off - Incubator ON/OFF
"0"; incubator OFF
"1"; incubator ON
<response>: "ERE"<space><error code><cr>

1-2-9. WINC (Set Incubator Temperature)

<command>: **"WINC"**
Set Incubator control temperature data
<arguments>: < temperature >
<cmd args>: Setting temperature value (degree).
ASCII encoded decimal(1-10)
temperature set range: 25.0 to 45.0 degree
Incubation adjustable in increments of 0.1 degree.
<response>: "ERE"<space><error code><cr>

1-2-10. FSTATUS (Get filter wheel status)

<command>: **"FSTATUS"**
Request filter wheel status from the reader.
<arguments>: none
<response>: "ERE"<space><error code><cr><filter status><cr>
<filter status>: <wl.1><space><wl.2><space><wl.3><space><wl.4><space>
<wl.5><space><wl.6><space><wl.7><space><wl.8>
wl.1 – wl.8:
filter wavelength at position 1 – position 8. ex."405"(ASCII encoded decimal)
"****" will be returned when filter is not installed

1-2-11. RWELL (Read a plate well)

<command>: **"RWELL"**
Read a plate well

<arguments>: Single reading: <cl><space><rw><space><wp1>
Dual reading: <cl><space><rw><space><wp1><space><wp2>

< cmd args>: <cl>: Column number ASCII encoded decimal(1-12)
<rw>: Row number ASCII encoded decimal(1-8)
<wp1>: Measurement filter position ASCII encoded decimal(1 to 8)
<wp2>: Reference filter position ASCII encoded decimal(1 to 8)
Optional; only present for Dual wavelength reading

<response>: "ERE"<space><error code><space><abs.val><space>
<optional abs.val2 for reference wavelength><cr>
<abs.val1>: Absorbance values at measurement wavelength
(ASCII encoded floating point format) ex. "1.234"
<abs.val2>: Absorbance values at reference wavelength
(ASCII encoded floating point format) ex. "1.234"

1-2-12. RPLATE (Read plate)

<command>: **"RPLATE"**
Perform plate reading once

<arguments>: <sp><speed><sp><mix time><sp><mix speed><sp><meas. filter><sp><ref. filter>

< cmd args>: <speed>: Plate reading speed, "1": fast speed, "2": Normal speed(ASCII encoded decimal)
<mix time>: Plate mixing time(0 to 999) (ASCII encoded decimal)
<mix speed>: Plate mixing power("L":Low, "M":middle,"H":High)
<meas. filter>: Measurement filter position(1 to 8)(ASCII encoded decimal)
<ref. filter>: Reference filter position(1 to 8)(ASCII encoded decimal)
(Optional; only present for Dual wavelength reading)

<sp>: space(' ')

<response>: "ERE"<space><error code><space><abs. data><cr>

1-2-13. RTPLATE (Retransmit plate data)

<command>: **"RTPLATE"**
Retransmit the last one plate data
If the previous reading was read in the kinetic mode, the last plate data means the final plate data from the set of plate data.

<arguments>: none

<response>: "ERE"<space><error code><space><abs. data><cr>

1-2-14. UPLD (Upload the protocol data)

<command>: **"UPLD"**
Upload the protocol data
<arguments>: <up load protocol number>
<cmd args>: <up load protocol number>: 1 to 66 (1 to 64 for Endpoint protocol, 65&66 for kinetic protocol)
Example: EIA.READER UPLD 1 <cr>
<response>: "ERE"<space><error code><space><protocol data><cr>

1-2-15. DOWNLD (Download the protocol data)

<command>: **"DOWNLD"**
Download the protocol data
<arguments>: <down load protocol number><space><protocol data>
<down load protocol number>: 1 to 66 (1 to 64 for Endpoint protocol, 65&66 for kinetic protocol)
<protocol data>: Down load protocol data(see "1-4 Protocol data")
<response>: "ERE"<space><error code><cr>

1-2-16. UTSE (Upload the TSE assay parameters)

<command>: **"UTSE"**
Upload the TSE assay parameters
<arguments>: <TSE type>:0= for TSE parameters / 1=for TSE EQ parameters
Example: EIA.READER UTSE 0 <cr>
<response>: "ERE"<space><error code><space><TSE or TSE eq assay parameters><cr>

1-2-17. DTSE (Download the TSE assay parameters)

<command>: **"DTSE"**
Download the TSE assay parameters
<arguments>: <TSE type><space><TSE or TSE eq assay parameters>
<TSE type>: 0= for TSE parameters / 1= for TSE eq parameters
<TSE assay parameters>: Down load TSE assay parameters (see"1-5 TSE and TSE eq assay parameters")
<response>: "ERE"<space><error code><cr>

1-2-18. URPD (Upload Raw Plate Data)

<command>: **"URPD"**
Upload Raw Plate Data
<arguments>: <type><space><memory number><space><data type>[<space><read number of kinetic >]
<cmd args>: <type>:Data type(Endpoint= 0, Kinetic= 1)
memory number>: Memory # (Endpoint: 1 to 10, Kinetic: 1 or 2)
<data type>: Data type (Header= 0, Full Data= 1)
<read number of kinetic>: Reading number of kinetic (0, 1 -> 30) Optional for Kinetic
It is only valid for the <data type>=1
Zero ("0") means that its parameter is inactive.
Example: EIA.READER URPD 0 1 1 0<cr>
<response>: "ERE"<space><error code><space><Raw plate data><cr>
<Raw plate data>: See "1-6. Upload Raw Plate Data format"

1-2-19. DRPD (Download Raw Plate Data)

<command>: **"DRPD"**
Download Raw Plate Data
<arguments>: <raw plate data>
<raw plate data>: See "1-7. Download Raw Plate Data format"
<response>: "ERE"<space><error code><cr>

1-2-20. SSN (Set Serial Number)

<command>: **"SSN"**
 Set Serial number
<arguments>: <Serial number>
 <Serial number>: Max 5 ASCII characters(""(0x20) to "~"(0x7e))
 Example: eia.reader ssn EP001<cr>
<response>: "ERE"<space><error code><cr>

1-2-21. GSN (Get Serial Number)

<command>: **"GSN"**
 Get Serial number
<arguments>: none
<response>: "ERE"<space><error code><space><serial number><cr>
 <Serial number>: 5 ASCII characters (The length of serial number is always 5.)
 Example: eia.reader gsn<cr>
<response>: "ERE" 0000 EP001<cr>

1-3. Absorbance Data

1-3-1. Abs data

<abs.data>:	<header><date time><reading info><Mes. data><cr>[<Ref. wavelength data><cr>] Ref.data present for dual wavelength readings.
<header>:	"BIO-RAD Model 680 Microplate READER"<cr>
<date time>:	<day> "/" <month> "/" <year> <space> <hour> ":" <minutes> "." <seconds> ><cr> ex. "01/01/2001 01:05:02"
<reading info>:	"Mes. filter:"<measurement filter wavelength data><cr> "Ref. filter:"<reference filter wavelength data><cr> Only when Dual wavelength reading
<Mes.data>:	"begin"<cr><8 rows of 12 wells of abs. values><checksum><cr>".end"<cr> Measurement wavelength absorbance values are in ASCII encoded floating point format. Each absorbance value is separated by a space, but in case of minus value, a minus sign is put instead. Row1=wells(A1-A12),Row2=wells(B1-B12),....Row8=wells(H1-H12)
<Ref.data>:	".begin"<cr><8 rows of 12 wells of abs. values><checksum><cr>".end"<cr> Reference wavelength absorbance values are in ASCII encoded floating point format. Each absorbance value is separated by a space, but in case of minus value, a minus sign is put instead. Row1=wells(A1-A12),Row2=wells(B1-B12),....Row8=wells(H1-H12)
<checksum>:	The checksum is a two byte sum in ASCII encoded decimal(0-255) of all the ASCII characters transmitted in the measurement or reference data block. The checksum does not include the character string ".begin"<cr> in the checksum calculations.

The following is an example of both <Mes.data> and <Ref.data>:

```
".begin"<cr>
" 0.101 0.102 0.103 0.104 0.105 0.106 0.107 0.108 0.109 0.110 0.111 *.*.*"<cr>
" 0.201 0.202 0.203 0.204 0.205 0.206 0.207 0.208 0.209 0.210 0.211 *.*.*"<cr>
" 0.301 0.302 0.303 0.304 0.305 0.306 0.307 0.308 0.309 0.310 0.311 *.*.*"<cr>
" 0.401 0.402 0.403 0.404 0.405 0.406 0.407 0.408 0.409 0.410 0.411 *.*.*"<cr>
" 0.501 0.502 0.503 0.504 0.505 0.506 0.507 0.508 0.509 0.510 0.511 *.*.*"<cr>
" 0.601 0.602 0.603 0.604 0.605 0.606 0.607 0.608 0.609 0.610 0.611 *.*.*"<cr>
" 0.701 0.702 0.703 0.704 0.705 0.706 0.707 0.708 0.709 0.710 0.711 *.*.*"<cr>
" 0.801 0.802 0.803 0.804 0.805 0.806 0.807 0.808 0.809 0.810 0.811 *.*.*"<cr>
<checksum><cr>
".end"<cr>
```

Note: Absorbance value greater than 3.500 or smaller than -3.500 shall be transmitted as asterisk.

1-4. Protocol data

All protocol data is ASCII code data.

Transmit format: <"(0x2c)><protocol data 1>< ",><protocol data 2><">...<protocol data 42><">,">(0x2c) delimits each protocol item.

Protocol data download or upload orders:

	Item	P.C or Reader Transmit data
1	Protocol mode	"0"(endpoint) or "1"(kinetic), "2"(TeSeE), "3"(TeSeE eq)
2	Security lock status	"0" unlock / "1" lock
3	Kit name[16]:	ASCII characters (max 15characters + null code)
4	Plate reading mode	Plate reading mode ("0":Single / "1":Dual)
5	Evaluation mode(endpoint only)	"1"(Normal) or "2"(Evaluation)
6	Precision mode	1:Standard precision mode / 2:High precision mode
7	Number of reads	"1" (endpoint) / "2" to "30"(kinetic mode)
8	Interval time [30](Kinetic mode)	[0]:Start delay time, [1] to [29]:interval time Start delay: "0" to "999" sec Interval time: "0" to "1029" sec
9	Measurement wavelength data	"400" to "750"nm
10	Reference wavelength data	"400" to "750"nm (When the single reading mode is single, Reference wavelength should be set to "(0x20).)
11	Shaking mode	"0" to "2" "0"(disable) "1"(1 st read(kinetic mode only)) "2"(before every read)
12	Shaking speed	"0" to "2" "0"(Low) / "1"(Middle) / "2"(High)
13	Shaking time	"0"to"999"sec
14	Incubation control temperature	"25.0" to"45.0" (include decimal point)
15	Incubator enabled	"0" or "1" "0"(No) / "1"(Yes)
16	Cutoff type	"0" to "4" "0"(Don't use cutoff) "1"(cutoff constant) "2"(cutoff control) "3"(value by formula) "4"(Ratio to calibrator)
17	Cutoff value	"0" to "1" "0"(Single cutoff) "1"(Ranged cutoff)
18	Cutoff formula type	"1" to "12" "1": k*CNx "7": k + CNx "2": k*CPx "8": k + CPx "3": k*COx "9": k + COx "4": CNx / k "10": k*CNx + CPx "5": CPx / k "11": (CNx+CPx) / k "6": COx / k "12": k1*CNx + k2*CPx
19	Cutoff unit<cr>	"0"(STD unit) / "1"(OD)
20	Cutoff K (K and K1)	"0.01" to "10.0" (data length max: 4 characters(include decimal point))
21	Cutoff K2	"0.01" to "10.0" (data length max: 4 characters(include decimal point))
22	Cutoff positive const value	".001 to 9999"

		(data length max: 4 characters(include decimal point))
23	Cutoff negative const value	“.001 to 9999” (data length max: 4 characters(include decimal point))
24	Gray zone	“0” to “99”
25	Calibrator concentration value	“0.001 to 9999” (data length max: 5 characters(include decimal point))
26	Recall setting of Standard curve [3]	[0] Recall setting: “1”: No recall, “2”: Recall [1] Recall STD curve number: “1” to “5” [2] No use: (Default= “1”) (“ (0x20) data delimits replicate number.)
27	Number of standard	“0” to “12”
28	Standard conc. value[12]	“0.000” to “9999” (“ (0x20) data delimits each standard conc..) (std.value < 1.0: max 5 characters(include decimal point)) (std.value >= 1.0: max 4 characters(include decimal point))
29	Standard unit	“1” to “17” 1: mol/l 2: mmol/l 3: umol/l 4: nmol/l 5: pmol/l 6: mg/l 7: ng/l 8: pg/l 9: ug/dl 10: ng/ml 11: pg/ml 12: U/ml 13: IU/ml 14: uIU/ml 15: mIU/ml 16: EU 17: ARBITRARY
30	Curve fit type	“1” to “10” 1: 5-parameter logistic Rodbard formula 2: 4-parameter logistic Rodbard formula 3: 5-parameter logistic Cook-Wilkenson 4: 4-parameter logistic Cook-Wilkenson 5: 5 Parameter Exponential 6: Sigmoid logistic 7: Linear regression 8: Quadratic regression 9: Cubic spline 10: Point to Point regression
31	Lower limit value	Lower limit value (0 to 3500(O.D value *1000))
32	Upper Limit value	Upper limit value (0 to 3500(O.D value *1000))
33	Correlation coefficient limit (kinetic)	Correlation coefficient limit value (0 to 999 (C.C value * 1000))
34	Calculation range start point (Kinetic)	Kinetic calculation range start point reading number (1 to 29) (This value is lower than calculation start point value.)
35	Calculation range endpoint (Kinetic)	Kinetic calculation range end point reading number (1 to 29) (This value is big than calculation end point value.)
36	GALT factor value	“0 to 9999.99” (data length max: 7characters(include floating point)) (A decimal place maximum length is 2.)
37	GALT assay status	0: other assay / 1: GALT assay
38	Kinetic print out report[4]	Kinetic mode Print out report types (0=no print / 1=print) [0]: Absorbance [1]: kinetic plots [2]: Linear regression [3]: GALT report
39	Print out Report [9]	Print out report types (0=no print / 1=print) [0]: Raw data [1]: Absorbance data [2]: Limit [3]: Matrix [4]: Cutoff [5]: Curvefit [6]: Difference

		[7]: Difference subtraction 0:Even-Odd (column) 1:Odd-Even(column) 2:Even-Odd(row) 3:Odd-Even(row) [8]: Concentration (“(0x20) data delimits print out report types.)
40	Graph Scale	print out graph scale (“1” to “4”) 1:X-Log,Y-Log 2:X-Log,Y-Linear 3:X-Linear,Y-Log 4:X-Linear,Y-Linear
41	Plate well format data[8][12]	Plate format data(“0” to “9”) “0”: Empty “1”: Sample “2”: Standard “3”: Positive control “4”: Negative control “5”: Cutoff control “6”: Weak positive control “7”: QC Control “8”: Blank “9”: Calibrator (“(0x20) data delimits each row format.)
42	Plate well solution number data[8][12]	Solution number (“0” to “99”) (“(0x20) data delimits each row solution number.)

Example:

```

“,0,0,End point #01 ,0,1,1,10,30 30 30 30 30 30 30 30 30 30 30 30 30 30 30 30 30 30 30 30 30 30 30 30
30 30 30 30 30 30 0,490,630,2,1,3,37.0,0,1,1,5,0,0.700,1.200,0.558,0.012,24,2.580,0 0 0,8,0.500
1.000 1.500 2.000 2.500 3.000 3.500 4.000 4.500 5.000 5.500
6.000,16,10,0.500,1.000,0.998,1,10,0.98,0,0 0 0,0 0 0 0 1 0 1 3 0,4,8 2 3 9 1 1 1 1 1 1 1,8 2 4 9 1 1
1 1 1 1 1 1,8 2 1 6 1 1 1 1 1 1 1,8 2 1 1 1 1 1 1 1 1,8 2 1 1 1 1 1 1 1,8 2 1 1 1 1 1 1 1 1,8
2 1 1 1 1 1 1 1 1,8 2 1 1 1 1 1 1 1 1,0 1 1 7 15 23 31 39 47 55 63 71,1 2 1 8 16 24 32 40 48 56 64
72,2 3 1 9 17 25 33 41 49 57 65 73,3 4 2 10 18 26 34 42 50 58 66 74,4 5 3 11 19 27 35 43 51 59 67
75,5 6 4 12 20 28 36 44 52 60 68 76,6 7 5 13 21 29 37 45 53 61 69 77,7 8 6 14 22 30 38 46 54 62 70
78,”

```

1-5. "TSE" and "TSE eq" Assay Parameter Format

"TSE" and "TSE eq" parameter is same format.

All parameter data is ASCII code data.

Transmit format: <"(0x2c)><TSE item 1><"><TSE item 2><"> ...<TSE item 7><">

"(0x2c) delimits each parameters item.

"TSE" and "TSE eq" assay data download or upload orders:

	Item	P.C or Reader Transmit data
1	Report title [24]:	Report title (for internal & external print report) ASCII characters (max 24characters)
2	Maximum OD value for Control Negative	"1" to "3500" This value is Maximum OD * 1000, no decimal point data length max: 4 characters
3	Minimum O.D value for Control Negative	"-3500" to "3500" This value is Minimum OD * 1000, no decimal point data length max: 5 characters (include sign character) (This value is lower than Max O.D value for CN.) This value is not being used.
4	validation data rang for Control Negative	"1" to "999" Data range (0.001 to 0.999 * 1000, no decimal point data length max: 3 characters
5	Minimum O.D value for Control Positive	"1" to "3500" This value is Minimum OD * 1000, no decimal point data length max: 4 characters include sign flag
6	Calculation value k1 (Positive Cut-off=(CNx + K1) * k2)	"0" to "9999" K1 Calculation value * 1000 data length max: 4 characters
7	Calculation value k2 (Positive Cut-off=(CNx + K1) * k2)	"0" to "9999" K2 Calculation value * 1000 data length max: 4 characters
8	Calculation value k3 (Negative Cut-off= (CNx + K3) * k4)	"0" to "9999" K3 Calculation value * 1000 data length max: 4 characters
9	Calculation value k4 (Negative Cut-off= (CNx + K3) * k4)	"0" to "9999" K4 Calculation value * 1000 data length max: 4 characters

Example:

"TSE assay report ,2500,123,400,1010,210,1000,210,900

1-6. Upload Raw Data Format

1-6-1. Header Type Format of the Upload Raw Plate Data

<upload raw plate data>: <memory #><data exist><date time><cr>
< memory #>: (1). End point
 "End point # " <memory number>"<cr>
 <memory number>: 1 to 10 (End point)
 ex. "End point #1"
(2). Kinetic
 "Kinetic # " <memory number>"<cr>
 1 or 2 (Kinetic)
<data exist>: "Exist: "<exist><cr>
 <exist>: Exist = "1", No exist= "0"
 ex. "Exist: 1"
<date time>: <day> "/" <month> "/" <year> <space> <hour> ":" <minutes> ":" <seconds> ><cr>
 ex. "01/01/2003 01:05:02"

1-6-2. Full Data Type Format of the Upload Raw Plate Data

1-6-2-1. Full Data Type Format for End point

<upload raw plate data>: <memory #><data exist><date time><reading info>
 <Mes. data><cr>
 [<Ref. data><cr>] --- Ref.data present only for dual wavelength reading.

<memory #><data exist><date time>: Same as "1-6-1. Header Type Format of the Upload Raw Plate Data"

<reading info>: "Protocol #: "<protocol number><cr>
 <protocol number>: 1 to 64
 "Kit name: "<kit name><cr>
 <kit name>: Max 15 char
 "Mes. filter:"<measurement filter wavelength data><space>("<filter number>")"<cr>
 <wavelength data>: 400 to 750
 <filter number>: 1 to 8
 "Ref. filter:"<reference filter wavelength data><space>("<filter number>")"<cr>
 Only when Dual wavelength reading

<Mes. data><cr>[<Ref. data><cr>]: Same as Abs. Data (See "1-3. Absorbance Data Format")

1-6-2-2. Full Data Type Format for Kinetic

<upload raw plate data>: <memory #><data exist><date time><plate #>< reading info> | <plate info>
<Mes. data><cr>
[<Ref. data><cr>] > --- Ref.data present only for dual wavelength reading.

<memory #><data exist><date time>: Same as "1-6-1. Header Type Format of the Upload Raw Plate Data"

<plate #>: 0 to 30

"0": It only generates <reading info>.

"1" to "30": this number generates each plate data.

(1). <plate #>= 0

<reading info>: "Protocol #: "<protocol number><cr>
 <protocol number>: 65 to 66
"Kit name: "<kit name><cr>
 <kit name>: Max 15 char
"Shaking mode: "<shaking mode><cr>
 <shaking mode>: "No" / "Before 1sr read" / "Before every read"
"Shaking speed: "<shaking speed><cr>
 <shaking speed>: "Low" / "Middle" / "High"
"Shaking time: "<shaking time><cr>
 <shaking time>: 0 to 999
"Number of reads: "<# of reads><cr>
 <# of reads>: 2 to 30
"Read interval: "<interval 1><space><interval 2><space>... <interval 29><cr>
 interval time: 6 to 1029
"Mes. filter: "<measurement filter wavelength data><space>("&<filter number>")"<cr>
 <wavelength data>: 400 to 750 for Model 680
 <filter number>: 1 to 8
"Ref. filter:"<reference filter wavelength data><space>("&<filter number>")"<cr>
 Only when Dual wavelength reading

(2). <plate #>= 1 to 30

<plate info>: "Plate #: "<plate number><cr>
 <date time><cr>

<Mes. data><cr>[<Ref. data><cr>]: Same as Abs. Data (See "1-3. Absorbance Data Format")

1-7. Download Raw Plate Data Format

All protocol data is ASCII code data.

Transmit format: <"(0x2c)><plate datum 1><"><plate datum 2><">...<plate datum n><">
 "(0x2c) delimits each parameters item.

1-7-1. End point's Download Raw Plate Data Format

The assignment of the Download Raw Plate Data format of End point:

#	Item of the plate datum	Details
1	Plate data mode	"0"(End point), "1"(Kinetic)
2	Memory number	"1" to "10" (End point), "1" or "2" (Kinetic)
3	Kit name [16]	ASCII characters (max 15characters + null code)
4	Plate reading mode (S/D)	Plate reading mode ("0": Single / "1": Dual)
5	Measurement wavelength	Model 680: "400" to "750"nm
6	Reference wavelength	Model 680: "400" to "750"nm A space character (0x20) is available for Single reading.
7	Measurement filter number	"1" to "8"
8	Reference filter number	"1" to "8" A space character (0x20) is available for Single reading.
9	Protocol number	"1" to "64" (End point), "65" or "66" (Kinetic)
10	Plate reading date	<year>"/<month>"/<day><space><hour>":"<minutes>":"<seconds> <year>: "00" to "99" (2000 to 2099) <month>: "1" to "12" <day>: "1" to "31" <hour>: "0" to "23" <minutes>: "0" to "59" <seconds>: "0" to "59"
11	Begin of <Mes. data>	"begin"
12	<Mes. data>	<Mes.data>: Abs. Data (See below "Abs. Data Sample") Measurement wavelength absorbance values are in ASCII encoded floating point format. Ex. 0.000 Each absorbance value is separated by a space, but in case of minus value, a minus sign is put instead. Each row of 12 well values is separated by a comma (.). <8 rows of 12 wells of abs. values>: Row1=wells (A1 to A12)," Row2=wells (B1 to B12),"... Row8=wells (H1 to H12)
13	End of <Mes. data>	"end"
14	Begin of <Ref. data>	"begin", put only for dual wavelength reading
15	<Ref. data>	<Ref.data>: Abs. data, put only for dual wavelength reading (See below "Abs. Data Sample") <8 rows of 12 wells of abs. values>: Row1=wells (A1 to A12)," Row2=wells (B1 to B12),"... Row8=wells (H1 to H12)
16	End of <Ref. data>	"end", put only for dual wavelength reading

Abs. Data Sample of <Mes. data> and <Ref. data>

```
" 0.101 0.102 0.103 0.104 0.105 0.106 0.107 0.108 0.109 0.110 0.111 0.112"<">
" 0.201 0.202 0.203 0.204 0.205 0.206 0.207 0.208 0.209 0.210 0.211 0.212"<">
" 0.301 0.302 0.303 0.304 0.305 0.306 0.307 0.308 0.309 0.310 0.311 0.312"<">
" 0.401 0.402 0.403 0.404 0.405 0.406 0.407 0.408 0.409 0.410 0.411 0.412"<">
" 0.501 0.502 0.503 0.504 0.505 0.506 0.507 0.508 0.509 0.510 0.511 0.512"<">
" 0.601 0.602 0.603 0.604 0.605 0.606 0.607 0.608 0.609 0.610 0.611 0.612"<">
" 0.701 0.702 0.703 0.704 0.705 0.706 0.707 0.708 0.709 0.710 0.711 0.712"<">
" 0.801 0.802 0.803 0.804 0.805 0.806 0.807 0.808 0.809 0.810 0.811 0.812"
```

Example:

```
eia.reader DRPD ,0,1,End point #1 ,0,415, ,2, ,1,03/2/18 14:00:00,begin, 0.101 0.102 0.103 0.104 0.105
0.106 0.107 0.108 0.109 0.110 0.111 0.112, 0.201 0.202 0.203 0.204 0.205 0.206 0.207 0.208 0.209
0.210 0.211 0.212, 0.301 0.302 0.303 0.304 0.305 0.306 0.307 0.308 0.309 0.310 0.311 0.312, 0.401
0.402 0.403 0.404 0.405 0.406 0.407 0.408 0.409 0.410 0.411 0.412, 0.501 0.502 0.503 0.504 0.505
0.506 0.507 0.508 0.509 0.510 0.511 0.512, 0.601 0.602 0.603 0.604 0.605 0.606 0.607 0.608 0.609
0.610 0.611 0.612, 0.701 0.702 0.703 0.704 0.705 0.706 0.707 0.708 0.709 0.710 0.711 0.712, 0.801
0.802 0.803 0.804 0.805 0.806 0.807 0.808 0.809 0.810 0.811 0.812,end,
```

1-7-2. Kinetic's Download Raw Plate Data Format

The assignment of the Download Raw Plate Data format of Kinetic:

#	Item of the plate datum	Details
1	Plate data mode	"0"(End point), "1"(Kinetic)
2	Memory number	"1" to "10" (End point), "1" or "2" (Kinetic)
3	Total number of reads	"2" to "30"
4	Reading number	"0", "1" to "30" (1). The number 0 means that the successive data from here are the reading condition. (2). The number 1 to 30 means the reading number of the series of Kinetic readings. It should not exceed the total number of reads.
(1) Reading number = "0"		
5	Kit name [16]	ASCII characters (max 15characters)
6	Plate reading mode (S/D)	Plate reading mode ("0": Single / "1": Dual)
7	Measurement wavelength	Model 680: "400" to "750"nm
8	Reference wavelength	Model 680: "400" to "750"nm A space character (0x20) is available for Single reading.
9	Measurement filter number	"1" to "8"
10	Reference filter number	"1" to "8" A space character (0x20) is available for Single reading.
11	Protocol number	"1" to "64" (End point), "65" or "66" (Kinetic)
12	Shaking mode	"0"(disable), "1"(before 1st read), "2"(before every read)
13	Shaking speed	"0"(low), "1"(Middle), "2"(High)
14	Shaking time	"0" to "999" sec
15	Start delay	"0" to "999" sec
16	Reading interval [29]	"6" to "1029" sec for Model 680 Interval time values must be separated by a space code. 1-2,2-3,3-4,4-5,5-6,6-7,7-8,8-9,9-10,10-11,11-12,12-13,13-14,14-15,15-16,16-17,17-18,18-19,19-20,20-21,21-22,22-23,23-24,24-25,25-26,26-27,27-28,28-29,29-30

(2) Reading number= "1" to "30"		
5	Plate reading date	<year>"/"<month>"/"<day><space><hour>:"<minutes>:"<seconds> <year>: "00" to "99" (2000 to 2099) <month>: "1" to "12" <day>: "1" to "31" <hour>: "0" to "23" <minutes>: "0" to "59" <seconds>: "0" to "59"
6	Begin of <Mes. data>	"begin"
7	<Mes. data>	<Mes.data>: Abs. Data (See "Abs. Data Sample") Measurement wavelength absorbance values are in ASCII encoded floating point format. Ex. 0.000 Each absorbance value is separated by a space, but in case of minus value, a minus sign is put instead. Each row of 12 well values is separated by a comma (,). <8 rows of 12 wells of abs. values>: Row1=wells (A1 to A12)," Row2=wells (B1 to B12),"... Row8=wells (H1 to H12)
8	End of <Mes. data>	"end"
9	Begin of <Ref. data>	"begin", put only for dual wavelength reading
10	<Ref. data>	<Ref.data>: Abs. data, put only for dual wavelength reading (See "Abs. Data Sample") <8 rows of 12 wells of abs. values>: Row1=wells (A1 to A12)," Row2=wells (B1 to B12),"... Row8=wells (H1 to H12)
11	End of <Ref. data>	"end", put only for dual wavelength reading

Example:

```
eia.reader DRPD ,1,1,10,0,Kinetic #1 ,0,415, ,2, ,65,0,0,0,30,20 20 20 20 20 20 20 20 10 10 10 10
10 10 10 10 10 10 10 10 10 10 10 10 10,
```

```
eia.reader DRPD ,1,1,10,1,03/3/19 15:00:00,begin, 0.101 0.102 0.103 0.104 0.105 0.106 0.107 0.108
0.109 0.110 0.111 0.112, 0.201 0.202 0.203 0.204 0.205 0.206 0.207 0.208 0.209 0.210 0.211 0.212,
0.301 0.302 0.303 0.304 0.305 0.306 0.307 0.308 0.309 0.310 0.311 0.312, 0.401 0.402 0.403 0.404
0.405 0.406 0.407 0.408 0.409 0.410 0.411 0.412, 0.501 0.502 0.503 0.504 0.505 0.506 0.507 0.508
0.509 0.510 0.511 0.512, 0.601 0.602 0.603 0.604 0.605 0.606 0.607 0.608 0.609 0.610 0.611 0.612,
0.701 0.702 0.703 0.704 0.705 0.706 0.707 0.708 0.709 0.710 0.711 0.712, 0.801 0.802 0.803 0.804
0.805 0.806 0.807 0.808 0.809 0.810 0.811 0.812,end,
```

7.3.2 Error Codes

Error code	Error	Cause	Recovery
0000	No error		
8071	Invalid Command	The received data is not a command for the instrument	
8072	Parameter out of range	The received parameter is out of range	
8073	Device Not In Remote Mode	The instrument is not in remote mode	
8074	Device busy	The instrument is doing a job.	
8075	Filter wheel	Filter wheel jammed.	"reset" command.
8076			
8077	Light bulb burned out	Insufficient light level	"reset" command.
8078			
8079			
8080			
8081			
8082			
8083	Incubator error	Incubator over heat.	
8084	Plate carrier error-1	Plate carrier home sensor closed status error	"reset" command.
8085	Plate carrier error-2	Plate carrier home sensor open status error	"reset" command.
8086	Plate carrier error-3	Plate carrier jammed before reading	"reset" command.
8087	Plate carrier Position	Plate carrier jammed after reading	"reset" command.
8088	Light level error	There is too big difference of light between channels	"reset" command.
8089	Filter missing	Light is exceeding allowable range	"reset" command.
8090	Disagreement of security status	The security status from P.C was disagreement.	
8091	RS232C error	RS232C hardware error	
8092	A/D converter error	Malfunction of A/D converter.	"reset" command.
8093	Measurement stop by stop key	The user input "stop" key during measurement.	"reset" command.



**Bio-Rad
Laboratories, Inc.**

**Life Science
Group**

Web site www.bio-rad.com **USA** (800) 4BIORAD **Australia** 02 9914 2800 **Austria** (01)-877 89 01 **Belgium** 09-385 55 11 **Brazil** 55 21 2527 3454
Canada (905) 712-2771 **China** (86 21) 6426 0808 **Czech Republic** + 420 2 41 43 05 32 **Denmark** 44 52 10 00 **Finland** 09 804 22 00
France 01 47 95 69 65 **Germany** 089 318 84-0 **Greece** 30 210 777 4396 **Hong Kong** (852) 2789 3300 **Hungary** 36 1 455 8800
India (91-124)-2398112/3/4, 5018111, 6450092/93 **Israel** 03 951 4127 **Italy** 39 02 216091 **Japan** 03-5811-6270 **Korea** 82-2-3473-4480
Latin America 305-894-5950 **Mexico** 55-52-00-05-20 **The Netherlands** 0318-540666 **New Zealand** 64 9 415 2280 **Norway** 23 38 41 30
Poland + 48 22 331 99 99 **Portugal** 351-21-472-7700 **Russia** 7 095 721 1404 **Singapore** 65-64153188 **South Africa** 00 27 11 4428508
Spain 34 91 590 52 00 **Sweden** 08 555 12700 **Switzerland** 061 717 95 55 **Taiwan** (886 2) 2578 7189/2578 7241 **United Kingdom** 020 8328 2000

Sig 1204

4000155 Rev F