

Digital HD Videocassette Recorder

Operating Instructions

Before operating the unit, please read this manual thoroughly,
and retain it for future reference.



PROGRESSIVE

HVR-M25AU/M25AN/M25AE/ M25AP

Table of Contents

Chapter 1 Overview

Features	4
Location and Function of Parts	6
Front Panel	6
Rear Panel	16
Supplied Remote Commander	21
Displaying Various Data	23

Chapter 2 Playback and Recording

Notes on Power Supply and Video Cassettes	28
Preparing the Power Supply	29
Turning the Power on.....	29
Inserting/Ejecting Cassettes	29
Notes on Playback/Recording	30
Recording Format and Input/Output Signals	31
Major Differences among HDV1080i, DVCAM, and DV Formats	31
Input/Output Signals in EE Mode.....	32
Recording Input Signals and Recording Formats	33
Playback Tape Format and Output Signals.....	33
Settings for Output Signals from Each Jack	34
Playback	36
Connections for Playback	36
Settings for Playback	38
Playback Procedures	38
Playback Functions	39
Auto Repeat (CUSTOM REPEAT)	42
EDGE CROP MARKER	44
MARKER BURN	45
Using the Unit as a Videocassette Recorder	46
Connections for Recording	46
Settings for Recording	48
Recording Procedures	50
Recording Functions	50

Chapter 3 Utilizing the Time Code

Setting the Time Code and User Bits	52
Using the Internal Time Code Generator.....	52

Chapter 4 Dubbing to Other Equipment Using the i.LINK Jack, Duplication, Audio Dubbing, and Connecting a Computer

Dubbing to Other Equipment Using the i.LINK Jack	57
Connections for Dubbing	57
Dubbing Procedures	58
Duplication (Generating a work tape with the same time code)	59
Audio Dubbing	63
Editing (Connecting a Computer)	65
Connecting the Unit to a Computer	65
Preparations.....	66

Chapter 5 Adjusting and Setting Through Menus

Operating Menus	68
Menu Structure.....	69
Menu Contents	70

Chapter 6 Maintenance

Troubleshooting	83
Warning Indicators and Messages	90
Notes on Use	92
Notes on the Videocassette Recorder.....	92
Cleaning of the Video Heads	92
Notes on the Video Cassettes.....	93
Notes on the LCD Screen.....	94
About Moisture Condensation	94
Digital Hours Meter	95
About the Built-in Rechargeable Battery.....	95
Notes on the License	95

Appendix

Notes on Dubbing	96
About i.LINK	99
Specifications	100
Index	103
Submenu Index	105

Overview

Features

The HVR-M25AU/M25AN/M25AE/M25AP is a digital HD videocassette recorder supporting the HDV and DVCAM/DV formats. The unit produces stable, superior picture quality using digital processing and by separating image signals into color difference signals and a luminance signal (component video).

The main features of the unit are described below.

HDV/DVCAM/DV format

The unit can perform HDV/DVCAM/DV recording and playback on a DVCAM format or DV format video cassette.

- **HDV format:** The unit can perform HDV (High-Definition Digital Video) recording and playback. The compression system of the HDV format is the MPEG2 system adopted in high-definition broadcasting and the Blu-ray Disc System. The unit adopts the 1080 scanning lines (interlaced 1080/60i, 1080/50i, progressive 1080/24p, 1080/30p and 1080/25p) format of the HDV specifications. The recording bit rate is approximately 25 Mbps. The unit is equipped with i.LINK and HDMI (output) digital interfaces, and can be digitally connected with televisions or computers which are compatible with the interfaces.
- **DVCAM/DV format:** DVCAM is based on the consumer DV format, which uses the 4:1:1 component digital format (60i) or the 4:2:0 format (50i), and provides a 1/4-inch digital recording format for professional use. The unit provides both DVCAM format recording/playback and DV format in SP mode recording/playback.

For details, see “Major Differences among HDV1080i, DVCAM, and DV Formats” on page 31.

Compatible with both interlaced and progressive HDV recording/playback

The unit can record or play back HDV 1080/60i, 1080/24p, 1080/30p, 1080/50i and 1080/25p videos.

Also, the unit can play back HDV 720/30p, 720/24p and 720/25p videos.

(For recording, signals can be input only via an i.LINK digital interface.)

Here for the unit, 60i indicates field frequency 59.94 Hz. 24p and 30p indicate frame frequency 23.98 Hz and 29.97 Hz, respectively.

High definition down convert function

When you want to play back a tape recorded in HDV format, you can down convert images to output them. This function allows you to preview recorded-images on a monitor which is not compatible with the High-Definition (HD) format. Also, you can select an aspect ratio from SQUEEZE, LETTER BOX (except  HDV/DV jack output), or EDGE CROP.

16:9 Built-in color LCD monitor

The unit has a 2.7-type 16:9 color LCD (liquid crystal display) monitor that lets you verify images on the spot. You can see the setup menus, audio levels, and system status. Menus and data can be superimposed over the picture being displayed.

Speaker

Using a built-in monaural speaker, you can easily monitor the sound being played back or sound being recorded.

Multiple input/output interfaces

The following jacks are provided with the unit and enable connection with various devices:

- **Input jacks:** S VIDEO IN jack, VIDEO IN jack and AUDIO IN jacks
- **Output jacks:** HDMI OUT jack, COMPONENT OUT jacks, S VIDEO OUT jack, VIDEO OUT jack and AUDIO OUT jacks
- **Input-output jack:**  HDV/DV jack

About HDMI (High Definition Multimedia Interface)

HDMI is an interface for connecting directly to a TV with digital pictures and digital audio signals. By connecting HDMI OUT jack to a HDMI compatible TV using a single HDMI cable, you can enjoy a high quality picture and digital sounds.

A variety of buttons and switches for VCR operations

The unit provides a variety of buttons for VCR operations, such as an INPUT SELECT switch, AUDIO REC LEVEL, PHONE LEVEL control knobs, and a STATUS CHECK button.

Time code and user bits

On the unit, you can use both time code and user bits. Using the menu, these can be set easily.

JOG AUDIO function

If you use the optional DSRM-10 remote control unit (not supplied), audio can be monitored at various playback speeds in jog/shuttle mode. (Jog audio cannot be output when the tape is recorded in HDV format.)

Screen Language Setting

You can select the language to be used for screen displays.

The default language setting is English.

See “LANGUAGE” in the “OTHERS” menu on page 80 for details on how to change the screen language.



Easy maintenance functions

• Self-diagnostics/alarm functions:

The system automatically detects an invalid operation, bad connection, or a malfunction, and displays a description, a cause, and a recovery method on the LCD monitor and outputs this information to the HDMI OUT jack, COMPONENT OUT jacks, S VIDEO OUT jack and VIDEO OUT jack.

• Digital hours meter:

A digital hours meter counts four types of time data—operating time, drum rotation time, tape running time, and tape threading/unthreading. The digital hours data is indicated on the menu.

.....
 ,  , and  are trademarks of Sony Corporation.

HDV is a trademark of Sony Corporation and Victor Company of Japan, Ltd.

HDMI, HDMI logo, and High Definition Multimedia Interface is a trademark or a registered trademark of HDMI Licensing LLC.

All other product names mentioned here may be the trademarks or registered trademarks of their respective companies. “TM” and “®” are not mentioned in every case in this manual.

Location and Function of Parts

Front Panel

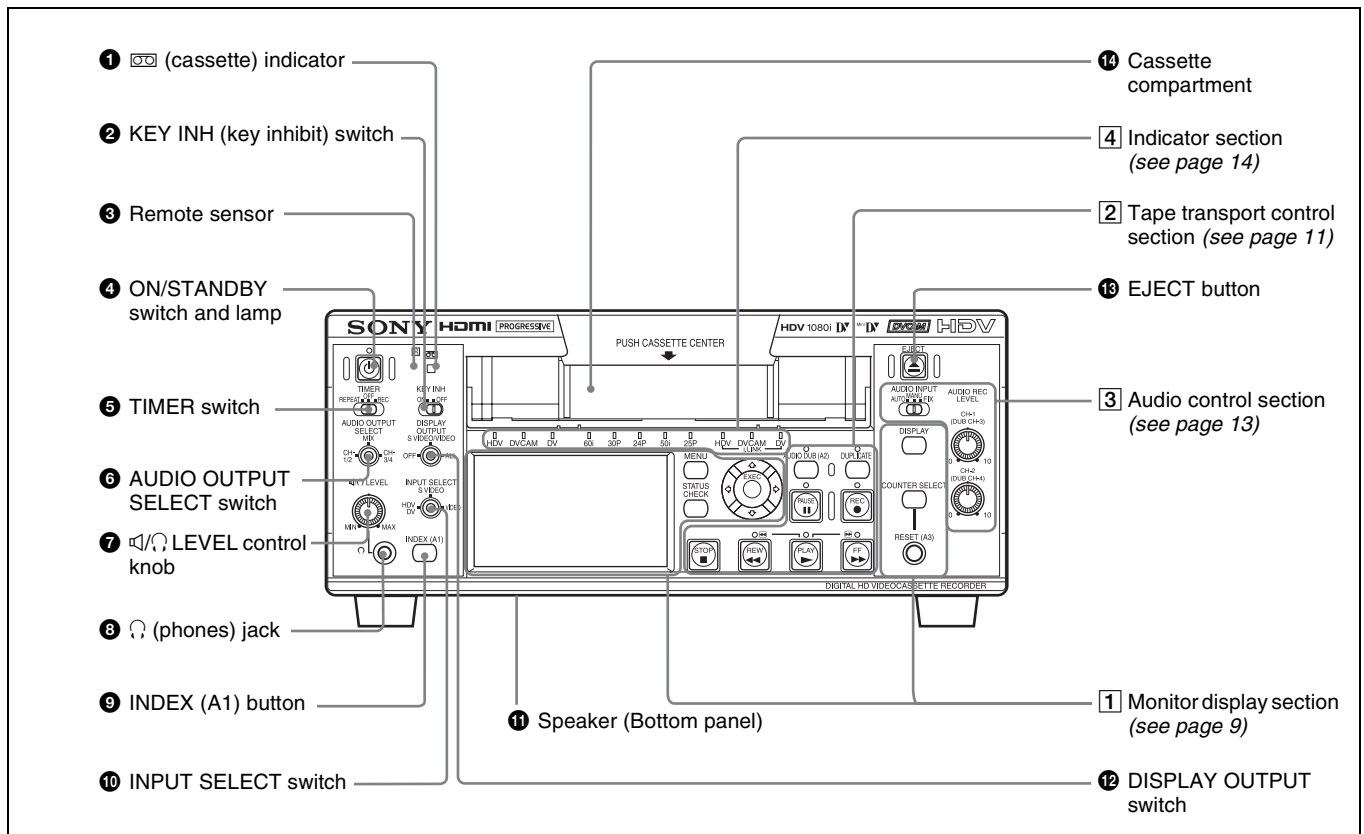

1 (cassette) indicator

Lights when a digital video cassette is loaded.
Does not light up when there is no cassette loaded in the unit.
This indicator blinks while a cassette is being ejected.
For details, see "Inserting/Ejecting Cassettes" on page 29.

2 KEY INH (key inhibit) switch

Turning on this switch disables all buttons to prevent accidental button operations.

Notes

- Even when this switch is set to ON, the switches **5**, **6**, **10**, **12**, and **3-1**, the knobs **7** and **3-2**, and the switch **4** on the rear panel can be used.
- Even when you set this switch to ON, you can operate the unit with the Remote Commander, or via the LANC jack, CONTROL S jack, and HDV/DV jack.

3 Remote sensor

Note

In addition to the Remote Commander supplied with the unit, the unit accepts signals from any Sony Remote Commander whose command mode is set to VTR4. To disable control from a Remote Commander, set [COMMANDER] in the [OTHERS] menu to [CONTROL S].

4 ON/STANDBY switch and lamp

The ON/STANDBY lamp lights up in green or red when the POWER switch on the rear panel of the unit is in the "I" position (ON). Press this switch while the lamp is lit in red (in the standby mode) to turn the unit on, and the lamp lights up in green. When you press this switch again, the unit goes into the standby mode.

Notes

- When the ON/STANDBY lamp is out, this switch does not operate. Press the “I” (ON) marked side of the POWER switch on the rear panel before operating the ON/STANDBY switch.

For details on the POWER switch, see “POWER (main power) switch” on page 20.

- When the KEY INH switch ② is set to ON, the ON/STANDBY switch does not operate. Set the KEY INH switch to OFF to enable the ON/STANDBY switch.

5 TIMER switch

Use this switch to select Auto Repeat or recording when using an external AC timer (not supplied).

REPEAT:

When power is supplied to the unit, the tape rewinds to its beginning automatically and playback starts. When one of the following items on the tape are detected, auto repeat playback starts automatically.

- Index signals
- An unrecorded portion
- A portion recorded in a format set by other than [AUTO] in [HDV/DV SEL] of the [IN/OUT REC] menu
- Tape end

Auto Repeat also functions if you set this switch to REPEAT during playback or rewind.

For details on Auto Repeat, see “Auto Repeat (CUSTOM REPEAT)” on page 42 and “CUSTOM REPEAT” in the “VTR SET” menu on page 77.

OFF: Auto Repeat or timer recording is disabled.

REC: Recording begins the moment the power is connected to the unit.

Note

The setting of this switch still activates the unit even when the KEY INH switch ② is set to ON.

6 AUDIO OUTPUT SELECT switch

When the audio mode is 32 kHz (4-channel), use this switch to select the audio channel to be output via the AUDIO OUT jack and HDMI OUT jack on the rear panel of the unit, as well as from the Ⓜ (phones) jack ⑧ and the Speaker ⑪.

CH-1/2: channels 1/2 only

MIX: channels 1/2 and channels 3/4

CH-3/4: channels 3/4 only

Notes

- During audio dubbing, if you want to listen to the sound recorded on the tape, set this switch to CH-1/2; if you want to listen to the sound being dubbed, set the switch to CH-3/4. (Only channels 3 and 4 can be used to dub.) To check the sound to be dubbed before dubbing, set this switch to CH-3/4, then press the AUDIO DUB button while the unit is in the stop mode. Then you can listen to the sound of the channels used to dub (channels 3 and 4) for a short period of time.

For details on audio dubbing, see page 63. Also refer to the instructions for the “AUDIO DUB (A2) ①” button on page 11.

- When the audio mode is 48 kHz (2-channel), sounds of channel 1 and 2 are output via the AUDIO OUT jack, Ⓜ (phones) jack ⑧, HDMI OUT jack and Speaker ⑪ regardless of the position of this switch.
- When this switch is set to MIX, the sound of the mixed level of the pair of channel 1 and 3 and that of channels 2 and 4 is output. The audio output level becomes 50% (–6 dB) of the original audio levels on each channel.
- The unit cannot play back 4-channel sound recorded in HDV format.

7 Ⓜ/Ⓜ (speaker/phones) LEVEL control knob

Controls the volume of the speaker ⑪ on the bottom plate of the unit as well as that of the headphones connected to the Ⓜ (phones) jack ⑧.

- The volume of the speaker and headphones are set together. The volumes cannot be set separately.
- By changing the setting of [SPEAKER/BEEP] in [OTHERS] (page 81), you can switch the speaker audio output on and off.

8 Ⓜ (phones) jack

Connect stereo headphones for monitoring sound during recording or playback. The audio signals you want to monitor can be selected with the AUDIO OUTPUT SELECT switch ⑥. By changing the setting of [AUDIO MONI] in the [AUDIO SET] menu (page 76), you can monitor the sound of a particular channel only. When headphones are connected, no sound is produced from the built-in speaker.

(Continued)

9 INDEX (A1) button

Press this button to write an index mark while recording. Indexing is useful when you search for scenes on a tape. Also, this button can be used as the ASSIGN (A1) button.

For details on Indexing, see “Recording Functions” on page 50.

When you change the ASSIGN button’s setting with [ASSIGN [A1]] of [ASSIGN BTN] in the [OTHERS] menu, this button executes the function you have set.

For details on ASSIGN buttons, see “ASSIGN BTN” in the “OTHERS” menu on page 80.

10 INPUT SELECT switch



Use this button to select the signal input jack from the  HDV/DV jack, S VIDEO IN jack, and VIDEO IN jack.

HDV/DV: Inputs a signal from the  HDV/DV jack.

S VIDEO: Inputs a signal from the S VIDEO IN jack.



VIDEO: Inputs a signal from the VIDEO IN jack.

Notes

- Do not change the setting of this switch while recording is in progress, or it will cause noise to be added to images and sounds. Also, the part of the tape where the change of setting is applied will not be recorded properly. Also, the time code may be recorded discontinuously.
- If you change the setting of this switch while recording is in progress, the output signal via the  HDV/DV jack may be interrupted. Also, the unit may detect signals, such as a copyright information signal, incorrectly.
- When a signal is input via the  HDV/DV jack, the settings of the menus listed below are unavailable.
 - 60i/50i SEL
 - AUDIO MODE
 - AUDIO LOCK
 - AUDIO INPUT LEVEL (–10/–2/+4) switch
 - AUDIO REC LEVEL control knob
 - AUDIO INPUT (AUTO/MANU/FIX) switch

11 Speaker (bottom panel)

Use this speaker to monitor sounds in monaural during recording or playback. The setting of volume control level and audio signals to be monitored are the same as those of output from the  (phones) jack **8**. When headphones are connected, no sound is produced from the built-in speaker.

*For details on the volume control, see “**7**  (speaker/phones) LEVEL control knob” on page 7. For details on the headphones output, see “**8**  (phones) jack” on page 7.*

12 DISPLAY OUTPUT switch

Selects the destination for the text data to be superimposed via output jacks.

OFF: Does not output text data to superimpose.

S VIDEO/VIDEO:

Superimposes text data to S VIDEO OUT jack and VIDEO OUT jack.

ALL: Superimposes text data to HDMI OUT jack, COMPONENT OUT jacks, S VIDEO OUT jack and VIDEO OUT jack.

13 EJECT button

Press this button to eject a cassette. If you press this button while a cassette is inside the unit, the cassette is ejected.

14 Cassette compartment

Insert a standard-size or mini-size cassette.

For details on cassettes that can be used, see “Notes on Power Supply and Video Cassettes” on page 28.

1 Monitor display section

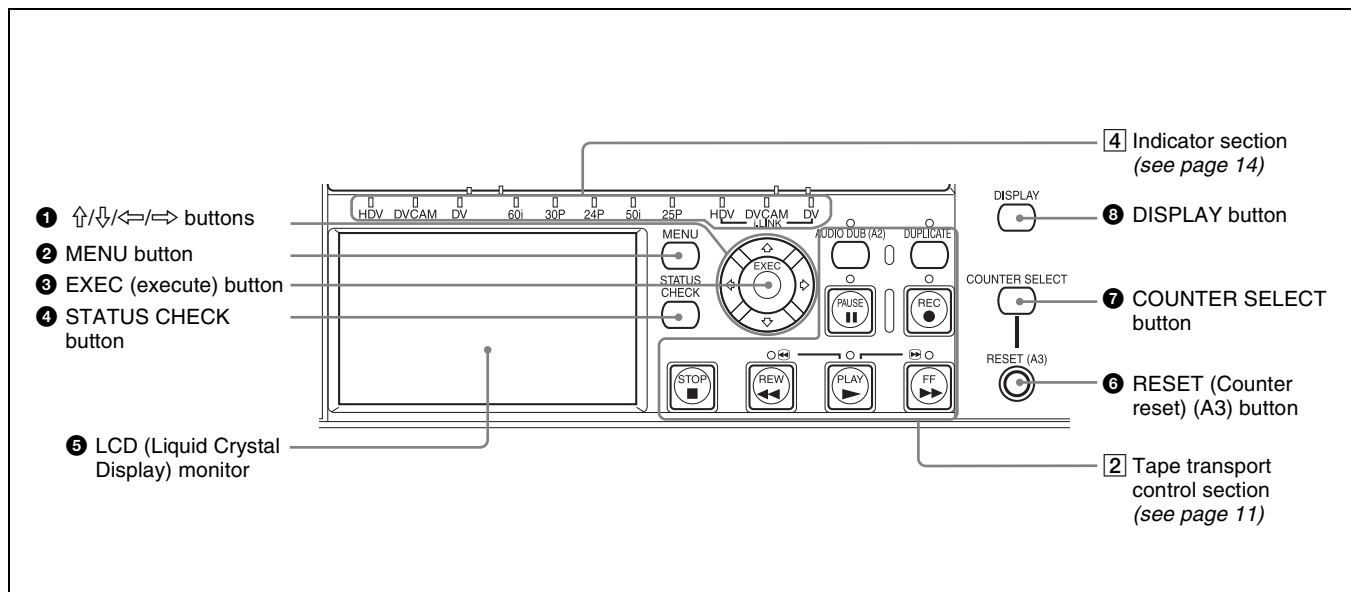

1 $\uparrow/\downarrow/\leftarrow/\rightarrow$ buttons

Use these buttons in making menu settings and other settings. You can adjust the brightness of images by pressing the \uparrow/\downarrow buttons, while the relevant data (format, the tape running mode) is displayed on the LCD screen.

The display of the brightness level adjustment disappears within a second after the adjustment completes.

While the time counter is displayed, you can move the position of the time counter up or down by pressing \uparrow/\downarrow buttons. When the small size time counter is displayed, the position of the time counter can be moved not only up and down, but also to the right and left by pressing the \leftarrow/\rightarrow buttons.

While the STATUS CHECK screen is displayed, you can switch the screen by pressing the \uparrow/\downarrow buttons.

2 MENU button

Press this button to display the menu list on screen.

For details on the menus, see “Operating Menus” on page 68.

3 EXEC (execute) button

Use this button in menu settings.

4 STATUS CHECK button

Press this button to check the audio level and menu settings. To display the STATUS CHECK screen, press the STATUS CHECK button.

Every time you press the \uparrow/\downarrow buttons, the STATUS CHECK screen switches in the order of AUDIO, OUTPUT, ASSIGN, and CUSTOM REPEAT. To hide the STATUS CHECK screen, press the STATUS CHECK button again.

Note

The audio level meter display varies depending on the settings of [AUDIO MODE] in the [AUDIO SET] menu (page 76), the AUDIO OUTPUT SELECT switch (page 7), and the audio mode on the tape played back.

5 LCD (Liquid Crystal Display) monitor

Display the playback or EE¹⁾ pictures. Also, superimposed time data, status information, menus, audio level meters, etc., are displayed.

(Continued)

1) “EE” stands for “Electric to Electric.” In EE mode, the video and audio signals input to the VCR’s recording circuitry do not pass through any magnetic conversion circuits but are output via electric circuits only. This mode is used to check the input signals and adjust input levels. The pictures output in EE mode are referred to as EE pictures.

6 RESET (Counter reset) (A3) button

Press this button when the count value of the counter is displayed. The count value is then reset to 0:00:00:00. Also, this button can be used as the ASSIGN (A3) button.

When you change the ASSIGN button setting with [ASSIGN [A3]] of [ASSIGN BTN] in the [OTHERS] menu, this button executes the function you have set.

For details on ASSIGN buttons, see “ASSIGN BTN” in the “OTHERS” menu on page 80.

Notes

- This button does not reset the value of the time code or user bits.
- To reset the value of the time code or user bits, use [TC PRESET] or [UB PRESET] in the [TC/UB SET] menu.

7 COUNTER SELECT button

While the data or time counter is displayed, press this button to change the time counter display in the order of time code, user bits, and tape counter.

The count value of the tape counter (seven digits) is displayed on a ± 12 -hour cycle.

Note

The count value of the counter of the unit is determined by calculation based on the time code, that is, simple approximation. Therefore, in cases such as the following, the value may be inaccurate.

- There is a portion where the time code is not continuous on the tape you are using.
- The time code in both the drop frame mode and the non-drop frame mode are recorded on the tape you are using (only for 60i signals, including 24p/30p).
- There is a blank portion between recorded portions on the tape you are using.
- A tape recorded using the 50i system or 25p system is being used in the unit when [60i/50i SEL] in the [OTHERS] menu is set to [60i].
- A tape recorded using the 60i system or 24p/30p system is being used in the unit when [60i/50i SEL] in the [OTHERS] menu is set to [50i].
- [TC RUN] in the [TC/UB SET] menu is set to [FREE RUN].

8 DISPLAY button

Use this button to change the text data displayed on the LCD monitor or the text data output from the video jacks on the rear panel of the unit. By pressing this button, the unit can be made to display the picture only, picture and data, or picture and time counter.

For details on the various data that can be displayed, see “Displaying Various Data” on page 23.

2 Tape transport control section

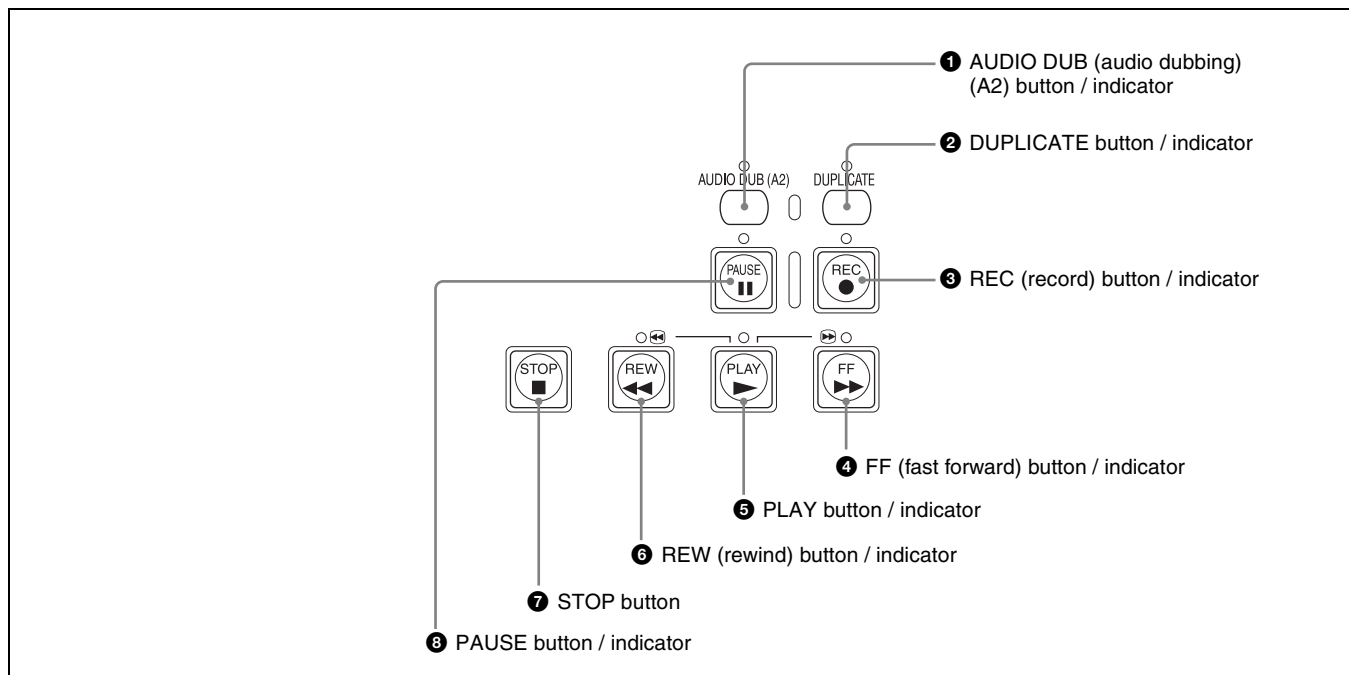

1 AUDIO DUB (audio dubbing) (A2) button / indicator

Use this button to dub sounds. The indicator lights while sounds are being dubbed. Also, this button can be used as the ASSIGN (A2) button.

For details on audio dubbing, see “Audio Dubbing” on page 63.

When the unit is in the stop mode, and the INPUT SELECT switch is set to other than HDV/DV and color bars are not displayed, you can check the EE signals of the sound (channels 3 and 4) to be dubbed by pressing this button. While the operation is in progress, the indicator lights. To stop the operation, press the STOP button.

For details, see “EE/PB SEL” in the “IN/OUT REC” menu on page 74.

When you change ASSIGN buttons setting with [ASSIGN [A2]] of [ASSIGN BTN] in the [OTHERS] menu, this button executes the function you have set.

For details on ASSIGN buttons, see “ASSIGN BTN” on page 80.

2 DUPLICATE button / indicator

Use this button to duplicate a tape, including the time code. While duplication is in progress, the indicator lights.

For details on the duplicate function, see “Duplication (Generating a work tape with the same time code)” on page 59.

When the unit is in the stop mode and HDV/DV signals are selected and input, you can check the EE signals for an image, sound and time code by pressing this button. While you are checking EE signals, the indicator lights. To stop this operation, press the STOP button.

For details, see “EE/PB SEL” in the “IN/OUT REC” menu on page 74.

For details on time codes, see “HVR-M25AU/M25AN/M25AE/M25AP time codes” on page 56.

(Continued)

3 REC (record) button / indicator

When you press and hold this button, then press the PLAY button, each indicator lights and recording starts. If you press this button while the tape is stopped, you can check EE picture and audio signals for a short time. When the  HDV/DV jack is selected, if [HDV/DV IN TC] in the [TC/UB SET] menu is set to [EXTERNAL], you can also check the EE time code signals. Press the STOP button to end the check.

For details, see “EE/PB SEL” in the “IN/OUT REC” menu on page 74.

For details on time codes, see “TC/UB SET” on page 78.

Notes

- The unit does not have an LP recording mode for the consumer DV format. Only SP recording mode is available.
- To set the unit to recording pause mode with the DSRM-10 remote control unit (not supplied), press the PAUSE button while holding down the PLAY button to set the unit to the playback pause mode, then press the REC button on the DSRM-10.
- When the recording mode is set to HDV format, it may take a few seconds to start recording. During this time, the REC indicator blinks.

4 FF (fast forward) button / indicator

When you press this button, the indicator lights and the tape is fast forwarded. During fast forward, the picture does not appear on the monitor. (You can see the picture as it is seen in EE mode during fast forward.) To locate a scene while monitoring the picture, press and hold this button during fast forward, playback or in the playback pause mode (picture search).

Notes

- If you set [EE/PB SEL] in the [IN/OUT REC] menu to [PB], EE picture and EE audio signals are not output (page 74).
- If you set [FF/REW SPEED] in the [VTR SET] menu to [SHUTTLEMAX], the picture is played back during fast forward.

For details on running speed with [SHUTTLEMAX], see “FF/REW SPEED” in “VTR SET menu” on page 77.

5 PLAY button / indicator

When you press this button, the indicator lights and playback begins.

If you press this button while holding down the REW button during stop, the tape is rewound to its beginning

and starts playing automatically (during rewind, the REW indicator lights and the PLAY indicator blinks).

Notes

- When the unit is playing back a part of the tape where the recording format has been changed to HDV format, DVCAM format, or DV format, or between 60i system (including 24p and 30p) and 50i system (including 25p), the picture and sound may be distorted.
- The unit cannot play back a tape recorded in the LP recording mode of the consumer DV format.

6 REW (rewind) button / indicator

When you press this button, the indicator lights and the tape starts rewinding. During rewind, the picture does not appear on the monitor. (You can see the picture as it is seen in EE mode during rewind.) To locate a scene while monitoring the picture, hold this button down during rewind, playback or in the playback pause mode. If you press the PLAY button while holding down this button during stop, the tape is rewound to its beginning and starts playing automatically. (During rewind, the REW indicator lights and the PLAY indicator blinks.)

Notes

- If you set [EE/PB SEL] in the [IN/OUT REC] menu to [PB], EE picture and EE audio signals are not output (page 74).
- If you set [FF/REW SPEED] in the [VTR SET] menu to [SHUTTLEMAX], the picture is played back during rewind.

For details on running speed with [SHUTTLEMAX], see “FF/REW SPEED” in “VTR SET menu” on page 77.

7 STOP button

Press this button to stop the tape transport operation completely.

Note

If you set [EE/PB SEL] in the [IN/OUT REC] menu to [PB], EE picture and EE audio signals are not output during stop (page 74).

8 PAUSE button / indicator

Press this button to set the unit to pause mode. The indicator lights during recording, playing, or audio dubbing. Press this button again to resume the operation.

3 Audio control section

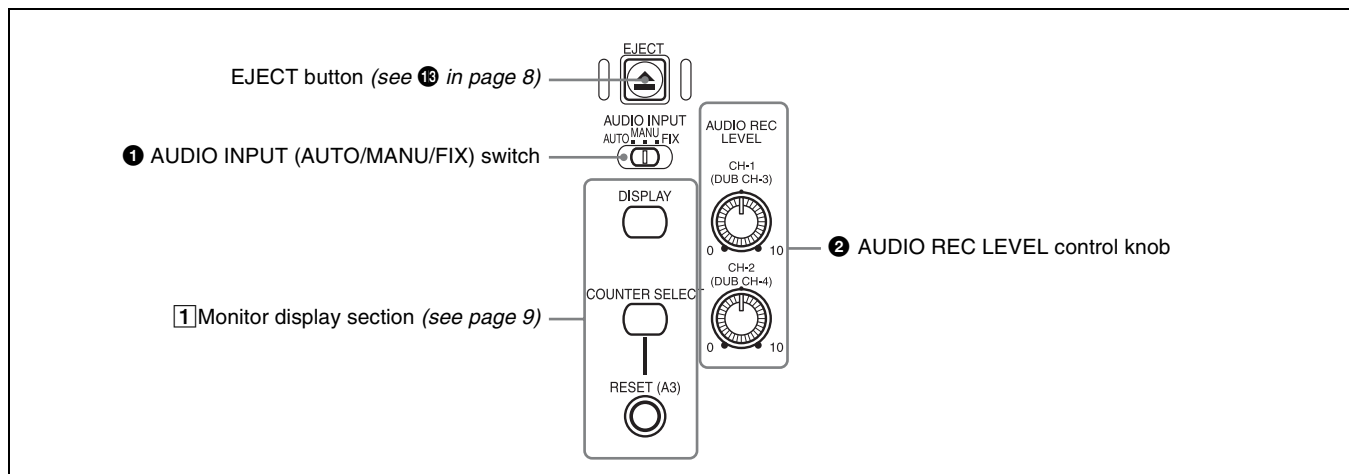

1 AUDIO INPUT (AUTO/MANU/FIX) switch

Switches the audio recording level adjustment mode.

AUTO : Adjusts AUDIO REC LEVEL

automatically. (Adjustment of AUDIO REC LEVEL control knobs 2 is disabled.)

For acceptable recording levels, see the table below.

AUDIO INPUT LEVEL switch (page 16)	Acceptable level (max.)
-10	+18 dBu
-2	+24 dBu
+4	+30 dBu

MANU : Enables the AUDIO REC LEVEL control knobs 2.

FIX : Fixes AUDIO REC LEVEL at the intermediate value. (Adjustment using the AUDIO REC LEVEL control knobs 2 is disabled.)

For acceptable recording levels, see the table below.

AUDIO INPUT LEVEL switch (page 16)	Acceptable level (max.)
-10	+18 dBu
-2	+24 dBu
+4	+30 dBu

Notes

- When i.LINK signals are input to the unit, the sound recorded retains the signal input level, regardless of the setting of this switch.
- Even when this switch is set to AUTO, the setting is not effective against a volume level which exceeds the dynamic range of the input amplifier.

- If you input a sound at a level that exceeds the acceptable range, the recorded sound is distorted.

2 AUDIO REC LEVEL control knobs (CH-1 (DUB CH-3) and CH-2 (DUB CH-4))

Use these knobs to adjust the levels of the analog audio signals input to the unit for each channel.

These knobs are enabled only when the AUDIO INPUT (AUTO/MANU/FIX) switch 1 is set to MANU.

To display the audio level meters on the LCD monitor, press the STATUS CHECK button.

For details on the audio level meter, see "STATUS CHECK screen" on page 25.

Note

You cannot adjust the audio level using these knobs while i.LINK signals are input.

4 Indicator section

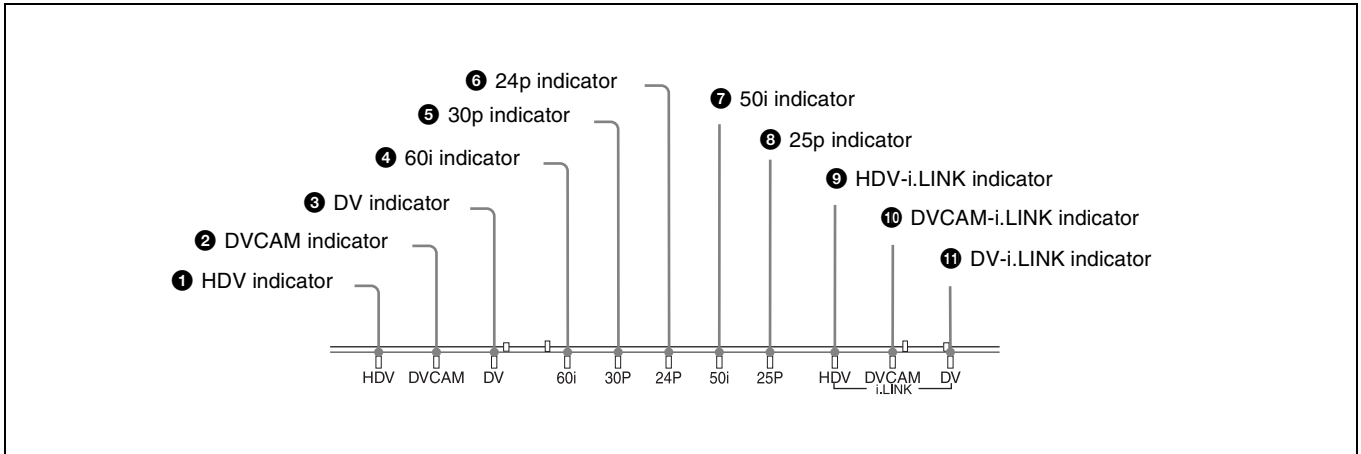

1 HDV indicator

Lights when the unit is in either of the following operating states.

- When a tape recorded in HDV format is being played back.
- When [HDV/DV SEL] in the [IN/OUT REC] menu is set to [AUTO] and HDV signals are being input from the **i** HDV/DV jack.
- When [HDV/DV SEL] in the [IN/OUT REC] menu is set to [HDV].

2 DVCAM indicator

Lights when the unit is in either of the following operating states.

- When a tape recorded in DVCAM format is being played back.
- When the following four conditions are met:
 - When [HDV/DV SEL] in the [IN/OUT REC] menu is set to [AUTO].
 - When [**REC** REC MODE] in the [IN/OUT REC] menu is set to [DVCAM].
 - When DV or DVCAM signals are being input from any of the input jacks.
 - During recording or in EE mode.
- When the following three conditions are met:
 - When [HDV/DV SEL] in the [IN/OUT REC] menu is set to [DV].
 - When [**REC** REC MODE] in the [IN/OUT REC] menu is set to [DVCAM].
 - During recording or in EE mode.

3 DV indicator

Lights when the unit is in either of the following operating states.

- When a tape recorded in DV format (SP mode only) is being played back.
- When the following four conditions are met:
 - When [HDV/DV SEL] in the [IN/OUT REC] menu is set to [AUTO].
 - When [**REC** REC MODE] in the [IN/OUT REC] menu is set to [DV].
 - When DV or DVCAM signals are being input from any of the input jacks.
 - During recording or in EE mode.
- When the following three conditions are met:
 - When [HDV/DV SEL] in the [IN/OUT REC] menu is set to [DV].
 - When [**REC** REC MODE] in the [IN/OUT REC] menu is set to [DV].
 - During recording or in EE mode.

4 60i indicator

Lights when the unit is in one of the following operating states.

- During recording or in EE mode when [60i/50i SEL] in the [OTHERS] menu is set to [60i].
- When 1080/60i signals or NTSC signals are input from the **i** HDV/DV jack.
- When a tape that has 1080/60i signals or NTSC signals is being played back.

5 30p indicator

Lights when the unit is in either of the following operating states.

- When a tape recorded in 1080/30p format or 720/30p format is being played back.
- When 1080/30p signals are input from the **i** HDV/DV jack.

6 24p indicator

Lights when the unit is in either of the following operating states.

- When a tape recorded in 1080/24p format or 720/24p format is being played back.
- When 1080/24p signals are input from the **i** HDV/DV jack.

7 50i indicator

Lights when the unit is in one of the following operating states.

- During recording or in EE mode when [60i/50i SEL] in the [OTHERS] menu is set to [50i].
- When 1080/50i signals, or PAL signals are input from the **i** HDV/DV jack.
- When a tape that has 1080/50i signals or PAL signals is being played back.

8 25p indicator

Lights when the unit is in either of the following operating states.

- When a tape recorded in 1080/25p format or 720/25p format is being played back.
- When 1080/25p signals are input from the **i** HDV/DV jack.

9 HDV-i.LINK indicator

Lights when HDV signals are input/output through the i.LINK interface.

10 DVCAM-i.LINK indicator

Lights when DVCAM signals are input/output through the i.LINK interface.

11 DV-i.LINK indicator

Lights when DV signals are input/output through the i.LINK interface.

Rear Panel

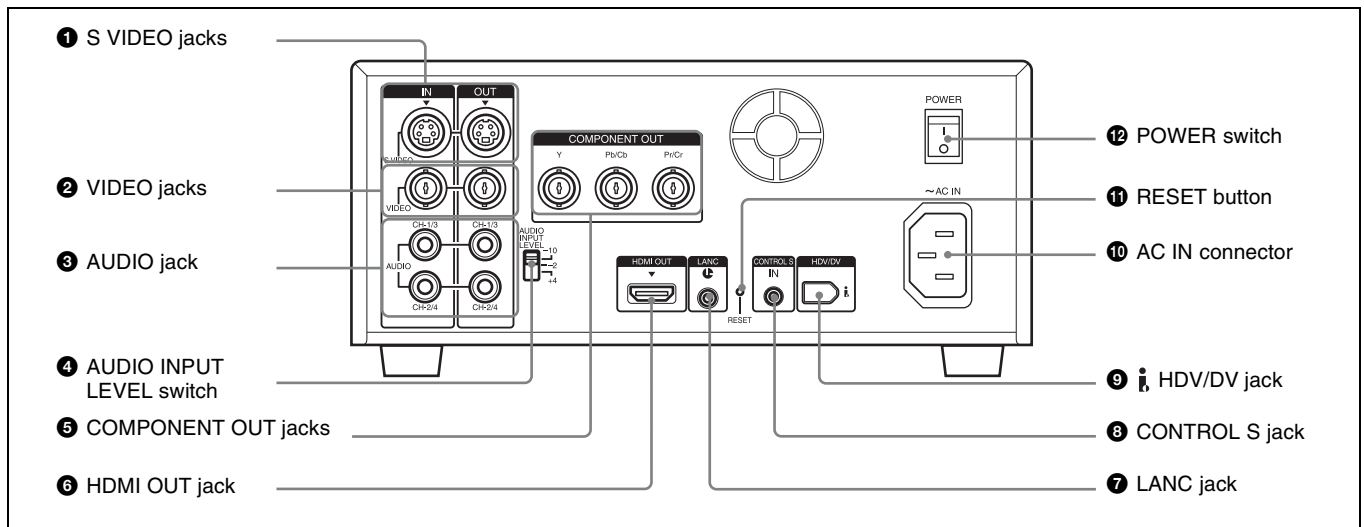

1 S VIDEO jacks

To connect a device equipped with S video jacks, use the S VIDEO jacks on the unit.
 If you use the S VIDEO jacks, you can input/output high-quality video with less signal quality deterioration than if connected to the standard VIDEO jack.
 When the DISPLAY OUTPUT switch on the front panel is set to S VIDEO/VIDEO or ALL, text data such as the time code, menus, and alarm messages are superimposed on an external monitor connected to the S VIDEO OUT jack (page 23).
 For details on the output of the S VIDEO jacks, see “Notes on all video output jacks” on page 19.

2 VIDEO jacks

Use these jacks to input and output analog video signals. Text data is superimposed on a monitor in the same way as with an S VIDEO jack connection (page 23).
 For details on the output of the VIDEO jacks, see “Notes on all video output jacks” on page 19.

3 AUDIO jacks

Use these jacks to input and output analog audio signals. During normal recording, sounds are recorded onto channels 1 and 2. During audio dubbing, sounds are dubbed onto channels 3 and 4.
 You can select audio signals to be output with the AUDIO OUTPUT SELECT switch (page 7).
 When the audio mode is FS32K (4 channel), if you set the AUDIO OUTPUT SELECT switch to MIX, the audio output level becomes 50% (–6 dB) of the original audio level on each channel.

Note

- During audio dubbing, CH-1/3 and CH-2/4 of the AUDIO IN jacks function as the channel 3 and channel 4 input jacks, respectively.
- To input balanced audio signals via the AUDIO IN jacks, use a conversion cable as shown below. (The COLD side is open.)

For details on conversion cables, refer to the instruction manual of the devices you use.

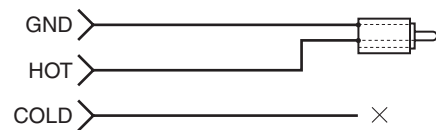

4 AUDIO INPUT LEVEL (–10/–2/+4) switch

Select one from –10 dB, –2 dB, or +4 dB, according to the audio level of the signal input via the AUDIO IN jacks.

Note

If this switch setting is not appropriate, clipping distortion or noise may occur.
 For more information on the setting of this switch, see “When you set the AUDIO INPUT LEVEL switch:” on page 89.

5 COMPONENT OUT jacks



Use these jacks to output component signals.

To connect a device equipped component video input connectors, use the COMPONENT OUT jacks on the unit. If you use the COMPONENT OUT jacks, you can output high-quality video with less signal quality deterioration than if you use the S VIDEO jacks.

You can set the output video format by using [HDMI/CMPNT] of [VIDEO OUT] in the [IN/OUT REC] menu.

When the DISPLAY OUTPUT switch is set to ALL, text data such as time code, menu, and alarm messages are superimposed on a monitor connected using the COMPONENT OUT jacks (page 23).

Notes

- When images are output in 720p format, some of the text image data (outer frame: underscan portion) on the monitor may appear cut out. In this case, check the text image data on the LCD monitor of the unit or on a monitor using the S VIDEO OUT jack or the VIDEO OUT jack. Also, when your monitor has an underscan function, you can check all the text data on the monitor while in underscan mode.
- The setting of [HDMI/CMPNT] of [VIDEO OUT] in the [IN/OUT REC] menu is effective for both the COMPONENT OUT jack and the HDMI OUT jack (page 71).
- When you change the video format setting of [HDMI/CMPNT] of [VIDEO OUT] in the [IN/OUT REC] menu, the video signal output from the S VIDEO OUT jack, VIDEO OUT jack, or  HDV/DV jack may be distorted for a moment.
- When you play back a tape in DVCAM/DV format and while an EE picture in NTSC/PAL is displayed, either the 480i resolution or the 576i resolution is output, regardless of the setting of [HDMI/CMPNT] of [VIDEO OUT] in the [IN/OUT REC] menu.
- When [HDMI/CMPNT] of [VIDEO OUT] in the [IN/OUT REC] menu is set to either [1080i/480i] or [1080i/576i], 1080/24p and 1080/30p video signals are converted to 1080/60i, 1080/25p video signals are to 1080/50i, and then output.
- When you play back an HDV-formatted tape with copyright protected signals or input HDV signals with copyright protection to the  HDV/DV jack, pictures may be output in either 480i (NTSC) or 576i (PAL) format, regardless of the setting of [HDMI/CMPNT] of [VIDEO OUT] in the [IN/OUT REC] menu.

- The output level of the COMPONENT OUT jacks is as follows:

Output at 480i (NTSC)

With [BETACAM] selected in [480i LEVEL] of the [IN/OUT REC] menu

Y: 1.0 Vp-p

(with 0.286 Vp-p sync negative,
output impedance 75 Ω (ohms), unbalanced)

Pb/Cb/B-Y, Pr/Cr/R-Y: 0.7 Vp-p

(output impedance 75 Ω (ohms), unbalanced)
(75% color bars with 7.5 IRE setup)

With [SMPTE] selected in [480i LEVEL] of the [IN/OUT REC] menu

Y: 1.0 Vp-p

(with 0.3 Vp-p sync negative,
output impedance 75 Ω (ohms), unbalanced)

Pb/Cb/B-Y, Pr/Cr/R-Y: 0.7 Vp-p

(output impedance 75 Ω (ohms), unbalanced)
(100% color bars with no setup)

Output with other settings

Y: 1.0 Vp-p

(output impedance 75 Ω (ohms), unbalanced)

Pb/Cb/B-Y, Pr/Cr/R-Y: 0.7 Vp-p

(output impedance 75 Ω (ohms), unbalanced)
(100% color bars with no setup)

480i/480p:

Y: with 0.3 Vp-p sync negative

1080i/720p:

Y/Pb/Pr: with 0.6 Vp-p 3-level sync

6 HDMI OUT jack

Use this jack to output HDMI signals. HDMI OUT jack outputs both pictures and audio. To connect a device equipped with HDMI input connector, use the HDMI OUT jack on the unit.

The HDMI OUT jack outputs high-quality video with even less signal deterioration in quality than the COMPONENT OUT jacks.

You can set the output video format by using [HDMI/CMPNT] of [VIDEO OUT] in the [IN/OUT REC] menu.

Text data is superimposed on a monitor in the same way as with a COMPONENT OUT jacks connection (page 23).

(Continued)

Notes

Use an HDMI cable with HDMI logo.

When you connect the unit with another device, some of the devices may not display pictures or sounds.

Also, when you connect the unit in the way described below, the unit or the device connected to the unit may be damaged.

- When HDMI OUT jack on the unit is connected to the HDMI OUT jack on another device
- When HDMI OUT jack on the unit is connected to the HDMI OUT jack of another unit (the same model)

There are following restrictions on the output of HDMI OUT jack.

- When you play back an HDV-formatted tape with copyright protected signals or input an HDV signal with copyright protection to **Ⓜ** HDV/DV jack, pictures and audio cannot be output from the HDMI OUT jack. (Copy-protected signals and programs such as digital broadcasts are also included.)
- You cannot output EE picture of analog video (NTSC, PAL) that are input from the VIDEO IN jack or S VIDEO IN jack to the HDMI OUT jack. Text data and menus cannot be displayed either. When you play back a DVCAM or DV (SP)-formatted tape recorded in either NTSC or PAL format, pictures are output to the HDMI OUT jack.
- You cannot output EE picture and sound of DVCAM/DV signals (NTSC, PAL) that are input from the **Ⓜ** HDV/DV jack to the HDMI OUT jack. Text data and menus cannot be displayed either.
- Sounds output via the HDMI OUT jack of the unit is 2-channel (stereo). To output the sound of CH3 and CH4 when playing back a tape recorded in 4-channel (32 kHz), audio recording, or pausing audio recording, select CH-3/4 with AUDIO OUTPUT SELECT switch. By selecting MIX with this switch, mixed sounds can be output to the HDMI OUT jack as well.
- Sounds output via the HDMI OUT jack are output with 16 bit of 48 kHz, 2-channel linear PCM mode regardless of the tape played back, the setting of the menus, or the signal format input to the **Ⓜ** HDV/DV jack.

- When images are output in 720p format, some of the text image data (outer frame: underscan portion) on the monitor may appear cut out. In this case, check the text image data on the LCD monitor of the unit or on a monitor using the S VIDEO OUT jack or the VIDEO OUT jack. Also, when your monitor has an underscan function, you can check all the text data on the monitor while in underscan mode.
- The setting of [HDMI/CMPNT] of [VIDEO OUT] in the [IN/OUT REC] menu is effective for both the COMPONENT OUT jack and the HDMI OUT jack (page 71).
- When [HDI/CMPNT] of [VIDEO OUT] in the [IN/OUT REC] menu is set to either [1080i/480i] or [1080i/576i], 1080/24p and 1080/30p video signals are converted to 1080/60i, 1080/25p video signals are to 1080/50i, and then output.
- When you change the video format setting of [HDMI/CMPNT] of [VIDEO OUT] in the [IN/OUT REC] menu, the video signal output from the S VIDEO OUT jack, VIDEO OUT jack, or **Ⓜ** HDV/DV jack may be distorted for a moment.
- If a monitor or other device connected to the unit does not have a display mode to display the resolution selected with [HDMI/CMPNT] of [VIDEO OUT] in [IN/OUT REC], noise may occur on the picture of the monitor, or a humming noise may be output from the speakers. Also, the picture may not be displayed or the sound may not be output. Be sure to check the displayable resolutions of the monitor by referring the operational instructions of your monitor, and select the appropriate menu for the unit.
- Depending on the monitor you have, the picture and sound on the monitor may be distorted when you change the resolution of the picture. This is not a malfunction.

Some monitors have a specification that does not allow them to display personal contents (such as a movie recorded for private use) played on the unit. To play the video properly, use the COMPONENT OUT jacks or the VIDEO OUT jacks to connect the monitor and the unit.

7 LANC jack

Use this jack when controlling the tape transport operation of the unit using a device that has a LANC¹⁾ jack.

1) LANC (Local Application Control bus system): Bidirectional interface used to control a consumer VCR

Notes

- The LANC jack on the unit has only LANC-S functions. The unit has no LANC-M functions. A device that is set to LANC-S mode cannot be connected to the unit. Either the unit or the other device may not operate properly.
- When using the unit as a player, set LANC mode on the recorder to M. A VCR that does not have an M/S switching function cannot be used to operate the unit.
- When the device to be connected to the unit has a LANC-M function to switch between SHUTTLE A/B, select SHUTTLE A for an HDV-formatted tape, and SHUTTLE B for a DVCAM/DV (SP)-formatted tape.
- A LANC connection transmits command signals for playback, stop, pause playback, as well as the time code, tape counter, and data status of the unit.
- Jacks labeled CONTROL L have the same function as LANC jacks.
- There are some limitations when you edit an HDV-formatted tape.
Refer to the “Notes” in “Editing (Connecting a Computer)” on page 65.

8 CONTROL S jack

Connect this jack to a DSRM-10 remote control unit (not supplied) to operate the unit. You can also use a DSRM-20 (no longer manufactured; not supplied).

Note

When you use a CONTROL S device, set [COMMANDER] in the [OTHERS] menu to [CONTROL S].

9 i HDV/DV jack (6-pin)

Use this jack to input/output digital signals that comply with the i.LINK standard. Use this jack when a device connected to the unit has an i.LINK jack. If you connect the unit and another device using the i HDV/DV jack, you can minimize deterioration of picture quality during recording, dubbing, or capturing still pictures, all by means of digital signals processing.

For details, refer to the instruction manual of the external device.

Notes

- When you connect a computer and the unit with an i.LINK cable, check the direction of the jack. If you forcibly insert the jack, the terminal may be damaged or cause the unit to malfunction.

- This jack is only compatible with HDV (1080i)/DVCAM/DV signals.
For details, see “About i.LINK” on page 99.
- If the unit is connected to a device equipped with an i.LINK jack, when you intend to disconnect or reconnect the i.LINK cable, turn off the device and pull out the plug of its power cord from the AC outlet beforehand. If you connect or disconnect the i.LINK cable while the device is connected to the AC outlet, high-voltage current (8 to 40 V) is output from the i.LINK jack of the device to the unit. This may cause a malfunction.
- Even though the i HDV/DV jack of the unit is a 6-pin type, no power is supplied.
For details on each setting when HDV/DV signals are input, see “HDV/DV SEL” (page 70).
- You cannot output EE picture and sound of DVCAM/DV signals (NTSC, PAL) that are input from the i HDV/DV jack to the HDMI OUT jack. However, HDV signals are output to the HDMI OUT jack.
- When you change the video format setting of [HDMI/CMPNT] in [VIDEO OUT] of the [IN/OUT REC] menu, the video signal output from the S VIDEO OUT jack, the VIDEO OUT jack, or the i HDV/DV jack may be distorted.
For details on the output of the i HDV/DV jack, see “Notes on all video output jacks” (page 19).

Notes on all video output jacks

- When you change the video format setting of [HDMI/CMPNT] and [DOWN CONVERT] of [VIDEO OUT] in the [IN/OUT REC] menu, [ALLSCAN MODE] in the [DISPLAY SET] menu, or [HDV → DV CONV] and [DOWN CONVERT] of [i.LINK SET] in the [IN/OUT REC] menu, the image may be distorted for a moment. Also, the above settings may cause restrictions on the video output of the unit.
For details, refer to the table on page 88 and the instructions for each menu setting.
- When you change the video format setting of [HDMI/CMPNT] of [VIDEO OUT] in the [IN/OUT REC] menu, the video signals output from S VIDEO OUT jack, VIDEO OUT jack, or i HDV/DV jack may be distorted.

(Continued)

Location and Function of Parts

- The unit is only compatible with standard video signals. If you input the types of video signals shown below, recorded picture and sound may be distorted.
 - Signals from some home game machines
 - Blue background screen or gray background screen images from a consumer VCR
 - Pictures played at a speed other than normal by a VCR that does not have TBC (Time Base Corrector)
 - Video signals in which the sync signals are distorted
 - Signals from a defective cassette (tape or recording condition is bad) played by an analog VCR that does not have TBC
- When DVCAM/DV signals which are input from the  HDV/DV jack, or video signals which are from the VIDEO IN jacks or S VIDEO IN jacks, are output to each analog output jack, the distortion of the video signals occurs at the bottom of the TV monitor display due to the jitter. Depending on the display area of the TV monitor you have, the distortion of the picture may appear at the bottom of the screen. This is not a malfunction.

Pictures may be distorted or not be displayed depending on the TV monitors. This will not appear while recording with the unit.

Be aware of these phenomena when you connect other recording device via the analog jacks of the unit.
- Depending on the TV monitor being connected, the screen may blink or be distorted when DVCAM/DV signals which are input from the  HDV/DV jack, or video signals which are from the VIDEO IN jacks or S VIDEO IN jacks, are output to the VIDEO OUT jacks.

Be aware of these phenomena when you connect other recording device to these jacks. This will not appear while recording with the unit.
- During recording or in EE mode, the subcarrier of the color signal to be output from the unit is not synchronized with the horizontal sync signal. The color of the picture or the horizontal position of the picture may be distorted depending on the type of monitor connected to the unit.
- To output video signals to the VIDEO, S VIDEO, or COMPONENT OUT jacks without text data, set the DISPLAY OUTPUT switch to OFF, or press the DATA CODE or SEARCH SELECT button on the remote commander.

10 AC IN connector

Connects to an AC outlet using the supplied power cord. Even if the unit is in the standby mode, it consumes power. To turn the power off completely, press the “O” (OFF) marked side of the POWER switch **12**.

11 RESET button

If you press this button with the tip of a ballpoint pen or similar tool, the following settings are initialized.

- [CLOCK SET] (*page 81*) and [60i/50i SEL] (*page 82*) in the [OTHERS] menu.
- The settings on the unit other than the menu settings.

12 POWER (main power) switch

The main power switch of the unit. When this switch is in the “I” position, the ON/STANDBY lamp on the front panel lights up in green. (In the standby mode, the ON/STANDBY lamp lights up in red.)

When you do not intend to use the unit for a long time, press the “O” (OFF) marked side of the POWER switch.

Supplied Remote Commander

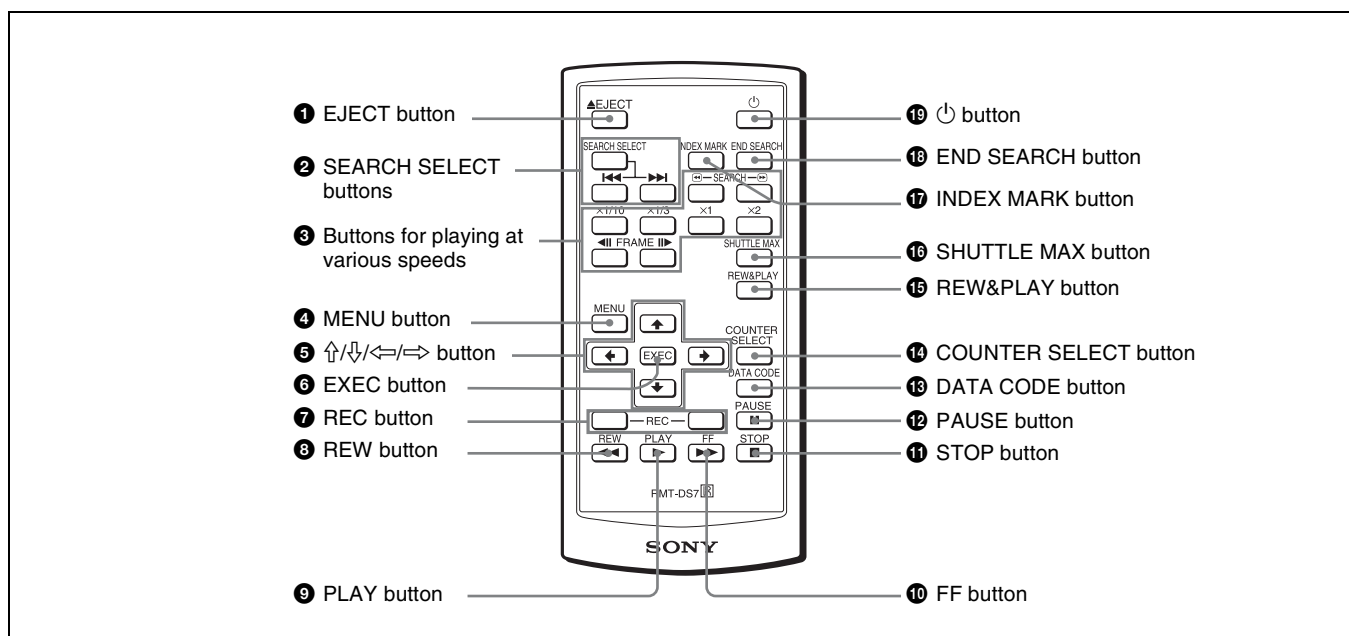

1 **EJECT button**

2 **SEARCH SELECT buttons**

Press these buttons to search for scenes using the search function.

For details on the search function, see “Searching using the search function” on page 41.

3 **Buttons for playing at various speeds**

You can play back a tape at normal speed or at a speed other than normal with these buttons.

For details, see “Playing at various speeds” on page 40.

4 **MENU button**

Press this button to display the menu on the screen.

For details on the menu, see “Operating Menus” on page 68.

5 **Cursor buttons**

Press these buttons to operate the cursor on the menu screen or to move the display position of the counter.

6 **EXEC (execute) button**

Press this button to input the value set on various menu setting screens.

7 **REC (record) buttons**

When you press both these buttons at the same time, the REC indicator and the PLAY indicator on the front panel light and recording begins.

8 **REW (rewind) button**

9 **PLAY button**

10 **FF (fast forward) button**

11 **STOP button**

12 **PAUSE button**

13 **DATA CODE button**

Press this button to display the data codes (recording date/time).

For details on data codes, see “Displaying information (data codes) recorded on a tape” on page 39.

14 **COUNTER SELECT button**

While the data or time counter is displayed, press this button to change the time counter display in the order of time code, user bits, and tape counter.

Count value of the tape counter (seven digits) is displayed on a ± 12 -hour cycle.

15 **REW&PLAY (rewind and play) button**

Press this button to rewind the tape to its beginning and start playing automatically. (During rewind, the REW indicator lights and the PLAY indicator blinks on the unit.)

(Continued)

Location and Function of Parts

16 SHUTTLE MAX button

During tape playback, press this button to play back the video at the maximum speed.

17 INDEX MARK button

Press this button during recording to mark an index.
For details on indexes, see “Marking an index” on page 50.

18 END SEARCH button

Press this button to play back the end of the last recorded part for only 5 seconds and stop automatically. Once you eject the video cassette, this function does not operate.

19 (on/standby) button

Notes

- The command mode of the supplied Remote Commander is set to VTR4. You cannot change the command mode setting.
- Set [COMMANDER] in the [OTHERS] menu to [WIRELESS] to enable the Remote Commander to control the unit (*page 80*).
- In addition to the Remote Commander supplied with the unit, the unit accepts signals from any Sony Remote Commander with a command mode set to VTR4.

To disable control from Remote Commander, set [COMMANDER] in the [OTHERS] menu to [CONTROL S].

Before using Remote Commander

Remove the insulation sheet before using the Remote Commander.

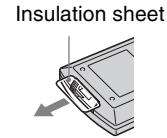

To change the battery of the Remote Commander

- 1 While pressing on the tab, inset your fingernail into the slit to pull out the battery case.
- 2 Place a new battery with the + side facing up.
- 3 Insert the battery case back into the Remote Commander until it clicks.

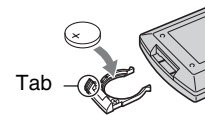

Note on batteries

When the lithium battery becomes weak, the operating distance of the Remote Commander may shorten, or the Remote Commander may not function properly. In this case, replace the battery with a Sony CR2025 lithium battery. Use of another battery may present a risk of fire or explosion.

WARNING

Battery may explode or leak if mistreated. Do not recharge, disassemble or dispose of in fire.

Caution

Replace the battery with the specified type only. Otherwise, fire or injury may result.

Displaying Various Data

The unit can display various superimposed text data on the built-in LCD monitor, and also on an external monitor connected to the unit. To display text data on an external monitor, set the DISPLAY OUTPUT switch to ALL or S VIDEO/VIDEO. You can turn various text data display on or off by pressing the DISPLAY button.

In this operation manual, the menu screen, etc., is displayed in English. You can change the desired language with the screen language setting.

For details, see “LANGUAGE” in the “OTHERS” menu on page 80.

Note

When images are output in 720p format, some of the text image data (outer frame: underscan portion) may appear cut out, depending on the displayable range of the monitor. In this case, check the text image data on the LCD monitor of the unit or on a monitor using the S VIDEO OUT jack or VIDEO OUT jack. Also, when your monitor has an underscan function, you can check all the text data on the monitor in the underscan mode.

Menu screen

Press the MENU button to display the menu screen.

For details on the menus, see “Chapter 5 Adjusting and Setting Through Menus” on page 68.

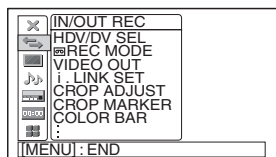

Data display screen

You can display the picture, picture and data, or picture and the time counter on the data screen by pressing the DISPLAY button when the unit is turned on.

Data display

You can confirm important information for normal recording or playback, such as time code or remaining tape time, on the screen.

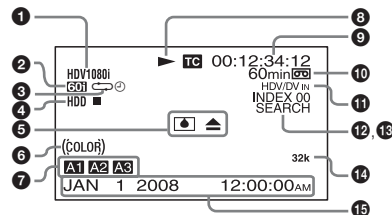

1 Format indicator

[HDV1080i], [HDV720p], [DVCAM], or [DV SP] are displayed.

2 60i/24p/30p/50i/25p indicator

3 Repeat indicator

Displays a repeat indicator when the TIMER switch is set to REPEAT. When [START TIME] of [CUSTOM REPEAT] is set to [ON] in the [VTR SET] menu, ☺ is also displayed (page 42).

4 HVR-DR60/HVR-MRC1 connection indicator

[HDD] is displayed while an HVR-DR60 is connected using the ⚡ HDV/DV jack. When an HVR-MRC1 is connected, [CF] is displayed (page 25).

5 Alarm indicator

Displays an alarm indicator.

For details on alarm indicators, see “Warning Indicators and Messages” on page 90.

6 x.v.Color indicator

Displays an x.v.Color indicator while pictures recorded in x.v.Color are played back.

For details on x.v.Color, see “Playback with x.v.Color output” on page 30.

7 ASSIGN buttons indicator

Displays an ASSIGN button indicator when an ASSIGN button is set to other than the default functions. For details on “ASSIGN buttons,” see page 80.

8 Tape transport mode indicator

Displays the tape transport mode.

(Continued)

9 Time counter (time code/user bits/count value of the counter) indicator

Displays the count value of the counter, time code, or user bits. By pressing the COUNTER SELECT button on the front panel, you can select the item to be displayed.

When the time code is displayed,  appears to its left. In the drop frame mode, a period is displayed between the minutes and seconds (i.e., 00:12.58:00).

When the user bits are displayed,  appears to their left.

When the count value of the counter is negative, “-” appears as the first digit (leftmost digit). When that value is positive, the first digit is blank.

The count value of the counter consists of seven digits. If the self-diagnostic function is enabled, diagnostics code numbers are displayed.

Note

When you playback a tape without a time code or with a time code recorded in different formats, the time code cannot be displayed correctly.

10 Remaining tape time indicator

Displays the remaining tape time.

For details, see “ REMAINING” in the “DISPLAY SET” menu on page 75.

Note

- The remaining tape time displayed is an estimated time.
- When you insert a cassette of which the tape has been rewound to the beginning, this indicator does not show the remaining tape time. The remaining tape time is displayed after the tape runs for a while.

11 INPUT SELECT indicator

Changes according to the position of the INPUT SELECT switch. ([HDV/DV IN], [S VIDEO IN] or [VIDEO IN])

12 (Index) indicator

Displays  when an index has been marked.

13 Search indicator

Displays the search mode when you search for scenes using the Remote Commander.

For details on the search function, see “Searching using the search function” on page 41.

14 Audio mode indicator

In the recording mode, displays 32k when you select [FS32K] for [AUDIO MODE] in the [AUDIO SET] menu.

When you select [FS48K], 48k is displayed.

During playback or audio dubbing, displays the audio mode recorded on the tape. During i.LINK input, displays the audio mode of the signal input to the  HDV/DV jack.

Notes

- The audio mode will not be displayed when [HDV/DV SEL] in the [IN/OUT REC] menu is set to [HDV].
- Signals other than HDV/DVCAM lock mode will become non-standard audio and NS32k/NS48k is displayed during playback or when the signal is input from the  HDV/DV jack.

15 Date/time indicator

When you press the DATA CODE button of the Remote Commander or set [DATA CODE] in the [DISPLAY SET] menu to [DATE], you can display the recording date/time.

For details on the date/time indicator, see “Displaying information (data codes) recorded on a tape” on page 39.

Time counter screen

To display the time counter on the LCD monitor, press the DISPLAY button. On the time counter screen, the time data (count value of the counter/time code/user bits) is displayed.

While the time counter is displayed, the position of the time counter can be moved up and down by pressing the \uparrow/\downarrow buttons. When the small size time counter is displayed, the position of the time counter can be moved not only up and down, but also to the left and right by pressing the \leftarrow/\rightarrow buttons.

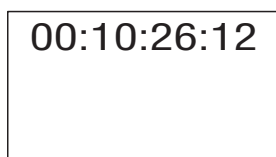

When the count value of the counter is negative, “-” appears as the first digit (leftmost digit). When that value is positive, the first digit is blank. When the format of the displayed time code is the drop frame mode, the drop frame indicator is displayed as a period between the minutes and seconds (i.e., 00:12.58:00). When user bits are displayed, the space between hour, minute, and second is blank.

Notes

- In the playback mode, if the tape has a portion where recorded signals are not continuous:
 - The count value of the counter may not advance correctly from that portion.
 - The displayed value of the time code or user bits may be temporarily inaccurate.
- When the unit plays back a part of the tape where the recorded systems of 60i (including 24p and 30p) and 50i (including 25p) are mixed, the displayed value of the counter may be inaccurate.
- When the unit plays back a part of the tape where the recording format has been changed among HDV, DVCAM and DV, the displayed value may be inaccurate.
- The counter operates on a ± 12 -hour cycle. You cannot make the counter operate on a 24-hour cycle.
- The count value of the counter consists of seven digits. The tens place of the “hour” is not displayed. (i.e., If the actual count value is “11:22:11:22”, the displayed value will be “1:22:11:22.”) However, the unit recognizes that the hours value is “11.”

Setting the time counter

You can adjust the settings of the time counter display in [COUNTER SET] in the [DISPLAY SET] menu.

DISPLAY : Selects whether to display the time counter or not.

SIZE : Selects the size of the time counter.

COLOR : Selects the color of the time counter.

For details on [COUNTER SET], see page 74.

STATUS CHECK screen

To display the STATUS CHECK screen, press the STATUS CHECK button.

Each time you press the \uparrow/\downarrow button, the STATUS CHECK screen switches in the order of AUDIO, OUTPUT, ASSIGN, and CUSTOM REPEAT.

To hide the STATUS CHECK screen, press the STATUS CHECK button again.

While an HVR-DR60 or an HVR-MRC1 is connected using the \blacksquare HDV/DV jack, the device information can be displayed using the \uparrow/\downarrow buttons of the unit.

Audio level meter and audio setting screen

The audio setting screen is displayed when the STATUS CHECK screen is set to [AUDIO]. This screen displays the audio level meter and the setting values of [AUDIO MONI] in the [AUDIO SET] menu.

For details on the [AUDIO SET] menu, see “AUDIO SET menu” on page 76.

Audio level meter

The audio level meter can be used to confirm and adjust the audio level.

The audio level meter is displayed in different patterns, depending on the audio mode and the AUDIO OUTPUT SELECT switch.

The unit detects the audio mode as follows:

In the playback mode: Detects the audio mode recorded on the tape.

In the recording/EE mode: Detects the selected audio mode in [AUDIO MODE] of the [AUDIO SET] menu.

When the INPUT SELECT switch is set to HDV/DV and HDV or DV signals are being input:

Detects the audio mode of the signals being input. (When i.LINK signals are input, the setting of [AUDIO MODE] in the [AUDIO SET] menu cannot be changed.)

(Continued)

Displaying Various Data

Audio mode: 48 kHz (2-channel, 16 bits)

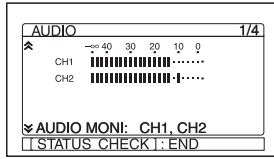

(The levels of two channels, channels 1 and 2, are displayed.)

Audio mode: 32 kHz (4-channel, 12 bits)

(a) When the AUDIO OUTPUT SELECT switch is set to CH-1/2 or CH-3/4

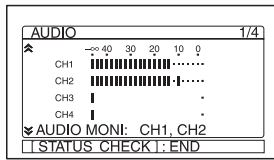

(The levels of four channels, channels 1 to 4, are displayed. During playback, if the sounds are recorded onto channels 3 and 4, their level meters fluctuate. However, during normal recording, you cannot record sounds onto the channels 3 and 4 on the unit.)

(b) When the AUDIO OUTPUT SELECT switch is set to MIX

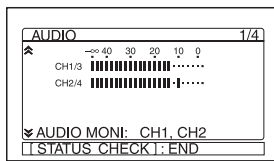

(The mixed level of channels 1 and 3 is displayed on CH1/3; that of channels 2 and 4 is displayed on CH2/4. The audio output level becomes 50% (-6 dB) of the original audio levels.)

(c) When the unit is in the audio dubbing mode and the AUDIO OUTPUT SELECT switch is set to CH-1/2 or CH-3/4

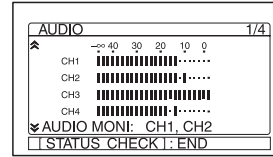

(The levels of playback sound are displayed on CH1 and CH2. The levels of input sound to be dubbed are displayed on CH3 and CH4. When AUDIO OUTPUT SELECT switch is set to MIX, the mixed level of the pair of channels 1 and 3 and that of channels 2 and 4 are displayed. The audio output level becomes 50% (-6 dB) of the original audio levels on each channel. In this case, the meters are as illustrated in (b) on this page. To check only the sound to be dubbed before dubbing, press the AUDIO DUB button while the unit is in the stop mode. The level meters fluctuate only when the channels (channel 3 and 4) are selected for audio dubbing.)

Note

In EE, recording, or audio dubbing (only the channels used to dub) mode, if the input levels exceed 0 dB, portions of the meters turn red. (However, when the audio mode is set to 32 kHz (4-channel, 12 bits), whereas the AUDIO OUTPUT SELECT switch is set to MIX, the mixed audio levels that exceed 0 dB do not turn red.) During playback or while HDV/DV signals are input, the levels meters do not turn red.

OUTPUT screen

The OUTPUT screen is displayed when STATUS CHECK screen is set to [OUTPUT].

You can confirm the following setting values:

- [HDV/DV SEL] in the [IN/OUT REC] menu
- [HDMI/CMPNT], [DOWN CONVERT] of [VIDEO OUT] in the [IN/OUT REC] menu
- [HDV → DV CONV], [DOWN CONVERT] of [i.LINK SET] in the [IN/OUT REC] menu

For details on OUTPUT settings, see "IN/OUT REC menu" on page 70.

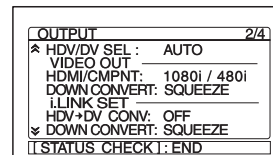

ASSIGN screen

The ASSIGN screen is displayed when STATUS CHECK screen is set to ASSIGN.

You can confirm the setting values of [ASSIGN BTN] in the [OTHERS] menu.

For details on ASSIGN buttons, see “ASSIGN BTN” in the “OTHERS” menu on page 80.

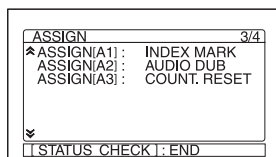

CUSTOM REPEAT screen

The CUSTOM REPEAT screen is displayed when STATUS CHECK screen is set to [CUSTOM REPEAT].

The settings of [CUSTOM REPEAT] in the [VTR SET] menu are displayed. While CUSTOM REPEAT is in progress, you can also confirm the current status of CUSTOM REPEAT.

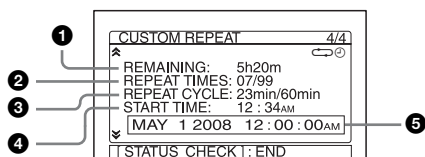

- ❶ **REMAINING** : displays the estimated remaining time of CUSTOM REPEAT.
- ❷ **REPEAT TIMES** : displays the times that the tape has played, and the total repeat times you have set in [REPEAT TIMES].
- ❸ **REPEAT CYCLE** : displays the playback time and the interval time of the tape which you have set in [REPEAT CYCLE].
- ❹ **START TIME** : displays the time CUSTOM REPEAT starts, which you have set in [START TIME].
- ❺ **Date and time** : displays the date and time set by [CLOCK SET] in the [OTHERS] menu, when [START TIME] is set to [ON].

Note

Items that have not been set up are displayed as [OFF].
For details on CUSTOM REPEAT, see “CUSTOM REPEAT” in the “VTR SET” menu on page 77.

Playback and Recording

Notes on Power Supply and Video Cassettes

Usable cassettes

For recording in the HDV/DV format, we recommend you use a DigitalMaster™ cassette such as standard HDV/DVCAM/DV cassette (PHDV-276DM, etc.), or mini HDV/DVCAM/DV cassette (PHDVM-63DM, etc.).

For recording in the DVCAM format, we recommend you use a standard DVCAM cassette, Mini-DVCAM cassette, or DigitalMaster™ shown above.

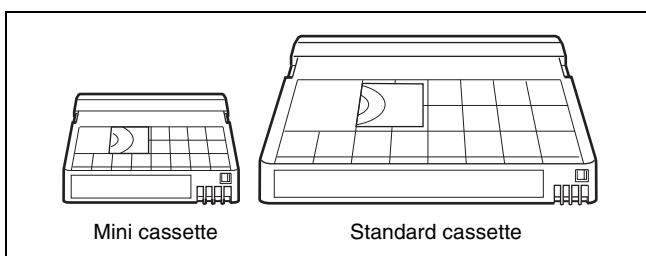

Cassette compatibility

A DV format cassette tape can be used for HDV. The recording bit rate and recording track pitch on a tape of the HDV1080i system used for the HVR-M25AU/M25AN/M25AE/M25AP are about 25 Mbps and 10 μ m, respectively. The specifications are the same as those of home use DV (SP) tapes. The recording time on an HDV tape is also the same as that of a DV (SP) tape. The track pitch of DVCAM is 15 μ m, which is 1.5 times that of HDV/DV (SP). Therefore, the recording time

using DVCAM recording on the same tape will be two-thirds of the time available when HDV/DV (SP) recording is used.

Cassette memory

Some mini cassettes and standard cassettes have the cassette memory (C// mark). The unit, however, does not support the cassette memory function.

However, if you use the DSR-25/45/50 as a recorder, the unit accesses cassette memory only if the recorder is set to [AUTO  C//].

To save a recording

To prevent accidental erasure of a recording, set the REC/SAVE switch on the cassette to SAVE. To record or dub audio on a tape, set the switch to REC.

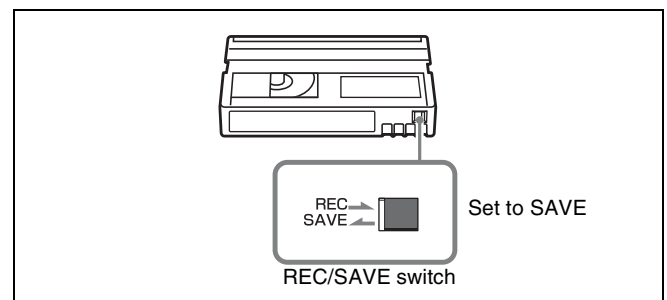

Checking the tape for slack

Using a paper clip or a similar object, turn the reel gently in the direction shown by the arrow. If the reel does not move, there is no slack.

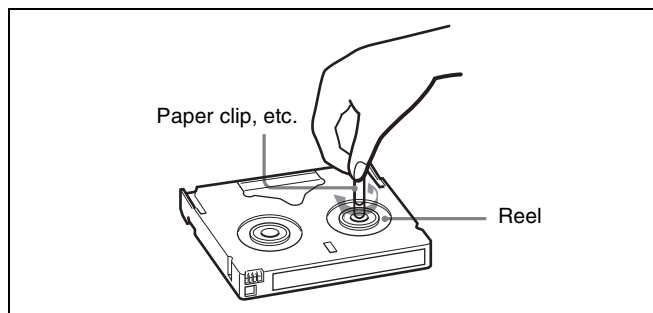

Preparing the Power Supply

Connect the power cord (supplied) to the AC IN connector. Then, connect the power plug to the wall outlet.

When you disconnect the power code from the wall outlet, be sure to unplug the power plug from the wall outlet first.

Turning the Power on

Press the POWER switch on the rear panel of the unit to the "I" (ON) position. Then press the ON/STANDBY button on the front panel.

The [CLOCK SET] screen appears when you turn on the unit for the first time.

For details on [CLOCK SET], see page 81.

Inserting/Ejecting Cassettes

To insert a cassette

After checking the tape for slack, hold the cassette so that the tape window is facing upward, then insert it into the unit.

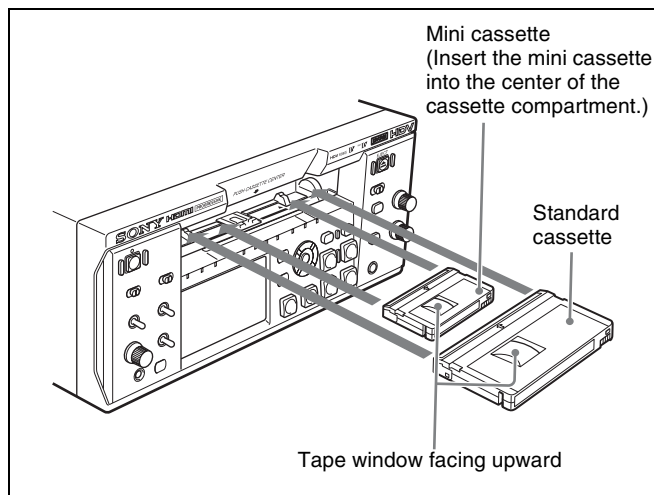

Notes

- Do not insert the cassette forcibly. The unit may be damaged.
- Do not eject/load the cassette in a place subject to light. The internal sensor of the unit may operate incorrectly if too much light falls on the unit.
- When inserting a cassette, hold the back edge of the cassette in the center and push it until the cassette is inserted deep into the unit. If you hold the ends, the cassette may not be loaded properly.
- If the cassette does not load or is loaded only halfway, eject it once, then insert it again. In such a case, if you insert the cassette forcibly, the cassette may not be loaded properly or malfunctions may occur.
- It takes a few seconds for the unit to recognize the cassette and find the proper location on the tape being loaded.

To eject the cassette

With the unit powered on, press the EJECT button.

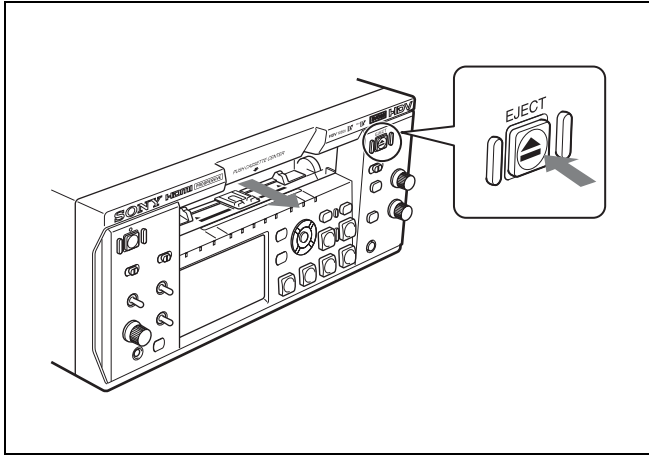

The cassette is disengaged and ejected.

Notes on Playback/Recording

No compensation for contents of the recording

Contents of the recording cannot be compensated for if recording or playback is not successful due to a malfunction of the unit, video tape, etc.

Copyright precautions

Television programs, films, video tapes, and other materials may be copyrighted. Unauthorized recording of such materials may be contrary to the copyright laws.

Copyright signal

On playback

When the cassette you play back on the unit contains copyright signals, you cannot copy it to a tape in another device connected to your unit.

On recording

You cannot record software on the unit that contains copyright control signals for copyright protection of software.

[Cannot record due to copyright protection.] appears on the LCD screen if you try to record such software. The unit does not record copyright control signals on the tape when it records.

Limitations caused by differences in format

The unit can record and play back tapes recorded in HDV format (1080/60i, 1080/24p, 1080/30p, 1080/50i and 1080/25p), DVCAM format, or DV format (SP mode).

The unit can input/output and record signals via the **i** HDV/DV jack.

The unit can play back pictures recorded in 720/24p, 720/25p or 720/30p of the HDV format, but you cannot input/output these pictures via the **i** HDV/DV jack.

The unit cannot input/output, record, or play back a tape recorded in 720/60p or 720/50p of the HDV format, and 480p/576p of the SD format.

For details, see "Major Differences among HDV1080i, DVCAM, and DV Formats" on page 31.

If a tape contains portions recorded in two or more different formats, the following limitations are applied when you play back the tape with the unit:

- The image may be distorted and noise may occur at the point where the recording format changes on the tape.
- The tape transport control buttons may be disabled until the tape speed is stabilized.

Note on playback on other equipment

A tape recorded in HDV format with the unit cannot be played back with devices not compatible with the same format. We recommend confirming the contents of the tape by playing back the tape with the unit before playing it back on another video equipment.

Playback with x.v.Color output

The unit can play back pictures recorded in x.v.Color.

- x.v.Color is a brand name that Sony is proposing as a easy-to-remember name for the xvYCC standard.
- The xvYCC standard is an international standard for color space within moving images. The xvYCC standard can reproduce a wider range of colors than the standards used for current broadcasting.

Recording Format and Input/Output Signals

Major Differences among HDV1080i, DVCAM, and DV Formats

(This unit and other equipment for professional use may be functionally extended. For details, see the notes below the table.)

Specification	HDV1080i ¹⁾	DVCAM	DV (SP)
Track pitch	10 μ m	15 μ m	10 μ m
Audio sampling frequency	16 bit: 48 kHz	12 bit: 32 kHz 16 bit: 48 kHz	12 bit: 32 kHz 16 bit: 32 kHz, 44.1 kHz, 48 kHz ³⁾
Audio recording mode ²⁾	Lock mode	Lock mode	Unlock mode ⁴⁾
Time code	Drop frame mode (60i/24p/30p only) ⁵⁾ No user bits ⁵⁾	NTSC: SMPTE time code (DF/NDF, including user bits) PAL: EBU time code (including user bits)	Drop frame mode (NTSC only) ⁵⁾ No user bits ⁵⁾

- 1) The unit cannot record 4-channel sound of HDV format.
- 2) There are two modes for audio signal recording: Lock mode and Unlock mode. In Lock mode, the sampling frequencies of audio and video are synchronized. In Unlock mode, adopted by the consumer DV format, the two sampling frequencies are independent. Lock mode maintains high compatibility with higher formats and offers better digital processing and smoother transition than Unlock mode when you edit audio.
- 3) The unit cannot record in DV format with 16 bit: 32 kHz or 44.1 kHz.
- 4) The unit has been functionally extended with a function for switching between Lock mode and Unlock mode.
- 5) The unit has been functionally extended with a function to enable selecting DF/NDF and user bits setting for 60i (including 24p and 30p) with HDV or DV (SP) format.

Recording Format and Input/Output Signals

Input/Output Signals in EE Mode

Select the signal input with the INPUT SELECT switch on the front panel (page 8).

○: Output, —: No output or N/A

Input signal	Input jack		Output jack					
			HDV/DV		HDMI OUT	COMPONENT OUT	VIDEO/S VIDEO	
			Output signal format	DVCAM/DV				HDV
		Input format						
Digital signal	HDV/DV	HDV	1080/60i	—	—	○ ¹⁾	○ ¹⁾	○ (480i) ²⁾
			1080/24p	—	—	○ ¹⁾	○ ¹⁾	○ (480i) ²⁾
			1080/30p	—	—	○ ¹⁾	○ ¹⁾	○ (480i) ²⁾
			1080/50i	—	—	○ ¹⁾	○ ¹⁾	○ (576i) ²⁾
			1080/25p	—	—	○ ¹⁾	○ ¹⁾	○ (576i) ²⁾
			720/30p/25p/24p	—	—	—	—	—
		DVCAM/DV	—	—	—	○ ³⁾	○ ³⁾	
Analog signal	VIDEO/S VIDEO		○	—	—	○ ³⁾	○ ^{3) 4)}	

1) The format of the picture output from the HDMI OUT jack and COMPONENT OUT jacks can be set in [HDMI/CMPNT] of [VIDEO OUT] in the [IN/OUT REC] menu (page 71). For details, see the settings for down conversion (page 34).

2) The signals are down converted and output.

The format of the picture output from the VIDEO OUT jack and the S VIDEO OUT jack can be selected from [SQUEEZE], [LETTER BOX] and [EDGE CROP] in [DOWN CONVERT] of [VIDEO OUT] in the [IN/OUT REC] menu (page 71).

3) When DVCAM/DV signals which are input from the HDV/DV jack, or video signals which are from the VIDEO IN jacks or S VIDEO IN jacks, are output to each analog output jack, the distortion of the video signals occurs at the bottom of the TV monitor display due to the jitter. Depending on the display area of the TV monitor you have, the distortion of the picture may appear at the bottom of the screen. This is not a malfunction.

Pictures may be distorted or not be displayed depending on the TV monitors. This will not appear while recording with the unit.

Be aware of these phenomena when you connect other recording device via the analog jacks of the unit.

4) Depending on the TV monitor being connected, the screen may blink or be distorted when DVCAM/DV signals which are input from the HDV/DV jack, or video signals which are from the VIDEO IN jacks or S VIDEO IN jacks, are output to the VIDEO OUT jacks.

Be aware of these phenomena when you connect other recording device to these jacks. This will not appear while recording with the unit.

Notes

- HDV 720/30p/25p/24p signals can be played back, but cannot be input/output via the HDV/DV jack on the unit.
- HDV 720/60p, HDV720/50p and SD 480p/576p signals cannot be input/output, recorded, or played back on the unit.

Recording Input Signals and Recording Formats

Select the signal input with the INPUT SELECT switch on the front panel (page 8).

○: Recordable, —: Not recordable

Input signal	Input jack		Recording format			
			HDV	DVCAM	DV (SP)	
						Input format
Digital signal	i HDV/DV	HDV	1080/60i	○	—	—
			1080/24p	○	—	—
			1080/30p	○	—	—
			1080/50i	○	—	—
			1080/25p	○	—	—
			720/30p/25p/24p	—	—	—
		DVCAM/DV		—	○	○
Analog signal	VIDEO/S VIDEO		—	○	○	

Notes

- HDV 720/30p/25p/24p signals can be played back, but cannot be input/output via the i HDV/DV jack on the unit.
- HDV 720/60p, HDV720/50p and SD 480p/576p signals cannot be input/output, recorded, or played back on the unit.

Playback Tape Format and Output Signals

○: Output, —: No output or N/A

Format of the signals recorded on the tape		Output jacks				
		i HDV/DV		HDMI OUT	COMPONENT OUT	VIDEO/S VIDEO
		Output signal format				
		DVCAM/DV	HDV			
HDV	1080/60i	○	○	○ ¹⁾	○ ¹⁾	○ (480i) ²⁾
	1080/24p	○	○	○ ¹⁾	○ ¹⁾	○ (480i) ²⁾
	1080/30p	○	○	○ ¹⁾	○ ¹⁾	○ (480i) ²⁾
	1080/50i	○	○	○ ¹⁾	○ ¹⁾	○ (576i) ²⁾
	1080/25p	○	○	○ ¹⁾	○ ¹⁾	○ (576i) ²⁾
	720/30p/24p	—	—	○ ¹⁾	○ ¹⁾	○ (480i) ²⁾
	720/25p	—	—	○ ¹⁾	○ ¹⁾	○ (576i) ²⁾
DVCAM/DV (SP)		○	—	○	○	○

1) The format of the picture output from the HDMI OUT jack and COMPONENT OUT jacks can be set in [HDMI/CMPNT] of [VIDEO OUT] in the [IN/OUT REC] menu (page 71). For details, see the settings for down conversion (page 34).

2) The signals are down converted and output.

For details on the format of signals output from each jack, see the settings for down conversion (page 34).

Notes

- HDV 720/30p/25p/24p signals can be played back but not input/output via the i HDV/DV jack on the unit.
- HDV 720/60p, HDV720/50p and SD 480p/576p signals cannot be input/output, recorded, or played back on the unit.

Recording Format and Input/Output Signals

Settings for Output Signals from Each Jack

Settings of output signals from the HDMI OUT/COMPONENT OUT/VIDEO OUT/S VIDEO OUT jacks

Set the output signals in [HDMI/CMPNT] of [VIDEO OUT] in the [IN/OUT REC] menu (page 71).

[60i/50i SEL]	Format of the original signals	Setting of the [HDMI/CMPNT] menu	Format of the signals output from each jack		
			HDMI OUT	COMPONENT OUT	VIDEO/S VIDEO
60i	HDV 1080/60i HDV 1080/24p HDV 1080/30p HDV 720/24p HDV 720/30p	480i	480/60i ¹⁾		480/60i ¹⁾
		480p/480i	480/60p ¹⁾		
		1080i/480i	1080/60i		
		720p/480i	720/60p		
	DVCAM/DV 480/60i	480i	480/60i	480/60i	480/60i
		480p/480i	480/60p ²⁾		
		1080i/480i	480/60i		
		720p/480i	480/60i		
	S VIDEO/VIDEO input	480i	—	480/60i	480/60i
		480p/480i			
		1080i/480i			
		720p/480i			
50i	HDV 1080/50i HDV 1080/25p HDV 720/25p	576i	576/50i ¹⁾		576/50i ¹⁾
		576p/576i	576/50p ¹⁾		
		1080i/576i	1080/50i		
		720p/576i	720/50p		
	DVCAM/DV 576/50i	576i	576/50i	576/50i	576/50i
		576p/576i	576/50p ²⁾		
		1080i/576i	576/50i		
		720p/576i	576/50i		
	S VIDEO/VIDEO input	576i	—	576/50i	576/50i
		576p/576i			
		1080i/576i			
		720p/576i			

1) You can select from [SQUEEZE], [LETTER BOX] or [EDGE CROP] in [DOWN CONVERT] of [VIDEO OUT] in the [IN/OUT REC] menu (page 71).

2) The setting of [480p/480i] and [576p/576i] are only effective for output from the HDMI OUT jack.

Notes

- HDV 720/30p/25p/24p signals can be played back but cannot be input/output via the  HDMI/DV jack on the unit.
- HDV 720/60p, HDV 720/50p and SD 480p/576p signals cannot be input/output, recorded, or played back on the unit.

Setting of output signals from the i HDV/DV jack

Set the output signals in [HDV → DV CONV] of [i.LINK SET] in the [IN/OUT REC] menu (page 72). The setting is available when [HDV/DV SEL] is set to [AUTO] or [HDV].

Format of the original signals	Setting of the [HDV → DV CONV] menu	Format of signals output from the i HDV/DV jack
HDV 1080/60i HDV 1080/30p HDV 1080/24p	OFF	Complies with input signals.
	DVCAM	DVCAM 480/60i ¹⁾
	DV SP	DV 480/60i ¹⁾
HDV 1080/50i HDV 1080/25p	OFF	Complies with input signals.
	DVCAM	DVCAM 576/50i ¹⁾
	DV SP	DV 576/50i ¹⁾

1) You can select [SQUEEZE] or [EDGE CROP] in [DOWN CONVERT] of [i.LINK SET] in the [IN/OUT REC] menu (page 72). You cannot set [LETTER BOX] in this menu.

Playback

This section describes the connections and settings for playback and functions such as playback at various speeds, and searching for a specific scene on a recorded tape.

Connections for Playback

Connecting the unit to a monitor without an i.LINK jack

You can connect the unit to a video monitor/recorder without an i.LINK jack. Connect video cables and audio cables as shown below. For each jack, *see page 16*.

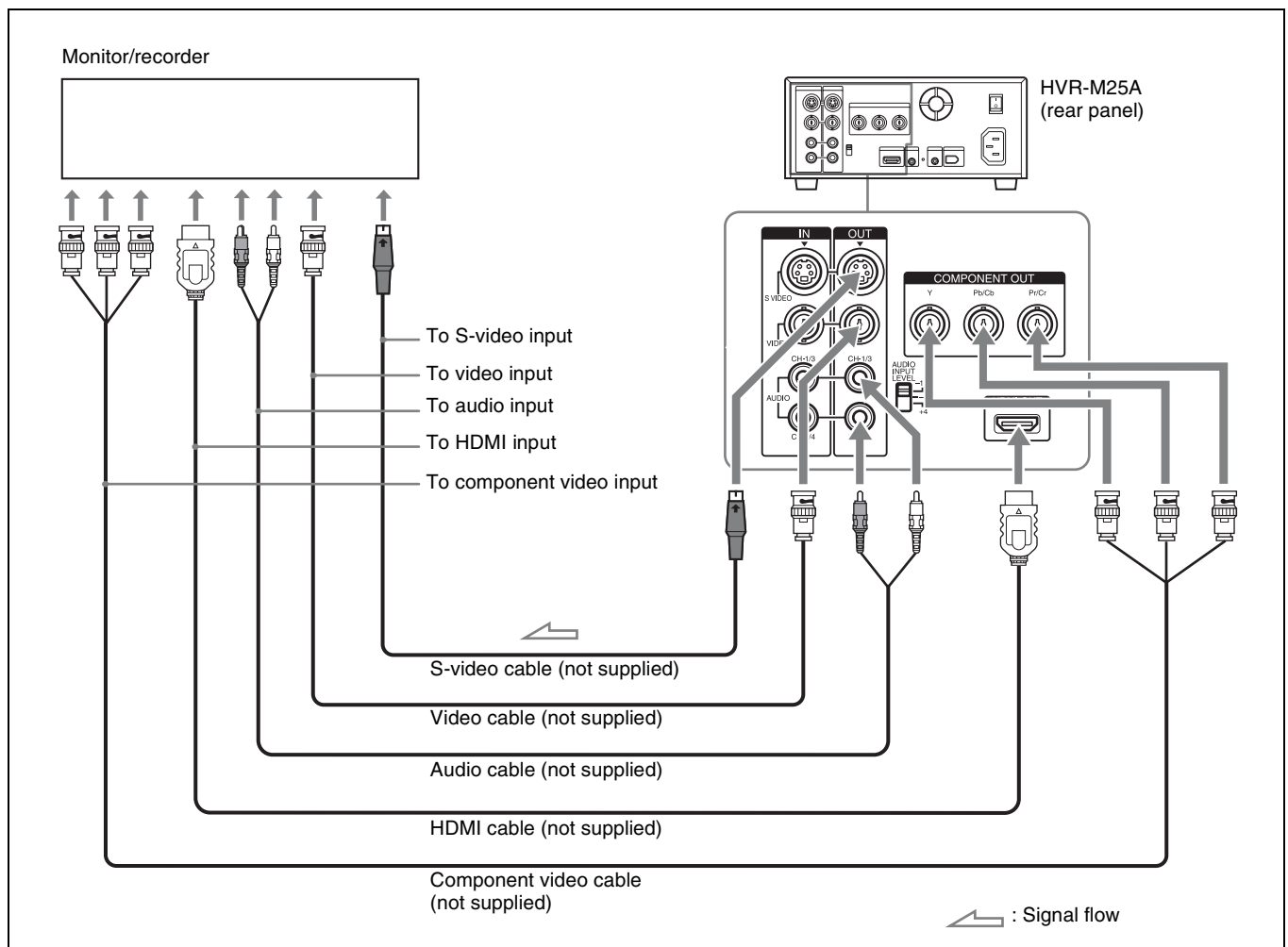

Notes

- To playback an image recorded in HDV format when you connect the monitor using an HDMI cable or a component video cable, set [HDMI/CMPNT] of [VIDEO OUT] in the [IN/OUT REC] menu according to the requirements of your monitor (page 71).
 - When an image recorded in DVCAM/DV format is played back, only an image with a quality equivalent to that of the DVCAM/DV format of 480i (NTSC) or 576i (PAL) is output via the COMPONENT OUT jacks, regardless of the [HDMI/CMPNT] setting.
 - For details on the output level from the HDMI OUT jack and the COMPONENT OUT jacks, see “Specifications” (page 100).
 - To change the output level from the COMPONENT OUT jacks, see [480i LEVEL] in the [IN/OUT REC] menu (page 74).
 - There are some restrictions on images output from the HDMI OUT jack and the COMPONENT OUT jacks of the unit.
- Refer to **HDMI OUT jack 6** (page 17), **COMPONENT OUT jacks 5** (page 17) of “Location and Function of Parts.”
- For more information, see “Recording Format and Input/Output Signals” on page 31.
- If you connect the input connectors of the unit to the output connectors of a monitor, a humming noise may be generated or the image may be distorted. If these phenomena occur, use the INPUT SELECT switch to select a signal that is not being input, or disconnect the cables.
 - When you play back an HDV-formatted tape with copyright protected signals or input HDV signals with copyright protection to the **i** HDV/DV jack, pictures may be output in either 480i (NTSC) or 576i (PAL) format, regardless of the setting of [HDMI/CMPNT] of [VIDEO OUT] in the [IN/OUT REC] menu.
 - The unit cannot up convert DVCAM/DV recordings to HDV at output.
 - When [HDMI/CMPNT] of [VIDEO OUT] in the [IN/OUT REC] menu is set to either [1080i/480i] or [1080i/576i], 1080/24p and 1080/30p video signals played back are converted to 1080/60i and 1080/25p video signals are to 1080/50i, and output from the COMPONENT OUT jacks and the HDMI OUT jack.

Connecting the unit to a monitor equipped with an i.LINK jack

The video and audio signals are sent with hardly any degradation, enabling high-quality playback to a monitor with an i.LINK connector that supports HDV, DVCAM, and DV formats.

For details on i.LINK output formats, see page 97.

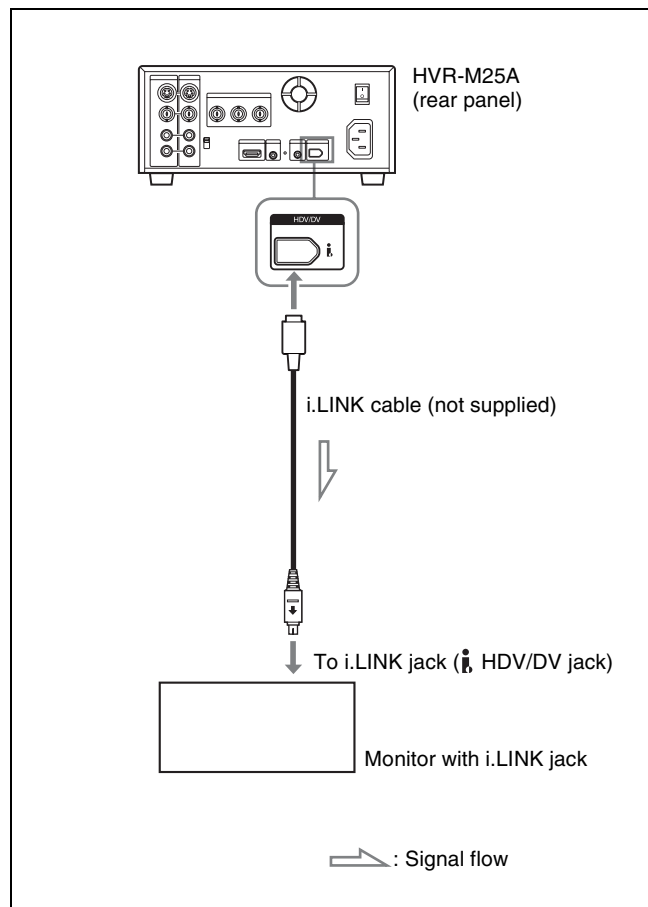
**Notes**

- Be sure that you set [HDV/DV SEL] in the [IN/OUT REC] menu to [AUTO] (default setting) before connecting the monitor to the unit with the i.LINK cable. If you change the setting after connecting the i.LINK cable, the monitor may not recognize the video signals correctly (page 70).
 - To connect the unit to a monitor equipped with an i.LINK jack, you may need to set the monitor so that it recognizes the unit.
- For details, refer to your monitor's instruction manual.
- When an i.LINK connection is made, the unit cannot output video or audio only.

(Continued)

- If you connect the input connectors of the unit to the output connectors of a monitor, a humming noise may be generated or the image may be distorted. If these phenomena occur, use the INPUT SELECT switch to select a signal that is not being input, or disconnect the cables.
- To connect the i.LINK cable between a monitor and the unit, use an HDV or DV-compatible monitor. To play back a tape recorded in the HDV mode on a DV-compatible monitor, set [HDV → DV CONV] of [i.LINK SET] in the [IN/OUT REC] menu to [DVCAM] or [DV SP] before connecting the unit with the i.LINK cable.
For details, refer to your monitor's instruction manual.
- With HDV signals, interlace to progressive or progressive to interlace conversions cannot be made and be output via the **i** HDV/DV jack.
- When HDV signals are down-converted to DVCAM (or DV) format during playback of HDV recorded in progressive and output to the **i** HDV/DV jack, the signals are converted to the interlace system. 1080/24p and 1080/30p are converted to 480i, and 1080/25p to 576i, respectively (*page 35*).
- Some general consumer television sets are provided with a function to control equipment connected with the i.LINK cable. Such a function, however, may not work with the unit.

Settings for Playback

Preparation on the unit

Notes

- Text information is superimposed to the VIDEO OUT jack, S VIDEO OUT jack, COMPONENT OUT jacks, and HDMI OUT jack. To output video signals without text data, set the DISPLAY OUTPUT switch to OFF.
For details on the DISPLAY OUTPUT switch, see page 8.
For details on text data, see "Displaying Various Data" on page 23.
- To view a tape recorded in HDV format by connecting the unit to a monitor that has a 4:3 aspect ratio, set [DOWN CONVERT] of [VIDEO OUT] in the [IN/OUT REC] menu to the desired mode (*page 71*).

- 1** Power on the monitor, then set the monitor's input switch according to the signals input.
- 2** Turn the unit on.

Playback Procedures

- 1** Insert a cassette and confirm that the  (cassette) indicator lights.
- 2** Press the PLAY button on the unit.

The unit starts playback.

To stop playback

Press the STOP button on the unit.

To pause playback

Press the PAUSE button on the unit.

Notes

- During playback, distortion of picture or noise in audio may occur at the portion where the recording format changes.
- You cannot play back an image recorded in DV (LP) mode on the unit.
- If the unit is playing a tape recorded with mixed video signals of the 60i system and 50i system, the picture and sound will be distorted on any portion of a tape where the recording system changes.
- During pause, a picture recorded on a tape in HDV format cannot be output from the **i** HDV/DV jack.

Playback Functions

This section describes useful functions that can be used during playback.

Displaying information (data codes) recorded on a tape

If you record on a tape using a Sony digital HD video camera recorder or digital camcorder, the recording information (data codes) is recorded on the tape. During playback, you can check the recording date and time from the data codes by displaying this information on the unit. Each time you press the DATA CODE button on the Remote Commander, the display switches between no data code display and recording date/time display. Also, you can change the display by setting [DATA CODE] in the [DISPLAY SET] menu.

For details, see “DATA CODE” on page 75.

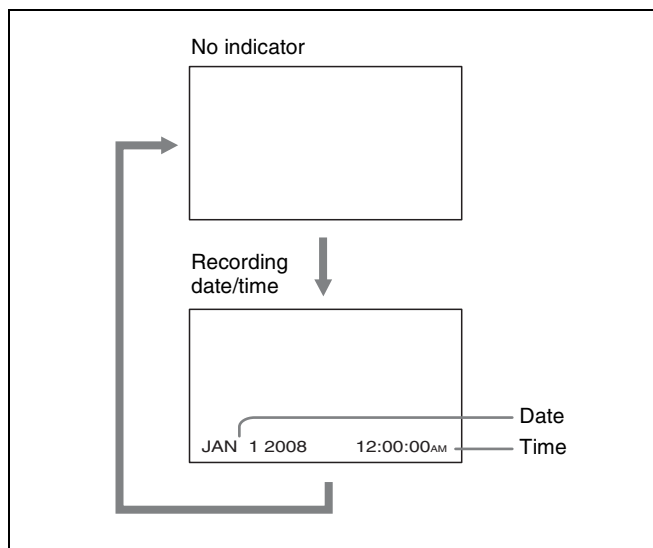

Notes

- If data codes were not recorded, “- - -” appears instead.
- The unit cannot record or play back camera data.

Playback

Playing at various speeds

You can playback a tape at various speeds using the Remote Commander.

By using the DSRM-10 remote control unit (not supplied), you can search for pictures while the video is played back at about +24 to -24 times of normal speed.

HDV-formatted tape

Button	Operation speed	Panel/analog output		i.LINK output	
		Forward direction	Reverse direction	Forward direction	Reverse direction
× 1/10	One-tenth of normal speed	⊙	—*	—*	—*
× 1/3	One-fifth of normal speed	⊙	—*	—*	—*
× 1	Playback at normal speed	⊙	○	⊙	○
× 2	Playback at normal speed	—*	—*	—*	—*
FRAME ◀ ▶	Frame-by-frame forward scanning	⊙	—*	—*	—*
⏮/⏭	8× speed	○	○	○	○
SHUTTLE MAX	24× speed	○	○	○	○

* The output will be the same as that of ×1.

⊙: Play at normal speed.

○: A rough image is output.

—: No playback takes place.

DVCAM/DV-formatted tape

Playback options	Operation
Play at 1/10 of normal speed	Press the × 1/10 button during playback.
Play at 1/3 of normal speed	Press the × 1/3 button during playback.
Play at normal speed	Press the × 1 button during playback.
Play at twice the normal speed	Press the × 2 button during playback.
Play frame by frame	Press the FRAME ◀ ▶ buttons during pause. To play back in the forward direction, press the ▶ button; in the backward direction, press the ◀ button. If you press and hold one of these buttons, playback continues, frame by frame.
Fast forward the tape while monitoring pictures	Press the ⏭ button during normal playback or when playing at various speeds.
Rewind the tape while monitoring pictures	Press the ⏮ button during normal playback or when playing at various speeds.
Play at the maximum speed	Press the SHUTTLE MAX button during playback.

To change playback direction

Press the FRAME ◀||/||▶ buttons during normal playback or when playing at various speeds. To play back in the forward direction, press the ||▶ button; in the backward direction, press the ◀|| button.

Notes

- When the command mode of a Sony device/remote commander is set to VTR4:
 - If you press the ×1/3 button on the supplied Remote Commander while pointing it toward a Sony device other than the unit, the playback speed may turn to 1/5 of normal speed.
 - When you play back a tape in DVCAM/DV format and press the ×1/5 button on the Remote Commander while pointing it toward the unit, the playback speed turns to 1/3 of normal speed.
- If the unit keeps playing at 1/10 of normal speed in forward or reverse for more than 1 minute, the unit begins to play back at normal speed.

To hear the sound while playing at various speeds

To hear the sound while playing at various speeds, set [JOG AUDIO] in the [AUDIO SET] menu to [ON].

For details on the [AUDIO SET] menu, see “AUDIO SET menu” on page 76.

Note

You cannot hear the sound while playing back a tape recorded in HDV format at various speeds.

Searching using the search function

The unit can immediately access the following signals recorded on a tape.

- Searching for the beginnings of the recordings: Index search
- Searching for a point on the tape where the recorded date changes: Date search

To search for scenes, use the supplied Remote Commander. Also, you can assign the same search function to the ASSIGN buttons.

For details on ASSIGN buttons, see “ASSIGN BTN” in the “OTHERS” menu on page 80.

- 1 Press the SEARCH SELECT button on the Remote Commander to select the search type.

The search type changes in the order of Index search → Date search → (No indication).

When selecting INDEX SEARCH



(The search screens are displayed only on Data display screen.)

- 2 Press the ◀◀ / ▶▶ button repeatedly to locate the scene you want.

Each time you press the ◀◀ / ▶▶ button, the unit searches for the previous or next search point. When a search point is located, its number is indicated on the monitor screen. The unit starts searching backwards or forwards until the number comes to zero, then plays back the scene.

How signals are recorded

There are four different signal types, one for each search method; index, title, date, and photo signals. The unit can record either index signals or date signals only on a tape.

Notes

- If you record another program over the beginning of the search signals, you cannot locate the original program.

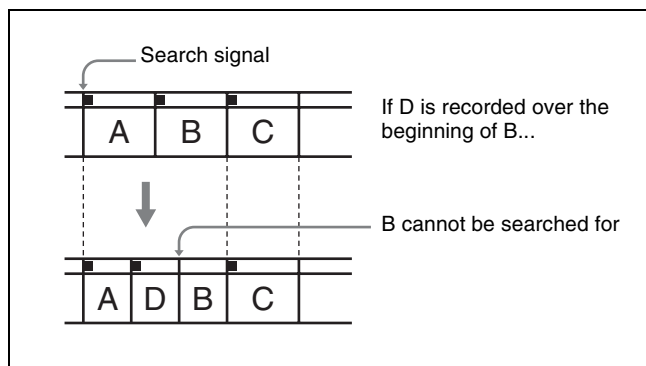

(Continued)

Playback

- The interval of a date or index must be 2 minutes or more. If the interval is short, the search signals may not be detected correctly.
- If non-recorded portions are included in the middle of a tape, signal search may not be performed correctly.
- You cannot add search signals after recording.
- The unit does not support searching, reading, or writing of data on cassette memory. For duplicating with the DSR-25/45/50, see “Cassette memory” on page 28.
- Searching may not be done correctly if the tapes were not recorded on Sony-brand digital video equipment.

Auto Repeat (CUSTOM REPEAT)

The unit can repeat playback of all or a part of a tape. When the following items on the tape are searched for, the unit rewinds the tape to its beginning and starts auto repeat playback automatically.

- Index signals
- A portion unrecorded
- A portion recorded in a format set by other than [AUTO] in [HDV/DV SEL] in the [IN/OUT REC] menu
- Tape end

By setting up [CUSTOM REPEAT] in the [VTR SET] menu, you can customize the repeat times, the repeat cycle, and the start time of repeat playbacks.

To set CUSTOM REPEAT

Set the following sub menus of [CUSTOM REPEAT] in the [VTR SET] menu.

REPEAT TIMES

- ON/OFF** : Selects either to enable or to disable REPEAT TIMES setting.
- TIMES** : Sets the number of times to repeat playback.

Repeat times can be set from 1 to 99 times. Set the number of repeat times by pressing the \uparrow/\downarrow buttons on the unit.

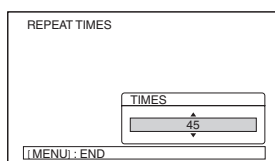

Press the EXEC button to complete the operation.

REPEAT CYCLE

- ON/OFF** : Selects either to enable or disable the REPEAT CYCLE setting.
- CYCLE** : Sets the time of intervals for playback.

The time of repeat interval is equal to the total time of tape in playback, rewind, and stop. Repeat intervals can be selected from 15 minutes to 300 minutes with 5 minute increments. Set the desired number by pressing the \uparrow/\downarrow button on the unit.

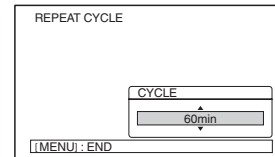

Press the EXEC button to complete the operation.

START TIME

- ON/OFF** : Selects either to enable or disable [START TIME].
- TIME** : Sets the start time of [CUSTOM REPEAT].

You can adjust the start time of [CUSTOM REPEAT]. Set the number for the hour and minute by pressing the \uparrow/\downarrow button on the unit. Press the EXEC button after the hour is set, then adjust the minute.

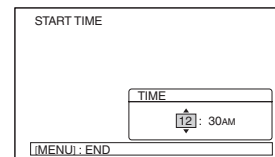

Press the EXEC button to complete the operation.

To play back at a pre-set START TIME, rewind the tape beforehand. If the tape is not rewound, the unit rewinds the tape to its beginning at the selected START TIME, then start playback.

Note

While the unit is in standby mode, even when the START TIME setting is applied and the start time comes, the unit will not power on automatically. For details on “CUSTOM REPEAT,” see page 77. Also, refer to “TIMER switch” (page 7), “STATUS CHECK screen” (page 25), and “CUSTOM REPEAT screen” (page 27).

To start CUSTOM REPEAT

When [START TIME] is set to [OFF]

- 1 Set the TIMER switch to REPEAT.

↺↻ is displayed on the Data display screen (*page 23*).

- 2 Press the REW button. (If the tape is already rewind, press the PLAY button.)

The unit rewinds the tape to its beginning and starts playback automatically.

When the following items on the tape are searched for, auto repeat playback starts automatically.

- Index signals
- A portion unrecorded
- A portion recorded in a format set by other than [AUTO] in [HDV/DV SEL] in the [IN/OUT REC] menu
- Tape end

When [REPEAT CYCLE] is set, the unit continues playback until a few minutes before the time reaches the actual selected time, or one of the items listed above is detected on a tape. The tape is rewind to the beginning and restarts playback when the selected CYCLE time comes. If you set [REPEAT TIMES], the unit repeats playback according to the times you have selected.

Auto Repeat using an external AC timer

Make sure that the POWER switch on the rear panel of the unit is in the “I” (ON) position beforehand.

- 1 Connect the unit to an external AC timer (not supplied).

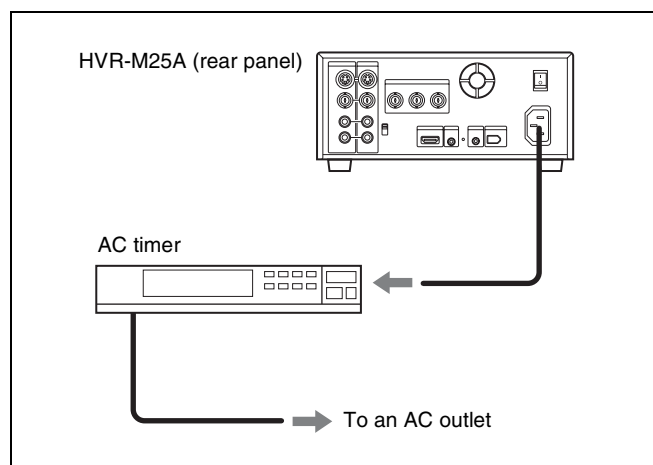

- 2 Set the TIMER switch on the front panel of the unit to REPEAT.

- 3 Set the start time on the external AC timer.

At the preset time, the power of the unit turns on, and after a few to several tens of seconds, auto repeat playback starts automatically. When the following items on the tape are searched for, the unit rewinds the tape to its beginning and starts auto repeat playback automatically.

- Index signals
- A portion unrecorded
- A portion recorded in a format set by other than [AUTO] in [HDV/DV SEL] in the [IN/OUT REC] menu
- Tape end

When [START TIME] is set to [ON]

Set the TIMER switch to REPEAT. When the unit is powered on, the unit waits to repeat playback until the time you have set in [START TIME]. Also, when the TIMER switch is set to REPEAT and the unit is powered on, auto playback is set to standby until the start time arrives.

Notes

- ↺↻⏰ is displayed on the Data display screen. When the tape on the unit is not in the playback mode, such as during recording or when no tape is inserted, ↺↻⏰ is displayed. When the start time reaches the selected time during this time, auto playback is not operated until the next starts time begins.
- To operate CUSTOM REPEAT automatically, the tape should be stopped before the start time begins.
- When [START TIME] for [CUSTOM REPEAT] is set, turn the unit on before the actual start time begins.

To stop CUSTOM REPEAT while the unit is in use

Press the STOP button on the front panel.

When both [REPEAT TIMES] and [START TIME] are set, if you stop CUSTOM REPEAT, the unit waits for the START TIME to come, regardless of the REPEAT TIMES setting. When the start time comes, the value of REPEAT TIMES is initialized to zero, and repeat playback starts.

To cancel CUSTOM REPEAT

Set the TIMER switch to OFF.

By using **CUSTOM REPEAT**, you can do the following (example)

Repeat playback at 30 minute intervals:

- 1 Set [ON/OFF] of [REPEAT CYCLE] to [ON].
- 2 Set [CYCLE] of [REPEAT CYCLE] to [30 min].
- 3 Press the REW or PLAY button.

Repeat playback at 2 hour intervals, 5 times a day, starting at 9 a.m.:

- 1 Set [ON/OFF] of [REPEAT CYCLE] to [ON].
- 2 Set [CYCLE] of [REPEAT CYCLE] to [120 min].
- 3 Set [ON/OFF] of [REPEAT TIMES] to [ON].
- 4 Set [TIMES] of [REPEAT TIMES] to [5].
- 5 Set [ON/OFF] of [START TIME] to [ON].
- 6 Set [TIME] of [START TIME] at [9:00].
- 7 Turn the unit on before 9 a.m.

Notes

- The unit cannot detect signals for an Index signal, a signal other than the one set by [AUTO] in [HDV/DV SEL], or an unrecorded portion within 20 seconds of the beginning of the playback.
- When you intend to turn the unit off, press the STOP button on the unit to stop the tape transport operation beforehand. If you turn the unit off while a tape is running, for example, by using an AC timer, the unit or the tape may be damaged.
- The editing software used by a digital non-linear editing system may mark index signals on a tape itself. Therefore, if you use a tape on which signals transmitted from a digital non-linear editing controller are recorded or a copy tape made from one, using digital dubbing, CUSTOM REPEAT may not be performed correctly.

EDGE CROP MARKER

The unit allows you to adjust the edge crop position when you output down converted HDV 16:9 wide screen pictures to 4:3 standard TV mode pictures. By displaying the edge crop marker on the monitor, you can check the crop position on the LCD monitor beforehand.

To set EDGE CROP MARKER

Before setting [CROP MARKER] in the [IN/OUT REC] menu to [ON] (page 72), check that any one of the following settings have been made:

- [DOWN CONVERT] of [VIDEO OUT] in the [IN/OUT REC] menu is set to [EDGE CROP] (page 71).
- [DOWN CONVERT] of [i.LINK SET] in the [IN/OUT REC] menu is set to [EDGE CROP] (page 72).

The EDGE CROP MARKER screen displays:

- Crop position of a 4:3 aspect screen
- Center marker
- 80% safety zone

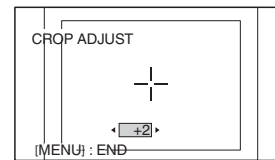

Select [CROP ADJUST] in the [IN/OUT REC] menu (page 72) and press the EXEC button again after the confirmation display appears. Then, the edge crop marker will appear on the monitor. Press the ←/→ buttons to move the marker to the left and right and adjust the crop position. Press the EXEC button to execute.

Notes

- When CROP MARKER is displayed on the LCD monitor, the text data and crop marker displayed on the LCD monitor are not output from the jacks on the rear panel of the unit. To output a 4:3 screen marker, see “MARKER BURN” (page 45).
- To output an edge cropped picture by down converting the HDV-formatted picture to 4:3, see “VIDEO OUT” (page 71) and “i.LINK SET” (page 72) in the “IN/OUT REC” menu.

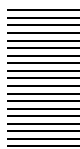



MARKER BURN

The unit can output to each video jack and display a 4:3 screen marker on 16:9 screen images. When you make an editing tape from an original tape, the MARKER BURN function can be used.

To set up MARKER BURN

Set [MARKER BURN] in the [DISPLAY SET] menu to [ON] (*page 75*).

Notes

- MARKER BURN is effective under the following conditions.
 - While playing back a tape in HDV or while an HDV signal is input via the  HDV/DV jack, and [DOWN CONVERT] of [VIDEO OUT] in the [IN/OUT REC] menu is set to [SQUEEZE] or [LETTER BOX]
 - When wide signals recorded in DVCAM or DV format are played back, or wide screen HDV/DVCAM/DV signals are input to each VIDEO jack
- While an HDV signal is input via the  HDV/DV jack, and [DOWN CONVERT] of [VIDEO OUT] in the [IN/OUT REC] menu is set to [EDGE CROP], the marker can not be displayed.
- The markers displayed with EDGE CROP MARKER and MARKER BURN show the available horizontal ratio range of the 4:3 screen to be cropped. The displayable image size of the standard 4:3 TV monitor may appear smaller than the size marked on the monitor of the unit.
- When EDGE CROP MARKER and MARKER BURN are enabled at the same time, EDGE CROP MARKER is given priority.
- When you set [MARKER BURN] and [ALLSCAN MODE] in the [DISPLAY SET] menu to [ON] at the same time, the marker will not appear in the correct position on the LCD monitor. This is not a malfunction. The marker will be output correctly via each video jack.

Using the Unit as a Videocassette Recorder

This section describes the connections, settings and operations necessary to perform recording on the unit. The same settings and operations apply when you are using the unit for dubbing.

Note

For details on connections of the player and the unit, refer to the instruction manual of the player.

For details, see also page 65 and 66.

Connections for Recording

To video equipment without an i.LINK jack

You can connect the unit to video equipment without an i.LINK jack. Use the unit as a recorder as follows.

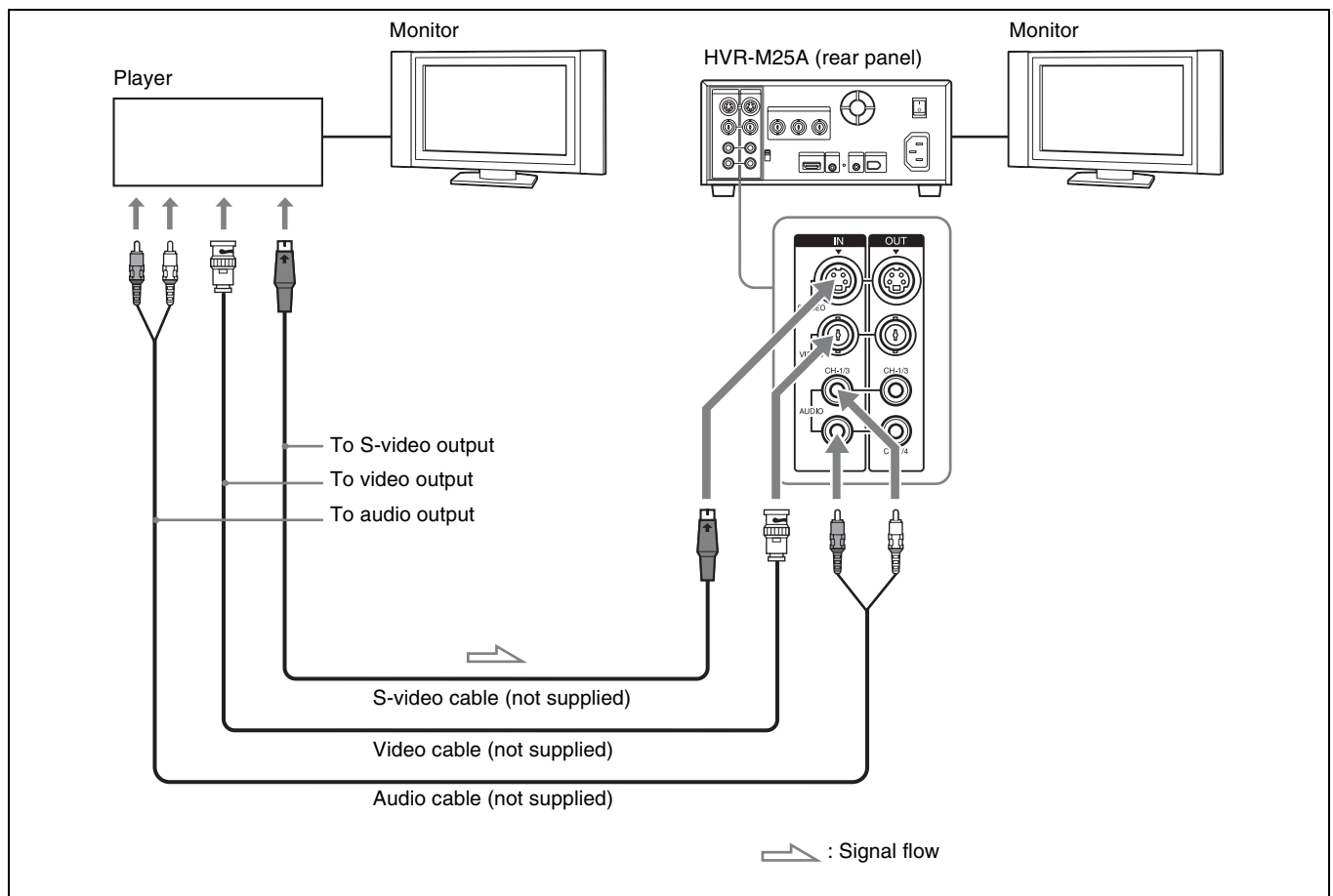

Connect either an S-video cable or a video cable.

Notes

- If you connect the output connectors of the unit to the input connectors of the player, a humming noise may be generated or the image may be distorted. If these phenomena occur, set the INPUT SELECT switch to a position where a signal is not currently being input, or disconnect the cables.
- Distorted signals (i.e., when played back at a speed other than normal) may not be recorded or may be distorted.
- When you connect only AUDIO IN jacks when the HDV indicator is lit, no audio is input. You must connect the VIDEO IN jack at the same time or set [HDV/DV SEL] in the [IN/OUT REC] menu to [DV].

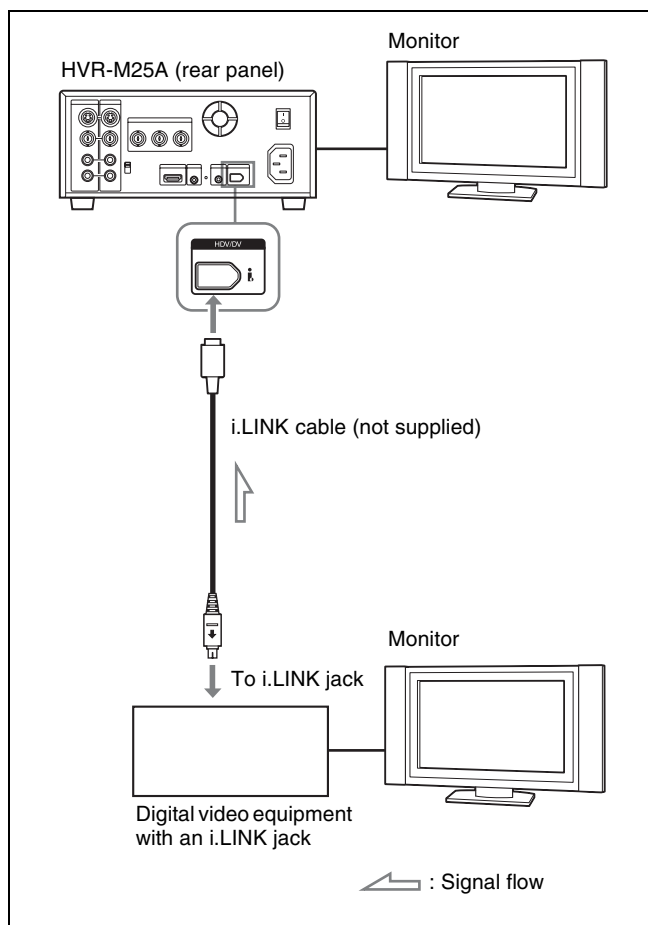

To digital video equipment with an i.LINK jack

When you record an HDV (1080/60i, 1080/24p, 1080/30p, 1080/50i, 1080/25p), DVCAM, or DV format i.LINK signal, the video and audio signals are sent without any degradation in quality, enabling high-quality recording. The signal flow is automatically detected so you do not need to make separate connections for input and output.

**Notes**

- When you record video from HDV-compatible equipment, set [HDV/DV SEL] in the [IN/OUT REC] menu to [AUTO]. To record video from DVCAM/DV equipment, set [HDV/DV SEL] in the [IN/OUT REC] menu to [AUTO] or [DV] before connecting the i.LINK cable (page 70). If you change the setting after connecting the i.LINK cable, the video equipment may not recognize the video signals correctly.
- Copy-protected programs such as digital broadcasts can not be input via the i.LINK jack.
- With an HDV/DV connection, the sound is recorded in the same audio recording mode as that of the source tape. To record in a different audio recording mode from that of the source tape, connect the equipment as shown in “To video equipment without an i.LINK jack” on page 46.

(Continued)

- With an HDV/DV connection, data codes (recording date/time, camera data) recorded on the source tape are transmitted to the recorder (the unit). As a result, when you play back a recorded tape on the unit and press the DATA CODE button on the Remote Commander, the same data codes as those recorded on the source tape are displayed on the monitor screen.
- If no picture appears via the  HDV/DV jack, disconnect the i.LINK cable, then reconnect it.
- The unit cannot record video or audio separately.
- If you record a picture in DVCAM/DV in the playback pause mode, the picture may be rough. When recording is set to HDV, the picture is not recorded.
- If the unit is connected to a device equipped with an i.LINK jack, when you intend to disconnect or reconnect the i.LINK cable, turn off the device and pull out the plug of its power cord from the AC outlet beforehand. If you connect or disconnect the i.LINK cable while the device is connected to the AC outlet, high-voltage current (8 to 40 V) is output from the i.LINK jack of the device to the unit, which may cause a malfunction.
- If you restart recording after a pause or stop, the images recorded before and after restarting operation will not be continuous.
- If you connect the output connectors of the unit to the input connectors of a player or that of a monitor, a humming noise may be generated or the image may be distorted. If these phenomena occur, use the INPUT SELECT switch to select a signal that is not being input, or disconnect the cables.
- The unit cannot record MPEG2 signals except 1080/60i, 1080/24p, 1080/30p, 1080/50i, 1080/25p of HDV.
- When you record HDV signals input from the  HDV/DV jack, the connection between the recorded signals pauses for about one second.
- The unit cannot record color bar output in the progressive system. Color bar outputs are recorded in 1080/60i or 1080/50i format according to the setting in [60i/50i SEL] of the [OTHERS] menu (page 82).

Settings for Recording

Preparation on the recorder (the unit)

Notes

- Before recording, set the date and time on the unit so that the recording time can be written into the search signal. You can set the date and time by setting [CLOCK SET] in the [OTHERS] menu (page 81).
- Editing may not be possible with a signal that is copyright protected.
- During recording, the tape transport control buttons (except STOP and PAUSE) are disabled to prevent the tape running mode from being changed by an incorrect operation. To disable the STOP and PAUSE buttons, set the KEY INH switch to ON after the unit starts recording. In this case, set the KEY INH switch to OFF first, then stop or pause the recording.

- 1 Turn the power of the monitor on, then set the monitor's input according to the input signals.
- 2 Set up the player to play back a tape.
For details, refer to the instruction manual of the player.
- 3 Turn the unit on.
- 4 When the player is connected to IN jacks on the unit, set [60i/50i SEL] in the [OTHERS] menu according to the input signals (page 82).

When you input 60i system signals, set [60i/50i SEL] to [60i]. When you input 50i system signals, set [60i/50i SEL] to [50i] (page 82).

Notes

- Do not change the [60i/50i SEL] setting during recording.
- When you select S VIDEO or VIDEO with the INPUT SELECT switch, if the field frequency of the input signal is different from that of the [60i/50i SEL] setting, the picture goes blank.

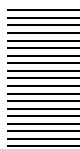

- When the signals are input through the i.LINK interface, the unit detects the field frequency of the input signal automatically. You do not need to change the [60i/50i SEL] setting. When [60i/50i SEL] is set to [50i], however, the time code generated by the unit is fixed to the non-drop frame mode. Even when 60i system signals are input to the i.LINK jack, the time code generated by the unit is the non-drop frame mode, regardless of the [TC FORMAT] setting in the [TC/UB SET] menu. To record in the drop frame mode, set [60i/50i SEL] to [60i].

5 Select input signals by switching the INPUT SELECT switch on the unit.

HDV/DV: to record input signals from the HDV/DV jack

S VIDEO: to record input signals from the S VIDEO IN jack

VIDEO: to record input signals from the VIDEO IN jack

You need to adjust [HDV/DV SEL] (page 70) and [REC MODE] (page 70) in the [IN/OUT REC] menu to the desired recording format.

For details on recording tape formats, see page 98.

Notes

- Do not change the INPUT SELECT switch setting during recording. If you change the setting of this switch during recording, recording will stop for several seconds. Recording will restart after the internal circuits are switched. During this time, no image is recorded.
- When DVCAM/DV signals which are input from the HDV/DV jack, or video signals which are from the VIDEO IN jacks or S VIDEO IN jacks, are output to each analog output jack, the distortion of the video signals occurs at the bottom of the TV monitor display due to the jitter. Depending on the display area of the TV monitor you have, the distortion of the picture may appear at the bottom of the screen. This is not a malfunction.
Pictures may be distorted or not be displayed depending on the TV monitors. This will not appear while recording with the unit.
Be aware of these phenomena when you connect other recording device via the analog jacks of the unit.

- Depending on the TV monitor being connected, the screen may blink or be distorted when DVCAM/DV signals which are input from the HDV/DV jack, or video signals which are from the VIDEO IN jacks or S VIDEO IN jacks, are output to the VIDEO OUT jacks.
Be aware of these phenomena when you connect other recording device to these jacks. This will not appear while recording with the unit.

6 Select the audio mode. (With an HDV/DV connection, skip this step.)

When you select S VIDEO or VIDEO with the INPUT SELECT switch, set the audio mode by setting [AUDIO MODE] in the [AUDIO SET] menu (page 76).

FS32K: Switches the audio mode to 4-channel mode

FS48K: Switches the audio mode to 2-channel mode

When recording a tape in DV (SP), you can set [AUDIO LOCK] in the [AUDIO SET] menu (page 76).

Note

When signals are input from the HDV/DV jack, the audio mode is the same as the one used to input signals from the player.
To dub audio after recording, see page 63.

7 Set the AUDIO INPUT LEVEL switch on the rear panel properly according to the audio level of the player.

8 Select the recording level adjustment mode using the AUDIO INPUT switch.

Note

You cannot adjust the recording level if you record signals input via the HDV/DV jack.

(Continued)

Using the Unit as a Videocassette Recorder

- 9** If necessary, adjust the audio recording level by turning the AUDIO REC LEVEL control knobs.

You can adjust the recording level with the AUDIO REC LEVEL control knobs if you have selected MANU in step 8. While looking at the STATUS CHECK screen, turn the AUDIO REC LEVEL control knobs to adjust the recording level. Adjust the audio recording level so that it does not exceed 0 dB when the audio signals are at their maximum. If the recording level exceeds 0 dB, the recorded sound will be distorted.

Notes

- When the unit records in DVCAM (DV) format, it supports two audio modes, with either 2-channels at FS48K or 4-channels at FS32K. It is not possible to select other modes (for example with 2-channels at FS32K).
- During recording, you cannot change the audio mode.
- To dub audio after recording using the unit, set [AUDIO MODE] in the [AUDIO SET] menu to [FS32K] (4-channel mode) before recording.
For details on the [AUDIO SET] menu, see “AUDIO SET menu” on page 76.
- The unit is able to dub audio on a tape recorded in DVCAM format with 4-channel (FS32K) sound.

Recording Procedures

This section describes the procedures used to record signals sent from another VCR to the unit.

For details on operation when the unit is connected to a computer via the  HDV/DV jack, refer to “Editing (Connecting a Computer)” on page 65.

- 1** Insert a cassette and confirm that the  (cassette) indicator lights up.
- 2** Press the playback button on the player.

The player starts playback.
- 3** On the unit, press the PLAY button while holding the REC button down.

Note

When the unit records HDV format images, it takes a while until recording starts. This delay, however, is not an error. ([STBY] is displayed on the screen and the REC indicator blinks until recording starts.)

To stop recording

Press the STOP button on the unit.

To pause recording

Press the PAUSE button on the unit.

Note

You cannot up convert NTSC or PAL signals in the HDV format for recording.

Recording Functions

Marking an index

By pressing the INDEX button on the unit or the INDEX MARK button on the Remote Commander during recording, you can mark an index signal at any place on the tape. If you mark an index at a scene you want to be able to search for, you can easily find the scene later. When [AUTO INDEX] in the [VTR SET] menu is set to [ON] (*page 77*), if you start recording while the tape is stopped, the unit automatically marks an index. While the index is being marked, the  indicator appears for about seven seconds on the Data display screen (*page 23*).

Notes

- You cannot mark a new index while the  indicator is being displayed.
- If you record on a portion of the tape where an index has been marked, the index will be erased. You cannot delete just an index while keeping the image or sound.
- You cannot mark an index during playback or audio dubbing operations. The INDEX button and the INDEX MARK button are disabled in these operations.

To use an index during playback

See “Searching using the search function” on page 41.

AC timer recording

By connecting the unit to an external AC timer (not supplied), you can start recording at a preset time. Make sure that the POWER switch on the rear panel of the unit is in the “I” (ON) position beforehand.

- 1 Connect the unit to an external AC timer (not supplied).

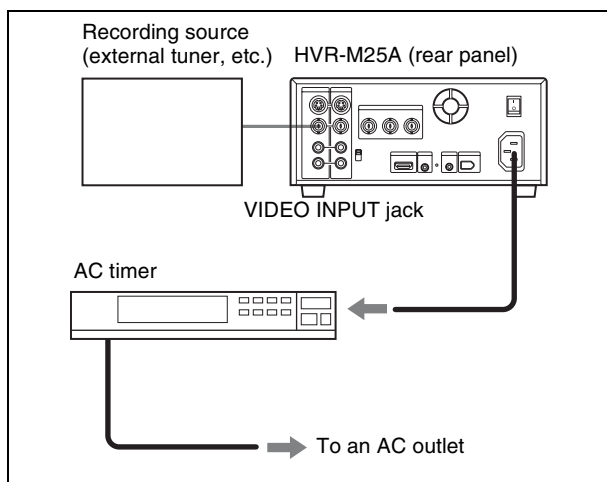

- 2 Insert a tape for recording.
- 3 Set the INPUT SELECT switch of the unit to select the input signals.
- 4 Set the TIMER switch on the front panel of the unit to REC.
- 5 Set the timer-on time on the connected AC timer.

At the preset time, the power of the unit turns on automatically and recording starts after a few to several tens of seconds. Set the timer allowing a margin for the recording to start. You do not need to press the REC button.

Note

To turn the unit off, press the STOP button on the unit to stop the tape transport operation beforehand. If you turn the unit off while a tape is running, for example, by using an AC timer, the unit or the tape may be damaged.

If the tape ends before the recording source stops operation

The tape stops.

To stop recording during timer recording

Press the STOP button on the unit.

To release the AC timer recording mode



Set the TIMER switch on the front panel of the unit to OFF.

Utilizing the Time Code

Setting the Time Code and User Bits

The unit can set, display, record and play back the time code and user bits.

Notes

- When HDV signals are recorded from the  HDV/DV jack on the unit, user bits are copied automatically and cannot be preset on this unit. However, usually the time code is set according to the [TC MAKE] setting. To copy the time code of a source tape, set [HDV/DV IN TC] in the [TC/UB SET] menu to [EXTERNAL] (page 79).
- When images recorded in DVCAM/DV format are input via the  HDV/DV jack, you can preset user bits and time code on the unit. To copy the user bit and time code of a source tape, use [DUPLICATE PLUS] in the [VTR SET] menu (page 77).
- For a tape recorded both in HDV and DVCAM/DV formats, the time code may become garbled at a connecting portion between scenes on the tape.
- If you play back an HDV tape with no signal recorded, the time cord may not be displayed properly.
- The code and user bits cannot be reset on the unit from a Remote Commander equipped with a counter reset function.

Using the Internal Time Code Generator

You can set the initial time code value generated by the internal time code generator. In addition, you can set the user bits to record data such as the date, time, scene number, reel number, or other useful information. The time data settings are set using the menu.

For details, see “TC/UB SET menu” on page 78.

To set the initial time code value

This section describes how to set the time code’s initial value.

Note

To set the initial time code value, you need to set [TC MAKE] in the [TC/UB SET] menu to [PRESET] beforehand.

For details, see “TC/UB SET menu” on page 78.

- 1 Press the MENU button to display the menu.

For details on the menu, see “Operating Menus” on page 68.

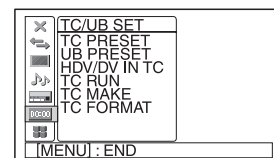

(You can set [TC FORMAT] only when [60i/50i SEL] in the [OTHERS] menu is set to [60i] (page 82).)

- 2** Press the \uparrow/\downarrow buttons to select [TC/UB SET], then press the EXEC button.

The following menu list is displayed.

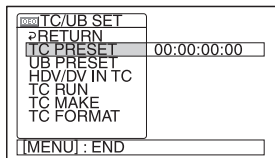

- 3** Press the \uparrow/\downarrow buttons to select [TC PRESET], then press the EXEC button.

The following menu is displayed.

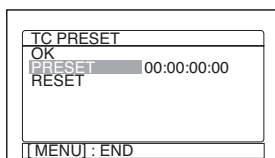

- 4** Press the \uparrow/\downarrow buttons to select [PRESET], then press the EXEC button.

The following menu is displayed.

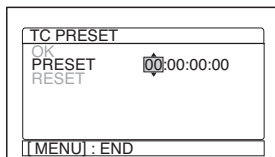

- 5** Set the first two digits. Press the \uparrow/\downarrow buttons to select the number, then press the EXEC button.
- 6** Repeat step 5 to set the other eight digits.
- 7** Press the \uparrow/\downarrow buttons to select [OK], then press the EXEC button.

The time code value is set. The menu display returns to that of step 3.

- 8** Press the \uparrow/\downarrow buttons to select [OK], then press the EXEC button.

The menu display returns to that of step 1.

To cancel the time code setting

Select [CANCEL] in step 7, then press the EXEC button.

To reset the time code

Select [RESET] in step 4, then press the EXEC button.

To set the value of the user bits

You can set the user bits as eight-digit hexadecimal values (base 16) to have the date, time, scene number, and other information inserted into the time code track.

Note

When HDV signals are input from the **i** HDV/DV jack, the user bits of HDV signals are applied.

In this case, you do not have to follow the procedures below.

When recording the internal color bars in HDV format, user bits can still be set.

- 1** Press the MENU button to display the menu.

For details on the menu, see “Operating Menus” on page 68.

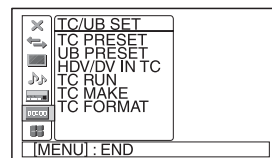

- 2** Press the \uparrow/\downarrow buttons to select [TC/UB SET], then press the EXEC button.

The following menu list is displayed.

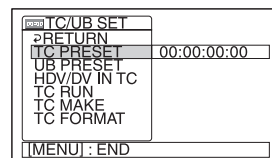

- 3** Press the \uparrow/\downarrow buttons to select [UB PRESET], then press the EXEC button.

The following menu is displayed.

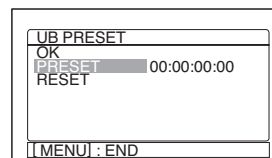

(Continued)

Setting the Time Code and User Bits

- 4 Press the \uparrow/\downarrow buttons to select [PRESET], then press the EXEC button.

The following menu is displayed.

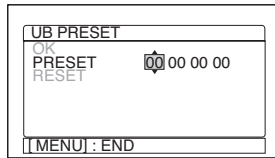

- 5 Set the first two digits. Press the \uparrow/\downarrow buttons to select the number, then press the EXEC button.
- 6 Repeat step 5 to set the rest of the digits.
- 7 Press the \uparrow/\downarrow buttons to select [OK], then press the EXEC button.
- 8 Press the \uparrow/\downarrow buttons to select [OK], then press the EXEC button.

The user bit value is set. The menu display returns to that of step 3.

The menu display returns to that of step 1.

To cancel the user bits setting

Select [CANCEL] in step 7, then press the EXEC button.

To reset the user bits

Select [RESET] in step 4, then press the EXEC button.

Note

A user bit is recorded at three-frame intervals for a tape recorded in HDV1080i format.

To select the time code when you record a signal input via the \mathbb{I} HDV/DV jack

Set [HDV/DV IN TC] in the [TC/UB SET] menu to select whether to record the internal time code or an external one (page 79).

INTERNAL: Records the time code internally generated.

EXTERNAL: Records the time code with video and audio signals input via the \mathbb{I} HDV/DV jack.

Notes

- When this item is set to [EXTERNAL], the time code input via the \mathbb{I} HDV/DV jack and the user bits set in [UB PRESET] are recorded.
- When HDV signals are input from the \mathbb{I} HDV/DV jack, the user bit value is also recorded regardless of the [HDV/DV IN TC] setting.
- Bars (---:---:---:---) are recorded as the time code if you start recording when this item is set to [EXTERNAL], the INPUT SELECT switch on the front panel is set to HDV/DV, and no signal is input via the \mathbb{I} HDV/DV jack, or the software of the editing controller does not output a time code. When any signals are input, the time code of those signals is recorded.
- When this item is set to [EXTERNAL] and time code input via the \mathbb{I} HDV/DV jack is not continuous or does not advance correctly, the value of the recorded or displayed time code may not be equal to the actual value of the input one. If you use a tape with this problem, you may not be able to perform searches or edits, depending on the devices you use.

To set the time code when recording starts

Set [TC MAKE] in the [TC/UB SET] menu to select the time code to be recorded when recording starts (page 79).

REGENERATE: The time code value is set to continue the time code from the time code already recorded on the tape. If you start recording from a blank portion of the tape, the time code starts from "00:00:00:00".

PRESET: The time code starts from the value set in [TC PRESET] in the [TC/UB SET] menu.

To set the advancement mode

Set [TC RUN] in the [TC/UB SET] menu to switch the advancement mode (counting up) (page 79).

REC RUN: Time code advances only while recording.

FREE RUN: Time code advances even when the unit is not recording and the time indicator is paused. Use this setting to adjust the default time code to the current time, and so on.

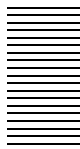
**Notes**

- To record the time code according to the setting of [TC RUN], set [TC MAKE] to [PRESET] (*page 79*).
- If you set the advancement mode to [FREE RUN], the time code will be updated by the internal clock while the unit's power is off. The time code may be delayed or advanced when you turn on the unit power again, play back a tape, or set the INPUT SELECT switch to HDV/DV.

To set the frame mode (For 60i only)

Set [TC FORMAT] in the [TC/UB SET] menu to switch the frame mode (*page 79*).

AUTO: Automatically sets the mode in accordance with the loaded tape.

If nothing is recorded on the tape, the mode is set to the non-drop frame mode. If the unit cannot read the frame mode correctly from the tape, the unit will use the mode that was set in the last position it was able to read correctly on the tape. If you remove the cassette, the mode of the last position it was able to read correctly is cleared and the mode is set to the non-drop frame mode. If [TC MAKE] is set to [PRESET], the mode is also set to the non-drop frame mode.

DF: Selects the drop frame mode.

NDF: Selects the non-drop frame mode.





Note

When you set [60i/50i SEL] in the [OTHERS] menu to [50i], the unit applies the 50i system specification. Therefore, the time code generated by the unit during recording is that of the non-drop frame mode. Even if 60i system signals are input to the  HDV/DV jack, when [60i/50i SEL] in the [OTHERS] menu is set to [50i], the time code generated by the unit is the non-drop frame mode, regardless of the [TC FORMAT] setting. To set the unit to generate the time code in the drop frame mode, set [60i/50i SEL] to [60i].

Setting the Time Code and User Bits

HVR-M25AU/M25AN/M25AE/M25AP time codes

The unit has a  HDV/DV jack. The time code displayed and recorded on the tape differs as shown below when the INPUT SELECT switch is set to HDV/DV and when it is set to other than HDV/DV.

	[HDV/DV IN TC] menu	INPUT SELECT switch	Mode	Time code/User bits displayed and recorded
Playback			Playback Audio dubbing Playback at various speeds ^{a)} DUB1 ^{b)}	Time code/user bits on the tape
EE	INTERNAL	HDV/DV	Duplicate DUPLICATE1 ^{b)}	Time code/user bits of another device connected to the  HDV/DV jack ^{c)}
			Recording Recording Pause REC1 ^{b)}	Time code/user bits internally generated ^{c)} When the input signal is HDV: User bits input via the  HDV/DV jack
		S VIDEO VIDEO	Recording Recording Pause REC1 ^{b)}	Time code/user bits internally generated ^{c)}
	EXTERNAL	HDV/DV	Duplicate DUPLICATE1 ^{b)}	Time code/user bits of the other device connected to the  HDV/DV jack ^{c)}
			Recording Recording Pause REC1 ^{b)}	Time code input from the other device connected to the  HDV/DV jack and user bits internally generated When the input signal is HDV: User bits input via the  HDV/DV jack.
		S VIDEO VIDEO	Recording Recording Pause REC1 ^{b)}	Time code/user bits internally generated ^{c)}

- a) This includes stop, fast-forward or rewind. If the unit cannot read the time code on the tape correctly, the counter displays “- -: - -: - -: - -”.
- b) “DUB1”, “DUPLICATE1”, and “REC1” represent the state of the unit when you press each of these buttons (AUDIO DUB, DUPLICATE, or REC) in the stop mode.
- c) The time code is also displayed on the time counter screen. For details on the time counter, *see page 25*.

Dubbing to Other Equipment Using the i.LINK Jack, Duplication, Audio Dubbing, and Connecting a Computer

Dubbing to Other Equipment Using the i.LINK Jack

This section describes the connections and settings necessary to perform dubbing on other equipment, using the unit as a video player.

Connections for Dubbing

Connect the unit to the recorder as shown on the right using an i.LINK cable.

The signal flow is automatically detected so you do not need to make separate connections for input and output. Also, by connecting the unit to an editing controller via the  HDV/DV jack, you can configure a digital non-linear editing system.

For connections of the editing controller and the unit, refer to the editing controller instruction manual.

Before dubbing, you must set the format in which you want to output signals. Make [HDV/DV SEL] (page 70) and [i.LINK SET] (page 72) settings in the [IN/OUT REC] menu.

For details, refer to “Major Differences among HDV1080i, DVCAM, and DV Formats” on page 31.

For details on i.LINK output formats, see page 97.

To dub a tape recorded in HDV format using the duplicate function on other units such as the DSR-25/45/50, select [DVCAM] in [HDV → DV CONV] of [i.LINK SET] in the [IN/OUT REC] menu.

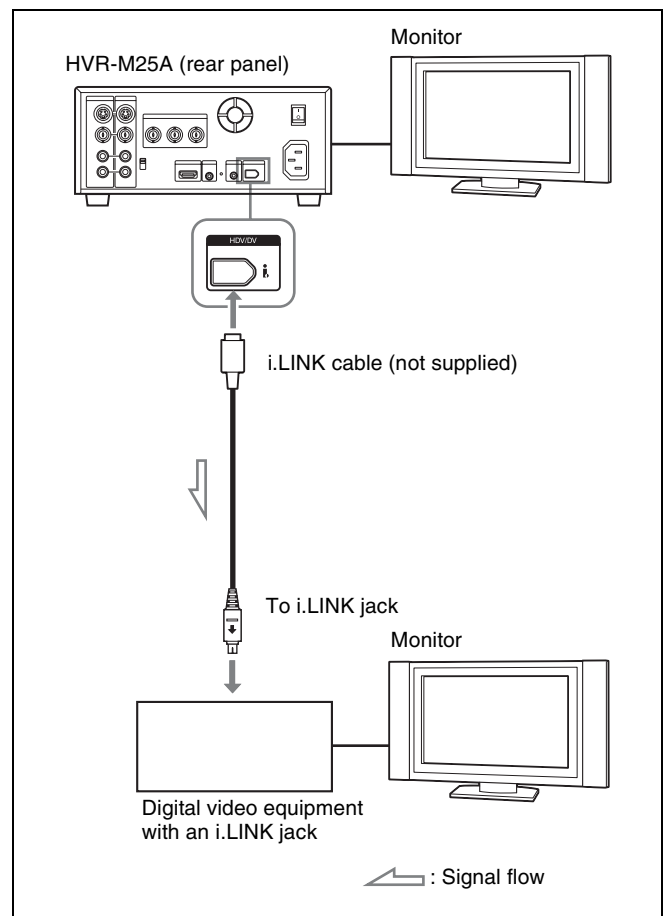

(Continued)

Dubbing to Other Equipment Using the i.LINK Jack

There are some limitations to down converting a tape recorded in HDV format to DVCAM format.

For details, see “i.LINK SET” in the “IN/OUT REC” menu on page 72.

Notes

- If you output pictures in the playback pause mode when using an i.LINK connection, recorded images may appear distorted.
- When the tape is recorded in HDV format, the picture is output as a simplified picture during playback at various speeds (page 40).
- When using an i.LINK connection, you cannot output only pictures or sounds separately.
- When you duplicate down converted signals from HDV to DVCAM on an HDV/DV cassette in DVCAM format, the available recording time is reduced to about 2/3 of the recording time indicated on the tape. However, when a DVCAM cassette is recorded using DVCAM format, the available recording time is the same as the recording time indicated on the DVCAM cassette.
- When progressive HDV signals are played back and down converted into DVCAM (or DV) format to output to i.LINK connection, the signals are converted to interlace system. 1080/24p and 1080/30p are converted to 480i, and 1080/25p to 576i, respectively.

Dubbing Procedures

- 1** Prepare the unit.
- 2** Prepare the recorder.
If the recorder has an input selector switch, select an input.
For details, refer to your recorder’s instruction manual.
- 3** Start playback on the unit and start recording on the recorder.
Refer to “Playback Procedures” on page 38.
For details, refer to your recorder’s instruction manual.
- 4** When dubbing is finished, stop recording on the recorder, and then stop playback of the unit.

Duplication (Generating a work tape with the same time code)

DUPLICATE PLUS is a dubbing function which duplicates the tape with time codes through an i.LINK connection. By using the DUPLICATE button, you can easily make a work tape which contains the exact same time code that the original source tape contains. DUPLICATE PLUS is applicable with HDV1080, DVCAM, and DV (SP) formats. Also, at the tape end or when the tape has been put in PAUSE mode by operating the STOP button, you can change the tape of both the player and recorder during duplication (*page 61*).

Therefore, multiple tapes can be duplicated from multiple resource tapes, continuously. (The unit does not support the cassette memory **C//** function.)

Note

Use this function when making a one-to-one connection. Also, do not disconnect the i.LINK cable during duplication.

Setting DUPLICATE PLUS mode

Set [DUPLICATE PLUS] mode in the [VTR SET] menu (*page 77*).

Setting the duplicating format

Select the duplicating format with [FORMAT SEL] in the [DUPLICATE PLUS] mode. The unit functions the same as when it has detected a blank portion on a tape, if the unit detects a format other than the selected format (*page 61*).

ALL : Duplicates the original tape on the recorder.

HDV1080: The player automatically detects only 1080 HDV (both interlaced and progressive) and duplicates.

HDV1080(i): The player automatically detects only 1080 interlaced HDV and duplicates.

HDV1080(p): The player automatically detects only 1080 progressive HDV and duplicates.

DVCAM : The player automatically detects DVCAM format and duplicates.

DV SP : The player automatically detects DV (SP) format and duplicates.

Notes

- If the original signal is mixed with other types of signal as you transfer the image to a computer, the transfer procedures may be interrupted. When transferring an image using a tape dubbed with DUPLICATE PLUS on the unit to a computer, we recommend you duplicate it in a single format.
- When non-compatible HDV signals (720/60p, etc.) are input during duplication after [FORMAT SEL] is set to [ALL], the HDV signals are recorded as an unrecorded portion. Also, when incompatible DV signals (DV LP etc.) are input, the signal is recorded in DV SP.
- When the format of a tape is switched to a different format during duplication, the portion where the format is switched may be distorted.
- When [HDV1080(i)] or [HDV1080(p)] is selected in [FORMAT SEL] of [DUPLICATE PLUS], the search speed becomes the same speed as normal playback.

Setting the auto rewind function

Set [AUTO REW] in [DUPLICATE PLUS] to select whether you want to use the auto rewind function.

ON : Rewinds the tape on both the player and the recorder, and starts duplication. Also, when you continue to duplicate a resource tape from multiple tapes, the new work tape will be rewound automatically and then duplication starts.

OFF : Starts duplicating from the current portion of the tape.

Note

Depending on the specification of the player, you may not search the beginning of a tape. In this case, set [AUTO REW] to [OFF].

Operating DUPLICATE PLUS

The duplicating procedure differs depending on the [DUPLICATE PLUS] settings.

Note

If you operate the player while duplicating, the duplicate process may be interrupted and the tape may not be correctly duplicated. Do not operate the player while duplicating.

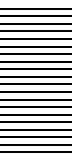

Duplication (Generating a work tape with the same time code)

When [AUTO REW] in [DUPLICATE PLUS] is set to [ON]:

- 1 Connect the unit and the player using an i.LINK cable (not supplied). After turning on the power of the unit, set the INPUT SELECT switch on the unit to HDV/DV.
- 2 Press the STOP button on the unit to stop the tape.
- 3 While holding the DUPLICATE button down, press the PLAY button on the unit.

The unit and the player will automatically rewind the tape to the beginning. The unit enters the duplicate-standby mode. The player enters the playback pause mode. Then the DUPLICATE and PLAY indicators on the unit light and the duplication starts.

Notes

- Before you start duplication, make sure that the player has finished loading the cassette.
- The duplication starts after the i.LINK connection is established so that the first part of the source tape is dropped on the copied tape.
- If the player has functions such as auto repeat, set them to OFF.
- If the player has a still timer function, set the still timer to the longest time to ensure enough time for rewinding the tape to the beginning.
- When you use a DSR-45 as the player, set the REMOTE/LOCAL switch of the DSR-45 to [LOCAL].
- If you operate the player while duplicating and the PLAYER UNCONTROLLABLE warning message appears and duplication stops, press the EXEC button on the unit to end duplication once, and then repeat the procedures.

When [AUTO REW] in [DUPLICATE PLUS] is set to [OFF]:

- 1 Connect the unit and the player using an i.LINK cable (not supplied). After turning on the power of the unit and the player, set the INPUT SELECT switch on the unit to HDV/DV.
- 2 Locate the points where you want to start playback and recording on each tape.
- 3 Press the STOP button on the unit.

- 4 While holding the DUPLICATE button down, press the PLAY button on the unit.

The unit enters the duplicate-standby mode. The player enters the playback pause mode. Then the DUPLICATE and PLAY indicators on the unit light and duplication starts.

To adjust the point where duplication starts, while holding the DUPLICATE button down, press the PAUSE button and PLAY button in step 4. The unit will not start duplication until you press the PAUSE button again. After confirming that the PLAYER display has changed to [READY] (blinking) on the LCD monitor, adjust the duplication start point using the player, then press the PAUSE button on the unit to start duplication.

Notes

- Before you start duplication, make sure that the player has finished loading the cassette.
- The duplication starts after the i.LINK connection is established so that the first part of the source tape is dropped on the copied tape. Play back the tape a few frames before of the portion where you want to begin the duplication.
- If the player has functions such as auto repeat, set them to OFF. Also, when the player has an auto rewind function, set the function to ON.
- You may not be able to duplicate the beginning of the source tape. Locate the start of the recorded portion on the source tape, and then start duplication.
- If there is a blank portion on the tape, the first part of the recorded portion that follows may be dropped on the copied tape.
- When the time code on a player operates either discontinuously or incorrectly, a difference in frame values between the numeric time codes may occur.

To cancel duplication

- 1 Press the STOP button on the unit, and pause duplicating.

During the pause, the following confirmation display appears.

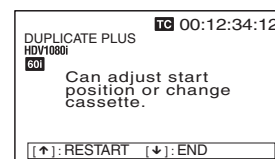

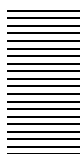

2 Press the \downarrow button.

Duplicating mode ends.

Duplicating a series of tapes

While pausing duplication mode, you can change the tape on the player. Therefore, you can duplicate a series of tapes on a single tape.

To change the tapes

1

By playing back the tape on the player to the end or by pressing the STOP button on the unit, confirm that the player has entered the playback pause mode.

During pause, the confirmation display appears.

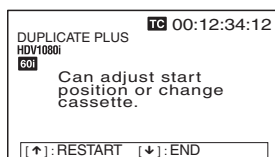

2

Eject the tape in the player, and load the other tape.

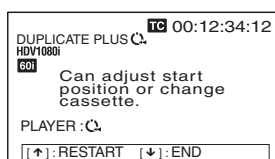

When [AUTO REW] is set to [ON], \odot is displayed.

You can eject the tape on the recorder to insert a new tape at this time.

3

Press the \uparrow button.

Duplication starts again.

When [AUTO REW] is set to [ON], the newly inserted tape is rewound automatically.

Notes

- When you change the source tapes, the beginning of the connecting portion of the recorded content of the work tape may be distorted.
- When you start duplication again, the beginning of the recorded content of the work tape may be distorted as playback starts again.

Detecting a blank portion during duplication

If the unit detects a blank portion on the source tape during duplication, it skips the blank portion automatically, reducing the length of the recorded part of the tape.

The operations of the player and recorder (the unit) when a blank portion is detected are as follows:

Detected status on source tape	Player/Recorder (the unit) operation
Detects a blank portion	Player: Continues playing the tape. Recorder: Continues recording.
Certain number of seconds after detection of a blank portion	Player: Continues playing the tape for another certain number of seconds and searches forward. Recorder: Stops.
Detects next recorded portion	Player: Rewinds the tape at about -2 times its normal speed to the location immediately before the blank portion ends. Recorder: Remains stopped.
Returns to the location immediately before the blank portion ends	Player: After entering the playback pause mode, starts playing the tape. Recorder: After entering the recording pause mode, starts recording.

The unit performs the above operations automatically to reduce the blank portions of a tape during duplication.

Notes

- Depending on the specifications, the skip function may not work on some players.
- When the unit resumes duplication, the first part of the recorded portion on the source tape may be dropped on the copied tape.
- A recorded portion of less than one minute between two blank portions may not be duplicated.

Duplication (Generating a work tape with the same time code)

Warning messages on duplication

If an error occurs during duplication, a STOP/CAUTION number and warning message will be displayed on the LCD monitor and the video output screen.

The following table lists these warnings and messages.

If a warning message is displayed, check this table and take the appropriate action.

STOP/ CAUTION No.	Warning Message	Cause/Remedy
00	RECORDER: INPUT SELECT is not set to HDV/DV.	The INPUT SELECT switch on the recorder (the unit) is not set to HDV/DV. → Set the INPUT SELECT switch to HDV/DV.
01	i.LINK : Cable not connected.	The i.LINK cable is not connected correctly. → Connect the i.LINK cable correctly.
02	i.LINK : Check i.LINK connection.	There are multiple i.LINK connections or the i.LINK connection is looped. → You cannot connect multiple devices. Connect only one player to the unit.
03	i.LINK : Check i.LINK connection.	The i.LINK cable has been unplugged and plugged in again. → Check the i.LINK cable connection. Try to duplicate again.
10	PLAYER: Recording.	The player is in the recording mode.
11	PLAYER: No cassette	There is no cassette in the player.
12	PLAYER: Cannot control.	The player cannot be operated.
13	PLAYER: Cannot control.	The player rejects operations.
14	PLAYER: Cannot control.	The player is disabled or is in a different mode than the recorder (the unit) has requested.
15	PLAYER: Cannot control.	The player is in an inappropriate condition.
16	PLAYER: Cannot record due to copyright protection.	A copyright protected signal is recorded on the cassette in the player. → You cannot duplicate the tape with copyright protected signals overlapped.
17	PLAYER: Error detected.	The player has detected self-diagnostics.
18	PLAYER: Moisture	Moisture condensation has occurred in the player. → Refer to the instruction manual of the player.
20	RECORDER: No cassette inserted.	There is no cassette in the recorder.
21	RECORDER: The tape is locked -check the tab.	The REC/SAVE switch is set to SAVE on the cassette. → Slide the REC/SAVE switch to REC on the cassette.
22	RECORDER: Reinsert the cassette.	The recorder (the unit) detected self-diagnostics. → Insert a cassette again.
23	RECORDER: Re-attach the power source	The recorder (the unit) detected self-diagnostics. → Disconnect the power cord from the recorder.
24	RECORDER: Moisture condensation. Eject the cassette	Moisture condensation has occurred while the cassette is in the recorder (the unit). → Remove the cassette and leave the unit for more than one hour.
25	RECORDER: Moisture condensation. Turn off for 1H.	Moisture condensation has occurred while the cassette is not in the recorder. → Leave the unit for more than one hour.
26	RECORDER: Dirty video head. Use a cleaning cassette.	The recorder's (the unit) video heads are clogged. → Clean the video heads with the supplied cleaning cassette (<i>see page 92</i>).

Note

When a warning message other than those above is displayed, consult your Sony dealer.

Audio Dubbing

You can record just the sound on a recorded tape.
(Audio dubbing)

Notes

- You can dub the sound onto a DVCAM-formatted tape recorded in the 32 kHz audio mode (4-channel/ 12 bits) only. You cannot dub the sound on a tape in the 48 kHz audio mode (2-channel/16 bits). If the audio mode of the recorded tape is 32 kHz, you can dub the sound regardless of the [AUDIO MODE] setting in the [AUDIO SET] menu.

For details on “AUDIO MODE,” see “AUDIO SET menu” on page 76.

- The sound is dubbed only onto channels 3/4. You cannot dub the sound onto channels 1/2.

Connection of external devices

The following shows an example of a basic connection for audio dubbing.

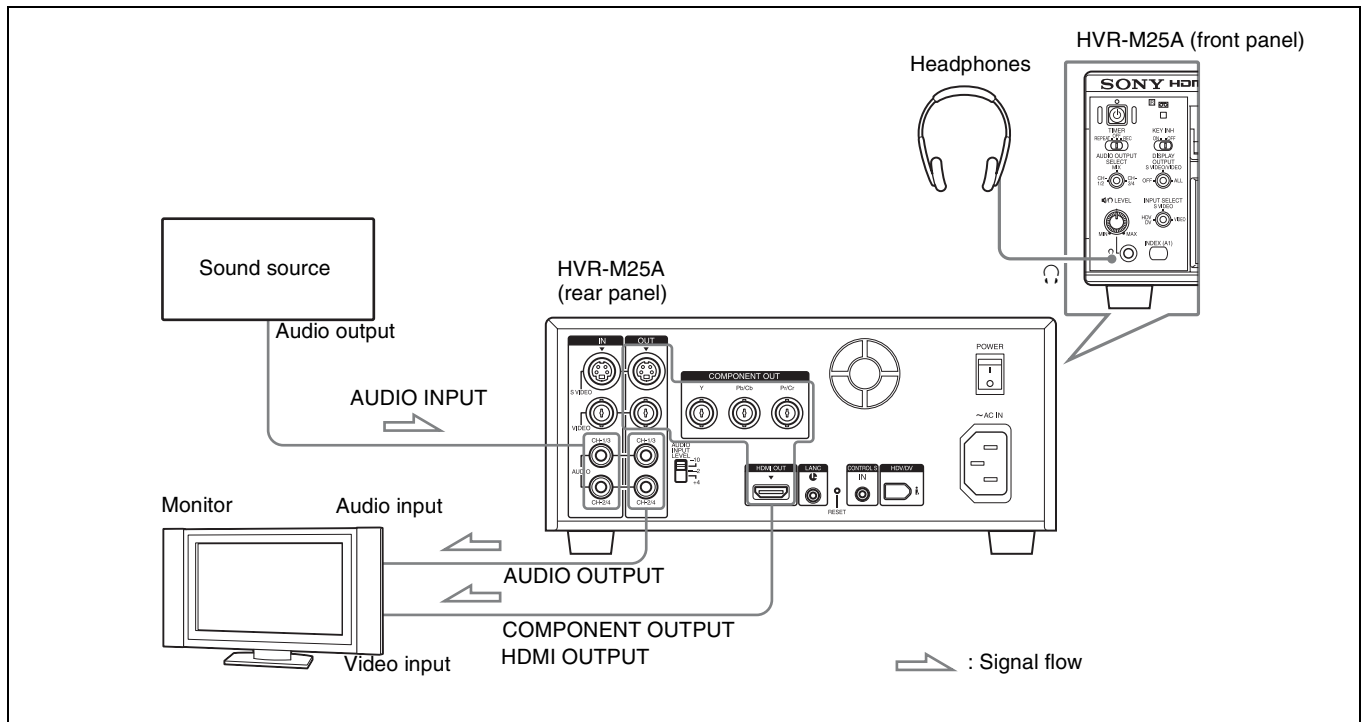

When you use the HDMI OUT jack, a separate connection using an audio cable is not needed.



Dubbing sound

- 1 Connect the AUDIO IN jack of the unit and the sound source using a phono jack cable (not supplied).
- 2 Set the INPUT SELECT switch to a setting other than HDV/DV.
- 3 Switch the AUDIO INPUT LEVEL switch to select the audio input signal level (-10, -2 or +4).
- 4 Play back the tape inserted in the unit.
- 5 At the point you want to start dubbing, press the PAUSE button to put the unit in the playback pause mode.
- 6 While holding the AUDIO DUB button down, press the PLAY button to put the unit in the audio dubbing pause mode.
The AUDIO DUB indicator on the unit lights.
- 7 Set the AUDIO INPUT switch to set the adjusting method of the recording level.
- 8 Adjust the recording level by turning the AUDIO REC LEVEL control knobs.

You can adjust the recording level with the AUDIO REC LEVEL control knobs if you have selected MANU in step 7. While looking at the audio level meters on the STATUS CHECK screen, turn the AUDIO REC LEVEL control knobs and adjust the recording level. Adjust the audio recording level so that the recording level does not exceed 0 dB when the audio signal is at its maximum. If the recording level exceeds 0 dB, the sound will be distorted.

- 9 Press the PAUSE button.

The PAUSE indicator goes off and audio dubbing starts.

To pause audio dubbing

Press the PAUSE button.

Pressing the PAUSE button again resumes audio dubbing.

To stop audio dubbing

Press the STOP button.

To monitor the sound you want

Set the AUDIO OUTPUT SELECT switch as follows:

CH-1/2: You can listen to sound recorded on channels 1 and 2 on the tape.

CH-3/4: You can listen to sound to be dubbed on channels 3 and 4.

MIX: You can listen to the sound on the tape and the dubbed sound.

For details on the audio level display during audio dubbing, see page 25.

Notes

- You can monitor the sound on the tape while dubbing the sound. However, there are some delays between the sound being recorded and the sound being played. When you play back the tape after audio dubbing, you might hear the dubbed sound later than the sound monitored during audio dubbing.
- You cannot dub sounds onto a blank portion of the tape.

Editing (Connecting a Computer)

You can set up an editing system by connecting the unit to a computer (editing machine) using the **i** HDV/DV jack (i.LINK connection) on the unit.

The unit can output HDV 1080/24p, 1080/30p, or 1080/25p (progressive) signals without conversion only via an i.LINK connection.

For details on the connection to the editing machine, refer to the supplied instruction manual of your editing unit.

The editing functions you can use depend on the editing software. For details on editing methods, refer to the instruction manual of your editing software.

Connecting the Unit to a Computer

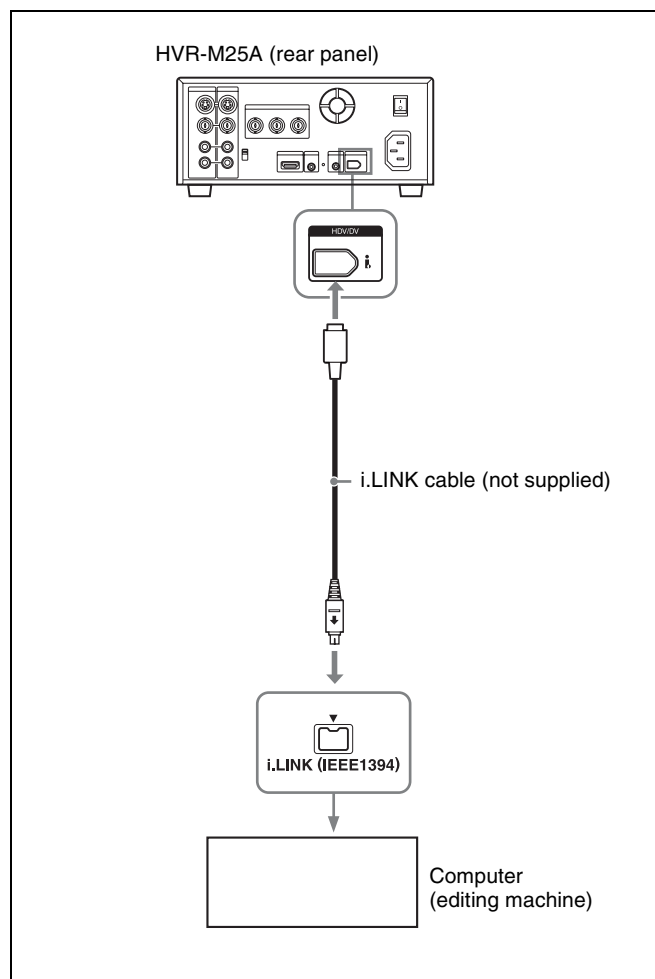

Notes

- Be sure to connect the i.LINK cable to the computer (editing machine) first and then connect it to the unit. If you connect the i.LINK cable to the unit first, it may cause the unit to malfunction because of static electricity.
- When the unit is connected to a computer equipped with an i.LINK jack and you intend to disconnect or reconnect the i.LINK cable, turn off the computer and pull out the plug of its power cord from the wall outlet beforehand. If you connect or disconnect the i.LINK cable while the computer is connected to the AC outlet, high-voltage current (8 to 40 V) is output from the i.LINK jack of the device to the unit, which may cause a malfunction.
- Before connecting the i.LINK cable, set [HDV/DV SEL] and [i.LINK SET] in the [IN/OUT REC] menu. If you perform the settings after connecting the cable, the computer (editing machine) may not recognize the unit correctly or may freeze.
- If you input or output signals in a format incompatible with the computer (editing machine), the computer may not recognize the unit correctly or may freeze.
- When set to EE mode, the unit outputs analog signals that are input from the **i** HDV/DV jack to the computer. S VIDEO or VIDEO signals are output from the **i** HDV/DV jack, according to the setting of the INPUT SELECT switch. To output the playback image from the unit through the **i** HDV/DV jack only, set the INPUT SELECT switch to HDV/DV.

Preparations

Transferring picture data from the unit to a computer (editing machine)



- To transfer picture data recorded on a tape to an editing machine in HDV, set [HDV/DV SEL] in the [IN/OUT REC] menu to [HDV] (page 70), then set [HDV → DV CONV] of [i.LINK SET] in the [IN/OUT REC] menu to [OFF] (page 72).
- To transfer the picture data recorded on a tape in DVCAM (DV) to an editing machine, set [HDV → DV CONV] of [i.LINK SET] in the [IN/OUT REC] menu to [OFF] (page 72).
- To transfer the picture data recorded on a tape in HDV to an editing machine in DVCAM (DV) format, select [DVCAM] or [DV SP] in [HDV → DV CONV] of [i.LINK SET] in the [IN/OUT REC] menu, then set [DOWN CONVERT] (page 72).

Notes

- The operation may not work with some of editing machine software. Before using the software, confirm that it is compatible with the unit.
- The unit cannot up convert a tape recorded in DVCAM (DV) format to HDV format when transferring the picture data on an editing machine.
- If you use a tape recorded both in HDV and DVCAM (DV) formats when [HDV/DV SEL] in the [IN/OUT REC] menu is set to [AUTO], the computer (editing machine) may not recognize the unit or you may not be able to edit the tape correctly.
- There are restrictions on the video output when you play back a tape recorded in HDV format at various speeds. Refer to the table for “HDV-formatted tape” in “Playing at various speeds” (page 40).
- When you use a tape that was down converted from HDV to DVCAM or DV, some conventional DVCAM/DV editing software may not perform a time code search, or this operation could result in an error.
- When you record HDV signals that are input through the  HDV/DV jack, the connecting portion between scenes on the tape will be displayed as a still picture for approximately 1 second. We recommend you perform digital nonlinear editing.

- If your editing software has the capability to output the time code as well as the video and audio signals to the unit, and you intend to record that time code, set [HDV/DV IN TC] in the [TC/UB SET] menu of the unit to [EXTERNAL].

For details on the TC/UB SET menu, see “TC/UB SET menu” on page 78.

- When [HDV/DV IN TC] in the [TC/UB SET] menu is set to [EXTERNAL], if you input time code to the  HDV/DV jack that is not continuous or does not advance correctly, the value of the recorder or displayed time code may not be equal to the actual value of the input one. If you use a tape recorded under such conditions, you may not be able to perform searches or edits of the picture, depending on the device you use.
- For connection of the editing controller and its peripheral devices, refer to the instruction manual of the editing controller and that of the editing software you use.
- The editing functions you can use depend on the editing software. For details on editing methods, refer to the instruction manual of your editing software.
- The unit has a function to down convert HDV signals to DVCAM (DV) signals to output them from the  HDV/DV jack. Some software may not edit DVCAM/DV signals that are down converted from HDV signals correctly. In this case, follow the procedures below for tape duplication, then use the duplicated tape when editing the picture.

Creating a DVCAM compatible tape

Set [HDV → DV CONV] of [i.LINK SET] in the [IN/OUT REC] menu to [DVCAM], then perform DVCAM recording using a recording device that accepts the DVCAM format.

Creating a general consumer DV compatible tape

Set [HDV → DV CONV] of [i.LINK SET] in the [IN/OUT REC] menu to [DV SP], set [DOWN CONVERT], then perform DV recording using a recording device that accepts DV format.

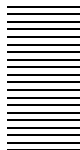

Transferring picture data from a computer (editing machine) to the unit

- To transfer data from a computer (editing machine) in HDV format, set [HDV/DV SEL] in the [IN/OUT REC] menu to [HDV] (*page 70*).
- To transfer data from a computer (editing machine) in DVCAM (DV) format, set [HDV/DV SEL] in the [IN/OUT REC] menu to [DV] (*page 70*). Then, according to the desired recording format, set [REC MODE] to [DVCAM] or [DV SP] (*page 70*).

Note

Before connecting the unit to a computer (editing machine), set [HDV → DV CONV] of [i.LINK SET] in the [IN/OUT REC] menu to [OFF] for HDV or to [DVCAM]/[DV SP] for DVCAM (DV) (*page 72*).

Adjusting and Setting Through Menus

Operating Menus

The unit allows you to set various parameters in the menus. Before you start using the unit, set the internal clock in [CLOCK SET] in the [OTHERS] menu. Except for clock setting, you can use the unit in the default settings for all other parameters as they are, and change them as needed.

Notes

- Do not pull out the power cord plug while operating the menus. Otherwise, the settings of the menu may be changed accidentally.
- If the internal backup battery is exhausted, the time set in the internal clock, the [60i/50i SEL] setting, and the time code of the [FREE RUN] setting will be initialized. The internal backup battery is fully charged if you connect the power to the unit for about 24 hours. A fully charged internal battery can run for about 1 month.

Changing a menu setting

- 1** Press the MENU button.
- 2** Pressing the \uparrow/\downarrow buttons, select the menu icon you want to change, then press the EXEC button.
- 3** Pressing the \uparrow/\downarrow buttons, select the submenu you want to change, then press the EXEC button.
- 4** Pressing the \uparrow/\downarrow buttons, change the setting.
- 5** Press the EXEC button to return to the submenu.
- 6** Repeat steps **1** to **5**, as needed.

To return to the previous menu level, press the \uparrow/\downarrow buttons and select [↩ RETURN].

You can use the \leftarrow/\rightarrow buttons to move the menu cursor and to adjust or increase/decrease setting values.

Menu Structure

The menu of the unit consists of the following menus and submenus.

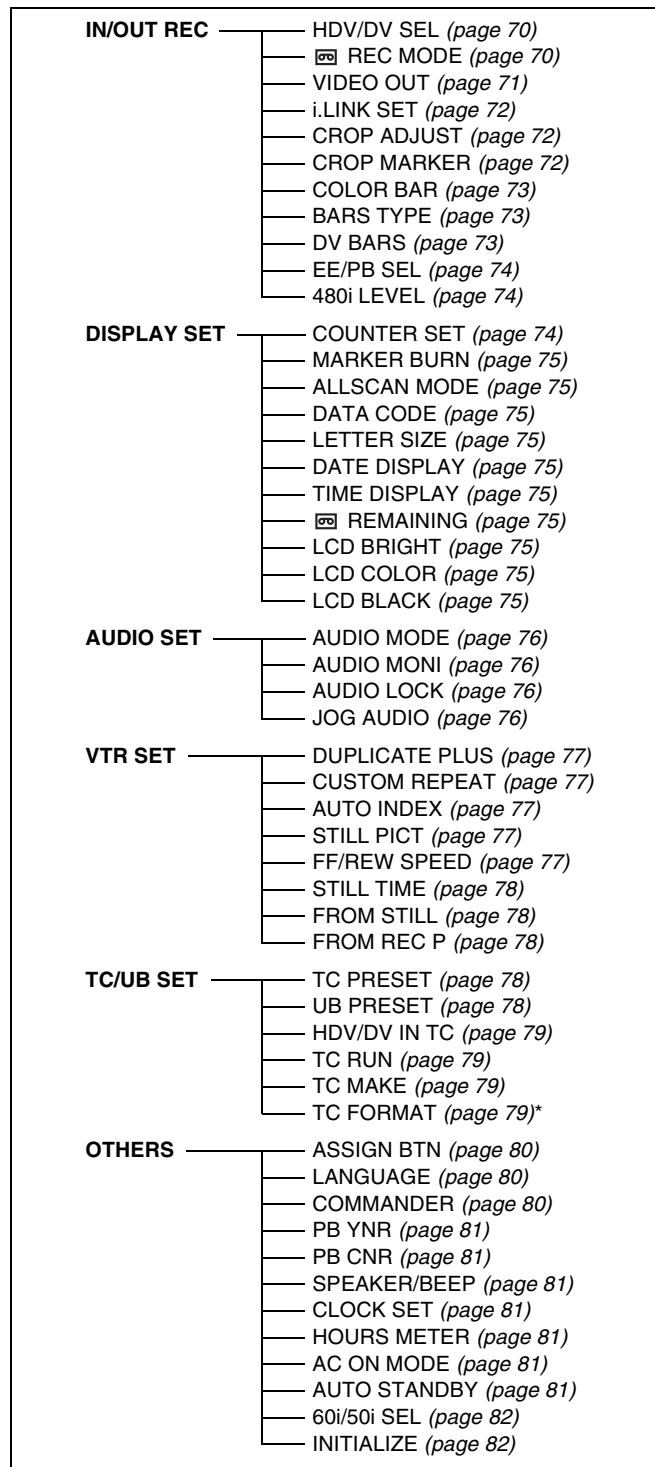



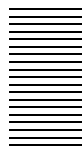



* available only when you use a 60i signal







Menu Contents

Default settings are indicated with rectangles.

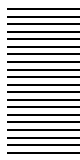

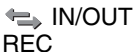
IN/OUT REC menu

Icon/Menu	Submenu	Setting
 IN/OUT REC	HDV/DV SEL <i>(pages 37, 47, 57, 65)</i>	<p>Normally, set this menu to [AUTO]. Select this menu when you want to limit the output format during tape playback or limit the signals to be input or output from the  HDV/DV jack. This setting will affect analog outputs.</p> <p>► AUTO : Automatically switches signals to HDV format or DVCAM/DV format during tape playback. When an i.LINK cable is connected, signals in HDV format or DVCAM/DV format will be switched automatically and signals from the  HDV/DV jack will be input/output for recording/playback.</p> <p>HDV : Outputs portions of signals recorded in HDV format during tape playback. When an i.LINK cable is connected, only signals in HDV format from the  HDV/DV jack will be input/output for recording/playback. Also, select this setting when the unit is connected via an i.LINK cable to a computer supporting HDV format (<i>see pages 47, 57</i>).</p> <p>DV : Outputs signals of portions recorded in DVCAM/DV format during tape playback. When an i.LINK cable is connected, only signals in DVCAM/DV format from the  HDV/DV jack are input or output for recording/playback. Also select this setting when the unit is connected via an i.LINK cable to a computer that supports DV format (<i>see pages 47, 57</i>).</p> <p>Notes</p> <ul style="list-style-type: none"> • Before changing the setting, be sure to disconnect the i.LINK cable, or turn the other device off. If an i.LINK cable is connected when you change the setting, the video equipment may not recognize the signals correctly. • If you select [AUTO], the screen turns off temporarily when HDV signals are switched to DVCAM/DV signals or vice versa. The video and audio also stops at the same time. • For details on the i.LINK output and the recording tape format, <i>see pages 97 and 98</i>.
	 REC MODE <i>(pages 49, 67)</i>	<p>Switches the recording mode between DVCAM and DV format (SP mode only).</p> <p>► DVCAM : Records in DVCAM format. DV SP : Records in DV format (SP mode).</p> <p>Note</p> <p>You cannot change the setting during recording.</p>





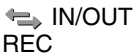

Icon/Menu	Submenu	Setting
 IN/OUT REC	VIDEO OUT (page 34)	<p>Selects the mode of the video output jacks.</p> <p>HDMI/CMPNT Selects the output format from the HDMI OUT jack and COMPONENT OUT jacks. Select from [480i], [480p/480i], [1080i/480i], or [720p/480i] when [60i/50i SEL] in the [OTHERS] menu is set to [60i]. Select from [576i], [576p/576i], [1080i/576i], or [720p/576i] when [60i/50i SEL] in the [OTHERS] menu is set to [50i].</p> <p>DOWN CONVERT Selects the setting for down converting images output from the HDMI OUT jack, COMPONENT OUT jacks and analog video jacks when playing back HDV format or inputting HDV signals from the  HDMI/DV jack.</p> <p>▶ SQUEEZE : Maintains the image vertically and horizontally by compressing the horizontal ratio. Images appear vertically long.</p> <p> LETTER BOX : Maintains the aspect ratio of the image by compressing the image vertically.</p> <p> EDGE CROP : Maintains the original image size and crops the left and right edges of the images.</p> <p>Notes</p> <ul style="list-style-type: none"> • Regardless of the playback tape or of the format input to the , HDV/DV jack, the selectable setting values displayed on this menu vary depending on the setting of [60i/50i SEL]. • WSS (Wide Screen Signaling) is not output when the picture is output to the COMPONENT OUT jacks in 480p or 576p. Set the monitor according to the down convert format of the picture that is output from the unit. • When you play back a tape in DVCAM (DV) format while an EE picture in NTSC/PAL is displayed, either the 480i resolution or the 576i resolution is output, regardless of the setting of [HDMI/CMPNT]. • When you play back an HDV-formatted tape with copyright protected signals or input an HDV signal with copyright protection to the , HDV/DV jack, pictures may be output in either 480i (NTSC) or 576i (PAL) format, regardless of the setting of [VIDEO OUT].

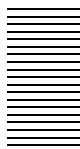
(Continued)







Icon/Menu	Submenu	Setting
 IN/OUT REC	i.LINK SET (pages 35, 44, 65)	<p>Adjusts the down conversion format. This menu is available when [HDV/DV SEL] is set to [AUTO] or [HDV].</p> <p>HDV → DV CONV</p> <ul style="list-style-type: none"> ▶ OFF : Disables down conversion. ▶ DVCAM : Down converts to DVCAM format. ▶ DV SP : Down converts to DV SP format. <p>DOWN CONVERT</p> <p>This setting is available when [HDV → DV CONV] is set to [DVCAM] or [DV SP].</p> <ul style="list-style-type: none"> ▶ SQUEEZE : Plays back with a compressed horizontal screen image and maintains all images on display. Images appear vertically long. ▶ EDGE CROP : Plays back with both left and right sides of the screen images cut off and maintains the original image appearance. <p>Notes</p> <ul style="list-style-type: none"> • When [DVCAM] is selected, there are some limitations, as described below. <ul style="list-style-type: none"> – ATN (Absolute Track Number) outputs the value counted in DVCAM format during playback at regular speed (×1) or recording of the internal color bars only. During playback at irregular speeds other than those described above, ATN outputs the value of a tape recorded in HDV format. – When the unit is playing back at regular speed (×1) and detects a blank portion on the tape, the unit counts the blank portion as ATN-formatted in DVCAM. – When using a duplicating function that is equipped with a device such as the DSR-25/45/50, select [DVCAM]. – Please note that a duplicated tape and the source tape recorded in HDV format with [DVCAM] selected do not share the same ATN (Time code value is displayed correctly). • When you change the video format setting of [DOWN CONVERT] of [i.LINK SET] in the [IN/OUT REC] menu, the video signal output from the COMPONENT OUT jacks, S VIDEO OUT jack, or VIDEO OUT jack may be distorted for a moment. • Before changing your setting, be sure to disconnect the i.LINK cable. If you change the setting while i.LINK is connected, the video device may not recognize the new setting. • When you select [EDGE CROP], the outputs of S VIDEO and VIDEO are limited. For details, see page 88.
	CROP ADJUST (page 44)	<p>Adjusts the position of edge cropping when down converting 16:9 to 4:3 aspect ratio. Adjust the position of the crop marker by pressing the \leftarrow/\rightarrow buttons to move either left or right, and then press the EXEC button. (You can also use the \uparrow/\downarrow buttons.)</p>
	CROP MARKER (page 44)	<p>Selects whether to display EDGE CROP MARKER or not.</p> <ul style="list-style-type: none"> ▶ OFF : Does not display the crop marker. ▶ ON : Displays the crop marker. <p>Notes</p> <ul style="list-style-type: none"> • This setting is only available when [DOWN CONVERT] of [VIDEO OUT], or [DOWN CONVERT] of [i.LINK SET] in the [IN/OUT REC] menu is set to [EDGE CROP]. • The edge crop marker is displayed under the following conditions: <ul style="list-style-type: none"> – When an HDV-formatted tape is played back – When HDV signals are input to the , HDV/DV jack – When a DV-wide formatted tape is played back – When DV-wide (SD) signals are input to the , HDV/DV jack, S VIDEO IN jack, or VIDEO IN jack

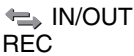

Icon/Menu	Submenu	Setting
 IN/OUT REC	COLOR BAR	<p>Selects whether to display color bars or not. Also, you may select color bars with or without tone signals (1 kHz full bit –20 dB at 60i, 1 kHz full bit –18 dB at 50i).</p> <p>▶ OFF : Does not display color bars and no tone signals. ON : Displays color bars without tone signals. ON[TONE] : Displays color bars with tone signals.</p> <p>Notes</p> <ul style="list-style-type: none"> • Color bars and tone signals are output from the HDMI OUT jack,  HDV/DV jack, COMPONENT OUT jacks, and analog output jacks. • Color bars and tone signals cannot be output when the tape is in playback mode. • The color bars output to i.LINK/the color bars and tone signals recorded on tapes/the format of tone signals can be set by [HDV/DV SEL] and [ REC MODE]. <ul style="list-style-type: none"> – When [HDV/DV SEL] is set to [AUTO], the format of the color bar and tone signals will be output/recorded according to the video format displayed in “1 Format indicator” (page 23) of the text data display on a monitor. – When [HDV/DV SEL] is set to [HDV], color bars and tone signals are output/recorded in HDV format. – When [HDV/DV SEL] is set to [DV] and [ REC MODE] in the [IN/OUT REC] menu is set to [DVCAM], color bars and tone signals will be output/recorded in DVCAM format. – When [HDV/DV SEL] is set to [DV] and [ REC MODE] in the [IN/OUT REC] menu is set to [DV SP], color bars will be output/recorded in DV (SP) format. • Color bar outputs cannot be recorded in progressive but are recorded in 1080/60i or 1080/50i format according to the setting of [60i/50i SEL] in the [OTHERS] menu (page 82). • When the unit is turned off and on again, [COLOR BAR] is automatically set to [OFF].
	BARS TYPE	<p>Selects the type of color bars.</p> <p>TYPE 1 : Outputs TYPE 1 color bars. ▶ TYPE 2 : Outputs TYPE 2 color bars. TYPE 3 : Outputs TYPE 3 color bars.</p> <p>Notes</p> <ul style="list-style-type: none"> • When color bars are output in NTSC (60i) mode on the unit, no-setup (0 IRE) signals are output. • Even when the unit’s screen aspect ratio displays at 4:3, the color bars are generated as 16:9. When an edge cropped (4:3) picture of a color bar is output in HDV format, or when [DV BARS] is set to [4:3] in DV format, select [TYPE 2]. • Color bars on the unit are generated in HDV (1080i) resolution. When a resolution other than HDV (1080i) is output, the color bars are down converted and output. The transition edges between the color bars are distorted. • You cannot change the current setting during recording.
	DV BARS	<p>Selects the aspect ratio of color bars set in [BARS TYPE] (DVCAM/DV (SP) format only).</p> <p>▶ 16:9 : Sets the aspect ratio of color bars to 16:9. 4:3 : Sets the aspect ratio of color bars to 4:3.</p> <p>Note</p> <p>You cannot change the current setting during recording.</p>

(Continued)



Operating Menus

Icon/Menu	Submenu	Setting																	
 IN/OUT REC	EE/PB SEL (page 11)	Sets the stop, fast-forward, and rewind modes. ►EE : Outputs EE picture and EE sound. PB : Mutes the image and sound. Note If this item is set to PB, the output from the unit will be as follows when you press any of the REC, DUPLICATE, or AUDIO DUB buttons separately when the unit is stopped (unless the cassette has been write-protected). <table border="1"> <thead> <tr> <th></th> <th>Image</th> <th>Sound</th> <th>Time code</th> </tr> </thead> <tbody> <tr> <td>REC button</td> <td>EE picture of the input image</td> <td>EE sound of the input sound (CH-1/2)^{a)}</td> <td rowspan="4">(See page 56)</td> </tr> <tr> <td>DUPLICATE button^{b)}</td> <td>Image input to  HDV/DV jack</td> <td>Sound input to  HDV/DV jack</td> </tr> <tr> <td>AUDIO DUB button</td> <td>Mute screen (black)</td> <td>EE sound of the input sound (CH-3/4)^{a)}</td> </tr> <tr> <td>No button is pressed</td> <td>Mute screen (black)</td> <td>Mute (no sound)</td> </tr> </tbody> </table> <p>a) Set the AUDIO OUTPUT SELECT switch appropriately. b) When the INPUT SELECT switch is set to HDV/DV.</p>		Image	Sound	Time code	REC button	EE picture of the input image	EE sound of the input sound (CH-1/2) ^{a)}	(See page 56)	DUPLICATE button ^{b)}	Image input to  HDV/DV jack	Sound input to  HDV/DV jack	AUDIO DUB button	Mute screen (black)	EE sound of the input sound (CH-3/4) ^{a)}	No button is pressed	Mute screen (black)	Mute (no sound)
		Image	Sound	Time code															
REC button	EE picture of the input image	EE sound of the input sound (CH-1/2) ^{a)}	(See page 56)																
DUPLICATE button ^{b)}	Image input to  HDV/DV jack	Sound input to  HDV/DV jack																	
AUDIO DUB button	Mute screen (black)	EE sound of the input sound (CH-3/4) ^{a)}																	
No button is pressed	Mute screen (black)	Mute (no sound)																	
	480i LEVEL (pages 17, 37)	Selects the component output level of luminance and chrominance from either BETACAM or SMPTE signals when the component output is set to 480i. ►BETACAM : Sets the COMPONENT OUT jacks to BETACAM level. SMPTE : Sets the COMPONENT OUT jacks to SMPTE level. Note For details on COMPONENT OUT jack specifications, see page 101.																	

DISPLAY SET menu

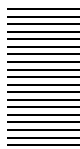

Icon/Menu	Submenu	Setting
 DISPLAY SET	COUNTER SET (page 25)	Selects the appearance of the time counter. DISPLAY ►ON : Enables the time counter display. OFF : Disables the time counter display. SIZE ►LARGE : Displays the time counter in large letters. SMALL : Displays the time counter in small letters. COLOR ►TYPE 1 : Displays the time counter with color type 1. TYPE 2 : Displays the time counter with color type 2. TYPE 3 : Displays the time counter with color type 3. TYPE 4 : Displays the time counter with color type 4.



Icon/Menu	Submenu	Setting
 DISPLAY SET (page 45)	MARKER BURN	Selects whether to output MARKER BURN or not. ▶OFF : Does not output MARKER BURN. ON : Outputs MARKER BURN. Note There are some limitations to the output of MARKER BURN. For details, <i>see page 45.</i>
	ALLSCAN MODE	Zooms out the image on the LCD monitor to check the area surrounding the picture frame where the external monitor can not display. ▶OFF : Disables the ALLSCAN MODE. ON : Enables the ALLSCAN MODE. Notes <ul style="list-style-type: none"> • ALLSCAN MODE is for HDV format only. ALLSCAN MODE does not activate when DVCAM and DV(SP)-formatted tapes are played. • If formats are mixed on a tape, the part where the format has changed on a tape causes distortion of images. • When [ON] is selected and the output level of COMPONENT OUT is set to 480i, 576i, 480p/480i, or 576p/576i, output images from the S VIDEO OUT jack and VIDEO OUT jack are down converted to letter box. For details, <i>see page 88.</i> • Once the unit turns off, the setting of [ALLSCAN MODE] is set to [OFF] automatically. • When you set [MARKER BURN] and [ALLSCAN MODE] in the [DISPLAY SET] menu to [ON] at the same time, the marker will not appear in the correct position on the LCD monitor. This is not a malfunction. The marker will be output correctly via each video jack.
	DATA CODE (page 39)	Selects whether or not to display the data codes on the analog video output. ▶OFF : Does not display the data codes. DATE : Displays the date and time when recorded.
	LETTER SIZE	Selects the character size of the menu at the cursor. ▶NORMAL : Normal size 2 x: Double height size
	DATE DISPLAY	Selects the date display in the data code display. Y/M/D : Displays YY/MM/DD (year/month/day). M/D/Y : Displays MM/DD/YY (month/day/year). (Default setting for the HVR-M25AU/M25AN.) D/M/Y : Displays DD/MM/YY (day/month/year). (Default setting for the HVR-M25AE/M25AP.)
	TIME DISPLAY	Selects the time display in the data code display. 12H : Displays 12-hour time. (Default setting for 60i.) 24H : Displays 24-hour time. (Default setting for 50i.)
	 REMAINING (page 24)	▶AUTO : The remaining tape time is displayed for 8 seconds under the following conditions. <ul style="list-style-type: none"> – If the remaining tape time is determined when you turn on power while a cassette is loaded in the unit. – When you press the PLAY button. Always displays under the following conditions. <ul style="list-style-type: none"> – Fast forward, rewind – Fast forward during playback, rewind during playback ON : Always displays the remaining tape time.
	LCD BRIGHT	Adjusts the LCD monitor brightness. Press the \uparrow/\downarrow buttons and the EXEC button to adjust the brightness. (The mark under the bar indicates the default setting value.)
	LCD COLOR	Adjusts the color density of the LCD monitor. Press the \uparrow/\downarrow buttons and the EXEC button to adjust the brightness. (The mark under the bar indicates the default setting value.)
	LCD BLACK	Mutes the images on the LCD monitor and displays only the text data. ▶OFF : Does not mute the images ON : Mutes the images Note When [ON] is selected, the images output from the rear panel to the external monitor are not muted.

Operating Menus

AUDIO SET menu

Icon/Menu	Submenu	Setting
 AUDIO SET <small>(page 49)</small>	AUDIO MODE	<p>Selects the audio mode.</p> <p>FS32K : Switches the audio mode to 4-channel mode (12-bit mode).</p> <p>▶FS48K : Switches the audio mode to 2-channel mode (16-bit mode). (This setting records the sound in all audio ranges, providing a high-quality sound recording.)</p> <p>Notes</p> <ul style="list-style-type: none"> • You can set this menu when recording in DV format only. • When signals are input from the , HDV/DV jack, the audio mode of the signals to be recorded is the same as that of the input signals. • Recording performs automatically in [FS48K] mode in HDV format. • You cannot change the current setting during recording. • Noise may occur at the instant you switch the audio mode. • When dubbing a sound source in DVCAM, select [FS32K].
	AUDIO MONI <small>(page 25)</small>	<p>Sets the audio that is output from the  (phones) jack, the HDMI OUT jack and the speaker.</p> <p>▶CH1, CH2 : Outputs CH1 and CH2 audio to each channel.</p> <p>CH1 : Outputs CH1 audio to 1/2 channel.</p> <p>CH2 : Outputs CH2 audio to 1/2 channel.</p> <p>Note</p> <p>When the AUDIO OUTPUT SELECT switch is set to CH-3/4, [CH1] and [CH2] correspond to [CH3] and [CH4], respectively. When it is set to MIX, [CH1] and [CH2] correspond to CH1/3 synthesized sound and CH2/4 synthesized sound, respectively.</p>
	AUDIO LOCK <small>(page 49, 96)</small>	<p>▶UNLOCK MODE : Records the sampling clocks of audio and video independently. This mode applies to a consumer DV tape.</p> <p>LOCK MODE : Synchronizes the sampling clocks of the audio and video for recording. This setting is effective for digital processing and performs a clean splice during the audio editing process.</p> <p>Notes</p> <ul style="list-style-type: none"> • You can set this menu when recording in DV (SP) format only. • When recording in HDV or DVCAM format, the menu is set to [LOCK MODE]. • During i.LINK input, the same setting as that of the input signal is selected, regardless of this setting.
	JOG AUDIO <small>(page 41)</small>	<p>Selects either to turn the sound output on or off when the tape is played at a speed other than normal. (Available in DVCAM/DV format only.)</p> <p>▶OFF : Does not output the sound when playing a tape at a speed other than normal.</p> <p>ON : Outputs the sound when playing a tape at a speed other than normal.</p> <p>Notes</p> <ul style="list-style-type: none"> • When a tape recorded in HDV format is played back, the sound cannot be output in various speeds. • Even if you have set this item to ON, the sound may not be output or may be interrupted depending on the recording format or tape conditions.

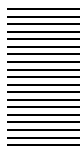

VTR SET menu

Icon/Menu	Submenu	Setting
 VTR SET	DUPLICATE PLUS (page 59)	<p>Selects the video format and whether or not to use auto rewind during duplication.</p> <p>FORMAT SEL</p> <p>▶ ALL : Duplicates all video formats.</p> <p>HDV1080 : The player automatically detects only 1080 HDV (both interlaced and progressive) and duplicates.</p> <p>HDV1080(i) : The player automatically detects only 1080 interlaced HDV and duplicate.</p> <p>HDV1080(p) : The player automatically detects only 1080 progressive HDV and duplicates.</p> <p>DVCAM : Duplicates DVCAM format only.</p> <p>DV SP : Duplicates DV (SP) format only.</p> <p>AUTO REW</p> <p>▶ ON : Rewinds the tape on both the player and the recorder, and starts duplication. Also, when you continue to duplicate a resource tape from multiple tapes, a new work tape will be rewound automatically and duplication starts.</p> <p>OFF : Starts duplicating from the current portion of the tape.</p> <p>Note</p> <p>You cannot use these settings during duplication.</p>
	CUSTOM REPEAT (page 42)	<p>Adjusts the REPEAT TIMES, REPEAT CYCLE, and START TIME of the CUSTOM REPEAT.</p> <p>REPEAT TIMES</p> <p>ON/OFF : Selects whether to apply the REPEAT TIMES setting or not.</p> <p>TIMES : Sets the number of times to repeat playbacks. Set the number by pressing the \uparrow/\downarrow buttons and then press the EXEC button.</p> <p>REPEAT CYCLE</p> <p>ON/OFF : Selects whether to apply the REPEAT CYCLE setting or not.</p> <p>CYCLE : Sets the time of intervals for playback. Set the number by pressing the \uparrow/\downarrow buttons and then press the EXEC button.</p> <p>START TIME</p> <p>ON/OFF : Selects whether to apply START TIME setting or not.</p> <p>TIME : Sets the starting time of CUSTOM REPEAT. Set the number by pressing the \uparrow/\downarrow buttons on the unit. To switch between hour and minute, press the \leftarrow/\rightarrow buttons. Press the EXEC button to execute.</p>
	AUTO INDEX (page 50)	<p>Selects whether or not to mark an index signal automatically when the unit in the stop mode starts recording.</p> <p>▶ ON : Marks an index signal at the beginning of the recording.</p> <p>OFF : Does not mark an index signal at the beginning of the recording.</p>
	STILL PICT	<p>Selects the image displayed in the still mode (DVCAM/DV (SP) format only).</p> <p>▶ AUTO : Displays an optimized image according to the movement in the image.</p> <p>FRAME : Displays a frame image.</p> <p>FIELD : Displays a field image.</p> <p>Notes</p> <ul style="list-style-type: none"> • If you select [FIELD], the image of field 2 is displayed. • For an HDV format video, an optimized image according to the movement in the image is displayed.
	FF/REW SPEED (page 12)	<p>Selects the tape transport mode in fast-forward and rewind.</p> <p>▶ FF/REW : Fast-forwards or rewinds the tape at maximum speed without displaying the picture.</p> <p>SHUTTLEMAX : Fast-forwards or rewinds the tape at maximum speed while displaying the picture.</p> <p>DVCAM</p> <p>NTSC: Approx. 14 times normal speed</p> <p>PAL: Approx. 17 times normal speed</p> <p>HDV/DV(SP)</p> <p>Approx. 24 times normal speed</p>

(Continued)



Operating Menus

Icon/Menu	Submenu	Setting
 VTR SET	STILL TIME	<p>Selects the time to switch to the tape protection mode from the still mode.</p> <p>▶30sec : 30 seconds 1min : 1 minute 2min : 2 minutes 3min : 3 minutes</p> <p>Notes</p> <ul style="list-style-type: none"> • If the unit is left in the playback pause mode for a long time, the tape or the video heads may be damaged or the video heads may become clogged. Select the shortest time possible. Particularly, when using a Mini-DV cassette that is longer than 60 minutes, select [30sec] or [1min]. • When the setting is changed in the playback pause mode, the first tape protection mode change uses the time setting from before the settings were changed. From the second tape protection mode change, the new time setting is used.
	FROM STILL	<p>Selects the tape protection mode to change the mode to after the time set in [STILL TIME] is past.</p> <p>▶STOP : Stops the tape. STEP FORWARD : Forwards one frame.</p> <p>Note</p> <p>If you play a tape recorded in HDV format with [STEP FORWARD] selected, the tape advances a few frames forward at a time.</p>
	FROM REC P	<p>Selects the tape protection mode which the unit changes to after the recording has been paused for more than 3 minutes.</p> <p>▶STOP : Stops the tape. REC PAUSE : Maintains the recording pause mode.</p> <p>Note</p> <p>When the recording pause mode continues for a long time after you select [REC PAUSE], the tape may be damaged or the video heads may be damaged or clogged. If there is no other reason to do otherwise, select [STOP]. Particularly when you use a Mini-DV cassette that is longer than 60 minutes, select [STOP].</p>

TC/UB SET menu

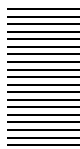
Icon/Menu	Submenu	Setting
 TC/UB SET	TC PRESET (page 52)	<p>Reset the time code value or set the desired time code value.</p> <p>PRESET : Sets the desired time code value. RESET : Resets the time code value to 00:00:00:00.</p> <p>Note</p> <p>To set the initial time code value, you need to set [TC MAKE] to [PRESET] first. If [TC MAKE] has been set to [REGENERATE], or [HDV/DV IN TC] has been set to [EXTERNAL], this setting is not effective.</p>
	UB PRESET (page 53)	<p>Resets the user bits value or sets the desired user bits value.</p> <p>PRESET : Sets the user bits value. (You can set the user bits as eight-digit hexadecimal values (0 to 9, A to F) (base 16) to have the date, time, scene number, and other information inserted into the user bits.) RESET : Resets the user bits value to 00 00 00 00.</p> <p>Note</p> <p>When the INPUT SELECT switch is set to HDV/DV and HDV signals are input to the unit, this setting is not effective. (When color bars are displayed or during recording, this setting is effective.)</p>



Icon/Menu	Submenu	Setting
00:00 TC/UB SET	HDV/DV IN TC (page 52)	<p>Selects whether to record internal time code or external time code while the unit records signals input from the  HDV/DV jack.</p> <p>► INTERNAL : Records the time code generated by the internal time code generator. (If [TC MAKE] is set to [REGENERATE] and no time code is recorded on the tape, the unit records time code from 00:00:00:00. If there is time code already recorded on the tape, the unit records continuous time code from this point.)</p> <p>EXTERNAL : Records the time code with video and audio signals input from the  HDV/DV jack.</p> <p>Notes</p> <ul style="list-style-type: none"> • Bars (---:---:---:---) are recorded as the time code if you start recording when this item is set to [EXTERNAL], the INPUT SELECT switch on the front panel is set to HDV/DV, and no signal is input via the  HDV/DV jack. • When any signals are input, the time code of the signals is recorded. • If you set this item to [EXTERNAL] and the external time code input is discontinuous or does not advance correctly, recording or displaying of the time code on the unit may not be done correctly. If there is a discontinuous time code on your recorded tape, you may not be able to edit or search correctly, depending on the device used to edit.
	TC RUN (page 54)	<p>Selects the advancement mode (counting up).</p> <p>► REC RUN : Time code value advances only while recording.</p> <p>FREE RUN : Time code value advances even when the unit is not recording. (Use this setting to adjust the initial value of the time code to the present time.)</p> <p>Notes</p> <ul style="list-style-type: none"> • To record the time code according to the setting of [TC RUN], set [TC MAKE] to [PRESET] (page 79) • If you set the advancement mode to [FREE RUN], the time code will be updated by the internal clock when the power is off. Therefore, when you turn on the unit again, the time code may be somewhat off. • If the internal backup battery is exhausted, the time code of the [FREE RUN] setting is initialized.
	TC MAKE (page 54)	<p>Selects the time code when you start recording.</p> <p>► REGENERATE : The time code value is set to continuous time code from the one already recorded on the tape. If no time code is recorded on the tape, it starts from 00:00:00:00.</p> <p>PRESET : The time code starts from the value set in [TC PRESET] in the [TC/UB SET] menu.</p>
	TC FORMAT (page 55)	<p>Selects the recording mode of the time code when 60i format is used.</p> <p>► AUTO : Automatically sets the mode in accordance with the mode already set on a cassette tape. (If nothing is recorded on the tape, the non-drop frame mode is set. If the unit cannot correctly read the frame mode on the tape, it will use the frame mode that was set in the last position on the tape that the unit can read correctly. If you remove the cassette, the mode of the last position that the unit was able to read correctly is cleared and the non-drop frame mode is set when recording is restarted from the same position. If [TC MAKE] is set to [PRESET], the non-drop frame mode is set.)</p> <p>DF : Selects the drop frame mode.</p> <p>NDF : Selects the non-drop frame mode.</p> <p>Note</p> <p>When [60i/50i SEL] is set to [50i], the unit operates as a 50i specification model. Therefore, the time code is set to the non-drop frame mode. Even if 60i signals are input via an i.LINK connection when [60i/50i SEL] is set to [50i], the time code generated by the unit is in the non-drop frame mode regardless of the [TC FORMAT] setting. To set the time code to the drop frame mode, set [60i/50i SEL] to [60i]. As a result, [TC FORMAT] setting will return to the status before the [60i/50i SEL] menu was set to [50i].</p>

Operating Menus

OTHERS menu

Icon/Menu	Submenu	Setting																																										
OTHERS	ASSIGN BTN (pages 8, 10, 11)	<p>Assigns a function other than the default functions to ASSIGN buttons (the INDEX (A1) button, AUDIO DUB (A2) button, and RESET (A3) button). The available functions for each ASSIGN button are as listed below.</p> <table border="1"> <thead> <tr> <th>INDEX (A1) button</th> <th>AUDIO DUB (A2) button</th> <th>RESET (A3) button</th> </tr> </thead> <tbody> <tr> <td>INDEX MARK ^{a)}</td> <td>AUDIO DUB ^{a)}</td> <td>COUNT. RESET ^{a)}</td> </tr> <tr> <td colspan="3">HDV → DV CONV ^{c)}</td> </tr> <tr> <td colspan="3">HDMI/CMPNT ^{c)}</td> </tr> <tr> <td colspan="3">END SEARCH ^{b)}</td> </tr> <tr> <td colspan="3">DATA CODE ^{b), c)}</td> </tr> <tr> <td colspan="3">ALLSCAN MODE ^{c)}</td> </tr> <tr> <td colspan="3">COLOR BAR ^{c)}</td> </tr> <tr> <td colspan="3">SEARCH SEL ^{b)}</td> </tr> <tr> <td colspan="3">SEARCH ►► ^{b)}</td> </tr> <tr> <td colspan="3">SEARCH ◀◀ ^{b)}</td> </tr> <tr> <td colspan="3">COUNT. SIZE ^{c)}</td> </tr> <tr> <td colspan="3">COUNT. COLOR ^{c)}</td> </tr> <tr> <td colspan="3">FF/REW SPEED ^{c)}</td> </tr> </tbody> </table> <p>a) Default setting b) Same functions as on the Remote Commander c) The above settings can be set with the menu on the unit. For details, refer to the menu items.</p> <p>END SEARCH: The last five second portion recorded on a tape is played back and stopped. Use END SEARCH to check the last picture recorded. Once you eject the tape from the unit, you cannot use this function.</p> <p>Notes</p> <ul style="list-style-type: none"> The default functions for each ASSIGN button can not be assigned to other ASSIGN buttons. If you assign other functions, A1, A2, and A3 will be displayed on the left corner of the Data display screen. 	INDEX (A1) button	AUDIO DUB (A2) button	RESET (A3) button	INDEX MARK ^{a)}	AUDIO DUB ^{a)}	COUNT. RESET ^{a)}	HDV → DV CONV ^{c)}			HDMI/CMPNT ^{c)}			END SEARCH ^{b)}			DATA CODE ^{b), c)}			ALLSCAN MODE ^{c)}			COLOR BAR ^{c)}			SEARCH SEL ^{b)}			SEARCH ►► ^{b)}			SEARCH ◀◀ ^{b)}			COUNT. SIZE ^{c)}			COUNT. COLOR ^{c)}			FF/REW SPEED ^{c)}		
	INDEX (A1) button	AUDIO DUB (A2) button	RESET (A3) button																																									
	INDEX MARK ^{a)}	AUDIO DUB ^{a)}	COUNT. RESET ^{a)}																																									
HDV → DV CONV ^{c)}																																												
HDMI/CMPNT ^{c)}																																												
END SEARCH ^{b)}																																												
DATA CODE ^{b), c)}																																												
ALLSCAN MODE ^{c)}																																												
COLOR BAR ^{c)}																																												
SEARCH SEL ^{b)}																																												
SEARCH ►► ^{b)}																																												
SEARCH ◀◀ ^{b)}																																												
COUNT. SIZE ^{c)}																																												
COUNT. COLOR ^{c)}																																												
FF/REW SPEED ^{c)}																																												
	LANGUAGE	You can select the desired language on the Data display screen. You can choose Simplified English if your native language is not available among the options.																																										
	COMMANDER (page 22)	<p>Selects the control device.</p> <p>► WIRELESS : Enables operation by the Remote Commander. CONTROL S : Enables operation by the DSRM-10 remote control unit (not supplied) connected to the CONTROL S jack. (The Remote Commander is disabled.)</p> <p>Notes</p> <ul style="list-style-type: none"> The unit accepts signals from any Sony Remote Commander with its command mode set to VTR4, not only the supplied one. To disable operation from any Remote Commander, set this item to CONTROL S. You can use the DSRM-20 (no longer manufactured: not supplied). 																																										

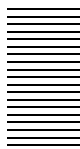

Icon/Menu	Submenu	Setting
OTHERS	PB YNR	<p>Selects the noise reduction level for the luminance signals when a tape is played.</p> <p>▶ OFF : No noise reduction LOW : Low noise reduction HIGH : High noise reduction</p> <p>Notes</p> <ul style="list-style-type: none"> When you use noise reduction, there may be an afterimage depending on the condition of the picture. Noise reduction is also available with pictures output from the HDV/DV jack. Use caution when dubbing and editing a picture via the HDV/DV jack.
	PB CNR	<p>Selects the noise reduction level for the chrominance signals when a tape is played.</p> <p>▶ OFF : No noise reduction LOW : Low noise reduction HIGH : High noise reduction</p> <p>Notes</p> <ul style="list-style-type: none"> When you use noise reduction, there may be an afterimage depending on the condition of the picture. Noise reduction is also available with pictures output from the HDV/DV jack. Use caution when dubbing and editing a picture via the HDV/DV jack.
	SPEAKER/ BEEP (page 7)	<p>Sets beeps and/or sounds from the speaker of the unit ON/OFF. When headphones are connected, sounds are heard from the headphones and no sound is produced from the built-in speaker, regardless of this setting.</p> <p>▶ ON[SPK/BEEP] : Outputs both beeps and speaker sounds. ON[SPEAKER] : Outputs sounds from the speaker only and disables beeps. ON[BEEP] : Outputs beeps and emits no sounds from the speaker. OFF : Disables beeps and does not output sounds from the speaker.</p>
	CLOCK SET (page 48)	<p>1 Press the buttons to adjust the number, then press the buttons to set the month, day, hour, and minute. 2 Press the EXEC button to execute.</p> <p>Notes</p> <ul style="list-style-type: none"> 12:00 AM stands for midnight and 12:00 stands for noon when [TIME DISPLAY] in [DISPLAY SET] menu is set to [12H]. If you do not use the unit for 3 months or more, the built-in rechargeable battery will become completely discharged, and the settings of the day and the time may be cleared from the memory. In this case, charge the built-in rechargeable battery and set the clock again (page 95).
	HOURS METER (page 95)	<p>Displays the accumulated time counts (using the digital hours meter) in units of 10 hours or 10 counts.</p> <p>OPERATION : Power on duration DRUM RUN : Drum rotation duration TAPE RUN : Tape run duration THREADING : Tape unthreading count</p>
	AC ON MODE	<p>Switches the state into which the unit goes when it is connected to the AC outlet.</p> <p>▶ STANDBY : Makes the unit go into the standby mode. ON : Turns the unit on.</p>
	AUTO STANDBY	<p>Selects whether the unit goes into the standby mode or not, if the unit has been in the stop mode and no key operations have been attempted for more than one hour.</p> <p>▶ OFF : Leaves the unit in the stop mode. ON : Makes the unit go into the standby mode.</p>

(Continued)

Operating Menus

Icon/Menu	Submenu	Setting
OTHERS	60i/50i SEL <i>(page 48)</i>	<p>Switches between 1080/60i (NTSC) and 1080/50i (PAL).</p> <p>1 Press the \uparrow/\downarrow buttons to select [YES], then press the EXEC button.</p> <div style="border: 1px solid black; padding: 5px; margin: 10px auto; width: fit-content;"> <p>60i/50i SEL Change to 50i? Reboots after change.</p> <hr/> <p>YES NO</p> </div> <p>2 Press the \uparrow/\downarrow buttons to select [YES] again, then press the EXEC button.</p>
	INITIALIZE	<p>Resets the settings to the default settings, except the CLOCK SET settings.</p> <p>1 Press the \uparrow/\downarrow buttons to select [YES], and then press the EXEC button.</p> <div style="border: 1px solid black; padding: 5px; margin: 10px auto; width: fit-content;"> <p>INITIALIZE Reset all settings except "CLOCK SET" to defaults.</p> <hr/> <p>YES NO</p> </div> <p>2 Press the \uparrow/\downarrow buttons to select [YES] again, then press the EXEC button.</p>

Maintenance

Troubleshooting

Please check the following before contacting your Sony dealer.

General Operation Troubles

Symptom	Cause/Remedy
Key operations cannot be made.	<ul style="list-style-type: none"> The KEY INH switch is set to ON. → Set the switch to OFF (<i>page 6</i>).
A menu item is not available.	<ul style="list-style-type: none"> The KEY INH switch is set to ON. → First, set the switch to OFF (<i>page 6</i>), then adjust the menu. There are menus that cannot be used depending in the [IN/OUT REC] menu setting. → Change the [IN/OUT REC] menu settings (<i>page 70</i>). Some menu items are only available in EE mode or playback mode. → Set the unit to EE mode or playback mode. Some menu items are only available when the tape is inactive. There are some menus you cannot use without setting the clock.
Some menu item settings change accidentally.	<ul style="list-style-type: none"> You have pulled out the power cord during a menu operation or LCD monitor brightness adjustment. → Adjust the menu again. To prevent this incident recurring, do not pull out the plug while adjusting the menu or the brightness of the LCD monitor.
The unit operates by itself.	<ul style="list-style-type: none"> [COMMANDER] in the [OTHERS] menu is set to [WIRELESS] and a Sony Remote Commander with its command mode set to VTR4 is operating near the unit. → Set [COMMANDER] to [CONTROL S] (<i>page 80</i>). When TIMER switch is set to REPEAT and [START TIME] of [CUSTOM REPEAT] in the [VTR SET] menu is set to [ON], the unit starts to repeat playback at the start time you have set. → Set the TIMER switch to OFF (<i>page 7</i>), or turn [START TIME] to [OFF] (<i>page 77</i>).
The supplied wireless Remote Commander does not work.	→ Set [COMMANDER] in the [OTHERS] menu to [WIRELESS] (<i>page 80</i>).
Even though the settings on the unit are correct, you cannot make the unit record using the DSRM-10 Remote Control Unit (not supplied).	→ On the DSRM-10 Remote Control Unit, press the PLAY button while holding the REC button down.

(Continued)

Troubleshooting

Symptom	Cause/Remedy
Even though KEY INH switch is set to ON, the unit responds to operations input using the Remote Commander.	<ul style="list-style-type: none"> Setting the KEY INH switch to ON does not disable the Remote Commander. To disable the Remote Commander, set [COMMANDER] in the [OTHERS] menu to [CONTROL S] (page 80).
Whenever you connect the unit to an AC outlet, the unit turns on automatically.	<ul style="list-style-type: none"> [AC ON MODE] in the [OTHERS] menu is set to [ON]. → Set [AC ON MODE] to [STANDBY] (page 81). There is a cassette inside the unit and the TIMER switch is set to REPEAT or REC. → Set the TIMER switch to OFF (page 7).
No picture on the LCD monitor.	<ul style="list-style-type: none"> [LCD BLACK] in the [DISPLAY SET] menu is set to [ON]. → Set it to [OFF] (page 75). With an analog connection, the current setting of [60i/50i SEL] in the [OTHERS] menu is not appropriate. → Set it to the appropriate position for the device you are using (page 82).

Power sources

Symptom	Cause/Remedy
The power cannot be turned on.	<ul style="list-style-type: none"> The AC power cord is disconnected. → Connect the AC power cord. The KEY INH switch is set to ON. → Set the switch to OFF (page 6). The POWER switch on the rear of the unit is in the “O” position (OFF). → Press the “I” marked side of the POWER switch (ON) (page 20).
The unit will not operate even if the power has been turned on.	<ul style="list-style-type: none"> The KEY INH switch is set to ON. → Set the switch to OFF. Moisture condensation has occurred (page 94). The cassette is not inserted straight. → Eject and reinsert it correctly. → Disconnect the power supply and then reconnect it after about 1 minute. If the unit does not operate even after you reconnect the power, use a sharp-tipped ballpoint pen or similar tool to press the RESET button. When you press the RESET button, all settings, including the date, time, and 60i/50i are initialized (page 20).

Cassette tapes

Symptom	Cause/Remedy
The cassette cannot be inserted.	<ul style="list-style-type: none"> There is moisture condensation on the head drum (page 94). → With the unit powered on, wait more than one hour. The cassette is not inserted straight. → Eject and reinsert it correctly. Another cassette has been loaded already. → Remove the cassette and insert the one you want to load.
It takes time to eject the cassette.	<ul style="list-style-type: none"> This is not a malfunction. → The unit ejects the cassette slowly to protect the tape. While the cassette is being ejected, the  (cassette) indicator blinks.
The cassette tape is not ejected when you press the EJECT button.	<ul style="list-style-type: none"> → Check whether the power supply is connected properly. The KEY INH switch is set to ON. → First, set the switch to OFF (page 6), then eject the cassette. Moisture condensation has occurred in the unit (page 94).

Symptom	Cause/Remedy
The cassette memory data and title are not displayed when using a cassette tape with the cassette memory function.	<ul style="list-style-type: none"> The unit does not support the cassette memory function and therefore such data is not displayed.
The remaining tape time is not displayed.	<ul style="list-style-type: none"> → To always display the remaining tape time, set [ REMAINING] in the [DISPLAY SET] menu to [ON] (page 75).

Output/Playback

Symptom	Cause/Remedy
Superimposed text data is displayed on the monitor.	<ul style="list-style-type: none"> → Change the setting of the DISPLAY OUTPUT switch on the front panel (page 8). You can also select the type of the text data to be displayed (page 23).
Cannot playback.	<ul style="list-style-type: none"> → If the tape has reached its end, rewind the tape.
Cannot playback in reverse at various speeds.	<ul style="list-style-type: none"> The unit cannot play back a tape recorded in HDV format in the reverse direction at various speeds (page 40).
30p and/or 24p characteristics of the tape are not detected.	<ul style="list-style-type: none"> While the tape is fast forwarding or rewinding during playback, a portion of the tape recorded using 30p or 24p system has been detected as that of a 60i system. → To detect the portion as 30p or 24p, search for the part during playback at normal speed.
Horizontal lines are displayed on an image. An image has block noise. An image is blurred or not displayed.	<ul style="list-style-type: none"> The video heads are dirty. <ul style="list-style-type: none"> → Clean the video heads using the supplied cleaning cassette. A damaged tape is loaded. <ul style="list-style-type: none"> → Remove the cassette and insert another one. You have tried to make the unit play back a tape recorded in LP mode of the DV format. <ul style="list-style-type: none"> → The unit can play back only tapes recorded in the HDV, DVCAM format or in SP mode of the DV format. A tape recorded in LP mode of the DV format cannot be played back on the unit (page 30).
A picture input via the  HDV/DV jack is not displayed.	<ul style="list-style-type: none"> → Reconnect the i.LINK cable (not supplied). The INPUT SELECT switch is set to a position other than HDV/DV. <ul style="list-style-type: none"> → Set the switch to HDV/DV (page 8). → Set [HDV/DV SEL] in the [IN/OUT REC] menu correctly (page 70).
EE picture and EE sound are not output.	<ul style="list-style-type: none"> [EE/PB SEL] in the [IN/OUT REC] menu is set to [PB]. <ul style="list-style-type: none"> → Set [EE/PB SEL] to [EE] (page 74). The setting of the INPUT SELECT switch does not match the signal input. <ul style="list-style-type: none"> → Set the switch according to the signal input (page 8).
The audio breaks up.	<ul style="list-style-type: none"> A damaged tape is loaded. <ul style="list-style-type: none"> → Remove the cassette and insert another one. The video heads are dirty. <ul style="list-style-type: none"> → Clean the video heads using the supplied cleaning cassette. You have tried to make the unit play back a tape recorded in LP mode of the DV format. <ul style="list-style-type: none"> → The unit can play back only tapes recorded in the HDV, DVCAM or DV (SP) formats. A tape recorded in LP mode of the DV format cannot be played back on the unit (page 30).
Duplication does not function.	<ul style="list-style-type: none"> Check the STOP/CAUTION No. and the warning messages displayed on the LCD monitor. Take the appropriate action (page 62).
Cannot perform a date search or index search.	<ul style="list-style-type: none"> There is a portion with no recording at the beginning or in the middle of a tape. This is not a malfunction.

(Continued)

Troubleshooting



Symptom	Cause/Remedy
The time code is not reset to "00:00:00:00" after rewinding a tape to the recording starting point.	<ul style="list-style-type: none"> The time code is not displayed correctly at the starting point of recording. This condition, however, is not a malfunction. When you restart playback, the time code and images are displayed correctly from the starting point.
A user bit is not displayed correctly during fast-forward/rewind.	<ul style="list-style-type: none"> When input video signals without a user bit are recorded while HDV is input via i.LINK, the user bit is not displayed correctly. Either "-- -- --" or "00 00 00 00" is displayed during playback and fast-forward/rewind, respectively.
"-- -- --" appears on the date display (page 39).	<ul style="list-style-type: none"> The tape has been played back without setting the date and time. <ul style="list-style-type: none"> → Set the date and time (page 81). The tape portion being played back has no recording. If there is a scratch or noise on the tape, the data code cannot be read.
Although the HDMI cable or component video cable is connected properly to a television set or monitor to play back a tape, no image or audio is output.	<ul style="list-style-type: none"> → Use the correct setting for [HDMI/CMPNT] in [VIDEO OUT] in the [IN/OUT REC] menu depending on the equipment connected (pages 34, 71). No audio is output from the COMPONENT OUT jacks. <ul style="list-style-type: none"> → Connect an audio cable.
When you connect the unit to a 4:3 television set, the displayed image appears flattened.	<ul style="list-style-type: none"> → When you output from the HDMI OUT jack and COMPONENT OUT jacks, set [HDMI/CMPNT] and [DOWN CONVERT] of [VIDEO OUT] in the [IN/OUT REC] menu correctly before playback (pages 34, 71). When you output from the i.LINK jack, set [HDV → DV CONV] and [DOWN CONVERT] of [i.LINK SET] in the [IN/OUT REC] menu correctly before playback (pages 35, 72). When you output from the S VIDEO jack and VIDEO jack, set [DOWN CONVERT] of [VIDEO OUT] in the [IN/OUT REC] menu correctly before playback. → DVCAM/DV tape images recorded in the wide mode are not displayed properly. Use a widescreen-compatible monitor.
Even though [HDV/DV IN TC] in the [TC/UB SET] menu is set to [EXTERNAL], the time code of the input i.LINK signal is not recorded.	<ul style="list-style-type: none"> The i.LINK signal output from the digital non-linear editing controller does not include a time code. <ul style="list-style-type: none"> → Confirm that the editing software you are using is capable of outputting a time code. The INPUT SELECT switch is not set to HDV/DV. <ul style="list-style-type: none"> → Set it to HDV/DV (page 8).
After playing at 1/10 of normal speed in forward or reverse for more than 1 minute, normal playback forward starts.	<ul style="list-style-type: none"> To protect a tape, the unit is set to start normal playback after playing at 1/10 of normal speed in forward or reverse for more than 1 minute. <ul style="list-style-type: none"> → Play back the tape at 1/3 of normal speed in forward or reverse.
Playback pause mode is released and the unit goes into the stop mode.	<ul style="list-style-type: none"> To protect the tape, the unit is set to go into the stop mode after the playback pause mode continues for a certain period. <ul style="list-style-type: none"> → Set [FROM STILL] in the [VTR SET] menu to [STEP FORWARD]. If you do so, the tape will forward by one frame for each time interval set in [STILL TIME] (page 78).
Playback pause mode is released and the tape forwards for each preset time interval.	<ul style="list-style-type: none"> To protect the tape, the unit is set to forward the tape after the playback pause mode continues for a certain period. <ul style="list-style-type: none"> → Set [FROM STILL] in the [VTR SET] menu to [STOP]. If you do so, the unit goes into the stop mode after the playback pause mode continues for the interval set in [STILL TIME] (page 78).
After the unit has been left in the stop mode and no key operations have been attempted for more than one hour, the unit goes into the standby mode (the unit's power turns off).	<ul style="list-style-type: none"> [AUTO STANDBY] in the [OTHERS] menu is set to [ON]. <ul style="list-style-type: none"> → Set [AUTO STANDBY] to [OFF] (page 81).
The pause mode of playback, recording, or audio dubbing is released automatically.	<ul style="list-style-type: none"> To protect the tape and the video heads, the unit goes into the stop mode after the pause mode of recording, audio dubbing, or duplicating continues for more than 3 minutes. <ul style="list-style-type: none"> → To maintain the pause mode, set [FROM REC P] in the [VTR SET] menu to [REC PAUSE] (page 78).



Symptom	Cause/Remedy
When the tape is rewound to its beginning, the playback automatically starts.	<ul style="list-style-type: none">• The TIMER switch is set to REPEAT. → Set the TIMER switch to OFF (page 7).• You pressed the PLAY button while holding the REW button down. → If you do this, the unit rewinds the tape to its beginning and begins playback (page 12).
During playback, the unit starts rewinding suddenly.	<ul style="list-style-type: none">• The TIMER switch is set to REPEAT. → When the TIMER switch is set to REPEAT, the unit starts rewinding at the moment when a signal for index search or a blank portion is detected. Set the TIMER switch to OFF (page 7).
When the tape reaches its end, rewinding starts automatically.	<ul style="list-style-type: none">• The TIMER switch is set to REPEAT. → When the TIMER switch is set to REPEAT, the unit starts rewinding at the moment when the end of the tape is detected. Set the TIMER switch to OFF (page 7).
The unit does not function as part of a digital non-linear editing system.	<ul style="list-style-type: none">• The INPUT SELECT switch is set to a setting other than HDV/DV. → Set it to HDV/DV (page 8).• The editing controller or the editing software is not compatible with the unit. → Refer to the instruction manuals of the controller or the software and consult their manufacturers.
Although the i.LINK cable is connected, the image from external equipment is not displayed.	<ul style="list-style-type: none">→ Disconnect and then reconnect the i.LINK cable correctly.• The INPUT SELECT switch is set to a setting other than HDV/DV. → Set it to HDV/DV (page 8).
No image is displayed even though the video cable is connected correctly.	<ul style="list-style-type: none">• There are output restrictions for some [HDMI/CMPNT] settings of [VIDEO OUT] in the [IN/OUT REC] menu. For details, see page 71.• The INPUT SELECT switch setting does not match the cable connected to the unit. → Set the INPUT SELECT switch to S VIDEO or VIDEO to match the cable connection.
The image loses color or is distorted when you play back the tape on a television set or monitor connected to the unit.	<ul style="list-style-type: none">→ Connect the unit to a television set or monitor that is compatible with its [60i/50i SEL] format.→ Set [60i/50i SEL] in the [OTHERS] menu, according to the signal-format (page 82).
2/2-ST is displayed on the screen.	<ul style="list-style-type: none">• This icon is displayed when you playback a tape recorded with 4-channel microphone recording on another device using external surround microphones. The unit does not support 4-channel microphone recording using external surround microphones. (This icon is displayed when you play back a tape recorded with external 4-channel recording using a surround microphone in DVCAM or DV (SP) format.)

(Continued)

Troubleshooting

Symptom	Cause/Remedy																											
The output from the S VIDEO OUT jack and VIDEO OUT jack is different from the [DOWN CONVERT] setting of [VIDEO OUT] in [IN/OUT REC].	<p>The output from the S VIDEO OUT jack and the VIDEO OUT jack is set as follows.</p> <ul style="list-style-type: none"> When the playback format of the unit is set as shown below and both the unit and the other equipment connected using the , HDV/DV jacks are powered on, the output from the S VIDEO OUT jack or VIDEO OUT jack is fixed to EDGE CROP. <table border="1"> <thead> <tr> <th colspan="2">Menu item</th> <th>Setting</th> </tr> </thead> <tbody> <tr> <td colspan="2">Playback format</td> <td>HDV (HDV1080i)</td> </tr> <tr> <td rowspan="2">[VIDEO OUT] in [IN/OUT REC] (page 71)</td> <td>[DOWN CONVERT]</td> <td>SQUEEZE or LETTER BOX</td> </tr> <tr> <td>[HDMI/CMPNT]</td> <td>480p/480i, 576p/576i</td> </tr> <tr> <td rowspan="2">[i.LINK SET] in [IN/OUT REC] (page 72)</td> <td>[HDV → DV CONV]</td> <td>DVCAM or DV SP</td> </tr> <tr> <td>[DOWN CONVERT]</td> <td>Set to EDGE CROP</td> </tr> </tbody> </table> <ul style="list-style-type: none"> When the playback format of the unit is set as shown below and both the unit and the other equipment connected using the , HDV/DV jacks are powered on, the output from the S VIDEO OUT jack or VIDEO OUT jack is fixed to LETTER BOX. <table border="1"> <thead> <tr> <th colspan="2">Menu item</th> <th>Setting</th> </tr> </thead> <tbody> <tr> <td colspan="2">Playback format</td> <td>HDV (1080i or 720p)</td> </tr> <tr> <td rowspan="2">[VIDEO OUT] in [IN/OUT REC] (page 71)</td> <td>[HDMI/CMPNT]</td> <td>480i, 576i, 480p/480i, 576p/576i</td> </tr> <tr> <td>[ALLSCAN MODE] in [DISPLAY SET] (page 75)</td> <td>ON</td> </tr> </tbody> </table>	Menu item		Setting	Playback format		HDV (HDV1080i)	[VIDEO OUT] in [IN/OUT REC] (page 71)	[DOWN CONVERT]	SQUEEZE or LETTER BOX	[HDMI/CMPNT]	480p/480i, 576p/576i	[i.LINK SET] in [IN/OUT REC] (page 72)	[HDV → DV CONV]	DVCAM or DV SP	[DOWN CONVERT]	Set to EDGE CROP	Menu item		Setting	Playback format		HDV (1080i or 720p)	[VIDEO OUT] in [IN/OUT REC] (page 71)	[HDMI/CMPNT]	480i, 576i, 480p/480i, 576p/576i	[ALLSCAN MODE] in [DISPLAY SET] (page 75)	ON
	Menu item		Setting																									
Playback format		HDV (HDV1080i)																										
[VIDEO OUT] in [IN/OUT REC] (page 71)	[DOWN CONVERT]	SQUEEZE or LETTER BOX																										
	[HDMI/CMPNT]	480p/480i, 576p/576i																										
[i.LINK SET] in [IN/OUT REC] (page 72)	[HDV → DV CONV]	DVCAM or DV SP																										
	[DOWN CONVERT]	Set to EDGE CROP																										
Menu item		Setting																										
Playback format		HDV (1080i or 720p)																										
[VIDEO OUT] in [IN/OUT REC] (page 71)	[HDMI/CMPNT]	480i, 576i, 480p/480i, 576p/576i																										
	[ALLSCAN MODE] in [DISPLAY SET] (page 75)	ON																										

Recording/Dubbing

Symptom	Cause/Remedy
Whenever you connect the unit to an AC outlet, the unit automatically starts recording.	<ul style="list-style-type: none"> The TIMER switch is set to REC. <ul style="list-style-type: none"> → When the TIMER switch is set to REC, the unit starts recording whenever the power is connected. Set the TIMER switch to OFF (page 7).
Even though the KEY INH switch is set to ON, the unit starts recording/playback by itself.	<ul style="list-style-type: none"> The TIMER switch is set to REPEAT or REC. <ul style="list-style-type: none"> → The TIMER switch setting has a higher priority than the KEY INH switch setting. Set the TIMER switch to OFF (page 7). When [COMMANDER] in the [OTHERS] menu is set to [WIRELESS], the unit responds to signals from the Remote Commander even though the KEY INH switch is set to ON. <ul style="list-style-type: none"> → Set [COMMANDER] to [CONTROL S] (page 80).
No picture is output via the  , HDV/DV jack.	<ul style="list-style-type: none"> → Reconnect the i.LINK cable (not supplied). INPUT SELECT switch is set to a position other than HDV/DV. <ul style="list-style-type: none"> → Set the switch to HDV/DV (page 8). → Set [HDV/DV SEL] in the [IN/OUT REC] menu correctly (page 70).



Symptom	Cause/Remedy
<p>When you set the AUDIO INPUT LEVEL switch:</p> <ul style="list-style-type: none"> • You do not know how to adjust the input level. • The recorded level is too low. • The recorded sound is distorted. 	<p>Confirm the level of the sound output from the player by referring to the player's instruction manual. According to that output level, set the AUDIO INPUT LEVEL switch on the rear panel of the unit so as to obtain an optimum level (page 16). If you are not clear about the player's output level, try the following procedures.</p> <ol style="list-style-type: none"> ① Set the AUDIO INPUT LEVEL switch by types of audio output connectors available on the player. <ul style="list-style-type: none"> • If the player is equipped with phone jacks: -10. • If the player is equipped with XLR connectors: +4 or -2. ② Set the AUDIO INPUT switch on the front panel to AUTO and play back the tape which you intend to use for playback. When the playback audio level is at its maximum, if the audio level meters exceed 0 dB, set the AUDIO INPUT LEVEL switch to the lower step (+4). Or, set AUDIO INPUT switch to MANU and turn the AUDIO REC LEVEL control knobs to adjust the recording level. The recorded sound at the portion where the meters exceed 0 dB will be distorted.
<p>Audio dubbing cannot be done. Audio dubbing is interrupted.</p>	<ul style="list-style-type: none"> • You are trying to dub the sound onto an HDV or DV-formatted tape. <ul style="list-style-type: none"> → Sounds can be dubbed only onto a DVCAM-formatted tape (recorded) in the 32 kHz audio mode (4-channel) (page 63). If the unit detects the following, audio dubbing will automatically abort, an alarm message will be superimposed on the LCD monitor and on an external monitor (page 91). <ul style="list-style-type: none"> - A blank portion - A section recorded in other than 32 kHz audio mode (4-channel) - A portion recorded in other than DVCAM format • You have tried to dub the sound onto channels 1 and 2. <ul style="list-style-type: none"> → Only channels 3 and 4 can be used for dubbing. You cannot dub the sound onto channels 1 and 2.
<p>No sound or undesired sound is output from the HDMI OUT jack, AUDIO OUT jacks, or (phones) jack.</p>	<ul style="list-style-type: none"> • Set the AUDIO OUTPUT SELECT switch depending on the audio channel you want to output the sound to (page 7). For the output from the HDMI OUT jack, (phones) jack or speaker, also check the setting of [AUDIO MONI] in the [AUDIO SET] menu (page 76).
<p>Cannot hear CH3 and CH4 audio.</p>	<p>→ Set the AUDIO OUTPUT SELECT switch to MIX or CH-3/4.</p>
<p>If an i.LINK cable is connected when you edit the dubbing, the monitor does not display any image.</p>	<p>→ Use the correct setting for [HDV/DV SEL] in the [IN/OUT REC] menu in accordance with the equipment to be connected (page 70).</p>
<p>The unit does not function as part of a digital non-linear editing system. The functions on the unit do not operate.</p>	<ul style="list-style-type: none"> • The INPUT SELECT switch is set to a setting other than HDV/DV. <ul style="list-style-type: none"> → Set it to HDV/DV (page 8). • The editing controller or the editing software is not compatible with the unit. <ul style="list-style-type: none"> → Refer to the instruction manuals of the controller or the software and consult their manufacturers.

Warning Indicators and Messages

Self-diagnosis display/Warning Indicators











The following alarm indicators may appear on the LCD monitor or an external monitor. For further information about each symptom and recovery method, see the relevant page indicated in the parentheses.

Message/Alarm Indicator	Cause/Corrective Action
C:□□:□□/E:□□:□□ (Self-diagnosis display)	<p>If an error still recurs after you retry the corrective action several times, contact Sony Customer Service or your place of purchase.</p> <p>C:21:□□ → Condensation has occurred. Remove the cassette and insert it again after approximately 1 hour (<i>page 94</i>).</p> <p>C:22:□□ → The video head is dirty. Use a cleaning cassette to clean the head (<i>page 92</i>).</p> <p>C:31:□□/C:32:□□ → Symptoms other than the above are occurring. Insert the cassette again and retry the operation. Do not take this action, however, if there is any condensation at all in the unit (<i>page 94</i>). → Unplug the power cord, plug it in again, and then retry the operation. → Replace the tape.</p>
☐ (Moisture condensation warning)*	→ Remove the cassette, unplug the power cord, and leave the unit for approximately 1 hour (<i>page 94</i>).
📺 (Warning indicator pertaining to the tape)	<p>The icon blinks slowly.</p> <ul style="list-style-type: none"> • The remaining tape time is less than 5 minutes.
▲ (Eject cassette warning)*	<p>The icon blinks rapidly.</p> <ul style="list-style-type: none"> • Condensation has occurred (<i>page 94</i>). • The self-diagnostics message is displayed (<i>page 90</i>).

* An alarm beep will be emitted when an alarm indicator or message is displayed (*page 81*).

Alarm Messages

The following alarm messages will appear together with the alarm indicators. Take corrective action according to the displayed message.

Item	Message	Cause/Corrective Action
Moisture condensation	  Moisture condensation. Eject the cassette.	→ See page 94 for details.
	 Moisture condensation. Turn off for 1H.	→ See page 94 for details.
Cassette/Tape	 Insert a cassette.	→ See page 29.
	 Reinsert the cassette.	Check for damage to the tape or other irregularities.
	  The tape is locked –check the tab.	→ See page 28.
	 The tape has reached the end.	—
Audio dubbing	Cannot add audio. INPUT SELECT is set to HDV/DV.	—
	Not recorded in DVCAM mode. Cannot add audio.	—
	Cannot add audio.	You cannot add audio unless the recorded audio format is 32 kHz (4-channel, 12 bit). Make sure that [60i/50i SEL] in the [OTHERS] menu is set correctly.
	Cannot add audio on the blank portion of a tape.	—
	HDV recorded tape. Cannot add audio.	—
	Cannot add audio. “HDV/DV SEL” is set to HDV.	—
Others	Cannot record due to copyright protection.	—
	Change to correct tape format.	This is an unsupported format and cannot be played back.
	No output image in “HDV/DV SEL”. Change format.	Stop playback or signal input, or change the [HDV/DV SEL] setting (page 70).
	  Dirty video head. Use a cleaning cassette.	→ See page 92.
	Unplug power cable.	—
	Reinsert the cassette.	—
	Invalid input signal.	The signal that has been input to the unit is invalid. Check the input signal.
	Power voltage error.	—

Notes on the Videocassette Recorder

Do not use the unit in a place subject to direct sunlight or heat sources

If you do, its cabinet, mechanical parts, etc., may be damaged.

Do not place the unit in humid places

Do not place the unit in places where they may be exposed to water-splash or to humidity. Do not place water-filled containers or vases on the unit. Doing so may cause the unit to malfunction.

Do not use the unit in an extremely hot place

If the unit is left in a car parked with the windows closed (especially in summer), its cabinet, mechanical parts, etc., may be damaged or it may not work correctly.

If the unit is brought directly from a cold to a warm location

Moisture may condense inside the unit and cause damage to the video heads and tape. If you use the unit in a place subject to direct cold currents from an air conditioner, moisture may also condense inside the unit.

Do not place a heavy object on the unit

The cabinet, mechanical parts, etc., may be damaged, or the unit may not work correctly.

Do not handle the unit roughly

Avoid rough handling or mechanical shock to the unit.

To avoid damaging the cabinet's finish

Plastic is often used for the surface finishing of the unit. Do not spray a volatile solvent such as an insecticide toward the cabinet or place rubber or vinyl products on the cabinet for a long time. If you do, the finish of the cabinet may be damaged or the coating may come off.

Do not clean the cabinet with thinner or benzine

The cabinet may be damaged or its coating may come off. When you use a chemical-impregnated cloth, use it according to its directions.

Clean the cabinet with a soft dry cloth

When the cabinet is very dirty, clean it with a soft dry cloth lightly moistened with a mild detergent solution and finish it with a dry cloth.

Do not put magnetic objects close to the unit

Magnetic fields may damage the recording.

To prevent electromagnetic interference caused by radio communication equipment such as cellular phones, transceivers, etc.

The use of radio communication equipment such as cellular phones or transceivers near the unit may cause a malfunction and can affect the audio/video signals. Cellular phones or transceivers near the unit should be switched off.

Do not use the unit in an area exposed to radiation

A malfunction may occur.

Checking the video heads every 1000 hours

A VCR is a high-precision piece of equipment that records and plays back the picture recorded on a magnetic tape. In particular, the video heads and other mechanical parts may become dirty or worn. To maintain a clean picture, we recommend maintenance every 1000 hours, even though the conditions of use may differ, depending on temperature, humidity, dust, etc.

Connecting other equipment

When you connect the unit to other equipment or a computer using an i.LINK cable, confirm the direction of the jack. If you forcibly insert the jack, the terminal may be damaged or cause the unit to malfunction.

Cleaning of the Video Heads

With clogged video heads, the unit cannot record properly. Clean the video heads to prevent noise on the recorded picture or audio. For cleaning, use the supplied cleaning cassette.

Before recording an important event

The unit cannot record properly with clogged video heads. To ensure normal recording and clear pictures and sound, clean the video heads before recording an important event.

Every 50 hours

If you repeat the tape transport operation, the video heads will become dirty and coated with fine dirt or dust. Clean the heads every 50 hours.

After using a tape prone to clog the heads

If using such a tape causes the symptoms illustrated below, clean the heads.

When the symptoms caused by clogged video heads appear

Even if you clean the heads periodically, clogging of the heads may occur anyway. Clean the heads when:

- mosaic-pattern noise appears on the playback picture.
- the playback picture freezes.
- a part of the playback picture does not move.
- playback pictures do not appear.
- playback audio is interrupted.
- “ Dirty video head. Use a cleaning cassette.” appears during recording.

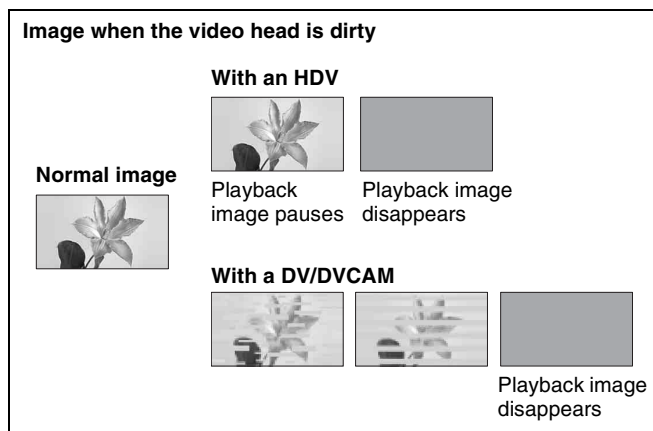

To use the cleaning cassette

Clean the video head by playing the cleaning cassette for ten seconds.

*If the playback image continues to be stationary or any of the symptoms above remain even after cleaning with the cleaning cassette, there may be a problem with the tape. Avoid using that tape.

For details, refer to your cleaning cassette's instruction manual.

Note

Using the unit as listed below will make the video head dirty.

- Subjecting the unit to temperature change or high humidity.
 - Condensation occurs. See page 94.
- Using a damaged tape.
- Using the unit for a long time.
- Using the unit where there is a lot of dirt, dust, or sand.
- Leaving a tape in the unit for a long time.

Cleaning cassettes are replaceable. After using the supplied cleaning cassette for the specified number of times, buy a replacement cleaning cassette.

After prolonged use, the video heads may become worn out. If optimum picture quality is not restored even after you have cleaned the video heads with the cleaning cassette, the video heads may have worn out. In that case, you have to replace the video heads with new ones. Please consult your Sony dealer.

Notes on the Video Cassettes

Note that using a tape such as those below can damage the unit.

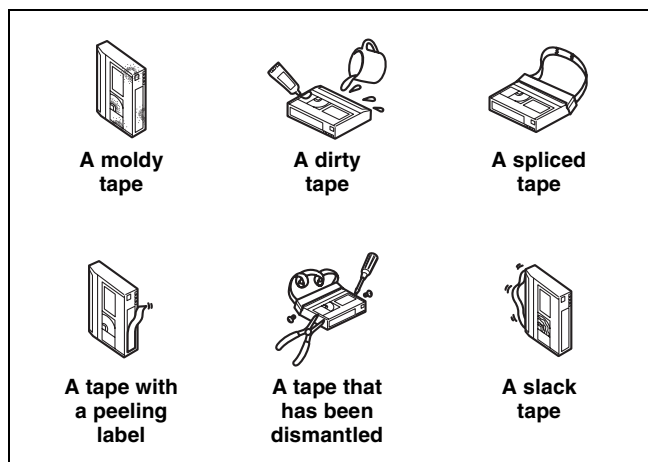

Using cassettes

- When using a cassette for the first time we recommend that you run the tape for about five seconds before recording.
- When using a cassette that has been stored for a long time we recommend that you fast-forward and rewind it for some time. This will correct any winding irregularity in the cassette.
- Do not repeatedly insert and remove a cassette without running it. The tape may become slacked or damaged.

Cleaning the terminal

If the gold-plated terminals of a cassette become dirty, or dirt accumulates on the terminals, the correct remaining tape time may not be displayed.

Clean the terminal with a swab once every ten times you eject that cassette.

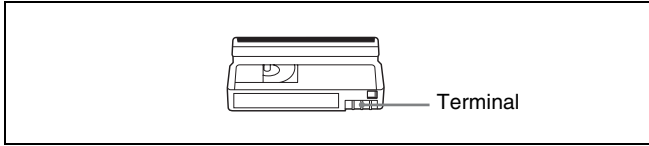

When affixing a label to the cassette

Be sure to affix a label only on the correct location so as not to cause malfunction of the unit.

Storing cassettes

- After using the tapes rewind it, put it in its case and store it vertically. (To prevent picture and sound distortion.)
- Do not store tapes in the following places:
 - Where the temperature gets high (in strong sunshine, inside a car or near a heater)
 - Where there is high humidity
 - In a strong magnetic field (near a TV or speakers)



Notes on the LCD Screen

The LCD screen is manufactured using high-precision technology. The ratio of effective pixels is 99.99% or more. However, there may be some tiny black points and/or bright points (red, blue, green or white) that constantly appear on the LCD screen. These points do not affect the recorded picture in any way. Do not place the unit with the LCD screen pointing toward the sun. Otherwise, the unit may be damaged.

To clean the LCD screen

To remove dirt or to clean fingerprints from the LCD screen, use an LCD cleaning kit (not supplied). When you use an LCD cleaning kit, do not pour the cleaning liquid directly on the LCD. Always pour the liquid onto cleaning paper and wipe the LCD with this paper.



About Moisture Condensation

If the unit or cassette is brought directly from a cold to a warm location, moisture may condense inside or outside the unit or tape. If you use the tape or video heads in this condition, the tape may adhere to the head drum, and the video heads or the tape may be damaged, or a malfunction may occur. When condensation occurs, the alarm messages “  Moisture condensation. Eject the cassette.” or “ Moisture condensation. Turn off for 1H.” appears. Moisture condensation is likely to occur under the following conditions:

- The unit or cassette is brought from the cold outdoors to a warm indoor location.
- The unit or cassette is brought from the air-conditioned indoors to the hot outdoors.
- The unit is used in a place subject to cold currents from an air conditioner.

When bringing the unit or cassette from a cold place to a warm place or vice versa, put it in a plastic bag and seal the bag tightly. After bringing it into the new place, leave the bag on for more than one hour, and remove the bag when the air temperature inside it has reached the temperature surrounding it.

If moisture condensation occurs

Remove the cassette immediately. While the alarm indicator is displayed, you cannot operate the unit except to press the EJECT button. Turn off the power until the condensation disappears (approximately 1 hour). If the alarm message does not appear when you turn on the unit, and if  or  does not blink when you insert a cassette and press the video operation button, you can use the unit again. If there is negligible condensation in the unit, this condensation may not be detected. In that case, the cassette may not be ejected for approximately 10 seconds. This is not a malfunction.

Digital Hours Meter

The digital hours meter keeps cumulative counts of the total operation time, the head drum rotation time, the tape running time and the number of unthreading operations. These counts can be displayed on the menu. Use them as guidelines for scheduling maintenance. In general, consult your Sony dealer about necessary periodic maintenance checks.

The digital hours meter has the following four display modes and you can check them in [HOURS METER] of the [OTHERS] menu (*page 81*).

• OPERATION mode

The cumulative total hours of operating time is displayed in 10-hour increments.

• DRUM RUN mode

The cumulative total hours of drum rotation with tape threaded is displayed in 10-hour increments.

• TAPE RUN mode

The cumulative total hours of tape running time is displayed in 10-hour increments.

• THREADING mode

The cumulative number of tape unthreading operations is displayed in 10-operation increments.

About the Built-in Rechargeable Battery

The unit is provided with a rechargeable battery that retains the date/time and various settings regardless of power-on and power-off status. The rechargeable battery is charged as long as the unit is operated. If the period the unit is operated is short, the battery discharges gradually and if it is not used at all for approximately 1 month, the battery will discharge completely. In that case, charge the battery and then start using the unit. If you do not need to record the date and time when the rechargeable battery is not fully charged, you can use the unit in this state.

Charging the rechargeable battery

Connect the power cord (supplied) to the AC IN connector and then connect the mains connector to an outlet. Keep the POWER switch on the rear side of the unit in the “I” position (ON) for about 24 hours. (The ON/STANDBY switch on the front panel does not need to be turned on.)

Notes on the License

ANY USE OF THIS PRODUCT OTHER THAN CONSUMER PERSONAL USE IN ANY MANNER THAT COMPLIES WITH THE MPEG-2 STANDARD FOR ENCODING VIDEO INFORMATION FOR PACKAGED MEDIA IS EXPRESSLY PROHIBITED WITHOUT A LICENSE UNDER APPLICABLE PATENTS IN THE MPEG-2 PATENT PORTFOLIO, WHICH LICENSE IS AVAILABLE FROM MPEG LA, L.L.C., 250 STEELE STREET, SUITE 300, DENVER, COLORADO 80206.

Appendix

Notes on Dubbing

Dubbing with the S VIDEO or VIDEO jacks

When you use the unit as a recorder to perform dubbing between the unit and other equipment using the S VIDEO jack and the VIDEO jack, the format to be used for recording is set according to the [ REC MODE] setting in the [IN/OUT REC] menu.

For details, see the following table.

Playback and editing of a tape may be restricted for some dubbing methods. Read Chapter 4 “Dubbing to Other Equipment Using the i.LINK Jack, Duplication, Audio Dubbing, and Connecting a Computer” before dubbing a tape. Some editing software can correctly edit even a tape created in [LOCK MODE]. In that case, select [LOCK MODE] if required.

Recording tapes used when the unit serves as a recorder

Input signal format	Menu item		Recording tape format (AUDIO MODE)
	 REC MODE	AUDIO LOCK	
NTSC or PAL	DVCAM	—	DVCAM (LOCK MODE)
	DV SP	LOCK MODE	DV (LOCK MODE)
		UNLOCK MODE	DV (UNLOCK MODE)

—: Setting independent

Dubbing with the **i** HDV/DV jack

When you perform dubbing between the unit and digital video equipment connected with an i.LINK cable using the unit as a player, the **i** HDV/DV jack output format is determined in accordance with the playback tape format and menu setting of the unit.

If you use the unit as a recorder, the format of a tape used for recording is determined in accordance with the **i** HDV/DV jack input format and menu setting of the unit. For details, check the following table on *page 98*.

Playback and editing using this tape may be limited for some dubbing methods. Before dubbing, read Chapter 4 “Dubbing to Other Equipment Using the i.LINK Jack, Duplication, Audio Dubbing, and Connecting a Computer.”

i.LINK output when the unit is used as a player

Playback tape format	Menu item		i.LINK output format (AUDIO MODE)
	HDV/DV SEL	i.LINK SET	
		HDV → DV CONV	
HDV	AUTO	OFF	HDV (LOCK MODE)
		DVCAM	DVCAM (LOCK MODE)
		DV (SP)	DV (UNLOCK MODE)
	HDV	OFF	HDV (LOCK MODE)
		DVCAM	DVCAM (LOCK MODE)
		DV (SP)	DV (UNLOCK MODE)
	DV	—	No output
DVCAM	AUTO	—	DVCAM (Complies with playback tape)
	HDV	—	No output
	DV	—	DVCAM (Complies with playback tape)
DV	AUTO	—	DV (Complies with playback tape)
	HDV	—	No output
	DV	—	DV (Complies with playback tape)

Notes

- When you play back a tape employing a copy-protection signal on the unit, you cannot record images from the unit to other equipment.
- You cannot up convert DVCAM(DV) format to HDV format on the unit.
- During playback in HDV, if [DV SP] is selected from [HDV → DV CONV] in [i.LINK SET], AUDIO MODE is fixed to UNLOCK MODE.
- When you play back a tape in DVCAM or DV format, the unit cannot convert between DVCAM and DV format, or switch between LOCK MODE and UNLOCK MODE.

Notes on Dubbing

Recording tape when the unit is used as a recorder

i.LINK input format	Menu item		Recording tape format (AUDIO MODE) ³⁾
	HDV/DV SEL	[] REC MODE ¹⁾	
HDV	AUTO	—	HDV (LOCK MODE)
	HDV	—	HDV (LOCK MODE)
	DV	—	No recording
DVCAM	AUTO	DVCAM	DVCAM (Complies with input signals)
		DV SP	DV (Complies with input signals)
	HDV	—	No recording
	DV	DVCAM	DVCAM (Complies with input signals)
		DV SP	DV (Complies with input signals)
	DV	AUTO	DVCAM
DV SP			DV (Complies with input signals)
HDV		—	No recording
DV		DVCAM	DVCAM ²⁾ (Complies with input signals)
		DV SP	DV (Complies with input signals)

- 1) When the unit is used as a recorder, the recording format is determined by the [] REC MODE] setting in the [IN/OUT REC] menu if the input signal format is DVCAM or DV.
- 2) If you duplicate a tape when the unit is set to DVCAM to be used as a recorder, the time code format of the duplicated tape will be partially different from the time code format specified as DVCAM (note, however, this does not affect editing accuracy in special cases).
- 3) The unit cannot switch between LOCK MODE and UNLOCK MODE. AUDIO MODE complies with input signals.

Notes

- On the unit, HDV signals input from an i.LINK connection cannot be down converted to DVCAM(DV) for recording.
- If you use the tapes described in 2) above for editing, you may encounter function limitations regardless of the player and recorder formats.
- Some DV video equipment may play back a DVCAM-formatted tape, however the contents cannot be guaranteed. Therefore, even though you use a proper DVCAM-formatted tape for playback, and the unit dubs and creates a DVCAM-formatted tape, the time code may be partially different from the time code format specified as DVCAM on other DV video equipment.
- You cannot use the unit to record video and audio recorded with copyright protection signals. If you try to record such video or audio materials, the message “Cannot record due to copyright protection.” appears on the LCD monitor.

About i.LINK

The  HDV/DV jack provided on the unit is an i.LINK-compliant jack. This section describes the i.LINK standard and its features.

What is i.LINK?

i.LINK is a digital serial interface for sending and receiving digital video, digital audio, and other data between the unit and other equipment equipped with an i.LINK terminal. You can also control other equipment using i.LINK. i.LINK-compatible equipment can be connected using an i.LINK cable. Possible applications are operations and data exchange with various digital AV equipment. When two or more i.LINK-compatible pieces of equipment are connected to the unit, operations and data exchange are possible with equipment directly connected to the unit and also with equipment connected to the unit via other equipment. Note, however, that the method of operation may vary depending on the characteristics and specifications of the equipment to be connected. Also, there are cases where operations and data exchange may not be possible even if the connection is made.

Notes

- Normally, only one device can be connected to the unit using an i.LINK cable. When you connect the unit to HDV/DVCAM (DV)-compliant equipment that allows multiple connections, refer to the operating instructions of the equipment to be connected.
- i.LINK is an easy-to-remember term for the IEEE 1394 standard proposed by Sony, and is a trademark approved by many corporations in Japan and overseas.
- IEEE 1394 is an international standard standardized by the Institute of Electrical and Electronics Engineers.

About the i.LINK baud rate

The maximum baud rate of i.LINK varies depending on the equipment. There are three types.

S100 (Approximately 100 Mbps*)

S200 (Approximately 200 Mbps)

S400 (Approximately 400 Mbps)

The baud rate is listed under “Specifications” in the operating instructions of individual equipment. It may be indicated near the i.LINK interface on some equipment.

The baud rate may vary from the indicated value when the unit is connected to equipment with a different maximum baud rate.

*What is Mbps?

Mbps stands for “megabits per second,” or the volume of data that can be sent or received in 1 second. For example,

a baud rate of 100 Mbps means that 100 megabits of data can be sent in 1 second.

To use the i.LINK functions of the unit

For details on how to perform dubbing when the unit is connected to other video equipment that has an i.LINK jack, *see page 47, 57*. The unit can also be connected to other i.LINK-compatible equipment made by Sony (i.e., a VAIO series computer) as well as video equipment. The unit may not be able operate with some i.LINK video equipment such as digital televisions, DVD recorders/players, and MICROMV recorders/players even if they are equipped with an i.LINK jack. Before connecting to another equipment, confirm whether this equipment is HDV/DVCAM (DV) compatible. For details on precautions on connections and whether or not software applications compatible with the unit are available, refer to the operating instructions of the equipment to be connected.

Notes

- When you connect a computer and the unit using an i.LINK cable, check the direction of the jack. If you forcibly insert the jack, the terminal may be damaged or cause the unit to malfunction.
- Be sure to connect the i.LINK cable to the computer first and then connect it to the unit. If you connect the i.LINK cable to the unit first, it may cause the unit to malfunction because of static electricity.
- When you connect the unit to equipment equipped with an i.LINK jack using the i.LINK cable, power off the equipment and remove the power cord from the AC outlet before connecting (or disconnecting) the i.LINK cable. If the i.LINK cable is connected (or disconnected) while the equipment power cord is connected to the AC outlet, a high-voltage current (8 to 40 V) output from the i.LINK jack of the equipment flows into the unit and may damage it.
- However the  HDV/DV jack of the unit is a 6-pin type, so no power is supplied.

Recommended i.LINK cables

Use a Sony i.LINK cable.

i.LINK and  are trademarks of Sony Corporation.

Specifications

System

Video/Audio recording/playing head system
Rotating dual-head helical scan

Audio recording format (HDV)
MPEG-1 Audio Layer2
(2-channel)
16-bit 48 kHz (stereo)
Transfer rate 384 kbps

Audio recording format (DVCAM (DV))
12-bit Fs32K (Channel 1/2,
Channel 3/4)
16-bit Fs48K (Channel 1/2)

Video signal
1080/60i, NTSC color,
EIA standard system
1080/50i, PAL color,
CCIR standard system

Usable cassettes
Standard DVCAM cassettes with
the **DVCAM**™ mark
Mini DVCAM cassettes with
the **DVCAM**™ mark

Tape speed (HDV)

Approx. 18.8 mm/s

Tape speed (DVCAM)

Approx. 28.2 mm/s

Tape speed (DV) SP: Approx. 18.8 mm/s

Recording/playback time (HDV)

Approx. 276 min
(using PHDV-276DM)

Approx. 63 min
(using PHDVM-63DM)

Recording/playback time (DVCAM)

Approx. 184 min
(using PHDV-276DM)

Approx. 41 min
(using PHDVM-63DM)

Recording/playback time (DV SP)

Approx. 276 min
(using PHDV-276DM)

Approx. 63 min
(using PHDVM-63DM)

AUDIO jacks

IN

Pin jack: -10/-2/+4 dBu
Impedance: Minimum 47 k Ω
(kilo ohms), unbalanced
Maximum input level:
-10: +18 dBu (approx. 6 Vrms)
-2: +24 dBu (approx. 12.5 Vrms)
+4: +30 dBu (approx. 25 Vrms)

OUT

Pin jack

Impedance: Maximum 1 k Ω
(kilo ohms)

Output level: 47 k Ω (kilo ohms)
loading, unbalanced
-10 dBu (= full bit -20 dB)
60i system
-10 dBu (= full bit -18 dB)
50i system

Headphone output

🔊 (phones)

Stereo minijack \times 1 (\varnothing 3.5),
16 Ω (ohms) loading

VIDEO jacks

IN/OUT

BNC type, unbalanced
1.0 Vp-p
(75 Ω (ohms), sync negative)
Sync signal:
0.286 Vp-p (60i/NTSC)
0.3 Vp-p (50i/PAL)
Burst signal:
0.286 Vp-p (60i/NTSC)
0.3 Vp-p (50i/PAL)

S VIDEO jacks

IN/OUT

Mini DIN 4-pin, unbalanced
Luminance signal:
1.0 Vp-p (75 Ω (ohms), sync
negative)
Sync signal:
0.286 Vp-p (60i/NTSC)
0.3 Vp-p (50i/PAL)
Chrominance signal:
0.286 Vp-p (60i/NTSC)
(burst, 75 Ω (ohms))
0.3 Vp-p (50i/PAL)
(burst, 75 Ω (ohms))

HDMI OUT jack

Video:

HDMI connector
480i, 576i, 480p, 576p, 1080i,
720p

Audio:

2 channel liner
PCM 48 kHz/16 bits

COMPONENT OUT jacks

OUT	BNC type
Output at 480i NTSC	
With [BETACAM] selected in [480i LEVEL] of the [IN/OUT REC] menu	
Y: 1.0 Vp-p (with 0.286 Vp-p sync negative, output impedance 75 Ω (ohms), unbalanced)	
Pb/Cb/B-Y, Pr/Cr/R-Y: 0.7 Vp-p (output impedance 75 Ω (ohms), unbalanced) (75% color bars with 7.5 IRE setup)	
With [SMPTE] selected in [480i LEVEL] of the [IN/OUT REC] menu	
Y: 1.0 Vp-p (with 0.3 Vp-p sync negative, output impedance 75 Ω (ohms), unbalanced)	
Pb/Cb/B-Y, Pr/Cr/R-Y: 0.7 Vp-p (output impedance 75 Ω (ohms), unbalanced) (100% color bars with no setup)	
Output with other settings	
Y: 1.0 Vp-p (output impedance 75 Ω (ohms), unbalanced)	
Pb/Cb/B-Y, Pr/Cr/R-Y: 0.7 Vp-p (output impedance 75 Ω (ohms), unbalanced) (100% color bars with no setup)	
480i/480p: Y: with 0.3 Vp-p sync negative	
1080i/720p: Y/Pb/Pr: with 0.6 Vp-p 3-level sync	

i HDV/DV jack

i.LINK (IEEE 1394,
6-pin connector S100)

Remote control

LANC	Stereo mini-mini jack (ø 2.5)
CONTROL S IN	Stereo mini jack (ø 3.5)

LCD screen

Picture	6.7 cm (2.7 type, aspect ratio 16:9)
Total dot number	211 200 dots 960 (Horizontal) × 220 (Vertical)

General

Peak inrush current	Hot switching inrush current, measured in accordance with European standard EN55103-1: 24.0 A (230 V)
Power requirements	HVR-M25AU AC120 V, 60 Hz HVR-M25AN AC100 V-240 V, 50 Hz/60 Hz HVR-M25AE AC220 V-240 V, 50 Hz HVR-M25AP AC100 V-240 V, 50 Hz/60 Hz
Power consumption (during playback)	13 W
Operating temperature	5 °C to 40 °C (41 °F to 104 °F)
Storage temperature	-20 °C to +60 °C (-4 °F to +140 °F)

(Continued)

Specifications

Dimensions Approx. 212 × 98 × 390.3 mm
(8³/₈ × 3⁷/₈ × 15³/₈ inches)
(w/h/d, including projecting parts
and controls)

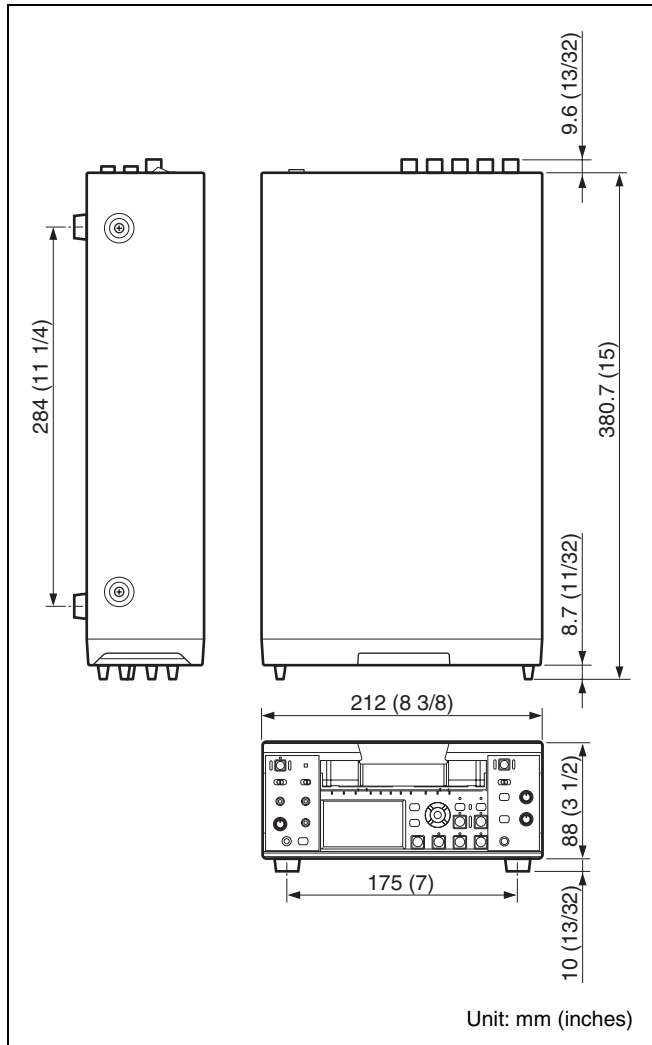

Mass Approx. 4.4 kg (9 lb. 12 oz.)

Supplied accessories

- Remote Commander (1)
- Power cord (1)
- Cleaning cassette (1)
- CD-ROM “Manuals for Digital HD
Videocassette Recorder” (1)
- Operating Instructions (2)

Design and specifications are subject to change without notice.

Index

P

PAUSE button	12
Phones jack	7
Phones LEVEL control knob	7
PLAY button	12
Playback	36
at various speed	40
frame by frame	40
Troubleshooting	85
Playing at various speed	
Button	21
Power	29
Troubleshooting	84
POWER switch	20

R

Rear panel	16
REC button	12
Rechargeable battery	95
Recording	46
Troubleshooting	88
Recording format	31
during recording	33
Remaining tape time	24
Remote Commander	21
REPEAT CYCLE	42
REPEAT TIMES	42
RESET button	20
Counter reset	10
REW button	12
REW&PLAY button	21

S

S VIDEO jack	16
Scheduled maintenance	95
Search	41
SEARCH SELECT button	21
Self-diagnosis	90
SHUTTLE MAX button	22
Speaker	8
Speaker LEVEL control knob	7
Specifications	100
START TIME	42
STATUS CHECK button	9
STATUS CHECK screen	25
STOP button	12

T

TC/UB SET menu	78
Time code	52
Selection	54
Timer	51
TIMER switch	7

Troubleshooting	83
-----------------------	----

U

Unlock mode	31
Usable cassette	28
User bits	52

V

VIDEO jack	16
VTR SET menu	77

W

Warning	90
---------------	----

X

x.v.Color	30
-----------------	----

Submenu Index

Numerics

480i LEVEL	74
60i/50i SEL	82

A

AC ON MODE.....	81
ALLSCAN MODE.....	75
ASSIGN BTN	80
AUDIO LOCK	76
AUDIO MODE	76
AUDIO MONI	76
AUTO INDEX	77
AUTO STANDBY	81

B

BARS TYPE	73
-----------------	----

C

CLOCK SET	81
COLOR BAR	73
COMMANDER	80
COUNTER SET	74
CROP ADJUST.....	72
CROP MARKER	72
CUSTOM REPEAT	77

D

DATA CODE.....	75
DATE DISPLAY	75
DUPLICATE PLUS	77
DV BARS.....	73

E

EE/PB SEL	74
-----------------	----

F

FF/REW SPEED	77
FROM REC P.....	78
FROM STILL.....	78

H

HDV/DV IN TC	79
HDV/DV SEL	70
HOURS METER.....	81

I

i.LINK SET	72
INITIALIZE	82

J

JOG AUDIO	76
-----------------	----

L

LANGUAGE	80
LCD BLACK	75
LCD BRIGHT.....	75
LCD COLOR	75
LETTER SIZE	75

M

MARKER BURN	75
-------------------	----

P

PB CNR	81
PB YNR	81

R

REC MODE	70
REMAINING.....	75

S

SPEAKER/BEEP	81
STILL PICT	77
STILL TIME.....	78

T

TC FORMAT	79
TC MAKE.....	79
TC PRESET	78
TC RUN	79
TIME DISPLAY	75

U

UB PRESET.....	78
----------------	----

V

VIDEO OUT	71
-----------------	----



<http://www.sony.net/>

Printed in Japan

GB



3878928130