

PHILIPS

www.philips.com

Home Ventilation Workshop

innovation  you

Objectives

- Describe the circuit options, breath types, modes, alarms, features and troubleshooting.
- Review the unique mouthpiece ventilation mode.
- Review the unique AVAPS-AE mode.
- Review the unique dynamic parameters.



Trilogy Evo

Invasive and non-invasive positive pressure ventilation for the care of **patients ≥ 2.5 kg through adults.**

Measure, display, record, and alarm SpO₂, FiO₂, CO₂, respiratory rate, and pulse rate data when integrated with the appropriate accessories.

Suitable for use in institutional, home, and non-emergency transport settings; for example: wheelchair, personal vehicle, or ambulance.

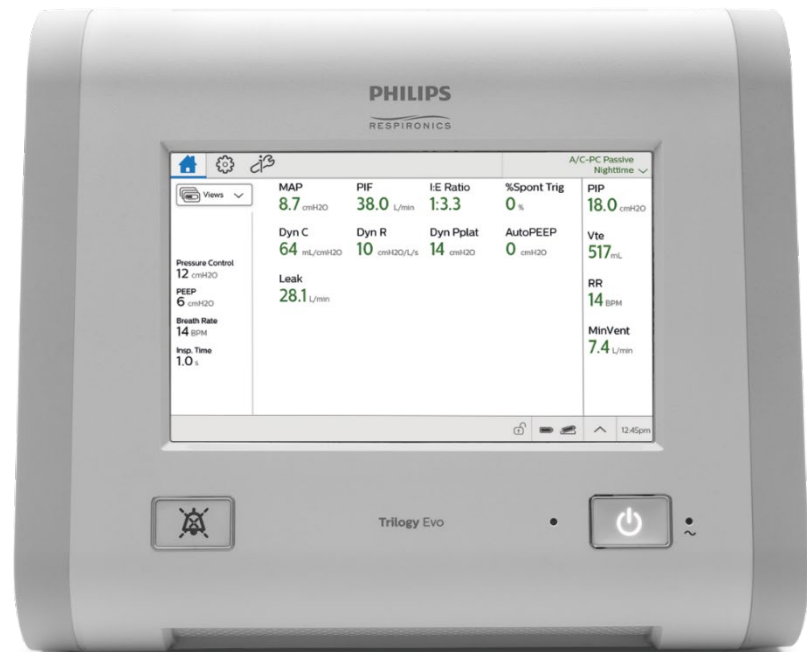

Features

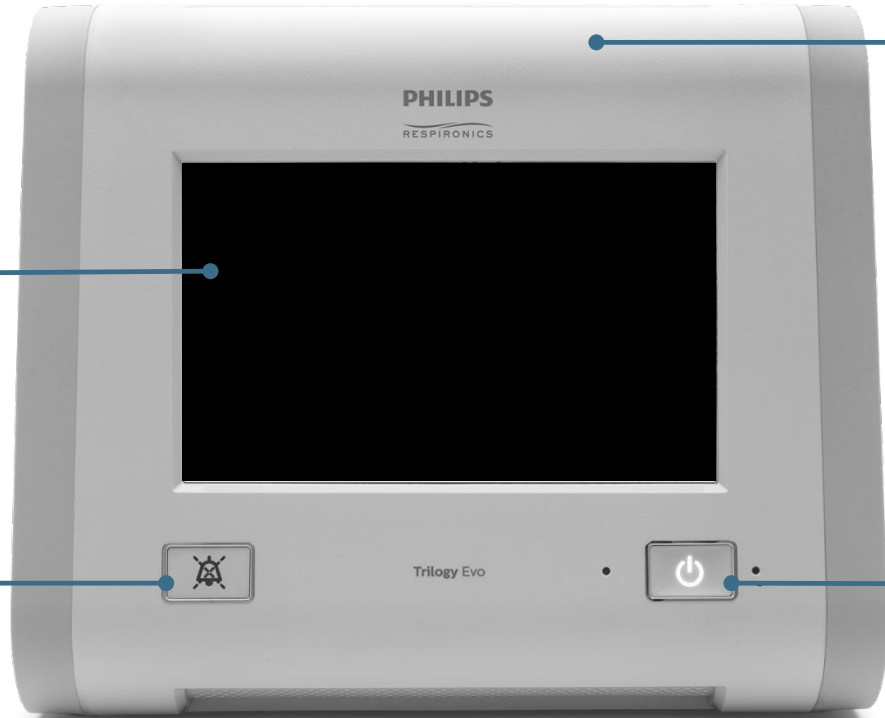

Light bar

Large 8" touch screen

Alarm indicator/alarm silence button

On/off (standby) button

Weight and power

Less than 13 lbs (5.8kg).

15 hours of battery.*

Hot swappable detachable battery provides uninterrupted therapy.**



*Nominal run time per method in International Electrotechnical Commission (7.5 hr/battery). Detachable battery charge time 0% to 80% is 2.5 hours, Internal battery charge time 0% to 100% is 3.5 hours. A/C-VC mode ActivePAP circuit, PEEP 3cmH₂O and Vt 800ml.

** When the internal battery is charged, batteries can be replaced without the ventilator pausing therapy.

Adaptable

FiO₂ sensor access
on back panel



Up to 30Lpm low flow O₂



Oxygen Blending Module
(optional)



AC power connector



DC power connector



Adaptable



Accessory USB port

Proximal pressure port

Active exhalation valve line connection
for ActivePAP and Active Flow circuits

Flow sensor cable connector

Adaptable

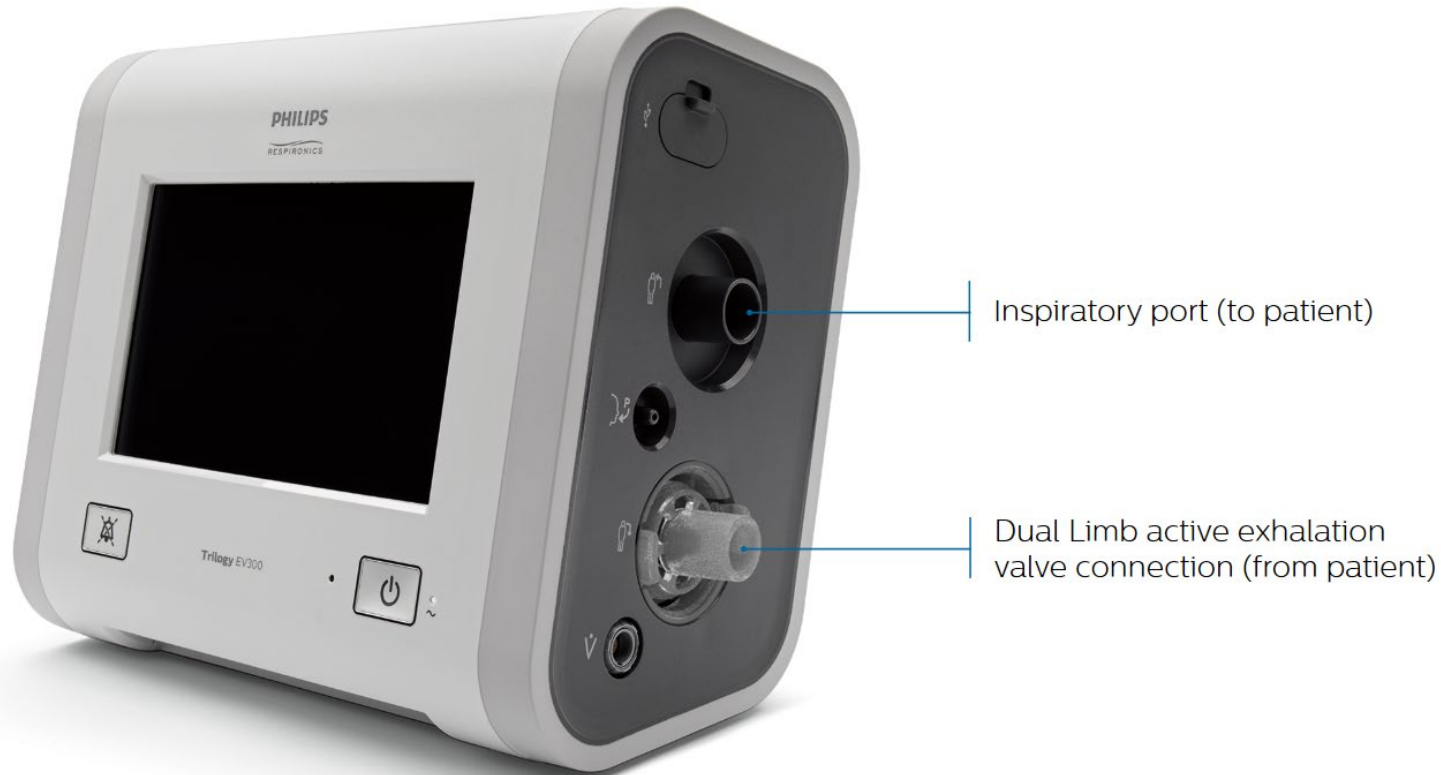

Adaptable

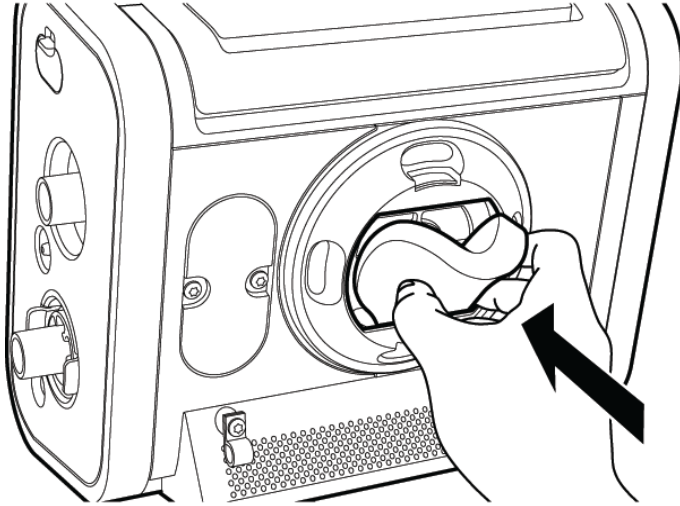

Install filter

To install the air-inlet foam filter, pinch the filter as you press it into the filter cover as shown. Position it securely behind the top and bottom restraints.

Available circuit options

Passive circuit

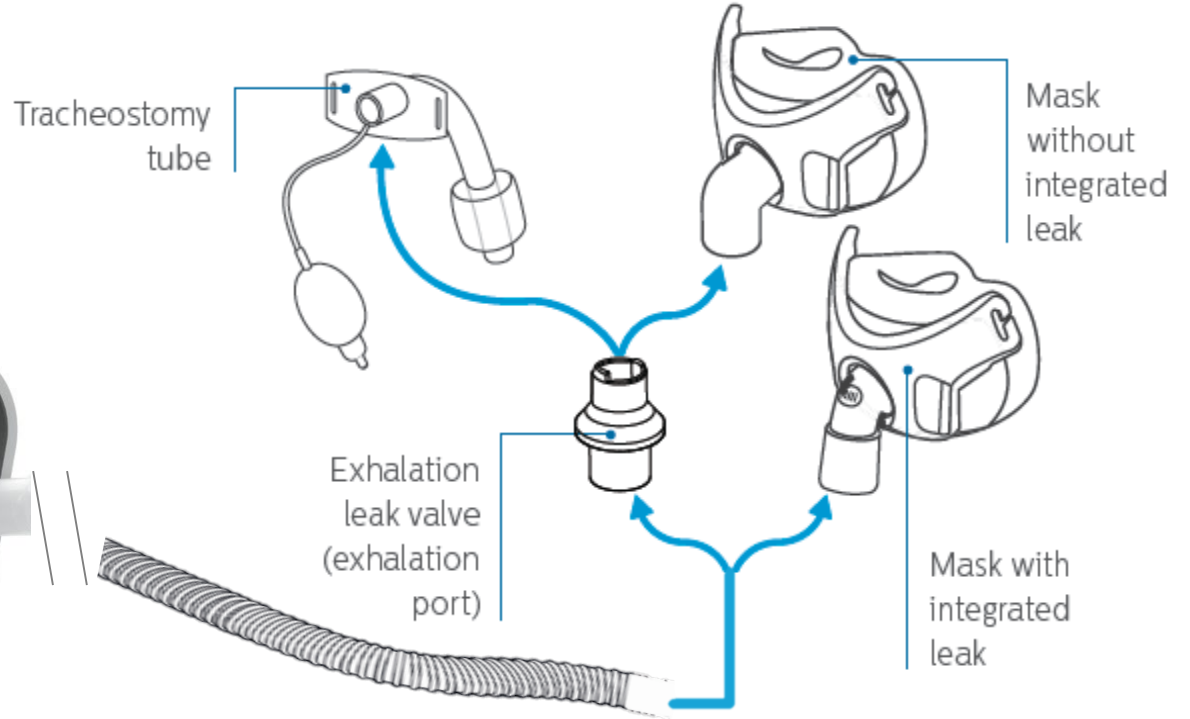

Available circuit options

Active PAP circuit

- A.** Connect the bacteria filter on the circuit to the inspiratory port.
- B.** Connect the proximal pressure line (wider diameter than active exhalation valve line) to the proximal pressure port.

- C.** Connect the active exhalation valve pressure line to the active exhalation valve line connection.

Active exhalation valve

Proximal pressure port



Available circuit options

Active Flow circuit

- A.** Connect the bacteria filter on the circuit to the inspiratory port.
- B.** Connect the proximal pressure line (wider diameter than active exhalation valve line) to the proximal pressure port.
- C.** Connect the active exhalation valve pressure line to the active exhalation valve line connection.
- D.** Attach the flow sensor cable to the flow sensor cable connector.
- E.** Attach the flow sensor to the active exhalation valve on the circuit.

Active exhalation valve

Proximal pressure port

Flow sensor



Available circuit options

Dual Limb circuit

- A.** Connect the bacteria filter end of the colored inspiration tube to the inspiratory port.
- B.** Connect the proximal pressure line to the proximal pressure port.
- C.** Install the active exhalation valve into the recessed AEV port. Press until both sides click into place.
- D.** Attach the bacteria filter end of the clear expiration tube to the AEV.
- E.** Attach the flow sensor cable to the flow sensor cable connector.
- F.** Attach the flow sensor to the Y-shaped connector on the circuit.



Available circuit options

MPV circuit

- A.** Fully extend and straighten the circuit support arm.
- B.** Feed the circuit tube (15mm) through the center of the circuit support arm until it exits the other end.
- C.** Attach the clamp to a wheelchair if required.
- D.** Attached the reducer cuff and then the bacteria filter onto the device-end of the circuit tube.
- E.** Connect the bacteria filter on the circuit to the inspiratory port on the Trilogy Evo.
- F.** Attach the coupler and miniature flextube (optional) onto the circuit support arm before connecting patient interface.

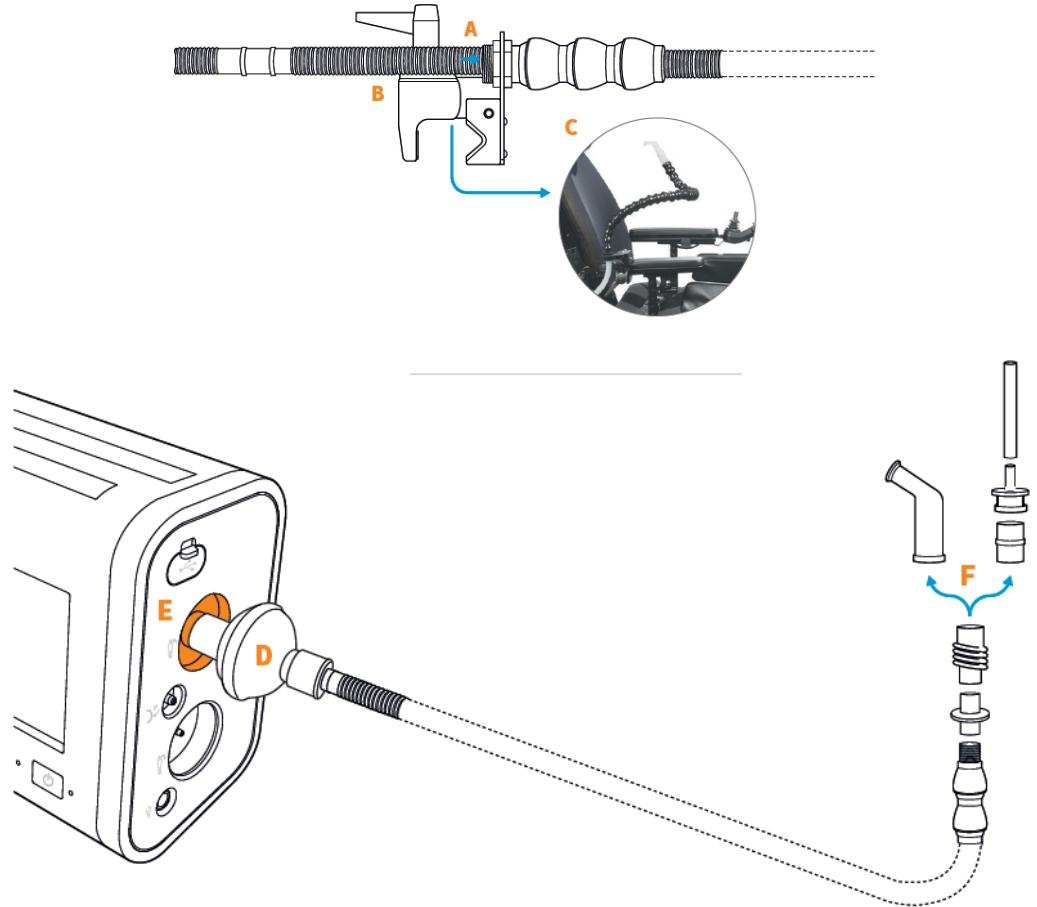

Available circuit options



Passive



Active PAP



Active Flow



Dual Limb



MPV

Circuits overview

Circuit	Infant (9-13mm)	Pediatric (14-18mm)	Adult/ Pediatric (19mm)	Adult (20-22mm)	Min Set Tidal Volume	External Flow Sensor Required
Passive		✓	✓	✓	50 ml	
ActivePAP		✓	✓	✓	50 ml	
Active Flow		✓	✓	✓	35 ml	✓
Dual Limb	✓	✓	✓	✓	35 ml	✓
MPV					200 ml	

Adaptable Circuit selection

Trilogy Evo includes a default calibration providing automatic tubing compensation for the recommended circuits in the accessory guide.



Volume modes with the Passive Circuit

Provide equivalent therapy

- EPAP with Passive and PEEP with Active remove CO₂
- Passive circuit with leak compensation delivers the prescribed tidal volume
- Noninvasive or invasive ventilation

Benefits

- Simpler circuit
- Ease of set up
- Leak compensation



Comparison

Traditional volume mode ventilation with valve circuit

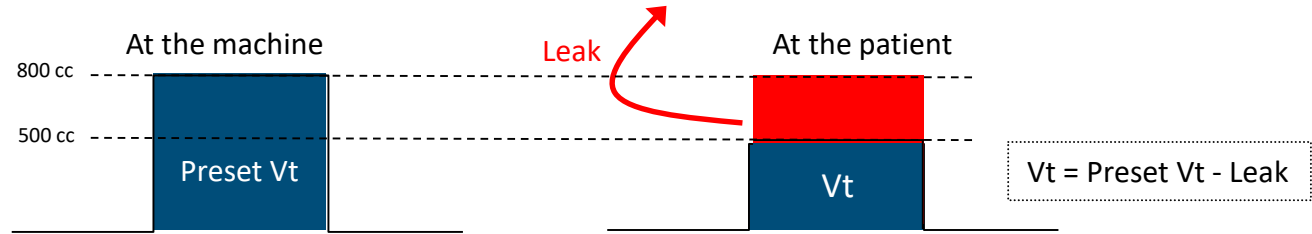

Trilogy Evo with Passive Circuit

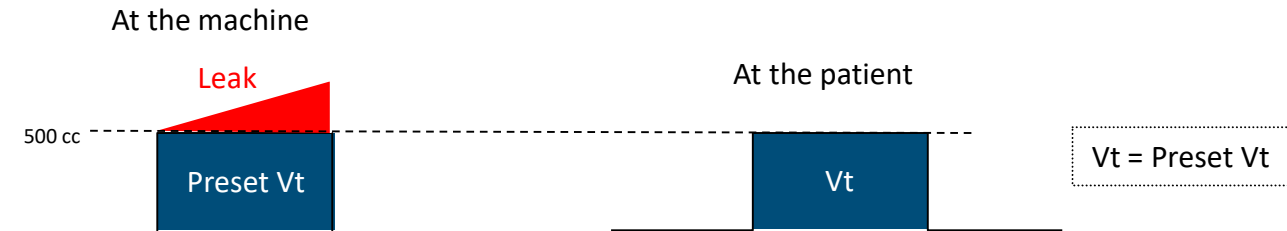

Volume mode in passive circuit

Leaks are compensated by:

- A Estimating the leak at the end of each breath
- B Compensating for that leak at the next breath

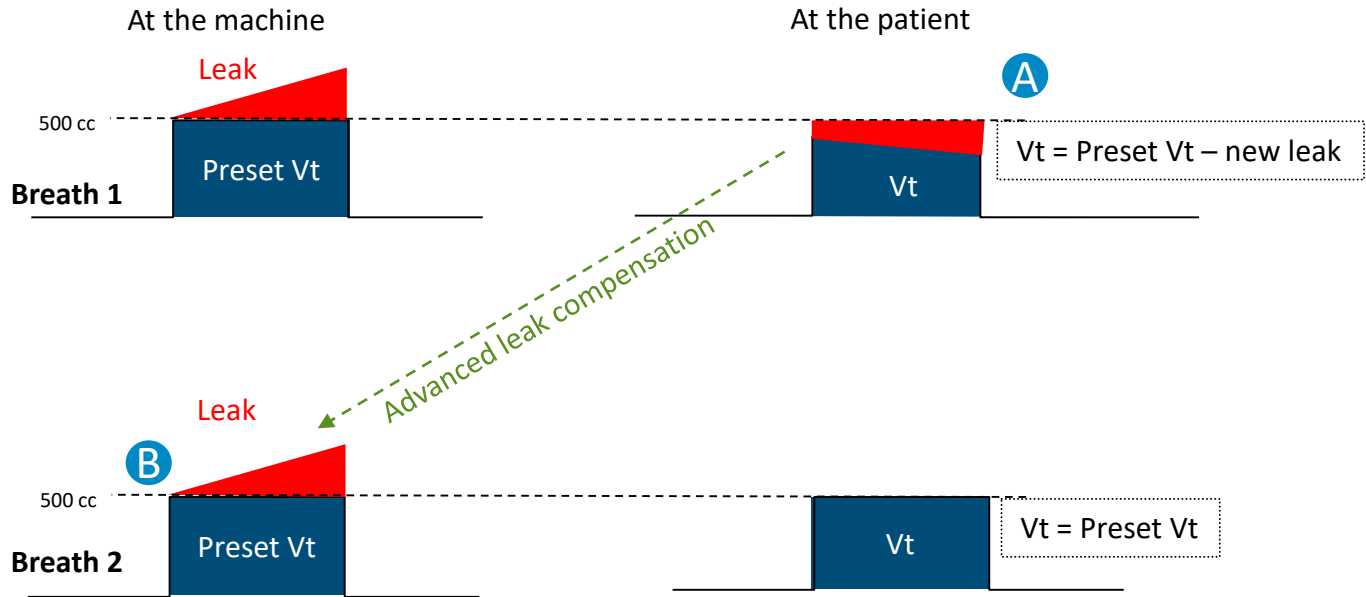

Ventilation types and modes



Modes

Trilogy to Trilogy Evo

Trilogy	Trilogy Evo	Description
AC	A/C - VC	Assist Control (Volume Control) mode provides volume-controlled mandatory or assist-control breaths. The set inspiratory time applies to all breaths.
CV		If you want to replicate CV mode where the ventilator triggers and cycles all breaths then set the trigger type to OFF.
PC	A/C - PC	Assist Control (Pressure Control) mode provides pressure-controlled mandatory or assist-control breaths. The set inspiratory time applies to all breaths. <i>Optional AVAPS.</i>
T		If you want to replicate T mode where the ventilator triggers and cycles all breaths then set the trigger type to OFF.
S	PSV	Pressure Support Ventilation mode is patient-triggered, pressure-limited, and flow-cycled. The patient determines the breath rate and timing so it is recommended to set back-up ventilation. <i>Optional: AVAPS and Ti min/max.</i>

Modes

Trilogy to Trilogy Evo

Trilogy	Trilogy Evo	Description
PC-SIMV	SIMV-PC	Synchronized Intermittent Mandatory Ventilation (Pressure Control) mode is a pressure control mode that provides a mixture of mandatory, assist-control and spontaneous breaths with optional pressure support. It guarantees one mandatory breath in each cycle. The breath rate determines the length of the cycle. <i>Optional: Inspiratory Time min/max. for the spontaneous breaths.</i>
SIMV	SIMV-VC	Synchronized Intermittent Mandatory Ventilation (Volume Control) mode is similar to SIMV-PC, but with volume control.
AC (MPV on)	MPV-VC	Mouthpiece Ventilation (Volume Control) provides on-demand volume-control ventilation using a Kiss trigger [®] that detects when the patient engages with the mouthpiece. No exhalation valve is required.
PC (MPV on)	MPV-PC	Mouthpiece Ventilation (Pressure Control) is similar to MPV-VC, but with pressure control.

Modes

Trilogy to Trilogy Evo

Trilogy	Trilogy Evo	Description
S/T	S/T	Spontaneous/Timed is a bi-level therapy mode where each breath is patient-triggered and patient-cycled, or ventilator-triggered and ventilator-cycled.
CPAP	CPAP	In Continuous Positive Airway Pressure mode , all breaths are spontaneous with the CPAP set pressure delivered in both inhalation and exhalation.
AVAPS-AE	AVAPS-AE	AVAPS-Auto EPAP mode automatically adjusts pressure support, to maintain the target tidal volume, and EPAP, to maintain a patent airway, within the set min/max ranges; and simplifies the set-up of the backup breath rate when set to auto. <i>Note: auto back-up rate maximum is 20bpm. Optional: Inspiratory Time min/max.</i>

Modes

Trilogy to Trilogy Evo

Trilogy	Trilogy Evo	Description
-	Inspiratory Time Min/Max	<p>Once enabled, this setting treats inspiration time as a variable value for patient-initiated, patient-cycled breaths.</p> <p>It is available in S/T, PSV, SIMV-PC, SIMV-VC, and AVAPS-AE modes, under Advanced in the Prescription Settings window.</p>
AVAPS Rate	AVAPS Speed	<p>This sets the maximum rate of change in pressure between the min and max values while AVAPS is seeking a volume target.</p>
-	PC Breath (AVAPS-AE)	<p>Available in AVAPS-AE mode. When PC Breath is on, the set inspiratory time applies to all breaths.</p>
Sigh	Sigh	<p>In Trilogy Evo, available in A/C-VC mode under Advanced in the Prescription window. Sigh volume can be set between 1.5 – 2.5 times the set volume and the frequency between 50 – 250 breaths. While in Trilogy, sigh was fixed at 1.5 times the set volume every 100 breaths.</p>
-	Back-up Ventilation	<p>Available under Advanced in the Prescription window. When turned on an Apnea interval needs to be set in the alarm settings tab. Within the apnea interval; if no breaths are triggered by the patient, the vent delivers breaths at the set pressure of volume based on the Backup Rate and Backup Insp Time.</p>

Waveform patterns

Ramp

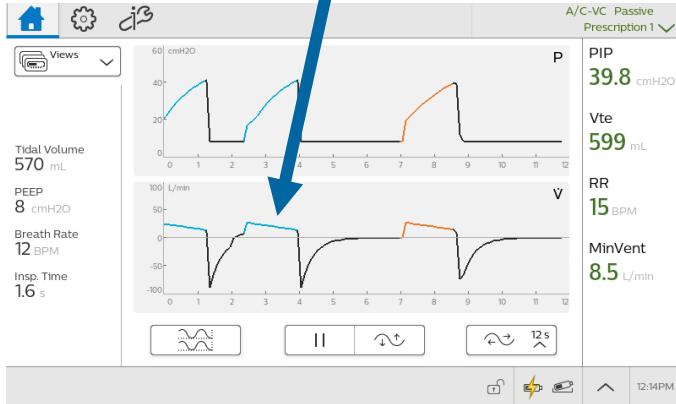
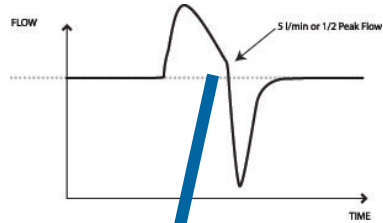

Square

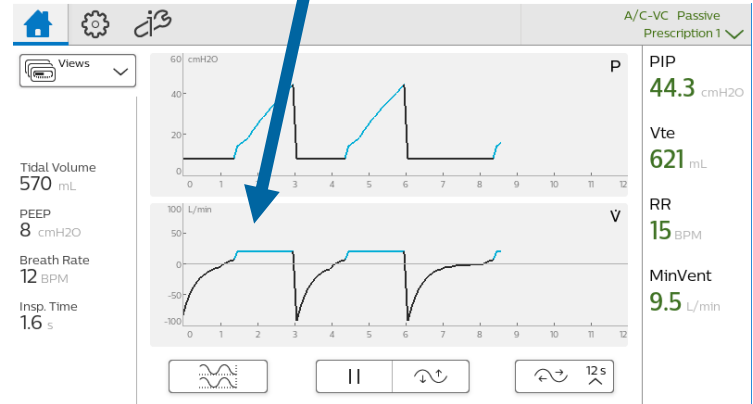
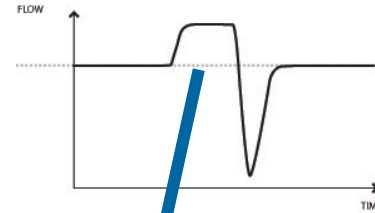

Best practice

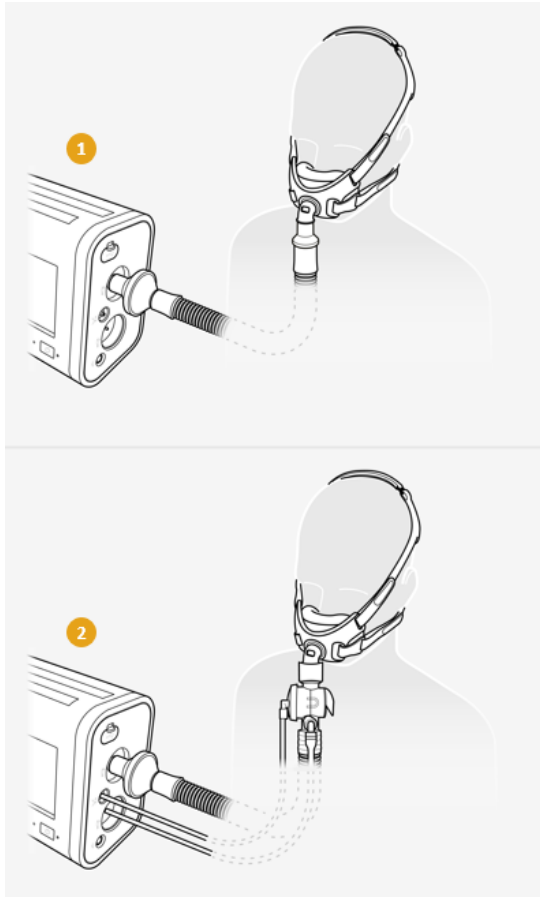

Using an active circuit, pressure and flow are moved proximal to the patient, limiting or eliminating several of the full features of the signal analysis.

	1 Passive circuit	2 Active circuit
Alarms	✓	?
Auto-Trak	✓	✗
Flow Trigger	✓	✓
Auto EPAP	✓	✗
AVAPS	✓	✗
Volume control	✓	?*
Auto backup rate	✓	✗
Spirometry	✓	?***

* some alarms

** no leak compensation for volume

*** limited

Triggering and cycling

Flow Trigger

- Passive, Active PAP, Active Flow, or Dual Limb circuits
- Volume and Pressure modes
- Invasive and noninvasive
- Range: 0.5 – 9 L/min
- Cycle sensitivity: 10% – 90% of peak flow

Auto-Trak

- Passive circuits only
 - Volume and Pressure modes
 - Invasive and noninvasive
 - No Trigger adjustments required
- *Monitors breathing patterns to accurately recognize when the ventilator should trigger inspiratory support or cycle to expiration.

Sensitive Auto-Trak

- Passive circuits only
- Volume and Pressure modes
- Invasive and noninvasive
- No Trigger adjustments required
- Suitable for patients with weaker inspiratory effort (pediatrics, neuromuscular)

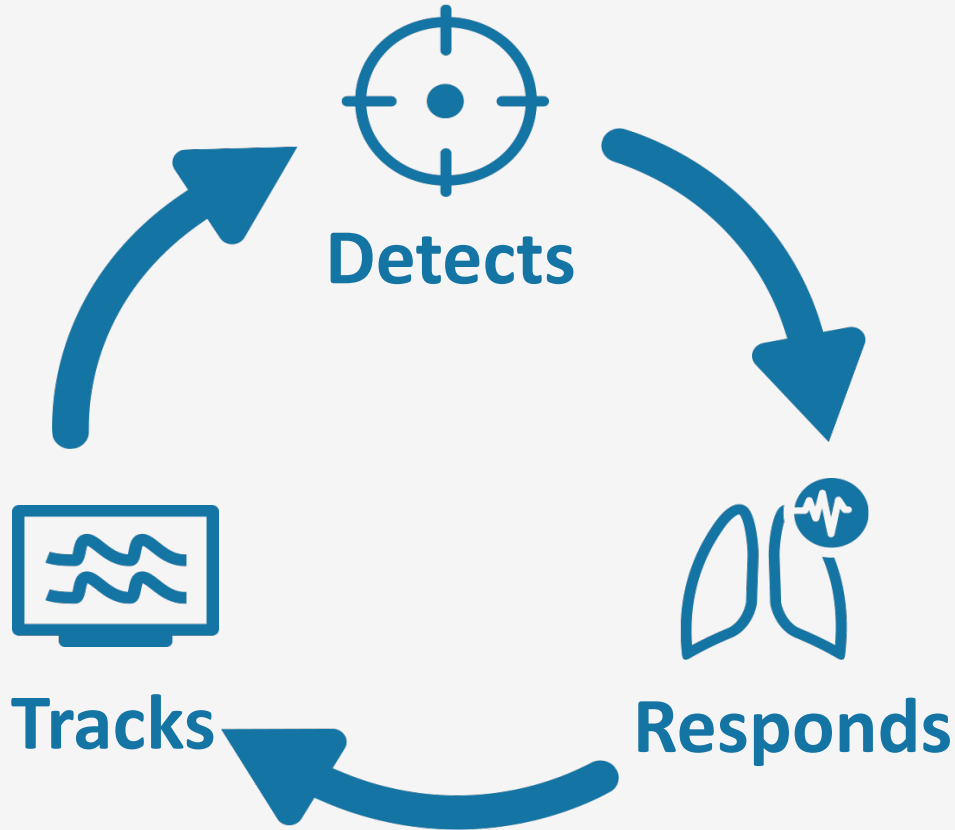

What is Auto-Trak?

Auto-Trak signal analysis simplifies set-up, with a repeating automatic cycle that:

- Detects;
- Responds and;
- Tracks patient synchrony

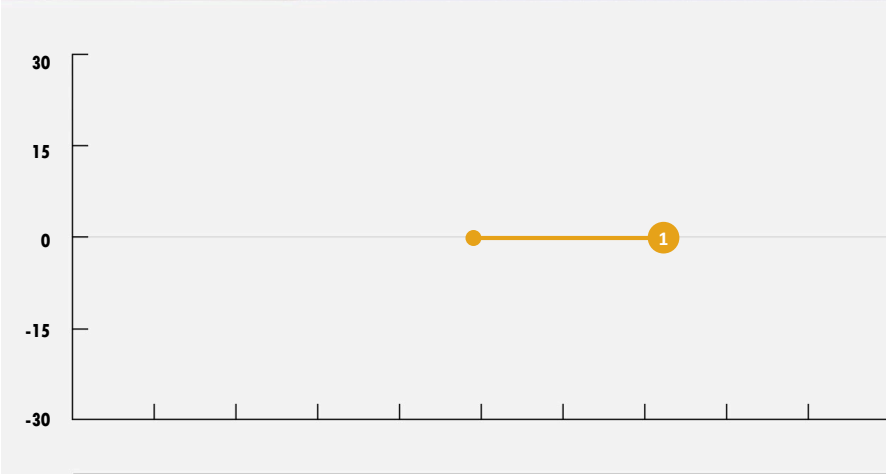

The components of Auto-Trak

Triggering

Volume trigger

The primary trigger for Auto-Trak measures inspired volume on positive flow. Once it detects an accumulated 6 ml volume above baseline flow, it will trigger inspiratory pressure.

- 1 Volume Trigger = 6 ml



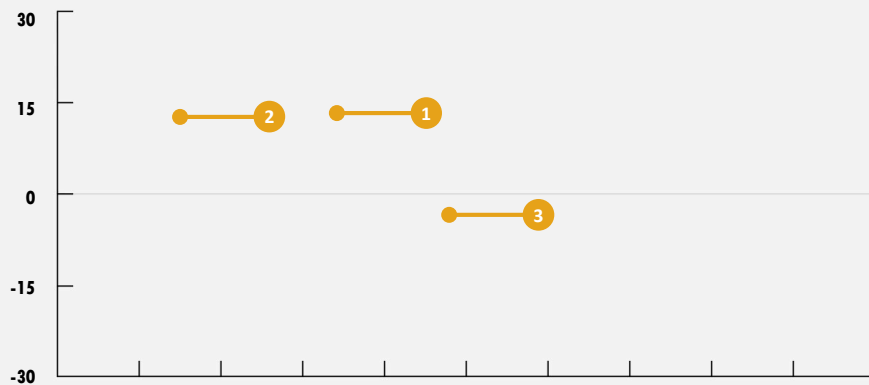

The components of Auto-Trak

Triggering

Shape signal trigger

The Shape Signal functions dually to both **trigger IPAP** and **cycle EPAP**. It appears as a slightly delayed shadow image of the patient's actual flow rate, which helps compensate for flow direction changes. When patient flow and the Shape Signal cross, **trigger** will occur automatically. **When triggering inspiratory pressure**, patient flow naturally increases.

Details of how the shape signal is calculated are covered in more detail within the cycling section.

- 1 Estimated patient flow
- 2 Shape Signal
- 3 Trigger to IPAP crossover point





The components of Auto-Trak

Triggering

Sensitive Auto-Trak

This works as per Volume trigger but provides an enhanced triggering response for patients with minimal respiratory effort. Auto-Trak requires 6 ml of volume change to initiate a breath, whereas Sensitive Auto-Trak only requires 3 ml.

- 1 Sensitive Volume Trigger = 3 ml
- 2 Standard Volume Trigger = 6 ml

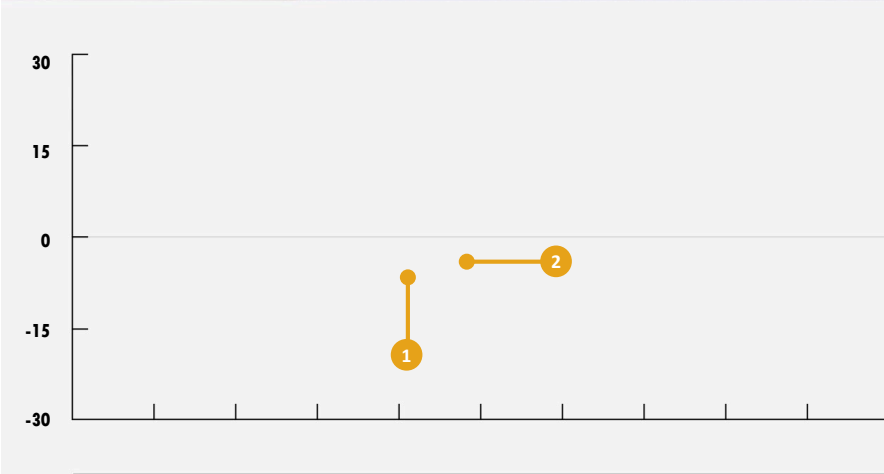

Sensitive Auto-Trak

- Provides an enhanced triggering response for patients with minimal respiratory effort
- Digital Auto-Trak requires 6 ml of volume change to initiate a breath
- Sensitive Auto-Trak requires 3 ml

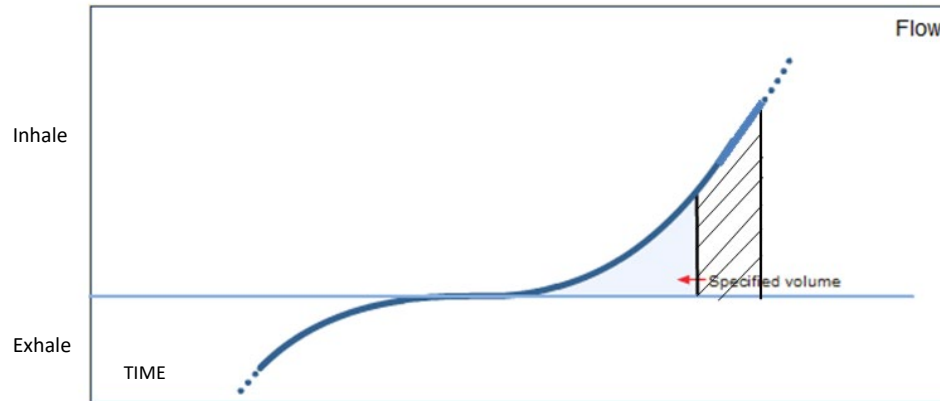

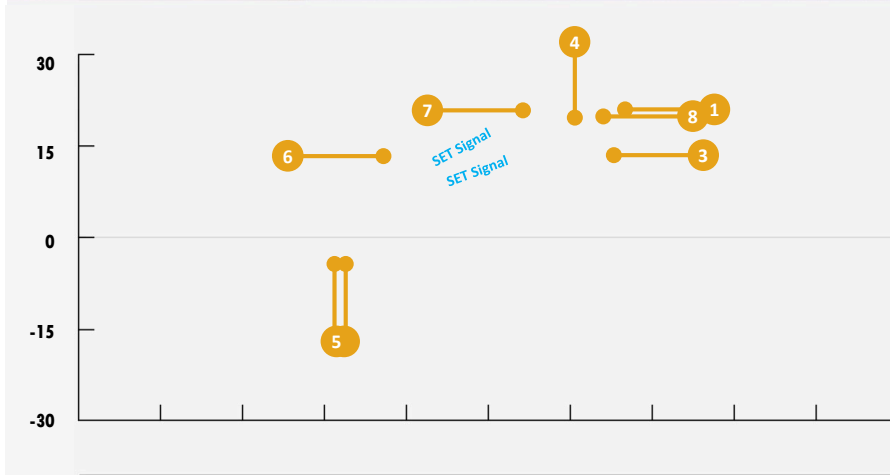

The components of Auto-Trak

Cycling

Spontaneous Expiratory Threshold (SET)

An electronic signal rises in proportion to the tidal volume of each breath. Once SET and actual patient flow are equal, expiration begins.

- 1 Spontaneous Expiratory Threshold
- 2 6 ml accumulated to start SET
- 3 Cycle to Expiration
- 4 SET

The SET signal automatically adjusts based on the speed on the patient's inspiratory flow.

- 5 6 ml accumulated to start SET
- 6 Patient flow increases
- 7 Adjusted SET when patient flow increases
- 8 Cycle to Expiration



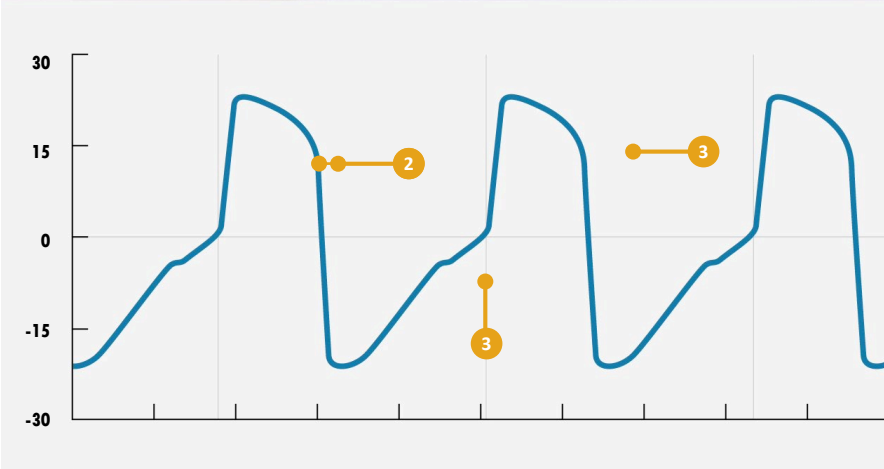

The components of Auto-Trak

Cycling

Shape Signal expiratory cycle

The Shape Signal functions dually to both **trigger IPAP** and **cycle EPAP**. It appears as a slightly delayed shadow image of the patient's actual flow rate, which helps compensate for flow direction changes. When patient flow and the Shape Signal cross, **cycle** will occur automatically. When **cycling to expiratory pressure**, patient flow naturally decreases.

- 1 A Shape signal is created based on the breathing pattern of the patient.
- 2 This Shape Signal is then fractionally delayed and shifted to help compensate for flow direction changes.
- 3 When patient flow and the Shape Signal cross, **trigger** and **cycle** will occur automatically.



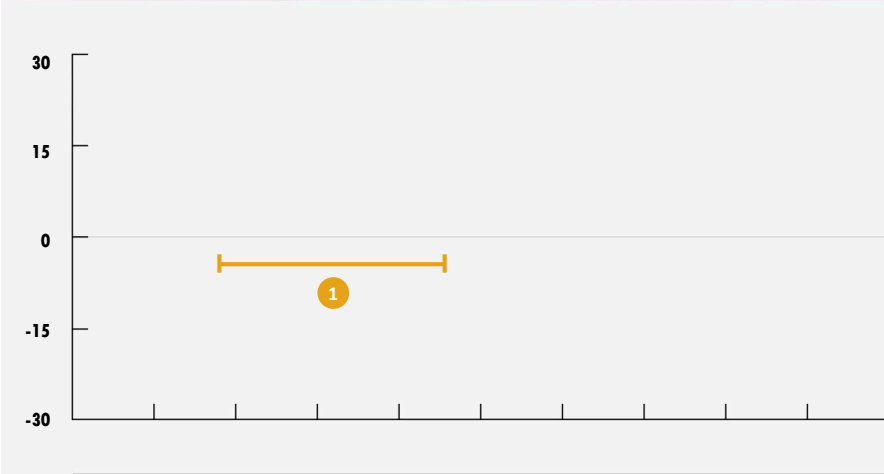

The components of Auto-Trak

Cycling

Safety feature

If the patient remains in the inspiratory phase of the breathing cycle for three seconds, Digital Auto-Trak will **cycle the device to the expiratory phase of pressure delivery.**

- 1 Max inspiratory time of 3 seconds.



AVAPS-AE

AVAPS-AE is a auto-titration mode of noninvasive ventilation designed to better treat respiratory insufficiency patients (OHS, COPD and NMD) in the hospital and homecare environments

Achieving a targeted volume is completely automatic

- Auto Pressure Support
- Auto EPAP
- Auto backup rate

Adjustable AVAPS

- Adjustable AVAPS allows you to adjust the maximum rate at which the pressure support automatically changes to achieve the target tidal volume
- It can be set from 1 cm H₂O per minute to 5 cm H₂O per minute
- Allows clinician to customize the setting to the patient's needs

AVAPS-AE

Auto EPAP maintains patent upper airway at a comfortable pressure

- Auto adjusting EPAP to meet changing patient needs
- Maintains a patent airway

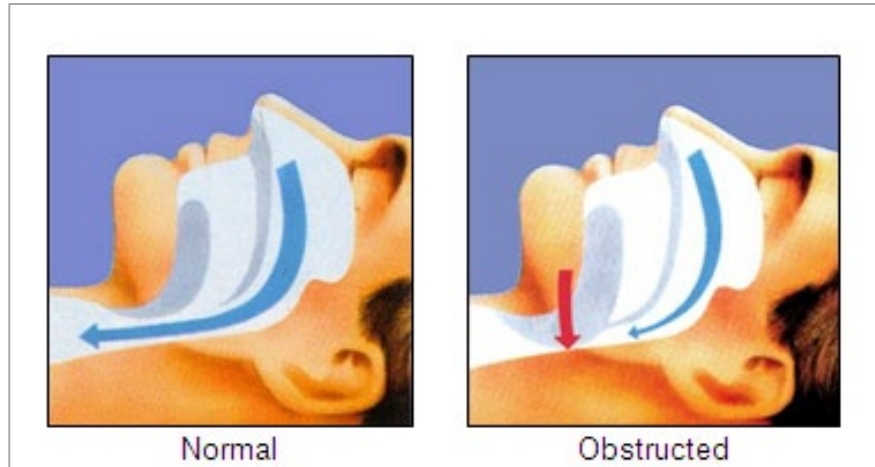

AVAPS-AE

Auto backup rate provides comfortable assistance when needed

- Auto backup rate is near resting rate
- No manual adjustments (auto-default setting)



Mouthpiece Ventilation (MPV)



Expanding ventilatory support

MPV

MPV is a form of ventilation whereby the patient's normal state is disconnected from the ventilator and the patient initiates a breath, as needed, through an oral interface

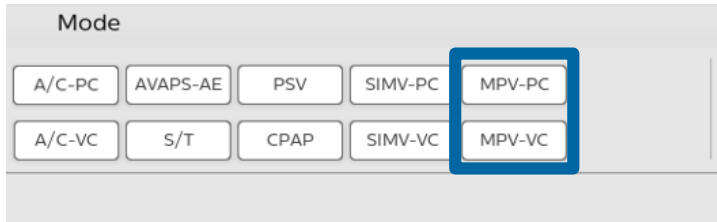

Patient selection

Respiratory muscle dysfunction

- Muscular dystrophies
- ALS
- Other myopathies: acide maltase deficiency, polymyositis, mitochondrial disorders
- Neurological disorders: spinal muscular atrophies (SMA I, II, III)
- Neuropathies: Guillain-Barre syndrome, multiple sclerosis
- Skeletal pathologies such as kyphoscoliosis, rigid spine syndrome



Is there a risk to using MPV?

- The MPV feature represents no more risk than any other form of NIV
- MPV may be used an entire lifetime by some neuromuscular patients and may extend the quality of life for patients who will eventually need invasive ventilation



“NIV via 15-mm angled mouthpiece
is the most important method of
daytime ventilatory support”



Kiss trigger and MPV support system

- The 'kiss' trigger with [signal flow technology](#) detects when the patient engages and disengages from the mouthpiece to deliver on-demand ventilation
- This feature combines with a [mouthpiece ventilation \(MPV\) support system](#) to enhance ease of use



MPV history

- MPV technique originated in 1950's as a therapeutic adjunct for dyspnea in polio patients
- John E. Affeldt of Rancho Los Amigos Hospital
 - IPPV with a mouthpiece could relieve dyspnea in ventilator-dependent polio patients
 - Used when negative pressure was interrupted by transfers, nursing care, physical therapy

Evolution of MPV

- Traditionally performed on volume ventilators that were adapted and modified to allow for “sip breathing”.
 - Resistance added to the circuit
 - Prevented nuisance low pressure alarms
- In 1980’s the introduction of masks and pressure ventilators which allowed for compensation of leaks resulted in a shift in methods. (Ease of use etc.)

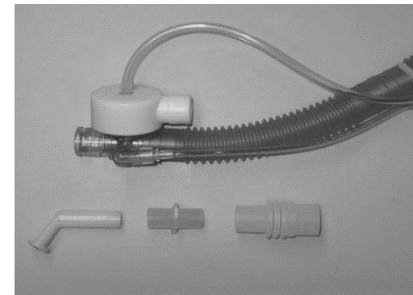

Disease state targets

- Neuromuscular disease
- Polio Myelitis
- Duchene Muscular Dystrophy (DMD)
- Quadriplegia (SCI)
- Amyotrophic Lateral Sclerosis (ALS)
- Multiple Sclerosis (MS)
- NIV dependent patients – breaks for activities of daily living

Daytime Ventilation via Mouthpiece: Clinical evidence

Objectives

Assess the impact of daytime MPV as an extension of nocturnal NIPPV

Methods

- 45 normocapnic patients at night on NIPPV
- Monitored TcCO₂ during night and day
- Assessed every 6 months

Results

- Daytime MPV provided a 50% survival
- Stabilized lung function for 5 years

Conclusion

- Daytime MPV as an extension to nocturnal NIPPV is safe
- Provides reliable survival
- Recommended use of cough assisting devices

Trilogy Evo

MPV

Optional time-based patient reminder

-MPV circuit disconnect alarm

Multiple prescription function

-Facilitates independent day and nighttime settings (i.e. MPV during day, mask ventilation at night)

Kiss trigger

- Unique algorithm for a normally *disconnected* state
- Eliminates issues with a traditional flow trigger:
 - no sensitivity to adjust (mitigates auto triggering)
 - does not require patient effort to generate a breath
 - important for progressively weaker respiratory muscles



Circuit configuration

MPV

MPV circuit support arm

- adjustable to fit most powered wheelchairs
- adjustable to optimize position of mouthpiece to patient
- no need to 'engineer' circuit and connection/support



Disposable MPV circuit

- includes small angled and dental straw-style mouthpieces

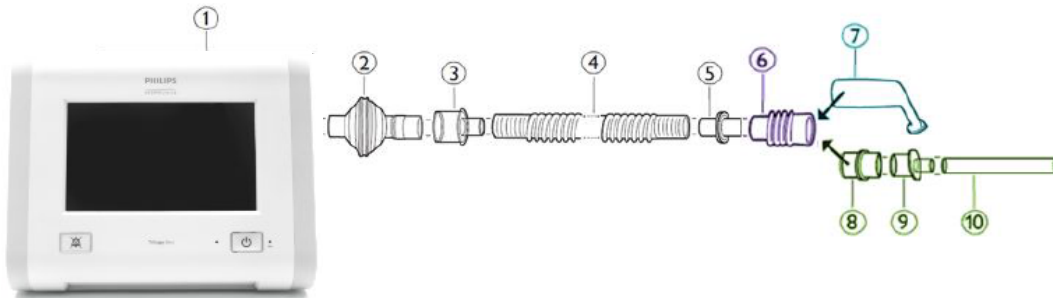

A photograph of a man in a wheelchair and a woman sitting on a lawn, overlaid with a blue tint. The man is smiling and looking to the right. The woman is sitting next to him, looking towards the camera. They are surrounded by other people sitting on lawn chairs, though they are out of focus. The background shows a fence and some trees.

Research evidence

Mouthpiece ventilation

Evaluation of ventilators for mouthpiece ventilation in neuromuscular disease.
Khirani S, et al. *Respir Care*. 2014 ;59(9):1329-37.

Evaluation of ventilators for mouthpiece ventilation in neuromuscular disease

Aim

The aims of the study were to analyze the practice of mouthpiece ventilation and to evaluate the performance of ventilators for mouthpiece ventilation.

Methods

Questionnaire:
Subject-reported benefits

Bench test:
Performance of 6 home ventilators with mouthpiece ventilation.

Results

n =30, mean age 33 ± 11 y, using NIV for 12 ± 7 y. Fifteen subjects used NIV for > 20 h/day, and 11 were totally ventilator-dependent

Questionnaire of subject-reported benefits:

- Reduction in dyspnea (73%) and fatigue (93%)
- Improvement in speech (43%) and eating (27%)

Bench test:
Alarms were common with home ventilators, although less common in those with mouthpiece ventilation software.

Conclusion:
Subjects are satisfied with MPV

Understanding the Trilogy Evo

Simple

User-friendly platform

Patient-friendly
performance

8" touchscreen

Note that the background images
are only visible on screen while in
limited access.



Simple

To prevent accidental therapy changes, use the **touchscreen lock**.

This is a temporary touchscreen lock, which can be changed back by tapping anywhere on the screen and following the onscreen instruction.

For automatic touchscreen lock, go to the Options screen then Device Options and select Automatic Touchscreen Lock On.



Simple Onscreen help

Entering a new prescription or placing a new circuit on the ventilator is simple thanks to the addition of onscreen help.

Simply tap the help icon (?) for more information regarding that prescription setting or alarm situation.



Simple Onscreen battery indicator

During ventilation you can check how much time remains on each battery, which is an estimate based on the current usage. This is done in one of two ways.

Option 1.

Tap the battery icons in the toolbar to see the time remaining on each battery.

Option 2.

Change the ventilation monitoring view to the large timer view for a constant reference to the remaining battery time.



Simple
Connected
Portable
Reliable
Adaptable



Connected Care Orchestrator

Cloud monitoring.
Proactive, targeted
intervention.



Connected Care Orchestrator

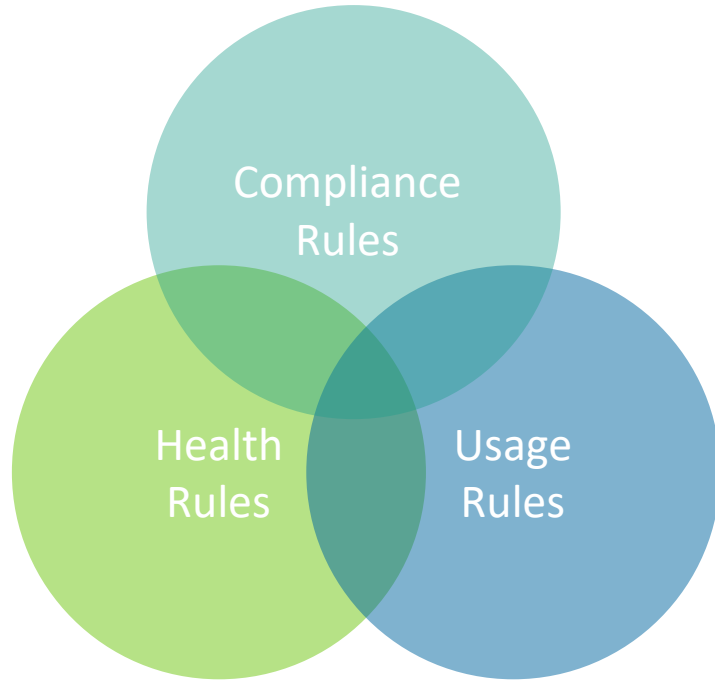

New possibilities for efficient resource management



Identify and efficiently manage compliance issues



Prioritize which patients require home visits – and which do not



Potential to avoid wasted labor, time, and spending

Connected

Care Orchestrator

Example: Pediatric Neuromuscular Patient

	When	Then
Minute Ventilation – Gross Change	The % change between (n) 7 day baseline average and 3 day evaluation period average exceeds 25% or is below 25%	<ul style="list-style-type: none">• Add a task to follow up with the patient• With a priority of Medium
Respiratory Rate – Threshold	The average respiratory rate is greater than 28 BPM or less than 18 BPM for the past 2 days	<ul style="list-style-type: none">• Add a task to follow up with the patient• With a priority of Medium
% Patient Triggered Breaths – Gross Change	The % change between (n) 7 day baseline average and 3 day evaluation period average exceeds 40% or is below 20%	<ul style="list-style-type: none">• Add a task to follow up with the patient• With a priority of High

Simple
Connected
Portable
Reliable
Adaptable



Portable

Ultimate Portability

15 hours of battery.*

Hot swappable detachable battery provides uninterrupted therapy.**



*Nominal run time per method in International Electrotechnical Commission (7.5 hr/battery). Detachable battery charge time 0% to 80% is 2.5 hours, Internal battery charge time 0% to 100% is 3.5 hours. A/C-VC mode ActivePAP circuit, PEEP 3cmH₂O and Vt 800ml.

** When the internal battery is charged, batteries can be replaced without the ventilator pausing therapy.

Simple
Connected
Portable
Reliable
Adaptable



Reliable

Low Total Cost of Ownership



Trilogi Evo



Trilogi

Trilogi Evo Service Solution
Avg. <20 mins



Service

Trilogi Service Solution
Avg. 1 hour 40 mins
FSA Test Station

1,200 cycles



Battery cycles

475 cycles

4 years



Blower hours

10,000 hours / 2 years

Simple
Connected
Portable
Reliable
Adaptable



Adaptable

Seamlessly transition across care environments
utilizing the same clinical technology



Different care
settings

Same clinical
technology

Adaptable

Evolution of ventilator technology

- ✓ Oxygen and FiO_2 cell
- ✓ 5 prescriptions
- ✓ 4 circuits: single and dual limb
- ✓ Circuit Calibration
- ✓ Tubing Compliance Compensation
- ✓ T_i min/max
- ✓ Flow Trigger 0.5
- ✓ Rise Time 0
- ✓ Dynamic Parameters
- ✓ AVAPS updates
- ✓ AVAPS-AE updates

Adaptable

Five prescriptions

Program up to 5 Prescriptions (presets) and select a name from the list of available prescription names.



Adaptable Tubing compliance compensation

Trilogy Evo excludes any losses in tidal volume due to the circuit.

Trilogy Evo includes a default calibration providing automatic tubing compensation for the recommended circuits in the accessory guide.



Adaptable Circuit calibration

Volume losses in circuit tubing can be calculated and programmed into the Trilogy Evo using the calibration method.



Adaptable Ti min/max

Available in S/T, PSV,
SIMV-PC, SIMV-VC, and
AVAPS-AE modes

Access under Advanced

Applicable to spontaneous
breaths only

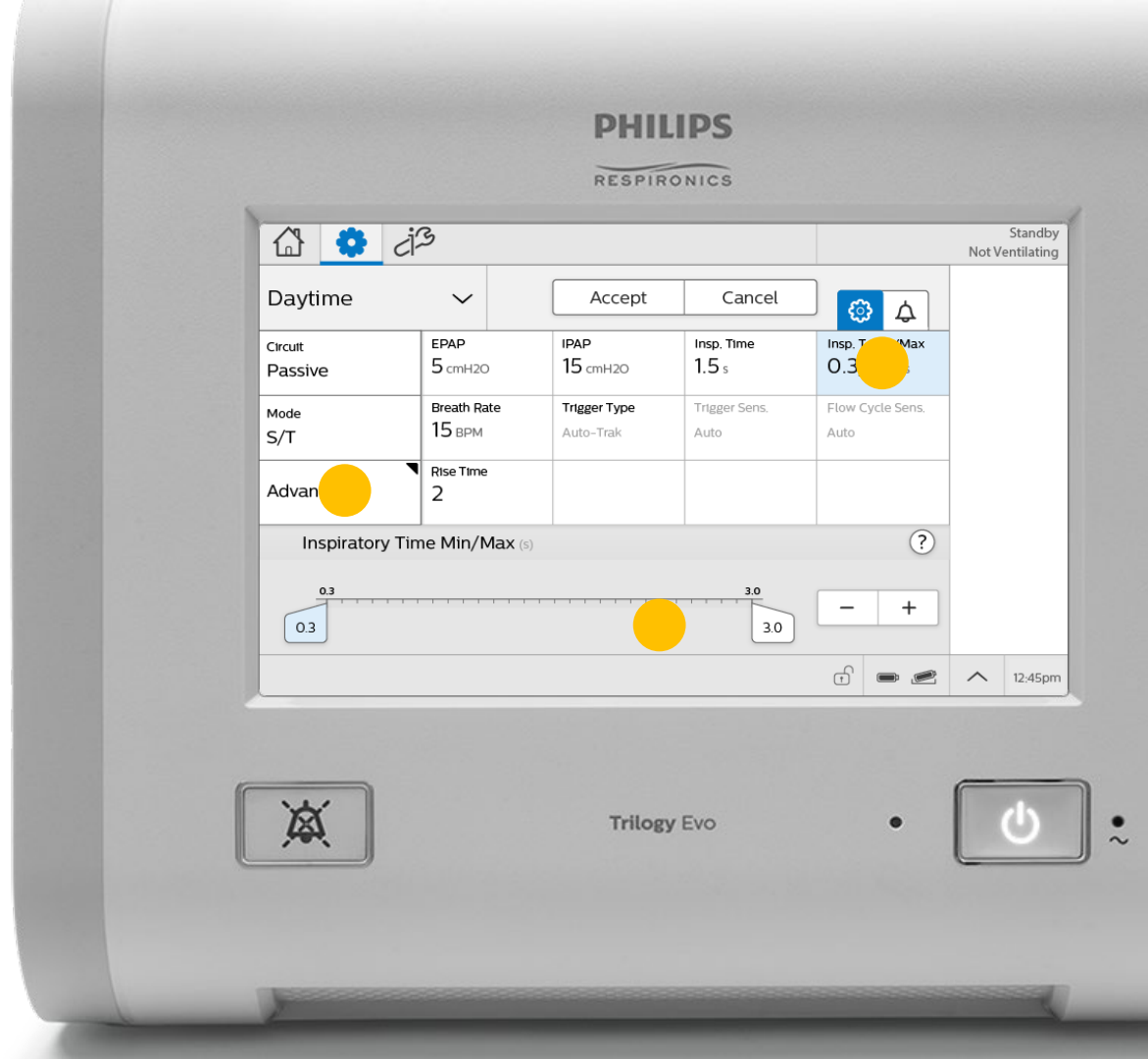

Adaptable Flow trigger

Flow trigger can be set to 0.5 L/min to offer increased sensitivity for your weakest patients.



Adaptable Rise Time

Rise Time is now even faster than Trilogy, and can be set to 0 to adapt to the needs of your patients.

Note: You can tap on the Help icon whenever it is visible and a screen will appear for information concerning that section.



Adaptable

AVAPS

Available in A/C-PC, S/T, and PSV modes

AVAPS Speed

- Replaced AVAPS Rate (of change) on Trilogy

AVAPS Startup

- First minute not limited by Speed setting
- Next session starts with the previous sessions final inspiratory pressure

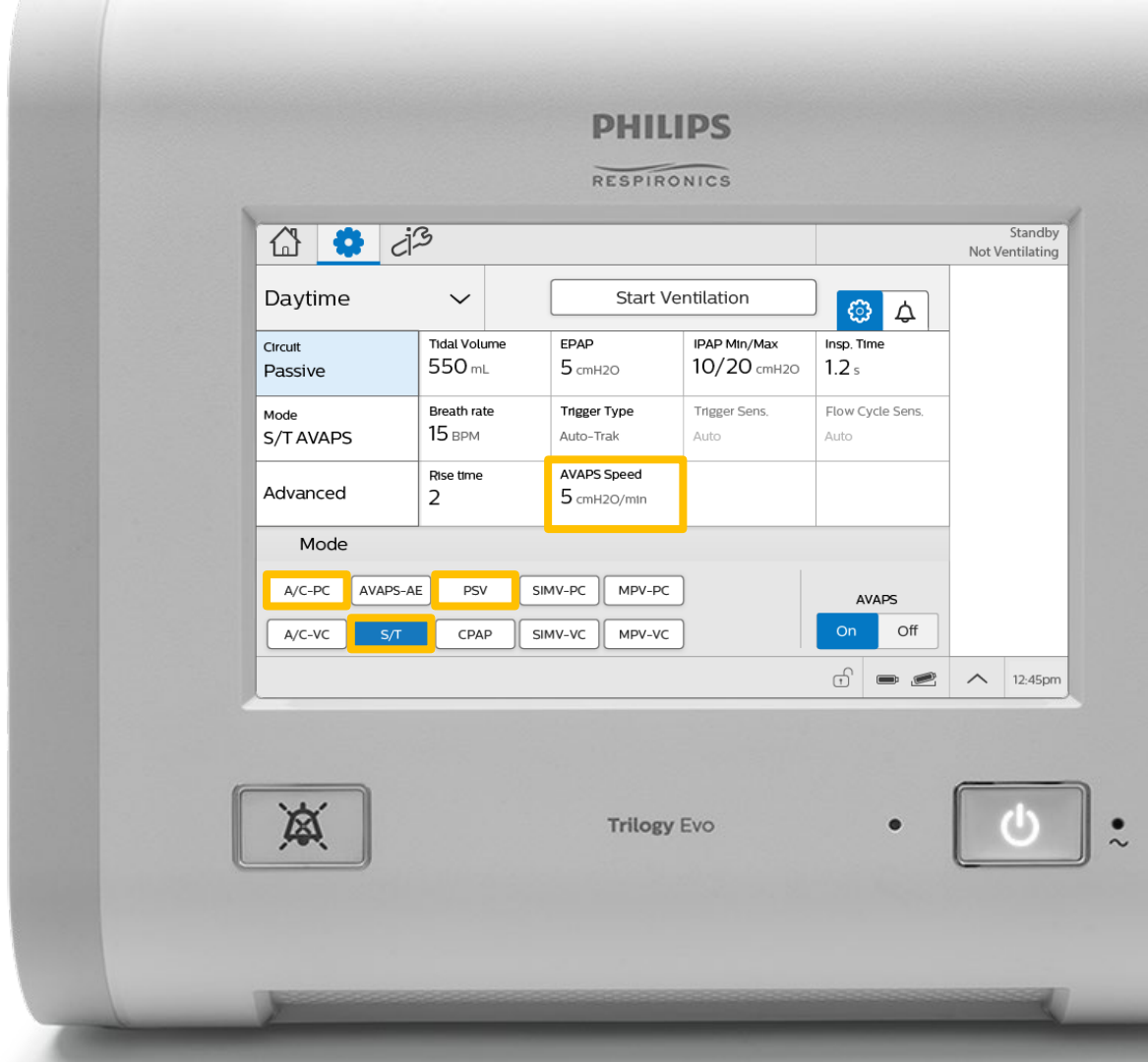

Adaptable

AVAPS

Available in A/C-PC, S/T, and PSV modes

Algorithm resets to pressure midpoint when:

- AVAPS restart icon (AVAPS) is tapped
- Changing to another pre-set prescription, then changing back

Algorithm does not reset to pressure midpoint when:

- Changing the target tidal volume
- Changing the insp. pressure ranges



Adaptable AVAPS-AE additional flexibility

PC Breath – On/Off



Adaptable AVAPS-AE additional flexibility

PS Min/Max can go to 0

Please note that PS Min/Max will change to PC Min/Max when PC Breath is set to On.



Adaptable AVAPS-AE additional flexibility

Automatic algorithm restart

- AVAPS restarts at pressure midpoint
- EPAP returns to EPAPmin for 100 breaths
- AutoBUR (if enabled) restarts



Adaptable

Dynamic parameters

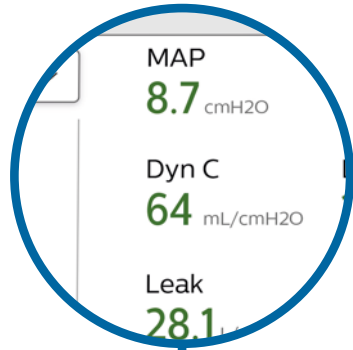

Dyn C

Static Compliance of respiratory system (lungs + chest wall), measured dynamically. Ratio between the change in volume to the change in pressure.

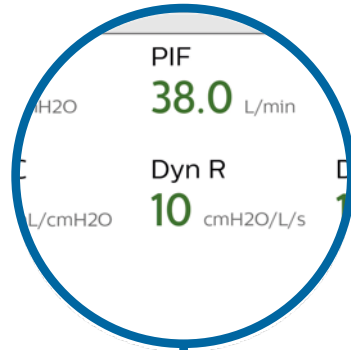

Dyn R

Airway Resistance Estimate of the change in pressure divided by the air flow through the airways.

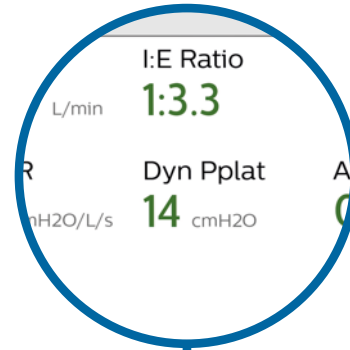

Dyn P_{plat}

Plateau pressure is the maximum pressure applied to small airways and alveoli during positive-pressure mechanical ventilation.

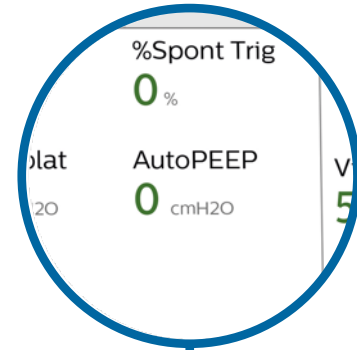

AutoPEEP

Estimate of the pressure (above PEEP) that exists in the patient airway at the end of exhalation.

Adaptable

Dynamic parameters

Available with:

Passive, Active Flow, and Dual Limb

NOT available in ActivePAP

Available in modes:

A/C-PC, A/C-VC, SIMV-PC, SIMV-VC

on Mandatory and Assist Control breaths

(VIM and PIM breaths)

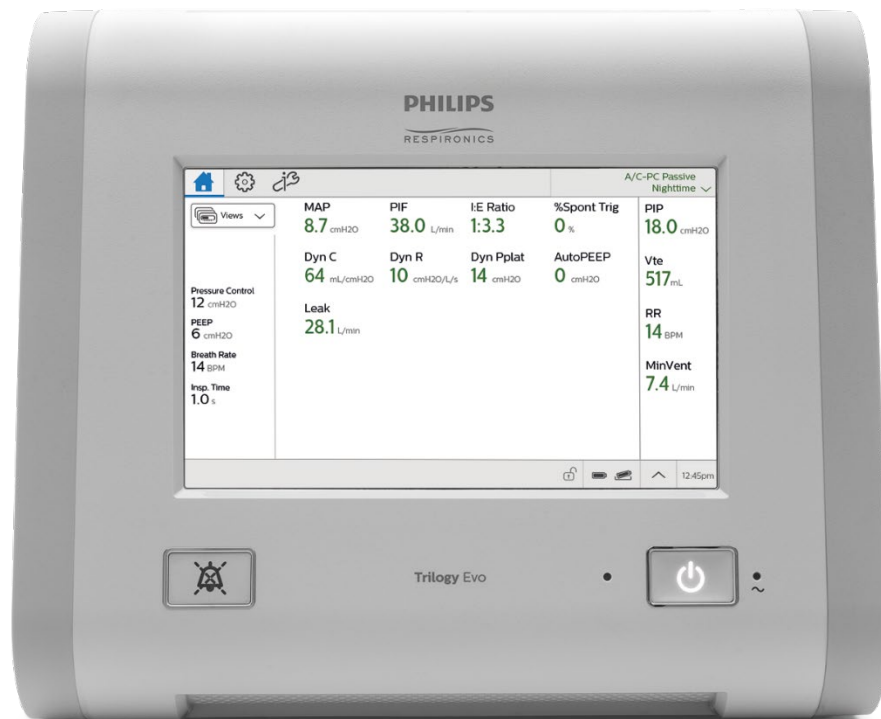

Adaptable

Pediatric Trached Patient Example:

Pediatric patient with tracheostomy tube on Trilogy Evo had an increase in resistance noted over a 300 second period that was resolved after suctioning.

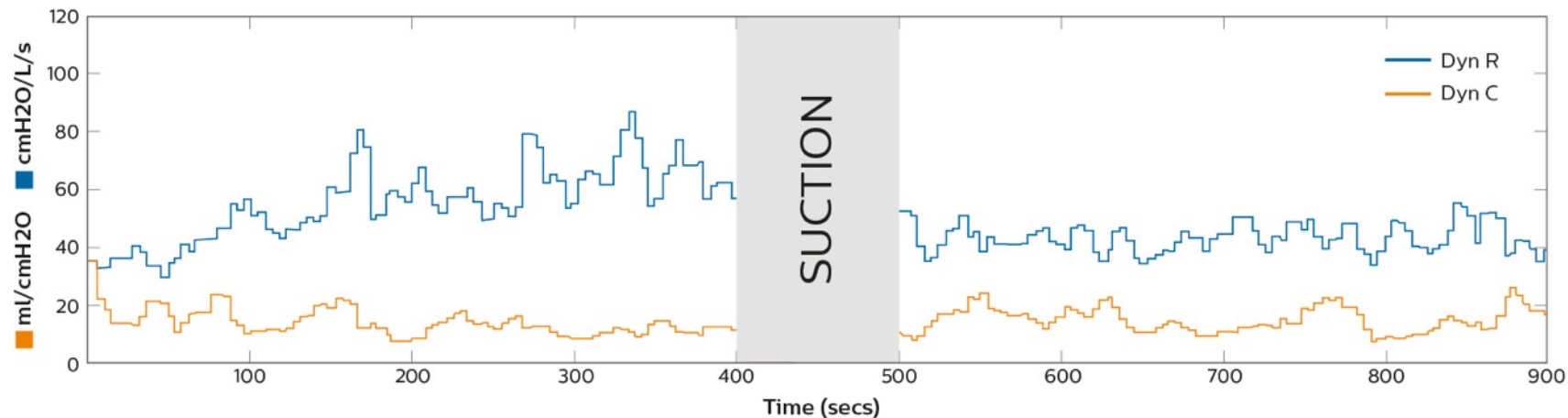



Trilogic Evo



Trilogic

Intended Use (weight)	>2.5 kg patient intended use (15 mL pressure modes / 35 mL volume modes)	>5 kg patient intended use
Battery	~7.5 internal + ~7.5 detachable	~3 internal + ~3 detachable
Circuits	Passive, Active PAP, Active Flow, Dual Limb, (MPV)	Passive, Active PAP, Active Flow, (MPV)
Pre-sets	5 pre-set prescriptions	2 pre-set prescriptions
Prescription naming	Prescription #, Nighttime, Mouthpiece, Transport, Exacerbation, Daytime, Exercise, Weaning, Emergency, Other	Primary Secondary
Standby	✓	✗
Modes	Pressure - CPAP, S/T, PSV, A/C-PC, SIMV-PC, AVAPS-AE Volume - A/C-VC, SIMV-VC MPV settings - MPV-PC, MPV-VC	Pressure - CPAP, S, S/T, T, PC, PC-SIMV, AVAPS-AE, PC-MPV Volume - AC, CV, SMIV, AC-MPV
AVAPS	First minute not limited by speed setting	Always limited by rate of change setting
Ti Min/Max	Spont. breaths (S/T, PSV, SIMV-PC, SIMV-VC, and AVAPS-AE modes)	Only set Ti
Flow Trigger	0.5 – 9 Lpm	1 – 9 Lpm



Trilogy Evo



Trilogy

Rise Time	0 - 6	1 - 6
Backup Ventilation	✓	✗
Dynamic lung parameters with no insp/exp hold	Dyn C, Dyn R, P _{plat} , autoPEEP	✗
FiO ₂ sensor and EtCO ₂ monitoring	✓	✗
Enhanced monitoring	Waveforms	Waveforms
Memory/Data transfer	Internal Memory (2GB) Data Transfer via Bluetooth or USB	No internal memory Data Transfer via Bluetooth or SD card
Circuit compensation	Circuit and humidifier selection Circuit calibration (optional)	✗
Touch Screen GUI	Touch Screen GUI	Non-touch screen GUI
On screen Alarm Guidance	✓	✗
Service/Maintenance	4 year interval	10,000; 17,500; (alternating every 10K and 7.5K blower hrs)



Simple

Easy-to-learn user interface, configurable to the care environment



Connected

Providing timely care information to the people who need it



Portable

15 hours of battery life, easily mounts on wheelchairs, and has a convenient carrying bag that lets you see the screen and alarms



Reliable

The most robust and durable device we've ever created



Adaptable

Stays with patients as their care settings and needs change

CEU certificate

- To obtain your CEU certificate log on to
 - <https://www.ganESCO.com/philips-attendeelogin.php>
 - Log in or create a log in if you are a new user
 - Complete the evaluation and print out your certificate.

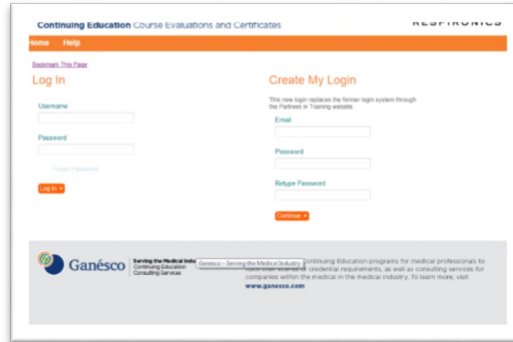

The screenshot shows the login page for the GanESCO Continuing Education system. The page title is "Continuing Education Course Evaluations and Certificates". It features a navigation bar with "Home" and "Help" links. Below the navigation bar, there are two main sections: "Log In" and "Create My Login". The "Log In" section includes fields for "Username" and "Password", with a "Forgot Password" link and a "Log In" button. The "Create My Login" section includes fields for "Email", "Password", and "Repeat Password", with a "Create" button. At the bottom of the page, there is a footer with the GanESCO logo and a brief description of their services: "GanESCO - Serving the Medical Industry" and "Continuing Education programs for medical professionals to meet their continuing education requirements, as well as consulting services for companies within the medical in the medical industry. To learn more, visit www.ganESCO.com".

- If you are claiming AARC credits, you **must** complete the evaluation within 30 days or you will **not** receive credit for the program.

