

Robot Vacuum and Mop Cleaner Operation Manual

Read this operation manual carefully before using the product, and store the manual safely.



Scan the QR code for manuals
in multiple languages

XCLEA

CONTENTS

Safety instructions	2
Warning	2
Caution	3
Product overview	5
Main unit	5
Dust box + water tank (2 in 1) and mopping module	5
Dust collector (optional)	6
Charging dock (optional)	7
Installation	7
Installing the dust collector (optional)	7
Installing the charging dock (optional)	7
Installing the mopping module	8
Use	9
APP downloads	9
Turning on/off and cleaning modes	10
Turning on/off and operating the dust collector (optional)	11
Dust collector status indicator	11
Cleaning and maintenance	12
Disassembling and installing the main brush	12
Disassembling and installing the side brush	12
Disassembling and installing the dust box and filter	13
Disassembling and installing the mop	14
Cleaning the replacement parts	14
Clean the charging dock (optional)	15
Clean the dust collector (optional)	15
Troubleshooting	16
FAQs	18
Technical data	19
Disposal	20
Warranty and limitations of liability	20
Warranty card	21
Maintenance records	21

IMPORTANT SAFETY INSTRUCTIONS

Read this operation manual before using the product

Warning: To avoid injury to yourself and others, and to avoid unnecessary property damage, read carefully before using the product and observe the following "Safety instructions". The safety instructions are divided into two sections, "Warning" and "Caution". The "Warning" and "Caution" sections contain important information for safe use of the product and must be followed.

 Warning Instructions against incorrect product use that may lead to death or serious injury

 Caution Instructions against incorrect product use that may lead to minor injury or product damage

 Warning

1. Do not use outdoors or on wet surfaces.
2. Do not allow to be used as a toy. Close attention is necessary when used by or near children, pets or plants.
3. Use only as described in this manual. Use only manufacturer's recommended attachments
4. Do not use with damaged cord or plug. If appliance or Docking Station is not working as it should, has been dropped, damaged, left outdoors, or dropped into water, return it to a service center.
5. Do not pull or carry by cord, use cord as a handle, close a door on cord, or pull cord around sharp edges or corners. Do not run appliance over cord. Keep cord away from heated surfaces.
6. Do not unplug by pulling on cord. To unplug, grasp the plug, not the cord.
7. Do not handle charger, including charger plug, and charger terminals with wet hands
8. Do not put any object into openings. Do not use with any opening blocked; keep free of dust, lint, hair, and anything that may reduce air flow.
9. Keep hair, loose clothing, fingers, and all parts of body away from openings and moving parts.
10. Do not use to pick up flammable or combustible liquids, such as gasoline, or use in areas where they may be present.
11. Do not pick up anything that is burning or smoking, such as cigarettes, matches, or hot ashes.
12. Do not use without dust bin and/or filters in place.
13. Prevent unintentional starting. Ensure the switch is in the off-position before connecting to battery pack, picking up or carrying the appliance. Carrying the appliance with your finger on the switch or energizing appliance that have the switch on invites accidents.
14. Disconnect the battery pack from the appliance before making any adjustments, changing accessories, or storing appliance. Such preventive safety measures reduce the risk of starting the appliance accidentally.
15. Recharge only with the charger specified by the manufacturer. A charger that is suitable for one type of battery pack may create a risk of fire when used with another battery pack.
16. Use appliances only with specifically designated battery packs. Use of any other battery packs may create a risk of injury and fire.
17. When battery pack is not in use, keep it away from other metal objects, like paper clips, coins, keys, nails, screws or other small metal objects, that can make a connection from one terminal to another. Shorting the battery terminals together may cause burns or a fire.
18. Under abusive conditions, liquid may be ejected from the battery; avoid contact. If contact accidentally occurs, flush with water. If liquid contacts eyes, additionally seek medical help. Liquid ejected from the battery may cause irritation or burns.
19. Do not use a battery pack or appliance that is damaged or modified. Damaged or modified batteries may exhibit unpredictable behavior resulting in fire, explosion or risk of injury.
20. Do not expose a battery pack or appliance to fire or excessive temperature. Exposure to fire or temperature above 130°C may cause explosion.
21. Do not use and store in extremely hot or cold environments (below -5°C or above 40°C). Please charge the robot in temperature above 4°C and below 40°C.

22. Follow all charging instructions and do not charge the battery pack or appliance outside of the temperature range specified in the instructions. Charging improperly or at temperatures outside of the specified range may damage the battery and increase the risk of fire.
23. Have servicing performed by a qualified repair person using only identical replacement parts. This will ensure that the safety of the product is maintained.
24. Do not modify or attempt to repair the appliance or the battery pack except as indicated in the instructions for use and care.
25. Place the cords from other appliances out of the area to be cleaned.
26. Do not operate the vacuum in a room where an infant or child is sleeping.
27. Do not operate the vacuum in an area where there are lit candles or fragile objects on the floor to be cleaned.
28. Do not operate the vacuum in a room that has lit candles on furniture that the vacuum may accidentally hit or bump into.
29. Do not allow children to sit on the vacuum.
30. Do not use the vacuum on a wet surface.
31. Do not use the Docking Station if it is damaged.
32. Turn off the power switch before cleaning or maintaining the appliance.
33. The plug must be removed from the receptacle before cleaning or maintain the Docking Station.
34. Remove the appliance from the docking station and turn off the power switch to the appliance before removing the battery for disposal of the appliance.
35. If the robot will not be used for a long time, fully charge the robot and power OFF for storage and unplug the charger.



Caution

1. Do not use this product outdoors, on surfaces other than the ground, or in commercial or industrial environments.
2. Do not use the product in environments without protective fencing (such as duplex floors, open balconies, furniture tops).
3. Do not block the air outlet (so as to avoid deformation, product failure, or fire due to overheating).
4. Do not drag the product body (so as not to scratch the ground).
5. Do not shake or let children play with the product body (so as to avoid injury or damage to the product body).
6. Do not drop the product, bump it against other objects, or apply pressure to the product (so as to avoid fire or electric shock due to product failure).
7. Be sure to install the main brush and filter before use (so as not to cause damage to the motor or product body).
8. Check if the power cable is in good condition before charging the product.
9. Before using the robot vacuum and mop cleaner for the first time or replacing the specified filter, turn off the power on the main unit and make sure that the filter is properly installed.
10. Used battery packs should be properly disposed off. Do not discard them randomly.
11. Before using the product, arrange the desks, chairs, household items, floor objects, etc. neatly, and clear power cords and small items laying on the ground to avoid the product being blocked during cleaning.
12. When the machine is running, keep curtains and tablecloths away from the ground, and keep the carpet flat, so as to prevent the product from being blocked during operation and causing damage to your valuables.
13. Be sure to open the door of each room before the first use, so that the product can build a complete home map.
14. Do not stand in front of the main unit when the appliance is running, to prevent the main unit from being unable to recognize the area to be cleaned.
15. Do not use and store the main unit under extreme adverse conditions, such as extreme temperatures. It is recommended to use it indoors. Store it in a cool and dry place.
16. Do not use the adapter and dust collector to recharge non-rechargeable batteries.

SAVE THESE INSTRUCTIONS

Household use only

User manual requirements for Part 15& IC wireless product:

The user manual shall include the following or similar statement, placed in a prominent location in the text of the manual:

This device complies with part 15 of the FCC Rules. Operation is subject to the following two conditions:

- (1) This device may not cause harmful interference,
- (2) this device must accept any interference received, including interference that may cause undesired operation.

FCC RF Radiation Exposure Statement Caution: To maintain compliance with the FCC's RF exposure guidelines, place the product at least 20cm from nearby persons.

Plus enter the CEC mode to test low power consumption, and the test method to enter the CEC mode: press the power button and the recharge button at the same time for 15 seconds, you will hear the WIFI reset halfway, and finally the power indicator turns off, and you enter the CEC mode.

Caution: Changes or modifications to this unit not expressly approved by the party responsible for compliance could void the user's authority to operate the equipment.

This device contains licence-exempt transmitter(s)/receiver(s) that comply with Innovation, Science and Economic Development Canada's licence-exempt RSS(s). Operation is subject to the following two conditions:

- (1) This device may not cause interference.
- (2) This device must accept any interference, including interference that may cause undesired operation of the device.

L'émetteur/récepteur exempt de licence contenu dans le présent appareil est conforme aux CNR d'Innovation, Sciences et Développement économique Canada applicables aux appareils radio exempts de licence. L'exploitation est autorisée aux deux conditions suivantes:

- 1) L'appareil ne doit pas produire de brouillage;
- 2) L'appareil doit accepter tout brouillage radioélectrique subi, même si le brouillage est susceptible d'en compromettre le fonctionnement.



NOTE

This equipment has been tested and found to comply with the limits for a Class B digital device, pursuant to part 15 of the FCC Rules. These limits are designed to provide reasonable protection against harmful interference in a residential installation. This equipment generates, uses and can radiate radio frequency energy and, if not installed and used in accordance with the instructions, may cause harmful interference to radio communications. However, there is no guarantee that interference will not occur in a particular installation. If this equipment does cause harmful interference to radio or television reception, which can be determined by turning the equipment off and on, the user is encouraged to try to correct the interference by one or more of the following measures:

- Reorient or relocate the receiving antenna.
- Increase the separation between the equipment and receiver.
- Connect the equipment into an outlet on a circuit different from that to which the receiver is connected.
- Consult the dealer or an experienced radio/TV technician for help.

Region Selection (for rWi-Fi 2.4G device)

Limited by local law regulations, version for North America does not have region selection option.

Product overview

Main unit

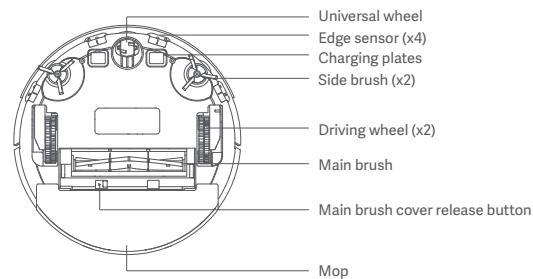
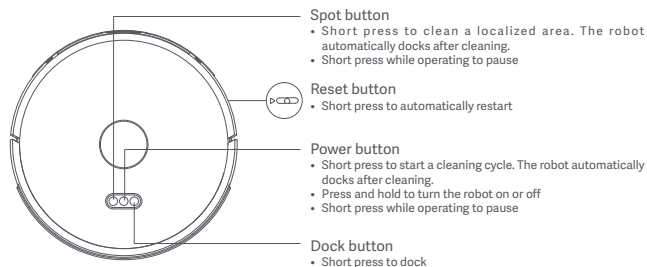
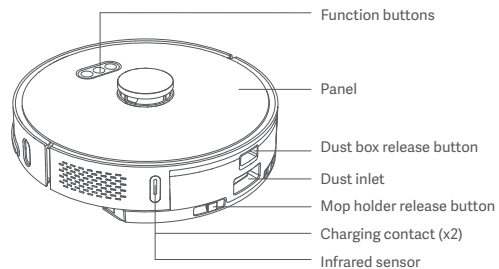
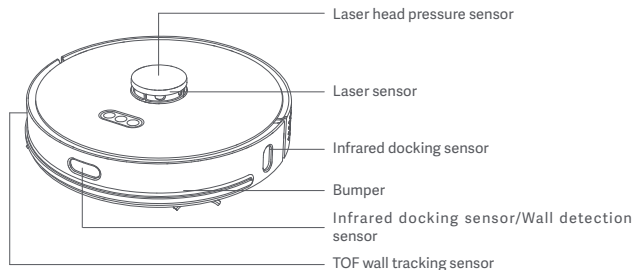

Dust box + water tank (2 in 1) and mopping module

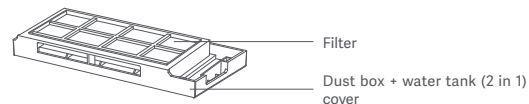
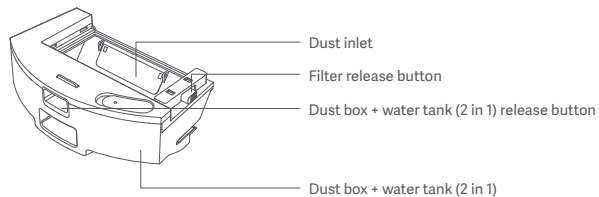

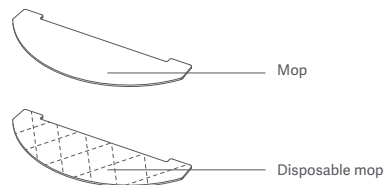
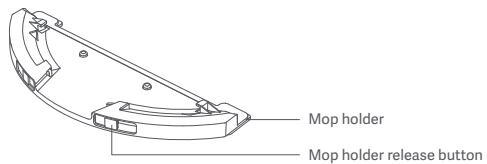

Dust collector (optional)

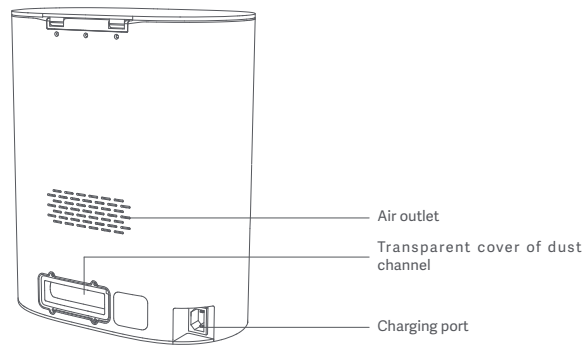
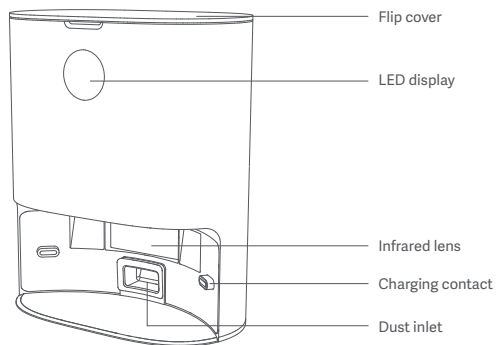

Charging dock (optional)

The recharger will not be sold in North America

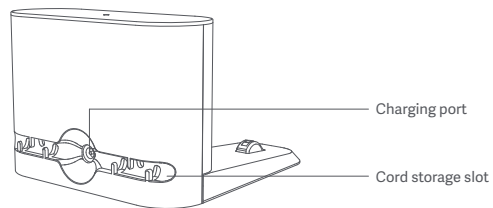
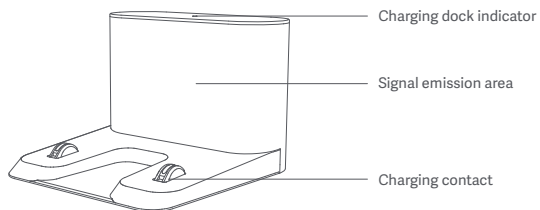

Installation

Installing the dust collector (optional)

Step 1: Find a suitable location to place the dust collector;

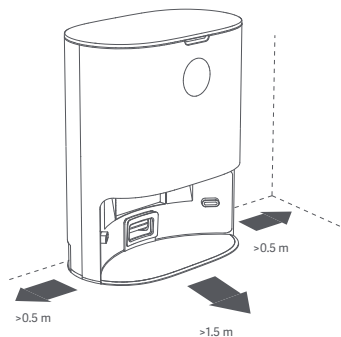

Step 2: Press and hold the Power button on the main unit to turn on the robot vacuum and mop cleaner, then press the Dock button for the robot to search for the dust collector to charge.

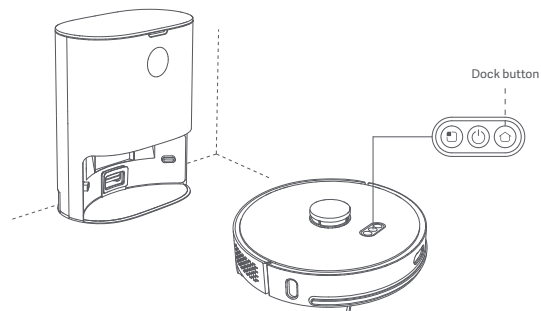

Caution

1. When charging, do not install the mopping module to prevent water seeping from the wet mop and damaging the floor.
2. Do not use this product in the room of infants and young children, keep it away from infants and young children.
3. When the main unit is docked at the dust collector, do not let children or pets approach it or collide with the main unit to avoid danger.
4. In order to facilitate the smooth return of the main unit to the dust collector after cleaning, it is recommended to start the appliance from the dust collector and that you do not move the dust collector during the cleaning process.
5. The dust collector has dust collection and charging functions, and a new dust bag is installed before the product leaves the factory.

Installing the charging dock (optional)

Step 1: Find a suitable location to place the charging dock;

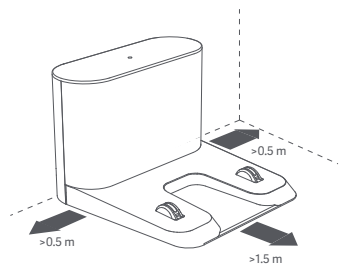

Step 2: Place the charging dock against the wall;

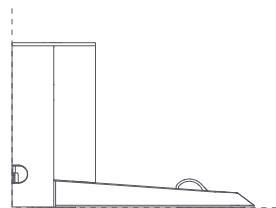

Step 3: Press and hold the Power button on the main unit to turn on the robot vacuum and mop cleaner, then press the Dock button for the robot to search for the charging dock to charge.

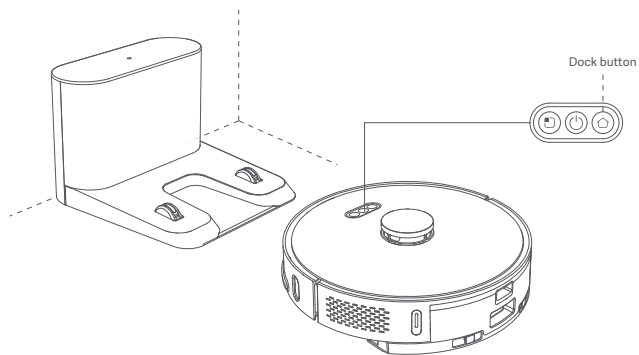

 Caution

1. When charging, do not install the mopping module to prevent water seeping from the wet mop and damaging the floor.
2. Do not use this product in the room of infants and young children, keep it away from infants and young children.
3. When the main unit is docked on the charging dock, do not let children or pets approach it or collide with the main unit to avoid danger.
4. In order to facilitate the smooth return of the main unit to the charging dock after cleaning, it is recommended to start the appliance from the charging dock and that you do not move the charging dock during the cleaning process.

Installing the mopping module

Step 1: Attach the mop
Stick the mop on the designated area on the mop holder

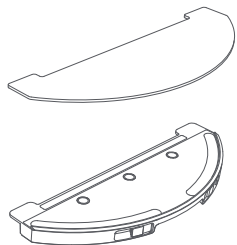

Step 2: Add water to the water tank
Open the cover of the water tank, add water, and then shut the cover

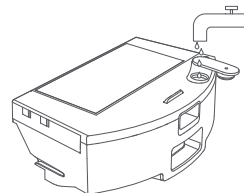

Step 3: Install the dust box + water tank (2 in 1)

Push the dust box + water tank (2 in 1) horizontally in the direction of the groove on the main unit until you hear a "click" sound.

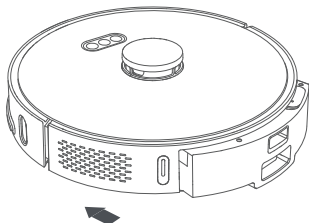

Step 4: Install the mopping module

Push the mopping module buckle in parallel along the dust box + water tank (2 in 1) until you hear a "click" sound.

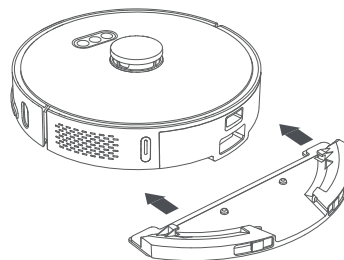

⚠ Caution

1. Do not use the mopping function on the carpet.
2. When charging or when the robot is not in use, remove the mopping module, pour out the excess water in the water tank and clean the mop to avoid mold or odor.
3. It is recommended to clean the mop each time to maintain water speed and cleaning effect. Replace with a new mop if necessary.
4. When charging the main unit on wooden floors, remove the mopping module in a timely manner to prevent water seeping from the mop and damaging the floor.

Downloading app

* Either of below apps can be installed and used

Installing XCLEA app

This product can be controlled using the XCLEA app, which supports both Android and iOS systems.

1. Search for "XCLEA" in the app store or scan the QR code below to download and install the app.
2. Sign in to the app. Long press and buttons on the robot cleaner at the same time for longer than 3 seconds to reset it. Click "+" at the upper right on the app's homepage to add device. Select the robot cleaner from the device list and connect it to WiFi according to the prompts.



3. If you have any question, please contact our service personnel or visit our official website.



* This product only supports 2.4G WiFi

Smart devices can be interconnected via HUAWEI HiLink app.

Devices which support HUAWEI HiLink app can be managed and controlled via Huawei SmartHome app.

Installing Huawei SmartHome app

Scan the QR code, or search for "Huawei SmartHome" in the app store to download and install the app.

① If your phone has Huawei SmartHome app installed, ensure that it is the latest version.

1. Connect your phone to the home WiFi.
2. Open the Huawei SmartHome app. At first use, register an account and log in to the app as per the instructions.
3. Long press and buttons on the robot cleaner at the same time for longer than 3 seconds to reset it. Click "+" at the upper right on the app's homepage to add device.
- ② If no devices are found, click "Add manually" to manually add a device according to the prompts.
4. Click the device you want to add from the device list found. As per the prompts, enter the password of the home WiFi to connect the device to the Home WiFi.
- ③ Only devices which support HUAWEI HiLink protocol (usually on the device's packaging or user manual is marked with text such as "works with HUAWEI HiLink") can be added via the app.



5. Name the device and arrange it in the virtual room created on the app. Once completed, the device is successfully added.

④ Once added, the smart device will be shown under "Home" on the app's homepage. Click the device on the app's homepage to enter the device control interface to control the device.

Turning on/off and cleaning modes

1. Turning on/off

Press and hold the Power button, the Power button indicator is ON and the main unit enters Standby mode. When the main unit is in Idle mode, press and hold the Power button, the indicator slowly turns off and the cleaning cycle is done.

When the main unit is running, press any button to pause the appliance. Press the Power button again to resume the cleaning cycle.

Press the Dock button, the main unit automatically docks and the cleaning cycle will end. Press the Spot button to clean a localized area.

2. Charging

When a cleaning cycle is complete, the main unit automatically docks and charges itself. If an error occurs, resolve the problem and press the Dock button after troubleshooting, the main unit automatically docks.

When the main unit is charging, the Power button indicator is always ON; when fully charged, the indicator breathes (breathes = dim and brighten at a certain rate).

If a cleaning cycle does not start from the charging dock or dust collector, the robot may fail to dock. When the cleaning cycle is complete, the main unit automatically returns to where it started. To return it to the charging dock or the dust collector, press the Dock button.

3. Clean mode

After the main unit is turned on, it scans and intelligently maps out a series of areas. Then it cleans along the wall and then in small arcs until the area is complete. When the cleaning cycle is complete, the main unit automatically returns to the charging dock or the dust collector.

Press the Power button to start a cleaning cycle. The cleaning path is as shown in the figure below. Press any button to pause the cleaning.

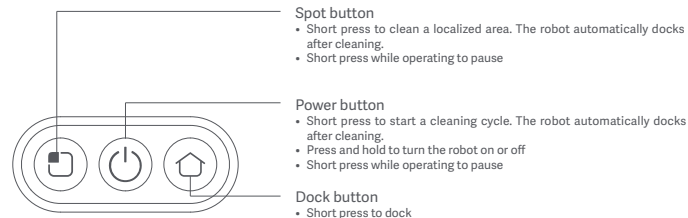
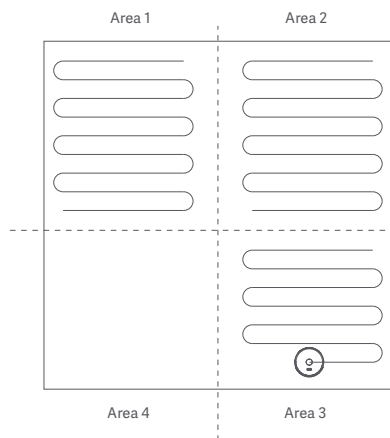

4. Cleaning a localized area

When the main unit is in Standby mode or paused, press the Spot button to start cleaning a localized area. The cleaning area is a 1.6 m x 1.6 m square centered on the main unit. After cleaning, the main unit automatically docks.

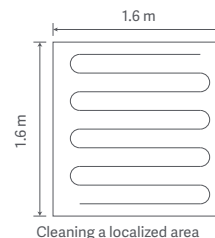

5. Room mode

If a room has been set in map management, select the room and press the Spot button to clean it. If not set, firstly set the room boundaries on the APP.

6. Adding water or cleaning the mop while operating

In Operating mode, to add water or clean the mop, press the Power button to pause the main unit, remove the dust box + water tank (2 in 1) and the mopping module. When finished, reinstall them back, and press the Power button to resume the cleaning cycle.

7. Error symptom

When an error occurs while the main unit is operating, the Power button indicator flashes quickly and a voice prompt will be heard. Refer to the "Troubleshooting" section in this manual to resolve the problem.

8. Sleep mode

After 10 minutes of no operation, the main unit automatically enters Sleep mode. Press any key to wake it up.

9. WiFi reset

When resetting the password or when your phone is unable to connect to the main unit for other reasons, reset the WiFi according to the instructions in "APP downloads" section of this manual.

10. Automatic dust collection (only applicable to robot vacuum and mop cleaner supplied with a dust collector)

When a cleaning cycle is complete, the robot automatically returns to the dust collector for charging and dust collection.

11. Reset button

When the button does not respond or cannot be turned on, please try to reset the system; after reset, the timing cleaning setting and cleaning mode setting of the host will be cleared. Set WiFi.



Caution

1. It is recommended to start cleaning when the main unit is on the charging dock or the dust collector.
2. When power is insufficient during cleaning, the main unit will automatically dock on the charging dock or the dust collector and charge itself. It will return to where it left off and resume cleaning after charging is completed.
3. Before using the product, arrange the desks, chairs, household items, floor objects, etc. neatly, and clear power cords and small items laying on the ground to avoid the product being blocked during cleaning.
4. Do not stand in front of the main unit when the appliance is running, to prevent the main unit from being unable to recognize the area to be cleaned.
5. After the main unit has finished working, it is recommended not to shut it down, and to keep the main unit in the charging state so it can better carry out the next cleaning task.

Turning on/off and operating the dust collector (optional)

Touch the LED display to turn on the dust collection function. When the dust collection function of the integrated station is normal, the outer ring indicator light shows the state of the running water light, and the smell ion generator indicator light is always on for 30 minutes and then goes out. The LED display will also display the remaining power; if the dust bag is not installed, the fault code will be displayed; in addition, the display There are also functions for reminding the work of the smell ion generator, the communication light of the dust collection station and the host, and the function of reminding that the dust is full.

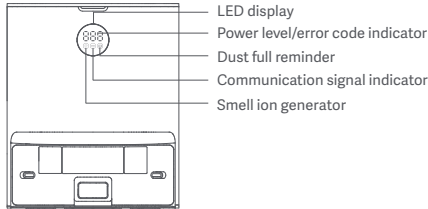

Dust collector status indicator

Status	Outer ring indicator	Power level indicator	Taste ion indicator	Communication signal indicator	Dust full reminder
Initializing	●	888	●	●	●
Main unit in place/dust collector functions well	○	●	○	●	○
Main unit absent/dust collector functions well	●	○	○	○	○
Collecting dust	☀	012 → 001	●	●	○
Normal suction during dust collection	○	○	●	○	○
Abnormal suction during dust collection	○	001	●	●	○
Dust bag full/main unit in place	○	●	●	●	●
Dust bag full/main unit absent	○	○	●	○	●
Dust bag not installed/main unit in place	○	000	○	○	○
Dust bag not installed/main unit absent	○	000	○	○	○
Communication is abnormal/host is in place	○	004	○	○	○
Powered off/indicators turned off via APP	○	○	○	○	○

Remarks: ☀ indicates blinking; ○ indicates off; ● indicates constant on

Reminder: Make sure the dust collector is connected to the power supply and the main unit is in place, so that you can start cleaning and dust collection remotely at any time through the APP.

Cleaning and maintenance

Always turn off the product before any maintenance!

Disassembling and installing the main brush

Step 1: Disassemble the main brush

Turn the robot vacuum and mop cleaner over, press the main brush cover release button to remove the main brush cover. Take out the main brush and clean it.

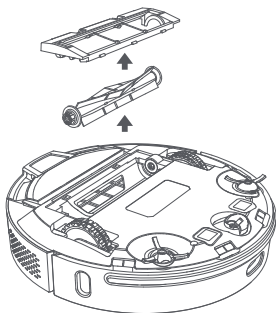

Step 2: Clean the main brush

Use the cleaning brush to pick up and cut away the hair and fibers entangled on the main brush. It is recommended to replace the main brush every 3-6 months.

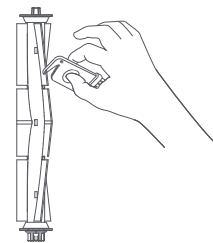

Caution

1. Turn off the product before replacing the main brush.
2. The cleaning brush has a sharp blade, which is used to cut away entangled objects that are difficult to clean. Keep the cleaning brush away from children.

Disassembling and installing the side brush

Step 1: Disassemble the side brush

Turn the robot vacuum and mop cleaner over, remove the screw with a screwdriver, and take out the side brush.

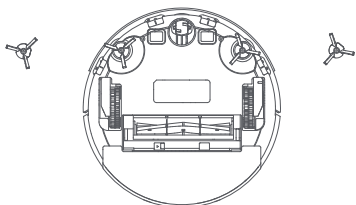

Step 2: Clean the side brush

Use the cleaning brush to pick up and cut away the hair and fibers entangled on the side brush. It is recommended to replace the side brush every 3-6 months to ensure effective cleaning.

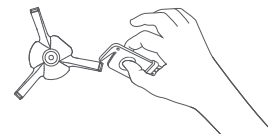



Caution

1. Only replace with a side brush supplied by XCLEA, otherwise, it may lead to damage to the main unit.
2. To avoid scratching yourself, be careful when using a screwdriver to replace the side brush.
3. Install the left and right side brushes correctly onto their respective pins.

Disassembling and installing the dust box and filter

Step 1: Disassemble the dust box + water tank (2 in 1)

Press the dust box + water tank (2 in 1) release button to remove the dust box + water tank (2 in 1).

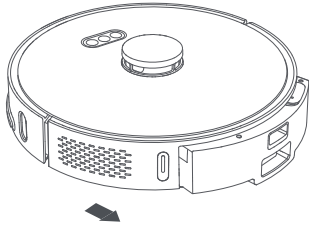

Step 2: Disassemble the filter

Press the filter release button on the right of the dust box + water tank (2 in 1) to remove the filter.

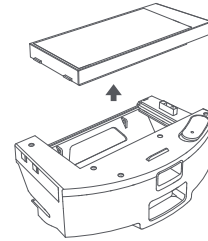

Step 3: Empty the dust box + water tank (2 in 1)

Align the dust box with the opening of a trash can and empty the dust. Use the cleaning brush to clean the dust box corners that are hard to reach.



Step 4: Clean the dust box + water tank (2 in 1)

Rinse the dust box + water tank (2 in 1) with clean water. Air-dry completely for at least 24 hours before reinstalling to prevent dust from clumping during the next use.

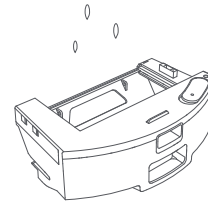

Disassembling and installing the mop

Step 1: Disassemble the mop

Remove the mopping module from the dust box + water tank (2 in 1), and remove the mop from the mopping module.

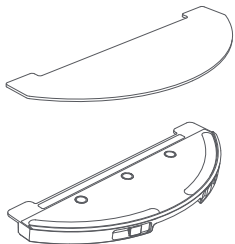

Step 2: Clean the mop

Rinse the mop with clean water. Air-dry completely before reinstalling to prevent dust from clumping during the next use.

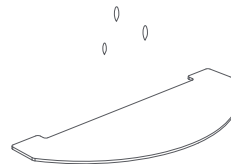

Caution

1. Only replace with a mop supplied by XCLEA, otherwise, it may lead to ineffective cleaning.
2. Be sure to remove and clean the mop to prevent dirty water flowing back.
3. It is recommended to replace the mop every 3-6 months to ensure effective cleaning.

Cleaning the replacement parts

Step 1: Clean the sensors

Use a soft clean cloth to wipe and clean the charging plates on the back, the laser distance sensor on the top, the edge sensors, the infrared docking sensors and the TOF wall tracking sensor.

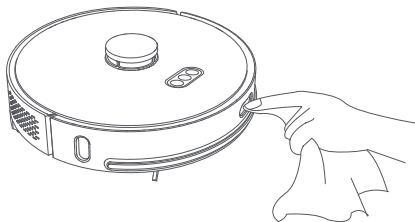

Step 2: Clean the universal wheel

Turn the robot vacuum and mop cleaner over and pull out the universal wheel, clean out the hair and dirt from the wheel and axle. Wash the universal wheel with water, air-dry completely and reinstall it.

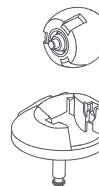

Step 3: Clean the filter

Rinse the dust box filter with clean water. Air-dry completely before reinstalling to prevent dust from clumping during the next use.

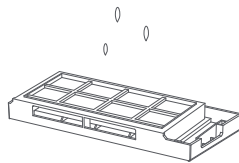

Clean the charging dock (optional)

Step 1: Clean the charging contact

Check whether there is dirt on the charging contacts. Wipe and clean the charging contacts with a soft clean cloth to keep it clean and free of debris.

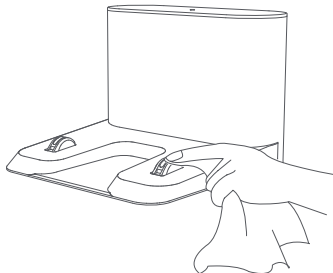

Caution

1. Use a dry cloth to clean the main unit's sensors, infrared sensors and charging contacts. Do not use a wet cloth to prevent water from entering the appliance and causing damage.
2. To avoid scratching yourself, be careful when using a screwdriver to replace the replacement parts.

Clean the dust collector (optional)

Step 1: Replace the dust bag

When the dust bag is full, the dust full indicator on the LED display of the dust collector becomes constant on, replace the dust bag. It is recommended to replace the dust bag every 4 weeks.

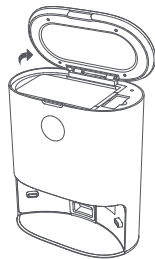

Open the cover of the dust collector

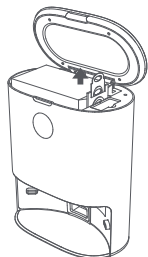

Pull the dust bag handle up to remove the dust bag

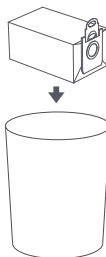

Dispose of the used dust bag

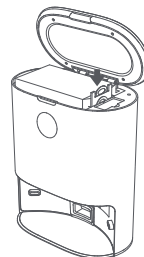

Replace with a new dust bag

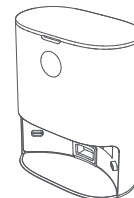

Close the cover of the dust collector

Step 2: Clean the dust channel

If the dust collector does not work while powered on and the dust bag is not full, firstly disconnect it from the power supply and check whether the dust channel is blocked. If it is blocked, use a screwdriver to open its transparent cover and clear out the obstructions.

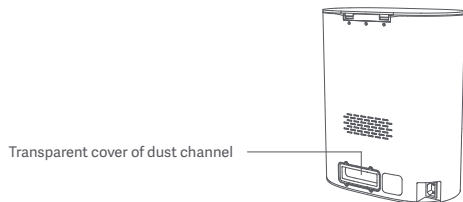

Step 3: Clean the infrared lens and charging contacts

Wipe and clean the infrared lens and charging contacts with a soft clean cloth to keep it clean and free of debris.

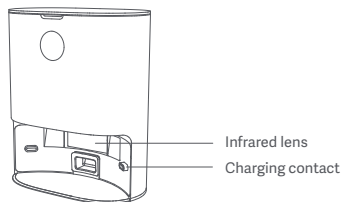

Step 4: Clean the fan filter bracket

Check whether the fan filter bracket is entangled with any foreign objects or debris. Wipe with a soft clean cloth to keep it clean and free of debris.

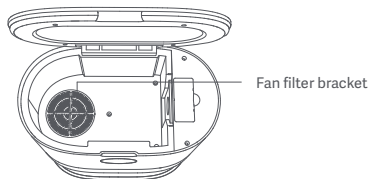

Caution

1. Use a dry cloth to clean. Do not use a wet cloth to prevent water from entering the appliance and causing damage.
2. To avoid scratching yourself, be careful when using a screwdriver to replace the replacement parts.

Troubleshooting

When an error occurs while the robot vacuum and mop cleaner is operating, the Power button indicator flashes quickly and a voice prompt will be heard. Refer to the "Troubleshooting" table below to fix the error.

Error message	Solution
Error 1: Check if the radar is obstructed or stuck. If it is, move the main unit to a new location and start it.	If the radar is obstructed or stuck, remove the obstruction or debris.
	Do not use the product outdoors under sunlight or in places with strong light. Use it indoors.
	If the solutions above do not work, move the main unit to a new location and start it.
	If the alert continues, contact the customer service.

Error message	Solution
Error 2: Check if the bumper is stuck.	If the bumper is stuck, remove the debris and briskly tap the bumper several times to dislodge any debris that may be trapped underneath.
	If the product is trapped because of insufficient space, move it to a new location and start it.
	If the alert continues, contact the customer service.
Error 3: Wipe the edge sensor, move the main unit away from edge and start it.	If the main unit is suspended in the air, move it to a new location and start it.
	If the edge sensor is dirty or obstructed by debris, clean the edge sensor regularly.
	If the alert continues, contact the customer service.
Error 4: Check if the main brush is stuck.	If the main brush is entangled with wool, wires and other debris, remove the main brush and clean it.
	Clean up wool, wires and other debris on the floor.
	Regularly clean the main brush, as it can easily be entangled with debris.
	If the alert continues, contact the customer service.
Error 5: Check if the side brushes are stuck.	If the side brushes are entangled with wool, wires and other debris, remove the side brushes and clean them.
	Clean up wool, wires and other debris on the floor.
	Regularly clean the side brushes, as they can easily be entangled with debris.
	If the alert continues, contact the customer service.
Error 6: Check if the driving wheel is stuck.	If the driving wheel is stuck, clean it.
	If the alert continues, contact the customer service.
Error 7: Reinstall the dust box + water tank (2 in 1).	Reinstall the dust box + water tank (2 in 1) and filter and make sure they are reinstalled properly.
	If the error persists, replace the filter.
	If the alert continues, contact the customer service.
Error 8: Battery is too low, please charge.	Battery is low, charge it before use.
Error 9: Cannot charge. Check if the main unit is correctly connected to the dust collector.	Use a dry clean cloth to wipe the charging contacts on the dust collector and the charging plates on the main unit.
Error 10: Battery pack temperature is too high or too low, try it again later.	If battery temperature is too high or too low, use the appliance when its temperature returns to normal.
Error 11: Check the wall tracking sensor.	If the wall tracking sensor is covered by dust, wipe and clean it.
Error 12: Place the main unit on level ground and start it.	If the main unit is detected to be tilted, place it on level ground and start it.
Error 13: Abnormal vacuum fan.	If the vacuum fan does not work properly, reset the system.
	If the alert continues, contact the customer service.
Error 14: Check if the top radar cover is stuck.	If the top radar cover is stuck or under pressure, move the appliance to a new location and start it.
Error 15: Move the main unit away from forbidden areas and start it.	Move the main unit away from the virtual walls or forbidden areas and start it.
Error 16: Cannot return to the charging dock. Remove any obstacles near the charging dock.	Remove any obstacles that are closer than 1.5 m from the front of the charging dock.
Error 17: Dust bag is not in place.	Check if the dust bag is installed.
	If installed, check if it reaches the bottom of the charging dock.
	If the alert continues, contact the customer service.
Error 18: Dust bag is full.	If the dust bag is full, replace with a new one.
	If the dust bag is not full, check if the dust collector's channel is clogged. If clogged, clean the dust channel.
	If the alert continues, contact the customer service.
Error 19: Clean the dust box + water tank (2 in 1) if it has not been cleaned for a long time.	If there is excessive dust in the dust box + water tank (2 in 1), clean it and the filter.

Error message	Solution
Error 20: Clean the filter.	Remove the filter and clean it.

Tip: Resetting the system can fix some errors.

FAQs

Question type	Solution
Cannot power on	If the battery power is insufficient, dock the main unit on the charging dock and fully charge it before next use. If the battery temperature is too low or too high, use the product at temperatures of 0-40 °C.
Cannot charge	Make sure both ends of the charging dock's power cable are firmly plugged in. If poor contact is detected, clean the charging contacts on the charging dock and the charging plates on the main unit. Confirm if the charging indicator turns on.
Slow charging	When the product is used at extreme temperatures, to extend the battery life, the main unit will automatically reduce the charging speed. If the charging contacts are dirty, clean them with a dry cloth.
Cannot dock	If there are many obstacles near the charging dock, place it in a clear, open space. If the main unit is far away from the charging dock, place it near to the charging dock and try again.
Abnormal operation	Restart the appliance.
Abnormal noises while cleaning	If the main brush, side brush or driving wheel is entangled with debris, turn off the appliance and clean. If the universal wheel is dusty or jammed while cleaning, it is recommended to use a screwdriver to remove the wheel and rinse it under water.
Decreased cleaning ability or dust falls out of the main unit	If the dust box is full, clean the dust box. If the filter is clogged, clean the filter. If the main brush is entangled with debris, clean the main brush.
Cannot connect to WiFi	If WiFi function is not activated, reset WiFi and try again.
	If WiFi signal is poor, place the main unit within the coverage of WiFi signal.
	If WiFi connection is abnormal, reset WiFi, download the latest mobile client and try again.
	If the APP does not support the current device model, follow the prompts to check the models supported.
Cannot connect to WiFi suddenly. If the router settings are incorrect, contact the customer service.	
Scheduled cleaning does not start	Insufficient power. Scheduled cleaning will only start when the power level is greater than 15%.
Is energy consumption high if the main unit is kept on the charging dock?	Keeping the main unit on the charging dock helps to keep the battery at its best performance, and the energy consumption is low.
Is it necessary to charge for 16 hours during the first three uses?	Lithium batteries exhibit no memory effect. You may use the appliance when the battery is full.
Mopping module discharges little or no water	Check whether there is sufficient water in the water tank. Adjust the water volume to Large via the APP. Make sure the mop and mop holder are installed correctly according to the instructions.
Main unit does not resume cleaning after docking for charging	Make sure the main unit is not in "Do Not Disturb" mode, in which the main unit does not resume cleaning. It also does not resume cleaning if it is docked by pressing the Dock button or manually returned to the charging dock.
Main unit does not return to charging dock after cleaning a localized area or after being moved	After cleaning a localized area or being moved far away, the robot vacuum and mop cleaner will generate a new map. If the charging dock is far away, the main unit may not automatically dock. In this case, manually return the main unit back on the charging dock to charge.
Robot vacuum and mop cleaner misses spots	If the wall tracking sensor or edge sensor is dirty, clean them with a soft dry cloth.

Technical data

Product name	Robot vacuum and mop cleaner	Product model	QYSDJ01
Rated operating voltage	14.4 V==	Rated power	50 W
Lithium battery capacity	5200mAh	Rated charging voltage	24 V==
Net weight	ca. 3.5 kg	Dimensions	355 x 355 x 100 mm
Charging time	ca. 250 minutes	Noise level (low/medium/high)	<75dB (A)
Dust box capacity	300 ml	Cleaning time	ca. 250 minutes
Water tank capacity	About 250 ml	Battery type	lithium battery

Product name	Dust collector	Product model	QYJCZ01
Rated power	850 W	Rated input	100 - 130 V~, 50-60 Hz
Rated output	24 V==, 1.2 A	Dimensions	358 x 300 x 174 mm
Net weight	ca. 4.3 kg	Noise level	≤82 dB(A)
Vacuum time	ca. 12 seconds	Dust bag capacity	ca. 3L

Product name	Charging dock	Product model	QYHCZ01
Rated operating voltage	24 V==	Rated power	30 W
Rated input	24 V==, 1.2 A	Rated output	24 V==, 1.2 A
Net weight	ca. 0.4 kg	Dimensions	145 x 140 x 99 mm

Product name	Power adapter	Power adapter
Rated input	100-240V~, 50-60 Hz, 0.9 A	100-240V~, 50-60 Hz, max. 1.0 A
Rated output	24 V == 1.2 A, 28.8 W	24 V == 1.2 A, 28.8 W
Product model	China: DBS036A-2401200C ; United Kingdom: DBS036A-2401200B ; Korea: DBS036A-2401200K ; United States: DBS036A-2401200U ; Japan: DBS036A-2401200J ; European Union: DBS036A-2401200G ;	China: KA3601A-2401200CN ; United Kingdom: KA3601A-2401200BS ; Korea: KA3601A-2401200KR ; United States: KA3601A-2401200US ; Japan: KA3601A-2401200JP ; Australia: KA3601A-2401200AU ; European Union: KA3601A-2401200EU ;

System requirements: Android 5.0 or later, iOS 10.0 or later (iPhone 5 or later)
 This product includes a WiFi module that supports the 802.11b/g/n transmission protocol.
 CMIIT ID:2020DP11783

Disposal

Correct disposal of this product



This marking indicates that this product should not be disposed with other household wastes throughout the EU. To prevent possible harm to the environment or human health from uncontrolled waste disposal, recycle it responsibly to promote the sustainable reuse of material resources. To return your used device, please use the return and collection systems or contact the retailer where the product was purchased. They can take this product for environmental safe recycling.

Warranty and limitations of liability

This product is guaranteed for a period of 12 months (defined by local law) from the date of purchase against any failure resulting from manufacturing or material defects.

This warranty does not cover damage caused by improper installation, improper use, or normal wear and tear of the product.

More specifically, the warranty does not cover:

- Dust bag, disposable mop, side brush, filter, mop, main brush and main brush cover are not covered by the warranty as they are consumable items.
- Damage or problems caused by improper use, accident, alteration or electrical connection of improper intensity or voltage.
- Modified products, those whose warranty seal or serial number have been damaged, altered, removed or oxidized.
- Failure of the battery due to overcharging or failure to observe the safety instructions explained in the instruction manual.
- Cosmetic damage, including scratches, dents, or any other element.
- Damage caused by any intervention carried out by an unauthorised person.
- Defects caused by normal wear and tear or due to normal ageing of the product.
- Software updates due to a change in network settings.
- Product failures due to the use of third party software to modify, change or adapt the existing software.
- Product failures caused by use without accessories approved by the manufacturer.
- Oxidised products.

Terms and conditions of implementation:

To obtain a warranty service, you are requested to return your product to the customer service desk of your retail outlet with your proof of purchase (receipt, invoice, ...), the product and its supplied accessories, with its original packaging.

It is important to have the date of purchase, the model and the serial or IMEI number on hand as information (this information usually appears on the product, the packaging or your proof of purchase).

Failing this, you must return the product with the accessories necessary for its proper operation (power supply, adaptor, etc.).

In the event that your claim is covered by the warranty, the after-sales service may, within the limits of local law, either:

- Repair or replace defective parts.
- Exchange the returned product with a product that has at least the same functionality and that is equivalent in terms of performance.
- Refund the product at the purchase price of the product mentioned on the proof of purchase.

If one of these 3 solutions is used, this does not give rise to the extension or renewal of the warranty period.

Warranty card

Customer name		Product name and model	
Mailing address		Main unit serial number	
Contact information		Purchase date	

This warranty card contains customers' personal information, keep it safe

Maintenance records

Servicing center	Fault description	Replacement parts	Servicing engineer	Servicing date



FCC ID:xxxxxxxxxx



Correct disposal
of this product



for indoor
use only



protection
fuse: T 3.15A



Scan the QR code for manuals
in multiple languages

Manufacturer: CLEA Smart Technology Co., Ltd.
Address: Floor 4, No. 1719-17, Huishan Road, Huishan Economic Development District, Wuxi City, China.
Executive standards:

10 C.F.R. section 430.23(aa)
CAN/CSA-C381.2-17
FCC 47 CFR Part 15: 2019 and ANSI C63.4: 2014
California Proposition 65 for client's requirement
- Total Lead (Pb) content
- Phthalate content
Service email: service@xclea.com
Website: www.xclea.com
Version: V2.0 09.2021
Only applicable to the robot vacuum and mop cleaner model QYSDJ01
Made in China