

VENUE SC48 Guide

and Software Version 2.8 for VENUE SC48 Systems

Digidesign

2001 Junipero Serra Boulevard
Daly City, CA 94014-3886 USA
tel: 650-731-6300
fax: 650-731-6399

Technical Support (USA)

tel: 650-731-6100
fax: 650-731-6375

Product Information (USA)

tel: 650-731-6102
tel: 800-333-2137

International Offices

Visit the Digidesign website
for contact information

Website

www.digidesign.com

Legal Notices

This guide is copyrighted ©2009 by Digidesign, a division of Avid Technology, Inc. (hereafter "Digidesign"), with all rights reserved. Under copyright laws, this guide may not be duplicated in whole or in part without the written consent of Digidesign.

003, 003 Rack, 96 I/O, 96i I/O, 192 Digital I/O, 192 I/O, 888|24 I/O, 882|20 I/O, 1622 I/O, 24-Bit ADAT Bridge I/O, AudioSuite, Avid, Avid DNA, Avid Mojo, Avid Unity, Avid Unity ISIS, Avid Unity MediaNetwork, Avid Xpress, AVoption, AVoption|V10, Beat Detective, Bruno, C|24, Command|8, Control|24, D-Command, D-Control, D-Fi, D-fx, D-Show, DAE, Digi 002, Digi 002 Rack, DigiBase, DigiDelivery, Digidesign, Digidesign Audio Engine, Digidesign Intelligent Noise Reduction, Digidesign TDM Bus, DigiDrive, DigiRack, DigiTest, DigiTranslator, DINR, DV Toolkit, EditPack, Eleven, Impact, Interplay, M-Audio, MachineControl, Maxim, Mbox, MediaComposer, MIDI I/O, MIX, MultiShell, OMF, OMF Interchange, PRE, ProControl, Pro Tools M-Powered, Pro Tools, Pro Tools|HD, Pro Tools LE, QuickPunch, Reel Tape, Reso, Reverb One, ReVibe, RM1, RM2, RTAS, Smack!, SoundReplacer, Sound Designer II, Strike, Structure, SYNC HD, SYNC I/O, Synchronic, TL Space, Velvet, X-Form, and Xpand! are trademarks or registered trademarks of Digidesign and/or Avid Technology, Inc. All other trademarks are the property of their respective owners.

Product features, specifications, system requirements, and availability are subject to change without notice.

Guide Part Number: 9322-61189-00 REV A 04/09

Comments or suggestions regarding our documentation?
email: techpubs@digidesign.com

Communications & Safety Regulation Information

Compliance Statement

The model VENUE SC48 complies with the following standards regulating interference and EMC:

- FCC Part 15 Class B
- EN55103-1 E3
- EN55103-2 E3
- AS/NZS 3548 Class B
- CISPR 22 Class B

Radio and Television Interference

This equipment has been tested and found to comply with the limits for a Class B digital device, pursuant to Part 15 of the FCC Rules.

DECLARATION OF CONFORMITY

We, Digidesign, 2001 Junipero Serra Boulevard
Daly City, CA 94014-3886, USA
650-731-6300

declare under our sole responsibility that the product
VENUE SC48

complies with Part 15 of FCC Rules.

Operation is subject to the following two conditions: (1) this device may not cause harmful interference, and (2) this device must accept any interference received, including interference that may cause undesired operation.

Communication Statement

NOTE: This equipment has been tested and found to comply with the limits for a Class B digital device, pursuant to Part 15 of the FCC Rules. These limits are designed to provide reasonable protection against harmful interference in a residential installation. This equipment generates, uses, and can radiate radio frequency energy and, if not installed and used in accordance with the instructions, may cause harmful interference to radio communications. However, there is no guarantee that interference will not occur in a particular installation. If this equipment does cause harmful interference to radio or television reception, which can be determined by turning the equipment off and on, the user is encouraged to try and correct the interference by one or more of the following measures:

- Reorient or locate the receiving antenna.
- Increase the separation between the equipment and receiver.
- Connect the equipment into an outlet on a circuit different from that to which the receiver is connected.
- Consult the dealer or an experienced radio/TV technician for help.

Any modifications to the unit, unless expressly approved by Digidesign, could void the user's authority to operate the equipment.

Canadian Compliance Statement:

This Class B digital apparatus complies with Canadian ICES-003

Cet appareil numérique de la classe B est conforme à la norme NMB-003 du Canada

Australian Compliance



CE Compliance Statement:



Digidesign is authorized to apply the CE (Conformité Européenne) mark on this compliant equipment thereby declaring conformity to EMC Directive 89/336/EEC and Low Voltage Directive 73/23/EEC.

Input Rating

I/P: 100-120V~/220-240V~, 50/60 Hz, 200W

Safety Statement

This equipment has been tested to comply with USA and Canadian safety certification in accordance with the specifications of UL Standards: UL60065 7th /IEC 60065 7th and Canadian CAN/CSA C22.2 60065:03. Digidesign Inc., has been authorized to apply the appropriate UL & CUL mark on its compliant equipment.

Warning



Important Safety Instructions

- 1) Read these instructions.
 - 2) Keep these instructions.
 - 3) Heed all warnings.
 - 4) Follow all instructions.
 - 5) Do not use this equipment near water.
 - 6) Clean only with dry cloth.
 - 7) Do not block any ventilation openings. Install in accordance with the manufacturer's instructions.
 - 8) Do not install near any heat sources such as radiators, heat registers, stoves, or other equipment (including amplifiers) that produce heat.
 - 9) Do not defeat the safety purpose of the polarized or grounding-type plug. A polarized plug has two blades with one wider than the other. A grounding type plug has two blades and a third grounding prong. The wide blade or the third prong are provided for your safety. If the provided plug does not fit into your outlet, consult an electrician for replacement of the obsolete outlet.
 - 10) Protect power cords from being walked on or pinched particularly at plugs, convenience receptacles, and the point where they exit from the equipment.
 - 11) Only use attachments/accessories specified by the manufacturer.
 - 12) Use only with a cart, stand, tripod, bracket, or table specified by the manufacturer, or sold with the equipment. When a cart is used, use caution when moving the cart/equipment combination to avoid injury from tip-over.
 - 13) Unplug this equipment during lightning storms or when unused for long periods of time.
 - 14) Refer all servicing to qualified service personnel. Servicing is required when the equipment has been damaged in any way, such as power-supply cord or plug is damaged, liquid has been spilled or objects have fallen into the equipment, the equipment has been exposed to rain or moisture, does not operate normally, or has been dropped.
 - 15) The equipment shall not be exposed to dripping or splashing and no objects filled with liquids (such as vases) shall be placed on the equipment.
- Warning!** To reduce the risk of fire or electric shock, do not expose this equipment to rain or moisture.
- 16) The equipment should be connected to a properly-grounded (earthed) receptacle.
 - 17) The main power switch is located on the back panel of the VENUE SC48. It should remain accessible after installation.
 - 18) The mains plug is used as the disconnecting device and shall remain readily operable.
 - 19) The equipment shall be used at a maximum ambient temperature of 40° C.
 - 20) CAUTION! Danger of explosion if battery is incorrectly replaced. Replace only with the same or equivalent type.

Contents

Part I Overview and Installation

Chapter 1. Introduction to VENUE SC48	3
VENUE SC48 Features	3
System Components	4
VENUE SC48 Expansion Options	5
Operational Requirements	5
Connection Requirements	5
Chapter 2. Configuring and Connecting SC48	7
Unpacking and Assembling the Console	7
Connecting the VENUE SC48	9
Connecting AC Power	9
Connecting a VGA or DVI Display	9
Connecting USB Keyboard and Mouse	9
Connecting Audio	10
Connecting Synchronization, Control, and Lights	11
Powering Up the System	13
Setting the System Clock	13
Installing Other Optional Software	13
About Digital Input and Sample Rate Conversion	13

Part II System Description

Chapter 3. VENUE SC48 Control Overview	17
VENUE SC48 Top Panel	17
Input Channels and Faders	18
Selected Channel Sections (ACS)	22
Flex Channel	23
Output Masters	24
Master and Global Controls	25
Chapter 4. Basic Commands and Modes	27
Control Overview	27
Config Mode and Show Mode	28
System Lock	28
Global Modifier Switches	29
Software Screen Pages and Tabs	30

Chapter 5. Navigating and Selecting Channels	33
Banking Input Channels and FX Returns	33
Banking the Output Section	36
Selecting and Targeting Channels	36
Targeting Plug-In Inserts	37
Screen Controls	38
Screen Shortcuts	39
Input Channel Presets	42
Chapter 6. Channel Control	45
Using Channel Control	45
Functions	46
User Assignment	48
Availability of Channel Control Functions	49
Chapter 7. Options	51
System	51
Devices	53
Other Options and Settings	53
Part III Signal Routing	
Chapter 8. Inputs and Input Routing	63
Configuring Inputs	63
Assigning Input Sources to Channels	64
Routing Input Channels	65
Using Built-In Dynamics and EQ	67
Using Inserts on Channels	68
Adjusting Input Controls	68
Flex Channel	71
Using Input Direct	72
Chapter 9. Outputs and Output Routing	73
Configuring Outputs	73
Assigning Busses to Hardware Outputs	74
Routing Group Outputs to the Main Busses	75
Using Inserts on Output Busses	75
Adjusting Output Controls	76
Adjusting Main Bus Controls	77
Direct Outputs	78
Matrix Mixers	79
Assigning and Using VCAs	79

Chapter 10. Groups	81
Configuring Group Busses	81
Routing Inputs to Group Busses	81
Routing Group Outputs to the Main Busses	81
Managing Group Bus Assignments	82
Group Bus Signal Flow Options	84
Adjusting Group Bus Output Controls	84
Simple and Expert Operational Modes	85
Chapter 11. Aux Sends	87
Configuring Aux Busses	87
Routing Inputs to Aux Busses	88
Routing Aux Busses to Outputs and Plug-Ins	89
Adjusting Aux Send Controls	90
Managing Aux Bus Assignments	91
Chapter 12. Matrix Mixers	93
Matrix Mixers	93
Configuring Matrix Mixers	94
Adjusting Matrix Mixer Input Controls	96
Adjusting Matrix Mixer Output Controls	98
Snapshot Data and Parameters for Matrix Mixers	98
Chapter 13. Patchbay	99
Accessing the Patchbay	99
Overview of the Patchbay	99
Navigating the Patchbay	101
Routing Channels in the Patchbay	102
Warning when Stealing Inputs or Outputs in the Patchbay	103
VENUE System Information Export	104
Patch List Export	105
Chapter 14. Metering	107
Channel Meters	107
ACS Input and Dynamics Meters	108
Metering Section	109
Metering Options	110
Chapter 15. Solo and Monitor Busses	111
Solo Bus Modes	111
Selecting a Solo Mode	111
Solo Operation Options	112
Solo Bus Operation	113
Soloing Single Channels	113
Solo Safing Channels	114
Monitor Bus Operation	114
Talkback, 2-Track and Oscillator Controls	116

Chapter 16. Muting and Mute Groups	119
Muting	119
Mute Groups	119
Function Switches	121

Part IV Processing

Chapter 17. Dynamics	125
Built-In Compressor/Limiter	125
Built-In Expander/Gate	126
Adjusting Dynamics	128
Channel Modes Affecting Dynamics	130
Dynamics Settings and Presets	130
Side-Chain Keys and Filters	131

Chapter 18. EQ	133
Built-In EQ Parameters	133
Channel Modes Affecting EQ	134
Adjusting EQ	135
Graphic EQ for Outputs	138
Adjusting EQ Plug-Ins	139
EQ Settings and Presets	139

Chapter 19. Plug-Ins	143
Installing and Authorizing Plug-Ins	143
Plug-in Version Checker	146
USB Ports for iLoks	147
Overview of Plug-Ins	147
Plug-In Racks	148
Rack Slots	150
Assigning and Routing Plug-Ins	151
Adjusting Plug-Ins	154
Plug-In Presets and Snapshots	156
Plug-In DSP Usage	157
Plug-In Levels	157
Plug-In Latency and Processing Delay	157

Part V Shows

Chapter 20. Shows and File Management	161
Creating Shows	161
Loading Shows	162
Working with Presets	163
Transferring Settings, Shows and Presets	165
Undoing Changes Using the History Feature	166

Chapter 21. Snapshots	167
Snapshots Page	167
Snapshot Controls on the SC48 Console	170
Snapshots List	170
Creating Snapshots	172
Recalling Snapshots	173
Recall Safe and Channel Automation Safe	174
Managing Snapshots	178
Making Changes to Snapshots	180
Preview Mode	181
Undoing Snapshot Commands	184
Disabling Snapshots	184
Adding MIDI Messages to Snapshots	185
Adding Tempo Data to Snapshots	186
Adding Plug-In Data to Snapshots	186
Snapshot Options	188
Snapshot Data Types and Parameters	190
Chapter 22. Events	191
Introduction	191
The Events Window	192
Creating Events	194
Creating Triggers	195
Creating Actions	197
Testing Events	198
Resetting Events	198
Snapshots and Events	199
Default Settings, Templates and Examples	200
Tap Tempo for Plug-ins	201
Trigger Types	203
Action Types	204
Chapter 23. Synchronization	207
Automating Recall of Snapshots with MIDI Time Code	207
Remote Control of Snapshot Recall	209
Triggering of External Devices on Snapshot Recall	210
Sending MIDI Messages on Snapshot Recall	210
Synchronizing with Word Clock and Digital Audio Input	210
Chapter 24. Using the Standalone Software	211
System Requirements	211
Installing the Standalone Software	211
Simulating a VENUE Configuration	212
Transfer and Filing Quick Start	212
Exporting System Information and Patchbay Information	214

Part VI Specifications

Chapter 25. Mechanical Specifications	217
Chapter 26. Audio Specifications	219
Stage I/O	220
FOH I/O	221
Chapter 27. Signal Flow Diagrams	223
VENUE SC48 Input Signal Flow Diagram	223
VENUE SC48 Output Signal Flow Diagram	224
Chapter 28. Troubleshooting	225
Problem Solving	225
In Case of System Failure	227
Performing a Soft Reset	229
Hardware Monitoring Window	230
Resetting Hardware Components	230
Using the System Restore CD to Update or Restore the System	231

Part VII Reference

Chapter 29. Console Reference	235
GPI (General Purpose Interface)	235
GPI Wiring Diagrams	236
Chapter 30. FWx	239
FWx Capabilities and Features	239
FWx Components	239
Pro Tools LE Requirements for FWx	239
Installing Pro Tools LE	240
Using FWx	240
Signal Routing for FWx Recording	240
Signal Routing for FWx Playback	242
Using Synchronization and Time Code with FWx	242

Chapter 31. ECx	243
ECx Capabilities and Features	243
ECx Components	243
System Requirements	243
Installing ECx Host Software	243
Overview of ECx Setup and Configuration	245
Connecting a Computer Directly to VENUE	245
Connecting a Wireless Router or WAP to VENUE	245
Setting VENUE and Client IP Addresses	246
Establishing a Wireless Connection	249
Enabling Remote Operation	250
Disconnecting ECx	251
Changing the Ethernet Control Password	251

Part I: Overview and Installation

Chapter 1: Introduction to VENUE SC48

Welcome to the VENUE SC48 live sound mixing console from Digidesign®. VENUE SC48, part of Digidesign's modular VENUE live sound environment, is a fully self-contained console with an intuitive control surface layout, a flexible I/O scheme, powerful digital processing and integrated Pro Tools recording and playback.

VENUE SC48 Features



Figure 1. VENUE SC48 console

SC48 Control Features

- 16 bankable input channel strips, each with a touch-sensitive fader, one multi-purpose assignable rotary encoder, solo, mute and select controls
- 48 input channels with full processing, plus 8 stereo FX Returns
- Built-In High-Pass Filter, Dynamics and EQ processors on each input channel strip
- Level meters on each input channel strip
- Channel Control section for customizable center section control of input settings, dynamics and EQ (or dyn/EQ plug-ins) settings, and Aux Sends.
- 1 FlexChannel for full-time, high-resolution control of your primary input (podium, lead vocal, soloist, or other)
- 8 multi-purpose Output faders strips, each with a touch-sensitive fader, one multi-purpose encoder, solo, mute and select controls
- 1 Mains fader
- Up to 24 31-band Graphic EQs available for Outputs
- Main Busses configurable as Left–Center–Right or Left–Right+Mono

SC48 Audio I/O

Stage I/O

- 48 analog mic/line inputs with mic preamps for stage inputs. Each fully recallable input provides discrete, selectable phantom power, input gain, polarity invert, and a High-Pass filter
- 16 analog output channels (expandable up to 32) to connect to mains and monitors

FOH I/O

- Talkback mic input, with gain and phantom power
- Headphone output
- Analog and digital (AES) 2-Track inputs and outputs
- FWx port (FireWire 1394) providing 18 channels of fully integrated recording and playback with a compatible Pro Tools LE system

Synchronization, Control and Utility I/O

- 4 external USB 2.0 inputs for keyboard, mouse, iLok USB Smart Keys, and USB storage devices
- 1 internally-mounted, secure USB 2.0 port
- Video monitor port (VGA and DVI connectors) for software screen display
- MIDI In and Out ports, providing 16 channels of MIDI input and 16 channels of MIDI output
- Word clock I/O for digital clock synchronization
- RJ-45 (100 BaseT Ethernet) port for ECx Ethernet-based remote control
- 2 GPI inputs and 2 GPI outputs (DB9)
- 2 three-pin XLR lamp light outputs

CPU, DSP, and System Drives

The VENUE SC48 also houses the CPU, DSP Mix Engine, hard drive and CD-ROM drive that run the VENUE D-Show software on your system. VENUE D-Show software is installed at the factory. The CD-ROM drive lets you update or restore your VENUE system software, and install compatible plug-ins from their installer discs.

Power Supply Units (PSUs)

All VENUE SC48 units ship with at least one universal PSU (100V to 240V nominal 50–60 Hz).

System Components

Included Components

All VENUE SC48 systems include the following:

VENUE SC48

- VENUE SC48 console
- One (1) or two (2) IEC power cables, North American standard
- Monitor mount (for VGA screen, screen not included)
- Mouse tray (mouse/trackball not included)
- Accessory tray
- VENUE SC48 Guide
- VENUE Mouse Pad
- Dust cover

Software CDs, iLoks

- System Restore CD
- ECx Ethernet Control Software Installer CD
- Standalone Software Installer CD
- iLok USB Smart Key (for storing plug-in authorizations)
- Plug-in installer discs (if purchased) with pre-authorized iLok

Additional Required Components

The following components must be purchased separately:

- Video Display (15-inch or greater flat-panel TFT display recommended; 1024x768 minimum resolution). VGA and DVI supported.
- USB keyboard and trackball/mouse (Windows compatible)

Optional Components

The following components are optional, and must be purchased separately:

- USB flash disk (or other portable USB storage device for transfer of Show data; 512 MB or larger recommended)
- Headphones with 1/4-inch jack (for FOH monitoring)
- Dynamic or condenser microphone and XLR mic cable (for Talkback)
- Footswitches (up to 2)
- MIDI cables (for connecting external MIDI devices)
- BNC cables (for connecting Word clock between the VENUE system and external digital devices)
- DB9 (9-pin) cables (for connecting to GPI devices)
- Two (2) Console lights

VENUE SC48 Expansion Options

The following options can be added to VENUE SC48 systems. For details on all VENUE systems and options, visit the DigiDesign website (www.digidesign.com).

Each SC48 supports a maximum of three input cards and two output cards.

Inputs You can replace any of the three input cards with a new AI16 Analog Input card.

Outputs Output can be expanded to up to 32 channels for expanded analog output, for mixed analog/digital output, or for personal monitoring.

- Analog outputs can be expanded by installing an additional AO16 Analog Output card.
- Analog and digital output can be added by installing an XO16 Analog/Digital Output card, providing eight digital output channels in addition to eight more analog outputs.
- For personal monitor mixing, the AT16 A-Net Output card can be added to integrate VENUE SC48 with Aviom® networks and Pro16™ Series mixers.

Operational Requirements

Temperature and Ventilation

VENUE units should be operated away from heat sources and with adequate ventilation.



Hardware monitoring and automatic warnings are provided for temperature, power and other factors. For more information, see “Hardware Monitoring Window” on page 230.

Storage

VENUE SC48 should be stored and transported at temperatures not lower than 0 degrees F (–18 degrees C) and not exceeding 140 degrees F (60 degrees C).

Operation

VENUE SC48 should be operated at temperatures not lower than 40 degrees F (4 degrees C) and not exceeding 104 degrees F (40 degrees C).

During operation, the front and back panels of VENUE SC48 should be exposed to ambient air. Do not block the ventilation holes on any VENUE SC48 component.

Do not operate in direct sunlight or at extreme ambient temperatures.

Water and Moisture

VENUE units should be operated away from sources of direct moisture and should be kept clear of liquids that might spill into the units. If condensation is present on the unit, leave the unit to dry in ambient air for at least one hour before powering the unit on.

Humidity ranges for storage and operation

Storage humidity range	5% to 95%, non-condensing
Operating humidity range	20% to 80%, non-condensing

Cleaning and Maintenance

If you need to clean the VENUE SC48 top surface, use a dry cloth. Do not apply any cleaning solutions, spray cleaners, or abrasives to the surface.

Connection Requirements

Power Connections

Each unit requires its own power connection for primary power, and for redundant power on systems with dual PSUs.

Make sure your power source is correctly rated for the number of units you are connecting. A surge-protected power source (not included) is highly recommended.

VENUE SC48 power supplies are capable of operating at 50 to 60 Hz across a voltage range of 100 to 240 V.

SC48 with Redundant PSUs

When using an uninterruptible power supply (UPS) it is recommended to connect one of the console power supplies to the UPS and the other directly to house power.

Audio Connections

All VENUE SC48 analog audio inputs and outputs (except Headphones) are balanced XLR or balanced 1/4-inch connections. All VENUE SC48 external digital audio inputs and outputs are AES/EBU (XLR) connections.



For more information on audio connectors and specifications, see Chapter 26, “Audio Specifications.”

Chapter 2: Configuring and Connecting SC48

The chapter shows how to get your SC48 console up and running by doing the following:

- Unpack and assemble the console
- Connect the following to the VENUE SC48:
 - Power (AC)
 - Display (VGA/DVI)
 - USB keyboard and mouse
 - Audio (stage and FOH inputs and outputs)
 - Synchronization and control (Ethernet, MIDI, or Word clock) and lights
- Power up the system
- Install other optional software or updates

Unpacking and Assembling the Console

Unpacking the VENUE SC48

▲ *Always use at least two people when lifting or moving VENUE SC48.*

- Remove all components from the shipping packaging. Keep included items organized, making sure to keep them with their associated component after unpacking.
- Place the VENUE SC48 console on a table or other stable surface that leaves full access to the front and back panel connectors.
- Make sure all components are free of any bags, padding or other materials.

Assembling the VENUE SC48

VENUE SC48 includes a Video Monitor Mount for your VGA/DVI monitor, a mouse tray, and an accessories tray. Follow the illustrations on the next page to attach your video monitor, mouse tray, and accessories tray to the console.

Video Mount, Mouse Tray, and Accessories Tray

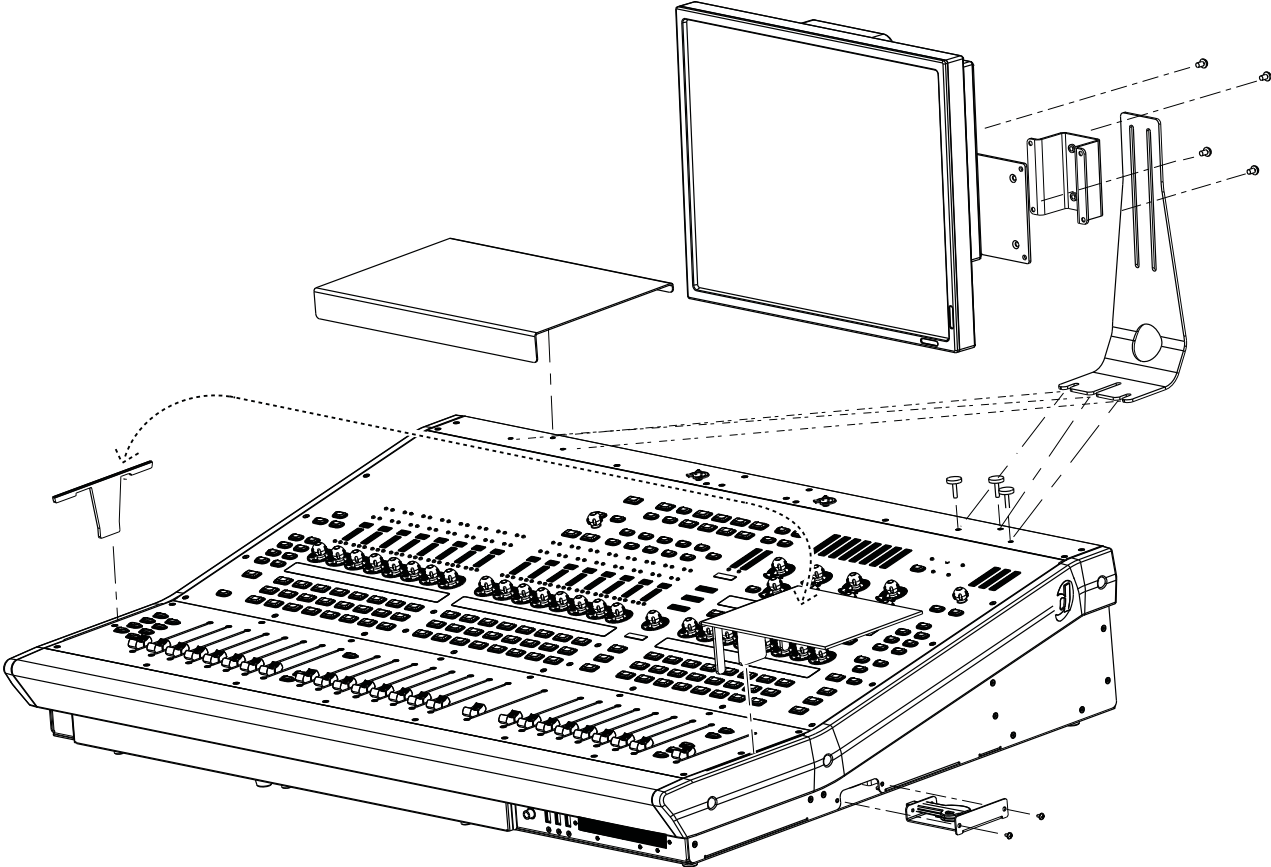

Figure 2. Video Mount, Mouse Tray and Accessory Tray

Connecting the VENUE SC48

The back panel provides power, audio and other connectors, as well as the master power (on/off) and reset switches.

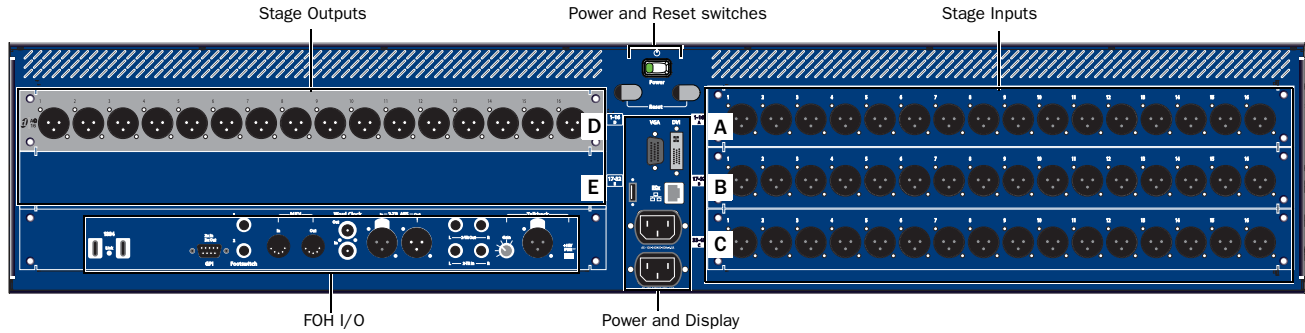
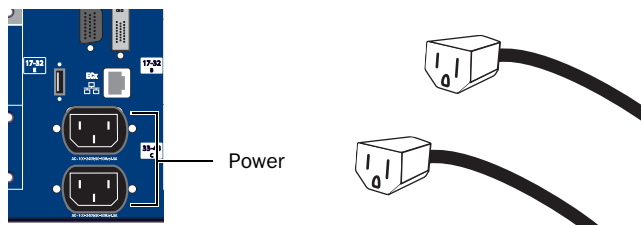

Figure 3. Back panel

Connecting AC Power

AC power connectors are located on the back panel. One (or two) male, 3-pin North American standard IEC power sockets with cable retaining clips are provided (one on standard SC48 units, and two on units ordered with a second redundant power supply).



Power connectors on the back panel (two-PSU model shown)

To connect power to SC48:

- Connect the included IEC power cable(s) between the Power connector(s) on SC48 and your power source.

Connecting a VGA or DVI Display

One VGA connector and one DVI connector are provided to connect a VGA/DVI-compatible video display (not included).

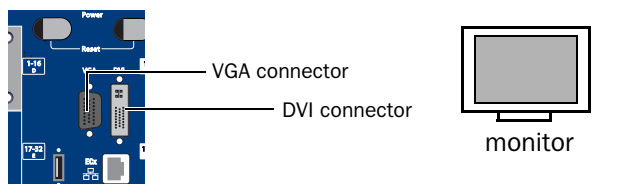

VGA and DVI display connectors on the back panel

To connect a computer display:

- Plug a VGA or DVI display cable into either the VGA or DVI connector. (These two ports mirror each other; they are not discrete video outputs.)

Connecting USB Keyboard and Mouse

There are three USB 2.0/Type A ports on the front of the SC48 to connect a USB keyboard, trackball/mouse, or key disks.

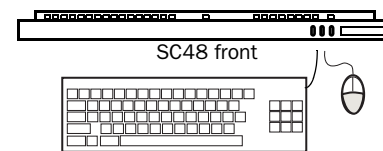

Front panel USB ports for keyboard and mouse

To connect a USB keyboard and trackball/mouse:

- Connect them to the USB ports on the front of SC48.

Two more USB ports are also provided, one on the back panel and one concealed within the console itself. For more information, see “Secure USB Port” on page 12.

Connecting Audio

SC48 provides 48 analog mic/line inputs and up to 32 analog line outputs for stage audio, and a variety of analog and digital audio inputs and outputs for FOH/mix position audio. You can use an analog multicore snake cable (not included) to carry multiple stage inputs and outputs to and from the console, or you can connect mics, instruments and other sources directly to SC48 analog mic/line inputs, and connect SC48 outputs directly to the inputs on your house/mains, monitors, or other destinations.

Stage Inputs 1–48

(Analog Mic/Line XLR Inputs)

The Stage Input section provides 48 channels of analog mic/line inputs (XLR), to connect stage input sources. Use a standard analog snake, or connect sources directly to Stage inputs 1–48.

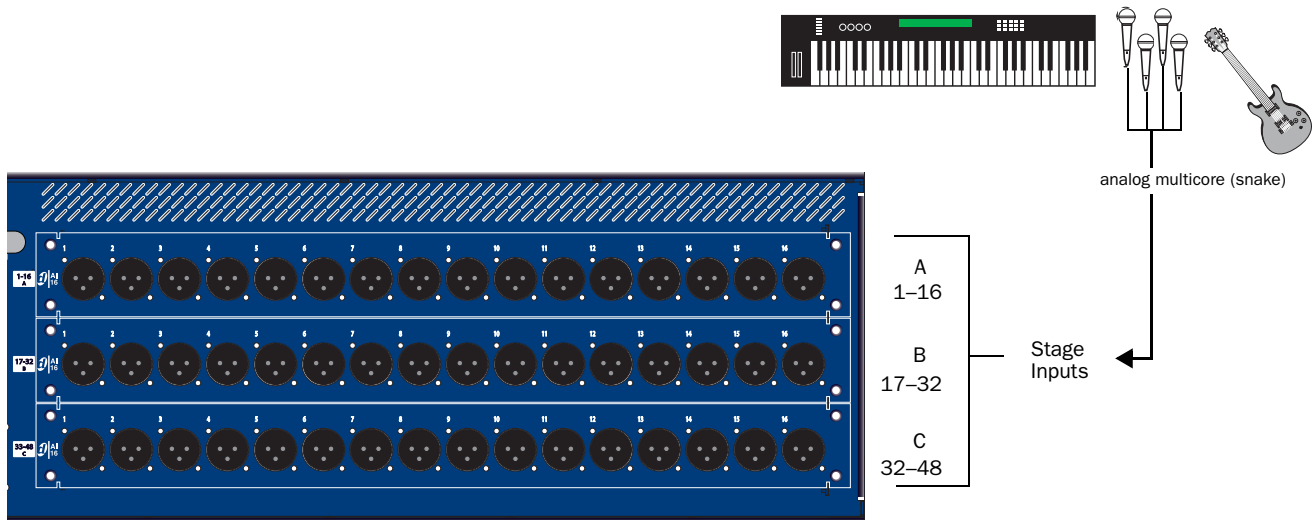

Figure 4. SC48 I/O slots A–C for stage inputs 1–48

Stage Outputs 1–16

(Analog Line XLR Outputs)

The Stage Output section provides up to 32 channels of stage output (XLR), to connect to house/mains, monitors, additional zones, or feeds to other devices.

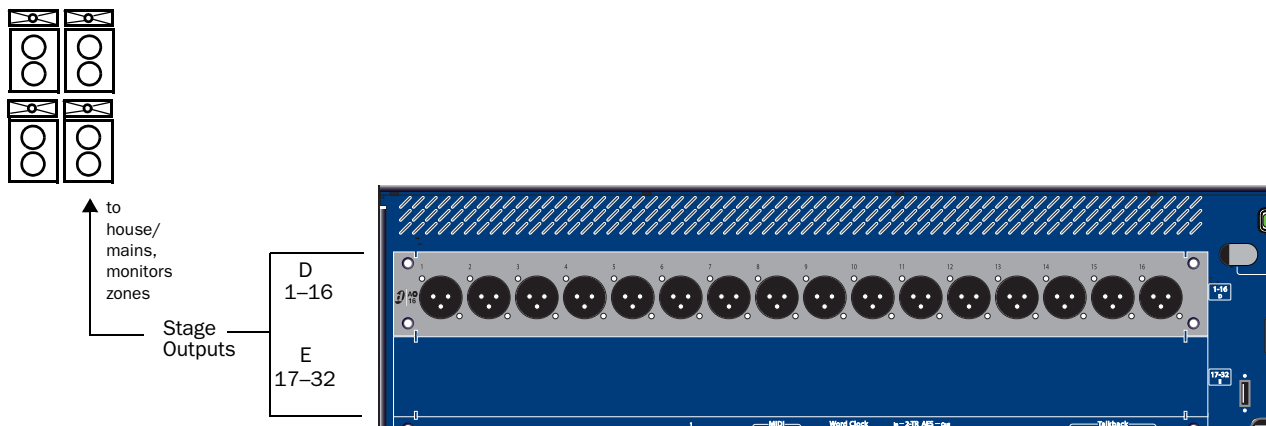

Figure 5. SC48 I/O slots D and E for stage Outputs 1–32

On standard systems with a single AO16 card in slot D, hardware outputs are numbered 1–16. Adding an AO16 or XO16 output expansion card will add outputs to slot E, and those hardware outputs will be numbered 17–32.

FOH Inputs and Outputs

The FOH I/O section provides connectors and controls for Talkback, 2-Track, Pro Tools and other sources and destinations used at the mix position, as explained in the following sections.

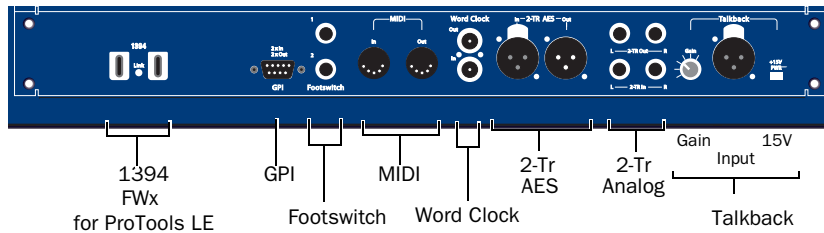

Figure 6. FOH connectors and controls

Talkback

The Talkback Mic connector and controls allow connection of a microphone for communicating to stage or through the Mains. The Talkback Mic input is a female XLR connector. The Talkback input has adjustable gain and switchable +15V phantom power.

To connect a mic for Talkback:

- Plug a dynamic or condenser talkback microphone into the back panel Talkback connector.

⚠ Do not connect an intercom system directly to the Talkback input, as some intercom systems use a signalling voltage which can damage the SC48 input card.

To adjust Talkback Gain:

- Turn the back panel Gain knob (or adjust the on-screen Talkback level control in the Options > Misc page).

To enable or disable phantom power on the Talkback input:

- Slide the +15V switch to the right “on” position

2-Track Digital Inputs and Outputs

These 2-Track digital connections are used for input and output of digital audio material. The stereo AES/EBU connectors support 24-bit, 48 kHz digital signals. Input signals with other sample rates are sample-rate converted to 48 kHz.

2-Track Analog Inputs and Outputs

These 2-Track analog connections are used for input and output of analog audio material. These are balanced 1/4-inch TRS connectors.

1394 (FWx)

This Firewire port is for integrated Pro Tools recording and playback with VENUE FWx. FWx provides 18 channels of I/O directly to a compatible Pro Tools LE system.

For more information, see Chapter 30, “FWx.”

Connecting Synchronization, Control, and Lights

SC48 provides the following connectors for synchronization, control, and illumination.

Word Clock

To sync an external digital device to SC48 Word Clock Out:

- ◆ Connect the Word Clock Out on the SC48 back panel to the corresponding digital device. Set the external device to slave to the incoming word clock signal.

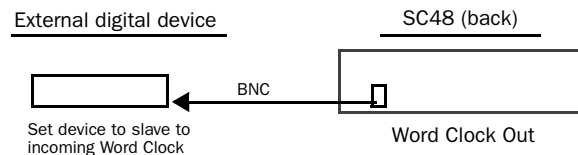

Using word clock from SC48 to clock an external device

MIDI

These MIDI In and Out Ports provide 16 channels of MIDI input and 16 channels of MIDI output to the system. The MIDI I/O ports are used in sending and receiving Snapshot MIDI messages, and in receiving MIDI Time Code from external devices.

To make MIDI connections to SC48:

- Connect a compatible MIDI device to the MIDI In and MIDI Out ports.

Footswitch 1 and 2

Two female 1/4-inch TS footswitch jacks are provided for switch input. Footswitches can be normally open or normally closed, latching or momentary. Functions are assigned to these jacks using the on-screen Options > Events page.

GPI Port

A 9-pin, female DB9 connector provides a 2-in/2-out GPI General Purpose Interface (GPI).

 For specifications, wiring diagrams and pinouts, see Chapter 29, “Console Reference.”

GPI Applications

GPI inputs are connected to the outputs of a variety of switching devices such as footswitches, momentary or latching push-button switches, or logic outputs of a larger show control system. Example applications of GPI inputs include remote toggling of a console function such as Talkback, muting a channel, or recalling a specific snapshot.

GPI outputs connect to compatible inputs found on a variety of external devices such as LEDs, small relays, power sequencers, and logic inputs on show control systems.

Example applications of GPI outputs include the following:

- Triggering a sound effects playback machine when a specific snapshot is recalled.
- Lighting a tally light whenever a fader is raised above a minimum threshold.
- Flashing or lighting a custom beacon or LED as a reminder of vital console mode, such as Solo in Place.
- Initiating power up of amplifiers and other down-stream systems when VENUE system is started up or shut down.

GPI functions are managed using the Events List in the Options > Events window. For more information, see Chapter 22, “Events.”

To connect GPI devices to VENUE SC48:

- 1 Connect one end of a DB9 cable (not included) to the GPI port on the back panel of VENUE SC48.
- 2 Connect the other end to the appropriate GPI port on the external device.

ECx

One RJ-45 connector is provided for remote Ethernet control of VENUE from a client computer (Mac or Windows laptop, tablet, or similar).

 For more information on ECx, see Chapter 31, “ECx.”

Console Lights

Two XLR3-F jacks on the top of the unit let you connect console lights (not included).

To use the console lights:

- Plug the console lights into the two Console Light XLR jacks on the upper part of the back panel.

You can adjust the brightness of the console lights, and separately for the LED and displays, from the Options > Interaction page (see “Lights” on page 59).

Secure USB Port

One USB 2.0 port is located within the console itself to connect and securely protect an iLok Smart Key. Use this port to keep one “master” iLok and its plug-in assets with the console at all times, safe from damage or loss. See Figure 2 on page 8 for an illustration that shows the location of the internal USB port.

To access the internal USB port:

- 1 Remove the two screws holding the tray in place and slide the tray out.
- 2 Insert (or remove) your iLok.
- 3 To reassemble, make sure the iLok is firmly seated in the tray before sliding it back into the unit. Replace the two screws to secure the tray.

Powering Up the System

⚠ *Faders move when power is turned on. Before powering up the system, make sure all fader paths are clear.*

Power up the system in the following sequence:

- 1 Press the Power switch on the back panel of VENUE SC48 (located on the back panel, center top).
- 2 Turn on any connected computers for recording/playback.
- 3 Turn on the audio monitoring system.

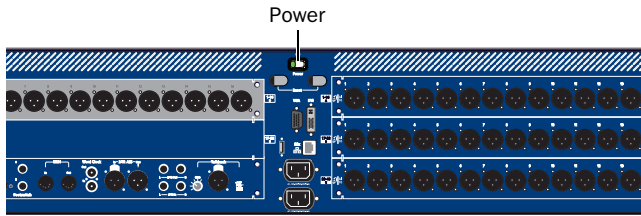

Power switch

Powering Down the System

Power down the system in the following sequence:

- 1 Turn off the audio monitoring system.
- 2 Turn off any connected computers for recording/playback.
- 3 Power down VENUE SC48.

💡 *It is not possible to accidentally power off the console by pressing the Power switch momentarily.*

Setting the System Clock

When you first work with a VENUE system, make sure the system clock time, date and time zone are set appropriately. The system clock setting can affect data synchronization with portable storage devices. See “Synchronizing Settings, Shows and Presets” on page 165.

The system clock time can be shown in the Status bar for constant time-of-day display. For more information, see “System Clock” on page 57.

⚠ *Changing the system clock while using a timed iLok license (for a plug-in with a demo period, or for a plug-in rental) may expire the plug-in authorization.*

After setting the system clock, do either of the following:

- To get started learning the console and configuring it, see Chapter 3, “VENUE SC48 Control Overview.”
- or –
- If you want to install any other optional software first (such as ECx, or included plug-ins) see the next section (“Installing Other Optional Software” on page 13).

Installing Other Optional Software

ECx, Plug-ins, and Other

After having unpacked, assembled, connected, and powered up your SC48 system, you can go ahead and add any additional software and plug-ins as explained in the following sections.

VENUE SC48 is loaded at the factory with the most recent version of its operating software (VENUE D-Show software), as well as the core set of VENUE plug-ins. You must manually install software for the following:

ECx Ethernet Control If you want to take advantage of the built-in Ethernet remote control option, install the ECx software from its included installer disc. For instructions, see Chapter 31, “ECx.”

Plug-ins All plug-ins (except the included plug-ins) must be installed manually from their installer discs, or from copies of the installers transferred to your USB key disk or other storage device. For more information, see Chapter 19, “Plug-Ins.”

About Digital Input and Sample Rate Conversion

VENUE systems operate at a native sample rate of 48 kHz. The 2-Track AES inputs on the SC48 provide sample rate conversion on input, letting you connect a wide variety of digital sources without having to be concerned with synchronization and clock connections.

Sample rate conversion does, however, induce processing delay to the incoming digital signal.

Sample Rate Conversion Latency

The following table illustrates the sample rate conversion processing delay at various sample rates.

Minimum Additional Latency due to Sample Rate Conversion

External Sample Rate	SRC Process Delay
32 kHz	1.50 ms
44.1 kHz	1.09 ms
48 kHz	1.00 ms
88.2 kHz	0.848 ms
96 kHz	0.833 ms

Part II: System Description

Chapter 3: VENUE SC48 Control Overview

VENUE SC48 Top Panel

The following figure identifies the main sections of the VENUE SC48 control surface:

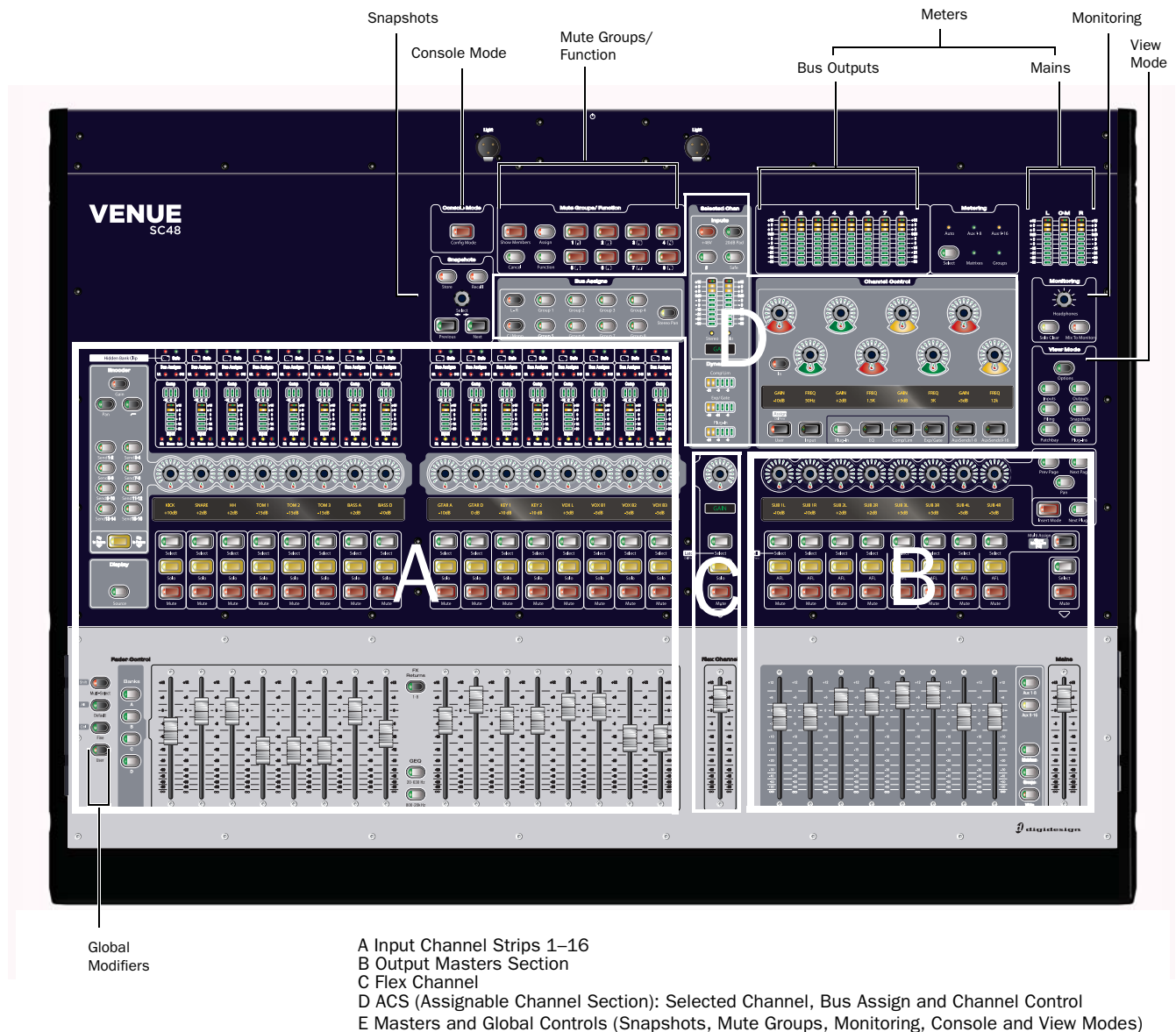

Figure 7. Main control sections on VENUE SC48

VENUE SC48 provides 16 bankable input channel strips in the *Input Channel* section, eight bankable output channel strips plus a Mains fader in the *Output Masters* section, the *Flex Channel* strip, and the ACS (or *Selected Channel* sections) including Input, Bus Assigns and Channel Control. Surrounding these sections are the masters and global modifiers sections (Console Mode, snapshots, metering, monitoring, and View Mode).

Input Channels and Faders

The Input section provides 16 faders and other controls for Input Channels and FX Returns. Additional channels are banked to the 16 faders using the Bank A, B, C and D switches. All 16 input channels bank together.

 *Input faders can also be assigned to control FX Returns 1–8, or the output EQ (graphic EQ).*

Each input channel strip includes a channel fader, channel Select, Mute and Solo switches, a rotary encoder, LCD display area and meters for channel level and dynamics gain reduction. The encoders and associated assignment switches access Gain, Pan, HPF and Aux Sends. Each bank of eight input channels provides a two-row LCD display that shows channel name, parameter names, values and other data as appropriate for the current action. Additional input parameters are controlled by selecting one or more channels to make them the target of the Selected Channel sections.

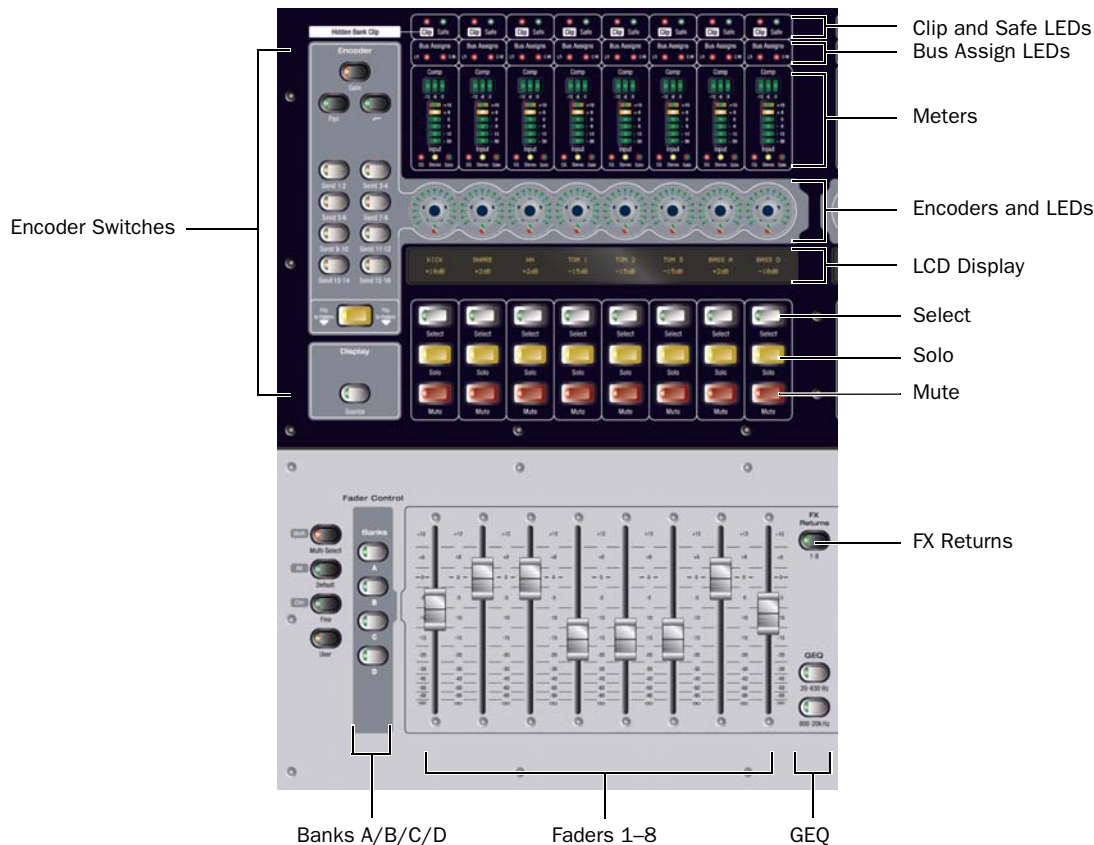

Figure 8. Input controls (Input Channels 1–8 shown)

Clip and Safe LEDs

At the top of each input strip are the Hidden Bank Clip and Safe LEDs.

Hidden Bank Clip LED

The Hidden Bank Clip LED lights to indicate a meter clip on an Input Channel or FX Return at the corresponding position in an alternate bank of channels. It gives you an indication of extreme signal level in a currently hidden (“off-bank”) layer. This indicator obeys the same clipping threshold display rules as the Input Channel meters (as set in the Options > Interaction page).

Safe LED

The Safe LED indicates either an input strip’s Automation, Solo, or Bank safe status, depending on the current Input Safe Switch setting. See “Input Safe Switches” on page 58.

Auto Safe Mode If the Safe LED is lit, the channel will not respond to Snapshot-driven changes. If the LED is off, that channel will respond to any applicable changes driven by Snapshots (subject to the current Recall Safe settings, if any).

Solo Safe Mode If the Safe LED is flashing slowly, the channel will not respond to solo commands (it will not be muted if another channel’s solo button is pressed). If the LED is off, that channel will be silenced when soloing another channel.

Bank Safe Mode If the Safe LED is flashing rapidly, the channel remains in place on the top fader layer when a different Bank (A–D) is selected (it will be unlinked from console banking). If the LED is off, the channel follows banking.

Bus Assigns LEDs

These red LEDs indicate Mains bus (LR or C/M) assignment.



Bus Assign indicator LEDs on an Input Channel

- ◆ If the LR LED is lit, the input channel feeds the Left and Right Main busses in either L–R or L–C–R panning mode (regardless of the Stereo Pan LED status).
- ◆ If the C/M LED is lit, the input channel feeds the C (center) bus from the pan in L–C–R mode, or the M (mono) bus before the pan. Stereo channels are summed to the mono bus.

Meters

Each Input Channel provides a Comp/Lim gain reduction meter and an input level meter, plus LEDs for EQ, Stereo and Gate status.

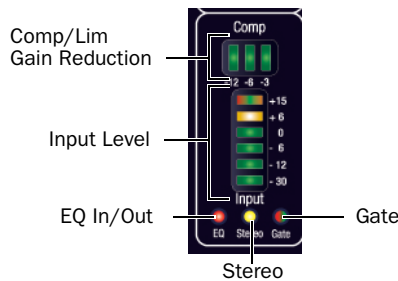

Input channel meters and LEDs

Comp Gain Reduction Meter

A 3-segment meter displays gain reduction for the channel compressor/limiter.

Input Level Meter

A 6-segment meter displays input level and indicates clipping. The top-most LED is bi-color and lights red to indicate clipping at any point in the channel.

For meter scales, see “Channel Meters” on page 107.

EQ Status LED

A single red LED indicates EQ In/Out status as shown in the following table.

Color	EQ Status
(none)	Not in circuit
Red	In circuit

Stereo LED

A single yellow LED indicates a stereo input channel. The stereo channel LED flashes if a 10 dB or greater offset is detected between left and right inputs.

Color	Channel Status
(none)	Mono
Yellow	Stereo

Gate Status LED

A single bi-color LED shows the current Expander or Gate status.

Input Encoders and Assignment Controls

Each input channel features one assignable input encoder that can be assigned to control input gain, HPF corner frequency, pan/balance/width, and sends (Auxes).

The Encoder Assignment switches, located to the left of the row of encoders, determine the function of the encoders on Input Channels. The LCD displays the current function (see “Input Channel LCD Displays” on page 20).

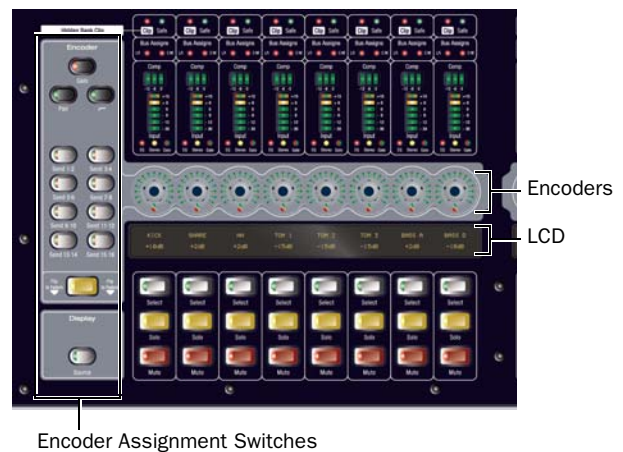

Encoder Assignment Switches

Input encoders, assignment switches, and LCD (inputs 1–8)

Rotary and Switch Functionality

VENUE rotary encoders are dual-function controls that provide rotary and switch functions. In addition to adjusting parameters by turning the encoder, you can toggle parameters (such as taking the HPF in or out of circuit) by pressing the encoder knob.

Encoder LEDs

Two types of LEDs surround each encoder:

- ◆ The LED ring around the encoder displays the relative position of its currently assigned parameter.
- ◆ Below each encoder is an indicator LED, which indicates parameter status (in/out), default setting, or other conditions related to the current encoder function.

Switches in the Encoder section assign each of the following parameters to the Input encoders:

Gain

Gain assigns the encoders to control input gain according to the range available for this input (head amp gain for analog inputs, digital gain for digital or line inputs). Pressing and holding the encoder initiates Gain Guess, in which a nominal input gain level is automatically set based on the incoming signal.

Pan

Pan assigns the encoders to control channel Pan if the channel is mono, or stereo channel balance if the channel is stereo. The indicator LED lights when the pan is at center.

HPF



HPF (High Pass Filter)

HPF assigns the encoders to control the HPF corner frequency. Pressing the encoder toggles the built-in HPF in and out of circuit. If the LED is lit, the filter is in circuit.

Send 1–2 to Send 15–16

These switches let you select one of two Aux sends in odd/even pairs (Send 1–2 through Send 15–16).

- ◆ With mono sends, the first press of the switch selects the odd numbered send (1, 3, 5, or 7) and the second press selects the even numbered send (2, 4, 6, or 8). The switch lights green for the odd-numbered selection, or yellow for the even-numbered selection.

- ◆ With stereo-linked sends, the first press of the switch controls level for the bus pair, and the second press controls pan for the bus pair. The switch lights green for level control, or yellow for pan control.

Pressing an encoder toggles the send on or off. When the send level is shown on the LED ring and the send is off, a single LED lights. When the send is on, all LEDs light in a clockwise sequence from the lower left to the send level.

Flip to Faders

When enabled, the current encoder parameter is mapped to the faders. It can still be controlled from the encoder row, so the channel fader mirrors the setting.



Using Flip to Faders, it is possible to control send level from the faders, and pan on the encoders. For information, see Chapter 11, “Aux Sends.”

Display

Source Switch

The Source switch in the Display section changes the Channel Name display to show the source input that is feeding each channel.

Input Channel LCD Displays

There are two Input Channel LCD displays, one each for Inputs 1–8 and 9–16.

Each LCD provides two rows of data with six characters per row, per input channel. The upper and lower rows let you see more than one type of channel data simultaneously, such as channel name in the lower row and Aux Send levels in the upper row. Data display depends on the current encoder assignment.

Input Encoder Assignments and Values

The current encoder assignment, parameter or value is displayed in the top row of the input displays. There are two states the top row can be in: Parameter Value mode and Parameter Name mode.

When necessary, the display abbreviates functions as shown in the following table.

Table 4. Encoder Assignment Displays

Switch	Display
Gain	Input Gain
Pan	Input Pan
	HPF Frequency
Send (n)	Aux (n) Level Aux (n) Pan (stereo-linked sends only) Variable Group (n) Level Variable Group (n) Pan (stereo-linked sends only)
Flip to Faders	Aux (n) Level and Pan (stereo-linked sends only)

Select Switch

The Select switch on each channel is used to target the channel in the Selected Channel and/or Flex Channel sections, and to include the channel in Multi-Select and Multi-Assign functions. A lit Select switch indicates the channel is selected. The name of the currently selected channel is displayed in the Channel Name display and in the Selected Channel display. When multiple channels are selected, the Channel Name display indicates which channel is the ACS target.

Solo Switch

The Solo switch toggles the solo state of that channel. When enabled, the Solo switch LED is lit. When the channel is in Solo Safe mode, the Solo switch LED flashes. Channel Solo latches on a momentary press, and automatically releases if held for 2 seconds or more and released.

Mute Switch

The Mute switch mutes the channel at the (pre-fader) mute point.

Input Faders and Banking

Each channel features a 100mm motorized, touch-sensitive fader. The Options > Interaction screen lets you enable touch-sensitive channel selection. When enabled, touching a channel fader automatically selects that channel and makes it the Selected Channel.

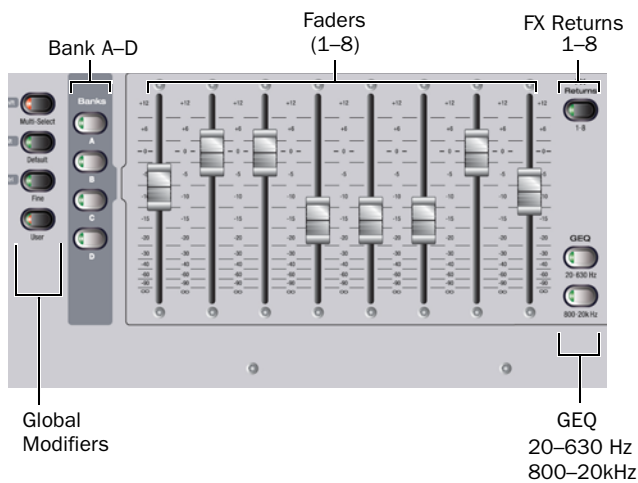

Input fader banking and assignment switches

The faders can be moved even when they do not sense a touch. This allows use of the faders while wearing gloves, and also lets you “throw” a fader and have it stay where it lands (not snap back to where it was last touched).

Fader Banking Controls

Bank A–D Banks the Input strips. Up to four banks (A through D) can be used to access up to 48 inputs from the 16 Input fader strips. Bank A is channels 1–16, Bank B is channels 17–32, and so on.

FX Returns Banks FX Return channels 1–8 to Input fader strips 1–8.

Important input channels can be put in Bank Safe mode, to keep them at the top layer of faders at all times (ignore input banking). For more information, see “Bank Safe Mode for Input Safe Switches” on page 34.

GEQ (Graphic EQ) Banks bands of graphic EQ to the faders. Graphic EQs can be used on outputs only. For more information, see Chapter 18, “EQ.”

Global Modifier Switches

To the left of the Bank A–D switches are the global modifier switches.

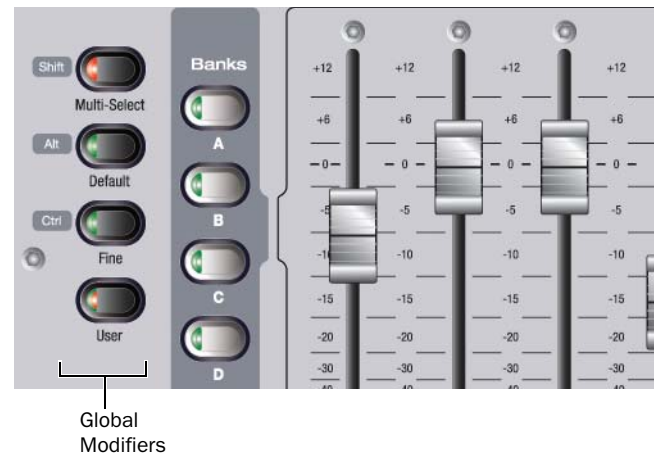

Global modifiers

Multi-Select (Shift) Lets you select multiple channels, and lets you select multiple items in lists.

Default (Alt) Lets you reset a parameter, section, or channel to default values. This switch also enables certain modes such as Show VCA Members mode.

Fine (Ctrl) Lets you adjust rotary encoders with greater resolution for finer control, or to select non-adjacent items in lists.

User This switch is reserved for future use.

For examples of these switches in use, see “Global Modifier Switches” on page 29.

Selected Channel Sections (ACS)

The Selected Chan (selected channel, or Assignable Channel Sections) include the Inputs, Bus Assigns, and Channel Control sections, along with stereo channel meters, an LCD display, and dynamics meters.

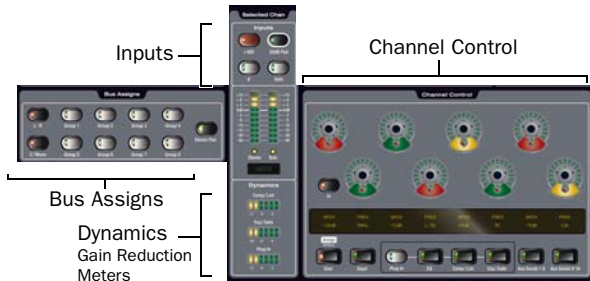

Selected Channel control and display sections

In addition, the Flex Channel provides a dedicated fader, channel encoder, Select, Solo and Mute switches for the currently selected channel, with the ability to be unlinked from input channel banking and selection (“latch” your most important input to the Flex Channel). For more information, see “Flex Channel” on page 23.

Input

This section provides switches for channel phantom power, input pad, polarity (phase), and Safe status.

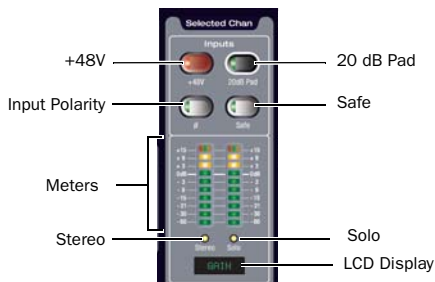

Selected Channel Input controls, meters and displays

Meters

Below the Inputs switches are two 10-segment Selected Channel meters, LEDs for Stereo and Solo state and a 6-character LCD display.

The dual, 10-segment, bi-color LED meters indicate input level and clip status for the currently targeted or Soloed channel.

For Selected Channel metering scale, see “Selected Channel Level Meters” on page 108.

The 6-character Selected Channel display shows the name of the currently selected channel. The Selected Channel display temporarily reverts to a parameter display mode any time an encoder is adjusted on the selected channel.

The Stereo LED lights solid when a stereo input or output is targeted. The Solo LED flashes any time a channel is in PFL, AFL or Solo in Place mode.

Dynamics

Gain Reduction Meters

The meters in the Dynamics section provide dedicated metering for built-in and plug-in dynamics processors.

Bus Assigns

The Bus Assigns switches are the primary routing controls for the currently selected channel, letting you bus it directly to the Mains (L-R) bus or to any other mono or stereo group.

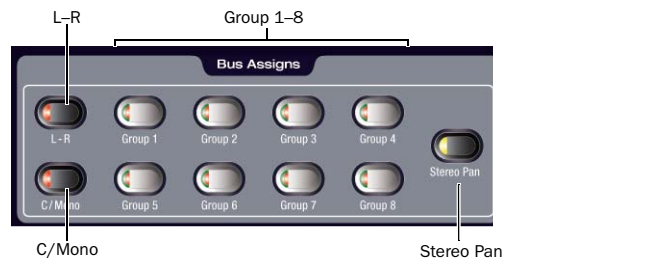

Bus assign switches

Channel Control

Gain, EQ, Dynamics, Plug-ins, Auxes

Channel Control is the “center section” panel for consistent display and control of EQ, dynamics, and plug-in processing and Auxes.

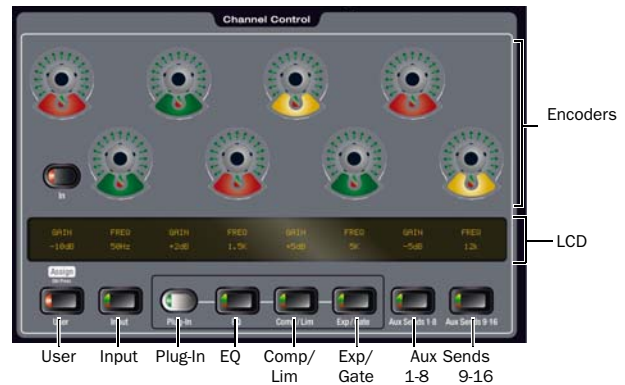

Channel Control encoders, LCD and mode switches

For optimal mixing flexibility, you can assign up to 8 parameters as a custom User layout.

Flex Channel

The Flex Channel is a special fader strip that provides a dedicated fader, encoder, and LCD display along with channel Select, Solo and Mute switches for the currently selected channel. The Flex Channel can also be latched to any channel for uninterrupted control of any vital channel.

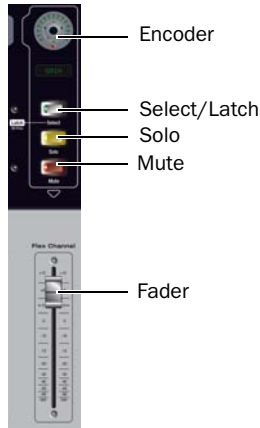

Flex Channel

In its default Selected Channel mode the Flex Channel mirrors the currently selected channel. The Flex Channel encoder follows the current Encoder Assignment mode (gain, pan, HPF, or a send). The Flex Channel LCD shows the current channel name.

In the optional Flex Channel mode, the Flex Channel is latched to the currently selected channel. Selecting a different channel or changing fader banks will not change the assignment of the Flex Channel, letting you keep constant control over your most important signal. The Flex Channel LCD is red when latched and green when not latched.

To latch a channel to the Flex Channel from the console:

- 1 Select the input or output channel you want assigned to the Flex Channel.
- 2 Press the Select/Latch switch on the Flex Channel. A dialog appears on-screen asking you to confirm the assignment.

 *Double-press the Select/Latch switch to latch that channel and clear the confirmation dialog in one action.*

- 3 Press the Flex Channel Select/Latch switch again (or click Latch on-screen) to confirm the assignment. Click Cancel to cancel the assignment.

To latch the Flex Channel on-screen:

- Right-click on the desired channel in the lower fader display and choose Latch <channel>.

To return to Selected Channel mode, do one of the following:

- Double-press the Flex Channel Select/Latch switch. The (former) channel assigned to the Flex Channel becomes the selected channel in the ACS, and the Flex Channel reverts to Selected Channel mode.

– or –

Right-click the currently latched channel on-screen in the lower fader display and choose Unlatch <channel>.

Output Masters

The Output Masters section includes eight bankable output channel strips, each with a fader, encoder and channel switches. The Mains fader provides master level control over the Mains (house) output.

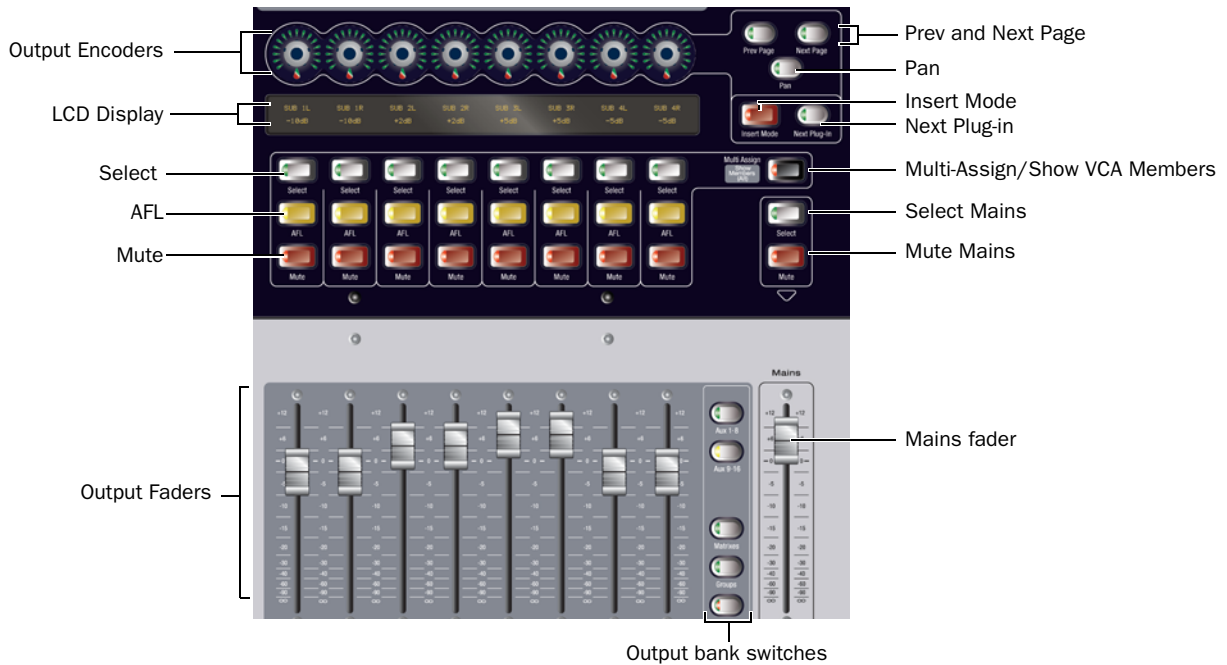

Figure 9. Input controls (Input Channels 1–8 shown)

Mains

Mains Fader

The Mains fader provides a single level control for the current Mains output.

Mains Select and Mute

Above the Mains fader are Select and Mute switches for selecting and muting the current mains output, respectively.

Output Faders

The eight Output Faders control level for Aux 1–8, Aux 9–16, Matrix busses, Group busses, and VCAs.

Output Fader Bank Switches

The Output faders and encoders are banked to the desired bus using the Output Faders switches.

Aux 1–8 Assigns the Output Faders to Aux 1–8 levels.

Aux 9–16 Assigns the Output Faders to Aux 9–16 levels.

Matrixes Assigns the Output Faders to control Matrix mixer output levels.

Groups Assigns the Output Faders to control Group levels.

VCAs Assigns the Output Faders to control VCAs.

Output Mute, AFL and Select Switches

Above the faders are the Mute, AFL and Select switches.

Output Encoders and Display

The eight Output Encoders adjust Group bus pan to Mains, Matrix input levels and pan, or plug-in parameters (when in Inserts mode).

The Output Masters LCD display is a two-row display that shows 6 characters in each row, per output bus. The display shows the name, parameter or value currently being controlled in the Output Masters section.

The Prev Page and Next Page switches light to indicate additional functions depending on the selected output or plug-in. When lit, pressing either switch scrolls the Output Encoders. The Inserts Mode switch puts the encoders in Inserts mode, in which the Output encoders select and adjust plug-ins. The Next Plug-in switch advances you to the next plug-in inserted on the current channel.

Master and Global Controls

Global and master controls are located in sections with a dark background, and include the Console Mode, Snapshots, Mute Groups/Function, Monitoring and View Mode sections.

Console Mode

The Config Mode switch toggles the system between Config and Show modes. See “Config Mode and Show Mode” on page 28.



Console Mode

Snapshots

The Snapshots section provides Store, Recall, Previous, Next, and Preview mode switches, along with a Select encoder and a 6-character Snapshot LCD display.

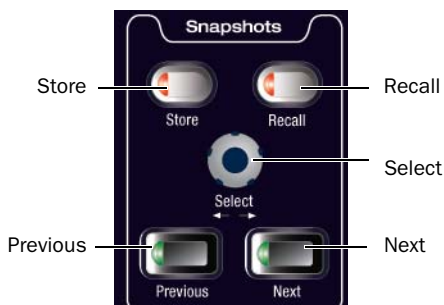

Snapshots

For more information, see Chapter 21, “Snapshots.”

Mute Groups/Function

Provides Mute Group assignment and selection in default Mute Groups mode, or can be switched to provide eight Function switches (F keys) in Function mode. The global Cancel switch is also located in this section.

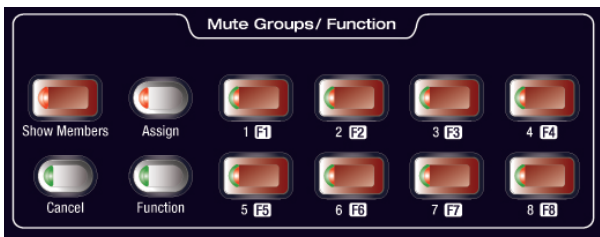

Mute Groups/Function

Mute Groups

Mute Groups let you quickly mute multiple channels at the same time. You can create and recall up to eight Mute Groups by assigning one or more channels to each Mute Group.

See Chapter 16, “Muting and Mute Groups.”

Function Switches

In Function mode, this section provides eight Main Function switches. The default assignments for the first four Function switches include Preview mode on/off (F1), Copy (F3) and Paste (F4).

Function switches can be assigned to perform any number of actions using the Events List. For more information, see Chapter 22, “Events.”

Cancel

This switch cancels the current operation, such as Multi-Select or Multi-Assign modes.

View Modes

The View Mode switches (Options, Inputs, Outputs, Filing, Snapshots, Patchbay, Plug-ins) display the corresponding pages on-screen. Pressing a View Mode switch repeatedly cycles through the individual tabs of that page. For example, pressing the Patchbay switch once displays the Patchbay page. Pressing Patchbay again cycles through various tabs within the Patchbay page.

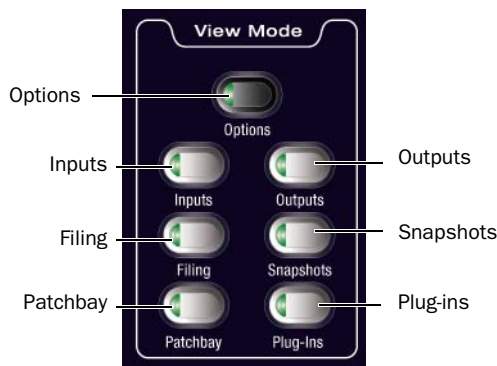

Snapshots

Monitoring

The Monitoring section provides a level encoder for the Headphone output (Monitor bus outputs).



Monitoring

Monitor bus delay can be set on-screen in the Options > Buses page.

Meters

The Meter section includes the following:

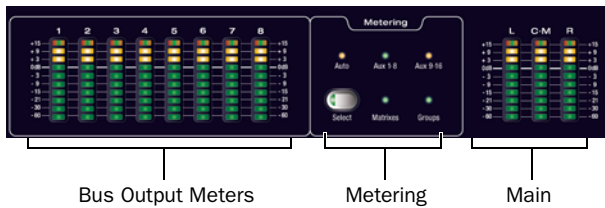

Meters

Bus Output Meters 1-8

Eight Bus Output meters provide selectable metering of Output busses.

L C M R

The Mains meters provide constant level indication of the house (Mains) output.

 For more information, see Chapter 14, "Metering."

Chapter 4: Basic Commands and Modes

Control Overview

Most VENUE features and controls that are used during a performance are available from both the console and on-screen. Changes made on one are immediately reflected in the other, letting you use almost any combination of console and screen controls to mix.

The software screen is not required in order to mix a performance, as all essential mixing controls are provided on the console. However, the screen is essential when setting up and configuring the system before a performance.

Software-Only Controls and Displays

Many configuration settings and options are only available on-screen, including hardware configuration settings, busses, plug-in installation, and system diagnostics. For more information, see “System” on page 51.

Software Screen Banner Display

The software screen provides a banner display in the lower left corner. This display is provided to maintain line-of-sight mixing by showing the currently adjusted parameter (such as fader level or compression threshold) as you make changes to the parameter. The banner display also provides Tool Tip text and status messages.

Tool Tips

With the mouse or trackball, place the cursor over a screen item to see a brief explanation in the banner display.



Status bar showing Tool Tip

Status Messages

The banner display alerts you to certain operating conditions such as Multi-Select and Multi-Assign modes.



Banner display

Mode display

Banner display showing current state of the system

Console and Software Screen Linking

The software screen is linked to console actions by default. For example, selecting an input channel on the console changes the screen to the Inputs page, and selecting an output bus changes the screen to the Outputs page. You can customize how VENUE targets channels to best match your working style. For more information, see “Interaction” on page 58.

Config Mode and Show Mode

There are two main operating modes, Config Mode and Show Mode. Use Config mode to set up your system and options; use Show mode to mix your performance.

Config Mode

Config mode provides access to the configuration settings that are typically performed as part of system setup (before mixing). For example, you must be in Config mode to do any of the following:

- Choose a Main mix format (L-R+M, or L-C-R)
- Designate the number and mono/stereo format of available auxes and groups, combine two mono channels into one stereo input channel, or split a stereo input channel into two mono channels.
- Install plug-ins
- Assign plug-ins in the software racks
- Route side-chain inputs to plug-ins
- Initialize (or reset) hardware devices and options
- Change Matrix Source pickoff points
- Change Master Insert points
- Customize console and software interaction
- Move channels to different fader strips
- Perform system tests and diagnostics

 *Some Config mode operations interrupt audio throughput.*

Show Mode

Show mode is the main operating mode for the system software. All mixing and routing features are available, based on your settings made in Config mode.

Toggle Between Config Mode and Show Mode

To toggle between Config mode and Show mode, do one of the following:

- Press the Console Mode switch (located above the Bus Assigns).
 - or –
- Double-click the Mode display in the Status Bar, located in lower-right hand corner of the screen.

System Lock

System Lock locks out all manual changes (console and screen actions), allowing the operator to safely step away from the system. Audio continues to pass but is not affected by console controls until the operator disables System Lock.

System Lock is activated by clicking the LOCK button on the Options > System page, which locks the console and hides the on-screen controls. (System Lock is not available in the Stand-alone software.)



System Lock button on the Options > System page

Locking and Unlocking the System

To engage System Lock:

- 1 Go to the Option > Systems page.
- 2 Click the Lock button in the System section.
- 3 In the dialog that appears, click Lock.

On the console, the LCDs for each 8-channel fader bank display System Locked.

On-screen, an Unlock button appears in the lower right corner in front of a dimmed background image.

 *You can add your own custom images to display in place of the default VENUE logo. See “Customizing the System Lock Display” on page 29 for information.*

To unlock the system (disengage System Lock):

- Do either of the following:
 - Press and hold the Cancel button on the console for two seconds.
 - or –
 - Click Unlock in the lower right corner of the screen.

 *the Unlock button is hidden after a few seconds. Touch the mouse or keyboard to bring it back.*

System Status while Locked

GPI All console GPI inputs and outputs are disabled while the system is locked.

Footswitches All Footswitch inputs are disabled while the system is locked.

Events All Event triggers and actions that include console or GPI/Footswitch functions are disabled while the system is locked.

MIDI and MTC

While the system is locked:

- Snapshots continue to be recalled via MTC, either internally or externally generated.
- The system continues to respond to snapshot changes via incoming MIDI program change commands if the Snapshots Respond option is selected on the Options > Snapshots page.
- The system continues to send MIDI program changes when a snapshot is recalled if the Snapshots Send option is selected on the Options > Snapshots page.
- The system continues to send MIDI messages stored within snapshots, provided the MIDI data type is scoped.

 MTC can be disabled using the CHASE MTC button on the Snapshots page. Also, the sending and receiving of MIDI data can be turned off by deselecting the MIDI options on the Options > Snapshots page.

Customizing the System Lock Display

You can manually add one or more custom images to display during System Lock, rather than the default VENUE logo background.

Multiple images are displayed one after the other for 20 seconds in a random order. (Pressing the Spacebar advances to the next image immediately.)

To install custom System Lock images:

- 1 Copy a .bmp or .jpg image file to a USB key disk or CD-ROM. (For optimal results image resolution should be 1024 x 768; smaller or larger images can be used, but will be centered or scaled, respectively.)
- 2 Put the system into Config mode.
- 3 Go to the Options > System page.
- 4 Ctrl-click the Shutdown button.
- 5 Copy the image from your USB key disk to the following location on the system drive:
User Data\D-Show\Images
- 6 Double-click the Return to D-Show icon on the Desktop to restart VENUE D-Show software.

Global Modifier Switches

VENUE SC48 provides a set of global modifier switches: Multi-Select (Shift), Default (Alt), Fine (Ctrl) and User. These are located to the left of the input faders

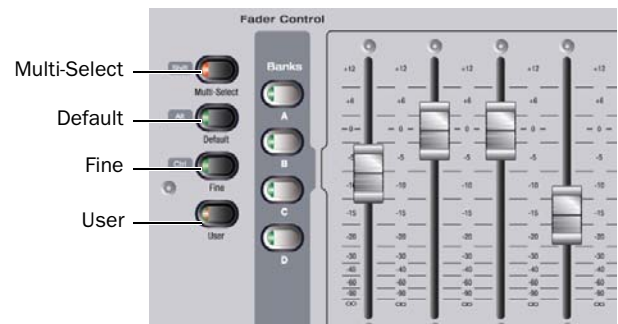

Global modifiers

These switches provide frequently used shortcuts that can be applied to console actions and software screen interactions.

Multi-Select Switch

The Multi-Select (Shift) switch lets you select multiple Input Channels and then apply an action to all selected channels. Multi-Select is useful for batch routing and assignment of input channels.

Most channel functions support Multi-Select (or Multi-Assign) as noted throughout this guide. For details on how to select one or more channels, see “Selecting and Targeting Channels” on page 36.

Default Switch

The Default (Alt) switch provides a quick way to reset a control to its default setting (or “zero” the setting). It is equivalent to, and interchangeable with, the Alt key on the keyboard.

Examples of Using Default

To reset a fader to 0 dB:

- 1 Press and hold the Default switch.
- 2 Press the Select switch on the channel you want to reset.

To reset a single EQ parameter:

- Hold the Default switch and press the encoder or switch for that parameter in the Channel Control section.

 To reset a parameter using only the keyboard and trackball, Alt-click the on-screen control.

Fine Switch

The Fine (Ctrl) switch lets you adjust controls (except for faders) on the console or on-screen with maximum resolution. For example, if by default a control adjusts a parameter in units of 1 dB, the Fine switch allows adjustment in units of 0.1 dB.

To adjust a control with fine resolution:

- Press and hold the Fine switch while moving a control. The display associated with the adjusted control will show the values change at the corresponding resolution.

Momentary and Latching Modes

The Fine switch supports momentary and latching operation.

Momentary In momentary mode, the Fine switch stays in effect for as long as you hold down that modifier switch.

Latching In latching mode, the Fine switch stays in effect until you explicitly clear its active state.

To use the Fine switch in Momentary mode:

- 1 Press and hold the Fine switch.
- 2 Adjust a channel, parameter, or processor.
- 3 Release the Fine switch.

To use the Fine switch in latching mode:

- 1 Double-press the Fine switch. The switch LED lights.
- 2 Select or adjust one or more channels, parameters, or processors.
- 3 Press the Fine switch again to exit latching mode.

User

The User switch is reserved for future use.

Software Screen Pages and Tabs

Viewing Pages

To view a page, do one of the following:

- Press a View Mode switch.
 - or –
- Click the page name at the top of the screen.

When additional tabs are available for a page, go to those tabs by pressing the corresponding View Mode switch again to cycle through the tabs on that page, or by clicking their names on-screen.

Click page name to display



Viewing pages

Overview of Software Pages

The software screen provides the following pages and tabs.

Inputs

Select, name, configure, and adjust parameters for input channels and FX Returns.



Inputs page (analog input shown)

See Chapter 8, “Inputs and Input Routing.”

Outputs

Select, name, configure, and adjust parameters for outputs.



Outputs page

See Chapter 9, “Outputs and Output Routing.”

Filing

Load, save, and transfer shows and presets, and access the console History.

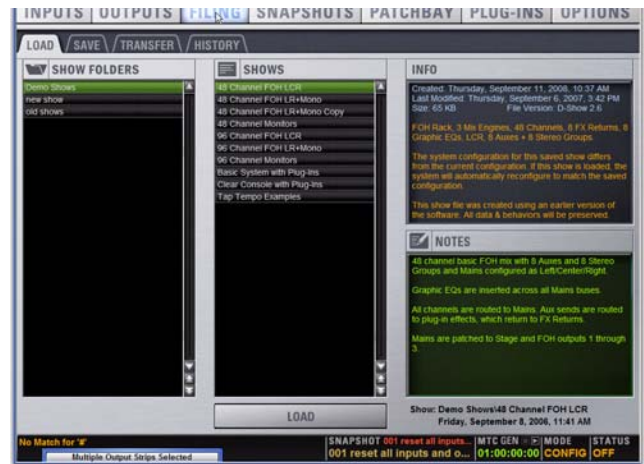

Filing (Load tab)

See Chapter 20, “Shows and File Management.”

Snapshots

Store and recall snapshots, and access the Recall Safe window.



Snapshots page

See Chapter 21, “Snapshots.”

Patchbay

Label your channels and assign input and output patching.

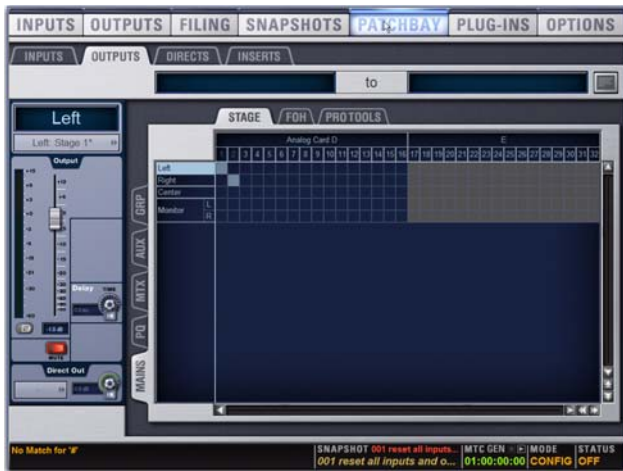

Patchbay (Outputs tab)

See Chapter 13, “Patchbay.”

Plug-Ins

Configure and arrange plug-in racks by assigning plug-ins; patch/route and manage plug-ins.



Plug-In page

See Chapter 19, “Plug-Ins.”

Options

Configure system, routing and metering options, set interaction, hardware and general preferences, install plug-ins, and access the Events window.

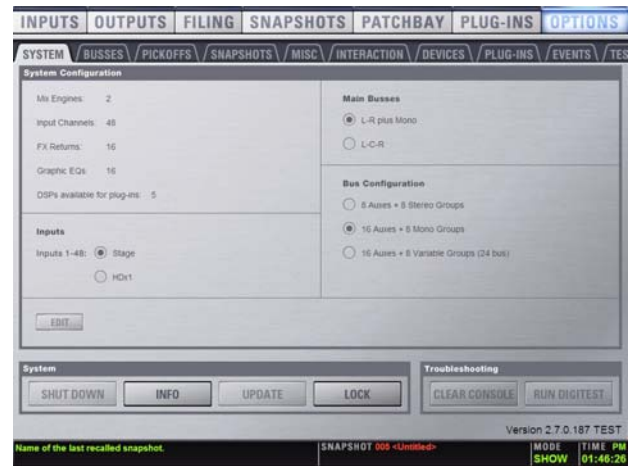

Options page (System tab)

See Chapter 7, “Options.”

Chapter 5: Navigating and Selecting Channels

Banking Input Channels and FX Returns

Many VENUE configurations utilize more physical inputs than input faders. To navigate to channels beyond the number of physical faders, the system provides channel *banking* controls.

The Bank switches navigate the display of input channels on the console.

- Input channel banks are accessed using the Bank A, B, C, and D switches, located to the left of the input faders.
- FX Returns are accessed using the FX Returns 1–8 switches, located between input faders 1–8 and 9–16.
- Input Channels and FX Returns can be put in Bank Safe mode, leaving them accessible regardless of the currently selected bank.

Input Channel Banking

The Bank A, B, C and D switches affect all input faders.

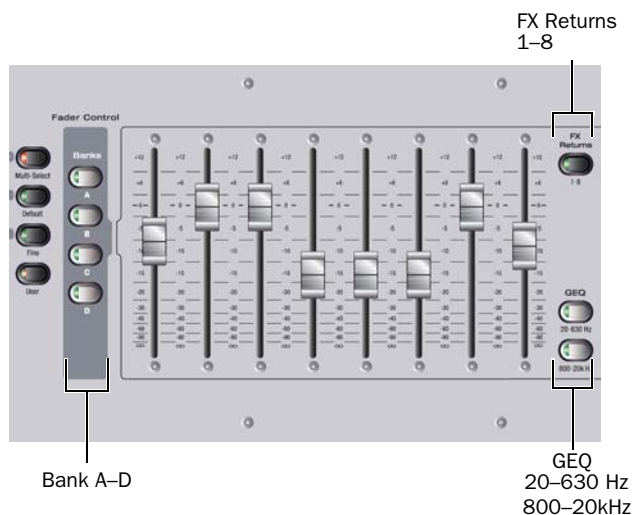

Input fader banking and assignment switches

To bank Input Channels to the input faders:

- Press the appropriate Bank switch (A, B, C, or D).

FX Returns Banking

The FX Returns 1–8 switch banks FX Return channels to input faders 1–8.

When the FX Return bank is selected, input faders 9–16 remain banked on their current input channels. The Input bank button flashes to indicate which bank is currently assigned to these channels.

To bank FX Returns:

- Press the FX Returns 1–8 switch.

The FX Returns are banked to the input faders. Bank switch A, B, C or D flashes in order to indicate the current bank assignment of other input faders.

To bank Input Channels while keeping FX Return channels on the input faders:

- Press any unlit Bank switch (A, B, C, D).

To return input faders to Input Channel banking, do one of the following:

- Press the lit FX Returns 1–8 switch.
 - or –
- Press the flashing Bank switch (A, B, C, D).

Banking Graphic EQ Frequency Bands

When a built-in Graphic EQ is inserted on a currently targeted output or bus, its frequency bands can be selected using the Graphic EQ switches. This replaces Inputs 1–16 with either bank of EQ bands shown for each Graphic EQ bank switch (20-630 Hz, 800-20 kHz).

See Chapter 18, "EQ."

Bank Safe Mode for Input Safe Switches

Bank Safe mode is a global Input Safe switch option available in the Option > Interaction page.

When Bank Safe mode is enabled, input channels and FX Returns can be Bank Safed using their Input Safe switches on the console, or on-screen. Bank Safed channels remain on the top fader layer of the console regardless of the current active bank, letting you temporarily “lock” the location of key input channels (such as a lead vocal, pulpit mics and similar) or FX returns to maintain immediate access while working with channels on a different layer.

For example, imagine 16 total input channels assigned to four banks (A through D) of an imaginary 4-fader console.

Default channel layout for a 4-fader example

Bank	Fader 1	Fader 2	Fader 3	Fader 4
A	Ch 1	Ch 2	Ch 3	Ch 4
B	Ch 5	Ch 6	Ch 7	Ch 8
C	Ch 9	Ch 10	Ch 11	Ch 12
D	Ch 13	Ch 14	Ch 15	Ch 16

Channel 6 on Bank B is then Bank Safed. Selecting the various banks gives the following results:

Channel layout with Bank Safe enabled on channel 6

Bank	Fader 1	Fader 2	Fader 3	Fader 4
A	Ch 1	Ch 6	Ch 3	Ch 4
B	Ch 5	Ch 6	Ch 7	Ch 8
C	Ch 9	Ch 6	Ch 11	Ch 12
D	Ch 13	Ch 6	Ch 15	Ch 16

Note that channels 2, 10, and 14 no longer appear on the console (though they remain accessible on-screen).

When an input channel or FX Return is removed from Bank Safe, the input channel that would normally appear in that fader location on the currently selected bank automatically re-appears.

Bank Safe is only available for Input channels (Output channels cannot be Bank Safed). Bank Safe status for all channels is stored with the Show file.

Enabling and Using Bank Safe Mode

Bank Safe mode can be enabled on-screen from the Options > Interaction page.

To enable Bank Safe mode on-screen:

- 1 Go to the Options > Interaction page.

- 2 In the Input Safe Switches section, click to enable Act as Bank Safes.



Choices for Input Safe Switches in the Options > Interaction page

On-screen, the Safe switches at the top of each fader display the letter B to indicate Bank Safe mode. (See “On-Screen Display of Safe Switch Status” on page 35.)

You can also use the Event List to configure the Safe mode. For more information, see Chapter 22, “Events.”

Using Bank Safe

To Bank Safe channels:

- 1 Make sure you have enabled Bank Safe mode for the Input Safe switches.
- 2 Select one or more input channels.
- 3 Press the Safe switch in the Inputs area of the Selected Channel section.

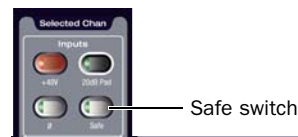

Selected Channel, Input Safe switch

- 4 Press a Bank switch (A, B, C or D) to navigate to a different bank. Notice that the channel you Bank Safed remains; corresponding channels on other banks, though not present on the console, are still accessible on-screen.

Toggling Bank Safe On-Screen

To Bank Safe channels on-screen:

- 1 Make sure you have enabled Bank Safe mode for the Input Safe switches.
- 2 Click the channel Safe buttons on-screen, located at the top of each input channel strip.



Toggling Bank Safe on-screen

Safe Switch LED and Indication

On VENUE SC48, the Safe LED at the top of each input strip flashes rapidly to indicate Bank Safe is enabled on that channel.

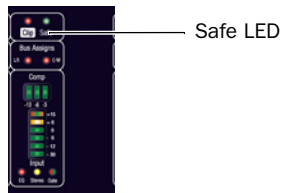

Channel Safe LED on VENUE SC48

When a Bank Safed channel is targeted, the Safe switch in the Input section also flashes rapidly.

On-Screen Display of Safe Switch Status

The channel Safe switches at the top of each strip of the on-screen faders light to indicate the current Safe status of each channel. When lit, that channel is enabled for the current Input Safe Switch mode (Automation, Solo, or Bank Safe). Each on-screen Safe switch indicates the current Input Safe Switch mode through use of a letter in the lit switch. For example, on-screen Safe switches show the letter B if Bank Safe mode is enabled and the channel is Bank Safed.



Bank Safe (two channels enabled)

Special Cases Affecting Bank Safe

Special rules and conditions are automatically applied to Bank Safe status whenever you do the following:

- Bank to GEQ faders
- Move channels or shuffle channel layout
- Change the system configuration

GEQ Fader Mode

Selecting a GEQ fader bank overrides Bank Safe. Returning to any fader bank (thus exiting GEQ Fader mode) restores the previous input layout, including Bank Safe status. This applies to channels 1–16 on VENUE SC48.

Moving or Shuffling Channels

Bank Safed channels shuffle accordingly when any operation is performed that results in a re-ordering of input channels, including the following:

- Inserting or Removing a Blank Strip
- Moving a strip
- Splitting a stereo strip(s)
- Opening a Show file that was saved on a VENUE system that used a different control surface layout than SC48.

Priority for Replacing Bank Safe Assignments

The following rules apply to resolve any potential collisions between Bank Safed channel assignments:

- Input channels always replace any FX Returns that are Bank Safed in that corresponding fader position.
- A lower numbered input channel always replaces a higher numbered input channel in that corresponding fader position.

In addition:

Make Stereo The Bank Safe status of the left channel is inherited by the newly created stereo channel.

Split Stereo The Bank Safe status of the stereo channel is applied to each of the newly created mono channels.

Bank Safe and Backup Personality

Channel Bank Safe remains in effect and available if Bank Safe mode is engaged. This ensures consistent and uninterrupted fader control during the rare case of a system reset.

Modified Bank Safe functionality is available while the Backup Personality is active. Specifically:

- Input Channel layout does not unexpectedly change when the backup personality is activated or de-activated.
- Input Channel Safe LEDs automatically revert to displaying Bank Safe status.
- The Safe switch in the Selected Channel Inputs section flashes rapidly if one or more channels are Bank Safed.
- Pressing the flashing Inputs Safe switch clears the Bank Safe status of *all safed channels*. Bank Safe status is not restored upon resuming normal operation, nor can it be re-enabled for any channel while the Backup Personality is active.

You cannot change the current Input Safe Switch mode while the Backup Personality is active.

After Resuming Normal Operation

Any changes to Bank Safe status made while the Backup Personality is active will persist when normal operation resumes. You can continue working uninterrupted knowing Bank Safe status will not be reset to its state prior to when the Backup Personality was activated.

Banking the Output Section

Outputs are controlled using the Output faders and Encoders.

The Mains fader provides constant access to the house output (Mains) bus, and does not follow Output fader banking.

To bank Auxes, Matrix, Groups, or VCAs to the Output faders:

- Press the corresponding switch in the Output Faders section.

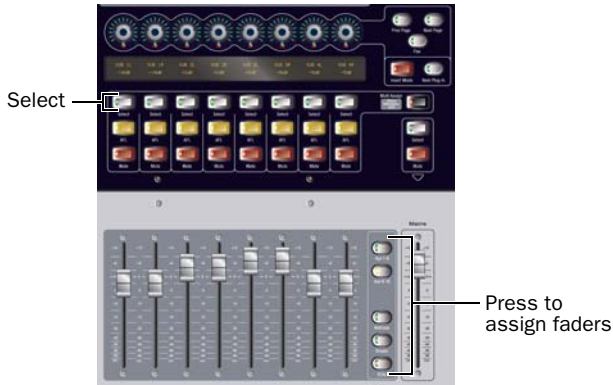

Bank switches for Output channels

Selecting and Targeting Channels

Each VENUE channel strip has a channel Select switch. The Select switch targets that channel for routing or processing assignment. When a single channel is selected it becomes the targeted channel, which can be adjusted from the console or on-screen. Channels can also be selected by clicking their fader strips on-screen.

To select a channel, do one of the following:

- Press the Select switch on the console channel strip.
 - or –
- Click anywhere in the on-screen channel fader strip, except on the fader, mute, solo or safe buttons.

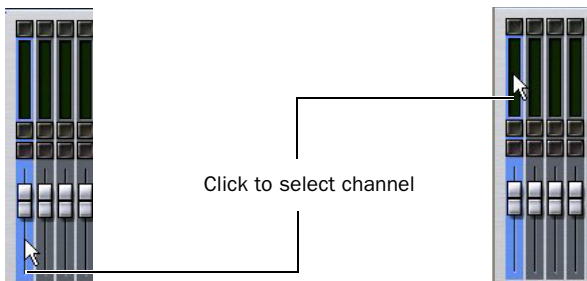

Clicking on-screen to select a channel

Multi-Select (Shift)

Multi-Select lets you select multiple channels in order to apply an action to them in one step.

To select multiple channels from the console:

- 1 Press and hold the Multi-Select switch (located next to the input Bank switches). The switch flashes to indicate Multi-Select mode.
- 2 Press Select on each channel you want to include in the selection.
- 3 Release the Multi-Select switch.
- 4 Perform a routing assignment or other function (for example, press a Bus Assign switch on one of the included channels). The operation is applied to all selected channels.

 You can use the Shift key on the keyboard or the Multi-Select (Shift) switch to select multiple channels.

To exit Multi-Select mode, do one of the following:

- Press Cancel.
 - or –
- Press the Select switch on a channel that is currently not selected.

To select multiple channels on-screen:

- Press and hold the Multi-Select switch (or hold Shift on the keyboard) and click the fader strips on-screen.

To select an 8-channel bank on-screen:

- Click the bank name below the on-screen fader strips. Shift-click to select additional banks or channels.

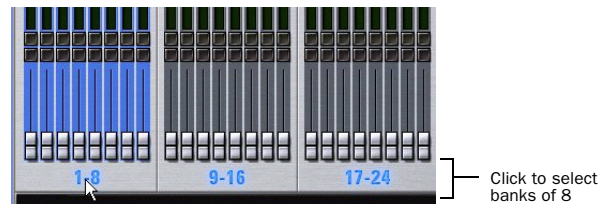

Clicking a bank display to select multiple channels on-screen

To select all input channels or all output channels on-screen:

- Double-click any bank name below the on-screen fader strips in the Input or Outputs screen.

To remove a channel from a selection:

- Control-click (or Fine-click) a highlighted channel.

 See "Screen Controls" on page 38 for additional on-screen features.

Multi-Assign

The Multi-Assign switch in the Output section is used to route multiple channels to the selected output bus.

To assign one or more channels to an Aux, Group, or VCA:

1 Press one of the following switches in the Output Fader assignment section:

- Aux 1–8
- Aux 9–16
- Groups
- VCAs

2 Press the Multi-Assign switch near the Output encoders. The flashing Multi-Assign switch and the banner display at the lower left of the screen indicate Multi-Assign mode is enabled.

3 Press the Select switches on the channels you want to assign to the Aux, Group, or VCA.

4 Select any other output to confirm the previous assignment and proceed to assigning channels to the new selection. To confirm the assignment and exit Multi-Assign mode, press the flashing Multi-Assign switch.

5 To cancel the assignment do either of the following:

- Press the Cancel switch (in the Mute Groups/Function section), or press the ESC key on your keyboard.
- or –
- Click Cancel in the on-screen Multi-Assign dialog box.

 See Chapter 9, “Outputs and Output Routing.”

Type Text Search

Type Text search lets you use the keyboard for fast navigation to a channel, or to quickly go to a specific snapshot or event. You can enter the first characters of a channel name or the absolute channel number to target that channel on the ACS. (See also “Selecting and Targeting Channels” on page 36.)

To search for and select a channel by name:

1 Go to the Inputs, Outputs, or Patchbay page.

2 Type the first few letters, channel number, or full name of the channel. For example, type “s” to go to the first channel beginning with the letter s (such as Snare).

3 Press the Tab key to cycle through and select any other channels beginning with that letter (such as *Snare Top*, *Snare Bottom*, or *Strings*).

To search for and select a list item by name (or number):

1 Go to the Snapshots, Events or Filing page. Or, click to open any Presets window (built-in Dynamics or EQ presets, Input Channel presets, or Scope Sets).

2 Type the first few letters or number of the desired item.

3 Press the Tab key to cycle through and select any other items that begin with the same letters.

Channel Numbers and Names

VENUE SC48 channel numbers are “absolute” channel numbers. Renaming changes the displayed name associated with each channel, but the absolute channel number remains fixed.

To search for and select a channel by absolute number:

- Type a number on the keyboard to select the corresponding channel.

 *Type Text search can also be used to select snapshots and events.*

Targeting Plug-In Inserts

Selecting a single channel targets that channel in the ACS. This lets you enable Inserts Mode to use the Output encoders to adjust plug-ins inserted on that channel.

 For more information, see See Chapter 19, “Plug-Ins.”

Screen Controls

Adjusting On-Screen Faders

You can move on-screen faders independently or in ganged fashion.

To adjust a single fader on-screen, do one of the following:

- Drag a fader in the on-screen channel strip section at the bottom of the screen.
 - or –
- Select a channel and move its fader in the on-screen selected channel controls.

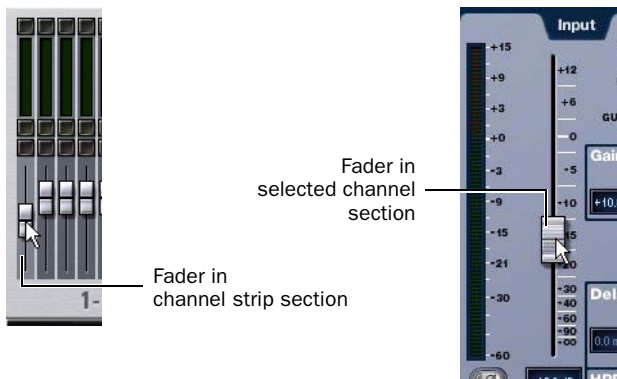

Dragging a fader on-screen

To move multiple faders on-screen in ganged fashion:

- 1 Select multiple channels on-screen by Shift-clicking.
- 2 Move the fader on one of the selected channels.

The faders on the selected channels will move in ganged fashion. Any offset between the faders is maintained until at least one of the faders is minimized (moved to $-\infty$) or maximized (set to +12 dB).

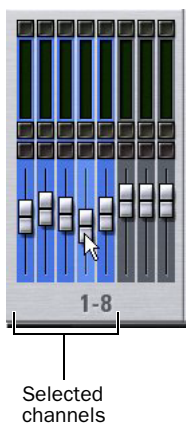

Dragging multiple faders on-screen

Adjusting On-Screen Encoders

You can adjust on-screen rotary encoders by dragging directly over the on-screen knob.

To adjust an on-screen rotary encoder:

- 1 Click on the knob so that it is highlighted.
- 2 Drag up to turn the encoder clockwise; drag down to turn the encoder counter-clockwise.



Dragging over an encoder on-screen

Adjusting Values On-Screen

In addition to typing numeric values in text boxes, you can adjust parameter values and numeric option settings on-screen by dragging directly over the corresponding text box.

To adjust a value on-screen by dragging:

- 1 Click in the text box to select the value.
- 2 Drag up to increase the value; drag down to decrease the value.



Adjusting a parameter value by dragging over its text box

Screen Shortcuts

The on-screen Fader display provides the following right-click shortcuts.

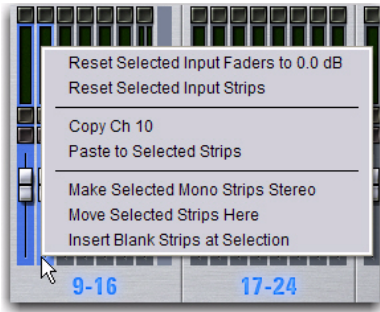

Right-clicking a fader on-screen

💡 See also “Fader and Encoder Shortcuts” on page 42.

Reset Fader to 0

Resets the fader position to zero.

Reset Selected Input Strips

Resets every parameter on the selected channel(s) to default settings.

Copy and Paste Channel

Channel settings can be copied in their entirety from one channel and pasted to one or more channels from the console or on-screen.

💡 You can also store and load settings as Input Channel Presets. For information, see “Input Channel Presets” on page 42.

By default, Function switches 3 and 4 (F3 and F4) are programmed for Copy and Paste, respectively.

💡 Using the Events List, Copy and Paste can be assigned to any trigger. For more information, see Chapter 22, “Events.”

To copy and paste channel settings from the console:

- 1 Press the Select switch on the channel you want to copy.
- 2 Press F3 to copy.
- 3 Press the Select switch on one or more destination channels (the channel or channels to which you want to paste the copied settings).
- 4 Press F4 to paste. The status displays shows a message confirming the Paste operation.

To copy and paste channel settings on-screen:

- 1 Do one of the following:
 - Right-click on a channel fader in the fader display across the lower half of the screen and choose Copy.
 - or –
 - Right-click within the upper channel display and choose Copy.



Copying channel settings

💡 You do not need to select the channel before copying its settings on-screen.

- 2 Select one or more destination channels. You can only paste to selected channels.

- 3 Right-click on the lower fader strip on-screen, or on any non-control area of the destination channel, and choose Paste to Selected Strip(s). The status displays shows a message confirming the Paste operation.

Parameters and Channel Types

Input channels can only be copied or pasted to other Input channels. Output channels can only be copied or pasted to other channels of the same type (such as Aux, Group, PQ, Matrix). When pasting channel settings:

- Settings common to the source and destination channel are always pasted.
- Copied settings with no corresponding parameter in the destination channel are ignored.
- Settings in the destination channel with no corresponding parameters are left unchanged.

Copying and Pasting Mono and Stereo Channel Settings

You can copy a mono channel and paste its settings to one or more stereo channels. Mono settings are applied equally to the left and right channels of the stereo destination. The stereo destination channel retains its current balance and width settings.

You can also copy a stereo channel and paste its settings to one or more mono channels. The left channel settings of the stereo source are applied to the mono channel(s). The mono destination channel retains its current pan setting.

Settings Excluded from Copy and Paste

Input Channels The following Input channel parameters are not copied or pasted (the current settings of the destination channels are retained):

- Patchbay assignments, including Direct Outs
- Channel Name
- Hardware and software insert (plug-ins) assignments and in/out state.

Output Channels The following Output channel parameters are not copied or pasted (the current settings of the destination channels are retained):

- Patchbay assignments, including Direct Outs
- Channel Name
- Hardware and software insert (plug-in) assignments and in/out status
- GEQ settings
- Output membership (the assignment of channels to an Aux, Group VCA, Matrix or PQ).

 *To copy GEQ settings, use the copy/paste GEQ shortcut or use GEQ Presets. Use the Replace with Mix (members) From command to replace output membership for an Aux, Group, VCA, Matrix or PQ.*

Make Selected Mono Strips Stereo/Make Selected Stereo Strip Mono

Combines two selected mono channels into a single stereo channel, or splits a selected stereo channel into two mono channels. VENUE must be in Config mode to change the stereo status of a channel.

Move Selected Strip

Moves a selected strip from its current position to a new location. When you move a channel strip, other channels are moved (and renumbered) lower or higher to accommodate the moved channel.

VENUE must be in Config mode to move channel strips.

To move a fader strip:

- 1 Put the system in Config mode.
- 2 Select the channel you want to move.
- 3 On-screen, right-click on the destination strip (where you want to move the selected channel).
- 4 Choose Move Selected Strip Here from the pop-up menu.

 *Snapshots cannot store and recall custom console channel position.*

Insert Blank Strip

The Insert Blank Strip command lets you insert one or more blank (or “spacer”) strips anywhere among your input channels. In addition, blank strips are automatically inserted when you use the Make Stereo command to convert two mono input channels into a single stereo channel, preserving the channel layout.

Blank strips are strictly placeholders (no audio or any type or processing take place), and therefore consume no additional processing overhead or DSP resources.

Use blank strips to create obvious divisions between groups of instruments, or to optimize the bank placement of inputs on the console.

Blank strips are saved and loaded as part of the Show file. Blank strips remain available during Backup Personality mode.

Blank Strips on the Console

A blank strip has no LCD channel name display, and all of its physical controls and indicators are inactive. Blank strip faders are set to the bottom (–inf) position and always revert to this position if moved.

Blank Strips On-Screen

Blank strips appear as a simple gray strip with no fader, buttons or meter. A blank strip can be right-clicked to reveal its context menu.

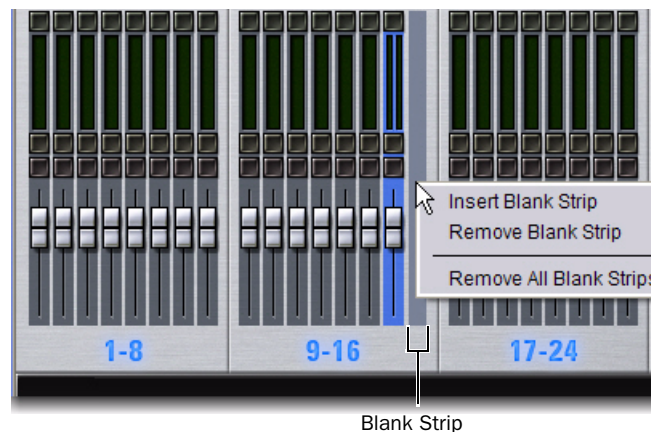

Blank strip in position 16, Right-click menu shown

Adding Blank Strips

Blank strips can be inserted manually, and are also created automatically when you use the Make Stereo command.

Manually Inserting Blank Strips

Config mode must be enabled to add or remove blank strips.

To manually add a blank strip:

- 1 Enable Config mode.
- 2 Right-click an input channel strip at the location where you want to insert a blank strip and choose Insert Blank Strip. For example, if you want to have a blank strip at channel strip 16, right-click on channel 16.

You can also select a blank strip and choose Insert Blank Strip to insert multiple blank strips.

All channels to the right of the insertion point (including the right-clicked channel) are shuffled one position to the right.



This command will be unavailable if the combined number of input channel strips plus blank strips equals or exceeds 96. For more information, see “Limits and Guidelines for Blank Strips” on page 41.

To insert multiple blank strips:

- 1 Enable Config mode.
- 2 Create a multi-selection of channels.
- 3 Right-click on one of the selected channels and choose Insert Blank Strips at Selection.

A blank strip is inserted in place of each selected channel strip, shifting all channels accordingly and maintaining the multi-selection.

Automatically Inserting Blank Strips using Make Stereo

VENUE automatically creates blank strips when you use the Make Stereo command in order to preserve the current channel layout. Similarly, blank strips may be automatically removed when you use the Split Stereo command to revert a stereo strip to its two contributing mono channels.

Make Stereo A blank strip is automatically inserted at the location previously occupied by the right-side channel of the newly-formed stereo pair. There is no shuffling of the remaining input channels as a result of this operation.

Split Stereo The behavior when splitting a stereo strip into two mono strips is as follows:

- If a blank strip is located immediately adjacent to the (previously) stereo channel, the right channel of the stereo pair occupies this position and the blank strip is automatically removed. No other channels shuffle.
- If no blank strip is located immediately adjacent to the (previously) stereo channel, all channels to the right of the split point shuffle one position to the right and the right channel of the stereo pair is inserted.

Removing Blank Strips

Blank strips can be removed manually.

Manually Removing Blank Strips

To remove a blank strip:

- Right-click the blank strip you wish to remove and choose Remove Blank Strip.

To remove all blank strips:

- Right-click any blank strip and choose Remove All Blank Strips.

Blank strips are removed and all channels to the right are shuffled one position to the left.

Limits and Guidelines for Blank Strips

The maximum number of fader strips is 96. These 96 positions can be comprised of any combination of mono or stereo input channels, as well as blank strips. (FX Returns are considered separate and are not included in this count.)

The maximum number of blank strips that can be used varies depending on the current system configuration and the number of stereo channels used in the configuration. This number can be calculated as:

$$(96 - \text{the number of input channels in System Configuration}) + \text{Number of stereo channels}$$

For example:

- A 96 channel configuration with 96 mono channels can have 0 blank strips.
- A 48 channel configuration with 48 mono channels can have 48 blank strips
- A 48 channel configuration with 4 stereo channels can have 52 blank strips ($52 = 96 - 48 + 4$)

Fader and Encoder Shortcuts

The on-screen channel faders and encoders provide the following right-click shortcuts to reset individual parameters and channel strips.



Right-clicking channel strip controls on-screen

Reset Parameter

To reset an on-screen fader or encoder to its default value, do one of the following:

- Right-click the control and choose Reset.
 - or –
- Alt-click the control.

Reset Channel

To reset an entire channel strip to its default settings:

- Right-click the on-screen channel fader and choose Reset Strip.

Channel Control

Channel Control provides a unified set of controls for input, EQ and dynamics processing (or equivalent plug-ins), and Aux Sends. You can also create a custom User assignment that includes any eight parameters.

To assign a compatible parameter to a Channel Control encoder:

- Right-click the on-screen channel fader and choose an encoder from the Channel Control sub-menu.

For more information, see Chapter 6, “Channel Control.”

Input Channel Presets

Input channel configuration (input name, gain, fader levels, send levels and bus routing) can be stored and recalled as Input Channel Presets. Input Channel Presets can be previewed, recalled and transferred just like other VENUE preset files, letting you quickly configure channels from among a library of favorite setups.

When an Input Channel is stored or recalled as a preset, all parameters are affected except the following:

- Patchbay assignments, including Direct Outs
- Hardware and software insert (plug-in) assignments and in/out state.

⚠ Selecting a channel preset automatically loads the saved settings into the selected channel. Depending on the stored settings this may dramatically change channel level and signal routing. Use caution when previewing Input Channel Presets with a live source.

To store a channel as an Input Channel Preset:

- Configure an Input Channel as desired.
- Click the Channel Presets icon (the folder icon located to the right of the Channel Routing indicator and +/- buttons).

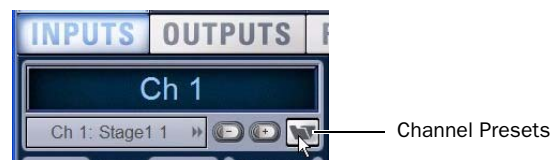

Channel Presets icon in the Inputs page

- Specify a folder in which to save the preset, if the currently selected folder is not appropriate, by clicking the Folder selector and selecting a different folder.

- Click New.

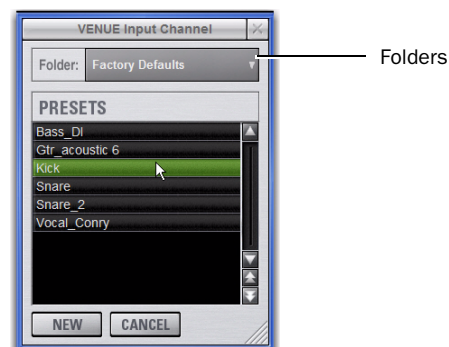

Input Channel Presets window

To preview and recall a saved Channel Preset:

- Navigate to the Inputs page for the desired channel. Channel Presets can only be loaded into a single channel at a time.
- Click the Channel Presets icon.
- If necessary, click the Folders icon and select the appropriate Channel Presets folder from the pop-up menu.
- Do any of the following:
 - To preview an existing Channel Preset, click its name in the Channel Presets window.
 - To load the currently selected Channel Preset, press Enter or click the Close box (X) in the Channel Presets window title bar.
 - To cancel without changing settings, click Cancel.

To rename, duplicate, overwrite or delete a Channel Preset:

- Right-click the preset name in the Channel Preset window and choose Rename, Duplicate, Delete, or Overwrite.

Channel Compatibility and Input Channel Presets

The following describe how different types of channel data is handled when storing or loading Input Channel Presets.

Channel Names and Presets

New presets automatically inherit the current Input Channel Name, or you can give them a custom name in the Presets window. The default channel number (such as "Ch 16") is used for the preset name if the channel has an empty (null) name.

Loading Mono and Stereo Channel Presets

You can load mono Channel Presets into stereo channels, and stereo Channel Presets into mono channels.

Loading Mono to Stereo Mono settings are applied equally to the left and right channels of the stereo destination. The stereo destination channel retains its current balance and width settings.

Loading Stereo to Mono When loading a stereo preset into a mono Input Channel, the left channel settings in the stereo preset are applied to the mono destination channel. The mono destination channel retains its current pan setting.

Channel Compatibility

When storing and loading Input Channel presets, remember the following:

- ◆ Group bus assignments are not applied if the settings in the preset do not match the current console Bus Configuration
- ◆ Aux send level or pan settings for individual aux pairs are not applied if the stored stereo link/unlink state does not match the current link/unlink state. For example, assume the stored preset has Aux 1–2 linked, but the current console configuration has these Auxes unlinked. When the preset is recalled Aux 1 and Aux 2 will retain their current settings (they will not be updated), while all other Auxes are updated to the preset settings.

Transferring Input Channel Presets

Input Channel Presets are available as Built-In Presets in the Transfer tab of the Filing page. This lets you transfer your Channel Presets to a USB key disk or other storage device for backup and transfer to other systems.

Input Channel Presets are supported on all systems running VENUE D-Show software 2.5 or later, including the Stand-alone software.

 *For more information, see Chapter 20, "Shows and File Management."*

Chapter 6: Channel Control

Channel Control's eight encoders and LCD displays are used to control different functions such as Input, EQ, Comp/Lim, Exp/Gate, Aux Sends 1-8, and Aux Sends 9-16. Channel Control also lets you create a custom User set of controls for immediate access to any eight parameters.

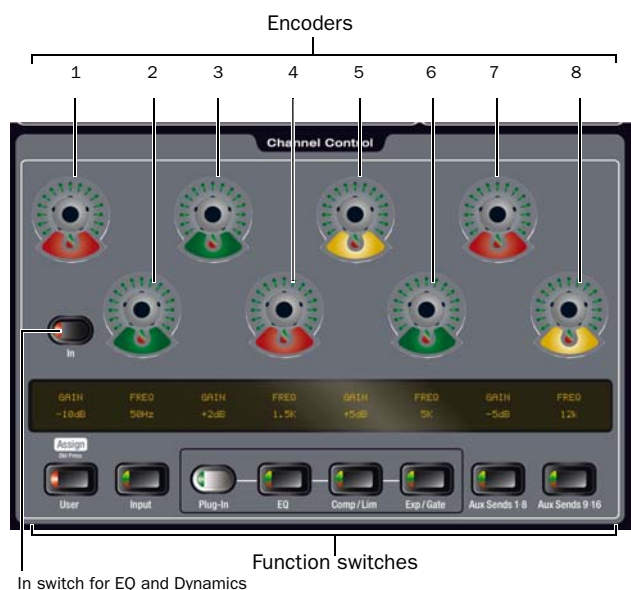

Channel Control encoders 1-8 and Function switches

Channel Control operations for inputs, EQ and dynamics processing, plug-ins, and Aux Sends are detailed in the relevant sections of this guide. The rest of this chapter shows you the basics of Channel Control, as well as how to create and manage the custom User assignment.

Using Channel Control

Using Channel Control is as simple as selecting one or more channels and choosing a Channel Control function to adjust the desired parameters.

To start using Channel Control:

- 1 Select one or more channels.
- 2 Press a Channel Control function switch.

The Channel Control LCD identifies the parameter now mapped to each encoder. On-screen, a matching color background indicates the currently active Channel Control function.

Adjust Parameters

To adjust parameters in Channel Control:

- Press an encoder to toggle its parameter on/off (such as turning an Aux send on/off).
- Rotate an encoder to adjust its current parameter (such as input gain, or comp/lim threshold).

To bypass a selected processor (toggle in/out):

- Press the In switch in the Channel Control section to toggle the module in or out. When lit, the module is in/engaged; when unlit, the module is out/bypassed.

To adjust a different type of parameter:

- Press a different Channel Control Function switch.

Encoders, Display and Modifiers with Channel Control

Rotary and Switch Encoders

The encoders in the Channel Control section are dual-function rotary/switch controls. For example, when Auxes are in Channel Control, pushing an encoder toggles that send on/off; rotating the encoder adjusts send level.

Color

Each function uses a unique color in its switch LED that is also shown on-screen to identify the currently assigned parameters. For example, when Channel Control is in EQ mode, the on-screen EQ section for the selected channel will have a green background.



On-screen color indication of Channel Control function

Function switches and background colors for Channel Control are listed in the following table.

Channel Control Functions and Color

Function	Color
Input	white
EQ	green
Comp/Lim	blue
Exp/Gate	yellow
Aux Sends 1-8	pink
Aux Sends 9-16	turquoise (blue/green)

LCD Displays

Each encoder has an associated LCD display that is 2 rows/6 characters per row. LCDs for each encoder show the current parameter name in the upper row (long parameter names will wrap down to the lower row of each LCD). Parameter values are shown below the parameter name whenever an encoder is being adjusted.

The LCD display mode can be changed to show all parameter values all the time.

To toggle Channel Control LCDs between temporary and persistent parameter value display:

- 1 Press and hold the Default (Alt) switch.
- 2 Press a Function switch in the Channel Control section.

Functions

The Channel Control function switches provide consistent, preconfigured mappings for fast and familiar access to input, EQ, dynamics, and Aux send parameters.

Input

Channel Control lets you adjust input gain, right offset, HPF, pan, balance/width, delay, and direct outs.

To access Input parameters in Channel Control:

- 1 Select one or more channels.
- 2 Press the Input switch in the Channel Control section.

The following tables list Input parameter mapping for mono and stereo channels in Channel Control.

Mono Input Parameters in Channel Control

Mono Input Channel Parameters in Channel Control

	1	2	3	4	5	6	7	8
Rotate	Gain		HPF frequency	Pan		Delay		Direct Out level
Push (Indicator LED)	Guess (green)		In (green) Out (off)	Center (green)		In (green) Out (off)		In (green) Out (off)

Stereo Input Parameters in Channel Control

Stereo Input Channel or FX Return Parameters in Channel Control

	1	2	3	4	5	6	7	8
Rotate	Gain	Right Offset	HPF frequency	Balance	Width	Delay		Direct Out level
Push (Indicator LED)	Guess (green)		In (green) Out (off)	Center (green)	Stereo (green)	In (green) Out (off)		In (green) Out (off)

For more information about input channels, see Chapter 8, “Inputs and Input Routing.”

EQ

To access EQ parameters in Channel Control:

- 1 Select one or more channels.
- 2 Press the EQ switch in Channel Control.
- 3 Press the In switch to toggle the band in or out (a lit In switch indicates the EQ is in circuit).

For complete information on using EQ, see Chapter 18, “EQ.”

Comp/Lim

To access compressor/limiter parameters in Channel Control:

- 1 Select one or more channels. (Built-in dynamics processing is available on Input Channels and FX Returns only).
- 2 Press the Comp/Lim switch. The Comp/Lim switch LED lights blue when engaged.

 For more information, see Chapter 17, “Dynamics.”

Exp/Gate

To access expander/gate parameters in Channel Control:

- 1 Select one or more channels. (Built-in dynamics processing is available on Input Channels and FX Returns only).
- 2 Press the Exp/Gate switch. The Exp/Gate switch LED lights yellow when engaged.

 For more information, see Chapter 17, “Dynamics.”

Plug-ins

The Channel Control Plug-In switch is available for EQ, Comp/Lim and Exp/Gate functions only. Use it to toggle between controlling built-in processing or a like (equivalent) plug-in inserted on the channel. Plug-ins use the same control mapping and text labels as their corresponding built-in functions. Plug-in parameters that don’t map to Channel Control will not be available.

The Plug-in switch LED is only lit and active when a controllable plug-in is already inserted and banked to Channel Control. The In button toggles the bypass state of the plug-in; all other parameters are adjusted identically to the built-in EQ, compressor/limiter, or expander/gate.

 For more information, see Chapter 19, “Plug-Ins.”

Aux Sends 1-8 and Aux Sends 9-16

To access Auxes in Channel Control:

- 1 Select one or more channels.
- 2 Press the Aux Sends 1-8 or Aux Sends 9-16 switch in Channel Control.

 For more information, see Chapter 11, “Aux Sends.”

User Assignment

User mode lets you mix and match parameters from different function types and save it as the single Channel Control User assignment.

The User assignment is stored with each Show file. A default (factory) User assignment is provided to get you started quickly.

To load the Default User assignment:

- 1 Select one or more channels.
- 2 Press the User switch (Channel Control Function switch).
- 3 Press the flashing In switch in the Channel Control section.

The factory Default User assignment is preconfigured to bring the following parameters to the Channel Control section.

Default User map

Encoder	Parameter	Function (type)
1	Input Gain (rotate) Gain Guess (push)	Input
2	HPF Freq (rotate) In/Out (push)	
3	Low Mid Gain (rotate) Q (push)	EQ
4	Low Mid Freq (rotate) In/Out (push)	
5	Hi Mid Gain (rotate) In/Out (push)	
6	Hi Mid Freq (rotate) Q (push)	
7	Comp/Lim Threshold	Dynamics
8	Exp/Gate Threshold	

Creating a Custom User Assignment

To assign Channel Control encoders to parameters:

- 1 Double-press the Channel Control User switch to enter User Assign mode.
- 2 Press a Channel Control encoder (1-8) to select it for assignment.
- 3 On-screen, click to select the parameter you want mapped to the selected Channel Control encoder. Continue clicking other parameters. Each click assigns that parameter to the next sequential Channel Control encoder, up to 8.
- 4 Press the flashing User switch to exit Assign mode and store your assignments.

To make Channel Control assignments on-screen:

- 1 Right-click any available encoder.
- 2 Select a Channel Control encoder (1-8) from the Channel Control sub-menu.
- 3 On-screen, click Done to confirm Assignment mode (or press the flashing User switch), or click Cancel.

To clear the User assignment:

- 1 Double-press the Channel Control User switch to enter User Assign mode.
- 2 Hold the Default (Alt) switch and press the flashing Channel Control In switch.

All assignments are cleared, and the first encoder flashes in Assign mode (ready to be re-assigned).

To clear a User assignment:

- 1 On-screen, right-click a parameter.
- 2 Choose Clear <param name> from the Channel Control sub-menu.

To clear all User assignments:

- 1 On-screen, right-click a parameter.
- 2 Choose Clear All Assignments.
- 3 Click Clear to confirm and clear all; click Cancel to cancel and leave the User assignment unchanged.

When no User assignments exist, the Channel Control In switch flashes. This will be the case after a Clear Console, after clearing all Channel Control assignments, after the first time the console is powered on, or after loading a Show file from a different system that does not support Channel Control.

Availability of Channel Control Functions

Channel Control functions will be available or unavailable depending on the type of channel currently selected, as shown in the following table.

Table 7. Channel Types and Available Functions

	Inputs	EQ	Comp/Lim	Exp/Gate	Aux 1-8	Aux 1-9
Input Channels	Yes	Yes ¹	Yes ¹	Yes ¹	Yes	Yes
FX Returns	Yes	Yes ¹	Yes ²	Yes ²	Yes	Yes
Aux Sends 1-8, Aux Sends 9-16	Yes ³	Yes ²	Yes ²	Yes ²		
Matrixes	Yes ³	Yes ³	Yes ²	Yes ²		
Groups	Yes ²	Yes ³	Yes ²	Yes ²		
VCAs						
Mains LR, C/M	Yes ³	Yes ³	Yes ²	Yes ²		

1 Built-in and plug-ins only

2 Plug-ins only

3 Processing available, but not all parameters are available due to the type of bus/channel.

Chapter 7: Options

The Options page provides several tabs. Of these, the System and Devices tabs are where most system configuration settings and options are enabled and customized:

- The System screen provides the primary tools by which you configure mixing, routing, and processing options.
- The Devices screen provides status, diagnostics, and options for hardware components.

This chapter shows you how to manage the most important System and Devices settings, and describes the settings available in other Options screens.

Overview of Options

The Options page provides the following tabs:

- “System” on page 51
- “Busses” on page 53
- “Pickoffs” on page 55
- “Snapshots” on page 55
- “Misc” on page 56
- “Interaction” on page 58
- “Devices” on page 53
- Chapter 22, “Events”
- Plug-Ins (see “Installing and Authorizing Plug-Ins” on page 143)

To display the Options page, do one of the following:

- Press the Options switch in the View Mode section.
– or –
- Click the Options tab on-screen.

To display different tabs of the Options page, do one of the following:

- Press the Options switch repeatedly to cycle through available tabs.
– or –

Click the desired tab at the top of the Options page (System, Busses, Pickoffs, Snapshots, Misc, Interaction, Devices, Events or Plug-Ins).

 *The Plug-Ins tab is not available in D-Show Standalone software.*

System

(System Configuration)

The System page lets you allocate DSP resources used for routing and processing, configure Mains and Aux/Group busses, reset the system (clear console), and quit (shut down VENUE).

To access the System Config page:

- Go to the Options page and click the System tab.

Basics of Editing System Settings

Settings available in the System screen can only be edited while in Config mode.

 *Changing the system configuration will restart the D-Show software and may interrupt audio.*

In Config mode, the Edit button becomes available to let you change settings. When a System Config setting is changed, the Apply button becomes available at the right of the screen to let you confirm and apply changes.



System Configuration tab of the Options page

In Show mode, the Edit button is unavailable. This protects these settings from being changed during a performance (since changes to these settings can interrupt audio).

VENUE SC48 Systems

System Configuration settings available with standard VENUE SC48

Input Channels	FX Returns	Graphic EQs
16, 24, 32, 48	8	0, 8, 16, or 24

To change a System Config option:

- 1 Put the system in Config mode.
- 2 Go to the Options page and click the System tab.
- 3 Click Edit.
- 4 Change a System Config, Main Bus, Inputs or Bus Configuration option.
- 5 Click Apply to confirm and apply your new settings.

System Configuration Settings

The System Configuration section shows the current allocation of system resources.

In Show mode, the System Config area is display-only. In Config mode, you can edit the system configuration to allocate resources for mixing and processing.

To change a System Configuration setting:

- 1 Put the system in Config mode.
- 2 Click the Edit button on-screen.
- 3 Choose a new setting for Input Channels or Graphic EQs.
- 4 Click Apply to confirm the settings.

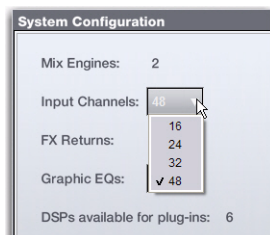

Designating the number of Input Channels

Mix Engines

The Mix Engine setting is determined by the number of DSP Engine Cards detected and cannot be changed. VENUE SC48 comes supplied with two Mix Engines.

Channels

Choose the total number of Input Channels you need. This number represents mono channels; each stereo channel uses two mono channels.

You can configure the VENUE SC48 to use 16, 24, 32, or 48 Input Channels.

Choosing a lower number of Input Channels leaves more DSP for plug-ins; choosing a higher number reduces the amount of DSP available for plug-ins.

FX Returns

Choose the number of FX Return channels you need. On VENUE SC48 the number of FX Returns is pre-configured to 8 stereo FX Return channels, and cannot be changed.

Graphic EQs

Choose the number of Graphic EQs you will need for output processing. You can choose to have 0, 8, 16, or 24 Graphic EQs. Choosing a lower number leaves more DSP for plug-ins; choosing a higher number reduces the amount of DSP available for plug-ins.

DSPs Available for Plug-Ins

The amount of DSP available for plug-ins depends on your other System Config settings, and cannot be changed directly. To change the amount of DSP available for plug-ins, reduce the number of Input Channels or Graphic EQs.

Main Bus Settings

The Main Bus Settings let you configure the Main mix bus. See “Configuring the Main Busses” on page 73.



Main Busses options in the System page

L-R plus Mono

This default setting provides a stereo bus, plus one mono bus.

L-C-R

This setting enables L-C-R mode, which lets you mix in “3-across-the-front” mode.

⚠ Changing the Main Bus mode will restart the system software and may interrupt audio.

To change the Main Bus configuration:

- 1 Put the system in Config mode.
- 2 Go to the Options page and click the System tab.
- 3 Click Edit.
- 4 Click to choose a Main Bus mode.
- 5 Click Apply; the system restarts.

Bus Configuration Settings

The Bus Configuration Settings let you choose the Aux and Group busses configuration. See “Configuring Aux and Group Busses” on page 74.

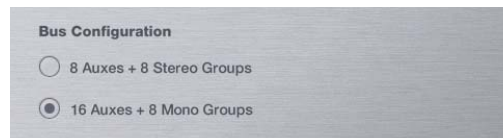

Bus Configuration in Config/Edit mode

To change the Aux/Group Bus Configuration:

- 1 Put the system in Config mode.
- 2 Click the Edit button on-screen.
- 3 Click to select a Bus Configuration option.
- 4 Click Apply; the system restarts.

Devices

The Devices page lets you view system connections, troubleshoot hardware and reset VENUE system components.

To display the Devices tab:

- Click Options > Devices.

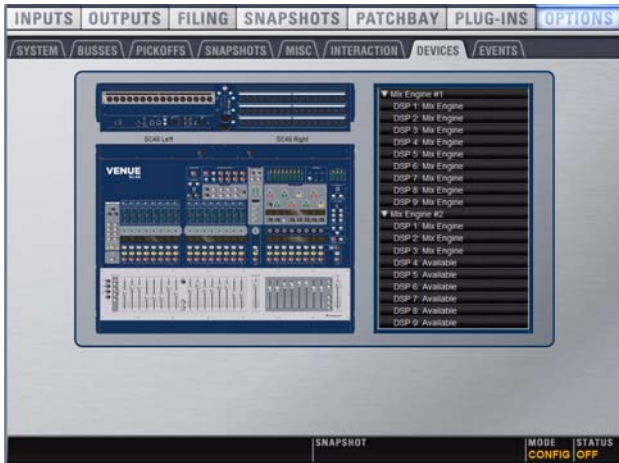

Devices tab of the Options page

You can use this page to view component status after diagnostics or troubleshooting.

To reset VENUE system hardware components:

- 1 Put the system in Config mode.
- 2 Go to the Options page and click the Devices tab.
- 3 Right-click any of the following hardware components:
 - Console sections
 - Stage or FOH Audio section
- 4 Choose Reset.

Simulating a VENUE Configuration with the Standalone Software

With the VENUE D-Show Standalone software, you can use the Devices page to simulate a VENUE system of any size for purposes of preparing shows and training. See “Simulating a VENUE Configuration” on page 212.

Other Options and Settings

Busses

The Busses page lets you customize characteristics for the Aux, Solo, Matrix, and Main busses.



Busses tab of the Options page

Auxiliaries

These options let you designate bus link status, pick off source, and stereo pan behavior for Auxiliaries (Aux Send busses). (Variable Group busses are available on VENUE Profile and D-Show systems only).

 For more information, see Chapter 11, “Aux Sends.”

Links When enabled, this option links the corresponding busses into bus pairs. Control changes affect both mono Aux busses, and the Follows Channel Pan option becomes available.

Pickoff These options let you designate the pre-fader pickoff point feeding each bus. Choices include pre-EQ, pre-mute, and pre-fader (post-mute).

Follows Channel Pan Each channel can be panned independently within each linked bus pair, or configured to follow the channel pan by enabling the Follows Channel Pan option.

To change the Aux bus configuration:

- 1 Put the system in Config mode.
- 2 Go to the Options page and click the Busses tab.
- 3 Click Edit.
- 4 Configure the following settings:
 - To link two mono Aux busses into a bus pair, select the Link option for the corresponding pair.
 - Specify the panning for channels routed to Aux bus pairs with the Follows Channel Pan option.
 - Click to select the pickoff point for each bus (Pre-EQ, Pre-Mute, or Pre-Fader).
- 5 Click Apply to reconfigure the system.
 - or –
 - Click Cancel to exit without changing system settings.

Solo and Monitor Operations

These settings customize Solo and Monitor bus mode and operation.



Solo controls in the Options > Busses page

Type Solo mode choices include PFL (Pre-Fader Listen), Stereo AFL (After-Fader Listen), and Solo-In-Place.

Auxes/Var Groups Follow AFL Causes the controls for an Aux Send or Variable Group Send to be automatically displayed on the Input Channel encoders whenever the AFL switch is pressed on the corresponding output bus.

AFL Follows Auxes Soloes the Aux (or Variable Group) bus currently being assigned to Input encoders.

Auto Cancel Soloing a channel strip automatically takes any currently soloed channels out of solo.

Input Priority Makes soloed inputs temporarily replace soloed output busses on the AFL/PFL bus.

Mix to Monitors Mirrors the functionality of the Mix to Monitors switch on the control surface.

Level Trim Mirrors the functionality of the Solo/PFL level control on the control surface.

Monitoring Sets the level of the headphone output.

Delay Sets a delay for time-aligning headphones to the house system.

To configure Solo settings on-screen:

- 1 Go to the Options page and click the Busses tab.
- 2 Configure settings as needed:

To adjust Monitor Bus Delay, do one of the following:

- Adjust the Delay encoder on-screen.
- Click the Delay value shown on-screen, and manually enter a new value.

To toggle Delay on or off:

- Click to toggle the Delay In switch on-screen.

 Delay settings are retained when toggled off or on.

 For more information on these features see “Solo and Monitor Busses” on page 111

Matrixes

The Matrixes section lets you link and unlink Matrix to form stereo Matrix busses.

Links When enabled, these options link corresponding mono Matrix busses into stereo-linked pairs. Control changes then affect both mono Matrix busses.

 For more information on these features see Chapter 12, “Matrix Mixers.”

Panning/Center Divergence

The Panning section provides control over center channel divergence when the Main Bus is set to L–C–R mode. See “Main Bus Center Divergence Options” on page 78.

To set Center Divergence:

- Enter a value or drag in the Center Divergence text box and press Enter.

Stereo Group Panning Operation

The Stereo Group Panning Operation options provide different levels of flexibility for how channels can be routed to Groups.

To change Stereo Group Panning Operation:

- 1 Put the system in Config mode.
- 2 Click to select Simple or Expert mode.

 For more information on these options, see “Simple and Expert Operational Modes” on page 85.

Pickoffs

The Pickoffs page lets you control the bus pickoff point on input strips, as well as specify source and insert points for output busses. The Pickoffs page also provides master control for Delay Compensation.

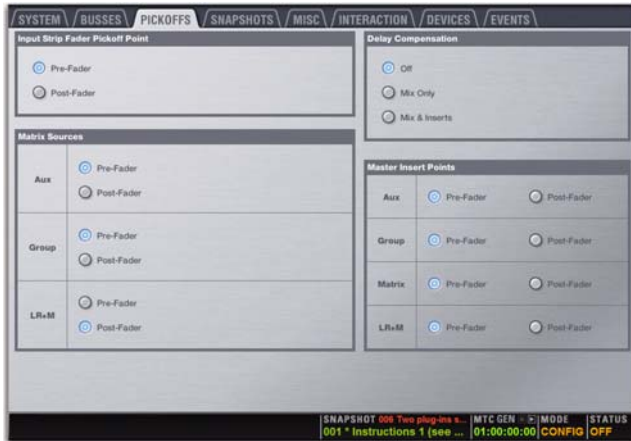

Pickoffs tab of the Options page

Settings for Delay Compensation

The Options > Pickoffs page provides three settings for Delay Compensation: Off, Mix Only, and Mix and Inserts.

Off No Delay Compensation is applied.

Mix Only VENUE automatically compensates for delays incurred by the use of Groups routed to the Mains busses.

Mix and Inserts VENUE automatically compensates for delays incurred by the use of plug-ins as well as those incurred by the use of Groups routed to the Mains busses.

Throughout this guide, other Pickoff options are explained where relevant.

Snapshots

The Snapshots page provides several snapshot preference settings to optimize Snapshot operation.

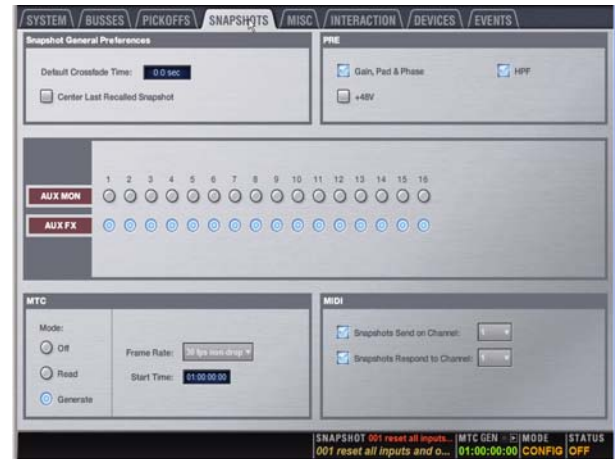

Snapshots tab of the Options page

Snapshot General Preferences

The following settings are available in the Snapshots page.

See Chapter 21, “Snapshots.”

Default Crossfade Time Defines the length of time it takes to crossfade between fader levels when recalling snapshots. Maximum crossfade time is 99.9 seconds.

Center Last Recalled Snapshot Manages the display of the Snapshots list so that the last recalled snapshot is always centered vertically, letting you maintain display of adjacent snapshots in the list.

PRE

The options in the PRE section let you specify which parameters are recalled with Snapshots whose scope includes Pre settings. Click to toggle whether recalled Input snapshot data includes the following:

- Gain, Pad, and Phase
- +48V (phantom power)
- HPF

 Delay is stored as a unique (discrete) data type for each channel.

Aux Mon and Aux FX

These settings let you classify individual Aux Sends (including linked bus pairs) as monitor sends (“Mon”) or as effects sends (“FX”), which lets you scope each type separately from the Snapshots page.

This option is for organizing Aux Sends for snapshot control only, and does not directly affect Aux bus operation.

MTC (MIDI Time Code)

The MIDI Time Code options let you control MTC operational modes, frame rate, and Start Time.

Modes Available MTC modes are MTC Off, MTC Read (slave), and MTC Generate (master).

Frame Rate This option sets the frame rate that is used when generating MTC.

Start Time This option sets the start time that is used when generating MTC.

MIDI

Designates the channel on which snapshots send or receive MIDI Bank Select and Program Change information.

 See Chapter 23, "Synchronization."

Snapshots Send on Channel This option sets snapshots to send Bank Select and Program Change commands on a selected MIDI channel. This provides a quick and easy way to send a MIDI command every time a snapshot is fired, without having to embed a MIDI program change within each snapshot.

Snapshot Send on Channel does not need to be turned on in order to send other types of MIDI data that *are* embedded in snapshots, such as note on/off or MMC.

Snapshots Respond to Channel This option sets snapshots to respond to incoming Bank Select and Program Change commands on the selected MIDI channel.

MIDI Snapshot Output Safe Safes (shuts off) VENUE MIDI output when snapshots are recalled. This does not affect sending of Bank Select and Program Change commands with the Snapshots Send on Channel option.

Misc

The Miscellaneous page provides utility and other settings.

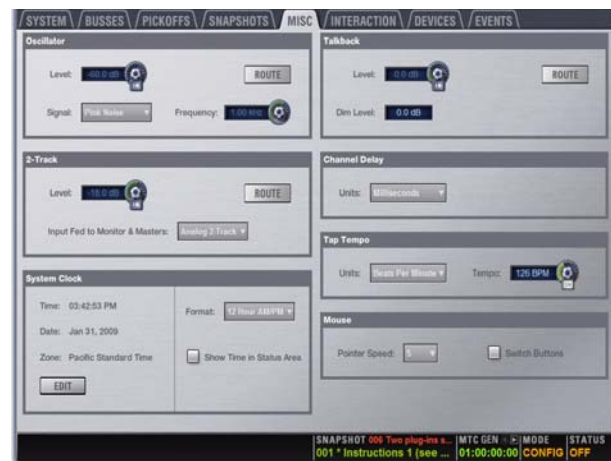

Misc tab of the Options page

Oscillator

Lets you choose the tone, frequency, and level for the built-in oscillator, and route it to an available output.

Signal Lets you choose the type of oscillator tone to use. Choices include sine, variable sine, and noise.

Frequency Lets you set the oscillator frequency.

Route Enables Route Osc to Selected mode, to assign the oscillator signal to the currently selected output channel(s).

2-Track

Lets you set the level and input source for the 2-Track analog and digital inputs, and route them to the desired outputs.

2-Track Level Lets you activate 2-Track input and set 2-Track input level.

2-Track Input Selects which 2-Track input (analog, or digital) is fed to the monitors and output busses.

Route Enables Route 2-Track to Selected mode, to assign the 2-Track signal to the currently selected output channel(s).

Talkback

Talkback Level Lets you activate Talkback and set Talkback input level.

Talkback Dim Level Sets the dim level, which is the amount of attenuation applied to the mix on the output bus when Talkback is activated.

Route Enables Route Talkback to Selected mode, to assign the Talkback signal to the currently selected output channel(s).

Routing Osc, 2-Track and Talkback

Use the Patchbay to assign the Oscillator, 2-Track inputs, or Talkback input to an Input or FX Return fader.

For more information, see Chapter 13, “Patchbay.”

You can use the on-screen Route buttons to route oscillator, 2-track and talkback signals to outputs.

To route the Oscillator, 2-Track, or Talkback outputs on-screen:

- 1 In the Options > Misc page, click the Route button in either the Oscillator, 2-Track, or Talkback sections.
- 2 Do either of the following:
 - If you had already selected the desired output, click to confirm the currently displayed Route To mode (in the lower left corner of the screen).
 - Go to the Outputs page and click to select an output (it flashes briefly, otherwise the Outputs page remains focussed on the currently selected Output channel).
- 3 In the confirmation dialog that appears, click Route to confirm your assignment or click Cancel to cancel without changing the current routing.

System Clock

Sets the date and time for the system.

Time of Day in Status Display

You can choose to show time of day in the lower right corner of the screen in the Status display area. This optional display can be configured for either 12 hour (AM/PM) or 24 hour format as follows:

To show time of day in the Status area:

- 1 Go to the Options > Misc page.
- 2 In the System Clock section, enable the Show Time in Status Area option.
- 3 Select a format for the displayed time: 12 hour (AM/PM) or 24 hour.

Time of day is shown whenever the status of the plug-in racks is OK; plug-in rack status messages (if any) temporarily replace time of day display to alert you to plug-in rack status.

Channel Delay

Lets you set the display units on all applicable input and output delay controls. This makes it possible to set the delay based on any of the following:

- delay time (in milliseconds)
- distance to the source (in feet or meters)
- number of samples of delay

Tap Tempo

Lets you set the global system tempo, toggle system tempo on/off, and choose to display tempo in BPM or ms.

On Turn on the global tempo sync by clicking the On switch directly below the encoder so that it is lit (on).

Tempo Sets a system tempo value using the encoder or by typing a value directly into the Tempo field.

Units Lets you choose Beats Per Minute (BPM) or Milliseconds as the units for displayed values.



Tap Tempo controls in the Options > Misc page

Mouse

Pointer Speed and Mouse L/R Settings

You can customize the response speed for the trackball (or mouse) and on-screen cursor, and reverse the left/right assignment of the Trackball buttons, from the Options > Misc page.

To customize Pointer Speed:

- 1 Go to the Options > Misc page.
- 2 Do any of the following:
 - To adjust cursor speed, click the Pointer Speed pop-up menu and choose a higher value for faster response, or a lower value for a slower response.
 - To reverse the left/right assignment of the two Trackball buttons, click to enable Switch Buttons.

Interaction

The Interaction page lets you configure behaviors for the Selected Channel (ACS) sections, Input Safe Switches, Lights, Meter, Ethernet, and LCD Display.

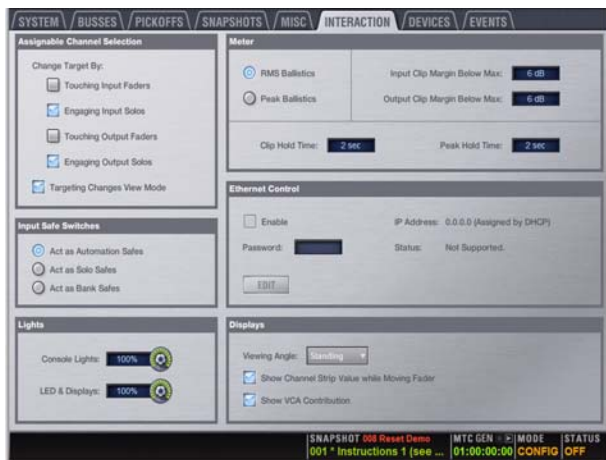

Interaction tab of the Options page

Assignable Channel Selection

Options in this section set the mechanism by which channels are targeted on the Selected Chan sections (also known as the ACS, or Assignable Channel Section).

On the VENUE SC48 this setting can also affect the Channel Control section and the Flex Channel.

To customize console and screen interaction:

- 1 Go to the Options page and click the Interaction tab.
- 2 Set the following Assignable Channel Selection options:

Change Target By

The Change Target By options let you specify whether the following actions target a channel on the ACS. More than one option can be selected simultaneously.

- Touching Input Faders
- Engaging Input Solos
- Touching Output Faders
- Engaging Output Solos

Targeting Changes View Mode

The Targeting Changes View Mode option updates the on-screen display to show the page for the channel targeted. When this option is deselected, the on-screen display does not update when a channel is targeted.

 *VENUE SC48 also provides the latching Flex Channel. For more information, see “Flex Channel” on page 71*

Meter

Metering settings provide the following options for meter ballistics, peak, and clip indication.

Ballistics This option lets you choose RMS or Peak ballistics for the control surface and on-screen meters.

Input Clip Margin and Output Clip Margin These options set the level, relative to the maximum (full scale) level, at which a clip is reported on a channel. When a clip is detected, the entire channel meter turns red.

To set Input or Output clip margin:

- 1 Click in the dB Below Max edit box for Input Clip Margin or Output Clip Margin.
- 2 Enter a value or drag to change the value and press Enter.

The entered value is interpreted as a relative dB value from the maximum (where “Max” is considered +20 dBVU). For example, with the Input Clip Margin set to 6 dB below max (the default), peak levels within 6 dB of maximum level will trigger a clip indication

Clip Hold Time and Peak Hold Time These options specify how long clips and peaks are held. Default is 2 seconds for both Clip and Peak hold.

Input Safe Switches

The Input Safe Switches let you control two independent Safe functions: Automation Safe and Solo Safe. Only one of these Safe functions can be viewed and controlled at a time.

Act as Automation Safes When selected, this option sets the console Safe switches and on-screen channel Safe buttons to toggle the Automation Safe status of the corresponding channel. For more information, see Chapter 21, “Snapshots.”

Act as Solo Safes Solo Safe applies only to Input Channels and FX Returns. When selected, this option sets the Safe switches to toggle the Solo Safe status of the corresponding channel. See “Solo Bus Operation” on page 113.

Act as Bank Safes When selected, this option sets the Safe switches of Input Channels and FX Returns to toggle that channel’s Bank Safe Status. (Bank Safe keeps channels at the top fader layer, immune to input banking.) For more information, see “Bank Safe Mode for Input Safe Switches” on page 34.

Ethernet Control

Ethernet Control settings let you configure ECx Ethernet Control for remote control of the VENUE system over a wireless Ethernet network.

 *For more information, see Chapter 31, “ECx.”*

Lights

Console and LED/Display settings let you adjust the brightness of the following items:

Console Lights Adjust brightness of external lights connected to the Console Lights connectors on the back panel.

LEDs and Displays Adjust brightness of LED and LCD displays on the control surface.

Displays

These options let you customize the behavior of the control surface LCDs.

Viewing Angle This option lets you configure the Selected Channel and Snapshots LCD displays for optimum viewing.

Show Channel Strip Value While Moving Fader This option determines what is displayed in the Channel Name display when a fader is adjusted. When selected (default), the Channel Name display switches from showing channel name to showing the value (level) when a fader is adjusted. When deselected, the Channel Name displays do not show values when a fader is adjusted.

Show VCA Contribution This option lets you display a secondary, transparent fader cap on each on-screen fader strip that represents the effective gain of the channel (channel gain plus associated VCA gain, if any). For more information, see “Assigning and Using VCAs” on page 79.

Events

The Events tab of the Options page lets you use the Event List to customize the function of switches, footswitches and General Purpose Interface (GPI)-connected devices. For information, see Chapter 22, “Events.”



Options > Events page

Plug-Ins

The Plug-Ins tab of the Options page is used to install plug-ins on the VENUE system. The Plug-Ins tab is available on complete VENUE systems only. It is not available in the D-Show Standalone software. See “Installing and Authorizing Plug-Ins” on page 143.

Part III: Signal Routing

Chapter 8: Inputs and Input Routing

This chapter shows how to do the following:

- Configure inputs (system settings for input channels), name channels, Make Stereo and Split to Mono)
- Assign input sources to Input Channels in the Patchbay
- Route input channels to Mains, Groups, and Aux Sends, to Matrix mixers and other output busses, and to plug-ins
- Adjust input channel parameters

Configuring Inputs

Two types of inputs are available: Input Channels and FX Returns.

Input Channels

Input Channels are used to control inputs from stage and FOH (local) audio inputs, from Pro Tools, or from bus-fed plug-ins.

Input channels can be mono or stereo. Each mono channel controls one input, and each stereo channel controls two inputs in tandem. Input channels can appear on any of the input channel strips. Up to 48 mono input channels are available. Input channels are displayed in banks on the 16 control surface input channel strips.

FX Returns

Effects Return channels (or *FX Returns*) are used to control signals from bus-fed plug-ins, from external hardware, or from Pro Tools.

FX Returns are always stereo, and appear on input channel strips 1–8. Up to 8 stereo FX Returns are available.

Configuring Input Channels

VENUE SC48 can be configured to have 16, 24, 32, or 48 available Input Channels.

To set the number of available Input Channels:

- 1 Put the system into Config mode.
- 2 Go to the Options page and click the System tab.
- 3 Click Edit.
- 4 Choose the number of channels from the Input Channels pop-up menu.

- 5 Click Apply. The system restarts with the new Input Channel configuration.

A *Audio will be interrupted when this configuration change is applied.*

Configuring FX Returns

VENUE SC48 provides 8 stereo FX returns, and this setting cannot be changed. You can, however, use the Standalone Software to simulate a different VENUE system and then configure the number of FX Returns, as available on those systems. This can be useful if you are planning to transfer a Show file to a larger VENUE system.

Combining Input Channels (Make Stereo)

Pairs of mono input channels can be combined to make stereo channels, whose left and right sides are then controlled by one input channel strip.

To combine two mono input channels into a single stereo channel:

- 1 Put the system into Config mode.
- 2 Select two mono channels by doing either of the following:
 - On the console, press and hold the Multi-Select switch, then press Select on each of the two mono channel strips you want to combine.
 - or –
 - On-screen, go to the Inputs page and click a fader strip to select the first mono channel, then hold Shift and click to select the second mono channel you want to combine.
- 3 Right-click either of the selected mono channels on-screen and choose Make Selected Mono Strips Stereo.



Two mono inputs about to be combined into one stereo channel

Each selected channel is combined with the next-highest selected channel, even if the selected channels are not contiguous. Blank strips are created and inserted where necessary to maintain channel layout in that bank. Parameter values from the leftmost channel of each pair are applied to both channels, and the pan control becomes a Balance/Width control.

Combined channels are shown in the patchbay as left and right sides of the Input Channel name. FX Returns are always stereo, so they cannot be combined or split.



Stereo Input Channel in the Patchbay Input page

On the console, the channel St (Stereo) LED lights to indicate that a channel is a stereo channel.

To split a stereo channel into two mono channels:

- 1 Put the system into Config mode.
- 2 Select the stereo channel you want to split.
- 3 Right-click the selected channel and choose Split Selected Stereo Strip to Mono.

Each selected stereo channel is split, placing the channels next to each other on the console and in the Patchbay. Blank strips are deleted to maintain channel layout.

Naming Channels

Input Channel and FX Return channel names can be changed from the Inputs page or from the Patchbay.

To change the name of an Input Channel or FX Return channel:

- 1 Go the Patchbay page and click the Inputs tab.
- 2 Target the channel whose name you want to change by pressing its Select switch or selecting it on-screen.
- 3 Double-click the channel name.



Changing the name of an Input Channel in the Inputs page

- 4 Type a new name and press Enter on the computer keyboard.

 *When naming channels in the Patchbay, you can double-click the channel name shown in the columns of the grid and type a name; press Tab on the keyboard to go to the next channel and Shift+Tab to go to the previous channel.*

Assigning Input Sources to Channels

Available input sources for Input Channels or FX Returns include:

- Stage inputs (slots A, B and C)
- Local FOH inputs (2-Track sources, Talkback, Oscillator)
- Pro Tools outputs (FWx)
- Plug-In outputs

Inputs sources are assigned to Input Channels or FX Returns in the Patchbay.

To assign an input source to an Input Channel or FX Return:

- 1 Go to the Patchbay page and click the Inputs tab.
- 2 To the left of the channel grid, click the Channels tab or the FX Returns tab.
- 3 Click the Stage, FOH, or Pro Tools tab to display the desired type of input sources.
- 4 Click in the channel grid to assign an input source to an Input Channel or FX Return.



Assigning input sources in the Patchbay Inputs page

The Inputs tab of the Patchbay shows the input source and destination above the grid. Input source is also shown below the channel name in the Inputs and Patchbay Inputs page.



Input source assignment shown in the Inputs page

A single input source can be assigned to multiple Input Channels or FX Returns (you can fan out a source to multiple channels). Gain control, phantom power and pad settings are linked across the channels. Each Input Channel or FX Return may be fed by only one input source (multiple sources cannot be routed to a single channel).

Assigning Bus-Fed Plug-Ins, Osc/Talkback/2-Track

Bus-fed plug-ins can be patched to Input Channels and FX Returns from the Plug-In Rack (see “Using Plug-Ins as a Bus Processor” on page 152).

You can also route the built-in Oscillator, Talkback input, and 2-Track sources to input channels (see “Routing the Oscillator” on page 118).

Routing Input Channels

Input Channels and FX Returns can be routed to the Mains, Groups, Auxes, and Matrixes (as well as being assigned to VCAs). This chapter shows how to route inputs using the controls available in the Input section and ACS.

 You can also configure signal routing from the Output section. See Chapter 9, “Outputs and Output Routing.”

Routing Channels to the Mains and Groups Busses

Input Channels and FX Returns can be routed to the Mains and Groups busses using the Bus Assigns section of the ACS.

To route a channel to Mains and Groups busses:

- 1 Target the channel by pressing its Select switch.
- 2 Do any of the following:
 - To route to Mains, press the L–R (left and right) and/or C/Mono (center/mono) switch in the Bus Assigns section so that is lit.
 - To route to a Group bus, press a Groups 1–8 switch.

The L–R and C/M LEDs on the channel light to indicate its routing to the corresponding bus.



Bus Assign switches

To route multiple channels to Mains and Groups busses:

- 1 Target the first channel you want to route by pressing its Select switch.
- 2 Press and hold the Multi-Select switch (located to the left of the input faders), then press the Select switches on the other channels you want to route to the Main busses.
- 3 In the Bus Assigns section, press the Bus Assign L–R (left and right), C/Mono (center/mono) and Group 1–8 switches to route the selected channels to those busses.

The L–R, C/M and 1–8 Bus Assign LEDs on each channel light to indicate routing to the corresponding busses.

Configuring Mains and Groups Busses

The Main busses can be configured to operate as L–R plus Mono (Left–Right stereo plus a Mono channel), or as L–C–R (Left–Center–Right). See “Configuring the Main Busses” on page 73.

VENUE SC48 has 8 Group busses that can be configured to be mono or stereo as part of the overall Aux/Group bus configuration. For more information on configuring Group busses, see “Configuring Aux and Group Busses” on page 74. For more information on using Group busses, see Chapter 10, “Groups.”

Routing Channels to Aux Sends

Input Channels and FX Returns can be routed to Aux sends using the input encoders, or using the Channel Control section.

To route channels to Aux sends using the input encoders:

1 To access Aux Sends on the input channel encoders, press an Encoder assign Aux Sends switch 1–2 through 15–16.

- The first press of an Aux Send switch assigns level control of the odd-numbered send to the encoders. The switch lights green to indicate an odd-numbered selection.
- The second press of an Aux Send switch assigns level control of the even-numbered send to the encoders. The switch lights yellow to indicate an even-numbered selection.

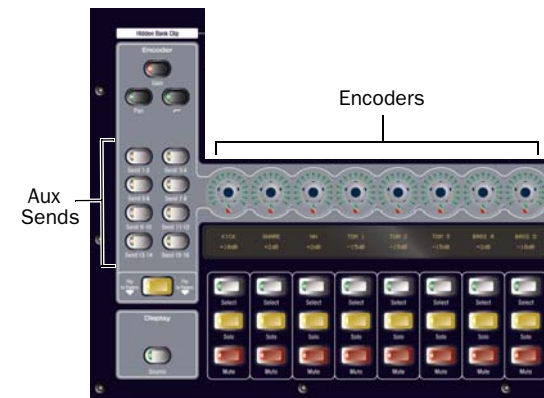

Encoder assignment switches for input channels

- 2 For each channel you want to assign to the selected Aux Send bus, press its channel encoder so that its “On” indicator LED lights.
- 3 To set the Aux Send level, do either of the following:
 - Turn the encoder on each channel.
 - Press the Flip to Faders switch, then adjust the channel fader.

To route channels to Aux Sends busses using the Channel Control section:

- 1 Target the first channel you want to route by pressing its Select switch.
- 2 Press and hold the Multi-Select switch next to the input faders, then press the Select switches on the other channels you want to route to the Auxes.

3 In the Channel Control section, press the Aux Sends 1–8 or Aux Sends 9–16 switch to bank the Channel Control encoders to those Auxes.

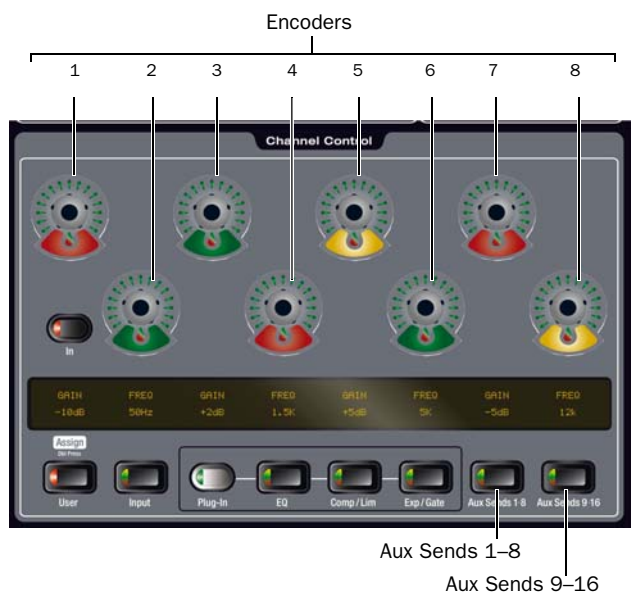

Channel Control

4 Press the Channel Control encoder that corresponds to the desired Aux Send bus so that its “On” indicator LED lights.

- The first press of an Aux Send switch assigns level control of the odd-numbered send. The switch lights green to indicate an odd-numbered selection.
- The second press of an Aux Send switch assigns level control of the even-numbered send. The switch lights yellow to indicate an even-numbered selection.

5 Turn the encoder to set the Aux Send level.

Configuring Aux Busses (Aux Sends)

VENUE SC48 can be configured to have 8 or 16 Aux busses as part of the overall Aux/Group bus configuration. Mono Aux busses can be linked in odd/even pairs to function in stereo (see “Configuring Aux Busses” on page 87).

 Some VENUE systems also offer Variable Groups. To learn more about these special busses, see the VENUE Profile Guide or the VENUE D-Show Guide.

Routing Channels to Matrix Busses

Matrix source assignments determine input signal routing to each of the Matrix mixers. Matrix source inputs can include up to 12 inputs per mixer.

Matrix signal routing is performed from the Matrix tabs of the Outputs page (see Chapter 12, “Matrix Mixers”).

Assigning Channels to VCAs

Channels can be assigned to VCAs for consolidated control of multiple channels.

To assign one or more channels to a VCA:

- 1 Press the VCA switch to bank the Output Faders to VCAs.
- 2 Select the VCA (1-8) you wish to assign to by pressing its Select switch.
- 3 Press the Multi Assign switch near the Output encoders. While engaged, the Multi Assign and output Select switch LEDs flash.
- 4 Press the Select switch on the inputs or outputs you want assigned to the currently targeted VCA. Use the Input and Output Fader bank switches to access the desired channel strips.
- 5 Press the Multi Assign switch again to confirm the action.
 - or –

Select another VCA to confirm the current assignment but remain in Multi Assign mode for the newly targeted VCA.

For more information on VCAs, see “Assigning and Using VCAs” on page 79.

Routing Inputs to Direct Outputs

All Input Channels and FX Returns have Direct Outputs, which can be assigned to hardware outputs, used as inputs to plug-ins, and sent to Pro Tools.

Direct Outs are assigned in the Patchbay, and can be controlled from Channel Control section or on-screen. For more information on routing and assigning Direct Outputs, see “Direct Outputs” on page 78.

Using Built-In Dynamics and EQ

Each Input Channel has built-in Dynamics processors, a High-Pass Filter and a 4-band EQ; each FX Return has a built-in 2-band EQ. If the channel is a stereo channel, the processor controls are linked and apply to both the left and right sides of the channel. Built-in EQ processors are controlled from the Channel Control section of the ACS.

Using Dynamics on Channels

A built-in Compressor/Limiter and Expander/Gate are available on each Input Channel. Controls for all of the built-in dynamics processors are provided in the Channel Control section, and an input/output curve appears on-screen.

Compressor/Limiter

To engage and adjust the built-in Compressor/Limiter:

- 1 Target a channel by pressing its Select switch.
- 2 Press the Comp/Lim switch in the Channel Control section. The switch lights to indicate control of the Compressor/Limiter.
- 3 Engage the built-in processor by pressing the In switch in the Channel Control section.
- 4 Press and/or adjust the Channel Control encoders for the displayed parameters.

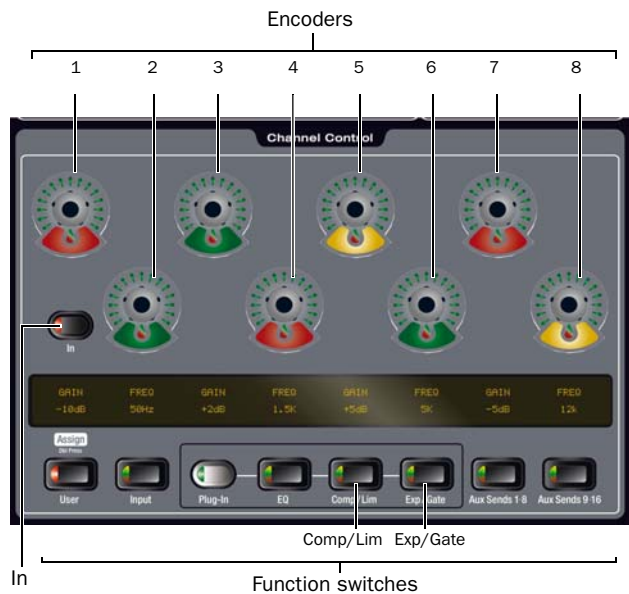

Controls for built-in dynamics processors in Channel Control

Expander/Gate

To engage the built-in Expander/Gate on the selected channel:

- Press the Exp/Gate switch in the Channel Control section.

To adjust Expander/Gate controls:

- 1 Target a channel by pressing its Select switch.
- 2 Press the Exp/Gate switch in the Channel Control section. The switch lights to indicate control of the Expander/Gate.
- 3 Press the In switch to engage the built-in expander/gate.
- 4 Press and/or rotate Channel Control encoders to adjust the displayed parameters.

For more information, see Chapter 17, "Dynamics."

Using Built-In EQ on Channels

A built-in High-Pass Filter and 4-band EQ are available on each Input Channel, and a 2-band EQ is available on each FX Return. Controls for built-in EQ processors are in the Channel Control section, and an EQ response curve appears on-screen.

One of two EQ types can be selected for the built-in EQ, on a per-channel basis: a full-spectrum parametric digital EQ or an analog-modeled EQ.

To use the built-in EQ on a channel:

- 1 Target the channel by pressing its Select switch.
- 2 Do any of the following:
 - To engage the channel High-Pass Filter, press the HPF switch in the Encoder Assignment section. Toggle HPF in/out on each channel by pressing its encoder; adjust HPF frequency by rotating its encoder.
 - To engage the built-in 4-band or 2-band EQ, press the EQ switch in the Channel Control section, then press the Channel Control In switch to put the EQ in circuit.



EQ switches in Channel Control

For more information, see Chapter 18, "EQ."

Using Inserts on Channels

You can use software plug-in inserts on any input channel or FX return.

Using Plug-In Inserts on Channels

Plug-Ins are arranged in virtual racks, which allow signals to be sent to and from each plug-in as if it were an external processor. Plug-Ins can be used in two ways: as inserts, or as effects in a Send/Return arrangement.

Insert The plug-in is patched in at the insert point on an input or FX return. Each input channel can have up to four plug-in inserts.

Send/Return Signal is sent to the plug-in over any of the system busses (usually an Aux Send or a Direct Out) and routed back to an input or FX return.

Inserting Plug-Ins on Channels

You can insert plug-ins on Input Channels and FX Returns directly from the Inputs page or from the Plug-In Rack.

To insert a plug-in on a channel:

- 1 Select a channel. If necessary, click to show the Inputs page.
- 2 In the Inserts section of the Inputs page, do one of the following:
 - Click one of the four Inserts pop-up menus and choose a plug-in directly from one of the Plug-In Rack submenus.
 - or –
 - Click one of the four Inserts buttons to go to the Plug-In Rack, and route the signal to the plug-in using Plug-In Rack controls.



Assigning a plug-in insert in the Inputs page

The name of the plug-in insert appears in the on-screen Plug-In Insert display.

 For more information on using plug-ins in a Send/Return arrangement, see “Using Plug-Ins as a Bus Processor” on page 152.

Adjusting Input Controls

Input Gain

Input Gain is adjustable from the rotary encoders on each Input Channel and FX Return. Mic inputs have a gain range from +10 dB to +60 dB. Analog line inputs and digital inputs have a gain range from –20 dB to +18 dB.

Gain Guess Feature

The automated Gain Guess function can be used to set a nominal level for a channel based on its incoming signal. When you press and hold a rotary encoder assigned to input gain, the system samples incoming signals and automatically sets the channel gain and pad for a 0 dB reference when the encoder is released. Gain Guess follows the current Meter mode (Peak or RMS).

Gain Indicators

When Gain is displayed on the input encoders, the encoder's indicator LED lights to indicate that the gain is set to the default value (+10 dB for analog inputs, and 0 dB for digital inputs). Gain change is indicated by the encoder ring LEDs, and gain value is shown in the channel display when adjusted.

Setting Input Gain

Gain can be controlled from individual channel strips or from the ACS section.

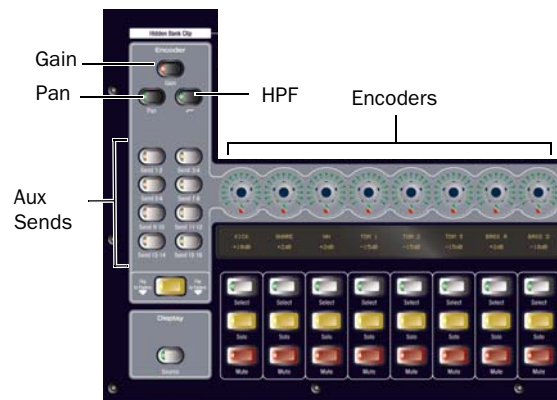

Encoder assignment switches for input channels

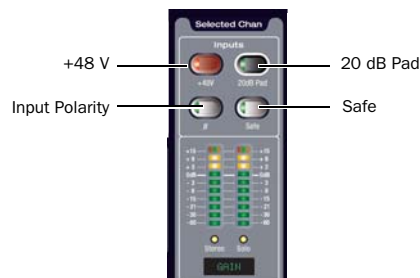

Input controls in the ACS

To adjust input gain from the encoders:

- 1 In the Encoder Assignment section, press the Gain switch to assign gain control to the channel encoders.
- 2 Rotate an encoder to adjust gain on its channel.

To adjust input gain from the ACS:

- 1 Select one or more channels to target them in the Channel Control section of the ACS.
- 2 Press the Input switch in the Channel Control section.
- 3 Gain (with Gain Guess) is assigned to the first encoder in the Channel Control section. Adjust the gain by turning the assigned encoder.

To adjust input gain using Gain Guess:

- 1 Press and hold the assigned Gain encoder (input channel encoder, or Channel Control encoder 1) while receiving an input signal. The LED flashes to indicate level sampling.
- 2 Release the rotary encoder. Gain will be set so the incoming signal reaches 0 dB peak (if Peak mode is selected) or 0 dB RMS (if RMS mode is selected).

Setting Right Offset on Stereo Channels

On stereo Input Channels and FX Returns, the Gain control affects both the left and right channels. The Right Offset feature lets you offset the gain of the right channel relative to the left channel by -20 dB to +20 dB, within the overall gain limits.

To adjust stereo channel gain offset from the console:

- 1 Select one or more channels to target them in the Channel Control section.
- 2 Press the Input switch in the Channel Control section.
- 3 Adjust the Right Offset encoder.

To adjust channel gain offset for a stereo channel on-screen:

- 1 Go to the Inputs page and target the stereo channel.
- 2 Adjust the right channel gain using the on-screen Right Offset encoder.

Stereo Level Offset Indication

The Stereo LED below the channel meter flashes when the difference in signal level between the left and right channels is 12 dB or greater.

Pan/Balance

Pan adjusts channel pan (for mono Input Channels) and stereo balance (for stereo Input Channels and FX Returns).

To adjust channel pan/balance from the encoders:

- 1 In the Encoder Assignment section, press the Pan switch to assign pan/balance control to the rotary encoders.
- 2 Adjust the channel pan/balance by turning the assigned rotary encoder.

To balance stereo signals from the ACS:

- 1 Select one or more channels to target them in the Channel Control section of the ACS.
- 2 Press the Input switch in the Channel Control section.
- 3 Rotate the Balance encoder.

Stereo Width

Width adjusts the stereo image of stereo input channels and FX returns by controlling ganged pan positions of the left and right channels, in opposite directions.

Width can be adjusted from full L-R, to mono, to full reversed L-R. Width controls are not available on mono channels.

To adjust width of stereo signals from the ACS:

- 1 Select one or more channels to target them in the Channel Control section.
- 2 Press the Input switch in the Channel Control section.
- 3 Rotate the Width encoder.

To adjust width of a stereo channel on-screen:

- 1 Select one or more channels.
- 2 In the Inputs page, adjust width by turning the on-screen Width rotary encoder. Turning the encoder clockwise moves the width to full stereo, and counter-clockwise moves the width to reverse stereo. The center position represents mono.

High-Pass Filter

A built-in 4th-order High-Pass Filter can be engaged on each Input Channel. The HPF corner frequency range is from 20 Hz to 500 Hz.

To engage the built-in HPF from the Input encoders:

- 1 In the Encoder Assignment section, press the HPF switch to assign HPF control to the rotary encoders.
- 2 Press a channel rotary encoder to insert the filter in that channel. The rotary encoder “On” indicator LED lights when the HPF is in circuit.
- 3 Adjust the HPF corner frequency by turning the assigned rotary encoder.

To engage the built-in HPF from the ACS:

- 1 Select one or more channels to target them in the Channel Control section of the ACS.
- 2 Press the Input switch in the Channel Control section.
- 3 Press the HPF encoder to toggle the HPF in/out.
- 4 Rotate the HPF encoder to adjust HPF frequency.

Phantom Power

48V phantom power can be applied to any analog Stage input assigned to an Input Channel or FX Return.

To apply phantom power to an input:

- 1 Assign a Stage input to a channel. See “Assigning Input Sources to Channels” on page 64.
- 2 Target the channel by pressing its Select switch.
- 3 Press the +48V switch in the ACS Input section. The switch lights when phantom power is applied.

 *If an input is moved to a different channel, the gain, pad, and phantom power setting will move with the input.*

20 dB Pad

A 20 dB pad can be applied to any analog Stage input assigned to an Input Channel or FX Return.

To apply a 20 dB pad to a Stage input:

- 1 Target the channel by pressing its Select switch.
- 2 Press the 20 dB Pad switch in the ACS Input section. The switch lights when the pad is applied to the Stage input.

 *The Gain Guess feature turns the Pad on or off as needed to accommodate incoming signal level*

Input Polarity (Phase) Invert

The polarity of any Input Channel or FX Return signal can be inverted. With stereo channels, only the left channel is inverted.

To invert the polarity of a channel:

- 1 Target the channel by pressing its Select switch.
- 2 Press the polarity inversion (Ø) switch in the ACS Input section. The switch lights when the polarity is inverted.

Safe

The Safe switch toggles Automation Safe, Solo Safe, or Bank Safe on/off. The current function of the ACS Safe switch is determined by the current Input Safe switch assignment in the Options > Interaction page.

When a Safe mode is enabled for the currently selected channel, the ACS Safe switch lights if that Safe mode is the currently assign Input Safe Switch mode. Channel safe status is also indicated by the lit or unlit state of each channel strip Safe LED.

To configure the Safe switches for Automation, Solo or Bank mode, see “Input Safe Switches” on page 58.

To toggle the current Safe state of a channel:

- 1 Target the channel by pressing its Select switch.
- 2 Press the Safe switch in the ACS Input section. The switch lights solid when the current channel is Automation Safe, flashes when the channel is Solo Safe, and flashes rapidly when in Bank Safe.

Delay

A variable delay can be applied to any Input Channel or FX Return. The delay range is from 0 to 250 milliseconds.

To apply delay to a channel from the console:

- 1 Select one or more channels to target them in the Channel Control section of the ACS.
- 2 Press the Input switch in the Channel Control section.
- 3 Press the Delay encoder to engage channel delay.
- 4 Adjust the Delay encoder to set the desired amount of channel delay.

Channel Solo

Three Solo modes are available: Solo In Place (SIP), Pre-Fader Listen (PFL), and After-Fader Listen (AFL), and several options are available for configuring Solo bus operation. Channels can also be implicitly soloed as part of a VCA.

 See Chapter 15, “Solo and Monitor Busses.”

To solo a channel:

- Press the channel’s Solo switch. The Solo switch lights solid to indicate the channel is explicitly soloed.

Channel Mute

To explicitly mute a channel:

- Press the Mute switch on the channel. The mute switch lights solid to indicate the channel is explicitly muted.

 Channels can be muted in three ways: explicitly with the channel mute switch; implicitly as a result of another channel being soloed, and as a member of a Mute Group or VCA. For more information see Chapter 16, “Muting and Mute Groups”

Channel Level

Channel level can be adjusted from the Input or FX Return faders and using the on-screen faders. The currently selected channel(s) can also be adjusted from the Flex Channel.

Input channel levels can also be affected by VCAs. For more information, see “Assigning and Using VCAs” on page 79.

Channel Faders

Channel Faders provide channel level control from $-\infty$ (–INF) to +12 dB. Use the faders on the console, or on-screen, to adjust individual channel levels.

 For more information on input and output fader banking, see Chapter 5, “Navigating and Selecting Channels.”

Flex Channel

The Flex Channel provides a dedicated fader, encoder, and LCD display along with channel Select, Solo and Mute switches for the currently selected input channel. The Flex Channel can be latched to any input channel for uninterrupted control of any vital input channel.

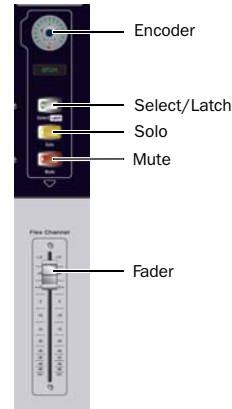

Flex Channel

In its default Selected Channel mode the Flex Channel mirrors the currently selected input channel. The Flex Channel encoder follows the current Encoder Assignment mode (Gain, Pan, HPF, or an Aux Send). The Flex Channel LCD shows the current channel name or encoder parameter in green.

In Flex Channel mode, the Flex Channel is latched (or locked) on a channel. Selecting a different channel or banking to a different bank or type of channels will not change the assignment of the Flex Channel, letting you keep constant control over your most important signal.

To latch the Flex Channel from the console:

1 Select the input or output channel you want assigned to the Flex Channel.

2 Press the Select/Latch switch on the Flex Channel. A dialog appears on-screen asking you to confirm the assignment.

 Double-press the Select/Latch switch to latch that channel and clear the confirmation dialog in one action.

3 Press the Flex Channel Select/Latch switch again (or click Latch on-screen) to confirm the assignment. Click Cancel to cancel the assignment.

The Flex Channel LCD shows red text when latched.

To latch the Flex Channel on-screen:

- Right-click on the desired channel and choose Latch <channel>.

To return to Selected Channel mode:

- Double-press the Flex Channel Select/Latch switch. The (former) channel assigned to the Flex Channel becomes the selected channel in the ACS, and the Flex Channel reverts to Selected Channel mode.

– or –

- Right-click the currently latched channel on-screen and choose Unlatch <channel>.

Using Input Direct

Input Direct mode lets you completely bypass the built-in dynamics and EQ processing, and all inserts on input channels and FX returns. This mode routes the input signal directly from the Top of Channel pickoff to the channel fader.

To bypass all processing on an input channel or FX return:

- 1 Target the channel by pressing its Select switch.
- 2 Go to the Inputs page.
- 3 Click the Input Direct button in the Config section of the Inputs page for the selected channel. The button flashes to indicate Input Direct mode is active.



Input Direct button

Chapter 9: Outputs and Output Routing

This chapter shows how to do the following:

- Configure and name Mains, outputs and busses
- Assign outputs and busses to hardware outputs in the Patchbay
- Route outputs to Mains, Groups, Aux Sends, and Matrix mixers
- Using plug-in inserts, and using Graphic EQ on outputs
- Assign and route Direct Outputs
- Adjust output channel parameters
- Use VCAs

Configuring Outputs

The following types of output busses are available on VENUE SC48: Mains, Groups, Auxes, and Matrixes.

Mains

The Main busses can be configured in L-R+M or L-C-R formats. For more information, see “Configuring the Main Busses” on page 73.

The Main busses are controlled from the dedicated Mains controls and fader in the Output section.

Groups

Eight Group busses are available. These Group busses can be globally configured to be mono or stereo as part of the system Aux/Group bus configuration. See “Configuring Aux and Group Busses” on page 74.

Group outputs can be controlled from the faders and encoders in the Output section.

 See Chapter 10, “Groups.”

Auxes

Up to 16 Aux busses are available. The number of available Aux busses is set as part of the system Aux/Group bus configuration. See “Configuring Aux and Group Busses” on page 74.

Aux bus outputs can be controlled from the Output faders.

 For more information, see Chapter 11, “Aux Sends.”

Matrix Mixers

Eight Matrix mixers are available. Each Matrix mixer is a discrete 12-in/1-out (mono) submixer, with the ability to link adjacent Matrix mixers into stereo pairs. Matrix mixer input sources can include up to 12 inputs, selectable from any combination of Aux, Group or Mains busses plus up to 8 unique Input Channels, FX Returns or hardware inputs.

 *User Source input assignments are stored in Snapshots as part of their distinct Matrix data type.*

Pre- and post-fader tap for Matrix sources are assigned in the Pickoffs tab of the Options page.

Matrix outputs are controlled from the output faders; matrix inputs are controlled from the encoders when a particular matrix is selected.

 See Chapter 12, “Matrix Mixers.”

Configuring the Main Busses

The Main busses can be configured to operate as either:

L-R plus Mono Pans signals between the left and right channels to the L-R bus, and sums signals to a separate mono bus.

L-C-R Pans signals across left, center and right channels.

 *Audio may be interrupted or may change levels during this configuration procedure.*

To configure the Main busses:

- 1 Put the system into Config mode.
- 2 Go to the Options page and click the System tab.
- 3 Click Edit.

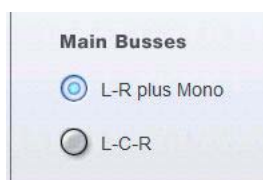

Setting the Main bus configuration

- 4 Select the configuration for the Main Busses.
- 5 Click Apply. The system restarts with the new Main bus configuration.

Configuring Aux and Group Busses

Auxes and Groups share the available system busses. Configuration options include the following:

16 Auxes + 8 Mono Groups Divides the available system busses between 16 mono Aux busses and 8 mono Group busses.

8 Auxes + 8 Stereo Groups Divides the available system busses between 8 mono Aux busses and 8 stereo Group busses.

⚠ *Audio may be interrupted or may change levels during this configuration procedure*

To configure the Aux/Group busses:

- 1 Put the system into Config mode.
- 2 Go to the Options page and click the System tab.
- 3 Click Edit.
- 4 Select a bus configuration.

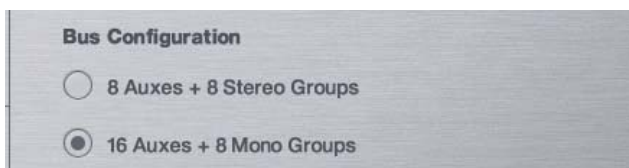

Selecting a bus configuration

- 5 Click Apply. The system restarts with the new bus configuration.

Data Cleared When Changing Bus Configurations

When the bus configuration is changed, all settings are cleared (or set to default) from the current console settings and from all stored snapshots, for all Groups.

Linking Aux Busses

You can link odd/even bus pairs and pan input signals into those bus pairs. Aux bus pairs are linked on a global basis, and appear as linked on all channels. For information on linking Auxes, see “Linking Aux Busses for Stereo Operation” on page 87.

Naming Channels

Output channel names can be changed from the Outputs page or from the Patchbay.

To change the name of an Output channel:

- 1 Go to the Outputs page or the Patchbay page.
- 2 Target the channel whose name you want to change by pressing its Select switch or selecting it on-screen.
- 3 Double-click the channel name.



Changing the name of an Output channel in the Outputs page

- 4 Type a new name and press Enter on the computer keyboard.

💡 *When naming channels in the Patchbay, double-click the channel name next to the grid to edit text; press Tab on the keyboard to go to the next channel and Shift+Tab to go to the previous channel.*

Assigning Busses to Hardware Outputs

Mains, Groups, Auxes, and Matrix mixer outputs can be assigned to any hardware output on the system. Available output destinations include:

- Stage audio outputs
- FOH (local) audio outputs
- Pro Tools recording inputs

To assign a bus or mixer output to a hardware output from the Patchbay:

- 1 Go to the Patchbay page and click the Outputs tab.
- 2 To the left of the channel grid, click the Mains, Mtx (Matrix), Aux or Grp (Groups) tab.
- 3 Click in the channel grid to assign a bus or Matrix mixer output (listed on the left) to a hardware output (listed across the top).



Assigning an output in the Patchbay Outputs page

The Patchbay Outputs page shows the name of the bus or mixer and its destination. The destination is also displayed below the channel name in the Outputs page and Patchbay Outputs page.



Output name and destination in the Patchbay Outputs page

Routing Group Outputs to the Main Busses

You can route Group outputs to the Main busses from the console or on-screen.

To route a Group output to the Main busses from the ACS:

1 Press the Groups switch in the Output Fader assignment section to assign control of Group levels to the faders.

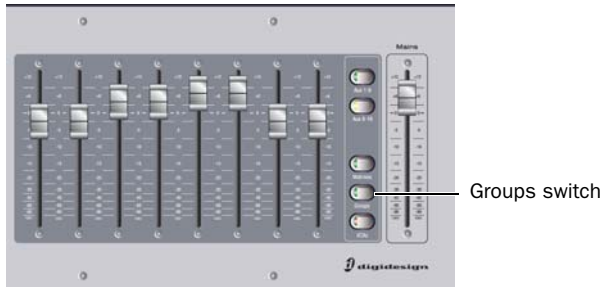

Assigning Groups to the Output faders

2 Select each Group that you want to assign to the Main busses by pressing their Select switches.

3 In the Bus Assigns section, press the L-R (left and right) or C/Mono (center/mono) switch so that it is lit.



Bus Assign switches

4 Move the channel's fader to set the Group output level.

Group Routing Indication on Output Encoders

Output encoder indicator LEDs indicate Main bus assignments as follows:

Off Group routing to Mains is turned off.

Yellow Group output is routed to the Mains L-R bus.

Green Group output is routed to the Mains C/M bus.

Red Group output is routed to both the Mains L-R bus and the Mains C/M bus.

To route a Group output to the Main busses on-screen:

1 Go to the Outputs page and select the channel fader strip for the Group you want to route to the Main busses.

2 Click the Bus Assign buttons on-screen to toggle the bus assignment for the selected Group.



Assigning a Group output to the Main busses from the Output page

Using Inserts on Output Busses

You can use software plug-in inserts and graphic EQ on Mains, Groups, Auxes, and Matrixes.

Using Plug-In Inserts on Output Busses

You can insert plug-ins on Output busses directly from the Outputs page.

To insert a plug-in on an output bus:

1 Go to the Outputs page and target the bus where you want to insert the plug-in.

2 In the Inserts section of the Outputs page, do one of the following:

- Click one of the four Inserts pop-up menus and choose a plug-in directly from one of the Plug-In Rack submenus.
- or –
- Click one of the four Inserts buttons to go to the Plug-In Rack, and route the signal to the plug-in using Plug-In Rack controls.

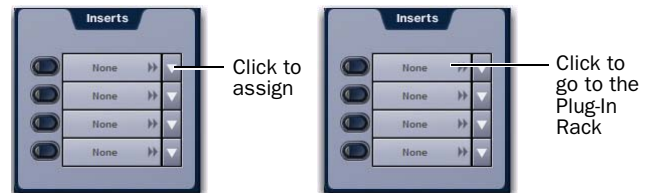

Assigning a Plug-In Insert in the Outputs page

The name of the plug-in insert appears in the on-screen Plug-In Insert button.

 For complete instructions on plug-ins, see Chapter 19, "Plug-Ins."

Activating and Bypassing Inserts

After plug-in inserts are assigned to an Output bus, they can be activated and bypassed on-screen using the corresponding Output page controls.

Inserting the Built-In Graphic EQs on Output Busses

A built-in 31-band Graphic EQ can be inserted on any of the following Output bus types: Mains, Groups, Auxes, and Matrixes. A maximum of 24 Graphic EQs are available, depending on the how they are configured in the System Configuration settings.

For more information on configuring and using Graphic EQs, see “Graphic EQ for Outputs” on page 138.

To insert a Graphic EQ on an Output bus:

- 1 Target the bus by pressing its Select switch.
- 2 In the Outputs page, click the 31-Band Graphic Equalizer tab.
- 3 Click the Graphic EQ pop-up menu and choose an available mono or stereo Graphic EQ. The entire Graphic EQ is displayed on-screen.

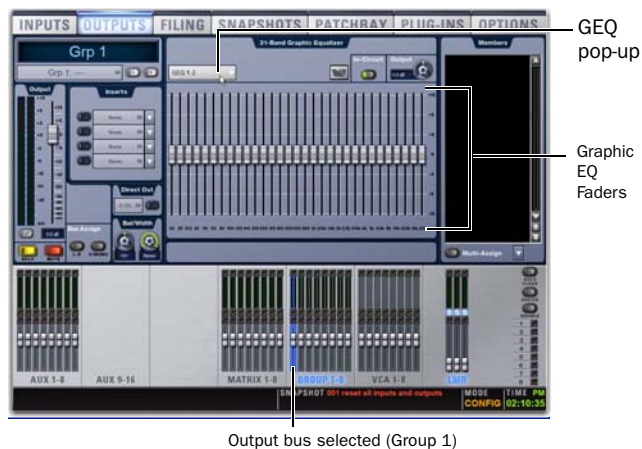

Graphic EQ displayed in the Outputs page

Adjusting Output Controls

Outputs are controlled from the Output faders, encoders and switches.

Output Levels

To control output levels from the Output faders:

- 1 Choose the output fader bank you wish to control.

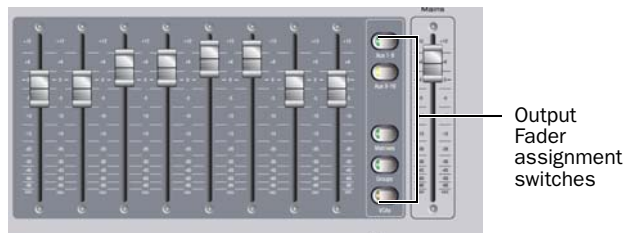

Output Fader controls

- 2 Move a fader to change the level of its assigned output.

To create a level offset between linked Aux bus output faders:

- 1 Press one of the switches in the Output Fader assignment section.
- 2 Do one of the following:
 - Touch one linked bus output fader while moving the other.
 - Hold the Start (Win) key on the keyboard and move one linked Aux bus fader on-screen.

The offset between the faders is maintained until the offset causes a fader to reach its maximum or minimum value.

Output Polarity (Phase) Invert

The polarity of any output bus signal can be inverted. With stereo outputs (stereo Group busses) only the left channel is inverted.

To invert the polarity of an output bus:

- 1 Target the bus by pressing its Select switch.
- 2 Press the polarity inversion (Ø) switch in the ACS Input section. The switch lights when the polarity is inverted.

Output Solo

To control the solo status of an output bus:

- 1 Press one of the switches in the Output section.
- 2 In the Output section, press an AFL switch to toggle the solo status of the corresponding output bus.

You can set Output banking to follow AFL selection, and vice versa. For more information on Solo bus operation, see Chapter 15, “Solo and Monitor Busses.”

Output Mute

To control the mute status of an output bus:

- 1 Press one of the following switches in the Output section:
- 2 In the Output section, press a Mute switch to toggle the mute status of the corresponding output bus.

For more information on Mute operation, see Chapter 16, “Muting and Mute Groups.”

Output Delay

A variable delay can be applied to any of the Main busses (L, R and C/M), Aux bus outputs, and Matrix mixer outputs.

To apply delay to an Aux bus:

- 1 Target the Aux bus by pressing its Select switch.
- 2 Press the Channel Control Input switch.
- 3 Press the Delay rotary encoder to engage the delay.
- 4 Adjust the delay value by turning the Delay rotary encoder.

The amount of delay available depends on the type of output, as follows:

- Up to 500 ms for Mains and Matrix mixers
- Up to 250 ms for Aux Sends

Adjusting Main Bus Controls

Main Bus Output Levels

The Main bus output levels are controlled from the single Mains Fader located to the right of the Output faders.

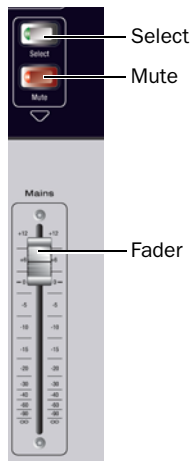

Mains Fader and controls in the Output section

The Left, Right, and Center/Mono busses can be controlled independently or in tandem. You can create an offset between any of the Main bus levels, and it will be preserved when controlling any combination of the Main busses. The offset between the busses is maintained until at least one of the busses is minimized or maximized.

Linking Mains

You can link any of the three Mains faders for grouped-control of level and mute.

To control the Main bus output levels:

1 In the Outputs page, click the on-screen channel Link buttons for any combination of Left, Right, or Center/Mono output strips to assign control of the corresponding busses to the Mains Fader.

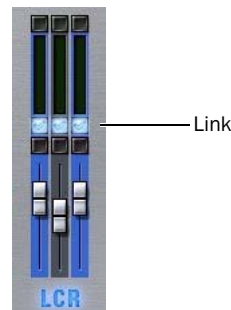

Mains fader Link selectors in the Outputs page

2 Move the Mains fader to change the level of the assigned busses.

Main Bus Mute

The mute status of the Main busses is controlled from the Mute switch located above the Mains Fader. When at least one of the Main busses is muted while others (unlinked) are not, the Mains mute switch flashes.

To control the mute status of the Main busses:

- 1 In the Outputs page, click the on-screen channel Link buttons for any combination of Left, Right, or Center/Mono output strips to assign control of the corresponding busses to the Mains Fader.
- 2 Press the Mute switch to toggle the mute status of the assigned busses.

Main Bus Delay

A variable delay (from 0 to 500 ms) can be applied to any of the Main busses.

To apply delay to a Main bus:

- 1 Target the Main bus where you want to apply delay by repeatedly pressing the Select switch in the Mains section, or by selecting it on-screen.
- 2 Press the Channel Control Input switch.
- 3 Press the Delay encoder to enable delay.
- 4 Adjust the Delay value by turning the on-screen Delay rotary encoder.

Main Bus Center Divergence Options

When the Main busses are set to L-C-R (Left-Center-Right) mode, the Center Divergence setting determines amount of center-panned signal sent to the center output.

- ◆ When Center Divergence is set to 100%, a channel panned to center is sent to the center output only.
- ◆ When Center Divergence is set to 0%, a channel panned to center is sent equally to the left and right outputs only (phantom center).
- ◆ A Center Divergence setting between 0% and 100% sends a center-panned channel to the left, center, and right outputs with the center channel more prominent as the value increases towards 100%.

To set Center Divergence:

- 1 Go to the Options > Busses tab.
- 2 In the Panning section, click in the Center Divergence field and drag up/down to increase/decrease the value (or type in a new value).
- 3 Press Enter or Return on your keyboard to confirm the setting.

Main Bus Automatic Delay Compensation

VENUE systems automatically compensate for delays incurred by the use of Groups and insertion of plug-ins in the signal path to the Main busses. Delays are automatically applied to signals arriving at the Main busses from multiple destinations to maintain the proper time alignment.

Monitoring the Main Mix

You can send the Main mix (the signal present on the Main busses) to the Monitor bus for routing to the monitor bus for headphones. See “Sending the Main Mix to the Monitor Bus” on page 115.

Direct Outputs

All input channels and output buses feature Direct Outputs.

Available destinations for Direct Outputs include:

- Stage audio outputs
- FOH audio outputs
- Pro Tools recording inputs
- Plug-ins

Each output destination may be fed by only one Direct Output signal (multiple Direct Output signals cannot be routed to a single output).

To route a channel or bus to a Direct Output:

- 1 Target the channel or bus you want to route to a Direct Output by pressing its Select switch.
- 2 In the Directs page of the Patchbay, click the tab for the channel or bus type you are routing.
- 3 Click in the channel grid to route the channel or bus (listed on the left) to an available output (listed across the top).



Assigning a Direct Output in the Patchbay Directs page

- 4 Select the pickoff point for the Direct Output by clicking the letter to the right of the channel or bus name and choosing from the pop-up menu.

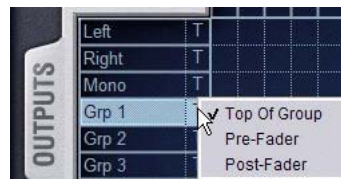

Selecting a Direct Output pickoff point in the Patchbay Directs page

- 5 On the console, press the Channel Control Input switch.
- 6 Press the Direct Out encoder so that its “On” indicator LED lights.
- 7 Turn the Direct Out encoder to set the Direct Output level.

Up to 12 dB of gain can be added to the Direct Output signal. Direct Output level is displayed in the Selected Channel display, and controls are provided on-screen in the Patchbay, Inputs, and Outputs pages.

Direct Output Pickoff Points

The pickoff points for the Direct Output signal are selected in the Directs page of the Patchbay. The following pickoff points are available for each type of channel or bus:

Configuring Direct Output Pickoff Points

To configure the Direct Output pickoff point for Inputs:

- 1 Go to the Options page and click the Pickoffs tab.

Pickoffs for Direct Outs

Channel Type	Available Pickoff Points
Input	Top of channel Insert return Pre/post fader
FX Returns	Top of return Pre/post fader
Outputs	Top of bus Pre fader Post fader

2 Under Input Strip Fader Pickoff Point, click Pre-Fader or Post-Fader.

Matrix Mixers

Eight Matrix mixers are available for sending up to eight mono mixes of input channels and busses to any available hardware output or bus-fed plug-in.

Each Matrix is a 12-in/1-out mono mixer with assignable input sources including Group busses or Aux busses, the 3 Main busses (L-C-R or L-R+M) and any of up to 8 user-selectable channels. Matrix input levels are controlled from the Output encoders when a Matrix is selected. Adjacent Matrix inputs can be linked or unlinked.

Odd/even pairs of Matrix mixers can be linked to form stereo Matrix output busses. The master output of each Matrix mixer is controlled from the Output faders.

See Chapter 12, “Matrix Mixers.”

Assigning and Using VCAs

VCA controls emulate the operation of traditional Voltage Controlled Amplifiers (VCAs). Up to eight VCA faders are available for remote control of Input Channel and FX Return, or Output channel fader gain.

VCAs control level of the assigned channels only. They do not act as a summing output bus.

VCAs remotely control the fader gain of each channel assigned to the VCA fader, but do not change the position of the faders on those channels. The accumulated gain of a channel belonging to several VCAs is limited to +12 dB.

Assigning Channels to VCAs

To assign channels to VCAs:

- 1 Press the VCAs switch in the Output faders section.
- 2 Select the VCA you want to target for membership assignment.

3 Press the Multi-Assign switch to the right of the Output section.

4 Press the Select switches on the Input Channels, FX Returns, or Output channels you want to assign to the VCA.

5 Press the flashing Multi-Assign switch to confirm the assignment, or press the Cancel switch to cancel the assignment.

Channel Strips Show VCA Contribution

The *effective gain* of any channel is equal to the combination of its individual channel fader, plus any (all) VCA level changes that affect that channel.

Input and output channels display the net effect of VCA level (effective gain) on-screen. This lets you keep track of what all currently assigned VCAs are doing to channels and busses at all times.

On-Screen VCA Indication

VENUE displays effective gain as a second, transparent fader cap on-screen in the fader displays of both the Inputs and Outputs pages.

Selected Channel When the currently selected channel is under VCA control, the net effect of all its assigned VCAs is shown in the form of a transparent fader cap.

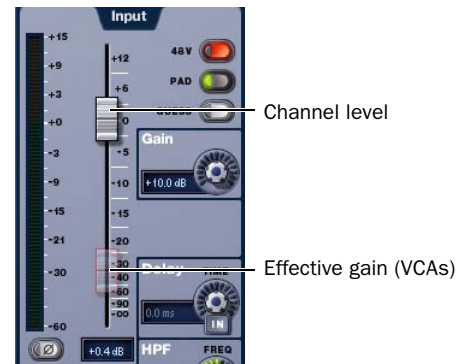

Effective gain (VCA contribution) shown on the selected channel

Inputs and Outputs Pages In the Inputs and Outputs pages, red “ghost” fader caps appear below the fader displays of channels that are currently assigned to one or more VCAs.

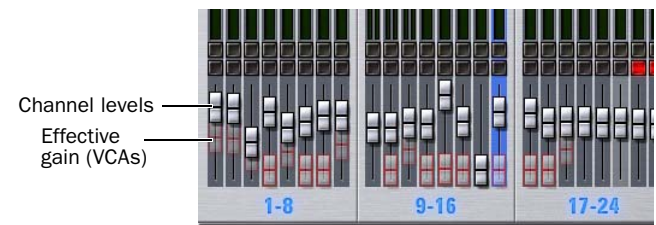

Effective gain (VCA contribution) shown in the on-screen fader displays

The opacity of the ghost caps vary with the actual VCA levels:

- Lighter caps indicate smaller amounts of VCA gain.
- Brighter caps indicate larger amounts of VCA gain.

Turning Channel VCA Indication On and Off

By default, channel VCA indication is on. You can turn off VCA indication in the Options > Interaction page.

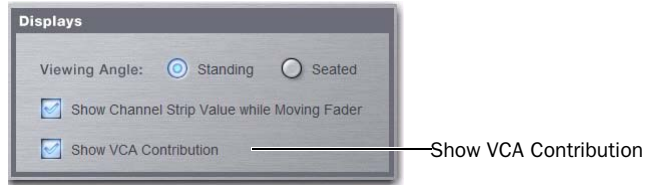

Displays settings in the Options > Interaction page.

To turn channel VCA indication off or on:

- 1 Go to the Options > Interaction page.
- 2 In the Displays section, click to enable (or disable) Show VCA Contribution.

Showing VCA Members

VENUE SC48 lets you quickly view members (assigned channels) for Groups, VCAs and Mute Groups.

To view VCA membership:

- 1 Press the VCA switch to bank the Output faders to VCAs.
- 2 Press and hold the Default (Alt) switch, then press the Multi Assign switch in the Output section. The Multi Assign switch LED lights to indicate Multi Assign mode.

VCA assignments are shown in each channel strip LCD with a flashing number (the number indicates the VCA to which each channel is assigned).

To exit Show VCA Members mode:

- Press the Multi Assign switch or the Cancel button.

Using VCAs

To adjust the levels of VCA members:

- 1 Press the VCAs switch to assign control of the VCAs to the Output faders.
- 2 Move the fader for the VCA whose members you want to adjust.

To solo the members of a VCA:

- Press the Solo switch on the VCA channels whose members you want to solo so that the Solo switch is lit.

Input channel solo mode (PFL or AFL) follows the current setting on the Options > Busses page.

 *Input channel solo mode (PFL or AFL) follows the current setting on the Options > Buses page.*

To mute the members of a VCA:

- Press the Mute switch on the VCA channels whose members you want to mute. The Mute LEDs on channels assigned to the VCA flash to indicate they are implicitly muted by the VCA.

VCA Spill

You can “spill” a VCA to have only its assigned channels banked to the Input section. VCA Spill lets you quickly access only those channels assigned to a specific VCA and immediately focus on those channels, without needing to search through the input fader banks.

To spill a VCA:

- 1 Select the VCA output fader bank.
- 2 Double-press a VCA Select switch to spill its members across the input faders.

The selected VCA Select switch LED flashes, as do the current input Bank (A-D) or FX Return (1-8) switch. Any Bank Safed channels are hidden (though their Bank Safe status is unaltered).

If the VCA contains fewer than 16 members the channels are right-justified within the input fader bank, in order to bring channels as close as possible to the center of the console. Unused channel strips are left blank and inactive.

If the VCA contains more than 16 members only the first 16 members are shown.

To cancel VCA Spill, do any of the following:

- Press or double-press the Select switch on the currently spilled VCA.
- Press any Bank (A-D) switch.
- Press the FX Returns 1-8 switch.
- Press a GEQ switch.
- In the on-screen dialog, click Exit VCA Spill.

Selecting Other VCAs While Spilled

Selecting another VCA while spill mode is active automatically spills that VCA.

Chapter 10: Groups

This chapter shows how to do the following:

- Configure Group busses
- Route Groups
- Adjust Group bus parameters

Configuring Group Busses

The Output section has 8 available Group busses. Group outputs can be assigned to the Main Output busses, to available bus-fed plug-ins, to Matrix mixers, and to any hardware outputs on the systems.

Group busses can be globally configured to be mono or stereo as part of the Aux/Group bus configuration. See “Configuring Aux and Group Busses” on page 74.

For information on routing input channels and FX Returns to Groups, see “Routing Channels to the Mains and Groups Busses” on page 65.

Routing Inputs to Group Busses

To route multiple channels to a single Group at a time:

- 1 Press the Groups switch to bank the Output faders to the Groups busses.
- 2 Press the Select switch in the Output strip for the Group (1–8) to which you want to assign channels.
- 3 Press the Multi-Assign switch near the Output encoders. The Multi Assign and output Select switches flash.
- 4 Press the Select switch on the channels you want routed to the selected Group.
- 5 Press the Multi Assign switch again to confirm the action.
– or –
 - Select another Group to confirm the current assignment but remain in Multi Assign mode to assign channels to the newly targeted Group bus.

To route channels to any number of Group busses:

- 1 Target one or more channels.
- 2 In the Bus Assigns section, press any of the Group switches so that they are lit.

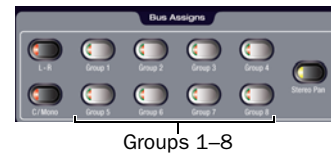

Bus Assign switches to assign Groups to Mains

Routing Group Outputs to the Main Busses

You can route Group outputs to the Main busses from the ACS or on-screen.

To route a Group output to the Main busses from the ACS:

- 1 Press the Groups switch in the Output Fader assignment section to assign control of Group levels to the faders.

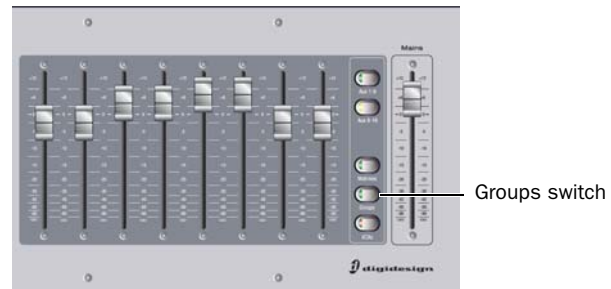

Assigning Groups to the Output faders

- 2 Select each Group that you want to assign to the Main busses by pressing their Select switches.
- 3 In the ACS Bus Assigns section, press the L–R (left and right) or C/Mono (center/mono) switch so that it is lit.



Bus Assign switches to assign Groups to Mains

To route a Group output to the Main busses on-screen:

- 1 Go to the Outputs page and select the Group you want to route to the Main busses.
- 2 Click the Bus Assign buttons on-screen to toggle the bus assignment for the selected Group.



Assigning a Group output to the Main busses from the Output page

Managing Group Bus Assignments

To help manage Groups, the following sections explain how you can spill, view, copy (duplicate) and reset Groups and Group bus assignments.

Group Spill

You can “spill” a Group to have only its assigned channels banked to the Input section. Group Spill lets you quickly access only those channels assigned to a specific Group and immediately focus on those channels, without needing to search through the input fader banks.

To spill a Group:

- 1 Select the Group output fader bank.
- 2 Double-press a Group Select switch to spill its members across the input faders.

The selected Group Select switch LED flashes, as do the current input Bank (A-D) or FX Return (1-8) switch. Any Bank Safe channels are hidden (though their Bank Safe status is unaltered).

If the Group contains fewer than 16 members the channels are right-justified within the input fader bank, in order to bring channels as close as possible to the center of the console. Unused channel strips are left blank and inactive.

If the Group contains more than 16 members only the first 16 members are shown.

To cancel Group Spill, do any of the following:

- Press or double-press the Select switch on the currently spilled Group.
- Press any Bank (A-D) switch.
- Press the FX Returns 1-8 switch.
- Press a GEQ switch.
- In the on-screen dialog, click Exit Group Spill.

Selecting Other Groups While Spilled

Selecting another Group while spill mode is active automatically spills that Group.

Special Cases with Spill

Faders

If you are touching a fader at the same time as you invoke Group Spill, that fader may be taken off-line. Let go of the fader to bring it back online.

Viewing Group Bus Assignments

You can view Group bus assignments from the Input section of the console or from an on-screen list of Group members.

Viewing Group Bus Assignments in the Input Section

To view Group membership on the console:

- 1 Press the Groups switch to bank the Output faders to Groups.
- 2 Press and hold the Default switch, then press the Multi Assign switch in the Output section.

Group numbers are shown (flashing) in each channel strip LCD; the number indicates the Group to which each channel is assigned.

Viewing Group Bus Assignments On-Screen

When a Group bus channel is targeted on-screen, its members are shown in a list on the right side of the Outputs page.

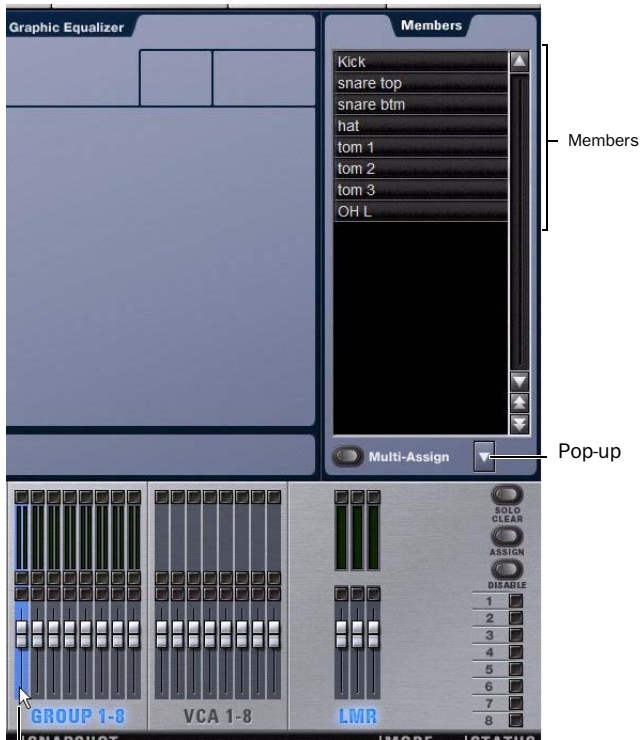

Currently selected output (Group)

Group members shown in the Outputs page

Copying Assignments Between Groups

You can copy the current input assignments from one Group bus to another. If the Groups are stereo, assignments can be copied from other linked busses. This lets you quickly duplicate monitor mixes.

⚠ Copying Group bus assignments overwrites all the assignments on the destination Group bus.

To copy input assignments between Group busses:

1 Target the Group bus that you want to be the destination of the copied assignments by selecting its on-screen channel strip.

2 Click the Input Assign pop-up menu at the bottom of the Members list, choose Replace With Mix From, then choose the Group whose assignments you want to copy to the currently selected bus.

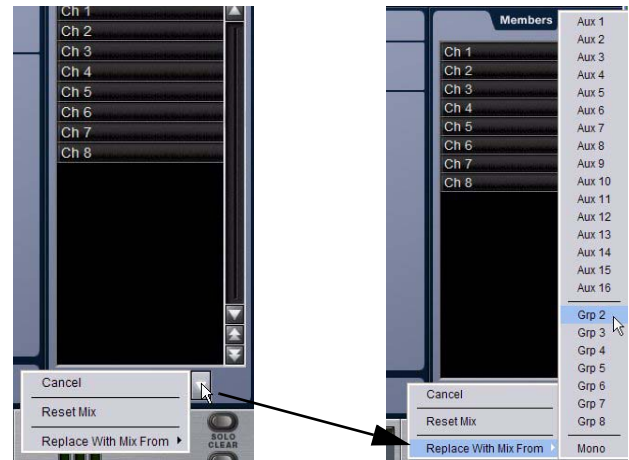

Copying input assignments between Groups

Resetting Group Bus Assignments

You can remove input assignments from a Group on-screen.

To remove an input assignment from a Group bus:

1 Select the Group bus you want to change so that its members are displayed on-screen.

2 In the list of Group bus members, right-click the input assignment you want to remove and choose Unassign.

To remove all input assignments from a Group bus:

1 Select the Group bus you want to change so that its members are displayed on-screen.

2 Click the pop-up menu at the bottom of the Members list and choose Reset Mix.



Group Bus Signal Flow Options

Routing Signals to a Mono Group Bus Configuration

When configured as mono busses, the eight Groups can be fed as 8 unlinked mono busses or up to 4 linked odd/even bus pairs.

Unlinked Mono Busses

To use unlinked mono Group busses:

- 1 Make sure the Group busses are configured as mono busses. See “Configuring Aux and Group Busses” on page 74.
- 2 While routing channels to Group busses, make sure the Stereo Pan switch is off.

The Group switches in the ACS Bus Assigns section light green to indicate mono operation. In this configuration, input signals are handled as follows:

Mono Input Signals Contributing mono signals are summed to the mono Group bus. Any pan information from mono input channels feeding the bus is ignored.

Stereo Input Signals Contributing stereo signals are summed to the mono Group bus with no attenuation. The balance and width information from each stereo input channel is ignored.

Linked Odd/Even Bus Pairs

To use linked mono Group bus pairs:

- 1 Make sure the Group busses are configured as mono busses. See “Configuring Aux and Group Busses” on page 74.
- 2 While routing channels to Group busses, press the Stereo Pan switch so that it lights yellow.

The Group switches in the ACS Bus Assigns section and the Stereo Pan LED in the channel’s Bus Assign indicator light yellow to indicate stereo operation. In this configuration, input signals are handled as follows:

Mono Input Signals Contributing mono signals are panned across the linked odd/even Group bus pair. Pan information from each mono input channel determines its pan position in the bus pair.

Stereo Input Signals Contributing stereo signals are panned across the linked odd/even Group bus pair. Balance and width information from each stereo input channel determines its contribution to the odd and even sides of the bus pair.

Routing Signals to a Stereo Group Bus Configuration

When configured as stereo busses, the eight Groups can be fed as 8 true stereo busses or (in Expert mode only) as 8 dual mono busses.

Stereo Busses

To use stereo Group busses:

- 1 Make sure the Group busses are configured as stereo busses. See “Configuring Aux and Group Busses” on page 74.
- 2 When routing channels to any of the Group busses, make sure the Stereo Pan switch is lit yellow.



When working with stereo Groups in Simple Mode, the Stereo Pan switch is always lit to indicate all Groups operate in true stereo.

Dual Mono Busses

Dual mono busses may only be used in Expert Mode. See “Simple and Expert Operational Modes” on page 85.

Adjusting Group Bus Output Controls

Group Bus Output Levels

Group bus levels are adjusted just like other Output busses (bank to Groups, adjust the fader). For more information, see “Adjusting Output Controls” on page 76.

Group Bus Output Pan

Group bus output pan is controlled from the Output encoders.

Groups-to-Mains assignment is displayed by the indicator LED for each Output encoder, when Groups are banked to the Output faders. The Output encoder Pan switch cycles the encoders and LCD to pan, balance and width parameters.

The pan controls adjust pan (when in mono Groups configuration) or stereo balance and width (when in stereo Groups configuration) of the Group output to the Main busses only. The Group outputs in the Patchbay are distinct left and right channels.

To control mono Group output pan:

- 1 Bank the Output faders to Groups.
- 2 Press the Pan switch in the Output encoder section once to assign control of Group pan to the Output encoders.
- 3 Turn a rotary encoder to adjust the pan for the corresponding mono Group.

To control stereo Group output balance and width:

- 1 Press the Pan switch in the Output encoder section.
- 2 Turn a rotary encoder to adjust the balance for the corresponding stereo Group.
- 3 Press the Group Pan switch in the Output Encoder assignment section an additional time to assign Group width control to the Output encoders.
- 4 Turn a rotary encoder to adjust the width for the corresponding stereo Group.

Simple and Expert Operational Modes

When configuring Group busses, you can choose between two operational modes that provide different levels of flexibility: *Simple mode* and *Expert mode*.

Setting the Operational Mode

To switch between Simple mode and Expert mode:

- 1 Put the system in Config mode.
- 2 Go to the Options page and click the Busses tab.
- 3 Under Stereo Group Panning Operation, select the mode you want to use (Simple or Expert).



Setting the Group bus operational mode

Working with Mono Group Busses

When configured as mono busses, Groups can operate in the following modes:

Simple Mode

In Simple mode, either all Groups on a channel are mono, or all Groups on a channel act as bus pairs.

Expert Mode

In Expert mode, any of the 4 bus pairs can be stereo linked individually while leaving the other busses as mono, on a per channel basis.

To set the link status of individual mono Group busses on a channel (Expert Mode only):

- 1 Make sure Stereo Group Panning is set to Expert Mode.
- 2 Select an input channel or FX return whose signal you want to send to a Group bus. To select multiple channels, use the Multi-Select switch next to the input faders.
- 3 In the Bus Assigns section, press the Stereo Pan switch. The switch flashes yellow to indicate bus link mode.
- 4 Press any of the Group switches to link or unlink the bus pairs (1–2, 3–4, 5–6, or 7–8). The Group switch pairs flash yellow to indicate stereo linked, or flash green to indicate mono.
- 5 Press the flashing Stereo Pan switch to confirm the bus link status for the selected channels.

Working with Stereo Group Busses

When configured as stereo busses, Groups can operate in the following modes:

Simple Mode In Simple Mode, all 8 Group busses function only as true stereo busses.

Expert Mode In Expert Mode, any of the 8 stereo Group busses can be set to act as true stereo or as dual mono busses, on a per channel basis.

To set the link status of individual stereo Group busses for a channel (Expert Mode only):

- 1 Make sure Stereo Group Panning is set to Expert Mode.
- 2 Select an Input Channel or FX Return whose signal you want to route to a Group bus. To select multiple channels, use the Multi-Select switch next to the input faders.
- 3 In the ACS Bus Assigns section, press the Stereo Pan switch. The switch flashes yellow to indicate bus link mode.
- 4 Press any of the Group switches (1–8) to set the corresponding bus to stereo or dual mono. The Group switches flash yellow to indicate stereo, or flash green to indicate dual mono.
- 5 Press the flashing Stereo Pan switch to confirm the bus link status for the selected channels.

To use dual mono Group busses (Expert Mode only):

- 1 Make sure the Group busses are configured as stereo busses. See "Configuring Aux and Group Busses" on page 74.
- 2 Make sure the link status of the Group busses you want to use is set to dual mono.

When routing channels to a dual mono Group bus, the Stereo Pan switch will be off and the Group switch will light green to indicate dual mono operation.

Chapter 11: Aux Sends

This chapter explains the following Aux Sends operations:

- Configuring Aux Send busses
- Routing to Aux Sends
- Adjusting Aux Send parameters
- Managing Auxes

Auxes can be fed by input channels and FX returns, and can be assigned to hardware outputs in the Patchbay.

Aux Send level controls provide a gain range of $-INF$ to $+12$ dB.

Configuring Aux Busses

Up to 16 Aux busses are available. Auxes can be mono, or linked to form stereo pairs. The number of available Aux busses is set as part of the overall Aux/Group bus configuration. (See “Configuring Aux and Group Busses” on page 74.)

Linking Aux Busses for Stereo Operation

When working with Aux busses, you can link odd/even bus pairs and pan input signals into those bus pairs.

To link Aux bus pairs:

- 1 Put the system into Config mode.
- 2 Go to the Options page and click the Busses tab.



Linking bus pairs in the Options > Busses page

- 3 Click *Edit*.
- 4 Click the checkboxes above any of the bus pairs to link or unlink each pair.
- 5 Click *Apply*.

When Aux busses are linked, signals are handled as follows:

Mono Input Signals Contributing mono signals are panned across the linked odd/even Aux bus pair.

- When the Follows Channels Pan option is off, panning of the mono signal to the bus pair is controlled by the Aux Pan control (the even-numbered send).
- When the Follows Channels Pan option is on, the pan information from each mono input channel determines its pan position in the bus pair.

Stereo Input Signals Contributing stereo signals are panned across the linked odd/even Aux bus pair. Stereo width information from the input channel is applied to the bus signal.

- When the Follows Channels Pan option is off, balance of the stereo signal to the bus pair is controlled by the Aux Pan control.

When the Follows Channels Pan option is on, the balance from each stereo input channel determines its contribution to the odd and even sides of the bus pair.

Selecting Aux Send Pickoff Points

The system lets you set the pickoff point on Input Channels or FX Returns channels for Aux Sends. Pickoff points are set for each Aux bus independently. If any Aux busses are linked, the pickoff point is set for the linked bus pair.

Each channel can be sent to an Aux either pre- or post-fader. Pre-fade offers several choices of pickoff.

Pre-EQ Post-HPF and pre-EQ, Dynamics and Channel Inserts, pre-Mute, and pre-Fader. The Aux Send is not affected by the channel mute.

Pre-Mute Post-HPF, post-EQ, Dynamics, and Channel Inserts, pre-Mute, and pre-Fader. The Aux Send is not affected by the channel mute.

Pre-Fader Post-HPF, post-EQ Dynamics, and Channel Inserts, post-Mute, and pre-Fader. The Aux Send is affected by the channel mute.

To set the Pre pickoff point for an Aux Send:

- 1 Go to the Options page and click the Busses tab.



Setting Aux bus pickoff points

- 2 Select a Pre pickoff point for any of the busses or linked bus pairs by clicking the Pre-EQ, Pre-Mute, or Pre-Fader button.

To activate a Pre pickoff point for an Aux Send:

- 1 Go to the Inputs page and target the channel with the pick-off point you want to activate.
- 2 Click the corresponding Pre button in the Aux Sends section.



Activating Pre pickoff for an Aux Send (Inputs page shown)

When the Pre button is lit, the selected Pre pickoff point is used. When the Pre button is off, the pickoff point is Post-Fader.

Classifying Auxes for Snapshots

You can classify Aux Sends as *monitor sends* (“Mon”) or as *effects sends* (“FX”) for the purposes of scoping and safing each type separately in snapshots. See “Classifying Aux Sends” on page 189.

Routing Inputs to Aux Busses

You can send signals from any Input Channel or FX Return to any number of Aux busses with the input encoders, Channel Control section, Output section, or on-screen.

To route channels to Aux sends using the input encoders:

- 1 To access Aux Sends on the input channel encoders, press an Encoder assign Sends switch 1–2 through 15–16.

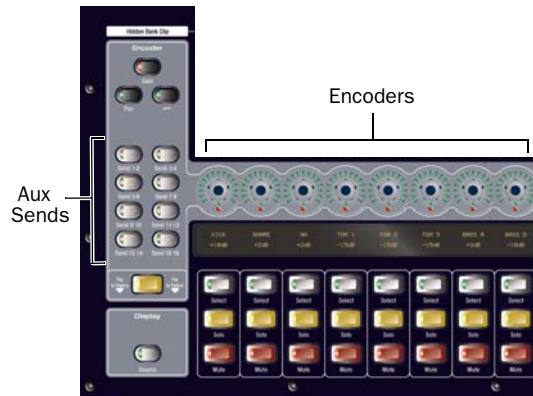

Encoder assignment switches for input channels

- 2 For each channel you want to assign to the selected Aux Send bus, press its channel encoder so that its “On” indicator LED lights.

- The first press of an Aux Send encoder assigns level control of the odd-numbered send. The switch lights green to indicate an odd-numbered selection.
- The second press of an Aux Send encoder assigns level control of the even-numbered send. The switch lights yellow to indicate an even-numbered selection.

- 3 To set the Aux Send level, do either of the following:

- Turn the encoder on each channel.
- Press the Flip to Faders switch, then adjust the channel fader.

To route channels to Aux Sends busses using the Channel Control section:

- 1 Target the first channel you want to route by pressing its Select switch.
- 2 Press and hold the Multi-Select switch next to the input faders, then press the Select switches on the other channels you want to route to the Auxes.
- 3 In the Channel Control section, press the Aux Sends 1–8 or Aux Sends 9–16 switch to bank the Channel Control encoders to those Auxes.

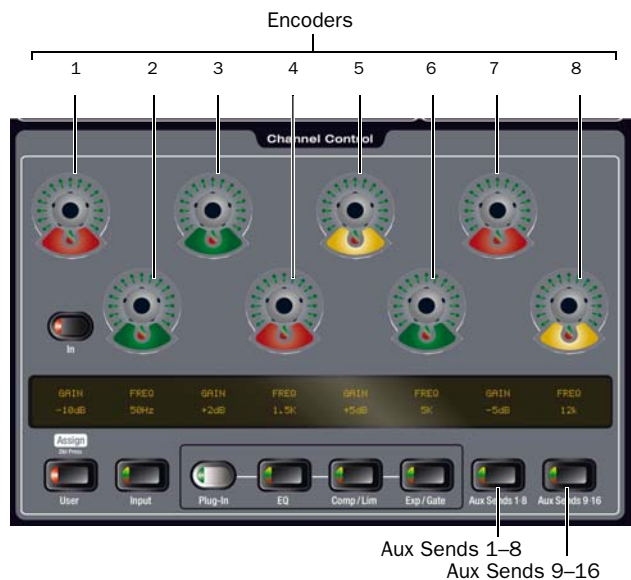

Channel Control

- 4 Press the Channel Control encoder that corresponds to the desired Aux Send bus so that its “On” indicator LED lights.
 - The first press of an Aux Send switch assigns level control of the odd-numbered send. The switch lights green to indicate an odd-numbered selection.
 - The second press of an Aux Send switch assigns level control of the even-numbered send. The switch lights yellow to indicate an even-numbered selection.

Turn the encoder to set the Aux Send level.

To route channels to Aux Sends from the Output section:

- 1 Press the Auxes 1–8 or 9–16 switch to bank the Output faders to those Aux busses.
- 2 Press the Select switch in the Output strip for the Aux Send to which you want to assign channels.
- 3 Press the Multi-Assign switch near the Output encoders. The Multi Assign and output Select switches flash.
- 4 Press the Select switch on the channels you want routed to the selected Aux Send.

- 5 Press the Multi Assign switch again to confirm the action.

– OR –

- Select another Aux Send to confirm the current assignment but remain in Multi Assign mode to assign channels to the newly targeted Aux bus.

Routing Aux Busses to Outputs and Plug-Ins

Aux busses can be routed to hardware outputs and to available bus-fed plug-ins.

To route an Aux output to the Main busses from the ACS:

- 1 Press an Auxes switch (1-8 or 9-16) in the Output section to assign control of Aux levels to the Output faders.

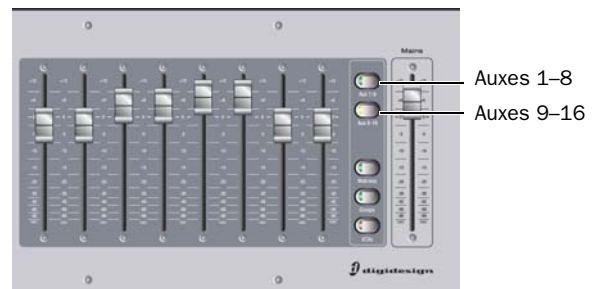

Auxes switches in the Output section

- 2 Select each Aux that you want to assign to the Main busses by pressing their Select switches.
- 3 In the ACS Bus Assigns section, press the L–R (left and right) or C/Mono (center/mono) switch so that it is lit.
- 4 Move the channel’s fader to set the Aux output level.

Aux busses also provide Direct Outs, inserts and built-in Graphic EQ capabilities. For details, see the following:

Direct Outs See “Direct Outputs” on page 78.

Inserts See “Using Inserts on Output Busses” on page 75.

Graphic EQ See “Inserting the Built-In Graphic EQs on Output Busses” on page 76.

Adjusting Aux Send Controls

You can adjust Aux Sends from the input encoders, from Channel Control, and on-screen.

Using the Input Encoders

To control Aux Sends using the input encoders:

- Press an Encoder assign Send switch (1–2/15–16) to bank that Aux Send to the input encoders.

To turn a send on or off:

- 1 Press the input encoder for the Aux on the desired channel to toggle that send on/off.

When Aux busses are linked, input signals are panned across the bus pair. Panning can be controlled from the Input encoders or from the ACS Aux Sends section.

To control panning of Aux bus pairs from the Input section:

- 1 Press an Encoder assign Send switch (1–2/15–16) to bank that Aux Send to the input encoders.
 - The first press of the Aux switch assigns control of the send level to the encoder. The switch lights green and the encoder display shows the odd-numbered send.
 - The second press of the Aux switch assigns control of the send pan to the encoder. The switch lights yellow and the display shows a “P” before the odd-numbered send.
- 2 With the Aux switch lit, turn the rotary encoder on each Input Channel or FX Return to adjust the send pan.

Using Channel Control

Channel Control lets you adjust Aux sends and send levels in two banks, Aux 1-9 and Aux 9-16.

To access Auxes in Channel Control:

- 1 Select one or more channels.
- 2 Press the Aux Sends 1-8 or Aux Sends 9-16 switch in Channel Control.

The Aux Sends 1-8 switch LED lights purple; the Aux Sends 9-16 switch LED lights teal (light blue). The LCD display identifies each send in the current bank (1-8 or 9-16).

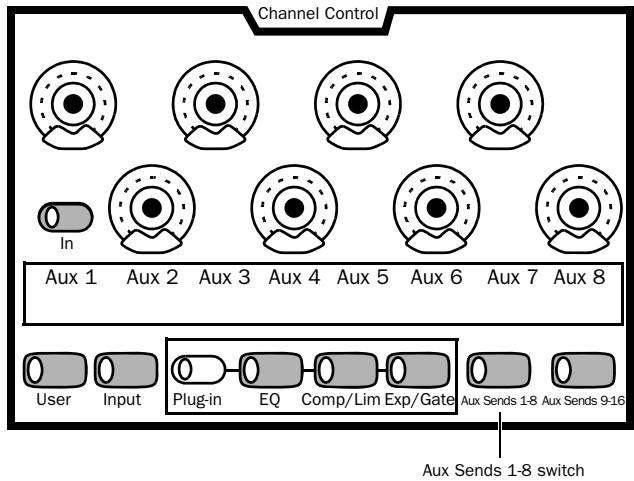

Aux sends in Channel Control (Auxes 1-8 shown)

To turn a send on or off:

- 1 Choose the desired bank of Auxes (1-8 or 9-16) by pressing the corresponding Aux Send switch. When engaged:
 - The Aux Sends 1-8 switch lights purple.
 - The Aux Sends 9-16 switch lights turquoise (blue/green).
- 2 Press the encoder (1-8) for the desired Aux to toggle that send on/off. While engaged, the indicator LED at the bottom of that encoder LED ring lights.

To adjust mono Aux send level:

- Adjust the encoder for each Aux as needed.

To adjust stereo linked Aux send level:

- Adjust the odd-numbered encoder for the desired pair of Auxes. For example, if Auxes 7 and 8 are stereo linked, adjust encoder 7 (labelled <Aux 7> in the LCD) to adjust send level.

To pan a stereo linked Aux:

- Adjust the even-numbered encoder for that pair (labelled with the letter P in front of the name of the Aux in the LCD). For example, if Auxes 7 and 8 are stereo linked, Aux 8 encoder will be labelled as P<Aux 7>; adjust encoder 8 (P<Aux 7>) to pan the send.

To control panning of Aux bus pairs from Channel Control:

1 Press the Aux Sends switch (1-8 or 9-16) in the Channel Control section to bank Channel Control to those Auxes. For linked bus pairs:

- Odd-numbered rotary encoders control send level
- Even-numbered rotary encoders control send pan

2 Turn the even-numbered rotary encoders in the Aux Sends section to adjust the corresponding send pan.



You can link the ACS Aux Sends section to follow AFL, letting you immediately access send controls for Auxes and Variable Groups by soloing any Aux or Group output strip. For more information, see “Auxes Follow AFL and AFL Follows Auxes” on page 112.

Using Flip to Faders to Access Send Level and Pan Simultaneously

You can use Flip to Faders mode to bring Aux level control to the input faders while retaining control of Send pan from the input encoders.

To access Aux Send level and pan simultaneously:

1 Assign the input encoders to Aux Sends by doing either of the following:

- Press a Send switch in the Input Encoder Assignment section to assign the encoders to control level for the selected send.
- Target an Aux bus by selecting it in the Output section.

2 Press the Flip to Faders switch, at the bottom of the Input Encoder Assignment section. The input faders now control and display level for the selected send, and the encoders display and control Send pan.

Setting Aux Send Pan to Follow Channel Pan

Panning of the input signal can be set to follow the pan or balance values of the Input Channel or FX Return feeding the Aux bus

To set the Aux Send pan to follow Channel pan:

1 Go to the Options page and click the Busses tab.

2 On any linked bus pairs, select the Follows Channel Pan option. This setting is applied globally to the corresponding Aux Send.

Managing Aux Bus Assignments

Viewing Aux Bus Assignments

When an Aux bus output channel is targeted on-screen, its members are shown in a list on the right side of the Outputs page.

To view input assignments to an Aux bus:

- 1 Go to the Outputs page.
- 2 Target an Aux bus output channel by selecting its on-screen channel fader strip. Input channels routed to the selected bus are displayed in the Members list on the right side of the page.

To go to any assigned input channel from the Outputs page:

- Click the name of the input channel in the Members list.



Aux bus assignments shown in the Outputs page

Resetting Aux Bus Assignments

You can remove input assignments from Aux bus output channels on-screen.

To remove an input assignment from an Aux bus:

- 1 Target the Aux bus output channel you want to change by selecting its on-screen channel strip.
- 2 In the list of member input channel assignments, right-click the input assignment you want to remove and choose Unassign.

To remove all input assignments from an Aux bus:

- 1 Target the Aux bus output channel you want to change by selecting its on-screen channel strip.
- 2 Click the pop-up menu at the bottom of the Members list and choose Reset Mix.

Copying Assignments Between Aux Busses

You can copy the current input assignments from one Aux bus (or Mains) to another bus of either type. If the busses are linked, assignments can be copied from other linked busses. This lets you quickly duplicate monitor mixes.

⚠ *Copying Aux bus assignments overwrites all the assignments on the destination Aux bus.*

To copy input assignments between Aux busses:

- 1 Target the Aux bus that you want to be the destination of the copied assignments by selecting its on-screen channel strip.
- 2 Click the Input Assign pop-up menu at the bottom of the Members list, choose Replace With Mix From, then choose the Aux bus whose assignments you want to copy to the currently selected bus.

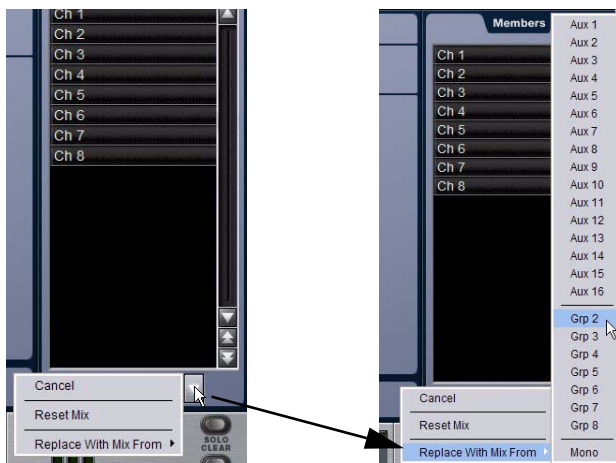

Copying input assignments between Aux busses

Copying Mains Assignments to Aux Busses

You can copy the current Main bus assignments to Aux busses to base monitor mixes from a main mix. Assignments to the Main Left/ Right busses can be copied to linked Aux busses, and assignments to the Center/Mono bus can be copied to mono Aux busses.

To copy bus assignments from the Mains to Auxes:

- 1 Target the Aux bus that you want to be the destination of the copied assignments by selecting its on-screen channel strip.
- 2 Click the Input Assign pop-up menu at the bottom of the Members list, choose Replace With Mix From, then choose the available Main bus (Left-Right or Mono) whose assignments you want to copy to the currently selected bus.

The state of the Aux controls follow the state of the corresponding controls on the Input Channels assigned to the Mains: Channel Mute maps to Bus Send, Channel Pan maps to Bus Pan, and Channel Fader level maps to Bus Send level.

Chapter 12: Matrix Mixers

The Outputs section offers 8 mono (or up to four pairs of stereo-linked) Matrix mixers for setting up alternate mixes, fill and delay feeds, and cue, monitor or press mixes.

Matrix Mixers

Each of the 8 available Matrix mixers can receive up to 12 channels of input. Input sources can be any combination of Auxes, Groups or Mains busses, or any of the eight available Matrix User Sends. By default, each Matrix mixer has a mono output, but outputs can be linked to form a stereo pair.

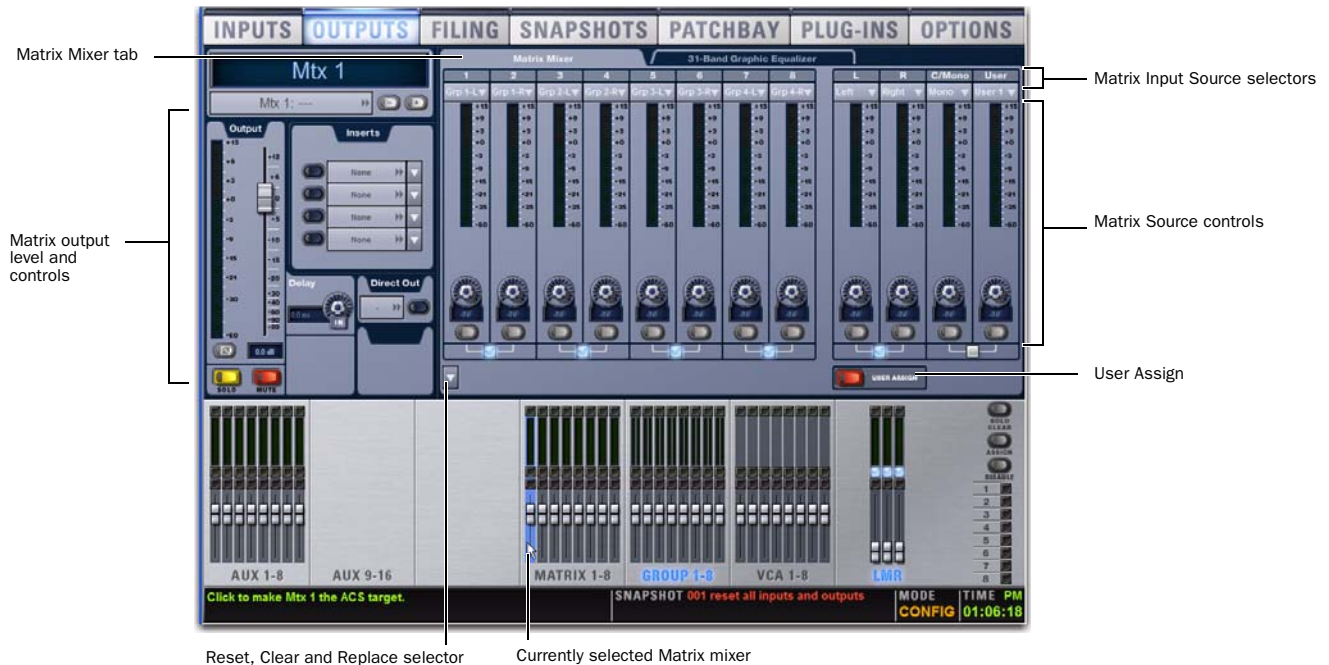

Matrix Mixer in Outputs page

Configuring Matrix Mixers

The 12 Inputs for each Matrix mixer can be any combination of these 35 potential sources:

- 24 shared Aux and Group sources
- 3 Mains sources (LCR or LR+M)
- 8 User Input sources

User Inputs can be input channels, FX Returns, physical stage audio or FOH audio inputs, or inputs from Pro Tools (FWx)

- One or more of the 8 available user inputs can be sent to one or more Matrix mixers.
- Input source assignment and user input assignment can be stored on a per-snapshot basis.
- The input sources for Matrix mixers are configured as Pre- or Post-Fader in the Pickoffs tab of the Options page.
- Input labels (1–8, Left, Right, C/Mono and User) are only intended as a guide. In use, any input source can be assigned to any mixer input (for example, Left doesn't always have to be assigned to the Left input of a mixer).

Configuring Aux, Group and Mains Pickoffs

To configure Groups, Auxes, and Mains pickoffs for the Matrix mixers:

1 Put the system in Config mode.

 *Configuring pickoff points may cause a momentary loss of audio, and therefore cannot be changed in Show mode.*

2 Go to the Options page and click the Pickoffs tab.

3 Under Matrix Sources, configure Aux, Groups and Mains (LCR or LR+M) as pre- or post-fader.

Linking and Unlinking Pairs to form Stereo Matrix Outputs

The eight mono Matrix mixers can be linked in odd/even pairs to form up to four stereo-linked pairs of matrix outputs. A combination of mono and stereo-linked Matrix mixers is possible. Odd-even matrix pairs are linked and unlinked using on-screen controls in the Options > Busses page.

 *Linking Matrixes is accomplished using the same Edit and Apply methods used for stereo linking Auxes.*

To stereo link Matrixes:

- 1 Put the system into Config mode.
- 2 Go to the Options > Busses page.
- 3 In the Matrix section, click Edit.
- 4 Click to enable the Link between any two adjacent (odd/even) Matrixes.
- 5 Click Apply. (Click Cancel to exit Edit mode without changes.)



Editing the link status of a Matrix pair in the Options > Busses page.

When a matrix pair is linked, the even-numbered channel inherits all parameter settings of the odd-numbered channel.

The matrix mixer changes to a stereo matrix mixer:

- A Pan control is added to each matrix mixer input source.
- All input sources are panned center upon linking.

Plug-in assignments to the formerly mono matrix channels are lost, including all snapshot references.

Unlinking Matrixes

To unlink a pair of Matrixes:

- 1 Put the system into Config mode.
- 2 Go to the Options > Busses page.
- 3 Click *Edit* in the Matrix section.
- 4 Click to unlink the desired Matrixes.
- 5 Click Apply.

When a Matrix pair is unlinked the even-numbered channel again inherits all parameter settings of the odd-numbered channel.

Pre-existing plug-in and GEQ routing may be affected when the matrix link state is changed. An alert dialog warning of data loss is shown prior to performing the link or unlink operation. Click OK to complete the link operation, or click Cancel to cancel without changes.

Snapshots

All matrix settings, including Pan but excluding the stereo link status, are stored and recalled with snapshots. The stereo link status of Matrix masters is not snapshottable.

Compatibility

Show files created in previous versions of software preserve all mono matrix settings in working memory and snapshots. Loading a Show file containing stereo-linked Matrixes in a previous version of software preserves all data except Matrix master link status.

Settings

You can copy and paste settings between mono and stereo Matrixes, and use the Replace with Mix command, by right-clicking on the Matrix and choosing Copy, Paste, or Replace with Mix from the menu.

Copy and Paste

Copy/paste only applies to master strip settings (fader, mute, polarity, delay, direct out). Mix parameters and mix sources are handled separately.

Replace

You can use the right-click menu to Replace mixer settings between mono and stereo Matrixes.

From	To	Result
Mono	Mono	All mix parameters and mix sources applied
Mono	Stereo	All mix parameters and mix sources applied; Pans default to center
Stereo	Stereo	All mix parameters and mix sources applied
Stereo	Mono	All mix parameters and mix sources except pan applied

Linking and Unlinking Adjacent Matrix Inputs

Adjacent inputs to Matrix mixers can be linked or unlinked on a per input pair basis. Link status can be specified on a per Matrix basis (for example, inputs 1 and 2 can be linked for Matrix 1, but unlinked for Matrix 2). This gives you the ability to control inputs as either a stereo-linked pair or as independent mono inputs.

- When linked, level and source on/off controls are linked.
- When unlinked, discrete level and on/off controls affect each individual channel.

Stereo inputs (such as stereo groups, Mains LR, and stereo-linked auxes) are linked by default, such as after a Clear Console operation. Adjacent inputs can be linked or unlinked at any time, in Config or Show mode.

To link or unlink inputs to Matrix mixers:

- 1 Go to the Outputs page, and click to display the Matrix mixer.
- 2 Click the checkboxes below any adjacent inputs to link or unlink them. A check mark in the checkbox indicates a linked input source; an empty checkbox indicates unlinked sources.



Link controls in the Outputs page

Relinking and Offsets

When inputs are relinked, their level and on/off state will change as follows:

Level Each channel maintains any offset between the two channels. This offset is not maintained if both linked controls are adjusted beyond their maximum or minimum.

On/Off Each channel maintains its discrete on/off state at the time the sources are relinked. For example, if one channel is on and the other is off the stereo input will maintain these settings after relinking, thus providing a stereo source with one channel on, and the other off. Toggling one channel from Off to On results in both channels switching On; toggling one of the linked channels from On to Off results in both channels switching Off.

Configuring User Inputs

You can assign up to eight User Inputs to be available globally to the Matrix mixers.

Any of the eight User Inputs defined for the Matrix can be assigned to any mixer input.

User Inputs are assigned for the Matrix from the User Assign panel of the Matrix main page.

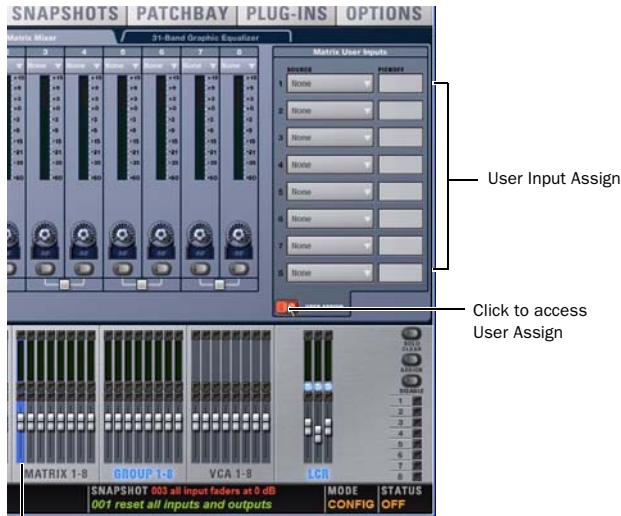

Currently selected Matrix mixer

User Input panel showing assignments for a Matrix mixer

To configure the User Inputs for a Matrix mixer:

- 1 Go to the Outputs page and click a Matrix mixer to navigate to that mixer page.
- 2 Click the User Assign button to display the User Assign panel.
- 3 For any of the eight available User Inputs, click the on-screen Source pop-up menu and select an available source. Choices include Channels, FX Returns, Stage and FOH audio sources, and FWx Pro Tools record/playback options.

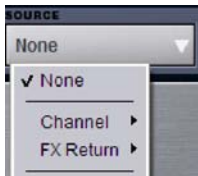

Choosing a User Assign source for a Matrix mixer

- 4 For any assigned User Inputs, click the Pickoff pop-up menu and choose the desired pickoff for that User Input source. Choices include Top of Channel, Insert Return, and Pre/Post-Fader (for Input Channels) or Top of FX Return and Pre/Post-Fader (for FX Returns). The Input Channel Fader Pick-off setting on the Options > Pickoffs page determines globally whether the fader pickoff points are pre- or post-fader.
- 5 Click the User Assign button again to return to the main Matrix screen.

Assigning Input Sources

To assign input sources to a Matrix mixer:

- 1 Go to the Outputs page and click to select a Matrix mixer.
- 2 Click the Input Source selector at the top of each Matrix channel and select the desired input source. Choices include Auxes, Groups, Mains and any of the 8 available User Inputs.

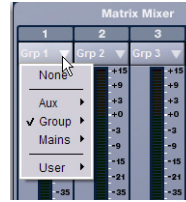

Choosing an Input Source for a mixer

 To use Input or FX Return channels in a Matrix mixer, assign them as User Inputs, then assign those User Inputs as input sources. For more information, see “Configuring User Inputs” on page 96

Assigning Sources to Multiple Mixers

You can select multiple Matrix mixers simultaneously and assign sources to all selected mixers at the same time.

To assign input sources to more than one Matrix mixer at a time:

- 1 Go to the Outputs page and use Multi-Select (or the Shift key) to select two or more Matrix mixers in the fader display at the bottom of the screen.
- 2 Click the Source selector at the top of a mixer channel (1–8, Left, Right, C/Mono, or User) and select the desired source.

Adjusting Matrix Mixer Input Controls

Matrix Mixer Input Levels

The levels for the first eight input sources (or “sends”) of a Matrix mixer are controlled by the Output Encoders.

The eight Output Encoders on VENUE SC48 control the input levels of the currently selected Matrix mixer input sources.

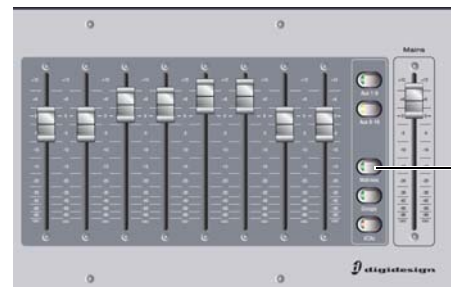

Assigning Matrixes to the Output faders

To control mixer input source (“send”) levels on the console:

- 1 Press the Matrixes switch in the Output fader assign section.
- 2 Press a Select switch for a Matrix to select that mixer and view its inputs. Input parameters are shown on the top row of the Output LCD. Input source levels are controlled by the encoders, and output levels are controlled by the faders.
- 3 Press the encoder to turn that mixer input source on or off.
- 4 Turn the Output encoders 1–8 to set the level for the first eight input sources assigned to the currently selected Matrix mixer.
- 5 To adjust source inputs 9–12, press the Next Page switch to bank those sources to Output Encoders 5–8. To return to sources 1–8, press the Prev Page switch.

Matrix Mixer Input Pan

The Matrix mixer input (or “send”) pan controls adjust the panning of each Matrix mixer input across the stereo outputs of a linked stereo Matrix mixer.

To control Matrix send pan:

- 1 Press the Matrixes switch in the Output fader assign section.
- 2 Press an Output channel Select switch to select a Matrix.
- 3 Press the Pan switch located below the Prev Page and Next Page switches.
- 4 Adjust the Output Encoder 1–8 to adjust pan on Matrix inputs 1–8. To access inputs 9–12 for the current mixer, press the Next Page switch.

Resetting Matrix Mixer Input Controls

You can reset level, pan and stereo link settings for any matrix mixer. Input source assignments persist.

To reset a Matrix mixer parameter to its default value:

- 1 Select one or more Matrix mixers you want to change.
- 2 Right-click the encoder on-screen and choose Reset.

To reset all Matrix mixer parameters to their default values:

- 1 Select one or more Matrix mixers you want to change.
- 2 Click the pop-up menu at the bottom of the mixer area and choose Reset Mix.



Resetting a mix

Clearing Matrix Mixer Settings

You can clear mixer input assignments to quickly set all the input sources to None.

To clear Matrix input assignments:

- 1 Select one or more Matrix mixers you want to clear.
- 2 Click the pop-up menu at the bottom of the mixer area and choose Clear Mix Sources.

Copying Matrix Mixer Input Settings

You can copy mixer settings from one Matrix mixer to another mixer of the same type. This lets you quickly duplicate monitor mixes or other signal feeds.

A *Copying mixer settings overwrites all the settings on the destination mixer.*

To copy settings between mixers:

- 1 Select the Matrix mixer that you want to be the destination of the copied settings so that it is displayed on-screen.
- 2 Click the pop-up menu at the bottom of the mixer area, choose Replace With Mix and Mix Sources From.
- 3 Choose the Mtx (Matrix mixer) from the sub-menu whose settings you want to copy to the current mixer.

Adjusting Matrix Mixer Output Controls

Matrix Mixer Output Levels

Matrix output levels are controlled by the Output faders.

To control mixer output levels:

- 1 Press the Matrixes switch to bank Matrix mixers to the Output faders.
- 2 Adjust the fader corresponding to the output level you want to change.

Matrix Mixer Output Delay

A variable delay (0–500 ms) can be applied to the output of Matrix mixers. For instructions, see “Output Delay” on page 77.

Delay Compensation with Matrix Mixers

VENUE automatically compensates for the delay offsets that can arise when combining different signal paths within a Matrix mixer.

Additional Information about Delay Compensation

- The overall latency through a Matrix is determined by the path with the highest latency.
- All inputs within a Matrix mix are guaranteed to be phase accurate, but mixes are not necessarily aligned to each other. This ensures that all mixes are not penalized in the case of one or more exceptionally high-latency signal paths.
- Delay compensation only accounts for a channel’s post-insert pickoff. Channels that feed User Inputs and Auxes (pre-insert) will not be fully compensated for.

Snapshot Data and Parameters for Matrix Mixers

Snapshots can store and recall all source assignments (of each matrix mixer) when the Matrix (“Mtx”) data type is scoped. In addition, all User Input assignments are stored, letting you re-configure Matrix mixers and User Input assignments on a per snapshot basis, if desired.

The following table describes what can be stored and recalled in each snapshot when the MTX data type is scoped.

Table 13. Snapshot data types and parameters for Matrix mixers

Snapshot Data Type	Included Parameters (for Each Scoped Channel Strip)
MTX	Mixer Input Sources, User Input Assignments (global to all Matrixes), and pickoffs; Mixer Input level, Mixer Input on/off state and Mixer <i>Input</i> Link state

 *You cannot snapshot link state of Matrix outputs.*

The Recall Safe tab of the Snapshots page provides two data “Mix” data types that let you discretely “safe” source and/or user input assignments to prevent them from being changed with a snapshot recall.

For complete information on VENUE snapshots, see Chapter 21, “Snapshots.”

Chapter 13: Patchbay

Accessing the Patchbay

To show the Patchbay screen:

- Press the Patchbay switch, located in the View Modes section, or click the Patchbay tab on-screen.

To jump to the Patchbay from the Inputs and Outputs screens:

- Click on the channel routing indicator, right below the channel name display. The screen automatically jumps to the corresponding Patchbay screen (whether an input, output, or bus).



Jump to Patchbay

Overview of the Patchbay

The Patchbay screen lets you patch hardware I/O to input and output channels.

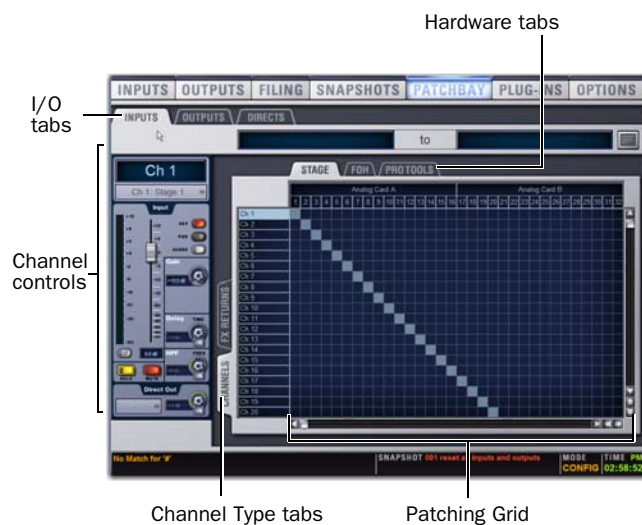

Patchbay page (Inputs tab shown)

The main tools and sections of the Patchbay screen are the following:

Tabs

The Patchbay is navigated using the following tabs.

I/O Tabs

Click to display and patch Inputs, Outputs, or Directs (Direct Outputs). Other options in the Patchbay screen change to reflect the currently selected I/O tab.

Channel Type Tabs

Click these tabs to select and display specific types of channels, as available for the currently selected I/O. The following table shows the available Channel Types for the current I/O.

I/O tab	Channel Types available
Inputs	Channels, FX Returns
Outputs	Groups, Auxes, Matrix, Mains
Directs	Channels, FX Returns, Outputs

Hardware Tabs

Click these tabs to display the hardware inputs and outputs available for the current I/O and Channel Type. These represent the physical inputs and outputs of the system.

Choices include Stage audio inputs and outputs, FOH (local) inputs and outputs, and FWx Pro Tools inputs and outputs. Available hardware inputs and outputs are based on channel type selection, system configuration and hardware device status. See “Unavailable I/O” on page 100.

Patching Grid

The Patching Grid shows hardware I/O across the top, and VENUE channels down the left side. The available channel tabs and choices are determined by the currently selected I/O tab and Channel type(s). The grid squares represent patch points between hardware I/O and VENUE mixing channels.

By default, hardware inputs are routed in a 1-to-1 pattern to input channels resulting in Stage inputs 1–48 appearing on Input Channels 1–16 (Bank A), 17–32 (Bank B) and so on.

Channel Controls

These controls mirror the controls for the currently selected channel. For example, when showing Inputs, the Channel controls let you adjust input gain, polarity, phantom power, HPF, Direct Out, and basic level without leaving the Patchbay.

Channel Direct Outs

The channel area in the Patchbay provides access to Direct Out controls.

To adjust Direct Output level from the Patchbay:

- 1 In the Patching Grid, patch the channel Direct Out to an available output.
- 2 In the channel controls, adjust the on-screen Direct Output encoder.



Adjusting Direct Output level from the Patchbay

Visual Indicators and Displays

The Patchbay uses the following visual display conventions in all its pages and tabs.

Unavailable I/O

The Patchbay displays hardware tabs for all possible configurations, even if your system does not include any expansion options.

The Patchbay indicates I/O that is offline or unavailable by graying out the columns beneath that device.



Unavailable I/O (grayed columns)

Unavailable hardware I/O appear grayed out in the patchbay and italicized in all routing pop-up lists. It is possible to make assignments to unavailable hardware I/O.

The VENUE D-Show Standalone software provides additional display options for hardware I/O (including unavailable I/O).

 See Chapter 24, “Using the Standalone Software.”

Assigned I/O

When a hardware connection is assigned, its connection is dimmed in all Patchbay screens. This lets you see which hardware connections are in use without having to switch back and forth between Patchbay screens. You can also use the dimmed column number indicator to jump to the Patchbay tab for the existing assignment (for more information, see “Shortcut for Locating Assignments” on page 104).

Text Display of Patch Source and Destination

Above the grid tabs are “from” and “to” text display fields that display the full text names of hardware I/O and channels.

To view full names of a patch source and destination:

- Place the cursor over a Channel Name. If the channel is already routed, its source and destination assignment appear directly above the Patching Grid, as shown below.

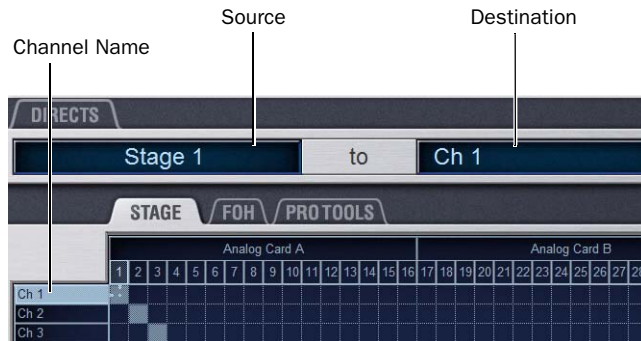

Channel source and destination display

An asterisk at the end of a destination name indicates a multiple output assignment. See “Multiple Input and Output Assignments in the Patchbay” on page 103.

Naming Channels from the Patchbay

Channel names can be changed from the Patchbay. Channel names can be up to 32 characters in length. When displayed on the console, names are abbreviated to fit the display.

To name or rename a channel from the Patchbay:

- 1 Double-click the channel name.
- 2 Type a new name and press Enter on the computer keyboard.

 *When naming channels in the Patchbay, press Tab on the keyboard to go to the next channel and Shift+Tab to go to the previous channel.*

Type Text Search

Type Text search lets you use the keyboard for fast navigation to a channel. You can enter the first characters of a channel name or the absolute channel number to target that channel on the ACS.

To search for and select a channel:

- 1 Type the first few letters, full name, or channel number of the channel. For example, type “s” to go to the first channel beginning with the letter s (such as *Snare*).
- 2 Press the Tab key to cycle through and select any other channels beginning with that letter (such as *Snare Top*, *Snare Bottom*, or *Strings*).

 *Avoid giving channels names that begin with numbers different from the absolute channel number. When you type a number, VENUE navigates to absolute channel numbers regardless of the channel name.*

Navigating the Patchbay

Navigating to Channel Types

The Patchbay uses multiple tabs to access different hardware I/O and channel types. For example, the Inputs screen provides Channels and FX Returns tabs for you to patch these different channel types independently.

Examples

To show Inputs:

- Go to the Patchbay page and click the Inputs tab.

To show a specific type of Input in the Patching grid:

- In the Patchbay page, click the Channels tab, or the FX Returns tab. Shift-Click to select and show multiple types at once.

To navigate to a different hardware source:

- Click the appropriate Hardware tab across the top of the Patching Grid.

Scrolling in the Patchbay

To scroll through the channel list (vertically):

- Move the cursor over a channel name at the left of the Patching Grid, then press the Up or Down Arrow keys on the keyboard.

To scroll through the hardware I/O list (horizontally):

- Move the cursor over a hardware I/O channel at the top of the Patching Grid, then press the Left or Right Arrow keys on the keyboard.

To scroll the Patching Grid, do one of the following:

- Click the up/down or left/right Patching Grid scroll arrows to move square by square.
- Click the up or down Patching Grid double arrows to move screen by screen.
- Right-click in the Patching Grid and drag in any direction.



Scrolling the Patching Grid by right-clicking and dragging

Routing Channels in the Patchbay

To route channels in the Patchbay:

- 1 Go to a Patchbay page by clicking the appropriate I/O tab, Channel Type tab, and Hardware tab.
- 2 Place the cursor over the Patching Grid. The cursor changes to a crosshair, and lines extend above and to the left of the current cursor location to identify the column and row in which it is located.
- 3 Click in the row for the channel and in the column for the hardware I/O source.



Routing a hardware input to an Input Channel

- 4 Click and drag vertically, horizontally, or at an angle to assign multiple patch points in a single action.
- 5 Repeat as needed.

Patchbay Click and Drag

You can quickly select a range of crosspoints in the Patchbay grid in one operation with a left-click and drag of the cursor. You can click and drag horizontally, vertically, and at 45 degree angles in any direction.

⚠ You cannot undo changes to the Patchbay grid.

To use click and drag in the Patchbay grid:

- 1 Left-click on the crosspoint defining the start of the range.
- 2 Continue to hold the left-click button, then drag horizontally (to populate a row), vertically (to populate a column), or horizontally and vertically (a 45 degree angle).
- 3 Release the left-click button when the destination crosspoint is reached. All crosspoints along the path are filled in.

The destination crosspoint sets the targeted channel. If the new assignments steal any previous assignments, a warning dialog will ask you to confirm or cancel the reassignment.

SHIFT To suppress the reassignment warning dialog, hold Default (on the control surface) or Alt (on the computer keyboard) while clicking in the patch grid. For more information, see “Warning when Stealing Inputs or Outputs in the Patchbay” on page 103.

Using the Arrow Keys to Route Channels

You can also use the Arrow keys instead of the trackball to assign routing.

To route channels using the Arrow Keys on the keyboard:

- 1 Place the cursor over the Patching Grid so that the cursor changes to the crosshair.
- 2 Press the Left or Right Arrow keys to move the crosshair to the next or previous hardware I/O column; press the Down or Up Arrow keys to move the cursor to the next or previous channel.
- 3 When the crosshair is over the correct square in the grid, press Enter to assign the patch.

Multiple Input and Output Assignments in the Patchbay

Input sources can be assigned to multiple Input Channels in the Patchbay. Output busses can be assigned to multiple hardware outputs.

Stage inputs assigned to multiple channels share a common preamp gain. Adjusting one channel's gain automatically adjusts all other channels. All other channel functions (such as EQ, dynamics, and panning) remain independent.

To assign a hardware input source to multiple Input Channels or FX Returns:

- 1 Go to the appropriate Input tab in the Patchbay.
- 2 Click in the Patching Grid to assign the source to the first Input Channel or FX Return.
- 3 Click additional grid squares in the same column to assign the source to additional channels. The selected hardware input is routed to each of the assigned Input Channels or FX Returns.

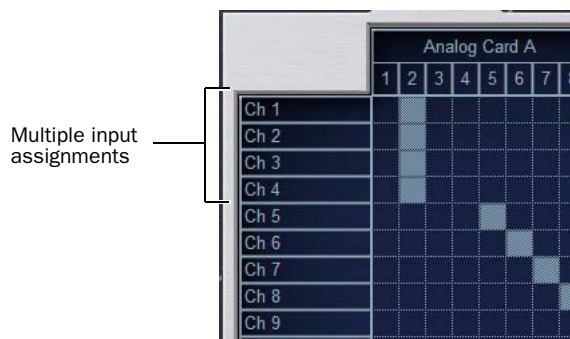

A hardware input routed to multiple Input Channels

To assign an Output bus to multiple hardware outputs:

- 1 Go to the appropriate Output tab in the Patchbay.
- 2 Click in the Patching Grid to assign the Output bus to the first hardware output.

- 3 Click additional grid squares in the same row to assign the same Output bus to additional hardware outputs. The selected bus is assigned to all the assigned hardware outputs. An asterisk (*) appears at the end of the displayed destination to indicate the multiple routing.

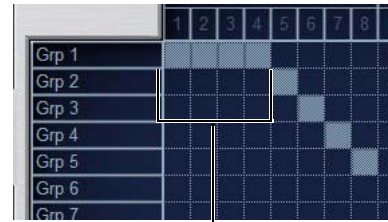

Multiple output assignments

An Output bus assigned to multiple hardware outputs

Warning when Stealing Inputs or Outputs in the Patchbay

The Patchbay indicates hardware outputs that are already in use by dimming the column number for that physical output. In addition, a dialog is shown if the patch will steal a hardware input or output that is already in use, asking you to confirm or cancel the reassignment.

To confirm a reassignment, do one of the following:

- Click Assign when prompted to confirm the reassignment.
- or –
- Click again on the same patch point.

To cancel a reassignment, do either of the following:

- Click Cancel to leave the patchpoint unchanged.
- Click any other point in the grid (the Patchbay grid remains active, even when the Confirm Assignment dialog is open on-screen).

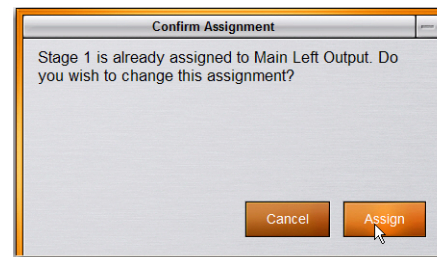

Warning when reassigning an output that is already in use

 To suppress the reassignment warning dialog, hold Default (on the control surface) or Alt (on the computer keyboard) while clicking in the patch grid to change the assignment.

Shortcut for Locating Assignments

Before reassigning in the Patchbay, you may want to double-check the existing assignment to the desired hardware output. This can be done quickly from within the Patchbay, as follows:

To identify the bus or channels currently assigned to a hardware output:

- Click on any dimmed (already assigned) column number at the top of the Patchbay. The Outputs tab containing the assignment is automatically revealed.



Clicking a column number to “go to” its current assignment

VENUE System Information Export

The System Information Export feature lets you generate an HTML (text) document that details the console’s hardware, software and currently loaded Show file configurations. This document can be read by any Internet browser, such as Internet Explorer, Mozilla Firefox or Safari.

 *The patch list can also be exported separately (for more information, see “Patch List Export” on page 105).*

The System Information document can be sent directly to production or rental companies to describe your exact console needs; alternately, the information can be re-formatted as desired by copying and pasting the data into a word processing or spreadsheet application.

To export VENUE System Information:

- 1 Insert a USB key disk into any available USB port on the console.
- 2 Go to the Options > System page.
- 3 Click the Info button.



Export VENUE System Information button in Options > System

- 4 Do any of the following:
 - If you have more than one USB key disk connected, make sure the correct USB key disk is selected. If it is not, click Next Disk to cycle through each available disk until the correct one is selected.
 - Click Save to proceed and export system info to the selected USB disk.
 - Click Cancel to dismiss the dialog without exporting.
- 5 Click OK to confirm the export procedure.

You can now remove the USB key disk —from there, you can transfer the exported file to a personal computer for printing, formatting, archiving or distribution.

Standalone Software

When exporting System Info from the Standalone software, the exported System Information file is displayed immediately using the default browser installed on your computer.

VENUE System Information Contents

Exported VENUE System Information is saved as an HTML file, and the file name includes the date and time of the export. Contents include the following (not all data will be generated from the Standalone software):

Digidesign VENUE

System Information Lists the date and time the Info file was generated.

Console Lists the current hardware configuration and installed options for the VENUE SC48, including ECx and FWx cards.

Stage Configuration Lists card slot contents for each detected Stage slot.

Installed Plug-ins Lists version and other information (as reported by each plug-in) for all currently installed plug-ins. The list groups plug-ins by whether they are Enabled or Disabled. Enabled and In Use plug-ins appear at the top, followed by any remaining enabled (but not In Use) plug-ins. Plug-in information is not available when exporting from the Standalone software.

Show File Information Lists the name, file path, date and time of the most recently loaded Show file.

System Configuration Lists information found on the Options > System tab.

DSP Usage Lists the processes assigned to each DSP of each Mix Engine card. Information is sub-divided by Mix Engine as displayed on the Options > Devices tab.

Patch List Lists the contents of each Patchbay page. A complete patch list is included in the System Information Export, or a detailed patch list can be exported separately from the Patchbay (see next).

Patch List Export

The Patchbay export generates a patch list in an easily readable format.

To export Patchbay information:

- 1 Insert a USB key disk into any USB port on the console.
- 2 Go to the Patchbay page.
- 3 Click the Export button on the Patchbay page.



Export Patchbay Information icon

- 4 Do any of the following:
 - If you have more than one USB key disk connected, make sure the correct USB one is selected. If it is not, click Next Disk to cycle through each available disk until the correct one is selected.
 - Click Save to proceed and export Patchbay info to the selected USB key disk.
 - Click Cancel to dismiss the dialog without exporting.
- 5 Click OK to confirm the export procedure. You can now remove the USB key disk and transfer the export file to a personal computer for printing, formatting, and distribution.

 *When exporting a Patch List from the Standalone software, the generated HTML file is automatically opened using your default Internet browser (such as Internet Explorer, Mozilla Firefox or other).*

Contents of Exported Patchbay Information

Exported Patchbay information is saved as an HTML file, and the file name includes the date and time of the export.

Contents include the following:

Digidesign VENUE Patch List

Show Name, file path, date and time of most recently loaded Show file.

Input and Output Patching

The patch list is divided into three sections: Stage, FOH, and Pro Tools (FWx).

- Stage inputs show global number 1-48, input name(s), card slot and number.
- Stage outputs show global number 1-16 (or 32 on expanded systems), output name, card slot and number.
- FOH (local) inputs and outputs show the physical input/output name and number, where applicable.
- Pro Tools inputs and outputs show all 18 possible input/output assignments.
- Unavailable channels are labelled N/A.
- Direct outs are identified uniquely.

Chapter 14: Metering

VENUE provides signal metering on the channels, in the metering section, and on-screen.

Channel Meters

Input and FX return channels provide a compressor/limiter gain reduction meter, an input level meter, and indicator LEDs for EQ, stereo, and gate status.

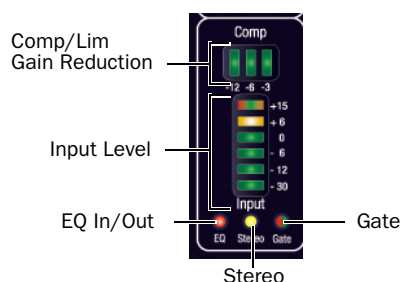

Input channel meters and LEDs

All console channel meters have higher resolution on-screen equivalents that appear in both the targeted channel controls and above the faders in the channel overview.

Meter ballistics and clip margin can be set for channel meters. For more information, see “Metering Options” on page 110.

Input Channels and FX Returns

Input Level Meters

Each Input Channel and FX Return channel strip has a 6-segment Input Level meter that shows input levels from bottom to top, according to the following scale:

LED	Level	Colors
1 (top)	Clip +15 dB	Red Yellow
2	+6 dB	Yellow
3	0 dB	Green
4	-6 dB	Green
5	-12 dB	Green
6 (bottom)	-30 dB	Green

Compressor/Limiter Gain Reduction Meter

The LEDs in the Compressor/Limiter meter show the amount of gain reduction being applied to the input channel by the built-in Compressor/limiter from right to left, according to the following scale:

Channel Compressor/Limiter gain reduction meter scale

LED	Gain Reduction	Color
none	0 dB	Off
1 (right)	≤ 3 dB	Green
2	≤ 6 dB	Green
3 (left)	≤ 12 dB	Green

EQ Status LED

A single red LED indicates EQ In/Out status as shown in the following table.

Color	EQ Status
(none)	Not in circuit
Red	In circuit

Stereo Channel LED

A single yellow LED indicates a stereo input channel. The stereo channel LED flashes if a 12 dB or greater offset is detected between left and right inputs.

Color	Channel Status
(none)	Mono
Yellow	Stereo

Gate Status LED

A single bi-color LED shows the current Expander or Gate status, as shown in the following table.

Color	Expander Status	Gate Status
(none)	Not in circuit	Not in circuit
Green	3 dB gain reduction	Gate Open & Hold
Yellow	21 dB gain reduction	Gate Release
Red	> 21 dB gain reduction	Gate Closed

Bank Clip Indicators

The Clip LED at the top of Input Channel and FX Return channels lights when clipping occurs on a hidden fader bank. The channel position of the Clip indication corresponds to the position of the off-bank channel. The Clip LED flashes to indicate momentary clips, and lights solid for sustained clipping.

To locate the clipped channel:

- Press the Bank switches until the Channel Input Level meters show clipping.

For more information on clip indication, see “Metering Options” on page 110.

ACS Input and Dynamics Meters

Selected Channel Level Meters

The Selected Channel meters in the ACS include two 10-segment level meters:

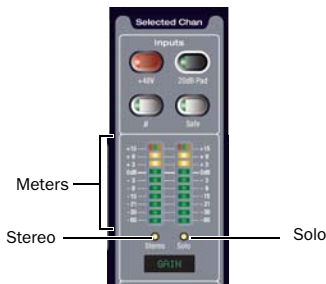

Selected Channel meters and LEDs

These meters show mono or stereo levels on the selected channel. The dual, 10-segment, bi-color LED meters indicate input level for the currently targeted or Solo'ed channel.

Selected Channel Meter Scale

LED	Level	Color
1 (top)	Clip +15 dB	Red Yellow
2	+9 dB	Yellow
3	+3 dB	Yellow
4	0 dB	Green
5	-3 dB	Green
6	-9 dB	Green
7	-15 dB	Green
8	-21 dB	Green
9	-30 dB	Green
10 (bottom)	-60 dB	Green

Selected Channel Gain Reduction Meters

The three dynamics gain reduction meters in the ACS section show gain reduction for the built-in Compressor/Limiter, the built-in Expander/Gate, and any applicable Dynamics plug-in on the selected channel.

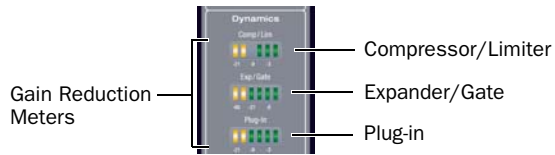

Selected Channel Gain Reduction meters

Compressor/Limiter and Plug-In Gain Reduction Meters

On the ACS Comp/Lim and Plug-In gain reduction meters, the 6 LEDs show dynamics gain reduction from right to left, according to the following scales

ACS gain reduction meter scale for comp/lim/plug-in

LED	Gain Reduction	Color
(none)	0 dB	(none)
1 (right)	1.5 dB	Green
2	3 dB	Green
3	6 dB	Green
4	9 dB	Green
5	15 dB	Yellow
6 (left)	21 dB	Yellow

Expander/Gate Gain Reduction Meter

On the ACS Exp/Gate gain reduction meter, the 6 LEDs show dynamics gain reduction from right to left, according to the following scales

ACS gain reduction meter scale for exp/gate/plug-in

LED	Gain Reduction	Color
(none)	0 dB	(none)
1 (right)	3 dB	Green
2	6 dB	Green
3	12 dB	Green
4	21 dB	Green
5	36 dB	Yellow
6 (left)	60 dB	Yellow

Metering Section

The Metering section includes Bus and Main Outputs meters.

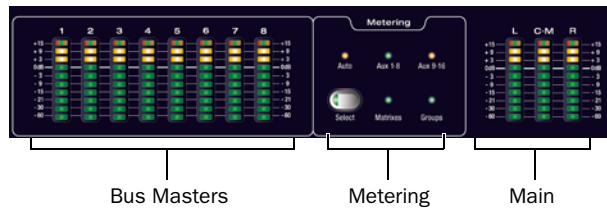

Meters

All of the 10-segment meters in the meter bridge show levels according to the following scale:

Table 15. Meter bridge 10-segment meter scale

LED	Level
1 (top)	+15 dB (red=clip)
2	+9 dB
3	+3 dB
4	0 dB
5	-3 dB
6	-9 dB
7	-15 dB
8	-21 dB
9	-30 dB
10 (bottom)	-60 dB

Bus Output Meters

The eight output level meters in the meter bridge are assignable as a unit for metering of Groups, Auxes, and Matrixes.

The Bus Output meters can automatically follow the current Output fader bank assignment (indicating level for the currently selected Output bus), or be assigned to a bus output for persistent bus level indication.

Stereo Output Metering

With stereo Groups the output level meters in the metering section show level for only the highest of the left and right channels.

To see level for both the left and right channels of a stereo output, refer to the on-screen meters, or target the channel on the ACS and use the Selected Channel Level Meters.

Selecting Output Meter Display

To select an output type for metering:

- Press the Select switch in the metering section to cycle through available choices (Auto, Aux 1–8, Aux 9–16, Matrixes or Groups). The currently assigned bus is indicated by its Meter LED lighting.

To set metering to follow the Output faders:

- Press the Meter Select switch repeatedly so that the Auto LED is lit.



Bus output LEDs and Select switch

Main Output Meters

The three Main output meters in the meter bridge show output levels for the three Main outputs (either in L–C–R or in L–R+M format).

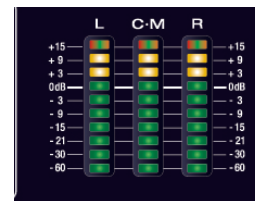

Main output level meters in the meter bridge

The 10 LEDs show input levels from bottom to top, according to the scale shown in Table 15 on page 109.

Metering on the Solo Bus

Metering Soloed Channels

Solo bus metering depends on the type of channel being soloed.

Single Channels

In PFL, AFL, or SIP (solo-in-place) modes, a single soloed channel is metered in the same way as if the channel were targeted on the ACS.

Multiple Channels

In PFL or AFL mode, when multiple channels are soloed, the left and right channels of the Solo bus are metered on the Selected Channel meters, pre-Solo Trim control.

In SIP mode, when multiple channels are soloed, the Left and Right Main bus meters are mirrored on the Selected Channel meters.

Dynamics Key Listen

When Key Listen is activated, the left and right channels of the Solo bus are metered on the Selected Channel meters, pre-Solo Trim control.

Solo Clip Indication

When the Selected Channel meters are showing levels of a single soloed channel, the clipping information in the metering section LEDs mirrors that on the channel itself.

When the Selected Channel meters in the metering section are showing Solo bus levels, the meter LEDs turn red to indicate clipping on the Solo bus.

Metering Options

Meter Display

The following display options can be configured for meters. These options affect all meters on the console.



Metering options in the Interactions tab of the Options page

Meter Ballistics

Meters can be set to operate in the following modes:

RMS Mode (Default) Meters follow the characteristics of a damped analog meter. In this mode, meter response and decay is slower than in Peak mode, providing an average reading of the metered signal. A single LED shows the peak level for the designated Peak Hold Time.

Peak Mode Meters follow the characteristics of a standard peak meter. In this mode, meter response is instantaneous, showing the true peak level of the metered signal.

Peak Hold Time

Peak Hold Time can be set within a range of 0–20 seconds.

To set the Peak Hold Time:

- 1 Go to the Options page and click the Interactions tab.
- 2 Under Meter, enter a value for the Peak Hold Time.
- 3 Press Enter on the keyboard.

Clipping Indication

VENUE meter clip indicators are proximity warnings that show when an input or output signal reaches or exceeds the configured Clip Margin.

Clipping can occur at several points throughout the signal chain. A clip at any one of these points is indicated by lighting the top LED red on the meter. For more information on the location of clip detect points, refer to Chapter 26, “Signal Flow Diagrams.”

Clip Margin

The Clip Margin setting lets you configure the amount of headroom you want before clipping indication begins. Clip Margin is expressed as *dB below maximum* (where maximum is a peak level of +20 dBVU).

Clip Margin can be set within a range of 0 dB to 30 dB below maximum, and is configured separately for inputs and outputs.

To set the Clip Margin:

- 1 Go to the Options page and click the Interaction tab.
- 2 Under Meter, enter values for Input Clip Margin Below Max and Output Clip Margin Below Max.
- 3 Press Enter to confirm the setting.

Clip Hold Time

The Clip Hold Time determines how long a clip indication lasts after the last clipped signal. Clip Hold Time can be set within a range of 0–20 seconds.

To set the Clip Hold Time:

- 1 Go to the Options page and click the Interaction tab.
- 2 Under Meter, enter a value for the Clip Hold Time.
- 3 Press Enter to confirm the setting.

Chapter 15: Solo and Monitor Busses

Solo Bus Modes

Three Solo modes are offered: Pre-Fader Listen (PFL), After-Fader Listen (AFL) and Solo In Place (SIP).

- In AFL or PFL mode, soloing only affects what you hear on the dedicated stereo AFL/PFL Solo bus, which feeds the Monitor Bus.
- In Solo In Place mode, soloing only affects what you hear in the Main busses.

Pre-Fader Listen (PFL)

PFL Solo mode sends the signal from explicitly soloed Input Channels and FX Returns to the AFL/PFL Solo bus. The signal is post-insert, pre-fader and pre-mute.

Mono input signals are sent to both sides of the Solo bus, and the left and right sides of stereo input signals are sent to the corresponding sides of the Solo bus.

PFL is the default Solo mode.

After-Fader Listen (AFL)

AFL Solo mode sends the signal from explicitly soloed channels and solo-safe inputs to the AFL/PFL Solo bus. Soloing of output busses is always AFL.

In AFL Solo mode, both input and output signals are sent to the Solo bus post-fader and post-pan/balance, and are always panned to stereo even if the Main busses are configured in L-C-R mode.

Monitoring Aux busses with AFL

Linked Aux busses use true stereo AFL. When you solo a linked Aux bus, the two busses are heard as a stereo pair on the Solo bus.

Mono Aux busses are heard as dual mono on the Solo bus.

Solo In Place (SIP)

SIP mode applies to Input Channels and FX Returns only. Solo In Place sends the signal from the soloed channel to the Mains and Monitor busses. Signal is sent post-pan/balance.

⚠ *In SIP Solo mode, audio is sent directly to the Main busses. Use this feature with caution.*

Selecting a Solo Mode

The Solo mode can be selected on-screen.

To select the Solo mode on-screen:

- 1 Go to the Options page and click the Busses tab.
- 2 Under Solo and Monitor Operations, click the Type pop-up and choose the desired Solo mode.



Choosing the Solo mode in Options > Busses

Solo States and Modes when Loading Shows

Channel Solo States When you load a Show file, all solos are cleared. Solo states are not saved with Show files.

Solo Mode Show files do not open in SIP mode. If you save a Show file while in SIP, when you reopen the Show file, it will open in AFL Solo mode.

Solo Operation Options

Momentary or Latching Switch Operation

Channel solo switches can operate with either momentary or latching behavior.

To engage momentary solo on a channel:

- Hold the solo switch for more than one second. Release the solo switch to unsolo the channel.

To latch solo on a channel:

- Press and release the solo switch. Press the switch a second time to unsolo the channel.

Auxes Follow AFL and AFL Follows Auxes

You can customize how encoder banking and AFL selection interact using the two settings for Auxes Follow AFL and AFL Follows Auxes.

Auxes Follow AFL

The “Auxes Follow AFL” option is especially useful for monitor mixing, because it provides instant access to any mix by the soloing the mix output.

When this option is selected, soloing an Aux output bus (by pressing its AFL switch) assigns the Aux Send level and pan controls for that bus to be displayed on the input encoders.

- With mono Aux busses, Send level is assigned to the Input encoders. With stereo (linked) Aux busses, Aux Send level is assigned to the encoders.
- When Flip to Faders is pressed, Send level is flipped to the faders and send pan for the Aux (even numbered send) is automatically mapped to the input encoders. The pan button flashes while this mode is enabled.

 *If the encoders were already flipped to the faders, flipped status is maintained when an Aux bus is soloed.*

To set Auxes to display send controls when soloed:

- 1 Go to the Options page and click the Busses tab.
- 2 Under Solo and Monitor Operation, select the Auxes Follow AFL option.



Solo and Monitor Operation settings in the Options > Busses page.

- 3 Solo an Aux output bus by pressing its AFL switch.

To cancel display of Aux send controls:

- Unsolo the Aux bus. The Input Encoders return to their previous display.
 - or –

- Select any other parameter for the Input Channel encoders to override the Aux follows AFL display. The encoders display the selected parameter until another output is soloed.

AFL Follows Auxes

When the AFL Follows Auxes option is selected, assigning encoders to an Aux Send will automatically solo that Aux bus. This speeds up AFL access, specifically for monitor mixing.

The AFL Follows Auxes option is set from the Solo and Monitor Operations section of the Options > Busses page. By default, the option is off (not selected).

The AFL Follows Auxes setting is stored and recalled with each Show file.

To set AFL to follow Aux encoder assignment:

- 1 Go to the Options > Busses tab and select the AFL Follows Auxes option.
- 2 In the Input section, assign encoders to an Aux Send bus.

To cancel (unsolo) in AFL Follows Auxes mode:

- Press the flashing Solo Clear button

 *The Events List can be used to assign the Solo Clear function to a footswitch or any other available trigger.*

Auto Cancel and Input Priority

The Auto Cancel option determines whether Solo switches cancel other soloed channels or are additive (latching). The Input Priority option determines whether soloed inputs replace soloed outputs on the AFL/PFL Solo bus.

Auto Cancel On, Input Priority Off A solo cancels all other solos (inputs and outputs)

Auto Cancel On, Input Priority On An input solo cancels all other soloed inputs; an output solo cancels all other output solos; soloed inputs temporarily replace soloed outputs

Auto Cancel Off, Input Priority Off Solos are additive, and soloed inputs and outputs are heard together

Auto Cancel Off, Input Priority On Solos are additive, and soloed inputs temporarily replace soloed outputs.

Solo Bus Operation

Soloing Channels

Solo operation depends on the type of channel being soloed, and on any selected Solo switch options. In all modes, a channel's Solo switch lights to indicate that the channel is soloed.

Input Channels

Pressing a Solo switch on an Input Channel or FX Return sends signal to the Solo bus (when in PFL or AFL modes) or to the Main bus (when in SIP mode).

In SIP mode only, when a channel is soloed, all other channels that are not soloed or solo safe are implicitly muted. Implicit mutes are indicated by a flashing mute switch.

Output Busses

When the AFL switch in the Output section is pressed, signal is sent to the AFL/PFL Solo bus. This applies to Groups, Auxes, and Matrixes. Outputs are always AFL.

Soloing Single Channels

To solo a single channel, do one of the following:

- Press the channel's Solo switch so it is lit. The solo switch latches on a momentary press.
 - or –
- Hold the channel Solo switch for more than one second for momentary solo. The channel will automatically unsolo when you release the switch.

Soloing Multiple Channels

To solo multiple channels, do one of the following:

- With the Auto Cancel option enabled, press the Solo switches on multiple channels simultaneously.
- Hold Multi-Select (Shift) and press the Solo switches on one or more channels.
 - or –
- With the Auto Cancel option disabled, press Solo switches on multiple channels in any sequence. The Solo switches latch on.

Toggleing the Solo Status of Multiple Channels

To toggle the Solo status of multiple channels, do one of the following:

- With the Auto Cancel option enabled, hold the Multi Select switch while pressing the Solo switches on channels you want to toggle.
 - or –
- With the Auto Cancel option disabled, press Solo switches in any sequence. The Solo switches latch on and off.

Soloing VCAs

When you solo a VCA, its member channels are soloed. If the VCA members include a combination of input and output channels, their solo status follows any Solo switch options. See "Solo Operation Options" on page 112.

To solo the members of a VCA:

- Press the Solo switch on the VCA channels whose members you want to solo so that the Solo switch is lit.

Clearing Solos

Press the flashing Solo Clear switch in the Monitoring section to clear all soloed channels.



Solo Clear

Solo Bus Metering

When a channel or dynamics key input is sent to the Solo bus, its signal is metered on the Selected Channel meters, temporarily replacing the metering for any currently targeted channel.

For more information, see "Metering on the Solo Bus" on page 109.

Solo Safing Channels

Solo Safe is a state which prevents a channel from being implicitly muted when any other channel is soloed. Only input and FX return channels can be made solo safe. Solo safed channels are automatically added to any explicitly soloed channels.

Solo Safe only applies to SIP and AFL modes. Solo safe status is ignored in PFL mode.

To toggle the solo safe status of Input Channels and FX Returns, the Safe switches must be set to control the Solo Safe function.

To set Safe switches to control the Solo Safe function:

- 1 Go to the Options page and click the Interaction tab.
- 2 Under Input Safe Switches, select Act as Solo Safes.

To toggle the solo safe status of a channel, do one of the following:

- Select one or more channels, then press the Safe switch in the Selected Channel Input section.
 - or –
- Click the on-screen Solo Safe button for the channel.



On-screen Solo Safe button

The Safe switch and button flash to indicate the channel is solo safe. When a channel is soloed because of its Solo Safe status, its Solo switch flashes.

Monitor Bus Operation

The Monitor bus outputs signal to the headphone output on the top of the console (in the Monitoring section). The Monitor bus outputs can also be routed to hardware outputs and to bus-fed plug-ins.

Monitor Bus Switching

The following signals can feed the Monitor bus, listed below in order of priority: Key Listen, Solo bus, and the Mains mix.

Dynamics Key Listen

Pressing a Key Listen button on-screen sends the key signal from the targeted channel's built-in dynamics processor to the Monitor bus.

Key Listen temporarily overrides the currently enabled Solo bus operation (PFL or AFL), and replaces any other signal on the Monitor bus with the mono key signal.

AFL/PFL Solo Bus

In AFL or PFL mode, signal from any soloed channels is sent to the Monitor bus. When any channel is soloed, the Solo bus overrides the 2-Track return if it is enabled, or the Main mix if it is currently being sent to the monitors.

Mix to Monitors

The Mains mix (the signal present on the Mains busses) can be sent to the Monitor bus.

Assignable Monitor Output

The Monitor bus can be routed to hardware outputs and to bus-fed plug-ins.

Hardware Outputs For routing to hardware outputs, the Monitor (Solo) bus outputs are available in the Mains tab of the Patchbay Outputs page. Monitor bus outputs are assignable to any number of physical outputs on the system. Use this capability to route monitor outputs to multiple cue stations (in-ear mix and wedge mix), or to an outboard analyzer.

Bus-Fed Plug-Ins For routing to bus-fed plug-ins, the Monitor bus appears as a choice in the plug-in routing selector. This lets you route the Monitor bus to a bus-fed stereo plug-in such as an onboard analyzer. Plug-ins can not be inserted on the Monitor bus.

Routing the Monitor Bus to Additional Outputs

To route the Monitor bus to additional outputs:

- 1 In the Patchbay, go to the Outputs page and click the Mains tab.
- 2 Click in the grid to assign the Monitor output to the desired destination.

 *Solo In Place, when engaged, is simultaneously routed to the Mains and Monitor busses.*

Routing the Monitor Bus to Plug-Ins

To route Monitor output to a bus-fed plug-in:

- 1 Go to the Plug-Ins page.
- 2 Make sure the desired stereo plug-in is installed and assigned to a rack slot.
- 3 Click the Plug-In Input selector at the top of the corresponding rack slot, and choose Bus Outs > Mains > Monitor - stereo.

 *Plug-in outputs can't be returned to input channels, in order to prevent feedback loops.*



Assigning monitor output to a bus-fed plug-in

Sending the Main Mix to the Monitor Bus

Monitor Output from an L-C-R Main Mix

The stereo Mix to Monitors signal is derived from the L-C-R Main mix by adding a -3 dB signal from the Center channel to the Left and Right monitor channels.

Monitor Output from an L-R+M Main Mix

In a L-R+M Main mix, only the Left and Right channels are heard in the Solo bus.

To send the Main mix to the monitors:

- 1 Do one of the following:
 - Press the Mix to Monitors switch in the Mains section.
 - or –
 - Go to the Options > Busses tab and select the Mix to Monitors option.
- 2 Turn the Monitor Speakers knob or the Headphones knob to adjust the corresponding output level.

Adjusting Solo Bus Level

PFL Solo bus monitoring levels can be controlled by the on-screen Level Trim control. The trim amount is adjustable over a range of -20 dB to +20 dB.

Because Level Trim only affects PFL signals, you can easily balance AFL signals or Mix to Monitors with PFL signals, with a minimum of Monitoring level adjustment during a show.

To trim the Solo bus level:

- 1 Solo a channel.
- 2 Go to the Options > Busses tab and adjust the Level Trim setting in the Solo and Monitor Operations section.

The following diagrams show the signal flow for PFL and AFL modes.

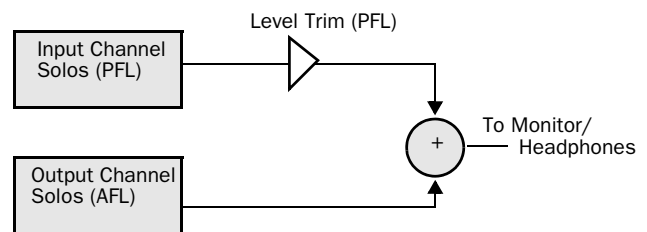

Level Trim in PFL mode

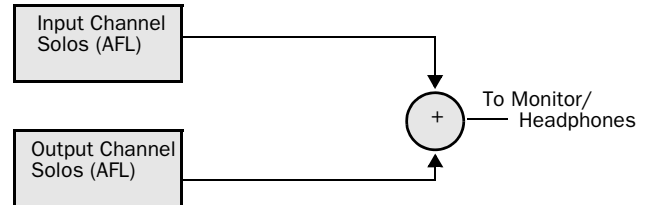

No Level Trim in AFL mode

Adjusting Headphone Level

Output levels for the headphones are controlled by the corresponding volume knob in the Monitoring section.



Monitoring controls

Adjusting Monitor Level and Delay

To adjust the Solo/Monitor level:

- 1 Go to the Options > Busses tab.
- 2 In the Solo and Monitor Operations section, adjust the Monitoring encoder.

You can apply an adjustable delay to the monitor outputs and headphone outputs to match the acoustic delay from the main speaker system.

To adjust monitor output delay:

- 1 Go to the Options > Busses tab.
- 2 Adjust the Delay setting in the Solo and Monitor Operations section. Be sure to click the In button beneath the on-screen encoder to enable Delay. When lit, the Delay setting is applied to the monitor output.

Talkback, 2-Track and Oscillator Controls

You can assign Talkback microphone input, 2-Track source inputs, and the built-in Oscillator to any Input Channel or FX Return. Talkback, 2-Track, and built-in Oscillator output can be routed to any output busses.

Using Talkback

The Talkback input on the back panel of the SC48 console accepts signal from any dynamic or condenser microphone.

Assigning Talkback Microphone Input

To assign input to an Input Channel or FX Return:

- 1 Go to the Patchbay > Inputs tab, then click the Channels tab or the FX Returns tab.
- 2 At the top of the channel grid, click the FOH tab.
- 3 Click in the channel grid to assign the “Talk” input source to an Input Channel or FX Return (listed on the left).



Assigning Talkback input to an Input Channel in the Patchbay

Routing Directly to an Output

To route the Oscillator, 2-Track, or Talkback directly to an output:

- 1 Go to the Options > Misc page and click the Route button in the Talkback sections.



Talkback controls in the Options > Misc page

- 2 Go to the Outputs page and click to select the desired output (it flashes briefly).
- 3 In the confirmation dialog that appears, click Route to confirm your assignment or click Cancel to cancel without changing the current routing.

A Signals are routed to output busses post-mute and post fader.

Activating Talkback Input and Setting Level

To activate and set the level for Talkback input:

- 1 Go to the Options > Misc page.
- 2 Click the on-screen In button in the Talkback section.
- 3 On the back panel, turn the Talkback Mic Gain knob.
- 4 Set the Talkback input level by adjusting the on-screen Level knob in the Talkback section.

💡 You can designate a footswitch, Function switch or other triggers to control Talkback. For more information, see Chapter 22, “Events.”

Setting Talkback Dim Level

When Talkback is sent directly to an Output bus, the bus program material (minus the talkback signal) is automatically reduced by the amount specified in the Dim Level setting.

To set the Talkback Dim Level:

- 1 Go to the Options page and click the Misc tab.
- 2 In the Talkback section, double-click the Dim Level text box and enter a Dim Level value in the range –60 dB (maximum gain reduction) to 0 dB (no gain reduction).

Activating Phantom Power for Talkback Input

The Talkback input on the back panel has available +15V phantom power for using a condenser microphone.

To apply phantom power to the talkback mic input:

- On the back panel, move the Talkback Mic Phantom Power switch to the right.

Using 2-Track Inputs and Outputs

Analog and Digital 2-Track Inputs and Outputs are available on the back panel of the console.

Assigning 2-Track Source Input

To assign the 2-Track inputs to Input Channels or FX Returns:

- 1 Go to the Patchbay > Inputs tab and click the Channels tab or the FX Returns tab.
- 2 At the top of the channel grid, click the FOH tab.
- 3 Click in the channel grid to assign any of the following 2-Track input sources (listed at the top right of the grid) to an Input Channel or FX Return (listed on the left):
 - AL (Analog Left)
 - AR (Analog Right)
 - DL (Digital Left)
 - DR (Digital Right)

Activating 2-Track Input and Setting Level

To feed 2-Track input to the Monitor and Mains busses:

- 1 Go to the Options > Misc screen.
- 2 In the 2-Track section, click the Input Fed to Monitors and Masters pop-up and select Analog 2-Track or Digital 2-Track.

To activate 2-Track input and set level:

- 1 Click the on-screen In button in the 2-Track section of the Options > Misc page.
- 2 Drag the on-screen Level knob in the 2-Track section of the Options > Misc page.



2-Track controls in the Options > Misc page

Routing 2-Track to an Output Bus

To route the 2-Track inputs directly to an output bus:

- 1 Go to the Options > Misc tab.
- 2 Click the Route button in the 2-Track section on-screen. The switch flashes to indicate Route to Selected mode.
- 3 Press the Select switch on each of the output channels (Auxes, Groups, Matrixes, or Mains) where you want to route 2-Track signal. The Select switches flash to indicate 2-Track assignment.
- 4 Click Done in the Route to Selected dialog to confirm the assignment.

 Signals are routed to output busses post-mute and post fader.

Routing to the 2-Track Outputs

You can route any output bus or Direct Output to the 2-Track outputs.

To route any output bus to the 2-Track outputs:

- 1 Go to the Patchbay and click the Outputs tab.
- 2 To the left of the channel grid, click the tab for an Output bus (Auxes, Groups, PQs, Matrixes, or Mains).
- 3 At the top of the channel grid, click the FOH tab.
- 4 Click in the channel grid to assign an Output bus (listed on the left) to any of the following 2-Track output sources (listed at the top right of the grid):
 - AL (Analog Left)
 - AR (Analog Right)
 - DL (Digital Left)
 - DR (Digital Right)

To route a Direct Output to the 2-Track outputs:

- 1 Go to the Patchbay and click the Directs tab.
- 2 To the left of the channel grid, click the tab for a channel source (Channels, FX Returns, or Outputs).
- 3 At the top of the channel grid, click the FOH tab.
- 4 Click in the channel grid to assign a channel source (listed on the left) to any of the following 2-Track output sources (listed at the top right of the grid):
 - AL (Analog Left)
 - AR (Analog Right)
 - DL (Digital Left)
 - DR (Digital Right)

Routing the Oscillator

The output of the internal oscillator can be routed to Input Channels, FX Returns, or any of the output busses. The Oscillator provides selectable signal type, frequency (for Variable Sine) and signal level, as well as a master on/off switch.

Configuring the Oscillator and Setting Level

To activate and set the level for the oscillator:

- 1 Go to the Options > Misc page.
- 2 As a precaution, click and drag the on-screen Level encoder down to set the Oscillator level to off before you go any further.



Oscillator controls in the Options > Misc page

- 3 In the Oscillator section, click the Signal pop-up and select from the following signal types:
 - 100 Hz Sine
 - 1 kHz Sine
 - 10 kHz Sine
 - Variable Sine
 - Pink Noise
 - White Noise
- 4 If you select Variable Sine, you can set the sine wave frequency with the on-screen frequency control (directly to the right of the Signal pop-up).
- 5 Click the on-screen In button in the Oscillator section.
- 6 Set oscillator level by slowly raising the on-screen Level encoder.

To assign the Oscillator signal to an output bus:

- 1 In the Options > Misc page, click the Route button in the Oscillator section.
- 2 Do either of the following:
 - If you had already selected the desired output, click to confirm the currently displayed Route To mode (in the lower left corner of the screen).
 - or –
 - Go to the Outputs page and click to select an output (it flashes briefly).
- 3 In the confirmation dialog that appears, click Route to confirm your assignment or click Cancel to cancel without changing the current routing.

⚠ Signals are routed to output busses post-mute and post fader.

Talkback, 2-Track and Oscillator States When Loading Shows

When you load a Show file, Talkback, 2-Track and Oscillator controls are set to off (deactivated), regardless of their state when the Show was last saved.

Chapter 16: Muting and Mute Groups

Muting

Channels can be muted in three ways: explicitly (lit solid), with the channel mute switch; implicitly (flashing), as a result of another channel being soloed, and as a member of a Mute Group or VCA (flashing).

Mute switches always behave in additive (latched) fashion. Channels can be muted in any sequence, and they will remain muted until they are unmuted.

The following provide some additional information about channels, busses, and muting:

Input Channels and FX Returns Channel mute is pre-fader on Input Channels and FX Returns.

Output Busses Mute operation is post-fader on all types of Output busses.

Mains The mute status of the Main busses is controlled from the Mute switch above the Mains Fader.

Only the linked Mains busses are muted. The Mains Mute switch flashes to indicate not all Mains are muted. For information on linking Mains, see “Linking Mains” on page 77.

VCAs When you mute a VCA, its member channels are muted. The member channel Mute switches flash to indicate they are muted as part of a VCA.

Flashing Mute Indication

A flashing Mute switch indicates the channel is implicitly muted as a result of a Solo or Mute Group activation.

Solo In Solo In Place mode, when a channel or VCA is soloed, all other channels that are not soloed or solo safe are implicitly muted.

Mute Group Members of a mute group are implicitly muted and flash when the mute group is active.

Mute Groups

Channels can be assigned to any of the 8 available Mute Groups. Mute Groups let you mute and unmute multiple channels simultaneously by pressing a single switch.

Any type of channel, including all Input Channels and all Output channels, except VCAs, can be assigned to Mute Groups.

Mute Groups only affect the status of channel Mute switches, and do not affect the on/off status of Aux Sends, output of the Talkback/Oscillator section, or the routing of signals to the monitor outputs.

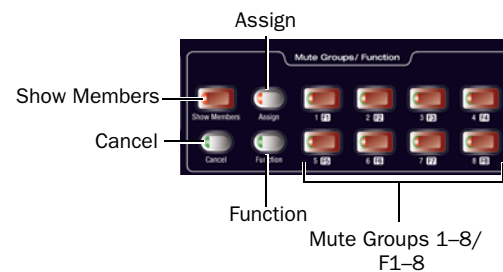

Mute Groups section

Assigning Mute Groups

Mute Groups can be defined from the console or on-screen. Any mixture of channel types can be assigned to a Mute Group. Channels can be assigned to more than one Mute Group.

To assign or remove channels from a Mute Group:

- 1 Make sure the Mute Groups/Function section is in Mute Groups mode. If the Function switch is lit, press it so that it turns off (indicating Mute Groups mode).
- 2 Press the Assign switch in the Mute Groups section. The Assign switch flashes to indicate Assign mode.
- 3 Press the Mute Group switch (1–8) for the group where you want to assign or remove a channel. This switch flashes to indicate the group is targeted for assignment.
- 4 Press the Select switch for each channel you want to assign or remove from the Mute Group. The Select switches on the selected channels flash.

5 Do one of the following:

- To confirm the Mute Group definition, press the flashing Assign switch or the flashing Mute Group switch (1–8).
- or –
- To cancel the Mute Group definition, press the Cancel switch in the Function section.

To assign or remove members of a Mute Group on-screen:

- 1 Go to the Inputs or Outputs page.
- 2 Click the Assign button in the Mute Groups section (to the right of the on-screen faders). The Assign button flashes to indicate Assign mode.



Mute Group Assign mode

- 3 Below the flashing Assign button, one of the Mute Group buttons 1–8 flashes to show which Mute Group is selected for assignment. If desired, click to select a different Mute Group.
- 4 Click to select the channels you want assigned to the selected Mute Group (click their fader strips to select individual channels; click their on-screen bank numbers to select multiple channels at once).
- 5 Do one of the following:
 - To confirm the Mute Group definition, click the flashing Assign button or the flashing Mute Group switch (1–8).
 - Click the on-screen banner display to show the confirmation dialog, then click Assign.
- or –
- To cancel the Mute Group definition, click the on-screen banner display and click Cancel.

Viewing Members of Mute Groups

You can view Mute Group members in Input Channels and FX Returns

To view the members of Mute Groups in the Inputs section:

- Press the Show Members switch in the Mute Groups section.

Mute Group assignments (1–8) are shown in the channel LCDs to indicate membership in the corresponding Mute Group.

Using Mute Groups

Mute Groups are activated from the Mute Groups section on the console or from the Mute Group controls on-screen in the Inputs and Outputs pages.

To activate a Mute Group:

- 1 Make sure the Mute Groups / Function section is in Mute Groups mode. If the Function switch is lit, press it so that it turns off (indicating Mute Groups mode).
- 2 Press a Mute Groups switch 1–8 to mute the members of the corresponding group. The Mute switches of the Mute Group members flash to indicate they are implicitly muted.

To activate multiple Mute Groups:

- Press any number of Mute Group switches 1–8 in any sequence. Mute Groups function in an additive fashion.

To deactivate a Mute Group:

- Press a lit Mute Group switch.

Explicit and Implicit Channel Mute with Mute Groups and VCAs

This section describes the behavior of channel Mute switches when used with Mute Groups and VCAs. Solo/PFL implicit mute behavior is unchanged.

Mute Groups, VCAs and Explicit Mutes

Channels can be muted in three ways:

Explicitly Using the channel Mute switch.

Implicitly As a member of a Mute Group or VCA.

– and –

Implicitly As a result of another channel being soloed.

Using Channel Mute Switches

Any input or output channel implicitly muted by a Mute Group or VCA can be explicitly *un*-muted, explicitly muted, and reset to its implicit mute state by repeatedly pressing a channel Mute switch. Explicitly unmuteing or muting a channel in this way does not permanently remove that channel from the Mute Group or VCA.

This feature is useful to temporarily unmute a channel during a line check without having to release the entire Mute Group or VCA.

To cycle through the available Mute modes:

- 1 Activate a Mute Group, or mute a VCA. The Mute switches on all implicitly muted channels flash.
- 2 Press a flashing Mute switch to explicitly unmute the channel. Its Mute switch is now unlit.
- 3 Press the same (now unlit) Mute switch again to explicitly mute the channel. Its Mute switch is now lit solid.
- 4 Press the same Mute switch again to implicitly mute the channel and return it to being controlled by the active Mute Group or VCA. Its Mute switch resumes flashing.

 *Select multiple channels first to be able to toggle all their states at once. The Mute behavior may vary if some, but not all, of the selected channels are members of a Mute Group or VCA.*

Disabling Mute Groups

You can temporarily disable all Mute Group functions. When Mute Groups are disabled, all channels implicitly muted as a result of Mute Group activation are unmuted.

Channels can still be explicitly muted when Mute Groups are disabled. Mute Group assignments are preserved and made available again when Mute Groups are re-enabled.

To disable Mute Groups:

- 1 Go to the Inputs or Outputs pages.
- 2 Click the Disable button on-screen in the Mute Groups section. The Disable switch flashes to indicated disabled state.

To re-enable Mute Groups:

- Click the flashing Disable button in the Mute Groups section.

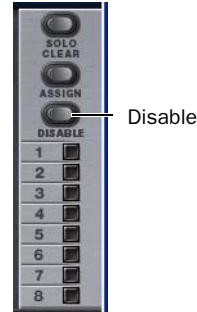

Mute Group controls on-screen

Function Switches

VENUE SC48 provides 8 Function switches (F keys).

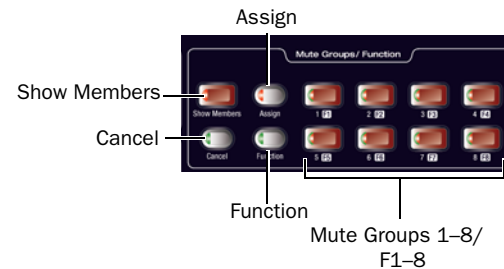

Function switches in the Mute Groups section

The function and behavior of each Function switch can be customized in the Event List. By default, Function switches 1–4 are mapped to Preview mode, channel copy and channel paste, respectively.

For more information, see Chapter 22, “Events.”

To access the Function switches:

- 1 Press the Function switch in the Mute Groups section. When in Function mode, the Function switch LED lights.
- 2 To return to Mute Groups mode, press the Function switch again.

Part IV: Processing

Chapter 17: Dynamics

VENUE SC48 provides the following dynamics features:

- A built-in Compressor/Limiter and Expander/Gate is available on each Input Channel.
- Dynamics plug-ins can be used on input and output channels.
- All built-in and most plug-in dynamic processors support side-chain keying with key filtering.

Built-In Dynamics

Each Input Channel provides a built-in Compressor/Limiter, and an Expander/Gate. Built-in dynamics are not limited by DSP resources, and can be configured as pre- or post the built-in EQ per channel. All built-in dynamics parameters are adjusted using the Channel Control encoders or on-screen.

Plug-Ins

Dynamics plug-ins can be used on input and output channels. When assigned in the plug-in racks, Dynamics plug-ins can be inserted on individual mono or stereo channels or fed by buses. Dynamics plug-ins can be adjusted using the Channel Control encoders, from the Output encoders (in Insert Mode), or from the on-screen Plug-Ins page. In addition, plug-in presets can be stored and loaded.

 Channel Control provides a unified set of controls for both built-in and plug-in dynamics processing.

Built-In Compressor/Limiter

One built-in Compressor/Limiter is available on each Input Channel. The Compressor/Limiter defaults to compression, or can be switched to a limiter by setting the Ratio to its maximum setting. Mono and stereo processing are supported.

To access compressor/limiter parameters:

- 1 Select one or more channels. (Built-in dynamics processing is available on Input Channels only).
- 2 Press the Comp/Lim switch in the Channel Control section of the ACS. The Comp/Lim switch LED lights blue when engaged, and Comp/Lim parameters appear in Channel Control.

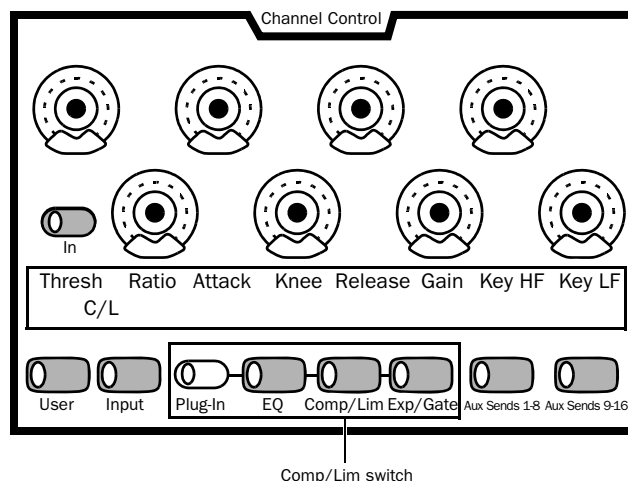

Compressor/limiter parameters in Channel Control

To adjust comp/lim parameters in Channel Control:

- Do the following:
 - Adjust an encoder (1-8) corresponding to the desired parameter (Threshold, Ratio, Attack, Knee, Release, Gain, Key HF and Key LF).
 - Press encoder 7 or 8 to engage/disengage Key HF or Key LF, respectively.

To bypass the current dynamics processor:

- Press the Channel Control In switch to toggle the process in/out.

The following section describes the available parameters.

Comp/Lim Parameters

All built-in Dynamics parameters can be adjusted using the Channel Control section of the ACS, or on-screen.

Threshold Increases or decreases the threshold level for the built-in Comp/Lim.

Ratio Increases or decreases the ratio for the built-in Comp/Lim. The most extreme clockwise setting (100:1) switches the process into Limiting mode.

Attack Increases or decreases the attack time for the built-in Comp/Lim.

Comp Knee Increases or decreases the knee width for the built-in Comp/Lim. A knee value of 0 provides a hard knee setting; 100 provides a soft knee.

Release Increases or decreases the release time for the built-in Comp/Lim.

Make-Up Gain Increases or decreases the make-up gain applied by the built-in Comp/Lim.

In/Out Takes the built-in Comp/Lim in or out of circuit (bypass). The Comp/Lim can be taken in or out of circuit using the Channel Control In switch, or by clicking the Comp/Lim button on-screen.

 Dynamics plug-ins can be taken in/out of circuit using the Channel Control In switch and software screen.

Side-Chain Keying Provides side-chain and key listen. Side-Chain features are available on-screen only. For details, see “Side-Chain Keys and Filters” on page 131.

Comp/Lim Gain Reduction Meters

Three-segment gain reduction meters for built-in Comp/Lim are located in each input channel strip. These provide constant display of gain reduction being applied by the built-in Comp/Lim from right to left, according to the following scale:

Channel Compressor/Limiter gain reduction meter scale

LED	Gain Reduction	Color
none	0 dB	Off
1 (right)	<= 3 dB	Green
2	<= 6 dB	Green
3 (left)	<= 12 dB	Green

Six-segment gain reduction meters are provided in the ACS for higher resolution metering of the currently selected channel or Dynamics plug-ins.

 See Chapter 14, “Metering.”

Comp/Lim Defaults and Ranges

The following table lists the default values and ranges for the built-in Comp/Lim:

Comp/Lim (defaults to Compressor mode)

Parameter	Default	Minimum	Maximum
Threshold	0 dB	-40 dB	+20 dB
Attack	10 ms	100 us	200 ms
Release	100 ms	10 ms	4 sec
Ratio	2:1	1.25:1	100:1
Knee	0 (hard)	0	100
Makeup Gain	0 dB	-40 dB	+20 dB

Built-In Expander/Gate

One built-in Expander/Gate is available on each Input Channel. The Expander/Gate defaults to gate (Ratio of 100:1, the maximum setting). It can be switched to Expander mode by setting the Range to its minimum setting. Mono and stereo processing are supported.

Expander/Gate parameters can be adjusted in the Channel Control section of the ACS or on-screen.

To access expander/gate parameters:

- 1 Select one or more channels. (Built-in dynamics processing is available on Input Channels only).
- 2 Press the Exp/Gate switch in the Channel Control section of the ACS. The Exp/Gate switch LED lights yellow when engaged, and Expander/Gate controls appear in the Channel Control section.

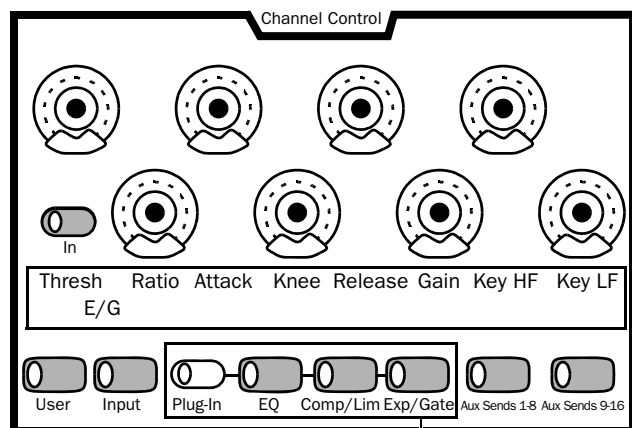

Exp/Gate switch

Expander/gate parameters in Channel Control

To adjust Exp/Gate parameters in Channel Control:

1 Press or rotate an encoder (1-8) corresponding to the desired parameter (Threshold, Ratio, Attack, Knee, Release, Gain, Key HF and Key LF).

2 Press the encoders for Key to engage/disengage Key HF or Key LF.

To bypass the current dynamics processor:

- Press the Channel Control In switch.

Expander/Gate Parameters

The Exp/Gate parameters can be adjusted using the Channel Control encoders (in Exp/Gate mode) or on-screen.

Threshold Increases or decreases the threshold level for the built-in Expander/Gate.

Ratio Increases or decreases the ratio for the built-in Expander/Gate. The most extreme clockwise setting (100:1) puts the process into Gate mode.

Attack Increases or decreases the attack time for the built-in Expander/Gate.

Gate Hold Increases or decreases the time the built-in gate holds.

Release Increases or decreases the release time for the built-in Expander/Gate.

Range Sets the maximum range or depth of attenuation of the gate on that channel.

In/Out Takes the built-in Expander/Gate in or out of circuit (bypass).

Side-Chain Keying The Expander/Gate supports side-chain and key listen. For details, see “Side-Chain Keys and Filters” on page 131.

Exp/Gate Gain Reduction Meters

A single bi-color Gate LED on each input channel indicates Exp/Gate activity, as shown in the following table.

Color	Expander Status	Gate Status
(none)	Not in circuit	Not in circuit
Green	3 dB gain reduction	Gate Open & Hold
Yellow	21 dB gain reduction	Gate Release
Red	> 21 dB gain reduction	Gate Closed

Six-segment gain reduction meters are provided in the ACS for metering of the Exp/Gate on the currently selected channel.

 See Chapter 14, “Metering.”

Expander/Gate Defaults and Ranges

The following table lists the default values for the Expander/Gate:

Exp/Gate Defaults (defaults to Gate mode)

Parameter	Default	Minimum	Maximum
Threshold	0 dB	-60 dB	+20 dB
Attack	1 ms	20 us	500 ms
Release	250 ms	10 ms	4 sec
Ratio	100:1 (Gate mode)	1.25:1	100:1
Gate Hold	100 ms	10 ms	4 sec
Gate Range	-20 dB	-80 dB	0 dB

Adjusting Dynamics

Dynamics controls can be adjusted using the Channel Control section of the ACS, or using on-screen controls.

Adjusting Dynamics in Channel Control

The 8 dual-purpose rotary/switch encoders, function switches, In/Out switch, and two-row LCD in Channel Control provide a unified, consistent set of controls to adjust built-in and plug-in dynamics processors for the currently selected channels.

To access comp/lim parameters:

- 1 Select one or more channels to target them in the ACS Channel Control section.
- 2 Press the Comp/Lim or Exp/Gate function switch in Channel Control.

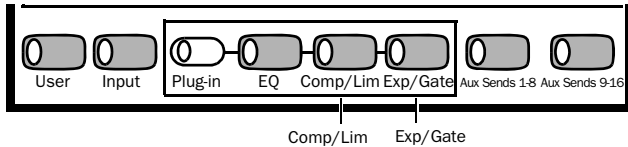

Dynamics switches in Channel Control

To adjust comp/lim parameters:

- Rotate or push an encoder (1-8) corresponding to the displayed parameter. For example, rotate encoder 1 to adjust threshold; press encoder 7 to engage/disengage Key HF.

To bypass the current dynamics processor:

- Press the Channel Control In switch to toggle the process in/out.

The table below shows how compressor/limiter parameters are mapped to Channel Control encoders.

Channel Control parameter mapping for Comp/Lim (built-in or plug-in)

Comp/Lim (blue)	1	2	3	4	5	6	7	8
Rotate	Threshold	Ratio	Attack	Knee	Release	Gain	Key hf	Key lf
Push (Indicator LED)							In (green) Out (off)	In (green) Out (off)

The table below shows how expander/gate parameters are mapped to Channel Control encoders.

Channel Control parameter mapping for Exp/Gate (built-in or plug-in)

Exp/Gate (yellow)	1	2	3	4	5	6	7	8
Rotate	threshold	ratio	attack	hold	release	range	Key HF	Key LF
Push (Indicator LED)							In (green) Out (off)	In (green) Out (off)

Software Screen Dynamics Controls

The software screen lets you adjust built-in or plug-in dynamics on-screen, with simultaneous access to Comp/Lim and Exp/Gate parameters (including their side-chain settings).

The Inputs screen also provides the Dynamics Graph display. The Dynamics Graph displays a composite response of the compressor and gate that you can use to view and edit built-in Dynamics parameters.

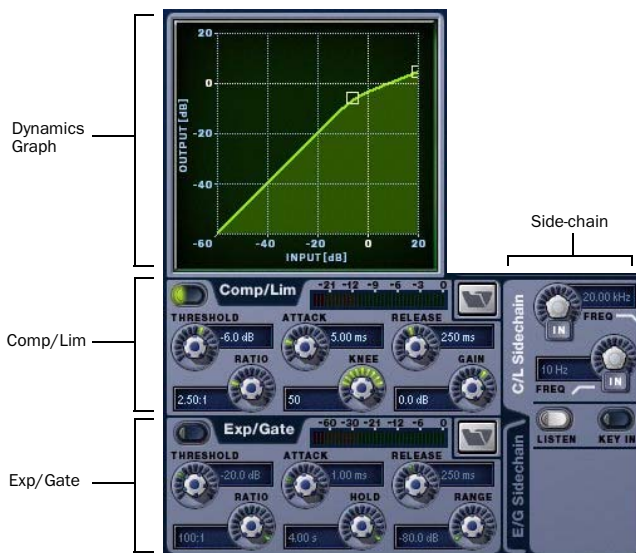

Dynamics controls in the software screen

To adjust Dynamics parameters on-screen:

- 1 Select a channel on-screen.
- 2 Adjust the on-screen controls as needed:
 - For the built-in comp/lim or exp/gate, adjust the parameter on-screen.
 - For plug-ins, click the Insert slot displaying the Dynamics plug-in to go to the Plug-Ins page.

To reset an on-screen Dynamics parameter to its default value, do one of the following:

- Alt-click the control.
 - or –
- Right-click the control and choose Reset.

To reset an entire Dynamics section to its default settings:

- Hold the Default switch and press the In switch in the Channel Control section.
 - or –
- On-screen, right-click anywhere on the Compressor/Limiter or Expander/Gate sections (but not directly on an encoder or button) and choose Reset.

Using the Dynamics Graph Display

In addition to the on-screen encoders and buttons, you can adjust Dynamics parameters using the Dynamics Graph.

To adjust Dynamics parameters on-screen using the Graph display:

- 1 Select a channel on-screen.
- 2 Make sure the Compressor/Limiter or the Expander/Gate is in circuit, and targeted in the Dynamics Graph.

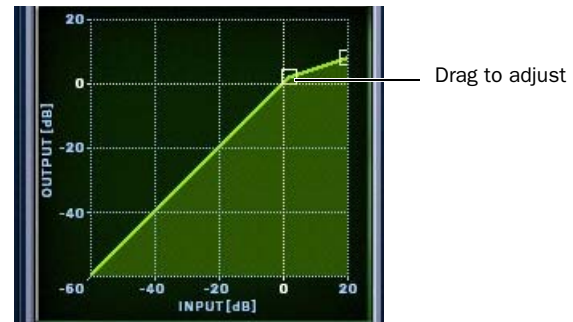

Dragging a handle in the Dynamics graph

💡 If the channel EQ is currently the target of the Dynamics Graph, click anywhere in the on-screen Compressor/Limiter or Expander/Gate sections to change the display.

- 3 Drag handles in the on-screen Dynamics Graph to adjust Threshold and Ratio.

💡 The Dynamics Graph does not support Fine adjust mode using the Fine switch.

Adjusting Dynamics Plug-Ins

Dynamics plug-ins map their threshold, ratio, attack, release, gain, and filter controls to the corresponding encoders in the Channel Control section of the ACS).

💡 All plug-ins, including dynamics plug-ins that do not map directly to Channel Control encoders, can be controlled using the Output encoders in Insert mode.

To adjust a Dynamics plug-in from the console:

- 1 Target the channel with the plug-in by pressing the channel Select switch.
- 2 Press the Comp/Lim or Exp/Gate function switch in the Channel Control section. Comp/Lim lights blue when enabled; Exp/Gate lights yellow.

3 Press the Plug-In switch in the Channel Control section. Plug-in parameters that match Channel Control parameters are mapped to the encoders, and shown in the LCD in ALL CAPS (upper case).

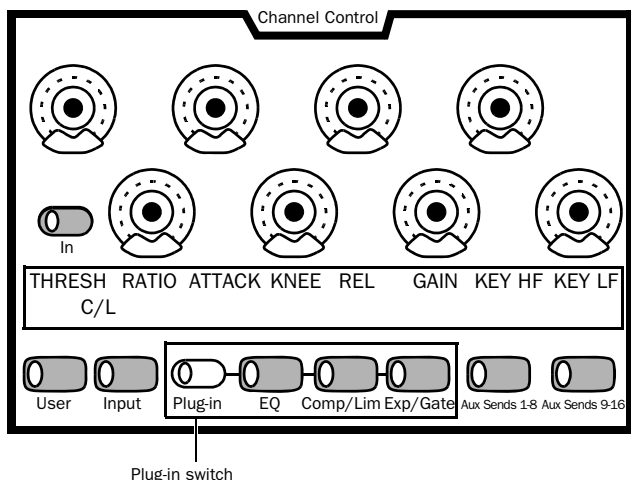

Plug-in switch in Channel Control

4 Adjust plug-in parameters by pressing or turning the corresponding Channel Control encoders.

Channel Modes Affecting Dynamics

Both the Channel Config settings for Input Direct mode and Dyn Pre EQ affect operation of built-in Dynamics.

On VENUE SC48 systems, both of these settings are available on-screen.

Dyn Pre EQ

By default, built-in Dynamics processing occurs before built-in EQ processing in the signal chain of Input Channels. This can be changed on a per-channel basis by toggling the channel's Dyn Pre EQ setting.

To toggle the Dyn Pre EQ setting of an Input Channel:

- 1 Target the Input Channel whose Dyn Pre EQ mode you want to change by pressing its Select switch, and make sure the Inputs page is displayed.
- 2 Click the Dyn Pre EQ button in the (channel) Config section in the upper right corner of the screen. When enabled, the Dyn Pre EQ LED lights.

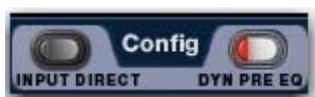

Channel Config controls in the Inputs page

Input Direct Mode

Input Direct mode lets you completely bypass the built-in dynamics and EQ processing, and all inserts on Input Channels and FX Returns.

To toggle Input Direct mode:

- 1 Target the Input Channel by pressing its Select switch, and make sure the Inputs page is displayed.
- 2 Click the Input Direct button in the (channel) Config section in the upper right corner of the screen. When enabled, the Input Direct LED lights.

For more information, see "Adjusting Input Controls" on page 68.

Dynamics Settings and Presets

Built-in Dynamics settings can be copied and pasted between Input Channels. Settings can also be stored and loaded as dynamics Presets to archive and transfer settings.

Copying and Pasting Dynamics Settings

To copy and paste dynamics settings:

- 1 Right-click anywhere in the Comp/Lim or Exp/Gate areas of the on-screen Dynamics section and choose Copy Comp/Lim Settings, or Copy Exp/Gate Settings.



Copying dynamics settings

- 2 Go to the channel where you want to paste the settings.
- 3 Right-click in the Comp/Lim or Exp/Gate areas of the on-screen Dynamics section and choose Paste Comp/Lim Settings or Paste Exp/Gate Settings.

To copy and paste all of a channel's built-in Dynamics settings:

- 1 Right-click in the on-screen Dynamics Graph and choose Copy Dynamics Settings.
- 2 Select the Input Channel where you want to paste the settings.
- 3 Right-click in the on-screen Dynamics Graph of the new channel and choose Paste Dynamics Settings.

Presets for Built-In Dynamics

You can store and load dynamics settings as presets for built-in and plug-in dynamics processors. Presets can be accessed from the control surface or on-screen.

To save or load a preset:

- 1 Adjust dynamics settings on a channel (if saving a preset), or select an Input Channel (to load a preset).
- 2 Click the Comp/Lim or Exp/Gate Presets icon on-screen. (The Presets icons are in the Inputs screen Dynamics section.)



Built-in dynamics Presets buttons

- 3 If necessary, select the appropriate Presets folder by clicking and selecting it from the Folder selector.

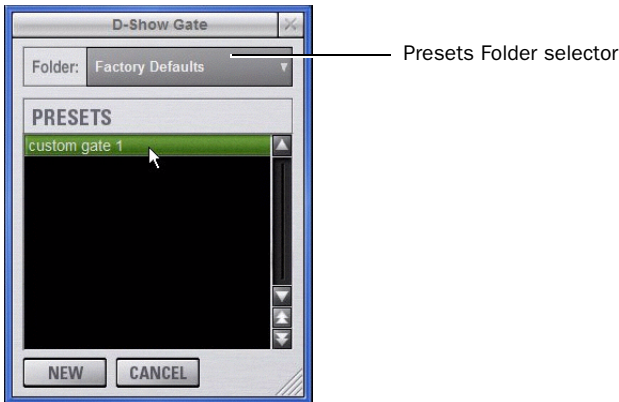

Previewing a preset in the Presets window

4 Do one of the following:

- To preview an existing preset, click its name in the Presets window.
- To load the currently selected preset, press Enter or click the Close box (X) in the Presets window title bar.
- To save the current dynamics settings as a new preset, click New and enter a name for the preset file.
- To cancel without changing settings, click Cancel.

Side-Chain Keys and Filters

The built-in Compressor/Limiter and Expander/Gate support side-chain triggering.

Key In/Out

The Key In switch toggles the key signal in or out of circuit for the built-in Comp/Lim or Exp/Gate.

To toggle the side-chain key signal in or out of circuit, do one of the following:

- Click the Key In button in the side-chain controls of the on-screen Dynamics section.

When the Compressor/Limiter key is in, it uses its own source channel (Self) as the key source signal.

When the Expander/Gate key is in, it can be self-keyed or use any other available channel.

Key Assign

The on-screen Key Assign selectors lets you select the side-chain source for a gate (compressors are always keyed by the channel signal) and its pickoff. The Key Source selector is provided in the Expander/Gate controls.

Key Sources

The Compressor/Limiter is self-keyed. You can use any of the following as the key source for the Expander/Gate:

- Self
- Any Input (Channel or FX Returns)
- Any hardware input
- You can also specify the pickoff source for the key signal for input channels.

To select the key signal for the Gate on-screen:

- 1 Select an Input Channel.
- 2 Click the E/G Side-Chain tab in the Dynamics section to select the gate.

3 Click the Key Source selector and choose an available channel or bus.



Choosing a Key Source

To select a pickoff point for the key source signal:

- Click the Source Pickoff selector and choose a pickoff source for the selected key signal:

Key Listen

The Key Listen button toggles the key onto the Solo bus, replacing the signal there. This happens regardless of whether the key is the channel signal or the external key, or whether it has been side-chain filtered.

Key Listen always overrides all other signals on the Solo bus. If soloed channels are already on the Solo bus, they are suppressed until Key Listen is cleared. If additional channels are soloed while Key Listen is on, they will be added but suppressed.

The Key Listen solo is also exclusive to itself; pressing Key Listen on a different processor or channel turns off the previous Key Listen and the new Key Listen takes over.

⚠ *Key Listen on a Dynamics plug-in does not route the signal to the solo bus, but to the plug-in output. Use caution when using the Key Listen with a plug-in dynamics processor.*

To engage Key Listen:

- Click the Listen button in the on-screen Exp/Gate controls.

To disengage Key Listen:

- Click Listen again. The Solo bus reverts to its previous signal (soloed channels, or none). You can also press Solo Clear once to turn off the any currently engaged Key Listen. Press Solo Clear a second time to clear channel solos, if any.

Side-Chain Filters

Both the Compressor/Limiter and the Expander/Gate side-chains provide two bands of EQ to band-limit the range of frequencies in the key signal.

To activate a side-chain EQ in Channel Control:

- Press the Key HF or Key LF encoder, as desired.

To enable a side-chain filter on-screen:

- Click the side-chain filter In buttons.

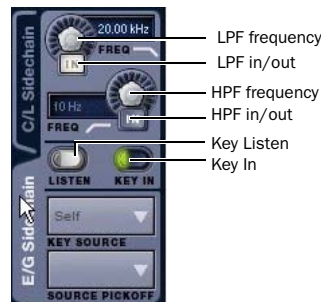

Side-Chain controls in the software screen (Expander/Gate shown)

To adjust a side-chain EQ:

- Turn the HPF or LPF encoder to adjust the frequency (each filter ranges from 10 Hz to 20 kHz). On-screen, the LEDs around the encoder light, and the current frequency value is displayed on-screen.

Dynamics side-chain EQ defaults and ranges

Filter	Default	Minimum	Maximum
HPF	10 Hz, Off	10 Hz	20 kHz
LPF	20 kHz, Off	10 Hz	20 kHz

Side-Chain Limitations

Side-chain Key signals can be routed from the following sources:

- Channel pre/post fader pickoff
- FX Return pre/post-fader pickoff
- Channel Insert return

There are no limits to the number of side-chain Key signals that can be routed from these sources, or from hardware inputs, Input Channel or FX Return top-of-channel pickoffs, or channel insert returns.

⚠ *Side-chain level may vary dramatically depending on where the Key signal is sourced. The top of channel pickoff can be as much as 18 dB louder than other pickoff points and sources.*

Chapter 18: EQ

The following EQ features are available:

- A built-in EQ is available on each input channel and FX return.
- Graphic EQs are available for use on output channels.
- EQ plug-ins can be used on input and output channels.

Built-In EQ

Different types of built-in EQ are available for input channels, FX returns, and outputs.

Input Channels Each input channel provides a high-pass filter plus a built-in four-band parametric EQ. EQ can be set for digital or analog mode. In digital mode only, the four-band EQ provides selectable Bell/Shelf shapes for the Hi and Lo bands. Input channel EQ can be configured as pre- or post-Dynamics on a per-channel basis.

FX Returns Each FX return provides a built-in two-band EQ. FX return EQ can be used in digital or analog mode; in digital mode, the bands can be individually configured for Bell or Shelf modes.

Graphic EQs

Output busses can have a built-in Graphic EQ assigned to them.

EQ Plug-Ins

EQ plug-ins can be used on input and output channels. When assigned in the plug-in racks, EQ plug-ins can be inserted on individual mono or stereo channels or fed by busses. EQ plug-ins can be adjusted using the Channel Control section of the ACS, using the Output encoders (in Insert mode), or from the on-screen Plug-Ins page. In addition, plug-in presets can be saved and loaded.

Built-In EQ Parameters

HPF

Each Input Channel provides a fourth-order high-pass filter (HPF) with adjustable corner frequency and in/out control. The input HPF defaults to 20 Hz, out-of-circuit.

You can adjust HPF frequency and in/out state from the input encoders, from the Channel Control section of the ACS, or on-screen.

Input Parametric EQ

Input Channels and FX Returns provide built-in parametric EQ. The following parameters are available in the built-in EQ, and can be adjusted using the EQ controls in the Channel Control section ACS or on-screen.

EQ In

EQ In toggles the built-in EQ processor (all bands) in or out of circuit on the selected channels. EQ In/Out can be controlled from the ACS or on-screen.

EQ Status LED

The (red) channel EQ In LED indicates EQ in/out status as shown in the following table.

Color	EQ Status
(none)	Not in circuit
Red	In circuit

Analog and Digital EQ Modes

The Analog/Digital button toggles the built-in parametric EQ between digital mode and analog mode, on a per-channel basis. Analog/digital mode switching is available on-screen.

Digital Mode A standard digital parametric EQ. Frequency range of 20 Hz to 20 kHz and gain range of +/-18 dB are available on all four bands. Hi and Lo bands can be Bell (default) or Shelf. Digital Q is expressed in Q factor terms in the range 10 (left, a narrow band) to 0.1 (right, a wide band). Digital Mode is the default EQ mode.

Analog Mode An EQ with a response modeled on that of an analog console renowned for its EQ section. Frequency range is limited to match, and the outer bands provide shelving only. Analog Q is expressed in octaves of *bandwidth* in the range 0.1 (left, a tenth of an octave) to 2 (right, two octaves.)

 *The HPF does not change when the EQ is switched between Digital and Analog mode.*

Gain, Frequency, and Q/Bandwidth

Each band of built-in parametric EQ provides the following parameters, as available on Input Channels or FX Returns:

Gain Boosts or cuts the corresponding band. The LEDs around the Gain encoder light from the center-point to the right (boost), or from the center-point to the left (cut) to illustrate current Gain.

Freq Sets the center or corner frequency for each band, as follows:

- Freq sets the center frequency for the Hi-Mid and Lo-Mid bands, and for the Hi and Lo filters when in Bell mode.
- Freq sets the corner frequency for the Hi and Lo filters when in Shelf mode. (See “Bell and Shelf Modes for Hi and Lo Filters” on page 134.)

Turning the encoder clockwise increases the frequency for that band; turning it counter-clockwise decreases the frequency. A single LED around the encoder illustrates the current encoder setting. The available range of each band depends on the EQ mode (Digital or Analog). See “Control Ranges for Built-In Parametric EQ (All Modes)” on page 141.

Q (Q/Bandwidth) Controls Q (in digital mode) or bandwidth (analog mode).

- ◆ In Digital mode, Q determines Q factor. When the Hi or Lo filters are in Shelf mode, the Q knob determines the Q of the shelf.
- ◆ In Analog mode, this control changes to a bandwidth control which performs essentially the same function.

Band In/Out Each of the available EQ bands can be taken in or out (bypassed) using their encoder (or on-screen).

- ◆ The Gain knob for each band serves as the in/out control by pushing the encoder. The indicator LED lights to indicate band In. (Same for Input encoders and Channel Control encoders when assigned to EQ).
- ◆ On-screen, a dedicated In/Out switch is located just below each Gain knob.

Bell and Shelf Modes for Hi and Lo Filters

In digital EQ mode, the Hi and Lo filters on Input Channels and FX Returns can be toggled between Bell and Shelf modes.

When in Bell mode, the Hi or Lo filters function as a parametric EQ with variable Q. When in Shelf mode, the Hi module is a high-shelf EQ, and the Lo module is a low-shelf EQ. For instructions on configuring these bands for Bell or Shelf mode, see “Adjusting EQ” on page 135.

Channel Modes Affecting EQ

The following features affect operation of built-in EQ.

Dyn Pre EQ

By default, built-in Dynamics processing occurs before built-in EQ processing in the signal chain of Input Channels. This can be changed on a per-channel basis by toggling the channel’s Dyn Pre EQ setting.

To toggle the Dyn Pre EQ setting of an Input Channel:

- 1 Target the Input Channel whose Dyn Pre EQ mode you want to change by pressing its Select switch.
- 2 In the on-screen Channel Config section, click the Dyn Pre EQ switch. When enabled, the Dyn Pre EQ switch LED lights.



Dyn Pre EQ button

Input Direct Mode

Input Direct mode lets you bypass the built-in dynamics and EQ processing, and all inserts on Input Channels and FX Returns. For more information, see “Adjusting Input Controls” on page 68.

Adjusting EQ

You can adjust EQ controls in input channel strips, in the Channel Control section of the ACS, and on-screen.

Adjusting HPF Controls

Each input strip provides HPF frequency control. HPF can be adjusted on each Input Channel using the Encoder HPF assignment switch and row of encoders.

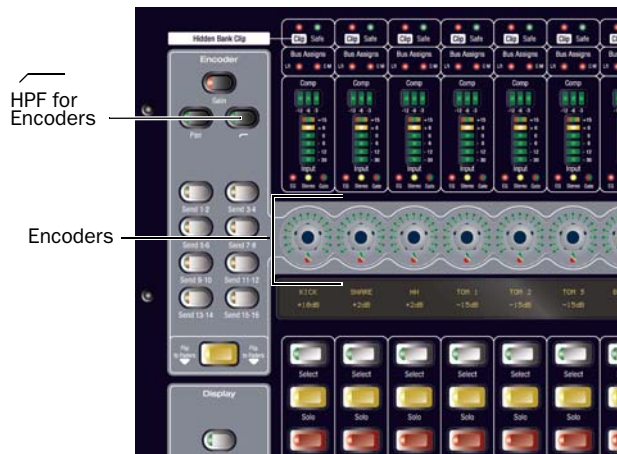

HPF controls for Input Channels

To adjust HPF from an input strip:

- 1 Bank the Input section to the desired channels.
- 2 Press the HPF Encoder Assign switch.
- 3 Rotate the appropriate channel Encoder to adjust HPF frequency. Press the appropriate encoder shaft switch to toggle HPF in or out.

 HPF can also be adjusted in the ACS and on-screen.

To adjust HPF from the ACS:

- 1 Select the channel to target it in the ACS.
- 2 Press the Input function switch in the Channel Control section (this brings a collection of Input parameters to the Channel Control encoders).
- 3 Adjust the encoder labelled HPF:
 - Press the encoder to toggle the HPF in/out.
 - Rotate the encoder to adjust HPF frequency.

Adjusting Channel Parametric EQ Controls

The Channel Control section of the ACS provides a unified, consistent set of controls for both built-in and plug-in EQ processing. Eight dual-purpose rotary/switch encoders control EQ parameters and their settings.

Compatible EQ plug-ins can map their controls to the Channel Control section, and all plug-ins can be controlled using the Output encoders in Insert mode.

To access EQ parameters:

- 1 Select one or more channels to target them in the ACS Channel Control section.
- 2 Press the EQ function switch in Channel Control (it lights green).
- 3 Press the In switch; when lit, the EQ is in circuit.

The LCD display identifies each parameter in the upper row and each band (as available) in the lower row.

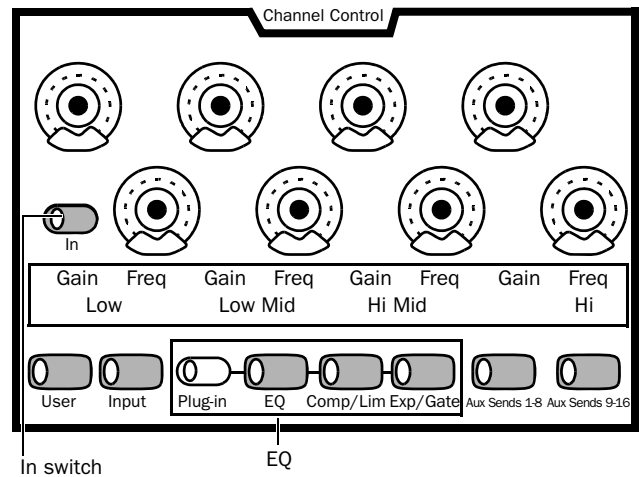

EQ controls in Channel Control (built-in 4-band shown)

EQ Controls in Channel Control

4-Band Parametric EQ (Digital Mode)

The table below shows how built-in EQ parameters (default digital EQ mode) are mapped to Channel Control encoders.

Channel Control parameter mapping for digital EQ (built-in or plug-in)

EQ (digital) (green)	1	2	3	4	5	6	7	8
Rotate	Lo Gain	Lo Freq (or Q)	Lo Mid Gain	Lo Mid Freq (or Q)	Hi Mid Gain	Hi Mid Freq (or Q)	Hi Gain	Hi Freq (or Q)
Push (Indicator LED) (Bell mode)	In (green) Out (off)	Q (red, flash) Freq (red)	In (green) Out (off)	Q (red, flash) Freq (red)	In (green) Out (off)	Q (red, flash) Freq (red)	In (green) Out (off)	Q (red, flash) Freq (red)
Shift+Push Shelf mode		Q (green flash) Freq (off)						Q (green flash) Freq (off)

4-Band Parametric EQ (Analog Mode)

This table shows how parameters are mapped to Channel Control encoders when using built-in EQ in analog mode.

Channel Control parameter mapping for analog EQ (built-in or plug-in)

EQ (analog) (green)	1	2	3	4	5	6	7	8
Rotate	Lo Gain	Lo Freq	Lo Mid Gain	Lo Mid Freq (or BW)	Hi Mid Gain	Hi Mid Freq (or BW)	Hi Gain	Hi Freq
Push (Indicator LED)	In (green) Out (off)	n/a	In/Out	Bandwidth (red, flash) Freq (red)	In/Out	Bandwidth (red, flash) Freq (red)	In/Out	n/a

To engage or disengage a band:

- Press the Gain encoder for that band to toggle it in/out. When engaged, the indicator LED at the bottom of that encoder LED ring lights as shown in the tables.

To bypass the current EQ module:

- Press the Channel Control In switch.

To adjust EQ gain and frequency parameters:

- Adjust the Gain and Freq encoders for each band as needed.

To reset an EQ parameter to its default value:

- Hold the Default switch and press the encoder.

To reset the entire EQ section (all bands) on a channel:

- Hold the Default switch and press the In switch.

Toggle Control Between Q/Balance/Width

Freq and Q (BW) share the same encoder in each EQ band. The built-in EQ and some plug-ins also provide Q (or BW/bandwidth) for Analog EQ mode.

To adjust Q (or B/W):

- Press the <Freq> encoder for the desired band to place that encoder in Q (or B/W) mode.
- Rotate the encoder to set the desired Q (or B/W).

Bell and Shelf Filters

The EQ filter type (Shelf or Bell) can be toggled from the console or on-screen using the mouse.

To toggle between Bell and Shelf filters:

- Hold the Shift switch and press the encoder for Freq.
 - or –
- Click the on-screen Bell/Shelf selector for that channel.

The indicator LED at the bottom of that encoder's ring indicates filter type and Freq/Q mapping as shown in the tables.

EQ Plug-Ins

Whenever a mappable EQ plug-in is present on a selected input channel, pressing the Plug-Ins switch brings the matching parameters of that plug-in to the Channel Control encoders. When mapped to a compatible EQ plug-in, the Channel Control In switch toggles the plug-in in/out (bypass).

Software Screen EQ Controls

You can adjust the built-in EQ using dedicated on-screen buttons for band in/out and bell/shelf toggling. When the Channel Control section is in EQ mode, the on-screen EQ controls for the currently selected channels have a green background.

The software screen also provides the EQ Graph display to adjust frequency and gain simultaneously.

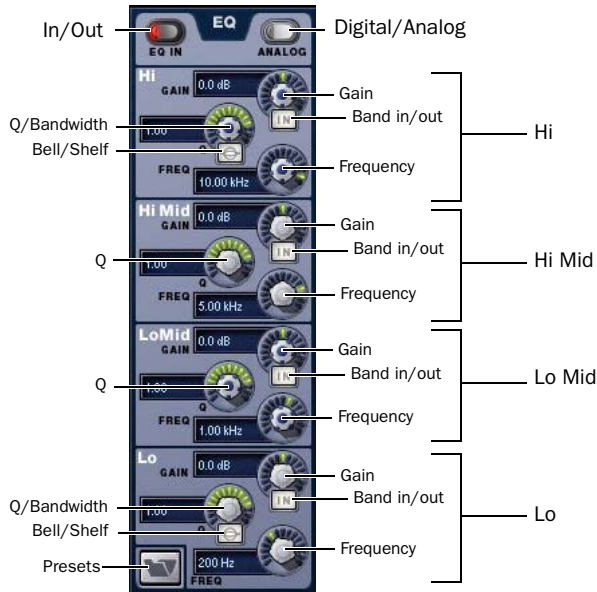

EQ controls in the software screen (4-band Input Channel EQ shown)

To adjust parametric EQ parameters on-screen:

- 1 Select a channel on-screen.
- 2 Click the EQ In switch to put the EQ in circuit.
- 3 Adjust the on-screen controls by doing one of the following:
 - Turn an on-screen knob (Gain, Q/Bandwidth, or Frequency) for each frequency band.
 - Click to toggle any on-screen EQ switch (EQ in/out, band in/out, or bell/shelf).
 - Click a displayed value and type a new value.
 - Drag up or down in a value display to increase or decrease the value.

To reset an on-screen EQ parameter to its default value, do one of the following:

- Alt-click the control (or, hold the console Default(Alt) switch and click the control).
- Right-click the control and choose *Reset*.

To reset the entire EQ section (all bands) on a channel, do one of the following:

- Right-click anywhere in the EQ section on-screen (but not directly on an encoder or button) and choose *Reset EQ Section*.
- Hold Default and click the on-screen EQ In button.

Using the EQ Graph Display

The on-screen EQ graph lets you use the mouse to adjust frequency and gain for any available EQ band.

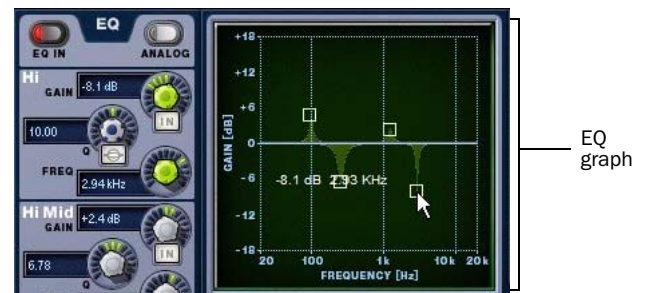

Dragging handles in the EQ graph display

To adjust EQ on-screen using the Graph display:

- 1 Select a channel on-screen.
- 2 Click the EQ In switch to put the EQ in circuit.
- 3 Drag the handles in the on-screen EQ graph display for each EQ band (Lo, Lo-Mid, Hi-Mid, or Hi), as follows:
 - Drag a handle right or left to increase or decrease frequency.
 - Drag a handle up or down to increase or decrease gain.

Graphic EQ for Outputs

A built-in 31-band Graphic EQ can be inserted on any of the following Output bus types: Mains, Groups, Auxes and Matrixes. The Graphic EQ provides +/- 12 dB of gain and constant Q.

Assigning a Graphic EQ to a mono channel uses one available Graphic EQ. Assigning a Graphic EQ to a stereo channel uses two available Graphic EQs.

Graphic EQs can be adjusted on-screen, or using the input faders, which provide access to two banks of 16 frequency bands each.

Configuring Graphic EQs

To configure the number of Graphic EQs:

- 1 Put the system into Config mode.
- 2 Go to the Options page and click the System tab.
- 3 Click the Edit button on-screen.
- 4 Choose the number of Graphic EQs from the pop-up menu. You can choose to have 0, 8, 16, or 24 Graphic EQs.

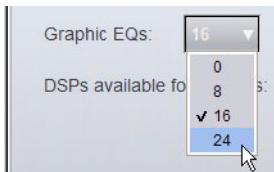

Configuring the number of Graphic EQs

Inserting Graphics EQs on Outputs

To insert a Graphic EQ on an Output bus:

- 1 Target the bus by pressing its Select switch.
- 2 In the Outputs page, click the 31-Band Graphic Equalizer tab.
- 3 Click the Graphic EQ pop-up menu and choose an available mono or stereo Graphic EQ.



Assigning a graphic EQ (mono)

The 31-Band Graphic EQ appears on-screen.

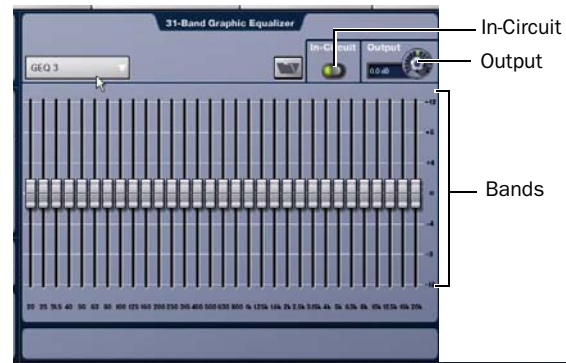

31-band graphic EQ

Graphic EQ Controls

Input faders 1-16 provide control of Graphic EQ frequency bands. You can also adjust graphic EQ parameters on-screen.

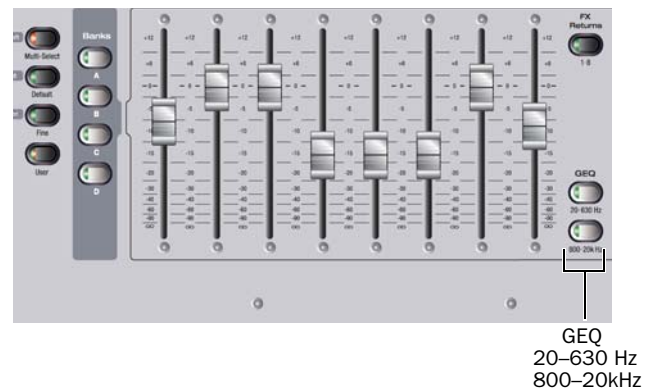

Input fader banking and assignment switches

To enable the graphic EQ:

- 1 Target an Output bus with a Graphic EQ assigned. If no graphic EQ is assigned, display the 31-Band Graphic Equalizer tab in the Outputs page and assign one using the Graphic EQ pop-up menu.
- 2 Click the In button on-screen to toggle in/out status. When enabled, the In/Out switch LED lights.

To set a graphic EQ curve:

- 1 Press the Graphic EQ band switch or click on-screen to select the appropriate bank of graphic EQ bands: (20 to 630 Hz, 800 Hz to 20 kHz). Inputs 1–16 are temporarily replaced with frequency fader controls.
- 2 Adjust one of the 16 faders controlling the selected graphic EQ bands.
- 3 Press another Graphic EQ band switch or click on-screen to select another bank of graphic EQ bands and adjust as needed.

To adjust graphic EQ gain:

- Press the GEQ 800–20kHz switch, then adjust the last encoder above that bank of GEQ faders.

– or –

Use the on-screen Output control.

Resetting Graphic EQ Parameters

To reset a band to its default setting, do one of the following:

- Hold the Default switch and press the Select switch on the fader corresponding to the graphic EQ band.
- Right-click the individual band fader on-screen and choose Reset.
- Alt-click the band on-screen.

To reset the entire graphic EQ to flat:

- Right-click anywhere in the Graphic EQ section on-screen (but not directly on a fader) and choose Reset GEQ Section.

Adjusting EQ Plug-Ins

EQ plug-ins can map their gain, frequency, and Q/bandwidth controls to corresponding encoders in the Channel Control section of the ACS.

When a plug-in provides additional parameters beyond those that map to the dedicated EQ encoders, you can use the Output encoders in Insert Mode and the Previous/Next switches.

 *All plug-ins, including EQ plug-ins that do not map directly to dedicated EQ encoders, can be controlled using the Output encoders in Insert mode.*

To adjust an EQ plug-in from the console:

- 1 Target the channel with the plug-in by pressing the channel Select switch.
- 2 Press the EQ function switch in the Channel Control section of the ACS.
- 3 Press the Plug-In switch, next to the EQ function switch.
- 4 Adjust parameters by pressing or turning the corresponding Channel Control encoders.

 *For more information, see Chapter 19, “Plug-Ins.”*

EQ Settings and Presets

Built-in parametric and Graphic EQ settings can be copied and pasted between channels. EQ presets can also be saved and loaded to archive and transfer settings.

Copying and Pasting EQ Settings

To copy and paste an EQ setting:

- 1 Do one of the following:

- To copy a parametric EQ setting, right-click the on-screen EQ section or EQ graph (not on an encoder) and choose Copy EQ Settings.

– or –

- To copy a Graphic EQ setting, right-click the graphic EQ display (not on a fader) and choose Copy GEQ Settings.



EQ Reset/Copy/Paste pop-up menu

- 2 Go to the channel where you want to paste the settings.

- 3 Do one of the following:

- To paste a parametric EQ setting, right-click in the new channel's EQ section or graph and choose Paste EQ Settings.

– or –

- To paste a Graphic EQ setting, right-click in the new channel's Graphic EQ section and choose Paste GEQ Settings.

Presets for Built-In and Graphic EQ

You can store and load EQ settings to disk as Preset files. Presets can be used with built-in and plug-in EQ processors, including the graphic EQ. Preset files can be moved between systems and used for other Shows. Presets can be accessed from the control surface or on-screen.

💡 *Check the Factory Presets folder for preconfigured settings.*

To save or load a preset:

- 1 Adjust EQ parameters as needed.
- 2 Click the EQ Presets icon on-screen. (The Presets icon is available in the Inputs screen EQ section, and in the graphic EQ screen for an output channel).
- 3 Choose a Presets folder in the Folder display at the top of the Presets window. If necessary, choose the appropriate Presets folder by clicking and selecting it from the Folder pop-up menu.

📄 *For information about creating and transferring folders and files, see Chapter 20, “Shows and File Management.”*



Presets window

Presets icon

EQ Presets window

- 4 Do any of the following:
 - To preview an existing preset, click its name in the Presets window.
 - To load the currently selected preset, press Enter or click the Close box in the Presets window title bar.
 - To load a preset and close the Presets window, double-click the preset.
 - To save the current EQ settings as a new preset, click New and enter a name for the preset file.
 - To cancel without changing settings, click Cancel.

To save or load a preset for the Graphic EQ:

- 1 Go to the Outputs page for the channel on which the graphic EQ is assigned. If necessary, click the 31-Band Graphic Equalizer tab to display the graphic EQ on that channel.
- 2 Click the graphic EQ Presets icon (above the EQ bands, next to the In-Circuit button).
- 3 Choose a Presets folder in the Folder display at the top of the Presets window. If necessary, choose the appropriate Presets folder by clicking and selecting it from the Folder pop-up menu.
- 4 Do any of the following:
 - To preview an existing preset, click its name in the Presets window.
 - To load the currently selected preset, press Enter or click the Close box in the Presets window title bar.
 - To load a preset and close the Presets window, double-click the preset.
 - To save the current graphic EQ settings as a new preset, click New and enter a name for the preset file.
 - To cancel without changing settings, click Cancel.

Control Ranges for Built-In Parametric EQ (All Modes)

Table 19. Control ranges for built-in parametric EQ

Band	Control	Range (Digital)	Defaults (Digital)	Range (Analog)	Defaults (Analog)
High (Bell/Shelf)	Frequency	20 Hz to 20 kHz	10 kHz	2 kHz to 20 kHz	6 kHz
	Gain	±18 dB	0 dB	±15 dB	0 dB
	Q/Bandwidth	10 to 0.1	1.0	Shelf only	none
High-Mid	Frequency	20 Hz to 20 kHz	5 kHz	400 Hz to 8 kHz	2 kHz
	Gain	±18 dB	0 dB	±15 dB	0 dB
	Q/Bandwidth	10 to 0.1	1.0	0.1 to 2.0 octaves	0.2
Low-Mid	Frequency	20 Hz to 20 kHz	1 kHz	100 Hz to 2 kHz	450 Hz
	Gain	±18 dB	0 dB	±15 dB	0 dB
	Q/Bandwidth	10 to 0.1	1.0	0.1 to 2.0 octaves	0.2
Low (Bell/Shelf)	Frequency	20 Hz to 20 kHz	200 Hz	30 Hz to 200 Hz	80 Hz
	Gain	±18 dB	0 dB	±15 dB	0 dB
	Q/Bandwidth	10 to 0.5	1.0	Shelf only	none

Fader Banks and Graphic EQ Frequency Bands

VENUE SC48 Fader Banks and Graphic EQ Frequency Bands

Bank 1 (20 to 630 Hz)								
Fader	1	2	3	4	5	6	7	8
Freq	20 Hz	25 Hz	31.5 Hz	40 Hz	50 Hz	63 Hz	80 Hz	100 Hz
Fader	9	10	11	12	13	14	15	16
Freq	125 Hz	160 Hz	200 Hz	250 Hz	315 Hz	400 Hz	500 Hz	630 Hz
Bank 2 (800 Hz to 20 kHz)								
Fader	1	2	3	4	5	6	7	8
Freq	800 Hz	1000 Hz	1.25 kHz	1.6 kHz	2 kHz	2.5 kHz	3.15 kHz	4 kHz
Fader	9	10	11	12	13	14	15	16
Freq	5 kHz	6.3 kHz	8 kHz	10 kHz	12.5 kHz	16 kHz	20 kHz	n/a

Chapter 19: Plug-Ins

This chapter explains how to configure plug-ins before a performance, and how to use plug-ins during a performance. Plug-Ins can be inserted on all channels and bus outputs, or used as bus processors for effects such as reverb and delay.

 For complete information on VENUE-compatible plug-ins, visit the Digidesign website (www.digidesign.com).

Plug-Ins Quick Start

Before a performance, enable Config mode and do any of the following:

- Install plug-ins (see “Installing and Authorizing Plug-Ins” on page 143).
- Assign plug-ins to racks and rack slots (see “Plug-In Racks” on page 148).
- Assign plug-in input and output routing, including side-chain routing (see “Assigning and Routing Plug-Ins” on page 151).
- View and adjust plug-ins using the console or software screen (see “Adjusting Plug-Ins” on page 154).
- Save and load plug-in settings as Presets, or with snapshots (see “Plug-In Presets and Snapshots” on page 156).

During a performance, do all of the following:

- Enable Show mode to “safe” (lock out) plug-in rack assignments and other plug-in rack operations that could interrupt a performance.
- Patch channels and busses to available plug-ins, re-assign plug-in routing, or re-assign existing side-chain routing.
- Adjust plug-in parameters from the ACS, Assignable Output Encoders, or on-screen.
- Save and load plug-in settings as Presets, or within snapshots.

Using Config and Show Modes for Plug-Ins

The current Console mode status (Config or Show mode) determines which plug-in functions are available.

Config mode is required to install plug-ins, assign them to rack slots, and to establish side-chain routing. When in Show mode, any operations that might interrupt audio throughput are locked out and unavailable.

 *Plug-In actions that interrupt audio require Config mode. For more information, see “Config Mode and Show Mode” on page 28.*

Installing and Authorizing Plug-Ins

Plug-ins can be installed on systems but not on the Stand-alone software.

 *Because installing plug-ins can interrupt audio throughput, always install plug-ins before a performance.*

Installing Plug-Ins

To install a plug-in:

- 1 Put the system into Config mode.
- 2 If installing from a CD-ROM, insert the installer disc into the system CD-ROM drive.
- 3 Go to the Options page and click the Plug-Ins tab. The following two lists are shown:

Plug-Ins to Install This list shows available plug-in installers. At the top of the list is the Device selector, which provides a pop-up menu of available media sources. Plug-In installers are stored locally after plug-in installation, and appear as available items when Previous Installs is selected from the Device selector. This lets you re-install plug-ins without the original CD-ROM or other media.

Installed Plug-Ins This list shows all plug-ins already installed on the system. The plug-ins shown in plain text are available to process audio. Plug-Ins listed in italics are disabled and unavailable (see “Enabling and Disabling Installed Plug-Ins” on page 146).

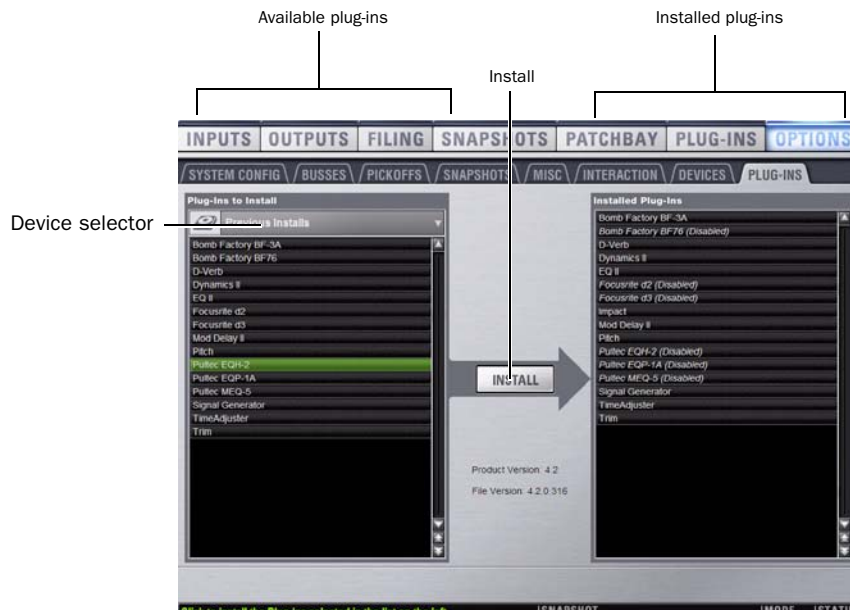

Figure 10. Options > Plug-Ins screen

4 Click the Device Selector pop-up menu and do one of the following:

- Choose Previous Installs to access any plug-in installers after a system update.
- Choose Console to access all factory-installed plug-in installers. after a system update or a full system restore.
- Choose an external storage device, as available, to access plug-in installers loaded in the CD-ROM drive.



Choosing a Device

5 Select a plug-in from the Plug-Ins to Install list on the left by doing any of the following:

- Click to select a single installer.
- Shift-click to select multiple contiguous installers.
- Control-click to select or deselect installers one at a time.

6 Click Install to install the selected plug-ins. Once installed, the plug-in appears in the Installed Plug-Ins list on the right.

7 Repeat as necessary to re-install all plug-ins needed on the system.

Removing Plug-Ins

Uninstalling a plug-in removes the plug-in from the racks but the installer remains in the Previous Installs cache, making it easier to reinstall the plug-in at a later time without requiring the installer CD or other media.

The list of available plug-ins you see in VENUE D-Show software is updated automatically each time you load a Show file to keep plug-in lists and menus uncluttered (see “Automatically Removing Plug-ins During Show Load” on page 146.)

You can also remove or delete plug-ins and/or their installers manually. In order to completely remove and delete a plug-in and its installer, you must explicitly Delete the plug-in, as described in the following sections.

 *Installing, uninstalling, and deleting plug-ins are not supported using the Standalone software.*

To uninstall a plug-in from the system but leave its installer available:

- 1 Put the system in Config mode.
- 2 Go to the Options page and click the Plug-Ins tab.
- 3 Right-click the specific plug-in name from the right-hand list and choose the Uninstall option for the selected plug-in.

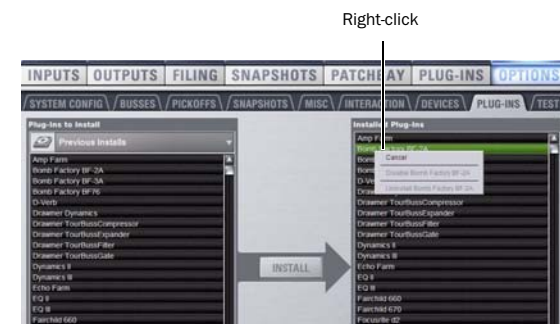

Uninstalling a plug-in

To reinstall a removed plug-in:

- 1 Put the system in Config mode.
- 2 Go to the Options page and click the Plug-Ins tab.
- 3 Click the Device selector and choose Previous Installs.



Choosing a Device

- 4 Select the plug-in and choose Install. If the desired plug-in is not listed, it must be re-installed from the original CD-ROM or other media.

Deleting Uninstalled Plug-Ins

Once a plug-in is uninstalled, its installer can be deleted from the system. (Plug-ins which are currently installed cannot be deleted).

To completely remove a plug-in and its installer:

- 1 Put the system in Config mode.
- 2 Go to the Options page and click the Plug-Ins tab.
- 3 Select Previous Installs from the Device selector.
- 4 Right-click the plug-in name and choose the Delete option for the selected plug-ins. The plug-in is removed from the system, and the stored plug-in installer is removed from the Previous Installs list.

Installing Plug-Ins Manually

If a plug-in does not appear in the Plug-Ins to Install list, it may not have a fully compatible VENUE installer and must be manually installed. This is required the first time you install the plug-in, and whenever you need to re-install a plug-in (such as after using the System Restore CD to update or reset the system).

 A plug-in without a VENUE installer may still be compatible. Consult the plug-in manufacturer for compatibility information.

To install a plug-in manually:

- 1 Make sure all sound systems are shut down or muted.
- 2 Insert the plug-in installer disc into the CD-ROM drive.
- 3 Go to the Options page and click the System tab.
- 4 Hold the Ctrl key and click Shutdown Console on-screen. Follow on-screen directions to exit to the Desktop.
- 5 Copy the plug-in installer to the partition named User Data.

- 6 Launch the plug-in installer application and follow any on-screen directions. If prompted, do not restart the system from a plug-in installer. (Doing so will not harm the system, but will take longer, especially if you have multiple plug-ins to install manually.)

- 7 Quit the installer application and eject the installer disc.

- 8 Click the Return to D-Show shortcut on the desktop to re-launch the VENUE D-Show software.

- 9 Go to the Options page and click the Plug-Ins tab. Verify that the manually installed plug-in appears in the Console list of available plug-ins.

Authorizing Plug-Ins

After installing a plug-in, the system re-creates the list of available plug-ins. Whenever the racks initialize, the system checks authorizations for all installed plug-ins. If no previous authorization for a plug-in is recognized, you will be prompted to try a demo version, or authorize the full version of the plug-in.

VENUE D-Show software supports challenge/response and iLok USB Smart Key authorization, including pre-authorized iLoks and iLok Authorization cards.

Challenge/Response Challenge/response authorization is only valid for the single system the plug-in is currently installed on. Challenge/response codes can be communicated using any computer with Internet access.

 It is not possible to connect a VENUE system to the Internet directly.

iLok USB Smart Key Plug-Ins supporting web authorizations through iLok.com can be authorized for your iLok Smart Key from any computer with Internet access. This lets you take your iLok and your plug-in authorizations anywhere, to use plug-ins installed on any system.

 For more information on using iLoks, refer to the iLok Usage Guide on the Standalone Software CD or at the Digidesign website (www.digidesign.com).

To authorize a plug-in:

- 1 When a plug-in authorization dialog appears, do one of the following:

- To try a demo of the plug-in, click Try.

– or –

- To have the system recognize the required authorization on your iLok, click Authorize. Insert your iLok Smart Key into any available USB port when prompted.

 Do not choose Internet Activation. Use Challenge/Response or an authorized iLok Smart Key for plug-in authorization.

- 2 Follow the instructions on-screen to complete the software authorization process.

Enabling and Disabling Installed Plug-Ins

The Installed Plug-Ins list shows Disabled plug-ins in *italics*. Plug-Ins can be manually disabled and enabled to manage DSP resources, troubleshoot possible conflicts, and to manage plug-in availability.

To globally disable or enable a plug-in:

- 1 Click to select the plug-in name in the Installed Plug-Ins list, at the right of the Options > Plug-Ins tab.
- 2 Right-click the plug-in and select whether to disable or enable the selected plug-in.

If assigned to any rack slots, the plug-in will be displayed as unavailable and inactive.

Automatically Removing Plug-ins During Show Load

Plug-ins are verified during the Show file load procedure to streamline plug-in lists and menus by automatically removing unused plug-ins (plug-ins that were once installed but subsequently uninstalled or disabled).

In addition, the plug-in lists can be reset manually using the Remove Unavailable Plug-ins command. Plug-ins which are not available and not in use in the rack are automatically filtered from all plug-in menu lists when the show file is subsequently stored. This filtered list is stored with the Show file.

Plug-ins which are not available but *are* in use will remain in the rack and display a warning icon indicating the plug-in isn't installed or is disabled. Such plug-ins appear as italicized entries in the plug-ins menu lists.

Manually Removing Unavailable Plug-ins from the Racks

Unavailable plug-ins can be easily removed from rack slots using the Remove Unavailable Plug-Ins command.

To manually remove unavailable plug-ins:

- 1 Put the system in Config mode. Make sure the plug-in rack is fully initialized (the Status indicator displays OK).
- 2 Click the Plug-In selector in any rack slot and choose Remove Unavailable Plug-Ins. This menu item is only available when one or more unavailable plug-ins are present in the rack.
- 3 Click Remove to confirm the operation, or click Cancel.

If you proceed with the removal:

- All unavailable plug-ins are removed from the plug-ins rack.
- The italicized entries for unavailable plug-ins are removed from all plug-in menu lists.

- All references to unavailable plug-ins are removed from the Insert Processing section of all affected channels, and the insert point plug-in is set to None.
- All references to unavailable plug-ins are removed from all snapshots.

The new, updated list of available plug-ins is subsequently saved to the Show file.

History File and Removing Plug-ins

A History file is written immediately before removing unavailable plug-ins from the rack, in order to provide a means of undoing the operation.

Plug-in Version Checker

VENUE D-Show software includes a comprehensive database of plug-in information, and this info can be used to greatly simplify the process of managing your VENUE plug-ins.

Use this feature to get version details and compatibility information for a plug-in prior to installing, or after it has been installed to help diagnose or troubleshoot plug-in performance.

Version checking also warns you when you are about to downgrade a plug-in (install an older version over a newer version).



In addition to using the plug-in version checker, also check the VENUE plug-in pages on the Digidesign website (www.digidesign.com) for the most up to date information

To view plug-in version information:

- 1 Go to the Options > Plug-Ins page.
- 2 Select a plug-in in either list (Plug-Ins to Install, or Installed Plug-Ins).



Version information is not shown for a multi-selection. Select an individual plug-in to view its version information.

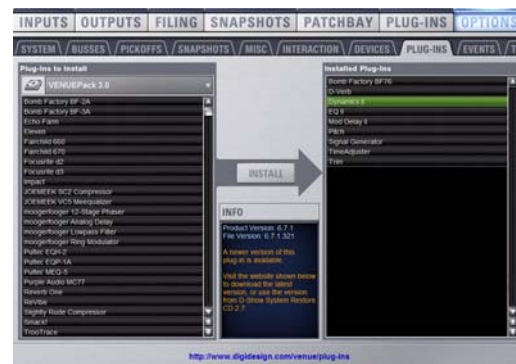

Info about a recommended update in Options > Plug-Ins

The Info pane displays details about the currently selected plug-in, including whether a newer version of the plug-in is available. If a new version is available, you can find out whether it is a recommended update or a critical update.

If you choose to install a plug-in for which there is a critical or recommended update, the system will ask you to confirm the installation procedure.

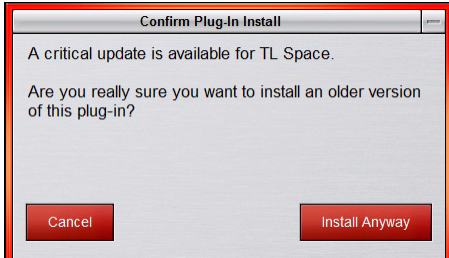

Dialog shown when attempting to install a plug-in that has a known newer version.

A similar dialog appears when attempting to replace an installed plug-in with an older version of the same plug-in. Follow the instructions on-screen to install anyway, or cancel.

Using System Info to View Plug-in Version Information

Plug-in version information is included in exported System Info data.

The Plug-in sections of the exported System Info file show critical and recommended updates, with links to sites to download or check for newer versions.

To use System Info for Plug-In Version Maintenance:

- 1 Insert a USB key disk into any available USB port on the console.
- 2 Go to the Options > System page.
- 3 Click the Info button.

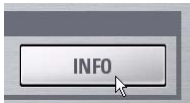

Export VENUE System Information button in Options > System

- 4 Do any of the following:
 - If you have more than one USB key disk connected, make sure the correct USB key disk is selected. If it is not, click Next Disk to cycle through each available disk until the correct one is selected.
 - Click Save to proceed and export system info to the selected USB disk.
 - Click Cancel to dismiss the dialog without exporting.
- 5 Click OK to confirm the export procedure.
- 6 Remove the USB key disk. Transfer the exported file to a personal computer for printing, formatting, archiving or distribution.

7 If viewing the System Info document from a computer with internet access, use the included links to check for plug-in updates.

USB Ports for iLoks

VENUE SC48 provides five USB ports, any of which can be used to connect an iLok. Multiple iLoks can be connected at one time.

For more information, see Chapter 2, “Configuring and Connecting SC48.”

Overview of Plug-Ins

The Plug-Ins screen displays the plug-in Racks, where the majority of plug-in set up features are located.

To access the Plug-Ins page:

- Press the Plug-Ins switch in the View Mode section (or click the Plug-Ins tab). By default, the Plug-Ins page displays all four racks, which are empty until plug-ins have been assigned. (See also ““Jump To” Plug-Ins” on page 155.)



Plug-In racks (no plug-ins assigned)

You populate the racks by *assigning* plug-ins in rack slots.

The following diagram shows an example of the racks with plug-ins assigned.

During a performance, plug-ins assigned in the racks can be inserted and routed on-screen and their parameters adjusted from the control surface or on-screen.

Plug-In Racks

The Plug-Ins page provides four plug-in racks. Each of the four racks has 5 slots into which you can load a plug-in. The four different racks can be viewed all at once, individually, and in varying zoom levels.



Figure 11. Plug-In racks and rack slots, Main view, with custom rack names shown.

Naming Plug-In Racks

By default, the racks are named Rack 1, Rack 2, Rack 3, and Rack 4. You can rename each rack as needed.

To rename a plug-in rack:

- 1 Double-click the rack name to highlight it on-screen.
- 2 Type a new name and press Enter. To return a rack to its default name, leave the name blank and press Enter.

 *Plug-Ins can be placed in any rack slot. Use the different racks to organize processing functions such as Dynamics, Vocal FX, Reverb, or Group Inserts.*

Rack Views

The Plug-Ins page can be displayed in Full or Zoom views.

Full View

The default view of the rack screen is Full view, in which all four racks are shown (see Figure 11). This screen provides access to all rack slot controls and shows an icon representing each assigned plug-in. This lets you quickly see what plug-ins are available, and adjust their routing.

Zoom View (Plug-In View Mode)

In Zoom view, a single rack remains on-screen to the left, and the rest of the screen displays the targeted plug-in.

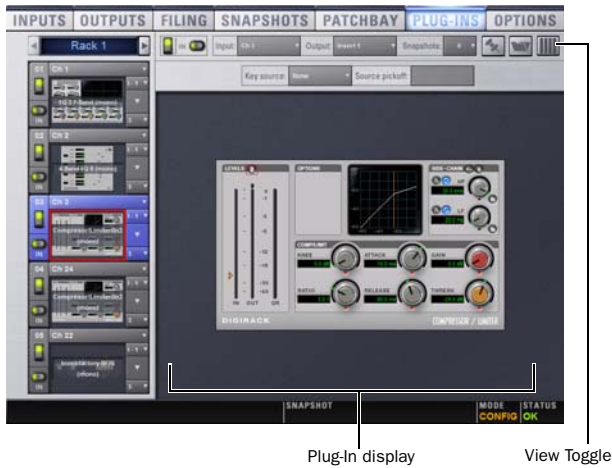

Zoom view, with a plug-in window open on-screen

To toggle Full or Zoom view modes, do one of the following:

- Press the Plug-Ins switch (in the View Modes section), or click the View toggle switch (upper right corner of the rack).

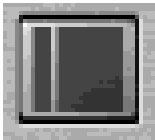

Zoom/Full view toggle

– or –

- Double-click a plug-in icon in any rack view to open that plug-in window in Zoom view.

 *VENUE provides other ways to jump to a plug-in view. For more information, see “Jump To” Plug-Ins” on page 155.*

Identifying Rack Slots

The racks indicate which plug-in is currently targeted by highlighting its rack slot controls in blue.

Targeted plug-in
(rack slot
highlighted in
blue)



Highlighted rack slot indicating targeted plug-in

Within each rack slot, color outlines appear around each plug-in to indicate the type of plug-in currently targeted on the control surface. The following colors are used:

Outline Color Coding of Rack Slots

Color Outline	Indication
Green	An EQ plug-in is mapped to the console
Blue	A Comp/Lim plug-in is mapped to the console
Yellow	An Exp/Gate plug-in is mapped to the console
Red	A plug-in is mapped to the Assignable Output Encoders (Insert mode)

Display of Unavailable or Inactive Plug-Ins

It is possible for a plug-in to be displayed in a rack slot but be unavailable for channel and bus processing. This can occur in any of the following circumstances:

- There are not enough DSP resources available for the plug-in.
- The assigned plug-in is part of the show file but is not installed on the current system.
- The plug-in has been disabled manually.

 *Place the cursor over the Tool Tips icon to see an explanation of why the plug-in is not available. To view DSP resource allocation, see “DSPs Available for Plug-Ins” on page 52.*

Unavailable Plug-Ins

When a plug-in cannot be used because of insufficient DSP resources, because it is disabled, or because it is not installed on the system, a warning icon is shown in front of the affected plug-in. The plug-in is greyed out, and the rack slot Power switch displays a yellow switch LED.



Unavailable plug-in

Indication of an unavailable plug-in

For more information, see “Installing and Authorizing Plug-Ins” on page 143.

Inactive Plug-Ins

When a plug-in has been manually made inactive, the plug-in icon is greyed out. Plug-Ins can be made inactive manually, letting you retain their assignment and settings in the rack while freeing up their DSP resources for other tasks.

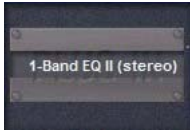

Indication of an inactive plug-in

For more information, see “Active and Inactive Plug-Ins” on page 152.

Scope Indication in the Plug-Ins Page

The Plug-In Rack provides visual indication whenever a plug-in is scoped in the currently targeted snapshot. The Snapshot pop-up menu turns red whenever that plug-in is scoped by the currently targeted snapshot.



Scoped (Snapshot menu red)

Indication of a scoped plug-in

For more information, see “Plug-In Presets and Snapshots” on page 156.

Rack Slots

Each rack provides five plug-in slots. You can assign any installed plug-in to any available rack slot.

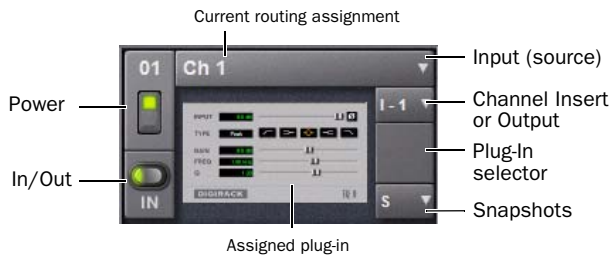

A rack slot and its controls, with an assigned plug-in shown

Each rack slot provides the following controls to select and manage plug-ins:

Power (Config Mode Only)

Power turns the rack slot on or off. When off, the plug-in consumes no DSP.

In/Out (bypass)

The In/Out switch takes the rack slot in or out of circuit (bypasses the slot and any plug-in assigned to it).

Input

The Input pop-up menu determines plug-in input (source). Use this menu to designate the plug-in as a channel insert or a bus processor by choosing from the Inserts or Bus sub-menus. For more information, see “Routing Plug-Ins” on page 152.

Once a plug-in has been routed, its input source is displayed in the Input area of each rack slot, as follows:

- If the plug-in is being used as an insert, the channel or bus name and number is shown, for example, *Kick (Ch 1)* or *Aux 1 (1–2)*. The Channel Insert/Bus Output selector automatically switches to Channel Insert mode, showing the insert point occupied by the plug-in.
- If the plug-in is on a bus, the selected bus source is shown in the Input selector, for example, *Aux 1* or *Grp 1*. The Channel Insert/Bus Output selector can be used to assign the output routing of the plug-in to a channel or bus.

Channel Insert or Bus Output

The Channel Insert/Bus Output pop-up menu displays different choices depending on whether the plug-in is being used as a channel insert, or as a bus processor, as follows:

- If the plug-in is being used as a channel insert, the Channel Insert selector shows the four insert points on that channel (1–4). The letter “I” is shown before the insert number (for example, I-1 indicates the current plug-in is inserted into the first insert position on its channel).
- If the plug-in is being used as a bus processor, the menu becomes the Output selector used to select the destination for plug-in output.



Channel Insert

Bus Output

A mono plug-in inserted on a channel (at left) and a stereo plug-in assigned as a bus processor (at right)

Plug-In Selector

The Plug-In selector displays a list of available plug-ins to load into that rack slot. Plug-Ins are arranged by process type (such as EQ, Dynamics, and Delay). For more information, see “Assigning and Routing Plug-Ins” on page 151.

Snapshots Menu

The Snapshots menu provides tools to manage snapshot-related plug-in features from within the Plug-Ins screen. Using the Snapshots menu, you can quickly check to see which existing snapshots refer to the current plug-in, as well as create, update, or remove snapshots.

Side-Chain Selector

The Side-Chain selector appears near the top of the Rack view when you select a plug-in that supports side-chain or “key” input. In Config mode, the Side-Chain selector lets you establish a side-chain routing to the plug-in. Once established, you can route and re-route side-chain signals in both Config and Show mode. For more information about side-chain signals, see “Side-Chain Routing” on page 153.

Assigning and Routing Plug-Ins

Before a plug-in can be used to process audio, it must be assigned to a rack slot. Once assigned, you can use the plug-in as a channel insert or bus processor.

 Before a plug-in can be assigned, it must be installed. See “Installing and Authorizing Plug-Ins” on page 143.

Assigning Plug-Ins to Rack Slots

To assign a plug-in:

- 1 Put the system into Config mode.
- 2 Go to the Plug-Ins page.
- 3 Click the Plug-In selector on an empty rack slot. (You can also use an already assigned rack slot to change a plug-in assignment.)
- 4 Choose an available plug-in from the Plug-In selector sub-menus. Only plug-ins that are installed will be available.



Plug-In selector menus

If the plug-in is not installed or there are insufficient DSP resources available, the plug-in will appear as unavailable, or inactive.

 Place the cursor over the plug-in to display a Tool Tip that explains why the plug-in is unavailable or inactive.

Plug-In Formats

Plug-Ins inserted on channels must be symmetrical (in other words, mono in/out or stereo in/out). Plug-Ins on busses can be asymmetrical (mono-in/stereo or multichannel out).

Mono Can be used as inserts only in mono strips or mono Auxes, mono Groups, or Matrix busses or on the C/M bus.

Stereo Can be used as inserts in stereo strips, stereo-linked Auxes, stereo Groups, PQ busses (which are always stereo) and across the L–R busses.

Other (Mono In/Stereo Out) Can be used on busses for delay, reverb, and similar processing.

Moving and Copying Plug-Ins

(Config Mode Only)

To move or copy a plug-in in the rack, drag the plug-in icon to a new rack slot. A pop-up menu appears offering three choices: Cancel, Copy Plug-In Here, or Move Plug-In Here.

Moving a Plug-In

When you move a plug-in from one rack slot to another, the plug-in type, in/out state, power on/off, current plug-in settings, and routing are maintained. In addition, all associated snapshots are updated to reflect the new rack position.

Copying a Plug-In

When you copy a plug-in to a new rack slot, the source plug-in type, in-circuit state, active state, and current plug-in settings are copied to the destination rack slot. However, the source plug-in routing is not copied. In addition, plug-in snapshots are not copied.

Overwriting An Existing Plug-In

When either moving or copying, if there is an existing plug-in in the destination rack slot, that plug-in is deleted. When the plug-in in the destination rack is deleted, any routing or references to the deleted plug-in in existing snapshots will be automatically cleared.

Active and Inactive Plug-Ins

To toggle the active/inactive state of a plug-in:

- Click the appropriate rack slot Power switch. When active, the Power switch is lit green. When a plug-in is unavailable (and inactive), the Power switch is lit yellow.



Indication of an inactive plug-in

Routing Plug-Ins

After a plug-in has been assigned to a rack slot, you can specify its routing. Plug-In routing determines whether the plug-in is used as a channel insert or as a bus processor.

Using Plug-Ins as Channel Inserts

Each VENUE SC48 channel provides four slots for channel inserts. Signal from the channel is routed to the insert and returned to the same channel. You can assign plug-ins to specific channel insert points from the Plug-Ins screen or from the Input screen.

To insert a plug-in on a channel from the Inputs or Outputs page:

- Go to the Input or Output screen.
- Click the first available Channel Insert selector and choose an available plug-in from the rack sub-menus. All currently available plug-ins of a compatible mono/stereo format are listed in the sub-menus. Plug-Ins that are unavailable are listed in italics. Plug-Ins that are already assigned as channel inserts are shown with their insert assignment.

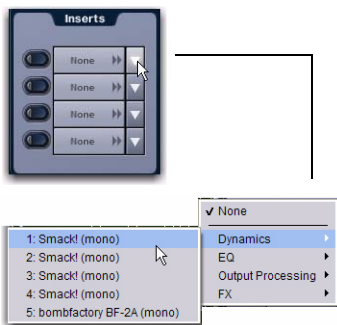

Clicking the Channel Insert selector (top)

- The plug-in appears in the Inserts list for that channel.

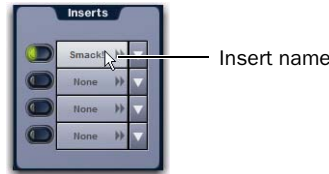

An assigned channel insert

- To open the window for an inserted plug-in, click its name in the channel Inserts list.

To insert a plug-in on a channel from the Plug-Ins page:

- Make sure the plug-in is already assigned to a rack slot. (See “Assigning and Routing Plug-Ins” on page 151.)
- Click the Input (source) selector in the rack slot and choose a channel from its Inserts sub-menu.



Inserting a rack slot on a channel from the Plug-Ins page

The rack slot automatically identifies and connects to the first available insert slot (1–4) on the selected channel. The Channel Insert selector shows the current insert position.



Channel Insert selector for a plug-in rack

If no insert slots are available on the channel, the selector displays a question mark.

Using Plug-Ins as a Bus Processor

Plug-Ins can be used on busses for send-and-return processing with effects such as reverb and delay. A plug-in is configured for bus processing by assigning an Aux, Group, Matrix, or Main bus (including Monitor output), or an Input Channel Direct Out, as the plug-in input source, then assigning the output of the plug-in to an Input Channel or FX Return, or to a hardware output, as follows:

- Return bus-fed plug-ins to an input or FX Return to establish an effects send-and-return path.
- Route bus-fed plug-ins to a hardware output for specialized processing needs (such as feeding an external crossover).

You assign plug-ins for bus processing from the Plug-Ins screen.

To use a plug-in as a bus processor:

- 1 Go to the Plug-Ins screen.
- 2 Make sure the plug-in is installed and assigned to a rack slot.

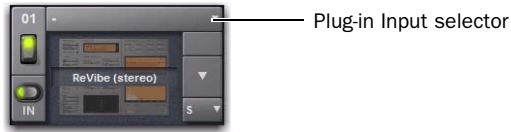

A plug-in assigned to a rack slot

- 3 Click the Plug-In Input selector at the top of the corresponding rack slot, and choose an available bus from the Input sub-menus.



Assigning plug-in input source to a Group bus

- 4 Click the Plug-In Output selector and choose an input, FX Return or hardware output.



Assigning plug-in output to an FX Return

When a bus-fed plug-in has both its input source and output assigned, it appears similar to the following in the rack:



A bus-fed plug-in in the rack

Routing Channel Direct Outs to Plug-Ins

You can route the Input channel Direct Outs to plug-ins. This lets you directly feed plug-ins from individual channels to preserve Aux busses for other uses, with control over send level using the channel Direct Out level control.



Assigning a channel Direct Out as a plug-in input source in the Plug-Ins page

When a channel Direct Out is routed to a plug-in, it follows the one global pickoff setting for that specific Direct Out (as set in the Patchbay), and is applied in addition to any other assignment made for that Direct Out. This makes it possible to use a channel's Direct Out to route that channel to both a Pro Tools recording option and to a plug-in.

⚠ If you do use a Direct Out to feed both a hardware output such as a Pro Tools recording option as well as a plug-in, be aware that any adjustments to that Direct Out affect both the output signal and the signal fed to the plug-in.

Side-Chain Routing

VENUE SC48 supports side-chain (key) processing for plug-ins that support side-chain triggering.

⚠ Side-chain routing is not stored in snapshots.

The Side-Chain selectors appear across the top of the plug-ins screen. You must be in Config mode to establish or remove a side-chain assignment. Once established, side-chain routing can be changed (but not added or removed) in Show mode.

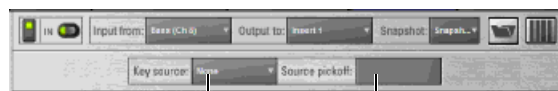

Click to select Key (side-chain) source Click to specify side-chain pickoff source

Side-Chain controls

To assign side-chain routing to a plug-in:

- 1 Select a plug-in that supports side-chain processing.
- 2 Put the system into Config mode to display the Side-chain tools.
- 3 Choose the side-chain source signal from the Key Source pop-up menu.
- 4 Choose the pickoff point (tap) for the side-chain signal from the Source Pickoff pop-up menu.

Adjusting Plug-Ins

Plug-Ins can be adjusted from the console or on-screen.

On the Console

VENUE SC48 lets you control plug-ins in the Channel Control section of the ACS (EQ and Dynamics only) and in the Output encoder section.

EQ Plug-Ins

EQ plug-ins can be selected and adjusted in the Channel Control section of the ACS. See “Adjusting EQ Plug-Ins” on page 139.

Dynamics Plug-Ins

Dynamics plug-ins can be selected and adjusted with the dedicated controls in the Dynamics section in the ACS. See “Adjusting Dynamics Plug-Ins” on page 129.

Output Encoders

The Output encoders can be placed into Insert mode to adjust any selected plug-in. Plug-in parameters map to the eight encoders and their switches; additional parameters are accessed with the Previous Page and Next Page switches.

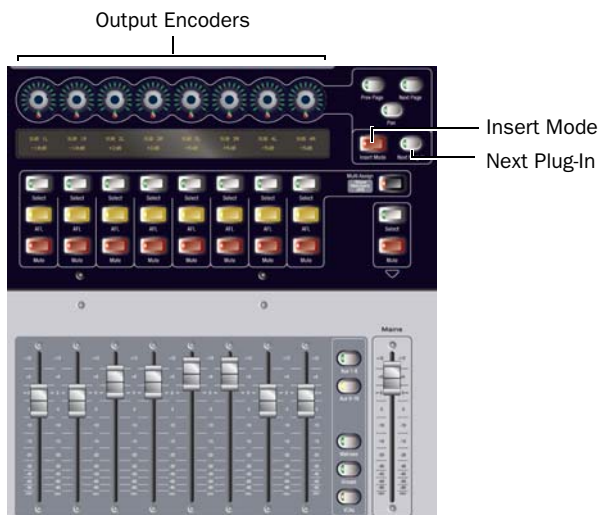

Encoders, Insert mode and Next Plug-In switches in the Output section

To adjust a plug-in from the console:

- 1 Do either of the following:
 - If the desired plug-in is being used as a channel insert, select the channel or bus on which the plug-in is inserted.
 - If the desired plug-in is being used as a bus processing plug-in, bank to and select the FX Return or other channel assigned as the plug-in output.
- 2 Press the Insert Mode switch, located near the Output encoders. The first page of plug-in parameters is mapped to the eight Output encoders.
- 3 To reset a parameter to its default value, hold Default/Alt while rotating or pushing an encoder.
- 4 To adjust with greater resolution, hold Ctrl/Fine while rotating an encoder.
- 5 Press Prev Page or Next Page to bank to other plug-in parameters.

To move to the next plug-in on that channel or bus:

- Press the Next Plug-In switch.

Display of Plug-Ins in Insert Mode

While in Insert Mode, the Output LCD displays the value and name of the 8 currently banked plug-in parameters in the upper and lower row, respectively, for each parameter.

In this default Insert Mode view, adjusting an Output fader temporarily shows fader level in the lower row of the Output LCD for that channel, replacing the parameter name display.

Alternate Insert Mode View

You can use an alternate view to have Insert Mode display parameter values in the upper row and the associated bus name in the lower row.

To view values and bus names for the Output encoders in Insert Mode:

- Press Default/Alt+Insert Mode.

Using the Source Switch

The Source switch toggles Input displays to show the names of bus-fed plug-ins routed to a channel. Use the Source switch to quickly identify which FX Returns or other channels are being used as plug-in returns.

To view encoder values and bus names for Input or FX Return channels:

- Press the Source switch, located in the Display section to the left of the input Mute/Solo/Select switches.

Bypassing Plug-Ins

To bypass a plug-in:

- 1 Select the channel on which the plug-in is inserted.
- 2 Click the In/Out switch for the plug-in to toggle between in-circuit/out-of-circuit. When the switch LED is lit, it indicates that the plug-in is in-circuit. When unlit, the plug-in is out-of-circuit (bypassed).

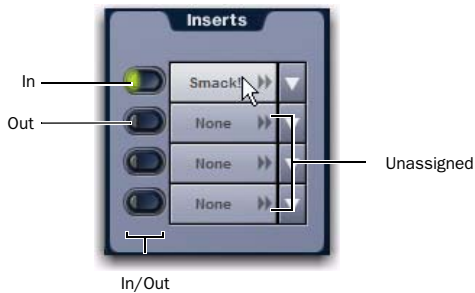

LED indication of in circuit and out of circuit (bypassed) inserts

Software Screen

The software screen can also be used to patch, route, or re-route plug-ins during a performance, even while in Show mode.

 *Plug-Ins must already be installed on the system, and assigned to a rack slot, to be available while mixing. See “Assigning Plug-Ins to Rack Slots” on page 151.*

“Jump To” Plug-Ins

The Input and Output screens let you “jump to” a specific plug-in insert to adjust it on-screen.

To jump to a plug-in insert from the Inputs or Outputs screen:

- 1 Select a channel to display it in the Inputs or Outputs screen.
- 2 Click the plug-in name shown in the channel Insert section.

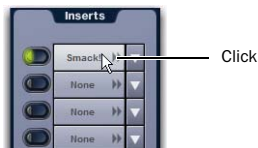

Jumping to a plug-in on a channel insert

To jump to a plug-in on a bus:

- 1 Bank to the FX Return or other channel type assigned as the plug-in output, or bank to the output feeding the plug-in.
- 2 Select the channel to display it in the Inputs or Outputs screen.
- 3 Click the routing displayed beneath the Channel Name.



Jumping to a plug-in on an FX Return

Plug-Ins Screens and Channel Selection

When jumping to a plug-in, display depends on the type of plug-in routing, as follows:

Channel Inserts If the Plug-Ins screen is in Zoom view while you select a channel, the last selected plug-in for that channel is automatically selected and displayed in the Plug-Ins screen.

Bus-Fed Plug-Ins If no plug-ins are inserted on a channel (such as when returning a bus-fed plug-in to an FX Return) the plug-in feeding that FX Return is displayed.

Pinning a Plug-In View

It is possible to decouple the plug-in view from the console for consistent and constant access to a single plug-in on-screen, while still being able to select and adjust other plug-ins from the console. This capability is useful any time you want to always display an important plug-in (such as an analysis plug-in or primary EQ).

To pin a plug-in view:

- 1 Bring the desired plug-in into the main plug-in view (use the channel Select and Insert Mode switches, or double-click the desired plug-in in the rack).
- 2 Click the Push-Pin icon in the upper-right of the screen (the icon is located just to the left of the Presets and View Toggle icons).
 - When enabled, the Push-Pin icon appears lit. This indicates that the current plug-in will remain on-screen and will not lose focus, even if another channel is targeted.
 - When not enabled, the Push-Pin icon appears unlit. Plug-in view follows control surface selections.



Push-Pin plug-in view icon

Plug-In Presets and Snapshots

You can save and load plug-in Presets files to import, export, and transfer plug-in settings files.

Snapshots can also be used to automate changes to plug-in routing and settings.

 *Presets can be applied to multiple Shows, while snapshots apply only to the Show file in which they are stored.*

Presets

Presets are files that you can create to save, load, archive and transfer custom plug-in settings. You can then create your own Preset folders to organize Preset files. Preset folders and files can be transferred using the Filing Page.

To create a custom Presets folder:

- 1 Go to the Filing page and click the Transfer tab.
- 2 Click the Preset Folders icon.
- 3 Click the New button at the left of the screen.
- 4 Do one of the following:
 - To leave the folder at its default name, press Enter.
 - or –
 - Type a new name and press Enter.

To save a Preset:

- 1 Adjust the plug-in parameters as desired.
- 2 Click the Presets icon in the Plug-Ins screen.
- 3 In the Presets window, click New.
- 4 Enter a custom name for the Preset.

To load a Preset into a plug-in:

- 1 Make sure the presets are already transferred and available on the current system. (Many plug-ins come with factory presets that will be installed along with the plug-in.)
- 2 Select the channel containing the plug-in, and target the desired plug-in (press the Insert Mode switch, or click the plug-in on-screen).
- 3 Click the Presets icon in the Plug-Ins screen.
- 4 Single-click a preset name in the Presets list to preview it. With the Presets list displayed, do any of the following:
 - To scroll through the list, press Up or Down arrow keys on your computer keyboard.
 - To load a preset and close the Presets list, double-click a name in the Presets list.
 - Click Cancel to close the Presets list without changing settings.

Snapshots

Snapshots can automate plug-in settings, including routing, and in/out state. (Side-chain routing is not supported in Snapshots.) Snapshots can also store and recall Tempo.

 *Snapshots do not store or recall Presets. Snapshots store plug-in settings as they were when the Snapshot was created or saved.*

Each rack slot in the Plug-Ins screen provides a Snapshot menu, with shortcuts for common snapshot-related tasks:

- Create a new snapshot
- Add one or more plug-ins to the MIDI/Plug-Ins list, and automatically re-scope the snapshot to include plug-ins.
- Remove plug-ins from one or more snapshots

Snapshots Containing this Plug-In Lists all currently loaded snapshots referencing the plug-in, in sequential order. Choose a snapshot to load it. (This menu option is useful for targeting snapshots while editing plug-in racks.)

Create New Snapshot Containing this Plug-In Adds a new snapshot to the snapshot list in which only plug-ins are scoped. This snapshot is inserted immediately after the currently targeted snapshot, which may not necessarily be the last snapshot. The snapshot is named to reflect the plug-in rack position, for example: “PI 1-1: Reverb One” is a Reverb One plug-in assigned to rack 1, slot 1.

Add (or Update) this Plug-In to Snapshot Adds a plug-in reference, with current settings, if the currently targeted snapshot does not already reference this plug-in. If the currently targeted snapshot already references this plug-in, the choice is Update (see next). If multiple snapshots are selected, this command changes to “Add Plug-In to Selected Snapshots” for batch-assignment.

Update this Plug-In in Snapshots Updates snapshots with current settings, if the currently targeted snapshot (or currently selected snapshots) already references this plug-in.

Remove this Plug-In in Snapshot Removes reference to this plug-in in the currently targeted snapshot, or from all currently selected snapshots.

 *See Chapter 21, “Snapshots.”*

Plug-Ins and VENUE D-Show Standalone Software

You can use VENUE D-Show Standalone software to preconfigure plug-in routing and in/out state, with the following limitations:

- Plug-Ins cannot be installed in the Standalone Software.
- A Show file must be transferred from a console on which plug-ins were previously installed.

Once a Show file containing plug-ins has been transferred to the standalone software, the following rules apply:

- Plug-Ins can be placed in racks and routed in Standalone mode.
- Snapshots can be created, loaded, and stored.
- Plug-In settings cannot be adjusted.
- Plug-In Presets cannot be saved or loaded.

Plug-In DSP Usage

Plug-Ins utilize DSP resources when they are assigned to a rack slot, and that rack slot is powered on. You can turn off unused plug-ins to reclaim their DSP by making them inactive, or by removing them from the system.

Plug-In availability is limited to the available DSP resources.

The amount of DSP available for plug-ins also varies with the current system configuration settings for Input Channels, FX Returns, and graphic EQs. Higher number of Input Channels leave fewer DSP resources for plug-ins, as shown in the Options > System Config screen.

Initializing the Plug-In Racks

The racks are initialized (or re-initialized) whenever the system is first powered on, whenever the FOH Rack is restarted, after installing a plug-in, and after disabling or re-enabling a plug-in.

While the racks are initializing, they are offline and do not process audio. Avoid performing any Filing or Transfer functions until the racks are finished initializing. Rack status is displayed on-screen in the banner display.

Plug-In Levels

VENUE systems display levels in meters in dBVU, with 0 dBVU = +4dBu analog out = -20dBFS.

Internally, VENUE SC48 provides up to 48-bit processing for built-in EQ and dynamics. Plug-Ins provide up to 24-bit processing, with level matching circuitry and logic ensuring maximum fidelity and sonic performance throughout the entire signal path. Due to variances in how plug-in metering is implemented by different manufacturers, performance may vary with regard to plug-in gain reduction meters and their relative levels.

When using side-chain routing, be aware of potential level differences between Input Channel pickoff points. For more information, see “Side-Chain Keys and Filters” on page 131.

Plug-In Latency and Processing Delay

Plug-In latency includes processing delay of the plug-in itself plus routing delay, as follows:

- Instance delay: 2 samples per plug-in
- DSP routing delay: 3 samples

Viewing Plug-In Latency

Cumulative channel processing delay can be viewed by right-clicking the Inserts area of the selected channel. The cumulative delay includes latency reported by all inserted plug-ins, signal routing and the known hardware insert delay, if applicable.



Viewing cumulative delay by right-clicking the Inserts section

Individual plug-In processing delay can be seen by right-clicking the plug-in icon in the rack. Use the number reported when calculating latency for manual delay compensation.

Examples

If there is only one plug-in on a channel, the total delay will be the amount of plug-in latency + 2 + 3. (2 samples for the one plug-in instance, plus 3 samples for the DSP routing to the racks and back.)

If you have two plug-ins on a channel or bus, the delay will be plug-in #1 latency + 2 + plug-in #2 latency + 2 + 3. If plug-in #1 has 12 samples of latency, and plug-in #2 has 15, total latency will be 34 samples (12 + 2 + 15 + 2 + 3).

Part V: Shows

Chapter 20: Shows and File Management

Data can be stored, recalled and transferred between VENUE systems. There are three types of information files that can be managed separately, as follows:

Show Files These files are used to store, recall and transfer system settings, snapshot, and events.

Preset Files These files are used to store settings for channel strips, built-in processors and plug-ins, and Recall Safe Scope Sets.

Console Setting Files These files are used to transfer or back up the current state of the VENUE SC48 system.

! *The system does not need to be in Config mode to carry out file management tasks. However, many file management operations, including loading Shows, may interrupt audio throughput. Make sure to perform all file management tasks before a performance.*

Creating Shows

A Show file contains all configuration, signal routing, mixer settings, plug-in information, snapshots, and other operational settings. Shows are grouped together in Show Folders.

Show Folders

Show Folders contain Show files. You can create and manage Show Folders from the Save tab of the Filing page.



Show Folders and Show files in the Save tab of the Filing page

Creating Show Folders

To create a new Show Folder:

- 1 Go to the Filing page and click the Save tab.
- 2 In the Show Folders column, click the New button.
- 3 Type a name for the Show Folder and press Enter.

Duplicating Show Folders

To duplicate a Show Folders:

- 1 In the Show Folders column, click a Show Folder name to select the folder.
- 2 Click the Duplicate button.

The folder and all of the Show files it contains are duplicated.

! *You can also duplicate folders by right-clicking a Show Folder name and choosing Duplicate.*

Renaming Show Folders

To rename a Show Folder:

- 1 In the Show Folders column, click a Show Folder name to select the folder.
- 2 Click the Rename button.

! *You can also rename Show Folders by right-clicking a Show Folder name and choosing Rename, or by double-clicking a Show Folder name.*

- 3 Type a new name for the Show Folder and press Enter.

Deleting Show Folders

When you delete a Show Folder, all Show files contained in that folder are also deleted.

To delete a Show Folder:

- 1 In the Show Folders column, click a Show Folder name to select the folder.
- 2 Click the Delete button.

! *You can also right-click a Show Folder name and choose Delete to delete the folder.*

Show Files

Creating and Saving Show Files

When you create a new Show file, it captures the current state of the system. Show files are automatically saved when they are created or overwritten.

To create a new Show file:

- 1 Go to the Filing page and click the Save tab.
- 2 In the Show Folders column, select the Show folder where you want to save the Show.
- 3 In the Shows column, click the New button. The new Show file captures the current state of the system.
- 4 Type a name for the Show file and press Enter.
- 5 Double-click in the Notes field for the Show and type any comments you want to save with the Show.

Information about the Show file is shown in the Info area of the Filing page.

 *Show files are automatically saved when they are created; no further action is required to save them.*

To update or overwrite an existing Show file:

- In the Shows column, right-click the Show file name you want to overwrite, and choose Overwrite from the pop-up menu. The current state of the system is saved to the selected Show file.



Right-clicking a Show file name in the Shows column

Duplicating Show Files

To duplicate a Show file:

- 1 In the Shows column, click a Show file name to select it.
- 2 In the Shows column, click the Duplicate button.

 *You can also right-click a Show file name and choose Duplicate to duplicate the file.*

Renaming Show Files

To rename a Show file:

- 1 In the Shows column, click a Show file name to select it.
- 2 In the Shows column, click the Rename button.

 *You can also right-click a Show file name and choose Rename, or double-click the Show file name to rename the file.*

- 3 Type a new name for the Show file and press Enter.

Deleting Show Files

To delete a Show file:

- 1 In the Shows column, click a Show file name to select it.
- 2 In the Shows column, click the Delete button.

 *You can also right-click a Show file name and choose Delete to delete the file.*

Loading Shows

You can load Show files using the Load tab of the Filing page.

Shows cannot be loaded onto the destination VENUE system directly from the portable storage device, but must first be transferred to the system before loading.

 *Loading a show automatically replaces the current console settings with those of the loaded show, and may interrupt audio throughput.*

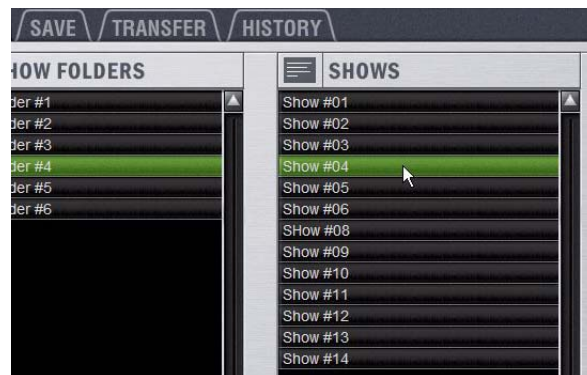

Show Folders and Show files in the Load tab of the Filing Page

To load a Show file:

- 1 Go to the Filing page and click the Load tab.
- 2 In the Show Folders column, click a Show Folder name to select the folder. Any Show files in the folder are displayed in the Shows column.
- 3 In the Shows column, click a Show file name to select it.
- 4 Click the Load button.

The system loads the new Show file, replacing the current system configuration, routing, and control settings with those contained in the new file.

System Configurations and Loading Shows

Show files include VENUE system configuration settings (such as the type of console (VENUE SC48) or control surface (VENUE Profile, or a VENUE D-Show Main and Sidecars); the number of Mix Engines; Number of Input Channels, FX Returns, and EQs; Aux and Group Bus configurations).

- If a Show file includes the same system configuration settings as the current configuration, the configuration information appears in blue text in the Info area.
- If a Show file differs from the current configuration, but can be loaded on the system, the relevant configuration changes appear in orange text in the Info area. When the Show file is loaded, the system restarts in the new configuration.
- If a Show file differs from the current configuration and cannot be loaded on the system in its entirety, the configuration information appears in red text in the Info area.

If a Show configuration is too large for the current system, mix elements are dropped in following order:

- 1 Plug-Ins are deactivated
- 2 Graphics EQs are dropped
- 3 Input Channels are dropped

Working with Presets

Preset files are used to store, recall and transfer factory or user-defined presets. Preset files are grouped in the following types of Preset Folders:

Built-in 4-band EQ, 31-band Graphic EQ, Compressor/Limiter, Expander/Gate, and Input Channel Presets

Plug-In Plug-ins Settings Files

Scope Sets Settings for Recall Safe configurations

 For information on saving, previewing and loading built-in dynamics and EQ presets, see Chapter 17, “Dynamics” and Chapter 18, “EQ.” For plug-in settings, see Chapter 19, “Plug-Ins.” For Scope Sets, see Chapter 21, “Snapshots.” For Input Channel Presets, see Chapter 5, “Navigating and Selecting Channels”,

Preset Folders

Preset Folders contain Preset files. Each of the built-in processors (Compressor/Limiter, Expander/Gate, 4-band EQ, 31-band Graphic EQ) and each plug-in has its own Factory Defaults folder. Additional folders are provided for Scope Sets.

You can create additional Preset Folders for each processor or plug-in and store new Presets in them. These folders can then be transferred to a portable storage device for transfer to other VENUE systems.

Creating Preset Folders

To create a new Preset Folder:

- 1 Go to the Filing page and click the Transfer tab.
- 2 Click the Preset Folders icon. A list of Preset Folders appears in the left column.



Preset Folders icon in the Transfer tab of the Filing page

- 3 In the left column, click the New button.
- 4 Type a name for the Preset Folder and press Enter.

The new Preset Folder is available in the Preset window for each processor or plug-in.

Duplicating Preset Folders

To duplicate a Preset Folder:

- 1 In the left column, click a Preset Folder name to select it.
- 2 Click the Duplicate button.

The folder and all of the Preset files it contains are duplicated.

 You can also right-click a Preset Folder name and choose Duplicate to duplicate the folder.

Renaming Preset Folders

To rename a Preset Folder:

- 1 In the left column, click a Preset Folder name to select it.
- 2 Click the Rename button.

 You can also right-click a Preset Folder name and choose Rename, or double-click a Preset Folder name to rename the folder.

- 3 Type a new name for the Preset Folder and press Enter.

Deleting Preset Folders

When you delete a Preset Folder, all Presets contained in that folder are also deleted.

To delete a Preset Folder:

- 1 In the left column, click a Preset Folder name to select it.
- 2 Click the Delete button.

 You can also right-click a Preset Folder name and choose *Delete* to delete the folder.

Preset Files

You can manage Preset files from the Transfer tab of the Filing page. You cannot create Preset files from the Filing page. Preset files are created from the Presets window of the channel, processor or plug-in; Scope Sets are created from the Scope Sets window of the Recall Safe page.

Duplicating Presets

To duplicate a Preset file:

- 1 Go to the Filing page and click the Transfer tab.
- 2 Click the Built-In or Plug-In icon and choose a processor or plug-in from the pop-up menu. The available Preset Folders for the processor or plug-in appear in a pop-up menu above the left column.

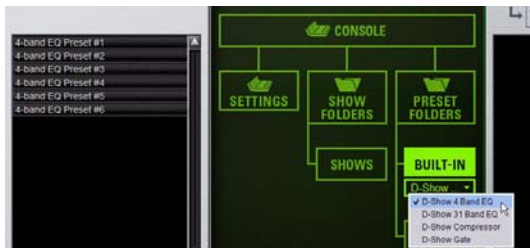

Built-In EQ in the Transfer tab of the Filing Page

- 3 Click the Preset Folder name and choose a Preset Folder from the pop-up menu. Any Presets in the folder appear in the left column.



Preset Folder names at the top of the Presets column

- 4 Click a Preset file name to select the file.
- 5 Click the Duplicate button.

 You can also right-click a Preset file name and choose *Duplicate* to duplicate the Preset.

Renaming Presets

To rename a Preset file:

- 1 In the left column, click a Preset file name to select the file.
- 2 Click the Rename button.

 You can also right-click a Preset file name and choose *Rename*, or double-click a Preset file name to rename the Preset.

- 3 Type a new name for the Preset file and press Enter.

Deleting Presets

To delete a Preset file:

- 1 In the left column, click a Preset file name to select it.
- 2 Click the Delete button.

 You can also right-click a Preset file name and choose *Delete* to delete the Preset.

Transferring Settings, Shows and Presets

You can copy Console Settings, Shows, and Presets to and from a portable storage device (such as a USB key disk) for backup, transfer from standalone software, and transfer between systems.

Settings, Shows and Presets cannot be loaded onto the destination system directly from the portable storage device, but must first be transferred to the system before loading.

Transfer of Settings files, Show files, and Preset files is managed from the Transfer tab of the Filing page. The Transfer tab shows the system-resident files in the left column and the contents of the portable storage device in the right column. Items are selected for transfer in the center.



File transfer controls

To transfer Settings, Shows or Presets between VENUE SC48 and a portable storage device:

- 1 Go to the Filing page and click the Transfer tab.
- 2 Connect a portable storage device (such as a USB key disk) to the system. The device appears above the right column.
- 3 Do one of the following to select the type of data to transfer:
 - To transfer all data, click the Console icon.
 - To transfer Console Settings, click the Settings icon.
 - To transfer Show Folders, click the Show Folders icon.
 - To transfer individual Shows, click the Shows icon.
 - To transfer Preset Folders, click the Preset Folders icon.
 - To transfer Presets for individual items, click the Built-In or Plug-In icon and choose a built-in processor or plug-in, or Input Channel from the pop-up menu.
 - To transfer Scope Sets for Recall Safe, click the Scope Sets icon.



Preparing to transfer items to USB key disk

- 4 Do one of the following to select the items to transfer:
 - In the left column, select the items you want to transfer to the portable storage device.
 - or –
 - In the right column, select the items you want to transfer from the portable storage device to VENUE SC48.
- 5 Click the Transfer button.

Large transfers may take time. Transfer status is shown by a progress bar. A transfer may be cancelled by clicking Cancel.

A Cancelled transfers may result in partial folder contents, which will have to be deleted manually.

Synchronizing Settings, Shows and Presets

Instead of transferring data in one direction between the VENUE system and a portable storage device, you can synchronize all data in both columns of the Transfer tab in a single operation.

Synchronizing data causes new files to be copied and files with the same name but a more recent modification date/time to be automatically updated.

A When synchronizing data, the VENUE D-Show software replaces data files of the same name with the file that has the most recent date/time. Check to be sure that the system clock times and time zones are correctly set on the system and on the computer running the Standalone software when preparing data for synchronization.

To synchronize Settings, Shows, or Presets between the VENUE system and a portable storage device:

- 1 Go to the Filing page and click the Transfer tab.
- 2 Connect a portable storage device (such as a USB key disk) to SC48. The device appears above the right column.
- 3 Do one of the following to select the type of data to synchronize:
 - To synchronize all data, click the Console icon.
 - To synchronize Console Settings, click the Settings icon.
 - To synchronize Show Folders, click the Show Folders icon.
 - To synchronize individual Shows, click the Show icon.
 - To synchronize Preset Folders, click the Preset Folders icon.
 - To synchronize Presets for individual items, click the Built-In icon or the Plug-In icon and choose a processor or plug-in from the pop-up menu.
- 4 From the pop-up menus above each column, choose the folders containing the elements you want to synchronize.
- 5 Click the Sync All button. The contents of the left and right columns are synchronized.

 *Using the Standalone software on a laptop computer, you can configure VENUE system routing, set up mixes, create Snapshots, and save Shows and Presets. You can then transfer your data to a USB disk for use on an SC48 console or other VENUE system. See Chapter 24, "Using the Standalone Software."*

Undoing Changes Using the History Feature

The VENUE system automatically saves the current state of the console while you are working, allowing you to quickly return the console to a previous state.

The History feature uses Show files to capture the console state, and displays the files in the History tab.

 *Show Folders and Show files displayed in the History tab can only be deleted. They cannot be duplicated or renamed.*

Show Folders in the History Tab

There are two Show Folders in the History tab:

- ◆ The *Most Recent Changes* folder includes all auto-saved Show files for a ten-hour period.
- ◆ The *Previous Days* folder includes only the last auto-saved Show file for each day since the console was last cleared.

Show Files in the History Tab

The auto-saved Show files displayed in the History Tab are named according to the date and time of their creation, and cannot be renamed.

The Notes field for each auto-saved Show file includes a description of the conditions that caused the automatic save.

Several conditions cause the system to automatically save a new Show file in the History tab, as follows:

- ◆ In the course of normal work, a new Show file is automatically saved in the History tab approximately every ten minutes. Saves are less frequent when the console is idle.
- ◆ A new Show file is automatically saved just prior to a significant change in the console setup, including:
 - Change of console channel or bus configuration
 - Recall, storage, or modification of a Snapshot
 - Loading of Console Settings or a Show

Loading an Auto-Saved Show

To return the console to an earlier state at any time, you can load any of the auto-saved Show files displayed in the History tab.

To load an auto-saved Show file:

- 1 Go to the Filing page and click the History tab.
- 2 In the Show Folders column, click the Show Folder name to select the folder and display its contents in the Shows column.
- 3 In the Shows column, click the name for the Show you want load.

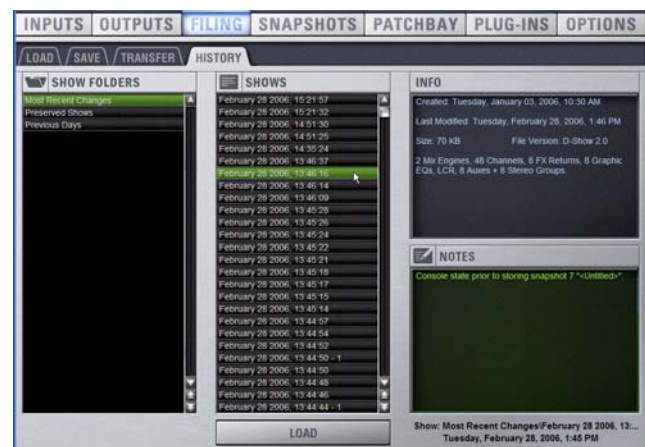

Loading an auto-saved Show file

- 4 Click the Load button.

The VENUE system loads the selected Show file, replacing the current system configuration, routing, and control settings with those contained in the selected file.

Chapter 21: Snapshots

Snapshots let you flexibly store and recall a wide range of mixing parameters. Snapshots are commonly used to store the mixer setup and levels for individual scenes, songs or sound cues in a performance. Snapshots store information about channels and mix parameters, and you can use a variety of methods to edit, preview, and manage snapshot data.

Snapshots are contained and stored as part of a Show. A single Show file can contain up to 999 snapshots. Snapshots are controlled from the on-screen Snapshots page, or from the Snapshot controls on the console. Once stored, snapshots can be recalled manually or automatically (triggered by events or MTC). Snapshots can also trigger events.

Snapshots Page

The Snapshots page provides controls for storing, recalling, and managing snapshots, providing a central location for setting up and replaying automated performances.

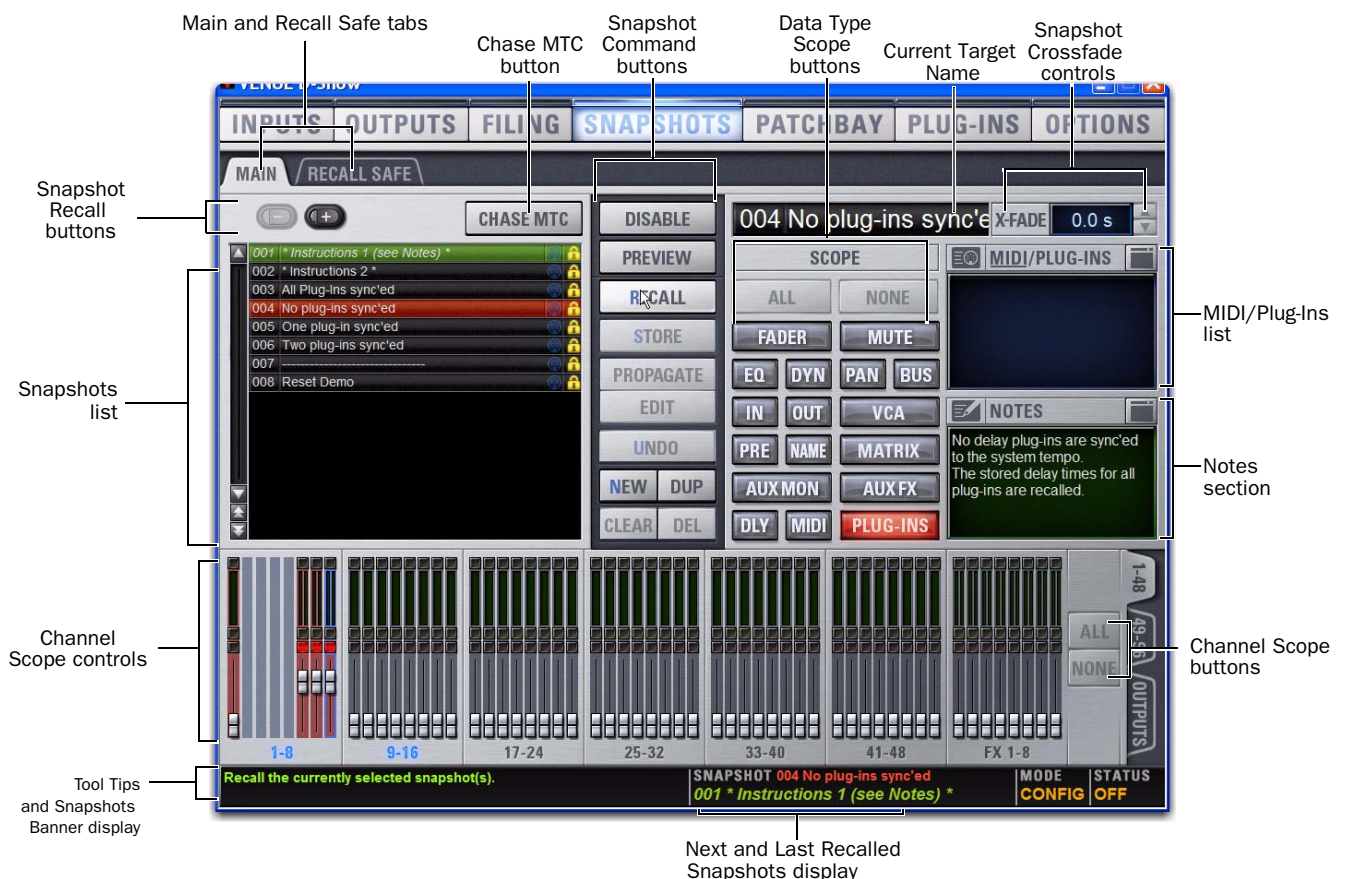



Figure 12. Sections of the Snapshots page

To display the Snapshots page, do one of the following:

- Click the Snapshots tab on-screen.
 - or –
- Press the Snapshots switch in the View Modes section (to the right of Channel Control).

 *Repeatedly pressing the Snapshots View Mode button toggles between the Main and Recall Safe tabs.*

Main and Recall Safe

The Snapshots screen provides the Main and Recall Safe tabs.

Main Provides the primary snapshot controls.

Recall Safe Provides a matrix of channel parameters that can be globally safed (or isolated) from Recall for all snapshots.

Snapshots List

Snapshots can be targeted, renamed, recalled, previewed, edited, locked, reordered, duplicated, searched, and deleted from the Snapshots list.

Snapshot Command Buttons

Disable Temporarily disables all snapshot functions.

Preview An “offline” mode in which the console continues to process audio using its settings at the time Preview is invoked, letting you recall, edit and manage snapshots without affecting the current mix.

Recall Recalls the targeted snapshot, updating the console to reflect the status of all scoped data types and channels in the snapshot (subject to the current Recall Safe settings).

Store Stores the current state of the console in the targeted snapshot for all data types and channels, overwriting any existing data in the snapshot.

Propagate Enables Propagate mode. Lets you apply isolated changes to one or more snapshots at once (such as updating a channel EQ across all snapshots).

Edit Enables Edit mode. Lets you adjust parameters freely and apply those changes to one or more snapshots. Changes can be applied in Absolute or Relative fashion.

Undo Returns the console to its state before the last snapshot command.

New Creates a new snapshot that captures the current state of all data types and channels.

Duplicate Creates a copy of the selected snapshots.

Clear Clears the contents of the targeted snapshot, but retains any associated MTC information.

Delete Deletes the targeted snapshots.

Snapshot Scope Controls

The selection of data types and channels to be recalled is referred to as the *scope* of a snapshot. The scope of data to be recalled is also stored within each snapshot.

The Snapshot Data Type buttons and on-screen Channels determine (and display) which data types are recalled for which channels on the console.

The Recall Safe tab provides global control of automation safe status for parameters on individual channels.

Scope States

Scoped Red display indicates that the data type or channel is currently scoped and will be affected by snapshot recall.

Not Scoped Gray display indicates that the data type or channel is not currently scoped and will not be affected by snapshot recall.

Data Type Scope Buttons

The Snapshot Data Type buttons display scope status for the corresponding types of controls on the console. See Table 23 on page 190 for a complete list.

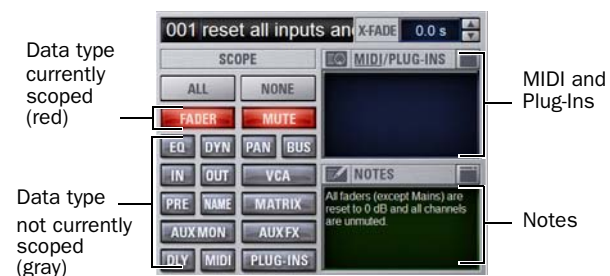

Data Type Scope buttons showing different scope states

Channel Scope Controls

Channels are included or excluded from snapshots by clicking them on-screen in the Snapshot Channel Faders display. The Snapshot faders display the scope status of each channel on the console, along with indication of the fader positions and mute states that will result by recalling the targeted snapshot.

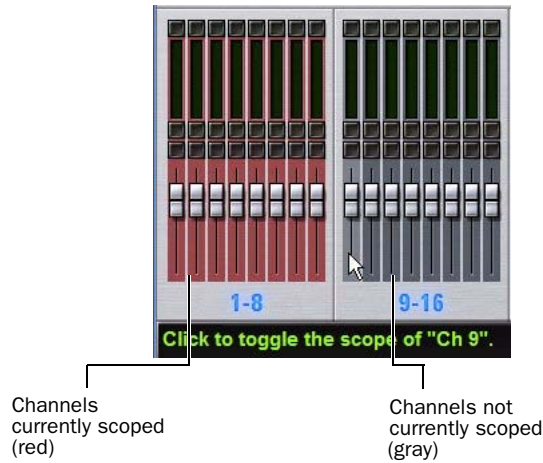

Snapshot channel fader display showing different scope states

Channel Fader Position

When you target a snapshot with scoped channels that have different fader positions from the current fader positions, the target fader positions are shown in bright red.



Snapshot channel fader display showing target fader positions

Channel Mute State

When you target a snapshot with scoped channels that have different mute states from the current mute states, the target mute buttons are outlined in yellow.



Snapshot channel fader display showing target mute states

Selected Channel Indication

The Snapshots page indicates the currently selected channel.

- ◆ If the selected channel is not scoped in the currently selected snapshot, it is indicated with a blue highlight.
- ◆ If the currently selected channel is scoped in the currently selected snapshot, it is indicated by a blue outline around the on-screen fader strip.

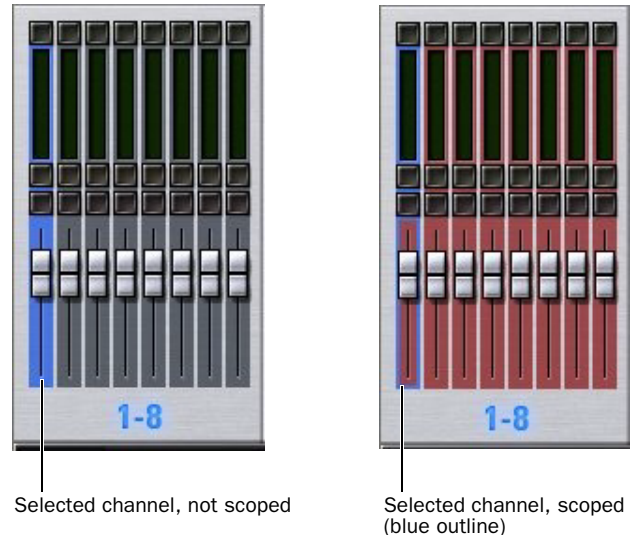

Selected channel indication in the Snapshots page

Though the currently selected channel is displayed in the Snapshots page, keep in mind that you cannot target a different channel from this page. The currently selected (target) channel is indicated for visual reference only. To select and target a different channel, use the channel Select switches or the Channel Scroll buttons.

Data Type Scope Action Buttons

All Turns on the scope for all data types at once. This is equivalent to clicking all of the Data Type buttons so they are red.

None Turns off the scope for all data types at once. This is equivalent to clicking all of the Data Type buttons so they are gray.

Channel Scope Action Buttons

All Turns on the scope for all channels displayed on the current tab (such as 1–48). Double-clicking the All button turns on the scope for all channels on the system.

None Clicking the None button turns off the scope for all channels on the current tab. Double-clicking the None button turns off the scope for all channels on the system.

Next Snapshot Indication in Status Display

The Snapshot Status display shows the currently targeted (next) snapshot in red text directly above the display of the last (most recently recalled) snapshot. Pressing the Snapshot Recall button immediately recalls the targeted snapshot and makes it the last recalled snapshot.



Next and Last Recalled snapshot display in the Status area

Snapshot Controls on the SC48 Console

Snapshot controls are provided in the Snapshots section. These controls provide direct access to a few basic snapshot commands and allow manual control of snapshot recall.

Snapshots Section

You can target (select), store, and recall snapshots from the Snapshots controls in this section.

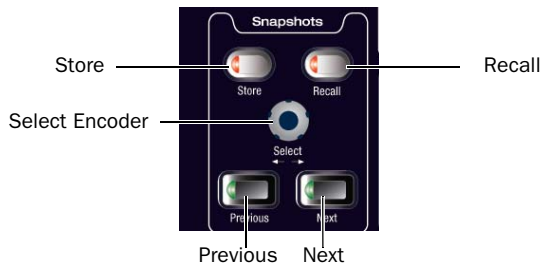

Snapshots section on the SC48 console

The Snapshot controls in the Snapshots section perform the following functions:

Store Stores the current state of all console parameters in the targeted snapshot. This switch mirrors the Store button in the Snapshots page.

Recall Recalls the targeted snapshot. This switch mirrors the Recall button in the Snapshots page.

Select Encoder Turning the Select encoder scrolls through and selects the targeted snapshot in the Snapshots list. The 6-character display shows the name of the currently targeted snapshot. A period is appended to the displayed snapshot name to indicate whenever it has been edited since being recalled.

Previous Instantly recalls the snapshot prior to the most recently recalled snapshot. This switch mirrors the Recall Previous button in the Snapshots page.

Next Instantly recalls the snapshot immediately following the most recently recalled snapshot. This switch mirrors the Recall Next button in the Snapshots page.

⚠ *The Previous and Next switches combine target and recall actions in one step, causing the next or previous snapshot to be instantly active. These switches cannot be used to preview snapshots before recalling them.*

F1 for Preview Mode

When the Mute Groups/Function section is in Function mode, pressing F1 engages Preview mode (see “Preview Mode” on page 181).

💡 *For more information on how to use the Event List to customize this or other console functions, see Chapter 22, “Events.”*

Snapshots List

Snapshot Entries

Each entry in the Snapshots List has a number (001–999) and name, along with icons for Lock and Enable status. If either the MIDI Read or Generate feature is enabled, each snapshot will also have a time code value, trigger indicator, or send indicator. Tempo can also be shown, instead of MIDI.

Recall Buttons

The Recall Previous (–) and Recall Next (+) buttons at the top of the Snapshots List cause the previous or next snapshot to be targeted and recalled in one step.

Chase MTC

Enables or suspends automated recall of snapshots when either the MTC Read or MTC Generate option is enabled.

Navigating the Snapshots List

Snapshots are highlighted in color in the Snapshots list to indicate the following:

Green Indicates the last recalled snapshot

Red Indicates the currently targeted snapshot

Yellow Indicates that the snapshot is both the last recalled and currently targeted snapshot

Blue Indicates that the snapshot is part of a multiple snapshot selection but not the last recalled or currently targeted snapshot. Recalled and Targeted snapshots can also be part of a multiple selection in the list. In this case, the sequence number is blue while the rest of the name is red, green or yellow.

Snapshot Keyboard Shortcuts

When the Snapshots page is displayed, you can perform the following Snapshot functions with these keyboard shortcuts:

Snapshot Function	Keyboard Shortcut
Target Next/Previous Snapshot	Up/Down Arrow keys
Target First Snapshot in List	Home key
Target Last Snapshot in List	End key
Target Snapshot at Top of Page	Page Up
Target Snapshot at Bottom of Page	Page Down
Select Multiple Contiguous Snapshots	Shift-click snapshots
Select Multiple Non-Contiguous Snapshots/Deselect any Snapshot	Ctrl-click snapshots
Select All Snapshots	Ctrl+A
Create New Snapshot	Ctrl+N
Recall Targeted Snapshot	Ctrl+R
Store Targeted Snapshot	Ctrl+S
Undo	Ctrl+U
Add or update MIDI/Plug-in data to snapshot	Right-click MIDI/Plug-ins entry

Selecting Snapshots

You can select single snapshots or multiple snapshots in order to target, recall, duplicate, edit, lock or delete them in the snapshots list.

To select multiple contiguous snapshots:

- Shift-click the snapshot names in the Snapshots list.

To clear a selection of multiple contiguous snapshots:

- Click any snapshot name in the Snapshots list.
 - or –
- Turn the Select knob in the Snapshots section.

To select or de-select non-contiguous snapshots:

- Ctrl-click the snapshot names in the Snapshots list.



Multiple items selected in the Snapshots list

Snapshot Type Text Search

Type Text search lets you use the keyboard for fast navigation of the Snapshots List.

To search for and target a snapshot:

- Go to the Snapshots page.
- Do one of the following:
 - Type the number of the snapshot.
 - or –
 - Type the first letters of the snapshot name.
- Press the Tab key to cycle through any snapshots that start with the same letter.

Centering the Snapshot List

The Options > Snapshots page provides a preference setting to always center the Snapshot list on the last recalled snapshot. This setting lets you always view the snapshots immediately above and below (prior to and following) the last recalled snapshot. This setting only affects the scroll position of items in the Snapshot list.



Snapshot list with Center Last Recalled Snapshot enabled

To center the Snapshot List on the last recalled snapshot:

- Go to the Options > Snapshots page.
- In the Snapshots General Preferences section, click to select the Center Last Recalled Snapshot setting.

Creating Snapshots

Snapshots can be created at any time to store the current channel and parameter settings. You can create new snapshots manually in the Snapshots page (see “Creating New Snapshots” on page 172), or by duplicating existing snapshots to build your mix as you work.

 Use the first snapshot in a Show file to establish the basic settings for a performance. For subsequent snapshots, use the scope controls and Recall Safe settings to selectively recall only those controls that need to change between sections or songs, leaving other controls unaffected by snapshot recall.

Creating New Snapshots

When you create a snapshot, it captures the current state of all console settings.

To create a new snapshot:

- 1 Set all parameters on the console whose state you want to store in the snapshot.
- 2 Click New. The new snapshot appears in the Snapshots List.
- 3 For each channel you want affected when the snapshot is later recalled, click the channel so that it is scoped (displayed in red).



Adding channels to the scope of a snapshot

 To quickly select (or de-select) banks of channels, click their blue labels below the Channel Faders in the Snapshots page.

- 4 For each parameter of the scoped channels you want affected when the snapshot is later recalled, click the corresponding Data Type button so that it is scoped (displayed in red).



Plug-ins included in the scope of a snapshot

 When you create a new snapshot it automatically inherits the channel and data type scope of the currently targeted snapshot.

 The New command can be undone.

Naming Snapshots

New snapshots are automatically numbered and appear as “<Untitled>” in the Snapshots list. Snapshots can be renamed at any time. You can undo snapshot naming operations.

To name a snapshot:

- 1 Do one of the following:
 - Double-click the snapshot name in the Snapshots list or the current target name display.
 - or –
 - Right-click the snapshot name and choose Rename.
- 2 Type a name for the snapshot.
- 3 Press Enter on the keyboard or click another snapshot name.

Adding Notes to Snapshots

You can add notes to snapshots at any time. You do not need to store the snapshot to save the notes in the snapshot.

To add or edit comments for a snapshot:

- 1 Double-click the Notes header or click the list icon to expand the Notes field.
- 2 Double-click in the Notes field and enter text.

Recalling Snapshots

Targeting Snapshots

Targeting a snapshot lets you preview which data types and channels will be affected by that snapshot before recalling it. When a snapshot is targeted, the on-screen Data Type buttons and Channel Faders update to show the data types and channels enabled for recall by the snapshot.

 *Preview mode lets you take the console offline to recall and edit snapshots in their entirety without affecting the current mix. See “Preview Mode” on page 181.*

To target a snapshot, do any of the following:

- Click the snapshot name in the Snapshot list.
- Type the number or name of the snapshot on the keyboard.
- Press the Home/End, Page Up/Page Down, and Up/Down Arrow keys to navigate the Snapshot list.
- Turn the Select knob in the ACS to scroll through the Snapshot list. Snapshot names appear in the display above the Select knob.

The current target snapshot is highlighted in red in the Snapshots list, and shown in red in the Status display.

Recalling Snapshots

You can do the following when recalling snapshots:

- Target and instantly recall successive snapshots (next or previous)
- Target first, then recall one or more snapshots
- Select multiple snapshots and recall them all sequentially
- Target snapshots, change Data Type or Channel Scope settings, then recall.

 *Undoing snapshot recall commands might cause audio to be interrupted. Use Undo with caution in performance.*

Recalling Successive Snapshots Instantly

You can instantly recall successive snapshots in the Snapshots list. This command references the previously recalled snapshot, not the last targeted snapshot.

To instantly recall successive snapshots, do one of the following:

- On the console, press the Previous or Next switch in the Snapshots section.
– or –
- On-screen, click the Recall Previous (–) or Recall Next (+) button at the top of the Snapshots list.

 *The Snapshot Recall buttons combine target and recall actions in one step, causing the previous or next snapshot to be instantly active. These buttons cannot be used to preview snapshots before recalling them.*

Targeting Before Recalling Snapshots

To target and then recall a snapshot:

- 1 Target the snapshot you want to recall by clicking the snapshot name in the Snapshot list, or turning the Select knob in the Snapshots section.
- 2 (Optional) Set the scope of the snapshot by doing the following:
 - For each channel you want to recall in the snapshot, click the channel so that it is scoped (displayed in red).
 - For each parameter of the scoped channels you want to recall in the snapshot, click the corresponding Data Type button so that it is scoped (displayed in red).
 - Configure the Recall Safe page to further filter snapshot data on recall. (See “Recall Safe and Channel Automation Safe” on page 174.)
- 3 Click the Recall button on-screen, or press the Recall switch in the Snapshots section.

 *Snapshot Recall can also be triggered by a footswitch or any number of other console functions in the Events window. For more information, see Chapter 22, “Events.”*

Selecting and Recalling Multiple Snapshots

You can select and recall multiple snapshots to load them all in sequence, and in one step. This is useful to quickly reset the console to a sub-cue or other specific point within a longer scene or cue and “pick up from there.”

To recall multiple snapshots:

- 1 Select multiple snapshots in the list (Shift-click to select multiple adjacent (contiguous) snapshots; Ctrl-click to select non-contiguous items or to deselect a single item).
- 2 Press the Recall switch, or click the Recall button on-screen.

 *If multiple snapshots are selected, toggling Data Type or Channel Scope buttons affects all selected snapshots. This provides a quick way of removing a channel or data type (such as EQ) from some or all snapshots. This action can be undone using the Undo button.*

Recall Safe and Channel Automation Safe

The Recall Safe tab in the Snapshots page provides global automation safe settings of nearly every section of the console.

You can also place individual channels in automation safe from the console or on-screen. For more information, see “Automation Safing Channels” on page 177.

Recall Safe

Recall Safe lets you select which parameters on which channels you want to be ‘safed’ from snapshots.

Recall Safe is global to all snapshots, can be turned on or off quickly, and provides preset capabilities in the form of Scope Sets. Scope Sets can be loaded and saved just like Presets for built-in EQ, Dynamics, and plug-in settings. Current Recall Safe settings are stored with the Show file.

Recall Safe Tab

The Recall Safe tab opens the Recall Safe page on-screen. The Recall Safe tab is red when Recall Safe is on and in effect, and gray when Recall Safe is off or when nothing is safed.



Indication of active Recall Safe from the main Snapshots page

Recall Safe Displays and Controls

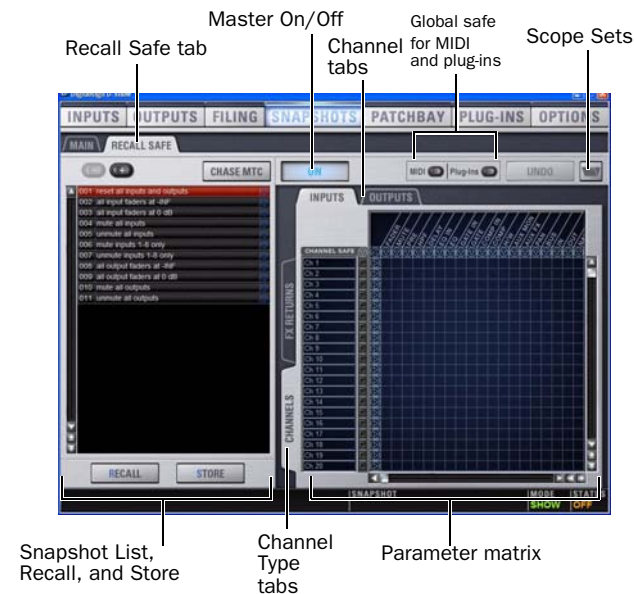

Displays and controls in the Recall Safe page

On

The master On button toggles the entire Recall Safe feature on or off globally. When lit (blue), Recall Safe is active. When dark, Recall Safe is suspended.

Snapshot List, Recall and Store

The Snapshot List and its Recall and Store functions remain visible and available from the Recall Safe page at all times.

Channel Tabs

The Inputs and Outputs tabs at the top of the parameter matrix selects the channel type whose safe status you want to view or edit. Along the left side of the parameter matrix are channel Type selector tabs, which will change depending on whether you are viewing Input or Output tabs.

 Shift-click channel type tabs to view more than one type at once in the scrollable parameter matrix.

Global Safe for MIDI Output and Plug-Ins

These checkboxes let you globally suspend recall of MIDI output and/or plug-in changes. They are considered separate from the parameter matrix and do not follow the Recall Safe master On (or Off) status.

Scope Sets

Scope Sets are presets for the Recall Safe page that can be stored and loaded, just like plug-in, EQ and Dynamics presets. Scope sets can be used as a template when creating new shows, or used to change Recall Safe settings during a performance. Like other presets and settings files, Scope Sets can be transferred from the Filing page, making it easy to maintain and transfer Recall Safe configurations. For more information, see “Using Scope Sets” on page 176.

Parameter Matrix

The parameter matrix is a scrollable grid in which you can safe parameters and channels. You can undo and redo parameter matrix operations.

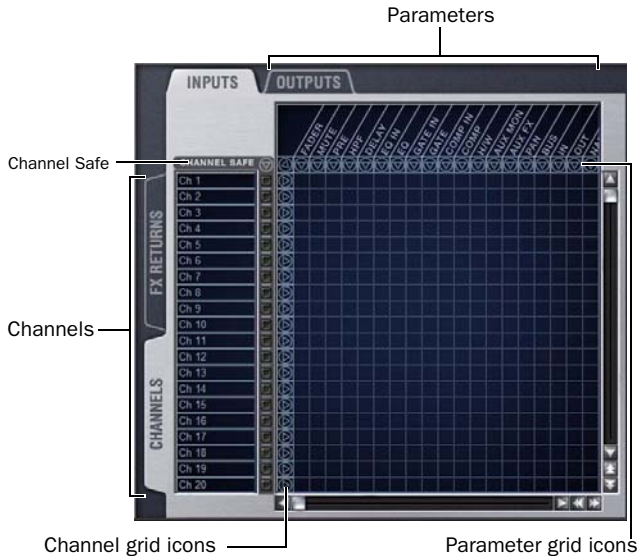

Parameter matrix for Recall Safe

Parameters are represented in the columns of the parameter matrix; channels are listed along the left side in rows.

Clicking in the grid enables safe status for that parameter on that channel. Parameter and Channel grid icons provide shortcuts to “safe all” parameters in a single-click, and to safe entire channels. Clicking these icons lets you quickly toggle recall safe status for entire columns and rows. You can also use the master grid icon located in the upper left most corner to toggle the entire grid.

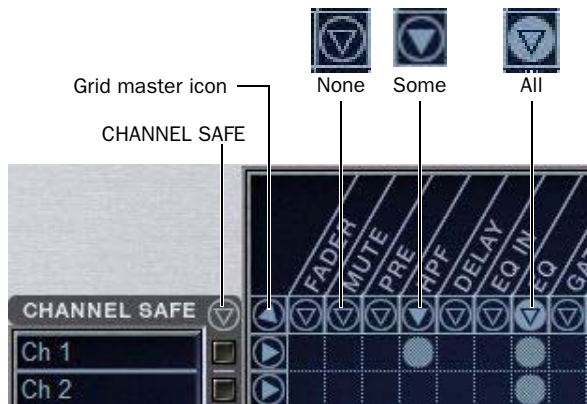

Display states for grid icons in Recall Safe

The display state of the Parameter and Channel grid icons indicate safe status for that column or row as follows:

None A dark Parameter or Channel grid icon indicates that no items in that column or row are safe enabled.

Some A dark triangle inside a lit blue circle indicates that at least one item in that column or row is safe enabled.

All A lit (white) triangle indicates that all items in that column or row are safe enabled.

Channel Safe Controls

The CHANNEL SAFE column acts as a global “all channel” setting or override, mirroring the SAFE switch on the console and on-screen (when in Input Safe Switches act as Automation Safes mode).

Controls in the CHANNEL SAFE column are not part of the parameter matrix; they function *in addition to* the parameter matrix. As a result, you do not need to enable any CHANNEL SAFE settings to use the Recall Safe parameter matrix.

For more information, see “Automation Safing Channels” on page 177.

Using Recall Safe

To access the Recall Safe page:

- Do one of the following:
 - Go to the Snapshots page and click the Recall Safe tab.
 - or –
 - Double-press the Snapshot View switch until the Recall Safe tab is displayed.

2 Click a channel type tab to display the desired channels.

To safe individual parameters on specific channels:

- Click in the grid at the intersection of the appropriate parameter (column) and channel (row). A blue dot appears, indicating a parameter is safed.



Enabling recall safe for channel 1 fader

To safe multiple parameters or channels at a time:

- Click and drag in a column, across a row, or at an angle.

To save individual parameters or channels using the computer keyboard:

- 1 Place the cursor above the grid, above a parameter or channel name, or above any Channel Safe button. To be sure the cursor is above a valid area, you should be able to see at least one parameter name or channel name highlight.
- 2 Use the Arrow keys of the computer keyboard to move the cursor right, left, up, or down to other grid points. (You cannot navigate to parameter or channel grid icons, or to the Channel Safe column.)
- 3 Press Enter to enable or disable safe status for the currently focused grid point. Continue navigating to and toggling safe status of other parameters and channels.

To save a parameter across all currently displayed channel types:

- Click the Parameter grid icon at the top of the appropriate column until the triangle is white.

To save all parameters for a particular channel:

- Click the Channel grid icon in the ALL column for that channel (row).

To toggle the status of a parameter column or channel row:

- Click the appropriate Parameter or Channel grid icon repeatedly until it displays the desired status. For more information, see “Parameter Matrix” on page 175.

To save all parameters across all channels and clear any current settings:

- Click the triangular icon at the top of the ALL column.

 You can undo or redo the last action taken in the parameter matrix.

Channel Safe

To automation safe an individual channel and retain all recall safe settings for that channel:

- Click in the CHANNEL SAFE column for the desired channels.

 A channel (row) Channel Safe button does not need to be lit in order to Recall Safe individual parameters for that channel.

To automation safe all parameters across all channels and retain all current recall safe settings:

- Click the CHANNEL SAFE master icon at the top of the Channel Safe column.

 The Channel Safe column mirrors the channel automation Safe controls. For more information, see “Automation Safing Channels” on page 177.

MIDI

To enable Recall Safe for MIDI Snapshot output:

- Click the MIDI Snapshot Output Safe button, located above the parameter matrix.

 For more information, see “Adding MIDI Messages to Snapshots” on page 185.

Plug-Ins

To enable Recall Safe for plug-ins:

- Click the Plug-In Snapshot Safe button, located above the parameter matrix.

 For more information, see “Adding Plug-In Data to Snapshots” on page 186.

Matrix

Snapshots can store and recall all source assignments of each matrix mixer when the Matrix data types is scoped. In addition, all User Input assignments are stored, letting you reconfigure Matrix mixers and User Input assignments on a per snapshot basis, if desired.

The Recall Safe tab of the Snapshots page provides two data “Mix” data types that let you discretely “safe” source and/or user input assignments to prevent them from being changed with a snapshot recall.

The following table describes what can be stored and recalled in each snapshot when the Matrix data types is scoped.

Table 22. Snapshot data types and parameters for Matrix mixers

Snapshot Data Type	Included Parameters (for Each Scoped Channel Strip)
Matrix	Mixer Input Sources, User Input Assignments (global to all Matrixes), and pickoffs; Mixer Input level, Mixer Input on/off and Mixer Input Link

Using Scope Sets

The configuration of the Recall Safe page can be stored as a Scope Set settings file. Scope Sets can be previewed, recalled and transferred just like plug-in, EQ and Dynamics settings.

To store the current Recall Safe settings as a Scope Set:

- 1 Configure the Recall Safe page as desired.
- 2 Click the Scope Sets icon (the folder icon located above and to the right of the parameter matrix).
- 3 Click New.

To preview and recall a saved Scope Set:

- 1 From the Recall Safe page, click the Scope Set icon to display the Scope Set window.
- 2 If necessary, choose the appropriate Scope Sets folder by clicking and selecting it from the Folder selector.
- 3 Do any of the following:
 - To preview an existing Scope Set, click its name in the Scope Sets window.
 - To load the currently selected Scope Set, press Enter or click the Close box (X) in the Scope Sets window title bar.
 - To cancel without changing Recall Safe settings, click Cancel.

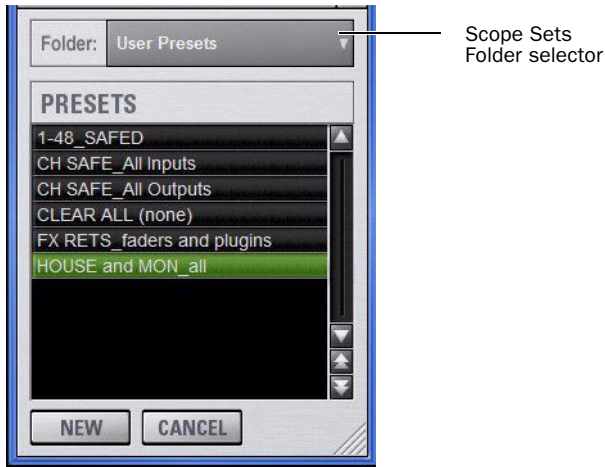

Scope Sets window

💡 See Chapter 20, “Shows and File Management” for complete information on transferring system data.

Automation Safing Channels

Input Safe switches (both console and on-screen) can be set to Automation, Solo, or Bank Safe modes. When set to act as Automation Safes, the Input Safe Switches let you suspend the effect of snapshots on all parameters of individual Input Channels and FX Returns.

💡 You can also control channel automation safe status in the Recall Safe tab. See “Channel Safe” on page 176.

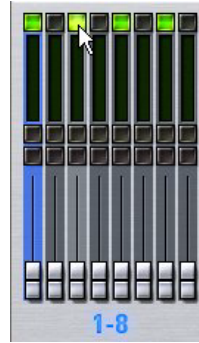

On-screen Automation Safe button

To toggle the Safe status of an Input Channel or FX Return directly from the channel strip:

- 1 Go to the Options page and click the Interaction tab.
- 2 Under , select the Act as Automation Safes option.
- 3 Press the Safe switch in the Input section, or click the on-screen Safe button for each of the Input Channels or FX Returns you want to safe. The Safe switch lights solid to indicate that the channel is automation safed.

💡 You can use the Event List to be able to cycle through the various Input Safe Switch modes using a footswitch, function switch or other available trigger. See Chapter 22, “Events.”

Managing Snapshots

You can manage snapshots in the list by storing, locking, clearing, duplicating, deleting, or moving them.

Storing Snapshots

You can modify the contents of an existing snapshot, overwriting it with new settings, using the *Store* command. It is not necessary to recall a snapshot to store it. Snapshots can be stored from on-screen or from the snapshot controls on the console. You can undo Store commands.

To store the current console state in an existing snapshot:

- 1 Set all parameters on the console as you want them to be stored in the snapshot.
- 2 Select the snapshot in the on-screen Snapshot list, or turn the Select knob in the Snapshots section to target a snapshot you want to overwrite.
- 3 Click the Store button on-screen, or press the Store switch in the Snapshots section.
- 4 Set the scope by doing the following:
 - For each parameter you want to be affected when the snapshot is recalled, click the corresponding Data Type button so that it is scoped (displayed in red).
 - For each channel you want affected when the snapshot is recalled, click the channel fader so that it is scoped (displayed in red).

Locking Snapshots

Snapshots can be *locked* to prevent them from being accidentally altered, overwritten or deleted.

Locked snapshots can be selected, recalled, moved and duplicated. They cannot be overwritten, renamed, rescoped or otherwise changed. New and duplicated snapshots default to unlocked. Lock status can be changed at any time, including while in Preview mode.

To lock a snapshot:

- 1 Go to the Main tab of the Snapshots page.

- 2 In the Snapshot list, click the padlock icon at the far right of the row for any item. The padlock icon illuminates to indicate the snapshot is now locked.

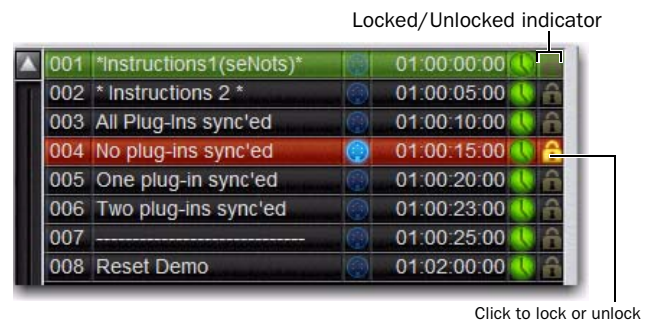

Snapshot lock controls

Select multiple snapshots using the Shift key or Multi-Select switch to lock or unlock multiple snapshots at once.

Once locked, operations that would otherwise affect the snapshot cause the Status display and channel LCDs and Snapshot LCD to temporarily show a message reminding you that the operation cannot be applied while the snapshot is locked.

To unlock a snapshot:

- Click the lit padlock icon in the row for that snapshot.

You can undo locking or unlocking of a snapshot by clicking the Undo button.

Undo and Locked Snapshots

You can undo locking or unlocking a snapshot. When toggling lock status for a selection of more than one snapshot, the entire operation creates a single undo point (it does not track and provide undo for each individual snapshot in the selection).

⚠ *Keep in mind that Undo can revert snapshots to “unlocked” status. For example, if you change the scope of an unlocked snapshot, lock the snapshot and then use Undo, the snapshot is unlocked. Pressing Undo one more time will revert the snapshot to its original scope.*

Locking Snapshots and MIDI Record

When using the MIDI Record feature, all MIDI data captured up to the point a snapshot is locked is preserved. If the MIDI Record operation is still active at the time the snapshot is locked, record mode is exited, the REC button becomes unavailable for that snapshot, and subsequent incoming MIDI messages are not captured.

Available Operations with Locked Snapshots

The following table details which operations can or can not be performed on a locked snapshot.

Summary of allowed/disallowed operations when locked

Operation	Allowed while Locked	Disallowed while locked
Select/target snapshot	X	
Recall snapshot	X	
Duplicate snapshot	X	
Re-sequence in snapshot list by:		
• Dragging in snapshot list	X	
• Manually editing sequence number	X	
• Re-sorting by time code	X	
Overwrite (Store to locked snapshot)		X
Propagate changes		X
Apply Edit mode changes		X
Clear		X
Delete		X
Modify Scope		X
Add/Modify stored MIDI data		X
Add/Modify stored Plug-In data		X
Modify Notes		X
Modify X-Fade time		X
Modify Snapshot Name		X
Modify Time Code Location		X
Toggle Time Code Enable		X
Undo changes	X	

Clearing Snapshots

The contents of a snapshot can be cleared while keeping the snapshot in the Snapshot list and retaining its MTC information. This lets you maintain a placeholder that you can use later to store new data. You can undo Clear commands.

To clear the contents of a snapshot:

- 1 Select the snapshots you want to clear.
- 2 Click Clear. Cleared snapshots are renamed "<Empty>."

Duplicating Snapshots

Snapshots can be duplicated from the Snapshots list. You can undo Duplicate commands.

To duplicate snapshots:

- 1 Select the snapshots you want to duplicate.
- 2 Do one of the following:
 - Click Dup (Duplicate).
 - or –
 - Right-click the snapshot name and choose Duplicate.

A copy of each selected snapshot is placed after the selection, with a plus sign (+) appended to the original snapshot name.

If multiple snapshots are selected in the list, the new (duplicate) items are added below their original source snapshots.

Deleting Snapshots

Snapshots can be deleted from the Snapshots list. You can undo Delete commands.

To delete snapshots:

- 1 Select the snapshots you want to delete.
- 2 Do one of the following:
 - Click Del (Delete).
 - or –
 - Right-click the snapshot name and choose Delete.

The snapshots are removed from the Snapshots list, and succeeding snapshots are renumbered.

Moving Snapshots

Existing snapshots can be rearranged in the Snapshots list. When you move one or more snapshots, they are automatically renumbered in the list, but MTC values are left unchanged. You can undo a snapshot move.

To move a snapshot, do one of the following:

- Drag the currently selected snapshots to a new location in the Snapshots list.
 - or –
- Double-click the snapshot number in the Snapshots list or the banner display, type a new number, and press Enter on the keyboard.

Making Changes to Snapshots

There may be situations where you need to change specific parameters in existing snapshots while leaving other parameters unchanged.

For example, if a guitarist changes instruments in the middle of a tour it might be necessary to change levels and EQ on the guitar channel in all the snapshots in a show. Snapshots provides the following modes to accommodate these types of situations:

Edit Mode Lets you capture individual control changes while you mix, and apply those changes to one or more pre-existing snapshots as absolute or relative changes. For example, you could enter Edit mode the first time a guitarist uses a new guitar in rehearsal. When you are satisfied with your settings you can apply them (in absolute or relative fashion) to update other snapshots. See “Using Edit Mode” on page 180.

Propagate Mode Lets you update data in pre-existing snapshots after you've already made changes and decided you want to keep them. While Edit mode requires you to know ahead of time that you will be updating snapshots, Propagate mode lets you decide to update other snapshots with current settings after making adjustments to your mix. For example, if its the third consecutive night you've reached to increase gain on the DI channel for a new guitar, you could use Propagate mode to quickly take the gain increase you just made and apply it to other snapshots. See “Using Propagate Mode” on page 181.

 *Events-driven recall of snapshots is disabled while in Propagate or Edit mode. For more information, see Chapter 22, “Events.”*

Using Edit Mode

Edit mode is a powerful way to update specific parameters across multiple snapshots without overwriting any settings you want to preserve. By entering Edit mode before making adjustments, you can edit a single control or any number of controls, and your changes are tracked from the point Edit mode was entered.

 *The ability to edit a single control in Edit mode provides more selectivity than Propagate mode.*

Absolute and Relative Edits

Changes can be applied to one or more selected snapshots as *absolute* or *relative* values. Any parameter can be edited in absolute fashion; all dB parameters can be edited in relative fashion.

Examples of Absolute and Relative Edits

Absolute Changing a fader level from 0 dB to -3 dB and applying that change as Absolute results in that fader being set identically to -3 dB in all selected snapshots.

Relative Changing a fader level from 0 to -3 dB and applying that change as Relative results in that fader being reduced by that amount in all selected snapshots, or 3 dB relative to the value previously stored in the snapshot(s). For example, a channel previously at -6 dB would be changed to -9 dB.

Making Relative Changes with Mixed Data Types

If a combination of dB and non-dB parameters (such as gain and EQ frequency) are edited and applied in relative fashion, the dB parameters are adjusted as relative (delta) changes and the non-dB are applied as absolute changes.

To update specific parameters in existing snapshots using Edit mode:

- 1 Navigate to the main Snapshots page.
- 2 Click the Edit button to enter Edit mode. The Edit button changes into two smaller flashing buttons: Abs, and Rel. The system begins tracking all changes while you make them.



Edit mode

- 3 Adjust any combination of snapshottable parameters on the console or on-screen.
- 4 Select the snapshot(s) to which you want to apply your edits.
- 5 Click either of the flashing buttons Abs (for Absolute) or Rel (for Relative). You can cancel Edit mode by pressing the Cancel button on the control surface, clicking the Cancel button on-screen, or by pressing the ESC key on your computer keyboard.

The selected snapshots are updated according to your changes and your choice of Absolute or Relative edit.

Using Propagate Mode

You can use the Propagate command to capture changes and apply them to existing snapshots. Propagate mode is most useful when you realize during the course of mixing that you want to capture your current settings to use in other snapshots. You can undo Propagate commands.

To update specific parameters in existing snapshots:

- 1 Make sure the channel is set as needed.
- 2 Click Propagate. The current data and channel scope is cleared.
- 3 Set the scope to reflect only those parameters you want to update by doing the following:
 - For each parameter you want to update, click the corresponding Data Type button so that it is scoped (displayed in red).
 - and –
 - For each channel you want to update, press its channel Select switch on the console, or click the channel on-screen so that it is scoped (displayed in red).



Propagating an EQ change for a channel

- 4 Select the snapshot or range of snapshots you want to update in the Snapshots list.
- 5 Click Propagate. The scoped parameters are updated in the selected snapshots.

Preview Mode

Preview mode lets you recall, store and edit snapshots without affecting the current mix.

When enabled, Preview mode takes the console offline from the live audio mix so you can “work ahead” during a rehearsal, performance or event to preview upcoming snapshots and edit them as needed. Any control that can be stored and recalled by snapshots is available while in Preview mode, and you can also modify the Snapshot List. Once you are done previewing or editing snapshots, you can store your changes to update the existing snapshots with your changes.

Using Preview Mode

The basic workflow for using Preview mode is as follows:

- 1 Make sure your active mix is set as desired, and make sure the rehearsal, event or performance has an upcoming opportunity for you to go offline.
- 2 Enter Preview mode by pressing F1 on the console, or by clicking the on-screen Preview button in the main Snapshots page. The word “PREVIEW” flashes in red across the screen for confirmation; on the console, the F1 (Preview) switch flashes, as do all input and output channel strip displays.



Preview mode

- 3 Do any of the following:

Edit the Snapshots List Reorder snapshots in the list, if desired, by clicking and dragging them. Changes to the order of items in the Snapshots list may affect the current active mix if the affected snapshots rely on MIDI or MTC triggering. (For more information, see “Changing Console Settings in Preview Mode” on page 182.)

Create a New Snapshot Adjust settings as desired and create a new snapshot by clicking New. (See “Creating New Snapshots” on page 172.)

Recall and Edit an Existing Snapshot Recall a snapshot to preview its settings and make any adjustments necessary, being sure to re-store the snapshot before exiting Preview mode. Storing a snapshot in Preview mode does not affect previously stored MIDI or Plug-in data (if any).

Edit Channel and Scope Settings Edit any channel settings, parameters, or scope associated with the snapshot being previewed. The Snapshots page displays the current snapshot name in italics to indicate that at least one parameter has been changed, and the Channel Faders show you the previous level for each channel in bright red. Scope Data Type buttons and Channel Scope functionality remain live and active at all times (in other words, changes made to these controls while in Preview mode will remain once Preview mode is exited).

Add and Edit MIDI or Plug-In Data To add MIDI or plug-in data associated with the snapshot, click the Add button in the MIDI or Plug-Ins snapshot list. With plug-ins this adds the current online plug-in settings to the snapshot. If you need to update pre-existing MIDI or plug-in data associated with a snapshot, right-click the corresponding entry in the MIDI/Plug-ins view of the Snapshots page and choose the Update option (this option will include the plug-in rack position, and the name of the associated snapshot). For more information, see “Plug-Ins and MIDI in Preview Mode” on page 183.

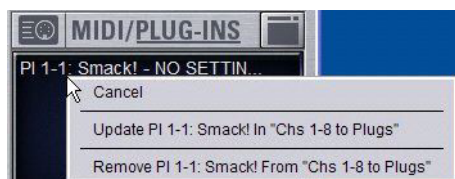

Updating snapshot plug-in data

4 To undo an action made while in Preview mode, click the Undo button on-screen. (For more information about Undo in Preview mode, see “Making Changes to Snapshots” on page 180.)

5 To update the currently previewed snapshot but remain in Preview mode, press or click Store.

6 Continue previewing and editing settings as needed (all snapshot functions are available in preview mode).

7 When you are finished and need to exit Preview mode, press F1 (or click the on-screen Preview button).

⚠ *Exiting Preview mode without storing will discard the changes made while in Preview mode (Preview mode is cleared each time you exit). You must explicitly store changes to update the associated snapshots.*

Undo and Preview Mode

In Preview mode, you can Undo actions applied to the Snapshot List (such as Recall, Store, New and Duplicate) without affecting the online mix.

 *Multiple levels of Undo are available.*

Changing Console Settings in Preview Mode

The system tracks any changes to console settings or to the Snapshot List while in Preview mode, but only Snapshot List actions create an Undo point. Choosing Undo will undo the last action you took while in Preview mode, up to a maximum of 100 levels of Undo. Any changes to console settings made after the last Preview action are also undone (the Snapshot screen is returned to its exact state prior to the action that created the Undo point).

Changing the Snapshot List in Preview Mode

Changes made to the Snapshot List are automatically tracked and available for Undo, regardless of whether Preview mode is enabled or not. This includes any Recall of snapshots triggered by incoming MIDI or MTC while in Preview mode.

For example, if a MIDI Snapshot Recall occurs while you are in Preview mode, the online mix will be updated with that snapshot. Pressing Undo immediately after that Recall will undo that Snapshot recall and revert the online mix to its state prior to the Undo.

Consider turning off the Chase MTC option while in Preview mode to disable all MIDI recall of snapshots. In addition, you can always use the History feature to recover from any unexpected results.

Changing MIDI or Plug-In Data in Preview Mode

Changes made to MIDI and Plug-In data cannot be undone. For more information, see “Adding MIDI Messages to Snapshots” on page 185 and “Adding Plug-In Data to Snapshots” on page 186.

 *Take advantage of Tool Tips in the banner display to confirm what action the Undo button will revert. See “Undoing Snapshot Commands” on page 184.*

Available and Unavailable Functions in Preview Mode

In order to maintain essential mix indicators and controls while in Preview mode, not all functions are taken offline.

The following sections detail what is and what is not available during Preview mode.

Always Active

Certain essential mix functions remain live and active at all times, regardless of whether Preview mode is enabled. The following vital mix functions continue to affect or be affected by the console and software:

- Metering (including input, output and dynamics meters, clip and bank clip indicators)
- AFL/PFL
- Dynamics Key Listen
- Monitoring level, Headphone level and Monitoring bus Delay
- Talkback, Osc and 2-Track
- Mute Groups (recall only)
- Recall Safe
- MIDI snapshot Recall, Chase MTC and Disable (Snapshots)
- Snapshot List and Recall Safe (deleting, adding, or editing snapshots are/will be reflected online and affect the mix)
- History (auto-save)

Recall Safe in Preview Mode

The Recall Safe settings are global, and are applied to filter snapshot data regardless of the current operating mode. For details on Recall Safe and other automation safe features, see “Recall Safe and Channel Automation Safe” on page 174.

Available and Editable in Preview Mode

Almost all system functions, such as selecting channels and banking faders, are available in Preview mode.

 Only those controls that can be stored and recalled via snapshots are available for offline previewing and editing.

Not Available in Preview Mode

The only controls not available while in Preview mode are those controls which are not able to be stored or recalled via snapshots. In addition, Config mode options are unavailable in Preview mode.

Unavailable functions include the following:

- Make Stereo, or Split to Mono
- Move channels
- Input channel Gain Guess
- Input channel and FX Return Input Direct switch
- Input channel Dyn Pre EQ switch
- Insert mode (plug-ins cannot be edited)
- Enabling or disabling sample rate conversion

 These functions are neither available for offline access in Preview mode, nor do they remain active (online) while in Preview mode. To adjust any of the above settings, you must exit Preview mode.

Config Mode

Config mode is not available while in Preview mode. Pressing the Config switch (or double-clicking the Config/Show mode icon on-screen) displays a dialog box in which you can choose to “Exit Preview” (return to online mix, in Config mode), or “OK” (remain in Preview mode).

The system automatically switches to Show mode if Config mode is active at the time Preview mode is entered.

Plug-Ins and MIDI in Preview Mode

In Preview mode, plug-ins and MIDI operate in a similar way as when using the standalone software.

Plug-Ins in Preview Mode

Recalling a snapshot that contains plug-in data affects the offline (Preview) routing and bypass state of the plug-in only; the online plug-in parameter settings are not recalled, and the online mix is not affected.

The following plug-in functions are available offline in Preview mode:

- Plug-in routing can be changed
- Plug-in rack view can be changed
- Plug-ins can be added to a snapshot to capture its current online parameter settings and (Preview mode) routing

The following plug-in functions are not available while in Preview mode:

- Plug-ins cannot be added to or removed from rack slots
- Plug-in presets cannot be recalled or saved
- Plug-in parameters cannot be changed (you cannot open plug-in windows while in Preview mode)
- Plug-ins cannot be installed

You must explicitly add or update plug-in (or MIDI) data to update snapshots, whether or not Preview mode is enabled. You can do this from the main Snapshot page, or from the plug-in racks.



Updating plug-in data in an associated snapshot from the plug-in view

MIDI in Preview Mode

Incoming MIDI or MTC continues to trigger snapshot recall while in Preview mode. However, MIDI messages stored to snapshots are not sent out when a snapshot is recalled in Preview mode. For more information, see “Adding MIDI Messages to Snapshots” on page 185 and “Adding Plug-In Data to Snapshots” on page 186.

MTC and Other Online Event Triggers

While in Preview mode, triggers that occur in the online state of the console are executed, including MTC-driven recall of snapshots. Triggers caused by changes to the offline (Preview) controls are ignored and do not cause events to occur. For more information, see Chapter 22, “Events.”

Undoing Snapshot Commands

The Undo function returns the console to the state immediately before the last snapshot command. Undo is multi-level (up to 100), is available while in Preview mode and after performing an Edit or Propagate mode action.

⚠ Undoing snapshot recall commands may cause audio to be interrupted. Use Undo with caution in performance.

- ◆ If the Undo button is highlighted, you can place the cursor over the button to display text in the status bar describing what snapshot actions will be undone.
- ◆ If the Undo button is dimmed, Undo is not available.

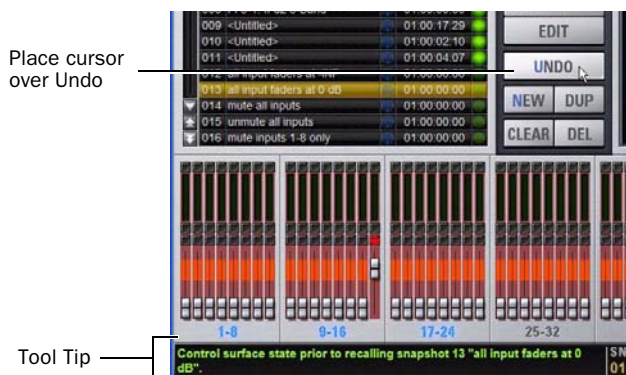

Using Tool Tips to verify the effect of Undo in the Snapshots page

To undo a snapshot command:

- Click the Undo button in the Snapshot commands section.

Disabling Snapshots

You can temporarily disable the storage and recall of all snapshots. While snapshots are globally disabled, you can target snapshots in the Snapshots List to preview their properties, but you cannot recall them.

To disable all snapshots:

- Click the Disable button in the Snapshot commands section.

Suspend MTC Recall

To disable MTC Recall of individual snapshots in the list:

- 1 Click the green Enable icon in the row for the desired snapshot so that it is unlit.
- 2 Click the Disable/Enable icon again to re-enable the snapshot.

Adding MIDI Messages to Snapshots

No MIDI message data is captured when a snapshot is first created. MIDI messages are added to existing snapshots directly from the MIDI list. You can store up to 20 MIDI messages in each snapshot.

When the MIDI data type is scoped for a snapshot, any stored MIDI messages are sent when the snapshot is recalled.

The following MIDI messages are supported and available in the MIDI list:

- Note Off
- Note On
- Poly Key Pressure
- Control Change
- Program Change
- Channel Pressure
- Pitch Bend
- MIDI Machine Control Stop
- MIDI Machine Control Play
- MIDI Machine Control Fast Forward
- MIDI Machine Control Rewind
- MIDI Machine Control Eject
- MIDI Machine Control Chase
- MIDI Machine Control Pause
- MIDI Machine Control Locate

When the MIDI data type is scoped for a snapshot, its MIDI messages are sent when the snapshot is recalled.

	MIDI Message Indicator	MTC Enable Icon
001 Snap 001		
002 Snap 002		
003 Snap 003		
004 Snap 004		
005 Snap 005		
006 Snap 006		
007 Snap 007		
008 Snap 008		

Snapshots List showing snapshot containing MIDI messages

To add a MIDI message to a snapshot:

- 1 Target the snapshot you want to modify.
- 2 Double-click the word MIDI in the MIDI/Plug-Ins list header to expand the MIDI list.

- 3 Click Add and choose a message from the pop-up menu.



Adding a message to the Snapshot MIDI list

A MIDI plug icon appears in the Snapshots List for each snapshot that contains MIDI messages.

To record incoming MIDI data to a snapshot.

- 1 Click REC.
- 2 Send a supported MIDI command.
- 3 Click REC again when done.

To edit a MIDI message in the MIDI list:

- 1 Double-click the message text to display the pop-up menu bar for the message.

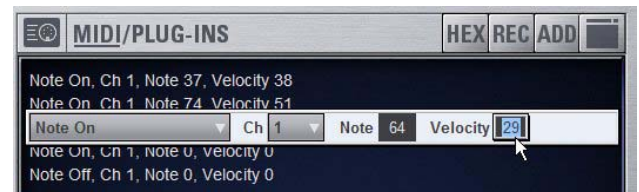

Editing a MIDI message in the snapshot MIDI list

- 2 Choose the message name and send channel or device ID from the pop-up menus.
- 3 Enter the message values in the text fields or drag up or down across the text field to change the values.
- 4 Click in the MIDI list area to dismiss the pop-up menu bar.

To remove a MIDI message from a snapshot:

- Right-click the MIDI message in the MIDI list and choose Delete.

Viewing MIDI Messages in Hexadecimal Format

You can toggle the view of MIDI messages in the MIDI list between hexadecimal and decimal formats.

To toggle the view format of the MIDI list:

- Click the Hex button in the MIDI/Plug-Ins list header.

Safing MIDI Message Output

You can temporarily disable output of embedded MIDI messages so that they are not sent when a snapshot is recalled, even when the MIDI data type is scoped.

 MIDI output is automatically suspended while in Preview mode.

To safe MIDI message output on-screen:

- 1 Go to the Snapshots page and click the Recall Safe tab.
- 2 Click the MIDI global output Safe button above the parameter matrix so that it is lit.

Adding Tempo Data to Snapshots

The Snapshots List can be toggled to display Tempo, along with a Tempo On/Off indicator for each snapshot entry.

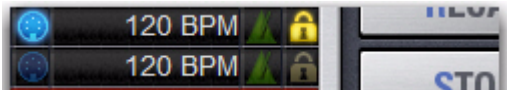

Snapshots List showing tempo

Storing a tempo with snapshots lets your system tempo change per song or scene. This lets you take full advantage of Tempo Sync (aka Tap Tempo) to synchronize delay and echo plug-ins.

Displaying Tempo in the Snapshots List

To show Tempo in the Snapshots List:

- Right-click anywhere in the Snapshots List and choose Show Tempo.

Tempo is displayed in BPM (beats per minute) or milliseconds, as set in the Options > Misc page.

To change the units for Tempo display:

- 1 Go to the Options > Misc page.
- 2 In the Tap Tempo section, click to select BPM or ms.

To sort items by tempo:

- With Tempo shown in the Snapshots List, right-click and choose Sort by Tempo.

Assigning and Enabling a Tempo

Each snapshot can store a custom tempo value. You can manually enter a custom tempo, or use a shortcut to assign the current System Tempo.

You can use the Tempo Enable icon to enable or disable tempo recall when the associated snapshot is recalled.

To assign a Tempo value to a snapshot manually:

- 1 In the Snapshots List, double-click the Tempo value you want to change, then do one of the following:
 - From the keyboard, type a new tempo value.
 - or –
 - Press the Up and Down Arrow keys to increase and decrease the selected value.
- 2 Press Enter or click another snapshot Tempo value to confirm the entry.

To assign the current System Tempo to a snapshot:

- 1 Make sure Tempo is shown in the Snapshots List.
- 2 Right-click and choose the Set Tempo to option, which will display the current System Tempo.

The System Tempo is set in the Options > Misc page. For details on configuring the system tempo and using it to synchronize plug-ins, see “Tap Tempo for Plug-ins” on page 201.

To toggle tempo on/off for each snapshot:

- 1 Make sure Tempo is shown in the Snapshots List (if not, right-click any item in the list and choose Show Tempo).
- 2 Click the Tempo icon so that it is lit (enabled) or unlit (disabled).

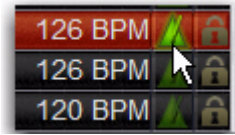

Snapshots List showing tempo

For more information on enabling Events for Tap Tempo, see “Tap Tempo for Plug-ins” on page 201.

Adding Plug-In Data to Snapshots

No Plug-In data is captured when a snapshot is first created. Plug-In data is added to existing snapshots from the Plug-Ins list or from the Plug-In rack.

When the Plug-In data type is scoped for a snapshot, plug-in routing, in/out state, and settings are recalled with the snapshot. (Adding or changing plug-in side-chain routing is not supported in snapshots.)

The Snapshots Plug-Ins list lets you select multiple plug-ins and add, remove and update them simultaneously across one or multiple snapshots. Multiple snapshots can be selected, and others can be added to or removed from the selection, at any time prior to adding, removing, or updating plug-ins and snapshots.

Plug-Ins List

To view plug-in data for snapshots in the MIDI/Plug-Ins list:

- 1 Target the snapshot you want to modify, or select multiple snapshots in the list.
- 2 Double-click Plug-Ins in the MIDI/Plug-Ins list header to expand the Plug-In list.



Expanded Plug-In list

It is also possible to select multiple plug-ins in the Snapshots Plug-Ins list and remove or update these plug-ins across multiple snapshots using Right-click commands. Selections can be contiguous or non-contiguous plug-ins in the list. This lets you more easily manage all plug-ins inserted on a single channel, for example.



Managing multiple plug-ins across multiple snapshots

Adding Plug-Ins to Snapshots

To add a plug-in to one or more snapshots from the Snapshots page:

- 1 Select an individual snapshot, or create a multi-selection of snapshots in the Snapshots list.
- 2 Display the Plug-Ins List (see "Plug-Ins List" on page 187).
- 3 Click the ADD button within the Snapshot Plug-Ins list and select a plug-in (or All Plug-Ins) from the menu.

To add a plug-in to multiple snapshots from the Plug-Ins page:

- 1 Create a multi-selection of snapshots on the Snapshots page
- 2 Go to the Plug-Ins page.
- 3 Click the Snapshots menu for the plug-in to be added and choose Add This Plug-In To Selected Snapshots. The selected plug-in is added to the currently targeted snapshot, as well as all other snapshots within the multi-selection.

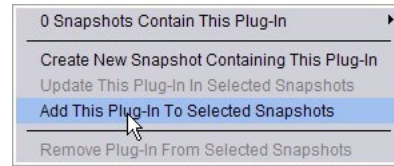

Using the Snapshots pop-up menu in the plug-in rack (Plug-Ins page)

Snapshots within the multi-selection that already contained the plug-in being added are unaffected and preserve any previously stored settings.

Removing a Plug-In from Snapshots

To remove a plug-in from snapshots from the Snapshots page:

- 1 Select an individual snapshot, or create a multi-selection of snapshots in the Snapshots List.
- 2 Click the Snapshots Plug-Ins icon to show the Snapshots Plug-Ins list.
- 3 Right-click a plug-in within the plug-in list of the currently targeted snapshot and choose Remove This Plug-In From Selected Snapshots.

To remove a plug-in from multiple snapshots from the Plug-Ins page:

- 1 Create a multi-selection of snapshots on the Snapshots page
- 2 Go to the Plug-Ins page.
- 3 Click the Snapshot menu for the plug-in to be removed and choose Remove This Plug-In From Selected Snapshots.

The selected plug-in is removed from the currently targeted snapshot, as well as all other snapshots within the multi-selection. Only snapshots within the multi-selection that contain the selected plug-in are affected.

Updating a Plug-In Across Multiple Snapshots

To update a plug-in across snapshots from the Snapshots page:

- 1 Select an individual snapshot, or create a multi-selection of snapshots on the Snapshots page.
- 2 Select a plug-in within the plug-in list of the currently targeted snapshot.
- 3 Right-click and choose Update Plug-In In Selected Snapshots.

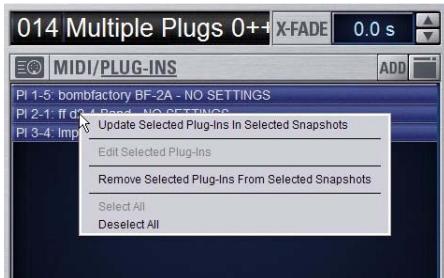

Snapshots plug-ins pop-up menu with multiple plug-ins selected in the Snapshots page

To update a plug-in across multiple snapshots from the Plug-Ins page:

- 1 Create a multi-selection of snapshots on the Snapshots page
- 2 Go to the Plug-Ins page. All plug-ins that are associated with any of the currently selected snapshots are identifiable by their red Snapshot menu.
- 3 Click the Snapshots menu for the plug-in to be updated and choose Update This Plug-In In Selected Snapshots.

The selected plug-in is updated within the currently targeted snapshot, as well as all other snapshots within the multi-selection. Snapshots within the multi-selection that do not already contain the plug-in being added are unaffected.

Editing Plug-Ins

The Snapshot page provides two ways to quickly navigate to a plug-in in order to edit its routing assignment or parameters.

To edit a plug-in associated with a snapshot:

- Double-click the item in the Snapshot Plug-Ins list. Or, right-click a plug-in in the Snapshots Plug-Ins list and choose Edit Plug-In.

Snapshot Options

Crossfade Time

You can set the X-fade (crossfade) time for the channel faders between snapshots from 0–99.9 seconds, in 0.1 second increments. This value determines the *fade time*, or the time it takes for the faders to move to their new positions when a snapshot is recalled.

All other controls are unaffected by the crossfade time, and are updated instantly when a snapshot is recalled. Each snapshot may be assigned its own crossfade time. In addition, crossfades will continue through a subsequent snapshot recall as long as the crossfading channels are not scoped in the incoming snapshot.

Default Crossfade Time

The default crossfade time assigned to new snapshots can be set with this option, with a possible range of 0–99.9 seconds.

To set the Default Crossfade Time:

- 1 Go to the Options page and click the Snapshot tab.
- 2 Under Snapshot General Preferences, enter a value or drag in the text box and press Enter.



Snapshot General Preferences

Crossfade Bypass

Snapshot crossfades can be up to 99.9 seconds. You can quickly bypass (cancel) a crossfade and immediately advance to the stored snapshot fader settings in order to speed up rehearsals, or whenever on-stage action moves faster than a programmed crossfade.

To bypass a snapshot crossfade:

- Recall the same snapshot at any point during the crossfade. Doing so recalls the entire contents of that snapshot, in addition to bypassing the crossfade. This is equivalent to recalling the snapshot with an effective crossfade time of 0 seconds. Any scoped parameters which were manually changed during the crossfade time will be reset to the values stored in the snapshot.

Special Cases for Crossfade Bypass

Incoming MIDI Commands

The snapshot crossfade is not bypassed if a MIDI Program Change message recalling the same snapshot is received during the crossfade.

MTC

The snapshot crossfade is not bypassed if a MTC trigger recalling the same snapshot occurs during the crossfade.

Multiple Simultaneous Crossfades

The crossfade can be bypassed for the most recently recalled snapshot only.

Preview Mode

If you enter Preview mode in between Recall commands, the offline (Preview mode) crossfade will be bypassed; the online crossfade will not.

Pre Settings

Snapshots can be used to recall the preamplifier settings on inputs for all scoped Input Channels. You can set any of the following Pre parameters to be recalled by the Pre data type button: Gain, Pad and Phase/polarity, +48V (Phantom Power), HPF corner frequency and in/out state.

To set the Pre parameters recalled by the Pre Data Type button:

- 1 Go to the Options page and click the Snapshot tab.
- 2 Under Pre, select the options you want to include. Selected items will be affected when the Pre data type is included in the scope of a snapshot.



Setting Pre parameters

Classifying Aux Sends

You can classify Aux Sends as *monitor sends* (“Mon”) or as *effects sends* (“FX”), which lets you scope each type separately from the Snapshots page.

 *This option is only a means of organizing Aux Sends for snapshot control, and does not directly affect Aux bus operation.*

To classify Aux Sends for snapshot scope:

- 1 Go to the Options page and click the Snapshots tab.
- 2 For each Aux Send bus or bus pair, click the Aux Mon or Aux FX buttons to classify it as a monitor send or effects send, respectively.



Classifying Aux Sends

Aux Pre/Post State

Select this option to include the pickoff point pre-fader or post-fader state of each Aux Send in snapshots.

Snapshot Data Types and Parameters

Table 23. Snapshot data types and parameters included in each data type

Snapshot Data Type	Included Parameters (for Each Scoped Channel Strip)
Fader	Main volume level
Mute	Mute state
EQ	EQ type selection (analog/digital); EQ in-circuit state; 4 bands (2 bands on FX Returns) of gain, freq, Q, bell/shelf selection (digital only), band on/off
Dyn	Compressor/Limiter in-circuit state; threshold, ratio, attack, release, knee, makeup gain Expander/Gate in-circuit state; threshold, ratio, attack, release, hold time, range, side-chain input
Pan	Channel pan or balance/width PQ strip balance Pan or balance/width for each Group bus returning back to L-R
Bus	Group bus assignments, group bus mono/stereo-linked state (if mono groups) or dual-mono/true stereo state (if stereo groups), L-R bus assignment and C/M bus assignments for input strips and groups
In	Input routing for Input Channels and FX Returns
Out	Main out assignments; direct out assignments, level, in-circuit state, & tap-off point (excluding VCAs)
VCA	VCA membership
Pre	Gain, pad, phase, phantom power, HPF corner frequency & in-circuit state
Name	Name for each strip
MTX	Mixer Input Sources, User Input Assignments, and pickoffs; Mixer Input level, Mixer Input on/off and Mixer Input Link state
Aux Mon	On/off, pre/post selection, level, and pan/balance for each Aux bus classified as a Monitor Aux
Aux FX	On/off, pre/post selection, level, and pan/balance for each Aux bus classified as an FX Aux
Dly	Channel delay time & in-circuit
MIDI	All MIDI messages that were added to the associated MIDI list for that snapshot.
Plug-Ins	Rack slot settings, in-circuit state, and I/O routing for each plug-in added to plug-ins list for that snapshot

Chapter 22: Events

This chapter introduces the Events window, and explains how to use the Event List.

Introduction

An *event* consists of one or more *triggers*, which are configured to cause one or more *actions* to occur.

Events can be very simple, such as a Footswitch input triggering a Recall Next Snapshot command. This is an example of a single *trigger* (a footswitch input) causing a single *action* (Recall Next Snapshot).

Events can also be quite complex and involve multiple triggers and actions. For example, a single event can be defined so that moving a specific fader above and/or below a certain level sends a General Purpose output, recalls a specific snapshot *and* mutes one or more channels. Multiple triggers can be considered conditionally using the available logic operators AND, OR, and XOR.

The Event List is easy to configure, and many preconfigured events are provided for Tap Tempo, snapshot Preview mode and other functions.

 *For more information on the default events and other examples, see “Default Settings, Templates and Examples” on page 200.*

Terminology

Event A user-defined combination of one or more triggers and one or more actions. Each event serves as a type of software “macro” in which you establish a cause-and-effect relationship between one or more console functions (triggers) and their results (actions).

Trigger A conditional check used to fire an event.

Action A console function, mode or other response resulting from an event being triggered.

GPI General Purpose Interface, also commonly known as a logic interface. SC48 provides 2 GPI inputs and 2 GPI outputs.

Open GPI input or GPI output is floating, or at its reference voltage.

Closed GPI input or GPI output is closed.

Footswitch Footswitch ports are functionally identical to GPI inputs and share all of the same properties and behaviors.

Important Information about Snapshots and Events

Because Events can trigger snapshot recalls, and because snapshot recalls can trigger other events, it is possible to create logic “feedback loops.” For more information, see “Avoid Feedback Loops” on page 199.

The Events Window

The Events window is the working area of the Event List system, and is available in the Options page (Options > Events).

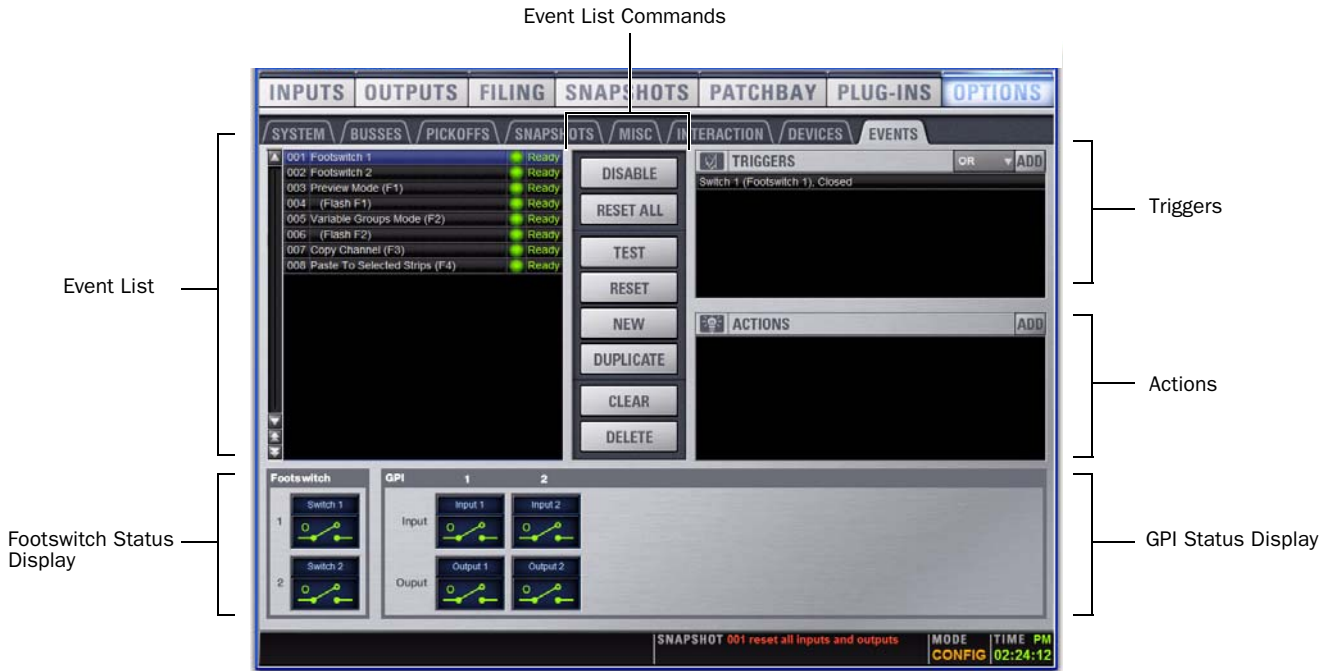

Figure 13. Events window (Options > Events)

Events are defined and managed from the upper Event List area of the Events window. This area includes the scrollable Event List at the left, plus the Triggers and Actions sections to its right. The lists and commands available in these sections create a powerful, user-programmable environment.

Events

An *event* consists of one or more *triggers*, which in turn cause one or more *actions* to occur. Up to 999 events can be created. Each event can have between 0 and 8 triggers, and each event can have between 0 and 8 actions.

Event List Each event is shown in its own row within the Event List. The list can be scrolled vertically when necessary.

Event Number Each event has an associated three digit sequence number, 001 through 999. Events are automatically re-numbered if items are moved, added or removed.

Event Name Events can be given custom names, up to a maximum length of 31 characters.

Event Enable Icon Events can be enabled or disabled individually by clicking the green Enable indicator to toggle its status. All events can be disabled (suspended) and enabled using the global Disable button.

Event Status The Event Status column shows Active (currently in effect), Ready, Disabled or Test state. For more information on the Status column, see “Resetting Events” on page 198.

Event List Commands You can test, reset, create, duplicate, clear or delete events in the list. These commands can be performed using the on-screen buttons or by right-clicking on list items. Multiple events can be selected to test, reset, duplicate, clear or delete them, but only one new event can be created at one time.

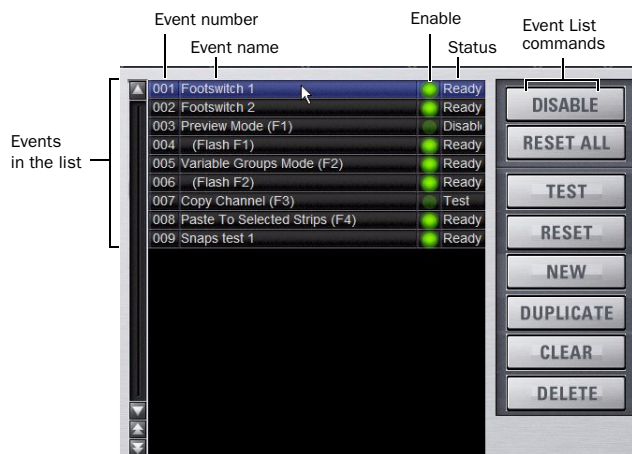

Event List items, commands and displays

Triggers

The Triggers list shows the name and properties of each trigger defined for the currently selected event, as well as commands to create and manage triggers.



Triggers list items, commands and displays

Triggers List

Each event can have up to eight triggers in the list. Triggers are shown in rows in the Triggers list. Right-click commands let you select, edit, duplicate and delete triggers.

Add

The Add pop-up menu lets you create new triggers. Triggers are organized in the menu according to the type of console function or input signal that initiates (or triggers) the event. Types of triggers include channel functions, footswitch/GPI inputs, snapshot recall, and other console functions such as talkback.

Type and Properties

Each row in the Triggers list shows the selected trigger Type. Some types of triggers have editable properties such as a dB level on a specific channel, or open/closed state of a footswitch input. Choices vary depending on the trigger type, and not all triggers have editable properties.

Logical Operators

Multiple triggers can be considered conditionally by applying a logical operator (AND, OR, XOR) to their properties.

 *Triggers and actions which are unavailable due to unavailable hardware or console configuration are shown as italicized in the Trigger (and Action) Add menus.*

Actions

The Actions list shows the actions defined in the currently selected event, as well as commands to create and manage actions.

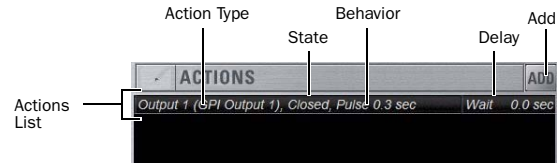

Actions list items, commands and displays

Actions List

Each event can have up to eight actions in the Actions list. All actions occur when the event is fired. Right-click commands let you select, edit, duplicate and delete actions.

Add

The Add pop-up menu lets you create new actions. Actions are organized in the menu according to the type of function they affect, such as channel functions, snapshots, GPI Output and Tap Tempo.

Type and Properties

Each row in the Actions list shows the selected action Type. Some actions have editable State and Behavior settings: all actions have a Wait (Delay) setting.

Footswitch and GPI Status

The Status display includes the Footswitch and GPI sections (see Figure 14), which show the present open or closed status of each logic port. Each footswitch or GPI port can be named.

Example uses of Switch and GPI inputs include remote snapshot recall from an external control system or custom control panel, or access to a console mode such as Preview mode, from any Function key or footswitch input.

Example uses of GPI output include the following:

- Sending a pulse to trigger samplers and playback devices
- Indicating when a microphone or channel is live by lighting an On Air or “tally” light
- Flashing or turning on a light when the console is in a particular mode (such as Solo In Place)
- Integrating with power sequencing devices for automated system turn-on



Figure 14. Footswitch and GPI Status Display in the Events window

Creating Events

The basic steps to create an event include the following:

- Add a new event in the Event List (see “Adding an Event” on page 194).
- Add and configure triggers for the event (see “Adding Triggers to an Event” on page 195).
- Add and configure actions for the event (see “Adding Actions to an Event” on page 197).

 Several pre-defined (default) events are available immediately; others are available among the Demo Shows installed with the system software. For more information, see “Default Events” on page 200.

Adding an Event

To add a new Event to the Event List:

- 1 Go to the Options > Events page.
 - 2 Do any of the following:
 - To create an empty, untitled new event, click the New button in the Event Commands section.
- or –
- To create a copy of a pre-existing event, select one or more events in the list and click the Duplicate button.

Selecting Events

Event list items can be selected, renamed, duplicated, deleted, cleared, enabled or disabled, tested and reset.

To select one or more events, do any of the following:

- To select a single event, click its row in the Event List.
- To select all events, right-click an event and choose Select All.
- To select multiple contiguous events, click the first desired event and then Shift-click (or Multi-Select-click) the last desired event. All events in between are selected.
- To select multiple discontinuous events, or to de-select an individual event, Ctrl-click (or Fine-click) its row in the Event List.

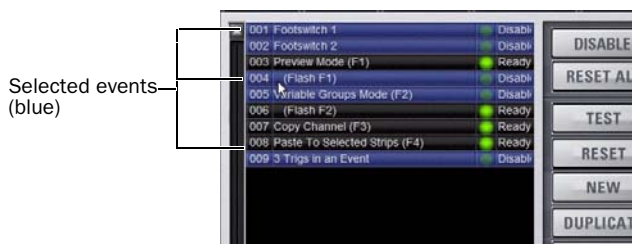

Events selected in the Event List

To deselect or ore more events:

- Right-click anywhere in the Event List and choose Deselect All.

Moving Events

Selected events can be dragged and dropped to new locations in the list. You can also manually edit the Event number to re-sequence items.

To move one or more events:

- 1 Select one or more events in the Event List.
- 2 Click in the row of any selected event and drag to a new location in the list. As you move events, a white line appears indicating the destination.
- 3 Release the mouse button to drop the events at the desired location in the Event List. When moving multiple events, moved events will be adjacent regardless of their original locations relative to each other (whether adjacent or non-adjacent). Events will be renumbered as necessary according to the new sequence of events.

To manually edit an Event number:

- Double-click the Event Number and enter a new three digit number to resequence the list accordingly.

Managing Events in the Event List

Once created, events in the list can be managed using on-screen buttons and right-click commands to rename, duplicate, delete, clear, enable or disable them.

 You can also use the Test and Reset commands to manually audition events for development and diagnostics. For more information, see “Testing Events” on page 198

Renaming an Event

To rename an event:

- 1 Double-click the Event Name in the list. Or right-click the Event Name and choose Rename.
- 2 Enter a new name.
- 3 Click Enter to confirm the new name.

Duplicating an Event

Duplicating an event can simplify Event List configuration when multiple, similar events need to be created, each with slightly different properties.

To duplicate an event:

- 1 Select one or more events in the Event List.
- 2 Click the Duplicate button on-screen. Or, right-click a selected event and choose Duplicate.

Deleting and Clearing an Event

Deleting an event removes it permanently from the Event List. *Clearing* an event leaves the named Event in the Event List but clears all associated triggers and actions.

To delete an event:

- 1 Select one or more events in the Event List.
- 2 Do one of the following:
 - Click the Delete button on-screen.
 - Right-click a selected event and choose Delete.
- 3 Click Delete in the Confirm Event Operation dialog to delete the event. Or click Cancel to cancel the operation.

To clear an event:

- 1 Select one or more events in the Event List.
- 2 Do one of the following:
 - Click the Clear button on-screen.
 - Right-click a selected event and choose Clear.
- 3 Click Clear in the Confirm Event Operation dialog to clear the event. Or click Cancel to cancel the operation.

Enabling and Disabling Events

Events can be disabled to suspend their operation. An event can be selected and edited while it is disabled.

You can toggle the enabled state of one or more events in the list by clicking the on-screen Enable icons in the Event List, or you can disable the Event List globally by clicking the master events Disable button.

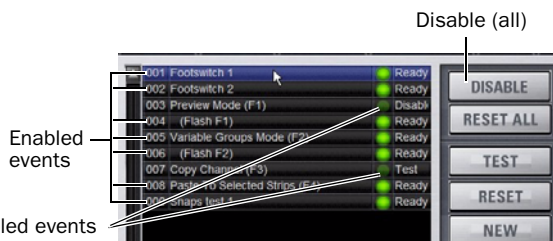

One selected event and two disabled events

Toggling Enable Status for Selected Events

To toggle the enable/disable status of an event in the list:

- 1 Select one or more events in the Event List.
- 2 Click the Enable icon for the selected event to toggle its state. Or, right-click an item and choose Enable or Disable as appropriate. When the Enable icon is lit (green) the event is enabled; when the icon is unlit the event is disabled.

Disabling an active event does not automatically de-activate any associated actions configured for While Active behavior. Use the Reset command instead (see “Resetting Events” on page 198).

Disabling an event stops all delay timers (Wait properties) associated with that event, preventing any pending (delayed) actions from occurring.

 *Disabling an event can be a useful troubleshooting tool, such as when an event has caused an action/trigger feedback loop and must be edited before being re-enabled.*

Disable All Events

The Disable button in the Events Commands section lets you temporarily disable all events in the event list.

To disable all Events:

- Click the on-screen Disable button in the Events Commands area. The Disable button lights, and all items in the Event List show “Disabled” in the Status column.

To re-enable Events:

- Click the Disable button again.

All Events are prevented from firing when the global Disable function is in effect. However, active events are not de-activated. Use Reset or Reset All for this (see “Resetting Events” on page 198).

Individual Event enable/disable status is preserved (events retain the current state of their Enable icons) and can be modified when globally disabling and enabling events using the master Disable button.

Disabling an event stops all timers (Wait/delay properties) associated with that event, preventing any pending (delayed) actions configured for While Active behavior from occurring.

Creating Triggers

Each event can have up to eight triggers. You create new triggers by selecting them from the Add pop-up menu. Once added, you can edit triggers and their properties to customize them.

Adding Triggers to an Event

To add a trigger:

- 1 Select an event in the Event List, or create a new one. (For details, see “Selecting Events” on page 194, and “Creating Events” on page 194.)

2 Click the ADD pop-up menu in the Trigger list and select an action type. The selected trigger type is added to the Trigger list for the currently selected event, with its default properties.

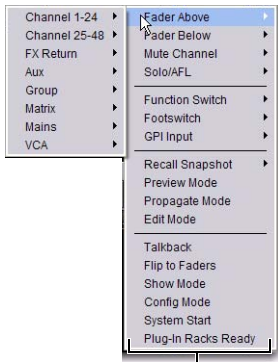

Trigger Types

Add Triggers

 For a list of available trigger types, see “Trigger Types” on page 203.

Editing Trigger Type and Properties

To edit the trigger and its properties:

- 1 Double-click the trigger row in the list. Or right-click the action item and choose Edit.
- 2 Choose a new Trigger Type, or edit any of the available properties in the row for that trigger. Properties vary depending on the type of trigger selected (not all trigger types have editable properties).

Logical Operators for Triggers

An individual trigger is considered to be “true” when the function described by its type and properties takes place, such as while a footswitch is actually pressed, or a fader is raised above its trigger threshold.

A trigger is considered to be “false” (or, not occurring) whenever its function and properties are not met, such as when a footswitch is not being pressed, or while a fader remains below its assigned trigger threshold.

When an event includes multiple triggers, a logical operator (OR, AND, XOR) must be chosen from the Operators pop-up menu. (The default Operator is OR.)

The logical operator has no effect when the Triggers list includes only one item.

To choose a logical operator for the current event:

- 1 Select the desired event to display its assigned triggers.
- 2 Click the Operators pop-up menu (by default, this pop-up menu displays “OR”) and choose AND, OR, or XOR.

Only one logical operator is permitted per event, and this operator applies to all triggers within the event. It is not possible to use a mix of logical operators within an event.

Examples of Logical Operators

Logical operators determine the precise state required in order for an event to occur as shown in the following tables:

OR At least one of the triggers must be true. The following table shows the effect of OR on events with multiple triggers. In the table, 0 indicates a false condition (not occurring) and 1 indicates a true condition (occurring).

Example truth table for OR, showing two triggers

Trigger A	Operator	Trigger B	Result
0	OR	0	0
0	OR	1	1
1	OR	0	1
1	OR	1	1

When using OR, if one or more (but not all) of the triggers go false, the event logic is only acted on again when all triggers evaluate to false (result = 0).

AND All triggers must be true. The following table shows the effect of AND on events with multiple triggers. In the table, 0 indicates a false condition (not occurring) and 1 indicates a true condition (occurring).

Example Truth table for AND showing two triggers

Trigger A	Operator	Trigger B	Result
0	AND	0	0
0	AND	1	0
1	AND	0	0
1	AND	1	1

XOR

At least one trigger, but not all, must be true. The following table shows the effect of XOR on events with multiple triggers. In the table, 0 indicates a false trigger condition (not occurring) and 1 indicates a true condition (occurring).

Example Truth table for XOR showing two triggers

Trigger A	Operator	Trigger B	Result
0	XOR	0	0
0	XOR	1	1
1	XOR	0	1
1	XOR	1	0

Managing Triggers in the Triggers List

Triggers in the list can be edited, duplicated and deleted.

Editing Triggers

To edit a trigger:

- 1 Double-click the trigger in the Triggers List. Or, right-click the item in the list and choose Edit.

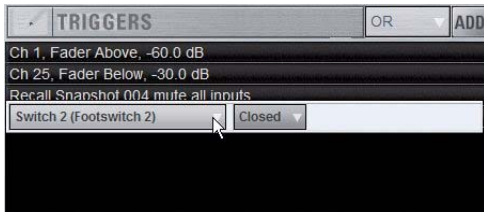

Editing a trigger

- 2 Do any of the following:
 - To change the trigger type, click the Type pop-up menu and make a new selection from the Type menu.
 - For Fader Above or Fader Below triggers, click the currently displayed dB value to highlight it, then type in a new value.
 - For switches, buttons and other two-state functions, click the State pop-up menu and make a selection. Choices for State vary as appropriate for the trigger type, and will include Closed or Open, On or Off, and Pressed or Released.
- 3 To confirm your changes, press Enter or click anywhere else in the Events window.

Selecting Triggers

Triggers can be selected using the same methods as used when selecting items in the Event List. For more information, see “Selecting Events” on page 194.

Duplicating Triggers

To duplicate a trigger:

- 1 Select one or more items in the Triggers List.
- 2 Right-click on any selected item and choose Duplicate.

Deleting Triggers

To delete a trigger:

- 1 Select one or more items in the Triggers List.
- 2 Right-click on any selected item and choose Delete.

Creating Actions

Each event can have up to eight actions. You create new actions by selecting them from the Add pop-up menu. Once added, you can customize actions by editing their properties, as available.

Adding Actions to an Event

To add an action:

- 1 Select an event, or create a new one.
- 2 Click the ADD pop-up menu in the Action list and select an action type. The selected action type, with its default settings, is added to the action list area.

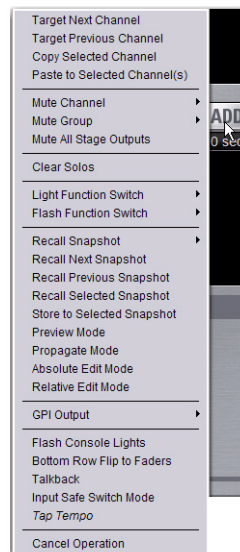

Add Actions

 For a list of available actions, see “Action Types” on page 204.

Editing an Action Type and Properties

To edit an action:

- 1 Double-click the action row in the list. Or, right-click the action item and choose Edit.
- 2 Click the displayed action Type and make a new selection.

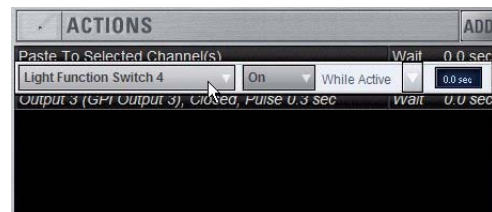

Editing an action

Action State

To edit an action State for switches, buttons and other two-state functions:

- Click the State pop-up menu and make a selection. Choices for State vary as appropriate for the trigger type, and will include Closed or Open, On or Off, and Toggle.

Action Behavior

To edit action behavior:

- Click the Behavior pop-up menu and choose Latch or While Active, as appropriate:

Latch Fixes the behavior in its defined state (such as open or closed) until unlatched by another event or operation.

While Active Latches the behavior in its defined state as long the associated trigger is in effect (active, or “true”), such as unmuting a channel only while a footswitch is pressed and held.

Pulse and Duration (GPI Output only) Produces a single-shot pulse output. Duration range is 0.1 second (100 ms) to 1.0 second, in 0.1 second increments. The default duration is 0.3 seconds (300 ms).

To configure GPI output pulse and duration for an action:

- 1 Double-click the action to edit it
- 2 Click the Behavior selector and choose Pulse.
- 3 Enter a value for Pulse Duration.
- 4 To confirm you changes, press Enter or click anywhere else in the Events window.

Action Wait

All actions let you specify a Wait time of up to 100 seconds for the action to wait before firing. This can be useful for synchronizing the timing of multiple external devices, or to build timed sequences of actions.

To configure action Wait (Delay):

- 1 Double-click the action to edit it.
- 2 To confirm your changes, click the Wait value to highlight it, then type in a new value.

Selecting Actions

Actions can be selected using the same methods as used when selecting items in the Event List. For more information, see “Selecting Events” on page 194.

Managing Actions in the List

Actions can be moved, renamed, duplicated, and deleted by right-clicking them and choosing the desired operation, just as you can with triggers. For instructions on managing items in the Actions List, follow the instructions for triggers in “Managing Triggers in the Triggers List” on page 197.

Testing Events

An event can be manually triggered to test it, regardless of its current Event Status or enabled/disabled state. Use this feature to verify action properties and confirm proper operation of devices connected to GPI output ports.

When an event is in Test mode, it is effectively considered true until the event is manually reset. An Event in test can be re-tested at any time by again pressing the Test button. You do not have to reset in-Test events to re-test them.

Incoming triggers are ignored when events are in Test mode. For example, if a footswitch event is being tested and you accidentally hit the footswitch at some point during the test, the event does not revert to Active the moment Test is cancelled.

Events always return to their ready state following a Reset. Events won't re-fire until the trigger logic re-asserts itself as true.

To test events:

- 1 Select one or more events in the Event List.
- 2 Click the Test button. Or, right-click an event and choose Test from the pop-up menu.
- 3 When you're satisfied the event is behaving correctly, click the Reset button. Or, Right-click an event and choose Reset.

Resetting Events

You can use the Reset features to quickly reset Active or in-Test events to “ready.” You can also use the Reset All command (in the Events Commands buttons) to immediately reset all events in the list.

The current status of each event is shown in the Status column in the Event List:

Event List Status indicators

Status	Description
Active	Event is currently true (triggered)
Ready	Event is currently false (not triggered)
Disabled	Event is disabled and can not be triggered
Test	Event has been manually triggered

To reset an event:

- 1 Select one or more events in the Event List. (See “Selecting Events” on page 194.)
- 2 Click the Reset button. Or, right-click an event and choose Reset to reset an Active or in-Test event back to a Ready state.

To reset all events:

- Click the Reset All button.

When events are reset, the following rules are applied:

- ◆ Latching or pulsed actions which have already occurred are unaffected. For example, reset doesn’t unlatch a previously latched function.
- ◆ All action delay timers (Wait) are immediately cancelled.
- ◆ Actions configured for While Active behavior are immediately cancelled.
- ◆ Events will not occur until the trigger logic again evaluates as true.

For example, let’s say you have an event configured to close a GPI Output whenever Channel 3 is muted (its behavior property is While Active). Resetting the event opens the GPI Output, even though the Channel 3 might still be muted. The event will re-trigger the next time the channel goes from an unmuted state to a muted state.

Snapshots and Events

Events can include snapshot functions among their triggers and actions.

Snapshots as Triggers

Events can be triggered by the following snapshot functions:

- Recall of specific snapshots
- Enabling of Snapshot modes (Preview, Propagate and Edit)

Snapshots as Actions

Event actions can include the following snapshot functions:

- Recall of a specific snapshot
- Recall the previous, next or selected snapshot.
- Initiate Store to Selected Snapshot commands (overwriting and updating snapshots)
- Enable different Snapshot modes (Preview, Propagate and Edit)

Snapshot Modes and Event Status

While in Propagate or Edit modes, events-driven snapshot recall is suspended.

While in Preview mode, triggers that occur in the online state of the console are executed, including MTC-driven recall of snapshots. Triggers caused by changes to the offline (Preview) controls are ignored and do not cause events to occur.

Avoid Feedback Loops

Because events can both affect and be affected by snapshots, it is possible for events to cause “feedback loops.”

Be especially careful when Recall Previous or Next snapshot triggers and actions are combined with events that recall a specific snapshot, as shown in the following diagram.

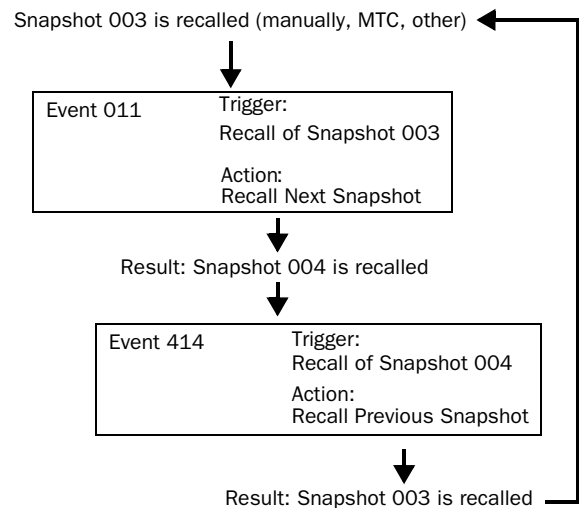

Diagram illustrating potential logic feedback loop between events and snapshots

💡 The global Event Disable and Reset All buttons can serve as “panic” buttons to temporarily suspend and/or reset all events, giving you a chance to diagnose the source of the problem. For more information, see “Resetting Events” on page 198.

Default Settings, Templates and Examples

Default Events

The following pre-defined events are included for you to use as examples and as the starting point for your own events.

Default events

Event Number	Type and Name	Triggers	Actions
001	Footswitch 1	Switch 1 (Footswitch 1) Closed	<i>undefined</i> (choose an action)
002	Footswitch 2	Switch 2 (Footswitch 2) Closed	<i>undefined</i> (choose an action)
003	Preview Mode (F1)	Function Switch 1, Pressed	Preview mode, Toggle, Latch
004	(Flash F1)	Preview Mode, On	Flash Function Switch 1, On, While Active
006	(Flash F2)	Variable Groups Mode, On	Flash Function Switch 2, On, While Active
007	Copy Channel (F3)	Function Switch 3, Pressed	Copy Selected Channel Light Function Switch 3, On, While Active
008	Paste to Selected Strip (F4)	Function Switch 4, Pressed	Paste to Selected Channel(s) Light Function Switch 4, On, While Active
009	Tap Tempo	Function Switch 8, Pressed	Tap to define system tempo for delay plug-ins that support Tempo Sync

Templates

The following table provides a listing of common event definitions. Use the techniques explained throughout this chapter to add one or more of the following events to establish your own set of events, triggers and actions.

Suggested event definitions for common functions

Event Name	Trigger Type	Trigger Properties		Action Type	Action Properties		Behavior
Talkback (Toggle)	Footswitch 1		Closed	Talkback		Toggle	Latch
Talkback (Momentary)	Footswitch 1		Closed	Talkback		On	While Active
Fader Start	Fader Above	Ch 1	-60 dB	GPI Output 1		Closed	Pulse (0.3 s)
Fader Stop	Fader Below	Ch 1	-inf dB	GPI Output 1		Closed	Pulse (0.3 s)
Fader Start/Stop	Fader Above	Ch 1	-60 dB	GPI Output 1		Closed	While Active
Mute Channel (Toggle)	Footswitch 1	1	Closed	Mute	Ch 1	Toggle	
Mute Channel (Momentary)	Footswitch 1	1	Closed	Mute	Ch 1	On	While Active
Toggle Input Safe Switch mode	Function Switch 1		Pressed	Input Safe Switch Mode			
Tap Tempo	Function Switch 1		Pressed	Tap Tempo			

Using the Templates

To add any of the Events listed in the table, do the following (using the first template, Talkback (Toggle) as an example):

To use the templates:

- 1 Create a new event.
- 2 Edit the event name (for example, “Talkback (Toggle)” as shown in the table). For renaming instructions, see “Renaming an Event” on page 194.
- 3 Click the (Trigger) Add pop-up menu and choose Footswitch > Switch 1 (Footswitch 1). The Switch 1 trigger type is added, with a default State setting of Closed.
- 4 Click the (Action) Add pop-up menu and choose Talkback. The Talkback action is added. By default, the action State is Toggle, and the behavior is Latched. There is no Wait (delay before firing) needed for this action.

Switch 1 (Footswitch 1) is now configured to toggle Talkback On or Off each time the footswitch is pressed.

If you prefer momentary talkback, edit the event by doing the following.

- 1 Double-click the Talkback action in the Actions list to access its editable properties. Or, right-click the action and choose Edit.

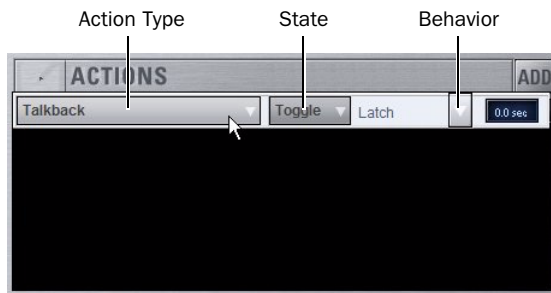

An action and its properties ready to be edited.

- 2 Click the action State pop-up menu (it displays Toggle by default, or the current State setting) and select On.
- 3 Click the action Behavior pop-up menu and select While Active. Together with the State setting (On), While Active establishes momentary control of the action; in this example, Footswitch 1 is now assigned to provide momentary Talkback control.

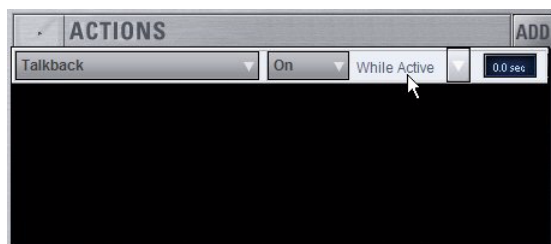

Talkback State and Behavior after editing

- 4 To quickly test the switch trigger, click the Test button, or press the Footswitch. Adjust the trigger State for your footswitch, as necessary, for its open/closed orientation. (For instructions, see “Editing Trigger Type and Properties” on page 196.)

- 5 After testing the trigger, click Reset to return the event to its Ready state.

Tap Tempo for Plug-ins

Tap Tempo lets you quickly establish a system tempo to use as a beat clock for delay and echo plug-ins that support Tempo Sync.

The system tempo defaults to 120 BPM (beats per minute). You can set a custom tempo in a number of ways including by tapping a Function switch, Footswitch or other control as explained below. The system tempo is stored as a console setting within the Show file.

Snapshots can also store and recall tempo.

 A preconfigured Event for tap tempo is installed in the Demo Shows folder when you install VENUE D-Show software. To use the example Event, go to the Filing page and click the Load tab, then select the file Tap Tempo Examples and click the Load button.

Using Tap Tempo

Do the following three steps to start using Tap Tempo:

Enable the System Tempo

- 1 Go to the Options > Misc page, locate the Tap Tempo section and do the following:
 - Turn on the global tempo sync by clicking the On switch directly below the encoder so that it is lit (on).
 - If desired, use the encoder to set a system tempo value, or type a value directly into the Tempo field.
 - If desired, click the Units selector to choose Beats Per Minute (BPM) or Milliseconds as the units for displayed values.

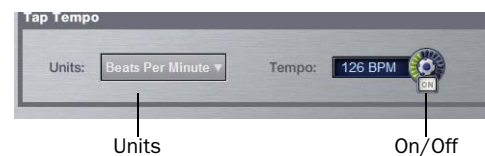

Tap Tempo settings

Create a Tap Tempo Event

2 Go to the Options > Events page and do the following in the order presented:

- Create a new Event and call it Tap Tempo.
- Click the Add button in the Trigger area, and select an available Function switch (F switch) or Footswitch.
- Click the Add button in the Action section, and choose Tap Tempo.

Enable the Plug-in's Tempo Sync and Start Tapping

Next, navigate to a delay plug-in and enable its Tempo Sync switch. Repeat for other delay plug-ins you want to sync.



Tempo Sync



Tempo Sync in Digidesign ModDelay and Line6 Echo Farm

3 Tap the assigned Tap Tempo trigger (Function switch or Footswitch) in time with the music. At least two taps are needed to set the tempo; additional taps can result in a more accurate tempo setting.

The delay time of all Tempo Sync-enabled plug-ins change to match the system tempo. While tapping, the calculated tempo is also shown in the Status area of the screen.

Tips for Using Tap Tempo

The plug-in Tempo Sync switch enables/disables that individual plug-in's delay value from following the system tempo. Use the individual plug-in Tempo Sync switches to sync one, some or all delay plug-ins.

Tempos can range from 20 BPM (3,000 ms) to 300 BPM (200 ms). Some delay plug-ins offer different time divisions (such as 1/8th, 16th, or dotted) that you can select for variations based on the system tempo. Check your delay plug-ins to see if they support Tempo Sync and subdivision settings (most, but not all, do).

Snapshots and Tempo Sync

If you need a specific delay time every time a certain snapshot is recalled, store Tempo with snapshots. For details, see "Adding Tempo Data to Snapshots" on page 186.

Trigger Types

The following table lists the available trigger types and properties, along with a description of each.

Table 23. Trigger List, with default settings

Trigger Type	Property 1	Property 2	Description
Fader Above	Channel name/number	Fader level –inf to +12 dB (Default: –60 dB)	Fader moved above threshold level
Fader Below	Channel name/number	Fader level –inf to +12 dB (Default: –inf)	Fader moved below threshold level
Mute	Channel name/number	On (default) Off	Mute active/inactive
Solo/AFL	Any input, output, VCA, Solo In Place	On (default) Off	Solo/AFL active/inactive
Function Switch	Function Switch 1–8	Press (default) Release	On button press (down) On button release (up)
Footswitch	Footswitch 1, 2	Open Closed (default)	Footswitch input high Footswitch input low
GPI Input	GPI input 1–2	Open Closed (default)	GPI Input high GPI Input low
Recall Snapshot	Snapshot number and name		Event triggered by snapshot
Preview Mode		On (default) Off	Preview Mode active/inactive
Propagate Mode		On (default) Off	Propagate Mode active/inactive
Edit Mode		On (default) Off	Edit Mode active/inactive
Talkback		On (default) Off	Talkback active/inactive
Flip to Faders		On (default) Off	Flip to Faders active/inactive
Show Mode			Console Show Mode is active
Config Mode			Console Config Mode is active
System Start			System software initialized
Plug-In Rack Ready			Mirrors plug-ins rack Ready state

Action Types

The following table lists the available Action types and properties, along with a description of each.

Table 24. Action types

Action Type	Property	State	Behavior	Description
Target Next Channel				Selected Channel advances by one
Target Previous Channel				Selected Channel reverses by one
Copy Selected Channel				Channel copy operation
Paste to Selected Channel(s)				Channel paste operation
Mute Channel	Channel name/number	On Off Toggle (default)	Latch (default) While Active	Mute selected channel
Mute Group	Mute Group 1–8	On Off Toggle (default)	Latch (default) While Active	Toggle Mute group status
Mute All Stage Outputs		On Off Toggle (default)	Latch (default) While Active	Mute all stage outputs
Clear Solos				Mirrors console Solo Clear
Light Function Switch	1–8	On (default) Off Toggle	Latch While Active (default)	Lights Function switch
Flash Function Switch	1–8	On (default) Off Toggle	Latch While Active (default)	Flashes Function switch
Recall Snapshot	Snapshot number and name			Recall specified snapshot
Recall Next Snapshot				Mirrors Snapshot Next switch
Recall Previous Snapshot				Mirrors Snapshot Previous switch
Recall Selected Snapshots				Mirrors Snapshot Recall switch
Store to Selected Snapshot				Mirrors Snapshot Store switch
Preview Mode		On Off Toggle (default)		Activate/deactivate Preview Mode
Propagate Mode		On Off Toggle		Propagate mode active while trigger is true
Absolute Edit Mode		On Off Toggle (default)		Enters Edit mode when trigger is true; exits via Absolute when trigger goes false
Relative Edit Mode		On Off Toggle (default)		Enters Edit mode when trigger is true; exits via Relative when trigger goes false

Table 24. Action types

Action Type	Property	State	Behavior	Description
GPI Output	1-2	Open Closed (default) Toggle	Pulse, 0.3s (default) Latch While Active	Pulses or latches selected GPI Output
Flash Console Lights				Flashes console lights
Top Row Flip to Faders (D-Show Main only)		On Off Toggle (default)	Latch (default) While Active	Mirrors top encoder row Flip to Faders
Bottom Row Flip to Faders		On Off Toggle (default)	Latch (default) While Active	Mirrors bottom encoder row Flip to Faders (D-Show Main only)
Link Main and Sidecar(s) (D-Show Main only)	Faders Encoders Both	On Off Toggle (default)	Latch (default) While Active	Mirrors console function
Variable Groups Mode (VENUE Profile and D-Show only)		On Off Toggle (default)	Latch (default) While Active	Toggles Variable Groups Mode on/off (only if console config is 24-bus mode)
Input Safe Switch Mode				Cycles through Input Safe Switch modes
Tap Tempo				Sets the system tempo to synchronize delay plug-ins that support Tempo Sync
Cancel Operation				Mirrors console Cancel switch (and Esc key on keyboard)

Chapter 23: Synchronization

VENUE SC48 provides a set of MIDI-based synchronization features that allow automation and remote control of snapshots, and triggering of external devices when snapshots are recalled.

Automating Recall of Snapshots with MIDI Time Code

You can automate the recall of snapshots with MIDI Time Code (MTC). The VENUE system can trigger snapshots with internally generated MIDI Time Code, or it can read MIDI Time Code from an external source.

 For instructions on MIDI and other connections required for synchronization, see Chapter 2, “Configuring and Connecting SC48.”

Generating MIDI Time Code

You can set the VENUE system to generate MIDI Time Code and automate the recall of snapshots based on MTC playback.

To generate MIDI Time Code from the VENUE system:

- 1 Go to the Options page and click the Snapshots tab.
- 2 Under MTC Mode, click Generate. MIDI Time Code generator controls appear at the bottom of the screen.

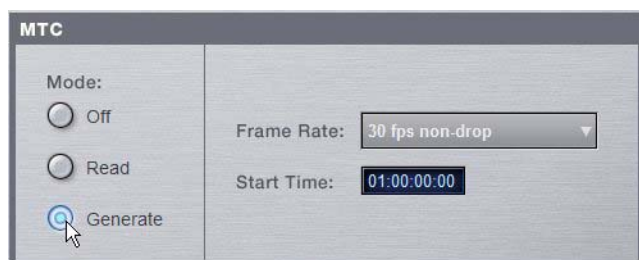

Setting the MIDI Time Code Mode

- 3 Choose the MTC Frame Rate from the Frame Rate pop-up menu (24 fps, 25 fps, 30 fps drop, or 30 fps non-drop).
- 4 If you want MTC playback to start at a different time than the currently displayed time, enter a start time in the Start Time field, and press Enter.

5 Control MTC playback from the MTC generator controls by doing any of the following:

- Start MTC playback by clicking the Play button.
- Pause MTC playback by clicking the Pause button.
- Stop MTC playback and reset to the Start Time by pressing the Stop button.



MIDI Time Code controls

Reading External MIDI Time Code

The VENUE system can slave to external MTC and automate the recall of snapshots based on the incoming MTC.

To read external MIDI Time Code:

- 1 Go to the Options page and click the Snapshots tab.
- 2 Under MTC Mode, click Read. A MIDI Time Code display appears at the bottom of the screen.



MIDI Time Code display

VENUE automatically detects the frame rate of the incoming time code (24 fps, 25 fps, 30 fps drop, or 30 fps non-drop).

The MIDI Time Code display indicates the following:

- When MIDI Time Code is not present, the display shows a series of dashes.
- When MIDI Time Code is present, the current time code value is shown in green.

Snapshot MIDI Time Code Display

When the system is set to generate or read MIDI Time Code, the Snapshots List shows time code values and a green Recall Enable indicator for each snapshot entry.



001	*Instructions1(seNots)*	01:00:00:00	🟢
002	* Instructions 2 *	01:00:05:00	🟢
003	All Plug-Ins sync'ed	01:00:10:00	🟢
004	No plug-ins sync'ed	01:00:15:00	🟡
005	One plug-in sync'ed	01:00:20:00	🟢
006	Two plug-ins sync'ed	01:00:23:00	🟢
007	-----	01:00:25:00	🟢
008	Reset Demo	01:02:00:00	🟢

Snapshots List showing time code values and indicators

Assigning Time Code Values to Snapshots

With the VENUE system set to generate or read MIDI Time Code, you can assign time code values to snapshots by entering values manually, or by capturing MTC playback values.

Manually Assigning Time Code Values to Snapshots

To manually assign an MTC value to a snapshot:

- 1 In the Snapshots List, double-click the MTC value you want to change.



003	Snap 003	01:00:11:19
004	Snap 004	01:00:20:15
005	Snap 005	01:00:23:19
006	Snap 006	01:00:29:23
007	Snap 007	01:00:35:08

Snapshot showing selected MTC value

- 2 Do one of the following:
 - From the keyboard, type a new MTC value.
 - or –
 - Press the Left and Right Arrow keys to move the cursor between number fields, and the Up and Down Arrow keys to increase and decrease the selected value.
- 3 Press Enter or click another snapshot MTC value to accept the entry.

Capturing Time Code Values in Snapshots

To capture the current MTC value in a new snapshot:

- 1 With the system in MTC Read or Generate mode, start time code playback.
- 2 Do one of the following:
 - During playback, click the New button.
 - or –
 - Pause playback at the time code value you want to capture, and click the New button.

A new snapshot appears with the time code value at the time of creation.

To capture the current MTC value in an existing snapshot:

- Right-click the snapshot in the Snapshots list and choose Set Timecode To.

The time code value is updated to the currently displayed value.

Sorting Snapshots by Time Code Value

You can sort snapshots in the Snapshots list by Time Code value, so that they appear in chronological order.

 When chasing to MTC, snapshots will always recall in chronological order, regardless of their order in the Snapshots list.

To sort snapshots by their assigned MIDI Time Code value:

- Right-click any snapshot in the Snapshots list and choose Re-Sort All By Time Code.

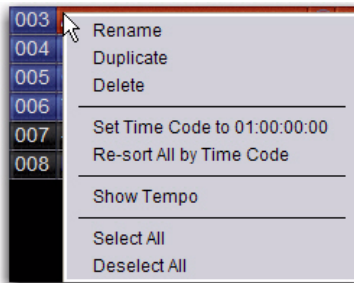

Right-click menu for items in the Snapshots list

Enabling Snapshots for Automated Recall

With time code values assigned to snapshots, you can then enable snapshots for recall with time code playback.

To enable snapshots for automated recall with MTC:

- Click the Time Code Recall Enable indicator on the right side of the Snapshots list. The indicator turns bright green to indicate that the snapshot is enabled for recall.



Snapshot enabled for automated recall with MTC

Chasing MIDI Time Code

With snapshots enabled for automated recall, the Chase MTC function needs to be engaged to allow automated recall to occur.

To initiate automated recall of snapshots:

- Click the Chase MTC button so that it is highlighted.
- Begin MTC playback by starting the internal generator (if set to MTC Generate) or the external device (if set to MTC Read).

When a recall-enabled snapshot's time code value is reached, the snapshot is recalled.

 Snapshot modes can affect MTC recall. For more information, see "MTC and Other Online Event Triggers" on page 184.

The Chase MTC button can be used to quickly take VENUE system offline from MTC-triggered recall in performance in the event of a change in timing, such as a missed cue or dropped verse. You can then advance manually to an appropriate snapshot, and re-enable Chase MTC.

 VENUE systems do not chase up to the current timecode value. If you start playback in the middle of a snapshot sequence, any prior snapshots will need to be recalled manually to update the console before beginning time code playback. For more information, see "Selecting and Recalling Multiple Snapshots" on page 173.

Remote Control of Snapshot Recall

The VENUE system can be set to recall snapshots in response to MIDI control messages sent from an external device such as an AV controller system. You can set the system to respond to control messages sent on any one of 16 available MIDI channels.

Snapshots are recalled when their snapshot number (1–999) is received in the form of MIDI Bank Select and Program Change messages. (See Table 24 on page 209.)

To enable recall of snapshots from an external device:

- Go to the Options page and click the Snapshots tab.
- Under MIDI, select the Snapshots Respond to Channel option, and choose the MIDI channel from the corresponding pop-up menu.



Snapshot MIDI respond option

The system listens on the specified channel for Bank Select and Program Change messages.



 The MIDI Snapshot Output Safe option does not affect this option. You can only turn off this feature by deselecting the "Snapshots Respond to Channel" option.

Table 24. MIDI Bank and Program Numbers for Snapshots

Bank	Program	Snapshot Number
0	0–127	001–128
1	0–127	129–256
2	0–127	257–384
3	0–127	385–512
4	0–127	513–640
5	0–127	641–768
6	0–127	769–896
7	0–103	897–999

 VENUE D-Show software stores Bank Select messages, so it is not necessary to send a Bank Select message prior to every Program Change message. You only need to send a Bank Select message when you want to recall a snapshot in a different bank from the previous snapshot.

Triggering of External Devices on Snapshot Recall

The VENUE system can be set to send MIDI Bank and Program Change messages whenever a snapshot is recalled, to trigger external devices whose cues are related to snapshots. You can set the system to send on any one of 16 available MIDI channels.

 MIDI output is automatically suspended while in Preview mode. For more information, see “Preview Mode” on page 181.

While it is possible to add Bank Select and Program Change messages to individual snapshots, this option lets you toggle messages on and off for all snapshots in one step. Using this option also ensures that the Bank Select and Program Change messages correspond to the snapshot number, even after snapshots are rearranged in the Snapshots list.

The Bank Select and Program Changes messages reflect the number (1–999) of the recalled snapshot. (See Table 24 on page 209.)

 VENUE systems always send a Bank Select message before every Program Change message, even if the bank number has not changed from the previous snapshot.

To enable triggering of external devices when snapshots are recalled:

- 1 Go to the Options page and click the Snapshots tab.
- 2 Under MIDI, select the Snapshots Send on Channel option, and choose the MIDI channel from the corresponding pop-up menu.



Snapshot MIDI send option

The VENUE system sends a Bank Select and Program Change message on the specified channel whenever a snapshot is recalled.

 The MIDI Snapshot Output Safe command does not affect the option to send on specific MIDI channels. You can only turn off this feature by deselecting the “Snapshots Send on Channel” option.

Sending MIDI Messages on Snapshot Recall

You can add up to 20 specific MIDI messages to each snapshot. These messages are sent whenever the snapshot is recalled. Sending of the messages is enabled with the MIDI scope control in the Snapshots window. For more information, see Chapter 21, “Snapshots.”

Synchronizing with Word Clock and Digital Audio Input

VENUE systems receive and output Word Clock (at a sample rate of 48 kHz ± 10ppm) for synchronization with a master clock generator (house sync) or other device that uses clock reference. VENUE systems can operate as a Word Clock master, or it can slave to Word Clock input.

The Word Clock In and Word Clock Out ports are located on the back panel of the SC48.

Synchronizing with Digital Audio Input

VENUE SC48 automatically synchronizes to the signal on digital inputs, performing sample rate conversion as necessary to the VENUE native sample rate of 48 kHz.

This lets you connect a variety of digital sources (such as a DAT machine or CD player with digital outputs), directly to the digital 2-track inputs on the back of the SC48.

For instructions on Word Clock and digital audio connections for synchronization, see Chapter 2, “Configuring and Connecting SC48.”

Chapter 24: Using the Standalone Software

VENUE D-Show Standalone software lets you do all of the following to preconfigure performances, wherever you can use your laptop:

- Learn the basics of the VENUE D-Show software interface in preparation for working at a full VENUE system.
- Assign hardware I/O and routing, and name channels.
- Set channel input, EQ, dynamics, pan, and other settings.
- Create and maintain a library of setups, with access to nearly all parameters available on the control surface.
- Store and recall Snapshots, and configure Events.
- Use the Filing features to transfer Shows, Shows Folders, and plug-in presets to/from a compatible USB storage device to transfer data between the standalone software and VENUE.

 *Transferring data must be done to/from a compatible USB storage device such as a USB key disk or other external USB hard drive.*

Differences Between Standalone Software and a VENUE System

The Standalone software is nearly identical to that on a full VENUE system, with the following differences:

Audio Throughput

You cannot play audio through the Standalone software. Real-time audio requires the VENUE hardware.

Plug-In Editing

When a Show is transferred from a complete VENUE system, all plug-ins installed on the D-Show system are visible in the Standalone software as *offline* (unavailable) plug-ins. You can assign offline plug-ins to racks, and assign plug-in rack routing in the Standalone software, and save the routing in snapshots.

 *You cannot install plug-ins or adjust plug-in parameters unless you are working on the complete VENUE system.*

Hardware Configuration

In the Standalone software, you can simulate the hardware configuration of a destination system from the Devices tab of the Options page.

System Requirements

The following are the minimum system requirements for using the VENUE Standalone software:

- Computer running Windows XP Pro or XP Home Edition O/S, Service Pack 1 (Macintosh not supported)
- Minimum 1024 x 768 screen resolution
- Minimum 16-bit color graphics, 32-bit recommended
- Minimum 256 MB RAM, 512 MB recommended
- Minimum 200 MB of available hard disk space, 512 MB recommended
- CD-ROM drive for installation (unless installing from web-download)
- Available USB 1.1 or 2.0 port and compatible USB storage device (such as a flash disk, key disk or other external hard drive) for file transfer

Installation requires Windows Administrator permissions. Once installed, the software can be run under Admin or User accounts.

Installing the Standalone Software

To install the VENUE Standalone software:

- 1 Do one of the following:
 - Download the VENUE Standalone Software Installer from the Digidesign website (www.digidesign.com).
 - or –
 - Insert your VENUE Software Installer into the CD-ROM drive on your Windows XP-compatible computer.
- 2 Launch the installer and follow the instructions on-screen. The VENUE Standalone software requires no authorization.

Removing the Standalone Software

To remove the VENUE Standalone software:

- 1 Launch the Add/Remove Programs Control Panel.
- 2 Choose Digidesign VENUE, then follow the instructions on-screen.

Simulating a VENUE Configuration

You can use the Standalone software to simulate a VENUE system with any number of input and outputs. The corresponding inputs and outputs become available in the Patchbay, allowing you to prepare a show that can transfer directly to the destination system.

To simulate a VENUE system:

- 1 Launch the Standalone software.
- 2 Go to the Options page and click the Devices tab.
- 3 Right-click the console graphic and choose the type of console you will be working with.
- 4 Right-click an I/O graphic and choose the type of I/O (as available) and specify the number of Input and Output cards on the destination system.

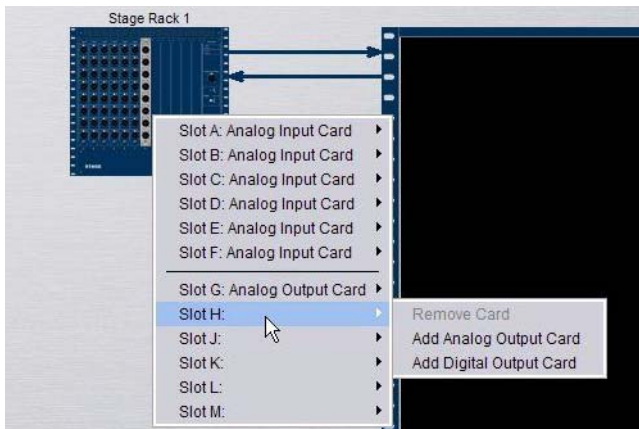

Adding Stage Rack inputs and outputs

Transfer and Filing Quick Start

The basic steps for using the Standalone software and data transfer are as follows:

- Save data to disk, then transfer it to an external USB storage device.
- Transfer data from the USB device, then load the data.

 For complete instructions on transferring data, see Chapter 20, “Shows and File Management.”

Save and Transfer Data from a VENUE System

To save and transfer data from the complete system:

- 1 Connect a USB storage device to a VENUE USB port.
- 2 Use the Save tab of the Filing page to save VENUE data to disk.
- 3 Go to the Filing page and click the Transfer tab.
- 4 Do one of the following to select the type of data to transfer:
 - To transfer all data, click the Console icon.
 - To transfer Console Settings, click the Settings icon.
 - To transfer Show Folders, click the Show Folders icon.
 - To transfer individual Shows, click the Shows icon.
 - To transfer Preset Folders, click the Preset Folders icon.
 - To transfer Presets for individual items, click the Built-In icon or the Plug-In icon and choose a processor, plug-in or Input Channel Presets item from the pop-up menu, or click the Scope Sets icon.
- 5 In the left column, select the items you want to transfer from VENUE to the portable storage device.



Transferring Show files from VENUE

- 6 Click the Transfer button.

Transfer and Load Data to the Standalone Software

- 1 Connect the USB storage device to your laptop. Make sure the drive is mounted before proceeding.
- 2 Launch the VENUE standalone software.
- 3 Go to the Filing page and click the Transfer tab.
- 4 Make sure your USB disk is available in the list at right.
- 5 Click the Console, Settings, Show Folders, Shows, Preset Folders, Built-In, Plug-In or Scope Set selectors to select the type of data you want to transfer.

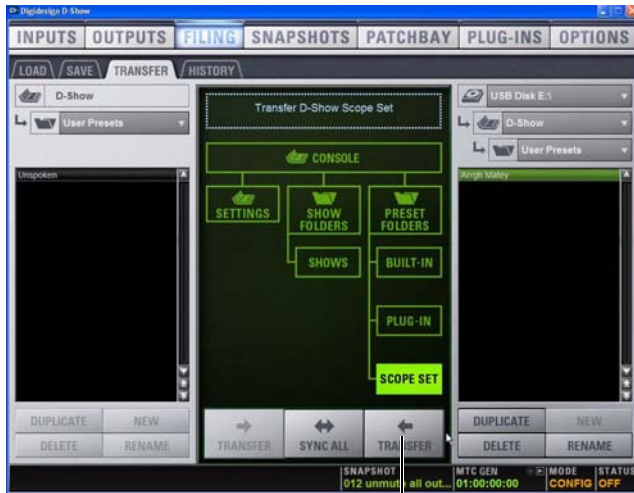

Click

Transferring a Scope Set for the standalone software

- 6 Click the Transfer button. The data is transferred from the USB device to the appropriate VENUE data folders on the laptop.
- 7 If you chose Console, data is automatically loaded and applied. If you chose any other data type, go to the Filing page and click the Load tab, and load the newly transferred data into the Standalone software.

Creating and Editing Shows and Presets

Use the techniques explained throughout this guide to assign routing, rename channels, and to configure other parameters. Then do the following to save and transfer your work to a complete system.

To save and transfer VENUE data from the standalone software to the complete system:

- 1 Connect a USB storage device to an available USB port on your laptop.
- 2 Using the Save tab of the Filing page, save data to disk.
- 3 Go to the Filing page and click the Transfer tab, and transfer saved data to a compatible USB storage device.
- 4 Connect the USB storage device to an available USB port on the complete system.
- 5 Use the Transfer tab of the Filing page to transfer the VENUE data from the USB storage device.
- 6 Use the Load tab of the Filing page to load the transferred data.

CD Transfer

The VENUE SC48 provides a CD-ROM drive that can also be used as a source device for VENUE data transfer. (You cannot write data to the FOH Rack CD-ROM drive; it is read-only.)

To use a CD for transfer:

- 1 Using the Standalone software on a laptop or other computer, create and save a show.
- 2 Locate the VENUE data folder on the system drive.
- 3 Copy that folder and its contents to a CD-ROM. Make sure the folder is at the root level of the CD-ROM.
- 4 Burn or write the disc as a Windows-compatible CD-ROM.
- 5 Insert the CD-ROM into a VENUE CD-ROM drive.
- 6 In the Filing screen, select the CD-ROM drive as the source for file transfer.
- 7 When the transfer is complete, eject the CD-ROM.

 Leaving a disc in the CD-ROM drive of a VENUE system can slow down the response of some software screens, so it is recommended that you not leave any disc in the drive during a performance. This only applies to a VENUE CD-ROM drive (not the laptop on which you're running the standalone software).

Exporting System Information and Patchbay Information

With Standalone software, a complete system description and/or the contents of each Patchbay page can be exported to a text file. These can be useful for generating an input list (line list) directly from the system. For example, build and customize the Patchbay for an upcoming show, then export and print the channel names list for use during sound check.

To print a system description:

- 1 Go to the Options > System tab.
- 2 Click the Info button and follow the on-screen instructions to print a complete system description.

For more information, see “VENUE System Information Export” on page 104.

To export Patchbay names:

- 1 Go to the Patchbay page you want to export.
- 2 Click the Export Patch List icon in the upper right corner of the screen.

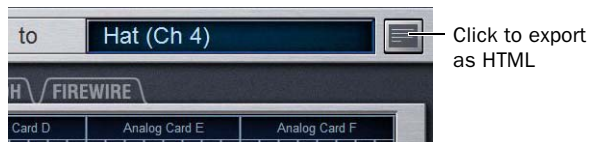

Export Patch List button

The Patchbay names appear in an open HTML file that you can save and print, or open in an HTML-compatible application for formatting or other modification. For more information, see “Patch List Export” on page 105.

Part VI: Specifications

Chapter 25: Mechanical Specifications

VENUE SC48 Mechanical Specifications	
Maximum Height (front)	3.9 inches (100 mm)
Maximum Height (rear)	7.3 inches (186 mm)
Maximum Width	38.95 inches (989 mm) with endcaps 37.6 inches (954 mm) without endcaps
Maximum Depth	28.15 inches (715 mm)
Weight	125 lbs (56.7 Kg)
Power Requirements	100–240 V, 50–60 Hz, 200 W
USB Ports (5)	USB 2.0
1394	1394 Firewire (for Pro Tools LE only)
GPI Port	DB9 female
Footswitch Connectors (2)	1/4-inch TRS
MIDI (In/Out)	5-pin DIN female
Word Clock (In/Out)	BNC female
VGA Port	DB-15 mini-female (1024 x 768 resolution)
DVI Port	DVI female (1024 x 768 resolution)
ECx Ethernet Control	RJ-45 (for ECx remote control)
Console Light Connectors (2)	XLR3-F

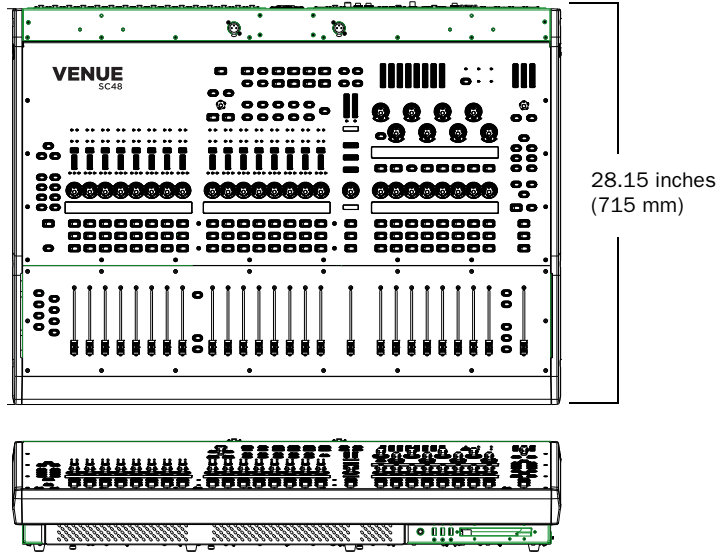
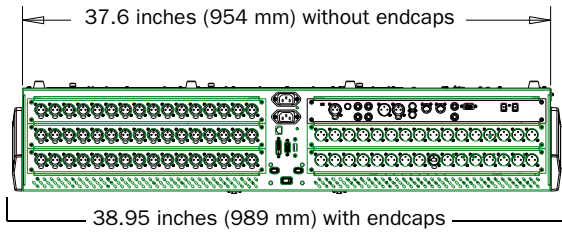

7.3 inches (186 mm)

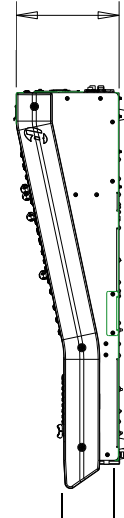

3.9 inches (100 mm)

Dimensions, VENUE SC48

Chapter 26: Audio Specifications

VENUE SC48 Console Audio Specifications	
Internal Sample Frequency	48 kHz
External Sample Frequency	48 kHz +/- 10 ppm (word clock input)
Processing Delay	less than 2.3 ms (48 channels, stage input through L-R bus to stage output)
Internal Processing	up to 48-bit, fixed point 288 dB internal dynamic range
Frequency Response	+/- 0.2 dB (22 Hz – 20 kHz BW, relative to 1 kHz)
THD + N	-90 dB (0.003 %) stage input to L-R bus, input gain @ min, -1 dBFS output, 20 Hz – 20 kHz BW
Dynamic Range	108 dB typ
Maximum Voltage Gain	84 dB (stage input to L-R bus, channel & L-R faders @ max)
Crosstalk	-100 dB typ (Adjacent stage inputs to L-R bus, @ 1 kHz)
Residual Output Noise	-90 dBu typ (20 Hz – 20 kHz BW)

VENUE SC48 Headphone Output	
Connector	1/4-inch TRS unbalanced
Output Impedance	50 ohms
Max RMS Power Output (at +21 dBu:	(with 32-ohm phones) 106 mW
	(with 600-ohm phones) 130 mW

All specifications subject to change.

Stage I/O

AI16 Analog Input Card

AI16 Analog Input Card	
Connectors (x16)	XLR3–F, balanced
Phantom Power	+48V, (individually switchable per channel via software), 10 mA max
Maximum Input Level	+32 dBu, with Pad *
Pad	20 dB
Gain	+10 dB to +60 dB
Input Impedance	pad off: 5.5k Ohm, leg to ground
	pad on: 3.8k Ohm, leg to ground
EIN	–126 dBu typ (Max gain, 150 ohm source, 20 Hz – 20 kHz BW, unweighted) *
A/D	24-bit, delta sigma

A016 Analog Output Card

A016 Analog Output Card	
Connector (x16)	XLR3–M, balanced
Maximum Output Level	+24 dBu *
Output Impedance	50 ohm, leg to ground
D/A	24-bit, delta sigma, 128x oversampling

* 0 dBu = 0.775 V rms

 If your system contains a different type of I/O card, see the guide that came with that I/O option.

FOH I/O

Talkback Input	
Connector	XLR3-F
Phantom Power	+15V @ 6mA (switchable)
Sensitivity	-2 to -32 dBu (variable in 6 gain steps)
Input Impedance	4k Ohm

2-Track Analog Inputs	
Connector	1/4-inch TRS
Maximum Input Level	+24 dBu
Input Impedance	10k Ohms

2-Track Analog Outputs	
Connector	1/4-inch TRS
Maximum Output Level	+24 dBu
Output Impedance	50 ohms

2-Track Digital AES Inputs	
Connector	XLR3-F
Format	AES/EBU
Word Length	24-bit
Sample Rate	48 kHz
Sample Rate Conversion	3:1 ratio

2-Track Digital AES Outputs	
Connector	XLR3-M
Format	AES/EBU
Word Length	24-bit
Sample Rate	48 kHz
Dithering	No
Channel Status Info	Pro, Audio 48K, No Emphasis

Chapter 27: Signal Flow Diagrams

VENUE SC48 Input Signal Flow Diagram

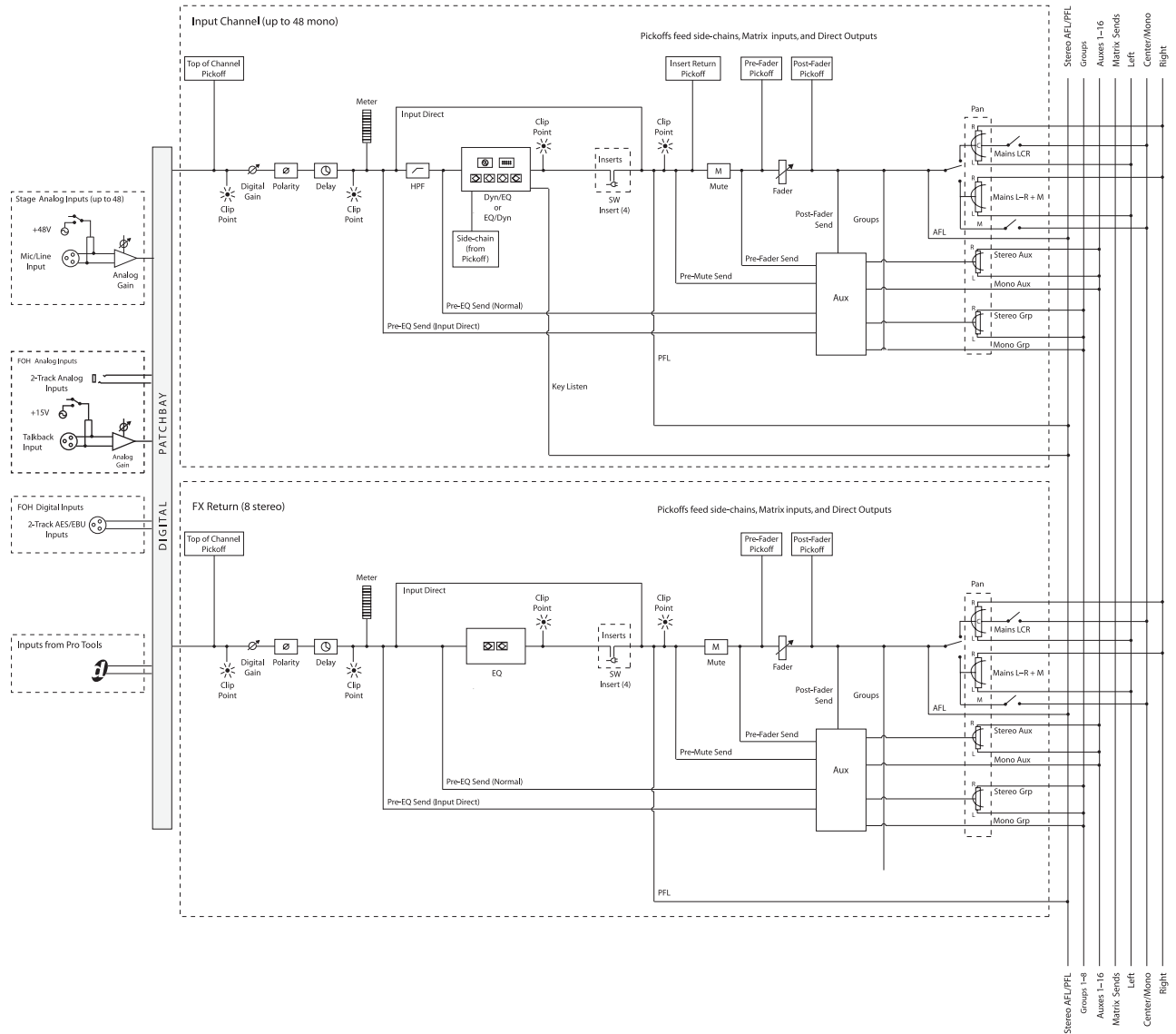

VENUE SC48 Output Signal Flow Diagram

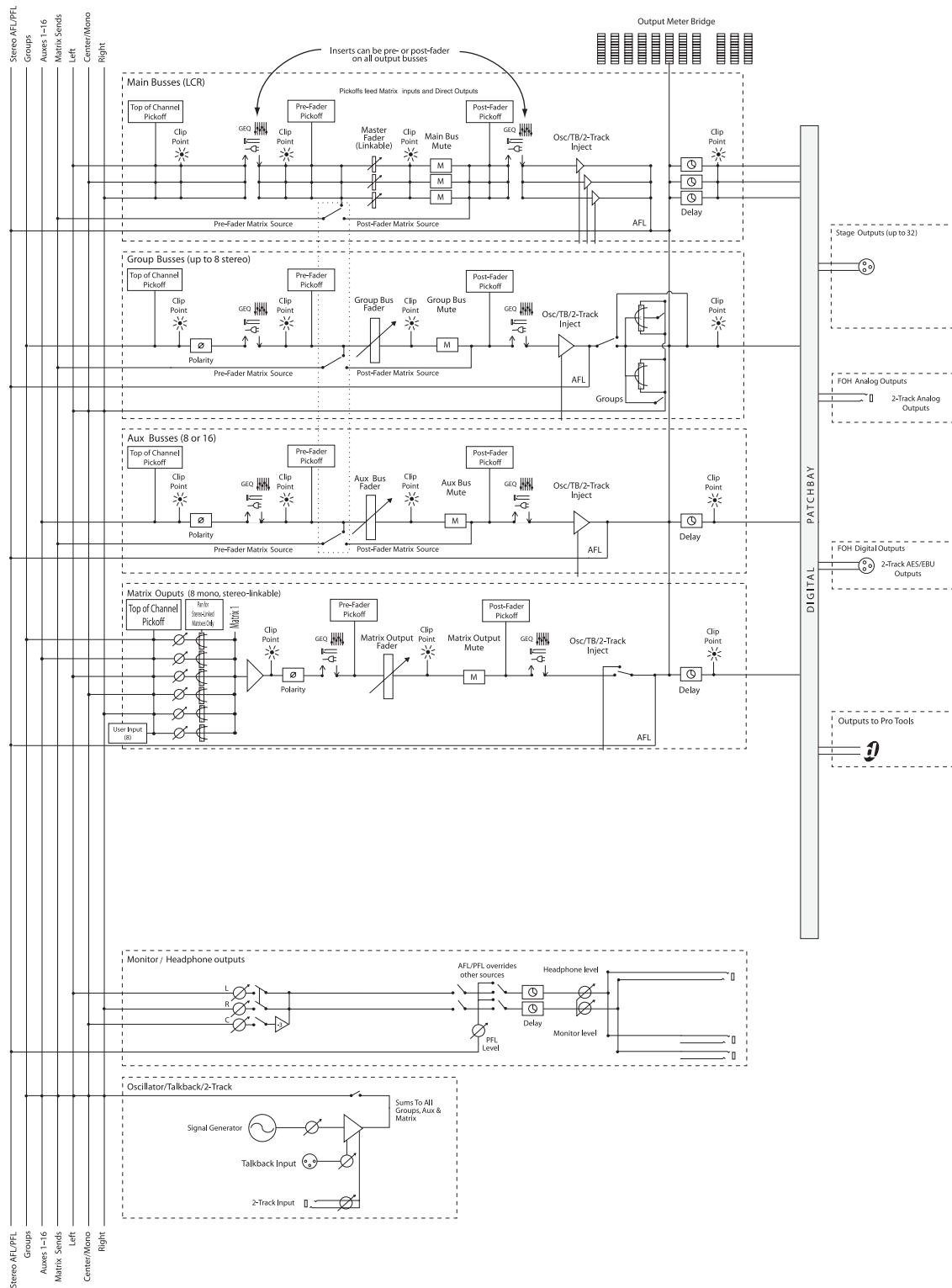

Chapter 28: Troubleshooting

This chapter provides troubleshooting and problem solving information. It includes a table of problems and solutions that provides answers to common questions, explains on-screen text messages, and refers you to specific sections later in this chapter or elsewhere in this guide for details and instructions.

Problem Solving

The following table provides descriptions of situations that may arise while operating a VENUE system and includes common questions, symptoms and error messages, along with possible solutions.

Table 29. Troubleshooting Errors and Messages

Symptom or Message	Possible Cause	Solution
Faders, Switches, Channels, and Devices		
Fader stuck	Fader path was blocked during startup calibration	Reset the unit on which the stuck fader resides by right-clicking the unit in the Options > Devices page and choosing Reset. If possible, wait for a silent portion of a performance to avoid unexpected gain changes upon reset. For details, see “Hardware Monitoring Window” on page 230).
Only faders and mutes are working	Backup personality is in effect	Wait for the system to recover and follow instructions on-screen to resume operations (see “Resuming Normal Operation” on page 228).
Channel meter Stereo LED is flashing	Indicates a difference of 12 dB or more between the two sides of the stereo signal.	Trim source levels or input gains to balance.
Cannot pan an Aux Send from the ACS	Aux panning is configured to follow channel pan	In the Options > Busses page, select the Follows Channel Pan option. Deselect for each Aux Send you want to pan independently from channel pan.
Startup and Restarts		
System failure and restart, then the Resume Operations dialog appears	The VENUE D-Show software has been forced to restart and the backup personality is now in effect.	Continue mixing using features available while the backup personality is in effect (see “In Case of System Failure” on page 227). Follow the instructions on-screen to resume operations after a restart (see “Resuming Normal Operation” on page 228).

Table 29. Troubleshooting Errors and Messages

Symptom or Message	Possible Cause	Solution
Repeated failures	An incompatible plug-in, a corrupted data file or application software, or a hardware error.	<p>Check to make sure you are using the most current versions of all your plug-ins (check with the manufacturers). If failures occur only when you try to use a certain plug-in, disable that plug-in and see if problems go away. Try re-installing plug-ins that are causing problems.</p> <p>Determine if a certain Show file causes the system to fail consistently. If so, delete that file and see if problems persist. For additional options, see “Performing a Soft Reset” on page 229.</p> <p>Clear the console from the Options > System Config page and see if problems persist.</p> <p>If necessary, you can reinstall D-Show software (see “Updating or Re-Installing” on page 231).</p> <p>If you suspect problems with the system hard drive, or the system software, you can do a complete restore (see “Full System Restore” on page 231).</p> <p>Power down all equipment and check all cards and cable connections and power supplies.</p>
Plug-Ins		
The plug-in racks need to be re-initialized	The racks have gone offline. The racks go offline whenever the backup personality is in effect, and after some conditions in which a plug-in or the DSP host failure causes significant problems.	Follow the instructions on-screen to reset the racks (see “Re-Initializing the Plug-In Racks” on page 228).
One or more plug-ins are unavailable	A Show was loaded that references plug-ins which are unavailable on the current system	<p>Install the plug-ins, if available (see “Installing and Authorizing Plug-Ins” on page 143).</p> <p>Remove or replace the plug-ins in the Show, or load a different Show file.</p>
	A plug-in is not fully compatible and is causing failures	<p>Check all plug-ins to make sure you are using the most recent versions. Go to Options > Plug-Ins and click the plug-in to display the version number.</p> <p>Try disabling plug-ins one-by-one to see if doing so eliminates problems (see “Enabling and Disabling Installed Plug-Ins” on page 146).</p>
Plug-in authorization dialogs appear every time the system starts or restarts	A plug-in is installed that needs to be authorized for demo or full use.	<p>Click Quit to dismiss the authorization dialog and continue starting up (the plug-in will be unavailable).</p> <p>Click Try to use the plug-in for a limited time in Demo mode.</p> <p>Click Authorize if you are ready to authorize a plug-in using an iLok. (See “Installing and Authorizing Plug-Ins” on page 143.)</p>
	A plug-in demo has expired	Uninstall the plug-in listed in the authorization dialog (see “Removing Plug-Ins” on page 144).
Error Messages		
One or More Units have Failed	Bad or missing connection	<p>Check all cables and connections. Make sure digital grade XLR cables are being used to connect Main Unit and all Sidecar units (VENUE D-Show systems only).</p> <p>Check to make sure that the last Sidecar in the chain is properly terminated (original D-Show systems only).</p>
	A unit needs to be reset	Reset the component in Options > Devices. If necessary, restart the VENUE system.
Plug-In Racks Need Reset	The racks have gone offline due to the backup personality being in effect, a plug-in has failed, or some circumstances have caused the DSP engines to require a reset.	Follow the instructions on-screen to reset the racks (see “Re-Initializing the Plug-In Racks” on page 228).

Table 29. Troubleshooting Errors and Messages

Symptom or Message	Possible Cause	Solution
Power Supply Alert	A power supply is failing or is not plugged in. A power supply jumper switch is set incorrectly.	Click Review to show the Options > Devices page. Reset units as needed (see “Hardware Monitoring Window” on page 230).
Control Surface Change (VENUE D-Show systems only)	A unit Bus ID has changed, a new console has been detected, or a new sidecar has been detected.	Click to clear the message. Check unit Bus IDs to make sure input channel strips are arranged as desired.
Date & Time Check	System clock setting for time of day should be checked against current time.	Check and reset system time in the Options > Misc page. Incorrect system time can affect data transfer and plug-in authorizations. If clock problems persist, the battery may need to be replaced.
Sample Rate Conversion Alert SRC OFF LEDs flashing (Systems with DSI option only)	A sample rate mismatch or lack of clock has been detected at a digital input.	No immediate action required; automatic sample rate conversion maintains digital throughput, allowing you to check settings and connections between D-Show and external digital devices later. For more information on digital connections and synchronization, see “About Digital Input and Sample Rate Conversion” on page 13.
Hardware Monitor Alert	The system has detected a hardware component that is performing above or below its hardware specification.	Click HW Monitor to access the Hardware Monitor Window for the device. See “Hardware Monitoring Window” on page 230.

In Case of System Failure

VENUE systems include multiple redundancy and fail-safe routines that help protect against problems that could interrupt audio. These include the ability to maintain mix control even if a failure occurs, to reset software and hardware components, and to completely reset and reinstall the system software.

For maximum protection, Redundant Power Supplies are available. For systems that utilize one or more VENUE hardware racks, redundant Snake options are available to provide additional backup system communication for uninterrupted operation.

Maintaining Mix Control

If at any time the system fails, or if the system is reset or restarted, the VENUE D-Show software backup mode is automatically engaged to maintain audio throughput and essential mix control.

While the backup personality is engaged, a dialog appears on-screen in the banner display. The system then begins to reset itself in the background, while you can continue to use the faders and mute switches to perform basic mixing. Plug-Ins continue to process audio but their controls cannot be changed until the process is complete.

Features that Remain Active

The following essential mixing features remain available while the backup personality is engaged:

- Bank Input Channels (Banks A–D); adjust levels and mutes. (FX Returns are banked independently of Input Channels.)
- Bank to FX Returns; adjust faders and mutes
- Bank Output faders; adjust faders and mutes
- Control VCA masters, including VCA mutes, and have all members of the VCA group reflect VCA adjustments
- Display the correct name for any fader in its LCD display, even while banking
- Meter input signals on the channel input meters, and meter bus outputs on the assignable meters. Meter mode selection buttons remain active on meterbridge (however, Meter mode does not automatically follow output selection, if configured to do so).
- Compressor and gate meters remain active for all Input Channels (however, Comp In and Gate In switches are not available)
- Meterbridge System Status LEDs turn off (VENUE D-Show and Profile only)

- Channel select is disabled for all inputs and outputs
- ◆ Switch the Mute Group Masters, and see the effect on the channels with member-mutes (flashing mute switches)
- ◆ All LCD displays illuminate (orange)
- Adjust near-field monitor and headphone levels

Unavailable Features

The following features are unavailable while the backup personality is in effect:

- Use the ACS
- Modify any other mixing parameters apart from faders and mutes (for example auxes)
- Use solos or Solo In Place
- Change the input or output routing, or order of inputs
- Make stereo, or unlink stereo to discrete mono channels
- Channel Control and Flex Channel
- Change bus or group assignments, or Group spill
- Change VCA membership, VCA spill, or show VCA members
- Change names or access any Filing functions
- Reconfigure any system parameters in the Options screens
- Access GEQs on the faders (GEQs continue to process audio in backup mode)
- Adjust the parameters of any existing Plug-In
- All LED indicators (except meters) and output fader CAL lights go dark and are inactive

Resuming Normal Operation

(Exiting the Backup Personality)

When the system has recovered and is prepared to return to normal operation, the Ready to Resume dialog appears on-screen.

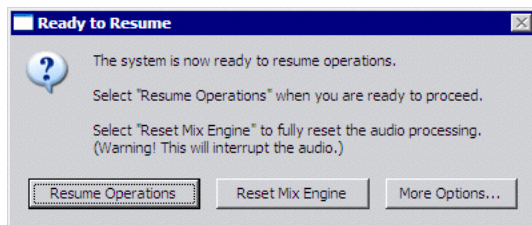

Ready to Resume dialog

Choices in the Ready to Resume dialog give you options for how and when critical functions are brought back online. Utility functions are also provided for reset and diagnostics, as described in the following sections.

⚠ *Because this process can interrupt audio throughput, wait for a silent portion of the performance before confirming (such as a break between songs, intermission, or similar).*

Resume Operations Use this option if you need to wait for a break in a performance to complete the resumption of normal operations.

Reset Mix Engines Use this option to do a full system reset in one step. All operations and controls including the plug-in racks return to full operation. This is the fastest way to resume operations, but it may interrupt audio.

More Options Use this option to clear the console (reset, or “zero” the board), or to perform hardware diagnostics.

Resume Operations

This option begins the process of resuming operations and lets you control precisely when the plug-in racks are re-initialized.

To begin the Resume Operations process:

- 1 Click Resume Operations. The console resets all parameters and configuration settings. When completed, the Plug-In Racks Reset dialog appears to let you initiate the process of re-initializing the plug-in racks.
- 2 Reset the plug-in racks (see next).

Re-Initializing the Plug-In Racks

The plug-in racks are taken offline during a Resume Operation process. Whenever the plug-in racks go offline they will need to be reinitialized to resume normal operation.

⚠ *Do not reset the racks until there is a long enough break in the performance that the rack can be fully rebuilt with no signal passing through. This is especially important when using crossover plug-ins or gain-attenuating plug-ins.*

The following conditions apply when resuming operations

- When offline, plug-ins on Input Channels and FX Returns continue to pass and process audio using their settings at the time the racks went offline.
- Offline plug-ins on output channels and busses are muted.
- You will not be able to adjust plug-ins settings until the racks fully re-initialize.
- Once the racks begin to reinitialize, plug-ins are unavailable and do not process audio.
- During reinitialization, plug-ins are loaded into rack slots according to the last loaded Show file; plug-in racks are turned off (all assigned plug-ins are made inactive).
- When all plug-ins have loaded and the racks initialized, the system displays a dialog alerting you that the racks are ready to be brought back online (reactivated). This is provided as a final precaution against sudden changes to audio when plug-ins resume processing.

Shortly after you confirm that you want the racks brought back online, plug-ins resume processing audio and all parameters become available for editing.

To re-initialize (reset) the racks:

- 1 In the Plug-In Racks Reset dialog, click Reset to begin the plug-in rack re-initialization.

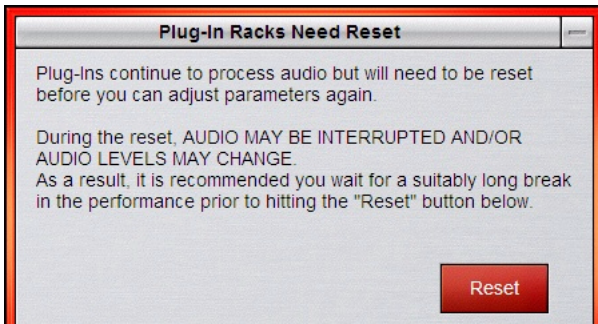

Resetting the plug-in racks

When this step is completed, the Plug-In Racks are Ready dialog appears alerting you that the plug-in racks are ready to be re-activated.

- 2 Click Use Racks to confirm that you want the racks to be re-initialized. Status is shown on-screen. After the process is complete, the console and all plug-ins are operational again.

Reset Mix Engines

Use this option to do a full system reset in one step. Reset Mix Engines resumes all operations automatically, including the console, settings, and plug-in racks.

 *Audio may be interrupted or may change levels during this reset procedure.*

To reset the Mix Engines and all operations immediately:

- Click Reset Mix Engines in the Ready to Resume dialog.

Operations are brought back online; no further interaction is required (no warning or confirmation dialogs appear).

More Options

Additional options are provided to clear the console, or to run DigiTest (hardware diagnostics).

To access additional options:

- Click More Options.

After clicking More Options, a dialog is displayed that provides the following options.

Clear Console

- Click Clear Console to reset all D-Show parameters on all channels to their factory default settings.

Run DigiTest

DigiTest is hardware diagnostics software for VENUE systems. Only use DigiTest at the request of a Digidesign technician to diagnose specific hardware problems.

Performing a Soft Reset

If your VENUE system ever needs to be reset, do the following:

To restart the system:

- 1 Go to the Options > System page.
- 2 Hold Default (Alt) and click the Shut Down button.



If restarting the system does not correct a problem, you may have to reset hardware components, identify and remove any incompatible plug-ins, or reinstall VENUE D-Show software using the System Restore CD.

Additional Reset Options

Additional shortcuts are provided while restarting the system, which let you do the following:

- Back up the current show settings and clear the console. Use this option if you suspect an auto-saved setting has become corrupted. This lets you save your most recent settings and clear the console without having to do a full system restore.

– OR –

- Launch into Explorer, to be able to manually manage software components. Use this option to troubleshoot the system if problems arise early in the startup process and persist through repeated restarts.

Backup and Clear Console

To backup and clear the console at restart:

- 1 Start or restart the system.
- 2 Watch the screen closely during the startup process. As soon as the cursor becomes visible (and before the VENUE D-Show Software logo screen appears) press and hold the C key on the computer keyboard. Continue to hold the C key (do not press it repeatedly).
- 3 A dialog appears that lets you choose to backup your auto-saved settings and clear the console, or to continue and load settings normally.

 *If you press the C key too early in the startup process, the USB keyboard is reset instead of calling the Backup and Clear dialog. If you do not see the backup and clear dialog, repeat the restart process and try again.*

Startup in Explorer

To start up the system in Explorer (bypassing VENUE D-Show software):

- 1 Start or restart the system, as necessary.
- 2 Watch the screen closely during the startup process. As soon as the cursor becomes visible (and before the VENUE D-Show Software logo screen appears) press and hold the E key on the computer keyboard. Continue to hold the E key (do not press it repeatedly) until you see the Explorer desktop.
- 3 From Explorer, you can manually find and delete suspect data files, plug-ins, or perform other file management tasks.

 *If you are unsure about how to troubleshoot a computer and its files, it is recommended that you contact Digidesign VENUE customer service.*

Hardware Monitoring Window

VENUE systems provide the Hardware Monitoring window in which performance of hardware components can be viewed and monitored.

 *The Hardware Monitoring window is not available in the Standalone version of VENUE D-Show software.*

Accessing Hardware Monitoring

To access the Hardware Monitoring window, do any of the following:

- Press Ctrl+Shift+M at any time to open the Hardware Monitoring window.
- In the Options > Devices page, right-click on SC48 and choose Hardware Monitoring in the pop-up menu. This opens the Hardware Monitoring window for the selected device.
- If the Hardware Monitoring Alert dialog appears on-screen, click to select Show Hardware Monitor. The Hardware Monitoring Alert dialog for the problem device appears automatically and identifies the reading that is out of specification.

The Hardware Monitoring Alert window is only displayed once per device (should a problem ever be detected with that device).

The following is an example of the Hardware Monitoring Alert:



Hardware Monitoring Alert

Should a problem occur with any of the components in your system, the Hardware Monitoring window will provide information that will be useful in troubleshooting while in contact with Digidesign VENUE customer service.

Resetting Hardware Components

(VENUE Profile and D-Show Systems Only)

Some VENUE hardware can be reset from the Options > Devices screen, or by power-cycling the component. It is recommended that you perform a reset if, for example, the Hardware Monitor Alert dialog appears, or if a connected device stops communicating with the rest of the system.

Indication

The system software will display error messages alerting you if a device fails or is no longer available.

The system remembers the last hardware configuration used. If it doesn't find all units at the next startup, it displays those units as grayed out in the Options > Devices page. Units remain offline (and the system displays error messages alerting you to their absence) until either the units are powered up and come online, or you tell the system to forget the offline units by right-clicking the missing devices and choosing Forget.

To reset system hardware:

- 1 Put the system in Config mode.
- 2 Go to the Options page and click the Devices tab.
- 3 Right-click any displayed hardware components:
 - Console
 - Inputs section
 - ACS sections
 - Outputs section
- 4 Choose Reset.



Resetting a unit in the Options > Devices page

Using the System Restore CD to Update or Restore the System

One copy of the System Restore CD is included with each system. The System Restore CD provides software installers to update or restore a system.

Updating or Re-Installing Updating or re-installing system software lets you replace Digidesign software (including new installers for factory-installed plug-ins) but preserve any saved Shows and Presets. Use this option to update system software or firmware, or to re-install system software or the installer for a factory-installed plug-in.

Factory-installed VENUE D-Show plug-ins are immediately available to be reinstalled from the Options > Plug-Ins page. Plug-ins that cannot be re-installed from the Options > Plug-Ins page must be reinstalled from their installer discs.

Full System Restore Performing a full system restore completely uninstalls system software before replacing it with new software. All data folders and files are removed. Be sure to transfer and archive needed data before performing a system restore. Factory plug-in installers will be available automatically, as part of the system restore. All other plug-ins must be re-installed from their installer discs.

 A System Restore CD and CDs of any plug-in installers should be kept with the system at all times.

To start, update, or restore a system using the System Restore CD:

- 1 Make sure outputs, speakers, and power amps are muted.
- 2 Insert the System Restore CD into the VENUE system CD-ROM drive.
- 3 Go to the Options > System page.
- 4 Alt-click the Shut Down button.
- 5 Click to restart the system, then press and hold F10 on the keyboard until either of the following occur, depending on your hardware:
 - If the system begins to boot off the Restore CD, proceed to step 4.
 - If the Restore CD text screen appears, release F10 and use the Up and Down Arrow keys to select the CD drive, then press Enter. This launches using the software on the inserted System Restore CD. Continue to step 4.

 Some models of USB keyboards require repeated pressing of F10 (holding it down in between pressings) to register.

- 6 Do one of the following to update or restore system software:
 - To update system software while keeping any Show files and Preset files on the system, press “u” (lower-case). In the Update confirmation screen, press Shift+U (upper-case) to proceed. Follow the on-screen instructions to begin installation.
 - or –
 - To fully restore the system (completely removing all files on the system), press “r” (lower-case). (Or press P to return to the previous screen.) When the Restore confirmation dialog appears, press Shift+R to proceed. Follow on-screen instructions to complete the system restore operation.
- 7 If prompted, select an option in the Ready to Resume dialog as appropriate (see “Resuming Normal Operation” on page 228). Follow any additional instructions on-screen for plug-ins or authorizations.
- 8 Remove the System Restore CD from the CD-ROM drive.
- 9 Re-install any plug-ins from their installer discs, as necessary.

 Before re-installing plug-ins after updating system software, check if there is a more current version available. If an updated version of a plug-in is available, install it from its installer CD-ROM.

To cancel without changing any installed software:

- Press E to exit from the Welcome to VENUE System Restore screen. The system resumes starting up using the currently installed version.

 *If you cancel a full system restore or an update, you may experience installation errors about unavailable space. If this occurs, repeat the system restore process, making sure to complete it in one pass.*

Updating Firmware

During an update or system restore, the system checks for new firmware. If newer firmware is found on the System Restore CD, it is installed while the system starts up.

Reinstalling Plug-Ins After Restoring the System

The System Restore CD reinstalls all system software and factory-installed plug-in installers only. DigiRack Plug-ins and any additional plug-ins from Digidesign or its Development Partners must be re-installed separately. (Factory-installed plug-ins will be available from the Previous Installs selector to re-install immediately after a system restore; other plug-ins must be completely re-installed.)

 *For instructions on re-installing plug-ins, see Chapter 19, "Plug-Ins."*

Part VII: Reference

Chapter 29: Console Reference

This chapter describes the GPI port and its capabilities on the VENUE SC48 console.

GPI (General Purpose Interface)

GPI Input Specifications

A 9-pin, female DB9 connector provides a total of 2 General Purpose Interface (GPI) Inputs and 2 Outputs.

- Inputs are logic inputs with pull-ups. They may be driven by logic outputs or contact closure to ground.
- Input signal range is 0 to 5.5V. The inputs are ESD protected.
- Input signaling uses standard TTL logic levels: 0.8V or less for a logic low. 2.0V or greater for a logic high.
- Inputs are compatible with 5V TTL (e.g. 74LS series), 5V CMOS (e.g. 74HC series), 3.3V CMOS (e.g. 74LVC series)
- Inputs provide an internal 5K ohm pull-up to +5V.
- All Inputs are referenced to the same internal ground, which is connected to AC safety ground.

GPI Connector Pin Assignments

The SC48 GPI port is a female DB9 connector that provides two GPI inputs and two GPI outputs.

DB9 GPI Connector Pin Assignments

Pin Number	Function	Comments
1	Input 1	Logic level (TTL, CMOS) input with pullup
2	Input 2	Logic level (TTL, CMOS) input with pullup
3, 8	Output 1	Floating contact closure output
4, 9	Output 2	Floating contact closure output
5, 6, 7	Ground	All ground pins are connected internally

Pinout for GPI Connector

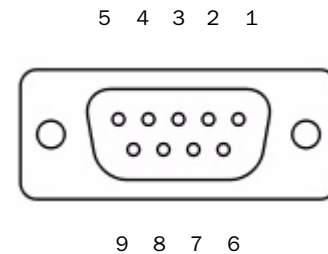

Pinout for VENUE SC48 DB9 GPI port (looking at back of console)

GPI Output Specifications

The VENUE SC48 GPI connector provides a total of 2 General Purpose Interface (GPI) Outputs in addition to its 2 inputs.

- Outputs are isolated, floating relay contacts (contact closure).
- Switched voltage is 200V max; 0.5A max.
- Switched voltage with respect to safety/chassis ground is 300V max.

⚠ *VENUE GPI Outputs can switch 500 mA maximum. This applies even to short term current surges. This limit can be exceeded when driving a capacitive or incandescent lamp load. An incandescent lamp may draw as much as ten times its steady state current when first turned on. Therefore such lamps are typically not appropriate loads for the GPI Outputs, and should instead be controlled by a secondary relay.*

GPI Output Ground Connections

The GPI Outputs provided are isolated contact-closure style. Each GPI output is presented on a pair of pins. These two pins represent the two sides of a switch that can be opened and closed. If it is desired to drive a signal to ground, then one of the pins must be wired to ground, and the other to the signal to be controlled.

GPI Wiring Diagrams

The following diagrams provide examples of GPI pinout and wiring for a few common uses.

All diagrams are shown from the rear (solder side) of the DB9 connector.

GPI Input Examples

The following diagrams provide simplified wiring examples for a customer-provided DB9 male connector, to attach to the female GPI connector on VENUE SC48.

Wiring a Switch to Drive GPI

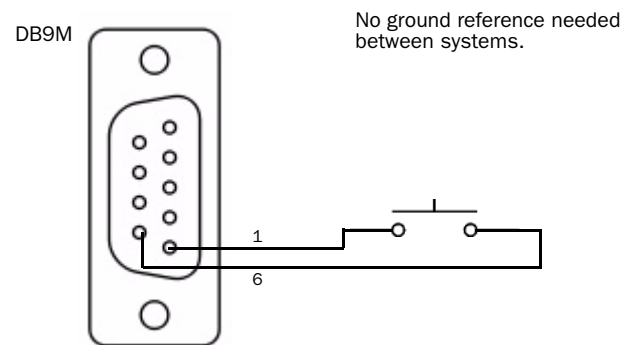

Wiring a Relay to Drive GPI

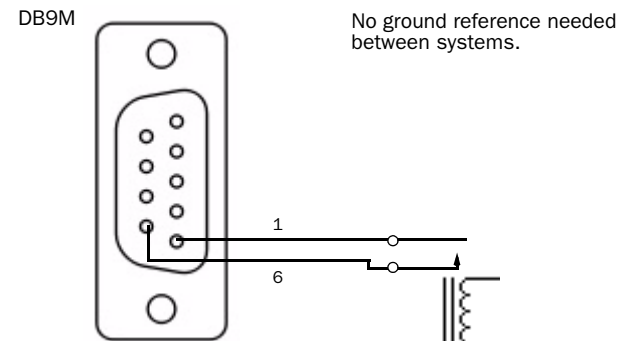

Wiring a Logic Signal to Drive GPI

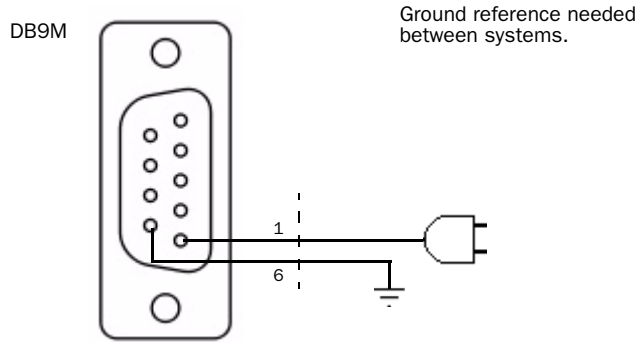

GPI Output Driving a Logic Input

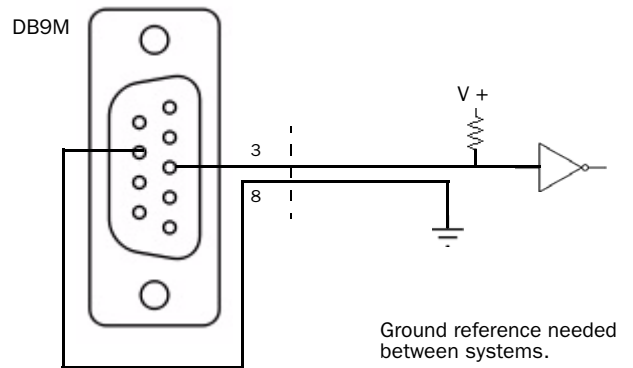

GPI Output Examples

The following diagrams depict wiring examples for a customer-provided DB9 male connector, to connect to the female GPI connector on VENUE SC48.

GPI Output Driving an Externally Powered LED

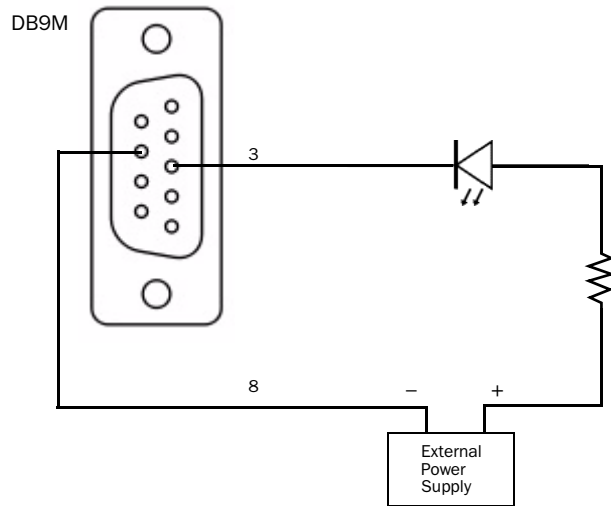

GPI Output Driving a Relay Using an External Power Supply

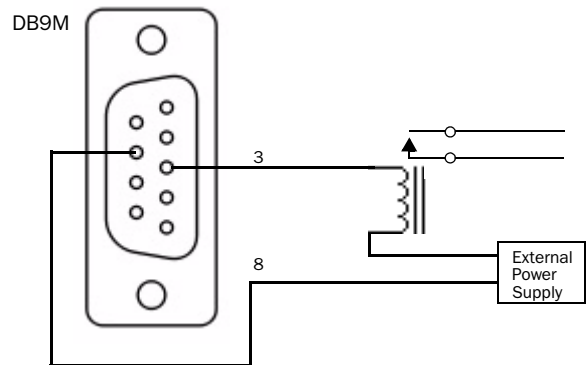

Chapter 30: FWx

VENUE SC48 includes the VENUE FWx FireWire Record/Playback card. The FWx card lets you integrate a Digidesign® Pro Tools® LE system with your VENUE system to record and archive live performances, and to integrate pre-recorded Pro Tools tracks with live inputs.

By combining the recording and playback features of Pro Tools with your VENUE system via FWx, you can record multiple tracks of a rehearsal or performance and then play them back for training, letting you and your staff learn the system and practice mixing without requiring a band or crew.

FWx Capabilities and Features

FWx provides the following features:

- Direct digital connection (24-bit, 48 kHz) between your VENUE system and a computer running Pro Tools LE
- Recording of up to 18 channels of digital audio directly to Pro Tools
- Playback of up to 18 Pro Tools tracks
- Pro Tools LE support for Windows XP, Vista, and Mac OS X versions
- A standard FireWire cable connection

 *VENUE SC48 does not support the HDx card.*

FWx Components

The FWx components of your VENUE SC48 package include the following items:

- FWx card and ribbon cable (installed in the SC48 at the factory)
- Pro Tools LE Installer Disc
- Digidesign Registration Information card
- A FireWire cables (six-pin to six-pin 1394)

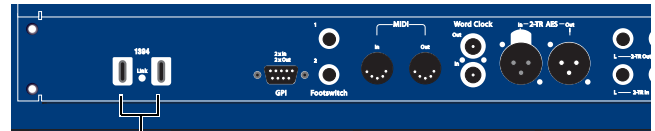

*FireWire ports for FWx
SC48 back panel*

Pro Tools LE Requirements for FWx

The following are required to use FWx with your installed and configured VENUE system:

- A compatible FireWire-equipped computer running Windows XP, Vista, or Mac OS X.
- A compatible version of Pro Tools LE version 6.7 or higher (Windows) or 6.9.2 or higher (Macintosh). Digidesign Pro Tools LE hardware is not required.

For complete system requirements, visit the Digidesign website (www.digidesign.com).

Compatibility Information

Digidesign can only assure compatibility and provide support for hardware and software it has tested and approved.

For a list of Digidesign-qualified computers, operating systems, hard drives, and third-party devices, refer to the latest compatibility information on the Digidesign website (www.digidesign.com/compatibility).

Installing Pro Tools LE

If you are installing Pro Tools LE on a computer for the first time, use the Pro Tools LE Installer disc included with the VENUE SC48 to install all software and drivers for FWx recording and playback.

For step-by-step instructions on installing and authorizing Pro Tools LE software and configuring your Pro Tools system, refer to the *003 & 003 Rack Setup* guide located on the Pro Tools Installer disc.

Using Lower Versions of Pro Tools LE with FWx

VENUE SC48 comes with a copy of the most recent version of Pro Tools LE software. Use the included version to guarantee that all software (drivers) for FWx are installed automatically.

If for whatever reason you want or need to use a lower version of Pro Tools, your exact software installation steps may vary as follows:

Pro Tools 7.1.1 or higher No extra installation is required. With Pro Tools 7.1.1 and higher, the Pro Tools software driver for FWx is installed automatically.

Pro Tools 6.7-7.1.0 You must manually install the Pro Tools software driver for FWx. The procedure for installing the driver differs for computers with DVD drives and computers with CD-ROM drives.

If your computer has a DVD drive, do the following:

- Use the Pro Tools Installer disc included with the SC48. Follow the installation and configuration instructions in the *003 & 003 Rack Setup* guide.

If your computer does not have a DVD drive, you will need the original Pro Tools LE Installer CD-ROM.

If your machine does NOT have a DVD drive, do the following:

- 1 Power up your VENUE system.
- 2 Connect one end of a FireWire cable to an FWx port on the SC48. Connect the other end to an available FireWire port on the Pro Tools host computer.
- 3 Insert the original Pro Tools LE Installer CD-ROM in your CD-ROM drive
- 4 Launch Pro Tools. Upon starting, Pro Tools LE detects the presence of FWx and automatically installs the FWx driver from the Pro Tools LE Installer CD-ROM

Using FWx

With FWx you can record and archive performances, as well as integrate pre-recorded Pro Tools tracks with your live inputs.

FWx Outputs (Recording) FWx provides 18 assignable outputs for recording into Pro Tools. For information on assigning channels for recording, see “Signal Routing for FWx Recording” on page 240.

FWx Inputs (Playback) FWx provides 18 assignable inputs for playback of Pro Tools tracks through your system. For information on assigning Pro Tools tracks for playback, see “Signal Routing for FWx Playback” on page 242.

Pro Tools Settings

The connection to the FWx card is reflected in the Pro Tools Hardware Setup dialog, and FWx inputs and outputs appear in the Pro Tools I/O Setup dialog and track I/O selectors. This lets you assign track inputs and outputs to FWx.



When using FWx, Pro Tools session bit depth and sample rate are fixed at 24-bit/48 kHz, and cannot be changed.



*For complete information on configuring your Pro Tools system, see the *003 & 003 Rack Setup* guide or the *Pro Tools Reference Guide*.*

Signal Routing for FWx Recording

You can assign any mono or stereo channel to FWx channels, including channel Direct Outputs, Mains, Auxes, mono or stereo Groups, and Matrix outputs. Use the Patchbay > Outputs page to route output busses or Direct Outputs to FWx channels 1-18 for recording.

- ◆ Using Direct Outputs lets you record discrete channels from the pickoff point you choose.
- ◆ Using Mains, Aux, Group, or Matrix lets you record a stereo main mix, one or more stereo submixes, or any combination of these, up to the number of available FWx channels.



If you configure the Patchbay for playback as well as recording through FWx, be sure to check Pro Tools track outputs for any potential feedback loops before recording enabling tracks.

To route multiple Direct Outputs to Pro Tools for a multitrack recording:

- 1 In the Patchbay, click the Directs tab.
- 2 Click the tab at the left of the grid for the channel or bus type you are routing.
- 3 Click the Pro Tools tab at the top right of the grid to show the available FWx channels.

4 Click in the channel grid to assign a channel or bus (listed on the left) to FWx channels (listed across the top).



Routing a Direct Output to an FWx channel

5 Activate and set the level for each Direct Output by clicking its In button and dragging its on-screen encoder in the Direct Out section.



Activating a Direct Output in the Directs page of the Patchbay

6 Click the Pickoff column in the Patchbay to specify one of the following the pickoff sources for each Direct Output:

- top of channel (indicated by a “T”)
- pre-fader (indicated by a lowercase “p”)
- post-fader (indicated by an uppercase “P”)

The available Direct Output pickoff points for Input Channels and FX Returns can be configured globally as pre- or post-fader in the Options > Pickoffs page.



Click to display Pickoff menu

Specifying the channel Pickoff source

7 Configure Pro Tools tracks for multitrack recording.

To route the L/R main mix to Pro Tools for a stereo recording:

1 In the Patchbay, go to the Outputs page.

2 Click the Mains tab to the left of the channel grid.

3 Click the Pro Tools tab at the top right of the grid to show the available FWx channels.

4 Click in the channel grid to route the Main Left and Right outputs to FWx channels 1–2.



Routing the Mains bus to FWx channels for recording

5 Configure Pro Tools for stereo recording.

To use an Output bus to route a submix to Pro Tools:

1 In the Patchbay, go to the Outputs page.

2 Click the Mains, Aux, Group, or Matrix tab to the left of the grid to display the type of bus you want to use.

Pickoff points for output busses in the Outputs tab are always post-fader. Use the Directs tab and select the pickoff point to record output busses pre-fader.

3 Click the Pro Tools hardware tab at the top right of the grid to show the available FWx channels.

4 Click in the grid to route busses (listed on the left) to FWx channels (listed across the top).

VENUE systems do not support using FWx channels for insert processing through Pro Tools.

5 Configure Pro Tools for recording.

Signal Routing for FWx Playback

You can route channels from Pro Tools to VENUE Input Channels and FX Returns. You can use this feature to use pre-recorded click tracks or other material in a performance, or mix down the Pro Tools session using the VENUE system.

Use the Patchbay>Inputs page to route FWx channels 1-18 to any available Input Channels or FX Returns.

To route FWx channels to Input Channels and FX Returns:

- 1 In the Patchbay, go to the Inputs page.
- 2 Click the Channels or FX Returns tab to the left of the grid to display the type of channels you want to use.
- 3 Click the Pro Tools tab at the top right of the grid to show the available FWx channels.
- 4 Click in the grid to route FWx channels to Input or FX Return channels.



Patching FWx channels to FX Returns for playback

- 5 Assign routing for each FWx channel as needed:
 - Assign to the main L/R bus to include FWx audio in the main mix of a performance.
 - Assign to a Group, Aux, or Matrix bus for submixing and monitoring.

You can leave FWx channels unassigned and still monitor them in the Solo bus and headphones.

⚠ To avoid potential feedback loops, make sure no channels are simultaneously routing to and receiving from any record-enabled Pro Tools tracks.

Monitoring FWx Recordings

To monitor a Pro Tools recording through the VENUE system, configure Pro Tools signal routing to play back the main stereo mix through two available Input or FX Return channels. On the VENUE system, leave the Input or FX Return signal routing unassigned and use Solo to monitor the recording.

To monitor FWx recordings:

1 In Pro Tools, check the output assignment shown for the currently record-enabled tracks, as follows.

- If Pro Tools is only being used for recording, make sure the recording tracks are assigned to an available FWx channel pair.

– OR –

- If simultaneously using Pro Tools to record and play back audio, check output routing to avoid potential feedback loops. Make sure record-enabled tracks do not share the same output assignment as any playback tracks. Assign output of the recording tracks to a discrete pair of FWx channels.

2 In the Patchbay, route the FWx channels to Input Channels or FX Returns. See “To route FWx channels to Input Channels and FX Returns:” on page 242.

3 Make sure the VENUE channels assigned as FWx record monitoring channels are not routed to any bus or output, as follows:

- Make sure no Group Bus indicators are lit; press any lit or flashing indicators to unassign.
- If you selected multiple channels, the LEDs will flash to indicate a mixed state of assignments among all the currently selected channels.
- Press a flashing indicator LED once to reset all selected to the same setting (usually, assigned). Press again to toggle and unassign all selected channels in unison.

Using Synchronization and Time Code with FWx

The FWx 1394 connection only communicates audio data between a VENUE system and Pro Tools.

If you plan to use Pro Tools as a MIDI Time Code master or slave, a separate MIDI connection for the Pro Tools host computer is required. Use a USB MIDI interface with Pro Tools, and connect its ports to the MIDI In/Out ports on the VENUE system.

Chapter 31: ECx

VENUE SC48 includes ECx Ethernet Control. ECx Option lets you control a VENUE system remotely over an Ethernet network, using compatible wired or wireless network equipment (purchased separately).

ECx Capabilities and Features

ECx provides the following:

- Remote control of a VENUE system from a client computer, including a laptop or Tablet PC
- Exact duplication of VENUE D-Show software on the remote client computer

ECx Components

The ECx components of your VENUE SC48 package include the following items:

- ECx Control (pre-installed in the VENUE SC48)
- Ethernet cable for connecting the ECx card to your client computer, wireless router, or wireless access point device
- ECx Ethernet Control Software installer CD-ROM (containing ECx host and client software)

System Requirements

The following are required to use ECx with your VENUE SC48:

- A Digidesign-qualified router or wireless access point (WAP) device
- A client computer running Digidesign-qualified Windows or Mac OS X software with wired or wireless Ethernet capability.
- For wireless communication with ECx, 802.11g capable devices are recommended.

Digidesign can only assure compatibility and provide support for hardware and software it has tested and approved.

For complete system requirements and a list of Digidesign-qualified computers, operating systems, and wireless devices, refer to the latest compatibility information on the Digidesign website:

www.digidesign.com/compatibility

Installing ECx Host Software

The ECx host software enables your VENUE system to communicate with computers running the remote client software.

To use ECx Ethernet Control, you must do the following:

- Install the ECx host software on your VENUE system.
- Install the ECx client software on your remote computer.

If you need to uninstall the ECx host software from your VENUE system, see “Uninstalling ECx Host Software” on page 244.

If you need to re-install the ECx host software, (after a System Restore or an Update), see “Reinstalling ECx Host Software” on page 244.

After you install the host and client software, see “Overview of ECx Setup and Configuration” on page 245 for information on setting up your VENUE system and client computer for remote operation using ECx.

Installing ECx Host Software

The ECx Ethernet Control Software installer disc contains the ECx host software. This software enables your VENUE system to communicate with computers running the remote client software.

To install ECx host software on your VENUE system:

- 1 Insert the ECx installer disc in the system CD-ROM drive.
- 2 Do one of the following to put your system into Config Mode:
 - Press the Console Config switch on the console.
 - or –
 - Double-click the Mode box in the bottom-right corner of the screen.
- 3 Go to Options > System page and click Update.
- 4 Click Yes to exit VENUE D-Show software and begin the installation.
- 5 After the installation is complete, the system restarts.

 *When you perform an Update or a System Restore of your VENUE system, you must reinstall the ECx host software. See “Reinstalling ECx Host Software” on page 244.*

Installing the ECx Client Software

The ECx Ethernet Control Software installer CD-ROM contains remote control applications for both Windows and Mac.

Installing the ECx Client in Windows

To install the ECx Control client application (“UltraVNC”) in Windows:

- 1 Insert the ECx installer disc in the computer CD or DVD drive.
- 2 Open the Windows Client folder.
- 3 Double-click the “UltraVNC-Viewer.exe” file.
- 4 Follow the on-screen installation instructions to complete the installation.

Installing the ECx Client on Mac

To install the ECx Control client application (“Chicken of the VNC”) on Mac:

- 1 Insert the ECx installer disc in the computer CD or DVD drive.
- 2 Open the Mac OS X Client folder.
- 3 Double-click the “cotvnc-20b4.dmg” file.
- 4 In the window that opens, drag the “Chicken of the VNC” icon to copy it to a location on your hard drive.

Uninstalling ECx Host Software

If you need to uninstall ECx software from your VENUE system, you can do so from the system desktop.

To uninstall ECx host software from your VENUE system:

- 1 Do one of the following to put your system into Config Mode:
 - Press the Console Config switch on the console
 - or –
 - Double-click the Mode box in the bottom-right corner of the screen.
- 2 Go to Options > System.
- 3 Hold the Control key and click Shut Down to go to the system desktop.
- 4 Locate and double-click the ECx host software uninstall program (C:\Program Files\D-Show Ethernet Control Software\Uninstall.bat).

The ECx host software is uninstalled, and the D-Show software automatically restarts.



The ECx folder will remain on your VENUE system hard drive after uninstalling.

Reinstalling ECx Host Software

If ECx is installed on your VENUE system, you will have to reinstall the ECx host software after performing a System Restore or an Update.

System Restore If you perform a complete System Restore, the ECx host software must be reinstalled from its original installer disc. See “Installing ECx Host Software” on page 243.

Update If you perform an Update, you must still reinstall the ECx host software. You can reinstall without using the ECx installer disc because an Update leaves the ECx installer on your VENUE system’s hard drive. You can also reinstall using the original installer disc.

To reinstall after an Update without using the ECx installer disc:

- 1 Remove any USB key disks from all USB ports, and make sure no installer discs are in the CD-ROM drive.
- 2 Do one of the following to put your system into Config Mode:
 - Press the Console Config switch on the console.
 - or –
 - Double-click the Mode box in the bottom-right corner of the screen.
- 3 Go to the Options > Systems page.

Click the Update button.

Overview of ECx Setup and Configuration

You can control your VENUE system (the “host”) with a remote computer (the “client”) using standard VNC (Virtual Network Computing) protocol over TCP/IP, allowing remote access to your system via a wired or wireless Ethernet-based network. This chapter covers the steps for configuring and using ECx.

For a wired network, the steps include:

- ◆ Connecting the remote computer directly to your VENUE system using an Ethernet cable.
- ◆ Setting the IP addresses of your VENUE system and your client computer manually.
- ◆ Enabling remote operation of your VENUE system.

For a wireless network, the steps include:

- ◆ Connecting a wireless router or a wireless access point (WAP) device to your VENUE system.
- ◆ Setting the IP addresses of your VENUE system and your client computer manually or automatically.
- ◆ Establishing a connection between your wireless router and the client computer.
- ◆ Enabling remote operation of your VENUE system.

Connecting a Computer Directly to VENUE

If you are establishing a fixed remote control station and do not need a mobile connection, you can connect the remote computer directly to your VENUE system using an Ethernet cable.

To connect a computer directly to your VENUE system:

1 Connect one end of the appropriate Ethernet cable type (with RJ-45 connectors) to the ECx port on your VENUE system, and the other end to the Ethernet port on the computer. The type of cable depends on the operating system of the remote computer:

Windows To connect a Windows computer directly to your VENUE system, an Ethernet crossover cable is required. Alternatively, you can use an Ethernet hub and connect standard Ethernet cables between your VENUE system, the hub and the remote computer.

Mac To connect a Mac computer directly to your VENUE system, you can use either a standard Ethernet cable or an Ethernet crossover cable.

2 Configure the VENUE system and the client computer IP addresses manually. See “Setting VENUE and Client IP Addresses Manually” on page 246.

Connecting a Wireless Router or WAP to VENUE

VENUE systems work with standard wireless routers or WAP devices.

Before connecting a wireless router or WAP device, you should configure the SSID of the device so that its wireless network can be easily identified on the client computer. You can specify any unique network name for the device, such as “VENUE Network.”

To configure the SSID and any network security features of your wireless router or WAP, refer to the manufacturer’s instructions.

To connect a wireless router or WAP device to your VENUE system:

1 Connect one end of the appropriate type of Ethernet cable to the ECx port and the other end to the Ethernet connector port on the router or WAP. Do one of the following depending on the type of device you are using

- If you are using a wireless router, use a standard Ethernet cable to your VENUE system.
- or –
- If you are using a WAP, use an Ethernet crossover cable to connect to your VENUE system.

2 Do one of the following:

- If you are using a wireless router or WAP device that does not include a DHCP server function (such as the Cisco Aironet 1230AG), you must configure your VENUE system and the client computer IP addresses manually. See “Setting VENUE and Client IP Addresses Manually” on page 246.
- or –
- If you are using a wireless router that includes a DHCP server function (such as the Belkin Pre-N), you can configure your VENUE system and the client computer to set the IP addresses automatically. See “Setting VENUE and Client IP Addresses Automatically” on page 248.

Setting VENUE and Client IP Addresses

You can set the IP addresses of your VENUE system and client computer manually or automatically. Do one of the following depending on the configuration of your network:

◆ If you are connecting a computer directly to your VENUE system, or you are using a wireless router or WAP device that does not include a DHCP server function, see “Setting VENUE and Client IP Addresses Manually” on page 246.

– or –

◆ If you are using a wireless router that includes a DHCP server function, see “Setting VENUE and Client IP Addresses Automatically” on page 248.

⚠ IP configuration changes on your VENUE system and client computer can take up to 2 minutes to become effective. After making changes, be sure to allow sufficient time for the system to assign IP addresses and establish communication between all the components.

If network communication is not established after allowing sufficient time for IP addressing, then you can verify that you are using the correct cable types, have correctly connected the system, and have working cables.

Setting VENUE and Client IP Addresses Manually

Set VENUE and client computer IP addresses manually if you are connecting a computer directly to your VENUE system, or you are using a wireless router or WAP device that does not include a DHCP server function.

Setting a VENUE System IP Address Manually

To manually set the IP address for your VENUE system:

- 1 In the D-Show software, go to the Options page and click the Interaction tab.
- 2 Under Ethernet Control, click Edit.

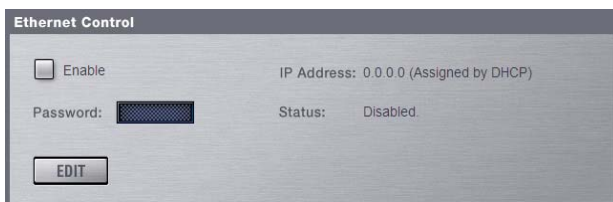

Ethernet Control section of the Interaction page

- 3 Select “Use the Following Address” and enter the following:
 - IP address: 10.0.0.1
 - Subnet Mask: 255.255.255.0
 - Default Gateway: 10.0.0.1

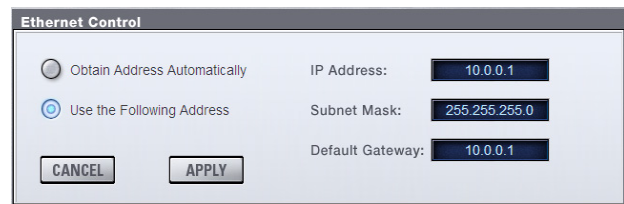

Setting an IP address manually

- 4 Click Apply.
- 5 Select Enable to activate the VENUE ECx host.
- 6 Go to “Setting the Client Computer IP Address Manually” on page 246.



Enabling the VENUE ECx host

Setting the Client Computer IP Address Manually

After manually setting your VENUE system’s IP address, you need to set your client computer’s IP address.

To manually set the IP address in Windows:

- 1 Go to Control Panels > Network Connections.
 - 2 In the Network Connections window, do one of the following:
 - If you are connecting the computer directly to your VENUE system, right-click the Local Area Connection icon and choose Properties.
- or –
- If you are connecting using a wireless router or WAP, right-click the Wireless Network Connection icon and choose Properties.

3 In the Connection Properties window, double-click Internet Protocol (TCP/IP).

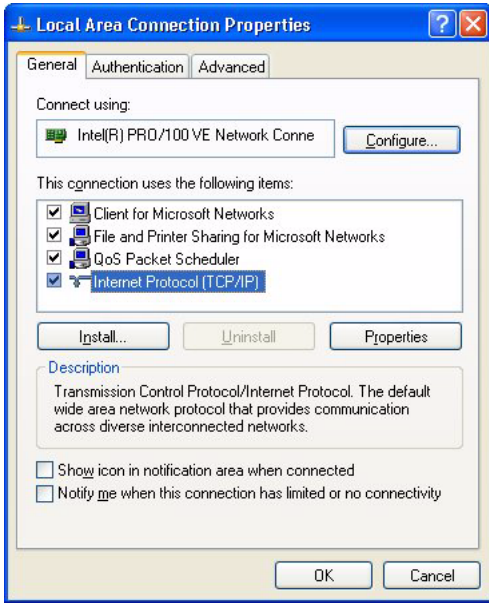

Local Area Connection Properties window

4 In the Internet Protocol Properties window, select “Use the following IP Address” and enter the following:

- IP address: 10.0.0.2
- Subnet Mask: 255.255.255.0
- Default Gateway: (none required)

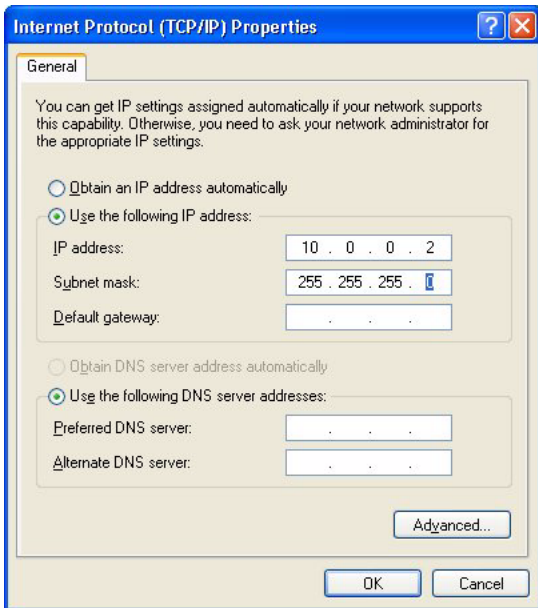

Internet Protocol Properties window

5 Click OK to close the Internet Protocol properties window.

6 Click OK to close the Network Connection Properties window.

7 Do one of the following depending on the configuration of your network:

- If you are using a wireless network, go to “Establishing a Wireless Connection” on page 249.
- or –
- If you are using a wired network, go to “Enabling Remote Operation” on page 250.

To manually set the IP address on a Mac:

1 Launch System Preferences > Network.

2 Do one of the following:

- If you are connecting the computer directly to your VENUE system, choose Ethernet from the network connections services list.
- or –
- If you are connecting using a wireless router or WAP, choose Airport from the network connections services list.

3 Choose Manually from the Configure menu.

4 Enter the following:

- IP address: 10.0.0.2
- Subnet Mask: 255.255.255.0
- Router: (none required)

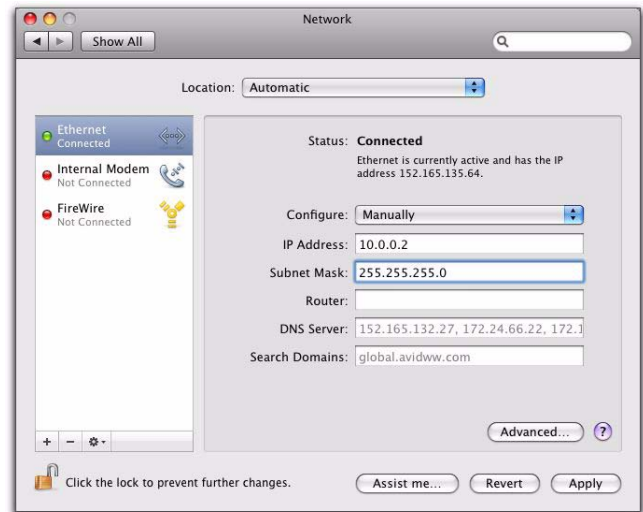

Network Preferences window

5 Click Apply.

6 Do one of the following depending on the configuration of your network:

- If you are using a wireless network, go to “Establishing a Wireless Connection” on page 249.
- or –
- If you are using a wired network, go to “Enabling Remote Operation” on page 250.

Setting VENUE and Client IP Addresses Automatically

You can configure your VENUE System and client computer to set their IP addresses automatically using DHCP. Set the IP automatically if you are using a wireless router that includes a DHCP server function.

Setting the VENUE IP Address Automatically

To set the IP address of your VENUE system automatically:

- 1 In the D-Show software, go to the Options page and click the Interaction tab.
- 2 Under Ethernet Control, click Edit.

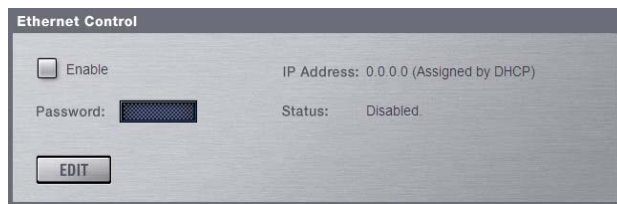

Ethernet Control section of the Interaction page

- 3 Select “Obtain Address Automatically.”

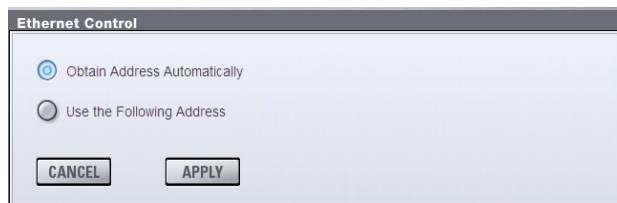

Configuring Ethernet Control in VENUE

- 4 Click Apply.
- 5 Wait until the VENUE System is assigned an IP address. This may take time (up to two minutes). If no DHCP server is found, the VENUE system will self-assign an IP address.

 *Make a note of the IP address assigned to your VENUE system, as you will need to enter it into the client software.*

- 6 Select Enable to activate the VENUE System ECx host. Your system’s status will be displayed as “Waiting for connection.”
- 7 Go to “Setting a Client Computer IP Address Automatically” on page 248.

Setting a Client Computer IP Address Automatically

After setting the IP address for your VENUE system using DHCP, you need to do the same for your client computer.

To automatically set the IP address in Windows:

- 1 Go to Control Panel > Network Connections.
- 2 Right-click the Wireless Network Connection icon and choose Properties.
- 3 In the Connection Properties window, double-click Internet Protocol (TCP/IP).

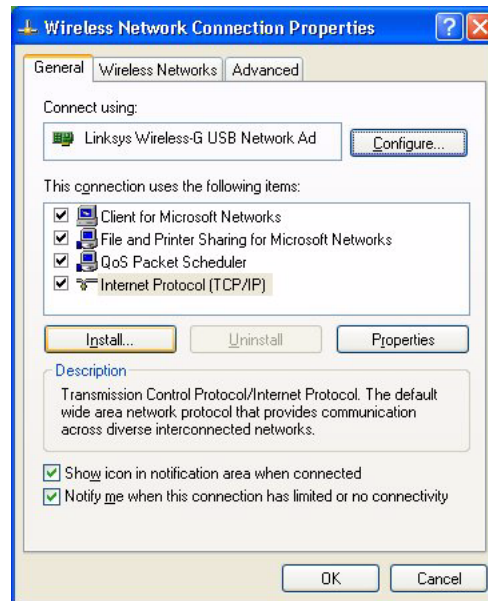

Connection Properties window

- 4 In the Internet Protocol Properties window, select “Obtain an Address Automatically.”

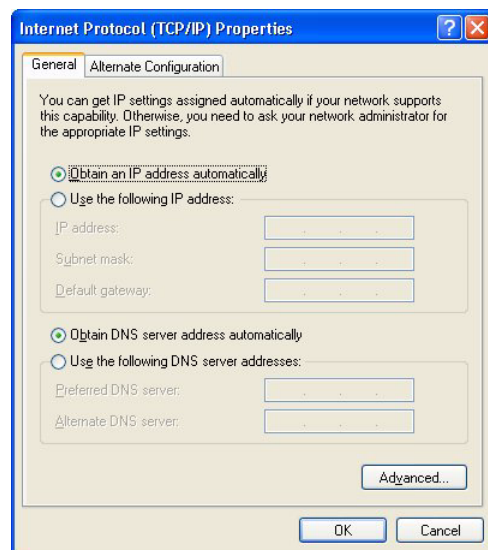

Internet Protocol (TCP/IP) Properties window

- 5 Click OK to close the Internet Protocol properties window.
- 6 Click OK to close the Network Connection Properties window.
- 7 Go to “Enabling Remote Operation” on page 250.

To automatically set the IP address on a Mac:

- 1 Launch System Preferences > Network.
- 2 Choose Airport from the network connections services list.
- 3 Click the Advanced button, then click the TCP/IP tab.
- 4 Choose Using DHCP from the Configure IPv4 menu.

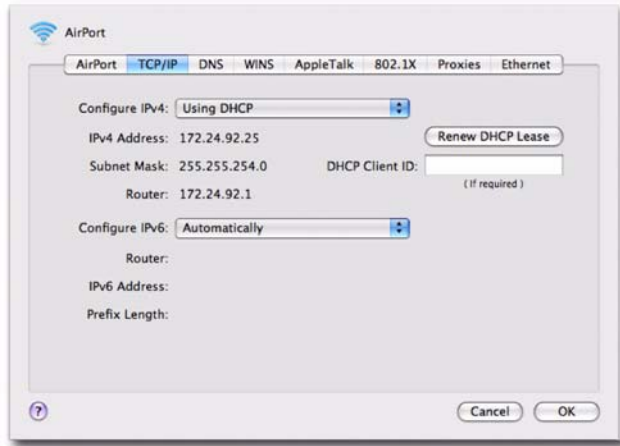

Airport Network Advanced window

- 5 Click OK.
- 6 Go to "Enabling Remote Operation" on page 250.

Establishing a Wireless Connection

Once IP addresses are set, you can establish a connection from the client computer to the wireless network.

To establish a wireless connection in Windows:

- 1 Go to Control Panel > Network Connections.
- 2 Right-click the Wireless Network Connection icon and choose Properties.

- 3 In the Connection Properties window, click the Wireless Networks tab.

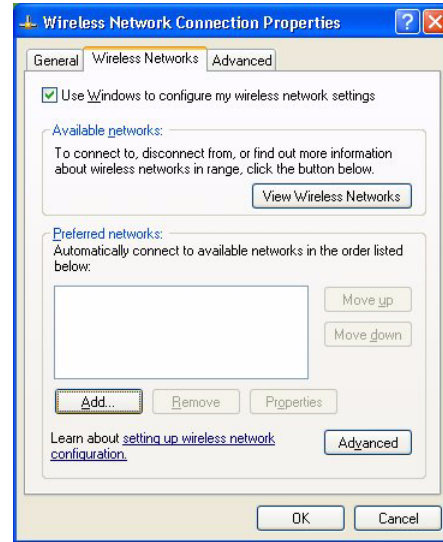

Configuring a wireless connection in Windows

- 4 Under Preferred Networks, click Add, and type the SSID of the wireless router or WAP device connected to your VENUE system.
- 5 Choose the Network Authentication and Data Encryption settings to match the corresponding router or WAP configuration settings.

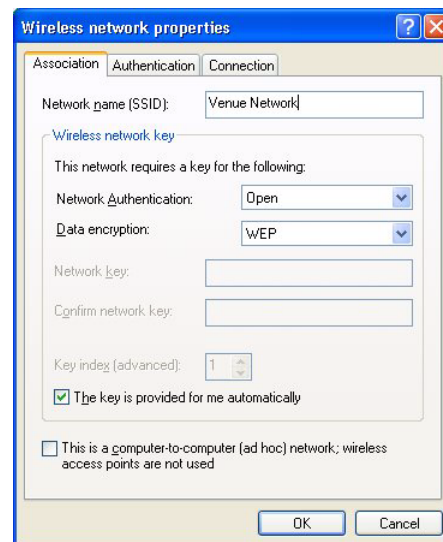

Entering an SSID and choosing settings in Windows

- 6 Click OK. The VENUE SSID should appear in the list of available wireless networks.
- 7 Go to "Enabling Remote Operation" on page 250.

To establish a wireless connection on Mac:

- 1 Go to System Preferences > Network.
- 2 Choose Airport from the network connections services list.
- 3 From the Network Name pop-up menu, choose your network.



Configuring a wireless connection on the Mac

 *If your network does not appear in the Network Name pop-up menu, choose “Join Other Network, type in the name of your network, and click Join. To assign your wireless router or WAP device a network name, see your device’s documentation.*

- 4 Go to “Enabling Remote Operation” on page 250.

Enabling Remote Operation

In order to enable remote operation of your VENUE system, you need to have obtained valid IP addresses for your VENUE system and your client computer. If you are using a wireless network, you also need to have established a network between the wireless router or WAP device that is connected to your VENUE system and your client computer.

To enable remote operation with a Windows client computer:

- 1 Double-click the “ECx Ethernet Control (UltraVNC Viewer)” icon on your desktop (or go to Start Menu > Programs > UltraVNC > Run UltraVNC Viewer) to launch the UltraVNC Viewer application.
- 2 Enter the IP address of the ECx host (your VENUE system).
- 3 Click Connect.
- 4 Enter the password when prompted (the default VENUE password is “password”) and click Connect.

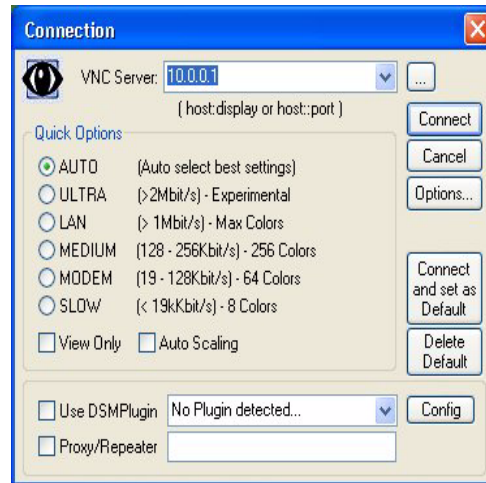

UltraVNC Viewer window

The client launches and displays the VENUE system screen. You can then view and operate all on-screen controls from the client computer.

To enable remote operation with a Mac client computer:

- 1 Double-click the “Chicken of the VNC” icon to launch the application.
- 2 Enter the IP address of the ECx host (your VENUE system).
- 3 Enter the password (VENUE’s default password is “password”) and click Connect.

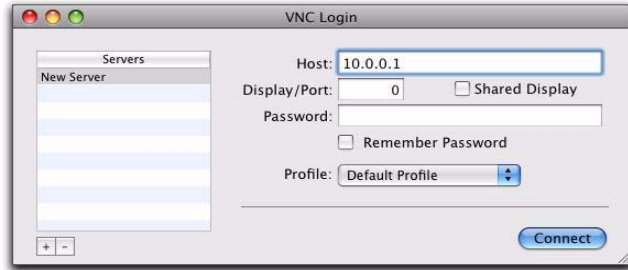

Chicken of the VNC window

The client launches and displays the VENUE system screen. You can then view and operate all on-screen controls from the client computer.

Disconnecting ECx

To disconnect ECx:

- 1 Close the ECx client application by doing one of the following:
 - In Windows, move the pointer to the top of the screen until the control strip appears, and click the close box.
 - or –
 - On Mac, press Command+Q to quit.
- 2 On the VENUE system, deselect Enable in the Ethernet Control section of the Options > Interaction page.

Changing the Ethernet Control Password

You can change the password that users need to enter in order to control your VENUE system from a remote client.

 *By default, the VENUE Ethernet Control password is “password” (all lowercase).*

To change the Ethernet Control password:

- 1 In the Ethernet Control section of the Options > Interaction page, double-click the Password field.
- 2 Enter a new password and press Enter.

 *Make a note of the new password and your system’s IP address, as you will need to enter it into the client software.*

Index

Numerics

0 dBVU 157
2-Track 56
48V 70

A

A Unit has gone Offline 231
Absolute (editing snapshots) 180
ACS
 Flex Channel 71
 target and channel Select switch 20
 targeting options 58
ACS (Assignable Channel Section) 22
Actions 193
 creating 197
 list 204
Add (or Update) this plug-in to Snapshot 156
AFL 111
All (snapshots) 169
AND (Event List) 196
assembling the mount 7
Assignable Channel Section (ACS) 22
attack
 compressor/limiter 126
 expander/gate 127
automation 174
 and Channel Safe 175
 see Snapshots
Automation Safe 58
auto-save and History 166
Aux
 banking 36
 busses 87
 configuring busses and Groups 74
 display in Input LCD 20
 level and pan via Flip to Faders 91
Aux Sends
 snapshot as monitor, or as effects sends 189
Auxes Follow AFL
 AFL
 and Aux banking 112

B

backup
 and History 166
 CD-ROM 231
Balance 64
balance (when pasting) 39
ballistics for meters 58, 110
bandwidth
 EQ 134
Bank A–D 33
Bank Safe 34
banking 33, 36
 Group Spill 82
 outputs 36
banner display 27
bell or shelf EQ 134
Blank Strip 40
blue (snapshot) 170
built-in
 compressor 125
 expander 125
 gate 125
 limiter 125
bus assignment indicators 19
bus processors
 assigning plug-ins 152
busses
 linked Matrix'stereo
 linked matrix 94
Busses page 53
bypass
 EQ in out 133
bypassing plug-ins 150

C

C/M
 LED 19
Cancel 25
CD-ROM
 using for Transfer and Filing 213
Center Last Recalled Snapshot 171
Change Target By 58
channel
 reset shortcut 39
Channel Name 20, 59
channel number (plug-in rack routing) 150
CHANNEL SAFE 176
Channel Safe 175
channels
 banking 33
 configuring number of 52
 copy and paste 39
 in the Patchbay 101
 moving 40
 selecting 36
 type text search 37
Chase MTC 170
Clear 168
Clear Console
 during reset 229
clip
 Hidden Bank Clip 18
 Hidden Bank LED 108
 Hold 110
 Margin 110
clock
 system date and time 57
clock (tempo) 57
clock (word) 11
colors in rack slots 149
comp knee
 compressor/limiter 126
compressor
 side-chain 131
compressor/limiter
 adjusting 128
 attack 126
 comp knee 126
 defaults 126
 Dynamics Graph 129
 gain reduction meters 126
 make-up gain 126
 ratio 126
 release 126
 threshold 126
Config Mode 28
 and plug-ins 143
Console Config 28
Console Mode (Config versus Show) 28
contact closure 236
Control Surface Change 227
controls
 input and FX return channels 18
copy and paste
 channel settings 39
 dynamics settings 130
 EQ settings 139
copying
 plug-ins 151
Create new snapshot containing this plug-in 156
crossfade time (snapshots) 188
crossfades
 bypassing 188
cursor 57

D

- Date & Time Check 227
- date and time 57
- dBVU, dBu, dBFS 157
- Default 29
- defaults
 - compressor/limiter 126
- delay
 - compensation 78
 - input channel built-in 70
 - mains (house) 77
 - Monitor Bus 54
 - Monitor bus 116
- delay (Event List Wait) 198
- Delay Compensation 55
- Delete (snapshots) 168
- Devices page 53
- Digital/Analog EQ 134
- DigiTest 229
- Dim
 - Talkback dim 56
- Direct Outs
 - from output busses 78
 - routing to plug-ins 153
- Disable
 - snapshots 168
- divergence 78
- Dly (channel Delay in snapshots) 190
- D-Show
 - Standalone software 211
- DSP
 - plug-in allocation tips 52
 - plug-ins 157
- Duplicate 168
- Dyn Pre-EQ 130, 134
- dynamics
 - adjusting 128
 - and plug-ins 129
 - built-in 67
 - comp/lim 126
 - Dynamics Graph 129
 - presets for built-in 131
 - reset 129
 - settings and presets 130
 - side-chain 131

E

- ECx 13, 243
 - installing software 243
- Edit (System Config) 51
- Edit mode 180
- EQ
 - adjusting 135
 - and plug-ins 139
 - bell or shelf 134
 - built-in HPF 133
 - built-in parametric 133
 - bypass via Input Direct mode 130, 134
 - digital/analog 134
 - Dyn Pre-EQ 130, 134
 - GEQ 76
 - in out 133
 - parametric 133
 - ranges of controls 141
 - settings and presets 139
- ethernet (see ECx) 243
- Events
 - actions 193
 - and Preview mode 184
 - and Snapshot modes 199
 - and snapshots 199
 - behavior 198
 - creating actions 197
 - creating triggers 196
 - creating, selecting, managing 194
 - defaults 200
 - enabling and disabling 195
 - Event List 192
 - list of action types and properties 204
 - list of trigger types and properties 203
 - reset 198
 - terminology 191
 - testing 198
 - triggers 193

- Wait 198
- window 192
- expander
 - side-chain 131
- Expander/Gate
 - threshold 127
- expander/gate
 - adjusting 128
 - attack 127
 - gain reduction meters 127
 - gate range 127
 - release 127
- Expert Mode 85

F

- faders
 - and Group Spill 82
 - Flip for Send level and pan 91
 - reset shortcut 39
- feedback 199, 242
- Filing
 - History 166
 - loading Shows 162
 - Presets and Scope Sets 163
 - Show files 162
 - Show Folders 161
- filtering with Recall Safe 174
- Fine 30
 - momentary or latching 30
- firmware 232
- Flex Channel 71
- Flip
 - Send level and pan 91
- Footswitch Status (Events) 193
- formats (plug-ins) 151
- Function switches 121
- Function switches (F1, F2, F3, F4) 25
- FX Returns
 - and plug-ins 152
 - banking 33
 - channel controls 18
 - configuring 52

G

- gain
 - and multiple input routing 103
 - Guess 20
 - setting 20
- gate
 - key source 131
 - range for expander/gate 127
 - side-chain 131
- General Purpose Interface (see GPI)
- global modifiers 29
- GPI
 - Input pinouts 235
 - input specifications 235
 - output specifications 236
 - pulse and duration 198
 - Status display (Events) 193
 - wiring diagrams 236
- Graphic EQs 76
 - configuring 52, 138
- green (snapshot) 170
- ground (GPI outputs) 236
- Groups
 - and Variable Groups 74
 - banking 36
 - using 81
- Guess (gain) 20

H

- hard knee 126
- hardware
 - display of unavailable 100
- headphones
 - level 115
- hexadecimal 185
- Hidden Bank Clip 108
- hidden bank clip 18
- high-pass filter 133
- History 166

house (Mains)
mute 119
HPF 20, 70

I

I/O
unavailable 100
iLok 145
USB ports 147
In/Out
EQ 133
Input Channels 63
Input Direct mode 72, 130, 134
Input Gain 20
Input Pan 20
Input Safe Switches
changing modes via an Event 200
inputs
20 dB pad 70
and Flex Channel 71
assigning Patchbay routing 64
assigning to VCAs 66
automation safe 177
built-in dynamics 67
built-in EQ 67
channel controls 18
connecting digital 11
faders 71
HPF 70
Input Channels and FX Returns 63
input channels and FX returns 18
Input Direct mode 72, 130, 134
make stereo 63
mute 71
naming 64
pan 69
phantom power 70
polarity (phase) 70
routing to Auxes 65
routing to Mains and Groups 65
Safe 70
solo 71
using inserts 68
width 69
Insert Blank Strip 40
Insert Mode 154
insert number (plug-in rack routing) 150
inserts
assigning plug-ins 152
on outputs 75
Installed Plug-Ins 143
Interaction page 58
invert output phase 76

J

jump (see crossfade bypass)

K

key assign 131
key listen 132
key source 131
knee
hard or soft 126
knobs
rotary and switch functionality 19

L

Latch (Event action behavior) 198
LCDs
options 59
LCR 52
level
Flex Channel 71
levels
plug-ins 157
limiter
adjusting 128
defaults 126
side-chain 131
linked Matrixes 94
linking
screen and console 27, 58

Lock (System Lock) 28
locking snapshots 178
logic (GPI) 235
LR
LED 19

M

Main 52
Main busses
configuring 52
Mains
input routing 65
linking 77
maintenance
system restore 231
Make Stereo 63
and Blank Strips 40
Make Stereo/Mono
shortcut 40
make-up gain
compressor/limiter 126
Matrix
banking 36
linked stereo 94
linking and unlinking inputs 95
Matrix and PQ Sources 94
metering 107
ACS 108
ballistics and options 110
channel meters 107
Hidden Bank Clip 108
output meter settings 109
outputs 109
Selected Channel 108
solo 109
MIDI
adding to snapshots 185
and Recall Safe 174
in Preview mode 184
output Safe 186
MIDI Snapshot Output Safe 210
Misc page 56
Mix (Recall Safe parameters) 176
Mix Engines 52
modes (Config versus Show) 28
Mon (Aux sends and Variable Groups) 189
Monitor
assignable output 114
Bus Delay 54
Delay 116
level 115
More Options (during resume) 229
mouse settings 57
Move Selected Strip Here 40
moving plug-ins 151
MTC
chase 170
configuring options 56
Events and Preview mode 184
in Preview mode 184
Multi 29
Multi-Assign 37
Multi-Select 29
Mute
channels, Mute Groups and VCAs 121
Groups 119
input channels 71
Mains (house) 119
outputs 76, 119

N

name (channel display) 20
naming channels 64
navigating 33
near-field levels 115
New 168
next (snapshot) 170
None (snapshots) 169
Notes (snapshots) 172

O

- offset
 - Right Offset 69
- On (Recall Safe) 174
- One or More Units have Failed 226
- operating modes 28
- Options 51
 - Busses 53
 - Devices 53
 - Interaction 58
 - Misc 56
 - Pickoffs 55
 - Plug-Ins 143
 - Snapshots 55
 - System (configuration) 51
 - viewing angle 59
- OR (Event List) 196
- oscillator
 - settings 56
- Other 151
- Output encoders
 - and plug-ins 154
- outputs
 - and mute 119
 - automation safe 177
 - banking 36
 - configuring 73
 - delay 77
 - divergence 78
 - graphic EQ 76
 - metering 109
 - mute 76
 - reassigning in Patchbay 103
 - routing 74
 - using inserts 75

P

- pad 70
- padlock (snapshots) 178
- Pan 69
 - see also Width 69
- pan
 - divergence 78
 - when pasting 39
- panning
 - 3-across-the-front 52
- parameters 98
- parametric EQ 133
- Patchbay
 - displays and indicators 100
 - navigating 101
 - overview 99
 - route multiple via click and drag 102
 - source and destination display 101
 - warning when reassigning 103
- Patching Grid 100
- Peak Hold 110
- Peak mode (metering) 110
- PFL 111
- phantom power 70
- phase (output) 76
- pickoffs
 - Matrix and PQ 94
- Pickoffs page 55
- Plug-In Racks are Ready 229
- Plug-In Racks Need Reset 229
- plug-ins 13, 143
 - allocating DSP 52
 - and channel Direct Outs 153
 - and Recall Safe 174
 - and snapshots 156
 - and standalone software 211
 - assigning to rack slots 151
 - Config and Show mode 143
 - display options 154
 - display unavailable and inactive 149
 - enabling and disabling 146
 - EQ 139
 - in Preview mode 183
 - in/out (bypass) 150
 - Insert Mode views 154
 - list and menu management 146
 - managing 144
 - mono, stereo, other 151

- moving and copying 151
- on outputs 75
- on the control surface 154
- on-screen 155
- pinning a view 155
- preset files 156
- rack slots 149, 150
- racks 148
 - re-initializing the racks 229
 - routing to and from 152
 - snapshot indication (red) 150
 - Source switch 154
 - targeting 154
 - Use Racks 229
 - views 148
- Plug-ins to Install 143
- polarity (input) 70
- polarity (output) 76
- power
 - connecting an uninterruptable power supply 5
 - start up/shut down guidelines 13
- Power Supply Alert 227
- PQ
 - banking 36
 - linking and unlinking inputs 95
- Pre (snapshot parameters) 189
- presets
 - dynamics 130
 - EQ 139
 - folders 163
 - for built-in dynamics 131
 - managing 164
 - plug-ins 156
 - Scope Sets 176
 - transferring 165
- Preview mode 181
 - and plug-ins 183
 - and Undo 182
 - capabilities and overview 182
 - MIDI and MTC 184
- previous (snapshot) 170
- Propagate mode 181
- Pulse and Duration (GPI) 198
- Push-Pin (plug-in view) 155

Q

- Q 134

R

- rack slots 148
- racks 229
- racks (plug-ins) 148
- ratio
 - compressor/limiter 126
- Ready to Resume 228
- Recall 168, 173
 - Next 170
 - Previous 170
 - Safe 174
- Recall Safe 174
 - and MIDI 174
 - and plug-ins 174
 - and Preview mode 183
 - CHANNEL SAFE 176
 - Matrix and PQ 176
 - turning on and off 174
 - using 175
- recovery 229
- red (snapshot) 170
- red plug-in rack 150
- Relative (editing snapshots) 180
- release
 - compressor/limiter 126
 - expander/gate 127
- remote control (ECx) 243
- Remove this plug-in in Snapshot 156
- Reset 229
 - reset 228
 - dynamics 129
- Reset (strip) 39
- reset a section or parameter 29
- Reset Fader 39
- Reset Mix Engines 229
- resolution (see Fine)

- restart 228
 - restore (software) 231
 - Resume Operations 228
 - right-click shortcuts 39
 - RMS mode 110
 - rotary encoders
 - rotary and switch functionality 19
 - routing
 - channel bus indicators 19
 - in the Patchbay 102
 - Monitor bus 114
 - multiple D-Show channels to a hardware output 103
- S**
- Safe
 - Automation 58
 - Recall Safe 174
 - Solo 58
 - using channel automation safe 177
 - Safe All 177
 - Safe Selected 177
 - save (History auto-save) 166
 - Scope Sets
 - transferring 165
 - using 176
 - security (System Lock) 28
 - Select
 - channel switch 20
 - Selected Chan
 - options 58
 - selected channel
 - Flex Channel 71
 - selecting channels 36
 - settings
 - dynamics 130
 - EQ 139
 - plug-ins 156
 - shelf or bell EQ 134
 - shortcuts 29
 - right-click 39
 - Snapshots 171
 - Show files 161
 - creating 161
 - deleting 161
 - Folders 161
 - loading 162
 - transferring 165
 - Show Folder 161
 - Show Mode 28
 - Shows
 - and plug-in management while loading 146
 - side-chain 131
 - assigning for plug-ins 153
 - assigning source (gate only) 131
 - signal routing
 - display in Patchbay 101
 - inputs 64
 - Simple Mode 85
 - SIP 111
 - Snapshots
 - adding MIDI messages 185
 - adding plug-in data 186
 - All 169
 - Center Last Recalled in list 171
 - Channel Safe 176
 - channel scope 168
 - chase MTC 170
 - classifying Auxes and Var Groups 189
 - Clear 168
 - color indication in List 170
 - creating 172
 - crossfade time 188
 - data type buttons 168
 - Delete 168
 - Disable 168
 - Duplicate 168
 - Edit mode 180
 - Events and Preview mode 184
 - faders 169
 - from the console 170
 - in Preview mode 182
 - keyboard shortcuts 171
 - List 168
 - list of data types and parameters 176, 190
 - locking and unlocking 178
 - managing (storing, clearing, deleting, moving, duplicating) 178
 - MIDI and plug-ins in Preview mode 182
 - naming and renaming 172
 - New 168
 - Next 170
 - None 169
 - notes 172
 - overview 167
 - plug-in menu 156
 - plug-in scope indication 150
 - Preview (editing and previewing snapshots) 181
 - Previous 170
 - Propagate mode (updating snapshot parameters) 181
 - Recall 168
 - Recall Safe 174
 - recalling 173
 - safe filter (Recall Safe) 175
 - Scope Sets 176
 - selecting 171
 - Store 168
 - target 173
 - type text search 37
 - x-Fade 188
 - snapshots
 - and Channel Safe 175
 - Snapshots containing this plug-in 156
 - Snapshots page 55
 - soft knee 126
 - software 13
 - overview of pages and tabs 31
 - standalone 211
 - system restore 231
 - updating 231
 - Solo
 - AFL, PFL, SIP modes 111
 - and key listen 132
 - input channels 71
 - metering 109
 - on-screen settings 54
 - Solo Safe 58
 - Source 20, 154
 - spill
 - Groups
 - spill 82
 - spill (VCAs) 80, 82
 - standalone software 211
 - and plug-ins 211
 - export System Info 104
 - installing and removing 211
 - system requirements 211
 - stereo
 - spread (Bal/Width) 64
 - stereo channels (see Make Stereo) 63
 - stereo plug-ins 151
 - Store 168
 - sync
 - plug-in tempo 57
 - synchronizing digital sources 11
 - System 51
 - system clock 57
 - System Config 51
 - System Lock 28
 - System Update and Restore CD 231
- T**
- takeover from backup mode 228
 - Talkback
 - dim level 56
 - Tap Tempo 205
 - tap tempo 57
 - target
 - channel Select switch 20
 - channels 36
 - plug-in 154
 - Targeting Changes View Mode 58
 - tempo
 - snapshots 186
 - threshold
 - compressor/limiter 126
 - Expander/Gate 127
 - time of day 57
 - Tool Tips 27

- Trackball
 - settings for 57
- transfer 165
- Triggers 193
 - creating 196
 - list 203
- troubleshooting
 - plug-ins 146
 - restore and replace all software 231
- Type Text search 37

U

- Undo
 - in Preview mode 182
 - via History 166
- Update this plug-in in Snapshot 156
- updating D-Show software 231
- UPS (uninterruptable power supply) 5
- USB
 - ports for iLoks 147
- Use Racks 229
- User 30

V

- Variable Groups
 - level and pan via Flip to Faders 91
 - snapshot as monitor, or as effects sends 189
- VCA
 - spill 80, 82
- VCAs
 - and snapshots 190
 - assigning 79
 - banking 36
 - mute 119
 - using 80
- VGA monitor 7
- Video Monitor Mount 7
- voltage 5

W

- Wait (Event List) 198
- While Active (Event action behavior) 198
- Width 69
- width (when pasting) 39
- wireless (ECx) 243
- word clock 11

X

- X-fade (crossfade) 188
- XOR (Event List) 196

Y

- yellow (snapshot) 170

Z

- zero
 - see Clear Console



www.digidesign.com

DIGIDESIGN

2001 Junipero Serra Boulevard
Daly City, CA 94014-3886 USA
Tel: 650.731.6300
Fax: 650.731.6399

TECHNICAL SUPPORT (USA)

Tel: 650.731.6100
Fax: 650.731.6375

PRODUCT INFORMATION (USA)

Tel: 800.333.2137

INTERNATIONAL OFFICES

Visit the Digidesign website
for contact information