

# Operating Instructions

## Liquisys M CLM223/253

Transmitter for Conductivity

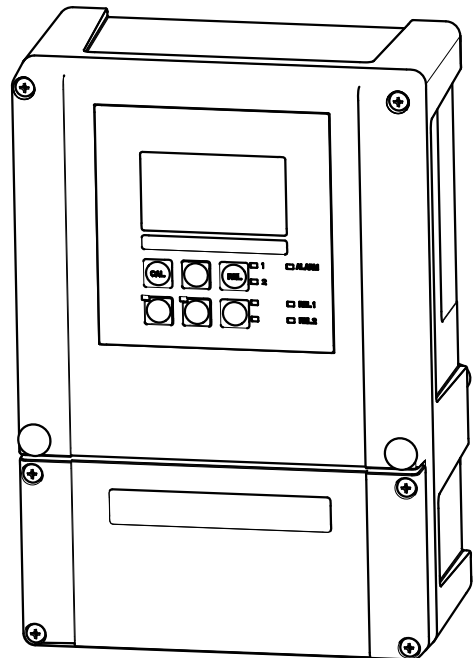

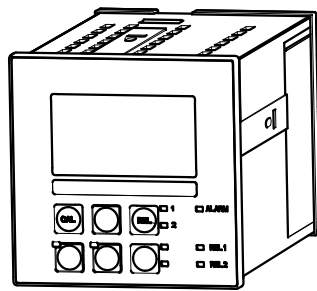

## Table of contents





<b>1</b>	<b>Document information</b> .....	<b>5</b>	6.3	Local operation .....	29
1.1	Warnings .....	5	6.3.1	Automatic/manual mode .....	29
1.2	Symbols used .....	5	6.3.2	Operating concept .....	30
1.3	Symbols on the device .....	5			
1.4	Electrical symbols .....	6	<b>7</b>	<b>Commissioning</b> .....	<b>32</b>
<b>2</b>	<b>Basic safety instructions</b> .....	<b>7</b>	7.1	Function check .....	32
2.1	Requirements for personnel .....	7	7.2	Switching on .....	32
2.2	Designated use .....	7	7.3	Quick Setup .....	34
2.3	Occupational safety .....	7	7.4	Device configuration .....	37
2.4	Operational safety .....	8	7.4.1	Setup 1 (conductivity) .....	37
2.5	Product safety .....	8	7.4.2	Setup 2 (temperature) .....	39
2.5.1	State of the art .....	8	7.4.3	Current input .....	42
2.5.2	IT security .....	8	7.4.4	Current outputs .....	45
<b>3</b>	<b>Incoming acceptance and product identification</b> .....	<b>9</b>	7.4.5	Alarm .....	49
3.1	Incoming acceptance .....	9	7.4.6	Check .....	50
3.2	Scope of delivery .....	9	7.4.7	Relay configuration .....	53
3.3	Product identification .....	10	7.4.8	Temperature compensation with table .....	69
3.3.1	Nameplate .....	10	7.4.9	Concentration Measurement .....	70
3.3.2	Product identification .....	10	7.4.10	Service .....	73
3.4	Certificates and approvals .....	10	7.4.11	E+H Service .....	75
3.4.1	CE mark .....	10	7.4.12	Interfaces .....	76
3.4.2	CSA General Purpose .....	10	7.4.13	Communication .....	76
<b>4</b>	<b>Installation</b> .....	<b>11</b>	7.5	Calibration .....	77
4.1	Installation at a glance .....	11	<b>8</b>	<b>Diagnostics and troubleshooting</b> ...	<b>81</b>
4.1.1	Measuring system .....	12	8.1	Trouble shooting instructions .....	81
4.2	Installation conditions .....	13	8.2	System error messages .....	81
4.2.1	Field device .....	13	8.3	Process-specific errors .....	84
4.2.2	Panel-mounted device .....	14	8.4	Device-specific errors .....	88
4.3	Installation instructions .....	15	<b>9</b>	<b>Maintenance</b> .....	<b>90</b>
4.3.1	Field device .....	15	9.1	Maintenance of the entire measuring point ..	90
4.3.2	Panel-mounted device .....	17	9.1.1	Cleaning the transmitter .....	90
4.4	Post-installation check .....	17	9.1.2	Cleaning the conductivity sensors ...	91
<b>5</b>	<b>Electrical connection</b> .....	<b>18</b>	9.1.3	Simulation of conductive sensors for device testing .....	91
5.1	Wiring .....	18	9.1.4	Simulation of inductive sensors for device testing .....	92
5.1.1	Wiring diagram .....	18	9.1.5	Checking conductive sensors .....	93
5.1.2	Measuring cables and sensor connection .....	21	9.1.6	Checking inductive sensors .....	94
5.2	Alarm contact .....	24	9.1.7	Assembly .....	94
5.3	Post-connection check .....	24	9.1.8	Connecting cables and junction boxes .....	94
<b>6</b>	<b>Operation options</b> .....	<b>25</b>	<b>10</b>	<b>Repair</b> .....	<b>95</b>
6.1	Quick operation guide .....	25	10.1	Spare parts .....	95
6.2	Display and operating elements .....	25	10.2	Disassembling the panel-mounted device ...	95
6.2.1	Display .....	25	10.3	Disassembling the field device .....	98
6.2.2	Operating elements .....	27	10.4	Replacing the central module .....	102
6.2.3	Key functions .....	27	10.5	Return .....	103
			10.6	Disposal .....	103

---



<b>11</b>	<b>Accessories</b> .....	<b>104</b>
11.1	Sensors .....	104
11.1.1	Sensors with conductive measurement of conductivity .....	104
11.1.2	Sensors with inductive measurement of conductivity .....	104
11.2	Connection accessories .....	105
11.3	Installation accessories .....	105
11.4	Software and hardware add-ons .....	106
11.5	Calibration solutions .....	107
<b>12</b>	<b>Technical data</b> .....	<b>108</b>
12.1	Input .....	108
12.2	Output .....	108
12.3	Power supply .....	112
12.4	Performance characteristics .....	113
12.5	Environment .....	113
12.6	Mechanical construction .....	114
<b>13</b>	<b>Appendix</b> .....	<b>115</b>
<b>Index</b>	.....	<b>120</b>

# 1 Document information

## 1.1 Warnings

Structure of information	Meaning
 <b>DANGER</b> <b>Causes (/consequences)</b> Consequences of non-compliance (if applicable) ► Corrective action	This symbol alerts you to a dangerous situation. Failure to avoid the dangerous situation <b>will</b> result in a fatal or serious injury.
 <b>WARNING</b> <b>Causes (/consequences)</b> Consequences of non-compliance (if applicable) ► Corrective action	This symbol alerts you to a dangerous situation. Failure to avoid the dangerous situation <b>can</b> result in a fatal or serious injury.
 <b>CAUTION</b> <b>Causes (/consequences)</b> Consequences of non-compliance (if applicable) ► Corrective action	This symbol alerts you to a dangerous situation. Failure to avoid this situation can result in minor or more serious injuries.
 <b>NOTICE</b> <b>Cause/situation</b> Consequences of non-compliance (if applicable) ► Action/note	This symbol alerts you to situations which may result in damage to property.











## 1.2 Symbols used

-  Additional information, tips
-  Permitted or recommended
-  Forbidden or not recommended

## 1.3 Symbols on the device

Symbol	Meaning
	Reference to device documentation

## 1.4 Electrical symbols

Symbol	Meaning
 A0027423	<b>Direct current</b> A terminal at which DC is present or through which DC flows.
 A0027424	<b>Alternating current</b> A terminal at which alternating voltage (sine-wave) is applied or through which alternating current flows.
 A0027425	<b>Direct current or alternating current</b> A terminal at which direct voltage or alternating voltage is present or through which direct current or alternating current flows.
 A0027426	<b>Ground connection</b> A terminal which, from the user's point of view, is already grounded via a grounding system.
 A0027427	<b>Protective ground connection</b> A terminal which must be connected to ground prior to establishing any other connections.
 A0019929	<b>Class II equipment</b> Reinforced or double insulation
 A0027420	<b>Alarm relay</b>
 A0027428	<b>Input</b>
 A0027429	<b>Output</b>
 A0027430	<b>DC voltage source</b>
 A0027431	<b>Temperature sensor</b>

## 2 Basic safety instructions

### 2.1 Requirements for personnel

- Installation, commissioning, operation and maintenance of the measuring system may be carried out only by specially trained technical personnel.
- The technical personnel must be authorized by the plant operator to carry out the specified activities.
- The electrical connection may be performed only by an electrical technician.
- The technical personnel must have read and understood these Operating Instructions and must follow the instructions contained therein.
- Measuring point faults may be repaired only by authorized and specially trained personnel.

 Repairs not described in the Operating Instructions provided may only be carried out directly by the manufacturer or by the service organization.

### 2.2 Designated use

Liquisys M is a transmitter for determining the conductivity and resistivity of liquid media.

The transmitter is particularly suited for use in the following areas:

- Ultrapure water
- Water treatment
- Cooling water desalination
- Condensate treatment
- Municipal wastewater treatment plants
- Chemical industry
- Food industry
- Pharmaceutical industry

Use of the device for any purpose other than that described, poses a threat to the safety of people and of the entire measuring system and is therefore not permitted.

The manufacturer is not liable for damage caused by improper or non-designated use.

### 2.3 Occupational safety

As the user, you are responsible for complying with the following safety conditions:

- Installation guidelines
- Local standards and regulations

#### **Electromagnetic compatibility**

- The product has been tested for electromagnetic compatibility in accordance with the applicable European standards for industrial applications.
- The electromagnetic compatibility indicated applies only to a product that has been connected in accordance with these Operating Instructions.

## 2.4 Operational safety

1. Before commissioning the entire measuring point, verify that all connections are correct. Ensure that electrical cables and hose connections are undamaged.
2. Do not operate damaged products, and safeguard them to ensure that they are not operated inadvertently. Label the damaged product as defective.
3. If faults cannot be rectified:  
Take the products out of operation and safeguard them to ensure that they are not operated inadvertently.

## 2.5 Product safety

### 2.5.1 State of the art

The product is designed to meet state-of-the-art safety requirements, has been tested, and left the factory in a condition in which it is safe to operate. The relevant regulations and European standards have been observed.

### 2.5.2 IT security

We only provide a warranty if the device is installed and used as described in the Operating Instructions. The device is equipped with security mechanisms to protect it against any inadvertent changes to the device settings.

IT security measures in line with operators' security standards and designed to provide additional protection for the device and device data transfer must be implemented by the operators themselves.



## 3 Incoming acceptance and product identification

### 3.1 Incoming acceptance

1. Verify that the packaging is undamaged.
  - ↳ Notify your supplier of any damage to the packaging.  
Keep the damaged packaging until the matter has been settled.
2. Verify that the contents are undamaged.
  - ↳ Notify your supplier of any damage to the delivery contents.  
Keep the damaged products until the matter has been settled.
3. Check the delivery for completeness.
  - ↳ Check it against the delivery papers and your order.
4. Pack the product for storage and transportation in such a way that it is protected against impact and moisture.
  - ↳ The original packaging offers the best protection.  
The permitted ambient conditions must be observed (see "Technical data").

If you have any questions, please contact your supplier or your local sales center.

### 3.2 Scope of delivery

The delivery of the field device comprises:

- 1 transmitter CLM253
- 1 plug-in screw terminal, 3-pin
- 1 cable gland Pg 7
- 1 cable gland Pg 16 reduced
- 2 cable glands Pg 13.5
- 1 set of Operating Instructions
- For versions with HART communication:
  - 1 set of Operating Instructions: Field communication with HART
- For versions with PROFIBUS interface:
  - 1 set of Operating Instructions: Field communication with PROFIBUS PA/DP

The delivery of the panel-mounted device comprises:

- 1 transmitter CLM223
- 1 set of plug-in screw terminals
- 2 tensioning screws
- 1 set of Operating Instructions
- For versions with HART communication:
  - 1 set of Operating Instructions: Field communication with HART
- For versions with PROFIBUS interface:
  - 1 set of Operating Instructions: Field communication with PROFIBUS PA/DP

## 3.3 Product identification

### 3.3.1 Nameplate

The nameplate provides you with the following information on your device:

- Manufacturer identification
- Order code
- Extended order code
- Serial number
- Ambient and process conditions
- Input and output values
- Safety information and warnings

 Compare the data on the nameplate with your order.

### 3.3.2 Product identification

The order code and serial number of your product can be found in the following locations:

- On the nameplate
- In the delivery papers

#### Obtaining information on the product

1. Go to the product page for your product on the Internet.
2. In the navigation area on the right-hand side, select "Check your device features" under "Device support".
  - ↳ An additional window opens.
3. Enter the order code from the nameplate into the search field.
  - ↳ You will receive information on each feature (selected option) of the order code.

## 3.4 Certificates and approvals

### 3.4.1 CE mark

The product meets the requirements of the harmonized European standards. As such, it complies with the legal specifications of the EC directives. The manufacturer confirms successful testing of the product by affixing to it the **CE** mark.

### 3.4.2 CSA General Purpose

The following device versions meet the requirements of CSA and ANSI/UL for Canada and the US:

- CLM253-\*\*2/3/7\*\*\*
- CLM223-\*\*2/3/7\*\*\*

## 4 Installation

### 4.1 Installation at a glance

Proceed as follows to completely install the measuring point:

- Install the transmitter (see the "Installation instructions" section).
- If the sensor is not yet installed in the measuring point, install it (see Technical Information of the sensor).
- Connect the sensor to the transmitter as illustrated in the "Electrical connection" section.
- Connect the transmitter as illustrated in the "Electrical connection" section.
- Commission the transmitter as explained in the "Commissioning" section.

### 4.1.1 Measuring system

A complete measuring system comprises:

- Transmitter Liquisys M CLM223 or CLM253
- sensor with or without an integrated temperature sensor
- If necessary, Measuring cable: CYK71 or CPK9 (conductive) or CLK6 (inductive)

Optionally:

- Eintaucharmatur, z.B. CLA111
- Extension cable, junction box VBM
- Weather protection cover CYY101 for field housing

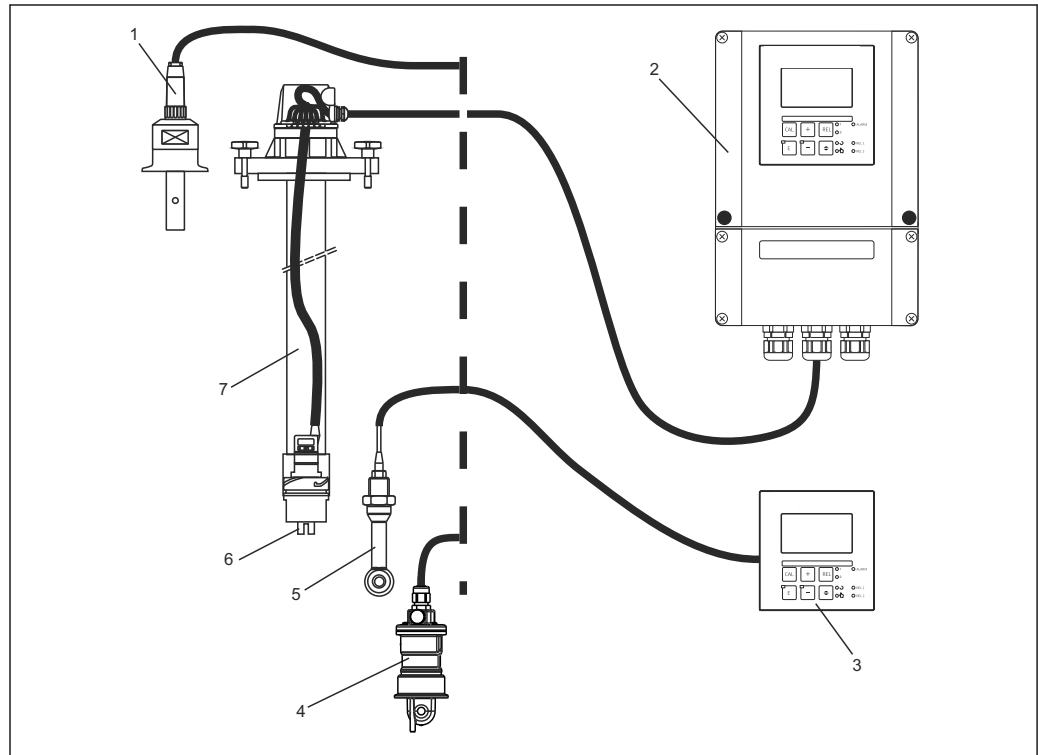

A0024642

#### 1 Complete measuring systems

- 1 Conductive sensor CLS15
- 2 Liquisys M CLM253
- 3 Liquisys M CLM223
- 4 Inductive sensor CLS54
- 5 Inductive sensor CLS50
- 6 Conductive sensor CLS21
- 7 Immersion assembly CLA111

## 4.2 Installation conditions

### 4.2.1 Field device

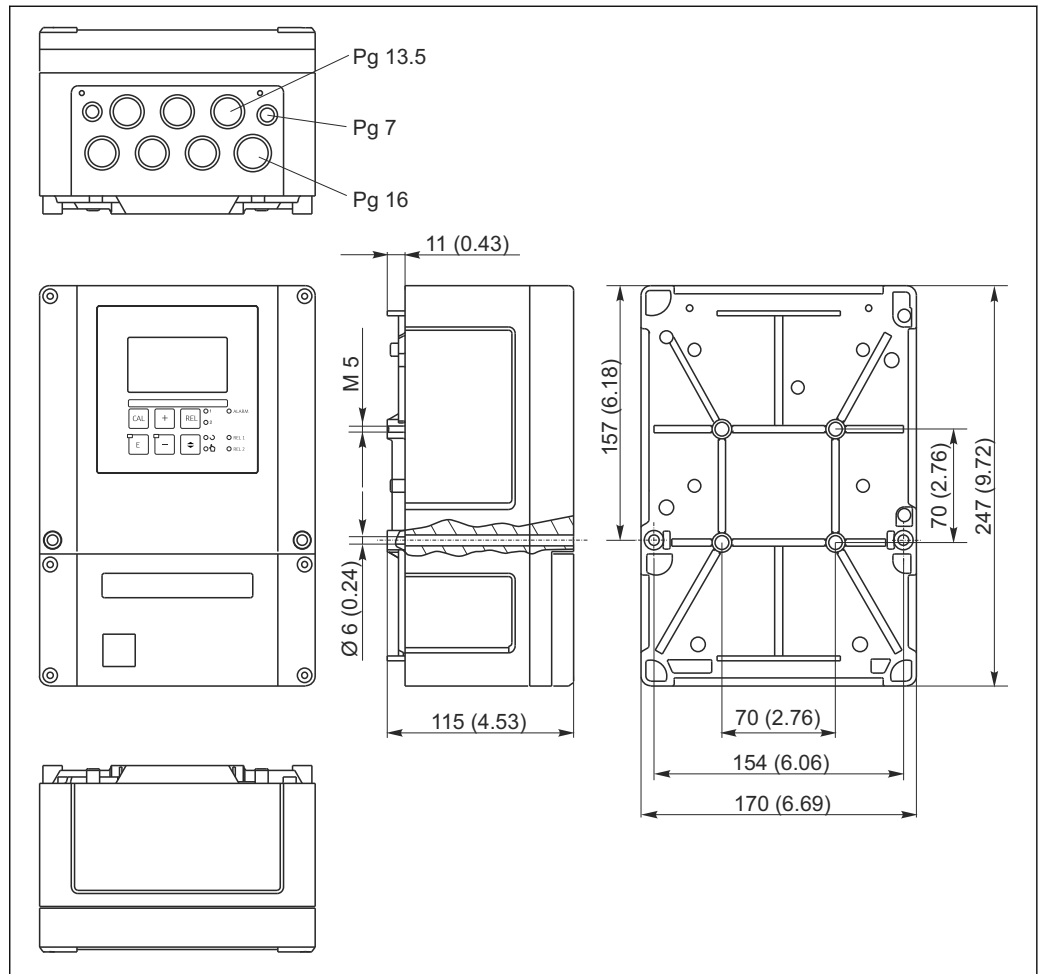

2 Field device, dimensions in mm (inch)

A0024637

- i** There is a hole in the perforation for the cable entry (connection of supply voltage). It serves as a pressure balance during air shipment. Make sure no moisture penetrates the inside of the housing before the cable installation. The housing is completely air-tight after cable installation.

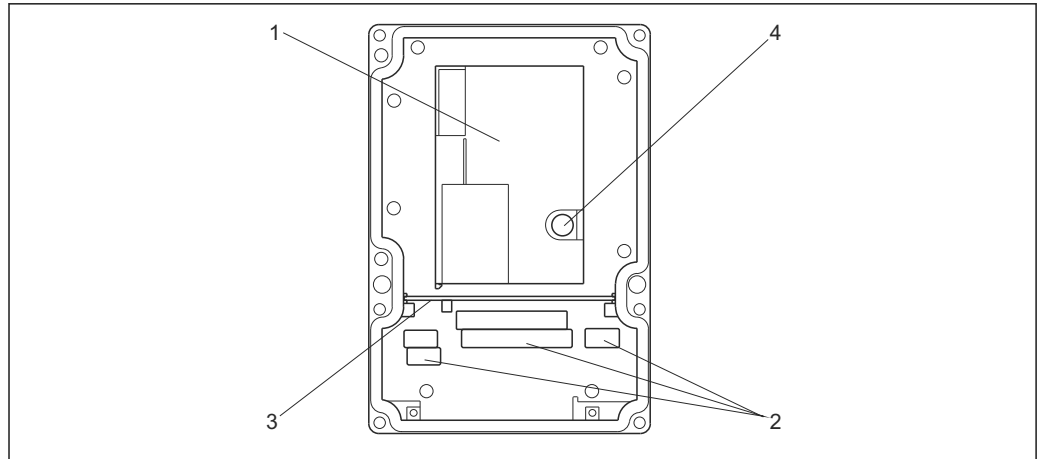

A0024640

3 View into the field housing

- 1 Removable electronics box
- 2 Terminals
- 3 Partition plate
- 4 Fuse

### 4.2.2 Panel-mounted device

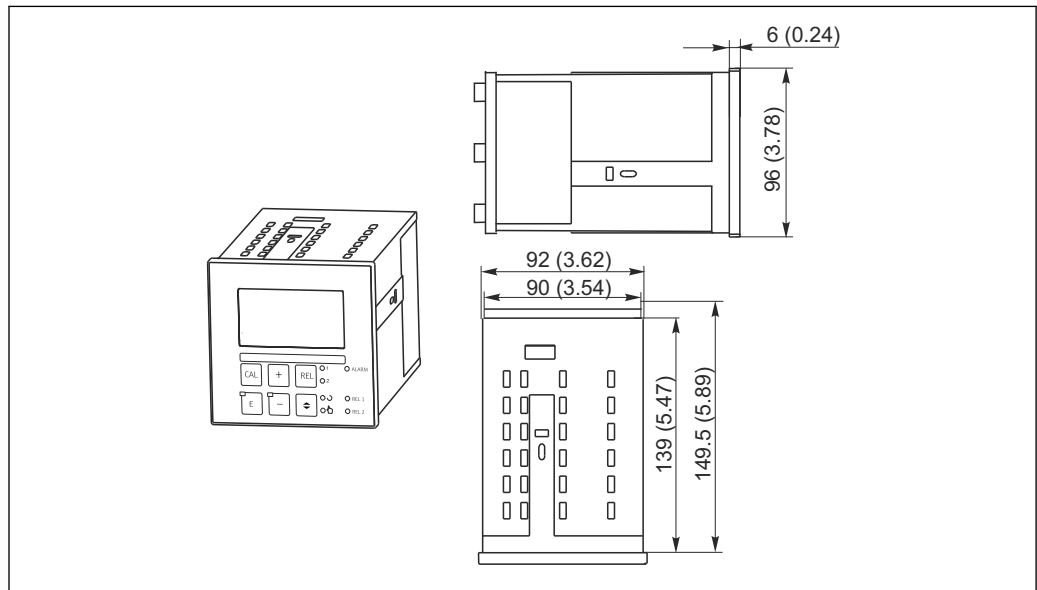

A0024641

4 Panel-mounted device, dimensions in mm (inch)

## 4.3 Installation instructions

### 4.3.1 Field device

There are several ways of securing the field housing:

- Wall mounting with fixing screws
- Post mounting to cylindrical pipes
- Post mounting to a square securing mast

#### NOTICE

**Effect of climatic conditions (rain, snow, direct sunlight etc.)**

Impaired operation to complete transmitter failure

- ▶ When installing outside, always use the weather protection cover (accessory).

#### Transmitter wall mounting

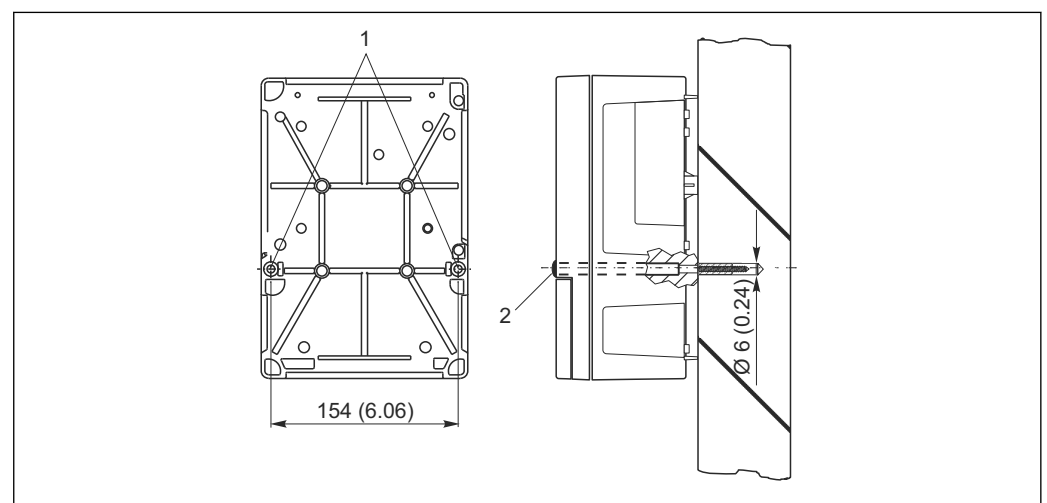

A0024638

#### 5 Field device wall mounting

- 1 Fixing bore holes
- 2 Plastic caps

Proceed as follows to mount the transmitter on the wall:

- Create the bore holes as shown in → 5.
- Drive two fixing screws through the fixing bore holes (1) from the front.
- Mount the transmitter on the wall as shown.
- Cover the bores with plastic caps (2).

#### Transmitter post mounting

- i** You require a post mounting kit to secure the field device to horizontal and vertical posts or pipes (max. Ø 60 mm (2.36")). This can be acquired as an accessory (see the "Accessories" section).

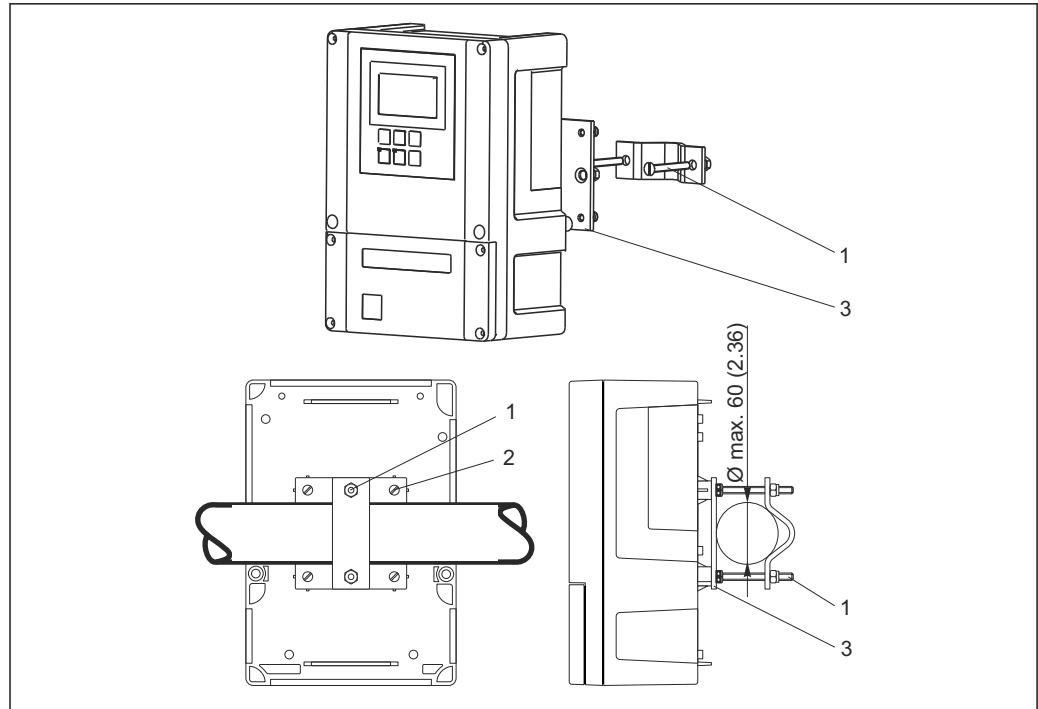

A0024635

6 Field device on horizontal or vertical pipes

- 1 Securing screws
- 2 Fixing screws
- 3 Securing plate

Proceed as follows to mount the transmitter on a post:

1. Guide the two securing screws (1) of the mounting kit through the openings on the securing plate (3).
2. Screw the securing plate onto the transmitter using the four fixing screws (2).
3. Secure the bracket with the field device on the post or pipe using the clip.

You can also secure the field device to the Flexdip CYH112 bracket in conjunction with the weather protection cover. These can be acquired as accessories, see the "Accessories" section.

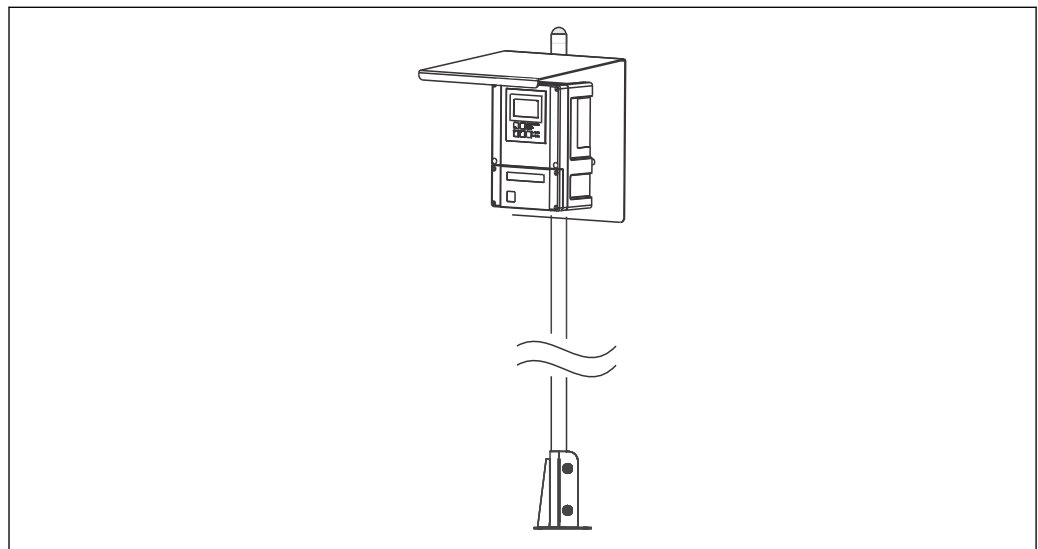

A0027433

7 Field device on Flexdip CYH112 bracket with weather protection cover



### 4.3.2 Panel-mounted device

The panel-mounted device is secured with the tensioning screws supplied →  8

The necessary installation depth is approx. 165 mm (6.50").

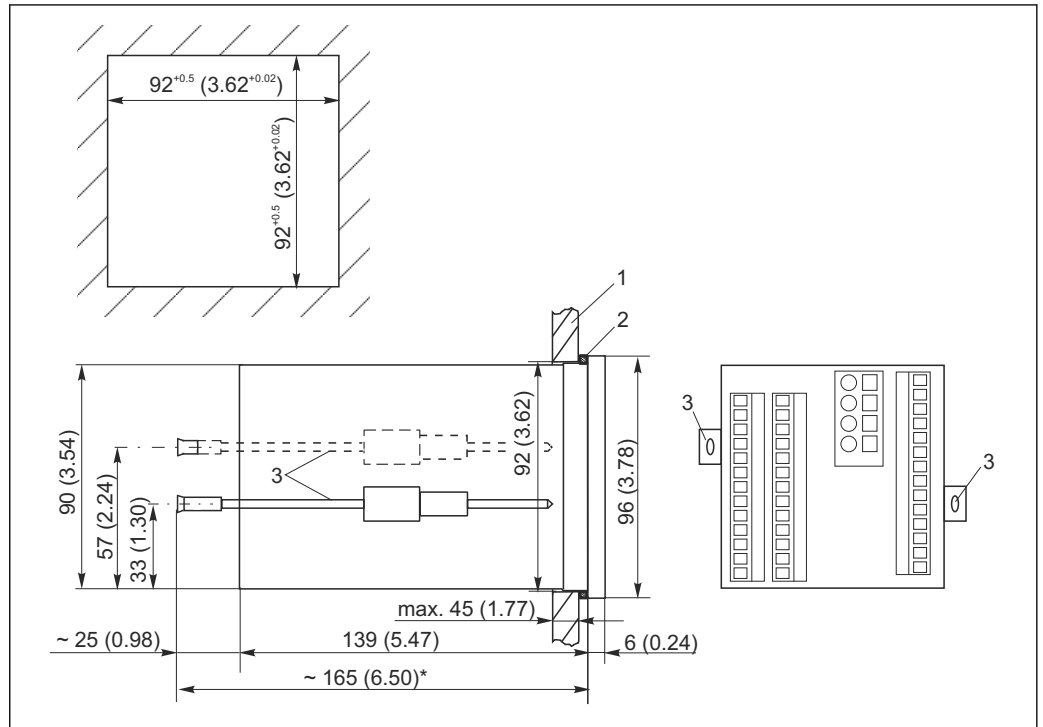

 8 Dimensions in mm (inch)

1 Mounting plate

2 Seal

3 Tensioning screws

\* Necessary installation depth

### 4.4 Post-installation check

- After installation, check the transmitter for damage.
- Check whether the transmitter is protected against moisture and direct sunlight (e.g. by the weather protection cover).

## 5 Electrical connection

### **⚠ WARNING**

#### **Device is live**

Incorrect connection may result in injury or death.

- ▶ The electrical connection may be performed only by an electrical technician.
- ▶ The electrical technician must have read and understood these Operating Instructions and must follow the instructions contained therein.
- ▶ **Prior** to commencing connection work, ensure that no voltage is present on any cable.

### 5.1 Wiring

#### **⚠ WARNING**

#### **Risk of electric shock!**

- ▶ At the supply point, the power supply must be isolated from dangerous live cables by double or reinforced insulation in the case of devices with a 24 V power supply.

#### **NOTICE**

#### **The device does not have a power switch**

- ▶ The customer must provide a protected circuit breaker in the vicinity of the device.
- ▶ The circuit breaker must be a switch or power switch, and you must label it as the circuit breaker for the device.

#### 5.1.1 Wiring diagram

The wiring diagram shows the connections of a device equipped with all the options. The connection of the sensors to the various measuring cables is explained in more detail in the "Measuring cables and sensor connection" section.

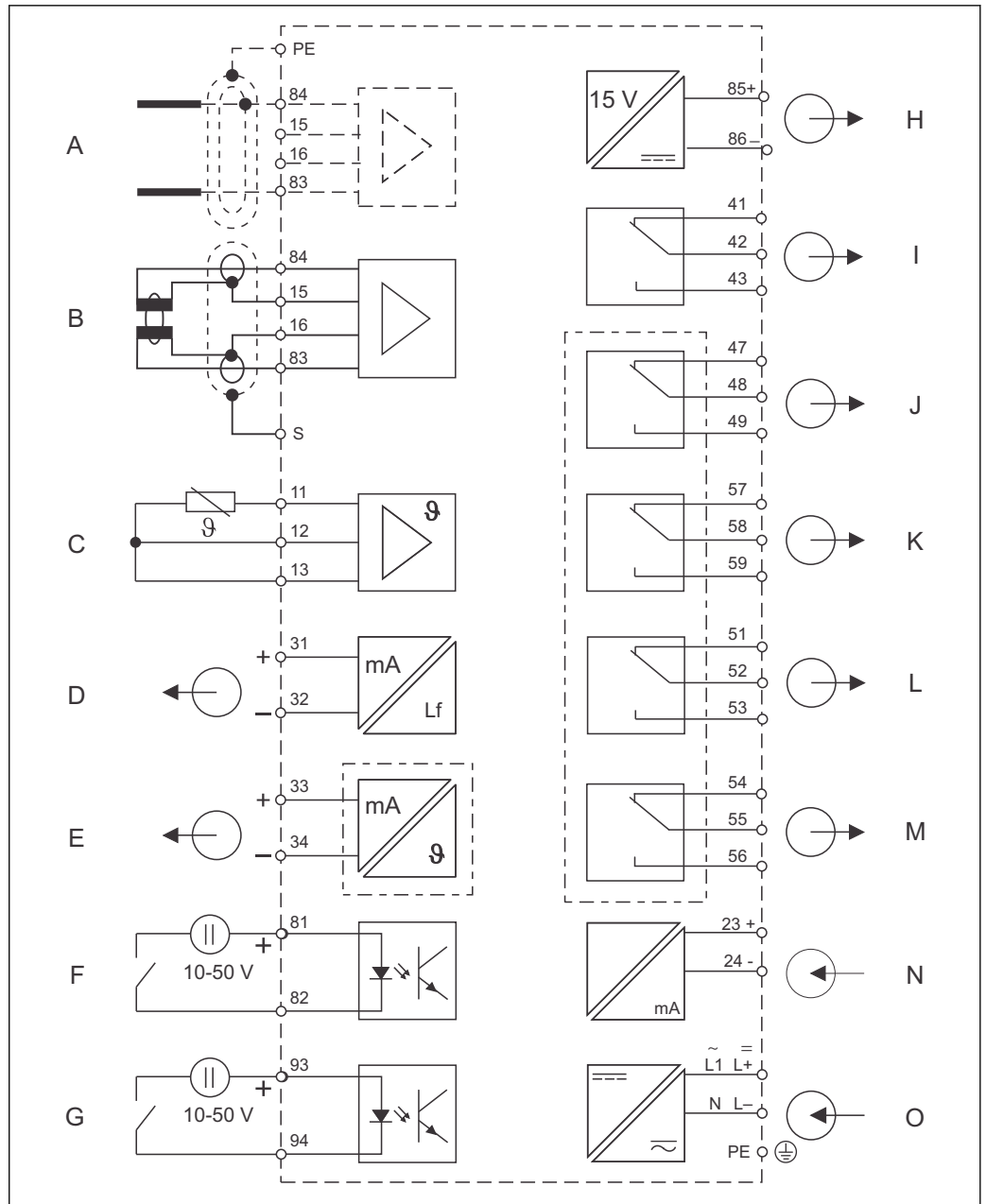

A0008920

9 Electrical connection of the transmitter

- |   |  |   |   |
|---|--|---|---|
| A | Sensor (conductive)                      | I | Alarm (current-free contact position)   |
| B | Sensor (inductive)                       | J | Relay 1 (current-free contact position) |
| C | Temperature sensor                       | K | Relay 2 (current-free contact position) |
| D | Signal output 1, conductivity            | L | Relay 3 (current-free contact position) |
| E | Signal output 2, user-definable variable | M | Relay 4 (current-free contact position) |
| F | Binary input 1 (hold)                    | N | Current input 4 to 20 mA                |
| G | Binary input 2 (Chemoclean)              | O | Power connection                        |
| H | Auxiliary voltage output                 |   |   |

Please note the following:

- The device is approved for protection class II and is generally operated without a protective ground connection.
- To guarantee measuring stability and functional safety, you must connect the outer shield of the sensor cable:

- Inductive sensors: terminal "S"
- Conductive sensors: PE distributor rail

This is on the cover frame in the case of panel-mounted devices, and in the connection compartment in the case of field devices. Ground this PE distributor rail or the ground terminal directly on site wherever possible.

- Circuits "E" and "H" are not galvanically isolated from each other.

**Field device connection**

Guide the measuring cables through the PG glands into the housing. Connect the measuring cables in accordance with the terminal assignment.

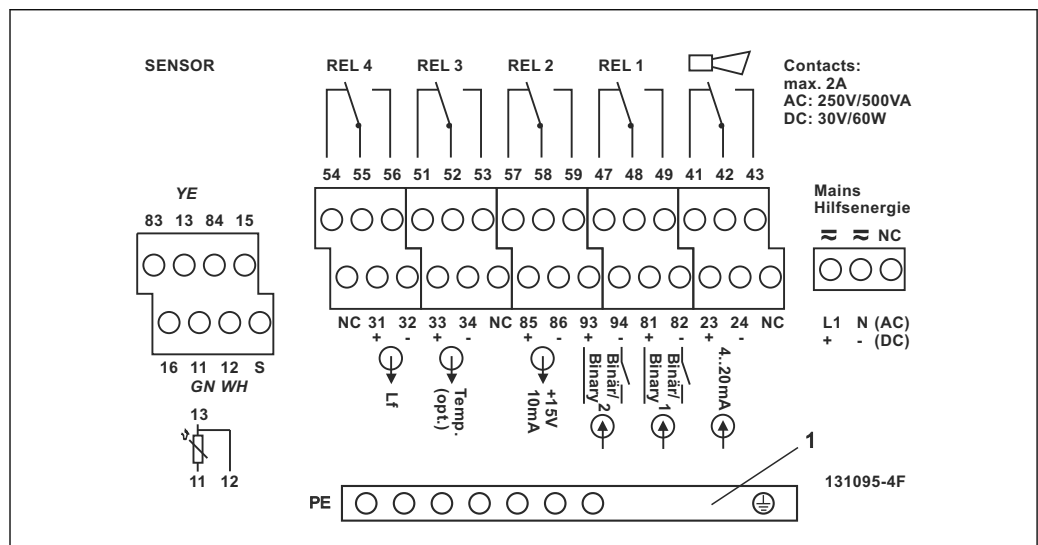

10 Field device connection compartment sticker

1 PE distributor rail for CD/CS device version (conductive sensors)

**Panel-mounted device connection**

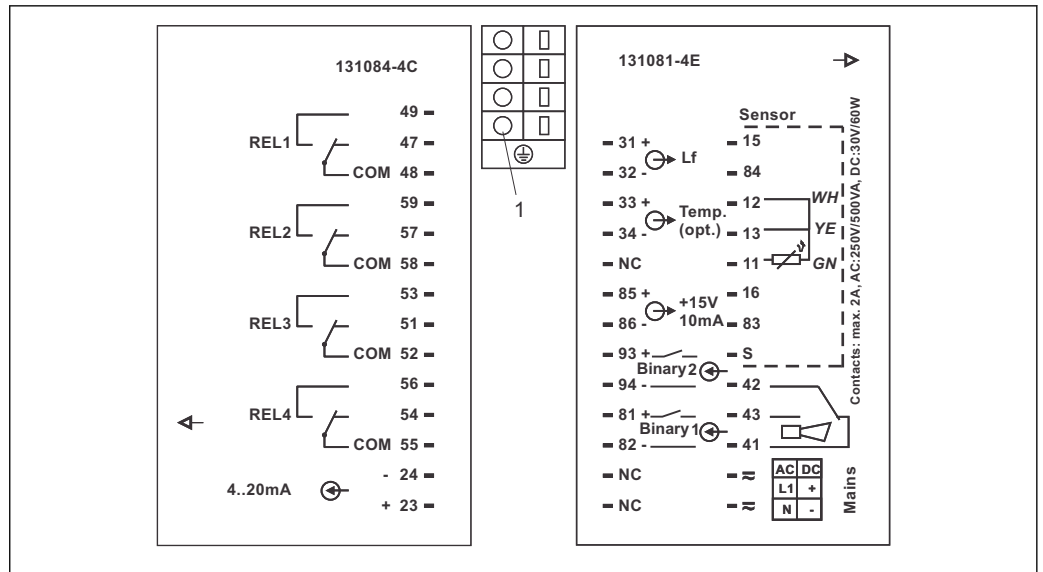

A0008912

11 Panel-mounted device connection sticker

1 Ground terminal

### 5.1.2 Measuring cables and sensor connection

You require shielded special measuring cables to connect conductivity sensors to the transmitter. The following multi-core, pre-terminated cable types can be used:

Sensor type	Cable	Extension
Two-electrode sensor with or without temperature sensor Pt 100	CYK71 CPK9* (for CLS16)	VBM box + CYK71 cable
Inductive sensor CLS50, CLS52	Fixed cable on sensor	VBM box + CLK6 cable

\* High-temperature version without PML

Maximum cable length	
Conductive measurement of conductivity	Max. 100 m (328 ft) with CYK71
Resistance measurement	Max 15 m (49.2 ft) with CYK71
Inductive measurement of conductivity	Max. 55 m ( 180 ft) with CLK5 (incl. sensor cable)

### Structure and termination of the measuring cables

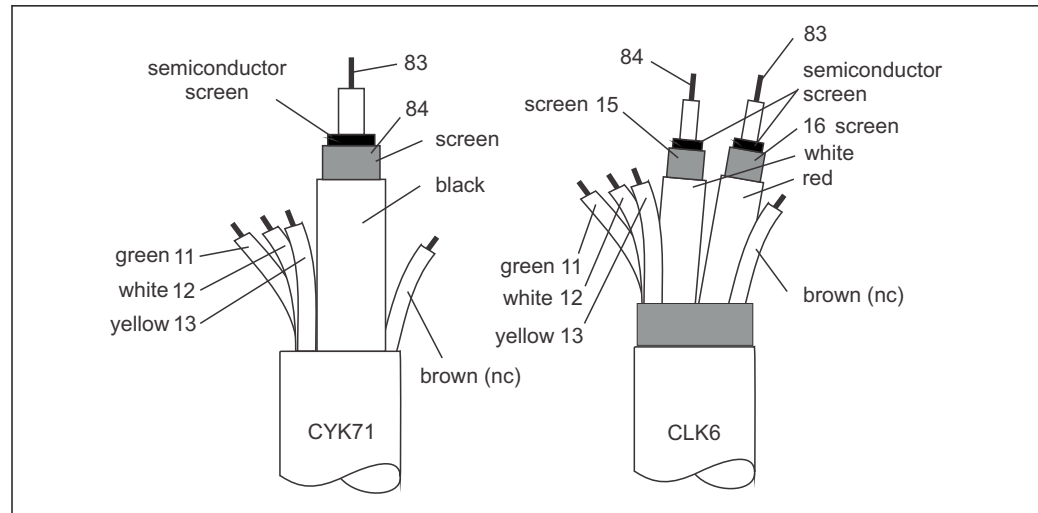

A0008938-EN

12 Structure of the special measuring cables

A Semi-conductor layer  
sc Shield

**i** For further information on the cables and junction boxes, please refer to the "Accessories" section.

### Field device measuring cable connection

Proceed as follows to connect a conductivity sensor to the field device:

1. Open the housing cover to access the terminal block in the connection compartment.
2. Break through the perforation for a cable gland, mount a cable gland and guide the cable through this gland.
3. Connect the cable in accordance with the terminal assignment (see connection compartment sticker).
4. Tighten the cable gland.

### Panel-mounted device measuring cable connection

To connect a conductivity sensor, connect the measuring cable in accordance with the terminal assignment to the terminals on the rear of the device (see connection sticker).

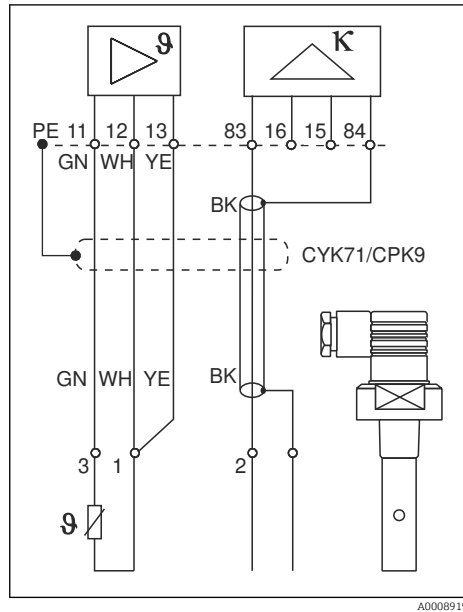

13 Connection of conductive sensors

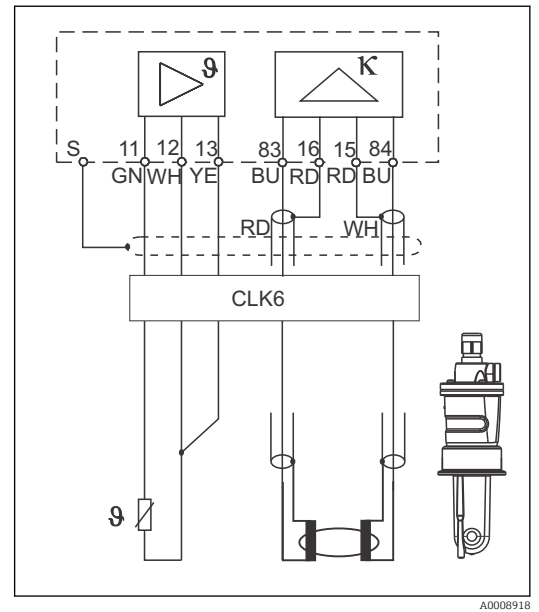

14 Connection of inductive sensors

## 5.2 Alarm contact

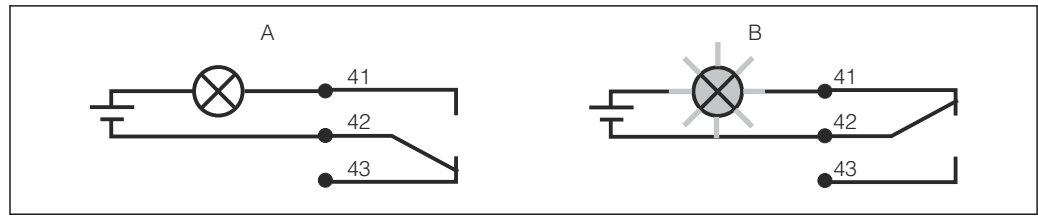

A0006415

15 Recommended fail-safe switching for the alarm contact

A Normal operating status  
 B Alarm condition

### Normal operating status

Device in operation and no error message present (alarm LED off):

- Relay energized
- Contact 42/43 closed

### Alarm condition

Error message present (alarm LED red) or device defective or de-energized (alarm LED off):

- Relay de-energized
- Contact 41/42 closed

## 5.3 Post-connection check

Carry out the following checks once you have made the electrical connection:

Device state and specifications	Notes
Are the devices and cables free from damage on the outside?	Visual inspection

Electrical connection	Notes
Are the mounted cables strain relieved?	
Are the connected cables provided with strain relief?	
Is the cable run correct, without loops and cross-overs?	
Are the power cable and signal cables connected correctly and in accordance with the wiring diagram?	
Are all the screw terminals tightened?	
Are all the cable entries fitted, tightened and leak-proof?	
Are the PE distributor blocks grounded (if present)?	Grounding is carried out at the point of installation.



## 6 Operation options

### 6.1 Quick operation guide

You have the following ways of operating the transmitter:

- On site via the key field
- Via the HART interface (optional, with corresponding order version) with:
  - HART handheld terminal
  - PC with HART modem and the Fieldcare software package
- Via PROFIBUS PA/DP (optional, with corresponding order version) by PC with a corresponding interface and the Fieldcare software package or via a programmable logic controller (PLC).

 For operation via HART or PROFIBUS PA/DP, please read the relevant sections in the additional Operating Instructions:







- PROFIBUS PA/DP, field communication for Liquisys M CXM223/253, BA00209C/07/EN
- HART, field communication for Liquisys M CXM223/253, BA00208C/07/EN

The following section only explains operation via the keys.

### 6.2 Display and operating elements

#### 6.2.1 Display

##### LED displays

  <small>A0027220</small>	Indicates the current operating mode, "Auto" (green LED) or "Manual" (yellow LED)
 1  2 <small>A0027222</small>	Indicates the activated relay in the "Manual" mode (red LED) The status of relays 3 and 4 is indicated on the LC display.
 REL 1  REL 2 <small>A0027221</small>	Indicates the working status of relay 1 and 2 LED green: measured value within the permitted limit, relay inactive LED red: measured value outside the permitted limit, relay active
 ALARM <small>A0027218</small>	Alarm display, e.g. in event of continuous limit value overshoot, temperature sensor failure or system error (see error list)

### LC display

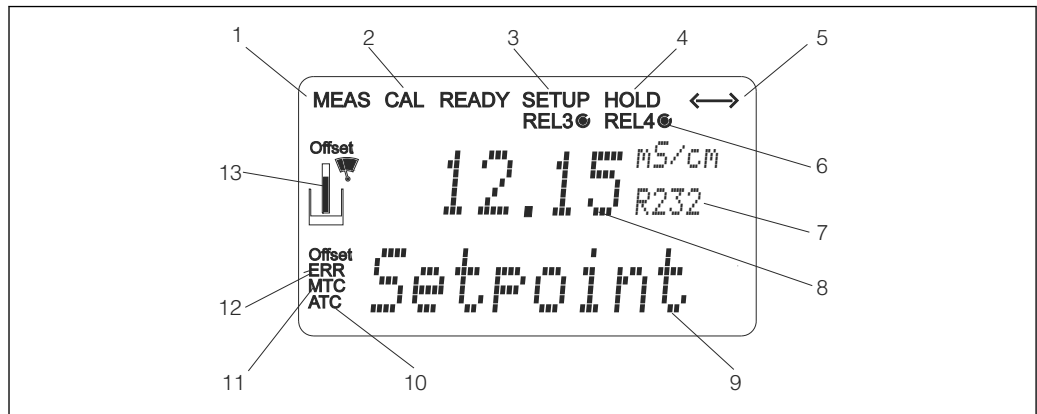

A0008922-EN

16 Transmitter LC display

- 1 Indicator for measuring mode (normal operation)
- 2 Indicator for calibration mode
- 3 Indicator for setup mode (configuration)
- 4 Indicator for "Hold" mode (current outputs remain at last current state)
- 5 Indicator for receipt of a message on devices with communication
- 6 Indicator of working status of relays 3/4: ○ inactive, ● active
- 7 Function code
- 8 In measuring mode: measured variable - in setup mode: configured variable
- 9 In measuring mode: secondary measured value - in setup/calibr. mode: e.g. set value
- 10 Indicator for autom. Temperature compensation
- 11 Indicator for man. Temperature compensation
- 12 "Error": error display
- 13 Sensor symbol (see the "Calibration" section)

### 6.2.2 Operating elements

The display shows the current measured value and the temperature simultaneously, which means you have an overview of the most important process data at once. Help text in the configuration menu helps users configure the device parameters.

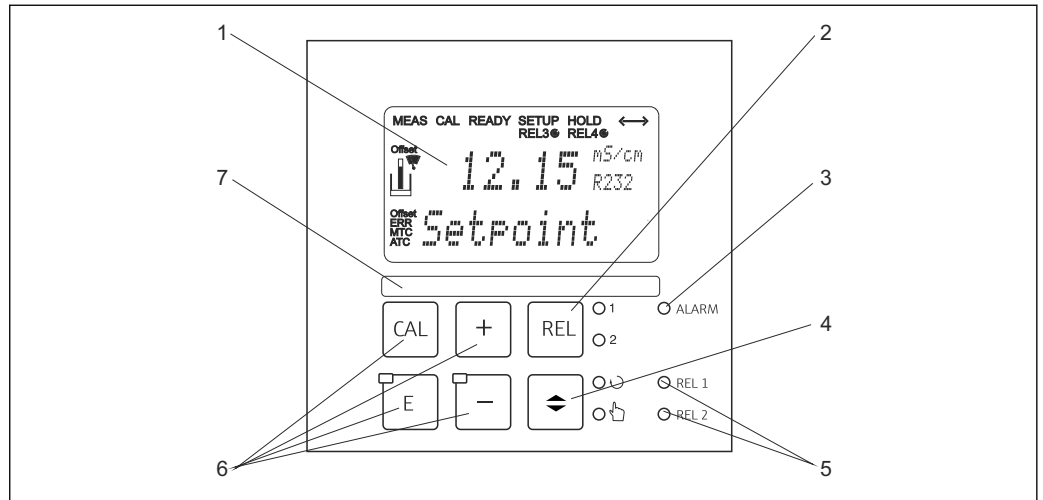







A0024632-EN

17 Operating elements

- 1 LC display for displaying the measured values and configuration data
- 2 Key to switch relays in manual mode and to display the active contact
- 3 LED for alarm function
- 4 Changeover switch for automatic/manual mode
- 4 LEDs for limit contactor relay (switch status)
- 5 LEDs for limit contactor relay (switch status)
- 6 Main operating keys for calibration and device configuration
- 7 Field for user-defined information

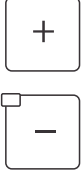
### 6.2.3 Key functions

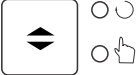
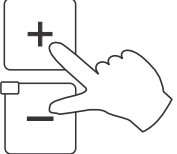
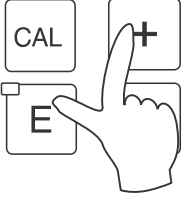
 <p style="text-align: right; font-size: small;">A0027235</p>	<p><b>CAL key</b></p> <p>When you press the CAL key, the device first prompts you for the calibration access code:</p> <ul style="list-style-type: none"> <li>■ Code 22 for calibration</li> <li>■ Code 0 or any other code for reading the last calibration data</li> </ul> <p>Use the CAL key to accept the calibration data or to switch from field to field within the calibration menu.</p>
 <p style="text-align: right; font-size: small;">A0027236</p>	<p><b>ENTER key</b></p> <p>When you press the ENTER key, the device first prompts you for the setup mode access code:</p> <ul style="list-style-type: none"> <li>■ Code 22 for setup and configuration</li> <li>■ Code 0 or any other code for reading all the configuration data.</li> </ul> <p>The ENTER key has several functions:</p> <ul style="list-style-type: none"> <li>■ Calls up the Setup menu from the measuring mode</li> <li>■ Saves (confirms) data entered in the setup mode</li> <li>■ Moves on within function groups</li> </ul>



 <p style="text-align: right; font-size: small;">A0027240</p>	<p><b>PLUS key and MINUS key</b></p> <p>In the <b>Setup mode</b>, the PLUS and MINUS keys have the following functions:</p> <ul style="list-style-type: none"> <li>■ Selection of function groups. Press the MINUS key to select the function groups in the order given in the "System configuration" section.</li> <li>■ Configuration of parameters and numerical values</li> <li>■ Operation of the relays in manual mode</li> </ul> <p>In the <b>measuring mode</b>, the following sequence of functions is accessed by <b>repeatedly pressing the PLUS key</b>:</p> <ul style="list-style-type: none"> <li>■ Temperature displayed in °F</li> <li>■ Temperature is hidden</li> <li>■ Current input signal in %</li> <li>■ Current input signal in mA</li> <li>■ Uncompensated conductivity value is displayed</li> <li>■ Return to basic settings</li> </ul> <p>In the measuring mode, the following sequence of information is displayed by <b>repeatedly pressing the MINUS key</b>:</p> <ul style="list-style-type: none"> <li>■ The current errors are displayed consecutively (max. 10).</li> <li>■ Once all the errors have been displayed, the standard measurement display appears. In the function group F, an alarm can be defined separately for each error code.</li> </ul>
 <p style="text-align: right; font-size: small;">A0027241</p>	<p><b>REL key</b></p> <p>In the manual mode, you can use the REL key to switch between the relay and the manual start of cleaning.</p> <p>In automatic mode, you can use the REL key to read out the switch-on points (for limit contactor) or set points (for PID controller) assigned to the relay in question.</p> <p>Press the PLUS key to jump to the settings of the next relay. Use the REL key to get back to the display mode (automatic return after 30 s).</p>
 <p style="text-align: right; font-size: small;">A0027234</p>	<p><b>AUTO key</b></p> <p>Use the AUTO key to switch between automatic mode and manual mode.</p>
 <p style="text-align: right; font-size: small;">A0027237</p>	<p><b>Escape function</b></p> <p>If you press the PLUS and MINUS key simultaneously, you return to the main menu, or are taken to the end of calibration if calibrating.</p> <p>If you press the PLUS and MINUS key again, you return to the measuring mode.</p>
 <p style="text-align: right; font-size: small;">A0027238</p>	<p><b>Locking the keyboard</b></p> <p>Press the PLUS and ENTER key simultaneously for at least 3 s to lock the keyboard against any unauthorized data entry. All the settings can continue to be read.</p> <p>The code prompt displays the code 9999.</p>
 <p style="text-align: right; font-size: small;">A0027239</p>	<p><b>Unlocking the keyboard</b></p> <p>Press the CAL and MINUS key simultaneously for at least 3 s to unlock the keyboard.</p> <p>The code prompt displays the code 0.</p>

## 6.3 Local operation

### 6.3.1 Automatic/manual mode

The transmitter normally operates in automatic mode. Here, the relays are triggered by the transmitter. In the manual mode, you can trigger the relays manually using the REL key or start the cleaning function.

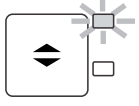
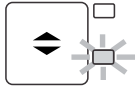
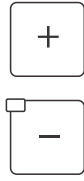
How to change the operating mode:

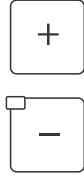
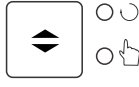
 <p>A0027242</p>	1.	The transmitter is in automatic mode. The top LED (green) next to the AUTO key is lit.
 <p>A0027243</p>	2.	Press the AUTOMATIC key.
 <p>A0027240</p>	3.	To enable the manual mode, enter the code 22 via the PLUS and MINUS keys and press ENTER to confirm. The lower LED (manual mode) is lit.
 <p>A0027241</p>	4.	Select the relay or the function. You can use the REL key to switch between the relays. The relay selected and the switch status (ON/OFF) is displayed on the second line of the display. In the manual mode, the measured value is displayed continuously (e.g. for measured value monitoring for dosing functions).
 <p>A0027240</p>	5.	Switch the relay. The relay is switched on with PLUS and switched off with MINUS. The relay remains in this switched state until it is switched again.
 <p>A0027234</p>	6.	Press the AUTOMATIC key to return to the measuring mode, i.e. to the automatic mode. All the relays are triggered again by the transmitter.

- 
  - The operating mode remains in effect even after a power failure. The relays assume the quiescent state, however.
  - The manual mode has priority over all other automatic functions.
  - Hardware locking is not possible in the manual mode.
  - The manual settings are kept until they are actively reset.
  - Error code E102 is signaled during manual operation.

### 6.3.2 Operating concept

#### Operating modes

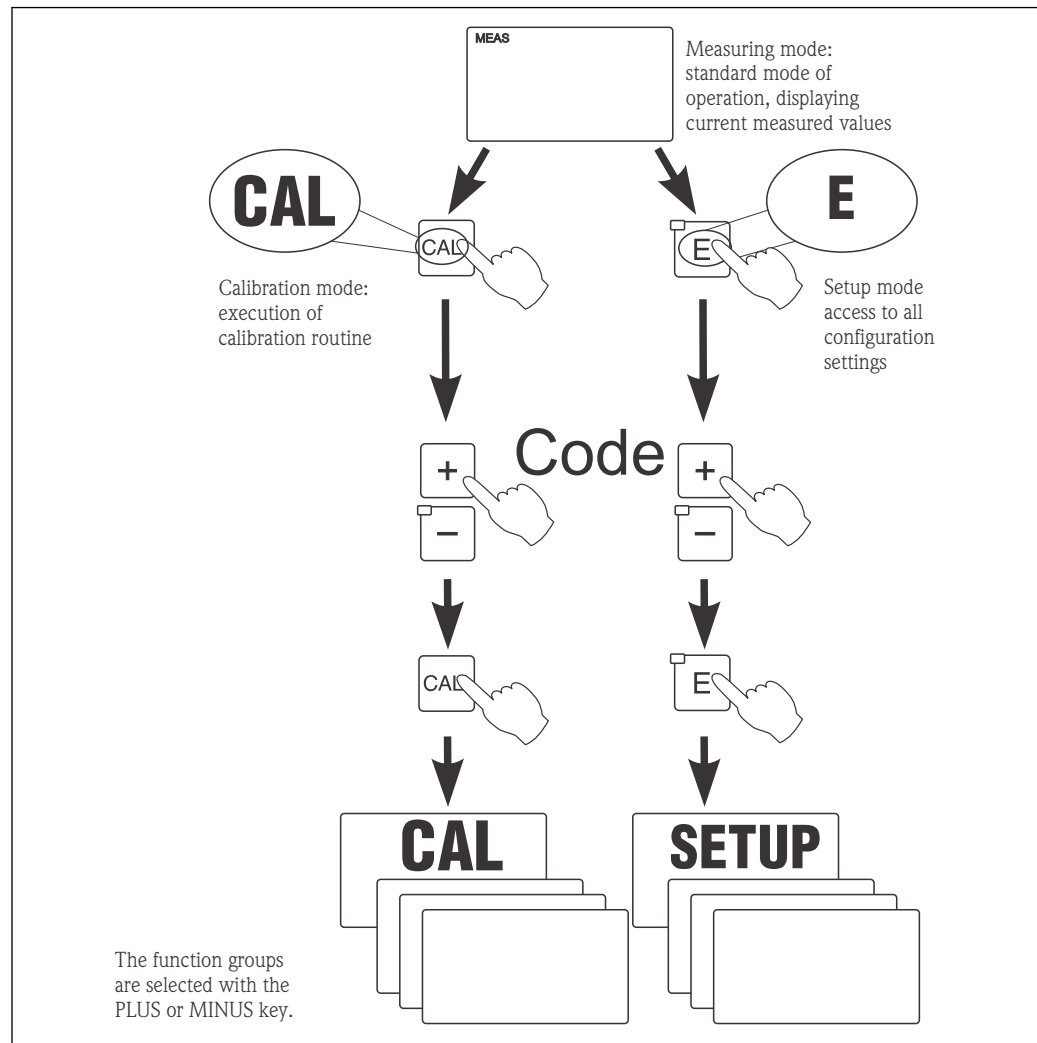

A0027244-EN

18 Description of the possible operating modes

**i** If no key is pressed in the setup mode for approx. 15 min, the device automatically returns to the measuring mode. Any active hold (hold during setup) is canceled.

#### Access codes

All device access codes are fixed and cannot be altered. When the device requests the access code, it distinguishes between different codes.

- **CAL key + code 22:** access to Calibration and Offset menu
- **ENTER key + code 22:** access to the menus for the parameters which make configuration and user-specific settings possible
- **PLUS + ENTER keys** simultaneously (min. 3 s): lock the keyboard
- **CAL + MINUS keys** simultaneously (min. 3 s): unlock the keyboard
- **CAL or ENTER key + any code:** access to read mode, i.e. all the settings can be read but not modified.

The device continues measuring in the read mode. It does not shift to the "Hold" status. The current output and the controllers remain active.

### Menu structure

The configuration and calibration functions are arranged in function groups.

- In the setup mode, select a function group with the PLUS and MINUS keys.
- In the function group itself, switch from function to function with the ENTER key.
- Within the function, select the desired option with the PLUS and MINUS keys or edit the settings with these keys. Then confirm with the ENTER key and continue.
- Press the PLUS and MINUS keys simultaneously (Escape function) to exit programming (return to the main menu).
- Press the PLUS and MINUS keys simultaneously again to switch to the measuring mode.

 If a modified setting is not confirmed by pressing ENTER, the old setting is retained.  
An overview of the menu structure is provided in the Appendix to these Operating Instructions.

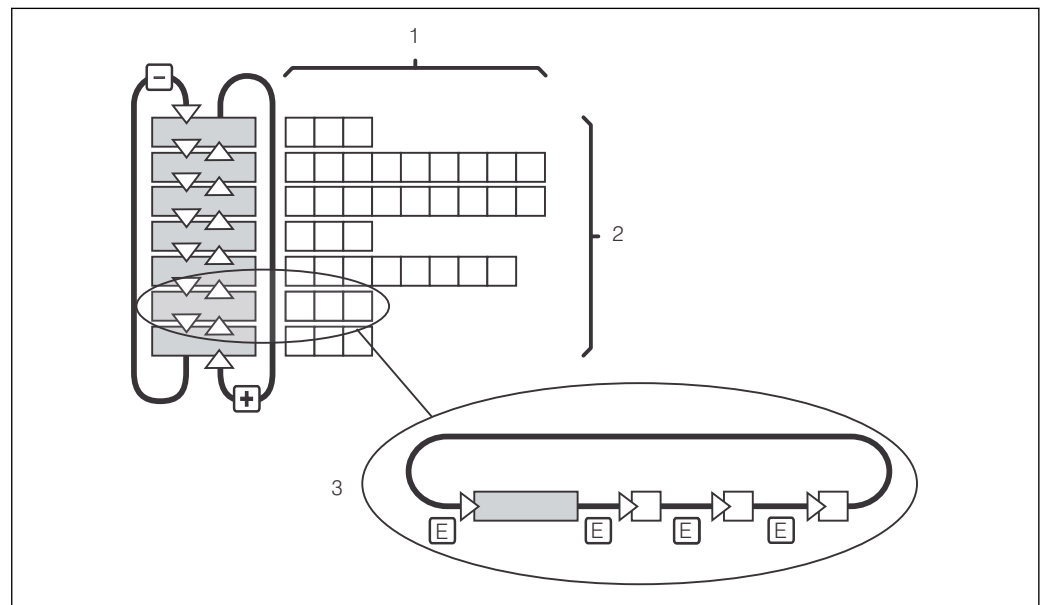

 19 Menu structure

- 1 Functions (selection of parameters, entry of numbers)
- 2 Function groups, scroll backwards and forwards with the PLUS and MINUS keys
- 3 Switch from function to function with the ENTER key

### Hold function: "freeze" the outputs

In both the setup mode and during calibration, the current output can be "frozen" (factory setting), i.e. it constantly retains its current status. "HOLD" appears on the display. If the controller actuating variable (steady control 4 to 20 mA) is output via current output 2, it is set to 0/4 mA during a hold.

- Hold settings can be found in the "Service" function group.
- During a hold, all contacts assume a quiescent state.
- An active hold has priority over all other automatic functions.
- With every hold, the I-component of the controller is set to "0".
- Any alarm delay is reset to "0".
- This function can also be activated externally via the hold input (see Wiring diagram; binary input 1).
- A manual hold (field S3) remains active even after a power failure.

## 7 Commissioning

### 7.1 Function check

#### **⚠ WARNING**

#### **Incorrect connection, incorrect supply voltage**

Safety risks for staff and device malfunctions

- ▶ Check that all connections have been established correctly in accordance with the wiring diagram.
- ▶ Ensure that the supply voltage matches the voltage indicated on the nameplate.

### 7.2 Switching on

Familiarize yourself with the operation of the transmitter before it is first switched on. In particular please read the "Basic safety instructions" and "Operation options" sections. After power-up, the device performs a self-test and then goes to the measuring mode.

Now calibrate the sensor in accordance with the instructions in the "Calibration" section.

**i** During initial commissioning, the sensor must be calibrated so that the measuring system can return precise measurement data.

Then perform the first configuration in accordance with the instructions in the "Quick setup" section. The values set by the user are kept even in the event of a power failure.

The following function groups are available in the transmitter (the groups that are only available in the Plus Package are marked accordingly in the functional description):

#### **Setup mode**

- SETUP 1 (A)
- SETUP 2 (B)
- CURRENT INPUT (Z)
- CURRENT OUTPUT (O)
- ALARM (F)
- CHECK (P)
- RELAY (R)
- TEMPERATURE COMPENSATION (T)
- CONCENTRATION MEASUREMENT (K)
- SERVICE (S)
- E+H SERVICE (E)
- INTERFACE (I)

#### **Calibration mode**

CALIBRATION (C)

**i** A detailed explanation of the function groups available in the transmitter can be found in the "Device configuration" section.

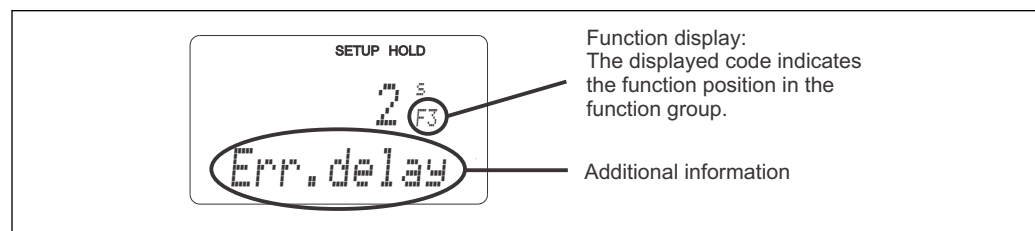

A0025560-EN

**i** 20 Information for the user on the display



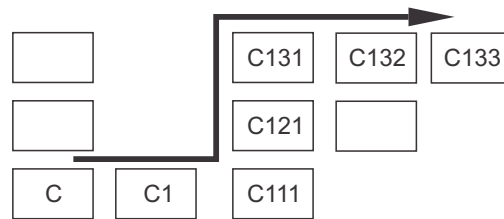

To make it easier for you to select and find function groups and functions, a code for the corresponding field is displayed for each function → 20. The structure of this code is illustrated in → 21. The function groups are indicated as letters in the first column (see the names of the function groups). The functions of the individual groups are displayed incrementally by row and by column.

A0027502

21 Function code

### Factory settings

The first time the device is switched on, the factory setting is set for all the functions. The table below provides an overview of the most important settings.

All other factory settings can be found in the description of the individual function groups in the "System configuration" section (the factory setting is highlighted in **bold**).

Function	Factory setting
Type of measurement	Conductive measurement of conductivity, Temperature measurement in °C
Type of temperature compensation	Linear with reference temperature 25 °C (77 °F)
Temperature compensation	Automatic (ATC on)
Limit value for controller 1	9999 mS/cm
Limit value for controller 2	9999 mS/cm
Hold	Active during configuration and calibration
Measuring range	0 µS/cm to 2000 mS/cm (no measuring ranges to be configured). The setting is flowing and depends on the sensors connected.
Current outputs 1 and 2*	4 to 20 mA
Current output 1: measured value for 4 mA signal current	0 µS/cm
Current output 1: measured value for 20 mA signal current	2000 mS/cm
Current output 2: temperature value for 4 mA signal current*	-35.0 °C (-31 °F)
Current output 2: temperature value for 20 mA signal current*	250.0 °C (482 °F)

\* with appropriate version

## 7.3 Quick Setup

After power-up, you must make some settings to configure the most important functions of the transmitter which are required for correct measurement. The following section gives an example of this.

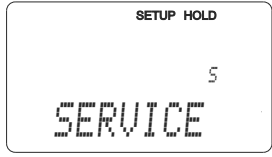
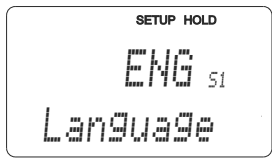
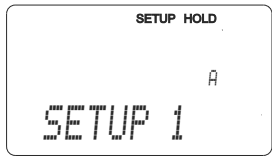
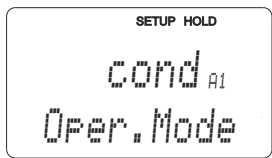
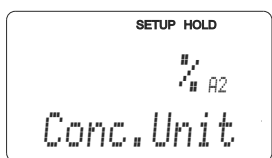
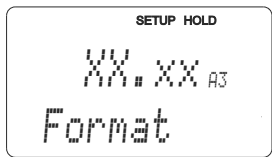
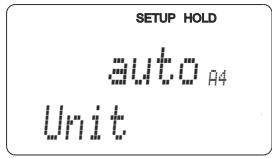
User entry		Range of adjustment (factory settings in bold)	Display
1.	Press the ENTER key		
2.	Enter the code 22 to open access to the menus. Press the ENTER key.		
3.	Press the MINUS key until you get to the "Service" function group.		 <p>SETUP HOLD 5 SERVICE</p> <p>A0008408-EN</p>
4.	Press ENTER to be able to make your settings.		
5.	Select your language in S1, e.g. "ENG" for English. Press ENTER to confirm your entry.	<b>ENG = English</b> GER = German FRA = French ITA = Italian NEL = Dutch ESP = Spanish	 <p>SETUP HOLD ENG S1 Language</p> <p>A0008409-EN</p>
6.	Press the PLUS and MINUS key simultaneously to exit the "Service" function group.		
7.	Press the MINUS key until you get to the "Setup 1" function group.		 <p>SETUP HOLD A SETUP 1</p> <p>A0007824-EN</p>
8.	Press ENTER to be able to make your settings for "Setup 1".		
9.	In A1, select the desired mode of operation, e.g. "cond" = conductive. Press ENTER to confirm your entry.	<b>cond = conductive</b> ind = inductive MOhm = resistance Conc = concentration	 <p>SETUP HOLD cond A1 Oper. Mode</p> <p>A0009002-EN</p>
10.	In A2, press ENTER to accept the factory setting. (Only if A1 = conc, otherwise continue with Step 12)	% <b>ppm</b> mg/l TDS = total dissolved solids None	 <p>SETUP HOLD % A2 Conc. Unit</p> <p>A0009003-EN</p>
11.	In A3, press ENTER to accept the standard setting.	<b>XX.xx</b> X.xxx XXX.x XXXX	 <p>SETUP HOLD XX.XX A3 Format</p> <p>A0009004-EN</p>
12.	In A4, press ENTER to accept the standard setting.	<b>auto</b> , µS/cm, mS/cm, S/cm, µS/m, mS/m, S/ m	 <p>SETUP HOLD auto A4 Unit</p> <p>A0009005-EN</p>

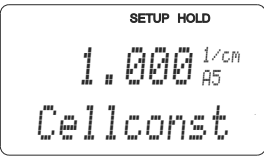
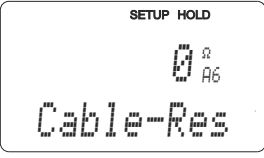
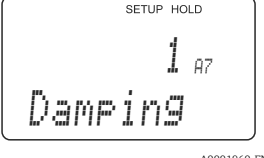
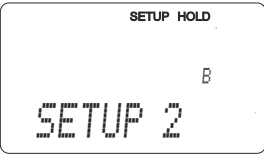
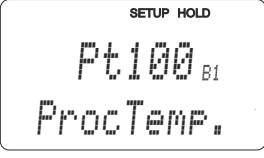
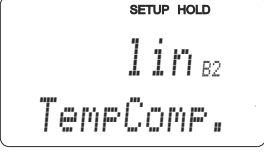
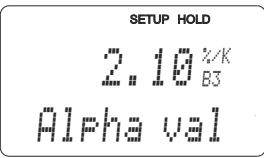
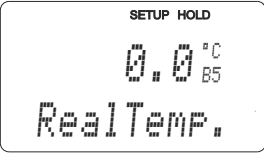
User entry		Range of adjustment (factory settings in bold)	Display
13.	In A5, enter the exact cell constant of the sensor. The cell constant is provided on the sensor quality certificate.	cond: <b>1.000</b> cm <sup>-1</sup> ind: <b>1.98</b> cm <sup>-1</sup> MOhm: <b>0.01</b> cm <sup>-1</sup> 0.0025 to 99.99 cm <sup>-1</sup>	 <p>1.000 <sup>1/CM</sup><sub>A5</sub> Cellconst</p> <p>A0009006-EN</p>
14.	In A6, enter the cable resistance (only applies to conductive sensors).	<b>0</b> Ω 0 to 99.99 Ω	 <p>0 Ω<sub>A6</sub> Cable-Res</p> <p>A0009007-EN</p>
15.	In A7, enter the measured value damping. Measured value damping causes the measured value to be averaged over the specified number of individual measured values (if A7 = 1, no damping takes place). Press ENTER to confirm your entry. The display returns to the initial display of the "Setup 1" function group.	<b>1</b> 1 to 60	 <p>1<sub>A7</sub> Damping</p> <p>A0001960-EN</p>
16.	Press the MINUS key until you get to the "Setup 2" function group. Press ENTER to make your settings for "Setup 2".		 <p>B SETUP 2</p> <p>A0007830-EN</p>
17.	In B1, select the temperature sensor. Press ENTER to confirm your entry.	<b>Pt100</b> Pt1k = Pt 1000 NTC30 Fixed	 <p>Pt100<sub>B1</sub> ProcTemp.</p> <p>A0009010-EN</p>
18.	In B2, select the appropriate type of temperature compensation for your process, e.g. "lin" = linear. Press ENTER to confirm your entry. Detailed information is provided in the "Setup 2" section.	None <b>Lin = linear</b> NaCl = table salt (IEC 746) Pure = ultrapure water NaCl PureH = ultrapure water HCl Tab = table	 <p>lin<sub>B2</sub> TempComp.</p> <p>A0009011-EN</p>
19.	In B3, enter the temperature coefficient α. Press ENTER to confirm your entry.	<b>2.1</b> %/K 0.0 to 20.0 %/K	 <p>2.10 <sup>%/K</sup><sub>B3</sub> Alpha val</p> <p>A0009012-EN</p>
20.	The current temperature is displayed in B5. If necessary, adjust the temperature sensor to an external measurement. Press ENTER to confirm your entry.	Actual value displayed and entered -35.0 to 250.0 °C	 <p>0.0 °C<sub>B5</sub> RealTemp.</p> <p>A0009014-EN</p>

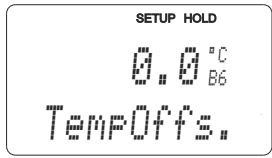
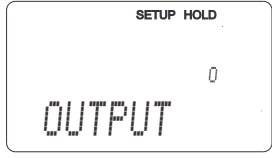
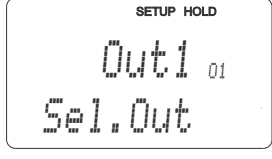
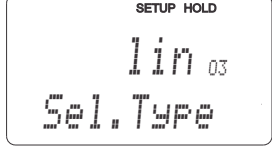
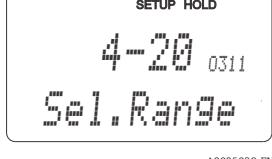
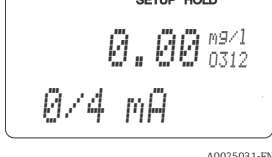
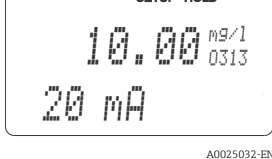
User entry		Range of adjustment (factory settings in bold)	Display
21.	The difference between the measured and entered temperature is displayed. Press the ENTER key. The display returns to the initial display of the "Setup 2" function group.	<b>0.0 °C</b> -5.0 to 5.0 °C	 A0009015-EN
22.	Press the MINUS key to get to the "Current output" function group. Press ENTER to make your settings for the current outputs.		 A0025026-EN
23.	In O1, select your current output, e.g. "Out 1" = output 1. Press ENTER to confirm your entry.	<b>Out 1</b> Out 2	 A0025027-EN
24.	In O3, select the linear characteristic. Press ENTER to confirm your entry.	<b>Lin = linear (1)</b> Lin = linear (1) Tab = table	 A0025029-EN
25.	In O311, select the current range for your current output, e.g. 4 to 20 mA. Press ENTER to confirm your entry.	<b>4 to 20mA</b> 0 to 20 mA	 A0025030-EN
26.	In O312, specify the conductivity at which the minimum current value is applied at the transmitter output, e.g. 0 µS/cm. Press ENTER to confirm your entry.	Cond/ind: <b>0.00 µS/cm</b> MOhm: <b>0.00 kΩ·cm</b> Conc: <b>0.00 %</b> Temp: <b>0.00 °C</b>	 A0025031-EN
27.	In O313, specify the conductivity at which the maximum current value is applied at the transmitter output, e.g. 2000 mS/cm. Press ENTER to confirm your entry. The display returns to the initial display of the "Current output" function group.	Cond/ind: <b>2000 mS/cm</b> MOhm: <b>500 kΩ·cm</b> Conc: <b>99.99 %</b> Temp: <b>150 °C</b>	 A0025032-EN
28.	Press PLUS and MINUS simultaneously to switch to the measurement mode.		





You must perform an air set before installing the inductive sensor. See the "Calibration" section for more information.

## 7.4 Device configuration

### 7.4.1 Setup 1 (conductivity)

In the SETUP 1 function group, you can change the settings for the measuring mode and the sensor.

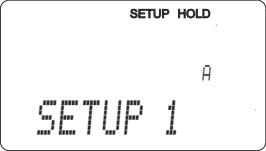
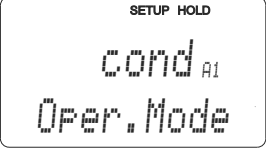
Functions marked in *italics* are not supported by the basic device version.

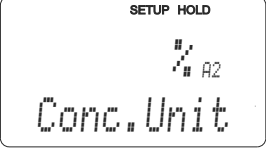
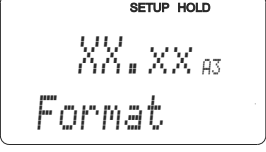
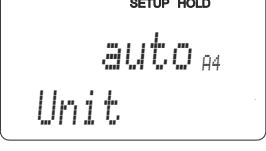
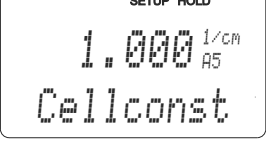
Coding	Field	Range of adjustment (factory settings in bold)	Display	Info
A	<b>SETUP 1</b> function group		 A0007824-EN	Configuration of basic functions
A1	Select the operating mode auswählen	<b>cond = conductive</b> ind = inductive M $\Omega$ m = resistance <i>conc = concentration</i>	 A0009002-EN	Display varies depending on the device: <ul style="list-style-type: none"> <li>Cond/resistance/conc</li> <li>Ind/conc</li> </ul>  When the operating mode is changed, all user settings are automatically reset.
A2	Select the concentration unit to be displayed (only for Plus Package)	% ppm mg/l TDS = total dissolved solids None	 A0009003-EN	A2 is only active if A1 = conc
A3	Select the display format for the concentration unit (only for Plus Package)	<b>XX.xx</b> X.xxx XXX.x XXXX	 A0009004-EN	A3 is only active if A1 = conc
A4	Select the unit to be displayed	<b>auto</b> , $\mu$ S/cm, mS/cm, S/cm, $\mu$ S/ m, mS/m, S/m, k $\Omega$ ·cm, M $\Omega$ ·cm, k $\Omega$ ·m	 A0009005-EN	If "auto" is selected, the highest possible resolution is automatically selected. A4 is not active if A1 = conc
A5	Enter the cell constant for the connected sensor	cond: <b>1.000</b> cm <sup>-1</sup> ind: <b>1.98</b> cm <sup>-1</sup> M $\Omega$ m: <b>0.01</b> cm <sup>-1</sup> 0.0025 to 99.99 cm <sup>-1</sup>	 A0009006-EN	The exact cell constant is provided on the sensor quality certificate.

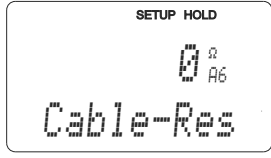
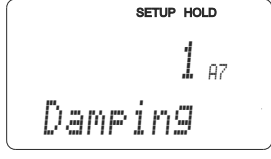
Coding	Field	Range of adjustment (factory settings in bold)	Display	Info
A6	Enter the cable resistance	<b>0</b> $\Omega$ 0 to 99.99 $\Omega$	 <p>SETUP HOLD 0 <math>\Omega</math> A6 Cable-Res A0009007-EN</p>	Only for conductive sensors. The standardized line resistance must be multiplied by the actual cable length. CYK71: 0.165 $\Omega$ /m
A7	Enter the value for measured value damping	<b>1</b> 1 to 60	 <p>SETUP HOLD 1 A7 Damping A0009008-EN</p>	Measured value damping causes averaging over the specified number of individual measured values. This is used, for example, to stabilize the display if the measurement is unstable. There is no damping if "1" is entered.

### 7.4.2 Setup 2 (temperature)

Temperature coefficient  $\alpha$  indicates the change in the conductivity per degree of temperature change:

$$\kappa(T) = \kappa(T_0) \cdot (1 + \alpha \cdot (T - T_0))$$

A0009163

Where

$\kappa(T)$  = conductivity at process temperature T

$\kappa(T_0)$  = conductivity at reference temperature  $T_0$

The temperature coefficient depends both on the chemical composition of the solution and the temperature itself.

To determine the level of dependency, four different types of compensation can be selected in the transmitter:

- Linear temperature compensation
- NaCl compensation
- NaCl ultrapure water compensation (neutral compensation)
- HCl ultrapure water compensation (acid compensation)
- Temperature compensation with table

#### Linear temperature compensation

The change between two temperature points is taken to be constant, i.e.  $\alpha = \text{const}$ . The  $\alpha$  value can be edited for linear compensation. The reference temperature can be edited in the B7 field. The default setting is 25 °C.

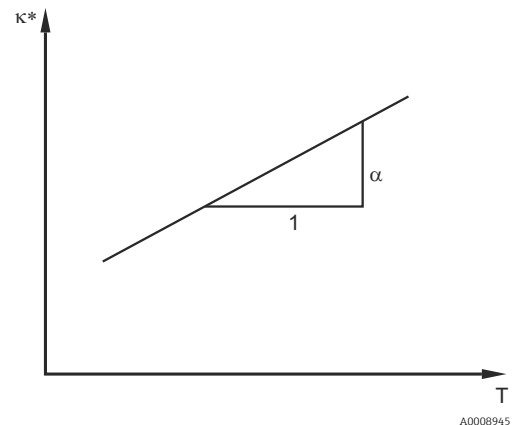

A0008945

22 Linear temperature compensation

\* Uncompensated conductivity

**NaCl compensation** In the case of NaCl compensation (as per IEC 60746), a fixed non-linear curve specifying the relationship between the temperature coefficient and temperature is saved in the device. This curve applies to low concentrations of up to approx. 5 % NaCl.

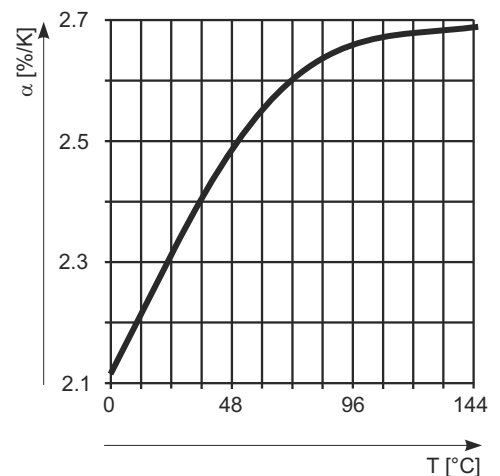

A0008939

23 NaCl compensation

### Ultrapure water compensation (for conductive sensors)

For pure and ultrapure water, algorithms are saved in the transmitter that consider the self-dissociation of ultra pure water and its strong temperature dependency. They are used for conductivity levels of approx. 100  $\mu\text{S}/\text{cm}$ .

Two types of compensation are available:

- NaCl ultrapure water compensation: this is optimized for pH-neutral contamination.
  - HCl ultrapure water compensation: this is optimized for measuring the acid conductivity downstream of a cation exchanger. It is also suitable for ammonia ( $\text{NH}_3$ ) and caustic soda ( $\text{NaOH}$ ).
- i** ▪ The ultrapure water compensation types always refer to a reference temperature of 25 °C (77 °F).
- The lowest conductivity displayed is the theoretical limit value of ultrapure water at 25 °C (77 °F) of 0.055  $\mu\text{S}/\text{cm}$ .

### Temperature compensation with table

For devices with the Plus Package, it is possible to enter a table with temperature coefficients  $\alpha$  as a function of the temperature. The following conductivity data of the medium under measurement are required to use the alpha table function for temperature compensation:

Value pairs comprising the temperature  $T$  and conductivity  $\kappa$  with:

- $\kappa(T_0)$  for the reference temperature  $T_0$
- $\kappa(T)$  for the temperatures that occur in the process

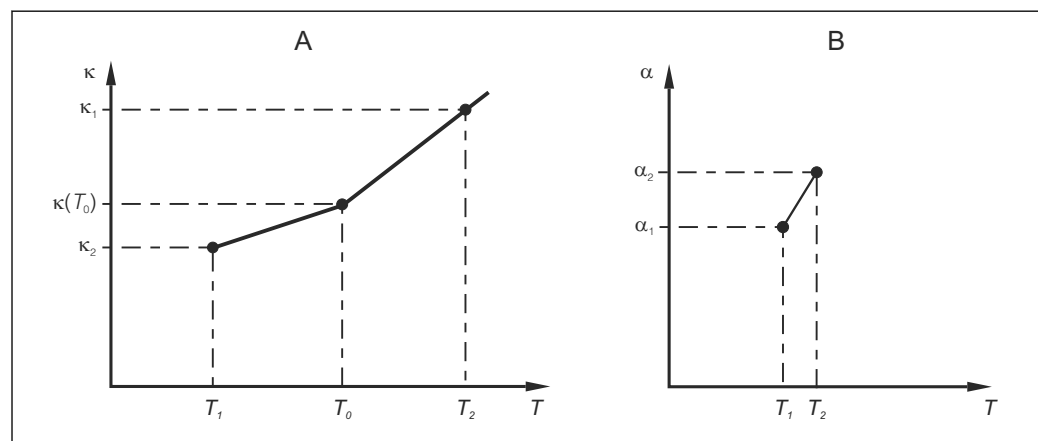

**24** Determination of the temperature coefficient

A Required data

B Calculated  $\alpha$  values

Use the following formula to calculate the  $\alpha$  values for the temperatures that are relevant in your process:



$$\alpha = \frac{100\%}{\kappa(T_0)} \cdot \frac{\kappa(T) - \kappa(T_0)}{T - T_0}; T \neq T_0$$

Enter the  $\alpha$ - $T$  value pairs obtained in this way in the T4 and T5 fields of the ALPHA TABLE function group.

Use this function group to change the settings for temperature measurement.

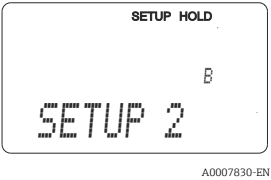
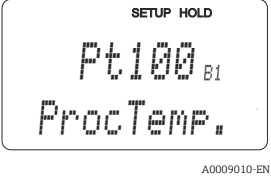

Functions marked in italics are not supported by the basic device version.

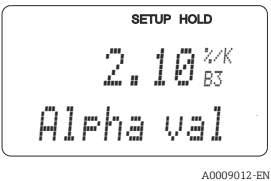
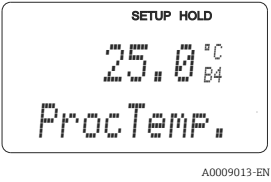
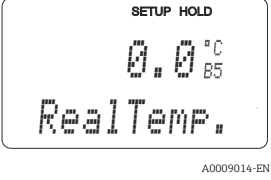
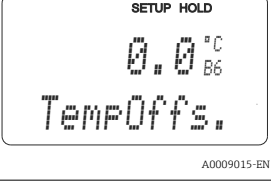
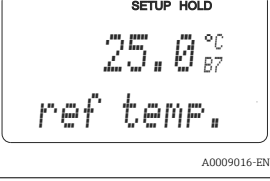
Coding	Field	Range of adjustment (factory settings in bold)	Display	Info
B	<b>SETUP 2 function group</b>		 A0007830-EN	Settings for temperature measurement
B1	Select the temperature sensor	<b>Pt100</b> Pt1k = Pt 1000 NTC30 Fixed	 A0009010-EN	"fixed": Manual temperature compensation (MTC), no temperature measurement. Instead a fixed temperature value is defined in B4.
B2	Select the type of temperature compensation	None <b>Lin = linear</b> NaCl = table salt (IEC 746) Pure = ultrapure water NaCl PureH = ultrapure water HCl <i>Tab = Table</i>	 A0009011-EN	This option does not appear for concentration measurement. "Pure" and "PureH" are only displayed for conductive devices.
B3	Enter temperature coefficient $\alpha$	<b>2.10 %/K</b> 0.00 to 20.00 %/K	 A0009012-EN	Only if B2 = lin. With other settings in B2, field B3 does not have any effect.
B4	Enter the process temperature	<b>25.0 °C</b> -35.0 to 250.0 °C	 A0009013-EN	Only if B1 = fixed. The value entered can only be in °C.
B5	Display the temperature and adjust the temperature sensor	Actual value displayed and entered -35.0 to 250.0 °C	 A0009014-EN	With the value entered here, the temperature sensor can be adjusted to an external measurement. Affects B6. Omitted if B1 = fixed.
B6	Enter the temperature differential (offset)	<b>Current offset</b> -5.0 to 5.0 °C	 A0009015-EN	The offset is the difference between the actual value entered and the measured temperature. Omitted if B1 = fixed.
B7	Enter reference temperature	<b>25.0 °C</b> -5.0 to 100 °C	 A0009016-EN	

### 7.4.3 Current input

For the "Current input" function group, you require a relay card with a current input which is not available in the basic device version. With this function group, you can monitor process parameters and use them for feedforward control. For this purpose, you must connect the current output of an external measured variable (e.g. flowmeter) to the 4 to 20mA input of the transmitter. The following assignment applies:

Flow in main stream	Current signal in mA	Current input signal in %
Flowmeter start of measuring range	4	0
Flowmeter end of measuring range	20	100

#### Flow monitoring in the main stream

This arrangement is particularly practical if the sample flow through a flow assembly in an open outlet is independent of the flow in the main stream.

This permits signaling of an alarm condition in the main stream (flow too low or has completely stopped) and triggers dosing switch-off even if the medium flow is maintained due to the method of installation.

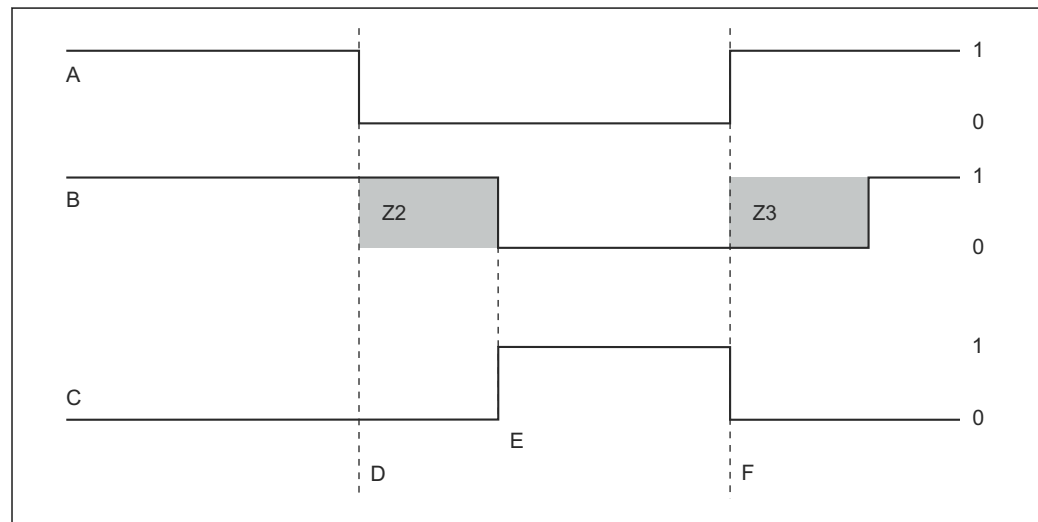

25 Alarm signaling and dosing switch-off by the main stream

- |   |   |    |   |
|---|---|----|---|
| A | Flow in main stream                             | F  | Flow restoration                              |
| B | Relay contacts of PID controller                | Z2 | Delay for controller switch-off, see field Z2 |
| C | Alarm relay                                     | Z3 | Delay for controller switch-on, see field Z3  |
| D | Flow below switch-off limit Z 4 or flow failure | 0  | Off   |
| E | Flow alarm                                      | 1  | On  |

#### Feedforward control to PID controller

You can optimize control on control systems with very short response times by measuring the medium flow rate in addition to the oxygen content. Then apply this flow rate value (4 to 20 mA) as feedforward control to the PID controller.

Feedforward control is a multiplying function as illustrated in the figure below (example with factory setting):

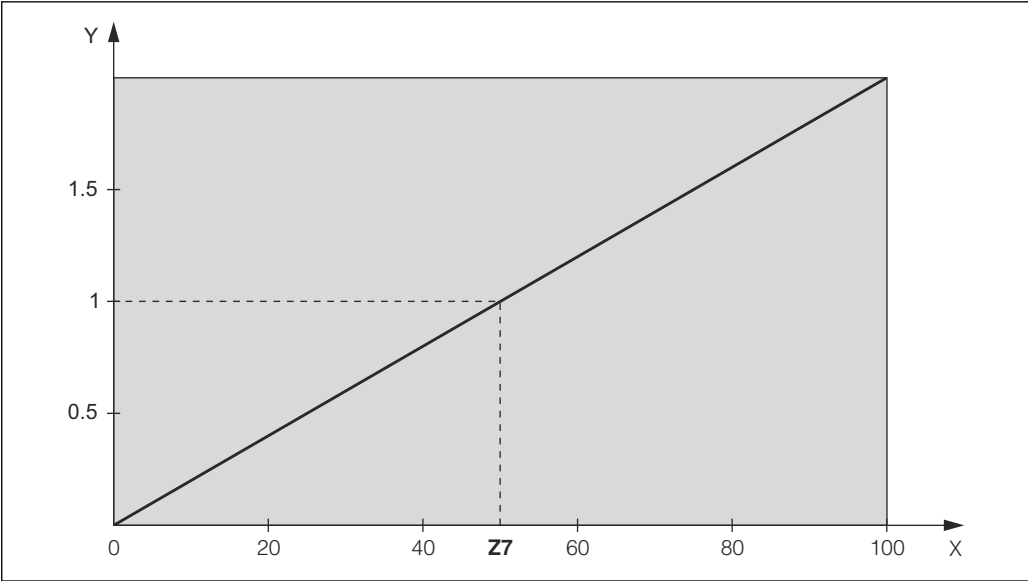



A0008942

26 Multiplying feedforward control

Y Gain  $K_{infl}$   
X Current input signal in [%]

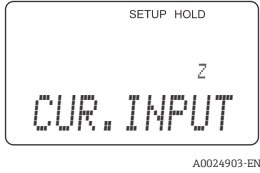
Functions marked in italics are not supported by the basic device version.

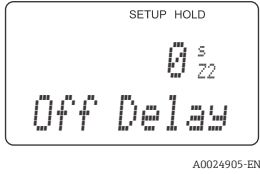
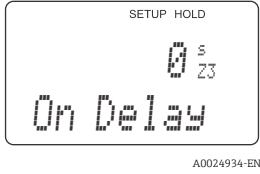
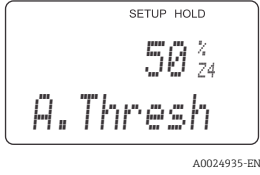
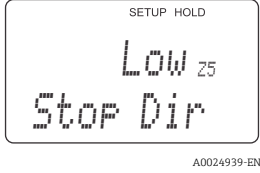
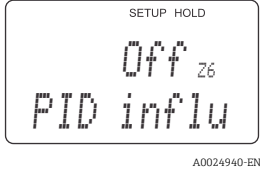
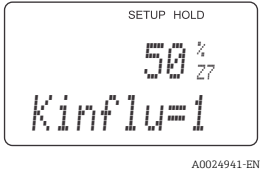
Coding	Field	Range of adjustment (factory settings in bold)	Display	Info
Z	<b>CURRENT INPUT function group</b>			Current input settings
Z1	Select flow monitoring of main stream (with controller switch-off)	<b>Off</b> On		Flow monitoring may only be switched on if the flowmeter is connected in the main stream. If Z1 = off, fields Z2 to Z5 are not available.
Z2	Enter the delay for controller switch-off through current input	<b>0 s</b> 0 to 2000 s		Brief flow shortfalls can be suppressed by this delay and do not result in controller switch-off.
Z3	Enter the delay for controller switch-on through current input	<b>0 s</b> 0 to 2000 s		In the case of a controller, a delay until the reception of a representative measured value is recommended after a long period without flow.
Z4	Enter the switch-off limit value for the current input	<b>50 %</b> 0 to 100 %		0 to 100% corresponds to 4 to 20 mA at the current input. Observe measured value assignment to the current output of the flowmeter.
Z5	Enter the switch-off direction for the current input	<b>Low</b> High		The controller is switched off if the value entered in Z4 is undershot or overshoot.
Z6	Select feedforward control to PID controller	<b>Off</b> Lin = linear Basic		If Z6 = off, the field Z7 is not available. Z6 = basic: disturbance variable only affects the basic load (alternatively dosing in proportion to quantity, if usual PID controller not possible, e.g. defective sensor).
Z7	Enter value for feedforward control at which gain = 1 applies	<b>50 %</b> 0 to 100 %		When the value is set, the controller actuating variable is the same size when feedforward control is switched on as when feedforward control is switched off.

### 7.4.4 Current outputs

Use the "Current output" function group to configure the individual outputs. You can enter either a linear characteristic (O3 (1)) or a user-defined current output characteristic in conjunction with the Plus Package (O3 (3)). Exception: if you have chosen a "continuous controller" for current output 2, you cannot enter a user-defined current output characteristic for this current output.

In addition, you can also simulate a current output value (O3 (2)) to check the current outputs.

If a second current output is present, you can output the controller actuating variable via the current output in accordance with field R237/O2.

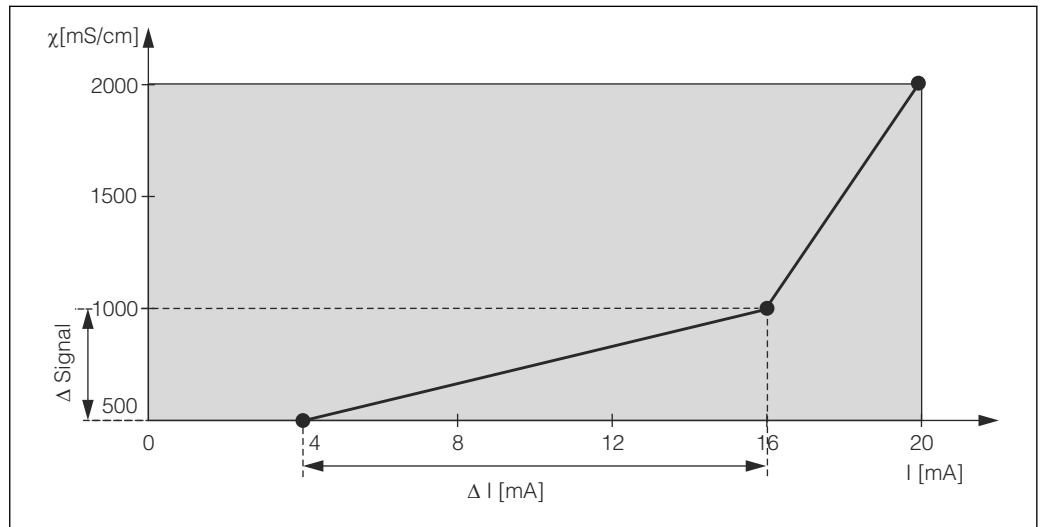

27 User-defined current output characteristic (example)

The current output characteristic must increase or decrease very monotonically.

The distance per mA between two table value pairs must be greater than:

- Conductivity: 0.5 % of measuring range
- Temperature: 0.25 °C

The values for the sample characteristic → 27 are entered in the following table. The distance per mA is calculated from  $\Delta \text{ signal} / \Delta \text{ mA}$ .

Value pair	Current output 1			Current output 2		
	[mS/cm] [%] [°C]	Current [mA]	Distance per mA	[mS/cm] [%] [°C]	Current [mA]	Distance per mA
1	500	4				
2	1000	16	41.66			
3	2000	20	250			

First enter the desired current output configuration into the following blank table with a pencil. Calculate the resulting signal distance per mA to observe the necessary minimum slope. Then enter the values in the device.

Value pair	Current output 1			Current output 2		
	[mS/cm] [%] [°C]	Current [mA]	Distance per mA	[mS/cm] [%] [°C]	Current [mA]	Distance per mA
1						
2						
3						
4						
5						
6						
7						
8						
9						
10						

Functions marked in *italics* are not supported by the basic device version.

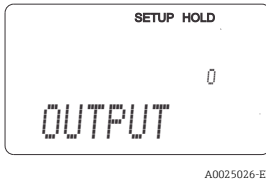
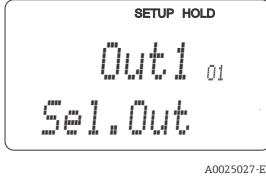
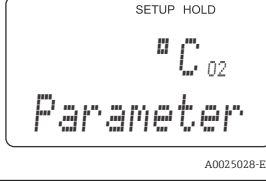
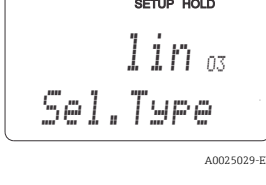
Coding	Field	Range of adjustment (factory settings in bold)	Display	Info
0	<b>CURRENT OUTPUT function group</b>			Configuration of the current output (does not apply for PROFIBUS).
01	Select current output	<b>Out 1</b> <i>Out 2</i>		A characteristic can be selected for every output.
02	Select measured variable for 2nd current output	<b>°C</b> <i>mS/cm, MΩ, % Contr</i>		R237=curr (current output 2) can only be selected if O2=Contr (controller) is selected (relay card required).
03 (1)	Enter the characteristic type	<b>Lin = linear (1)</b> <i>Sim = simulation (2) Tab = table (3)</i>		The characteristic can have a positive or negative slope for the measured value output. In the case of actuating variable output (O2 = Contr), an increasing current corresponds to an increasing actuating variable.

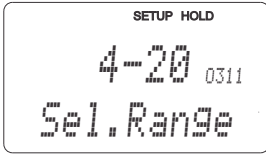
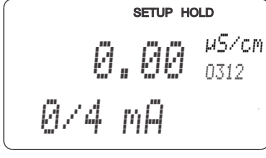
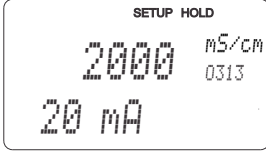
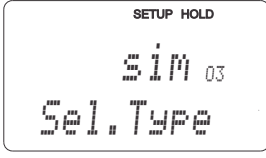
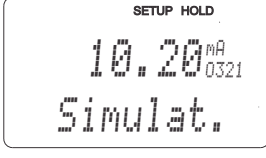
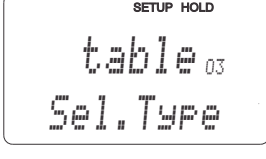
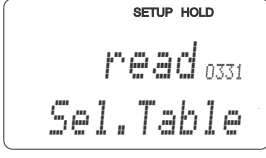
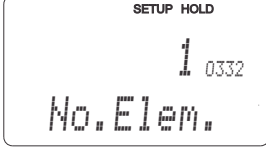
Coding	Field	Range of adjustment (factory settings in bold)	Display	Info
0311	Select current range	<b>4 to 20mA</b> 0 to 20 mA	 <p style="text-align: right; font-size: small;">A0025030-EN</p>	
0312	0/4 mA value: Enter the associated measured value	Cond/ind: <b>0.00</b> $\mu\text{S/cm}$ MOhm: <b>0.00k<math>\Omega</math>*cm</b> Conc: <b>0.00 %</b> Temp: <b>0.00 °C</b>	 <p style="text-align: right; font-size: small;">A0025034-EN</p>	Here you can enter the measured value at which the min. current value (0/4 mA) is applied at the transmitter output (not for controller). (Turndown see Technical data.)
0313	20 mA value: Enter the associated measured value	Cond/ind: <b>2000</b> $\mu\text{S/cm}$ MOhm: <b>500</b> <b>k<math>\Omega</math>*cm</b> Conc: <b>99.99 %</b> Temp: <b>150 °C</b>	 <p style="text-align: right; font-size: small;">A0025035-EN</p>	Here you can enter the measured value at which the max. current value (20 mA) is applied at the transmitter output (not for controller). (Turndown see Technical data.)
03 (2)	Simulate current output	Lin = linear (1) <b>Sim = simulation (2)</b> Tab = table (3)	 <p style="text-align: right; font-size: small;">A0025039-EN</p>	Simulation is not ended until O3(1) or O3(3) is selected. For further characteristics, see O3 (1), O3 (3).
0321	Enter simulation value	<b>Current value</b> 0.00 to 22.00 mA	 <p style="text-align: right; font-size: small;">A0025040-EN</p>	Entering a current value results in this value being directly output at the current output.
03 (3)	Enter current output table	Lin = linear (1) Sim = simulation (2) <b>Tab = table (3)</b>	 <p style="text-align: right; font-size: small;">A0025041-EN</p>	Only for Plus Package Values can also be subsequently added or modified. The values entered are automatically sorted by increasing current value. For further characteristics, see O3 (1), O3 (2).
0331	Select table option	<b>Read</b> Edit	 <p style="text-align: right; font-size: small;">A0025042-EN</p>	
0332	Enter number of table value pairs	<b>1</b> 1 to 10	 <p style="text-align: right; font-size: small;">A0025043-EN</p>	Enter the number of pairs of x and y values (measured value and current value) here.

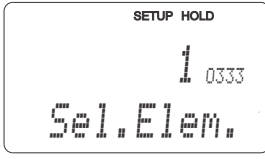
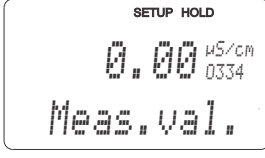
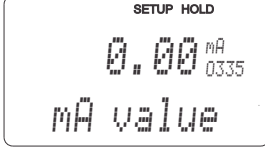
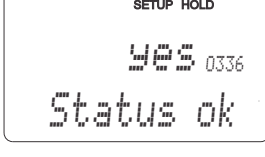
Coding	Field	Range of adjustment (factory settings in bold)	Display	Info
0333	Select table value pair	<b>1</b> 1 to no. elem. Assign	 <p>A0025044-EN</p>	The system runs through the 0333 to 0335 function chain as often as indicated in 0332. "Assign" appears as the last step. The display goes to 0336 after confirmation.
0334	Enter x value	Cond/ind: <b>0.00</b> $\mu\text{S}/\text{cm}$ MOhm: <b>0.00k<math>\Omega</math>*cm</b> Conc: <b>0.00</b> % Temp: <b>0.00</b> °C	 <p>A0025045-EN</p>	x value = measured value specified by user.
0335	Enter y value	<b>0.00 mA</b> 0.00 to 20.00 mA	 <p>A0025048-EN</p>	y value = user-defined current value pertaining to 0334. Return to 0333 until all values are entered.
0336	Message as to whether table status is OK	<b>Yes</b> No	 <p>A0025049-EN</p>	Back to 03. If status = no, correct the table (all settings made up until now remain intact) or go back to the measuring mode (table is deleted).







### 7.4.5 Alarm

You can use the "Alarm" function group to define various alarms and configure output contacts.

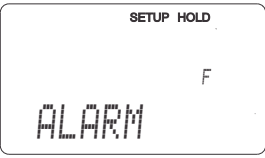
Each individual error can be defined to be effective or not (at the contact or as an error current).

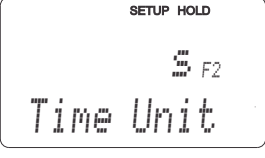
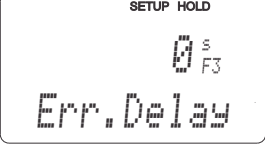
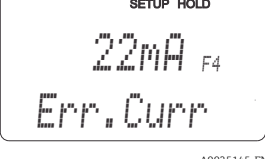
Functions marked in *italics* are not supported by the basic device version.

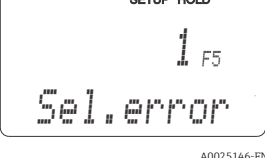
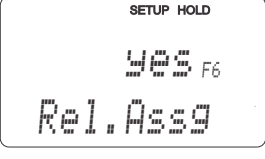
Coding	Field	Range of adjustment (factory settings in bold)	Display	Info
F	<b>ALARM</b> function group		 <small>A0025141-EN</small>	Alarm function settings.
F1	Select contact type	<b>Latch = latching contact</b> Momen = momentary contact	 <small>A0025142-EN</small>	The option selected only applies for the fault-signaling contact, not for the error current.
F2	Select the time unit for the alarm delay	<b>s</b> min	 <small>A0025143-EN</small>	
F3	Enter alarm delay	<b>0 s (min)</b> 0 to 2000 s (min)	 <small>A0025144-EN</small>	Depending on the option selected in F2, the alarm delay can be entered in s or min.
F4	Select error current	<b>22 mA</b> 2.4 mA	 <small>A0025145-EN</small>	 If "0-20 mA" was selected in O311, "2.4 mA" may not be used.
F5	Select the error number	<b>1</b> 1 to 255	 <small>A0025146-EN</small>	Here you can select all the errors which should trigger an alarm. The errors are selected by the error numbers. Please refer to the table in the "System error messages" section for the meaning of the individual error numbers. The factory settings remain in effect for all errors that are not edited.
F6	Set alarm contact to be effective for the selected error	<b>Yes</b> No	 <small>A0025147-EN</small>	If "no" is selected, all the other alarm settings are deactivated (e.g. alarm delay). The settings themselves are maintained. This setting <b>only</b> applies to the error currently selected in F5.

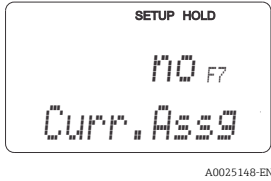
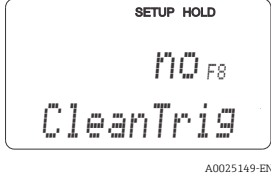
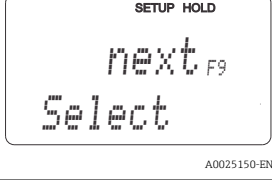
Coding	Field	Range of adjustment (factory settings in bold)	Display	Info
F7	Set error current to be effective for the selected error	<b>No</b> Yes		The option selected in F4 is effective or not effective in the event of an error. This setting <b>only</b> applies to the error currently selected in F5.
F8	<i>Automatic cleaning function start</i>	<b>No</b> Yes		This field is not available for certain errors, see the "Troubleshooting and fault elimination" section.
F9	Select return to menu or next error	<b>Next</b> = next error number ←R		If ←R is selected, you return to F. If Next is selected, you go to F5.

#### 7.4.6 Check

The CHECK function group is only available for devices with a Plus Package.

In the CHECK function group, you can select different monitoring functions for the measurement.

##### Polarization detection (field P1)

In the case of conductive sensors, the effects of polarization in the boundary layer between the sensor and medium restrict the measuring range. The transmitter can detect polarization effects by using a smart signal analysis process. Error message E071 is displayed.

##### Alarm threshold monitoring (fields P2 to P5)

You can use this function to monitor the measured value for permissible upper and lower limits and trigger an alarm (error messages E154, E155).

##### PCS alarm (process check system), (fields P6 to P9)

**AC (alternation check; sensor activity monitoring):** The function AC (field P6) is used to check measuring signals for deviations. An alarm (E152) is triggered if the measuring signal remains constant within the space of one hour. The reason for such sensor behavior can be contamination, cable open circuit or similar.

**CC (controller check):** You can monitor the controller activity with the CC function. This function is primarily suited to batch operation and single-sided limit switches. A malfunction of the controller is detected and reported thanks to freely adjustable monitoring times (E156, E157).

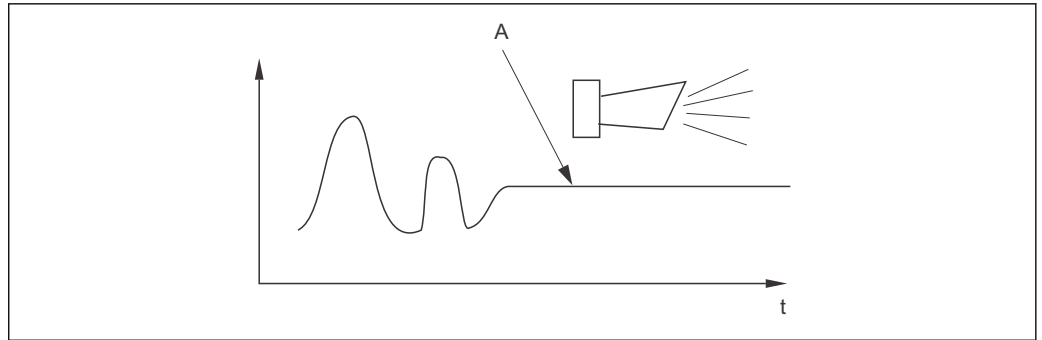

A0025196

28 PCS alarm (live check)

A Constant measuring signal = alarm triggered after PCS alarm time has elapsed

**i** Any PCS alarm pending is automatically deleted as soon as the sensor signal changes.

You can use the "Check" function group to monitor the measured value for permissible upper and lower limits and trigger an alarm.

Functions marked in italics are not supported by the basic device version.

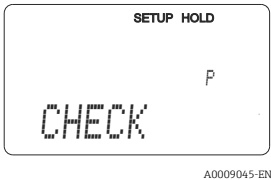
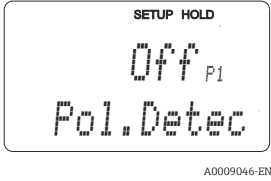
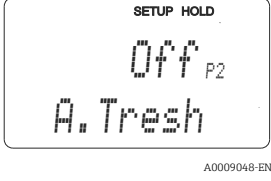
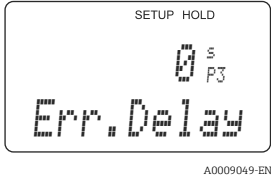
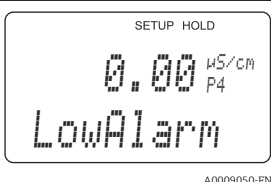
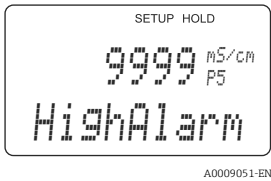
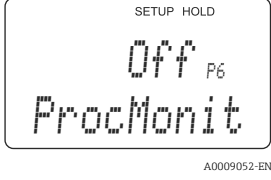
Coding	Field	Range of adjustment (factory settings in bold)	Display	Info
P	<b>CHECK function group</b>			Settings for sensor and process monitoring
P1	<i>Switch polarization detection on or off (only for conductive sensors)</i>	<b>Off</b> On		Polarization only occurs with conductive sensors. Any polarization that may occur is detected but is not compensated for. (Error no.: E071)
P2	<i>Select alarm threshold monitoring</i>	<b>Off</b> Low High LoHi = low and high Lo! Hi! LoHi!		Alarm possible with or without controller switch-off. xxxx = without controller switch-off xxxx! = with controller switch-off (Error no.: E154, E155)
P3	<i>Enter alarm delay</i>	<b>0 min (s)</b> 0 to 2000 min (s)		Depending on the option selected in F2, the alarm delay can be entered in s or min. This delay must first elapse before undershooting/overshooting in accordance with fields P4/P5 results in an alarm.
P4	<i>Enter lower alarm threshold</i>	<b>0 µS/cm</b> 0 to 9999 mS/cm		
P5	<i>Enter upper alarm threshold</i>	<b>9999 µS/cm</b> 0 to 9999 mS/cm		
P6	<i>Select process monitoring</i>	<b>Off</b> AC CC AC+CC AC! CC! AC+CC!		AC = sensor activity monitoring (E152) CC = controller monitoring (E156, E157) Alarm possible with or without simultaneous controller switch-off. xxxx = without controller switch-off xxxx! = with controller switch-off

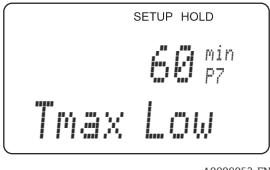
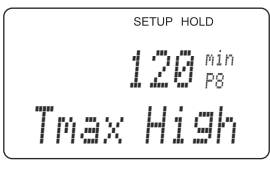
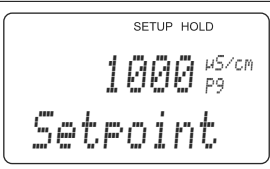
Coding	Field	Range of adjustment (factory settings in bold)	Display	Info
P7	Enter maximum permissible duration for lower CC setpoint limit violation (field P9)	<b>60 min</b> 0 to 2000 min		Only if P6=CC or AC CC.
P8	Enter maximum permissible duration for upper CC setpoint limit violation (field P9)	<b>120 min</b> 0 to 2000 min		Only if P6=CC or AC CC.
P9	Enter CC set point (for P7/P8)	<b>1000 µS/cm</b> 0 to 9999 mS/cm		Set value is an absolute value. This function is primarily suited to batch operation and single-sided limit switches.

### 7.4.7 Relay configuration

For the "RELAY" function group, you require a relay card which is not available in the basic device version.

The following relay contacts can be selected and configured as desired (max. four contacts, depending on options installed):

- Limit contactor for conductivity measured value: R2 (1)
- Limit contactor for temperature: R2 (2)
- PID controller: R2 (3)
- Timer for cleaning function: R2 (4)
- Chemoclean function: R2 (5)
- USP/EP: R2 (6) and R2 (7) (for Plus Package, only conductive sensors)

#### Limit contactor for conductivity measured value and temperature

The transmitter has different ways of assigning a relay contact. Switch-on and switch-off points and pickup and dropout delays can be assigned to the limit contactor. In addition, you can configure an alarm threshold to output an error message and to start a cleaning function in conjunction with this.

These functions can be used both for the primary value and for temperature measurement.

Please refer to the switch states in →  29 for a clear illustration of the relay contact states.

- When the measured values increase (maximum function), the relay contact is closed as of t2 after the switch-on point (t1) has been exceeded and the pickup delay has elapsed (t2-t1).  
The alarm contact switches if the alarm threshold (t3) is reached and the alarm delay (t4-t3) has also elapsed (errors E067 to E070).
- When the measured values decrease, the alarm contact is reset when the value falls below the alarm threshold (t5) again, as is the relay contact (t7) after the dropout delay (t7-t6).
- If the pickup and dropout delays are set to 0 s, the switch-on and switch-off points are also switch points of the contacts.

The same settings can also be made for a minimum function in the same way as for the maximum function.

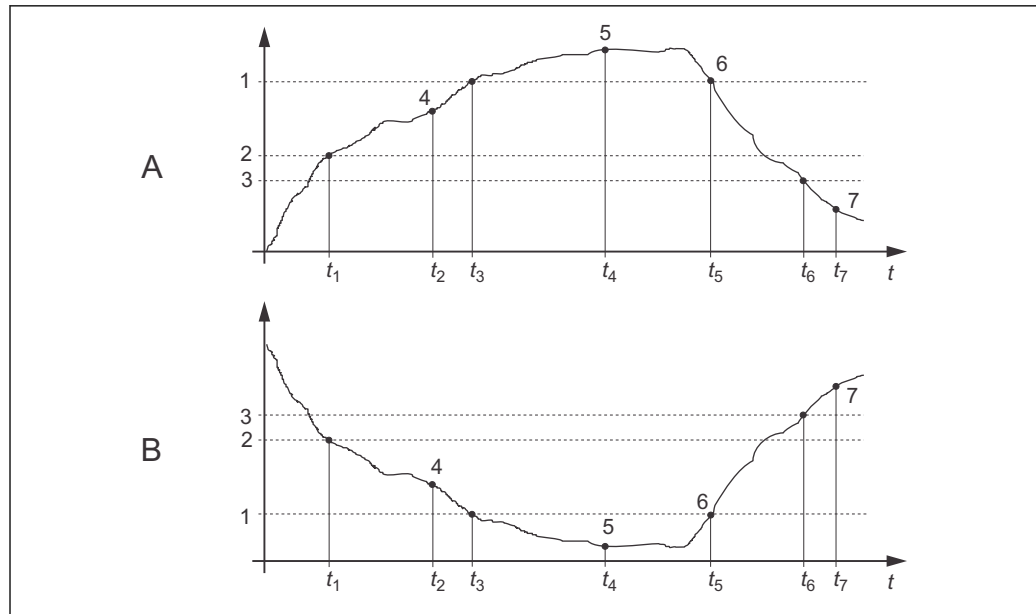

A0025215

29 Illustration of the alarm and limit value functions

A Switch-on point > switch-off point: Max. function

B Switch-on point < switch-off point: Min. function

1 Alarm threshold

2 Switch-on point

3 Switch-off value

4 Contact ON

5 Alarm ON

6 Alarm OFF

7 Contact OFF

### P(ID) controller

You can define various controller functions for the transmitter. On the basis of the PID controller, P, PI, PD and PID controllers can be implemented. For an optimum control system, use the controller that best suits your application.

#### ■ P controller

Used for simple linear control purposes with small system deviations. Where major changes are to be controlled, overshooting may occur. In addition, a lasting control deviation must be expected.

#### ■ PI controller

Is used for control systems where overshooting is to be avoided and no lasting control deviation should occur.

#### ■ PD controller

Is used for processes that require quick changes and where peaks must be corrected.

#### ■ PID controller

Is used for processes where a P, PI or PD controller does not control sufficiently.

### Configuration options of the P(ID) controller

The following configuration options are available for a PID controller:

- Change control gain  $K_p$  (P influence)
- Set integral action time  $T_n$  (I influence)
- Set derivative action time  $T_v$  (D influence)

### Basic load dosing (basic)

You can set a constant dosage amount (field R2311) with basic load dosing (field R231).

### PID control plus basic load dosing

If you have selected this function (PID + Basic) in field R231, the PID-controlled dosage amount does not drop below the basic load value entered in field R2311.

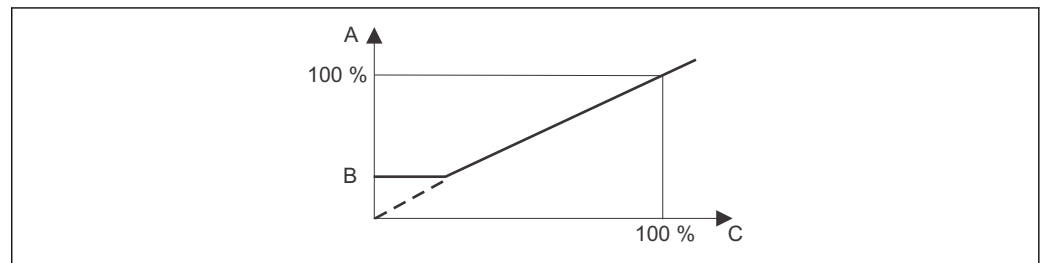

30 Control characteristic of PID controller with basic load dosing

A PID plus basic load

B Basic load

C PID

### Commissioning

If you do not yet have any experience for setting the control parameters, set the values that yield the greatest possible stability in the control circuit. Proceed as follows to optimize the control circuit further:

- Increase the control gain  $K_p$  until the controlled variable just starts to overshoot.
- Reduce  $K_p$  slightly again and then reduce the integral action time  $T_n$  so that the shortest possible correction time without overshooting is achieved.
- To reduce the response time of the controller, also set the derivative action time  $T_v$ .

### Control and fine optimization of the set parameters with a recorder

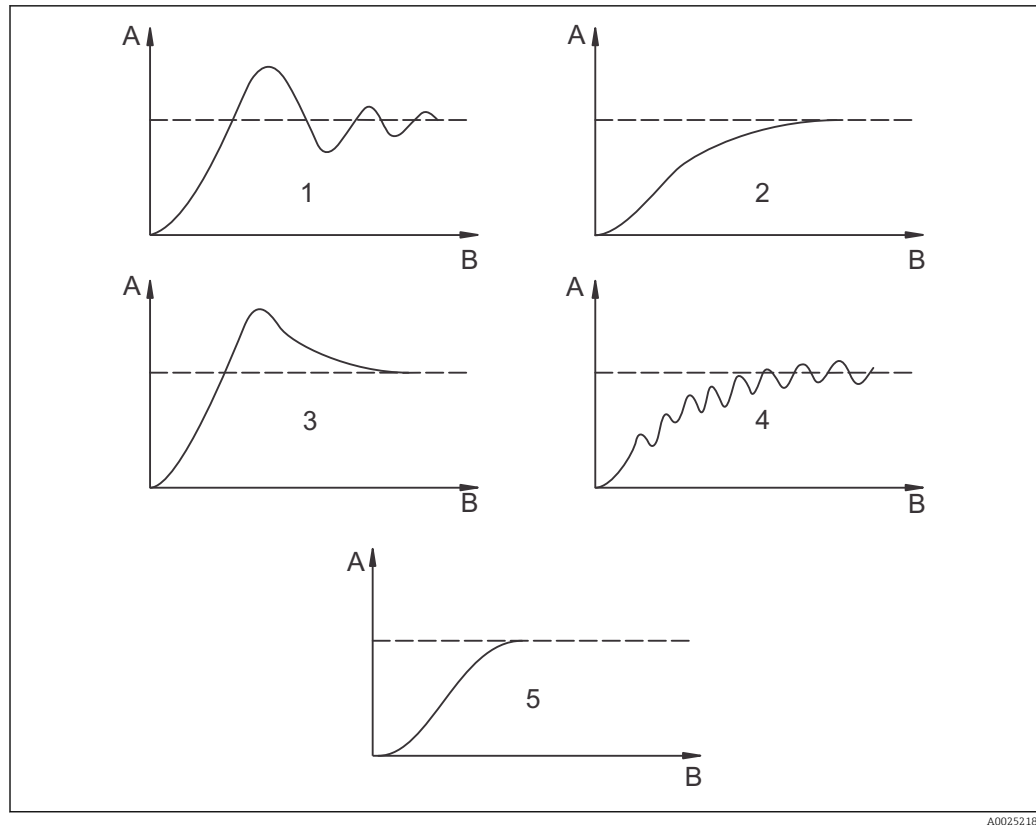

31 Optimization of settings  $T_n$  and  $K_p$

- A Actual value  
 B Time  
 1  $T_n$  too small  
 2  $T_n$  too large  
 3  $K_p$  too large  
 4  $K_p$  too small  
 5 Optimum setting

### Actuating signal outputs via contacts (R237 to R2310)

Each control contact outputs a cyclical signal whose intensity corresponds to the controller's actuating value. A distinction is made according to the type of signal cycle:

#### ■ Pulse length modulation

The bigger the calculated manipulated variable is, the longer the contact affected remains picked up. The period  $T$  can be set to be between 0.5 and 99 s (field R238). Outputs with pulse length modulation are used to activate solenoid valves.

#### ■ Pulse frequency modulation

The bigger the calculated manipulated variable is, the higher the switching frequency of the contact affected. The maximum switching frequency  $1/T$  can be set to be between 60 and 180  $\text{min}^{-1}$  (field R239). The on-time  $t_{\text{on}}$  is constant. It depends on the set maximum frequency and is approx. 0.5 s for 60  $\text{min}^{-1}$  and approx. 170 ms for 180  $\text{min}^{-1}$ . 170 ms. Outputs with pulse frequency modulation are used to activate directly controlled solenoid dosing pumps.



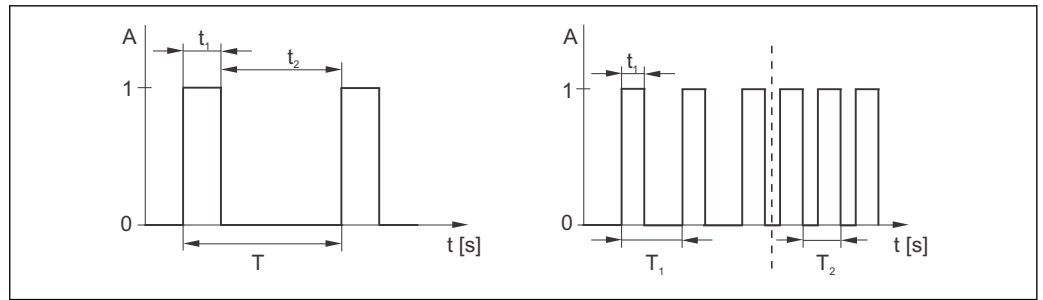

32 Signal of a pulse-length modulated controller contact (left) and of a pulse frequency-modulated controller contact (right)

Contact: 1 = on, 0 = off T Period  
 Time (s):  $t_1 = t_{on}$   $t_2 = t_{off}$  T1 T2 Impulse period length (  $1/T_1$  and  $1/T_2$ )

**Constant controller**

The controller can also control the second analog current output (if provided). This is configured in fields R237 and O2.

**Control characteristic for direct and inverse control action**

You can choose between two control characteristics in the R236 field:

- Direct control action = maximum function
- Inverse control action = minimum function

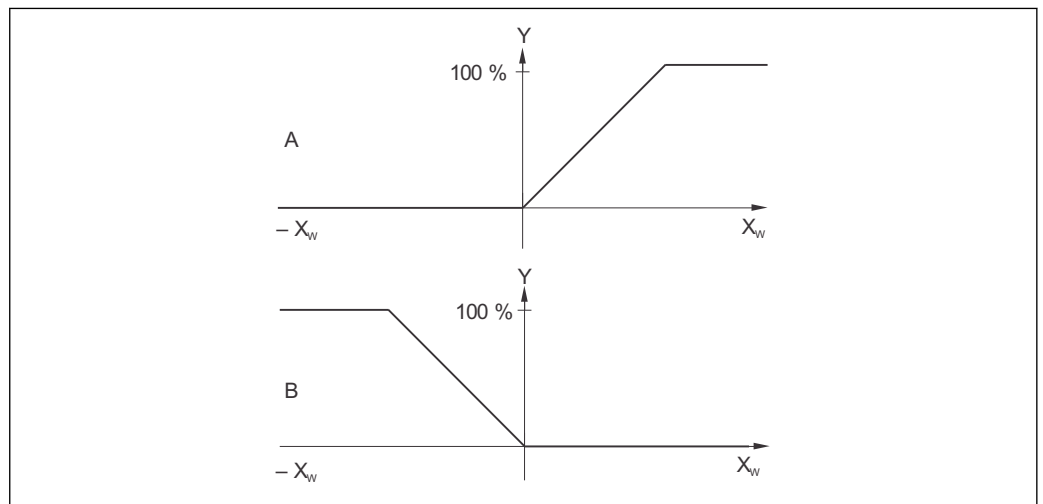

33 Control characteristic of a proportional controller with direct and inverse control action

A Direct = maximum function  
 B Inverse = minimum function  
 XW Control deviation  
 Y Current output signal = controller actuating variable

**Timer for cleaning function**

This function includes a simple cleaning option. You can set the time interval after which cleaning should start. Therefore you can only select a constant interval sequence.

Other cleaning functions are available for selection in conjunction with the Chemoclean function (device version with four contacts required, see the "Chemoclean function" section).

**i** The timer and Chemoclean do not work independently of one another. While one of the two functions is active, the other cannot be started.

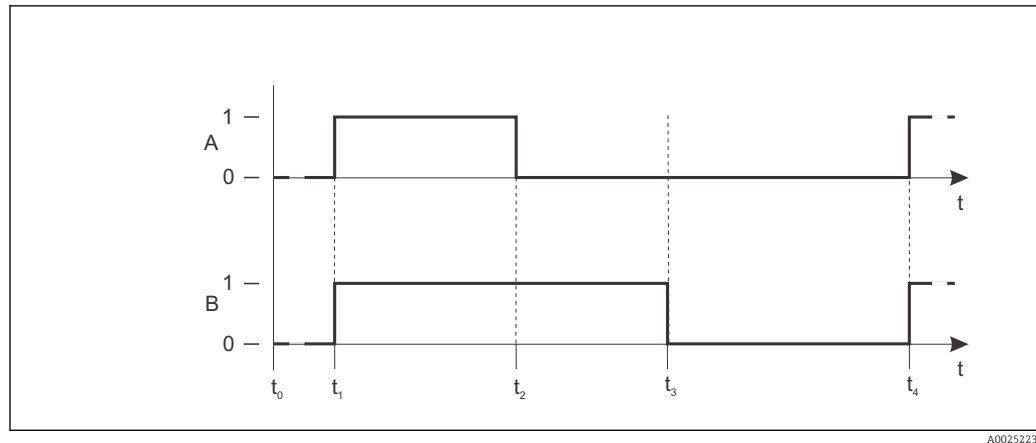

34 Connection between cleaning time, pause time and hold dwell period

A Wiper and/or spray cleaning system

B Hold function

0 Inactive

1 active

t0 Normal operation

t1 cleaning start

t2-t1 Cleaning time

t3-t2 Clean hold dwell period (0 to 999 s)

t4-t3 Pause time between two cleaning intervals (1 to 7200 min)

### Chemoclean function

Just like the timer function, Chemoclean can also be used to start a cleaning cycle. However, Chemoclean also gives you the added option of defining various cleaning and rinsing intervals and of dosing cleaning agent.

Therefore, it is possible to clean irregularly with different repeat cycles and to separately set the cleaning times with post rinse times.

Please note the following:

- To use the Chemoclean function the transmitter has to be equipped with a designated relay board (see product structure or chapter "accessories").
- The timer and Chemoclean are mutually dependent. While one of the two functions is active, the other cannot be started.
- For the Chemoclean function, the relays 3 (water) and 4 (cleaner) are used.
- If the cleaning is prematurely aborted, a post rinse time always follows.
- If the setting is "Economy", cleaning only takes place with water.

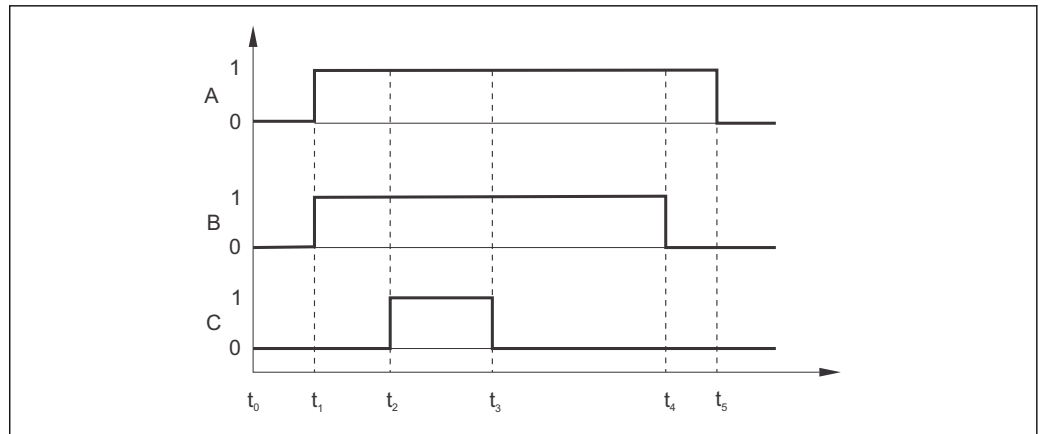

A0025216

35 Sequence of a cleaning cycle

- A Hold function
- B Water valve is triggered
- C Cleaning valve is triggered
- 0 Contact off
- 1 Contact on
- t0 Normal operation
- t1 cleaning start
- t2-t1 Pre-rinse time
- t3-t2 Cleaning time
- t4-t3 Post rinse time
- t5-t4 Hold dwell period

### Limit values for pharmaceutical water according to United States Pharmacopoeia (USP) and European Pharmacopoeia (EP) (only for conductive sensors)

In the case of conductive sensors, the transmitter has functions for monitoring "Water for Injection" (WFI), "Highly Purified Water" (HPW) and "Purified Water" (PW) according to the United States Pharmacopoeia (USP) Part 645 and European Pharmacopoeia (EP) standards.

**USP function:** The temperature-dependent limit values in the following table apply for "Water for Injection" (WFI) according to USP and EP and for "Highly Purified Water" (HPW) according to EP. The table is programmed into the transmitter.

Temperature [°C]	Conductivity [ $\mu\text{S}/\text{cm}$ ]	Temperature [°C]	Conductivity [ $\mu\text{S}/\text{cm}$ ]
0	0.6	55	2.1
5	0.8	60	2.2
10	0.9	65	2.4
15	1.0	70	2.5
20	1.1	75	2.7
25	1.3	80	2.7
30	1.4	85	2.7
35	1.5	90	2.7
40	1.7	95	2.9
45	1.8	100	3.1
50	1.9		

The measurement is performed in the following steps:

- The transmitter determines the uncompensated conductivity and the water temperature.
- The transmitter rounds the temperature off to the nearest 5 °C and compares the measured conductivity with the associated value in the table.
- If the measured value is larger than the value in the table, an alarm is triggered (E151).

**EP-PW function:** The following table lists the temperature-dependent limit values for "Purified Water" (PW) in accordance with EP; this table is also programmed into the transmitter.

Temperature [°C]	Conductivity [µS/cm]	Temperature [°C]	Conductivity [µS/cm]
0	2.4	60	8.1
10	3.6	70	9.1
20	4.3	75	9.7
25	5.1	80	9.7
30	5.4	90	9.7
40	6.5	100	10.2
50	7.1		

The measurement is performed in the following steps:

- The transmitter determines the uncompensated conductivity and the water temperature.
- If the temperature is between two table entries, the limit value for the conductivity is determined by interpolation of the two neighboring points.
- If the measured value is larger than the limit value, an alarm is triggered (E151).

**Early warning:** A USP early warning is also available. This is activated at a configurable switch-on point (e.g. 80 % of USP/EP limit value). This means that the user is alerted to be able to regenerate the plant in time. Der Voralarm wird in Feld R262 bzw. R272 eingestellt.



Please note the following:

- The device must be equipped with a relay card and the Plus Package to be able to use the USP and EP function.
- To output an alarm, enable the fault-signaling contact or the error current in field F5 - F7 (error code E151 and E153).
- The switch-off point of the pre-alarm is 1 % below of the switch-on point (R262 / R272), related to the main limit value.
- The transmitter also uses the uncompensated values for the USP and EP function when it displays temperature-compensated values.
- The limit value of 100 °C (212 °F) is used for temperatures over 100 °C (212 °F).

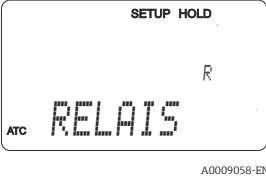
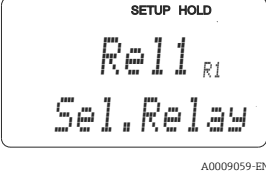
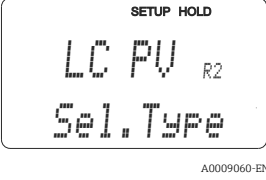
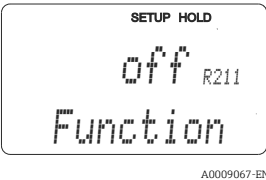
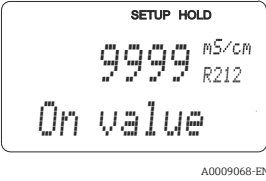
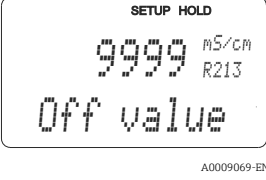
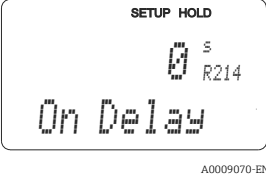
Functions marked in *italics* are not supported by the basic device version.

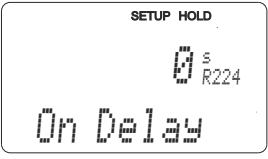
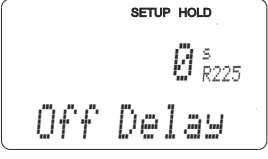
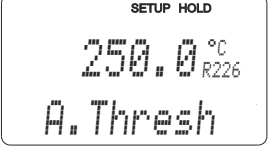
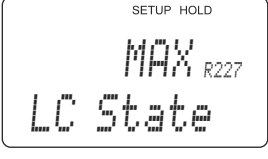
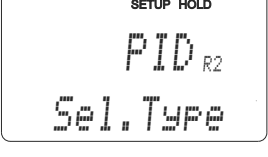

Coding	Field	Range of adjustment (factory settings in bold)	Display	Info
R	<b>RELAY</b>			Relay contact settings
R1	Select the contact to be configured	<b>Rel1</b> Rel2 Rel3 Rel4		Rel3 (water) and Rel4 (cleaner) are only available with the relevant version of the transmitter. If Chemoclean is used as the cleaning method, Rel4 is not available.
R2 (1)	Configure limit contactor for conductivity, resistance or concentration measurement	<b>LC PV = limit contactor conductivity (1)</b> LC °C = limit contactor T (2) PID controller (3) Timer (4) <i>Clean=</i> <i>Chemoclean (5)</i> <i>USP (6)</i> <i>EP PV(7)</i>		PV = process value If Rel4 is selected in the R1 field, Clean = Chemoclean cannot be selected. By confirming with ENTER, another relay function already switched on is switched off and its settings are reset to the factory settings.
R211	Switch function of R2 (1) off or on	<b>Off</b> On		All the settings are retained.
R212	Enter the switch-on point of the contact	Cond/ind: <b>9999 mS/cm</b> MΩm: <b>200</b> MΩ·cm Conc: <b>9999 %</b>		Never set the switch-on point and the switch-off point to the same value! (Only the operating mode selected in A1 is displayed.)
R213	Enter the switch-off point of the contact	Cond/ind: <b>9999 mS/cm</b> MΩm: <b>200</b> MΩ·cm Conc: <b>9999 %</b>		Entering a switch-off point selects either a Max contact (switch-off point < switch-on point) or a Min contact (switch-off point > switch-on point), thereby implementing a hysteresis that is constantly required (see "Illustration of the alarm and limit functions" figure).
R214	Enter pickup delay	<b>0 s</b> 0 to 2000 s		

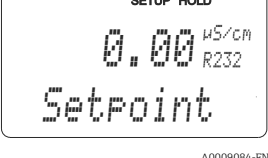
Coding	Field	Range of adjustment (factory settings in bold)	Display	Info
R215	Enter dropout delay	<b>0 s</b> 0 to 2000 s	<p>SETUP HOLD 0<sup>s</sup> R215 Off Delay A0009071-EN</p>	
R216	Enter alarm threshold	Cond/ind: <b>9999</b> <b>mS/cm</b> MOhm: <b>200</b> <b>MΩ-cm</b> Conc: <b>9999 %</b>	<p>SETUP HOLD 9999<sup>mS/cm</sup> R216 A.Thresh A0009072-EN</p>	If the alarm threshold is undershot/overshot, this triggers an alarm with the error message (E067 to E070) and an error current at the transmitter (note alarm delay in field F3). If defined as a Min contact, the alarm threshold must be < switch-off point.
R217	Display status for limit contactor	<b>MAX</b> MIN	<p>SETUP HOLD MAX R217 LC State A0009073-EN</p>	Display only
R2 (2)	Configure limit contactor for temperature measurement	LC PV = limit contactor conductivity (1) <b>LC °C = limit contactor T (2)</b> PID controller (3) Timer (4) Clean= Chemoclean (5) USP (6) EP PV(7)	<p>SETUP HOLD LC °C R2 Sel.Type A0009061-EN</p>	By confirming with ENTER, another relay function already switched on is switched off and its settings are reset to the factory settings.
R221	Switch function of R2 (2) off or on	<b>Off</b> On	<p>SETUP HOLD off R221 Function A0009074-EN</p>	
R222	Enter switch-on temperature	<b>250.0 °C</b> -35.0 to 250.0 °C	<p>SETUP HOLD 250.0 °C R222 On value A0009075-EN</p>	Never set the switch-on point and the switch-off point to the same value!
R223	Enter switch-off temperature	<b>250.0 °C</b> -35.0 to 250.0 °C	<p>SETUP HOLD 250.0 °C R223 Off value A0009076-EN</p>	Entering a switch-off point selects either a Max contact (switch-off point < switch-on point) or a Min contact (switch-off point > switch-on point), thereby implementing a hysteresis that is constantly required (see "Illustration of the alarm and limit functions" figure).

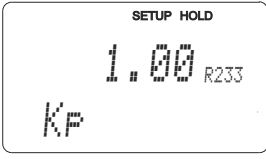
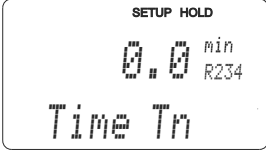
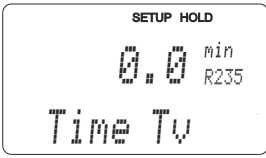
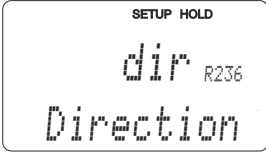
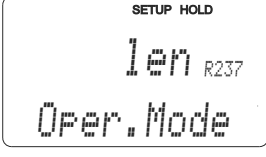
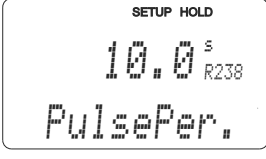
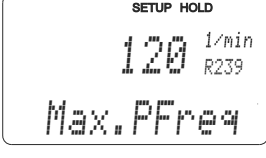
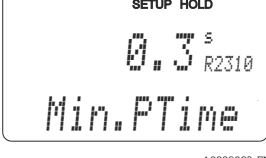
Coding	Field	Range of adjustment (factory settings in bold)	Display	Info
R224	Enter pickup delay	<b>0 s</b> 0 to 2000 s	 A0009077-EN	
R225	Enter dropout delay	<b>0 s</b> 0 to 2000 s	 A0009078-EN	
R226	Enter alarm threshold (as absolute value)	<b>250.0 °C</b> -35.0 to 250 °C	 A0009079-EN	If the alarm threshold is undershot/overshot, this triggers an alarm with the error message (E067 to E070) and an error current at the transmitter (note alarm delay in field F3). If defined as a Min contact, the alarm threshold must be < switch-off point.
R227	Display status for limit contactor	<b>MAX</b> MIN	 A0009080-EN	Display only
R2 (3)	Configure P(ID) controller	LC PV = limit contactor conductivity (1) LC °C = limit contactor T (2) <b>PID controller (3)</b> Timer (4) Clean= Chemoclean (5) USP (6) EP PV(7)	 A0009062-EN	By confirming with ENTER, another relay function already switched on is switched off and its settings are reset to the factory settings.
R231	Switch function of R2 (3) off or on	<b>Off</b> On Basic PID+B	 A0009081-EN	On = PID controller Basic = basic load dosing PID+B = PID controller + basic load dosing
R232	Enter set point	Cond/ind: <b>0.00</b> <b>µS/cm</b> MOhm: <b>0.00</b> <b>kΩ·cm</b> Conc: <b>0.00 %</b>	 A0009084-EN	The set point is the value to be maintained by the control system. Using this control process, this value is restored when an upwards or downwards deviation occurs.

Coding	Field	Range of adjustment (factory settings in bold)	Display	Info
R233	Enter control gain $K_P$	<b>1.00</b> 0.01 to 20.00	 A0009085-EN	See the "P(ID) controller" section.
R234	Enter integral action time $T_n$ (0.0 = no I-component)	<b>0.0 min</b> 0.0 to 999.9 min	 A0009086-EN	See the "P(ID) controller" section. With every hold, the I-component is set to zero. Although the hold can be deactivated in field S2, this does not apply for Chemoclean and timer!
R235	Enter derivative action time $T_v$ (0.0 = no D-component)	<b>0.0 min</b> 0.0 to 999.9 min	 A0009087-EN	See the "P(ID) controller" section.
R236	Select controller characteristic	<b>Dir = direct</b> Inv = inverse	 A0009088-EN	The setting is required depending on the control deviation (upward or downward deviation, see the "P(ID) controller" section).
R237	Select pulse length or pulse frequency	Len = pulse length Freq = pulse frequency Curr = current output 2	 A0009089-EN	Pulse length e.g. for solenoid valve, pulse frequency e.g. for solenoid dosing pump, see the "Actuating signal outputs" section. Curr = current output 2 can only be selected if O2 = Contr.
R238	Enter pulse interval	<b>10.0 s</b> 0.5 to 999.9 s	 A0009090-EN	This field only appears if pulse length is selected in R237. If pulse frequency is selected, R238 is skipped and entries continue with R239.
R239	Enter maximum pulse frequency of the adjuster	<b>120 min<sup>-1</sup></b> 60 to 180 min <sup>-1</sup>	 A0009091-EN	This field only appears if pulse frequency is selected in R237. If pulse length is selected, R239 is skipped and entries continue with R2310.
R2310	Enter minimum switch-on time $t_{ON}$	<b>0.3 s</b> 0.1 to 5.0 s	 A0009082-EN	This field only appears if pulse length is selected in R237.

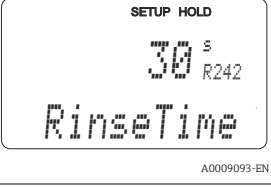

Coding	Field	Range of adjustment (factory settings in bold)	Display	Info
R2311	Enter basic load	<b>0 %</b> 0 to 40 %		When you select the basic load, you enter the desired dosing quantity. 100% basic load would correspond to: <ul style="list-style-type: none"> <li>Constantly on if R237 = len</li> <li>Fmax if R237 = freq (field R239)</li> <li>20 mA if R237 = curr</li> </ul>
R2 (4)	Configure cleaning function (timer)	LC PV = limit contactor conductivity (1) LC °C = limit contactor T (2) PID controller (3) <b>Timer (4)</b> Clean= Chemoclean (5) USP (6) EP PV(7)		Only one cleaning agent (generally water) is used for the cleaning. By confirming with ENTER, another relay function already switched on is switched off and its settings are reset to the factory settings.
R241	Switch function of R2 (4) off or on	<b>Off</b> On		
R242	Enter rinsing/ cleaning time	<b>30 s</b> 0 to 999 s		Settings for hold and relay are active for this time.
R243	Enter pause time	<b>360 min</b> 1 to 7200 min		The pause time is the time between two cleaning cycles (see the "Timer for cleaning function" section).
R244	Enter minimum pause time	<b>120 min</b> 1 to R243		The minimum pause time prevents constant cleaning if a cleaning trigger is pending.
R2 (5)	Configure cleaning with Chemoclean (for version with four contacts, Chemoclean option and contacts 3 and 4 assigned)	LC PV = limit contactor conductivity (1) LC °C = limit contactor T (2) PID controller (3) Timer (4) <b>Clean=</b> <b>Chemoclean (5)</b> USP (6) EP PV(7)		See the "Chemoclean function" section. By confirming with ENTER, another relay function already switched on is switched off and its settings are reset to the factory settings.

Coding	Field	Range of adjustment (factory settings in bold)	Display	Info
R251	Switch function of R2 (5) off or on	<b>Off</b> On		
R252	Select type of start pulse	<b>Int = internal (time- controlled)</b> Ext = external (digital input 2) I+ext = internal + external I+stp = internal, suppressed by external		The cycle for the "int" function is started when the pause time ends (R257). No real time clock is available. External suppression is required for irregular time intervals (e.g. weekends).
R253	Enter pre-rinse time	<b>20 s</b> 0 to 999 s		Rinsing is performed with water.
R254	Enter cleaning time	<b>10 s</b> 0 to 999 s		Cleaning is performed with cleaning agent and water.
R255	Enter post rinse time	<b>20 s</b> 0 to 999 s		Rinsing is performed with water.
R256	Enter number of repeat cycles	<b>0</b> 0 to 5		R253 to R255 is repeated.
R257	Enter pause time	<b>360 min</b> 1 to 7200 min		The pause time is the time between two cleaning cycles (see the "Chemoclean function" section).
R258	Enter minimum pause time	<b>120 min</b> 1 to R257		The minimum pause time prevents constant cleaning if an external cleaning start is pending.

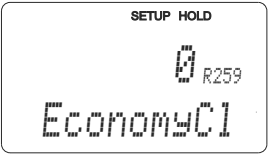
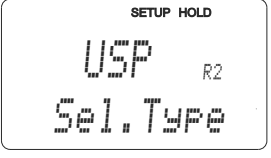
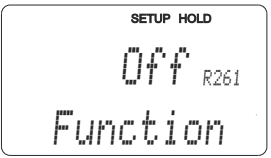
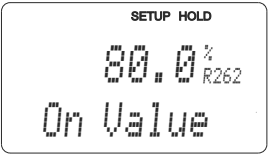
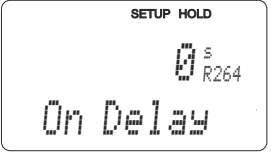
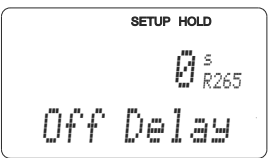
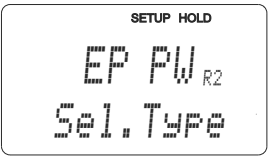
Coding	Field	Range of adjustment (factory settings in bold)	Display	Info
R259	Enter number of cleaning cycles without cleaning agent (economy function)	<b>0</b> 0 to 9	 A0009104-EN	After cleaning with cleaner, up to 9 cleaning sessions can be carried out with water only until the next cleaning session with cleaner takes place.
R2 (6)	Configure USP contact (only for Plus Package with relay card)	LC PV = limit contactor conductivity (1) LC °C = limit contactor T (2) PID controller (3) Timer (4) Clean= Chemoclean (5) <b>USP (6)</b> EP PV(7)	 A0009065-EN	The USP contact can be configured as an early warning alarm, i.e. it alerts the user before the actual limit value is reached. Error no. E151 appears in the event of an alarm. WFI according to USP; HPW according to EP
R261	Switch function of R2 (6) off or on	<b>Off</b> On	 A0009105-EN	
R262	Early warning threshold: enter switch-on point	<b>80.0 %</b> 0.0 to 100.0 %	 A0009106-EN	The early warning triggers the contact. When the alarm value is reached (100%), the alarm relay is also triggered. Example: Given 15 °C and 1.0 µS/cm, a USP early warning alarm is triggered at 0.8 µS/cm when the setting is 80%.
R264	Early warning threshold: enter pickup delay	<b>0 s</b> 0 to 2000 s	 A0009107-EN	
R265	Early warning threshold: enter dropout delay	<b>0 s</b> 0 to 2000 s	 A0009108-EN	
R2 (7)	Configure EP PV contact (only for Plus Package with relay card)	LC PV = limit contactor conductivity (1) LC °C = limit contactor T (2) PID controller (3) Timer (4) Clean= Chemoclean (5) USP (6) <b>EP PV(7)</b>	 A0009066-EN	The EP PV contact can be configured as an early warning alarm, i.e. it alerts the user before the actual limit value is reached. Error no. E151 appears in the event of an alarm. PV according to EP

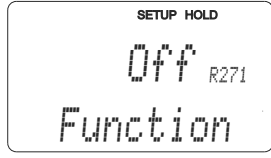
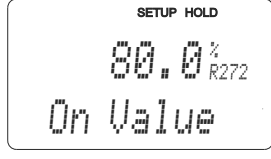
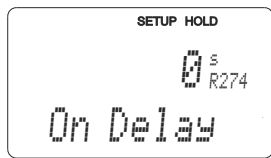
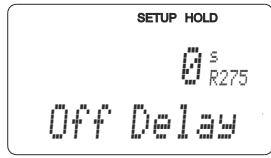
Coding	Field	Range of adjustment (factory settings in bold)	Display	Info
R271	Switch function of R2 (7) off or on	<b>Off</b> On	 <p>A0009109-EN</p>	
R272	Early warning threshold: enter switch-on point	<b>80.0 %</b> 0.0 to 100.0 %	 <p>A0009110-EN</p>	The early warning triggers the contact. When the alarm value is reached (100%), the alarm relay is also triggered. Example: Given 15 °C and 1.0 µS/cm, an EP PV early warning alarm is triggered at 0.8 µS/cm when the setting is 80%.
R274	Early warning threshold: enter pickup delay	<b>0 s</b> 0 to 2000 s	 <p>A0009111-EN</p>	
R275	Early warning threshold: enter dropout delay	<b>0 s</b> 0 to 2000 s	 <p>A0009112-EN</p>	

### 7.4.8 Temperature compensation with table

The "ALPHA TABLE" function group is not available in the basic device version. You require the Plus Package to access this function group. With this function group, you can perform temperature compensation using a table (field B2).

Enter the  $\alpha$ -T value pairs (see SETUP 2) in the T4 and T5 fields.

Functions marked in italics are not supported by the basic device version.

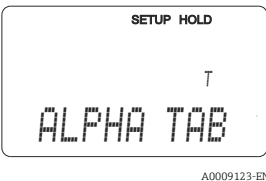
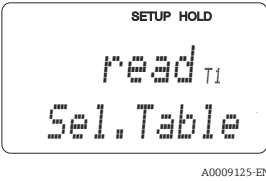
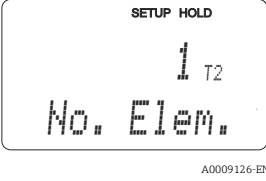
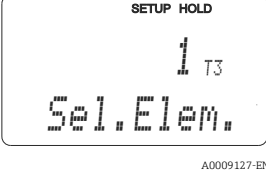
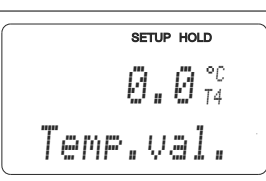
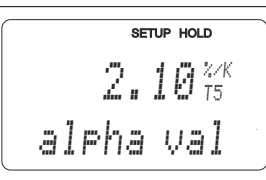
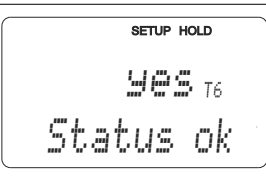
Coding	Field	Range of adjustment (factory settings in bold)	Display	Info
T	<b>ALPHA TABLE</b> function group		 A0009123-EN	Settings for temperature compensation.
T1	Select table option	Read Edit	 A0009125-EN	
T2	Enter number of table value pairs	<b>1</b> 1 to 10	 A0009126-EN	In the $\alpha$ -table, you can enter a maximum of 10 value pairs. These pairs are saved under numbers 1 to 10 and can be changed individually or consecutively.
T3	Select table value pair	<b>1</b> 1 to number of table value pairs Assign	 A0009127-EN	The system automatically runs through the T3 to T5 function chain as often as corresponds to the value indicated in T2. "Assign" appears as the last value. The display goes to T6 once the process is finished.
T4	Enter temperature value	<b>0.0 °C</b> -35.0 to 250.0 °C	 A0009128-EN	The temperature values must be at least 1 K apart. Factory setting for the temperature value in the table value pairs: 0.0 °C; 10.0 °C; 20.0 °C; 30.0 °C ...
T5	Enter temperature coefficient $\alpha$	<b>2.10 %/K</b> 0.00 to 20.00 %/K	 A0009129-EN	
T6	Message as to whether table status is OK	<b>Yes</b> No	 A0009130-EN	Display only If status = "no", you must set correct values in the table (all settings made up until now remain intact) or go back to the measuring mode (then the table is not valid).

### 7.4.9 Concentration Measurement

The CONCENTRATION function group is only available for devices with a Plus Package.

The transmitter can convert from conductivity values to concentration values. For this purpose, the operating mode is first set to concentration measurement (see field A1).

Afterwards, in the measuring device you must specify the basic data on the basis of which the concentration is to be calculated. You require the conductivity characteristic curves of the medium for this.

In the case of conductive sensors, the effects of polarization in the boundary layer between the sensor and medium restrict the measuring range. The transmitter can detect polarization effects by using a smart signal analysis process. Error message E071 is displayed.

You can either refer to your data sheets for these characteristic curves or determine the characteristic curves yourself.

1. Create samples of the medium in the concentrations that occur in the process.
2. Then measure the uncompensated conductivity of these samples at temperatures that also occur in the process.
  - For variable process temperatures:
 

If variable process temperatures are to be taken into consideration, you must measure the conductivity for at least two temperatures (ideally the minimum and maximum process temperature) for the samples created. The temperature values of the various samples must be identical in each case. The temperatures must be at least 0.5 °C apart.

At least two samples of different concentrations, taken at two different temperatures in each case, are required as the transmitter needs at least four points in the table (this must include the minimum and maximum concentration values).
  - For constant process temperatures:
 

Measure the differently concentrated samples at this temperature. At least two samples are required.

At the end you should have measuring data which resemble those shown in the following figures.

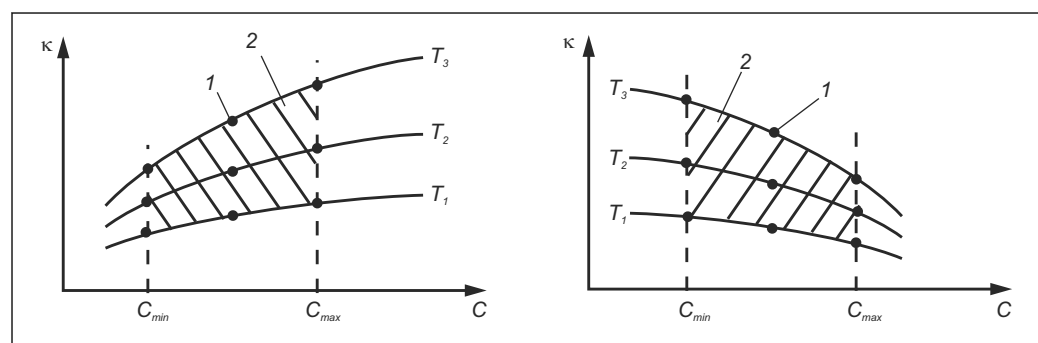

36 Example of measured data for variable temperatures

- $\kappa$  Conductivity
- $C$  Concentration
- $T$  Temperature
- 1 Measuring point
- 2 Measuring range

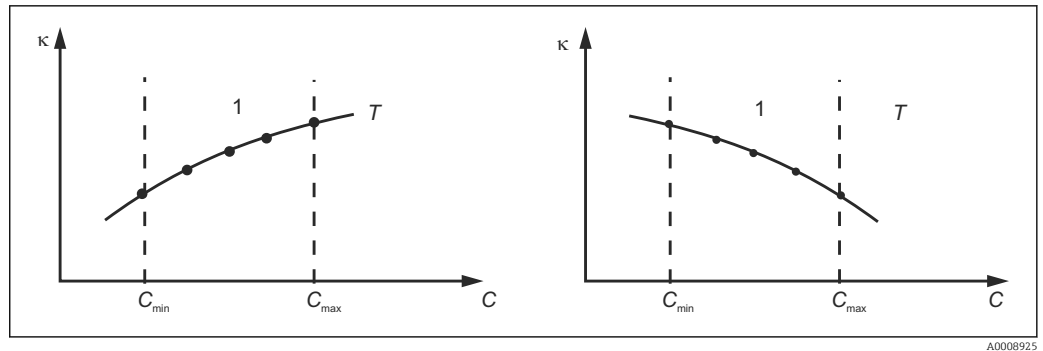

37 Example of measured data for constant temperatures

- κ Conductivity
- C Concentration
- T Constant temperature
- 1 Measuring range

**i** The characteristic curves received from the measuring points must increase or decrease very monotonically in the range of the process conditions, i.e. neither maximum points, nor minimum points, nor ranges with a constant behavior can occur. The curve profiles opposite are therefore not permitted.

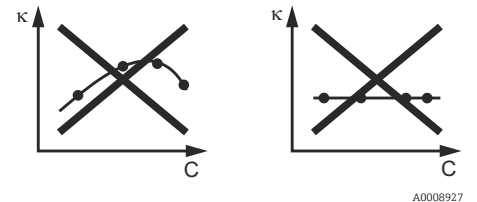

38 Impermissible curve profiles

- κ Conductivity
- C Concentration

**Value entry**

Enter the three characteristic values for each measured sample in the fields K6 to K8 (value triplets of uncompensated conductivity, temperature and concentration).

- Variable process temperature:  
Enter at least the four value triplets needed.
- Constant process temperature:  
Enter at least the two value triplets needed.

Please note the following:

If the measured values of the process are outside the range of your sample values, this considerably reduces the level of accuracy and the error message E078 or E079 will be displayed. Therefore, take the limit values of your process into consideration when determining the characteristic curves. Wird bei aufsteigender

If you enter an additional value triplet of 0 μS/cm and 0% for every temperature used when the characteristic curve is increasing, you can work from the start of the measuring range with sufficient accuracy and without an error message.

Enter the values in order of increasing concentration (see the following example).

mS/cm	%	°C
240	96	60
380	96	90
220	97	60
340	97	90
120	99	60
200	99	90

As the temperature is already processed in the concentration tables, the settings for temperature compensation in the Setup 2 menu (fields B2 and B3) are ineffectual for concentration measurement.

Functions marked in italics are not supported by the basic device version.

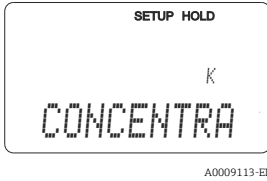
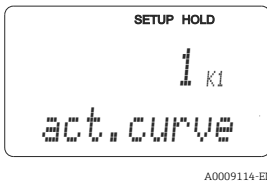
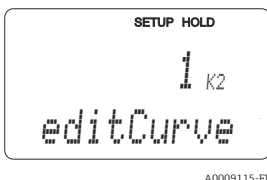
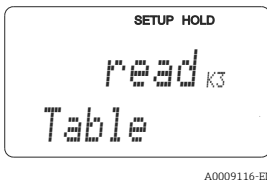
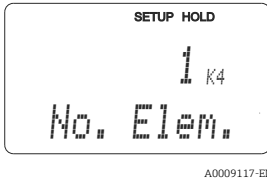
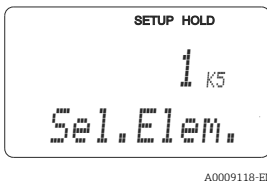
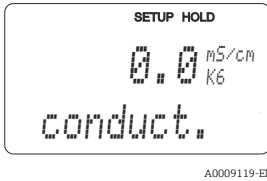
Coding	Field	Range of adjustment (factory settings in bold)	Display	Info
K	<b>CONCENTRATION function group</b>			Four different concentration fields can be entered in this function group.
K1	Select the active concentration curve on which the calculation of the display value is based	<b>1</b> 1 to 4		The curves are independent of one another. Four different curves can be defined.
K2	Select the curve to be edited	<b>1</b> 1 to 4		If a curve is being edited, another curve should be used to calculate the current display values. Example: If curve 2 is being edited, either curve 1, curve 3 or curve 4 should be active (see K1).
K3	Select table option	<b>Read</b> Edit		This option is valid for all concentration curves.
K4	Enter number of reference triplets	<b>1</b> 1 to 10		Each triplet consists of three numeric values.
K5	Select triplet	<b>1</b> 1 to number of triplets in K4 Assign		Any triplet can be edited. "Assign" takes the user to K9
K6	Enter uncompensated conductivity value	<b>0.0 mS/cm</b> 0.0 to 9999 mS/cm		The system automatically runs through the K5 to K6 function chain as often as corresponds to the value indicated in K4. The display then goes to K9.





Coding	Field	Range of adjustment (factory settings in bold)	Display	Info
K7	Enter concentration value for K6	<b>0.00 %</b> 0.00 to 99.99 %		Engineering unit as selected in A2. Format as selected in A3.
K8	Enter temperature value for K6	<b>0.0 °C</b> -35.0 to 250.0 °C		
K9	Message as to whether table status is OK	<b>Yes</b> No		Read only. If "No", then set correct values in the table (all settings made up until now remain intact) or go back to the measuring mode (then the table is not valid).

#### 7.4.10 Service

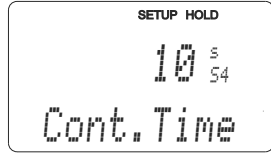
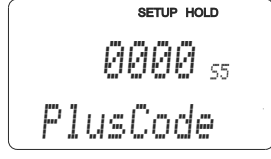
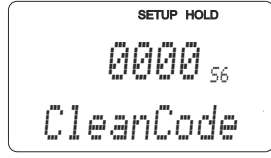
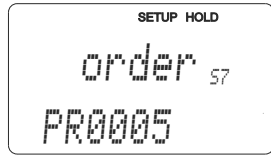
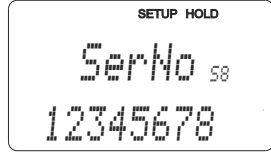
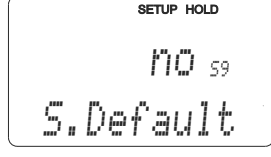
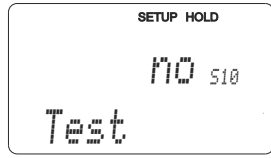
Coding	Field	Range of adjustment (factory settings in bold)	Display	Info
S	<b>SERVICE</b> function group			Service function settings.
S1	Select language	<b>ENG = English</b> GER = German FRA = French ITA = Italian NL = Dutch ESP = Spanish		The option selected only applies for the fault-signaling contact, not for the error current.
S2	Configure a hold	<b>S+C = hold during configuration and calibration</b> Cal = hold during calibration Setup = hold during configuration None = no hold		S = setup C = calibration
S3	Manual hold	<b>Off</b> On		The setting is retained even in the event of a power failure.

Coding	Field	Range of adjustment (factory settings in bold)	Display	Info
S4	Enter hold dwell period	<b>10 s</b> 0 to 999 s	 <p>SETUP HOLD 10<sup>s</sup><sub>54</sub> Cont. Time</p> <p>A0008415-EN</p>	
S5	Enter SW upgrade release code (Plus Package)	<b>0000</b> 0000 to 9999	 <p>SETUP HOLD 0000<sup>55</sup> PlusCode</p> <p>A0008416-EN</p>	The code can be found on the nameplate. If an incorrect code is entered, you are taken back to the measurement menu. The number is edited with the PLUS or MINUS key and confirmed with the ENTER key. "1" is displayed if the code is active.
S6	Enter SW upgrade release code for Chemoclean	<b>0000</b> 0000 to 9999	 <p>SETUP HOLD 0000<sup>56</sup> CleanCode</p> <p>A0008417-EN</p>	The code can be found on the nameplate. If an incorrect code is entered, you are taken back to the measurement menu. The number is edited with the PLUS or MINUS key and confirmed with the ENTER key. "1" is displayed if the code is active.
S7	Order number is displayed		 <p>SETUP HOLD order<sup>57</sup> PR0005</p> <p>A0008418-EN</p>	If the device is upgraded, the order code is changed automatically.
S8	Serial number is displayed		 <p>SETUP HOLD SerNo<sup>58</sup> 12345678</p> <p>A0008420-EN</p>	
S9	Reset the device to the basic settings	<b>No</b> Sens = sensor data Facy = factory settings	 <p>SETUP HOLD NO<sup>59</sup> S.Default</p> <p>A0008421-EN</p>	Sens = last calibration is deleted and is reset to factory setting. Facy = all data (apart from A1 and S1) are deleted and reset to the factory setting!
S10	Perform device test	<b>No</b> Displ = display test	 <p>SETUP HOLD NO<sup>S10</sup> Test</p> <p>A0008410-EN</p>	

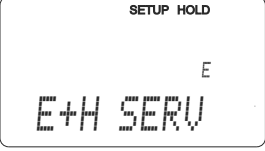
## 7.4.11 E+H Service

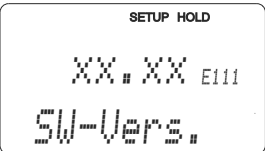
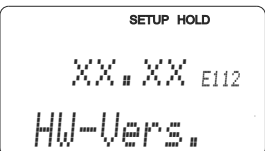
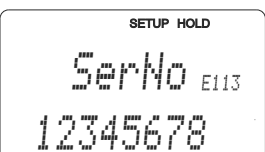
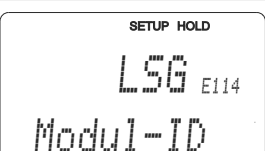
Coding	Field	Range of adjustment (factory settings in bold)	Display	Info
E	E+H SERVICE function group		 <small>A0007857-EN</small>	Information on the device version
E1	Select module	<b>Contr = controller (central module) (1)</b> Trans = transmitter (2) Main = power unit (3) Rel = relay module (4) Sens = sensor (5)	 <small>A0007858-EN</small>	
E111 E121 E131 E141 E151	Software version is displayed		 <small>A0007859-EN</small>	If E1 = contr: device software If E1 = trans, main, rel: module firmware If E1 = sens: sensor software
E112 E122 E132 E142 E152	Hardware version is displayed		 <small>A0007861-EN</small>	Info display
E113 E123 E133 E143 E153	Serial number is displayed		 <small>A0007860-EN</small>	Info display
E114 E124 E134 E144 E154	Module ID is displayed		 <small>A0007862-EN</small>	Info display

### 7.4.12 Interfaces

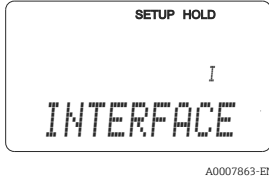
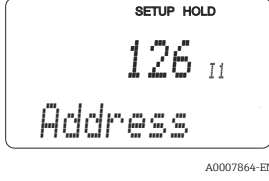
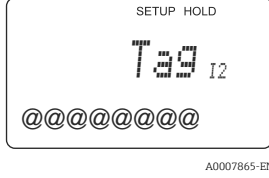
Coding	Field	Range of adjustment (factory settings in bold)	Display	Info
I	<b>INTERFACE</b> function group			Communication settings (only for HART or PROFIBUS device version).
I1	Enter bus address	Address HART: <b>0</b> to 15 or PROFIBUS: 0 to <b>126</b>		Each address may only be assigned once in a network. If a device address ≠ 0 is selected for a HART device, the current output is automatically set to 4 mA and the device prepares for multi-drop operation.
I2	The tag name is displayed			

### 7.4.13 Communication

For devices with a communication interface, please also refer to the separate Operating Instructions BA00208C/07/EN (HART®) or BA00209C/07/DE (PROFIBUS®).

## 7.5 Calibration

Use the CAL key to access the calibration function group.

Use this function group to calibrate and adjust the transmitter. The calibration can be performed in two different ways:

- By measuring in a calibration solution of known conductivity.
- By entering the exact cell constant of the conductivity sensor.

Please note the following:

- During initial commissioning of inductive sensors, an air set is absolutely essential for residual coupling compensation (from field C111) so that the measuring system can return precise measurement data.
- If the calibration procedure is aborted by pressing the PLUS and MINUS keys at the same time (return to C114, C126 or C136) or if the calibration is faulty, then the previous calibration data are reinstated. A calibration error is indicated by "ERR" and the sensor symbol flashes on the display.
- Repeat calibration!
- For each calibration, the device automatically switches to hold (factory setting).
- On completion of the calibration, the device returns to the measurement mode. The "hold" symbol appears on the display during the hold dwell period (field S4).
- Only items C121 to C126 are relevant for conductive sensors.

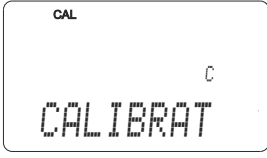
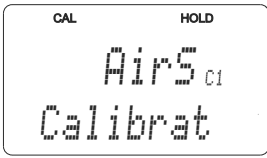
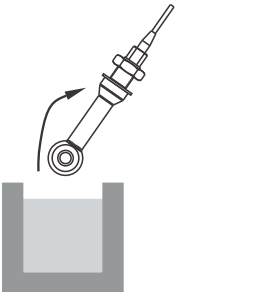
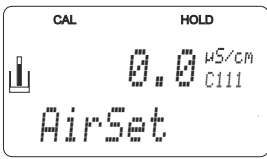
Coding	Field	Range of adjustment (factory settings in bold)	Display	Info
C	<b>CALIBRATION</b> function group:		 <small>A0009141-EN</small>	Airs and InstF do not apply for conductive measurement.
C1(1)	Calibration of inductive sensors with annular opening	<b>Airs = air set (1)</b> Cellc = cell constant (2) InstF = installation factor (3)	 <small>A0009142-EN</small>	When commissioning inductive sensors, an air set is mandatory. The sensor air set must be performed in air and in a dry state.
	Take the inductive sensor out of the liquid and dry it fully.		 <small>A0025597</small>	
C111	Residual coupling start calibration (air set)	<b>Current measured value</b>	 <small>A0009145-EN</small>	Press CAL to start the calibration.

Coding	Field	Range of adjustment (factory settings in bold)	Display	Info
C112	The residual coupling is displayed (air set)	-80.0 to 80.0 $\mu\text{S}/\text{cm}$		Residual coupling of measuring system (sensor and transmitter).
C113	Calibration status is displayed	<b>o.k.</b> E xxx		If the calibration status is not o.k., a reason for the error is provided on the second line of the display.
C114	Store calibration result?	<b>Yes</b> No New		If C113 = E xxx, then only No or New. If New, return to C. If Yes/No, return to "Measurement".
<b>C1(2)</b>	Cell constant calibration	Airs = air set (1) <b>Cellc = cell constant (2)</b> InstF = installation factor (3)		The sensor should be immersed in such a way that there is sufficient distance to the vessel wall (the installation factor has no influence if a > 15 mm).
Immerse the sensor in the calibration solution. The following section describes calibration with the temperature-compensated conductivity value of the reference solution. If calibration is to be performed with the uncompensated conductivity value, you must set the temperature coefficient $\alpha$ to zero.				
C121	Enter calibration temperature (MTC)	<b>25 °C</b> -35.0 to 250.0 °C		Only available if B1 = fixed.
C122	Enter the $\alpha$ value of the calibration solution	<b>2.10 %/K</b> 0.00 to 20.00 %/K		The value is given in the Technical Information for all E+H calibration solutions. You can also use the printed-on table to calculate the value. Set $\alpha$ to 0 for calibration with uncompensated values.
C123	Enter the correct conductivity value of the calibration solution	<b>Current measured value</b> 0.0 $\mu\text{S}/\text{cm}$ to 9999 mS/cm		A value close to the subsequent operating range should be selected.

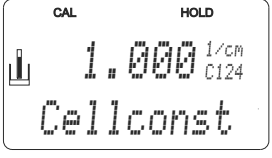
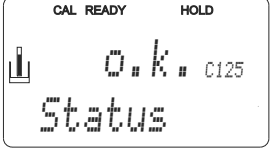
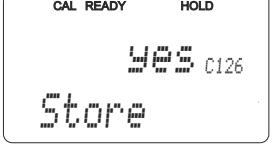
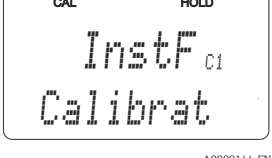
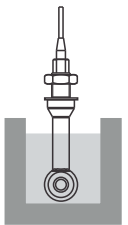
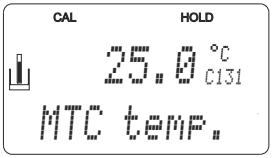
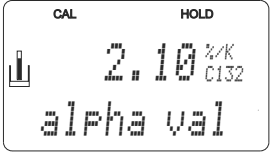
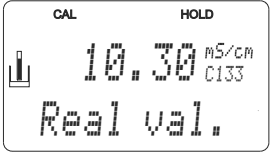
Coding	Field	Range of adjustment (factory settings in bold)	Display	Info
C124	The calculated cell constant is displayed	0.0025 to 99.99 cm <sup>-1</sup>	 <p>CAL HOLD 1.000 1/cm C124 Cellconst A0009152-EN</p>	The calculated cell constant is displayed and accepted in A5.
C125	Calibration status is displayed	<b>o.k.</b> E xxx	 <p>CAL READY HOLD o.k. C125 Status A0009153-EN</p>	If the calibration status is not o.k., a reason for the error is provided on the second line of the display.
C126	Store calibration result?	<b>Yes</b> No New	 <p>CAL READY HOLD yes C126 Store A0009154-EN</p>	If C125 = E xxx, then only <b>No</b> or <b>New</b> . If New, return to C. If Yes/No, return to "Measurement".
C1(3)	<i>Calibration with sensor adjustment for inductive sensors (only for Plus Package)</i>	Airs = air set (1) Cellc = cell constant (2) <b>InstF = installation factor (3)</b>	 <p>CAL HOLD InstF C1 Calibrat A0009144-EN</p>	Sensor adjustment with compensation for wall effects. In the case of inductive sensors, the measured value is influenced by the distance between the sensor and the pipe wall and by the material of the pipe (conductive or insulating). The installation factor indicates these dependencies. See the Technical Information of the sensor used for more information
The inductive sensor is mounted at the place of installation.			 <p>A0025599</p>	
C131	<i>Enter the process temperature (MTC)</i>	<b>25 °C</b> -35.0 to 250.0 °C	 <p>CAL HOLD 25.0 °C C131 MTC temp. A0009155-EN</p>	Only available if B1 = fixed.
C132	<i>Enter the a value of the calibration solution</i>	<b>2.10 %/K</b> 0.00 to 20.00 %/K	 <p>CAL HOLD 2.10 %/K C132 alpha val A0009156-EN</p>	The value is given in the TI for all E+H calibration solutions. You can also use the printed-on table to calculate the value. Set a to 0 for calibration with uncompensated values.
C133	<i>Enter the correct conductivity value of the calibration solution</i>	<b>Current measured value</b> 0.0 µS/cm to 9999 mS/cm	 <p>CAL HOLD 10.30 mS/cm C133 Real val. A0009157-EN</p>	A value close to the subsequent operating range should be selected.

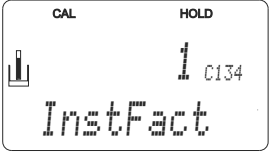
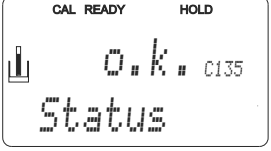
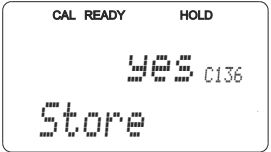
Coding	Field	Range of adjustment (factory settings in bold)	Display	Info
C134	<i>Calculated installation factor is displayed</i>	<b>1</b> 0.10 to 5.00	 <p>A0009158-EN</p>	The installation factor indicates the dependency between the measured value and the distance between the sensor and pipe wall. See the Technical Information of the sensor used for more information.
C135	<i>Calibration status is displayed</i>	<b>o.k.</b> E xxx	 <p>A0009159-EN</p>	If the calibration status is not o.k., a reason for the error is provided on the second line of the display.
C136	<i>Store calibration result?</i>	<b>Yes</b> No New	 <p>A0009160-EN</p>	If C135 = E xxx, then only No or <b>New</b> . If New, return to C. If Yes/No, return to "Measurement".



## 8 Diagnostics and troubleshooting

### 8.1 Trouble shooting instructions

The transmitter continuously monitors its functions itself. If an error occurs which the device recognizes, this is indicated on the display. The error number is shown below the display of the main measured value. If more than one error occurs, you can call these up with the MINUS key.

Refer to the "System error messages" table for the possible error numbers and remedial measures.

Should a malfunction occur without any transmitter error message, please refer to the "Process-specific errors" or the "Device-specific errors" tables to localize and rectify the error. These tables provide you with additional information on any spare parts required.

### 8.2 System error messages

You can display and select the error messages with the MINUS key.

Error No.	Display	Tests/remedial action	Alarm contact	Error current	Autom. cleaning start	PROFIBUS Status
			Facty	Facty	Facty	PV <sup>1)</sup>
			User	User	User	Temp
E001	EEPROM memory error	<ul style="list-style-type: none"> <li>▪ Switch off device and switch it on again.</li> <li>▪ Load software compatible with hardware</li> </ul>	Yes	No	X	OC
					X	OC
E002	Device not calibrated, calibration data invalid, no user data or user data invalid (EEPROM error), device software not suitable for hardware (controller)	<ul style="list-style-type: none"> <li>▪ Load measurement-parameter specific device software.</li> <li>▪ If the error persists, send in the device for repair to your local sales center or replace the device.</li> </ul>	Yes	No	X	OC
					X	OC
E003	Download error	Invalid configuration. Repeat download.	Yes	No	No	OC
						OC
E004	Device software version not compatible with module hardware version	Load software compatible with hardware Load measurement-parameter specific device software.	Yes	No	No	OC
						OC
E007	Transmitter malfunction, device software not compatible with transmitter version		Yes	No	X	OC
					X	OC
E008	Sensor or sensor connection faulty	Check sensor and sensor connection	Yes	No	Yes	OC
						OC
E010	Temperature sensor defective, not connected or short-circuited (measurement continues with 25 °C)	Check temperature sensor and connections; check the measuring device and measuring cable with a temperature simulator if necessary. Check that correct option is selected in field B1	Yes	No	No	80
						OC

Error No.	Display	Tests/remedial action	Alarm contact	Error current	Autom. cleaning start	PROFIBUS Status
			Facty	Facty	Facty	PV <sup>1)</sup>
			User	User	User	Temp
E025	Limit value for air set offset exceeded	Perform air set again (in air) or replace sensor. Dry sensor.	No	No	No	80
						80
E036	Calibration range of sensor exceeded	Clean sensor and recalibrate; if necessary, check sensor and connections.	No	No	No	80
						80
E037	Below calibration range of sensor		No	No	No	80
						80
E045	Calibration aborted	Repeat the calibration	No	No	X	80
					X	80
E049	Calibration range of installation factor exceeded	Check pipe diameter, clean sensor and perform calibration again.	No	No	X	80
					X	80
E050	Below calibration range of installation factor		No	No	X	80
					X	80
E055	Below main parameter measuring range	Check measurement, control and connections	Yes	No	No	44
						80
E057	Main parameter measuring range exceeded		Yes	No	No	44
						80
E059	Below temperature measuring range		Yes	No	No	80
						44
E061	Temperature measuring range exceeded		Yes	No	No	80
						44
E063	Below current output range 1	Check measured value and current assignment	Yes	No	No	80
						80
E064	Current output range 1 exceeded		Yes	No	No	80
						80
E065	Below current output range 2		Yes	No	No	80
						80
E066	Current output range 2 exceeded		Yes	No	No	80
						80
E067	Set point exceeded limit contactor 1	Check configuration	Yes	No	No	80
						80
E068	Set point exceeded limit contactor 2		Yes	No	No	80
						80
E069	Set point exceeded limit contactor 3		Yes	No	No	80
						80
E070	Set point exceeded limit contactor 4		Yes	No	No	80
						80
E071	Incorrect measurement / polarization	Clean sensor; check table; select suitable sensor.	Yes	No	No	44
						80

Error No.	Display	Tests/remedial action	Alarm contact	Error current	Autom. cleaning start	PROFIBUS Status
			Facty	Facty	Facty	PV <sup>1)</sup>
			User	User	User	Temp
E077	Temperature outside $\alpha$ value table range	Clean sensor; check tables	Yes	No	No	44
						80
E078	Temperature outside concentration table		Yes	No	No	44
						80
E079	Conductivity outside concentration table		Yes	No	No	44
						80
E080	Current output 1 range too small	Yes	No	X	80	
				X	80	
E081	Current output 2 range too small	Yes	No	X	80	
				X	80	
E085	Incorrect setting for error current	If the current range "0 to 20 mA" was selected in field O311, the error current may not be set to "2.4 mA".	Yes	No	No	80
						80
E100	Current simulation active		Yes	No	X	80
					X	80
E101	Service function active	Switch off service function or switch device off and then on again.	No	No	X	80
					X	80
E102	Manual mode active		No	No	X	80
					X	80
E106	Download active	Wait for download to finish.	No	No	X	80
					X	80
E116	Download error	Repeat download.	Yes	No	X	0C
					X	0C
E150	Distance between temp. values in $\alpha$ value table too small or not monotonously increasing	Enter correct $\alpha$ value table (temperatures must be entered at intervals of at least 1 K)	No	No	No	44
						80
E151	USP-EP error		Yes	No	No	44
						80
E152	PCS alarm	Check sensor and connection.	Yes	No	No	44
						44
E153	USP-EP temperature error		Yes	No	No	80
						44
E154	Below lower alarm threshold for period exceeding alarm delay	Perform manual comparison measurement if necessary. Service sensor and recalibrate.	Yes	No	No	X
						X
E155	Above upper alarm threshold for period exceeding alarm delay		Yes	No	No	X
						X
E156	Actual value undershoots alarm threshold for longer		Yes	No	No	X

Error No.	Display	Tests/remedial action	Alarm contact	Error current	Autom. cleaning start	PROFIBUS Status
			Facty	Facty	Facty	PV <sup>1)</sup>
			User	User	User	Temp
	than the set permissible maximum period					X
E157	Actual value exceeds alarm threshold for longer than the set permissible maximum period		Yes	No	No	X
						X
E162	Dosage stop	Check settings in the CURRENT INPUT and CHECK function groups.	Yes	No	No	X
						X
E171	Flow in main stream too low or zero	Restore flow.	Yes	No	No	X
						X
E172	Switch-off limit for current input exceeded	Check process variables at sending measuring device. Change range assignment if necessary.	Yes	No	No	X
						X
E173	Current input < 4 mA		Yes	No	No	X
						X
E174	Current input > 20 mA		Yes	No	No	X
						X

1) PV = process variable, primary value

### 8.3 Process-specific errors

Use the following table to localize and rectify any errors occurring.

Error	Possible cause	Tests/remedial action	Tools, spare parts
Incorrect reading compared to comparison measurement	Device calibrated incorrectly	Calibrate the device according to Kap. the "Calibration" section	Calibration solution or cell certificate
	Sensor fouled	Clean sensor	See the "Cleaning of conductivity sensors" section
	Incorrect temperature measurement	Check temperature measured value in measuring device and reference device	Temperature measuring device, precision thermometer
	Temperature compensation incorrect	Check compensation method (none / ATC / MTC) and compensation type (linear/ substance/user table)	Please note: the transmitter has separate calibration and operating temperature coefficients
	Reference device is calibrated incorrectly	Calibrate reference device or use verified device	Calibration solution, Operating Instructions of reference device
	Incorrect ATC setting in reference device	Compensation method and compensation type must be identical on both devices.	Operating Instructions of reference device
	Polarization errors	Use suitable sensor: <ul style="list-style-type: none"> <li>■ Use larger cell constant</li> <li>■ Use graphite instead of stainless steel (check resistance)</li> </ul>	Measuring range tables e.g. in SI "Conductivity" or technical data of conductivity sensors

Error	Possible cause	Tests/remedial action	Tools, spare parts
	Incorrect line resistance in field A6	Enter correct value	CYK71: 165 Ω/km
Implausible measured values in general: <ul style="list-style-type: none"> <li>▪ Continuous measured value overflow</li> <li>▪ Measured value constantly 000</li> <li>▪ Measured value too low</li> <li>▪ Measured value too high</li> <li>▪ Measured value frozen</li> <li>▪ Current output value not as expected</li> </ul>	Short-circuit/moisture in sensor	Check sensor	See the "Checking inductive conductivity sensors" section.
	Short-circuit in cable or socket	Check cable and socket	See the "Connecting lines and junction boxes" section.
	Disconnection in sensor	Check sensor	See the "Checking inductive conductivity sensors" section.
	Disconnection in cable or socket	Check cable and socket	See the "Connecting lines and junction boxes" section.
	Incorrect cell constant setting	Check cell constant	Sensor nameplate or certificate
	Incorrect output assignment	Check assignment of measured value to current signal	
	Incorrect output function	Check preset value (0-20 / 4 -20 mA) and curve shape (linear / table)	
	Air pockets in assembly	Check assembly and installation position	
	Grounding short at or in device	Measure in insulated device	Plastic vessel, calibration solutions
Transmitter module defective	Check with new module	See the "Spare parts" section	
Device in impermissible operating condition (does not respond when key pressed)	Switch off device and switch it on again	EMC problem: if this persists, check the grounding, shields and line routing or have checked by E+H Service.	
Incorrect conductivity measured value in the process	No/incorrect temperature compensation	ATC: select type of compensation; if linear, set suitable coefficients. MTC: set process temperature.	
	Incorrect temperature measurement	Check temperature measured value.	Reference device, thermometer
	Bubbles in medium	Suppress formation of bubbles by: <ul style="list-style-type: none"> <li>▪ Gas bubble trap</li> <li>▪ Creating counterpressure (orifice plate)</li> <li>▪ Measurement in bypass</li> </ul>	
	Polarization effects (only with conductive sensors)	Use suitable sensor: <ul style="list-style-type: none"> <li>▪ Use larger cell constant</li> <li>▪ Use graphite instead of stainless steel (check resistance)</li> </ul>	Measuring range tables e.g. in SI "Conductivity" or technical data of conductivity sensors
	Flow rate too high (can lead to bubble formation)	Reduce flow rate or select less turbulent mounting location.	
	Voltage potential in medium (only for conductive)	Ground medium close to sensor.	Problem mainly occurs in plastic lines and tanks
	Sensor fouling or buildup on sensor	Clean the sensor (see the "Cleaning the conductivity sensors" section).	For heavily contaminated media: Use spray cleaning
	Incorrect line resistance in field A6	Enter correct value	CYK71: 165 Ω/km

Error	Possible cause	Tests/remedial action	Tools, spare parts
Incorrect temperature value	Incorrect sensor connection	Check connections using wiring diagram. Three-wire connection always required.	Wiring diagram in "Electrical connection" section
	Measuring cable defective	Check cable for interruptions/short-circuit/shunt.	Ohmmeter
	Incorrect sensor type	Set type of temperature sensor at the device (field B1).	
Fluctuations in measured value	Interference on measuring cable	Connect cable shield as per wiring diagram	See the "Electrical connection" section
	Interference on signal output cable	Check cable routing, possibly route cable separately	Route signal output and measuring input lines separately
	Interference potential in medium	Eliminate source of interference or ground medium as close as possible to sensor.	
	Electromagnetic interference on signal lines with conductive sensors	Use shielded cables and ground the cable shield	
Controller or timer cannot be activated	No relay module available	Install LSR1-2 or LSR1-4 module	
Controller/limit contact does not work	Controller switched off	Activate controller	See fields R2xx
	Controller in operating mode "Manual off"	Select "Auto" or "Manual on" mode	Keyboard, REL key
	Pickup delay setting too long	Switch off or shorten pickup delay time	See fields R2xx
	"Hold" function active	"Auto hold" for calibration, "Hold" input activated; "Hold" active via keyboard	See fields S2 to S5
Controller/limit contact works continuously	Controller in operating mode "Manual on"	Select "Auto" or "Manual off" mode	Keyboard, REL and AUTO keys
	Dropout delay setting too long	Shorten dropout delay time	See fields R2xx
	Control loop interruption	Check measured value, current output value, actuators, chemical supply	
No conductivity current output signal	Cable disconnected or short-circuited	Disconnect cable and measure directly at device	mA meter 0–20 mA
	Output defective	See the "Device-specific errors" section	
Fixed conductivity current output signal	Current simulation active	Switch off simulation.	See field O3
	Impermissible operating state of processor system	Disconnect line voltage for approx. 10 seconds	Possibly EMC problem: if problem persists, check grounding and wire routing.
Incorrect current output signal	Incorrect current assignment	Check current assignment: 0–20 mA or 4–20 mA?	Field O311
	Total load in the current loop too high (> 500 Ω)	Disconnect output and measure directly at device	mA meter for 0–20 mA DC
	EMC (interference coupling)	Disconnect both output cables and measure directly at device	Use shielded cables, ground shields at both ends, where necessary route cable in another cable duct

Error	Possible cause	Tests/remedial action	Tools, spare parts
Current output table is not accepted	Value interval too small	Select practical intervals	
No temperature output signal	Device does not have a second current output	Check version using nameplate, if necessary replace the LSCH-x1 module	LSCH-x2 module, see the "Spare parts" section
	Device with PROFIBUS-PA	PA device has no current output!	
Chemoclean function not available	No relay module (LSR1-x) installed or only LSR1-2 available Additional function not enabled	Install LSR1-4 module. Chemoclean is enabled using the release code supplied by the manufacturer in the Chemoclean retrofit kit. To check the version, see the nameplate	LSR1-4 module, see the "Spare parts" section
Plus Package functions not available	Plus Package not enabled (enable by entering a code which depends on the serial number and which is supplied by E+H when a Plus Package is ordered)	<ul style="list-style-type: none"> <li>▪ For Plus Package retrofit: code is supplied by E+H → enter this code.</li> <li>▪ After replacing a defective LSCH/LSCP module: first enter device serial number manually (see nameplate), then enter the existing code number.</li> </ul>	For a detailed description, see the "Replacement of central module" section.
No HART communication	No HART central module	Verify using nameplate: HART = -xxx5xx and -xxx6xx	Upgrade to LSCH-H1 / -H2
	No or incorrect DD (device description)	For further information, see BA00208C/07/EN, "HART field communication with Liquisys CxM223/253"	
	HART interface missing		
	Current output < 4 mA		
	Load too small (must be > 230 Ω)		
	HART receiver (e.g. FXA 191) not connected via load but via power supply		
	Incorrect device address (addr. = 0 for single operation, addr. > 0 for multidrop operation)		
	Line capacitance too high		
	Interference on line		
	Several devices set to same address	Assign addresses correctly	No communication possible if several devices set to the same address
No PROFIBUS communication	No PA/DP central module	Verify using the nameplate: PA = -xxx3xx /DP = xxx4xx	Upgrade to LSCP module, see the "Spare parts" section
	Incorrect device software version (without PROFIBUS)	For further information, see BA00209C/07/EN "PROFIBUS PA/DP - Field communication for Liquisys CxM223/253".	Information about PROFIBUS configuration is provided in Technical Information TI00260F, while detailed information about instrumentation and accessories is provided in Operating Instructions BA00198F
	With Commuwin (CW) II: CW II version and device software version incompatible		
	No or incorrect DD/DLL		
	Incorrect baud rate setting for segment coupler in DPV-1 server		

Error	Possible cause	Tests/remedial action	Tools, spare parts
	Bus user (master) has wrong address or address assigned twice		
	Bus user (slave) has wrong address		
	Bus line not terminated		
	Line problems (too long, cross-section too small, not shielded, shield not grounded, wires not twisted)		
	Bus voltage too low (Bus voltage typ. 24 V DC for non-Ex)	The voltage at the device's PA/DP connector must be at least 9 V	

## 8.4 Device-specific errors

The following table helps you during the diagnosis and points to any spare parts required.

Depending on the degree of difficulty and the measuring equipment present, diagnosis is carried out by:

- Trained operator personnel
- The user's trained electrical technicians
- Company responsible for system installation/operation
- Endress+Hauser Service

Information on the exact spare part designations and on how to install these parts can be found in the "Spare parts" section.

Error	Possible cause	Tests/remedial action	Execution, tools, spare parts
Device cannot be operated, display value 9999	Operation locked	Press CAL and MINUS keys simultaneously.	See the "Key functions" section
Display dark, no light-emitting diode active	No line voltage	Check whether line voltage is present	Electrical technician / e.g. multimeter
	Supply voltage wrong/too low	Compare actual line voltage and nameplate data	User (data for energy supply company or multimeter)
	Connection faulty	<ul style="list-style-type: none"> <li>■ Terminal not tightened</li> <li>■ Insulation jammed</li> <li>■ Wrong terminals used</li> </ul>	Electrical technician
	Device fuse defective	Compare line voltage and the nameplate data and replace fuse	Electrical technician/suitable fuse; see exploded drawing in the the "Spare parts" section
	Power unit defective	Replace power unit, note version	Onsite diagnosis by Endress+Hauser Service, test module necessary
	Central module defective	Replace central module, note version	Onsite diagnosis by Endress+Hauser Service, test module necessary
Field device: ribbon cable loose or defective	Check ribbon cable, replace if necessary	See the "Spare parts" section	
Display dark, light-emitting diode active	Central module defective (module: LSCH/LSCP)	Replace central module, note version	Onsite diagnosis by Endress+Hauser Service, test module necessary



Error	Possible cause	Tests/remedial action	Execution, tools, spare parts
Values appear on display but: <ul style="list-style-type: none"> <li>■ Display does not change and / or</li> <li>■ Device cannot be operated</li> </ul>	Device or module in device not correctly mounted	Panel-mounted device: reinstall insert. Field device: remount display module	Perform with the aid of the installation drawings in the "Spare parts" section
	Impermissible operating system condition	Disconnect line voltage for approx. 10 seconds	Possibly Possible EMC problem: if this persists, check the installation or have checked by Endress+Hauser Service
Device gets hot	Voltage wrong/too high	Compare line voltage and nameplate data	User, electrical technician
	Power unit defective	Replace power unit	Diagnosis only by Endress+Hauser Service
Conductivity/MΩ measured value and/or temperature measured value incorrect	Transmitter module defective (module: MKIC), please first carry out tests and take measures as per the "Process-specific errors" section	Measuring input test: <ul style="list-style-type: none"> <li>■ Connect a resistor instead of the conductivity sensor</li> <li>■ 100 Ω resistance at terminals 11/ 12 + 13 = display 0 °C</li> </ul>	If the test is negative: replace module (note version). Perform with the aid of the exploded drawings in the "Spare parts" section.
Current output, incorrect current value	Incorrect adjustment	Check with integrated current simulation, connect mA meter directly to current output.	If simulation value incorrect: adjustment in factory or new LSCH module required. If simulation value correct: check current loop for load and shunts.
	Load too large		
	Shunt / short to ground in current loop		
	Incorrect mode of operation	Check whether 0–20 mA or 4–20 mA is selected.	
No current output signal	Current output stage defective (only for LSCH module; LSCP has no current output)	Check with integrated current simulation, connect mA meter directly to current output	If test negative: Replace central module (note version)
Additional relays not working	Field device: ribbon cable loose or defective	Check ribbon cable seating, replace cable if required.	See the "Spare parts" section
Only 2 additional relays can be triggered	LSR1-2 relay module with 2 relays is installed	Upgrade to LSR1-4 with 4 relays.	User or Endress+Hauser Service
Additional functions (Plus Package) missing	No or incorrect release code used	If retrofitting: check whether the correct serial number was quoted when ordering the Plus Package.	Handled by Endress+Hauser Sales
	Incorrect device serial number saved in LSCH/ LSCP module	Check whether serial number on the nameplate matches SNR in LSCH/ LSCP (field S 8).	The serial number of the device is definitive for the Plus Package.
Additional functions (Plus Package and/or Chemoclean) missing after LSCH/LSCP module replacement	Replacement modules LSCH or LSCP have the device serial number 0000 when they leave the factory. The Plus Package or Chemoclean are not enabled on leaving the factory.	In the case of LSCH/LSCP with SNR 0000, a device serial number can be entered once in fields E115 to E117. Then enter the release codes for the Plus Package and/or Chemoclean if necessary.	For a detailed description, see the "Replacement of central module" section.
No HART or PROFIBUS PA/DP interface function	Incorrect central module	HART: LSCH-H1 or H2 module, PROFIBUS-PA: LSCP-PA module, PROFIBUS-DP: LSCP-DP module, see field E112.	Replace central module; User or Endress+Hauser Service.

Error	Possible cause	Tests/remedial action	Execution, tools, spare parts
	Wrong software	SW version, see field E111.	
	Bus problem	Remove some devices and repeat the test.	Contact Endress+Hauser Service.

## 9 Maintenance

### **⚠ WARNING**

#### **Process pressure and temperature, contamination, electrical voltage**

Risk of serious or fatal injury

- ▶ If the sensor has to be removed during maintenance work, avoid hazards posed by pressure, temperature and contamination.
- ▶ Make sure the device is de-energized before you open it.
- ▶ Power can be supplied to switching contacts from separate circuits. De-energize these circuits before working on the terminals.

Take all the necessary precautions in time to ensure the operational safety and reliability of the entire measuring point.

The maintenance of the measuring point comprises:

- Calibration
- Cleaning the controller, assembly and sensor
- Checking the cables and connections

When performing any work on the device, bear in mind any potential impact this may have on the process control system or on the process itself.

### **NOTICE**

#### **Electrostatic discharge (ESD)**

Risk of damaging the electronic components

- ▶ Take personal protective measures to avoid ESD, such as discharging beforehand at PE or permanent grounding with a wrist strap.
- ▶ For your own safety, only use genuine spare parts. With genuine parts, the function, accuracy and reliability are also ensured after maintenance work.

## 9.1 Maintenance of the entire measuring point

### 9.1.1 Cleaning the transmitter

Clean the front of the housing using commercially available cleaning agents only.

The front of the housing is resistant to the following in accordance with DIN 42 115:

- Ethanol (for a short time)
- Diluted acids (max. 2% HCl)
- Diluted alkaline solutions (max. 3% NaOH)
- Soap-based household cleaning agents

When performing any work on the device, bear in mind any potential impact this may have on the process control system or on the process itself.

**NOTICE****Prohibited cleaning agents**

Damage to the housing surface or housing seal

- ▶ Never use concentrated mineral acids or alkaline solutions for cleaning.
- ▶ Never use organic cleaners such as benzyl alcohol, methanol, methylene chloride, xylene or concentrated glycerol cleaner.
- ▶ Never use high-pressure steam for cleaning purposes.

**9.1.2 Cleaning the conductivity sensors****CAUTION****Risk of injury from cleaning agents, damage to clothing and equipment**

- ▶ Wear protective goggles and safety gloves.
- ▶ Clean away splashes on clothes and other objects.
- ▶ Pay particular attention to the information provided in the safety data sheets for the chemicals used.

Clean away fouling on the sensor as follows depending on the type of fouling:

- Oily and greasy films:  
Clean with grease remover, e.g. alcohol, acetone, possibly hot water and dishwashing detergent.
- Lime and metal hydroxide buildup:  
Dissolve buildup with diluted hydrochloric acid (3 %) and then rinse thoroughly with plenty of clear water.
- Sulfidic buildup (from flue gas desulfurization or sewage treatment plants):  
Use a mixture of hydrochloric acid (3 %) and thiocarbamide (commercially available) and then rinse thoroughly with plenty of clear water.
- Buildup containing proteins (e.g. food industry):  
Use a mixture of hydrochloric acid (0.5 %) and pepsin (commercially available) and then rinse thoroughly with plenty of clear water.

**9.1.3 Simulation of conductive sensors for device testing**

You can test the transmitter for conductive conductivity by replacing the measurement section and temperature sensor with resistors. The accuracy of the simulation will depend on the accuracy of the resistors.

**Temperature**

If a temperature offset is not set at the transmitter, the temperature values of the following table apply:

Pt 100 equivalent resistors	
Temperature	Resistance value
-20 °C (-4 °F)	92.13 Ω
-10 °C (14 °F)	96.07 Ω
0 °C (32 °F)	100.00 Ω
10 °C (50 °F)	103.90 Ω
20 °C (68 °F)	107.79 Ω
25 °C (77 °F)	109.73 Ω
50 °C (122 °F)	119.40 Ω
80 °C (176 °F)	130.89 Ω
100 °C (212 °F)	138.50 Ω
200 °C (392 °F)	175.84 Ω

With the Pt 1000 type of temperature sensor, all the resistance values are increased by a factor of 10.

 Attach the temperature equivalent resistor in a three-wire system.

### Conductivity

If the cell constant  $k$  is set to the value in column 2 of the following table, then the conductivity values of this table apply.

Otherwise the following applies: Conductivity [mS/cm] =  $k[\text{cm}^{-1}] \cdot 1 / R[\text{k}\Omega]$

Resistance R	Cell constant k	Display for conductivity	Display for M $\Omega$
10 $\Omega$	1 $\text{cm}^{-1}$	100 mS/cm	
	10 $\text{cm}^{-1}$	1000 mS/cm	
100 $\Omega$	0.1 $\text{cm}^{-1}$	1 mS/cm	1 $\text{k}\Omega \cdot \text{cm}$
	1 $\text{cm}^{-1}$	10 mS/cm	
	10 $\text{cm}^{-1}$	100 mS/cm	
1000 $\Omega$	0.1 $\text{cm}^{-1}$	0.1 mS/cm	10 $\text{k}\Omega \cdot \text{cm}$
	1 $\text{cm}^{-1}$	1 mS/cm	
	10 $\text{cm}^{-1}$	10 mS/cm	
10 $\text{k}\Omega$	0.01 $\text{cm}^{-1}$	1 $\mu\text{S}/\text{cm}$	1 $\text{M}\Omega \cdot \text{cm}$
	0.1 $\text{cm}^{-1}$	10 $\mu\text{S}/\text{cm}$	100 $\text{k}\Omega \cdot \text{cm}$
	1 $\text{cm}^{-1}$	100 $\mu\text{S}/\text{cm}$	
	10 $\text{cm}^{-1}$	1 mS/cm	
100 $\text{k}\Omega$	0.01 $\text{cm}^{-1}$	0.1 $\mu\text{S}/\text{cm}$	10 $\text{M}\Omega \cdot \text{cm}$
	0.1 $\text{cm}^{-1}$	1 $\mu\text{S}/\text{cm}$	1 $\text{M}\Omega \cdot \text{cm}$
	1 $\text{cm}^{-1}$	10 $\mu\text{S}/\text{cm}$	
1 $\text{M}\Omega$	0.01 $\text{cm}^{-1}$	0.01 $\mu\text{S}/\text{cm}$	100 $\text{M}\Omega \cdot \text{cm}$
	0.1 $\text{cm}^{-1}$	0.1 $\mu\text{S}/\text{cm}$	10 $\text{M}\Omega \cdot \text{cm}$
	1 $\text{cm}^{-1}$	1 $\mu\text{S}/\text{cm}$	
10 $\text{M}\Omega$	0.01 $\text{cm}^{-1}$	0.001 $\mu\text{S}/\text{cm}$	
	0.1 $\text{cm}^{-1}$	0.01 $\mu\text{S}/\text{cm}$	100 $\text{M}\Omega \cdot \text{cm}$

 The M $\Omega$  measurement is normally used for pure and ultrapure water and therefore only makes sense for cell constants  $k = 0.01 \text{ cm}^{-1}$  or  $k = 0.1 \text{ cm}^{-1}$ .

#### 9.1.4 Simulation of inductive sensors for device testing

The inductive sensor cannot be simulated.

However, the overall system comprising the transmitter and inductive sensor can be tested using equivalent resistors. Note the cell constant  $k$  (e.g.  $k_{\text{nominal}} = 1.98 \text{ cm}^{-1}$  for CLS50,  $k_{\text{nominal}} = 5.9 \text{ cm}^{-1}$  for CLS52,  $k_{\text{nominal}} = 6.3 \text{ cm}^{-1}$  for CLS54).

For accurate simulation, the actual cell constant used (visible in field C124) must be used to calculate the display value.

The formula for calculation also depends on the type of sensor:

- CLS50 and CLS52: conductivity reading [mS/cm] =  $k[\text{cm}^{-1}] \cdot 1/R[\text{k}\Omega]$
- CLS54: conductivity reading [mS/cm] =  $k[\text{cm}^{-1}] \cdot 1/R[\text{k}\Omega] \cdot 1.21$

Values for simulation with CLS50 at 25 °C (77 °F):

Simulation resistance R	Default cell constant k	Conductivity reading
2 Ω	1.98 cm <sup>-1</sup>	990 mS/cm
10 Ω	1.98 cm <sup>-1</sup>	198 mS/cm
100 Ω	1.98 cm <sup>-1</sup>	19.8 mS/cm
1 kΩ	1.98 cm <sup>-1</sup>	1.98 mS/cm

Simulation with CLS54 at 25 °C (77 °F):

Simulation resistance R	Default cell constant k	Conductivity reading
10 Ω	6.3 cm <sup>-1</sup>	520 mS/cm
26 Ω	6.3 cm <sup>-1</sup>	200 mS/cm
100 Ω	6.3 cm <sup>-1</sup>	52 mS/cm
260 Ω	6.3 cm <sup>-1</sup>	20 mS/cm
2.6 kΩ	6.3 cm <sup>-1</sup>	2 mS/cm
26 kΩ	6.3 cm <sup>-1</sup>	200 μS/cm
52 kΩ	6.3 cm <sup>-1</sup>	100 μS/cm

#### Conductivity simulation:

Pull a cable through the sensor opening and then connect it to a decade resistor, for instance.

### 9.1.5 Checking conductive sensors

- Measuring surface connection:  
The measuring surfaces are directly connected to the connections of the sensor connector. Check with ohmmeter for < 1 Ω.
- Measuring surface shunt:  
A shunt is not permitted between the measuring surfaces. Check with ohmmeter for > 20 MΩ.
- Temperature sensor shunt:  
A shunt is not permitted between the measuring surfaces and the temperature sensor. Check with ohmmeter for > 20 MΩ.
- Temperature sensor:  
See the sensor nameplate for information on the type of the temperature sensor being used.  
The sensor can be checked at the sensor connector with an ohmmeter:
  - Pt 100 at 25 °C (77 °F) = 109.79 Ω
  - Pt 1000 at 25 °C (77 °F) = 1097.9 Ω
  - NTC 30 k at 25 °C (77 °F) = 30 kΩ
- Terminal:  
For sensors with a terminal connection (CLS12/13) check the assignment of the terminals to ensure they have not been inadvertently interchanged. Check the tightness of the terminal screws.

### 9.1.6 Checking inductive sensors

The following applies to the CLS50, CLS52 and CLS54 sensors.

The sensor cables must be disconnected at the device or junction box for all tests described here!

- Testing the transmitting and receiving coils:
  - Perform the measurement at the white and red coaxial cables, between the inner conductor and shield in each case.
    - Ohmic resistance
      - CLS50/52: approx. 0.5 to 2  $\Omega$
      - CLS54: approx. 1 to 3  $\Omega$
    - Inductance approx. 180 to 500 mH (for 2 kHz, series circuit as equivalent circuit diagram)
      - CLS50: approx. 250 to 450 mH
      - CLS52/54: approx. 180 to 550 mH
- Testing the coil shunt:
  - A shunt is not permitted between the two sensor coils (from red coax to white coax). The measured resistance must be > 20 M $\Omega$ .
  - Test with the ohmmeter from the red coax cable to the white coax cable.
- Temperature sensor test:
  - Use the table in the "Simulation of conductive sensors for device testing" section to check the Pt 100 / Pt 1000 in the sensor.
  - Measure between the green and white wires and between the green and yellow wires.
  - The resistance values must be identical.
- Temperature sensor shunt test:
  - Shunts are not permitted between the temperature sensor and the coils. Check with ohmmeter for > 20 M $\Omega$
  - Measure between the temperature sensor wires (green + white + yellow) and the coils (red and white coax).

### 9.1.7 Assembly

Refer to the assembly operating manual for information on servicing and troubleshooting the assembly. The assembly operating manual describes the procedure for mounting and disassembling the assembly, replacing the sensors and seals, and contains information on the material resistance properties, as well as on spare parts and accessories.

### 9.1.8 Connecting cables and junction boxes

- Use the methods described in chapters "Simulation of conductive/inductive sensors for device test" to perform a quick functional check from the conductivity sensor (sensor connector) to the measuring instrument via an extension. The easiest way to connect resistor decades is with the "Conductivity testing adapter" service kit, order number: 51500629
- Check junction boxes for:
  - Moisture (influence at low conductivity or for M $\Omega$  measurement, where necessary dry box, replace seals, insert dehydrating bag)
  - Correct connection of all lines
  - Connection of the outer shields
  - Tightness of the terminal screws

## 10 Repair

### 10.1 Spare parts

Please order spare parts from your local Sales Office. For this purpose, use the order numbers listed in the "Spare part kits" section.

For safety, you should always provide the following additional data when ordering spare parts:

- Device order code
- Serial number
- Software version, if possible

You can take the order code and serial number from the nameplate.

The software version is provided in the device software provided that the device processor system is still working.

For more detailed information on spare parts kits, please refer to the "Spare Part Finding Tool" on the Internet:

[www.endress.com/spareparts\\_consumables](http://www.endress.com/spareparts_consumables)

### 10.2 Disassembling the panel-mounted device

 Please note the effects on the process if the device is taken out of service!

See the exploded drawing for the item numbers.

1. Disconnect the terminal block (item 420 b) from the rear of the device to de-energize the device.
2. Then disconnect the terminal blocks (item 420 a and 430 where applicable) from the rear of the device. Now you can disassemble the device.
3. Press in the latches of the end frame (item 340) and remove the frame from the rear.
4. Release the special screw (item 400) by turning it counter-clockwise.
5. Remove the entire electronics block from the housing. The modules are only mechanically connected and can be easily separated:
6. Simply remove the processor/display module towards the front.
7. Pull out the brackets of the rear plate (item 320) slightly.
8. Now you can remove the side modules.
9. Remove the conductivity transmitter (item 240) as follows:
10. Using a fine wire cutter, nip off the heads of the synthetic distance holders.
11. Then remove the module from above.

Assembly is the reverse of the disassembly sequence. Tighten the special screw finger-tight without using a tool.

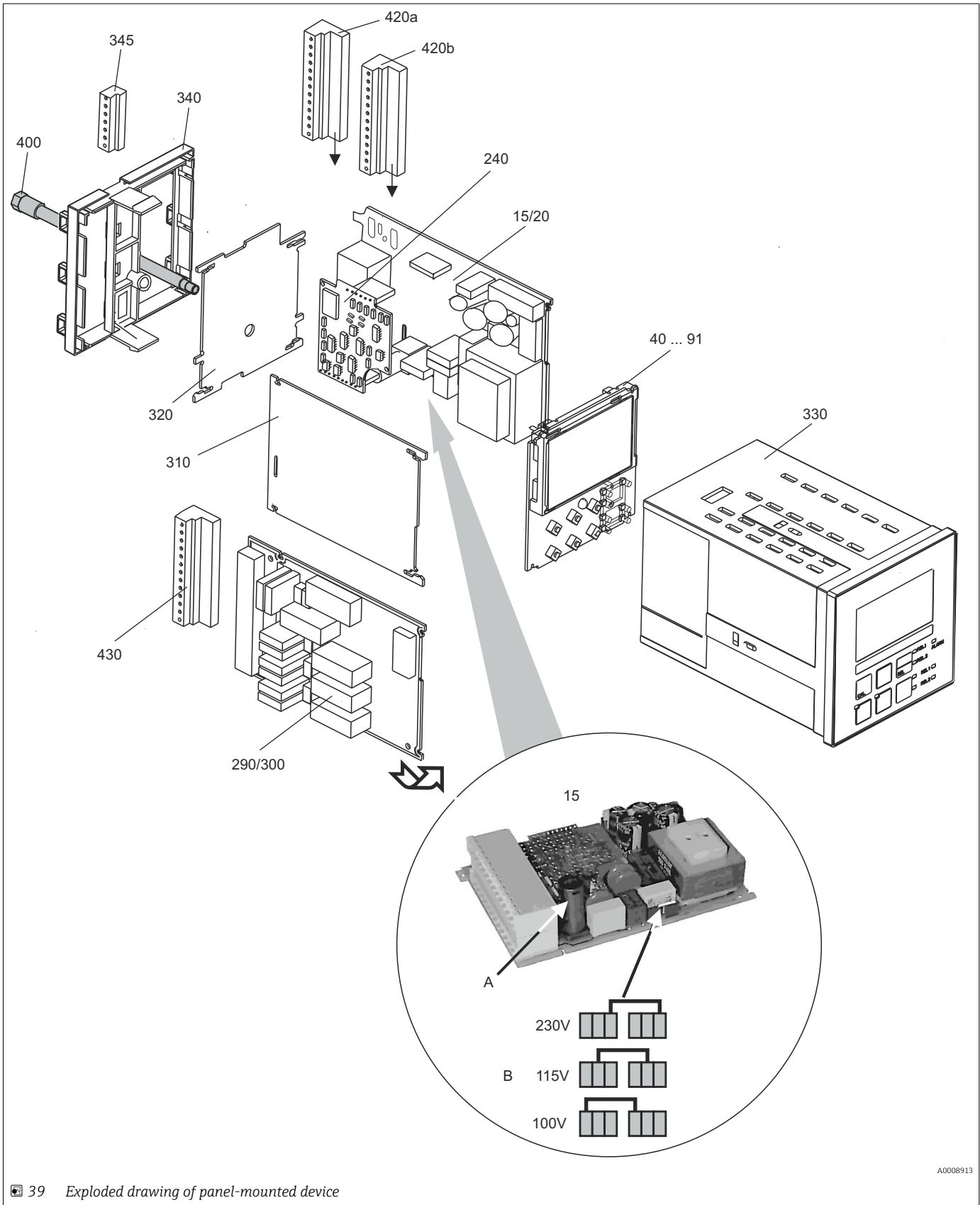



The exploded drawing contains the components and spare parts of the panel-mounted device. You can take the spare parts and the corresponding order number from the following section using the item numbers.

Item	Kit description	Name	Function/contents	Order no.
15	Power unit (main module)	LSGA	100/115/230 V AC	51500317
20	Power unit (main module)	LSGD	24 V AC + DC	51500318
40	Central module (contr.), conductive	LSCH-S1	1 current output	51501210
50	Central module (contr.), conductive	LSCH-S2	2 current outputs	51501212
60	Central module (contr.), conductive	LSCH-H1	1 current output + HART	51501213
70	Central module (contr.), conductive	LSCH-H2	2 current outputs + HART	51501214
80	Central module (contr.), conductive	LSCP-PA	PROFIBUS PA/no current output	51501215
90	Central module (contr.), conductive	LSCP-DP	PROFIBUS DP/no current output	51502502
90	Kit for CLM2x3 conductivity central module, conductive, PROFIBUS DP	LSCP-DP	PROFIBUS DP central module Relay module + 2 relays Current inp. + DP terminals Hardware version 2.10 and higher	71134726
41	Central module (contr.), inductive	LSCH-S1	1 current output	51501216
51	Central module (contr.), inductive	LSCH-S2	2 current outputs	51501218
61	Central module (contr.), inductive	LSCH-H1	1 current output + HART	51501219
71	Central module (contr.), inductive	LSCH-H2	2 current outputs + HART	51501220
81	Central module (contr.), inductive	LSCP-PA	PROFIBUS PA/no current output	51501221
91	Central module (contr.), inductive	LSCP-DP	PROFIBUS DP/no current output	51502501
91	Kit for CLM2x3 conductivity central module, inductive, PROFIBUS DP	LSCP-DP	PROFIBUS DP central module Relay module + 2 relays Current inp. + DP terminals Hardware version 2.10 and higher	71134727
240	Conductivity transmitter (hazardous area version)	MKIC	Conductivity + temperature input	71161137
	Conductivity transmitter	MKIC	Conductivity + temperature input	71161133
290	Relay module	LSR1-2	2 relays	51500320
290	Relay module	LSR2-2i	2 relays + 4-20 mA current input	51504304
290	Kit for Cxm2x3 relay module PROFIBUS DP	LSR2-DP	Relay module + 2 relays Curr. input + DP terminals Hardware version 2.10 and higher	71134732
300	Relay module	LSR1-4	4 relays	51500321
300	Relay module	LSR2-4i	4 relays + 4-20 mA current input	51504305
310	Side panel		Kit with 10 parts	51502124
310, 320, 340, 400	Housing mechanical parts		Rear plate, side panel, end frame, special screw	51501076

Item	Kit description	Name	Function/contents	Order no.
330, 400	Housing module		Housing with front membrane, sensory tappets, seal, special screw, tensioning dogs, connection plates and nameplates	51501075
340	End frame PROFIBUS-DP		Rear frame for PROFIBUS DP, with D-submin plug connector	51502513
345	Grounding terminal strip		PE and shielding terminals	51501086
420a, 420b	Terminal strip set		Complete terminal strip set, standard + HART	51501203
420a, 420b	Terminal strip set		Complete terminal strip set PROFIBUS PA	51502126
420a, 420b	Terminal strip set		Complete terminal strip set PROFIBUS DP	51502493
430	Terminal strip		Terminal strip for relay module	51501078
A	Fuse		Part of power unit, item 15	
B	Choice of line voltage		Position of jumper on power unit, item 15 depending on line voltage	

### 10.3 Disassembling the field device

 Please note the effects on the process if the device is taken out of service!

See the exploded drawing for the item numbers.

You require the following tools to disassemble the field device:

- Standard set of screwdrivers
- Torx screwdriver, size TX 20

Proceed as follows to disassemble the field device:

1. Open and remove the cover of the connection compartment (item 420).
2. Disconnect the supply terminal (item 470) to de-energize the device.
3. Open the display cover (item 410) and release the ribbon cables (item 310/320) on the central module side (item 40 to 91).
4. To remove the central module (item 40) release the screw in the display cover (item 450 b).
5. Proceed as follows to remove the electronics box (item 330):
6. Turn the screws in the housing base (item 450 a) by two revolutions to release them.
7. Then push the entire box backwards and remove it from above while making sure that the module locks do not open.
8. Release the ribbon cables (item 310/320).
9. Bend the module locks out and remove the modules.
10. To remove the docking module (item 340) remove the screws in the housing base (item 450 c) and remove the entire assembly from above.
11. To remove the conductivity transmitter (item 240) nip off the heads of the synthetic distance sleeves using a fine wire cutter.
12. Then remove the module from above.

To assemble, carefully push the modules into the guide rails of the electronics box and let them engage in the side box noses.



It is not possible to mount the modules incorrectly. Modules inserted in the electronics box incorrectly are not operable since the ribbon cables cannot be connected.

Make sure the cover seals are intact to guarantee IP 65 ingress protection.

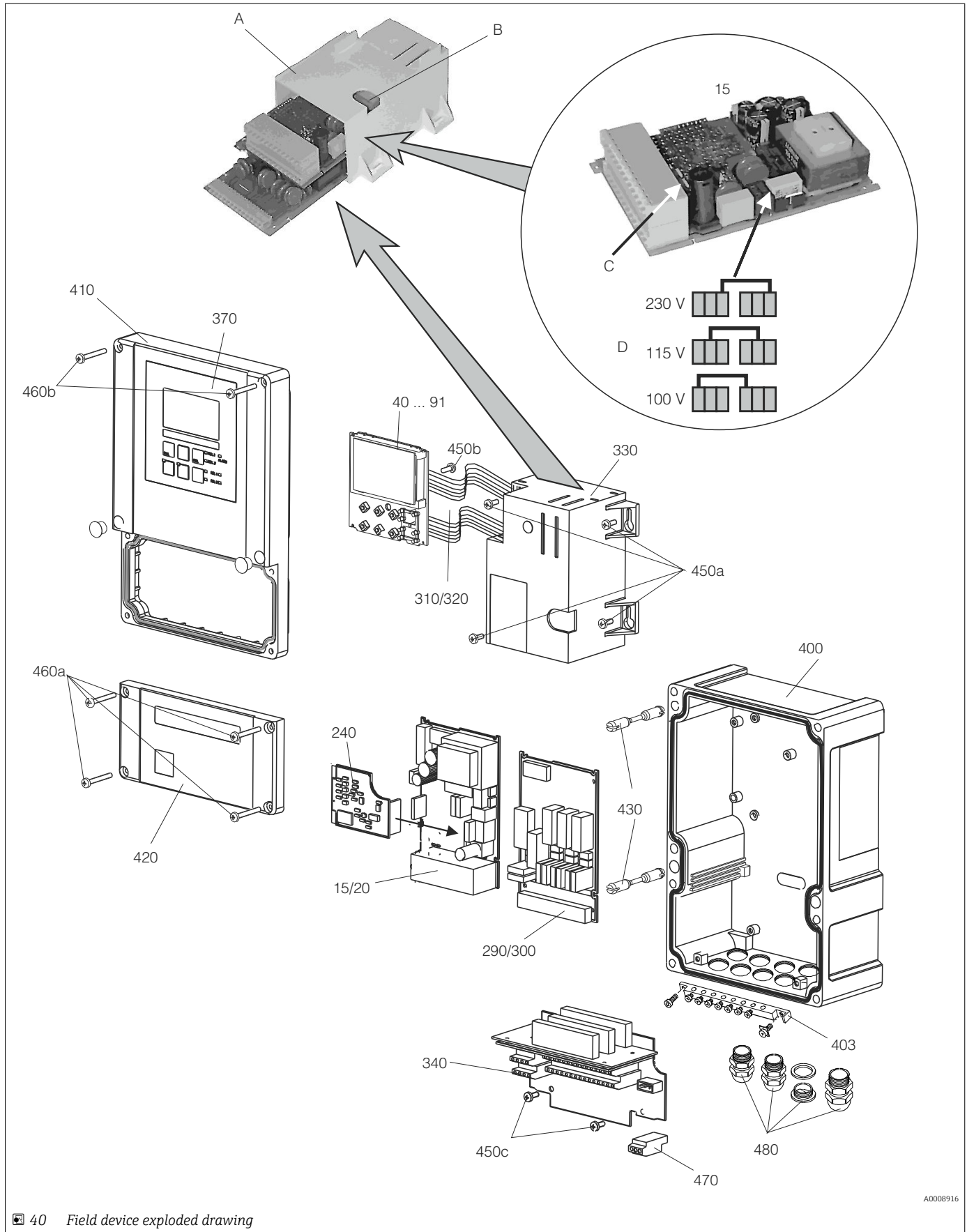

40 Field device exploded drawing

A0008916

The exploded drawing contains the components and spare parts of the field device. You can take the spare parts and the corresponding order number from the following section using the item numbers.

Item	Kit description	Name	Function/contents	Order no.
15	Power unit (main module)	LSGA	100/115/230 V AC	51500317
20	Power unit (main module)	LSGD	24 V AC + DC	51500318
40	Central module (contr.), conductive	LSCH-S1	1 current output	51501210
50	Central module (contr.), conductive	LSCH-S2	2 current outputs	51501212
60	Central module (contr.), conductive	LSCH-H1	1 current output + HART	51501213
70	Central module (contr.), conductive	LSCH-H2	2 current outputs + HART	51501214
80	Central module (contr.), conductive	LSCP-PA	PROFIBUS PA/no current output	51501215
90	Central module (contr.), conductive	LSCP-DP	PROFIBUS DP/no current output	51502502
90	Kit for CLM2x3 conductivity central module, conductive, PROFIBUS DP	LSCP-DP	PROFIBUS DP central module Relay module + 2 relays Current inp. + DP terminals Hardware version 2.10 and higher	71134726
41	Central module (contr.), inductive	LSCH-S1	1 current output	51501216
51	Central module (contr.), inductive	LSCH-S2	2 current outputs	51501218
61	Central module (contr.), inductive	LSCH-H1	1 current output + HART	51501219
71	Central module (contr.), inductive	LSCH-H2	2 current outputs + HART	51501220
81	Central module (contr.), inductive	LSCP-PA	PROFIBUS PA/no current output	51501221
91	Central module (contr.), inductive	LSCP-DP	PROFIBUS DP/no current output	51502501
91	Kit for CLM2x3 conductivity central module, inductive, PROFIBUS DP	LSCP-DP	PROFIBUS DP central module Relay module + 2 relays Current inp. + DP terminals Hardware version 2.10 and higher	71134727
240	Conductivity transmitter (hazardous area version)	MKIC	Conductivity + temperature input	71161137
	Conductivity transmitter	MKIC	Conductivity + temperature input	71161133
290	Relay module	LSR1-2	2 relays	51500320
290	Relay module	LSR2-2i	2 relays + 4-20 mA current input	51504304
290	Kit for Cxm2x3 relay module PROFIBUS DP	LSR2-DP	Relay module + 2 relays Curr. input + DP terminals Hardware version 2.10 and higher	71134732
300	Relay module	LSR1-4	4 relays	51500321
300	Relay module	LSR2-4i	4 relays + 4-20 mA current input	51504305
370, 410, 420, 430	Complete housing cover		Display cover, hinges, connection compartment cover, front membrane	51501068
400, 480	Housing base (mechanics)		Base, threaded joint	51501072

Item	Kit description	Name	Function/contents	Order no.
330, 340, 450	Inner housing fittings		Docking module, empty electronics box, small parts	51501073
310, 320	Ribbon cable lines		2 ribbon cable lines	51501074
430	Hinges		2 pairs of hinges	51501069
470	Terminal strip power supply		2-pin terminal strip	51501079
420a, 420b	Terminal strip set		Complete terminal strip set PROFIBUS DP	51502493
403	PE terminal strip		PE and shielding terminals	51501087
A	Electronics box with relay module LSR-1 (bottom) and power unit LSGA/LSGD (top)			
B	Fuse also accessible if electronics box installed			
C	Fuse		Part of power unit, item 15	
D	Choice of line voltage		Position of jumper on power unit, item 15 depending on line voltage	

## 10.4 Replacing the central module

**i** Generally, when a central module has been replaced, all data which can be changed are set to the factory setting.

If possible, note the customized settings of the device, such as:

- Calibration data
- Current assignment, main parameter and temperature
- Relay function selections
- Limit value/controller settings
- Cleaning settings
- Monitoring functions
- Interface parameters

Proceed as described below if a central module is replaced:

1. Disassemble the device as explained in the "Dismantling the panel-mounted instrument" or "Dismantling the field instrument" section.
2. Use the part number on the central module to check whether the new module has the same part number as the previous module.
3. Reassemble the device with the new module.
4. Put the device back into operation and check the basic functions (e.g. measured value and temperature display, operation via keyboard).
5. Read the serial number ("ser-no.") off the nameplate of the device (e.g. 6A345605G00) and enter this number in fields E115 (1st digit = year, one-digit (6 in the example)), E116 (2nd digit: month, one-digit (A in the example)), E117 (digits 3-6 cons. number, four-digit (3456 in the example)).
  - ↳ In the field E118, the complete number is displayed again so you can check it is correct.

**i** You can only enter the serial number for new modules with the serial number 0000. This can only be done once! For this reason, make sure the number entered is correct before you press ENTER to confirm!

If an incorrect code is entered, the additional functions are not enabled. An incorrect serial number can only be corrected at the factory!

1. Press ENTER to confirm the serial number or cancel the entry to enter the number again.
2. If available, enter the release codes for the Plus Package and/or Chemoclean in the "Service" menu.
3. Check the Plus Package release (e.g. by opening the function group CHECK / Code P) or the Chemoclean function.
4. Make the customized device settings again.

## 10.5 Return

The product must be returned if repairs or a factory calibration are required, or if the wrong product was ordered or delivered. As an ISO-certified company and also due to legal regulations, Endress+Hauser is obliged to follow certain procedures when handling any returned products that have been in contact with medium.

To ensure swift, safe and professional device returns, please read the return procedures and conditions at [www.endress.com/support/return-material](http://www.endress.com/support/return-material).

## 10.6 Disposal

The device contains electronic components and must therefore be disposed of in accordance with regulations on the disposal of electronic waste.

Observe the local regulations.

# 11 Accessories

## 11.1 Sensors

### 11.1.1 Sensors with conductive measurement of conductivity

#### Condumax CLS12

- Conductive conductivity sensor
- For pure water, Ex and high-temperature applications
- Product Configurator on the product page: [www.endress.com/CLS12](http://www.endress.com/CLS12)



Technical Information TI00082C

#### Condumax CLS13

- Conductive conductivity sensor
- For pure water, Ex and high-temperature applications
- Product Configurator on the product page: [www.endress.com/CLS13](http://www.endress.com/CLS13)



Technical Information TI00083C

#### Condumax CLS15

- Conductive conductivity sensor
- For pure water applications, ultrapure water applications and Ex applications
- Product Configurator on the product page: [www.endress.com/CLS15](http://www.endress.com/CLS15)



Technical Information TI00109C

#### Condumax CLS16

- Hygienic, conductive conductivity sensor
- For pure water applications, ultrapure water applications and Ex applications
- With EHEDG and 3A approval
- Product Configurator on the product page: [www.endress.com/CLS16](http://www.endress.com/CLS16)



Technical Information TI00227C

#### Condumax CLS19

- Cost-effective, conductive conductivity sensor
- For applications with pure and ultrapure water
- Product Configurator on the product page: [www.endress.com/CLS19](http://www.endress.com/CLS19)



Technical Information TI00110C

#### Condumax

- Two-electrode sensor in plug-in head version version
- Product Configurator on the product page: [www.endress.com/CLS21](http://www.endress.com/CLS21)



Technical Information TI00085C

### 11.1.2 Sensors with inductive measurement of conductivity

#### Indumax CLS50

- High-durability inductive conductivity sensor
- For standard and hazardous area applications
- Product Configurator on the product page: [www.endress.com/cls50](http://www.endress.com/cls50)



Technical Information TI00182C



**Indumax CLS52**

- Inductive conductivity sensor
- Short response times for the food industry
- Product Configurator on the product page: [www.endress.com/CLS52](http://www.endress.com/CLS52)



Technical Information TI00167C

**Indumax CLS54**

- Inductive conductivity sensor
- For standard and hazardous area applications, available with hygienic design for food, beverages, pharmaceuticals and biotechnology
- Product Configurator on the product page: [www.endress.com/CLS54](http://www.endress.com/CLS54)



Technical Information TI00400C

## 11.2 Connection accessories

**Measuring cable CYK71**

- Underterminated cable for connecting analog sensors and for extending sensor cables
- Sold by the meter, order numbers:
  - Non-Ex version, black: 50085333
  - Ex-version, blue: 50085673

**Measuring cable CLK6**

- Extension cable for inductive conductivity sensors, for extension via VBM junction box
- Sold by the meter, order number: 71183688

**VBM**

- Junction box for cable extension
- 10 terminal strips
- Cable entries: 2 x Pg 13.5 or 2 x NPT ½"
- Material: aluminum
- Degree of protection: IP 65
- Order numbers
  - Cable entries Pg 13.5 : 50003987
  - Cable entries NPT ½": 51500177

## 11.3 Installation accessories

**CYY101**

- Weather protection cover for field devices
- Absolutely essential for field installation
- Material: stainless steel 1.4301 (AISI 304)
- Order No. CYY101-A

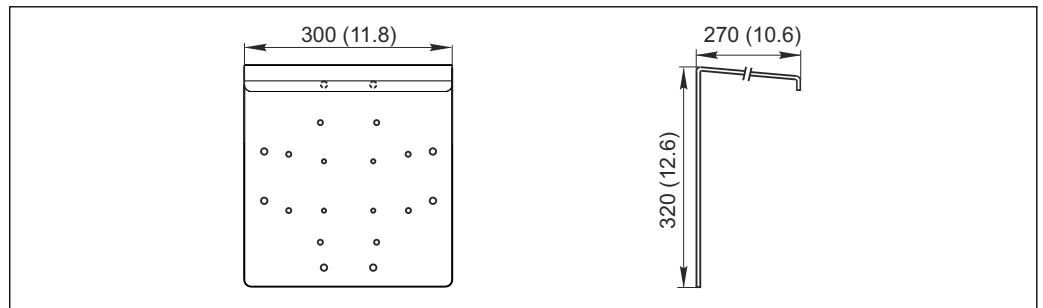

41 Dimensions in mm (inch)

A0024627

**Flexdip CYH112**

- Modular holder system for sensors and assemblies in open basins, channels and tanks
- For Flexdip CYA112 water and wastewater assemblies
- Can be affixed anywhere: on the ground, on the capstone, on the wall or directly onto railings.
- Stainless steel version
- Product Configurator on the product page: [www.endress.com/cyh112](http://www.endress.com/cyh112)



Technical Information TI00430C

**Post mounting kit**

- For securing the field housing to horizontal and vertical posts and pipes
- Material: stainless steel 1.4301 (AISI 304)
- Order No. 50086842

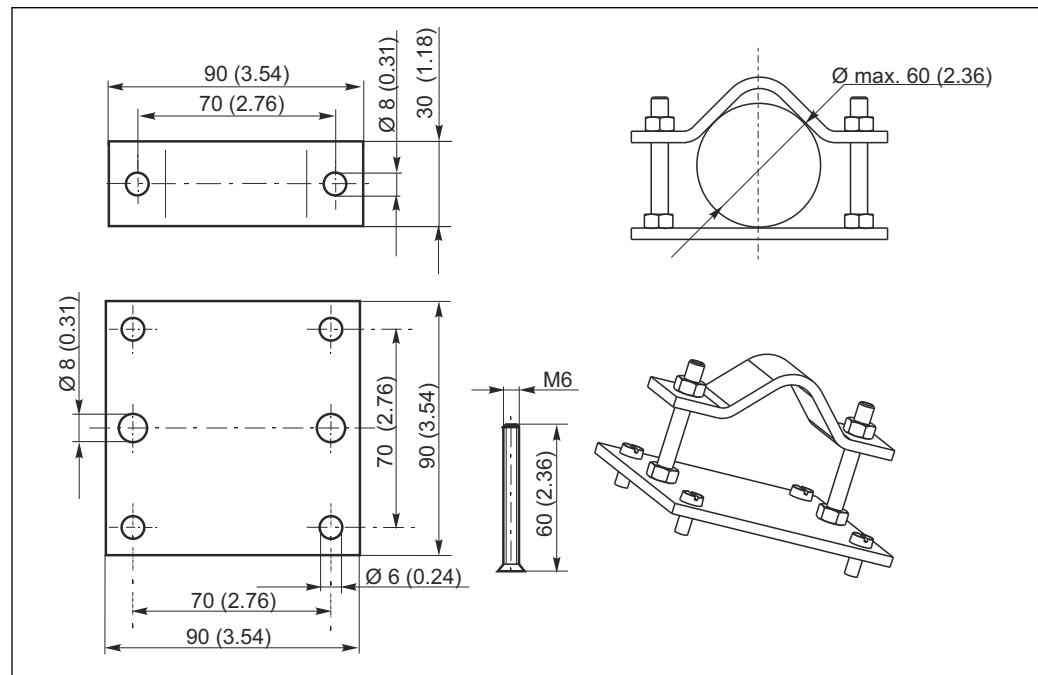

42 Dimensions in mm (inch)

**11.4 Software and hardware add-ons**

The add-ons can only be ordered by quoting the serial number of the device in question.

- Plus Package  
Order No. 51500385
- Chemoclean function (requires four-relay card)  
Order No. 51500963
- Two-relay card  
Order No. 51500320
- Four-relay card  
Order No. 51500321
- Two-relay card with current input  
Order No. 51504304
- Four-relay card with current input  
Order No. 51504305

## 11.5 Calibration solutions

### Conductivity calibration solutions CLY11

Precision solutions referenced to SRM (Standard Reference Material) by NIST for qualified calibration of conductivity measuring systems in accordance with ISO 9000

CLY11-B, 149.6  $\mu\text{S}/\text{cm}$  (reference temperature 25 °C (77 °F)), 500 ml (16.9 fl.oz)

Order No. 50081903



Technical Information TI00162C

## 12 Technical data

### 12.1 Input

Measured variables	Conductivity Resistivity Temperature	
Measuring range	Conductivity (conductive)	0 to 600 mS/cm (uncompensated)
	Conductivity (inductive)	0 to 2000 mS/cm (uncompensated)
	Resistance	0 to 200 MΩcm
	Concentration	0 to 9999 (% , ppm, mg/l, TDS)
	Temperature	-35 to +250 °C (can also be displayed in °F)
Cell constant	Configurable cell constant	k = 0.0025 to 99.99 cm <sup>-1</sup>
Connectable temperature sensors	Pt 100, Pt 1000, NTC 30K	
Measuring frequency	Conductivity, resistance (conductive)	170 Hz to 2 kHz
	Conductivity (inductive)	2 kHz
Binary inputs	Voltage	10 to 50 V
	Current consumption	Max. 10 mA
Current input	4 to 20 mA, galvanically isolated Load: 260 Ω for 20 mA (voltage drop 5.2 V)	

### 12.2 Output

Output signal	<b>HART</b>	
	Signal encoding	Frequency Shift Keying (FSK) + 0.5 mA via current output signal
	Data transmission rate	1200 baud
	Galvanic isolation	Yes
	<b>PROFIBUS PA</b>	
	Signal encoding	Manchester Bus Powered (MBP)
	Data transmission rate	31.25 kBit/s, voltage mode
	Galvanic isolation	Yes (IO modules)

PROFIBUS DP	
Signal encoding	RS485
Data transmission rate	9.6 kBd, 19.2 kBd, 93.75 kBd, 187.5 kBd, 500 kBd, 1.5 MBd
Galvanic isolation	Yes (IO modules)

Signal on alarm 2.4 or 22 mA in the event of an error

Load Max. 500  $\Omega$

Transmission range	Conductivity	Configurable
	Resistivity	Configurable
	Concentration	Configurable
	actuating variable	Configurable
	Temperature	Configurable

Signal resolution Max. 700 digits/mA

Minimum turndown of output signal	Conductivity	
	Measured value 0 to 1.999 $\mu\text{S/cm}$	0.2 $\mu\text{S/cm}$
	Measured value 0 to 19.99 $\mu\text{S/cm}$	2 $\mu\text{S/cm}$
	Measured value 20 to 199.9 $\mu\text{S/cm}$	20 $\mu\text{S/cm}$
	Measured value 200 to 1999 $\mu\text{S/cm}$	200 $\mu\text{S/cm}$
	Measured value 2 to 19.99 mS/cm	2 mS/cm
	Measured value 20 to 2000 mS/cm	20 mS/cm
	Resistance	
	Measured value 0 to 199.9 k $\Omega\text{cm}$	20 k $\Omega\text{cm}$
	Measured value 200 to 1999 k $\Omega\text{cm}$	200 k $\Omega\text{cm}$
	Measured value 2 to 19.99 M $\Omega\text{cm}$	2.0 M $\Omega\text{cm}$
	Measured value 20 to 200 M $\Omega\text{cm}$	20 M $\Omega\text{cm}$
	Concentration	No minimum turndown
	Temperature	15 $^{\circ}\text{C}$

Separation voltage Max. 350 V<sub>RMS</sub> / 500 V DC

Auxiliary voltage output	Output voltage	15 V $\pm$ 0.6 V
	Output current	Max. 10 mA

Contact outputs	Switching current with ohmic load ( $\cos \varphi = 1$ )	Max. 2 A
	Switching current with inductive load ( $\cos \varphi = 0.4$ )	Max. 2 A
	Switching voltage	Max. 250 V AC, 30 V DC
	Switching power with ohmic load ( $\cos \varphi = 1$ )	Max. 500 VA AC, 60 W DC
	Switching power with inductive load ( $\cos \varphi = 0.4$ )	Max. 500 VA AC, 60 W DC

Limit contactors Pickup/dropout delay 0 to 2000 s

Controller	Function (configurable)	Pulse length/pulse frequency controller, continuous controller
	Controller behavior	P, PI, PD, PID, basic load dosing
	Control gain $K_p$	0.01 to 20.00
	Integral action time $T_n$	0.0 to 999.9 min
	Derivative action time $T_v$	0.0 to 999.9 min
	Period length for pulse length controller	0.5 to 999.9 s
	Frequency for pulse frequency controller	60 to 180 min <sup>-1</sup>
	Basic load	0 to 40 % of max. actuating variable

Alarm	Function (switchable)	Latching/momentary contact
	Alarm threshold adjustment range	Conductivity/resistance/concentration/temperature/USP/EP: entire range
	Alarm delay	0 to 2000 s
	Monitoring time for lower limit violation	0 to 2000 min
	Monitoring time for upper limit violation	0 to 2000 min

Protocol-specific data	<b>HART</b>	
	Manufacturer ID	11 <sub>h</sub>
	Device type	0092 <sub>h</sub> (inductive measurement), 0093 <sub>h</sub> (conductive measurement)
	Transmitter-specific revision	0001 <sub>h</sub>
	HART version	5.0
	Device description files (DD)	<a href="http://www.endress.com/hart">www.endress.com/hart</a>
	HART load (communication resistor)	250 Ω
	Device variables	None (only dynamic variables PV and SV)
	Supported features	-

<b>PROFIBUS PA</b>	
Manufacturer ID	11 <sub>h</sub>
Device type	1515 <sub>h</sub>
Device revision	0001 <sub>h</sub>
Profile version	2.0
GSD files	<a href="http://www.endress.com/profibus">www.endress.com/profibus</a>
GSD version	
Output values	Primary value, temperature
Input variables	PCS display value
Supported features	Device lock: The device can be locked using the hardware or software.

<b>PROFIBUS DP</b>	
Manufacturer ID	11 <sub>h</sub>
Device type	1521 <sub>h</sub>
Profile version	2.0
GSD files	<a href="http://www.endress.com/profibus">www.endress.com/profibus</a>
GSD version	
Output values	Primary value, temperature
Input variables	PCS display value
Supported features	Device lock: The device can be locked using the hardware or software.

## 12.3 Power supply

Supply voltage	Depending on order version: <ul style="list-style-type: none"> <li>■ 100/115/230 V AC +10/-15 %, 48 to 62 Hz</li> <li>■ 24 V AC/DC +20/-15 %</li> </ul>
----------------	--

Power supply via fieldbus

<b>HART</b>	
Supply voltage	Not applicable, active current outputs
Reverse polarity protection	Not applicable, active current outputs

<b>PROFIBUS PA</b>	
Supply voltage	9 V to 32 V, max. 35 V
Sensitivity to reverse polarity	No
FISCO/FNICO compliant according to IEC 60079-27	No

<b>PROFIBUS DP</b>	
Supply voltage	9 V to 32 V, max. 35 V
Sensitivity to reverse polarity	Not applicable
FISCO/FNICO compliant according to IEC 60079-27	No

Power consumption	Max. 7.5 VA
-------------------	-------------

Mains fuse	Fine-wire fuse, semi-delay 250 V/3.15 A
------------	---

Circuit breaker	<p><b>NOTICE</b></p> <p><b>The device does not have a power switch</b></p> <ul style="list-style-type: none"> <li>▶ The customer must provide a protected circuit breaker in the vicinity of the device.</li> <li>▶ The circuit breaker must be a switch or power switch, and you must label it as the circuit breaker for the device.</li> <li>▶ At the supply point, the power supply for the 24 V versions must be isolated from dangerous live cables by double or reinforced insulation.</li> </ul>
-----------------	--

Cable specification	Cable length (conductive)	Conductivity: max. 100 m (330 ft) (CYK71) Resistance: max. 15 m (49 ft) (CYK71)
	Cable length (inductive)	Max. 55 m (180 ft) (CLK5)
	CYK71 cable resistance	165 Ω/km (conductivity measurement)

Overvoltage protection	According to EN 61000-4-5
------------------------	---------------------------



## 12.4 Performance characteristics

Reference operating conditions	Reference temperature:	25 °C (77 °F)
Measured value resolution	Conductivity	Depends on measured value; 0.001 $\mu\text{S}/\text{cm}$ up to a measured value of 1.999 $\mu\text{S}/\text{cm}$ and $k \leq 0.5 \text{ cm}^{-1}$
	Temperature	0.1 °C
Maximum measured error	Display	
	Conductivity	Max. 0.5 % of measured value $\pm$ 4 digits
	Resistance	Max. 0.5 % of measured value $\pm$ 4 digits
	Temperature	Max. 1.0 % of measuring range
	Signal output	
	Conductivity	Max. 0.75 % of current output range
	Resistance	Max. 0.75 % of current output range
Temperature	Max. 1.25 % of measuring range	
 Measured errors in accordance with DIN IEC 746 Part 1, at rated operating conditions		
Repeatability	Max. 0.2% of measured value $\pm$ 2 digits	
Temperature compensation	Range	-35 to +250 °C (-30 to 480 °F)
	Types of compensation	Uncompensated, linear, NaCl, table Conductive only: ultrapure water NaCl, ultrapure water HCl
Offset	Temperature	$\pm$ 5 °C for adjusting the temperature display

## 12.5 Environment

Ambient temperature range	-10 to +55 °C (+10 to +130 °F)	
Storage temperature	-25 to +65 °C (-10 to +150 °F)	
Electromagnetic compatibility	Interference emission and interference immunity as per EN 61326-1:2006, EN 61326-2-3:2006	
Degree of protection	Field device	IP 65 / integrity according to NEMA 4X
	Panel-mounted device	IP 54 (front), IP 30 (housing)
Electrical safety	As per EN/IEC 61010-1:2010, overvoltage category II for installations up to 2000 m (6500 ft) above MSL	
CSA	Device versions with CSA General Purpose approval are certified for indoor use.	

---

Relative humidity            10 to 95%, not condensing

---

Degree of contamination    The product is suitable for pollution degree 2.

## 12.6 Mechanical construction

---

Dimensions	Panel-mounted device	L x B x D: 96 x 96 x 145 mm (3.78" x 3.78" x 5.71") Installation depth: approx. 165 mm (6.50 ")
	Field device	L x B x D: 247 x 170 x 115 mm (9.72" x 6.69" x 4.53")
Weight	Panel-mounted device	Max. 0.7 kg (1.54 lbs.)
	Field device	Max. 2.3 kg (5.07 lbs.)
Materials	Panel-mounted device housing	Polycarbonate
	Field housing	ABS PC FR
	Front membrane	Polyester, UV-resistant
Terminals	Cable cross-section	Max. 2.5 mm <sup>2</sup> (14 AWG)

---

# 13 Appendix

<p>Function group <b>CALIBRATION</b> C</p> <p>MEAS. VALUE DISPLAY with TEMPERATURE DISPLAY in °C</p> <p>Function group <b>SETUP 1</b> A</p> <p>Function group <b>SETUP 2</b> B</p> <p>Function group <b>CURRENT INPUT</b> Z</p>	<p>Calibration</p> <p>InstF = Installation factor C1 (3)</p>	<p>Calibration temperature entry (MTC)</p> <p>25.0 °C -35.0 ... +250.0 °C C131</p>	<p>Entry of <math>\alpha</math> value of calibration solution</p> <p>2.10 %/K 0.00 ... 20.00 %/K C132</p>	<p>Entry of correct conductivity value of calibration solution</p> <p>Current meas. value C133 0.0 <math>\mu</math>S/cm ... 9999 mS/cm</p>	<p>Display of calculated installation factor</p> <p>1.0 0.10 ... 5.0 C134</p>	<p>Calibration status is displayed</p> <p>o.k.; E--- C135</p>	
	<p>Cellc = Cell constant C1 (2)</p>	<p>Calibration temperature entry (if B1 = fixed)</p> <p>25.0 °C -35.0 ... +250.0 °C C121</p>	<p>Entry of <math>\alpha</math> value of calibration solution</p> <p>2.10 %/K 0.00 ... 20.00 %/K C122</p>	<p>Entry of correct</p> <p>C123</p>	<p>Display of calculated cell constant</p> <p>0.0025 ... 99.99 1/cm C124</p>	<p>Calibration status is displayed</p> <p>o.k.; E--- C125</p>	
	<p>AirS = Airset C1 (1)</p>	<p>Residual coupling Start calibration</p> <p>Current meas. value C111</p>	<p>Display of residual coupling (Airset)</p> <p>0.0 <math>\mu</math>S C112</p>	<p>Calibration status is displayed</p> <p>o.k. E--- C113</p>	<p>Store calibration results</p> <p>yes; no; new C114</p>		
		<p>Temperature display in °F</p>	<p>Temperature display suppressed</p>	<p>Measured value display Current output in %</p>	<p>Measured value display Current output in mA</p>	<p>Uncompensated measured value is displayed</p>	
		<p>1st error is displayed (if present)</p>	<p>Other errors are displayed (up to 10 errors)</p>				
	<p>Selection of operation mode</p> <p>cond = conductive ind = inductive MOhm = resistance conc = concentration A1</p>	<p>Selection of unit displayed</p> <p>ppm; mg/l; %; TDS; none (% only if A1 = conc) A2</p>	<p>Display format selection (if A1 = conc)</p> <p>XX.xx; X.xxx; XXX.x; XXXX A3</p>	<p>Selection of unit displayed</p> <p>auto; <math>\mu</math>S/cm; mS/cm; S/cm; <math>\mu</math>S/m; mS/m; S/m autoQ; k<math>\Omega</math>cm; M<math>\Omega</math>cm; k<math>\Omega</math>m (omitted if A1 = conc) A4</p>	<p>Entry of cell constant</p> <p>cond / ind / MOhm 1.000 / 1.98 / 0.01 1/cm 0.0025 ... 99.99 1/cm for cond; ind; MOhm A5</p>	<p>Entry of cable resistance (if A1 = cond)</p> <p>0.00 <math>\Omega</math> 0.00 ... 99.99 <math>\Omega</math> A6</p>	
	<p>Selection of temperature measurement</p> <p>PT100 Pt1k (= Pt 1000) NTC30 (= NTC 30 k<math>\Omega</math>) fixed B1</p>	<p>Selection of temperature</p> <p>B2</p>	<p>Entry of a value (if B2 = linear)</p> <p>2.10 %/K 0.00 ... 20.00 %/K B3</p>	<p>Entry of correct process temperature (if B1 = fixed)</p> <p>25.0 °C -35.0 °C ... +250.0 °C B4</p>	<p>Temperature sensor calibration (omitted if B1 = fixed)</p> <p>Display of actual value -35.0 ... +250.0 °C B5</p>	<p>Enter temperature difference (omitted if B1 = fixed)</p> <p>Current offset -5.0 ... 5.0 °C B6</p>	
	<p>Cont. switch-off by current input</p> <p>Off; Input Z1</p>	<p>Delay for cont. switch-off current input</p> <p>0 s 0 ... 2000 s Z2</p>	<p>Delay for cont. switch-on current input</p> <p>0 s 0 ... 2000 s Z3</p>	<p>Switch-off limit value for current input</p> <p>50% 0 ... 100% Z4</p>	<p>Switch-off direction for current input</p> <p>Low; High Z5</p>	<p>Feedforward control to PID controller</p> <p>Off; lin = linear Z6</p>	
			<p>Characteristic selection</p> <p>table O3 (3)</p>	<p>Table option selection</p> <p>read edit O331</p>	<p>Entry of number of value pairs in table</p> <p>1 1 ... 10 O332</p>	<p>Selection of value pair in table</p> <p>1 1 ... number of value pairs assign O333</p>	
			<p>sim = simulation O3 (2)</p>	<p>Simulation value entry</p> <p>current value 0 ... 22.00 mA O321</p>			
	<p>Current output selection</p> <p>Out1; Out2 O1</p>	<p>Select measured variable for 2nd current output</p> <p>°C; mS/cm; Contr O2</p>	<p>lin = linear O3 (1)</p>	<p>Current range selection</p> <p>4-20 mA; 0-20 mA O311</p>	<p>Entry of 0/4 mA value</p> <p>0 <math>\mu</math>S/cm / 0 k<math>\Omega</math>cm / 0 % / 0 °C entire measuring range O312</p>	<p>Entry of 20 mA value</p> <p>2000 mS/cm / 500 k<math>\Omega</math>cm / 9999 % / 150.0 °C entire measuring range O313</p>	
	<p>Select contact type</p> <p>Stead = steady contact; Fleet = fleeting contact F1</p>	<p>Select alarm delay unit</p> <p>s; min F2</p>	<p>Alarm delay</p> <p>0 s (min) 0 s ... 2000 s (min) (depends on F2) F3</p>	<p>Error current setting</p> <p>22 mA 2.4 mA F4</p>	<p>Error number selection</p> <p>1 1 ... 255 F5</p>	<p>Set alarm contact to be effective</p> <p>yes; no F6</p>	
	<p>Switch polarisation detection on or off</p> <p>off; on P1</p>	<p>Set alarm threshold</p> <p>Off; Low; High; Lo+Hi; Lo!; Hi!; LoHi! P2</p>	<p>Enter alarm delay</p> <p>0 s (min) 0 ... 2000 s (min) P3</p>	<p>Set lower alarm threshold</p> <p>0 <math>\mu</math>S/cm 0 ... 9999 mS/cm P4</p>	<p>Set upper alarm threshold</p> <p>9999 <math>\mu</math>S/cm 0 ... 9999 mS/cm P5</p>	<p>Select process monitoring</p> <p>Off; AC; CC; AC+CC AC!; CC!; ACCC! P6</p>	

A0027482-EN

Store calibration results yes; no; new C136		
Store calibration results yes; no; new C126		
Entry of measured value damping 1 (no damping) 1 ... 60 A7		
Entry of reference temperature 25 °C -35 ... 250 °C B7		
Feedforward control = 1 at 50% 0 ... 100% Z7		
x value entry (measured value) 0 µS/cm / 0 kΩ*cm / 0 % / 0 °C entire measuring range O334	y value entry (current value) 0.00 mA 0 ... 20.00 mA entire measuring range O235	Table status ok yes; no O236
Field for customer settings		
Activate error current for previously set error no; yes F7	Automatic start of cleaning function no; yes (not always displayed, see error messages) F8	Select "next error" or return to menu next = next error; ~R F9
Set max. perm. period for lower limit exceeded 60 min 0 ... 2000 min P7	Set max. perm. period for upper limit exceeded 120 min 0 ... 2000 min P8	Set monitoring value 1000 µS/cm 0 ... 9999 mS/cm P9

	Limit contactor configuration EP PW R2 (7)	Function of R2 (7) Switch off or on Off On R271	Entry of alarm threshold (switch-on point) 80 % 0.0 ... 100.0 % R272		Pickup delay entry 0 0 ... 2000 s R274	
	USP R2 (6)	Function of R2 (6) Switch off or on Off On R261	Entry of alarm threshold (switch-on point) 80 % 0.0 ... 100.0 % R262		Pickup delay entry 0 0 ... 2000 s R264	
	Clean = Chemoclean (only with rel. 3) R2 (5)	Function of R2 (5) Switch off or on Off; On R251	Start pulse selection int = internal ext = external i+ext = internal + external i+stp = internal, suppr. by ext R252	Entry of pre-rinse time 20 s 0 ... 999 s R253	Entry of cleaning time 10 s 0 ... 999 s R254	
	Timer R2 (4)	Function of R2 (4) Switch off or on Off; On R241	Rinse time setting 30 s 0 ... 999 s R242	Pause time setting 360 min 1 ... 7200 min R243	Set minimum pause time 120 min 1...3600 min R244	
	PID controller R2 (3)	Function of R2 (3) Switch off or on Off; On; Basic; PID+B R231	Entry of set point 0 µS/cm / 0 kΩ×cm / 0 % entire meas. range R232	Entry of control gain Kp 1.00 0.01 ... 20.00 R233	Entry of integral action time T <sub>i</sub> (0.0 = no I component) 0.0 min 0.0 ... 999.9 min R234	
	LC °C = T limit contactor R2 (2)	Function of R2 (2) Switch off or on Off; On R221	Entry of switch-on temperature 250.0 °C -35.0 ... +250.0 °C R222	Entry of switch-off temperature 250.0 °C -35.0 ... +250.0 °C R223	Pickup delay setting 0 s 0 ... 2000 s R224	
Function group RELAY R	Select contact to be configured Rel1; Rel2; Rel3; Rel4 R1	Function of R2 (1) Switch off or on Off; On R211	Select contact switch-on point 9999 mS/cm / 200 MΩ×cm / 9999 % entire meas. range R212	Select contact switch-off point 9999 mS/cm / 200 MΩ×cm / 9999 % entire meas. range R213	Pickup delay setting 0 s 0 ... 2000 s R214	
Function group ALPHA TABLE T	Table option selection read edit T1	Entry of number of table value pairs 1 1 ... 10 T2	Selection of table value 1 1 ... number of table value pairs assign T3	Entry of temperature value (x value) 0.0 °C -35.0 ... +250.0 °C T4	Entry of temperature coefficient a (y value) 2.10 %/K 0.00 ... 20.00 %/K T5	Table status o.k. yes; no T6
Function group CONCENTRATION K	Selection of concentration curve for calculation of display value Curve 1 ... 4 K1	Selection of table to be edited 1 1 ... 4 K2	Table option selection read edit K3	Set number of value pairs 1 1 ... 10 K4	Select value pair 1 1 ... number of value pairs in K4 K5	Entry of uncompensated conductivity value 0.0 µS/cm 0.0 ... 9999 mS/cm K6
Function group SERVICE S	Language selection ENG; GER ITA; FRA ESP; NEL S1	Hold configuration - none = no hold - s+c = during setup and calibration - CAL = during calibration - Setup = during setup S2	Manual hold off; on S3	Entry of hold dwell period 10 s 0 ... 999 s S4	Entry of SW upgrade release code (plus package) 0000 0000 ... 9999 S5	Entry of SW upgrade release code Chemoclean 0000 0000 ... 9999 S6
	Module selection Relay E1 (4)	Software version SW version E141	Hardware version HW version E142	Serial number is displayed E143	Module name is displayed E144	
	MainB = mainboard E1 (3)	Software version SW version E131	Hardware version HW version E132	Serial number is displayed E133	Module name is displayed E134	
	E1 (2)	Software version SW version E121	Hardware version HW version E122	Serial number is displayed E123	Module name is displayed E124	
Function group E + H SERVICE E	Contr = controller E1 (1)	Software version SW version E111	Hardware version HW version E112	Serial number is displayed E113	Module name is displayed E114	
Function group INTERFACE I	Entry of address HART: 0 ... 15 or Profibus 1 ... 126 I1	Tag description @@@@@@@@ I2				

Dropout delay entry 0 0 ... 2000 s R275						
Dropout delay entry 0 0 ... 2000 s R265						
Entry of post-rinse time 20 s 0 ... 999 s R255	Number of repeat cycles 0 0 ... 5 R256	Set interval between two cleaning cycles (pause time) 360 min 1 ... 7200 min R257	Set minimum pause time 120 min 1 ... R357 min R258	Number of cleaning cycles without cleaning agent 0 0 ... 9 R259		
Entry of derivative action time Tv (0.0 = no D component) 0.0 min 0.0 ... 999.9 min R235	Selection of control characteristic dir = direct; inv = inverted R236	Selection len = pulse length freq = pulse frequency curr = current input 2 R237	Entry of pulse interval 10.0 s 0.5 ... 999.9 s R238	Entry of max. pulse frequency 120 1/min 60 ... 180 1/min R239	Entry of min. ON time t <sub>on</sub> 0.3 s 0.1 ... 5.0 s R2310	Enter basic load 40% 0 ... 40% R2311
Dropout delay setting 0 s 0 ... 2000 s R225	Setting of alarm threshold 250.0 °C -35.0 ... +250.0 °C R226	Display of LC status MAX MIN R227				
Dropout delay setting 0 s 0 ... 2000 s R215	Setting of alarm threshold (as an absolute value) 9999 mS/cm / 200 MΩ×cm / 9999 % entire meas. range R216	Display of LC status MAX MIN R217				
Entry of associated concentration value 0.00 % 0 ... 99.99 % K7	Entry of associated temperature value 0.0 °C -35.0 ... 250.0 °C K8	Table status o.k. yes; no K9				
Order number is displayed S7	Serial number is displayed S8	Reset instrument (restore default values) no; Sens = sensor data; Factly = factory settings S9	Perform instrument test no; Displ = display S10			

A0027485-EN

# Index

## A

Access codes . . . . .	30
Accessories . . . . .	104
Alarm . . . . .	49
Alarm contact . . . . .	24
Approvals . . . . .	10
Automatic mode . . . . .	29

## C

Calibration . . . . .	77
Calibration solutions . . . . .	107
Central module replacement . . . . .	102
Certificates . . . . .	10
Check . . . . .	50
Conductive sensors . . . . .	93
Inductive sensors . . . . .	94
Cleaning	
Sensors . . . . .	91
Transmitter . . . . .	90
Commissioning . . . . .	32
Communication . . . . .	76
Concentration Measurement . . . . .	70
Conductive sensors	
Check . . . . .	93
Simulation . . . . .	91
Connecting cables . . . . .	94
Current input . . . . .	42
Current outputs . . . . .	45

## D

Designated use . . . . .	7
Device configuration . . . . .	37
Device-specific errors . . . . .	88
Diagnostics . . . . .	81
Disassembling	
Field device . . . . .	98
Panel-mounted device . . . . .	95
Display . . . . .	25
Disposal . . . . .	103

## E

E+H Service . . . . .	75
Electrical connection . . . . .	18
Environment . . . . .	113
EP-PW function . . . . .	59

## F

Feedforward control . . . . .	42
-------------------------------	----

## H

Hold function . . . . .	31
-------------------------	----

## I

Incoming acceptance . . . . .	9
Inductive sensors	
Check . . . . .	94
Simulation . . . . .	92

Input . . . . .	108
Installation . . . . .	11
Installation conditions . . . . .	13
Installation instructions . . . . .	15
Interfaces . . . . .	76

## J

Junction boxes . . . . .	94
--------------------------	----

## K

Key functions . . . . .	27
-------------------------	----

## L

Local operation . . . . .	29
---------------------------	----

## M

Maintenance . . . . .	90
Assembly . . . . .	94
Maintenance of the entire measuring point . . . . .	90
Manual mode . . . . .	29
Measuring system . . . . .	12
Mechanical construction . . . . .	114
Menu structure . . . . .	31

## N

Nameplate . . . . .	10
---------------------	----

## O

Operating concept . . . . .	30
Operating elements . . . . .	27
Operating modes . . . . .	30
Operation . . . . .	25
Output . . . . .	108

## P

P(ID) controller . . . . .	55
Performance characteristics . . . . .	113
Post mounting . . . . .	15
Post-connection check . . . . .	24
Post-installation check . . . . .	17
Power supply . . . . .	112
Process-specific errors . . . . .	84
Product identification . . . . .	9

## Q

Quick Setup . . . . .	34
-----------------------	----

## R

Relay configuration . . . . .	53
Repair . . . . .	95
Replacing the central module . . . . .	102
Return . . . . .	103

## S

Safety instructions . . . . .	7
Scope of delivery . . . . .	9
Sensor connection . . . . .	21



---

Service .....	73
Setup 1 .....	37
Setup 2 .....	39
Simulation	
Conductive sensors .....	91
Inductive sensors .....	92
Spare parts .....	95
Switching on .....	32
Symbols .....	5
System error messages .....	81
<b>T</b>	
Technical data .....	108
Temperature compensation with table .....	69
Trouble shooting instructions .....	81
Troubleshooting .....	81
<b>U</b>	
Use .....	7
USP function .....	59
<b>W</b>	
Wall mounting .....	15
Warnings .....	5
Wiring .....	18
Wiring diagram .....	18



[www.addresses.endress.com](http://www.addresses.endress.com)

---