



Power Meter

Operating Instructions

Setra Systems, Inc.
159 Swanson Road, Boxborough, MA 01719
800.257.3872 • www.setra.com



© 2020 Setra Systems, Inc.

BACnet is a registered trademark of the American Society of Heating, Refrigerating, and Air-Conditioning Engineers (ASHRAE).

The material in this document is for information purposes only and is subject to change without notice. Setra Systems assumes no responsibility for any errors or for consequential damages that may result from the use or misrepresentation of any of the material in this publication.

Table of Contents

1.0 Introduction	8
1.1 Web Portal meter setup & configuration	8
1.2 Field selectable communication.....	8
1.3 Intended use	8
1.4 Product differentiation	9
1.5 Product unpacking	10
2.0 Safety information	11
2.1 Safety symbols.....	11
2.2 Please note	11
2.3 Safety approval.....	11
2.4 General safety requirements.....	13
2.5 Power Meter installation safety requirements.....	13
3.0 Meter overview	17
3.1 Installation overview	22
3.2 Main assembly and back housing separation/attachment	22
4.0 Planning for installation	24
4.1 Meter configuration overview	24
4.2 Meter installation overview.....	24
4.3 Verification & communication overview.....	24
4.4 RTU programming and script overview.....	25
5.0 Changing conduit position	25
6.0 Meter configuration	26
7.0 Connecting high voltage inputs	27
8.0 Current transformer wiring	34
9.0 CTs wiring example.....	39
10.0 EIA-485 communication wiring	40
11.0 Ethernet communication wiring.....	42

Table of Contents

12.0 Pulse inputs wiring	43
12.1 Pulse output wiring	43
13.0 Alarm relay (SPDT) wiring	44
14.0 Installing front cover	45
15.0 Meter configuration	46
15.1 LCD user interface for simple configuration	46
15.2 Web portal for main configuration	46
15.3 Connect the Meter	46
15.4 Web portal setup	47
15.5 Web portal overview	47
15.6 Meter communication bar	48
15.7 Menu navigation sidebar	48
16.0 Halo-dot	49
16.1 Configuration indication dot	49
16.2 Halo	49
16.3 Numerical indication	49
17.0 Setup menu	50
18.0 Setup menu help legend	51
19.0 General settings	52
19.1 Device setting within the Device settings section	52
19.2 General Settings	53
19.3 Site information	57
19.4 Uploading to meter	57
20.0 Voltage inputs	58
21.0 Load setup	62
21.1 Configuring a Load	63
21.2 Visual load indication	64
22.0 CT inputs	65
23.0 Communications/Network settings	71

Table of Contents

23.1 Network settings	73
24.0 Pulse IO setup	74
24.1 Pulse output	75
25.0 Alarm setup	79
25.1 Over power	80
25.2 Under power	80
25.3 Energy usage (Vin)	81
25.4 Energy usage (Load)	81
25.5 Polarity CT	82
25.6 Under voltage	82
25.7 Under current CT	83
25.8 Over current CT	83
25.9 Phase loss CT	84
25.10 Over voltage	84
25.11 Over current (Load)	85
25.12 Peak demand (Load)	85
25.13 Low power factor	86
25.14 Summary alarm table	86
26.0 Installation report	87
26.1 General information	87
26.2 Meter information	88
26.3 General notes	88
26.4 Measurements	89
26.5 Export the report	90
27.0 Power analytics	90
27.1 Parameters within Trends & Odometer menus	90

Table of Contents

27.2 Trends	91
27.3 Odometer	93
27.4 Time interval definition	94
27.5 Export logged data	94
28.0 Event Log	95
29.0 Alarm status	96
29.1 Active alarm states	96
29.2 Active LED states	96
29.3 Active relay states	96
29.4 Alarm log	96
29.5 Export of Alarm Logs	97
29.6 Example of Alarm Logs Record	97
30.0 System	98
30.1 Software version	98
30.2 Factory reset	98
30.3 Trend data rest	99
30.4 Reboot	99
30.5 System log	99
31.0 Export configuration	100
31.1 Configuration record	100
31.2 Example of configuration record	101
31.3 Clone/Import meter setup	101
32.0 Help	102
33.0 Troubleshooting	102
34.0 Replace battery	103
35.0 User interface	105
36.0 Main Menu	105
37.0 Real-time values	106
38.0 Odometer	107

Table of Contents

39.0 Configuration.....	108
40.0 Communication	109
41.0 Network.....	110
42.0 Alarm	111
43.0 About	112
44.0 Factory reset at meter	113
45.0 Returning products for repair.....	114
46.0 Limited warranty & limitation of repair	114
47.0 Equipment service & access	115
47.1 Access to equipment	115
47.2 Servicing the equipment.....	115
47.3 Component servicing	115
48.0 Support.....	115
48.1 Setra contact	115

1.0 Introduction

The Power Meter from Setra is a networked revenue grade power meter built on a versatile and powerful platform designed to meet the high demands for any submetering application. Available in a 3, 12 or 48 load configurations, the meter enclosure & intuitive web portal interface significantly reduce installation time and cost per metering point. The Power Meter 12 & 48 load meters come standard with dual voltage inputs, and all versions are field configurable for use of standard or Rogowski style current transformers, enabling safe and accurate measurement of both low and high amperage services.

The Setra Power Meter can be ordered in the following configurations, which are identifiable on the part number label.

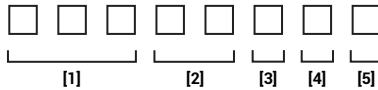

[1]	[2]	[3]	[4]	[5]
Model	Loads	Communication	Display	Option
SPM Power Meter	03 3 loads	E Ethernet & serial	D Onboard display	N None
	12 12 loads			
	48 48 loads			

1.1 Web Portal meter setup & configuration

Setup is both intuitive and time-saving through the Setra Power Meter Web Portal. The software can be easily accessed through the meter itself, either through simple USB connection to your PC or through Ethernet connection over a shared network.

1.2 Field selectable communication

Integration with building automation systems is made easy through field selectable BACnet and Modbus communication protocols. The meter's communications interface is enabled through either an EIA-485 serial connection (BACnet MS/TP or Modbus RTU) or over Ethernet (BACnet/IP or Modbus TCP). Along with these advanced network communication protocols, the Setra Power Meter offers a connection interface with adjacent equipment through one configurable pulse output and two configurable pulse inputs, enabling even more data collection through the meter.

1.3 Intended use

Setra Power Meter is designed to closely monitor and provide detailed information of the building and/or equipment. The meter can be used in varying capacities, measuring varying loads with up to two different voltage reference points. Typical applications include measuring power of buildings, leased building space, large machinery or equipment, lighting loads, and more.

The meter will monitor and provide visual indicators on the Backlit Display, Error Indication LED and Power Indication LED.

Each Power Meter comes standard with field selectable BACnet and Modbus communication protocols. The communications interface is through either an EIA-485 serial connection (BACnet MS/TP or Modbus RTU) or over Ethernet (BACnet/IP or Modbus TCP). Along with these advanced network communication protocols, the Power Meter offers one configurable pulse output and two configurable pulse inputs, enabling more data collection at the meter.

1.4 Product differentiation

The Setra Power Meter has been designed in three different "Load" configurations, with following differences in each product:

3 Load:

- Three CT terminal blocks
- One voltage input terminal block
- 6.8" x 7" x 3.8" form factor
- Six conduit openings



12 Load:

- Twelve CT terminal blocks
- Two voltage input terminal blocks
- 6.8" x 7" x 3.8" form factor
- Six conduit openings



48 Load:

- Forty-eight CT terminal blocks
- Two voltage input terminal blocks
- 10.8" x 17.2" x 4.4" form factor
- Fifteen conduit openings

1.5 Product unpacking

What's in the box



Preparing for install



Auxiliary equipment & hardware kit contents

Item	P/N: SPM03EDN Included w/ meter	P/N: SPM12EDN Included w/ meter	P/N: SPM48EDN Included w/ meter
Power Meter	1	1	1
CT connector	4	13	49
Hardware kit	1	1	1
Calibration certificate	1	1	1

2.0 Safety Information

Read these instructions carefully and look at the equipment to become familiar with the device before trying to install, operate, service or maintain it. The following special messages may appear throughout this manual or on the equipment to warn of potential hazards or to call attention to information that clarifies or simplifies a procedure.

2.1 Safety symbols

The following international symbols are used on the Power Meter and in this manual:



Denotes warning or caution. See manual for a description of the meanings.



DENOTES HIGH VOLTAGE. RISK OF ELECTRICAL SHOCK. LIFE THREATENING VOLTAGES MAY BE PRESENT. QUALIFIED PERSONNEL ONLY.



Equipment protected throughout by double insulation (IEC 536 Class II)



Contains additional information pertinent to current subject.

2.2 Please note

Electrical equipment should be installed, operated, serviced and maintained only by qualified personnel. No responsibility is assumed by Setra for any consequences arising out of the use of this material. A qualified person is one who has skills and knowledge related to the construction, installation, and operation of electrical equipment and has received safety training to recognize and avoid the hazards involved.

2.3 Safety approval

The Setra Networked Multi-load Power Meter is UL listed and complies with the following safety standards for 600V CAT III Pollution Degree 2:



UL 61010-1 Edition 3 (2016),

CSA C22.2 No 61010-1-12 Edition 3 Update 2 (2016),

IEC/EN61010-1 Edition 3 (2013),

Safety Requirements for Electrical Equipment for Measurement, Control and Laboratory Use, Part 1: General requirements

UL 61010-2-030 Edition 2,

CSA C22.2 No 61010-2-030-12 Edition 1 (2012),

IEC/EN61010-2-030 Edition 1 (2011),

Safety Requirements for Electrical Equipment for Measurement, Control and Laboratory Use, Part 2-030: Particular Requirements for Testing and Measuring Circuits

2.0 Informations de sécurité

Lisez attentivement ces instructions et examinez l'équipement pour vous familiariser avec l'appareil avant d'essayer de l'installer, de le faire fonctionner, de le réparer ou de l'entretenir. Les messages spéciaux suivants peuvent apparaître dans ce manuel ou sur l'équipement pour avertir des dangers potentiels ou pour attirer l'attention sur des informations qui clarifient ou simplifient une procédure.

2.1 Symboles de sécurité

Les symboles internationaux suivants sont utilisés sur le Power Meter et dans ce manuel:



Indique un avertissement ou une prudence. Voir le manuel pour une description des significations.



INDIQUE HAUTE TENSION. RISQUE DE CHOC ÉLECTRIQUE. DES TENSIONS MENACANTES POUR LA VIE PEUVENT ÊTRE PRÉSENTES. PERSONNEL QUALIFIÉ UNIQUEMENT.



Équipement protégé partout par une double isolation (IEC 536 classe II)



Contient des informations supplémentaires pertinentes au sujet actuel.

2.2 Veuillez noter

L'équipement électrique doit être installé, utilisé, entretenu et entretenu uniquement par du personnel qualifié. Aucune responsabilité est assumée par Setra des conséquences découlant de l'utilisation de ce matériel. Une personne qualifiée est une personne qui possède des compétences et des connaissances liées à la construction, à l'installation et au fonctionnement de l'équipement électrique et qui a reçu une formation en sécurité pour reconnaître et éviter les dangers impliqués.

2.3 Approbation de sécurité

Le Setra Networked Multi-Load Power Meter est UL et conforme aux normes de sécurité suivantes pour 600V CAT III Degré de pollution 2:



UL 61010-1 Edition 3 (2016),

CSA C22.2 No 61010-1-12 Edition 3 Update 2 (2016),

IEC/EN61010-1 Edition 3 (2013),

Safety Requirements for Electrical Equipment for Measurement, Control and Laboratory Use, Part 1: General requirements

UL 61010-2-030 Edition 2,

CSA C22.2 No 61010-2-030-12 Edition 1 (2012),

IEC/EN61010-2-030 Edition 1 (2011),

Safety Requirements for Electrical Equipment for Measurement, Control and Laboratory Use, Part 2-030: Particular Requirements for Testing and Measuring Circuits

UL Safety Ratings

Equipment function	Networked Multi-circuit power meter
Connection to mains supply	Permanently
Overvoltage/ Measurement category	III
Pollution degree	2
Means of protection	Class II (double insulated)
Environmental condition	
Temperature:	-20°C to +60°C
Humidity:	5% to 95% non-condensing humidity
Altitude:	Max. 2000 meters
For use in wet location	No
Equipment mobility	Wall/surface mounted
Operating conditions	Continuous
Marked degree of protection	Type 1

Input supply rating: 80-600 Vac (Vin1 L1 & L2), 50/60 Hz, 5W max, Overvoltage Category III

Voltage measurement:

Three phase max. 347/600 Vac WYE earthed
Three phase max. 347 Vac DELTA earthed/unearthed
Split phase max. 240/480 Vac
Single phase max. 480 Vac
Measurement Category III

Frequency measurement:

50/60 Hz

Current measurement:

Up to 6000 A (through use of CTs or Rogowski coils with voltage output up to 2V)

Alarm relay output ratings: 30 Vdc/ac, 2 Arms, resistive, Class 2

Pulse I/O: 30 Vdc

Évaluations de sécurité UL

Fonction d'équipement	Compteur de puissance multi-circuits en réseau
Connexion à l'alimentation principale	Connecté en permanence
Surtension / Catégorie de mesure	III
Degré de pollution	2
Moyens de protection	Class II (double isolation)
Conditions environnementales	
Température:	-20°C à +60°C
Humidité:	5% à 95% d'humidité sans condensation
Altitude:	Max. 2000 mètres
Pour une utilisation dans des endroits humides	Non
Mobilité de l'équipement	Montage mural / en surface
Conditions de fonctionnement	Continu
Degré de protection marqué	Type 1

Capacité d'alimentation d'entrée: 80-600 Vac (Vin1 L1 & L2), 50/60 Hz, 5W max, catégorie de surtension III

Mesure de tension:

Triphasé max. 347/600 Vac WYE mis à terre
 Triphasé max. 347 Vac DELTA mis à la terre / déterré
 Phase divisée max. 240/480 Vac
 Monophasé max. 480 Vac
 Catégorie de mesure III

Mesure de fréquence:

50/60 Hz

Mesure de courant:

Jusqu'à 6000 A (grâce à l'utilisation de TC ou de bobines Rogowski avec une tension de sortie jusqu'à 2 V)

Évaluations de sortie de relais d'alarme: 30 Vdc / ac, 2 bras, résistif, classe 2

Puissance d'entrée / sortie d'impulsion: 30 Vdc



General safety requirements

To ensure the safe operation and service of the device, follow these instructions closely. Failure to observe warnings can result in severe personal injury or permanent damage to the device.

- Review the entire manual before use of the Meter and its accessories.
- Comply with local and national safety codes. Use personal protective equipment to prevent shock and arc flash injury where hazardous live conductors are exposed.
- Only licensed electricians should install this equipment. Such work should be performed only after reading this entire set of instructions.
- The equipment must be accessible to authorized personnel only. Equipment must be installed in areas where access can be restricted.
- If the meter appears damaged or defective or internal fuse blowout, first disconnect all power to the meter. Then contact Setra technical support for assistance.
- If the products are used in a manner not specified by Setra, the protection provided by the equipment may be impaired.



Power Meter installation safety requirements

- Use copper conductors only.
- Wiring to voltage input terminals and mains shall have minimal temperature rating of 90°C (194°F) and minimal wire gauge of 14 AWG (1.63 mm).
- External secondary inputs and outputs should be connected to devices meeting the requirements of IEC 60950.
- For use only with Listed Energy-Monitoring Current Transformers
- Warning - To reduce risk of electric shock, always open or disconnect circuit from power-distribution system (or service) of building before installing or servicing current-sensing transformers
- Current transformers may not be installed in equipment where they exceed 75 percent of the wiring space of any cross-sectional area within the equipment.
- Current transformers may not be installed in an area where they block ventilation openings.
- Current transformers may not be installed in an area of breaker arc venting.
- Current transformers are not suitable for Class 2 wiring method nor intended for connection to Class 2 equipment.
- Secure current transformer and route conductors so that they do not directly contact live terminals or bus.
- Wiring to terminal blocks shall have minimal temperature rating at least 75°C (167°F)
- When connecting power meter to conduit, a threaded hub shall be installed at conduit entrances. When using rigid conduit connect the hub to the conduit before connecting to power meter enclosure.

FCC PART 15 Notice

This equipment has been tested and found to comply with the limits for a Class B digital device, pursuant to part 15 of the FCC Rules. These limits are designed to provide reasonable protection against harmful interference when the equipment is operated in a commercial environment. This equipment generates, uses, and can radiate radio frequency energy and, if not installed and used in accordance with the instructions, may cause harmful interference to radio communications. However, there is no guarantee that interference will not occur in an installation



Règles générales de sécurité

Pour garantir le fonctionnement et l'entretien en toute sécurité de l'appareil, suivez attentivement ces instructions. Le non-respect des avertissements peut entraîner des blessures graves ou des dommages permanents à l'appareil.

- Revoir le manuel en entier avant l'utilisation de l'appareil et de ses accessoires.
- Respectez les codes de sécurité locaux et nationaux. Utilisez un équipement de protection individuelle pour éviter les chocs et les arcs électriques lorsque des conducteurs sous tension dangereux sont exposés.
- Seuls des électriciens agréés doivent installer cet équipement. Un tel travail ne doit être effectué qu'après avoir lu l'ensemble de ces instructions.
- L'équipement doit être accessible uniquement au personnel autorisé. L'équipement doit être installé dans des zones où l'accès peut être restreint.
- Si le compteur semble endommagé ou défectueux ou que le fusible a sauté, débranchez d'abord l'alimentation du compteur. Contactez ensuite le support technique de Setra pour obtenir de l'aide.
- Si les produits sont utilisés d'une manière non spécifiée par Setra, la protection fournie par l'équipement peut être altérée.



Règles de sécurité pour l'installation du Power Meter

- Utilisez uniquement des conducteurs en cuivre.
- Le câblage aux bornes d'entrée de tension et au secteur doit avoir une température nominale minimale de 90 ° C (194 ° F) et un calibre de fil minimal de 14 AWG (1,63 mm).
- Les entrées et sorties secondaires externes doivent être connectées à des appareils répondant aux exigences de la CEI 60950.
- À utiliser uniquement avec les transformateurs de courant à surveillance d'énergie répertoriés
- Avertissement - Pour réduire le risque de choc électrique, ouvrez ou déconnectez toujours le circuit du système de distribution électrique (ou du service) du bâtiment avant d'installer ou d'entretenir des transformateurs de détection de courant
- Les transformateurs de courant ne doivent pas être installés dans l'équipement où ils dépassent 75 pour cent de l'espace de câblage de toute section transversale de l'équipement.
- Les transformateurs de courant ne doivent pas être installés dans une zone où ils bloquent les ouvertures de ventilation.
- Les transformateurs de courant ne doivent pas être installés dans une zone d'évacuation d'arc du discontacteur.
- Les transformateurs de courant ne sont pas adaptés à la méthode de câblage de classe 2 ni destinés à être connectés à un équipement de classe 2.
- affixez le transformateur de courant et circulez les conducteurs afin qu'ils n'entrent pas directement en contact avec les bornes sous tension ou le bus.
- Le câblage aux borniers doit avoir une température nominale minimale d'au moins 75 ° C (167 ° F)
- Lors de la connexion du wattmètre au conduit, un moyeu fileté doit être installé aux entrées du conduit. Lorsque vous utilisez un conduit rigide, connectez le moyeu au conduit avant de le connecter au boîtier du wattmètre.

Avis FCC PARTIE 15

Cet équipement a été testé et déclaré conforme aux limites d'un appareil numérique de classe B, conformément à la partie 15 des règles de la FCC. Ces limites sont conçues pour fournir une protection raisonnable contre les interférences nuisibles lorsque l'équipement est utilisé dans un environnement commercial. Cet équipement génère, utilise et peut émettre de l'énergie radiofréquence et, s'il n'est pas installé et utilisé conformément aux instructions, peut provoquer des interférences nuisibles aux communications radio. Cependant, il n'y a aucune garantie qu'aucune interférence ne se produira dans une installation.

3.0 Meter overview

This section is intended so that you can familiarize yourself with the features of the meter prior to installation, while size and amount of current transformer connection differ most features and terminology remain the same between the 3, 12, and 48 load power meters.

Power meter sections

(12 load meter shown)

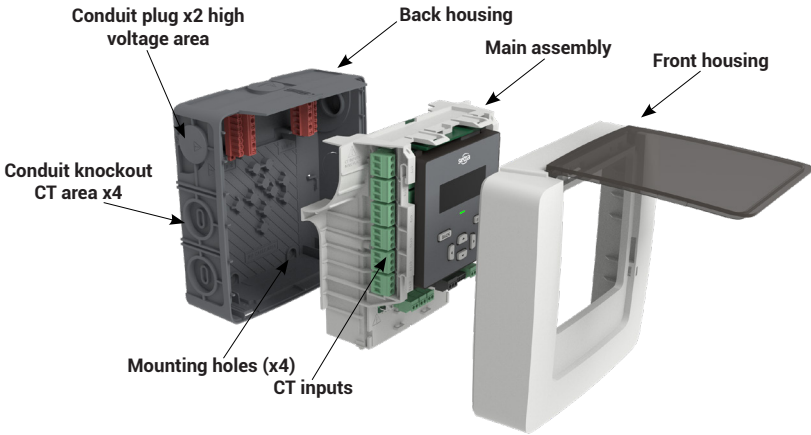

3/12-load meter

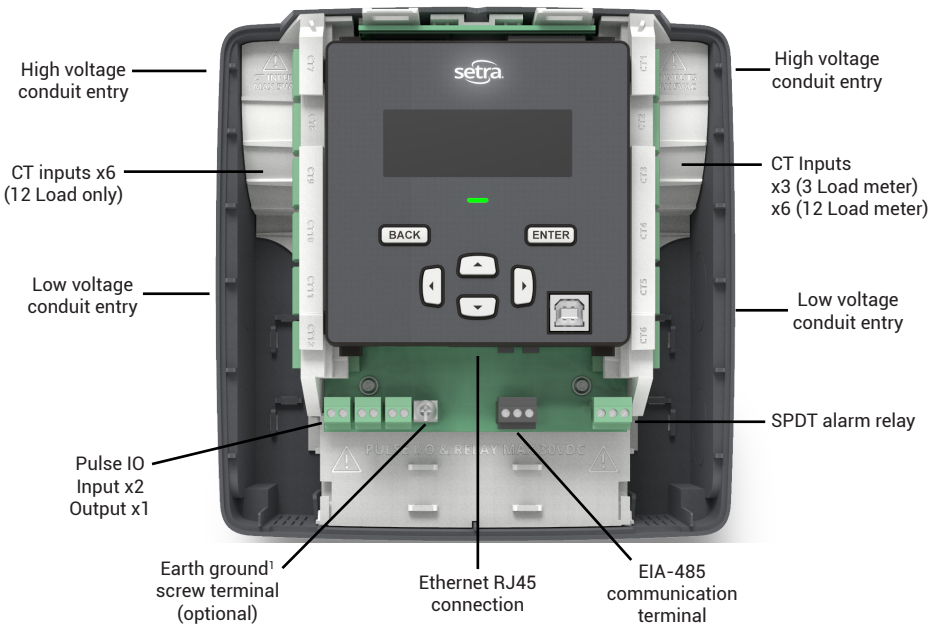

¹ Earth ground Screw: In noisy environments connect earth ground terminal to electrical panel earth ground to reduce noise pickup

Dimensions

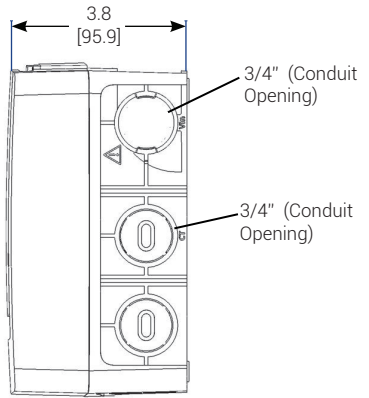
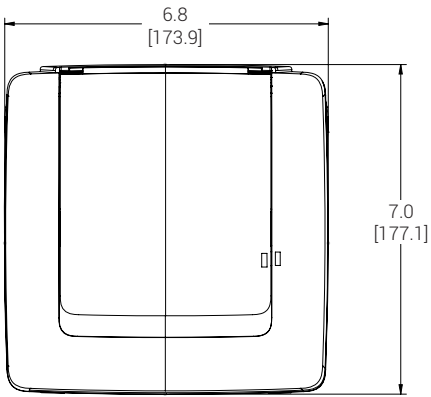
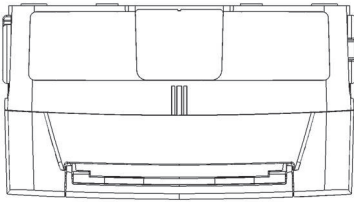

48-Load Meter

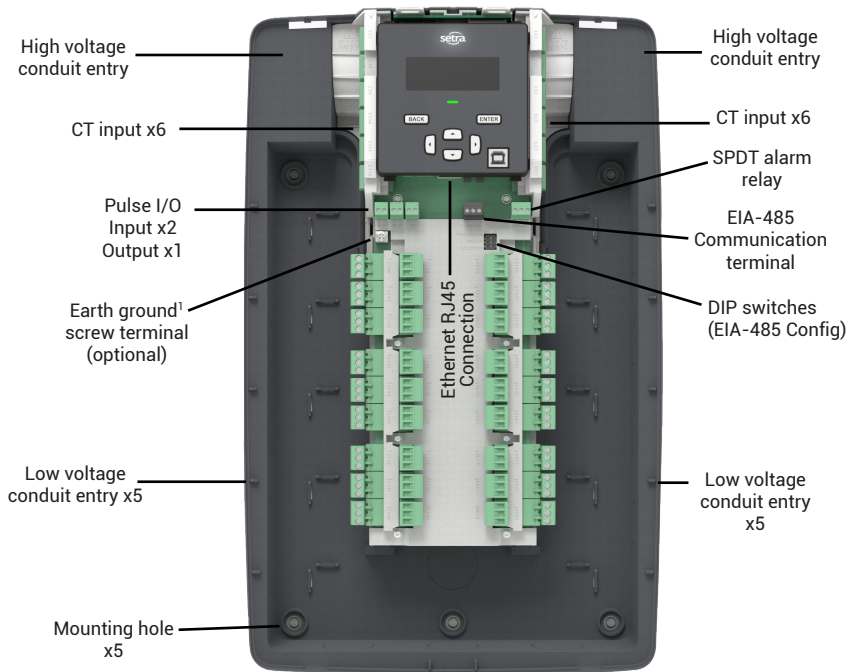

Dimensions

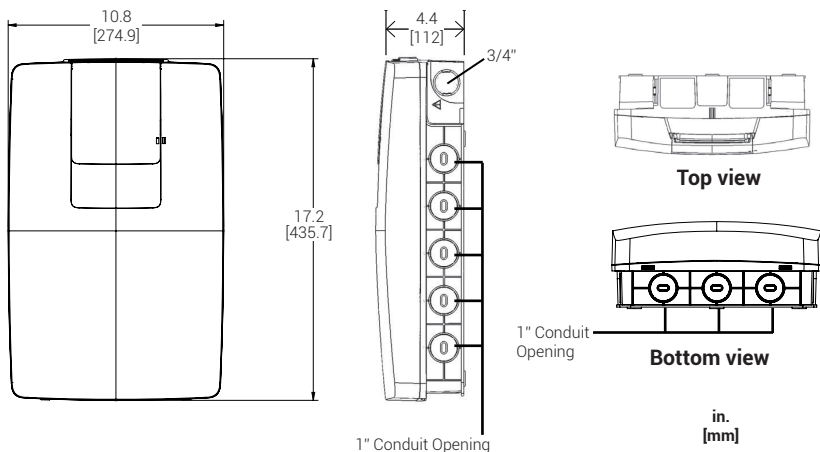

Display interface



Available conduit

3/12 Load meter

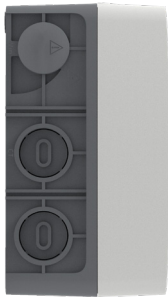

High voltage area – 3/4" EMT conduit fitting x2

Low voltage (CT, Comm, I/O) – 3/4" EMT conduit fitting x4

48 Load meter



High voltage area – 3/4" EMT conduit fitting x2

Low voltage (CT, Comm, I/O) – 1" EMT conduit fitting x13



Typical EMT conduit fitting (Not included)

3.1 Installation overview



1. Mount unit in preferred conduit orientation with provided mounting screws.
2. After safely de-energizing the circuit, properly wire in the lines voltage per local electrical codes.
3. Install the "Main assembly" into the back housing until it locks in place.

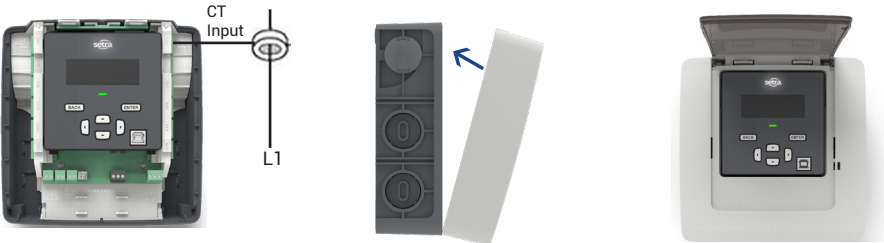

4. Following local electrical codes. Wire in the current transformers and communication lines to the meter.
5. Install front cover by engaging the two tabs at the bottom and rotate the cover until clicked in-place.
6. After meter is fully wired, safely re-energize the circuit and begin gathering data.

3.2 Main assembly and back housing separation/attachment

1. Remove the power meter's front housing (cover) by depressing the tab(s) on the bottom of the meter, found on the main assembly. Simultaneously, lift the front housing off the still-assembled main assembly and back housing.



2. Next, remove the main assembly from back housing by flexing the rear housing away from the main assembly using a flat screwdriver where indicated on the rear housing. This will release the locking mechanism. Now, pull delete out the main assembly, rotating from the top.



3. To reassemble, first, insert the bottom of the Main Assembly into the Back Housing and rotate the top of the main assembly into position, connecting high voltage and accompanied by a "click" to ensure the assembly is in place.

12 Load Meter shown below:



48 Load Meter shown below:



4. Attach the front housing by tilting the cover such that the bottom makes contact with the Main Assembly first, locking in the two securement tabs. Once the tabs are resting in their respective securement slots, rotate and push the top of the cover onto the Back Housing and Main assembly.

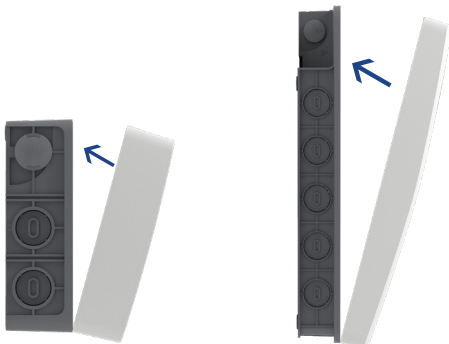

4.0 Planning for installation

Meter installation often includes coordination between individuals or groups of people with different responsibilities. Spend a few minutes considering who will be executing each portion of the installation and what tools are needed at each stage. Things to consider include determining how to communicate with the meter, setting address configuration, access to passwords, etc. The more tasks completed before installation means less time in the field. The following section gives an overview of these activities followed by details in the next section.

4.1 Meter configuration overview

Work performed ahead of the installation saves time in the field and allows a more streamlined installation. Typically performed at the workstation with a computer.



Tools	Typical work
Desktop or laptop PC	Connect USB/Ethernet cable from PC to meter
USB type AB cable (preferred) or Ethernet cable	Establish communication with meter Firmware update (if desired)
Web browser and electrical schematics of project	Meter setup and configuration generate field wiring and installation report

4.2 Meter installation overview

Performed by a licensed electrician



Tools	Typical work
Mounting hardware (customer supplied)	Mechanical mounting
Wiring & supplies, labels, wire ties	Electrical installation
Laptop PC	Install voltage cover
Multimeter, current clamp	Apply power to meter
Camera	Confirm basic operation of meter

4.3 Verification & communication overview

Can be modified with power applied to the meter



Tools	Typical work
Laptop PC/Tablet, BAS system	Confirm device communication
On site troubleshooting	Add wire terminations (if required)
Multi meter	Confirm and correct wiring issues
Current clamp	Meter health metrics (check for setup errors)
Oscilloscope (optional)	Check signal and noise
BACnet or Modbus polling tool (optional)	Network verification



4.4 RTU programming and script overview

Tools	Typical work
Laptop PC (remote access to RTU)	Confirm meter communication setting
Remote trouble shooting	Confirm communication protocols
Register	Exercise remote connectivity
	Run configuration scripting
	Confirm integrity

5.0 Changing Conduit Position

The Setra power meter can support various applications via rotatable display to allow the user to mount in any configuration, without impacting the user interface experience.

To rotate the orientation of the display, remove the front housing cover and slide the display module along the main assembly, toward the bottom of the meter. Once it becomes dislodged, simply rotate the display to the desired orientation and slide again toward the top of the meter. Ensure the meter is de-energized prior to changing orientation.

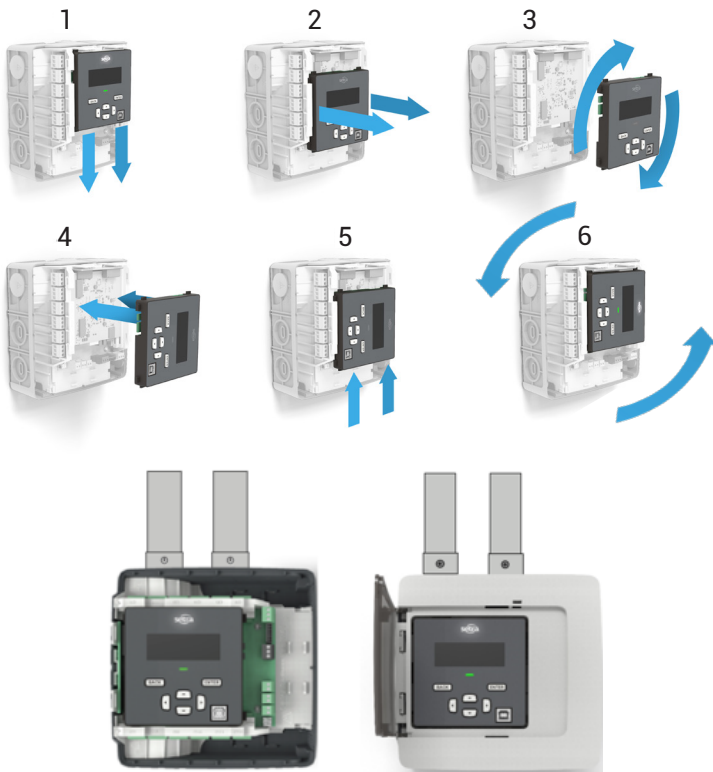

6.0 Meter configuration

The following section illustrates the recommended installation of 12-load Power Meter. The 3-load and 48-load meter are slightly different but can follow the same procedure.

1. Remove all packaging material and separate the housing from the other components.
2. Locate a flat, clean portion of wall space for mounting. Decide meter orientation.
3. Remove main assembly for back housing by depressing the tab on the top of the meter, to release the locking mechanism.
4. Locate, mark, level, and drill wall mounting points. The plastic back cover can be used as a template for marking the drill locations on the wall. Using the four #8-15 x 5/8 screws provided, fasten the housing to the wall.

Notes

¹If mounting on masonry wall, use the four blue Topcon screws provided. The correct masonry drill size for these screws is 5/32 inch diameter

²If mounting on drywall, use the four plastic drywall anchors in addition to the #8-15 x 5/8 screws provided.

³To avoid damage to the housing desired knockouts should be removed prior to mounting on the wall

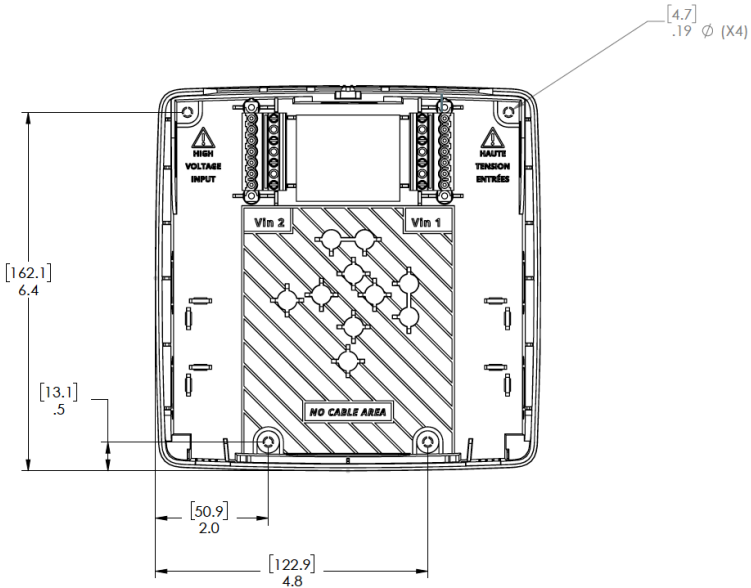

7.0 Connecting high voltage inputs

 **DANGER**- Failure to follow these instructions will result in death or serious injury.

 **HAZARD OF ELECTRIC SHOCK, EXPLOSION, OR ARC FLASH**

- Apply appropriate personal protective equipment (PPE) and follow safe electrical work practices. See NFPA 70E.
- This equipment must only be installed and serviced by qualified electrical personnel.
- Turn off all power supplying this equipment before working on or inside equipment.
- The meters voltage leads (L1, L2, L3, and N, as necessary) must be connected to a dedicated disconnect or a properly rated (15A) breaker.
- A voltage lead of 14 AWG THHN minimum 600VAC rating or equivalent is required.
- Wiring to these terminal blocks shall be tightened to 3.54 lb.-in torque.
- DO NOT EXCEED 347V Line to Neutral or 600V line to line. This meter is equipped to monitor loads up to 347V L-N. Exceeding this voltage will cause damage to the meter and danger to the user. Always use a Potential Transformer (PT) for voltages in excess of 347V L-N or 600V line to line. The Setra Power Meters are 600V Over Voltage Category III device.
- When using rigid conduit, connect the hub to the conduit before connecting to power meter enclosure.
- All unused conduit openings need to be closed using Setra provided conduit plug.

IMPORTANT- Verify the circuit breaker is marked as the disconnected breaker for the meter.

Setra Power Meter's high voltage inputs must be connected through properly rated (15 Amp) disconnects or breakers that disconnect all line wires so that they can be powered down. Each disconnect or breaker must be located within easy reach of the meter operator and must be labeled to indicate which set of device inputs it supplies power to. One disconnects is required for each voltage input. The disconnect device or devices must meet IEC 60947-1, IEC 60947-3 and/or comply with the local electrical code.

Connection to the mains terminals shall be made with 14 AWG (1.63 mm) minimal wire gauge THHN 600VAC rating. All high voltage input wires shall be routed through the high voltage conduit entry and do not mix with other low voltage wiring. Any unused high voltage conduit holes shall be plugged securely with supplied "safety cap". Wiring to these terminal blocks shall be tightened to 3.54 lb.-in torque.

Please note that there are two voltage inputs (Vin1 and Vin2) for 12-load and 48-load power meter but only one voltage input (Vin1) for 3-load power meter. Each voltage inputs contain up to four leads, namely L1, L2, L3, and N (neutral) which can be configured by software to measure up to three phases voltage signal with respect to N (neutral). Vin1 L1 and L2 are also connected to meter's 80-600V wide input power supply to power the meter. When installing a 12 or 48 load power meter, Vin 1 must be used to power the unit. The meter will not power off of Vin 2.

7.0 Connexion des entrées haute tension

 **DANGER** - Le non-respect de ces instructions entraînera la mort ou des blessures graves.

 **RISQUE DE CHOC ÉLECTRIQUE, D'EXPLOSION OU D'ARC ÉLECTRIQUE**

- Appliquez l'équipement de protection individuelle (EPI) approprié et suivez les pratiques de travail électriques sécuritaires. Voir NFPA 70E.
- Cet équipement ne doit être installé et entretenu que par du personnel électrique qualifié.
- Coupez l'alimentation électrique de cet équipement avant de travailler sur ou à l'intérieur de l'équipement.
- Les fils de tension des compteurs (L1, L2, L3 et N, si nécessaire) doivent être connectés à un sectionneur dédié ou à un disjoncteur de calibre approprié (15A).
- Un câble de tension de 14 AWG THHN de 600VAC minimum ou équivalent est requis.
- Le câblage de ces borniers doit être serré à un couple de 3,54 lb-in.
- NE DÉPASSEZ PAS la ligne 347 V au neutre ou la ligne 600 V à la ligne. Ce compteur est équipé pour surveiller des charges jusqu'à 347V L-N. Le dépassement de cette tension endommagera le compteur et mettra en danger l'utilisateur. Utilisez toujours un transformateur de potentiel (PT) pour les tensions supérieures à 347 V L-N ou 600 V ligne à ligne. Les wattmètres Setra sont des machines de catégorie III de survoltage de 600 V.
- Lorsque vous utilisez un conduit rigide, connectez le moyeu au conduit avant de le connecter au boîtier du wattmètre.
- Toutes les ouvertures de conduit inutilisées doivent être fermées à l'aide du bouchon de conduit fourni par Setra.



DO NOT EXCEED 347V Line to Neutral or 600V line to line. This meter is equipped to monitor loads up to 347V L-N. Exceeding this voltage will cause damage to the meter and danger to the user. Always use a Potential Transformer (PT) for voltages in excess of 347V L-N or 600V line to line. The Setra Power Meters are 600V Over Voltage Category III device.

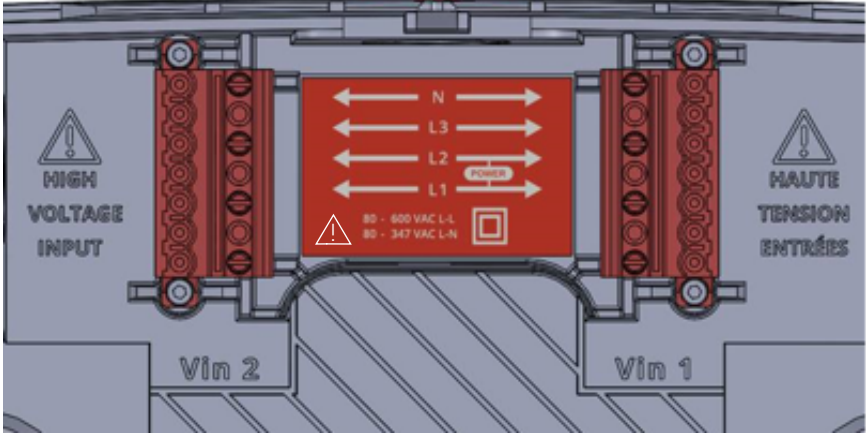

Français



NE DÉPASSEZ PAS la ligne 347 V au neutre ou la ligne 600 V à la ligne. Ce compteur est équipé pour surveiller des charges jusqu'à 347V L-N. Le dépassement de cette tension risque d'endommager l'appareil et de danger pour l'utilisateur. Utilisez toujours un transformateur de potentiel (PT) pour les tensions supérieures à 347 V L-N ou 600 V ligne à ligne. Les wattmètres Setra sont des dispositifs de catégorie III de surtension de 600 V

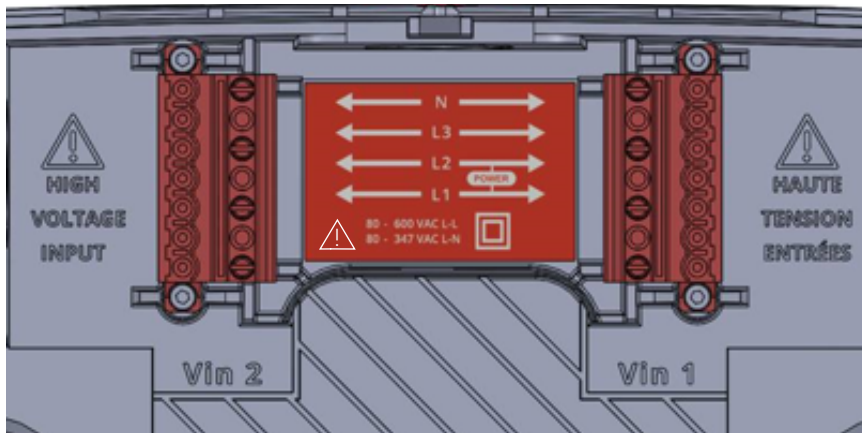

It is important to understand the electrical service type and voltage before voltage input wiring. Setra power meter supports all major service types.

1. Identify conduit plug(s) to remove for high voltage input. Identify desired conduit holes for CT and I/O inputs.
2. Power lines can be brought to the meter through any of the top two ports on the housing, located left side, top, or right side.
3. Once you have identified the convenient routing of conduit to the meter, proceed to step 4

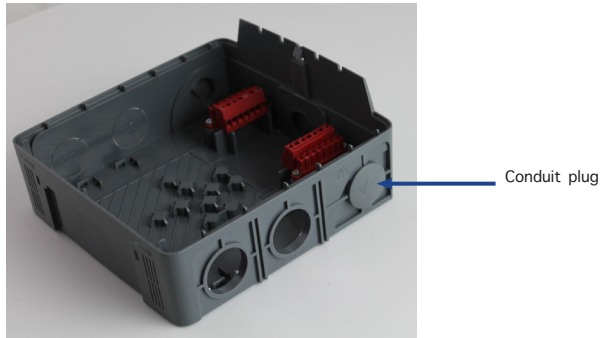

4. Insert conduit fitting through 3/4" opening. Thread nut onto the fitting. Tighten until secure.

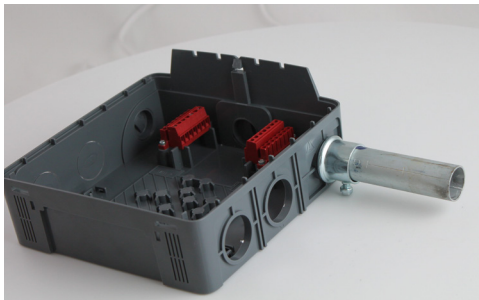
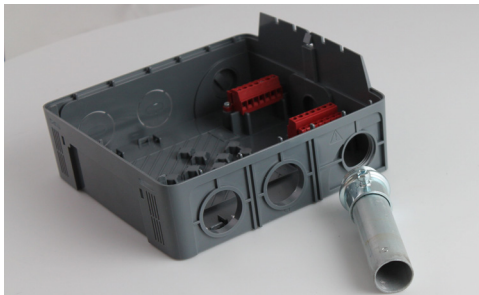

**DO NOT ENERGIZE METER FOR VOLTAGE INPUT WIRING.
SEE SECTION "CONNECTING HIGH VOLTAGE INPUTS" FOR MORE INSTRUCTIONS**

5. Strip back Romex wire sheathing approximately 3-1/2 inches. Strip each wire back approximately 3/8 inches.



6. Route the power wires beneath the RED power connectors and form the wires using pliers for easy insertion into the connector according to the owner's manual wiring diagram.

! WARNING

- Conduit plug – do not allow a pass through to a high voltage area to remain open. Utilize the provided plugs if conduit is not connected
- Do not route wires around or over the RED connector or allow wires to traverse the safety "No Cable Area"

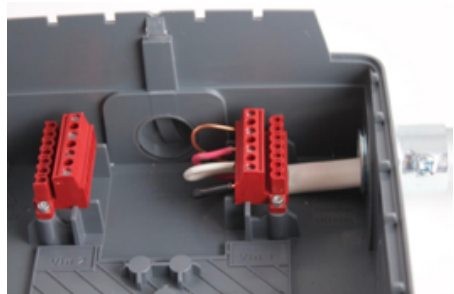
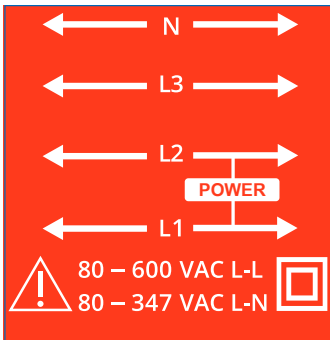

Figure 6

7. Upon completion of the wiring, you are ready to insert the Main Assembly. Insert the two feet of the Main Assembly into the receivers found in the rear housing. Rotating the Control Board into position, depress the top portion into place, connecting the two RED power connectors to the Control Board assembly. Correct positioning will be accompanied by a clicking sound as the assembly becomes locked into place in the housing.



Français

ATTENTION

- Prise Conduit - ne permettent pas de passer à travers une zone à haute tension reste ouverte. Utiliser les bouchons fournis si le conduit n'est pas connecté
- Ne pas passer les fils autour ou sur le connecteur ROUGE ou permettre des fils de traverser la sécurité "Non Zone câble "

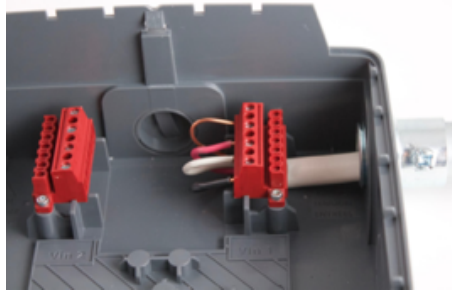
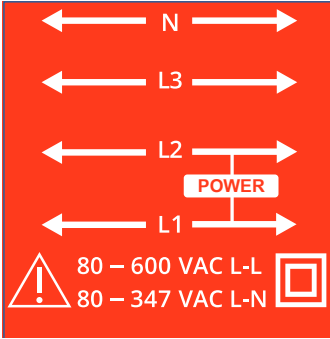

Figure 6

8.0 Current transformer wiring

Mount conduit fittings and conduits

WARNING

- Conduit grounding – required electrical grounding of the meter through conduit
- EMT fitting – EMT fitting must comply with all local electrical codes
- Current Transducers may not be installed in a panel where they exceed 75% of the wiring space of any cross-sectional area within the panel.
- Restrict installation of current transformer in an area where it would block ventilation openings
- Restrict installation of current transformer in an area of breaker arc venting.
- Not suitable for Class 2 wiring methods
- Not intended for connection to Class 2 equipment
- Secure current transformer and route conductors so that they do not directly contact live terminals or bus

1. Place tool in the center feature of the molded in knockout
2. Force tool through the knockout
3. Insert conduit fitting through knockout
4. Thread nut onto the fitting
5. Tighten until secure

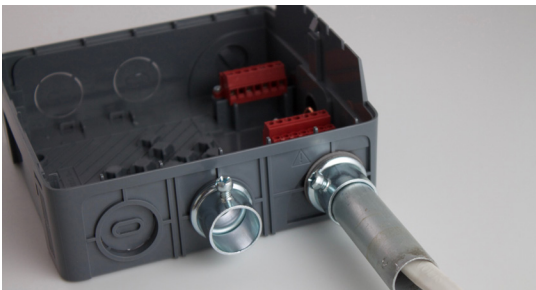
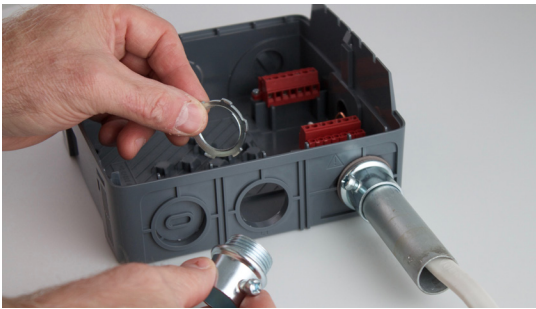

8.0 Câblage du transformateur de courant

ATTENTION

- Mise à la terre conduit – mise à la terre électrique nécessaire du compteur par le conduit
- Montage EMT – raccord EMT doit être conforme à tous les codes locaux
- Transducteurs actuel ne peut pas être installé dans un panneau où ils dépassent 75% de l'espace de câblage d'une section transversale dans le panneau.
- Restreindre l'installation d'un transformateur de courant dans une zone où il bloquerait les ouvertures de ventilation
- Restreindre l'installation du transformateur de courant dans une zone de ventilation d'arc du disjoncteur.
- Ne convient pas aux méthodes de câblage classe 2
- Non destiné à être connecté à un équipement de classe 2
- Fixez le transformateur de courant et acheminez les conducteurs de manière à ce qu'ils n'entrent pas directement en contact avec les bornes sous tension ou le bus



WARNING- Failure to follow these instructions may result in safety concern or damage to meter.

- To reduce the risk of electric shock, always open or disconnect circuit from power-distribution system (or service) or building before installing or servicing current transformers.
- The meter shall use Listed Energy-Monitoring Current Transformers
- Setra Power Meter can accept Rogowski Coil and voltage output current transformer up to 2V rms. Recommended CT rated output is 333 mV (rms). Apply CT output higher than 4Vrms can damage the meter.
- Current Transducers may not be installed in a panel where they exceed 75% of the wiring space of any cross-sectional area within the panel.
- Wiring to CT terminal blocks shall be tightened to 4.43 lb-in torque.
- All unused conduit opening need to be closed using UL listed conduit plugs.
- When using rigid conduit, connect the hub to the conduit before connecting to power meter enclosure

Ensure CT orientation & placement:

- Arrow points toward load (or as instructed by CT label)
- Placed on First Conductor of voltage reference (L1-L2) circuits are placed on L1
- Observe wiring color and polarity
- Use the Shield wire if provided (connect to PCB terminal marked S)



Setra CT wiring guide

Split Core CTs



White: Positive
Black: Negative
(No shield)

Rogowski CTs



Red: Positive
Black: Negative
Bare Wire: Shield

6. Attach Main Assembly to Back Housing, ensuring housing is secure and clicks into place.



Français



ATTENTION- LE NON-RESPECT DE CES INSTRUCTIONS PEUT ENTRAÎNER DES PROBLÈMES DE SÉCURITÉ OU DE DOMMAGES MÈTRES.

- Pour réduire le risque de choc électrique, ouvrez ou déconnectez toujours le circuit du système de distribution électrique (ou du service) ou du bâtiment avant d'installer ou d'entretenir les transformateurs de courant.
- Le compteur doit utiliser des transformateurs de courant de surveillance de l'énergie répertoriés
- Le Power Meter de Setra peut accepter une bobine Rogowski et un transformateur de courant de sortie de tension jusqu'à 2 V eff. La sortie nominale CT recommandée est de 333 mV (valeur efficace). Appliquer une sortie CT supérieure à 4 Vrms peut endommager le multimètre.
- Les transducteurs de courant ne doivent pas être installés dans un panneau où ils dépassent 75% de l'espace de câblage de toute section transversale du panneau.
- Le câblage aux borniers CT doit être serré à un couple de 4,43 lb-in.
- Toutes les ouvertures de conduit inutilisées doivent être fermées à l'aide de bouchons de conduit approuvés UL.
- Lorsque vous utilisez un conduit rigide, connectez le concentrateur au conduit avant de le connecter au boîtier du wattmètre

7. Insert CT wire through the conduit and strip the wire approximately 3/8" (if necessary)

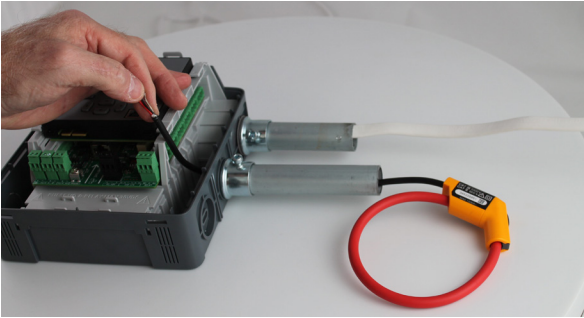

8. Connect the CT wires to the CT connectors provided with your meter in accordance to the wiring diagram provided by the manufacturer



9. Plug connector into mating connection on the Main Assembly and note the CT location for configuration.

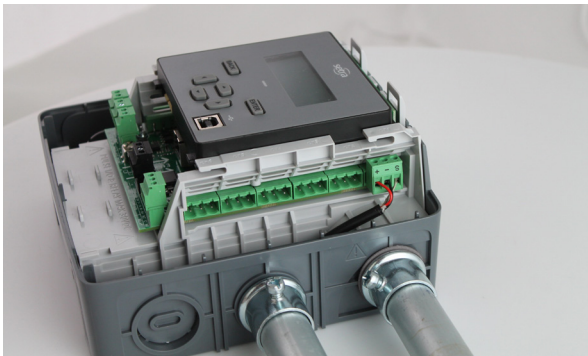

9.0 CTs wiring example

The image below is the counterpart to the service panel illustration and indicates how to connect CTs to Setra Power Meter for each service type. For service types that are not specifically listed, it is recommended to choose "single phase" service and configure each channel individually. Three phase loads are illustrated on the left and split phase loads on the right as an example only. CT inputs are fully interchangeable on the meter.

3-Phase

4-Wire wye

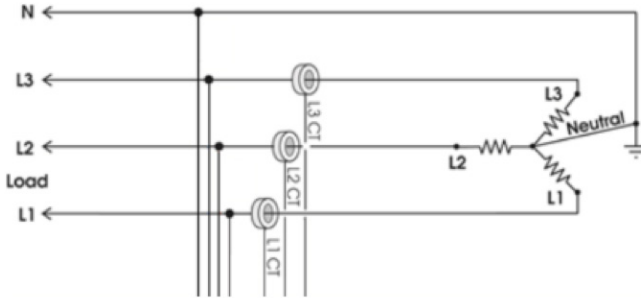

3-Wire delta

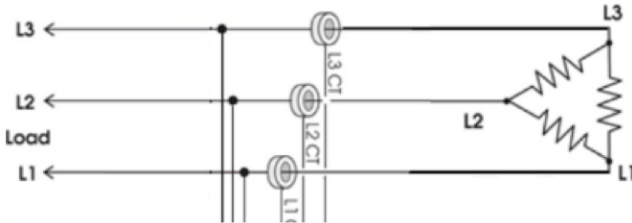

3-Wire single phase

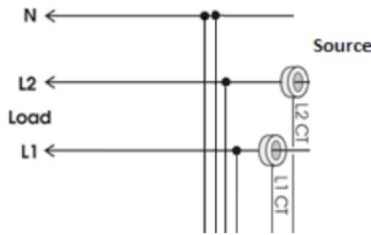

2-Wire single phase

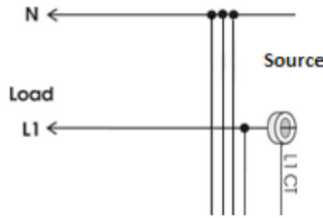

10.0 EIA-485 communication wiring

Setra meter uses a 2-Wire isolated Half Duplex EIA-485 implementation. It is used for BACnet MS/TP or Modbus RTU communication. Supported baud rate are 9600, 19200, 38400 (default), 57600, and 76800. 8 data bits, no parity, 1 start, 1 stop bit. Maximum distance is 1000m.



The recommended wiring for EIA485 is 20 AWG or 22 AWG shielded twisted pair wires. Connect the shield to earth/ ground at one end only. Wiring to terminal blocks shall be tightened to 1.77 lb-in torque.

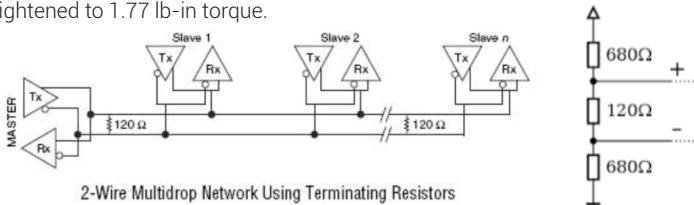

2-Wire Multidrop Network Using Terminating Resistors

- **Termination Resistors** – are NOT included on 3/12-load meter. If the meter is at the end of a daisy-chain, then connect a 120-ohm leaded resistor between the + and - terminal at the RS485 connector. For 48-load meter please use the DIP switch to turn it on or off accordingly.
- **Bias Resistors** – are not included on 3/12-load meter. Bias resistors are needed if the idle conditions of the bus are in an indeterminate logic voltage. Bias resistors are usually located at the master node and are usually 680 ohms for an EIA-485 network. For 48-load meter please use the DIP switch to turn on or off the pull up/pull down bias resistors accordingly.
- **Network Topology** – EIA-485 is designed to be implemented as a daisy chain (series connections) rather than star or cascade topologies.
- **Signal Names** – Some EIA-485 devices use the terminology A/B while others use +/- . Note that A is (-) and B is (+). Many manufacturers incorrectly label the terminals.
- **Bus Loading** – The meter is a 1/8th unit load allowing up to 256 like devices in parallel.

10.0 Câblage de communication EIA-485



Le câblage recommandé pour EIA485 est de 20 AWG ou 22 AWG câbles blindés à paire torsadée. Connectez le blindage à la terre / terre à une seule extrémité. Le câblage aux borniers doit être serré à un couple de 1,77 lb-po.

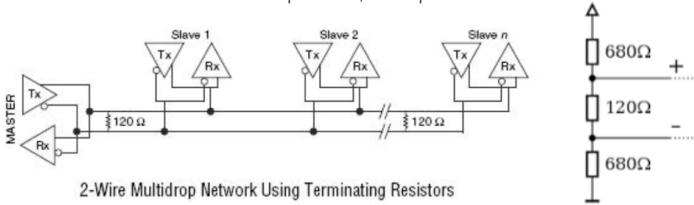

 Verification includes confirmation of BOTH the physical interface settings (Serial or Ethernet) and the protocol (Modbus or BACnet) settings.

11.0 Ethernet communication wiring

Connect Setra Power Meter to a 10/100 Baset 802.3-2002 compliant IP network or device by connecting a CAT5 Ethernet cable to the RJ45 Ethernet port on the Meter. The Ethernet supports BACnet/IP and Modbus TCP protocol.

1. Install communication and other I/O as your application requires.

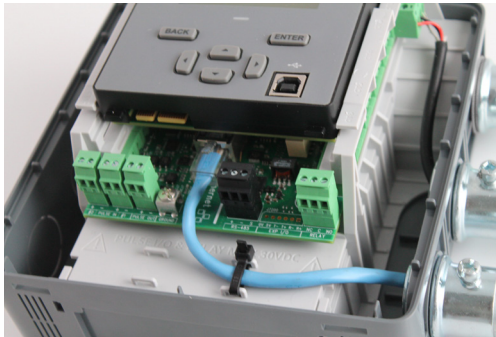
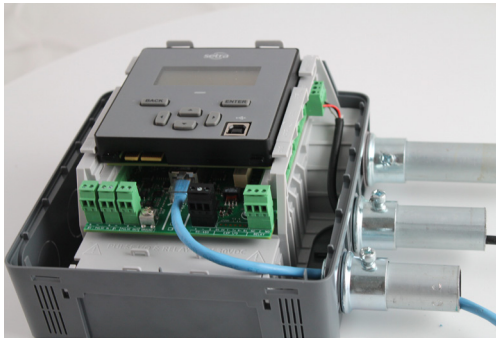
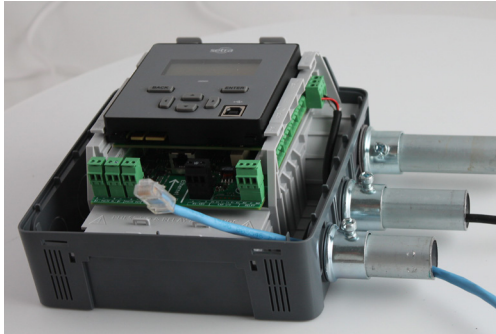

12.0 Pulse inputs wiring

 Pulse input expects dry contact or unpowered opto-isolator open collector. **APPLY VOLTAGE OR WETTED CONTACT MAY DAMAGE THE METER AND VOID WARRANTY.**

 The recommended wiring is 20 AWG or 22 AWG twisted pair wires. Wiring to terminal blocks shall be tightened to 1.77 lb-in torque.

Setra meters are equipped with two pulse inputs. Pulse counting supports accumulation of consumption data from any external meter (e.g., gas, water, BTU meter) using a dry contact (Form A relay) or unpowered opto-isolator open collector outputs. **APPLY VOLTAGE OR WETTED CONTACT MAY DAMAGE THE METER AND VOID WARRANTY.** The pulse inputs are compatible with “low speed” meters. The minimal pulse width is 20 mS is both the logic low and high state and pulse rate is 20 Hz.

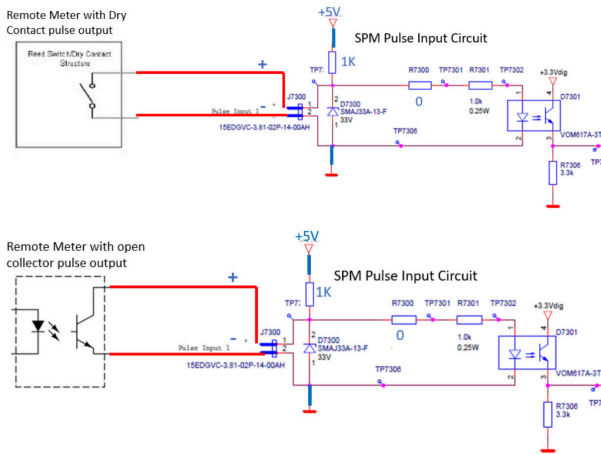

12.1 Pulse output wiring

The pulse output is electrically isolated from the meter power supply and requires the user to connect a voltage source (5-30 VDC), a ground wire (connected to the host ground), and a pull-up resistor. A 10K resistor is the recommended value. The pull up resistor shall be sized to limit the current through the isolator to 5 mA.

 If the collector is connected directly to a source of voltage, the pulse isolator will immediately burn out and become non-responsive.

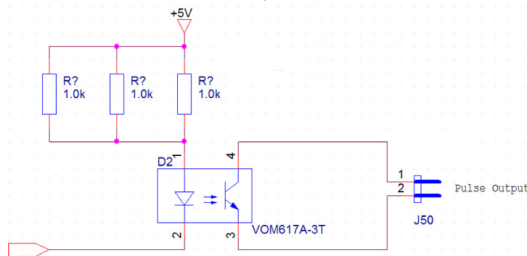

Output connections

13.0 Alarm relay (SPDT) wiring

 The recommended wiring is 20 AWG or 22 AWG twisted pair wires. Wiring to terminal blocks shall be tightened to 1.77 lb-in torque.

Setra meter include a single pole double throw electromechanical relay that can be configured to trigger under loss of voltage conditions. This feature will alert building systems to a "loss of phase" condition within 100 mSec of occurrence without being polled. Once triggered this relay will need to be reset via a register command.

 Please note this relay shall only be used for Class 2 limited energy wiring. The maximum contact rating is 2A and 30VDC/30VAC.

Français

12.0 Câblage des entrées d'impulsion

 Le câblage recommandé est des fils à paire torsadée de 20 AWG ou 22 AWG. Le câblage aux borniers doit être serré à un couple de 1,77 lb-po.

13.0 Alarm relay (SPDT) wiring

 Le câblage recommandé est des fils à paire torsadée de 20 AWG ou 22 AWG. Le câblage aux borniers doit être serré à un couple de 1,77 lb-po.

 Veuillez noter que ce relais ne doit être utilisé que pour le câblage à énergie limitée de classe 2. La valeur nominale maximale des contacts est de 2A et 30VDC / 30VAC.

14.0 Installing front cover

1. Install front cover by inserting tabs into bottom of the back housing and rotate until it clicks.



1. Turn on Power. It will take a couple minutes for the meter to start up. When the meter is fully powered up, the status LED will show either Green (no error detected) or Red (configuration or measurement error detected). The backlit LCD will show start up message.

15.0 Meter configuration

The Setra Power Meter's configurability allows each product to accurately measure in each unique application. Simple configuration can be leveraged on the unit's main LCD display, and more detailed configuration is best completed using Meter's integrated Web Portal setup software. The Web Portal can be accessed using a USB or Ethernet port.

15.1 LCD user interface for simple configuration

To use the LCD display, the meter must be powered either through USB or the high voltage inputs. The LCD will light up upon receiving power. This will follow with easy-to-follow prompts that allow the user to simply step through each screen.

15.2 Web portal for main configuration

The meter's Web Portal is an intuitive, web based setup guide for the 3, 12, and 48 load meters. To access the meter, the user will first need to connect with a PC.

15.3 Connect the Meter

USB Connection (Power & Communications)

The preferred method for configuring the meter from a locally connected computer is through the USB port which provides power to the meter as well as communications. The USB port of most computers will be able to provide enough current to power the meter for configuration. However, it shall not be used to measure electrical parameters without the meter connected to line voltage (Vin 1).

Note: It is normal to see blinking red light when SPM is powered by USB without line power during meter configuration. The blinking red light indicates the measurement cannot be completed and the LCD screen will display "E1:EC_SELECT_TIMEOUT".

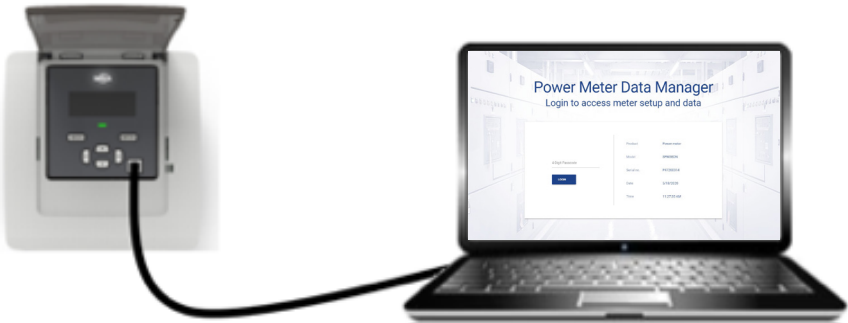

To check the status of the meter, the user can reference both the LCD display and the LED light indicator. If the LED is green, the status is clear. If the LED is blinking red, there is an error – which requires investigation; detailed information can be found in the unit through the LCD display. If LED remains "green" for extended period of time, the meter is not communicating.

Blinking green = Good

Blinking red = Error

Ethernet Port Connection (Communications only)

The meter can also be configured through the Ethernet port. Please note that this connection is for communication only and will not power the unit.

15.4 Web portal setup

After enabling a connection with the meter, open a web browser on the connected PC and enter `http://10.10.5.2` (this is the static address of the USB port) to start the Web Portal home page. The user will be prompted to LOGIN to the Portal with a Pin code, for additional security, if desired.

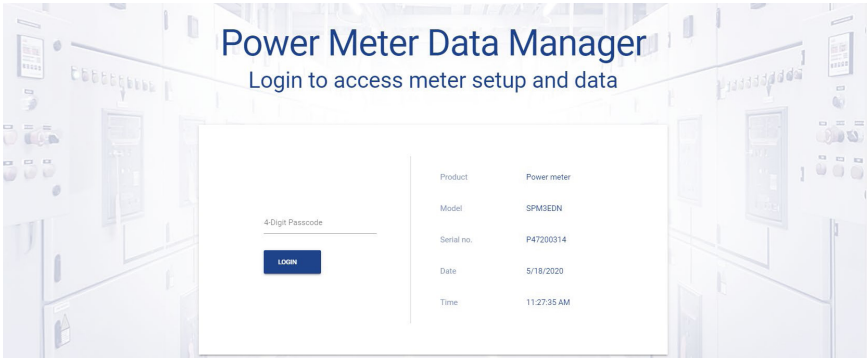

Upon login, the web portal software will open with the menu navigation sidebar appearing along the left side.

15.5 Web portal overview

The web portal is structured into three main sections: the meter communication bar, menu navigation sidebar, and the configuration/data window. The web portal software will allow the user to configure the meter for their installation as well as view/access data once the meter fully installed and collecting data.

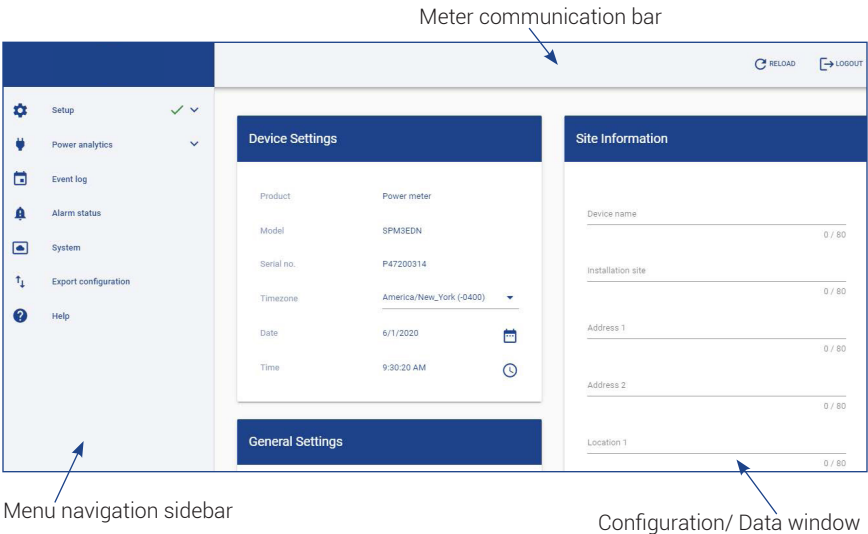

15.6 Meter communication bar

The meter communication bar is the 3-button user interface that links the web portal software to the configuration file on the meter.

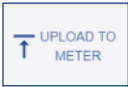

Send/store the configuration to the meter

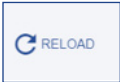

Reload/retrieve the current stored configuration from the meter to the portal



Logs out of the current session of the portal, pin code may be needed to log back in

15.7 Menu navigation sidebar

The menu navigation sidebar allows the user to navigate through the web portal software. The sidebar is split into seven sections:

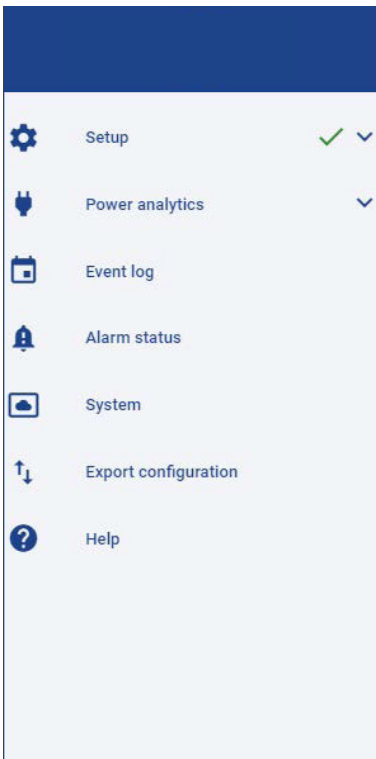

1. Setup

Configure unit defaults, define voltage input(s), load setup, CT inputs, communication output, pulse input(s) & output, alarming, and complete installation report.

2. Power analysis

Access energy & power details for the configured loads of the meter including: trending, harmonics, waveform, and running "odometer" measurement.

3. Event log

Access to previously occurring errors and configuration changes to the meter setup.

4. Alarm status

Access to current alarm status (including LED and relay state) and previously triggered alarms

5. System

Update current software version, perform factory and trend data reset, and reboot the meter.

6. Export configuration

Export or import configuration file for a backup of the fully configured meter or use to import setup to another meter being installed with a similar setup & export configuration report.

7. Help

Access technical documentation for the meter and contact information for technical assistance.

16.0 Halo-dot

The Halo-dot is a visual indication to the user of where to click to begin configuration, current status of a given attribute, or numeric indication of the item selected.

16.1 Configuration indication dot

The configuration indication dot resides on or next to an input or output that can be configured or grouped together by the web portal. The color of the indication dot changes based on the state of configuration, while the meaning of the color may change slightly depending on the menu.



16.2 Halo

When the indication dot is surrounded by a “Halo”, it indicates the input or output is selected and currently being configured.



16.3 Numerical indication

When the configuration indication dot—has a number inside the symbol, it reflects either the input number, output number, or the load assignment based on the configuration menu the user is in.



17.0 Setup menu

The power meter's web portal configuration software is intended to intuitively walk the user through the setup of all the crucial inputs and outputs to gain insights into energy usage, allowing them to make better energy management decisions and support energy strategy initiatives.

The setup menu is divided into eight menu areas:

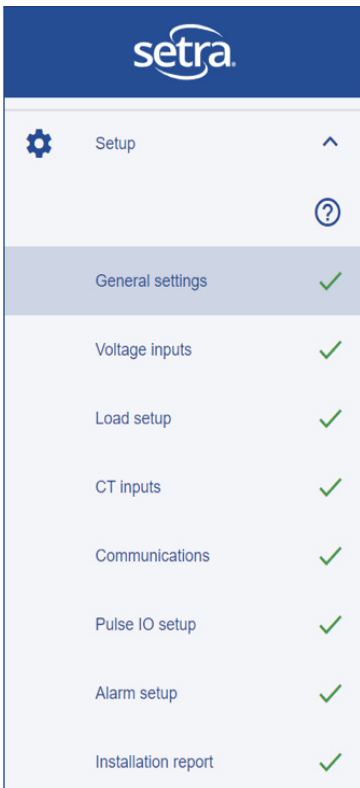





- 1. General settings**
Configure/edit general settings for the device, edit unit defaults & add site specific information about installation (optional)
- 2. Voltage inputs**
Configure/edit expected line voltage (voltage reference) & define service type (wiring) of the voltage input(s)
- 3. Load setup**
Define/edit the relationship between the voltage input(s) and CT(s) for the electrical load being measured
- 4. CT inputs**
Configure/edit the CT type, rated current, voltage at rated current and CT polarity
- 5. Communication**
Configure/edit communications type, protocol parameters, and define network settings
- 6. Pulse IO setup**
Define & configure the (2) pulse inputs & (1) pulse output on the meter
- 7. Alarm setup**
Configure/edit alarm type, setpoint, deadband, delay, LED indication, relay trigger for conditions that require notification
- 8. Installation report**
Generate record of installation with snapshot of live data in a pdf









18.0 Setup menu help legend





Throughout the web portal there are icons and coloring to help the user know the state of the configuration and if further action might be needed. These legends are accessible by clicking the encircled question mark icon and opening the relevant legend on the page.

Within the setup menu, the legend is below:

Legend	
	Page is configured, valid and uploaded to device
	Page is configured and valid but not yet uploaded to device
	Page has configured elements which are not used
	Page has configuration errors. Cannot upload configuration to device

[CLOSE](#)

General settings	
Voltage inputs	
Load setup	
CT inputs	
Communications	
Pulse IO setup	
Alarm setup	
Installation report	

-  If the section has this symbol to the right of title, it requires no further action from user.
Note: When first logging into the web portal, the user will see the green checkmark since the defaults are loading at the time of manufacturing.
-  If the section has this symbol to the right of title the user is required to click the Upload to Meter button in the Meter communication bar.
Note: The upload to meter button only appears when there is something to upload.
-  If the section has this symbol to the right of title, it serves as a warning that there may or may not be more work to do to fully configure the meter.
Note: This will not prevent you from uploading the configuration to the meter, (warning only).
-  If the section has this symbol to the right of title, the configuration has a fundamental error and cannot be uploaded to the meter.

19.0 General settings

The General Settings menu is where the user can find general device information, set unit default parameters, and enter any detailed information about the site where the meter is being installed. The general settings configuration/data window can be accessed by clicking the Setup section (if minimized) and then clicking the General Settings menu.

Once in the General settings menu, the user can access three sub menus: Device general, Unit defaults, and Site information.

19.1 Device settings within the Device Settings section

Within the Device general section, the Product, Model, and Serial no. will automatically be pulled from the stored values on the meter. The date and time can be set following the procedures below.

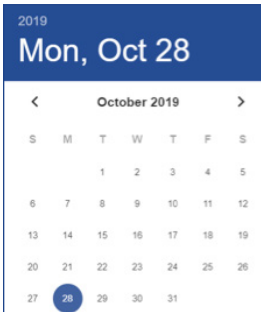
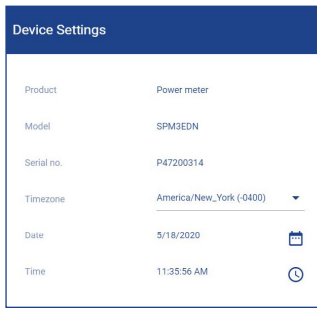

The date can be set by:

1. Click the calendar icon
2. Use the left & right arrow to scroll to the correct month/year
3. Click the correct day within the month
4. Click out of the window and your date should be changed
5. To upload changes to the meter, click Upload to Meter in the communication bar

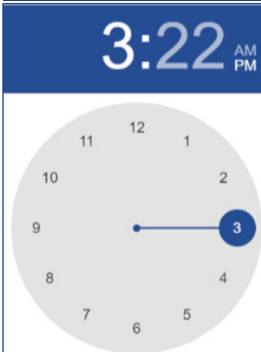

The time can be set by:

6. Click the clock icon
7. With the hour highlighted in white, click the number that needs to be set
8. With the Minute highlighted in white, click the number that needs to be set
9. Click out of the window and your time should be changed
10. To upload changes to the meter, click Upload to Meter in the communication bar

Note: The date & time set will be used for time stamping during data collection. The unit will not adjust for daylight savings time.

19.2 General Settings

Within the General Settings section, the user can change global settings that will apply to all measurements and/or operation of the power meter. Within the Unit defaults menu, the user can edit: Display backlight, Display scrolling, Password enablement, Power factor sign convention, frequency, and demand window. Within the General Settings menu, the user can change/set the: Display backlight, Display scrolling, Power factor sign convention, Frequency, Demand window, Billing cycle day, Billing cycle time, Peak demand reset, and the Passcode.

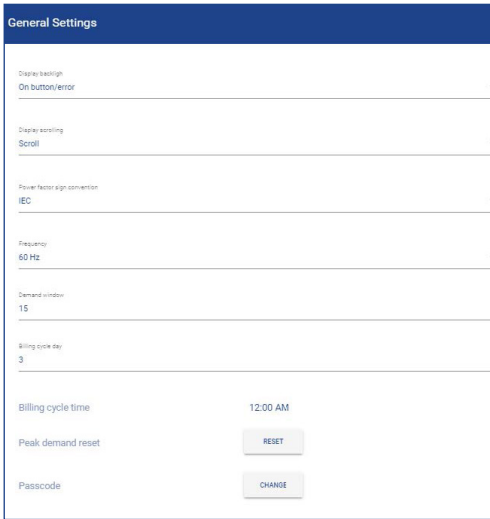

General Settings

Display backlight
On button/error

Display scrolling
Scroll

Power factor sign convention
IEC

Frequency
60 Hz

Demand window
15

Billing cycle day
3

Billing cycle time
12:00 AM

Peak demand reset
RESET

Passcode
CHANGE



Display backlight

Always on

On button/error

Always off

Power factor sign convention
IEEEE

Display backlight

This setting changes the backlight behavior on the physical meter

1. Click the drop down arrow
2. Select Always on (stays on all the time), On button/error (display will be backlit after a button press or if there is an error, or always off (back light is never on)
3. To upload changes to the meter, click Upload to Meter in the communication bar if configuration is complete



Display backlight

Always on

Display scrolling

Scroll

Static

Display scrolling

This setting changes the behavior of the data on LCD screen

1. Click the drop down arrow
2. Select scroll (real-time data will scroll from load to load), or Static (real-time data will remain static until user clicks left/right arrow)
3. To upload changes to the meter, click Upload to Meter in the communication bar if configuration is complete

Display scrolling
Scroll ▼

Power factor sign convention

IEC

IEEE

Power factor sign convention

This setting changes the convention for the power factor sign

1. Click the drop down arrow
2. Select IEC or IEEE
3. To upload changes to the meter, click Upload to Meter in the communication bar if configuration is complete

Note: Click help icon to display chart for sign convention

IEC Power Factor Sign Convention

IEC 62053-23:2016

PF sign depends on Real Power flow direction. Positive sign for normal (positive) Real Power flow into load.

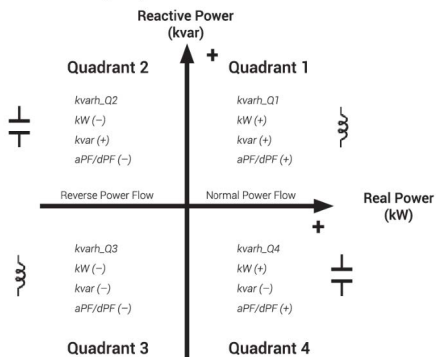

IEEE Power Factor Sign Convention

IEEE 1459:2010

PF sign depends on load type (inductive/capacitive). Positive sign for Inductive type load.

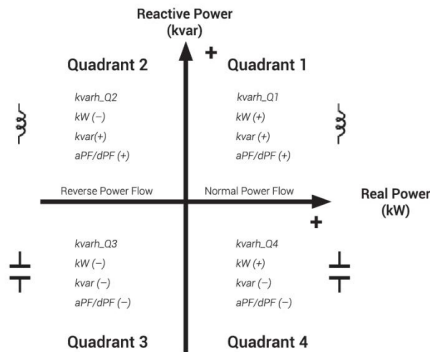

Display backlight
Always on ▼

Display scrolling
Scroll ▼

Power factor sign convention
IEEE ▼

Frequency

50 Hz

60 Hz

Frequency

This setting changes the frequency setting, based on region

1. Click the drop down arrow
2. Select 50 or 60 Hz
3. To upload changes to the meter, click Upload to Meter in the communication bar if configuration is complete

Display backlight	Always on	▼
Display scrolling	Scroll	▼
Power factor sign convention	IEEE	▼ ⓘ
Frequency	60 Hz	▼
Demand window	15	

Demand window

This setting changes the time interval for peak demand window

1. Click into the field
2. Enter desired time interval (1 to 120 minutes)
3. To upload changes to the meter, click Upload to Meter in the communication bar if configuration is complete

Power factor sign convention	IEEE	▼
Frequency	60 Hz	▼
Demand window	15	
Billing cycle day	11	
Billing cycle time	12:00 AM	🕒
Peak demand reset	<input type="button" value="RESET"/>	ⓘ

Billing cycle day

This setting changes day of the month, the peak demand value in the meter is reset, and is also used to see the last month date window in the odometer

1. Click into the Billing Cycle day field
2. Enter day of the month for the peak demand and odometer the user wants the change to occur (i.e. if the user enters a value, every 11th day of the month the peak demand and odometer would reset)
3. To upload changes to the meter, click Upload to Meter in the communication bar if configuration is complete

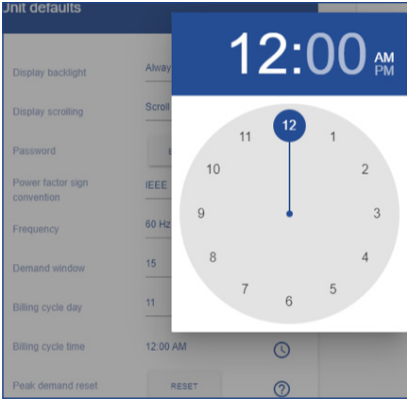

Billing cycle time

This setting changes time of day on the billing cycle day the peak value in the meter is reset and is also used to set the last month date window in the odometer

1. Click on the clock symbol to the right of the current time setting
2. Select new time for reset to occur
3. Click into the grayed out area, new time will show in the billing cycle time field
4. To upload changes to the meter, click Upload to Meter in the communication bar if configuration is complete

Note: The unit will not adjust for daylight savings time

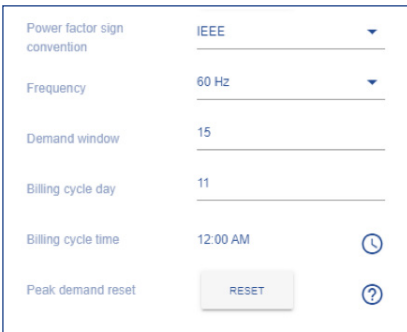

Peak demand reset

The peak demand is reset automatically every month on the day and time as configured in the billing cycle. Pressing the 'Reset' button resets the peak demand directly once.

1. Click Reset
2. Click OK or CANCEL to continue/not continue with reset of the current peak demand value

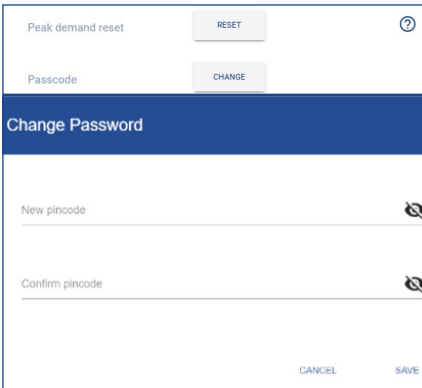

Passcode

This setting allows the user to change the passcode used to access the meter

1. Click CHANGE
2. Type 4 digit pin code
3. Confirm 4 digit pin code
4. Click save
5. To upload changes to the meter, click Upload to Meter in the communication bar if configuration is complete
6. Unit will go to login screen. Enter pin and circle login button.

Note: Some version of the software require a pin code. Disabling is not an option.

19.3 Site information

The Site information section allows the user to store pertinent information about the job site directly on the meter. While optional, this information gives the user detailed information about the site that can be accessed through BACnet, transferred directly to the installation report, and stored in a job file.

Site information	
Device name	0 / 80
Installation site	0 / 80
Address 1	0 / 80
Address 2	0 / 80
Location 1	0 / 20
Location 2	0 / 80
Panel #	0 / 30
Panel type	0 / 20

Site information

This is a repository for pertinent job site information

1. User fills out fields that are pertinent to the job

Note: Each field has a character limit that is noted in grey.

19.4 Uploading to meter

With the General settings menu complete, the user can click Upload to meter to load settings and information on to the meter.

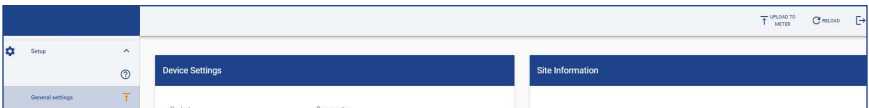

Once the user sees the "Successfully saved device info" flag, the upload is complete, and changes have been saved.

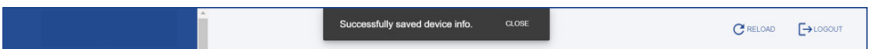

20.0 Voltage inputs

The Voltage inputs menu is where the user enters the expected voltage, reads the actual voltage (if unit is line powered), configures the service type (wiring), and corrects the service wiring electronically.

To begin setting up the Voltage inputs, click one of the grey configuration dots next to the Voltage input connector that needs to be configured. The example below shows Voltage input 1 (Vin 1) being selected on a 12 Load meter.

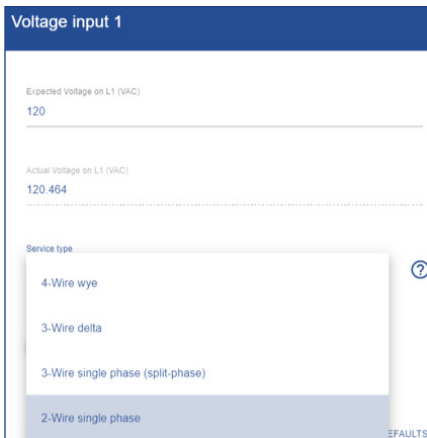
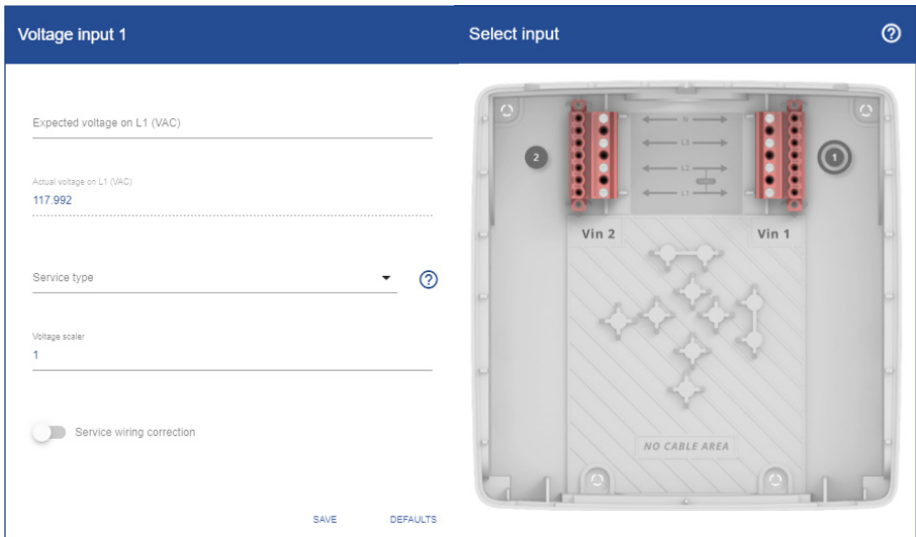

1. Enter the expected voltage for the input; this can be used for reference and for an alarm setpoint
2. Select Service type from the drop down list, wiring diagrams can be accessed by clicking the help icon

Voltage input 1

Expected voltage on L1 (VAC)
120

Actual voltage on L1 (VAC)
118.181

Service type
2-Wire single phase

Voltage scaler
1

Service wiring correction

SAVE DEFAULTS

Voltage input configuration

1. Click Save

Note: The "Halo-dot" may turn amber until the input is assigned to a load.

Service wiring correction

Voltage input 1

Expected voltage on L1 (VAC)
120

Actual voltage on L1 (VAC)
118.298

Service type
2-Wire single phase

Voltage scaler
1

Service wiring correction

L1-connector
L1

SAVE DEFAULTS

Voltage input configuration, service wiring correction

To correct any field wiring issue the wiring can be changed electronically by re-assigning the inputs

1. Click the slide switch to enable feature
2. Click drop down
3. Align L1 voltage wire from the panel with the correct input terminal on the voltage input connector
4. Click save

L1-connector

L1

L2

L3

Clear configuration of Voltage input

1. Click Defaults in the lower right of the configuration window to clear values

Voltage input 1

Expected voltage on L1 (VAC)
120

Actual voltage on L1 (VAC)
118.142

Service type
2-Wire single phase

Voltage scaler
1

Service wiring correction

SAVE DEFAULTS

2. Values will clear, click SAVE

Voltage input 1

Expected voltage on L1 (VAC)

Actual voltage on L1 (VAC)
118.253

Service type

Voltage scaler
1

Service wiring correction

SAVE DEFAULTS

3. Warning message appears, alerting the user that all loads associated with the input will be removed, if ok, click OK

Confirm

Changing the service type of an input will remove all loads configured for that input. Are you sure you want to save the change and remove assigned loads for input 2?

CANCEL OK

Voltage input returns to grey, unused state per legend



Halo-dot Legend: Voltage input

Legend

- Fully configured
- Assigned to load, but CT not configured
- CT configured, but CT not assigned to load
- Unused
- Number indicates CT number

CLOSE

21.0 Load setup

The Load setup menu is where the user defines the relationship between the voltage input and the CT(s) for the electrical load to be measured.

What is a Load?

A Load is a grouping of a voltage input and current transformer(s) that provides meaningful energy and power consumption data. A Load can be a voltage reference and (1), (2), or (3) CT(s) based on your wiring service type and whether it is a single, dual, or three-phase service.

The key feature of the Load setup menu is the flexibility given to the user to mix and match any combination of single, dual, or three-phase loads within the limit of the Load meter order (3, 12, or 48).

The Load setup menu is designed to let the user easily configure Loads into meaningful groupings to support an energy management strategy. Within the Load Configuration window, the user assigns a Load name, voltage input, and which CT(s) reference which line input based on the service type (i.e. L1,L2, or L3).

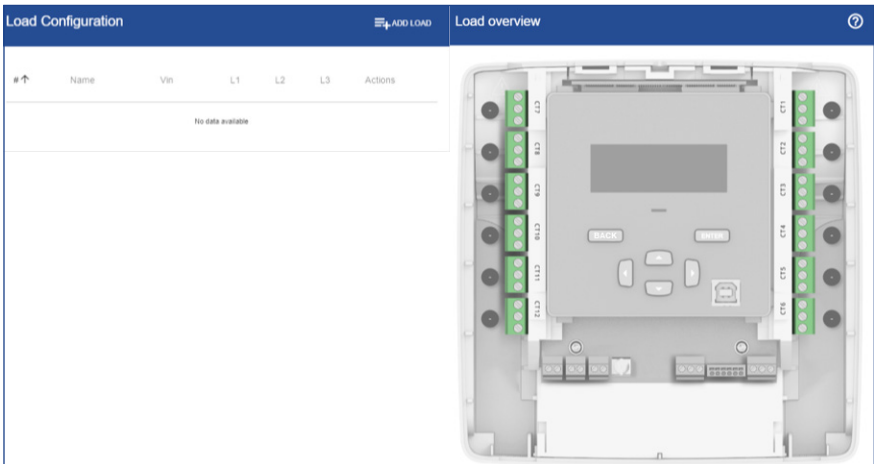

21.1 Configuring a Load

Load Configuration ADD LOAD

New Load

Name: Lighting Load 1 15 / 40

Voltage input: Input 1 (120 VAC)

Input 1 (120 VAC)

Input 2 (480 VAC)

CANCEL SAVE

Load configuration

1. Click ADD LOAD
2. Type in name for Load
3. Select voltage input; Vin1 or Vin2 (3-load meter only has Vin1)

New Load

Name: Lighting Load 1 15 / 40

Voltage input: Input 1 (120 VAC)

L1

None

CT 1

CT 2

CT 3

CT 4

CT 5

4. Select CT that ties into L1 for single phase, L1 & L2, for dual phase, and L1, L2, & L3 for three-phase
5. Click save
6. Continue configuring Loads until all CT inputs are full or all loads being measured by the meter are configured (See example below)

Note: The number of CTs needed is determined by configured service type on the selected voltage input.

If unit is configured to run on a BACnet network, each load will need a unique virtual device instance (VDI) assigned to it.

Load Configuration ADD LOAD

	Name	Vin	L1	L2	L3	Actions
1	Lighting	1	CT1	None	None	
2	Office	2	CT2	CT3	CT5	
3	Light 2	1	CT4	None	None	
4	Building Store	2	CT6	CT7	CT8	
5	Light 3	1	CT9	None	None	
6	Light 4	1	CT10	None	None	
7	Light 5	1	CT11	None	None	
8	Light 6	1	CT12	None	None	

Confirm

Are you sure you want to delete Lighting

CANCEL OK

Edit a configured Load

1. Click on the pencil icon to the right of the Load in the Actions column
2. Make change in voltage input or CT
3. Click save

Delete a configured Load

1. Click on the trash can icon to the right of the Load in the Actions column
2. Confirm deletion of Load by clicking ok

Note: After changes have been made and saved the information needs to be uploaded to the meter to take affect.

21.2 Visual load indication

To the right of the table is an image of the power meter. Next to each CT input there is a colored indication dot. Once a Load is defined, a number will appear inside of the indication dot. The number corresponds to Load number in the table.

Note: CTs do not need to be consecutive to be grouped into a Load.

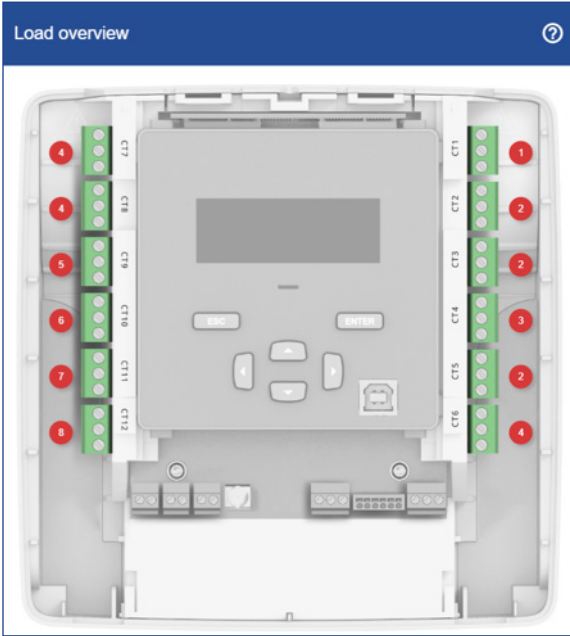

Halo-dot Legend: Voltage input

Legend

- Fully configured
- Assigned to load, but CT not configured
- CT configured, but CT not assigned to load
- Unused
- Number indicates CT number

CLOSE

22.0 CT Inputs

The CT inputs menu is where the user goes to define which CT will be wired into each terminal block of the power meter. The configuration software has been pre-loaded with configurations for both Setra's split core CTs and Patrol Flex Rogowski coils. The user can also configure a user defined CT, provided the max rating is less than 2V.

Note: 5A CTs cannot be used with the power meter.

To begin setting up the CT inputs, click one of the indication dots near the terminal block until the "Halo" appears and the heading of the configuration table matches the selected CT terminal block to be configured. The example below shows Current Transformer input 1 (CT1) being selected on a 12 Load meter.

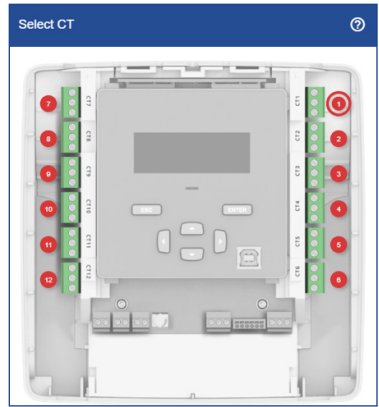

Configure CT Input



Configure a CT Input

After clicking on the indication dot next to the CT terminal block as shown above:

1. Click drop down arrow under CT type
2. Scroll until you find the part number of the Setra CT or select user defined

CT 1 Configuration

CT type
 CT_S_20A

Rated current (A)
 20

Voltage at rated current (mV)
 333

CT polarity correction

COPY SAVE DEFAULTS

3. If a Setra CT is selected, Click SAVE, and configuration is complete. If user defined is chosen, continue to step 4

CT 1 Configuration

CT type
 User defined

Rated current (A)
 10

Voltage at rated current (mV)
 333

CT polarity correction

COPY SAVE DEFAULTS

4. Type in rated current of the CT configured

Note: A average range for user defined must be between 10 to 10,000 Amps

5. Type in the mV Output at the rated current
 6. Click SAVE

Note: Non Setra rogowski coils are not compatible with the power meter

Copy a CT configuration

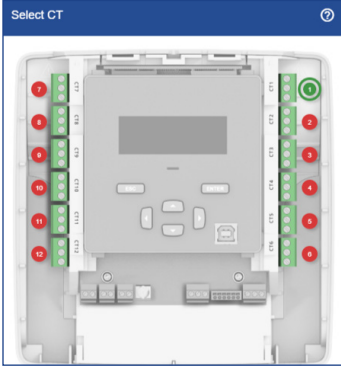

1. Click the indication dot of the CT input that needs to be copied



2. Click copy in the lower left corner of the configuration window

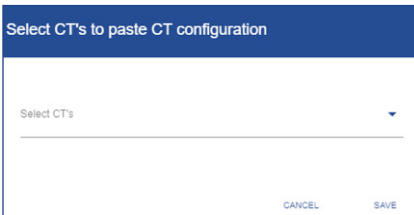

3. Click the drop down to select the CT of CTs the configuration to.

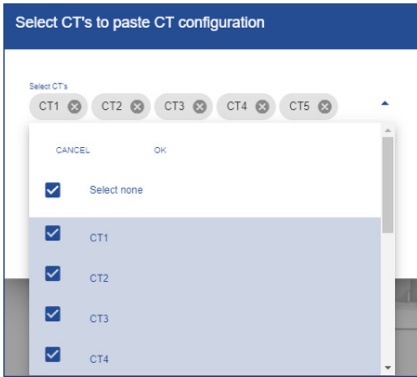

4. Select the CT or CTs to copy the configuration to
5. Once all are selected, click OK

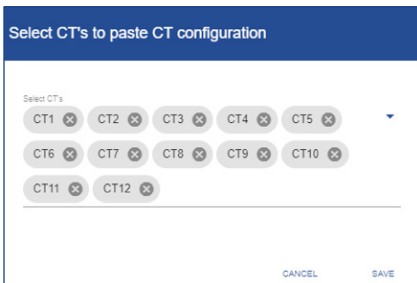

6. Review list of CTs that are selected, if needed click the "X" next to the CT number to remove it from list
5. Click SAVE

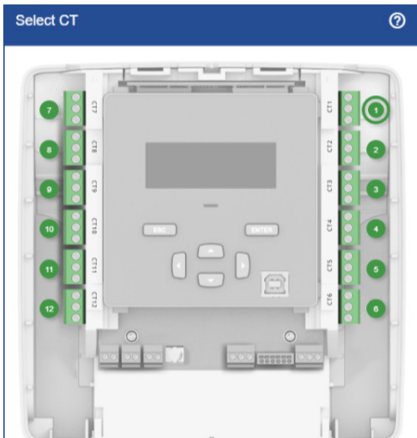

All CTs that were copied to should be either green or amber based on the state of the configuration process.

Note: After CT's have been configured the information needs to be uploaded to the meter.

Clear configuration of CT input

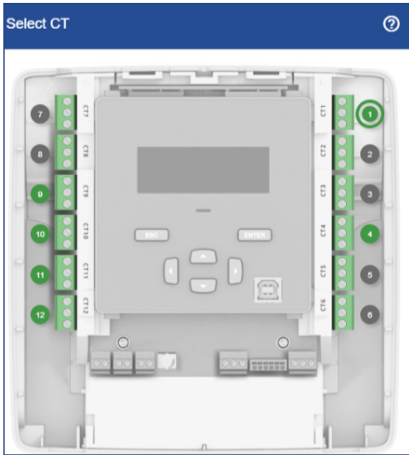

1. Click indication dot until "Halo" appears around the CT input you want to clear

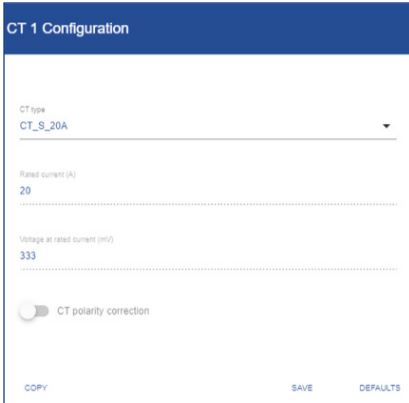

2. Click Defaults in the lower right of the configuration window to clear values



3. Values will clear, click SAVE

Select CT



The indication dot will change color per the Halo-dot legend to reflect to reflect state

Halo-dot Legend: CT input

Legend

- Fully configured
- Assigned to load, but CT not configured
- CT configured, but CT not assigned to load
- Unused
- Number indicates CT number

CLOSE

23.0 Communications/ Network settings

The communications menu is where the user defines the communications protocol and network settings for the power meter. The power meter comes standard with 4 advanced protocol options to fit the installation requirements: BACnet MSTP, BACnet IP, Modbus RTU, and Modbus TCP.

To begin configuration of the communications protocol:

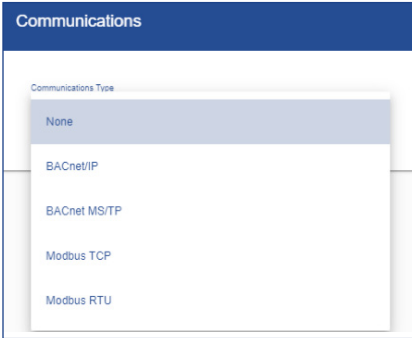

1. Click drop down arrow under communications type
2. Select protocol to match your building automation system or energy software platform

Note: Information needed will change based on the protocol selected. Continue reading below for more details on each protocol.

BACnet IP



3. Fill out each attribute in the setup menu shown to the left

Field Limits are below:

Base Device Instance: 0 – 4194328

Base Device Name: 80 Characters

Virtual Network #: 1 – 65534

UDP Port: 1 – 65534

BBMD address: valid address

BBMD TTL: 1 – 28800

Note: Click BACnet object link for full list.

When BACnet is selected as the communication protocol, a virtual device instance (VDI) is assigned to each configured load. The user must go back and assign a unique VDI to each configured load to ensure reliable network performance.

BACnet MS/TP

Communications

Communications Type
BACnet MS/TP

Base Device Instance
394000

Base Device Name
Setra Power Meter

Virtual Network #
39400

Baudrate
38400

MAC Address
127

Max Master
127

Max Info Frames
10

 [BACnet Objects List](#)

3. Fill out each attribute in the setup menu shown to the left

Field Limits are below:

Base Device Instance: 0 – 4194328

Base Device Name: 80 Characters

Virtual Network #: 1 – 65534

Baud Rate: Selectable 9600, 19200, 38400, 57600, or 76800

MAC Address: 0 – 127

Max Master: (MAC Address + 1) – 127

Max info Frames: 1 - 100

Note: Click BACnet object link for full list.

When BACnet is selected as the communication protocol, a virtual device instance (VDI) is assigned to each configured load. The user must go back and assign a unique VDI to each configured load to ensure reliable network performance.

Modbus TCP

Communications

Communications Type
Modbus TCP

TCP port
502

 [Modbus Register List](#)

3. Fill out each attribute in the setup menu shown to the left

Field Limits are below:

TCP port: 1–65534

Note: Click Modbus Register link for full list.

Modbus RTU

Communications

Communications Type
Modbus RTU

Baudrate
38400

Parity
None

Node Address
1

 [Modbus Register List](#)

3. Fill out each attribute in the setup menu shown to the left

Field Limits are below:

Baud Rate: Selectable 9600, 19200, 38400, 57600, or 76800

Node Address: 1 - 247

Parity: Odd, Even, or None (default)

Note: Click Modbus Register link for full list.

23.1 Network Settings

In the network settings window, the user can configure the IP Address. The power meter's IP Address supports either addresses obtained via Dynamic Host Control Protocol (DHCP) or static IP addresses.

DHCP

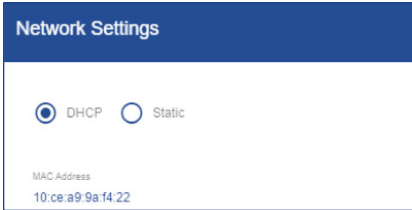

The screenshot shows the 'Network Settings' window with a blue header. Below the header, there are two radio buttons: 'DHCP' (which is selected) and 'Static'. Below the radio buttons, the 'MAC Address' is displayed as '10.ce.a9.9a.14.22'.

If the DHCP server is active on the IP network, then it will automatically assign an IP address to the Power Meter

Static

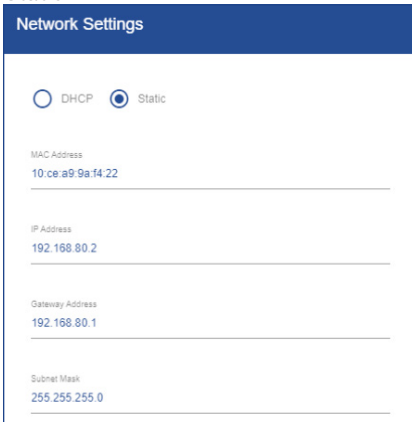

The screenshot shows the 'Network Settings' window with a blue header. Below the header, there are two radio buttons: 'DHCP' and 'Static' (which is selected). Below the radio buttons, there are four input fields with their respective values: 'MAC Address' (10.ce.a9.9a.14.22), 'IP Address' (192.168.80.2), 'Gateway Address' (192.168.80.1), and 'Subnet Mask' (255.255.255.0).

The user can assign a static IP address by selecting the Static radio button and filling out the desired MAC address, IP address, Gateway address, & Subnet mask.

24.0 Pulse IO setup

The power meter comes standard with (2) pulse inputs and (1) pulse output. The Pulse IO setup menu is where the user goes to enable/define either inputs from an external meter or to enable/define the pulse output from the power meter.

To begin configuration, click the indication dot above either the pulse input or output connection to the meter as shown below. Once the "Halo" appears around the indication dot the header for the input/output configuration window will change to match the selection.



Pulse In

The (2) pulse inputs can be configured to accept a pulse input from several types of meters including Electrical, Water, Gas, Steam, BTU/Energy, or used as an Event counter.

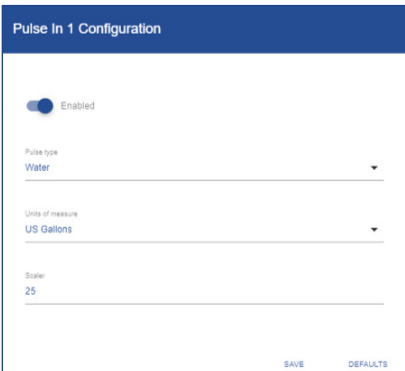

To begin configuration:

1. Click slide bar to enable input
2. Click drop down to select pulse type
3. Click drop down to select unit of measure
4. Type in the Scaler; value of each pulse in UOM
5. Click SAVE, Indication dot will become green

24.1 Pulse Output

The (1) pulse output can be configured to send out a defined pulse to an external pulse counting source.

The screenshot shows the 'Pulse Out 1 Configuration' page. At the top, there is a blue header with the title. Below the header, there is a toggle switch labeled 'Enabled' which is turned on. Underneath, there is a 'Load' dropdown menu with 'Light 1' selected. Below that is a 'Pulse type' dropdown menu with 'Energy' selected. The 'Units of measure' dropdown menu is open, showing a red error message: 'Please select a unit of measure.' Below this, there is a 'Scaler' input field with the value '1' and a 'Pulse Width (ms)' input field with the value '20'. At the bottom right, there are 'SAVE' and 'DEFAULTS' buttons.

To begin configuration

1. Click the grey indication dot above the pulse output terminal block (O1), halo will surround dot
2. Click slide bar to enable output
3. Select a configured load from the drop down

The screenshot shows the 'Pulse Out 1 Configuration' page. At the top, there is a blue header with the title. Below the header, there is a toggle switch labeled 'Enabled' which is turned on. Underneath, there is a 'Load' dropdown menu with 'Light 1' selected. Below that is a 'Pulse type' dropdown menu with 'Energy' selected. The 'Units of measure' dropdown menu is open, showing three options: 'Kilowatt Hours (kWh+)', 'Kilovolt Ampere Hours Reactive (kVARh+ plus kVARh+)', and 'Kilovolt Ampere Hours (kVAh+)'. Below this, there is a 'Scaler' input field with the value '20' and a 'Pulse Width (ms)' input field with the value '20'. At the bottom right, there are 'SAVE' and 'DEFAULTS' buttons.

4. Click drop down to select unit of measure

Pulse Out 1 Configuration

Enabled

Load
Light 1

Pulse type
Energy

Units of measure
Kilowatt Hours (kWh*)

Scaler
250

Pulse Width (ms)
20

SAVE DEFAULTS

5. Enter in the Scaler; value of each pulse in UOM
6. Enter pulse width (ms)
7. Click SAVE, indication dot will become green

Select Pulse IO



Clear configuration of pulse IO



1. Click indication dot until "Halo" appears around the Pulse input or output you want to clear

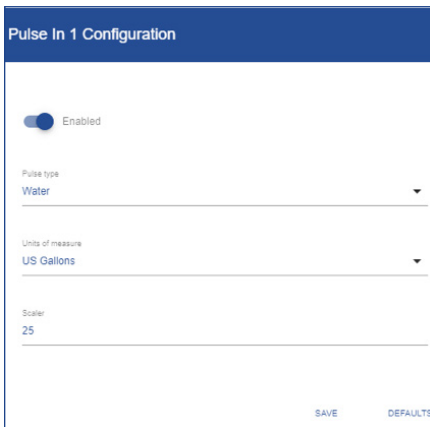

2. Click Defaults in the lower right of the configuration window to clear values



3. Values will clear, click SAVE

Select Pulse IO





The indication dot will change color per the Halo-dot legend to reflect state.



Halo-dot Legend: Pulse IO setup

Legend

-  Active
-  Unused

CLOSE

25.0 Alarm setup

The Alarm setup menu is designed to let the user easily configure alarms and present the alarms to the user in simple defined list. Alarms can be configured to trigger a Relay, show a warning LED and create warning logs for undesirable conditions. An alarm has up to 7 properties that can be configured:

Error Type

The type of the error to look out for. There are 13 types that can be configured, namely: 'Over Power', 'Under Power', 'Energy Usage (Vin)', 'Energy Usage (Load)', 'Polarity CT', 'Under Voltage', 'Under Current CT', 'Over Current CT', 'Phase Loss', 'Over Voltage', 'Over Current (Load)', 'Peak Demand (Load)' and 'Low Power Factor'.

Vin / Line / Load / CT

Depending on the alarm type you can configure either a Voltage input (Vin), Line, Load or CT.

Alarm Set Point

At what value the alarm should be triggered.

Deadband

The deadband defines the range the alarm will not change the alarm state after it is triggered. For example, when configuring 'Over Power' on a load with a Set Point of 1000kW the alarm will be triggered when the load uses 1000kW. When a Deadband of 50kW is configured the alarm will deactivate when the load consumes power below 950kW.

Delay Seconds

How long the error-condition should exist before the alarm is triggered. This is helpful to prevent nuisance alarms.



LED Indication

Whether to turn on Led when the alarm is active.

Relay Trigger

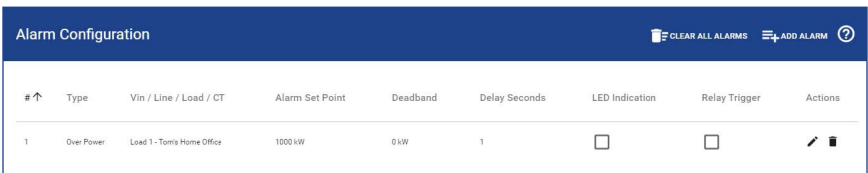
Whether to turn on Relay when the alarm is active.



# ↑	Type	Vin / Line / Load / CT	Alarm Set Point	Deadband	Delay Seconds	LED Indication	Relay Trigger	Actions
1	Over Power	Load 1 - Tom's Home Office	1000 kW	0 kW	1	<input type="checkbox"/>	<input type="checkbox"/>	 

To complete an alarm setup the user must click ADD ALARM in the upper right hand corner, select the alarm type from the dropdown list and fill out all pertinent information needed for the selected error type. When alarm condition is fully defined, click SAVE. To restart the alarm definition, click CANCEL.

25.1 Over Power

This alarm will activate when instantaneous power is above a kW setpoint exceeding the alarm delay of delay setpoint in second (s) for a defined load. The user can configure the LED and/or the alarm relay to be triggered when conditions of the alarm are met (active). The user can configure a deadband (warning) and alarm delay for the alarm condition to prevent nuisance alarming in the application.

Note: If this alarm is set on the same load as an Under Power alarm type, the delay value and deadband value will be common between the alarms. The last of these two alarms listed in the Alarm Configuration table will take precedence

Example:

New Alarm

Alarm Type	Load
Over Power	Load 1 - V1-CT7

Alarm Set Point	Deadband	Delay Seconds
1000	50	15
	kW	kW

LED Indication Relay Trigger

This alarm will activate when instantaneous power is above 1000kW exceeding the delay of 15 seconds for Load 1. Both the LED and the Relay will be triggered when this alarm is active. The alarm will deactivate when instantaneous power is below 950kW exceeding the delay of 15 seconds.

Note: If this alarm is set on the same load as an Under Power alarm type, the delay value and deadband value will be common between the alarms. The last of these two alarms listed in the Alarm Configuration table will take precedence.

25.2 Under Power

This alarm will activate when instantaneous power is below a kW setpoint exceeding the alarm delay of delay setpoint in second (s) for a defined load. The user can configure the LED and/or the alarm relay to be triggered when conditions of the alarm are met (active). The user can configure a deadband (warning) and alarm delay for the alarm condition to prevent nuisance alarming in the application.

Note: If this alarm is set on the same load as an Over Power alarm type, the delay value and deadband value will be common between the alarms. The last of these two alarms listed in the Alarm Configuration table will take precedence.

Example:

New Alarm

Alarm Type	Load
Under Power	Load 1 - V1-CT7

Alarm Set Point	Deadband	Delay Seconds
1000	50	15
	kW	kW

LED Indication Relay Trigger

This alarm will activate when instantaneous power is below 1000kW exceeding the delay of 15 seconds for Load 1. Both the LED and the Relay will be triggered when this alarm is active. The alarm will deactivate when instantaneous power is above 1050kW exceeding the delay of 15 seconds.

Note: If this alarm is set on the same load as an Over Power alarm type, the delay value and deadband value will be common between the alarms. The last of these two alarms listed in the Alarm Configuration table will take precedence.

25.3 Energy usage (Vin)

This alarm will activate when energy consumption for selected voltage input (Vin) exceeds a kWh setpoint. The user can configure the LED and/or the alarm relay to be triggered when conditions of the alarm are met (active). This includes energy consumption for all loads with the selected voltage input (Vin).

Example:

New Alarm

Alarm Type: Energy Usage (Vin) | Vin: Vin 1

Alarm Set Point: 1000 kWh | Deadband: Not applicable | Delay Seconds: Not applicable

LED Indication Relay Trigger

This alarm will activate when energy (kWh+) usage for Vin 1 exceeds 1000kWh. Both the LED and the Relay will be triggered when this alarm is active.

25.4 Energy Usage (Load)

This alarm will activate when energy consumption for selected Load exceeds a kWh setpoint. The user can configure the LED and/or the alarm relay to be triggered when conditions of the alarm are met (active).

Example:

New Alarm

Alarm Type: Energy Usage (Load) | Load: Load 1 - V1-CT7

Alarm Set Point: 1000 kWh | Deadband: Not applicable | Delay Seconds: Not applicable

LED Indication Relay Trigger

This alarm will activate when energy (kWh+) usage for Load 1 exceeds 1000kWh. Both the LED and the Relay will be triggered when this alarm is active.

25.5 Polarity CT

This alarm will activate on negative power calculation caused by mis wired CT. The user can configure the LED and/or the alarm relay to be triggered when conditions of the alarm are met (active).

Example:

New Alarm

Alarm Type	CT	
Polarity CT	CT 1	
Alarm Set Point	Deadband	Delay Seconds
Not applicable	Not applicable	Not applicable
<input checked="" type="checkbox"/> LED Indication	<input checked="" type="checkbox"/> Relay Trigger	

This alarm will activate on negative power for CT 1. Both the LED and the Relay will be triggered when this alarm is active.

25.6 Under voltage

This alarm will activate when the voltage of selected Line goes below the setpoint percentage of the Line's expected voltage for more than the entered delay. The user can configure the LED and/or the alarm relay to be triggered when conditions of the alarm are met (active). Care must be taken to define the expected voltages level in the voltage setup page.

Note: If this alarm is set on the same load as an Over Power alarm type, the delay value and deadband value will be common between the alarms. The last of these two alarms listed in the Alarm Configuration table will take precedence.

Example:

New Alarm

Alarm Type	Line	
Under Voltage	Vin 1 - Line 1	
Alarm Set Point	Deadband	Delay Seconds
90 %	Not applicable	5
<input checked="" type="checkbox"/> LED Indication	<input checked="" type="checkbox"/> Relay Trigger	

This alarm will activate when the voltage of Line 1 goes below 90% of Line 1's expected voltage of 600V for 5 seconds. Both the LED and the Relay will be triggered when this alarm is active.

Note: If this alarm is set on the same line as an Over Voltage alarm type, the delay value will be common between the alarms. The last of these two alarms listed in the Alarm Configuration table will take precedence.

25.7 Under current CT

This alarm will activate when the current flow is equal or less than the setpoint for the selected CT for more than the entered delay. The user can configure the LED and/or the alarm relay to be triggered when conditions of the alarm are met (active).

Example:

New Alarm

Alarm Type: Under Current CT CT: CT 1

Alarm Set Point: 20 A Deadband: Not applicable Delay Seconds: 1

LED Indication Relay Trigger

This alarm will activate on 20A or less flowing through CT 1 for 1 second. Both the LED and the Relay will be triggered when this alarm is active.

Note: If this alarm is set on the same CT as an Over Current CT alarm type, the delay value will be common between the alarms. The last of these two alarms listed in the Alarm Configuration table will take precedence.

25.8 Over current CT

This alarm will activate when the current flow is equal or more than the setpoint for the selected CT for more than the entered delay. The user can configure the LED and/or the alarm relay to be triggered when conditions of the alarm are met (active).

Example:

New Alarm

Alarm Type: Over Current CT CT: CT 1

Alarm Set Point: 20 A Deadband: Not applicable Delay Seconds: 5

LED Indication Relay Trigger

This alarm will activate on more than 20A flowing through CT 1 for 5 seconds. Both the LED and the Relay will be triggered when this alarm is active.

Note: If this alarm is set on the same CT as an Under Current CT alarm type, the delay value will be common between the alarms. The last of these two alarms listed in the Alarm Configuration table will take precedence.

25.9 Phase loss

This alarm will activate when the calculated current unbalance is greater than entered setpoint percentage for longer than the entered delay. Current unbalance is calculated as the maximum deviation divided by the load phases multiplied by 100%. This alarm is intended to alert the user to a lost phase or significant phase current imbalance. The user can configure the LED and/or the alarm relay to be triggered when conditions of the alarm are met (active).

Example:

New Alarm

Alarm Type	Load
Phase Loss	Load 2 - V2-CT1-CT2-CT3

Alarm Set Point	Deadband	Delay Seconds
10 %	Not applicable	5

LED Indication Relay Trigger

This alarm will activate when the calculated current unbalance is greater than 10% for 5 seconds. Current unbalance is calculated as the maximum deviation divided by the average current of the load phases multiplied by 100%. This alarm is intended to alert the user to a lost phase or significant phase current imbalance. Both the LED and the Relay will be triggered when this alarm is active.

25.10 Over voltage

This alarm will activate when the voltage of selected Line goes above entered percentage of the selected Line's expected voltage (value from voltage input configuration) for entered amount of time. The user can configure the LED and/or the alarm relay to be triggered when conditions of the alarm are met (active). Care must be taken to define the expected voltage level in the voltage setup page.

Note: If this alarm is set on the same line as an Under Voltage alarm type, the delay value will be common between the alarms. The last of these two alarms listed in the Alarm Configuration table will take precedence.

Example:

New Alarm

Alarm Type	Line
Over Voltage	Vin 1 - Line 1

Alarm Set Point	Deadband	Delay Seconds
110 %	Not applicable	1

LED Indication Relay Trigger

This alarm will activate when the voltage of Line 1 goes above 110% of Line 1's expected voltage of 600V for 1 second. Both the LED and the Relay will be triggered when this alarm is active.

Note: If this alarm is set on the same line as an Under Voltage alarm type, the delay value will be common between the alarms. The last of these two alarms listed in the Alarm Configuration table will take precedence.

25.11 Over current (Load)

This alarm will activate when the current exceeds a set amperage for an entered time for a selected load. The user can configure the LED and/or the alarm relay to be triggered when conditions of the alarm are met (active).

Example:

New Alarm

Alarm Type: **Over Current (Load)** Load: **Load 2 - V2-CT1-CT2-CT3**

Alarm Set Point: **100** A Deadband: **10** A Delay Seconds: **10**

LED Indication Relay Trigger

This alarm will activate when the current exceeds 100A for 10 seconds for Load 2. Both the LED and the Relay will be triggered when this alarm is active. A warning will be logged when the current exceeds 90A for 10 seconds.

Note: Alarm Set Point should not exceed the maximum rating of any CT configured for the load.

25.12 Peak demand (Load)

This alarm will activate when the peak demand of selected load exceeds an entered setpoint. The user can configure the LED and/or the alarm relay to be triggered when conditions of the alarm are met (active).

Example:

New Alarm

Alarm Type: **Peak Demand (Load)** Load: **Load 1 - V1-CT7**

Alarm Set Point: **1000** kW Deadband: **Not applicable** Delay Seconds: **Not applicable**

LED Indication Relay Trigger

This alarm will activate when peak demand of 1000kW is exceeded for Load 1. Both the LED and the Relay will be triggered when this alarm is active.

25.13 Low power factor

This alarm will activate when the Power factor is below an entered setpoint for a selected Load. The user can configure the LED and/or the alarm relay to be triggered when conditions of the alarm are met (active).

Example:

New Alarm

Alarm Type: **Low Power Factor** | Load: **Load 1 - V1-CT7**

Alarm Set Point: **0.6** | Deadband: **Not applicable** | Delay Seconds: **Not applicable**

LED Indication | Relay Trigger

This alarm will activate when the Power Factor is below 0.6 for Load 1. Both the LED and the Relay will be triggered when this alarm is active.

25.14 Summary alarm table

As each new alarm is created and saved to the meter, the summary table continues to build as each alarm is added. Alarms that are saved can be edited by clicking the pencil icon to the right of the alarm. Alarms can also be deleted by clicking the trash can icon to the right of the configured alarm.

Example:

# ↑	Type	Vin / Line / Load / CT	Alarm Set Point	Deadband	Delay Seconds	LED Indication	Relay Trigger	Actions
1	Over Power	Load 1 - Tom's Home Office	1 kW	0 kW	1	<input checked="" type="checkbox"/>	<input type="checkbox"/>	
2	Low Power Factor	Load 1 - Tom's Home Office	0.7	#NA	#NA	<input checked="" type="checkbox"/>	<input checked="" type="checkbox"/>	
3	Over Voltage	Vin 1 - Line 1	101 %	#NA	1	<input checked="" type="checkbox"/>	<input type="checkbox"/>	

26.0 Installation report

The Installation report menu is designed to let the user easily create a document of record of a power meters' condition, snapshot of measurement data and information the user thinks is valuable to retain about the installation. While nothing in this menu is required, the installation report serves as a valuable tool should different job functions need to find or diagnosis problems with the meter. The menu is split into 4 main windows General Information, Meter Information, General Notes & Measurements.

26.1 General Information

Within the General Information window of the menu, information about the installation site, electrical contractor, and panel information. If information has been previously entered within the general settings menu it will be carried over to the general information window; this information is shown by a dashed data entry line.

General Information

Installation Site 0 / 80

Address 1 0 / 80

Address 2 0 / 80

Electrical Contractor 0 / 80

Electrician 0 / 80

Electrician Phone # 0 / 80

Panel Number 0 / 80

Panel Type 0 / 80

Panel Maximum Fault Current 0 / 80

Panel Location 1 0 / 80

Panel Location 2 0 / 80

26.2 Meter information

Within the Meter Information window of the menu, information about the meter itself is pulled into window such as manufacturer, product part number & serial number. The window has a field that the user can enter the meter install location so it can be found later after leaving the site.

The screenshot shows a window titled "Meter Information" with a dark blue header. Below the header, there are four sections, each with a label, a value, and a character count:

- Manufacturer:** Setra Systems, Inc. (19 / 80)
- Product:** SPM12EDN (11 / 80)
- SN:** PP47601205 (10 / 80)
- Meter Install Location:** Right of Panel 123 (18 / 80)

26.3 General notes

Within the General Notes window of the menu, the user can enter information up to 1000 characters that the electrician/installer wants to note in the report.

The screenshot shows a window titled "General Notes" with a dark blue header. Below the header, there is a text area for notes. The text in the notes area reads: "The door for the panel would not lock, called to the office to order new lock and will install next week before sign-off takes place." At the bottom right of the window, there is a character count: "133 / 1000".

26.4 Measurements

The Measurements window of the menu allows the user to take a snapshot of real-time measurement data the power meter is reading in the installation.

To take a snapshot of real-time voltage and current data the user must click UPDATE POWERMETER VALUES in the blue window bar. By pressing the UPDATE POWERMETER VALUES the meter fills in the real-time values of all voltage and current inputs that are configured to a Load under the Measured Powermeter Values column (right side) of the window.

The window also has a Measured Multimeter Values column where the user can measure the same parameters to make sure the readings are verified with what the electrician/installer would expect based on the installation. This step verifies and gives confidence that the configuration of the meter is correct prior to the electrician/installer leaving the site.

Once all information is entered, click UPLOAD TO METER to save the entered information.

Measured Multimeter Values	Measured Powermeter Values
Input 1 L1-N 118.7	Input 1 L1-N 118.77
Input 2 L1-N 0	Input 2 L1-N 0
Input 2 L2-N 0	Input 2 L2-N 0
Input 2 L3-N 0	Input 2 L3-N 0
CT 1 0	CT 1 0
CT 2 .74	CT 2 0.74
CT 3 0	CT 3 0
CT 4 0	CT 4 0

26.5 Export the report

All the information entered in the Installation report menu can be exported to a pdf to be saved locally to a PC and stored as a record of installation.

To export the Installation report as well as the configuration record, go the Export Configuration section of the manual (31.0) & check all aspects of the configuration that are to be grouped in a .pdf.

Note: Different browsers will have different icons for the download, but should be like typical browser based downloads from previous downloads.

27.0 Power analytics

The power meter logs up to 62 days of data, which the user can access through the power analytics tools. The Power analytics section of the web portal is made up of two menus; Trends and Odometer. This section empowers the user to look at logged or live information both graphically (Trends) and in time based tabular form (Odometer).

27.1 Parameters within Trends & Odometer menus

Energy:

Total active energy delivered (imported) from all phases (kWh+)

Total active energy received (exported) from all phases (kWh-)

Total apparent energy delivered (imported) from all phases (kVAh+)

Total apparent energy received (exported) from all phases (kVAh-)

Total reactive energy accumulated in Quadrant 1 from all phases (kvarh_Q1)

Total reactive energy accumulated in Quadrant 2 from all phases (kvarh_Q2)

Total reactive energy accumulated in Quadrant 3 from all phases (kvarh_Q3)

Total reactive energy accumulated in Quadrant 4 from all phases (kvarh_Q4)

Power:

Total active (real) power from all phases (kW)

Total current from all phases (A)

Average line to neutral voltage (V)

Average line to line voltage (Vll)

Total apparent power over all phases (kVA)

Total reactive power from all phases (kvar)

Average power factor from all phases (aPF)

Average displacement (fundimantal frequency) power factor from all phases (dPF)

Frequency:

Frequency (Hz)

Distortion:

Total harmonic distortion from all phases (TDH (%))

Peak Demand:

Peak demand in kW over all phases for the configured demand window (kW)

27.2 Trends

To begin looking at the live or logged Information on the meter the user must first select the load to look at.



Select Load

Load

Live
 Hourly
 Daily

To begin looking at trend data

1. Click drop down



Select Load

Load

Load 1 - Light 1

Load 2 - Chiller 1

2. Selected Load



Select Load

Load

Load 1 - Light 1

Live
 Hourly
 Daily

3. Click radio button to select time interval; Live, Hourly, or Daily
4. Scroll to view graph of parameter

Example:

Live Data

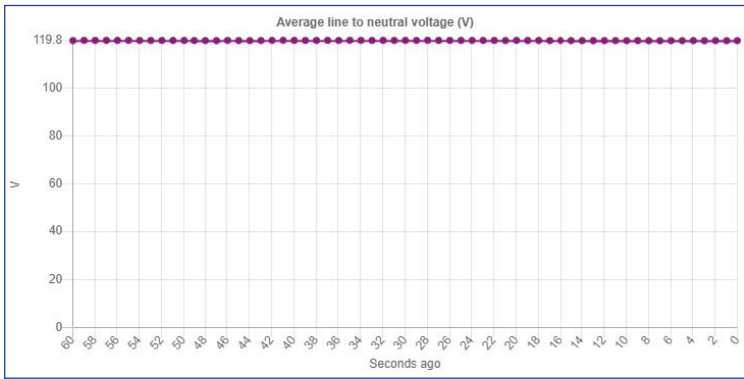

Hourly

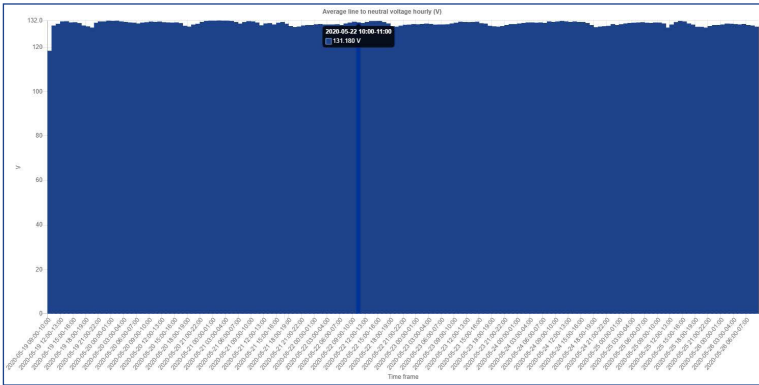

Daily

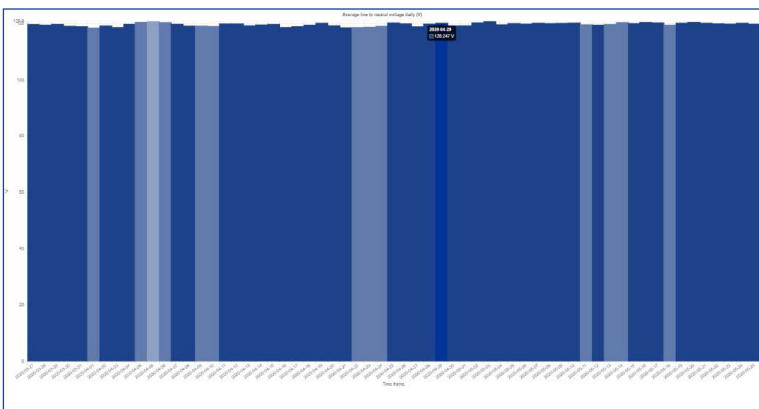

27.3 Odometer

The odometer simplifies time based data for the user, segmenting parameters into Live Data, Last Hour, Last Day, Last Week, and Last Month time intervals.



To begin using odometer

1. Click drop down

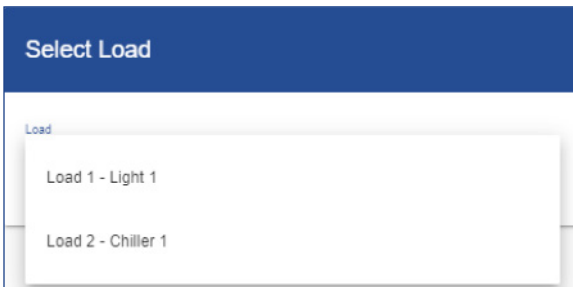

2. Select Load

Data will display in the set time intervals

Live Data		Last Hour		Last Day		Last Week		Last Month	
Energy	Total	Energy	Total	Energy	Total	Energy	Total	Energy	Total
kWh+	47.13	kWh+	0.064	kWh+	0.156	kWh+	4.805	kWh+	20.90
kWh-	0.000	kWh-	0.000	kWh-	0.000	kWh-	0.000	kWh-	0.000
kVAh+	60.82	kVAh+	0.079	kVAh+	0.296	kVAh+	6.148	kVAh+	27.52
kVAh-	0.000	kVAh-	0.000	kVAh-	0.000	kVAh-	0.000	kVAh-	0.000
kvarh_01	0.027	kvarh_01	0.000	kvarh_01	0.000	kvarh_01	0.001	kvarh_01	0.021
kvarh_02	0.000	kvarh_02	0.000	kvarh_02	0.000	kvarh_02	0.000	kvarh_02	0.000
kvarh_03	0.000	kvarh_03	0.000	kvarh_03	0.000	kvarh_03	0.000	kvarh_03	0.000
kvarh_04	17.37	kvarh_04	0.012	kvarh_04	0.192	kvarh_04	1.618	kvarh_04	8.815
Power		Power		Power		Power		Power	
kW	0.062	kW	0.064	kW	0.007	kW	0.029	kW	0.051
A	0.644	A	0.661	A	0.103	A	0.307	A	0.969
V	119.8	V	119.3	V	119.6	V	119.6	V	119.2
VF	0.000	VF	#NA	VF	#NA	VF	#NA	VF	#NA
kVA	0.077	kVA	0.079	kVA	0.012	kVA	0.038	kVA	0.071
kvar	-0.012	kvar	-0.012	kvar	-0.008	kvar	-0.010	kvar	-0.018
dPF	0.805	dPF	0.810	dPF	0.827	dPF	0.837	dPF	0.818
dPF	0.981	dPF	0.982	dPF	0.833	dPF	0.761	dPF	0.608
Frequency		Frequency		Frequency		Frequency		Frequency	
Hz	60.01	Hz	60.00	Hz	60.00	Hz	60.00	Hz	60.00
Distortion		Distortion		Distortion		Distortion		Distortion	
THD	66.19	THD	64.65	THD	63.09	THD	58.03	THD	48.25
Peak Demand		Peak Demand		Peak Demand		Peak Demand		Peak Demand	
kPD	1.016	kPD	1.016	kPD	1.016	kPD	1.016	kPD	1.162

EXPORT ALL

To view the time intervals and additional data

Last Week (2019-11-03 - 2019-11-09)			Last Month	
Energy	CT_1	Total	Energy	Total
kWh-	#NA	#NA	kWh-	#NA
kWh+	#NA	#NA	kWh+	#NA
kVAh-	#NA	#NA	kVAh-	#NA
kVAh+	#NA	#NA	kVAh+	#NA
CKVARh-	#NA	#NA	CKVARh-	#NA
IKVARh-	#NA	#NA	IKVARh-	#NA
CKVARh+	#NA	#NA	CKVARh+	#NA
IKVARh+	#NA	#NA	IKVARh+	#NA

1. Click Header, to see time interval and CT information

27.4 Time Interval definition

Live Data

Data is live and changing based on meter update rate

Last Hour

Data is from the last complete whole hour interval, i.e. 9:00:00 to 10:00:00

Last Day

Data is from the last complete calendar day, i.e. Yesterday

Last Week

Data is from the last complete week, week is based on a Sunday to Saturday time interval

Last Month

Data is based on the last complete month (billing cycle), user can change day in general settings.

27.5 Export Logged data

The power stores up 62 days worth of trend data in non-volatile memory that can be exported to a .CSV file format.

Live Data	
Energy	Total
kWh-	47.13
kWh+	0.000
kVAh-	60.82
kVAh+	0.000
kvarh_01	0.027
kvarh_02	0.000
kvarh_03	0.000
kvarh_04	17.37
Power	
kW	0.062
A	0.644
V	119.8
Vll	0.000
kVA	0.077
kvar	-0.012
spF	0.805
dpF	0.981
Frequency	
Hz	60.01
Distortion	
THD	66.19
Peak Demand	
kPD	1.016

To begin exporting trend data:

1. Go to power analytics page
2. CLICK Odometer
3. Select the load that is to be exported
4. At the bottom of the table, underneath the Live data column, CLICK EXPORT ALL
5. The file Download window will be displayed on the browser, this may take several minutes to complete
6. Once downloaded you will see the file available in the downloads section, location varies by browser, of the web browser being used.

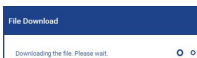

28.0 Event Log

The Event log section will log any user driven changes to the device. This includes login sessions or configuration changes. The user can change row per page and navigate pages at the bottom of the log data.

Example:

Event Log		
Date ↓	Time	Event
11/15/2019	2:17:30 PM	User login
11/15/2019	1:47:25 PM	Saved report configuration to device
11/15/2019	1:23:29 PM	User login
11/15/2019	1:16:24 PM	Saved report configuration to device
11/15/2019	1:09:38 PM	User login
11/15/2019	10:25:11 AM	Saved alarm configuration to device
11/15/2019	10:13:27 AM	User login
11/15/2019	8:26:50 AM	User login
11/15/2019	8:02:36 AM	Saved time to device
11/15/2019	8:02:19 AM	Saved time to device

Rows per page: 10 1-10 of 13 < >

29.0 Alarm status

The Alarm status section is made up of 4 windows; Active alarm States, Active Led State, Active Relay State, and Alarm Log.

29.1 Active Alarm states

In the Active alarm states window the user can see the configured alarms and see if the alarm is currently triggered or not triggered at that moment in time.

Active Alarm States								
#↑	Error Type	Vin / Load / CT	Alarm Set Point	Deadband	Delay Seconds	Led Indication	Relay Trigger	Active State
1	Low Power Factor	Load 1 - Light 1	0.5	#NA	#NA	<input type="checkbox"/>	<input checked="" type="checkbox"/>	Unchecked
2	Low Power Factor	Load 2 - Chiller 1	0.5	#NA	#NA	<input type="checkbox"/>	<input checked="" type="checkbox"/>	Unchecked
3	Peak Demand (W)	#NA	1000 kW	#NA	#NA	<input type="checkbox"/>	<input type="checkbox"/>	Unchecked

29.2 Active LED states

In the Active LED State window the user can see if the LED on the meter is current on or off based the status of any configured alarm.



29.3 Active relay states

In the Active Relay State window the user can see if the relay on the meter is current triggered (closed) or untriggered (open) based on the status of any configured alarm.



29.4 Alarm Log

In the Active Log window the user can see a log of any triggered alarms that previously occurred for any configured alarm. Within this window the user can click the RELOAD ALARM LOG VALUES on the blue title bar to refresh the list from the previous page load, this will not delete any alarms The user can change row per page and navigate pages at the bottom of the log data.

Alarm Log							EXPORT ALARM LOG	RELOAD ALARM LOG VALUES
Date↓	Time	Alarm Config	Old State	New State	Current LED State	Current Relay State		
11/16/2023	11:05:57 AM	Low Power - Load #1 @ 10% with delay of 1 seconds. Turn Led on when state is Alarm.	Normal	Alarm	<input type="checkbox"/>	<input type="checkbox"/>		
11/16/2023	11:05:57 AM	Low Power - Load #1 @ 10% Turn Led on and trigger relay when state is Alarm.	Normal	Alarm	<input type="checkbox"/>	<input type="checkbox"/>		
11/16/2023	11:05:57 AM	Over Voltage @ 10% with delay of 1 seconds. Turn Led on when state is Alarm.	Normal	Alarm	<input type="checkbox"/>	<input type="checkbox"/>		
11/16/2023	11:05:57 AM	Over Power - Load #1 @ 10% with delay of 1 seconds. Turn Led on when state is Alarm.	Normal	Alarm	<input type="checkbox"/>	<input type="checkbox"/>		
11/16/2023	11:05:57 AM	Low Power - Load #1 @ 10% Turn Led on and trigger relay when state is Alarm.	Normal	Alarm	<input type="checkbox"/>	<input type="checkbox"/>		
11/16/2023	11:05:57 AM	Over Power - Load #1 @ 10% with delay of 1 seconds. Turn Led on when state is Alarm.	Normal	Alarm	<input type="checkbox"/>	<input type="checkbox"/>		
11/16/2023	11:05:57 AM	Low Power - Load #1 @ 10% Turn Led on and trigger relay when state is Alarm.	Normal	Alarm	<input type="checkbox"/>	<input type="checkbox"/>		
11/16/2023	11:05:57 AM	Over Voltage @ 10% with delay of 1 seconds. Turn Led on when state is Alarm.	Normal	Alarm	<input type="checkbox"/>	<input type="checkbox"/>		
11/16/2023	11:05:57 AM	Low Power - Load #1 @ 10% Turn Led on and trigger relay when state is Alarm.	Normal	Alarm	<input type="checkbox"/>	<input type="checkbox"/>		
11/16/2023	11:05:57 AM	Over Power - Load #1 @ 10% with delay of 1 seconds. Turn Led on when state is Alarm.	Normal	Alarm	<input type="checkbox"/>	<input type="checkbox"/>		
11/16/2023	11:05:57 AM	Low Power - Load #1 @ 10% Turn Led on and trigger relay when state is Alarm.	Normal	Alarm	<input type="checkbox"/>	<input type="checkbox"/>		

Rows per page: 10 | 116 of 116

29.5 Export of Alarm Logs

Alarm Log
EXPORT ALARM LOGS
RELOAD ALARM LOG VALUES

Add User Details

Generated by:
John Sample

Max 30 characters 11 / 30

CANCEL OK

File Download

Downloading the file. Please wait. ○ ○

To update software version:

1. Go to Alarm status page
2. Scroll to Alarm Log window
3. Click EXPORT ALARM LOGS

4. In Add User Details, type in name of user generating the log
5. Click OK
6. File Download window appear
7. Once downloaded you will see the file available in the downloads section of the web browser being used, location varies by browser

Note: Exporting of Alarm Logs can also be done on the Export Configuration page

29.6 Example of Alarm Logs Record

Powermeter Alarm Logs Record

Generated on: 5/26/2020, 11:11:04 AM
Generated by: John Sample

Meter Information

Manufacturer	Setra Systems, Inc.
Product	SPM3EDN
Serial Number	P47200314
Meter Install Location	
Power Factor Sign Convention	IEC
Demand Window	15

Alarm Setup

#	Type	Vin/Line/Load/CT	Alarm Set Point	Deadband	Delay Seconds	LED	Relay
1	Over Power	Load 1 - Tom's Home Office	1 kW	0 kW	1	Yes	No
2	Low Power Factor	Load 1 - Tom's Home Office	0.7	#NA	#NA	Yes	Yes
3	Over Voltage	Line 1	101 %	#NA	1	Yes	No

Alarm Logs

Date	Time	Alarm Config	Old State	New State	LED State	Relay State
4/1/2020	1:11:26 PM	Over Power - Load #1 @ 1kW with delay of 1 seconds. Turn Led on when state is Alarm.		Normal	No	No
4/1/2020	12:17:53 PM	Energy Usage - Load #1 @ 6kWh. Turn Led on when state is Alarm.		Normal	No	No
4/1/2020	12:17:43 PM	Energy Usage - Load #1 @ 6kWh. Turn Led on when state is Alarm.		Normal	No	No
4/24/2020	2:57:56 PM	Low Power Factor - Load #1 @ 70. Turn Led on and trigger relay when state is Alarm.		Normal	No	No
4/24/2020	2:57:56 PM	Over Power - Load #1 @ 1kW with delay of 1 seconds. Turn Led on when state is Alarm.		Normal	No	No

30.0 System

The System section is designed to give the user an interface to view, update, reset, reboot global software, trend and power settings. The section is made up of 5 windows; Software version, Factory reset, Trend data reset, Reboot, and system log.

30.1 Software version

In the Software version window, the user can see the current software version loaded on the power meter and also update the meter with a future software update. The latest software version can be downloaded from the Setra Power Meter product Page: <https://www.setra.com/product/power-meters/setra-power-meter>

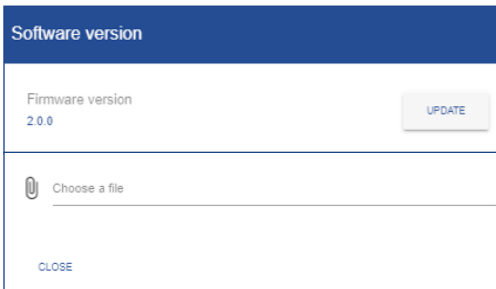

To update software version:

1. Download new software version from link above
2. Click UPDATE button
3. Choose new file from saved location, unit will take a few minutes to load new software and reboot

Note: All trend data will be lost after as of future update is preferred.

30.2 Factory reset

In the Factory reset window, the user can reset all settings on the meter and restore the power meter to its as shipped condition.

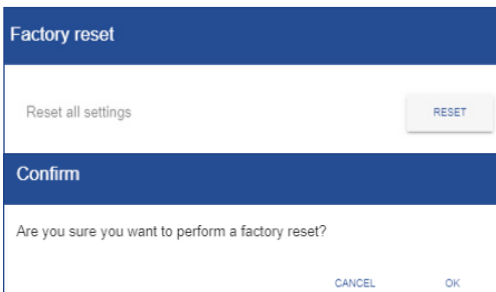

To perform Factory reset

1. Click RESET button
2. Click OK to continue or CANCEL to stop factory reset

30.3 Trend data reset

In the Trend data reset window, the user can reset all stored data on the meter. This provides a clear start date and time for future trend data.

Trend data reset

Reset trend data

Confirm

Are you sure you want to clear all trend data?

To perform Factory reset

1. Click RESET button
2. Click OK to continue or CANCEL to reset trend data

30.4 Reboot

In the Reboot window, the user can reboot (restart) the meter.

Reboot

Reboot device

Confirm

Are you sure you want to perform a reboot?

To reboot the meter

1. Click REBOOT
2. Click OK to reboot the power meter or CANCEL to exit

30.5 System Log

In the System Log window, the user can view and download journal information of the meters software performance. The user can change row per page and navigate pages at the bottom of the log data.

Date	Time	Source	Event
11/05/2019	2:58:23 PM	com.fgl.watn61(D2)	uartbrccomfgt-watshlog: tns 01, dev: not found
11/05/2019	2:58:23 PM	com.fgl.watn61(D2)	uartbrccomfgt-watshlog: tns 01, dev: not found
11/05/2019	2:58:18 PM	com.fgl.watn61(D2)	uartbrccomfgt-watshlog: tns 01, dev: not found
11/05/2019	2:58:18 PM	com.fgl.watn61(D2)	uartbrccomfgt-watshlog: tns 01, dev: not found
11/05/2019	2:58:18 PM	com.fgl.watn61(D2)	uartbrccomfgt-watshlog: tns 01, dev: not found
11/05/2019	2:58:18 PM	com.fgl.watn61(D2)	uartbrccomfgt-watshlog: tns 01, dev: not found
11/05/2019	2:58:18 PM	com.fgl.watn61(D2)	uartbrccomfgt-watshlog: tns 01, dev: not found
11/05/2019	2:58:13 PM	com.fgl.watn61(D2)	uartbrccomfgt-watshlog: tns 01, dev: not found
11/05/2019	2:58:13 PM	com.fgl.watn61(D2)	uartbrccomfgt-watshlog: tns 01, dev: not found
11/05/2019	2:58:13 PM	com.fgl.watn61(D2)	uartbrccomfgt-watshlog: tns 01, dev: not found

Rows per page: 10 1-10 of 100 < >

31.0 Export configuration

The Export Configuration section is designed to give the user an interface to generate configuration records and clone/import a setup from/to the power meter.

31.1 Configuration record

In the Configuration Record window the user can select any section of configuration files that need to be converted to a pdf and stored as a state of record for a job file or troubleshooting assistance.

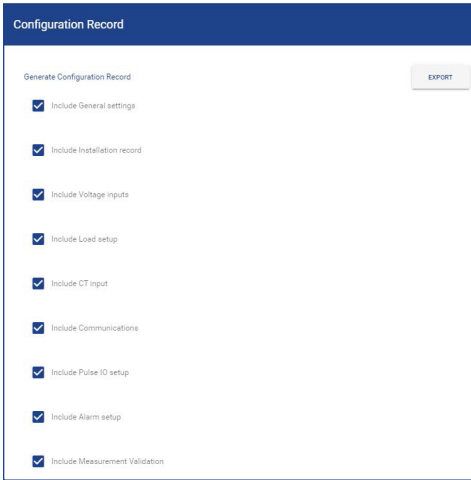

To export a Configuration Record

1. Check off all parts of the power meter's configuration to be included in the pdf record
2. Click EXPORT button
3. Click on downloaded pdf and save to desired location

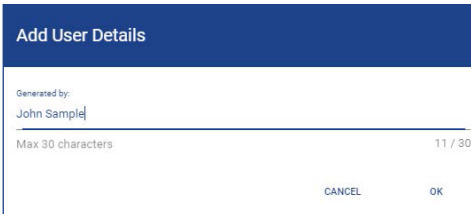

4. In Add User Details, Type in name of user generating the log
5. Click OK
6. File Download window will appear
7. Once downloaded you will see the file available in the downloads section of the web browser being used, location varies by browser

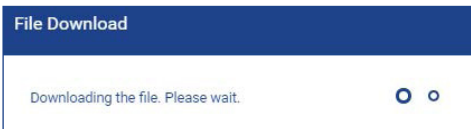

Note: Exporting of Alarm Logs can also be done on the Export Configuration page.

31.2 Example of configuration Record

Powermeter Installation Record
 Generated on: 5/26/2020, 11:24:44 AM
 Generated by: John Sample

General Information
 Installation Site: Templeton, Ma
 Address 1: 123 Main Street
 Address 2: Templeton, Ma 01468
 Electrical Contractor: J.L. & Son, Inc.
 Electrician: John Lish
 Electrician Phone #: 807-5309
 Panel Number: 2-A
 Panel Type: Distribution
 Panel Maximum Fault Current: 4000A
 Panel Location 1: 2nd Floor
 Panel Location 2: BR2

Meter Information
 Manufacturer: Setra Systems, Inc.
 Product: SPIM3EDN
 Serial Number: F47200314
 Meter Install Location:
 Power Factor Sign Convention: IEC
 Demand Window: 15

General Notes
 4/2/20 - Left key taped to side of panel for building owner to pick up tomorrow.

Input Voltage
 Vin1
 Service Type: 2-Wire single phase
 Expected Voltage (VAC): 120
 Actual Voltage (VAC): 120
 Potential Transformer Multiplier: 1
 Service Wire Correction: No

Load Configuration

Load #	Load Name	V01	Vin	L1	L2	L3
1	Tom's Home Office	1234	Vin1	CT1	-	-

CT Inputs

31.3 Clone/ Import meter setup

In the Configuration Record window the user can export a clone of the power meter's settings or import settings from a previously cloned power meter.

The screenshot shows a window titled "Clone / Import Meter Setup". The "Clone Meter Setup" section is active, and an "EXPORT" button is visible on the right side of the window.

To Clone the setup of the meter

1. Click EXPORT button
2. Save file to desired location

The screenshot shows the same window, but the "Import Meter Setup" section is active. It features a list of checkboxes for selecting which settings to import:

- Import General settings
- Import Voltage inputs
- Import Load setup
- Import CT input
- Import Communications
- Import Pulse IO setup
- Import Alarm setup

Buttons for "EXPORT" and "IMPORT" are visible on the right side of the window.

To import settings from a previous meter

1. Check all configuration to be copied from the cloned file
2. Click IMPORT
3. Select file to import
4. Click open
5. Click UPLOAD TO METER

Note: The pass code is not a cloneable feature and must be set on each meter manually.

32.0 Help

The Help section is designed to give the user an interface to access information files and contact information for technical support.

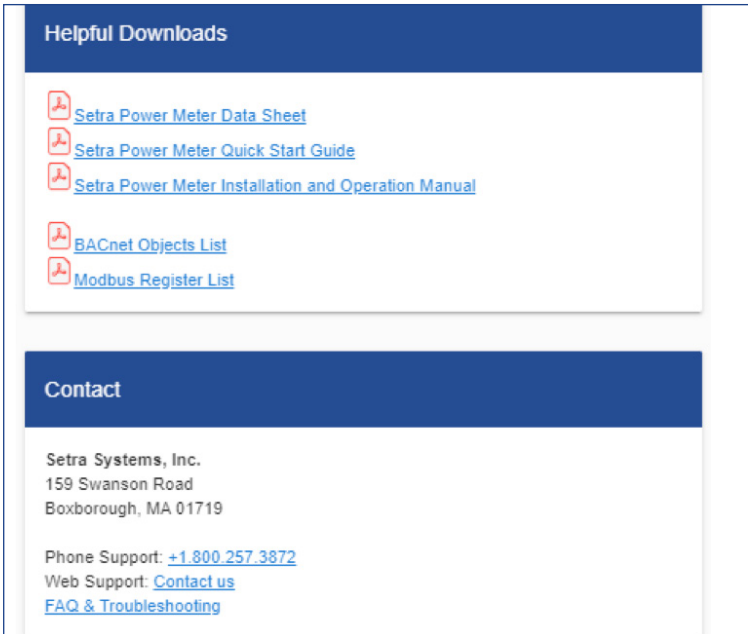

The screenshot displays a web interface with two main sections. The first section, titled 'Helpful Downloads', features a dark blue header and a list of five links, each accompanied by a red document icon. The links are: 'Setra Power Meter Data Sheet', 'Setra Power Meter Quick Start Guide', 'Setra Power Meter Installation and Operation Manual', 'BACnet Objects List', and 'Modbus Register List'. The second section, titled 'Contact', also has a dark blue header and contains the following text: 'Setra Systems, Inc.', '159 Swanson Road', 'Boxborough, MA 01719', 'Phone Support: +1.800.257.3872', 'Web Support: [Contact us](#)', and '[FAQ & Troubleshooting](#)'.

33.0 Troubleshooting

Visit Setra's FAQ page for troubleshooting assistance at <https://faq.setra.com>

34.0 Replace battery

The Setra Power meter comes standard with a battery backup for the real time clock to prevent the user from losing the date and time if a power outage occurs. The battery shall last at least five years, but if it does need to be replaced, it must be replaced with a UL recognized CR2016 lithium battery. See below for instruction on replacing the battery.

1. First, need to turn off the power to the meter.
Turn off power to the meter

2. Remove the power meter's front housing (cover) by depressing the tab(s) near the hinge-point of the dust cover and rotate the front cover away from the back housing.



3. Slide display module down (away from the front cover release tabs)

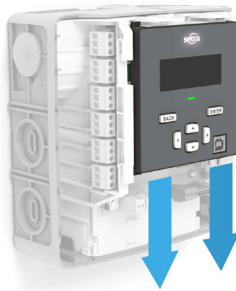

4. Pull display housing away from the main assembly

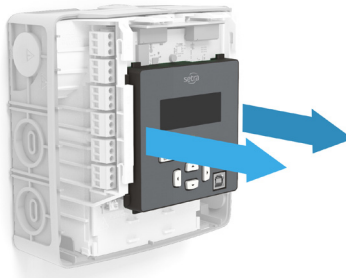

5. Flip over display



6. Slide battery out of holder



7. Insert new battery, ensuring the orientation of battery is correct; position side away from board

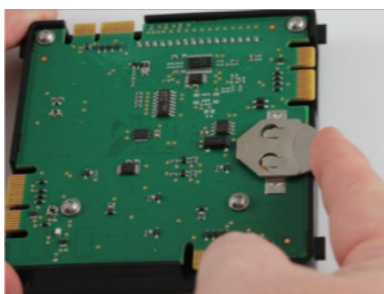

8. Put display module back into the main assembly and reinstall the front cover assembly.
(reverse removal directions in steps 1,2, and 3)

9. Power up the unit

35.0 User Interface

User interface overview

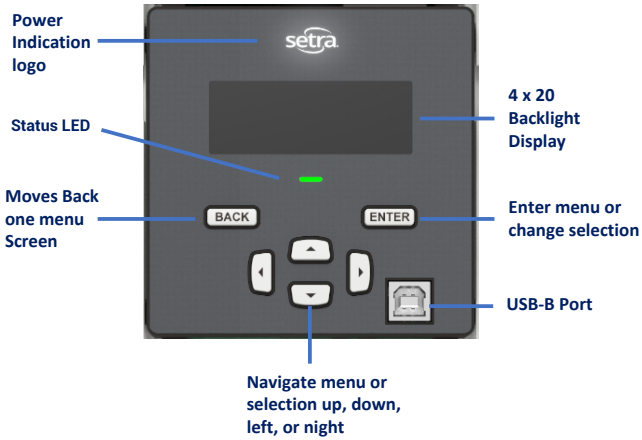

36.0 Main menu

The Main Menu is the first point of entry in the meter’s menu structure. It gives access to the lower menu structure for important data and information screens.

Screen navigation example:

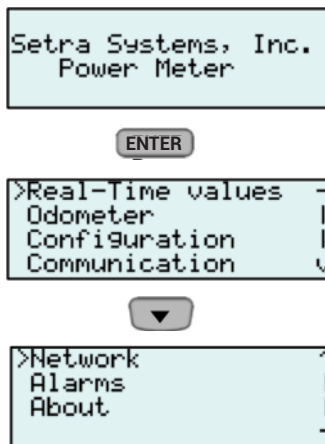

37.0 Real-time values

The Real-Time Values Menu let's the user see actual real time data for all configured loads on the meter. After entering the menu and selecting the load the user can scroll down to power and energy information based on the service connection. Within the same menu, the user can also scroll to the right or left to access another load.

If the user wishes to know how the Load was configured and does not have access to the web portal there is an easy way to access the configuration right on the meter. While navigating the load power and energy data, the user can scroll all the way up to the top of the load and see the Vin (input used for the load), Vref (the line/phase for the CT/Load), and CT# (CT or CT's associated with the load).

Screen navigation example:

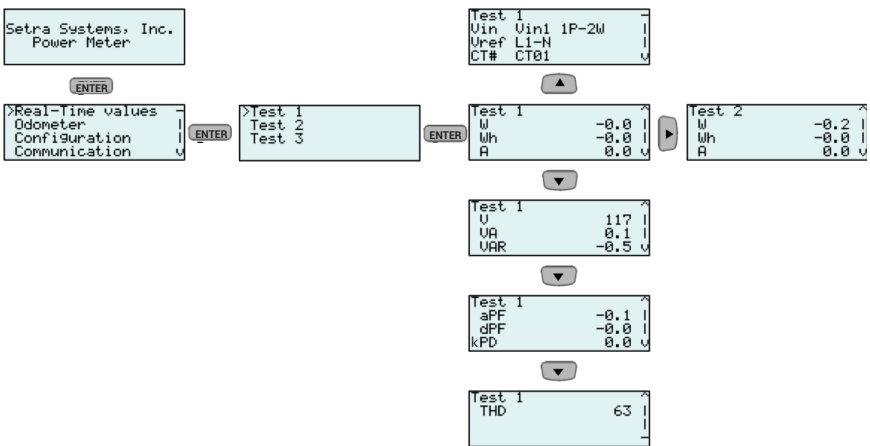

38.0 Odometer

The Odometer menu lets the user see actual live or accumulated data for all configured loads on the meter. After entering the menu and selecting the load the user can scroll down to see power and energy information based on the service connection; similar to the real-time values menu. The odometer simplifies time based data for the user, segmenting parameters into Live Data, Last Hour, Last Day, Last Week, and Last Month time Intervals by scrolling left or right.

If the user wishes to know how the Load was configured and does not have access to the web portal there is an easy way to access the configuration right on the meter. While navigating the load power and energy data, the user can scroll all the way up to the top of the load and see the Vin (input used for the load), Vref (the line/phase for the CT/Load), and CT# (CT or CT's associated with the load).

Screen navigation example:

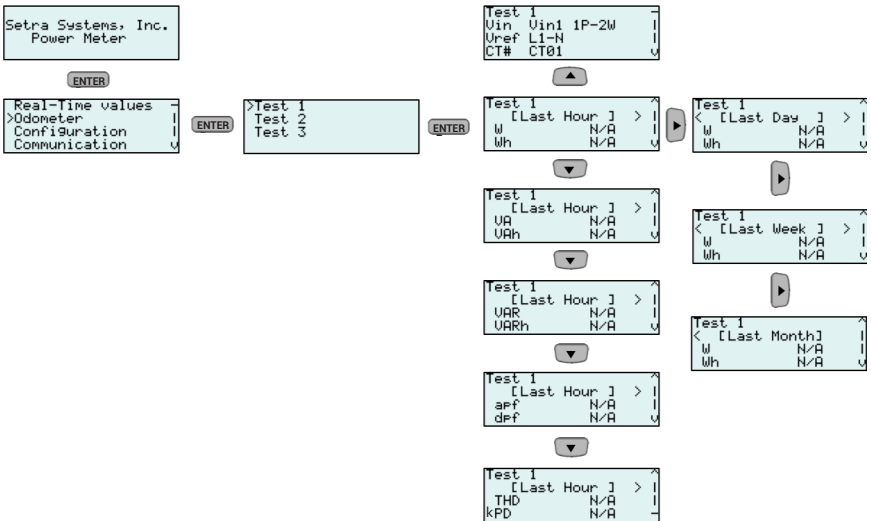

39.0 Configuration

The Configuration menu lets the user see and change the display settings for the meter. After entering the menu the user can change backlight settings from "Always on", or have backlight illuminate when a key is pressed or there is an error; "On key/error", or "Always off". The user can also see and change whether the display will scroll or remain static when left in the real-time menu.

Screen navigation example:

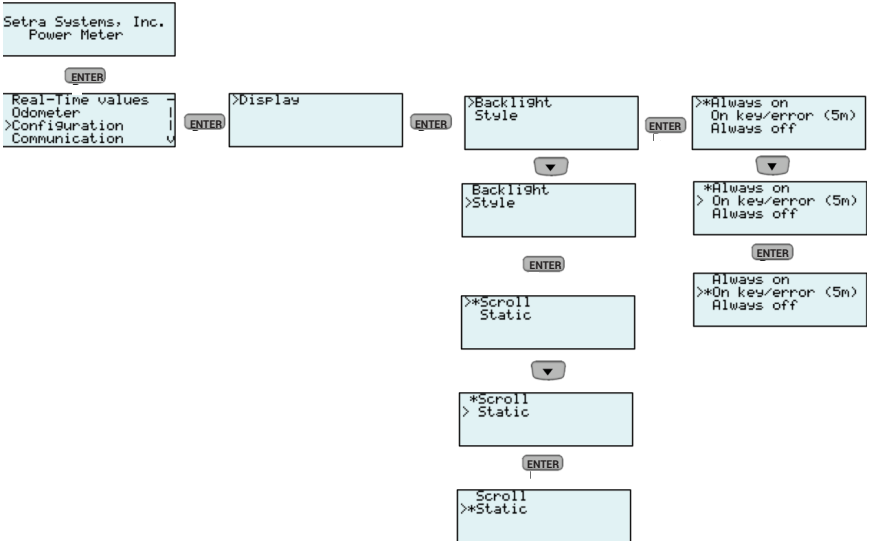

40.0 Communication

The Communication menu lets the user see the communication settings that were configured through the web portal and stored on the meter. The user cannot make changes to the communication setup from the LCD menu.

Screen navigation example:

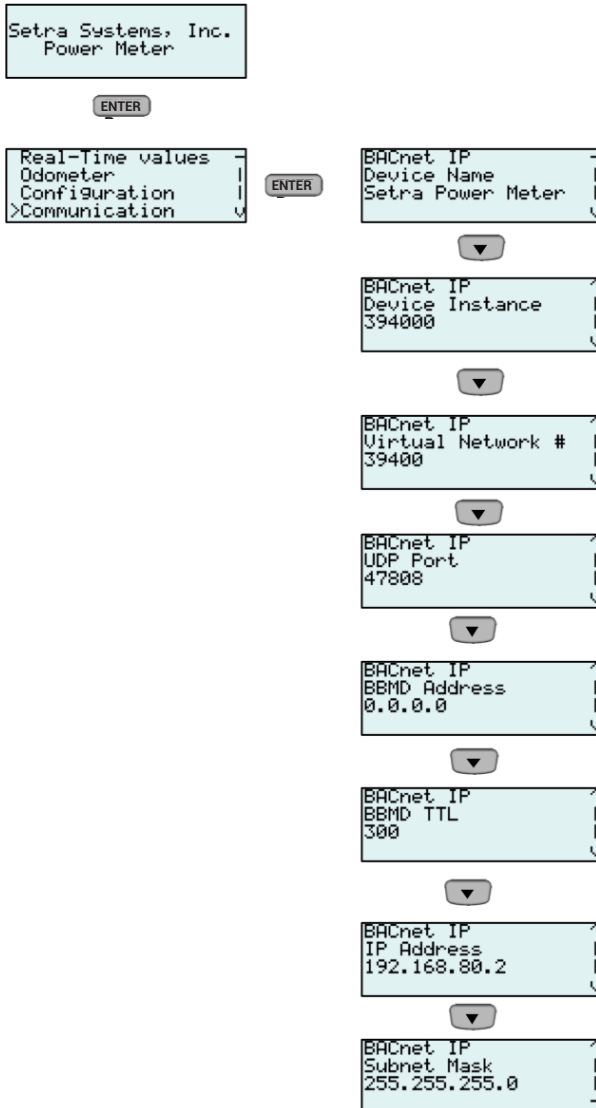

41.0 Network

The Network menu lets the user see the network settings that were configured through the web portal and stored on the meter.

Screen navigation example:

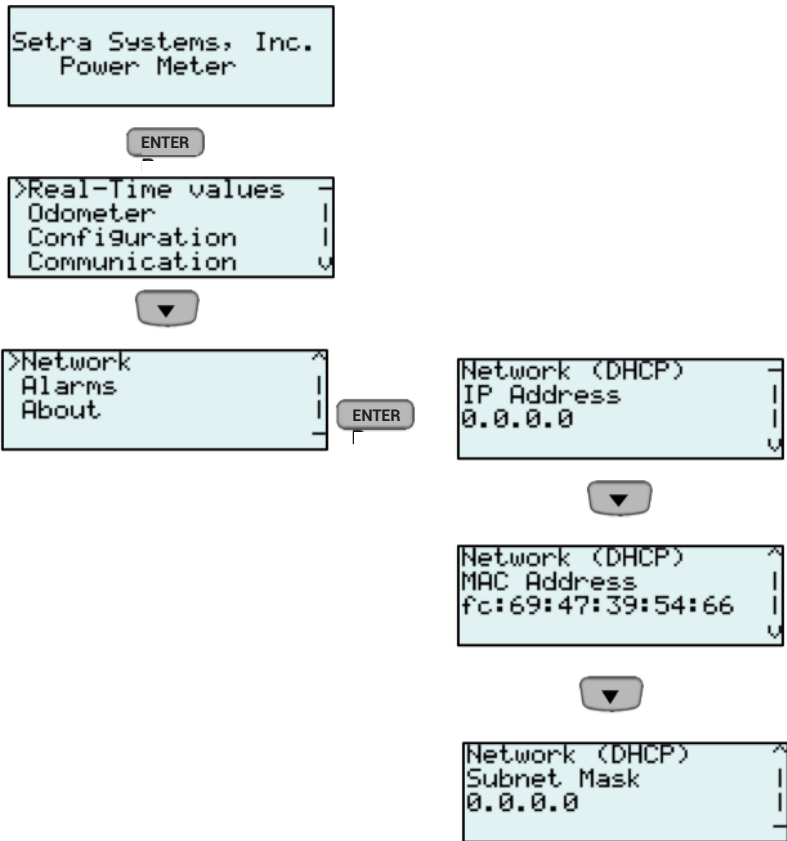

42.0 Alarm

The Alarm menu lets the user see triggered alarms that were configured through the web portal and stored on the meter. The user cannot make changes to the alarm setup from the LCD menu.

Screen navigation example:

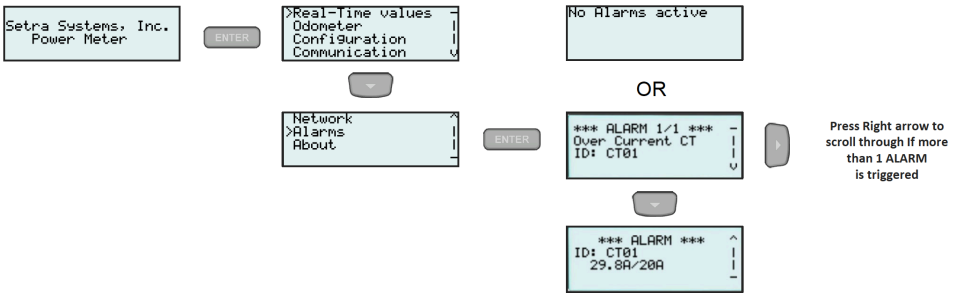

43.0 About

The About menu lets the user see the Part number, serial number, firmware revision, and communication setup (if applicable).

Screen navigation example:

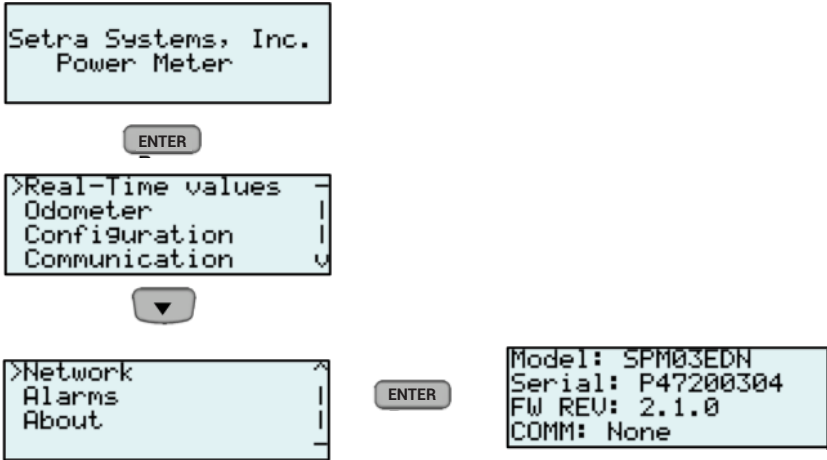

44.0 Factory reset at meter

The power meter may be restored to the factory default settings directly from the hardware itself. The factory reset functionality will clear all of the configuration settings, logged data, and will reset the pin-code.

To begin the factory reset procedure the user must hold down the BACK, ENTER, and Down Arrow button simultaneously for >10 seconds. Once LCD display will say "Factory Reset in progress" the user can release the buttons and then the meter will perform a power cycle. The user can reset a pin-code and configure the unit as needed for the application by connecting to the web portal.

Note: If a password/ pin is forgotten, the only way to reset is through a factory reset. All configuration information is lost.

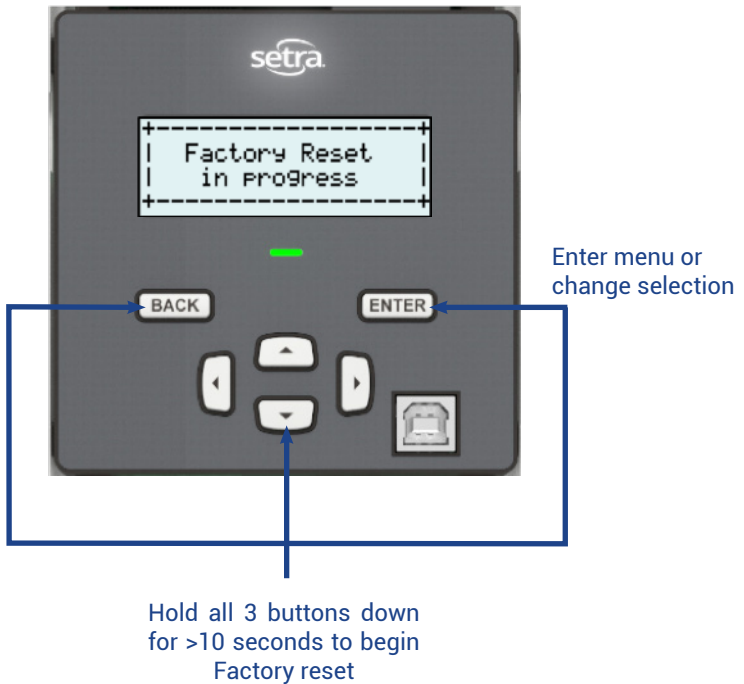

45.0 Returning products for repair

Please contact a Setra application engineer (800-257-3872, 978-263-1400) before returning unit for repair to review information relative to your application. Many times only minor field adjustments may be necessary. When returning a product to Setra, the material should be carefully packaged and shipped prepaid to:

Setra Systems, Inc.
159 Swanson Road
Boxborough, MA 01719-1304
Attn: Repair Department

To ensure prompt handling, please supply the following information and include it inside the package or returned material:

- Name and phone number of person to contact.
- Shipping and billing instructions.
- Full description of the malfunctions.
- Identify any hazardous material used with the product.

NOTES:

Please remove any pressure fittings and plumbing that you have installed and enclose any required mating electrical connectors and wiring diagrams.

Allow approximately 3 weeks after receipt at Setra for the repair and return of the unit. Non-warranty repairs will not be made without customer approval and a purchase order to cover repair chargers.

Calibration Services

Setra maintains a complete calibrations facility that is traceable to the National Institute of Standards and Technology (NIST). If you would like to recalibrate or recertify your Setra pressure transducers or transmitters, please call our Repair Department at 800-257-3872 (978-263-1400) for scheduling.

46.0 Limited warranty & limitation of repair

SETRA warrants its products to be free from defects in materials and workmanship, subject to the following terms and conditions: Without charge, SETRA will repair or replace products found to be defective in materials or workmanship within the warranty period; provided that:

- a) the product has not been subjected to abuse, neglect, accident, incorrect wiring not our own, improper installation or servicing, or use in violation of instructions furnished by SETRA;
- b) the product has not been repaired or altered by anyone except SETRA or its authorized service agencies;
- c) the serial number or date code has not been removed, defaced, or otherwise changed; and
- d) examination discloses, in the judgment of SETRA, the defect in materials or workmanship developed under normal installation, use and service;
- e) SETRA is notified in advance of and the product is returned to SETRA transportation prepaid.

Unless otherwise specified in a manual or warranty card, or agreed to in a writing signed by a SETRA officer, SETRA power metering products shall be warranted for 5 year from date of sale.

The foregoing warranty is in lieu of all warranties, express, implied or statutory, including but not limited to, any implied warranty of merchantability for a particular purpose.

SETRA's liability for breach of warranty is limited to repair or replacement, or if the goods cannot be repaired or replaced, to a refund of the purchase price.

SETRA's liability for all other breaches is limited to a refund of the purchase price. In no instance shall SETRA be liable for incidental or consequential damages arising from a breach of warranty, or from the use or installation of its products.

No representative or person is authorized to give any warranty other than as set out above or to assume for SETRA any other liability in connection with the sale of its products.

For all CE technical questions, contact Setra Systems, USA. EU customers may contact our EU representative Hengstler GmbH, Umlandstr 49, 78554 Aldingen, Germany (Tel: +49-7424-890; Fax: +49-7424-89500).

47.0 Equipment service & access

47.1 Access to equipment

The equipment must be accessible to authorized personnel only. Equipment must be installed in areas where access can be restricted.

47.2 Servicing the equipment

No preventive maintenance is required on any of the equipment. Visually inspect the equipment yearly and ensure it is free of dust or other particles. If necessary, wipe with a clean cloth.

47.3 Component servicing

Individual components, except battery, are not user-serviceable, and must be returned to Setra for repair, except battery. If an equipment fault occurs, do not attempt to repair the faulty component.

All maintenance activities should be performed by qualified personnel only. Do not perform any operating or maintenance procedures that are not described in the product documentation.

48.0 Support

48.1 Setra contact

Setra Systems, Inc.
159 Swanson Road
Boxborough, MA 01719
USA

Phone: 1-800-257-3872
Email: techsupport@setra.com
Website: www.setra.com

Technical Support



800.257.3872



www.setra.com



techsupport@setra.com



Setra Systems, Inc.
159 Swanson Road, Boxborough, MA 01719
800.257.3872 • www.setra.com

47.0 Service d'équipement et accès

47.1 Accès à l'équipement

L'équipement doit être accessible uniquement au personnel autorisé. L'équipement doit être installé dans des zones où l'accès peut être restreint.

47.2 Entretien de l'équipement

Aucun entretien préventif n'est requis sur aucun des équipements. Inspectez visuellement l'équipement chaque année et assurez-vous qu'il est libre de poussière ou d'autres particules. Si nécessaire, essayez avec un chiffon propre.

47.3 Entretien des composants

Les composants individuels, à l'exception de la batterie, ne sont pas réparables par l'utilisateur et doivent être retournés à Setra pour réparation, à l'exception de la batterie. En cas de panne de l'équipement, n'essayez pas de réparer le composant défectueux.

Toutes les activités de maintenance doivent être effectuées uniquement par du personnel qualifié. N'effectuez aucune procédure de fonctionnement ou de maintenance non décrite dans la documentation du produit.

48.0 Support

48.1 Setra contact

Setra Systems, Inc.
159 Swanson Road
Boxborough, MA 01719
USA

Phone: 1-800-257-3872
Email: techsupport@setra.com
Website: www.setra.com

Technical Support



800.257.3872



www.setra.com



techsupport@setra.com