

# New Bike

E X C I T E +

## *Technical Service guide*

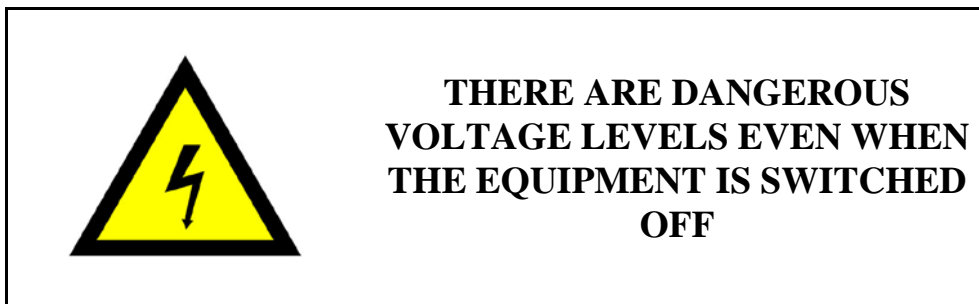
*REV. 4.1*





The information in this manual is aimed at QUALIFIED TECHNICAL PERSONNEL, who have been specifically trained by TECHNOGYM and been qualified to carry out fine adjustments and start-ups, as well as major maintenance work and repairs, requiring in-depth understanding of the equipment, how it works, its safety devices and maintenance procedures.

**READ ALL THE INFORMATION IN THIS DOCUMENT VERY CAREFULLY BEFORE CARRYING OUT ANY WORK AT ALL ON THE EQUIPMENT**



**WARNING:**

The information contained in this document may be changed without prior notification.

Technogym does not issue guarantees of any kind regarding this material. Technogym will not be held responsible for any errors contained herein or for any accidental damage or damage consequent to the supply, services or use of this material.

This document contains proprietary information that is covered by copyright. All rights are reserved. No part of this document may be photocopied, reproduced or translated into another language without the prior written consent of Technogym.

Technogym™ is a trademark owned by Technogym S.p.A.

**NEW BIKE Excite +™** is a trademark owned by Technogym S.p.A.





# Contents

<b>1. GENERAL WARNINGS.....</b>	<b>1.1</b>
1.1. INTRODUCTION.....	1.1
1.2. USEFUL ADVICE.....	1.1
1.3. GENERAL REGULATIONS REGARDING SERVICE WORK.....	1.3
<b>2. TECHNICAL SPECIFICATIONS.....</b>	<b>2.1</b>
2.1. EQUIPMENT CODING.....	2.1
2.2. SERIAL NUMBER STRUCTURE.....	2.3
2.3. COLOUR COMBINATIONS.....	2.3
2.4. PRODUCT CHARACTERISTICS.....	2.4
2.4.1. <i>EXCITE models characteristics</i> .....	2.4
2.4.2. <i>DISPLAY Comparison</i> .....	2.5
2.4.3. <i>Monitor &amp; commands</i> .....	2.6
2.4.4. <i>Training contents</i> .....	2.6
2.4.5. <i>User connectivity options / MyWellness Cloud access</i> .....	2.6
2.4.6. <i>User personal profile</i> .....	2.7
2.4.7. <i>Connectivity</i> .....	2.7
2.4.8. <i>Entertainment and Multimedial contents</i> .....	2.8
2.4.9. <i>Supported Professional APPS</i> .....	2.9
2.5. MECHANICAL CHARACTERISTICS.....	2.10
2.5.1. <i>Bulk dimensions</i> .....	2.10
2.5.2. <i>Packing dimensions Europe and Overseas</i> .....	2.11
2.6. ENVIRONMENTAL CHARACTERISTICS.....	2.12
2.7. COMPLIANCE WITH REGULATIONS.....	2.12
2.8. WIRING DIAGRAM.....	2.13
2.8.1. <i>500 LED Powered Model (ARM Board)</i> .....	2.13
2.8.2. <i>500SP LED Self-Powered Model (ARM Board)</i> .....	2.14
2.8.3. <i>700 LED Powered Model (ARM Board)</i> .....	2.15
2.8.4. <i>700SP LED Self-Powered Model (ARM Board)</i> .....	2.16
2.8.5. <i>700 VISIOWEB Powered Model (CPU Board)</i> .....	2.17
2.8.6. <i>700 UNITY Powered Model</i> .....	2.18
2.9. CABLES.....	2.19
2.9.1. <i>CBQ Cables</i> .....	2.19
2.9.2. <i>CU Cables</i> .....	2.20
2.1. UNITY CONNECTION CABLES.....	2.25
<b>3. OPERATING PRINCIPLE.....</b>	<b>3.1</b>
3.1. BLOCK DIAGRAM LED AND VISIOWEB MODELS.....	3.1
3.1. UNITY MODELS.....	3.2
3.2. LED DISPLAY BOARDS.....	3.3
3.2.1. <i>ARM Board: 500 and 500SP models</i> .....	3.3
3.2.2. <i>ARM Board: 700 and 700SP models</i> .....	3.4
3.2.3. <i>C-Safe Board</i> .....	3.4
3.2.4. <i>Dual TGS Reader</i> .....	3.4
3.3. VISIO/VISIOWEB DISPLAY BOARDS.....	3.5
3.3.1. <i>CPU Board: 700VISIO/VISIOWEB model</i> .....	3.5
3.3.1.1. <i>Back-Up Battery</i> .....	3.5
3.4. LCD INVERTER.....	3.6
3.5. DIGITAL/ANALOGUE TUNER BOARD.....	3.6
3.6. INTEGRATED LAN NETWORK BOARD (CABLED NETWORK).....	3.6
3.7. WIRELESS NETWORK BOARD.....	3.7
3.8. CONNECTOR BOARD FOR ENTRY OF EXTERNAL AUDIO/VIDEO DEVICES.....	3.8
3.9. HEADPHONES JACK.....	3.8

3.10. C-SAFE BOARD (BUILT-IN) .....	3.8
3.11. USB SERVICE PORT (BUILT-IN) .....	3.8
3.12. OPTIONAL ACCESSORIES .....	3.9
3.12.1. iPod docking station.....	3.9
3.12.2. Client USB port .....	3.9
3.12.3. Dual TGS Reader.....	3.9
3.13. UNITY DISPLAY .....	3.10
3.13.1. Main Board (Middelboar).....	3.10
3.13.2. CPU module .....	3.10
3.13.3. Wi-fi module:.....	3.10
3.13.4. Controller TS.....	3.10
3.13.5. Bluetooth Module .....	3.11
3.13.6. The function of the Main board is to control.....	3.11
3.14. UNITY DEVICE .....	3.12
3.14.1. Headphone and Microphone jack.....	3.12
3.14.2. C-SAFE board .....	3.12
3.14.3. NFC board (proximity sensor).....	3.12
3.14.4. TV Tuner.....	3.12
3.14.5. TGS reader .....	3.12
3.14.6. USB port .....	3.12
3.14.7. Stand-by LED .....	3.12
3.14.8. Back-Up battery.....	3.12
3.14.9. Docking Station and battery charger .....	3.13
3.15. CARDIO RECEIVER BOARD .....	3.14
3.15.1. HR/HS (Heart Rate/Hand Sensor).....	3.14
3.15.2. HR (Band).....	3.15
3.16. BRAKE BOARD .....	3.16
3.16.1. Brake Board Models.....	3.17
3.17. ELECTROMAGNETIC BRAKE.....	3.18
3.18. SPEED SENSOR .....	3.18
3.19. INPUT MODULE .....	3.19
3.20. GENERATOR .....	3.19
3.21. BATTERY 3.20	
3.22. EXTERNAL POWER SUPPLY INPUT .....	3.20
3.23. BRAKE COMMAND.....	3.21
3.23.1. The Mechanics.....	3.21
3.23.2. Control.....	3.21
3.23.3. The signals involved .....	3.23
<b>4. ACCESSORIES.....</b>	<b>4.1</b>
4.1. CONNECTION TO THE CARDIO THEATER .....	4.1
4.2. CONNECTION TO THE PC FOR PROGRAMMING.....	4.2
4.3. MONITOR PLUG FOR C-SAFE PORT .....	4.3
4.4. VISIOWEB UPGRADE.....	4.3
4.4.1. VISIO vs VISIOWEB.....	4.3
4.4.2. UpGrade from VISIO to VisioWEB .....	4.3
4.4.3. UpGrade from LED to VisioWEB.....	4.4
4.5. ACCESSORIES .....	4.4
<b>5. INSTALLATION INSTRUCTIONS .....</b>	<b>5.1</b>
5.1. SPECIFICATIONS AND REQUIREMENTS .....	5.1
5.2. HANDLING THE EQUIPMENT .....	5.2
5.3. SPECIFICATIONS AND MINIMUM AERIAL SIGNAL REQUIREMENTS.....	5.3
5.4. INSTALLATION .....	5.4
5.5. FIRST START-UP .....	5.4
<b>6. TROUBLESHOOTING.....</b>	<b>6.1</b>
6.1. TROUBLESHOOTING MENU: LEDMODELS .....	6.2

6.1.1.	Configuration activation for 500 models.....	6.2
6.1.2.	Configuration activation for 700 models.....	6.2
6.1.3.	Automatic Tests.....	6.3
6.1.3.1.	I2C Devices Test.....	6.3
6.1.3.2.	LED Test.....	6.4
6.1.3.3.	Serial Ports Test.....	6.4
6.1.4.	Manual Test.....	6.4
6.1.4.1.	Man. Keyboard Test.....	6.4
6.2.	TROUBLESHOOTING MENU: VISIO/VISIOWEB MODELS.....	6.5
6.3.	THE DISPLAY REMAINS OFF.....	6.6
6.3.1.	LED Models with mains power supply.....	6.6
6.3.2.	LED Models: Self Powered.....	6.8
6.3.2.1.	The Display remains off.....	6.8
6.3.2.2.	The Display does not remain ON if you stop performing the exercise.....	6.10
6.3.3.	VISIO/VISIOWEB Models with mains power supply.....	6.12
6.3.4.	UNITY Models.....	6.15
6.4.	TOUCH SCREEN NEEDS CALIBRATING /DOES NOT WORK.....	6.16
6.5.	YOU CANNOT HEAR THE AUDIO.....	6.16
6.6.	YOU CANNOT SEE THE TV.....	6.16
6.7.	YOU CANNOT HEAR THE RADIO.....	6.16
6.8.	THE IPOD DOES NOT WORK.....	6.17
6.8.1.	WISIOWEB MANUAL.....	6.17
6.8.2.	UNITY Models.....	6.18
6.9.	THE DISPLAY SHOWS THE MESSAGE “THE EQUIPMENT IS BLOCKED (COM)”.....	6.19
6.10.	THE BRAKE BOARD HAS DETECTED AN ERROR.....	6.20
6.11.	THERE IS NO RESISTANCE.....	6.23
6.12.	THE RESISTANCE IS NOT CORRECT.....	6.26
6.13.	THE SPEED SIGNAL IS NOT CORRECT.....	6.28
6.14.	THE EQUIPMENT DOES NOT READ THE TGS KEY.....	6.30
6.14.1.	WISIOWEB Models.....	6.30
6.14.2.	UNITY Models.....	6.31
6.15.	THERE IS NO HEART FREQUENCY SIGNAL.....	6.32
6.15.1.	HR/HS receiver (Hand sensor).....	6.32
6.15.2.	HR/HS Receiver (Heart Rate Band).....	6.36
6.15.3.	HR Receiver (Heart Rate Band).....	6.39
6.16.	TELEMETRIC SIGNAL OF HEART RATE IS NOT CORRECT.....	6.41
6.16.1.	Heart Rate Band.....	6.41
6.16.2.	Hand Sensor.....	6.45
<b>7.</b>	<b>DISMANTLING THE PARTS.....</b>	<b>7.1</b>
7.1.	IMPORTANT NOTE ON DISMANTLING.....	7.1
7.2.	DISMANTLING THE CONTROL PANEL.....	7.3
7.2.1.	500 and 500SP versions.....	7.3
7.2.2.	700 and 700SP versions.....	7.4
7.2.3.	700VISIO/VISIOWEB version.....	7.5
7.3.	DISMANTLING THE COMPONENT BOARDS.....	7.6
7.3.1.	LED Display (ARM Board).....	7.6
7.3.1.1.	ARM Board (A).....	7.7
7.3.1.2.	C-Safe Board (B).....	7.8
7.3.2.	VISIO/VISIOWEB Display 15” (CPU Board).....	7.9
7.3.2.1.	Wireless Board (A).....	7.10
7.3.2.2.	DVB-T Tuner Board (B).....	7.12
7.3.2.3.	ATSC (B1) and ISDB-T (B2) Tuner Board.....	7.13
7.3.2.4.	LCD Inverter (C).....	7.14
7.3.2.5.	CPU Board (D).....	7.15
7.3.2.6.	LCD (E) + Touch Screen.....	7.16
7.3.2.7.	Headphones Jack (F).....	7.17
7.3.2.8.	Dual TGS Reader + USB port (G).....	7.18
7.3.2.9.	iPod Docking Station (H).....	7.19
7.3.2.10.	TGS frontal plugs + USB and cover.....	7.20
7.4.	DISMANTLING THE KEYBOARD / TOUCH SCREEN.....	7.21
7.4.1.	LED Keyboard.....	7.21

7.4.2.	<i>VISIO/VISIOWEB Touch Screen</i> .....	7.23
7.5.	<b>DISMANTLING THE CARDIO RECEIVER</b> .....	7.24
7.5.1.	<i>HS/HR Receiver (Band/Hand Sensor)</i> .....	7.24
7.5.2.	<i>HR Receiver (HR Band)</i> .....	7.26
7.6.	<b>DISMANTLING THE HANDLEBARS</b> .....	7.27
7.7.	<b>DISMANTLING THE HAND SENSOR</b> .....	7.28
7.8.	<b>DISMANTLING THE PEDAL AND THE PEDAL LEVER WITH GUARD</b> .....	7.29
7.9.	<b>DISMANTLING THE GUARD</b> .....	7.30
7.10.	<b>DISMANTLING THE PULLEY UNIT WITH PEDAL CRANK</b> .....	7.33
7.11.	<b>DISMANTLING THE SEAT</b> .....	7.35
7.12.	<b>DISMANTLING THE RETAINER BUSHING</b> .....	7.36
7.12.1.	<i>VERS. 2, macchine valide da matricola:</i> .....	7.36
7.12.2.	<i>VERS. 2, valid on equipment from serial numbers:</i> .....	7.37
7.13.	<b>DISMANTLING THE SADDLE</b> .....	7.39
7.13.1.	<i>VERS. 2, macchine valide da matricola:</i> .....	7.39
7.13.1.1.	<i>Dismantling the saddle padding</i> .....	7.39
7.13.1.2.	<i>Dismantling the saddle selection system</i> .....	7.41
7.13.2.	<i>VERS. 2, valid on equipment from serial numbers:</i> .....	7.43
7.13.2.1.	<i>Dismantling the saddle padding</i> .....	7.43
7.13.2.2.	<i>Dismantling the saddle handle pin</i> .....	7.44
7.13.2.3.	<i>Dismantling the spring pin and the handle</i> .....	7.45
7.13.2.4.	<i>Dismantling the handle support plate</i> .....	7.49
7.13.2.5.	<i>Dismantling the handle pin</i> .....	7.50
7.14.	<b>DISMANTLING THE RACING SADDLE ACCESSORY</b> .....	7.52
7.14.1.	<i>Dismantling the racing saddle</i> .....	7.52
7.14.2.	<i>Dismantling the racing saddle support unit</i> .....	7.53
7.15.	<b>DISMANTLING THE BELT AND BELT-TENSIONER</b> .....	7.55
7.16.	<b>DISMANTLING THE BRAKE AND THE FLYWHEEL UNIT</b> .....	7.57
7.17.	<b>DISMANTLING THE STATOR</b> .....	7.59
7.18.	<b>DISMANTLING THE SPEED SENSOR</b> .....	7.60
7.19.	<b>DISMANTLING THE BRAKE BOARD</b> .....	7.61
7.20.	<b>DISMANTLING THE BATTERY</b> .....	7.62
7.21.	<b>DISMANTLING THE PLATFORMS</b> .....	7.63
7.22.	<b>DISMANTLING THE INPUT MODULE</b> .....	7.64
<b>8.</b>	<b>ADJUSTMENTS</b> .....	<b>8.1</b>
8.1.	<b>BELT TENSION</b> .....	8.1
8.2.	<b>ALIGNING THE BELT</b> .....	8.2
8.3.	<b>ADJUSTMENT OF THE PLAY ON THE SEAT COLUMN</b> .....	8.3
8.4.	<b>ADJUSTING THE POSITION OF THE SPEED SENSOR</b> .....	8.4
8.5.	<b>ADJUSTING THE POSITION OF THE BRAKE UNIT</b> .....	8.5
8.6.	<b>THE EQUIPMENT IS NOT LEVEL</b> .....	8.6
<b>9.</b>	<b>EQUIPMENT CONFIGURATION</b> .....	<b>9.1</b>
9.1.	<b>USER MENU: 500 LED</b> .....	9.1
9.1.1.	<i>Language</i> .....	9.2
9.1.2.	<i>Units of measurement</i> .....	9.2
9.1.3.	<i>Maximum exercise time</i> .....	9.2
9.1.4.	<i>Pause time</i> .....	9.3
9.1.5.	<i>Cooldown time</i> .....	9.3
9.1.6.	<i>Default age</i> .....	9.3
9.1.7.	<i>Default weight</i> .....	9.4
9.1.8.	<i>Default time</i> .....	9.4
9.1.9.	<i>Default calories</i> .....	9.4
9.1.10.	<i>Default distance</i> .....	9.5
9.1.11.	<i>Enabling the TGS</i> .....	9.5
9.1.12.	<i>Activating the Keyboard</i> .....	9.5
9.1.13.	<i>Modifiability of target heart rate</i> .....	9.6
9.1.14.	<i>Enabling custom messages</i> .....	9.6
9.1.15.	<i>Setting the parameters to default values</i> .....	9.6



9.1.16.	<i>Formatting the P&amp;P key</i> .....	9.7
9.1.17.	<i>SN</i> .....	9.7
9.2.	USER MENU: 700 LED.....	9.8
9.2.1.	<i>Language</i> .....	9.9
9.2.2.	<i>Units of measurement</i> .....	9.9
9.2.3.	<i>Maximum exercise time</i> .....	9.9
9.2.4.	<i>Pause time</i> .....	9.9
9.2.5.	<i>Cooldown time</i> .....	9.10
9.2.6.	<i>Enabling the TGS</i> .....	9.10
9.2.7.	<i>Activating the Keyboard</i> .....	9.10
9.2.8.	<i>Modifiability of target heart rate</i> .....	9.11
9.2.9.	<i>Enabling custom messages</i> .....	9.11
9.2.10.	<i>Changing (custom) messages</i> .....	9.11
9.2.11.	<i>Changing the message language</i> .....	9.11
9.2.12.	<i>Enabling the multi-language mode</i> .....	9.12
9.2.13.	<i>Setting the parameters to default values</i> .....	9.12
9.2.14.	<i>Formatting the P&amp;P key</i> .....	9.12
9.2.15.	<i>SN</i> .....	9.12
9.3.	CONFIGURATION OF THE ASSISTANCE MENU: LED MODELS.....	9.13
9.3.1.	<i>Configuration activation for 500 models</i> .....	9.13
9.3.2.	<i>Configuration activation for 700 models</i> .....	9.13
9.3.3.	<i>Low kit parameter</i> .....	9.15
9.3.3.1.	Read from low kit .....	9.15
9.3.3.2.	Write to low kit .....	9.15
9.3.3.3.	Default Setting .....	9.16
9.3.3.4.	Table of Configuration parameters: .....	9.16
9.3.4.	<i>Operating data</i> .....	9.17
9.3.4.1.	Read from low kit .....	9.17
9.3.4.2.	Write to low kit .....	9.18
9.3.4.3.	Operating data.....	9.18
9.3.5.	<i>Errors Log</i> .....	9.19
9.3.5.1.	Read from low kit .....	9.19
9.3.5.2.	Reset errors .....	9.19
9.3.5.3.	COM.Fault .....	9.20
9.3.5.4.	Display errors.....	9.20
9.3.6.	<i>Standard settings</i> .....	9.21
9.3.7.	<i>Low kit menu</i> .....	9.21
9.3.7.1.	Low kit version .....	9.21
9.3.7.2.	Low Kit fault code .....	9.22
9.3.8.	<i>High kit version</i> .....	9.22
9.3.9.	<i>BOOT version</i> .....	9.22
9.3.10.	<i>Key Reader Version</i> .....	9.22
9.4.	USER MENU: VISIO/VISIOWEB .....	9.23
9.5.	ASSISTANCE MENU: VISIO/VISIOWEB.....	9.24
9.5.1.1.	Table of configuration parameters .....	9.25
9.6.	UNITY CONFIGURATION.....	9.26
<b>10.</b>	<b>UPDATING THE SW</b> .....	<b>10.1</b>
10.1.	VISIO/VISIOWEB .....	10.1
10.2.	UNITY 10.2	
<b>11.</b>	<b>FUNCTIONAL TESTS FOR THE MD MODELS</b> .....	<b>11.1</b>
11.1.	ELECTRICAL SAFETY TESTS.....	11.1
11.2.	MECHANICAL SAFETY TESTS.....	11.3
11.2.1.	<i>Test on the assembly of the movement transmission system and platform leverage</i> .....	11.3
11.2.2.	<i>Checks on the fitting of guards</i> .....	11.3
11.3.	START-UP TEST .....	11.3
11.4.	LIST OF CRITICAL SPARE PARTS .....	11.4
<b>12.</b>	<b>PLANNED MAINTENANCE</b> .....	<b>12.1</b>
<b>13.</b>	<b>APPENDIX</b> .....	<b>13.1</b>



13.1. TABLE OF PASSWORDS TO ACCESS THE MENUS ..... 13.1

**14. TOOLS..... 14.1**

*Blank page*





# 1. GENERAL WARNINGS

## 1.1. INTRODUCTION

This document has been prepared specifically for Technogym After Sales Service with the aim of providing authorised personnel with the information for carrying out maintenance and repair operations in the correct manner. A thorough understanding of the technical data contained herein is absolutely fundamental for the operator to achieve the highest level in professional training.

In order to make the reading more readily understandable, the paragraphs have illustrations and diagrams which highlight the specific subject matter.

This manual includes informative notes with specific meanings:



**WARNING: regulation which may lead to injury if not complied with.**



**WARNING: regulation which may lead to damaging the equipment if not complied with.**



**Information regarding the operation in progress.**



**Detail regarding the operation in progress.**

## 1.2. USEFUL ADVICE

Technogym advises you to program your technical assistance task in the following way:

- Make a careful assessment of the impressions given by the Customer regarding the equipment's operating faults and formulate some appropriate questions to clarify the symptoms relating to the defect.
- Be clear in your diagnosis of the reasons for the fault. You can pick up the basic theoretical information from this manual, but this needs to be bolstered by your own personal experience and by taking part in the training courses organised periodically by Technogym.
- Plan the repair work in a rational manner so as to avoid wasting any time, e.g. collecting spare parts, preparing tools and equipment etc.

- Gain access to the part that needs to be repaired and limit yourself to the essential operations. On this point, it will be extremely helpful if you consult the dismantling sequences shown in this manual.

---

### 1.3. GENERAL REGULATIONS REGARDING SERVICE WORK

1. Always mark components or positions which might easily be confused with each other during re-assembly.
2. Use original Technogym spare parts and recommended brand lubricants.
3. Use special tools when specified to do so.
4. Consult the Technical Newsletters as they might contain more up-to-date details on regulation and servicing procedures compared to those in this manual.
5. Before undertaking any work, check that the recommended tools are available and that they are in good condition.
6. With regard to the procedures given in this manual, only use the tools that have been indicated.

 **Tool measurements in this manual are expressed in mm.**




## 2. TECHNICAL SPECIFICATIONS


### 2.1. EQUIPMENT CODING

The equipment code numbering takes into account all the possible variants and available options for the products. The equipment code number, which does not contain the *Serial Number*, is made up of 16 alphanumeric characters as follows:

<b>Characters</b>	<b>Description</b>	<b>Values and meaning</b>
<b>1,2,</b>	<i>Type of Line</i>	<b>DA</b> = Excite +
<b>3,</b>	<i>Type of equipment</i>	<b>C</b> = New Bike
<b>4,</b>	<i>Model</i>	<b>2</b> = 500 <b>3</b> = 700
<b>5,</b>	<i>Type of energy supply used</i>	<b>3</b> = Powered <b>4</b> = Self-Powered <b>M</b> = Medical Device - CE
<b>6,</b>	<i>Type of Display</i>	<b>L</b> = LED <b>Y</b> = VISIOWEB <b>V</b> = UNITY
<b>7,</b>	<i>Built-in devices</i>	<b>N</b> = None <b>T</b> = Wellness System (WS) <b>I</b> = iPod + USB <b>A</b> = iPod + USB + WS
<b>8,9,</b>	<i>Frame Colour,</i>	<b>AL</b> = Aluminium <b>AN</b> = Anthracite
<b>10, 11,</b>	<i>Upholstery Colour,</i>	<b>00</b> = none <b>AG</b> = Grey <b>K0</b> = Blue <b>M0</b> = Bordeaux <b>NA</b> = Black <b>Z0</b> = Brown
<b>12,</b>	<i>Guard Colour,</i>	<b>G</b> = Mercury Grey <b>R</b> = Renault Grey
<b>13,</b>	<i>Type of standard TV,</i>	<b>0</b> = none <b>C</b> = DVB-T/C HD <b>A</b> = ATSC / QAM-B <b>I</b> = ISDB-T

<i>Characters</i>	<i>Description</i>	<i>Values and meaning</i>
14,15,	Language,	<b>00</b> = Multi-language <b>BR</b> = Portuguese <b>CN</b> = Chinese <b>DA</b> = Danish <b>DE</b> = German <b>ES</b> = Spanish <b>FR</b> = French <b>IT</b> = Italian <b>JP</b> = Japanese <b>NL</b> = Dutch <b>RU</b> = Russian <b>TR</b> = Turkish <b>UK</b> = British English <b>US</b> = American English
16.	Type of packing.	<b>A, B, C, D, E, F, G, H, I, J, K, S, U</b>  See the table below.

### DAC33VAANM0RD00E

 all of the Excite + line machines will be shipped with the specific power cable for the destination country. In particular this means a cable with the standard plug used in the installation country.

This implementation also means a change in the product code. Specifically the last character of the product code will be characterised based on the options shown in the table below:

16th Character Product code	Main country of use	Plug standard	Type of packaging
<b>A</b>	Australia	A S/NZS 3112	Overseas
<b>B</b>	Brazil	NBR 14136	Overseas
<b>C</b>	China	CPC S-CCC	Overseas
<b>D</b>	South Africa	SANS 164-2	Overseas
<b>E</b>	Europe (EC)	EEC 7/16	European
<b>F</b>	USA (UL 250 V)	NEMA 5-15/ NEMA 5-20	Overseas
<b>G</b>	Great Britain	BS1363	European
<b>H</b>	Argentina	IRAM 2073	Overseas
<b>I</b>	Italy	EEC 7/16	Italy
<b>J</b>	Japan	JIS 8303	Overseas
<b>K</b>	Great Britain	BS1363	Overseas
<b>S</b>	Europe (EC)	EEC 7/16	Overseas
<b>U</b>	USA (UL 110 V)	NEMA 6-15/ NEMA 6-20	Overseas

As shown in the table above, the 16th character also identifies the type of packaging depending on the destination country, i.e. DAD33WAANM0RD00**E**.

## 2.2. SERIAL NUMBER STRUCTURE

The *Serial Number* is made up of 14 alphanumeric characters as follows:

Characters	Description	Values and meaning
1,2,3,4,5,6,	Type of product,	<b>DAC</b> = NEW BIKE Excite +
		<b>2</b> = 500
		<b>3</b> = 700
		<b>3</b> = Multi-tension
		<b>4</b> = Self-Powered
		<b>M</b> = Medical Device - CE
		<b>L</b> = LED
		<b>Y</b> = VISIOWEB
		<b>V</b> = UNITY
7,8,	Year of production,	<b>11</b> = 2011
9,10,11,12,13,14.	Progressive.	<b>000001</b>

For example, a possible code number could be the following:

**DAC33V11000001**

## 2.3. COLOUR COMBINATIONS

FRAME		UPHOLSTERY				
		NA. Black	Z0. Brown	M0. Bordeaux	K0. Blu	AG. Grey
AL. Silver (Metalized)				✓	✓	✓
AN. Anthracite		✓	✓			
GUARD						
R. Grey		✓	✓			
G. Flint Grey				✓	✓	✓

## 2.4. PRODUCT CHARACTERISTICS

### 2.4.1. EXCITE MODELS CHARACTERISTICS

	<b>VISIOWEB (700)</b>	<b>LED (700)</b>	<b>LED (700SP)</b>	<b>LED (500)</b>	<b>LED (500SP)</b>
<b>Resistance:</b>	30 – 500 Watt (at 70 rpm)		40 – 500 Watt (at 70 rpm)	30 – 500 Watt (at 70 rpm)	40 – 500 Watt (at 70 rpm)
<b>Difficulty Levels:</b>	1 - 25				
<b>Max. user weight:</b>	180Kg – 397lbs				
<b>Seat height adjustment:</b>	Yes				
<b>Steps of seat height adjustment:</b>	12.5mm				
<b>Fast Track Control:</b>	Yes		NO		
<b>Easy-to-adjust buckles on pedals:</b>	Yes		NO		
<b>Easy Entry Pedals:</b>	Yes		NO		
<b>HR Monitoring:</b>	Double Hand Sensor, Telemetry			Telemetry	
<b>Maintenance:</b>	Maintenance not required, serial software upload				
<b>Goal oriented display:</b>	Yes				
<b>Selection of language at start of training:</b>	Yes		NO		
<b>Plug &amp; Play System:</b>	Yes				
<b>Total number of programs:</b>	<b>23</b> Quick Start, Goals (Time; Distance, Calories), CPR, Profiles (6 pre-defined, 9 customizable), Custom, Training Zone, Weight Loss.			<b>11</b> Quick Start, Goals (Time; Distance; Calories), CPR, Profiles (6 predefined),	
<b>Sub-maximum Tests:</b>	Fitness test		NO		
<b>Wellness System:</b>	Optional				
<b>93/42/EEC Certification:</b>	NO	Yes (700MD)	NO	Yes (500MD)	NO



## 2.4.2. DISPLAY COMPARISON



For all specifications, refer to the manual VISIO/VISIOWEB and/or UNITY.



	<b>VISIOWEB (700)</b>	<b>LED (700)</b>	<b>LED (700SP)</b>	<b>LED (500)</b>	<b>LED (500SP)</b>
<b>Power supply:</b>	<i>100÷240Vac ±10% 50/60Hz</i>		<i>Self powered</i>	<i>100÷240Vac ±10% 50/60Hz</i>	<i>Self powered</i>
<b>Energy consumption:</b>	<i>Max 75W (50VA)</i>	<i>Max 35W</i>	<i>NO</i>	<i>Max 35W (50VA)</i>	<i>NO</i>
<b>Energy consumption: Stand-by:</b>	<i>47W</i>	<i>9W</i>	<i>NO</i>	<i>9W</i>	<i>NO</i>
<b>Plug &amp; Play System:</b>	<i>YES</i>				
<b>Sub-maximal Test:</b>	<i>Fitness test</i>			<i>NO</i>	
<b>Wellness System:</b>	<i>Optional</i>				

	<b>UNITY (700)</b>
<b>Power supply</b>	<i>100÷240Vac ±10% 50/60Hz</i>
<b>Energy consumption:</b>	<i>???</i>
<b>Energy consumption: Stand-by:</b>	<i>???</i>
<b>Plug &amp; Play System:</b>	<i>???</i>
<b>Sub-maximal Test:</b>	<i>Fitness Test - Smart Test Single Stage - Multi Stage</i>
<b>Wellness System:</b>	<i>optional</i>
<b>93/42/CEE Certification:</b>	<i>???</i>

### 2.4.3. MONITOR & COMMANDS

	<b>UNITY (700)</b>	<b>VISIOWEB (700)</b>	<b>LED (700)</b>	<b>LED (500)</b>
<b>LCD dimensions</b>	<i>15,6" LCD - WIDE 16:9</i>		<i>Led</i>	<i>Led</i>
<b>Android OS</b>	<i>X</i>	<i>X</i>	<i>-</i>	<i>-</i>
<b>Capacitive Touch Screen</b>	<i>X</i>	<i>X</i>	<i>-</i>	<i>-</i>
<b>Gesture interaction</b>	<i>X</i>	<i>-</i>	<i>-</i>	<i>-</i>
<b>Classic keypad</b>	<i>-</i>	<i>-</i>	<i>-</i>	<i>X</i>

### 2.4.4. TRAINING CONTENTS

	<b>UNITY (700)</b>	<b>VISIOWEB (700)</b>	<b>LED (700)</b>	<b>LED (500)</b>
<b>Guide Me</b>	<i>X</i>	<i>X</i>	<i>-</i>	<i>-</i>
<b>Embedded Workout Programmes:</b>	<i>25</i>	<i>25</i>	<i>22</i>	<i>11</i>
<b>Languages</b>	<i>18: (US English, UK English, Spanish, Portuguese, French, German, Dutch, Chinese, Japanese, Russian, Turkish, Danish, Italian, Arabic, Korean, Norwegian, Swedish, Finnish)</i>	<i>15: (US English, UK English, Spanish, Portuguese, French, German, Dutch, Chinese, Japanese, Russian, Turkish, Danish, Italian, Arabic, Korean)</i>	<i>13: (US English, UK English, Spanish, Portuguese, French, German, Dutch, Chinese, Japanese, Russian, Danish, Italian, Turkish)</i>	

### 2.4.5. USER CONNECTIVITY OPTIONS / MYWELLNESS CLOUD ACCESS

	<b>UNITY (700)</b>	<b>VISIOWEB (700)</b>	<b>LED (700)</b>	<b>LED (500)</b>
<b>TGS reader and Mywellness Key</b>	<i>X</i>	<i>Optional</i>	<i>Optional</i>	<i>Optional</i>
<b>QR code</b>	<i>X</i>	<i>X</i>	<i>-</i>	<i>-</i>
<b>NFC reader (RFID)</b>	<i>X</i>	<i>-</i>	<i>-</i>	<i>-</i>
<b>Login with username and PW</b>	<i>X</i>	<i>X</i>	<i>-</i>	<i>-</i>

### 2.4.6. USER PERSONAL PROFILE

	<b>UNITY (700)</b>	<b>VISIOWEB (700)</b>	<b>LED (700)</b>	<b>LED (500)</b>
<b>MY TRAINING PROGRAM</b>	X	X	X	X
<b>MY WEATHER</b>	X	X	-	-
<b>MY CHALLENGES</b>	X	X	-	-
<b>FAVORITE TV CHANNELS</b>	X	-	-	-
<b>FAVORITE WEB BOOKMARKS</b>	X	X	-	-
<b>USERCONTENT SYNC</b>	X	-	-	-

### 2.4.7. CONNECTIVITY

	<b>UNITY (700)</b>	<b>VISIOWEB (700)</b>	<b>LED (700)</b>	<b>LED (500)</b>
<b>LAN</b>	X	X	-	-
<b>WiFi</b>	<i>Wi-Fi IEEE 802.11b/g/n 2.4GHZ ISM Band; SECURITY: WPA/WPA2, 64,128,152-bit WEP, WPS</i>	<i>IEEE 802.11 b/g</i>	-	-
<b>Csafe</b>	X	X	X	X

## 2.4.8. ENTERTAINMENT AND MULTIMEDIA CONTENTS

	<b>UNITY (700)</b>	<b>VISIOWEB (700)</b>	<b>LED (700)</b>	<b>LED (500)</b>
<b>TV</b>	<p><b>Analogue:</b> PAL: (BG, DK, I, BH, M, N), SECAM: (L, LI, DK, H, BG) NTSC:(NTSC M, NTSC4.43 M)</p> <p><b>Digital:</b> DVB-T HD, DVB-C HD, ATSC+QAM B, ISDB-T</p>			-
<b>IPTV</b>	<p><b>SD, HD:</b> MPEG-2 Standard Definition.; MPEG -4 pt10 AVC/H.264 Standard Definition &amp; HD; <b>PROTOCOLS:</b> UDP/RTP RTSP</p>	<p><b>SD:</b> mpeg2, mpeg4 TS SD - UDP, RTP, multicast &amp; unicast protocols</p>		-
<b>Radio</b>	X	X		-
<b>Free WEB browsing</b>	X	X		-
<b>Games</b>	<p>YES (Technogym App store)</p>	<p>Four-in-a-row, TG Math, Backgammon, Mah-Jong, TG pairs, TG cards</p>		-
<b>Integrated WebCam</b>	X	-		-
<b>USB Media: Audio</b>	MP3, AAC, WAV (uncompressed)	mp3, wav		-
<b>USB Media: Video</b>	Video codec: XVID, MPEG4, H264 - Audio codec: MP3, AC3	MPEG2, MPEG4, DivX		-
<b>USB Media: Pictures and documents reader</b>	JPEG, BMP, GIF, PNG	PDF, jpg		-
<b>iPod /iPhone Audio **</b>	X	X		-
<b>iPod/iPhone Video **</b>	X	X		-
<b>iPod (support &amp; charge) **</b>	X	X		-
<b>iPad (holder &amp;battery charge)</b>	X	-		-
<b>Nike + iPod</b>	X	X		-
<b>Virtual training</b>	X	-		-
<b>Netpulse multimedia content</b>	X	X		-
<b>Netpulse Virtual Active Video</b>	X	X		-

### 2.4.9. SUPPORTED PROFESSIONAL APPS

	<i>UNITY</i> (700)	<i>VISIOWEB</i> (700)	<i>LED</i> (700)	<i>LED</i> (500)
<b>Communicator – Messagges</b>	X	X	X	-
<b>Communicator – Club area</b>	X	X	-	-
<b>Asset Management</b>	X	X	-	-
<b>Technogym App store</b>	X	-	-	-
<b>Prescribe</b>	X	X	X	X
<b>Self</b>	X	X	X	X
<b>Challenge</b>	X	X	X	X

(\*) The total number of workouts could change.

(\*\*) Only iPod dock connector (up to iPhone 4S – 30 pins).

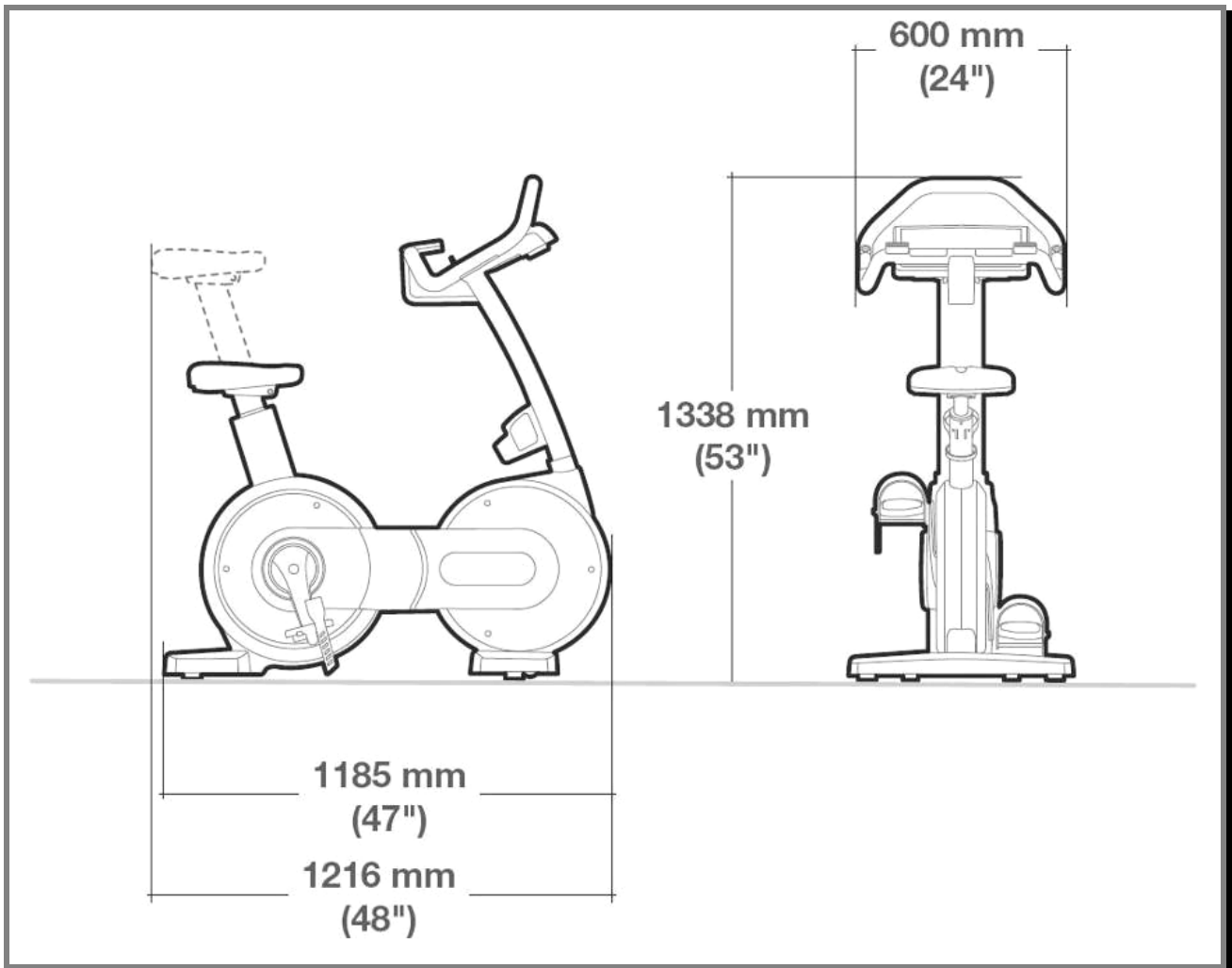


**WARNING:** Some of the above options, tests or features could not be present but coming soon.

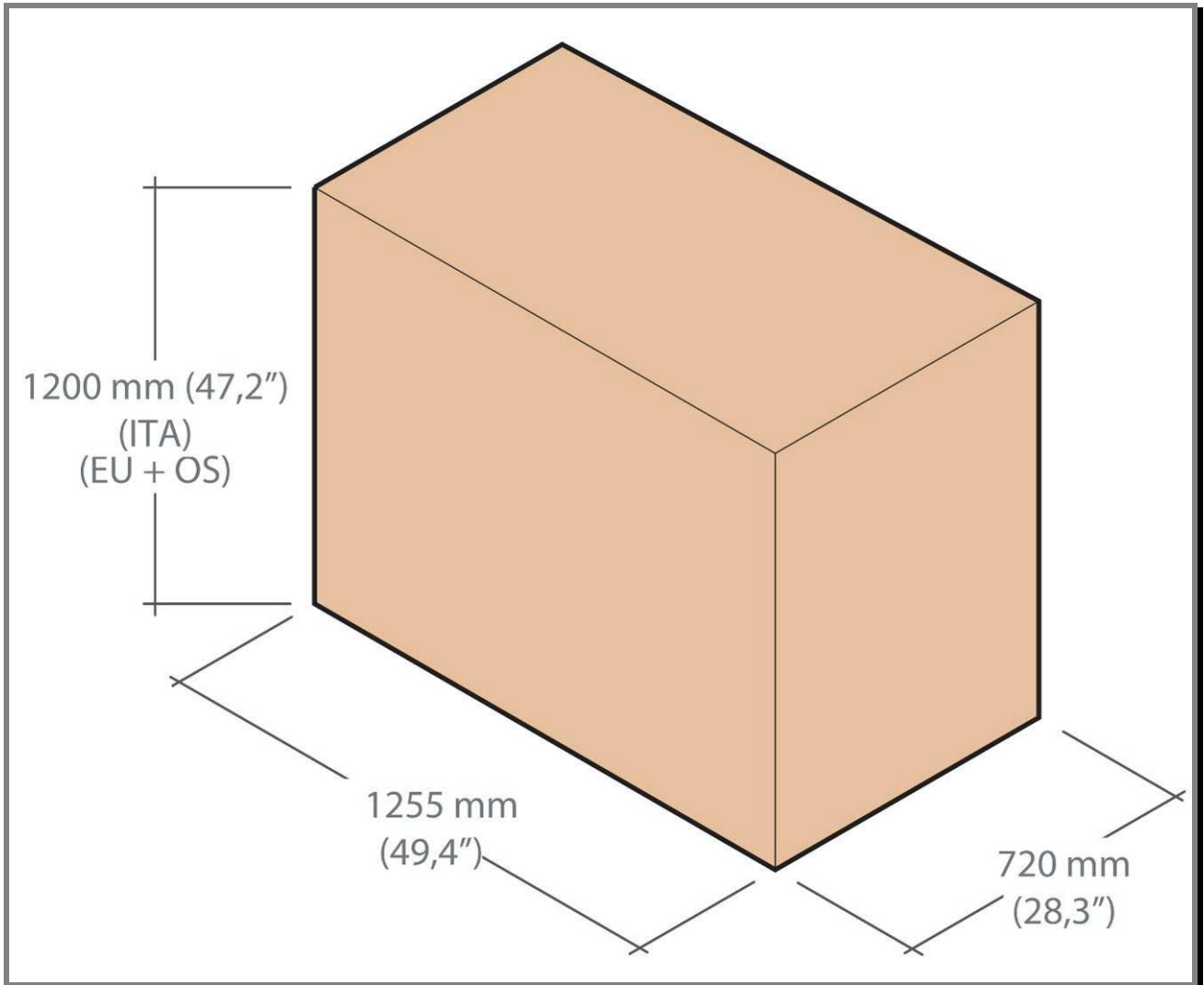
## 2.5. MECHANICAL CHARACTERISTICS

<b>MECHANICAL CHARACTERISTICS</b>	
<b>Length (mm   in)</b>	1216mm -48"
<b>Width (mm   in)</b>	600mm -24"
<b>Height (mm   in)</b>	1338mm -53"
<b>Total weight (kg   lbs)</b>	61Kg -134.5lbs

### 2.5.1. BULK DIMENSIONS



### 2.5.2. PACKING DIMENSIONS EUROPE AND OVERSEAS



## 2.6. ENVIRONMENTAL CHARACTERISTICS

<b>Temperature</b>	<i>In operation</i>	<i>from 5° to 35° C</i>
	<i>In storage</i>	<i>from -10° to 70° C</i>
<b>Dampness</b>	<i>In operation</i>	<i>from 30% to 80% without condensation</i>
	<i>In storage</i>	<i>from 5% to 85% without condensation</i>

## 2.7. COMPLIANCE WITH REGULATIONS

The equipment complies with the following directives:

	<b>EUROPE</b>	<b>USA</b>
<b>EMI</b>	<i>EN 55014-1 (2008)</i> <i>EN 55014-2 (1998)</i> <i>EN 61000-3-2 (2007)</i> <i>EN 61000-3-3 (2009)</i>	<i>UL 1647</i>
<b>Safety</b>	<i>EN 60335-1 (2008)</i> <i>EN 957-1 (2006)</i> <i>EN 957-5 class SA (2009)</i>	
<b>Directives</b>	<i>2006/42/EC</i> <i>2004/108/EC</i> <i>2006/95/EC</i>	

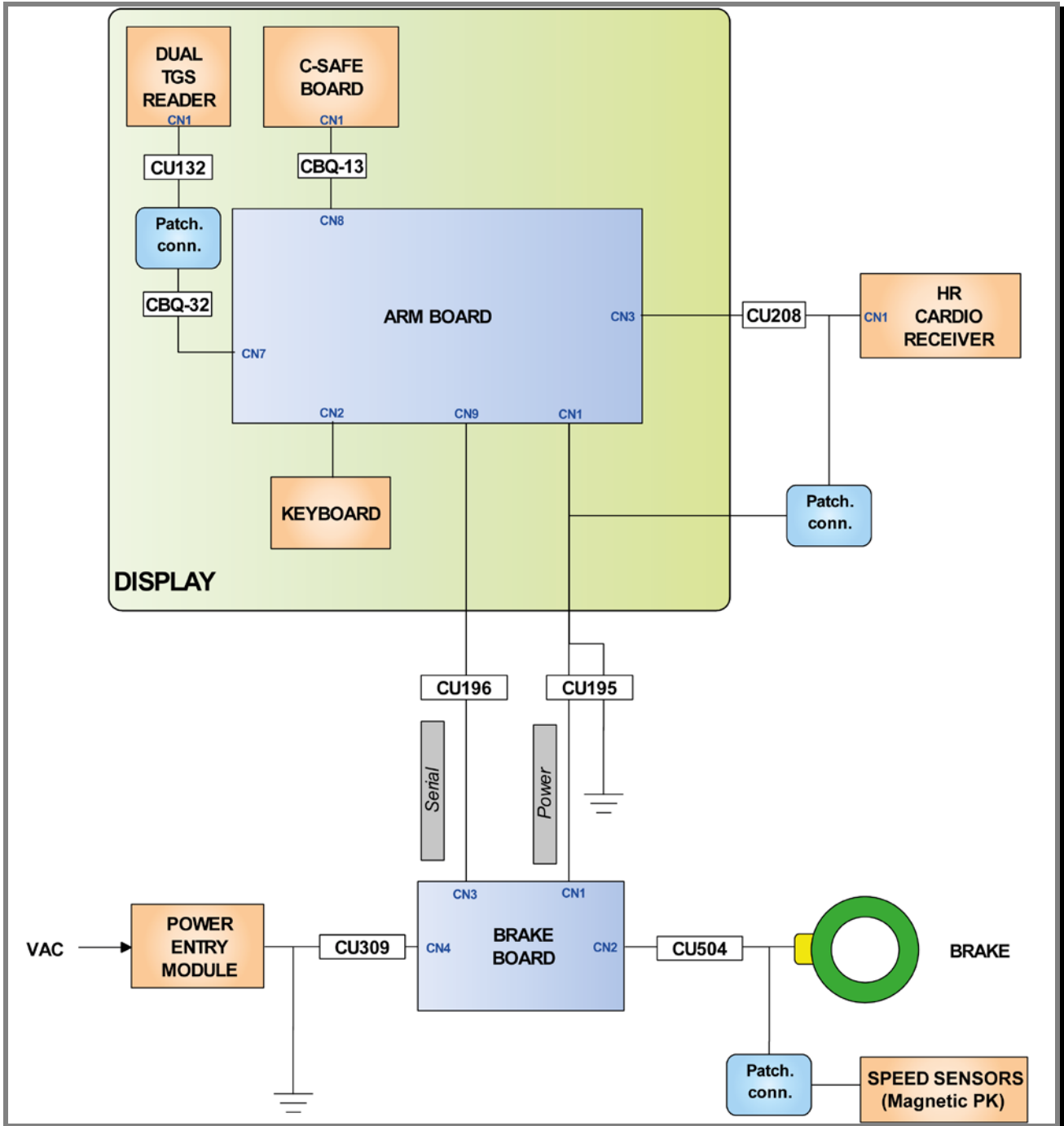
In addition:

- *Electrical insulation class: **Class I**;*
- *Protection rating: **IP20**.*

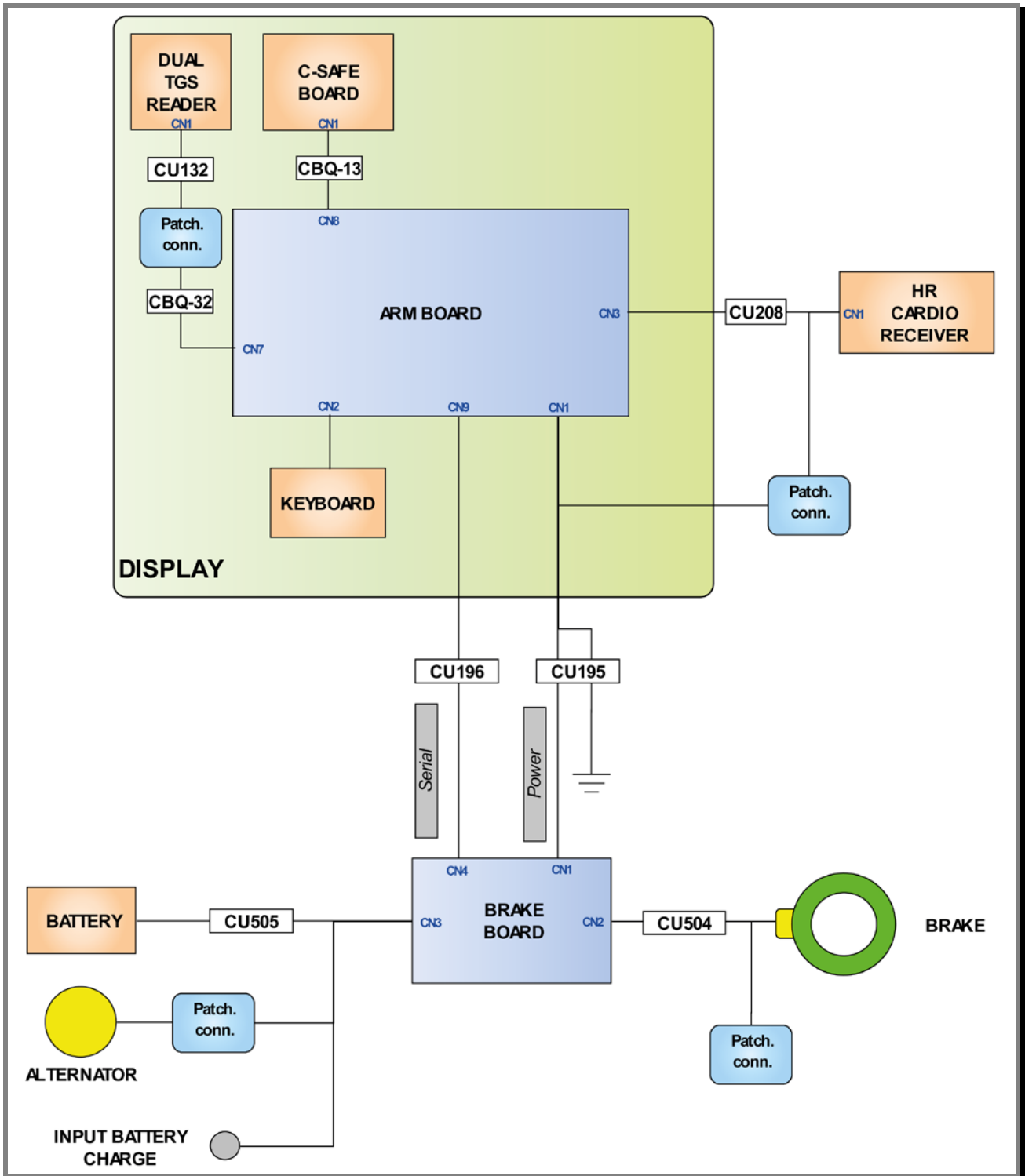


## 2.8. WIRING DIAGRAM

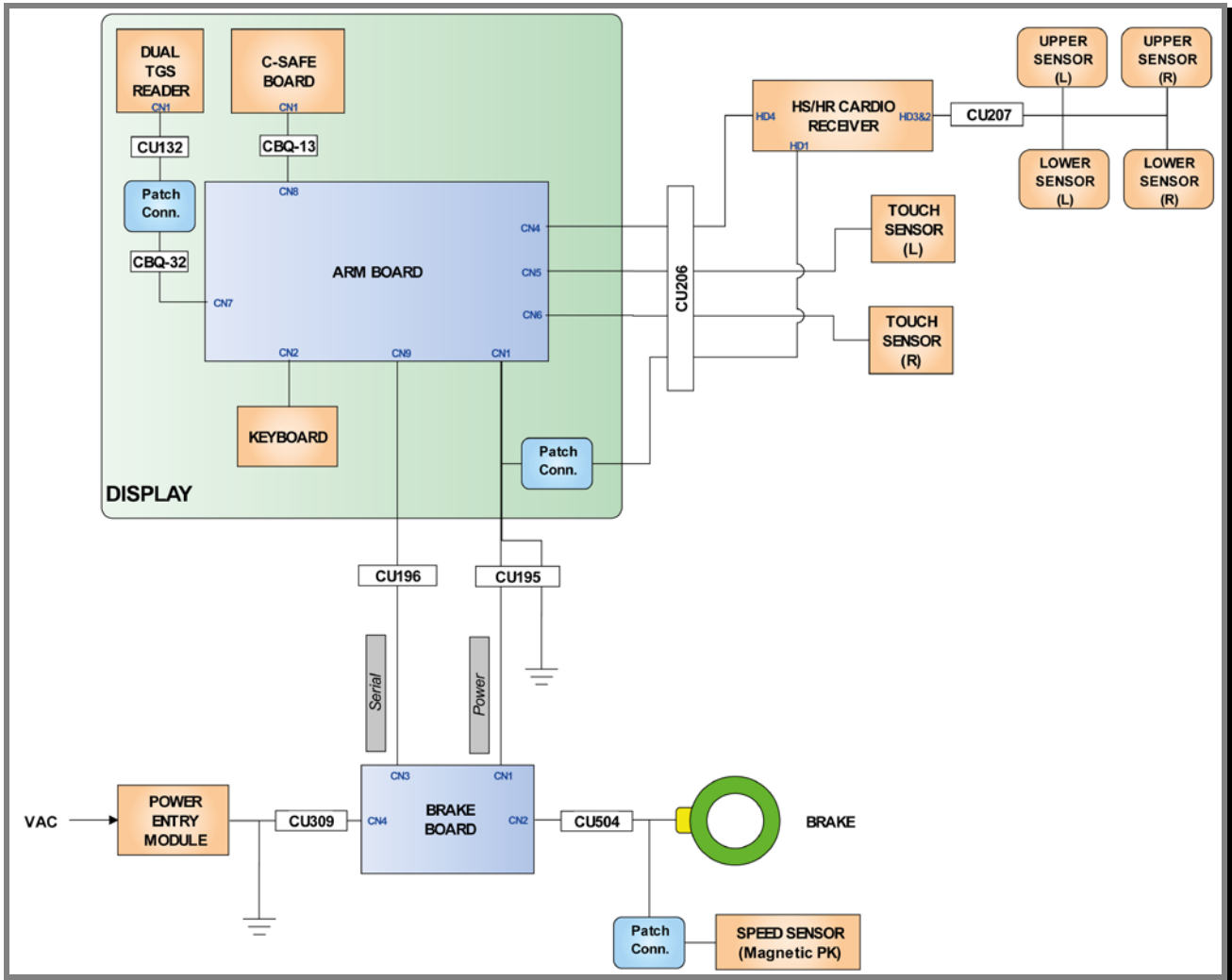
### 2.8.1. 500 LED POWERED MODEL (ARM BOARD)



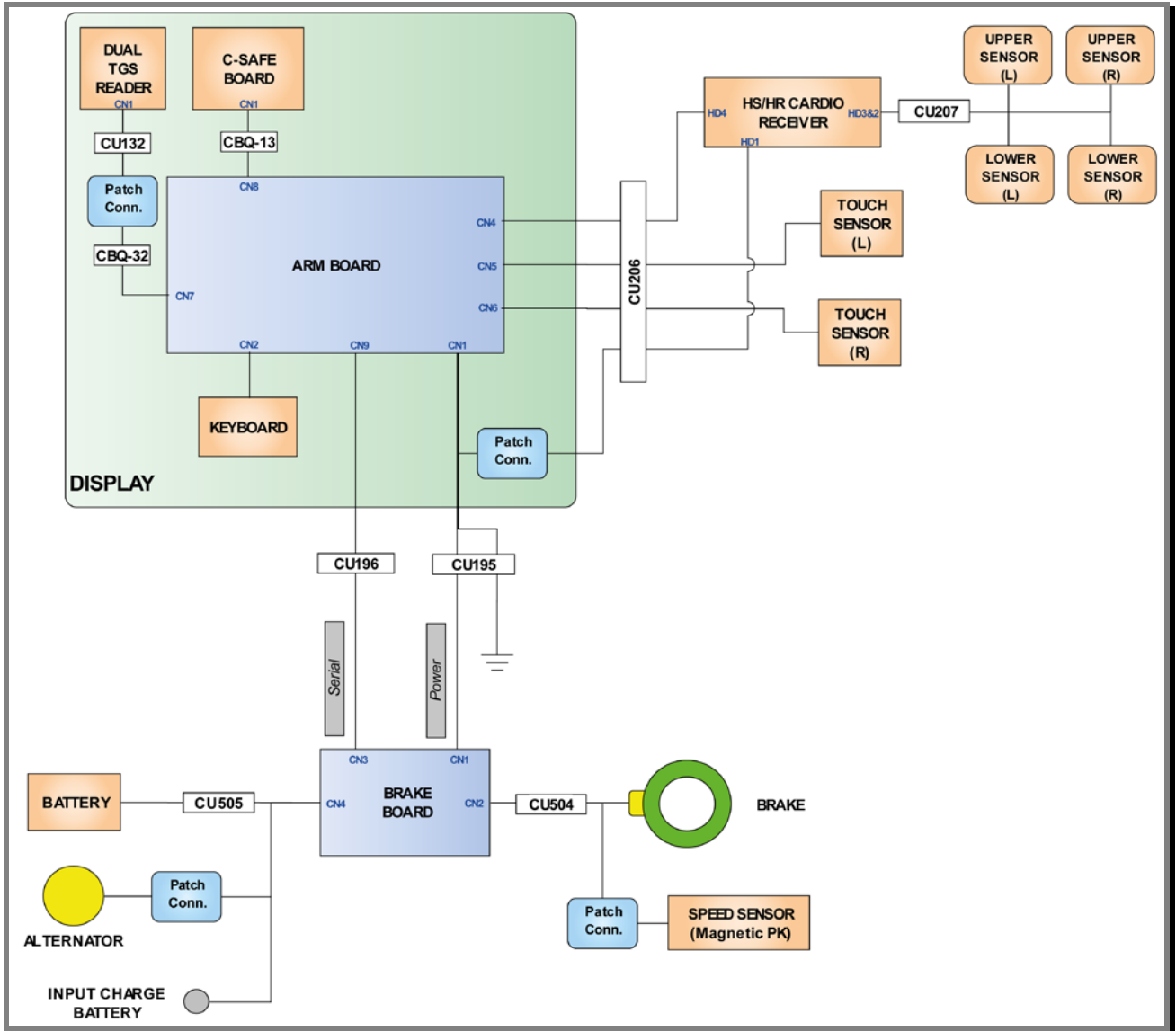
### 2.8.2. 500SP LED SELF-POWERED MODEL (ARM BOARD)



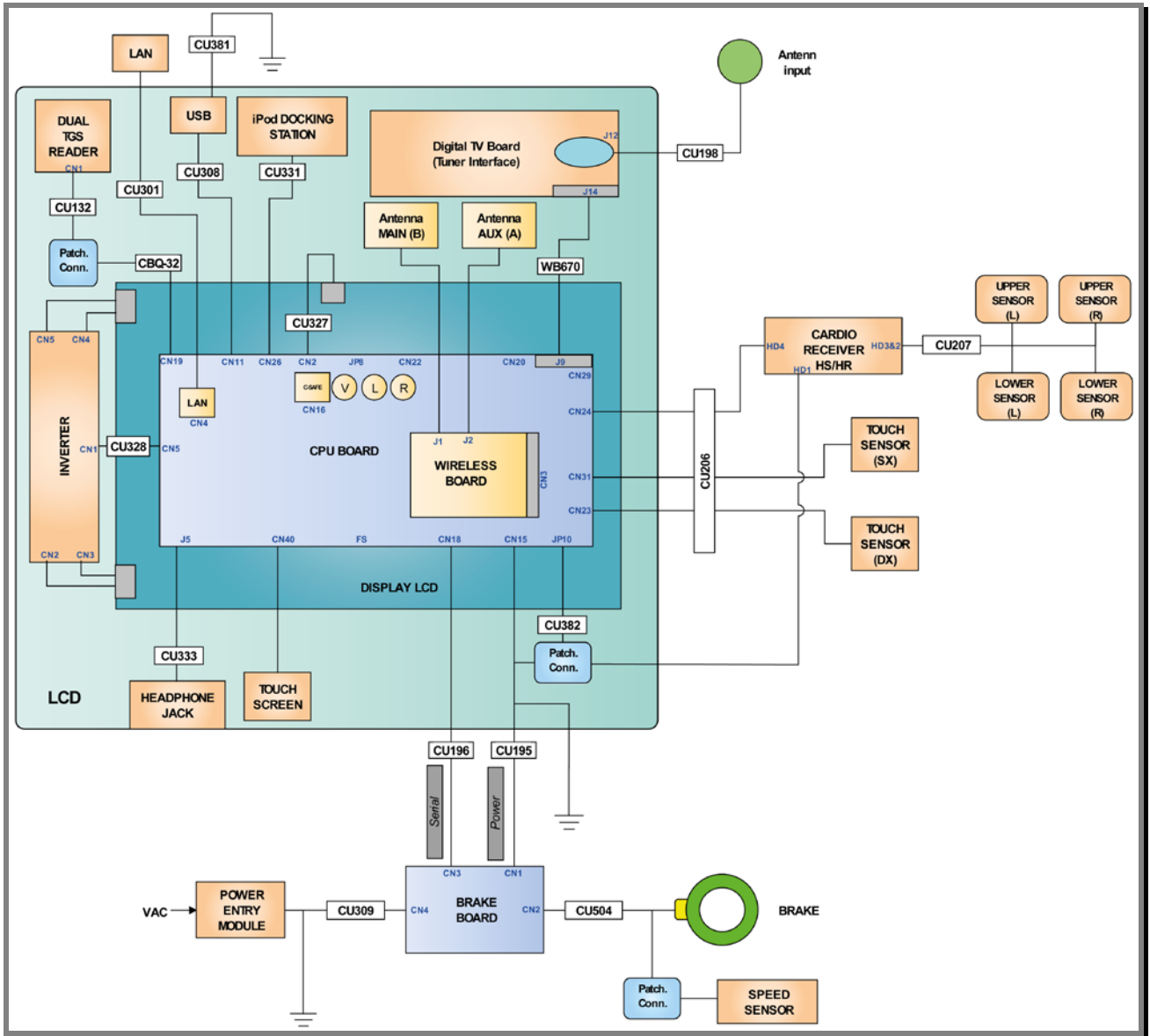
### 2.8.3. 700 LED POWERED MODEL (ARM BOARD)



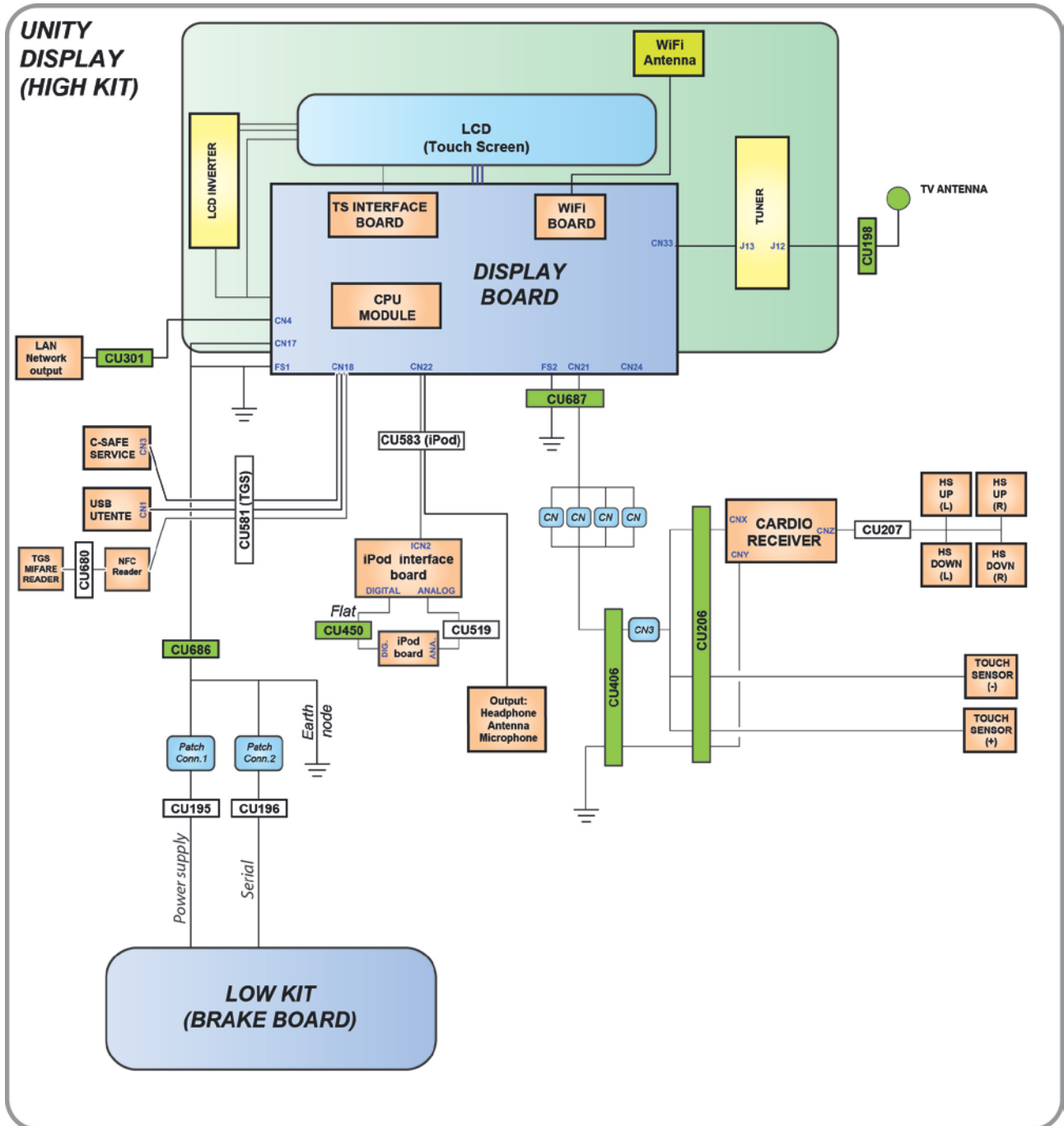
### 2.8.4. 700SP LED SELF-POWERED MODEL (ARM BOARD)



### 2.8.5. 700 VISIOWEB POWERED MODEL (CPU BOARD)



### 2.8.6. 700 UNITY POWERED MODEL



## 2.9. CABLES



The colour of the cables may change: in particular, refer to the Pin Out.

### 2.9.1. CBQ CABLES

<b>CBQ-13: C-Safe Board Cable (Only LED) (ARM Board - C-Safe Board)</b>			
<b>ARM Board CN8</b>	<b>Signal</b>	<b>Colour</b>	<b>C-Safe Board CN1</b>
<i>1</i>	<i>Digital #1</i>	<i>Flat cable</i>	<i>1</i>
<i>...</i>	<i>...</i>	<i>...</i>	<i>...</i>
<i>14</i>	<i>Digital #14</i>	<i>Flat cable</i>	<i>14</i>

<b>CBQ32: TGS Cable (Hanging Conn. - DISPLAY Board)</b>			
<b>ARM Board: CN7 CPU Board: CN19</b>	<b>Signal</b>	<b>Colour</b>	<b>Hanging conn.</b>
<i>1</i>	<i>Power supply +12Vdc</i>	<i>Brown</i>	<i>3</i>
<i>2</i>	<i>RX</i>	<i>Blue</i>	<i>5</i>
<i>6</i>	<i>TX</i>	<i>Black</i>	<i>9</i>
<i>8</i>	<i>GND</i>	<i>Red</i>	<i>1</i>

## 2.9.2. CU CABLES

<b>CU132: TGS signal cable (Hanging Conn. – Dual TGS Reader)</b>			
<b>Hanging Conn.</b>	<b>Signal</b>	<b>Colour</b>	<b>Dual TGS Reader CN1</b>
3	Power supply +12Vdc	Black	1
5	RX	Green	2
9	TX	Black	3
1	GND	Black	8

<b>CU195: Power supply cable for High Kit and Low Kit (Brake Board - CPU/ARM Board)</b>			
<b>Brake Board CN1</b>	<b>Signal</b>	<b>Colour</b>	<b>ARM Board: CN1 CPU Board: CN15</b>
1	GND	Yellow/Green	Faston/Eyelet
2	GND -12V	White	2
3	GND -5V	Yellow	3
4	sensing GND + 5V	Pink	4
5	n.c.	-	5
6	+ 12 Vdc	Brown	6
7	+ 5 Vdc	Green	7
8	sensing + 5V	Grey	8

<b>CU196: Serial communication cable for High Kit and Low Kit (Brake Board - CPU/ARM Board)</b>			
<b>Brake Board CN3</b>	<b>Signal</b>	<b>Colour</b>	<b>ARM Board: CN9 CPU Board: CN18</b>
1	n.c.	Orange-White	1
2	n.c.	Orange	2
3	n.c.	Green-White	3
4	n.c.	Blue	4
5	n.c.	Blue-White	5
6	n.c.	Green	6
7	485 TX/RX +	Brown-White	7
8	485 TX/RX -	Brown	8



<b>CU206: HS / HR Touch Sensor Cable (ARM/CPU Board– HR/HS Receiver– Touch Sensor)</b>			
<b>Right Touch Sensor (RED)</b>			
<b>ARM Board:CN6 CPU Board: CN23</b>	<b>Signal</b>	<b>Colour</b>	<b>Right Touch Sensor</b>
1	Power supply + 5Vdc DIG	White	1
2	OUT (level +)	Brown	2
4	GND-DIG	Green	4
<b>Left Touch Sensor (WHITE)</b>			
<b>ARM Board:CN5 CPU Board: CN31</b>	<b>Signal</b>	<b>Colour</b>	<b>Left Touch Sensor</b>
1	Power supply + 5Vdc Dig	White	1
2	OUT (level -)	Brown	2
4	GND-DIG	Green	4
<b>HS / HR Cardio Receiver</b>			
<b>ARM Board:CN4 CPU Board: CN24</b>	<b>Signal</b>	<b>Colour</b>	<b>HS/HR Cardio Receiver HD4</b>
1	Power supply + 5Vdc CARD 2	White	2
5	Out impulse HD-CARD3	Brown	3
6	GND	Green	1
<b>Hanging Conn.</b>	<b>Signal</b>	<b>Colour</b>	<b>Cardio Receiver HD1</b>
<i>faston</i>	GND	Yellow/Green	<i>faston</i>

<b>CU207: Hand Sensor Cable (HS/HR Cardio Receiver - Hand Sensor)</b>						
<b>Receiver HD3&amp;2</b>	<b>Signal</b>	<b>Colour</b>	<b>Hand Sensor</b>			
			<b>(R) Upp.</b>	<b>(R) Low.</b>	<b>(L) Upp.</b>	<b>(L) Low.</b>
1	Right sensor signal	White	up	up	-	-
2	Sensor signal reference	Brown	down	down	-	-
3	GND	Shield	-			
4	Left sensor signal	White	-	-	up	up
5	Sensor signal reference	Brown	-	-	down	down
6	GND	Shield	-			

**CU208: Cable for HR Cardio Receiver (only 500)  
(ARM Board - HR Receiver)**

ARM Board: CN3	Signal	Colour	HR Receiver: CN1
1	Power supply + 5Vdc	White	2
7	Impulse (beat to beat)	Brown	4
8	Gnd	Green	1

**CU309: Cable for 100/220V internal power supply signal  
(Input module - Brake Board)**

Input Module	Signal	Colour	Brake Board CN4
N	NEUTRAL	Light Blue	1
F	PHASE	Brown	3
T	Earth cable	Yellow/Green	5

**CU327: LVDS Cable (Hitachi – ChiMei) (only VISIO)  
(CPU Board – LCD)**

CPU Board: CN2	Signal	Colour	LCD
1	Vcc LCD	Orange	5
2	Vcc LCD	Purple	11
3	GND	Brown	23
4	GND	Green	29
5	Ztxn0	Black	3
6	Ztxp0	Yellow	1
7	GND	Blue	30
8	Ztxn1	Black	9
9	Ztxp1	Red	7
10	GND	Black	24
11	Ztxn2	Black	15
12	Ztxp2	Grey	13
13	GND	Red	17
14	Ztxcn	Black	27
15	Ztxcp	White	25

<b>CU328: “Fronteck” LCD Inverter Cable (only VISIO) (CPU Board – LCD Inverter)</b>			
<b>LCD Inverter CN1</b>	<b>Signal</b>	<b>Colour</b>	<b>CPU Board: CN5</b>
11	Power supply input +12Vdc	Black	1
1	GND	Black	2 (*)
4	ON - OFF	Black	3
3	GND	Black	4
12	+12Vdc	Black	5 (*)
2	Save - lamp	Black	6
5	GND	Black	2 (*)
10	+12Vdc	Black	5 (*)

(\*) = Attach two wires on the same contact.

<b>CU331: iPod signal Cable (only VISIO) (CPU Board – Docking Station)</b>			
<b>CPU Board: CN26</b>	<b>Signal</b>	<b>Colour</b>	<b>Docking Station</b>
1	+V bus USB	Black	14
2	GND bus USB	Black	13
3	TX - RX	Black	11
4	RX – TX	Black	12
5	CTS	Black	10
6	+5Vdc	Black	9
7	GND	Black	8
8	GND	Black	7
9	Gnd video	Black	6
10	video signal	Black	5
11	Gnd audio L	Black	4
12	audio signal L	Black	3
13	audio signal R	Black	2
14	Gnd audio R	Black	1

<b>CU333: Audio cable for Headphones Jack (only VISIO) (CPU Board – Headphones Jack)</b>			
<b>CPU Board: J5</b>	<b>Signal</b>	<b>Colour</b>	<b>Headphones Jack</b>
2	Out_R	Green	4
4	Shield	Yellow	5
1	GND	Red	2
3	Out_L	Black	1

<b>CU504: Brake power supply cable (Brake Board - Brake - Speed sensor)</b>				
<b>Brake Board CN2</b>	<b>Signal</b>	<b>Colour</b>	<b>Brake</b>	<b>Speed Sensor (magnetic PK)</b>
1	Brake power supply +	Brown	Faston	-
2	Brake power supply -	White	Faston	-
3	R.P.M.Sens.	Yellow	-	Faston
4	GND-RPM Reference	Black	-	eyelet
5	n.c.	-	-	-
6	n. c.	-	-	-

<b>CU505: Generator cable (only self-powered) (Brake Board - Generator - Battery - Battery charger input)</b>					
<b>Brake Board: CN3</b>	<b>Signal</b>	<b>Colour</b>	<b>Generator</b>	<b>Battery</b>	<b>Battery charger input</b>
10	+Vgen	Red	Faston		-
8	- Vgen	Black	Faston		-
4	RPM signal	White	Faston		
2	Voltage V+ from battery charger	Red	-		soldered to internal contact (+)
7	Voltage V- from battery charger	Black	-		soldered to external contact (-)
1	Battery V+	Red	-	Faston (+)	-
6	Battery V-	Black	-	Faston (-)	-

## 2.1. UNITY CONNECTION CABLES

<b>CU406: CARDIO receiver and TOUCH Sensor patch cable (Patch Conn. 3 – Cardio Receiver/Touch Sensor)</b>					
Patch Conn CN3	Signal	Color	TS (+) CN	TS (-) CN	Cardio receiver CN
1	+5V – CARD.2	White	-	-	1
2	HD – CARD.3	Brown		-	5
3	+5V – DIG (col. 7)	White		1	-
4	OUT (level -)	Brown		2	-
5	GND – DIG	Green		4	-
6	GND-CARD	Green		-	6
7	n.c.	-	-		
8	+5V – DIG (col. 7)	White	1	-	-
9	OUT (level +)	Brown	2		
10	GND – DIG	Green	4		

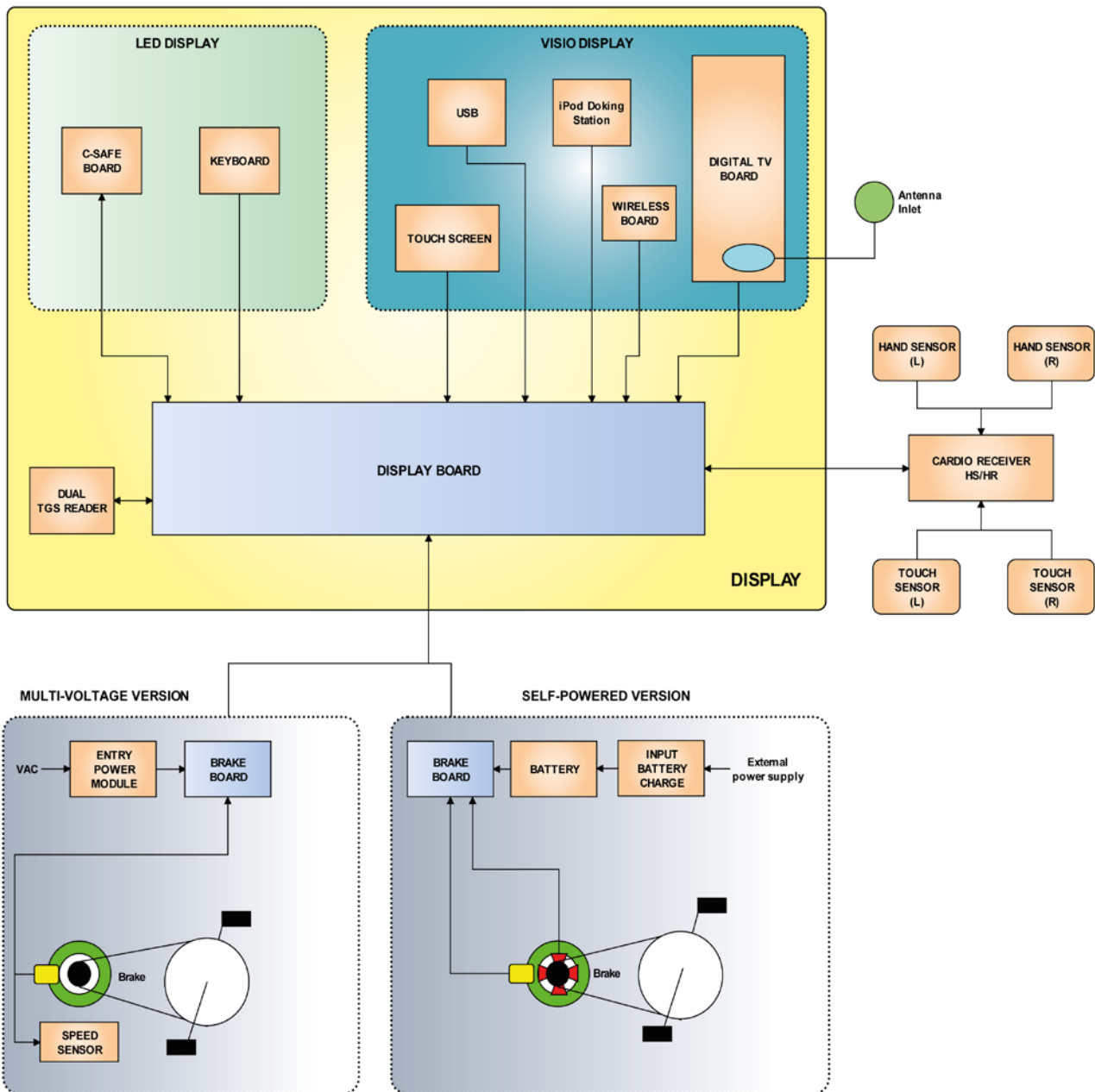
<b>CU686: Display power supply patch cable (High Kit – Low Kit)</b>				
Display board CN17	Signal	Color	Power Supply CNI	Serial CN2
3	GND +12V	Black	2	-
4	GND +12V	Black	2	-
5	LAN 485 TRD – RXD (-)	Brown	-	8
9	12Vdc	Red	6	-
10	12Vdc	Red	6	-
13	LAN 485 TRD – RXD (+)	Brown/White	-	7
faston	GND	Yellow/Green	faston	

<b>CU687: CARDIO receiver and TOUCH Sensor patch cable (Display board – Cardio receiver/Touch Sensor)</b>							
<b>Display Board CN21</b>	<b>Signal</b>	<b>Color</b>	<b>TS (+) CN</b>	<b>TS (-) CN</b>	<b>Cardio Receiver CN</b>		
1	+5vdc_extJoy SX (Touch -)	Green	-	1	-		
2	+5vdc_extJoy SX (Touch +)	Yellow	1	-			
13	Out_joy_sx/GND/IN- Keyrow0 (Touch -)	White	-	2			
14	Out_joy_sx/GND/IN- Keyrow0 (Touch +)	Rose	2	-			
15	Dgnd (TOUCH -)	Brown	-	4			
16	Dgnd (TOUCH +)	Grey	4	-			
19	Dgnd_ch0	Black	-	-	8	-	
20	Dgnd_ch1	White			-	6	
21	In_cardio_ch0	Red			7	-	
22	In_cardio_ch1	Green			-	5	
23	+5vdc_cardio ch0	Blue			1	-	
24	-5vdc_cardio ch0	Brown			-	1	
faston	GND	Yellow/Green			faston		

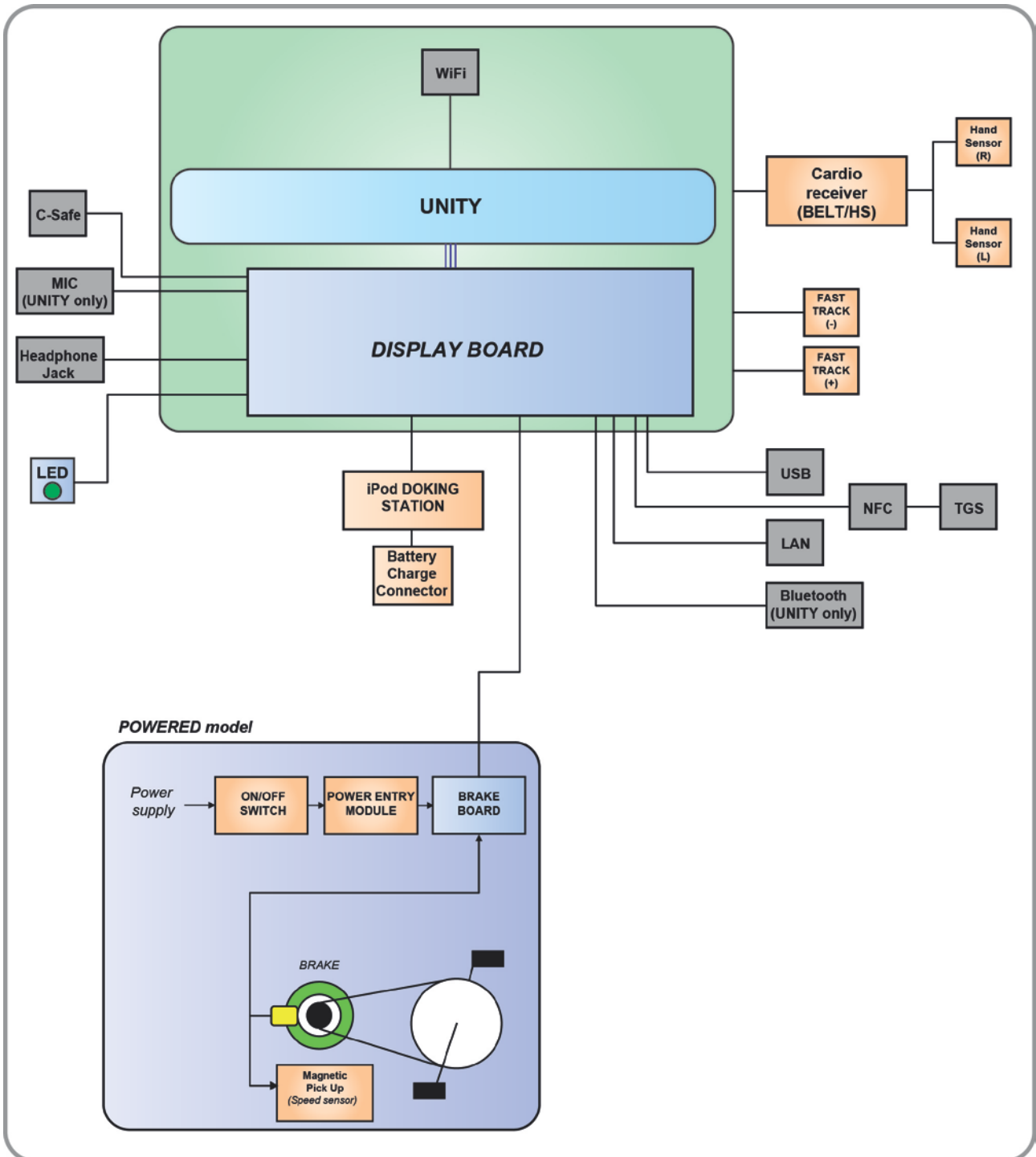
# 3. OPERATING PRINCIPLE

## 3.1. BLOCK DIAGRAM LED AND VISIOWEB MODELS

The block diagram for the equipment is represented in the following figure:



### 3.1. UNITY MODELS





## 3.2. LED DISPLAY BOARDS

### 3.2.1. ARM BOARD: 500 AND 500SP MODELS

The Display includes a single board which contains the CPU, an ARM microprocessor, the logic for its operation and the EPROM FLASH containing the equipment's work program, and also acts as a connection centre for all the display components and a connection point with the Brake Board.

The main functions of the board are:

- manage and process the signals from:

- (1) Keyboard;
- (2) HR Receiver;
- (3) C-Safe Board;

Optional:

- (4) Dual TGS Reader.

- distribute on the display the supplies it receives from the Brake Board;
- exchange with the Brake Board the piloting commands for the brake on the RS-485 serial line;
- manage the LEDs and the 7 display segments to provide feedback on operating.

There are some signal LEDs on the board:

<b>LED Name</b>	<b>Colour</b>	<b>Description</b>
<b>LED1</b>	<b>GREEN</b>	<i>if ON, the +12Vdc power supply, provided by the Brake Board, is reaching the board correctly.</i>
<b>LED2</b>	<b>YELLOW</b>	<i>if ON, the +5Vdc power supply, provided by the Brake Board, is reaching the board correctly.</i>

### 3.2.2. ARM BOARD: 700 AND 700SP MODELS

The Display includes a Board which contains an ARM microprocessor, the logic for its operation and the FLASH memory containing the equipment's work program, which acts as a connection centre for all the Display components and a connection point with the Brake Board.

The main functions of the board are:

- Manage and process the signals from:

- (1) Keyboard;
- (2) HS/HR Receiver
- (3) Fast Track;
- (4) C-Safe Board;

Optional:

- (5) Dual TGS Reader.

- Distribute on the display the supplies it receives from the Brake Board;
- Exchange with the Brake Board the piloting commands for the Electromagnetic Brake on the RS-485 serial line;
- Manage the LEDs and the 7 display segments to provide feedback on operating.

There are some signal LEDs on the board:

LED Name	Colour	Description
LED1	GREEN	If ON, the +12Vdc power supply, provided by the Brake Board, is reaching the Display Board correctly.
LED2	YELLOW	If ON, the +5Vdc power supply, provided by the Brake Board, is reaching the Display Board correctly.

### 3.2.3. C-SAFE BOARD

This is the board that makes available 1 connector for communication between the outside world and the C-Safe compatible devices, such as: Cardio Theater readers. This connector is located at the back of the display.

Using a special cable, this connector can be interfaced with an external PC to program the FLASH memory.

### 3.2.4. DUAL TGS READER

This is the device that allows the equipment to interact with the Wellness System.

The equipment reads the TGS key, which the user uses for running a training session, through the Wellness System programs.

The dual TGS reader allows you to read both Botom and Mifare keys.

### 3.3. VISIO/VISIOWEB DISPLAY BOARDS

#### 3.3.1. CPU BOARD: 700VISIO/VISIOWEB MODEL

The Board contains: a microprocessor, the logic for its operation, the FLASH memory (Operating System), a FLASH memory divided into two sections (HD1 and HD2) used for the equipment's work program, saving videos and information/support materials and one for saving messages from the COMMUNICATOR and a third FLASH memory (HD3) used for the BACK-UP function. This is the board that acts as a connection centre for all the Display components and a connection point with the Brake Board.

The main functions of the board are:

■ Manage and process the signals from:

- (1) LCD;
- (2) LCD Inverter;
- (3) Touch Screen;
- (4) Digital/Analogue TUNER Board;
- (5) LAN network board (built-in);
- (6) Wireless network board;
- (7) HR/HS Receiver;
- (8) Connector board for entry of external Audio/video devices;
- (9) Headphones Jack;
- (10) C-Safe (built-in);
- (11) USB service port (built-in).

Optional:

- (12) Dual TGS Reader,
- (13) User USB port;
- (14) iPod docking station.

- Distribute on the display the supplies it receives from the Brake Board;
- Exchange with the Brake Board the piloting commands of the motors on the RS-485 serial line;

There is also a signal LED on the board:

LED Name	Colour	Description
LED 1	GREEN	If ON the +12Vdc power supply from the Brake Board is reaching the board correctly.

##### 3.3.1.1. Back-Up Battery

There is a battery on the Display Board which is used to supply power to the internal clock, when the equipment is not connected to the mains power supply.

### 3.4. LCD INVERTER

It is the device which provides power to the LCD lamps. It receives the direct currents (12Vdc of power supply and the 3.3Vdc enabling signal) from the Display Board and generates the alternating current (380Vac) required to provide power to the LCD lamps.

### 3.5. DIGITAL/ANALOGUE TUNER BOARD

This is the board which receives and manages the **audio/video** signal coming from the aerial. It can receive both digital and analogue signals.

The aerial cable is connected directly to it and the aerial signal is amplified and divided between video and audio channels, coded by the decoder and processed by a TUNER which allows you to search for and tune in to both TV and radio channels.

The data is then sent to the Display Board which processes and manages the data so that it is correctly displayed on the LCD Display.

LED Name	Colour	Description
D4	RED	<p>If <b>ON</b>, power supply is reaching the board.            If <b>OFF</b>, power supply is not reaching the board.            If <b>FLASHING</b>:</p> <ul style="list-style-type: none"> <li>▪ It is loading/booting the SW in the first seconds after being switched on;</li> <li>▪ It is uploading Firmware (FW);</li> <li>▪ There is a HW/SW malfunction (and it continues flashing).</li> </ul>

### 3.6. INTEGRATED LAN NETWORK BOARD (CABLED NETWORK)

The Display Board has a built-in **LAN** (*Local Area Network*) board which can be used to connect the VISIO/VISIOWEB devices onto a network. The connection is performed using a UTP cable with a RJ45 cat.5e/6 connector.

VISIO/VISIOWEB is compatible with LANs which have a maximum transmission speed of between 10 and 100 Mbps.



**A cabled network is a must if you want to receive an IPTV stream.**

### 3.7. WIRELESS NETWORK BOARD

This is a board which is directly connected onto the **Display Board**, which allows a VISIO/VISIOWEB device to be connected to a wireless network - **WLAN** (*Wireless Local Area Network*) - as opposed to a cabled network. The VISIO/VISIOWEB device was developed to be compatible with **Wi-Fi** technology (in particular with the **IEEE 802.11b/g** standard), which offers theoretical band capacities of up to 54Mbps over a distance which depends on the characteristics of the premises in which it is installed.

A typical indoor distance would be 30m (free space):

- *Standard: IEEE 802.11b/g;*
- *Frequency band: 2.4GHz;*
- *Security protocol: WPA/WPA2 or even less recent (e.g. WEP).*

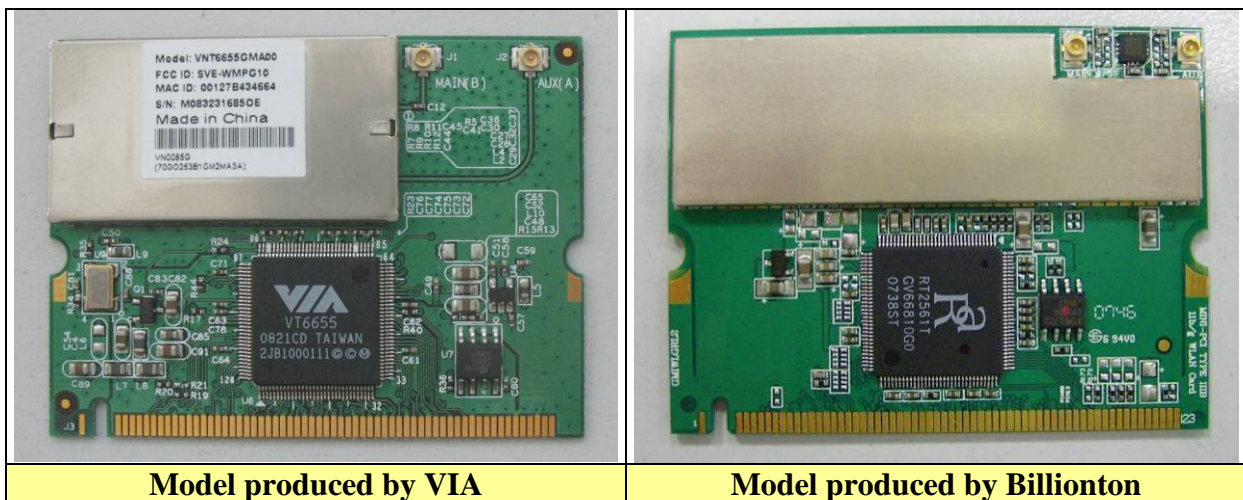


**A WLAN connection may not guarantee the same connection performance levels as a cabled network. The advantage of Wi-Fi is the absence of cables but this is also its limitation in terms of protection from disturbance/interference with its performance (stability of the service and band may be patchy) and with security (possible attacks from hackers). Where possible, it is preferable to use a cabled network. The possibility of using Wi-Fi or otherwise may also depend a lot on the type of service/application which you want to use with VISIO.**

**In particular:**

- **Technogym Communicator: useable with an appropriate Wi-Fi network,**
- **IPTV: NOT useable with WI-FI network; this kind of application needs a cabled network.**

Technogym uses 2 different models of wireless network boards: one produced by *VIA* and the other by *Billionton*. The two different boards are easily recognizable as is clear from the pictures below:



**If a board has to be replaced with a different model, you must reset the system by using the appropriate USB Recovery Key and the related “System recovery” function.**

### **3.8. CONNECTOR BOARD FOR ENTRY OF EXTERNAL AUDIO/VIDEO DEVICES**

The board provides connectors in order to connect with external Audio/Video sources and then to display them on the LCD on the base band; it is positioned behind the display guard.

### **3.9. HEADPHONES JACK**

There is a jack available on the equipment display in order to connect with ear-piece headphones. The jack is connected parallel with the stereo exit on the Display Board.

### **3.10. C-SAFE BOARD (BUILT-IN)**

This is a function that allows you to connect with certain other devices using a cable, such as: external PCs, that may be programmed to control the equipment (speed, level of difficulty, etc...)

### **3.11. USB SERVICE PORT (BUILT-IN)**

This is used to connect USB keys to provide updates for: High Kit, Low Kit, TUNER Board, dual TGS Reader and for transferring radio and TV channels, from one VISIO/VISIOWEB device to another.

## 3.12. OPTIONAL ACCESSORIES

### 3.12.1. IPOD DOCKING STATION.



This board allows you to connect the equipment with iPod models and control them directly from the VISIO/VISIOWEB interface.

This device, which is developed for total compatibility with iPods, allows you to provide power supply to, re-charge and control an iPod through the equipment Touch Screen.

*In the table below, you can see all the compatible iPod (APPLE) models:*

<p><i>iPod 5th gen.</i></p> 	<p><i>iPod Classic</i></p> 	<p><i>iPod mini</i></p> 
<p><i>iPod Nano</i></p> 	<p><i>iPod Touch</i></p> 	<p><i>iPhone</i></p> 

### 3.12.2. CLIENT USB PORT



This is an additional port which can be installed on the VISIO/VISIOWEB Displays and provides a USB connector to connect with external devices. The user can connect USB devices for the reproduction of a vast range of multimedia files, including: *mp3, wma, wav, wmv, MPEG2, MPEG4, DivX, XVID jpg.*

### 3.12.3. DUAL TGS READER

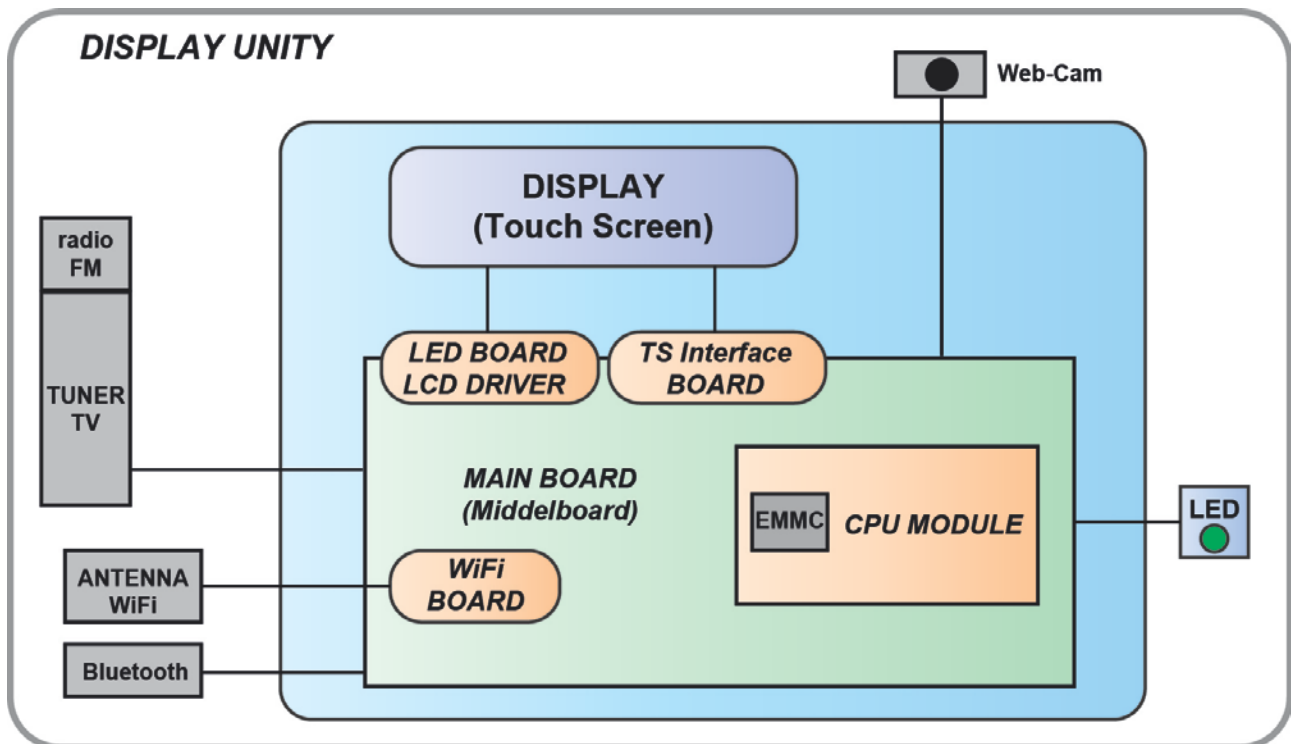
This is the device that allows the equipment to interact with the Wellness System.

The equipment reads the TGS key, which the user uses for running a training session, through the Wellness System programs.

The dual TGS reader allows you to read both Botom and Mifare keys.



### 3.13. UNITY DISPLAY



#### 3.13.1. MAIN BOARD (MIDDELBOAR)

Main board (Middleboard): this is the control board for the cardio receiver and the interface board for all the peripheral devices. In fact, all the electrical wiring and connections of the equipment are hooked up to this board. It also includes a microcontroller, the software of which can be updated (middleboard update) using a USB flash drive or Asset management tools.

#### 3.13.2. CPU MODULE

This is a module (standard Q7 format) which contains the equipment's "heart" and intelligence. It has an eMMC memory where the operating system and the software version of the application that can be updated by USB flash drive or asset manager reside.

#### 3.13.3. WI-FI MODULE:

2.4 GHz 802.11b/g/n Wi-Fi module

#### 3.13.4. CONTROLLER TS

TS control board to which the flat cables of the TS are connected.



### **3.13.5. BLUETOOTH MODULE**

Bluetooth v.4.0 module board, dual mode compliant (classic & low energy master mode) controls:

- *Bluetooth Heart Rate Band*
- *Bluetooth wireless headphones*
- *Connection to Apple devices (iPhone 5/ iPod) and Android devices.*

This module permits surfing of smartphone contents using the Touch Screen of UNITY.

### **3.13.6. THE FUNCTION OF THE MAIN BOARD IS TO CONTROL...**

- *RS-485 series line to the LOW KIT;*
- *CPU Module;*
- *The LCD Display;*
- *The TV Tuner;*
- *FM Radio;*
- *The signals related to heartbeat measurement (reception from Chest Band and Hand Sensor);*
- *Fast Track Sensors;*
- *iPod/iPhone docking station (audio and video contents and battery charger);*
- *iPad battery charger (USB type socket);*
- *Keyboard;*
- *Stand-by LED;*
- *Headphone jacks with microphone;*
- *NFC reader to exchange data with smartphone devices;*
- *TGS reader to exchange data with TGS pen drive and MyWellness Key;*
- *C-Safe devices;*
- *WiFi and LAN network connections;*
- *USB port (audio, video and photo contents);*
- *Webcam (NOT enabled)*
- *Bluetooth Module;*
- *“Ready to run” device and fan (only Run).*

## **3.14. UNITY DEVICE**

### **3.14.1. HEADPHONE AND MICROPHONE JACK**

Earphones with microphone (For iPhone and/or Blackberry).

### **3.14.2. C-SAFE BOARD**

This board provides a connector for communication between the outside world and compatible C-Safe devices, for example: Cardio Theater players. This connector is located on the back of the display.

This connector can be interfaced with an external PC to program the FLASH memory, using a special cable.

### **3.14.3. NFC BOARD (PROXIMITY SENSOR)**

The NFC board is located on the back of the keyboard for Minimal and U-TV, or on the back of the front protection panel for UNITY, next to the related NFC / Wellness Cloud logo.

With this device it is possible to interface with smartphones equipped with NFC technology.

### **3.14.4. TV TUNER**

This board receives and controls both digital and analogue Audio/Video signals arriving from the aerial.

The aerial cable is connected directly to it, and the signal from the aerial is then amplified, divided between the video and audio channels, coded by the decoder and processed by a tuner which makes it possible to search for and tune into TV and Radio channels. The data are then sent to the Display Board which processes them and controls them for correct viewing.

### **3.14.5. TGS READER**

This device permits interaction of the equipment with the Wellness System.

It reads TGS and MyWellness Keys used by users to perform their workouts, by means of the special Wellness System programmes.

The dual reader makes it possible to read both Botom and Mifare keys.

### **3.14.6. USB PORT**

This is used for connection of USB devices for updates of: High Kit, Low Kit, TUNER board, TGS reader and for transfer of network and RADIO and TV channel configurations from one interface to another.

### **3.14.7. STAND-BY LED**

This LED flashes when the equipment is started during the boot-up and whenever the LCD display is switched off to reduce energy consumption.

When the LCD display is switched on, the LED is always switched off.

### **3.14.8. BACK-UP BATTERY**

There is a battery on the Main Board which powers the internal clock when the equipment is not connected to a power outlet.

### 3.14.9. DOCKING STATION AND BATTERY CHARGER

The Board makes it possible to connect iPod devices and to control them directly from the UNITY interface.

Connection with UNITY permits you to: power, recharge and fully control iPod devices.

The table below lists all the compatible iPod (APPLE) models:

<b>Recharging battery</b>	<i>All iPod &amp; iPhone models (except: iPod shuffle and first generation of models*)</i>
<b>Play &amp; Control Audio</b>	<i>All iPod &amp; iPhone models (except: iPod shuffle and first generation of models*)</i>
<b>Play &amp; Control Video</b>	<i>All iPod models from the iPod 5 generation, all iPod Nano models from the Nano 3G &amp; 4G versions, all iPod Touch models from the iPod Touch 1G &amp; 2G versions, all iPhones from the iPhone &amp; iPhone 3G models</i>
<b>Nike+Gym</b>	<i>All iPod Nano models from the iPod Nano 3G model, all iPods from the Touch 2G model and all iPhones from the iPhone 3GS. (For further information: <a href="http://www.apple.com/ipod/nike/workout.html">http://www.apple.com/ipod/nike/workout.html</a>)</i>

**☞ (\*)**:The equipment is compatible with all devices that have a standard iPod connector, and therefore is NOT compatible with the new iPhone 5 devices featuring Retina display which use the new Lightning connector ([http://en.wikipedia.org/wiki/Lightning\\_\(connector\)](http://en.wikipedia.org/wiki/Lightning_(connector))). This is valid for ALL iPod devices EXCEPT the iPod shuffle model and iPod versions previous to June 2004 (1st, 2nd and 3rd generation).

**☞** The docking station is compatible with iPhone 5 with Lightning connector only if an adapter is used. In this case, the functions are limited to streaming and audio control.

**☞** In order to be able to correctly view videos from iPhone and iPod Touch, the device must be updated via iTunes to the latest version of firmware released.

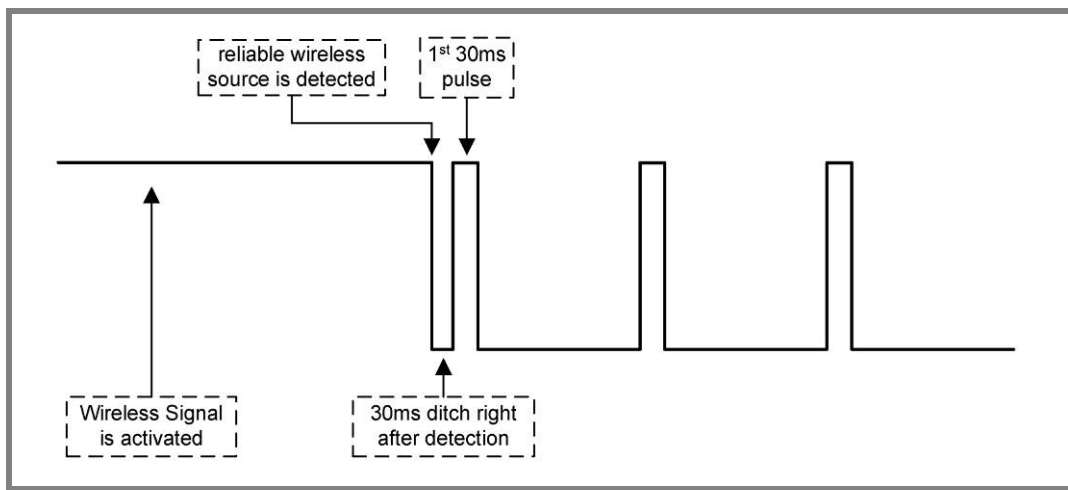
## 3.15. CARDIO RECEIVER BOARD

### 3.15.1. HR/HS (HEART RATE/HAND SENSOR)

**■** The area of reception has a radius of approximately 90cm. If there is any electromagnetic noise within this area produced by high voltage cables, radio transmitter stations, monitors, motors etc...the receiver will get flooded and will not pick up any signal. Additionally, if there is more than one transmitter in the reception area, the signal may be distorted by picking up other signals.

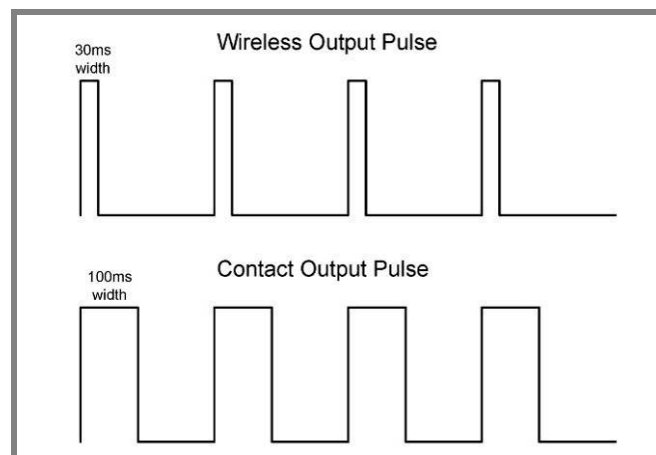
This is the Board that manages the signals sent by the Telemetric Transmitter (*Heart Rate Band*) and by the Hand Sensors, used by the user during training sessions. The Receiver Board receives a power supply of +5Vdc from the Display Board.

The Receiver Board communicates with the Display Board using **positive logic** procedures. When it is in stand-by, the signal has a +5Vdc value and as soon as it receives a signal indicating the presence of a heart beat, it passes to 0Vdc and then with every heart beat it picks up, it generates an impulse and returns to +5Vdc.



The Display Board distinguishes whether the signal is generated by a Heart Rate Band (*wireless signal*) or by the Hand Sensors (*contact signal*) by recognizing their amplitude.

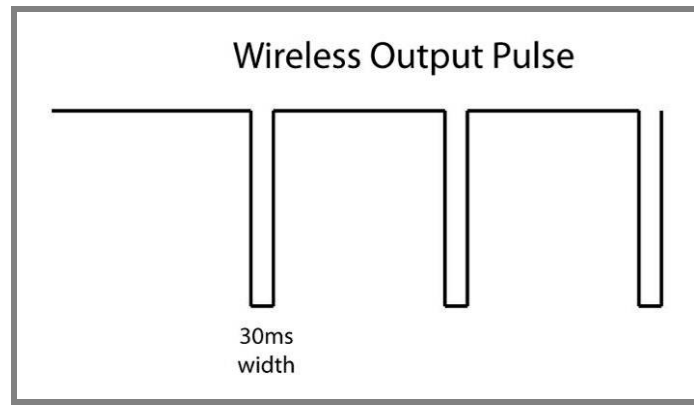
In particular, if the signal has an amplitude of 30msec, it comes from the Heart Rate Band (*wireless*); if it has an amplitude of 100msec, it comes from the Hand Sensors (*contact*).



### 3.15.2. HR (BAND)

This is the Board that manages the signal sent by the Telemetric Transmitter (*Heart Rate Band*), used by the user during training sessions. The Receiver Board receives a power supply of +5Vdc from the Display Board.

The Receiver Board communicates with the Display Board using *negative logic* procedures. When it is in stand-by, the signal has a +5Vdc value and with every heart beat it picks up, it generates an impulse of +0Vdc with an amplitude of 30msec.



### 3.16. BRAKE BOARD

Currently there are 2 models of Brake Boards to be used on the versions of the equipment that are **Powered from the mains** and **Self-Powered** (500SP/700SP).

Every Brake Board is divided up into:

1. Power supply section which generates the low voltages used by the equipment: +5Vdc (used only by high kits of the LED type) and +12Vdc (used by all types of high kits). Depending on the equipment version, these voltage levels are originally generated from mains voltage (both 110Vac and 220Vac) or by a battery-generator.
2. Section that communicates with the Display Board (high kit) on the RS-485 serial line in order to manage:
  - *the signals for controlling the resistance which needs to be supplied to the Electromagnetic Brake;*
  - *the error messages relating to the Electromagnetic Brake;*
  - *the signals modifying the board's configuration parameters;*
  - *the signals displaying the memory of errors detected by the board;*
  - *the signals relating to use of the equipment (RPM, WATT, distance etc...)*
3. Section that generates the current for the winding of the Electromagnetic Brake: when the current varies, the resistance supplied to the Brake itself also varies proportionately. The excitation current supplied to the Brake varies according to the user power/torque requested by the display and the number of revolutions detected by the speed sensor (RPM).


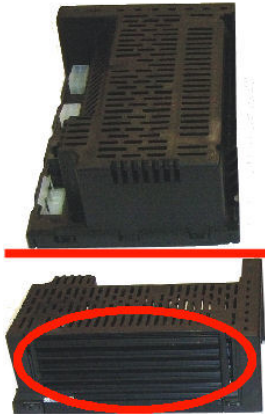
On the Brake Board there are some signal LEDs:

LED Name	Colour	Description
LED1	GREEN	<i>If ON, the board is supplying power to the winding of the brake. If it is FLASHING, there is a fault on the Brake Board and there is no current on the brake.</i>
LED2	YELLOW (if board has supplier code EFI F10549)	<i>If ON, the Brake Board is on.</i>
	RED (if board has supplier code LASER F04010)	

During movement, the Brake Board is capable of detecting possible faults. Any possible errors are detailed in paragraph: 6.10. "The Brake Board has detected an error".

### 3.16.1. BRAKE BOARD MODELS

Two interchangeable models of Brake Board (**LASER** and **NEW EFI**) are used, each is characterized by a specific SW. They can be distinguished from each other by different features on the cover, while the SW is identifiable according to the version of the **kernel**.

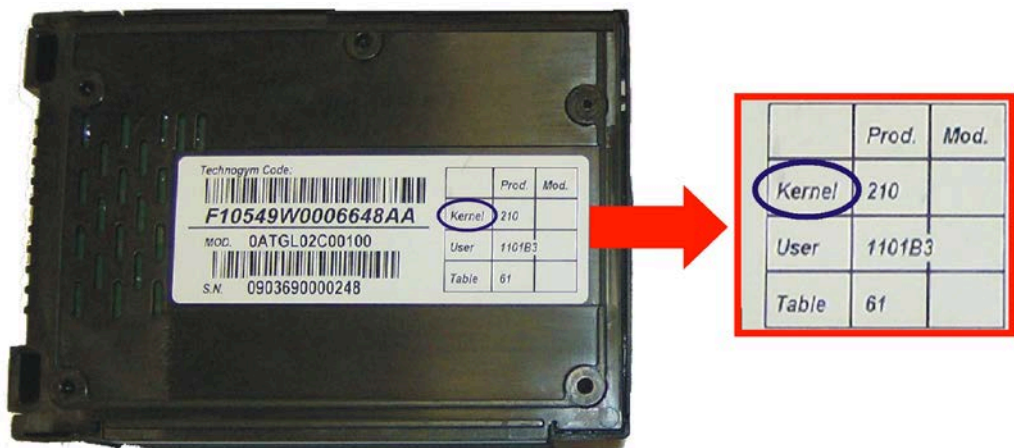
MODELS	
Brake Board - <u>LASER</u> (Black plastic box)	Brake Board - <u>NEW EFI</u> (Black plastic box)
	
<b>Rev. Kernel: 310</b>	<b>Rev. Kernel: 210</b>

You can see, as regards appearance, that:

- the **LASER** board (compared with the previous 65W board, which also was in the form of a black plastic box) has a bevel on one of its sides.
- the **NEW EFI** board (as opposed to all the other brake boxes used up to now) has a metal heat dissipator on one of its sides.



In order to identify the board unequivocally, you should refer to the kernel revision, which can be found on the label that is usually attached to the rear of the box (see example in the figure below).



If it is programmed with an incorrect SW, it causes communication problems between the high kit and the low kit and the following message appears on the display **“THE EQUIPMENT IS BLOCKED (COM)”**.

### 3.17. ELECTROMAGNETIC BRAKE

It is an eddy current Brake, consisting of a flywheel mass and a flat copper disk which turns in the air gap of a winding. When there is a variation in the current to the winding, the field produced by it also varies and there is a consequent variation in the eddy currents induced in the copper disk and the resistance supplied to the movement of the pedals on the equipment.

Two solenoids (*Coils of a cylindrical shape consisting of a series of tight coils made with a single thread of conducting material*) that are connected in line are provided with a power supply through an adjustable direct current generator, so as to create a more or less intense magnetic field. The inertia disk (flywheel) turns between the coils.

Due to the movement, each sector of the disk is crossed by a magnetic field flow that varies in continuation and, as a consequence, electromotive forces are generated which cause the circulation of induced currents. These currents have a direction that is opposite to the element that generated them i.e. the movement of the disk inside the magnetic field itself. As a consequence a braking effect is created which slows down the movement of the disk. The effect increases in intensity according to the size of the magnetic field of the coils and the speed level of the disk. Due to this operating principle, it is clear that when the disk is stationary, the braking effect is non-existent.

As opposed to the majority of mechanical brakes, which function by exploiting friction force, here there are no parts subject to wear and tear.

The winding has a resistance of about 5Ω (Ohm), so, consequently, the brake absorbs a maximum current of 2.2 A.

### 3.18. SPEED SENSOR

 **Only for models: POWERED.**

It consists of a magnetic induction sensor which detects the heads of the screws that fix the disk of the Electromagnetic Brake.

On self-powered equipment, the speed is measured by a built-in sensor on the generator (see paragraph: 3.20. “Generator”).



## 3.19. INPUT MODULE

 Only for models: **POWERED**.

It is a module consisting of:

- *Input power supply socket;*
- *Output power supply socket;*
- *Fuse holder with two rapid 3.15 A fuses to protect the line and the neutral.*

It is located on the front platform.



**WARNING:** The maximum current that can be taken from the equipment's Input Module is 7A. This limits the maximum number of pieces of equipment that can be connected with each other. Do not connect up more than 8 pieces of equipment if the mains power supply is 220Vac and 5 if the mains power supply is 110Vac. If you would like to connect up other types of equipment, the maximum limit would be determined by their current absorption.

## 3.20. GENERATOR

 Only for models: **SELF-POWERED**.

*It is a generator consisting of a stator winding which, following the movement of its rotor, which is set in rotation by the pedals, generates the voltage required to make the equipment work.*

*This alternator is supplied with a rectifier bridge which provides the Low Kit with DC voltage.*

*In addition, by analysing the AC voltage frequency generated, it is possible to calculate the rotation of the rotor and therefore calculate the speed of the user.*

## 3.21. BATTERY

 **Only for models: SELF-POWERED.**

It is a 12 V - 4.5 AH battery, which, in the self-powered version, supplies power when the generator is not capable of generating the voltage required to make the equipment work and for at least 30 seconds, when the user has stopped pedalling in order to allow data to be saved.

*There are 2 ways of re-charging the battery.*

- *during workout, via the Brake Board;*
- *when in Stand-By, through an external power supply, provided together with the equipment, which fully charges the battery in 8 hours.*



**During the charge through an external power supply, the equipment MUST NOT be used.**

## 3.22. EXTERNAL POWER SUPPLY INPUT

 **Only for models: SELF-POWERED.**

This is a socket where you can connect the jack of the external power pack supplied with the equipment which can be used to re-charge the battery. It is located on the front platform.

## 3.23. BRAKE COMMAND

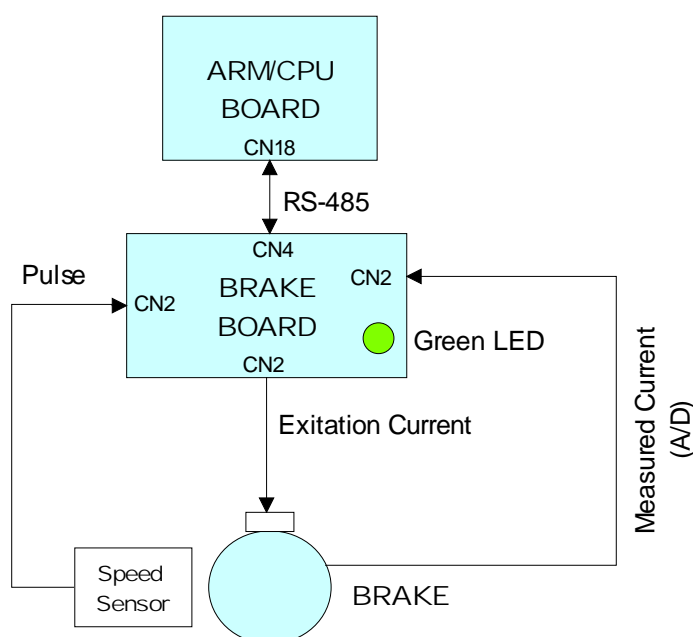
### 3.23.1. THE MECHANICS

The movement of the pedals sets the primary shaft into rotation.

The primary shaft is attached to the secondary shaft and then to the brake, via a belt. The speed sensor, built into the frame, detects the heads of the screws that fix the disk to the flywheel and generates a signal representing the speed.

### 3.23.2. CONTROL

The control diagram is as follows:



In order to set up a specific exercise difficulty, the Brake Board communicates with the Display Board via the RS-485 serial cable indicating speed value of the exercise in *revs per minute (RPM)*. On the basis of the commands received from the Display Board, the Brake Board sends an excitation current to the winding on the brake which will generate an electromagnetic field.

**WARNING:** When the Brake Board receives the signal to start the exercise from the Display Board, the green LED comes on and current is supplied to the electromagnetic brake; provided that  $RPM \neq 0$ .

**When the Brake Board receives the signal to generate resistance, the green LED comes on.**

Due to the electromagnetic field produced by the *Current* sent from the Brake Board to the winding, and by the rotation of the disk, eddy currents will be induced on the disk itself which will generate a force that will tend to slow down its movement. This will then generate *Resistance* on the pedals.

The higher the value of the *Current* sent by the Brake Board to the winding, the greater the *Resistance* produced. In addition, when the excitation of the brake is the same, the higher the speed of the disk rotation, the higher the resistance produced.

Heat energy is dissipated on the brake disk due to the eddy currents.



The control over the **CURRENT** is **CLOSED LOOP**. The Brake Board calculates which level of current to send to the brake winding, commands for it to be supplied with a special driving circuit, and lastly checks that it is actually reaching the brake through a reading circuit and the A/D conversion of the signal of the current as read.



The control over the **RESISTANCE** that is actually present on the pedals (effective user torque) is via **OPEN LOOP**. The system (Brake Board) + (brake) does not envisage any regulation in order to adjust the value of the resistance produced, but solely the use of the braking value table as memorized on the Brake Board. The precision of the braking system has a tolerance of  $\pm 10\%$ .

*Certain pieces of equipment (e.g. floating ones, but not only those) as opposed to the common training sessions with constant torque and constant power, provide for a training mode with constant speed level. With this kind of training, the Brake Board always operates a **CLOSED LOOP** control over the **CURRENT**, but does not operate any control over the **RESISTANCE**, since it only needs to maintain a constant RPM value. In practice, in addition to the control over the **CURRENT**, the Brake Board exercises in this case a **CLOSED LOOP** control over the **RPM**, since it knows the target value to be achieved. It activates the current to achieve it and constantly reads the RPM value on the speed sensor so as to converge the control.*

During movement, the speed sensor detects the heads of the screws that fix the disk of the brake and produces a signal representing the speed, which is sent to the Brake Board. The Brake Board will regulate the excitation current to the winding so that the speed measured by the speed sensor corresponds to the set speed.



If the Brake Board does not receive the speed signal which confirms that an exercise is in progress, the equipment does not produce any resistance (current equal to zero). This occurs mainly for two reasons: the equipment is stationary or there is a problem with the RPM pick up.

During movement, the Brake Board is capable of detecting possible faults. Any possible errors are detailed in paragraph: 6.10. "The Brake Board has detected an error".

In all circumstances, the Brake Board interrupts the supply of current to the brake, the green LED switches from "on" to flashing mode and sends an appropriate error message to the Display Board which visualizes the following message on the display: "THE EQUIPMENT IS BLOCKED. CONTACT THE TECHNOGYM TECHNICAL SERVICE (X)", where "X" represents the Error Code for the error that has occurred.



Other error codes that may be displayed on the high kit but are not included in the table and are different from (COM), do not relate to the POWERED kind of Brake Board.

### 3.23.3. THE SIGNALS INVOLVED

During control, the following signals may occur:

- **RS-485 Signal**  
It is a digital signal between the Brake Board and Display Board. We have no possibility of monitoring its state.
- **Excitation current**  
This is the current generated by the Brake Board (*pin 1-2 of the CN2 connector*) and used to power the brake winding. The power supplied is a function of the adjustment algorithm.
- **Impulses from the speed sensor (speed sensor or generator, according to the type of equipment)**  
This is the signal produced by the speed sensor and it normally appears as in the following illustration:

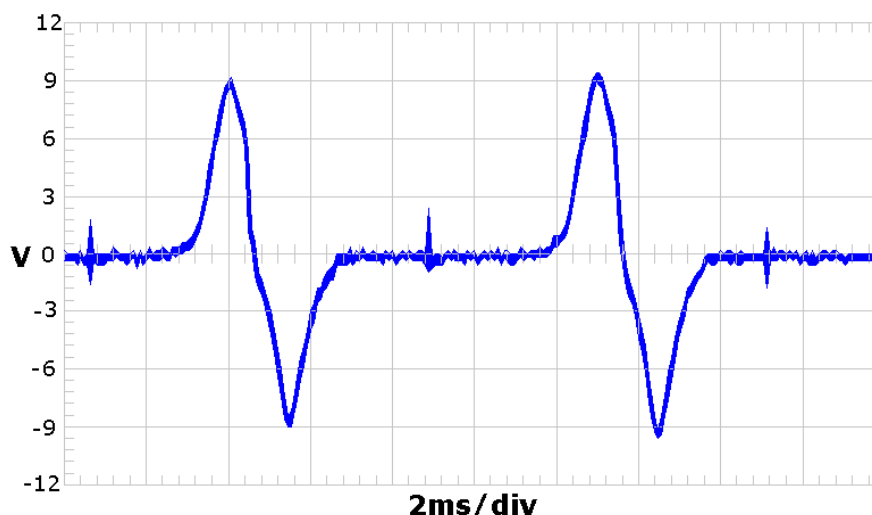


Figure 3.23-1

This enters the Brake Board (*pin 3-4 on CN2 connector*) and here it is used to determine the speed value (*RPM*) which is sent to the Display Board via the RS-485 serial cable.



**This signal can also be measured qualitatively using a multimeter. When the equipment is stationary, the voltage measured on the sensor is 0Vdc, whereas it varies by several hundred mV and more during pedalling: the higher the speed, the greater the value measured.**



**In the SP version, since the speed is calculated from the hexaphase VAC of the generator, it is not possible to measure or monitor this signal using a multimeter.**



# 4. ACCESSORIES

## 4.1. CONNECTION TO THE CARDIO THEATER



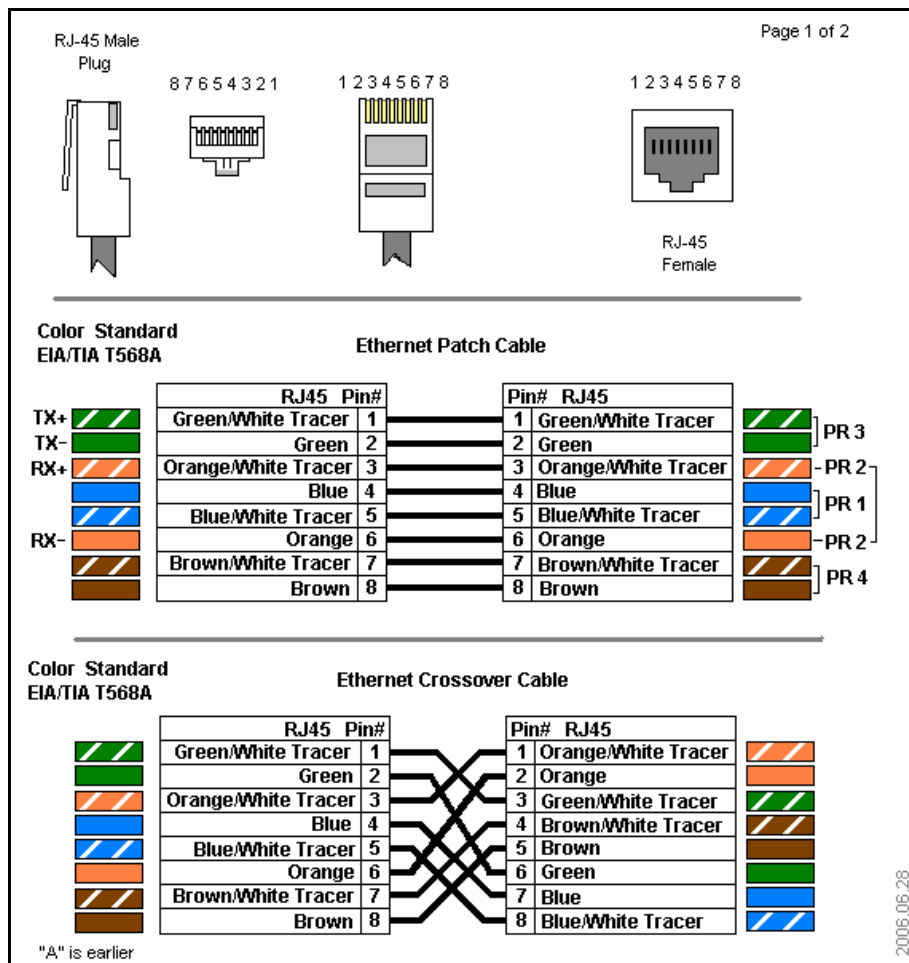
Only for LED version

The equipment is connected to the Cardio Theater via the **RJ45** connector of the C-Safe Board. The Cardio Theater unit must have a power supply cable whose pin out is:

Connector RJ45	Signal
5	+5Vdc
7	Ground



**WARNING:** in order to identify the numbering of the pins on the RJ45 connector, you should refer to the following diagram:

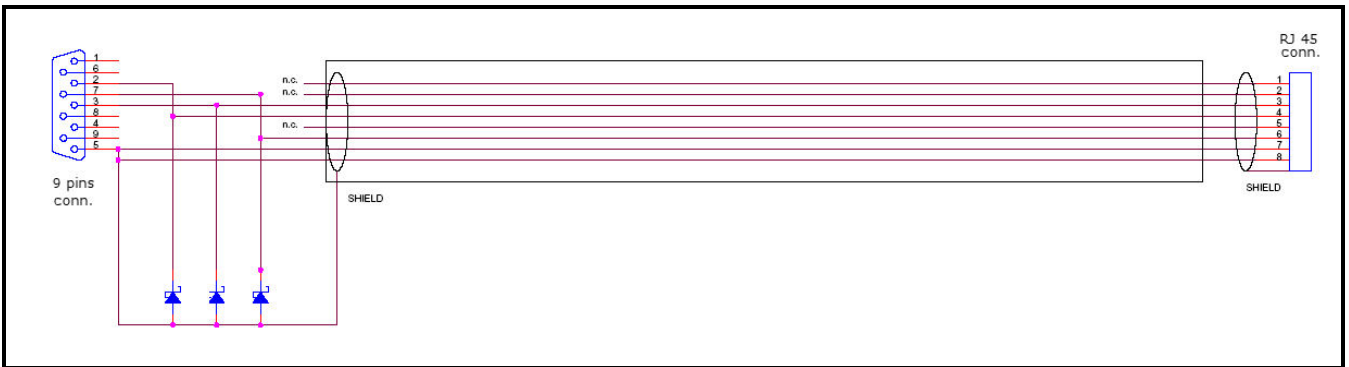


## 4.2. CONNECTION TO THE PC FOR PROGRAMMING

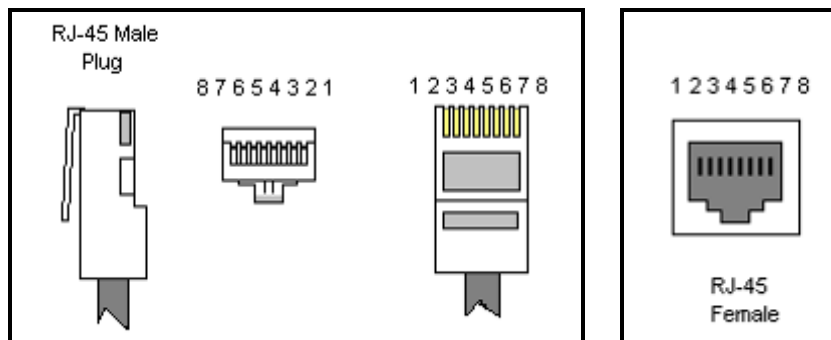


**Only for LED version**

The equipment is connected to a PC for programming via the RJ45 connector of the C-Safe Board.

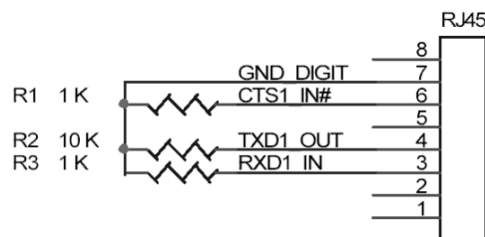


**WARNING:** in order to identify the numbering of the pins on the RJ45 connector, you should refer to the following diagram:



While programming the equipment, sometimes you need to use an RJ45 plug on the vacant RJ45 port on the back of the display, to avoid interference of any kind during the operation.

The diagram of the RJ45 plug is as follows:



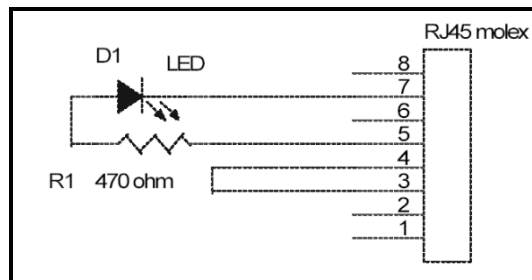
The RJ45 connection cable and plug are both available by ordering code **R0002534AC**.



### 4.3. MONITOR PLUG FOR C-SAFE PORT

By inserting the plug - code number **0WC00639AA** - into the C-Safe port on the equipment, the LED mounted on it must come on as a signal that the 5Vdc is reaching the port.

During the test function for the C-Safe ports, the plug allows the transmission channel to be diverted onto the reception channel, thereby obtaining a positive result for the test if the port is functioning.



### 4.4. VISIOWEB UPGRADE

#### 4.4.1. VISIO vs VISIOWEB

The two versions of the product differentiate from each other for two main reasons: firstly, on a product functionality level, and secondly as regards the technical characteristics, which we briefly outline below:

1. With **VISIOWEB** it is possible to surf the internet via the display and use all the internet services during training sessions;
2. **VISIOWEB** was developed on a Linux platform as opposed to Windows CE which is used for **VISIO**. This difference is not detectable by the end user since both product versions have the same graphic interface and just a few parts of the network configuration differ slightly from each other.

#### 4.4.2. UPGRADE FROM VISIO TO VISIOWEB

It is possible to upgrade equipment from VISIO to VISIOWEB by upgrading the SW with a specific USB device and appropriate configuration in order to use internet (provided that the infrastructures exist).

The code to use for the upgrade is **ATS600**.



**WARNING: This operation must categorically be performed by a Qualified TECHNOGYM Technician.**

### 4.4.3. UPGRADE FROM LED TO VISIOWEB

Upgrade kits are available to modify Excite + equipment from the traditional *LED Display* version to the *VISIO/VISIOWEB Display* version.

The kit also includes all the necessary components to install the kit and the related assembly instructions. In the following table there is a list of the kit code numbers corresponding to the standard TV used in the installation country.

VISIO UPGRADE KIT	CODE No.
New Bike DVB-T	A0000473-D
New Bike ATSC	A0000473-A
New Bike ISDB-T	A0000473-I

Table 4-1



**WARNING:** At the end of the UpGrade run the Standard Settings.

## 4.5. ACCESSORIES

ACCESSORIES	CODE No.
Dual TGS Reader 15"	A0000481
iPod Docking Station 15"	A0000484
15" USB Port	A0000485

Table 4-2

## 5. INSTALLATION INSTRUCTIONS

### 5.1. SPECIFICATIONS AND REQUIREMENTS

**In order to install the equipment correctly, you need to make sure that:**

1. The equipment is installed on a flat surface, where there are no vibrations and adequate weight capacity also taking into consideration the weight of the user.
2. The environment must not be dusty or sandy.
3. The requirements regarding temperature and humidity levels must be complied with. See paragraph: 2.6. “Environmental Characteristics”.
4. The equipment must not be placed near heat sources or sources causing electromagnetic disturbance (televisions, electric motors, aerials, high voltage cables, domestic appliances etc...) and medical equipment.
5. In order to eliminate any disturbance on the cardio receiver, no transmitter must be within a distance of 90cm from the display.

**Only for powered models:**

1. The mains voltage must be the same as the voltage indicated on the equipment label.
2. The electric circuit must have a good earth connection.
3. The electricity socket must be used exclusively for the equipment and have a power of at least 100VA.
4. Connect a maximum number of pieces of equipment in cascade according to the information in paragraph: 3.19. “Input Module”.
5. Place the power supply cable so that it will not get in anyone's way.
6. As regards the installation characteristics for equipment equipped with VISIO, you should refer to the relevant chapter in the specific manual.

## 5.2. HANDLING THE EQUIPMENT

In order to move the equipment from the packing pallet to the floor, you should lift it as indicated in the figure and then slide it to the ground.



Considering its weight, we suggest that at least 2 people help with moving the equipment.



**WARNING:** When moving and positioning the equipment on the ground, great care must be taken because the equipment could easily lose stability.

1. *The equipment is equipped with fixed front wheels. In order to move it, you need to lift it slightly, as shown in the figure, and push it forwards or backwards.*

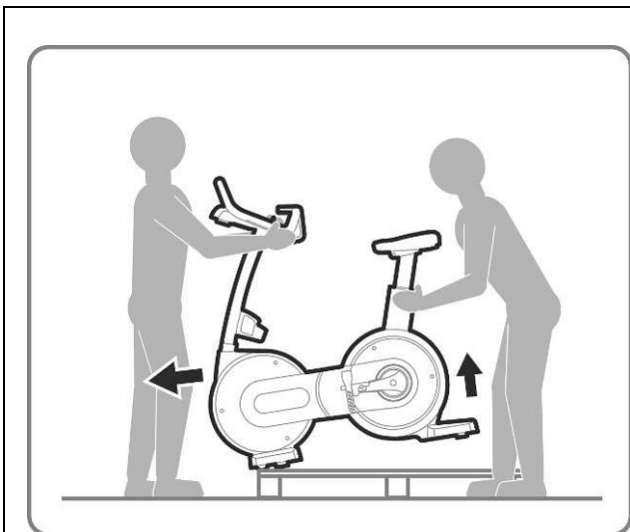


Figure 5.2-1

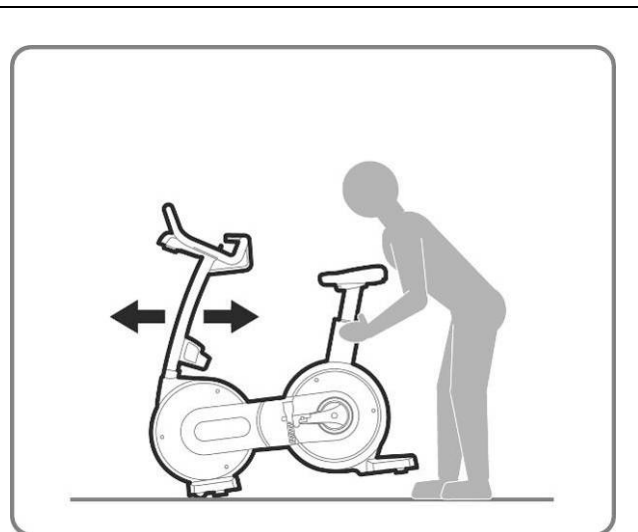


Figure 5.2-2



Once the equipment is placed in its working position, you can regulate the height of one or two of the equipment's feet in order to get it level, as indicated in paragraph: 8.6. "The equipment is not level".

2. *If the conditions of the floor do not allow the wheels to be used, the equipment can be moved by using normal lifting and transport equipment.*

---

## 5.3. SPECIFICATIONS AND MINIMUM AERIAL SIGNAL REQUIREMENTS



All the information about the minimum requirements concerning the antenna signal are detailed in the proper manual:

- For VISIOWEB: “*ELECTRICAL and ANTENNA Requirements*” manual;
- For UNITY: “*ARTIS Installation Requirements*”.

These documents are located in the TG DIRECT in section: MISCELLANEOUS DOCUMENTATIONS.

## 5.4. INSTALLATION

**In order to install the equipment correctly, you need to proceed as follows:**

1. Check that there is compliance with the assembly specifications and requirements as described in paragraph: 5.1. “Specifications and requirements”.
2. Position the equipment, as indicated above, on a flat surface, where there are no vibrations and adequate weight capacity also taking into consideration the weight of the user.
3. According to which country the equipment is going to, it may be sent partially assembled, sealed within its cardboard packaging and fixed onto a pallet, or it may be fully assembled within a transparent plastic wrap, fixed onto a wooden pallet.

Follow the assembly operations shown in the instruction sheets attached to the equipment.

**Only for POWERED models:**

4. Connect the power supply cable to the equipment.
5. Position the start switch on position 0.
6. Connect the power supply cable to the socket.

**Only for VISIO/VISIOWEB models:**

7. Connect the aerial cable to the socket and comply with all requirements by referring to the relevant chapter in the specific manual.

## 5.5. FIRST START-UP

After completing the installation procedure the equipment is ready for use.

On **POWERED** models, all you need to do to start the equipment is turn the start switch from position 0 to position 1.

With **SELF-POWERED** models (*identified with the initials SP*), you need to get on the equipment and pedal for a few moments.


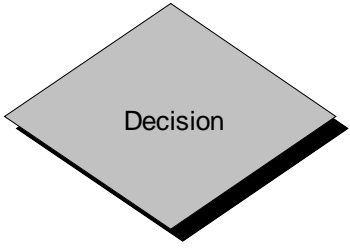

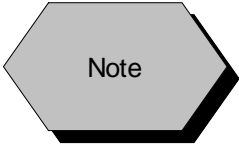


When it starts up, the equipment performs a *Check-Up* between the High Kit and Low Kit. At the end, the equipment goes into *Stand-By* position while waiting for a command from the keyboard.


**In order to check that the equipment functions correctly:**

- *Get on the equipment and start an exercise;*
- *Check that the speed indicator varies;*
- *Check that the hardness of the exercise and the level of difficulty varies from 1 to 25, when you press the difficulty level “+” and “-” buttons and Touch Sensors on the keyboard;*
- *Put on the cardio transmitter and check that the equipment reads your heart beat rate correctly;*
- *Grasp the sensors and check that the equipment reads your heart beat rate correctly;*
- *Only on VISIO/VISIOWEB models, carry out the “Touch Screen Calibration” procedure.*

## 6. TROUBLESHOOTING

The troubleshooting procedures are shown on flow charts. In order to make reading easier, the following standards have been adopted:

	<p>This box is the point of departure, where you start your troubleshooting procedure. These boxes usually include a description of the type of problem.</p>
	<p>This box is a phase in the troubleshooting procedure, where a test needs to be done. This box usually has a detailed description of the type of TEST to be done. On the basis of the test results, you come out with a positive (YES) or negative (NO) answer.</p>
	<p>This box is a phase in the troubleshooting procedure, where an ACTION needs to be taken. This box usually has a detailed description of the type of ACTION to be taken, which should be the one to resolve the problem. Therefore after taking this ACTION, we advise you to:</p> <ol style="list-style-type: none"> <li>1. <i>Check that the problem has been solved;</i></li> <li>2. <i>If the problem persists, we would recommend that you continue to follow the procedure from the point where you left it in order to perform the action.</i></li> </ol>
	<p>Detail regarding the operation in progress or those that will come later.</p>
	<p>When a box with a <u>circled number</u> appears next to the box in the procedure, as in the figure at the side, you will find, at the end of the flow chart, a detailed explanation of the operations to be performed for the test or action described inside the box.</p>
	<p>A box with a <u>circled letter</u>, like the one in the figure at the side, highlights a point in the procedure, which is typically used in page changes as a sign of continuity.</p>

 The connectors indicated in the following pages refer to Sheets on the powered 700 version, unless specified otherwise.

## 6.1. TROUBLESHOOTING MENU: LEDMODELS

The configuration procedure for the equipment is activated when the equipment is in Stand-By and differs according to whether you are working on 500 or 700 equipment.

### 6.1.1. CONFIGURATION ACTIVATION FOR 500 MODELS

Press the **ENTER**, **↑** and **CLEAR** keys at the same time. The following will appear on the display:

#### **ENTER PASSWORD:**

In order to access the procedure you need to enter the password **2501** which protects against unauthorised accesses and press the **ENTER** key in order to confirm. To enter the password, the displayed value may be increased or reduced by using the **↑** and **↓** keys, whereas with the **+/- GOAL** keys, it is possible to scroll the numbers and change them individually.

At this point two choices are offered:

**↑ = Tech Config**  
**↓ = Troubleshooting**

Press the numerical **↓** key to enter the *technical parameter configuration menu*, and the equipment will start to show you on the display the current configuration structure as detailed later on.

### 6.1.2. CONFIGURATION ACTIVATION FOR 700 MODELS

The configuration procedure for the equipment is activated when the equipment is in Stand-By.

Press the **369** keys at the same time and the Display will show:

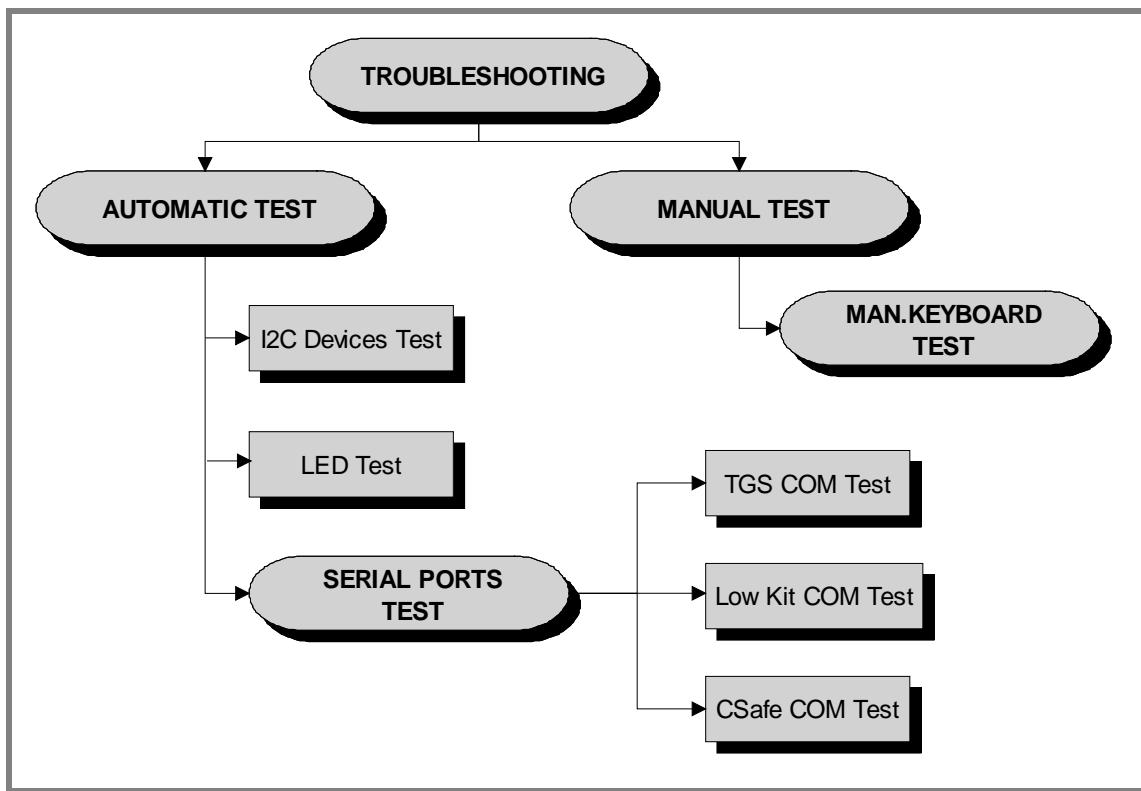
#### **ENTER PASSWORD:**

In order to access the procedure you need to enter the password **2501** which protects against unauthorised accesses and press the **ENTER** key in order to confirm. At this point two choices are offered:

**1 = Tech Config**  
**2 = Troubleshooting**

Press the numerical key **2** to enter the *Troubleshooting menu* and the equipment will start to display the current configuration structure as detailed later on.





**■** Use the **ENTER** key to scroll from one parameter to another saving the data if modified, whereas with the **+** and **- speed** keys, you can scroll from one parameter to another without saving data; to cancel the operation, press the **CANCEL** key for a few seconds.

The available tests are split into two groups: *Automatic* and *Manual*, and the choice is proposed as soon as the troubleshooting menu is accessed.

### 6.1.3. AUTOMATIC TESTS

The tests that the equipment proposes in this section perform checks in a wholly automatic manner. After selecting the item for the test you require by using the **+** and **-** difficulty level keys, you activate it by pressing the **ENTER** key and wait for the result. Press **ENTER** again in order to continue and use the **CANCEL** key to return to the superior level, by holding it down for a few seconds.

The various tests are detailed below:

#### 6.1.3.1. I2C Devices Test

The I2C Devices test is used to test the connection with the 32K and 256K memories. The test can have the following results:

- **“Test Successful, press Enter to continue”**: It means that the transmission and reception of data packs by the I2C devices to the Display Board were successful.
- **“EEPROM Error, press Enter to continue”**: It means that the Display Board has some communication problems with the memories.

### 6.1.3.2. LED Test

The LED test checks on the functioning of all the LEDs in the display by turning on all the matrices. The BUZZER is also tested by varying the frequency which causes a variation in the tone of the sound.

The test does not issue any message with the test results, so you need to check the outcome visually.

### 6.1.3.3. Serial Ports Test

The serial ports test performs a communication check on the connection ports using:

- *C-Safe COM test;*
- *Low Kit COM test;*
- *TGS COM test.*

By using the + and - difficulty level keys, select the test you require and confirm your choice by pressing the **ENTER** key.

The test can produce two results:

- *“Test Successful, press Enter to continue”:* This means the test was successful and that the communication with the selected serial port is correct.
- *“COMx error, press Enter to continue”:* This means the test was a failure and the term COM1 will be displayed if the communication test related to the C-Safe COM test, COM2 if relating to communication with the Low Kit and COM3 if relating to communication of the TGS COM test.



A “TGS COM test” performed on equipment that does not have a TGS reader will have a negative result as will a “C-Safe COM test” if the equipment is not connected to the monitor plug indicated in paragraph: 4.3. “Monitor plug for C-Safe port”.

## 6.1.4. MANUAL TEST

The tests that the equipment proposes in this section perform manual checks on some of the peripheral devices.

After selecting the item for the test you require by using the + and - difficulty level keys, you access the test by pressing the **ENTER** key.

To quit the test phase you press the **CANCEL** for a few seconds.

### 6.1.4.1. Man. Keyboard Test

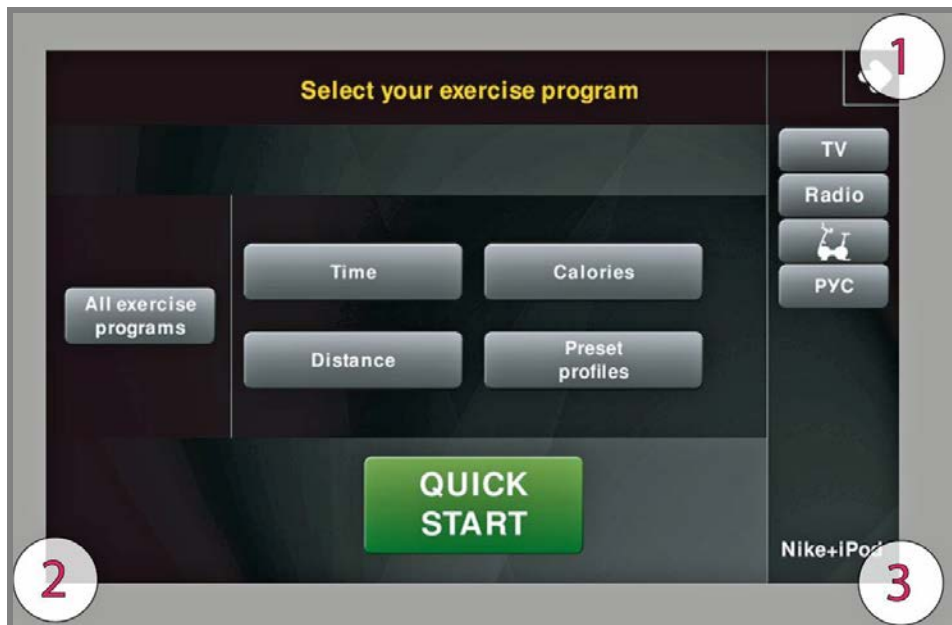
The keyboard manual test runs a check on all the keys on the keyboard.

Once you have accessed the test by pressing the **ENTER** key, a message will appear, saying “**Press all buttons (beep=OK)**”.

When you press each key a "beep" is produced but if a key fails to produce a "beep", it means it does not work.

## 6.2. TROUBLESHOOTING MENU: VISIO/VISIOWEB MODELS

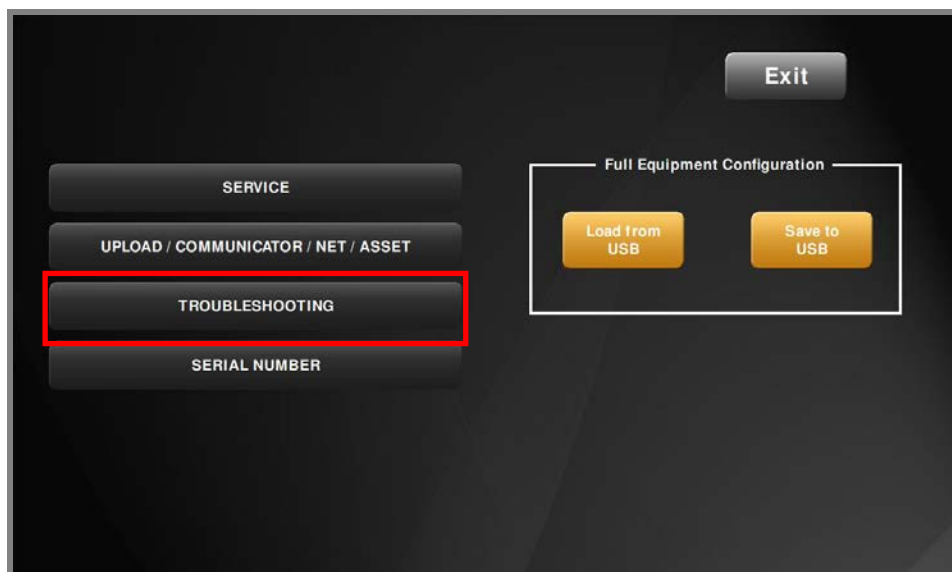
The procedure is activated by pressing the top right-hand corner, the bottom left-hand corner and the bottom right-hand corner of the screen in that sequence when the equipment is in Stand-By, as shown in the figure below.



A new display will appear from which you can gain access to the various configuration menus, by entering the password on the number keyboard:

Enter the password **2501** and press the **ENTER** key to confirm or **EXIT** to quit.

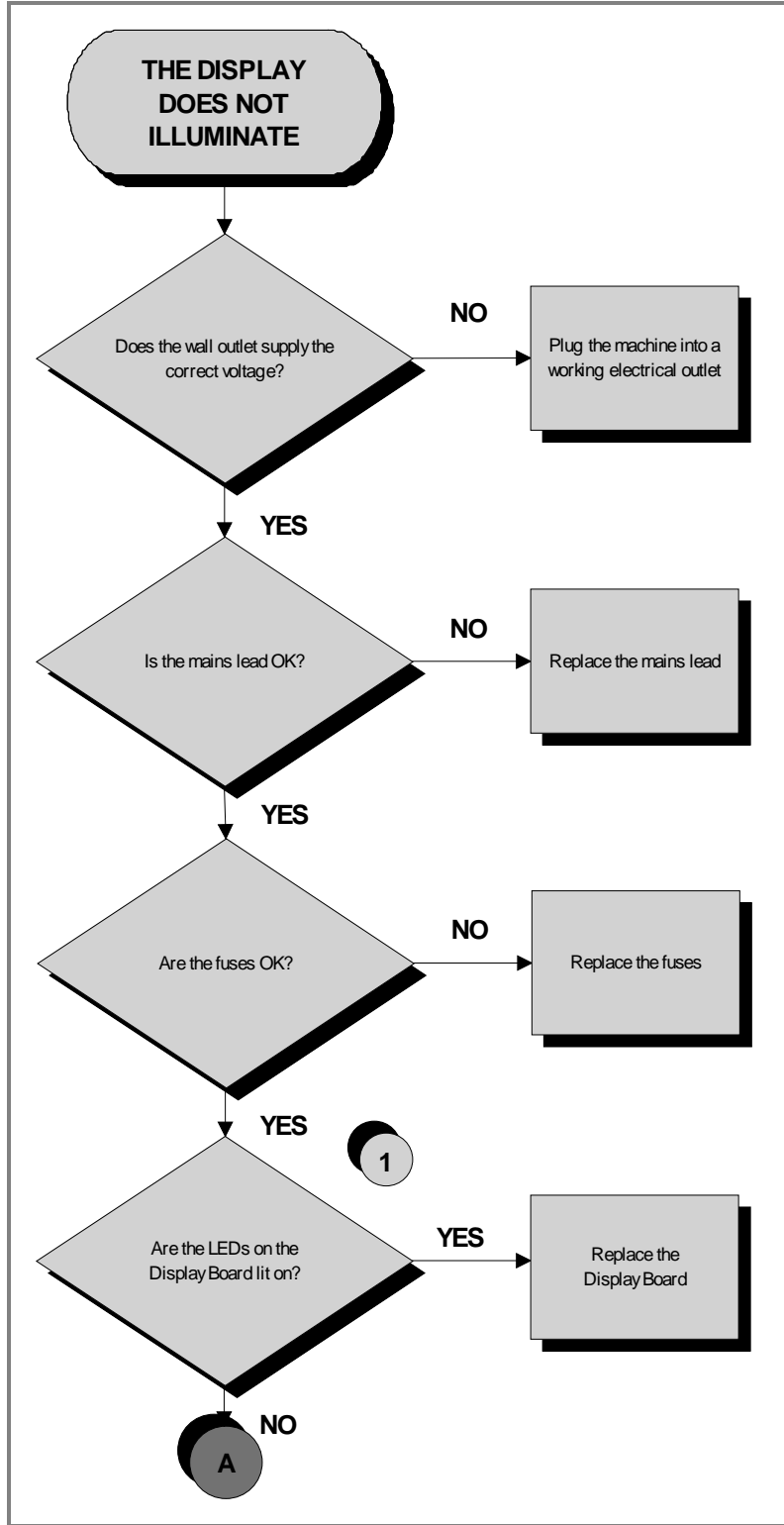
By selecting the key which is highlighted in red, you will gain access to the **TROUBLESHOOTING** menu:



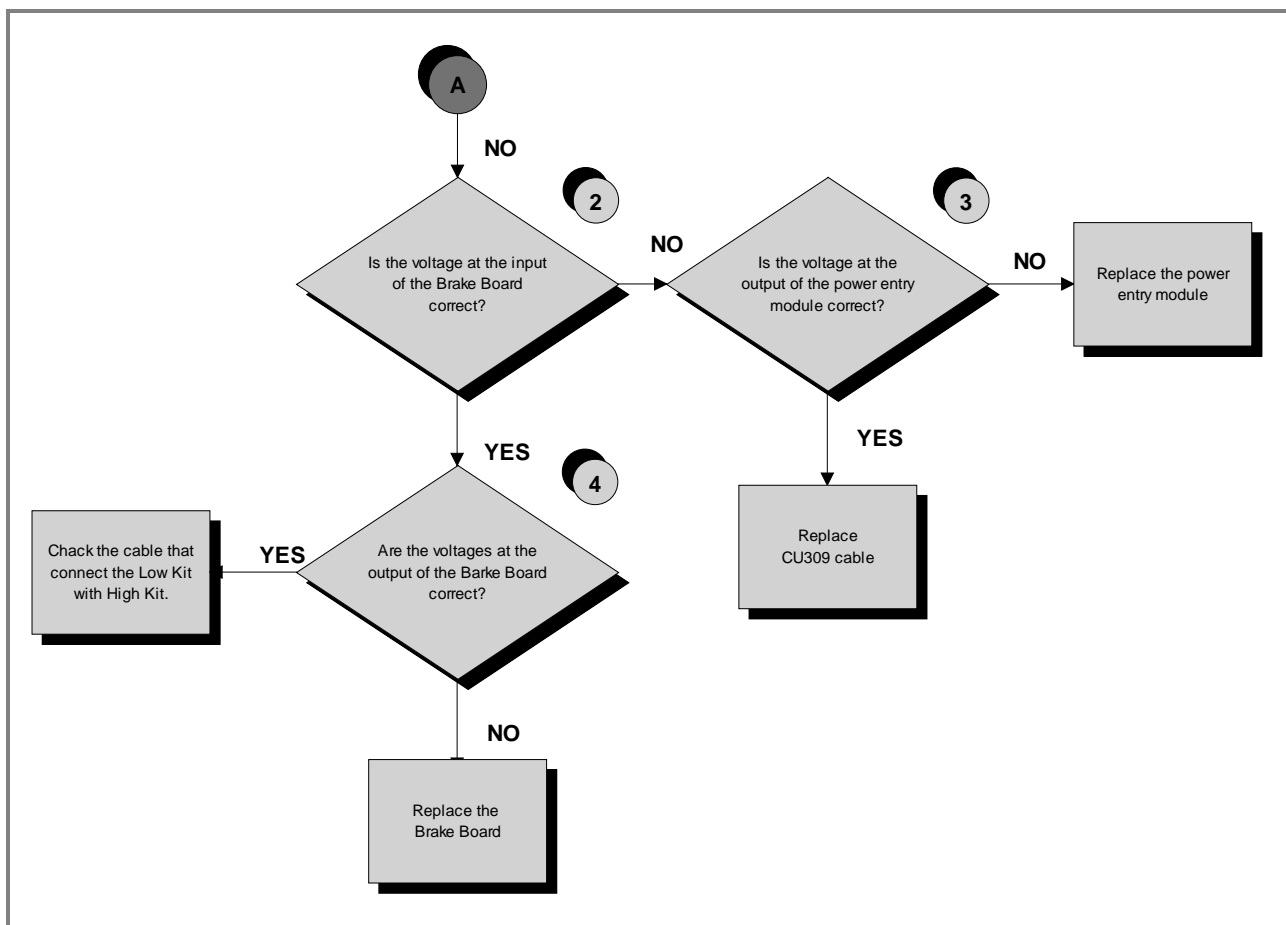
For the following menu, please refer to the relevant chapter in the VISIO/VISIOWEB manual.

## 6.3. THE DISPLAY REMAINS OFF

### 6.3.1. LED MODELS WITH MAINS POWER SUPPLY



*Continues on the next page...*



Follow the chart step by step in order to make a correct diagnosis. In particular, pay attention to the checks highlighted in the numbered boxes and listed here below:

- (1) Check that **LEDs 1 and 2** (green and yellow) are lit on the Display Board.
- (2) Insert the tips of the tester onto pins **3 and 1** of the **CN4** connector on the Brake Board. They should register about 220Vac or 110Vac according to the mains voltage.
- (3) Gently lift the fastons on the power supply socket on the equipment. Insert the tips of the tester between the phase and neutral on the connector. They should register about 220Vac or 110Vac according to the mains voltage.
- (4) Using the tester, measure the voltages on the **CN1** connector on the Brake Board. They must register:
  - +12 Vdc between pins **6-2**;
  - +5 Vdc between pins **7-3**.



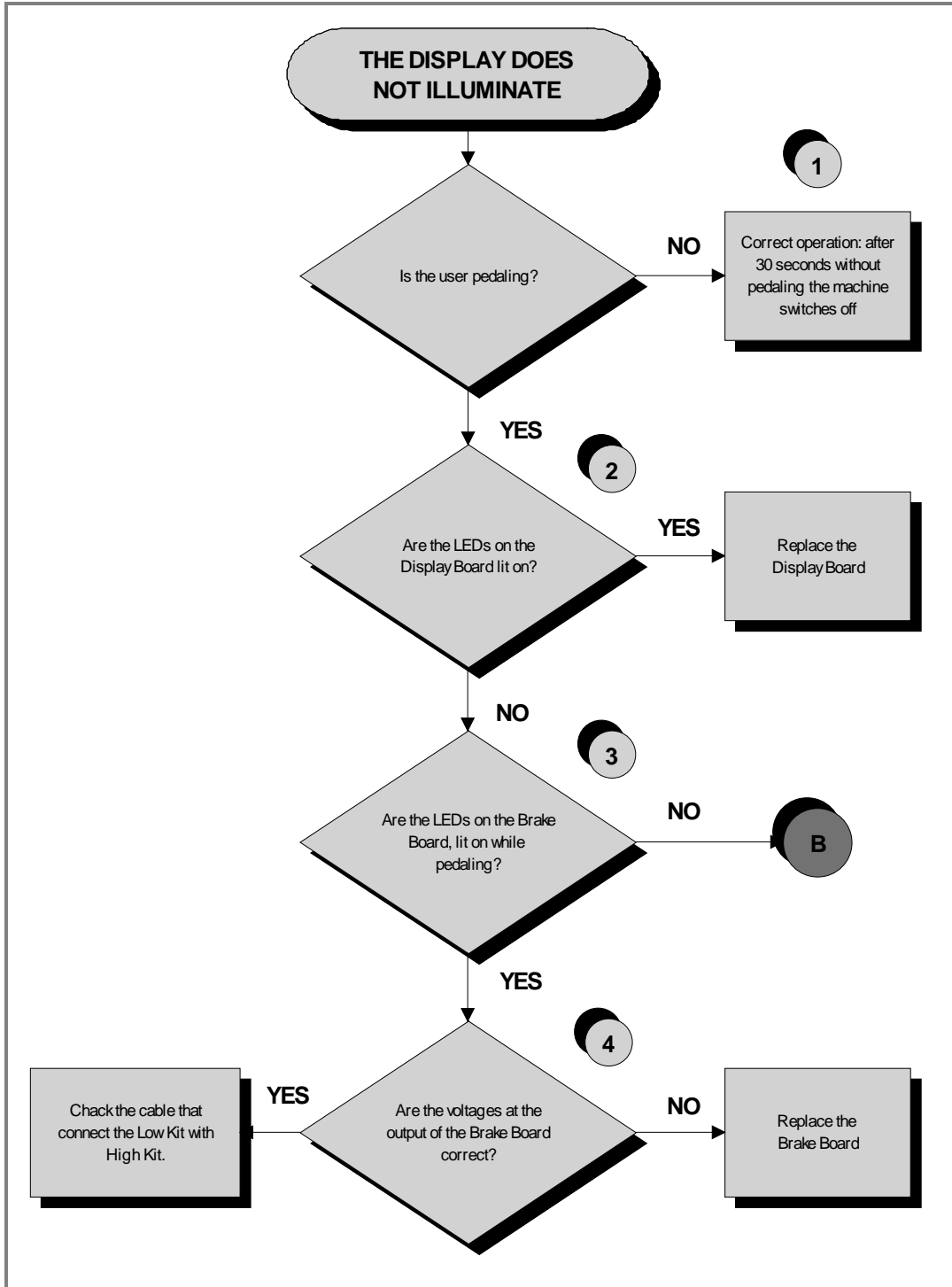
**If the Display Board is replaced, check that the upgraded SW version is installed or proceed with the upgrade.**



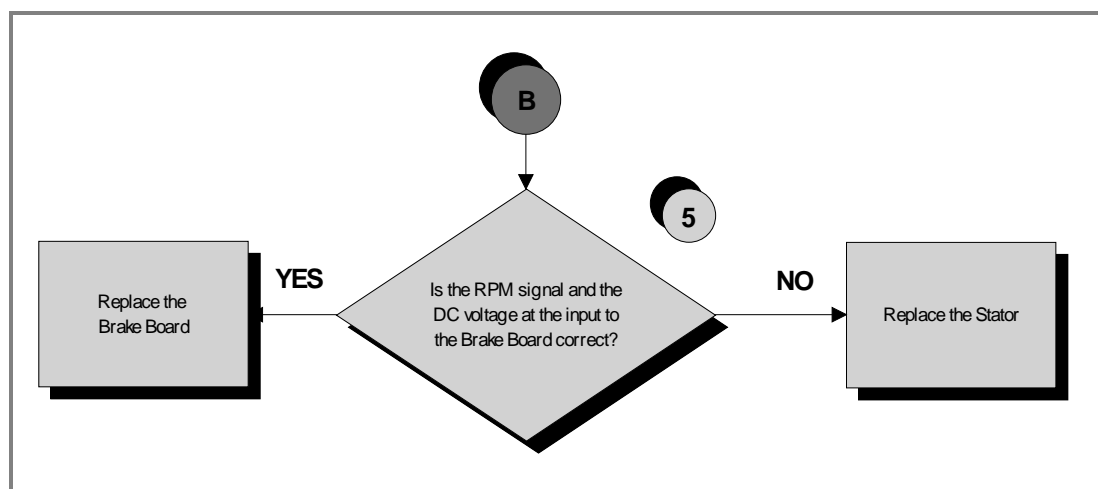
**If the Brake Board is replaced, check that the correct SW version is installed or proceed with the upgrading of the Firmware (FW), the Brake Table and the Standard Settings.**

### 6.3.2. LED MODELS: SELF POWERED

#### 6.3.2.1. The Display remains off



*Continues on the next page...*



Follow the chart step by step in order to make a correct diagnosis. In particular, pay attention to the checks highlighted in the numbered boxes and listed here below:



**In order to speed up the solution to the problem, it may be useful to refer to the status of the monitor LEDs of the power supplies to the Display Board and Brake Board.**

- (1) Check that the equipment remains on for about 30 seconds once you have stopped pedalling. If it does not and switches off after just a few seconds, then check that the fuse connected to the battery via the **CU505** cable is intact. After this, check the charge level on the battery; if it is not at about 12Vdc, re-charge the battery for 8 hours using the external power pack and without using the equipment.
- (2) Check that **LEDs 1 and 2 (green and yellow)** are lit on the Display Board.
- (3) Check that **LEDs 1 and 2 (green and yellow/Red)** on the Brake Board light up correctly according to the description in paragraph: 3.16. “Brake Board”.
- (4) Using the tester, measure the voltages on the **CN1** connector on the Brake Board. They must register:
  - +12Vdc between pins **6-2**;
  - +5Vdc between pins **7-3**;
- (5) Measure the voltage on the **CN3** connector on the Brake Board, checking that it registers 16-19Vdc, between pins **10** and **8**, when pedalling at a speed of about 50RPM. Measure the quality of the RPM signal on the **CN3** connector on the Brake Board, by checking it registers about 30Vac between pin **4** and an earth point.

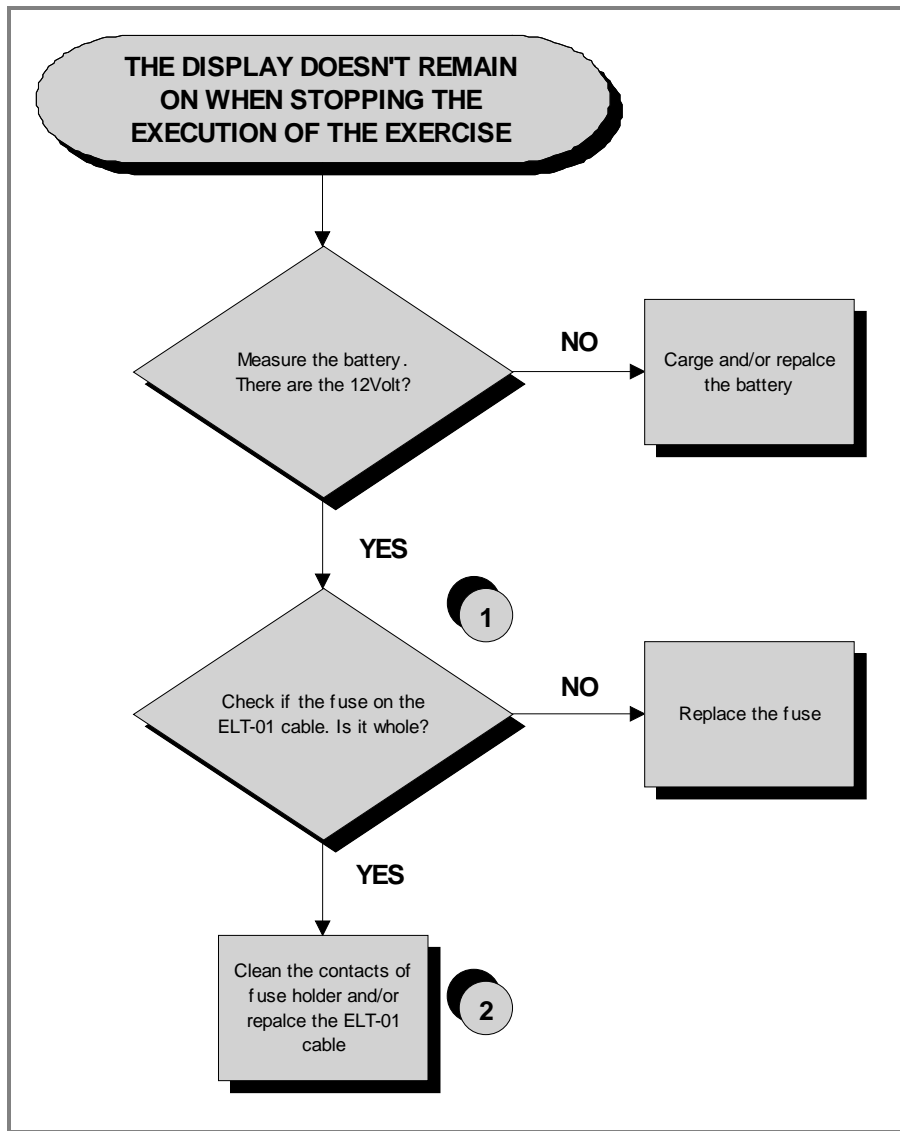


**If the Display Board is replaced, check that the upgraded SW version is installed or proceed with the upgrade.**



**If the Brake Board is replaced, check that the correct SW version is installed or proceed with the upgrading of the Firmware (FW), the Brake Table and the Standard Settings.**

6.3.2.2. The Display does not remain ON if you stop performing the exercise.



*Continues on the next page...*



Follow the chart step by step in order to make a correct diagnosis. In particular, pay attention to the checks highlighted in the numbered boxes and listed here below:

- (1) Check that the fuse on the **ELT-01** cable is intact. If necessary, replace the **F5A (A)** fuse, as indicated in the following figure.
- (2) Clean the contacts on the fuse housing as shown in the following picture:

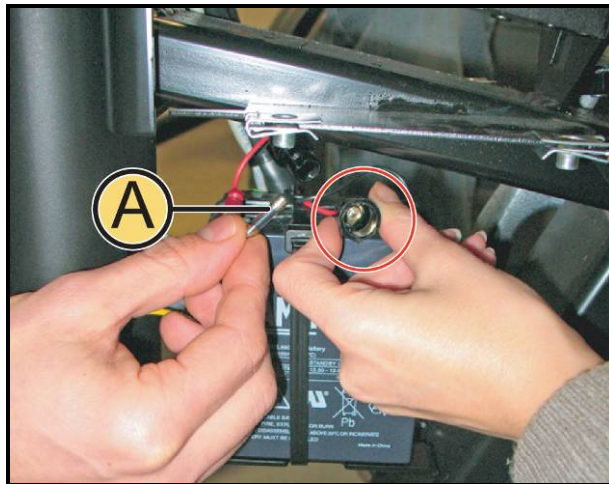


Figure 6.3-1

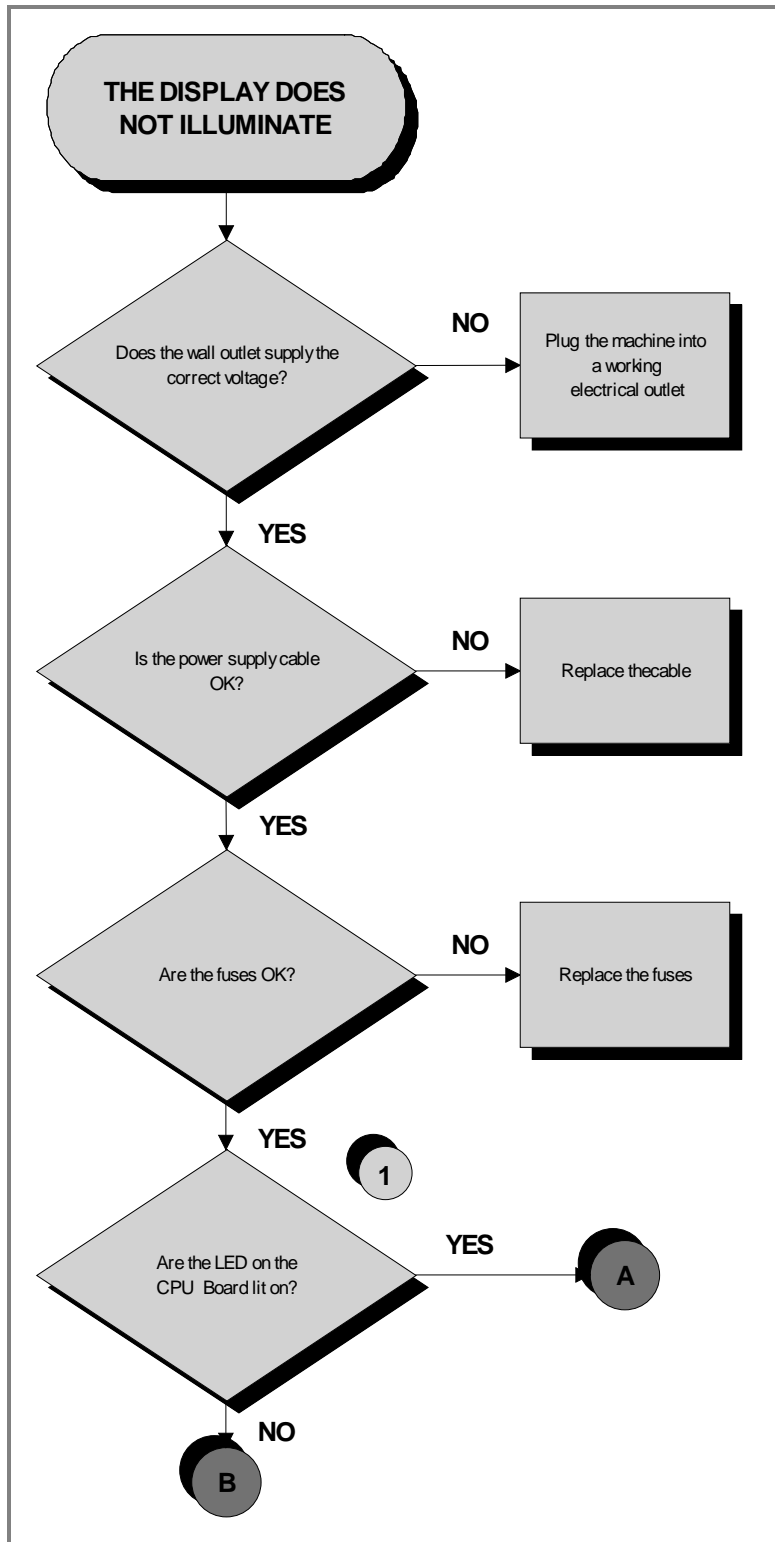


Lastly, in order to check that the contacts inside the fuse housing are intact and functioning, check the continuity of the red cable (battery V+). Take a measurement on the CN3 connector on the Brake Board and on the faston connector on the battery. The result should be 0Ω (ohm).

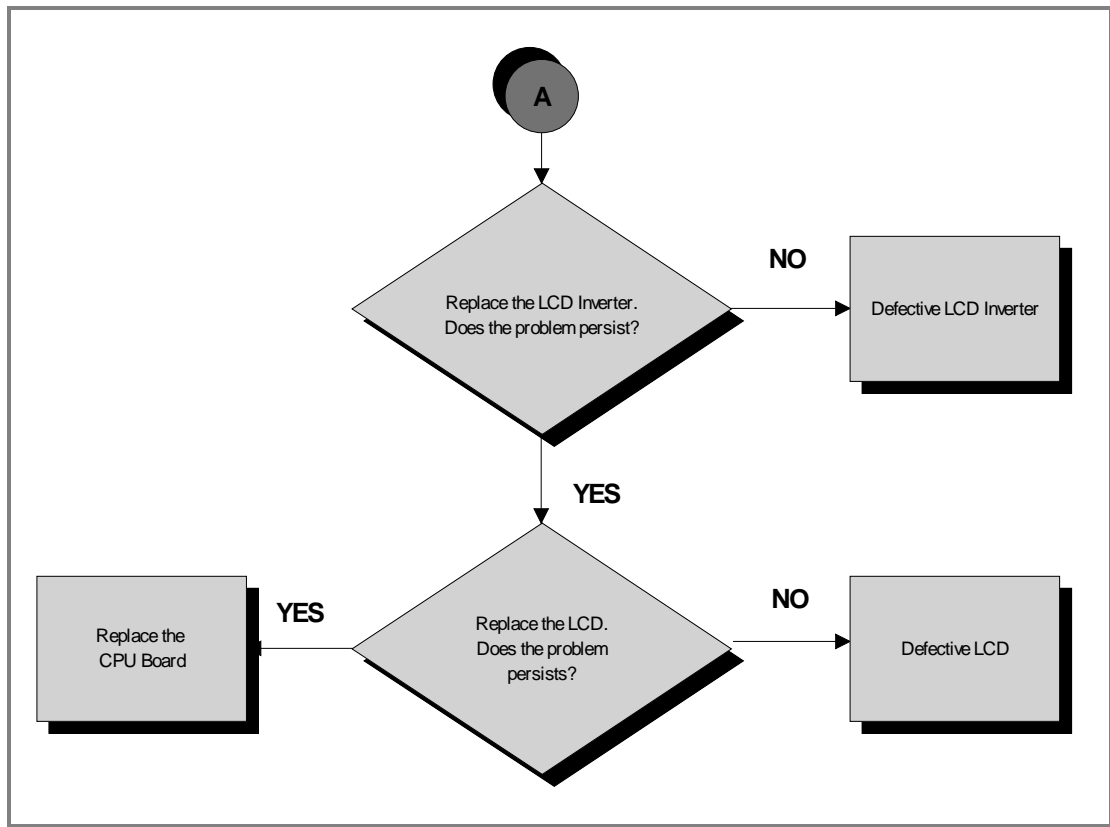


Figure 6.3-2

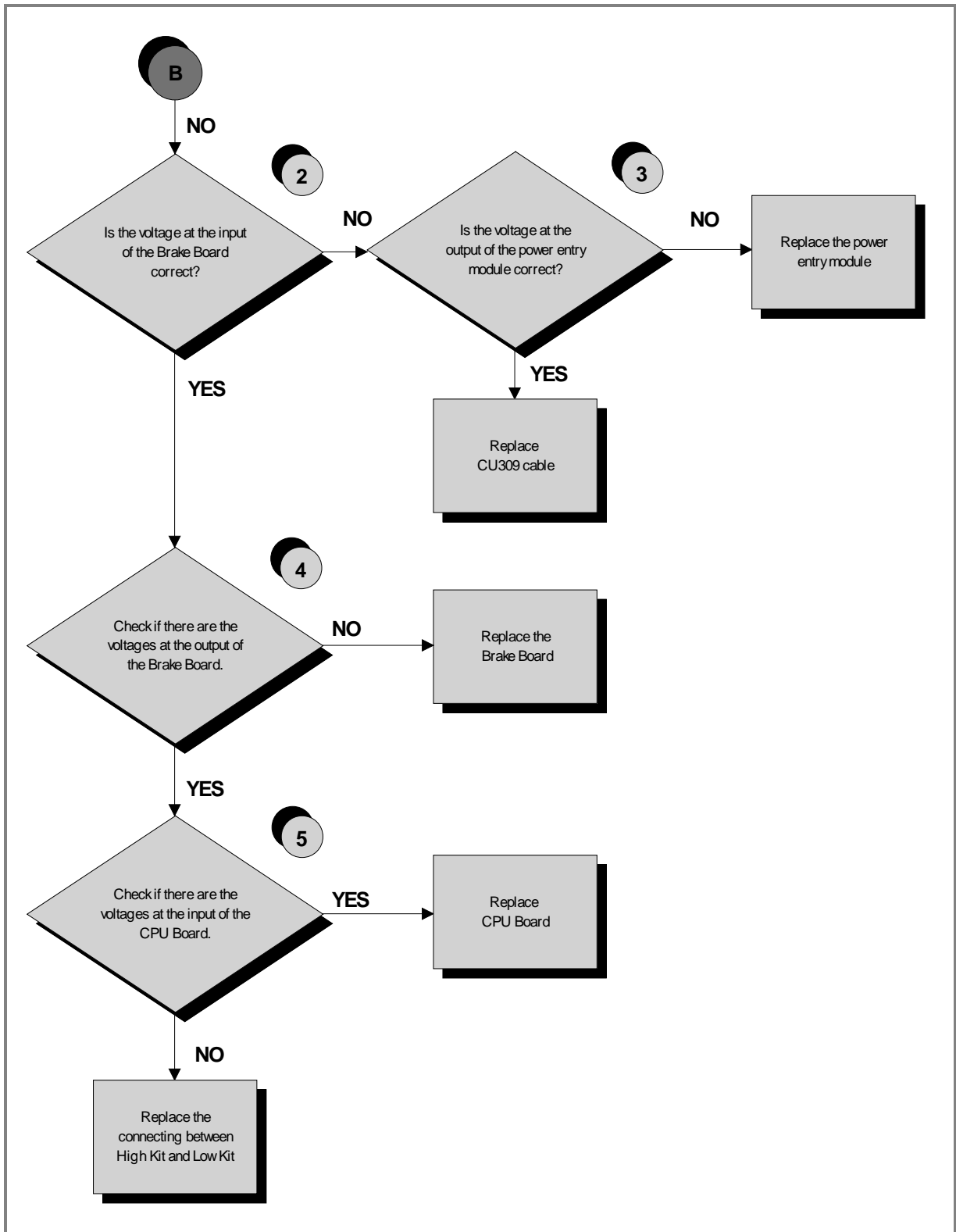
### 6.3.3. VISIO/VISIOWEB MODELS WITH MAINS POWER SUPPLY



*Continues on the next page...*



*Continues on the next page...*



Follow the chart step by step in order to make a correct diagnosis. In particular, pay attention to the checks highlighted in the numbered boxes and listed here below:

- (1) Check that **LED 1**(green) is lit on the Display Board.
- (2) Insert the tips of the tester onto pins **3** and **1** of the **CN4** connector on the *Brake Board*. They should register about 220Vac or 110Vac according to the mains voltage.
- (3) Gently lift the Fastons on the power supply socket on the equipment. Insert the tips of the tester between the phase and neutral on the connector. They should register about 220Vac or 110Vac according to the mains voltage.
- (4) Using the tester, measure the voltages on the **CN1** connector on the *Brake Board*. They must register:
  - +12Vdc between pins **6-2**;
  - +5Vdc between pins **7-3**;

Insert the tips of the tester onto pins **1** and **2** of the **CN15** connector on the Display Board. They must register +12Vdc.



**If the Display Board is replaced, check that the upgraded SW version is installed or proceed with the upgrade.**



**If the Brake Board is replaced, check that the correct SW version is installed or proceed with the upgrading of the Firmware (FW), the Brake Table and the Standard Settings.**



**The TELEVISION and RADIO channels are only memorized in a file contained in the fixed memory of the Display board. Therefore the channels need to be re-memorized if the Display Board is replaced.**

#### 6.3.4. UNITY MODELS



**For the following menu, please refer to the UNITY Manual (User Interfaces).**

## **6.4. TOUCH SCREEN NEEDS CALIBRATING /DOES NOT WORK**

 Only for VISIO/VISIOWEB and UNITY models.



For the following menu, please refer to the VISIO/VISIOWEB and UNITY manuals.

## **6.5. YOU CANNOT HEAR THE AUDIO**

 Only for VISIO/VISIOWEB and UNITY models.



For the following menu, please refer to the VISIO/VISIOWEB and UNITY manuals.

## **6.6. YOU CANNOT SEE THE TV**

 Only for VISIO/VISIOWEB and UNITY models.



For the following menu, please refer to the VISIO/VISIOWEB and UNITY manuals.

## **6.7. YOU CANNOT HEAR THE RADIO**

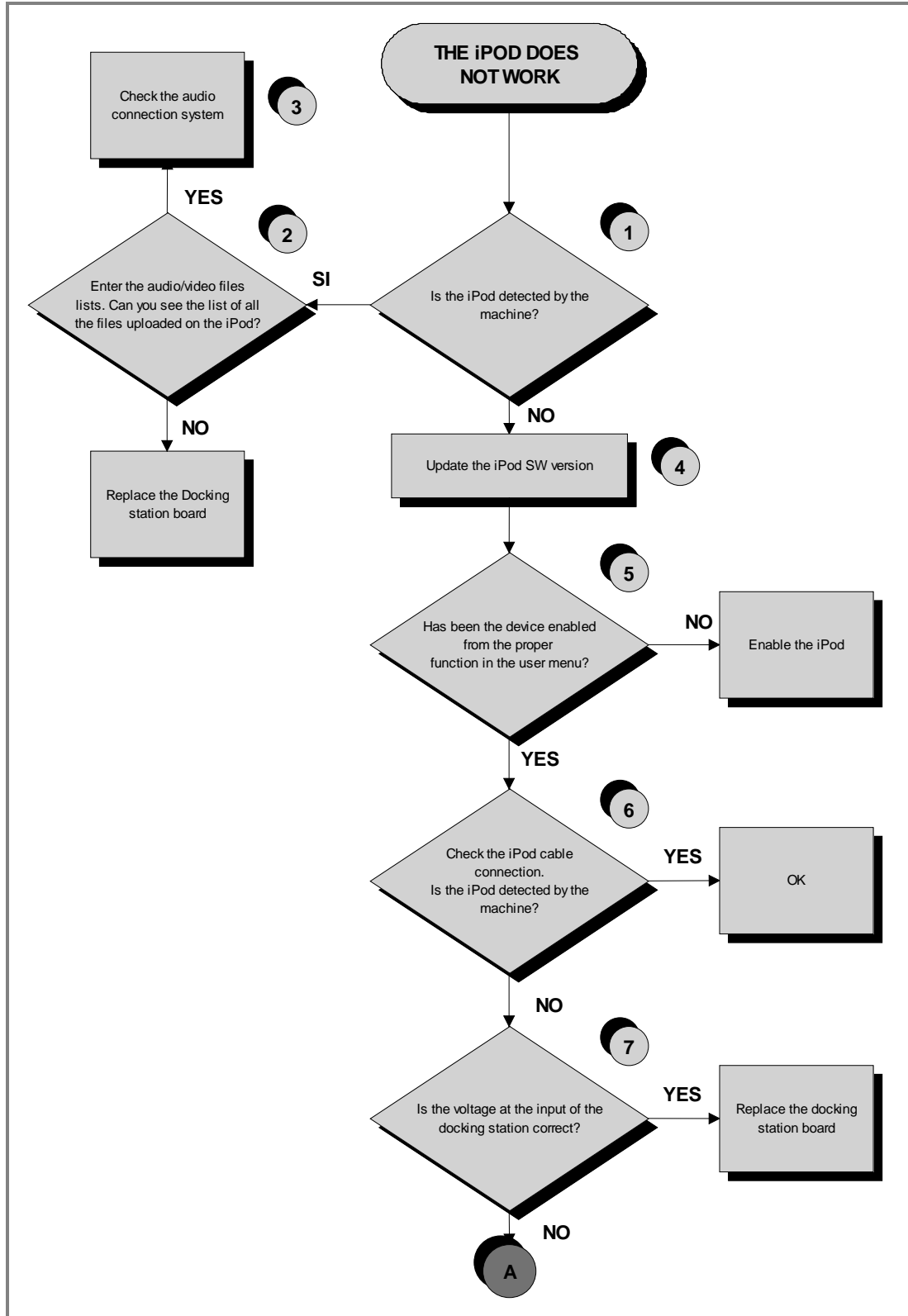
 Only for VISIO/VISIOWEB and UNITY models.



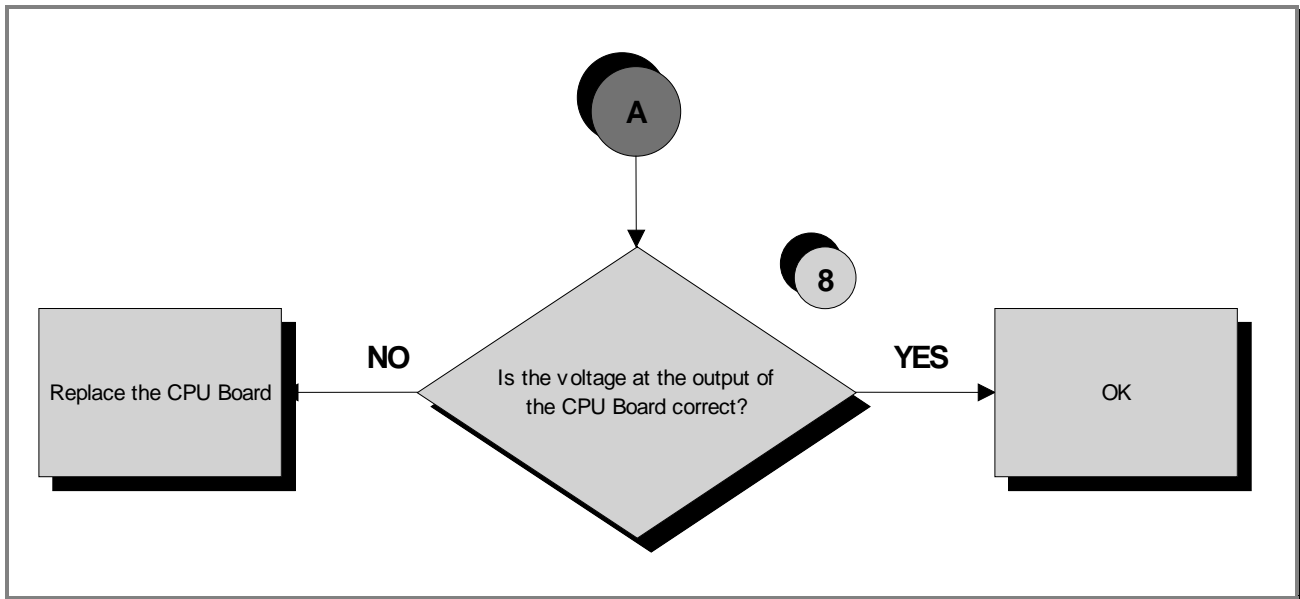
For the following menu, please refer to the VISIO/VISIOWEB and UNITY manuals.

## 6.8. THE IPOD DOES NOT WORK

### 6.8.1. WISIOWEB MANUAL



*Continues on the next page...*



Follow the chart step by step in order to make a correct diagnosis. In particular, pay attention to the checks highlighted in the numbered boxes and listed here below:

- (1) Switch on the equipment, connect the iPod into the docking station and check that the device has been correctly detected.
- (2) Check that the audio/video files on the iPod are visible and can be selected, through the VISIO/VISIOWEB interface.
- (3) Carry out the *troubleshooting* procedure as illustrated in paragraph: 6.5. “You cannot hear the audio”.
- (4) In order to upgrade the iPod SW, all you need do is connect to iTunes and it will be automatically upgraded to the latest version.
- (5) Enable the iPod device as indicated in relevant paragraph in the user menu.
- (6) It might be that the **CU331** cable is connected the wrong way round, as the two ends have the same kind of connector.
- (7) Insert the tips of the tester onto pins **8** and **9** on the connector on the Docking Station to which the **CU331** cable is connected. They must register +5Vdc.
- (8) Do the same as in point (7) but between pins **6** and **7** on the connector of the Display Board to which the **CU331** cable is connected.



**If the Display Board is replaced, check that the upgraded SW version is installed or proceed with the upgrade.**

## 6.8.2. UNITY MODELS



**For the following menu, please refer to the UNITY Manual (User Interfaces).**



## 6.9. THE DISPLAY SHOWS THE MESSAGE “THE EQUIPMENT IS BLOCKED (COM)”

*The (COM) error indicates that there is no communication between the two KITs. This may occur essentially in the following cases:*

1. *Interruption in communication on the serial line between the Display Board (High Kit) and the Brake Board (Low Kit):* communication cabling is defective, replace cabling;
2. *The SW of the Brake Board Firmware (FW) and/or the Brake Table is incorrect /corrupt:* example where the operator manually loads the FW and chooses the wrong one. The solution is to re-load the Firmware (FW) (an action which is always possible for any Brake Board);
3. *The SW of the Display Board is incorrect /corrupt:* the High Kit SW has not been upgraded - proceed with upgrading.

*The error is displayed with a message on the display and recorded in the “Errors Log” section.*

*In order to re-instate communication between the High Kit and the Brake Board, proceed as follows:*

- (1) Check that the **Serial Communication Cable (CU196)** is intact, by using the *Test Box Excite* and if necessary, replace it.
- (2) Upgrade the SW on the **Brake Board** by loading: the Firmware (FW) and the Brake Table and run the Standard Setting.
- (3) Upgrade the SW on the **Display Board**.
- (4) Try and replace the Brake Board and the Display Board one at a time and check whether the serial communication is re-enabled (you can use a standard network cable for the test).



**If the Display Board is replaced, check that the upgraded SW version is installed or proceed with the upgrade.**



**If the Brake Board is replaced, check that the correct SW version is installed or proceed with the upgrading of the Firmware (FW), the Brake Table and the Standard Settings.**

## 6.10. THE BRAKE BOARD HAS DETECTED AN ERROR

When the **Brake Board** detects an error, it blocks by interrupting the power supply and memorizes a numeric code in its memory which identifies the detected error. In addition it sends a signal regarding the status of the error to the DISPLAY Board, via the serial line. When the DISPLAY Board receives this signal, it interrupts the exercise and displays the following message on the screen “THE EQUIPMENT IS BLOCKED”.

The errors memorized on the **Brake Board** can be displayed as illustrated in the relevant paragraph of the Service Menu.

The following table provides information regarding error codes, meanings and possible solutions:

<b>Error Cod.</b>	<b>Description</b>	<b>Meaning</b>	<b>Solution</b>
<b>0</b>	<i>Not used.</i>	-	Upgrade the Firmware (FW) on the Brake Board. If the same errors occur after upgrading has been successfully completed, the problem is NOT the brake board.
<b>1</b>	<i>Electrical Overtemperature.</i>	<b>Overtemperature error - internal NTC.</b> This error occurs when the temperature measured by the internal NTC probe exceeds 90°C (OLD EFI board), 110°C (NEW EFI board) or 105°C (Laser board). In this case the board passes into fault status and the error is recorded in the error log.	Switch off the equipment and switch it back on again. If the error persists, replace the brake board.
<b>2</b>	<i>Trip overcurrent brake kit.</i>	<b>Trip overcurrent error.</b> Equipment that only provides for constant RPM training sessions (e.g. STEP/WAVE) does not perform this control. With equipment that provides various kinds of training, the control for this error is not performed if the selected training is of the constant speed type. The error occurs when the current on the brake suddenly rises. The <i>trip overcurrent</i> condition happens if the level of braking current corresponds to 150% of the maximum value taken from the braking table, for 5 consecutive iterations of the brake control algorithm. In this case the error must be recorded in EEPROM and the equipment must be placed in fault.	Switch off the equipment and switch it back on again. If the error persists, replace the brake board.

<b>Error Cod.</b>	<b>Description</b>	<b>Meaning</b>	<b>Solution</b>
4	<i>Not used.</i>	-	Upgrade the Firmware (FW) on the Brake Board. If the same errors occur after upgrading has been successfully completed, the problem is NOT the brake board.
8	<i>Overvoltage</i>	<p><b>Overvoltage error.</b> The <i>overvoltage</i> error only occurs for powered equipment when the Vout voltage exceeds 14.0V and is memorized in the error log.</p>	The error relates to the Powered EFI board (therefore it is not codified for the Self-Powered EFI board or the Powered Laser board).
16	<i>Opening of Klixon coil.</i>	<p><b>Error in opening of Klixon coil</b> (or brake circuit in general). This error must be checked with all kinds of brake. If the Klixon is integrated in line on the brake, it means that its opening has taken place. If the brake does not include a Klixon (e.g. a 2 A brake), this means in general that a hardware error has occurred that does not allow the brake to be controlled. After verifying that the braking current is zero against a braking current control other than zero, the control unit goes into fault and saves the event in the error log. The control is performed for any kind of training and only for brake control duty cycle above 20%: Fault condition occurs when the check has a positive result for 5 consecutive iterations.</p>	Check that the cabling on the electromagnet is correct.

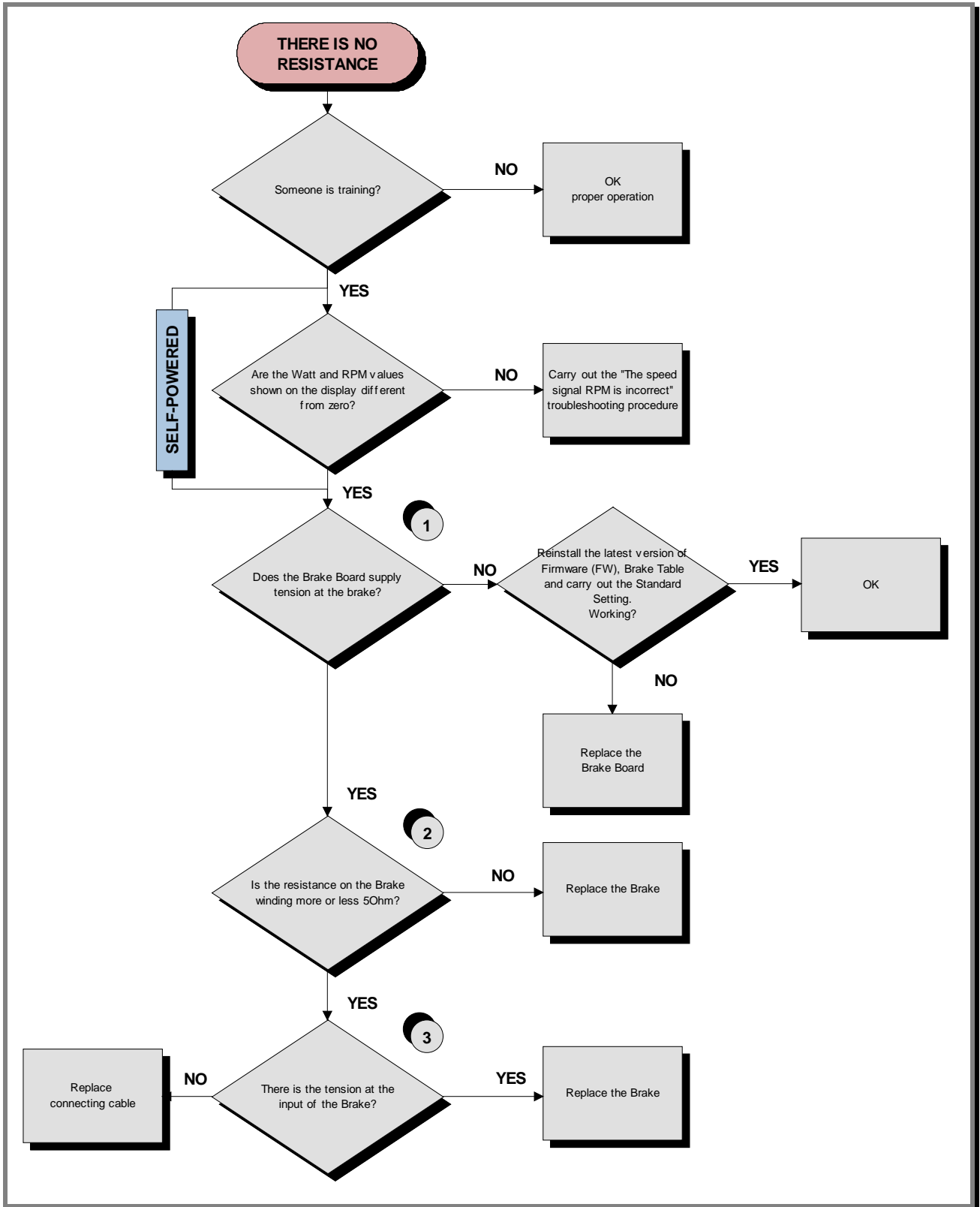
<i>Error Cod.</i>	<i>Description</i>	<i>Meaning</i>	<i>Solution</i>
<b>32</b>	<i>CRC fault on the braking table.</i>	<p><b>CRC fault error on the braking table.</b> This occurs when the installed braking table has an erroneous CRC. It is saved in the error log. This control is not performed for equipment which only provides for constant RPM training sessions (e.g. STEP/WAVE).</p>	Re-load the braking table.
<b>64</b>	<i>EEPROM Fault.</i>	<p><b>Corrupt EEPROM.</b> This happens when the flag relating to the CURRENT zone and the flag relating to the MIRROR zone (in EEPROM) indicate results that are not consistent.</p>	Re-load the braking table.
<b>128</b>	<i>Not used.</i>	-	Upgrade the Firmware (FW) on the brake board. If the same errors occur after upgrading has been successfully completed, the problem is NOT the brake board.

## 6.11. THERE IS NO RESISTANCE

The equipment does not produce resistance if:

1. the **Brake Board** does not receive a speed signal: if the equipment is stationary, then this behaviour is correct. If, on the other hand, the equipment is in movement, then there might be a problem with the reading of the RPM by the speed sensor, if it is mains-powered equipment.
2. the **Brake Board** does not generate any current: if the equipment is stationary, then this behaviour is correct. If, on the other hand, the equipment is in movement, then there might be a problem with the reading of the RPM by the speed sensor, if it is mains-powered equipment.
3. the **Brake Board** was not programmed correctly with the sequence of Firmware (FW), Brake Table and Standard Settings;
4. the **Electromagnetic Brake** is faulty;
5. the **Speed Sensor** does not read the RPM correctly: it is faulty or incorrectly assembled (this is only valid for mains-powered boards);

*Continues on the next page...*



Continues on the next page...

*Follow the chart step by step in order to make a correct diagnosis. In particular, pay attention to the checks highlighted in the numbered boxes and listed here below:*

- (1) Measure the voltage leaving the Brake Board on pins **1** and **2** of the **CN2** connector by maintaining a constant 60Rpm and increasing the level of difficulty: the Vdc measurement must increase.
- (2) Measure the resistance on the two fastons on input to the Brake, with the equipment stationary.
- (3) Same as point (1) but reconnecting what was disconnected and on the winding of the Electromagnetic Brake.

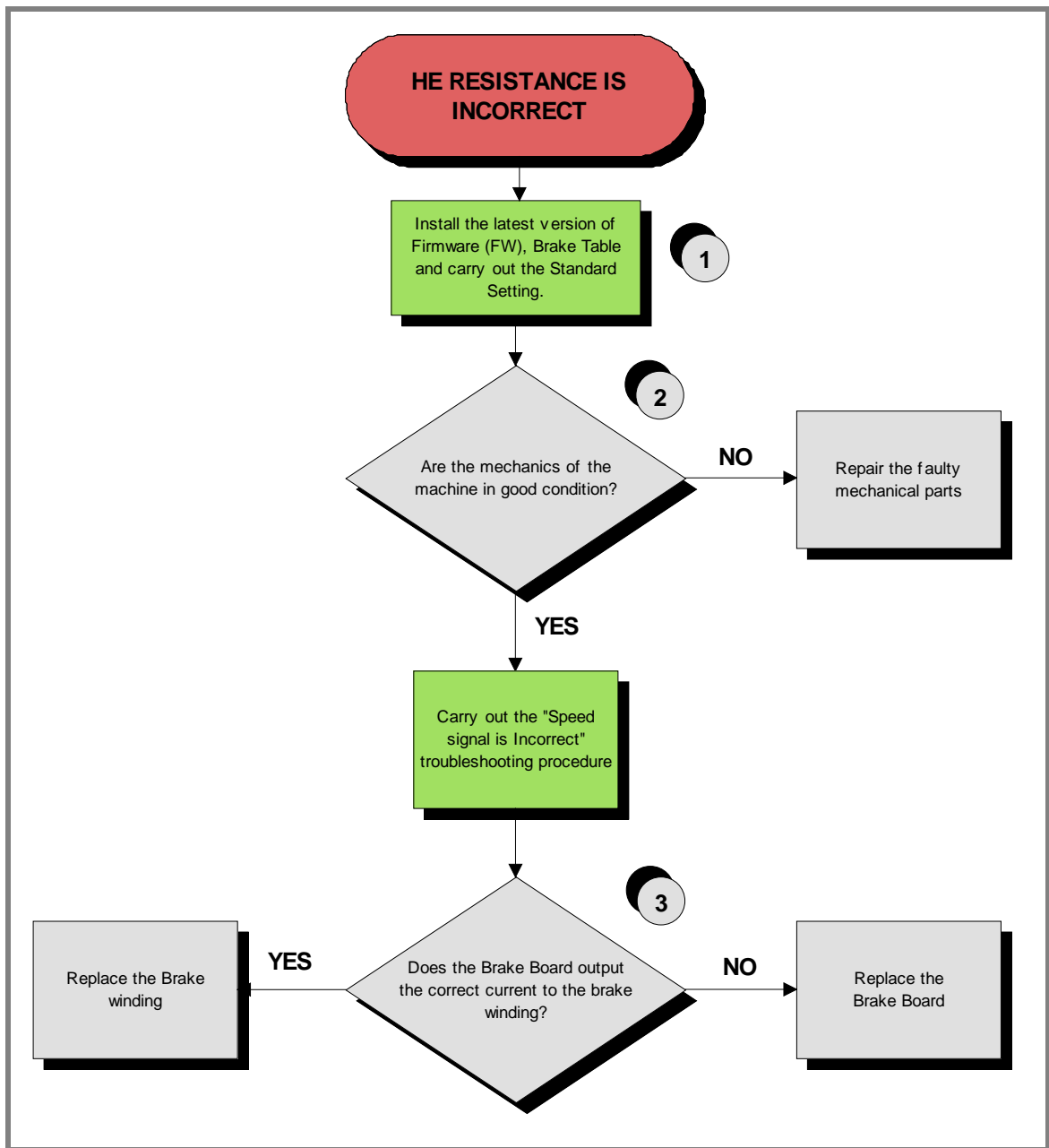


**If the Brake Board is replaced, check that the correct SW version is installed or proceed with the upgrading of the Firmware (FW), the Brake Table and the Standard Settings.**

## 6.12. THE RESISTANCE IS NOT CORRECT

The equipment produces an incorrect resistance if:

1. *the **mechanics** are not perfect;*
2. *the **speed** as measured is not correct;*
3. *the **Brake Board** is faulty;*
4. *the **Brake Board** was not programmed correctly with the sequence of:*
  - a. Firmware (FW).
  - b. Brake Table;
  - c. Standard Settings.
5. *the **Electromagnetic Brake** is faulty.*





*Follow the chart step by step in order to make a correct diagnosis. In particular, pay attention to the checks highlighted in the numbered boxes and listed here below:*

- (1) Carry out the *Standard Settings*, as described in the relevant paragraph of the Service Menu.
- (2) Check that the mechanical system consisting of pedals, belt and Brake is fluid and does not provide resistance and friction above the norm.
- (3) Measure the voltage that the Brake Board provides at the winding. In the Rapid Start-up mode, set the level of difficulty and check that the value is different from 0.

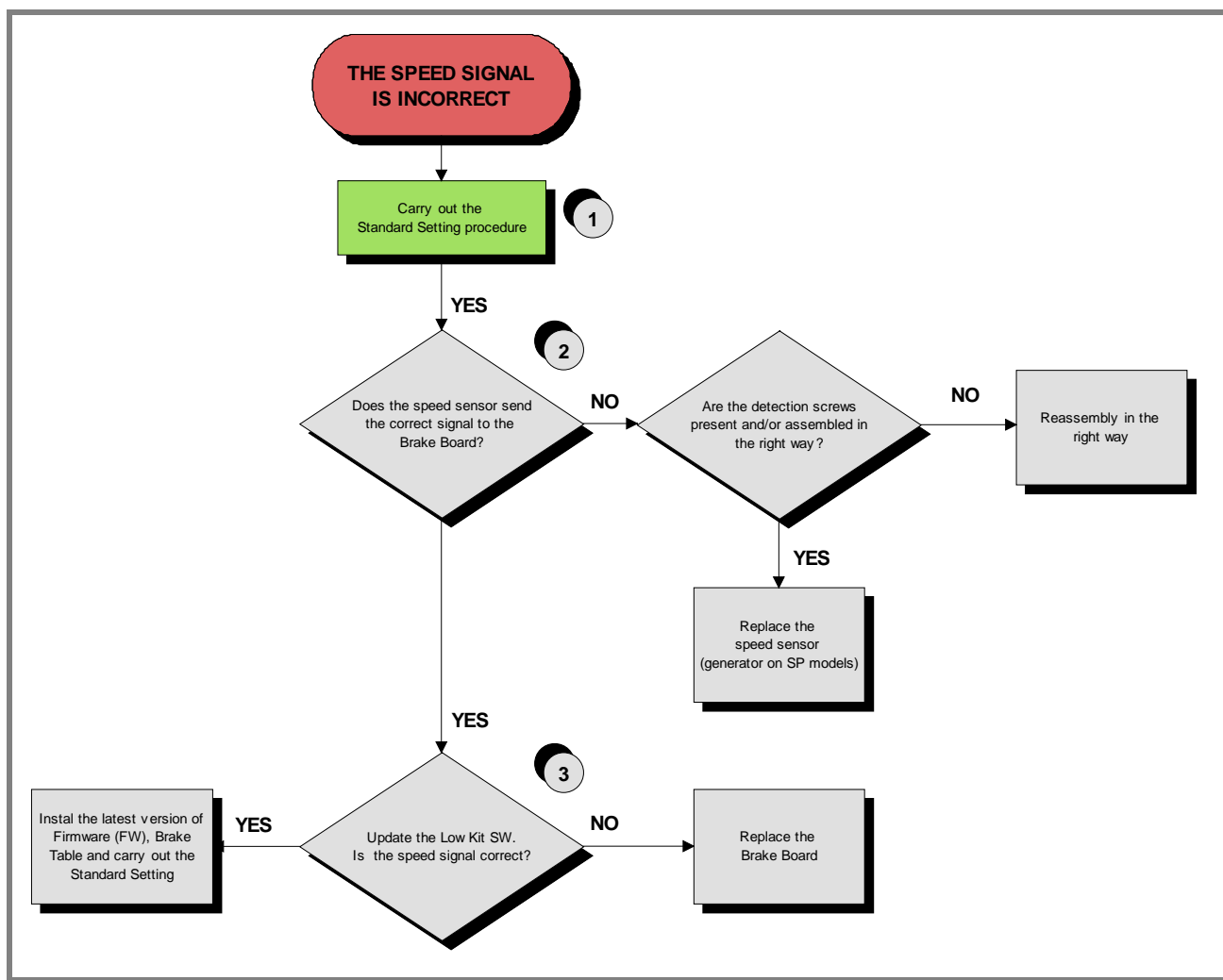


**If the Brake Board is replaced, check that the correct SW version is installed or proceed with the upgrading of the Firmware (FW), the Brake Table and the Standard Settings.**

## 6.13. THE SPEED SIGNAL IS NOT CORRECT

The speed signal is not correct if:

1. The disk of the **Electromagnetic Brake** is incorrectly mounted on the flywheel;
2. The special speed **measurement screws** are missing or badly assembled (only for Crossover)
3. The **Speed Sensor** (for the mains-powered boards) and the **Generator** (for the self-powered boards) is defective or badly assembled;
4. the **Brake Board** was not programmed correctly with the sequence of:
  - a. Firmware (FW),
  - b. Brake Table;
  - c. Standard Settings.
5. The **Brake Board** is faulty.



Follow the chart step by step in order to make a correct diagnosis. In particular, pay attention to the checks highlighted in the numbered boxes and listed here below:

- (1) Carry out the Standard Settings, as described in the paragraph: “STANDARD SETTINGS”.
- (2) **Mains-powered equipment:** Insert the tips of the tester on the ends of the speed sensor. If you have an oscilloscope, the signal that should be measured is like the one indicated in Figure 3.23-1, at about 80rpm user. *For Crossover the signal period corresponding to about 80rpm user is 3 times greater than that in the figure.*

**Self-Powered Equipment:** Check the signal by referring to paragraph: 2.9. “Cables”. If you have an oscilloscope, the signal that should be measured is like the one indicated in Figure 3.23-1, at about 80rpm user.



The speed signal can also be measured in a qualitative manner using a multimeter. When the equipment is stationary, you should register a value of 0Vdc, which will tend to grow as the speed increases.



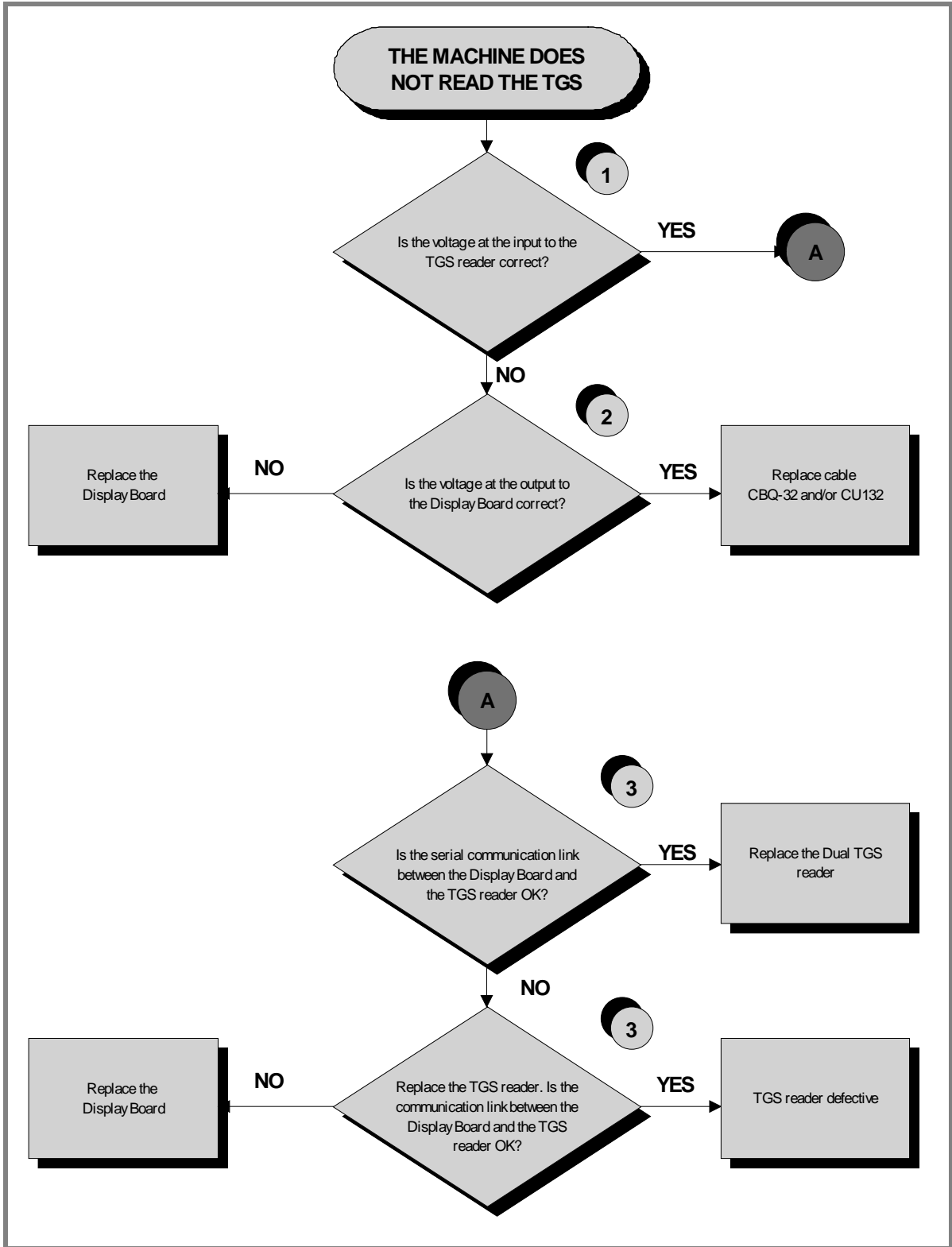
With mains-powered equipment, the Speed Sensor detects the heads of the screws that fix the copper disk to the flywheel (this is valid for all pieces of equipment except Crossover, which also has the disk fixing screws, but the speed measurement is performed on other screws fixed on the flywheel).

- (3) Perform a Low Kit SW Update, by first loading the **Firmware (FW)** and then the **Brake Table**. At the end of the operation, launch the **Standard Settings**, to update the Low Kit parameters.

## 6.14. THE EQUIPMENT DOES NOT READ THE TGS KEY

### 6.14.1. WISIOWEB MODELS

The error is due to the fact that the TGS reader does not work or does not receive power from the CPU/ARM Board.



Follow the chart step by step in order to make a correct diagnosis. In particular, pay attention to the checks highlighted in the numbered boxes and listed here below:

- (1) Insert the tips of the tester onto pins **1** and **3** of the **CN1** of the TGS reader. They must register +12Vdc.
- (2) Do the same as in point (1) but between pins **1** and **8** on the **CN19** connector (CPU Board) or on the **CN7** connector (ARM Board).
- (3) Use the serial communication test described in paragraph: 6.1.3.3 “Serial Ports Test”.



**If the Display Board is replaced, check that the upgraded SW version is installed or proceed with the upgrade.**

#### 6.14.2. UNITY MODELS



**For the following menu, please refer to the UNITY Manual (User Interfaces).**

## 6.15. THERE IS NO HEART FREQUENCY SIGNAL

### 6.15.1. HR/HS RECEIVER (HAND SENSOR)

 700 Models.



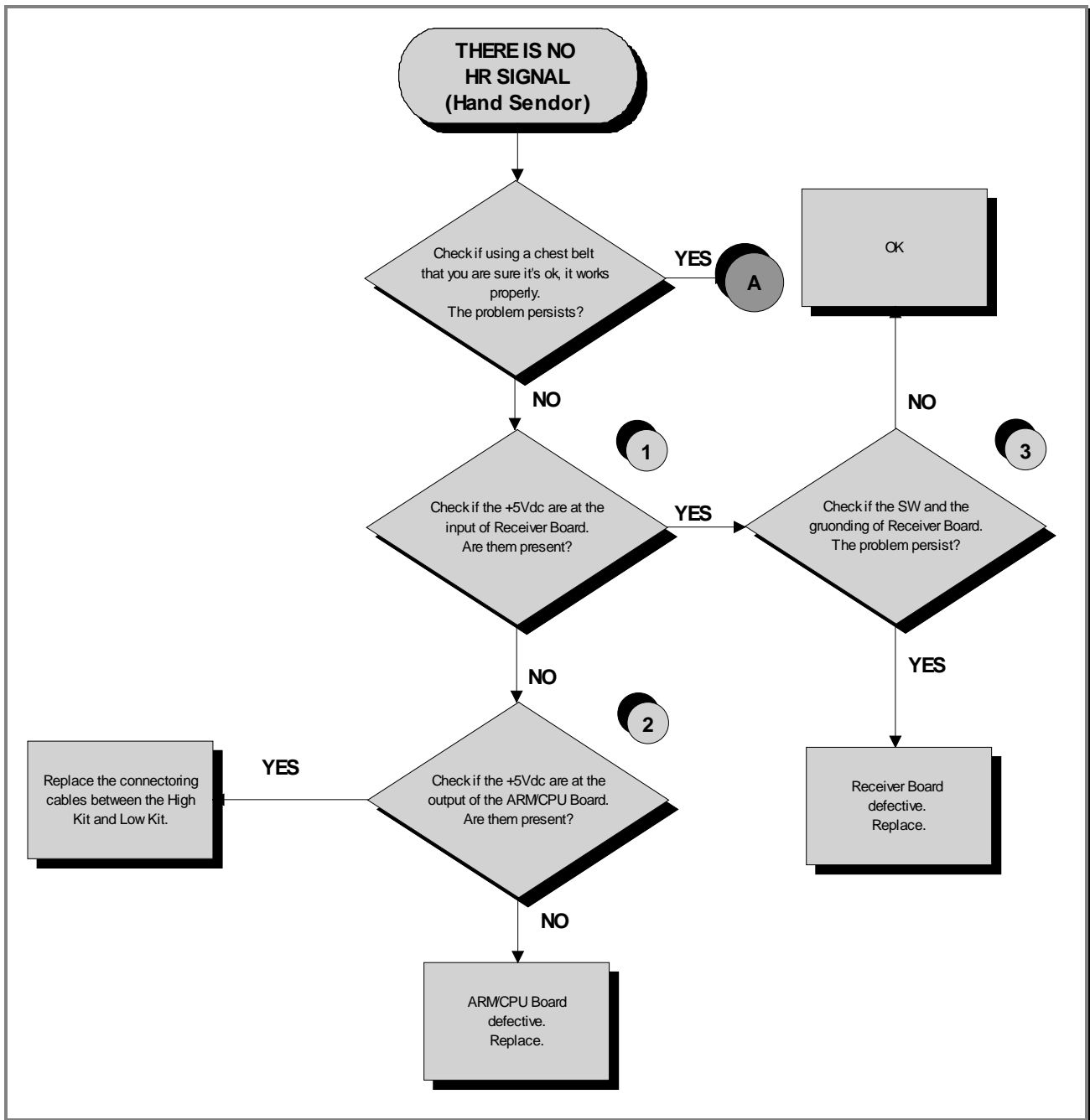
**BODY CONTINUITY:** It is statistically recognized that it is difficult (if not impossible) to measure the HR of certain people using a Hand Sensor. This may be caused by a number of reasons which may affect the effectiveness of the "electric" contact between the skin of the user and the HS electrodes, such as: freshly-washed or particularly dry hands, particular acidity level of the skin and/or particular body fat index. For these persons one should use a Heart Rate Band.



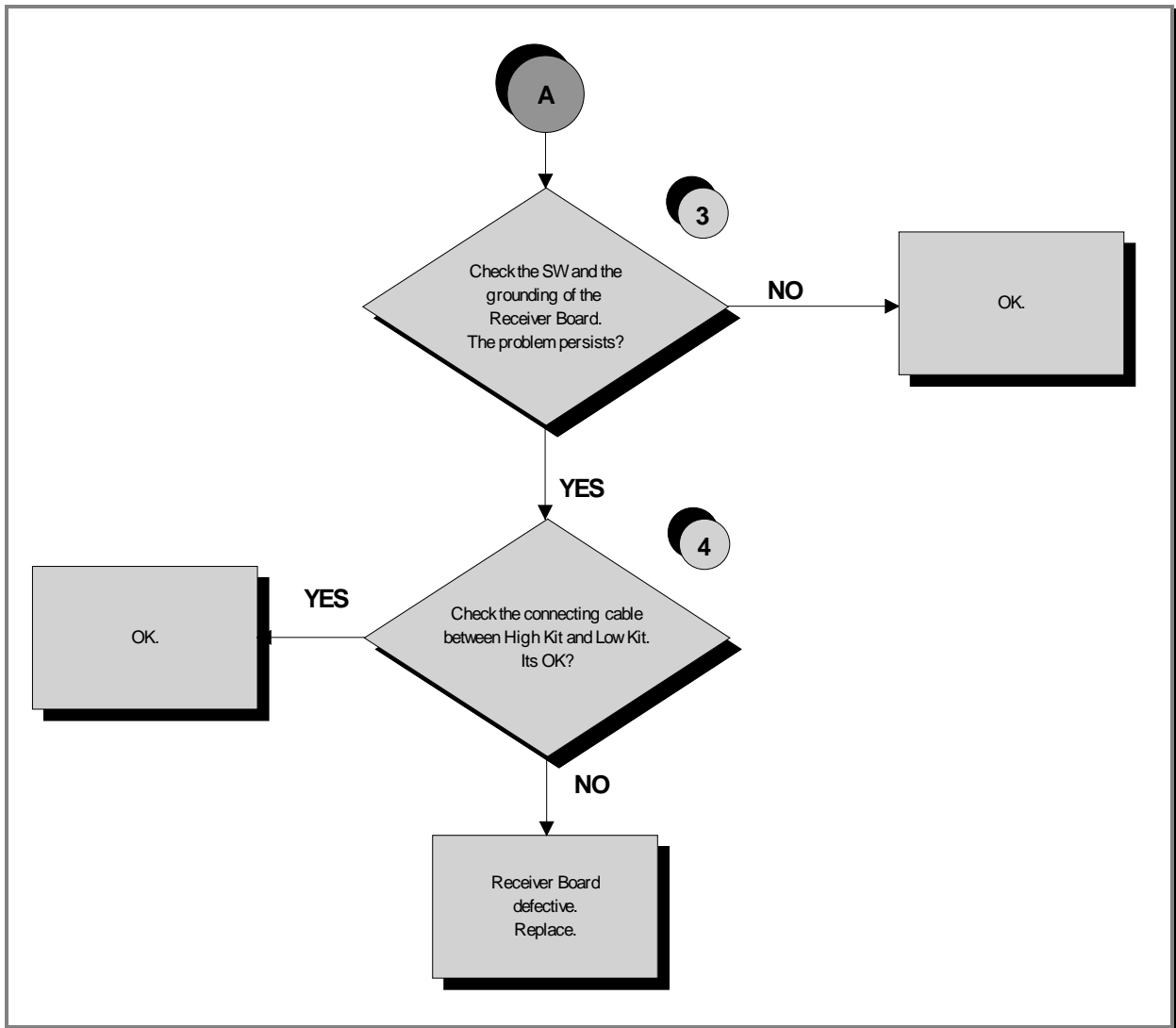
**CORRECT USE OF HAND SENSOR:** Grasp both the top and bottom plate without doing so too tightly and avoid washing your hands aggressively so as to avoid particular dryness.

The equipment displays this error if the HS/HR Receiver does not work or does not receive power from the Display Board.

*Continues on the next page...*



Continues on the next page...





Follow the chart step by step in order to make a correct diagnosis. In particular, pay attention to the checks highlighted in the numbered boxes and listed here below:

- (1) Insert the tips of the tester onto pins **1** and **2** on the **HD4** connector on the receiver. They must register +5Vdc.
- (2) Do the same as in point (1) but between pins **1** and **6** on the **CN4** connector (ARM Board) or on the **CN24** connector (CPU Board); of the **CU206** cable.
- (3) Check on the correct SW version, according to the “EXCITE SW SMART TABLE” table found in the **TG Direct**, section “NEWS”.

Carry out the earth check on the **HS/HR Receiver**, by measuring the resistance value between the following points with a tester:

- a. The faston on the **HR/HS board** and the earth pole on the Power Supply Box;
- b. The earth pole on the Power Supply Box and the wall socket.

The value must be less than 1Ω (Ohm).

Lastly check the earth on the wall socket, making sure there are the following voltages:

<b>P – N (phase– neutral) = 220Vac / 110Vac</b>
<b>P – E (phase– earth) = 220Vac / 110Vac</b>
<b>N – E (neutral– earth) = 0Vac</b>

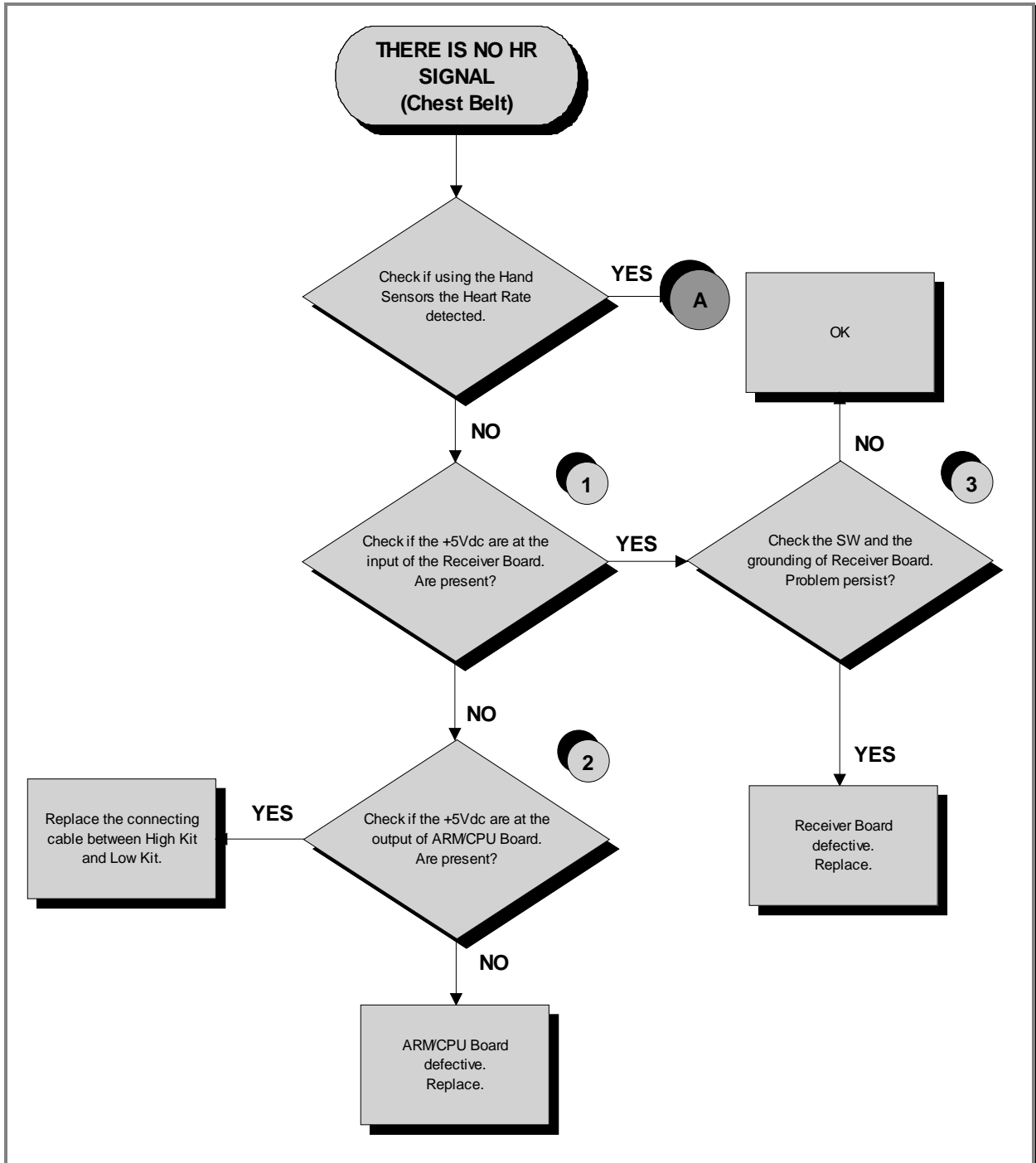
- (4) Check:
  - a. The connection of the fastons on the Hand Sensor plates;
  - b. using a tester, the continuity of the signal between the Hand Sensor plates and the relative pin on the HD3&2 connector of the Receiver, by referring to the paragraph: 2.9. “Cables”.;
  - c. that there is NO continuity between the plates and the earth on the Cardio Receiver (so as to avoid discharging the signal to earth).

### 6.15.2. HR/HS RECEIVER (HEART RATE BAND)

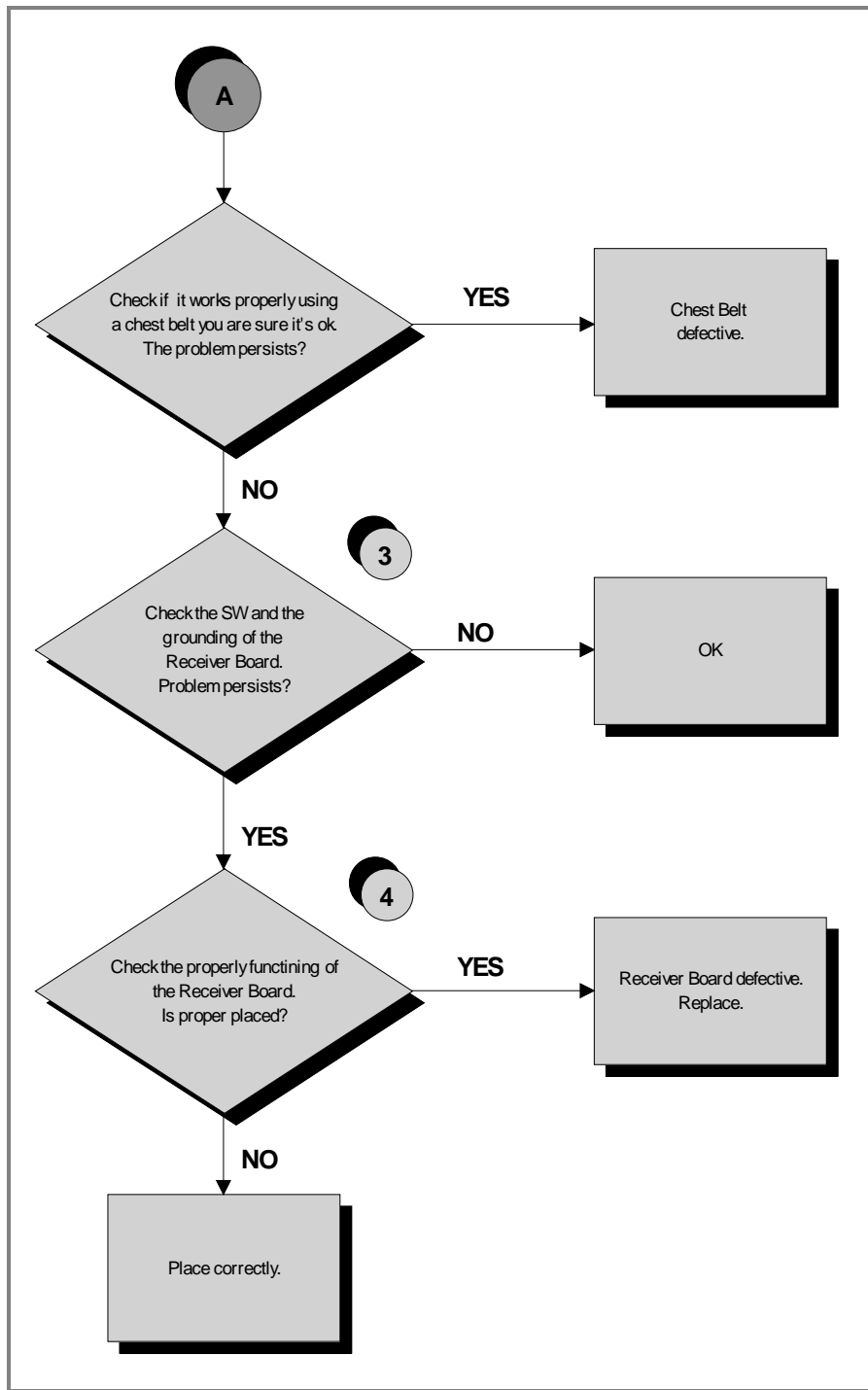
 700 Models



**CORRECT USE OF BAND:** Place the heart-rate band on the chest in direct contact with the skin and make sure that it is moist in the contact area.



*Continues on the next page...*



Follow the chart step by step in order to make a correct diagnosis. In particular, pay attention to the checks highlighted in the numbered boxes and listed here below:

- (1) Insert the tips of the tester onto pins **1** and **2** on the **HD4** connector on the receiver. They must register +5Vdc.
- (2) Do the same as in point (1) but between pins **1** and **6** on the **CN4** connector (ARM Board) or on the **CN31** connector (CPU Board); of the **CU206** cable.
- (3) Check on the correct SW version, according to the “EXCITE SW SMART TABLE” table found in the **TG Direct**.  
Carry out the earth check on the **HS/HR Receiver**, by measuring the resistance value between the following points with a tester:

- a. The faston on the **HR/HS board** and the earth pole on the Power Supply Box;
- b. The earth pole on the Power Supply Box and the wall socket.

The value must be less than 1Ω (Ohm).

Lastly check the earth on the wall socket, making sure there are the following voltages:

<b>P – N (phase– neutral) = 220Vac / 110Vac</b>
<b>P – E (phase– earth) = 220Vac / 110Vac</b>
<b>N – E (neutral– earth) = 0Vac</b>

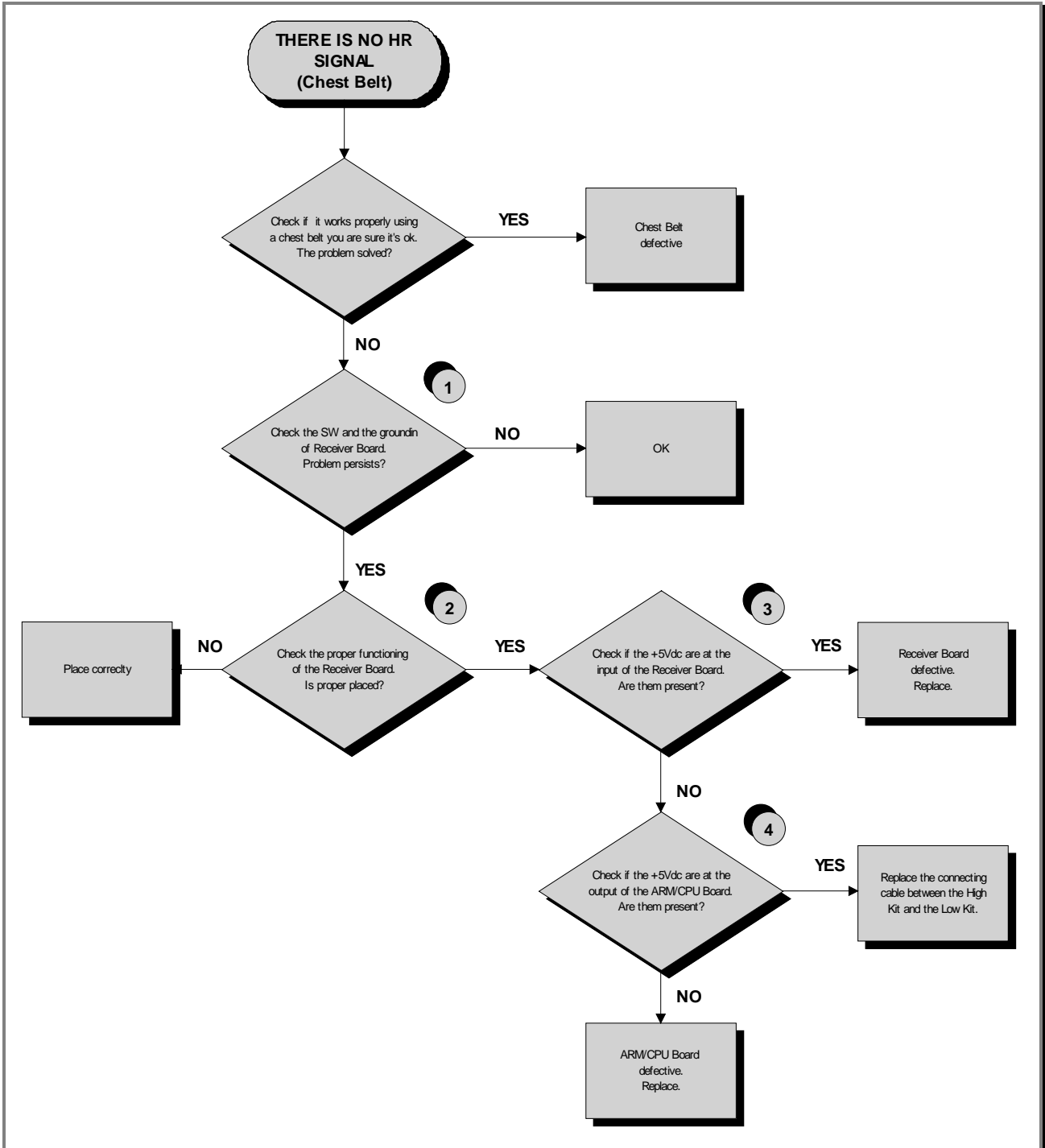
- (4) Check on the correct positioning of the Receiver Board as indicated in paragraph: 7.5.1. “HR/HS Receiver (Heart Rate/Hand Sensor)”.



**If the Display Board is replaced, check that the upgraded SW version is installed or proceed with the upgrade.**

### 6.15.3. HR RECEIVER (HEART RATE BAND)

#### 500 Models



*Continues on the next page...*

*Follow the chart step by step in order to make a correct diagnosis. In particular, pay attention to the checks highlighted in the numbered boxes and listed here below:*

- (1) Check on the correct SW version, according to the “EXCITE SW SMART TABLE” table found in the **TG Direct**.
- (2) Check on the correct positioning of the Receiver Board as indicated in paragraph: 7.5.2. “HR Receiver (Band)”.
- (3) Insert the tips of the tester onto pins **1** and **2** on the **CN1** connector on the receiver. They must register +5Vdc.
- (4) Do the same as in point (3) but between pins **1** and **8** on the **CN3** connector of the **CU208** cable (ARM Board).



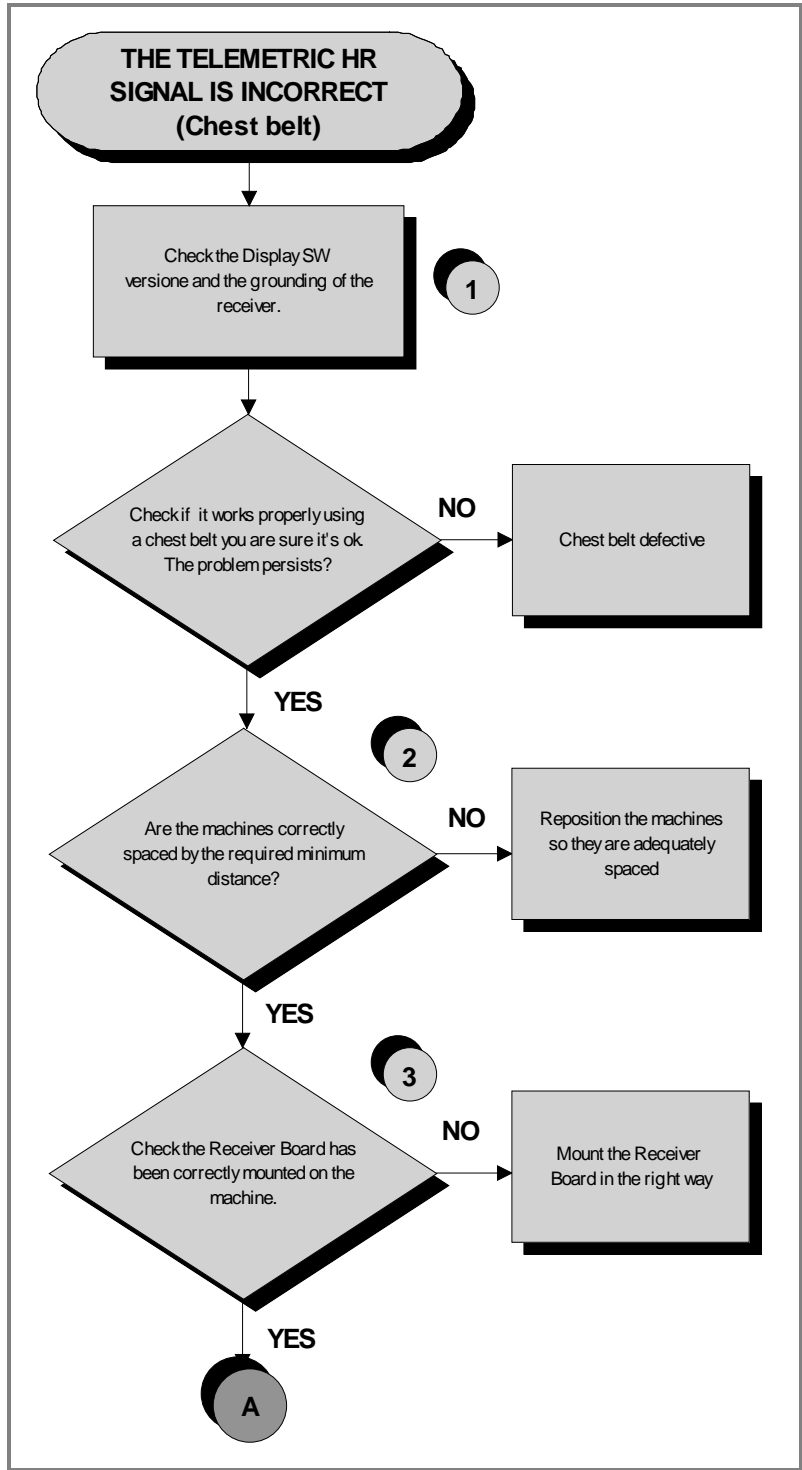
**If the Display Board is replaced, check that the upgraded SW version is installed or proceed with the upgrade.**

## 6.16. TELEMETRIC SIGNAL OF HEART RATE IS NOT CORRECT

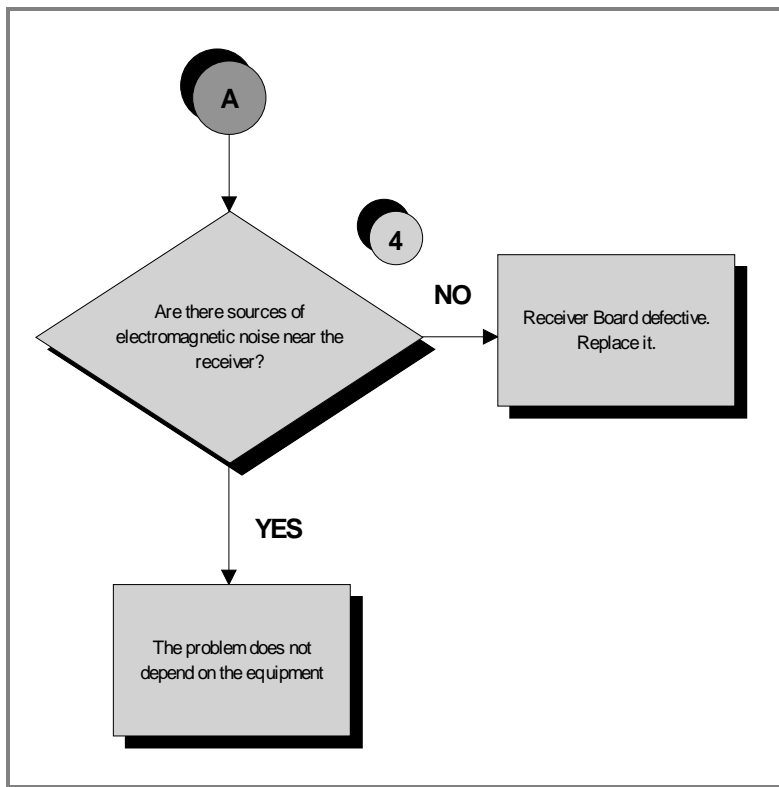
### 6.16.1. HEART RATE BAND



**CORRECT USE OF BAND:** Place the heart-rate band on the chest in direct contact with the skin and make sure that it is moist in the contact area.



*Continues on the next page...*



Follow the chart step by step in order to make a correct diagnosis. In particular, pay attention to the checks highlighted in the numbered boxes and listed here below:

- (1) Check on the correct SW version, according to the “EXCITE SW SMART TABLE” table found in the **TG Direct**.

**🔧 HR/HS Receiver (Band/Hand Sensor): Only for 700 and 700VISIO/VISIOWEB models.**

Carry out the earth check on the **HS/HR Receiver**, by measuring the resistance value between the following points with a tester:

- a. The faston on the **HR/HS board** and the earth pole on the Power Supply Box;
- b. The earth pole on the Power Supply Box and the wall socket.

The value must be less than 1Ω (Ohm).

Lastly check the earth on the wall socket, making sure there are the following voltages:

<b>P – N (phase- neutral) = 220Vac / 110Vac</b>
<b>P – E (phase- earth) = 220Vac / 110Vac</b>
<b>N – E (neutral- earth) = 0Vac</b>

*Continues on the next page...*



- (2) Comply with the distance and positioning of the pieces of equipment with each other, keeping to the following diagram:

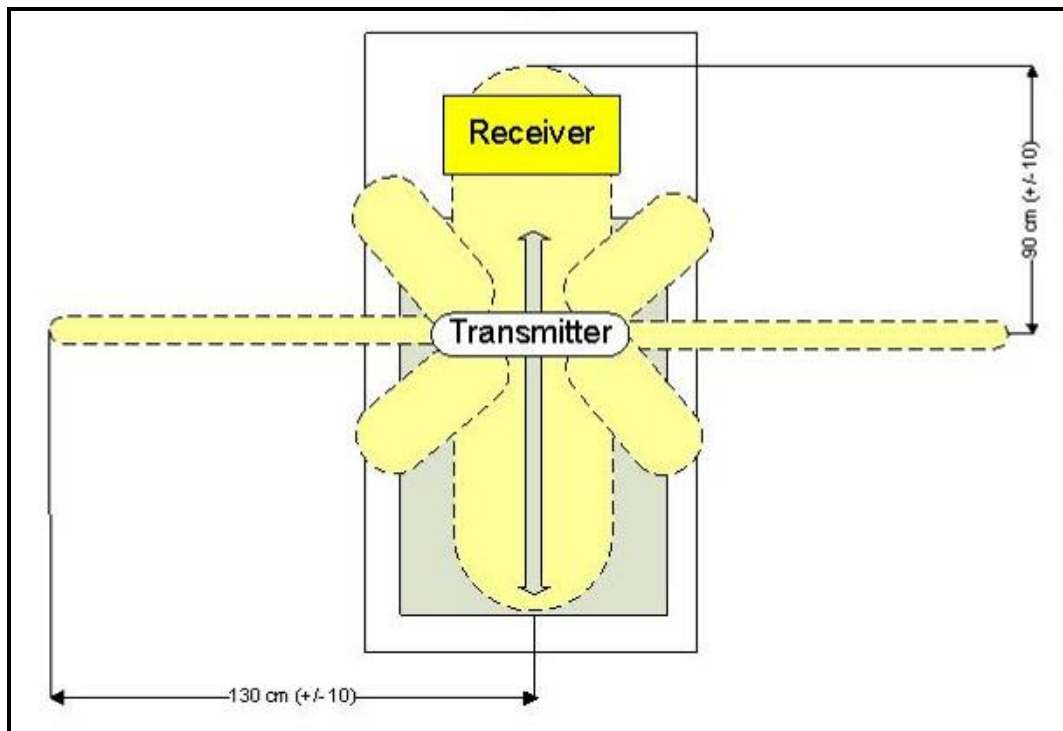


Figure 6-3



The lateral range (130cm) is greater than the frontal range (90cm) even though it covers a tighter area. Position the pieces of equipment, therefore, as shown in the following diagram:

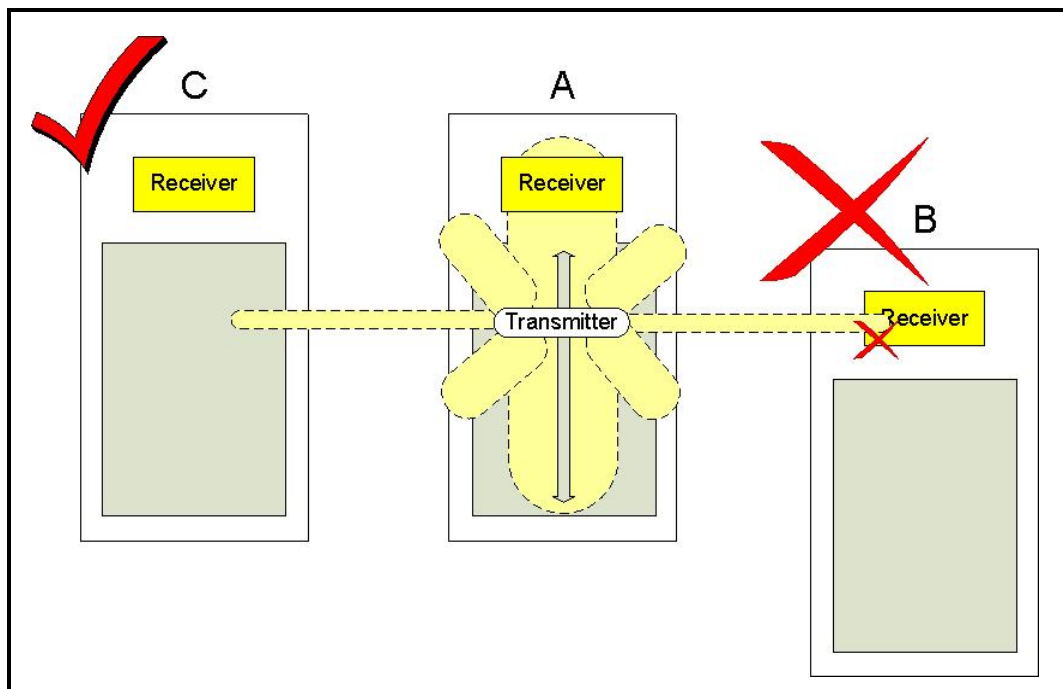
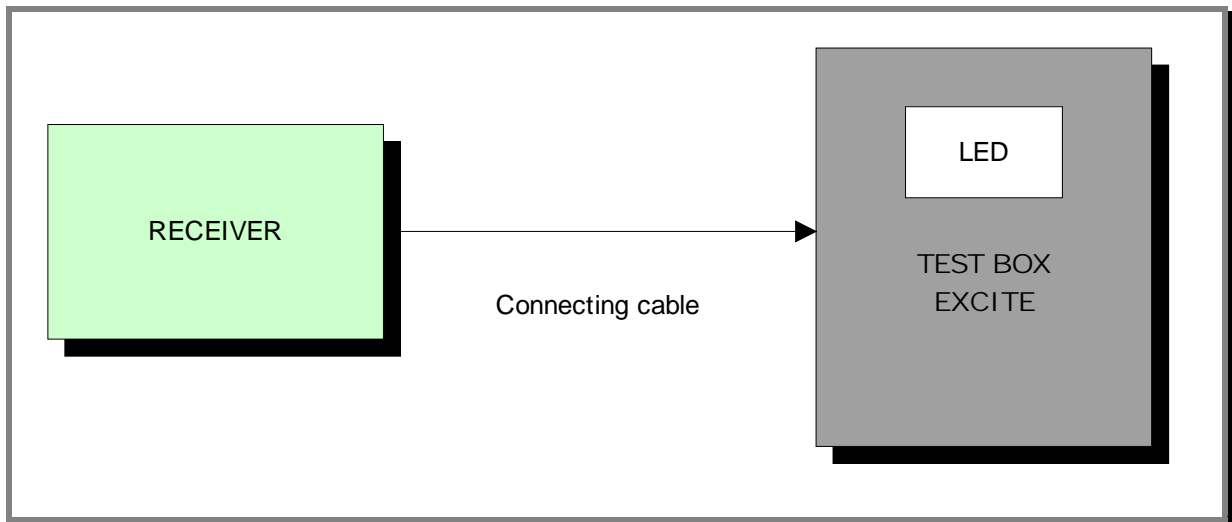


Figure 6-4

- (3) Check on the correct positioning of the Receiver Board as indicated in paragraph: 7.5. “Dismantling the Cardio Receiver”.
- (4) In order to check whether there is electromagnetic noise near the equipment, use the Text Box Excite as detailed below. You can use one of the following cables as the connection cable between the receiver and the Test Box: **ELT-16** (0WC00518AB), **CBQ-28** (0WC00390AC) or **TRM-28** (0WC00336AC).



The circuit switches on the LED for each heart beat and/or disturbance received. In this way, it is possible to assess whether there is any disturbance and what produces it.

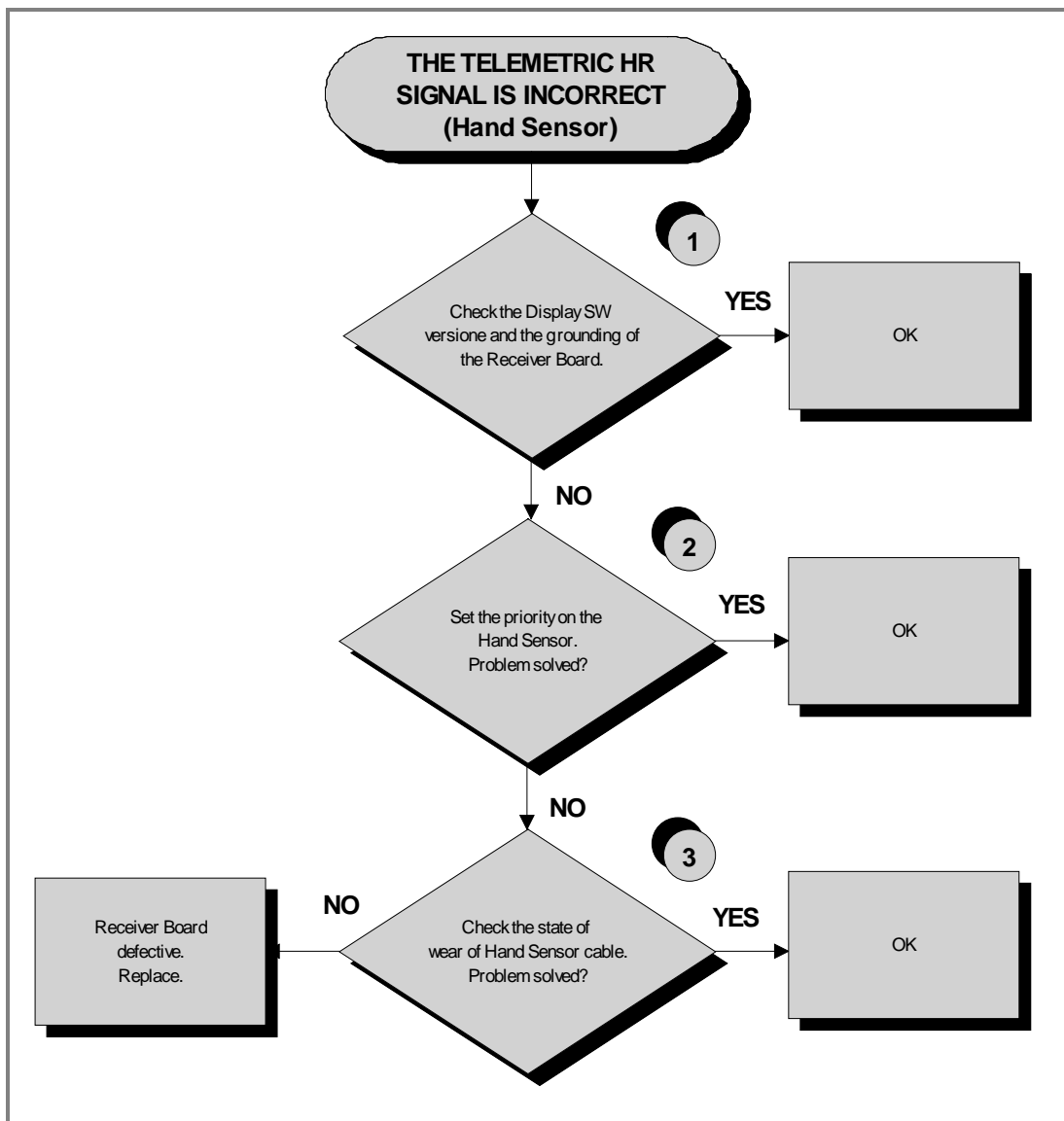


**Do not move too close to the LED Display with the Test Box Excite, because it is known that this emits interference.**

### 6.16.2. HAND SENSOR

**BODY CONTINUITY:** It is statistically recognized that it is difficult (if not impossible) to measure the HR of certain people using a Hand Sensor. This may be caused by a number of reasons which may affect the effectiveness of the "electric" contact between the skin of the user and the HS electrodes, such as: freshly-washed or particularly dry hands, particular acidity level of the skin and/or particular body fat index. For these persons one should use a Heart Rate Band.

**CORRECT USE OF HAND SENSOR:** Grasp both the top and bottom plate without doing so too tightly and avoid washing your hands aggressively so as to avoid particular dryness.



Follow the chart step by step in order to make a correct diagnosis. In particular, pay attention to the checks highlighted in the numbered boxes and listed here below:

- (1) Check on the correct SW version, according to the “EXCITE SW SMART TABLE” table found in the **TG Direct**.

Carry out the earth check on the **HS/HR Receiver**, by measuring the resistance value between the following points with a tester:

- a. The faston on the **HS/HR Board** and the earth pole on the Power Supply Box;
- b. The earth pole on the Power Supply Box and the wall socket.

The value must be less than 1Ω (Ohm).

Lastly check the earth on the wall socket, making sure there are the following voltages:

<b>P – N (phase– neutral) = 220Vac / 110Vac</b>
<b>P – E (phase– earth) = 220Vac / 110Vac</b>
<b>N – E (neutral– earth) = 0Vac</b>

- (2) Select “Hand Sensor” as the priority mode for acquiring the Heart Rate, through the HW configuration of the Jumper (**JP1**) on the receiver:

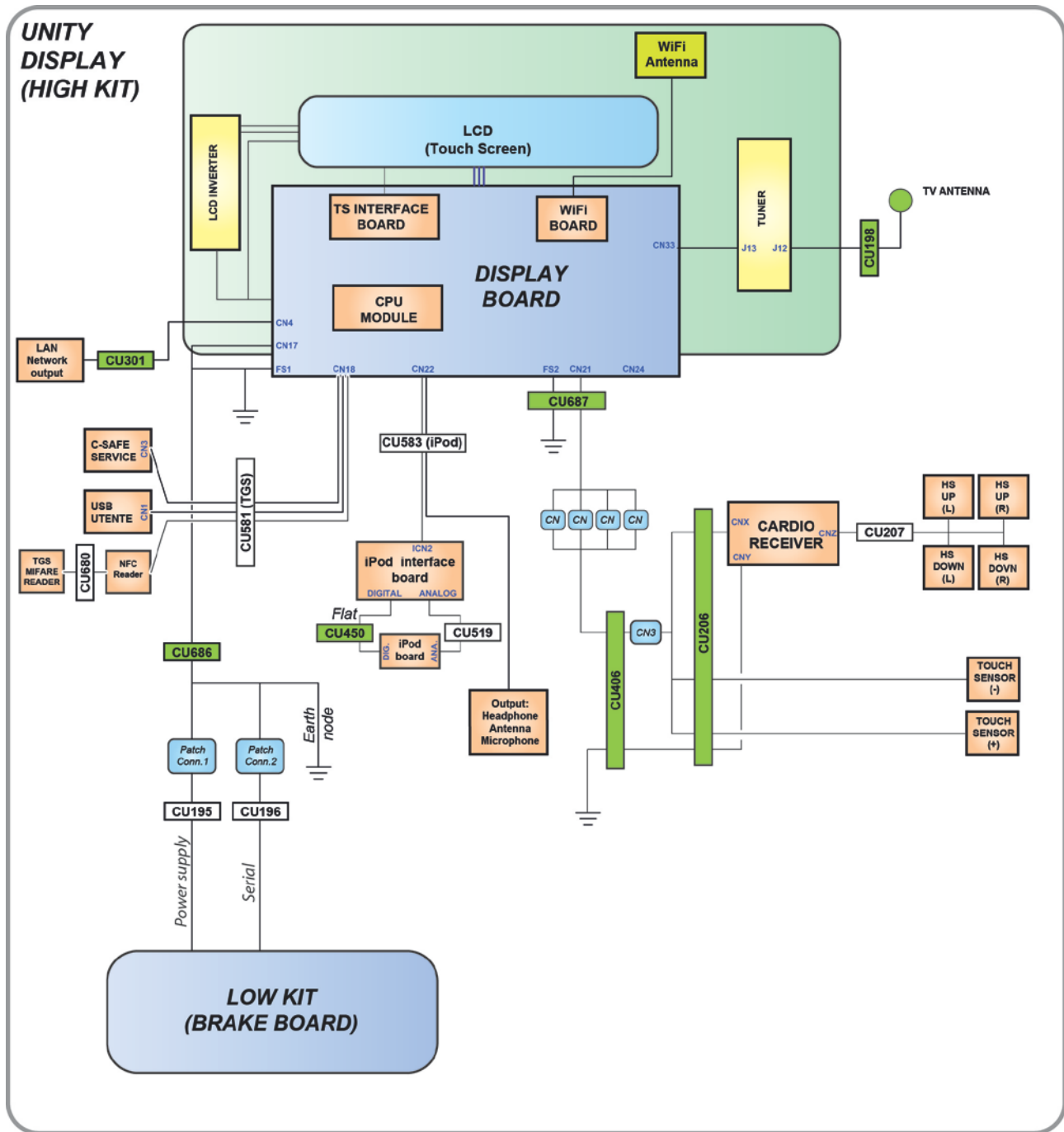
- **JP1 CLOSED** = Priority for Band
- **JP1 OPEN** = Priority for Hand Sensor



**The standard configuration of the receiver is with priority for band.**

- (3) Check:

- a. The connection of the fastons on the Hand Sensor plates;
- b. using a tester, the continuity of the signal between the Hand Sensor plates and the relative pin on the HD3&2 connector of the Receiver, by referring to the paragraph: 2.8.6. “700 UNITY Powered Model



- c. Cables”;
- d. that there is NO continuity between the plates and the earth on the Cardio Receiver (so as to avoid discharging the signal to earth).

## 7. DISMANTLING THE PARTS

### 7.1. IMPORTANT NOTE ON DISMANTLING

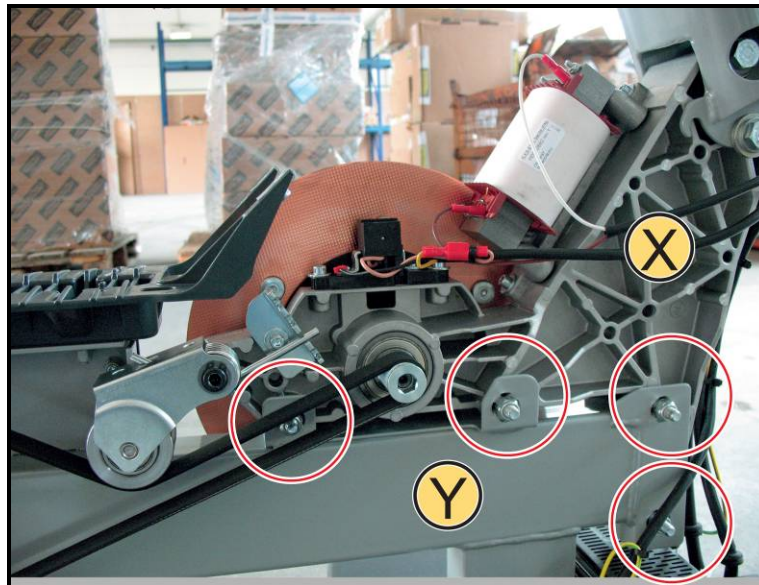


Figure 7.1-1

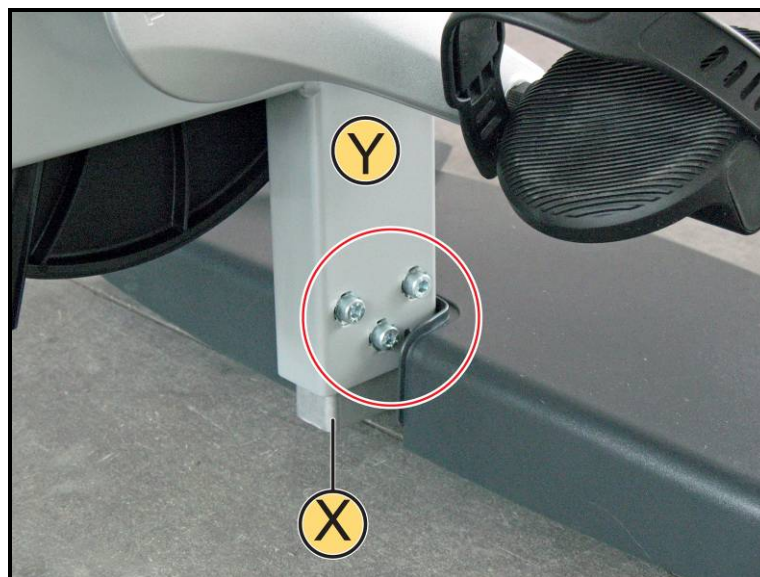


Figure 7.1-2



**WARNING: DO NOT** under any circumstances unscrew the screws and nuts highlighted in the figure. During the initial assembling during production of the (X) and (Y) components, the highlighted screws and nuts are tightened, buckling the frame on the fusion component, making them integral with each other. These will together

**constitute a single frame for the equipment.**



## 7.2. DISMANTLING THE CONTROL PANEL

### 7.2.1. 500 AND 500SP VERSIONS



Figure 7.2-1

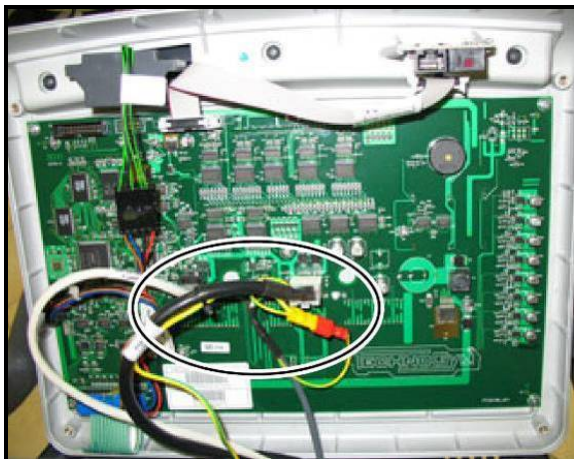


Figure 7.2-2

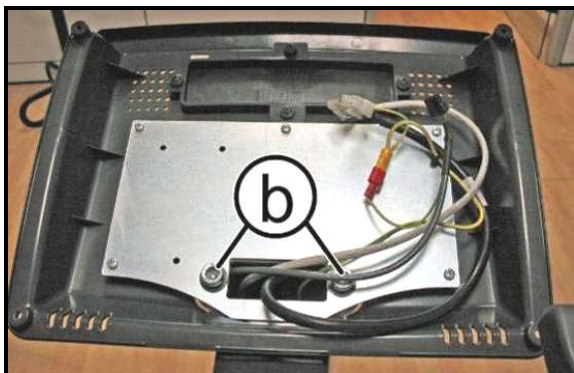


Figure 7.2-3

Switch off the equipment and remove the power supply plug from the wall socket.

1. Unscrew the 4 screws (a) using a medium-sized Phillips screwdriver.
2. Disconnect the connectors highlighted in the figure at the side.
3. Remove the control panel.
4. Unscrew the 2 screws (b) using an 8mm Allen wrench in order to remove the rear support of the Display.



**WARNING:** During re-assembly, tighten the screws (b) using a torque wrench set at 40Nm.

*To re-fit the control panel, follow the above operations in reverse.*

### 7.2.2. 700 AND 700SP VERSIONS



Figure 7.2-4

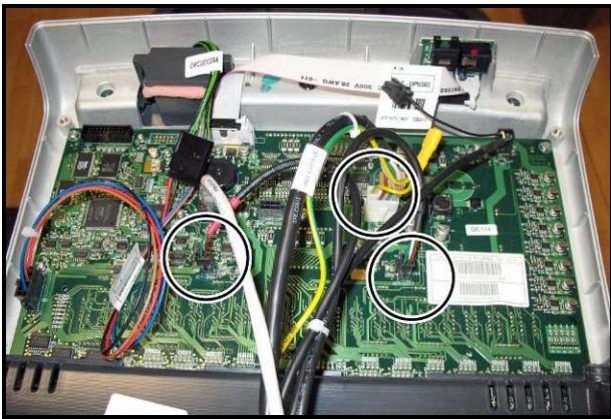


Figure 7.2-5

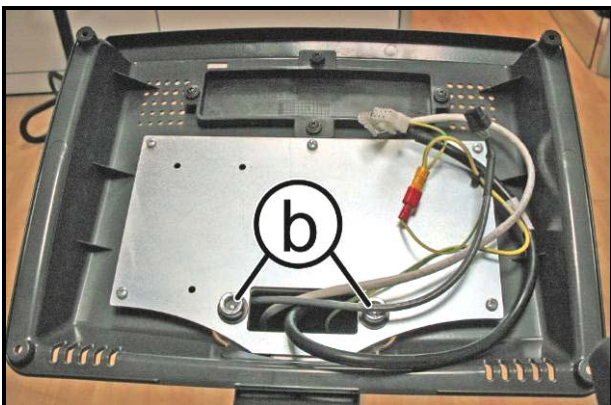


Figure 7.2-6

Switch off the equipment and remove the power supply plug from the wall socket.

1. Unscrew the 4 screws (a) using a medium-sized Phillips screwdriver.
2. Disconnect the connectors highlighted in the figure at the side.
3. Remove the control panel.
4. Unscrew the 2 screws (b) using an 8mm Allen wrench in order to remove the rear support of the Display.

**WARNING:** During re-assembly, tighten the screws (b) using a torque wrench set at 40Nm.

*To re-fit the control panel, follow the above operations in reverse.*

### 7.2.3. 700VISIO/VISIOWEB VERSION

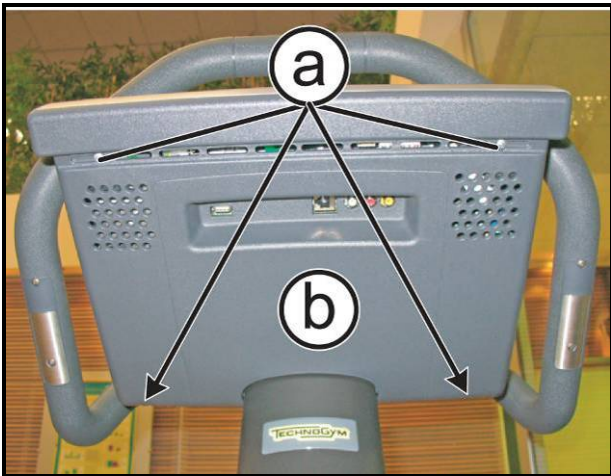


Figure 7.2-7

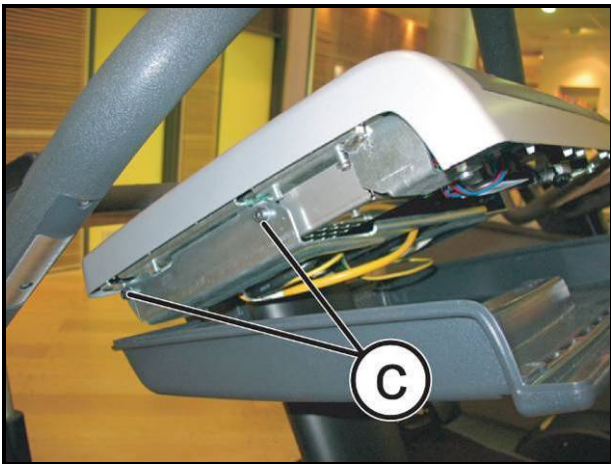


Figure 7.2-8

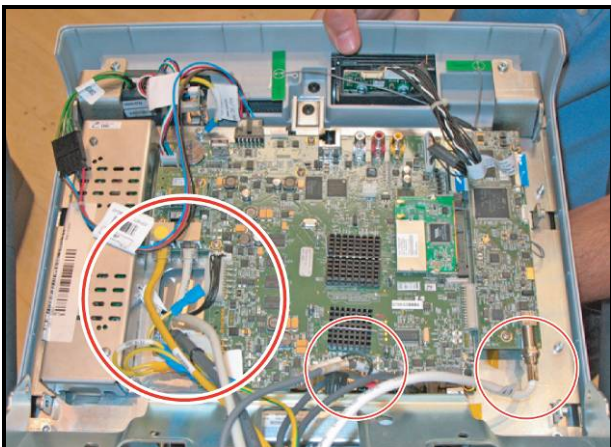


Figure 7.2-9

Switch off the equipment and remove the power supply plug from the wall socket.

1. Unscrew the 4 screws (a) using a medium-sized Phillips screwdriver.
2. Lower the guard (b).
3. Unscrew the 2 screws (c) using a 3mm Allen wrench on both sides.
4. Disconnect the connectors highlighted in the figure at the side.
5. Remove the control panel.

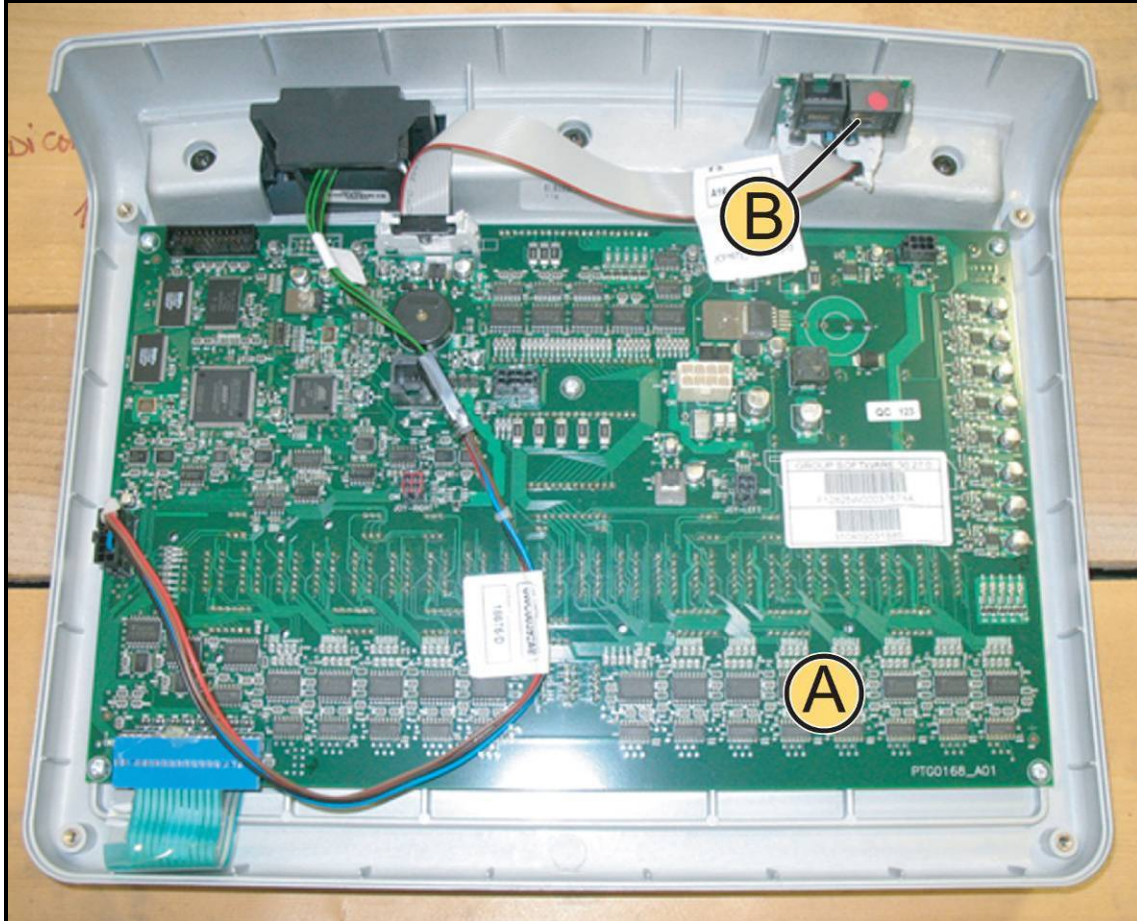
**WARNING:** Connect the mains cables (in the photo on the left) in the correct manner, as they could be inverted.

*In order to re-assemble the control panel, carry out the above operations in reverse.*



## 7.3. DISMANTLING THE COMPONENT BOARDS

### 7.3.1. LED DISPLAY (ARM BOARD)



**Figure 7.3-1**

*Carry out the operations in the paragraph: 7.2. “Dismantling the control panel”.*

*Place the control panel on a workbench:*

Now it is possible to remove the boards it contains:

- *The ARM Board(A);*
- *The C-Safe Board(B);*

### 7.3.1.1. ARM Board (A)

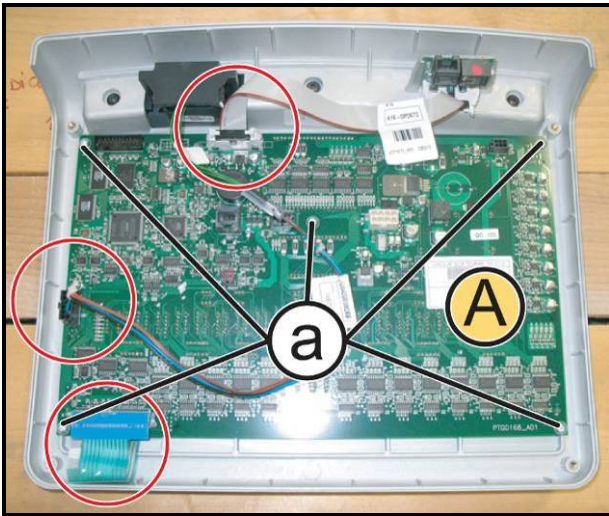
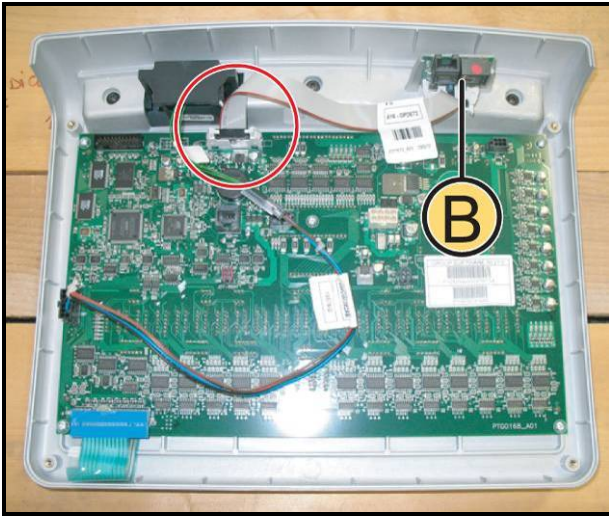


Figure 7.3-2

1. Disconnect the connectors highlighted in the figure.
2. Unscrew the 5 screws (c) using a medium-sized Phillips screwdriver.
1. Remove the Display Board (A).

*In order to re-fit the Display Board, carry out the above operations in reverse.*

### 7.3.1.2. C-Safe Board (B)



**Figure 7.3-3**

1. Disconnect the connector highlighted in the figure, from the Display Board.
2. Remove the hot-melt glue which fixes the board to the plastic and remove the C-Safe Board (B), sliding it upwards.

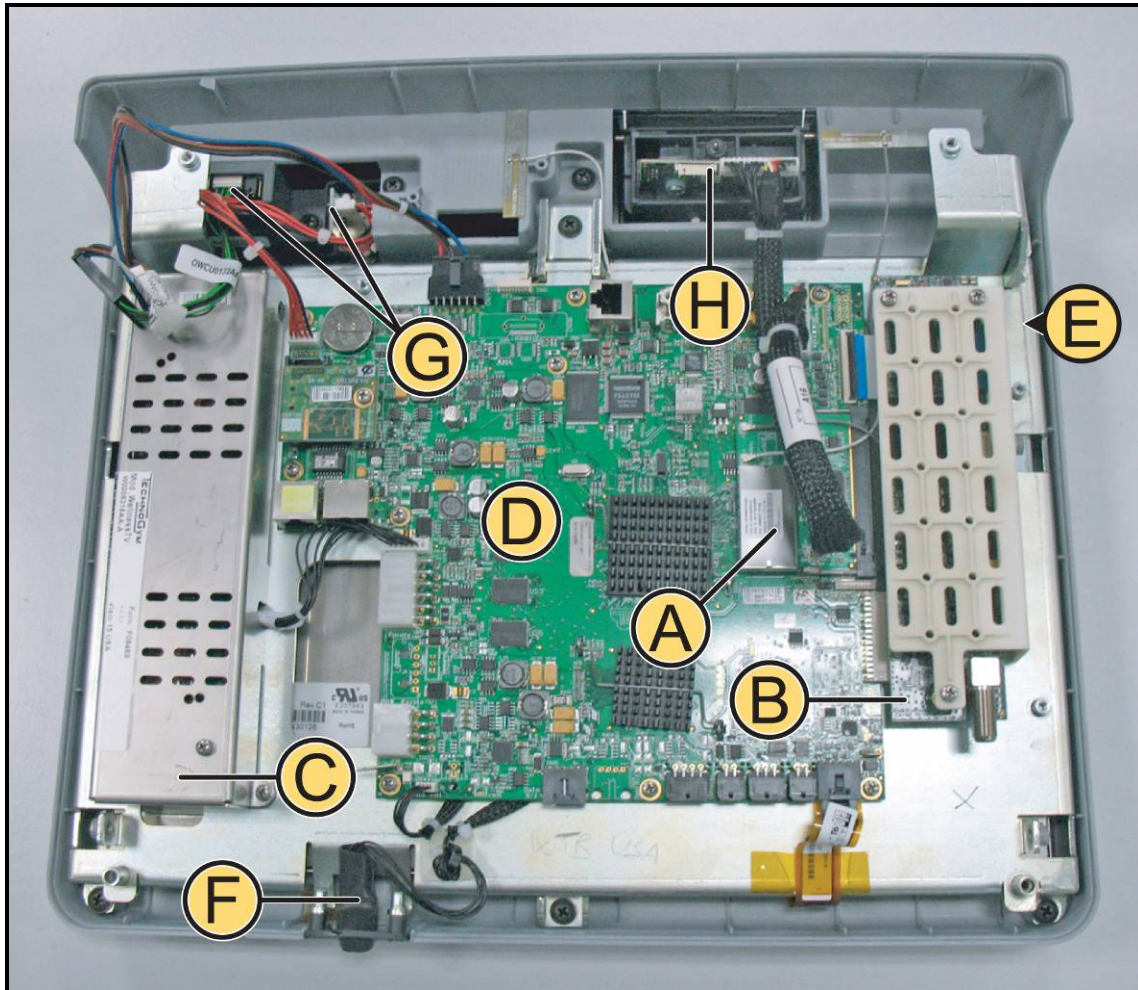


**During re-assembly, use hot-melt glue again to fix the C-Safe Board.**

*To re-assemble the C-Safe Board, carry out the above operations in reverse.*



### 7.3.2. VISIO/VISIOWEB DISPLAY 15" (CPU BOARD)



**Figure 7.3-4**

Carry out the operations in the paragraph: 7.2. "Dismantling the control panel".

Place the control panel on a workbench:

Now it is possible to remove the following components:

- *Wireless Board (A);*
- *TUNER Board (B);*
- *LCD Inverter(C);*
- *CPU Board (D);*
- *LCD + Touch Screen (E);*
- *Headphones Jack(F);*
- *Dual TGS Reader + USB port (G);*
- *iPod Docking Station (H);*
- *TGS frontal plugs + USB and cover.*

*Continues on the next page...*

### 7.3.2.1. Wireless Board (A)

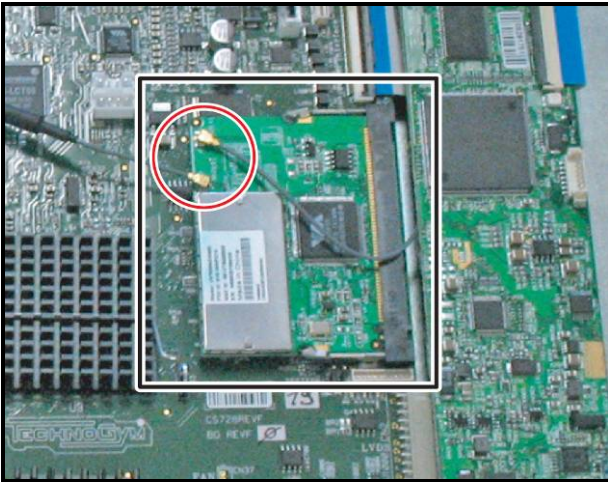


Figure 7.3-5

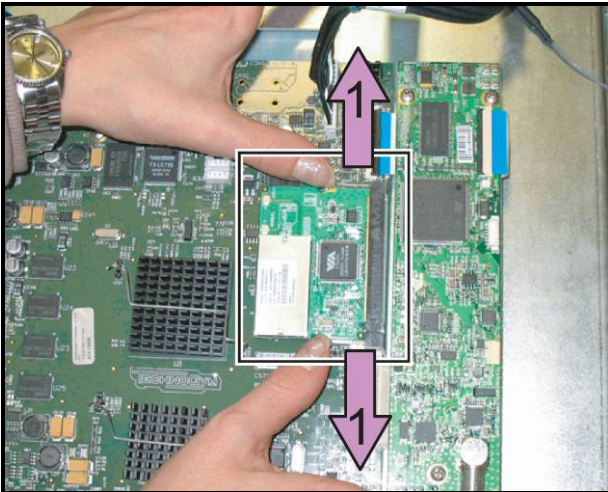


Figure 7.3-6

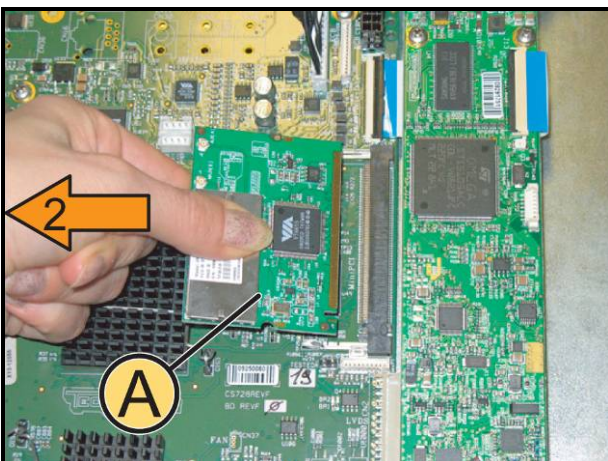


Figure 7.3-7

1. Disconnect the 2 aerial connectors on the wireless board highlighted in the figure.

**WARNING:** Be extremely careful with the wireless aerial cables and their connectors as they are particularly delicate. In addition, if you need to dismantle, it is important to follow the route of the cables indicated in Figure 7.3-8.

2. Widen the two catches in the direction of the purple arrows (1) so as to be able to lift the Board.


3. Remove the Wireless Board (A) in the direction of the orange arrow (2), as shown in the figure at the side.

**WARNING:** During re-assembly, you must re-fit the aerials in Figure 7.3-5 onto the Wireless Board and then fit the board back into its seat so as to avoid pressing onto the CPU circuits.

*In order to re-fit the Wireless Board, carry out the above operations in reverse.*

*Continues on the next page...*



 In order to re-fit the aerial cables (X) and (Y), follow the course indicated below.

 The Heat Dissipator (Z) only exists on the ATSC and ISDB-T versions.

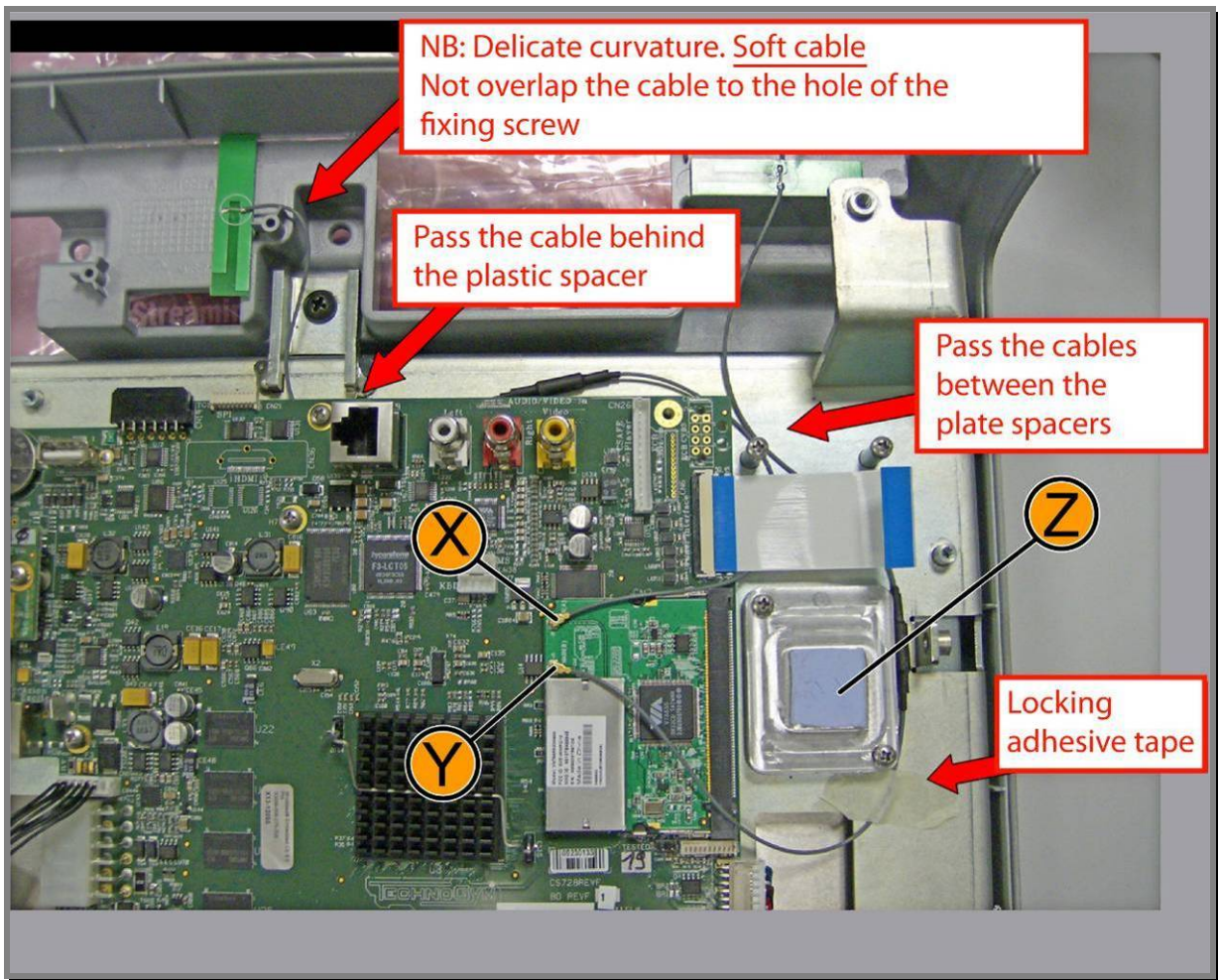


Figure 7.3-8

### 7.3.2.2. DVB-T Tuner Board (B)

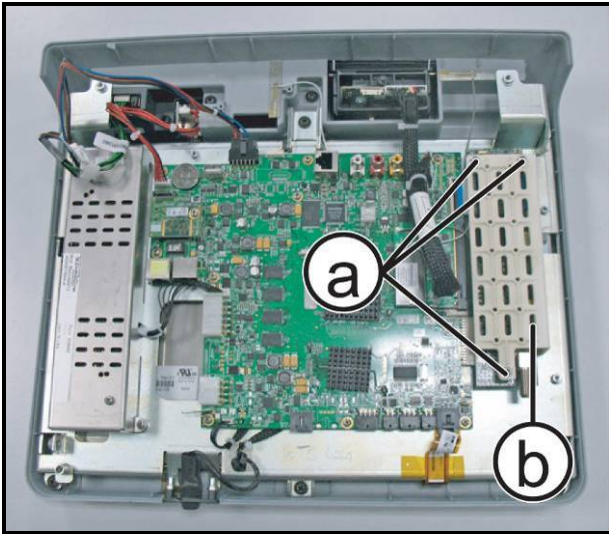


Figure 7.3-9

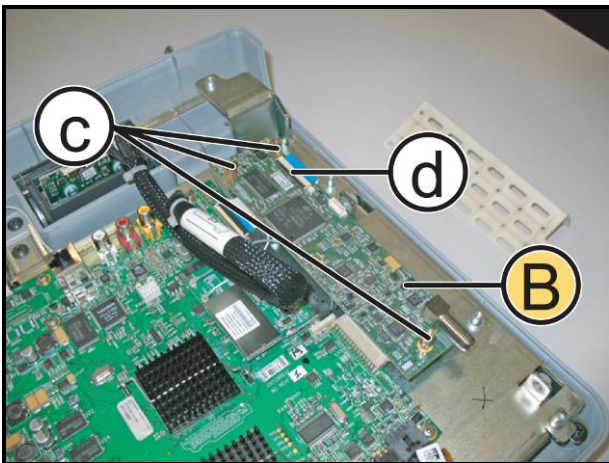


Figure 7.3-10

1. Unscrew the 3 screws (a) using a medium-sized Phillips screwdriver.
2. Remove the guard protecting the Tuner Board (b).
3. Unscrew the 3 turrets (c).
4. Lift the black tongue and disconnect the cable (d).
5. Remove the Tuner Board (B).

*In order to re-fit the Tuner Board, carry out the above operations in reverse.*



### 7.3.2.3. ATSC (B1) and ISDB-T (B2) Tuner Board

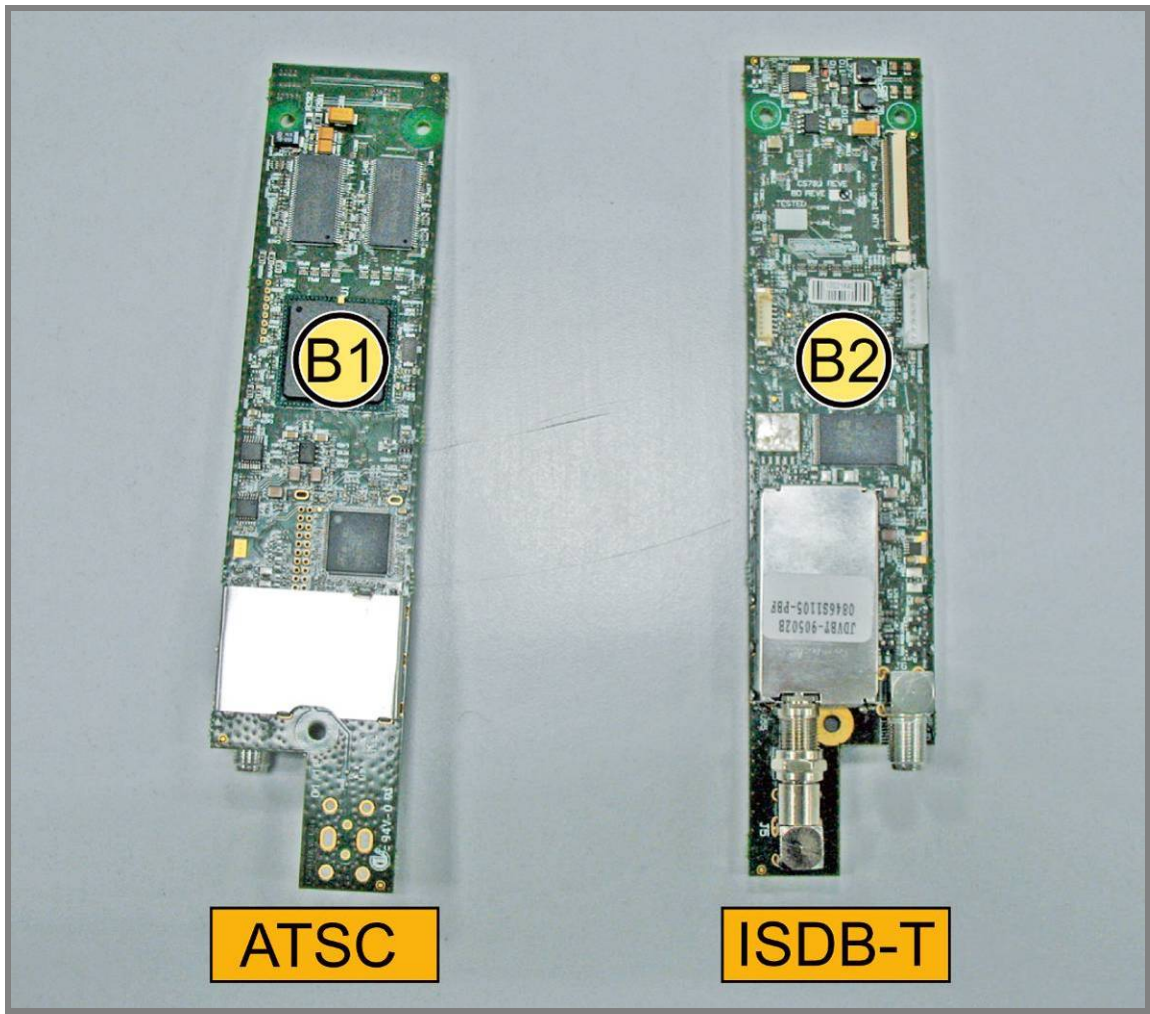


Figure 7.3-11

Carry out the operations in the paragraph: 7.3.2.2“DVB-T Tuner Board (B)” as far as point (4).

1. Remove the ATSC (B1), or ISDB-T (B2) version Tuner Board.

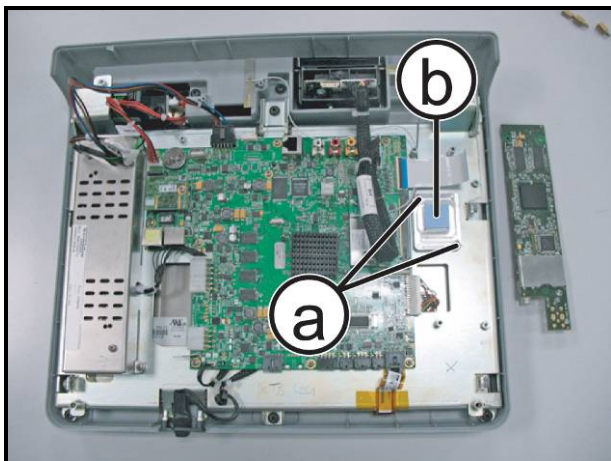


Figure 7.3-12

2. Unscrew the 2 screws (a) using a medium-sized Phillips screwdriver.
3. Remove the Heat Dissipator (b).

*In order to re-fit the Tuner Boards, carry out the above operations in reverse.*

### 7.3.2.4. LCD Inverter (C)

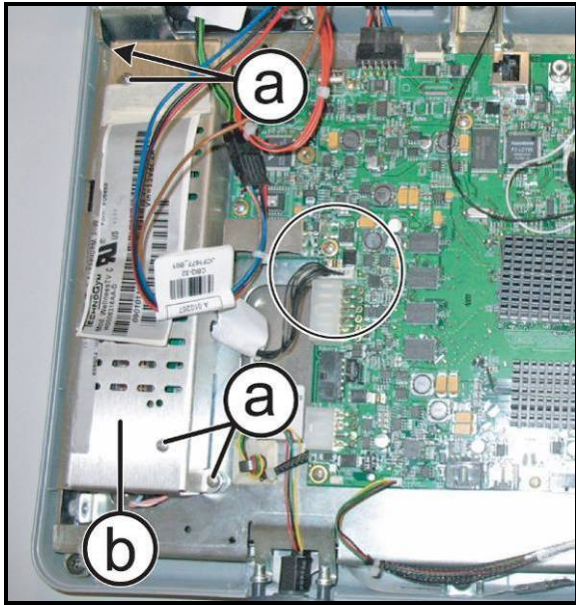


Figure 7.3-13



Figure 7.3-14

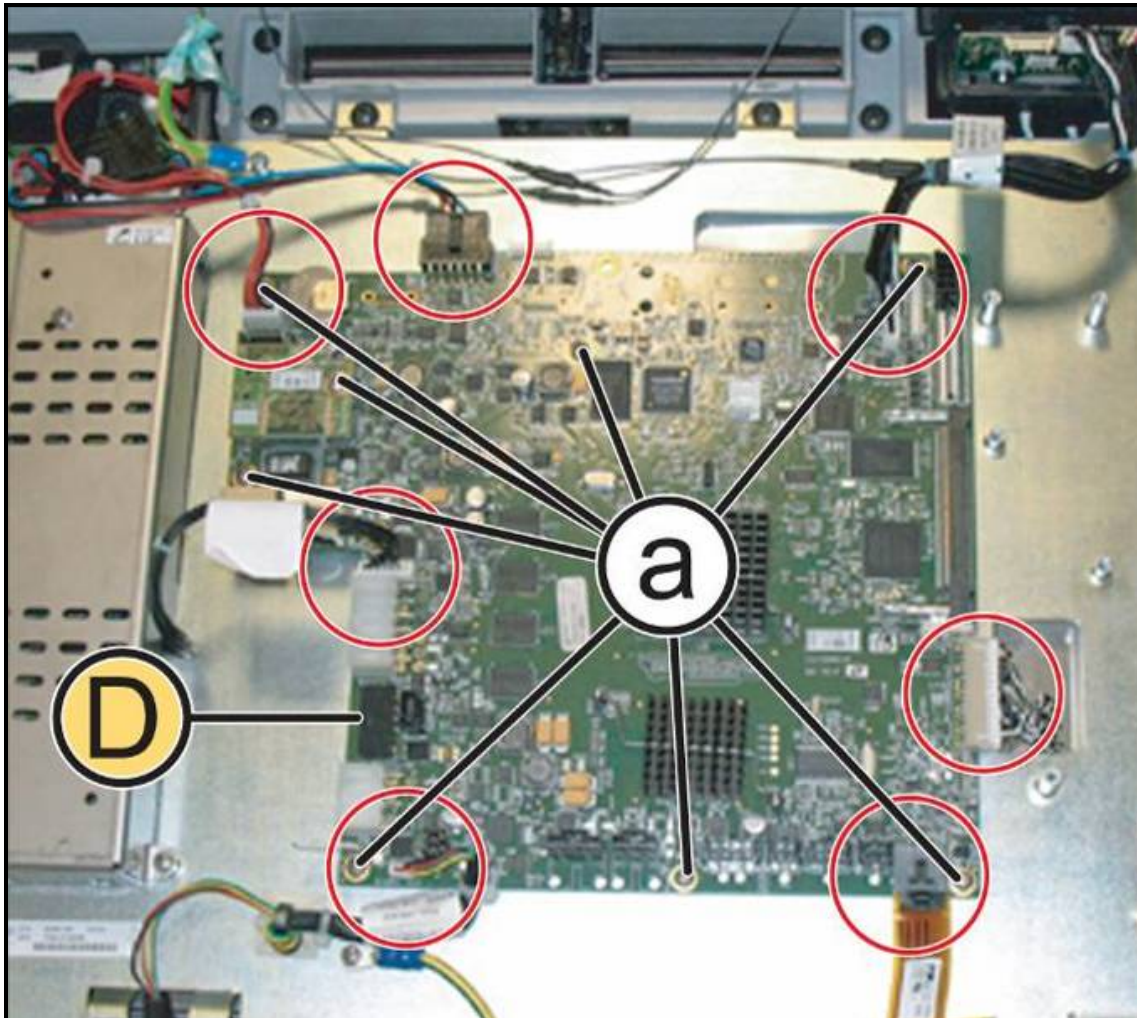
1. Disconnect the connector highlighted in the figure.
2. Unscrew the 4 screws (a) using a medium-sized Phillips screwdriver.
3. Remove the LCD inverter cover (b).

4. Disconnect the 4 connectors highlighted in the figure.
5. Remove the LCD Inverter Board (C).

*In order to re-fit the LCD Inverter Board, carry out the above operations in reverse.*



### 7.3.2.5. CPU Board (D)



**Figure 7.3-15**

*Carry out the operations in the paragraph: 7.3.2.1 “Wireless Board (A)” and 7.3.2.2 “DVB-T Tuner Board (B)”.*

1. Disconnect the connectors highlighted in the figure.
2. Unscrew the 8 screws (a) using a medium-sized Phillips screwdriver.
3. Remove the Display Board (D).

*In order to re-fit the Display Board, carry out the above operations in reverse.*

### 7.3.2.6. LCD (E) + Touch Screen

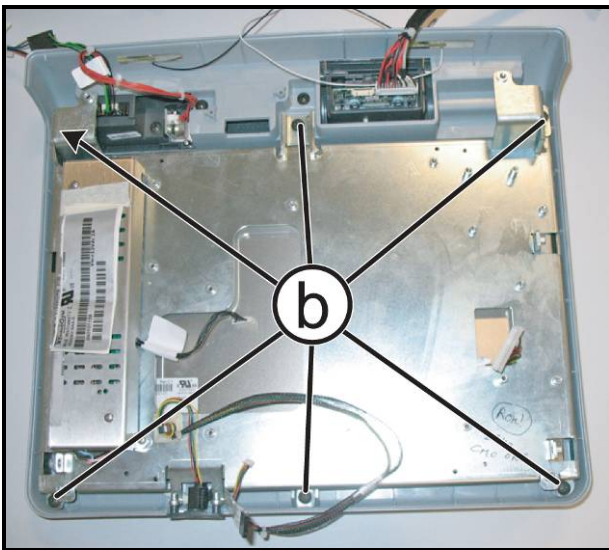


Figure 7.3-16

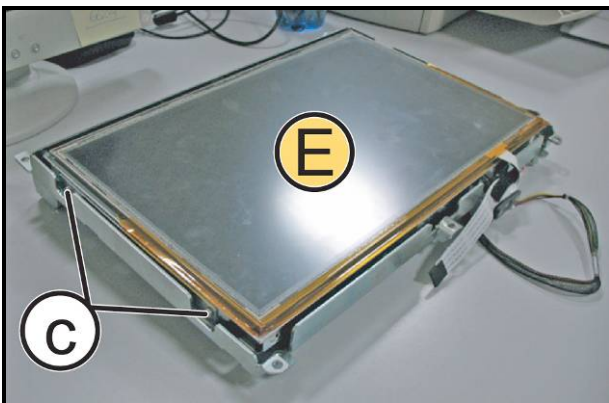


Figure 7.3-17

Carry out the operations in the paragraph: 7.3.2.5 “CPU Board (D)”.

1. Unscrew the 6 screws (b) using a medium-sized Phillips screwdriver.
2. Remove the LCD Inverter as described in the paragraph: 7.3.2.4 “LCD Inverter (C)”.
3. Remove the entire LCD unit.
4. With care, turn the LCD unit over.
5. Unscrew the 2 screws (c) on both sides, using a medium-sized Phillips screwdriver.
6. Remove the LCD (E) from the support sheet.

*In order to re-fit the LCD and the Touch Screen, carry out the above operations in reverse.*

### 7.3.2.7. Headphones Jack (F)

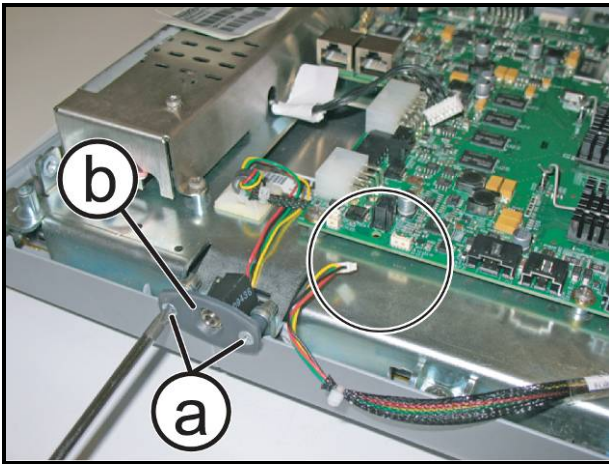


Figure 7.3-18

1. Disconnect the connector highlighted in the figure.
2. Unscrew the 2 screws (a) using a small Phillips screwdriver.
3. Remove the Headphones Jack (F).

*In order to re-fit the Headphones Jack, carry out the above operations in reverse.*

### 7.3.2.8. Dual TGS Reader + USB port (G)

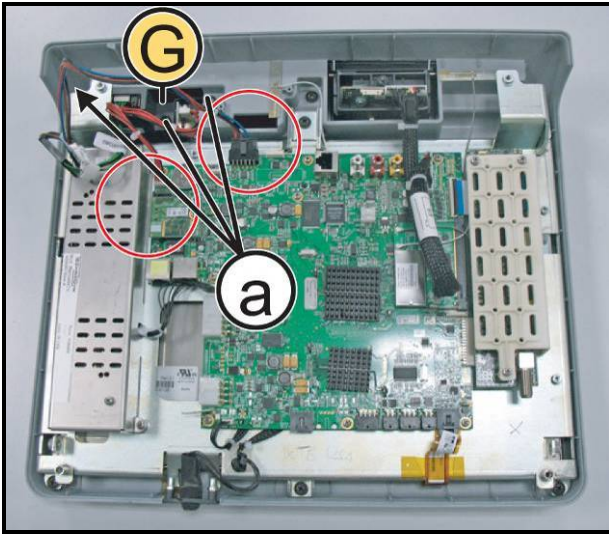


Figure 7.3-19

1. Disconnect the cables highlighted in the figure.
2. Unscrew the 3 screws (a) using a medium-sized Phillips screwdriver.
3. Remove the TGS unit and the USB port (G), as shown in the figure at the side.

*In order to re-fit the TGS and the USB port, carry out the above operations in reverse.*



### 7.3.2.9. iPod Docking Station (H)

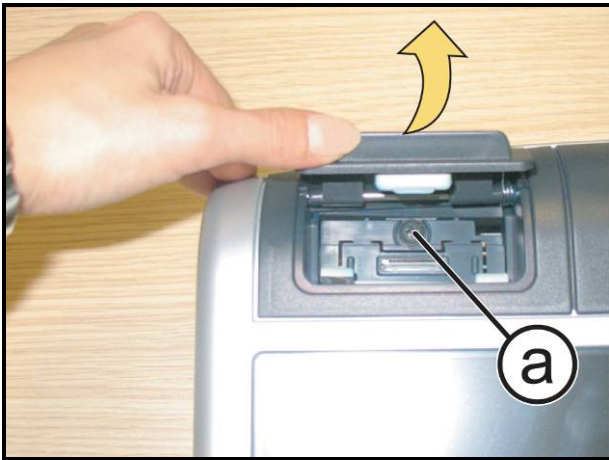


Figure 7.3-20

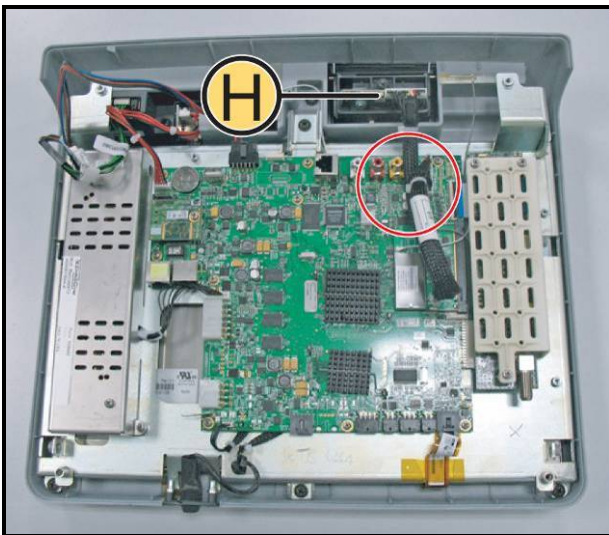


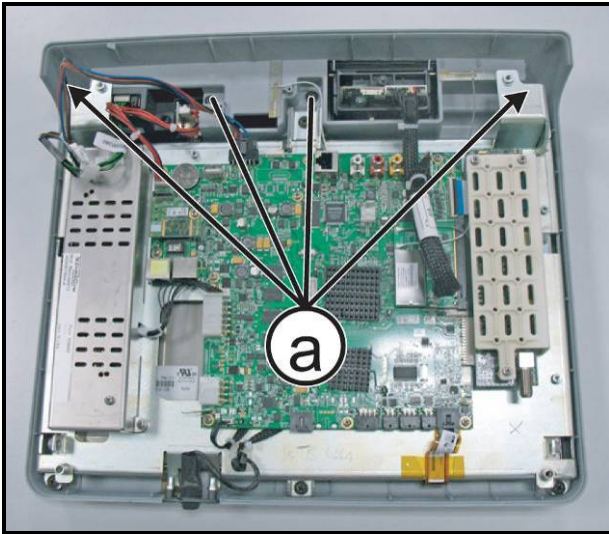
Figure 7.3-21

1. Lift the cover of the Docking Station and unscrew the screw (a) using a medium-sized Phillips screwdriver.

2. Disconnect the cable highlighted in the figure and remove the iPod Docking Station (H).

*In order to re-fit iPod Docking Station, carry out the above operations in reverse.*

### 7.3.2.10. TGS frontal plugs + USB and cover



**Figure 7.3-22**

1. Unscrew the 4 screws (**a**) using a medium-sized Phillips screwdriver.
2. Remove the frontal plugs from the front side.

*To re-fit the frontal plugs and USB cover, follow the above operations in reverse.*

## 7.4. DISMANTLING THE KEYBOARD / TOUCH SCREEN

### 7.4.1. LED KEYBOARD

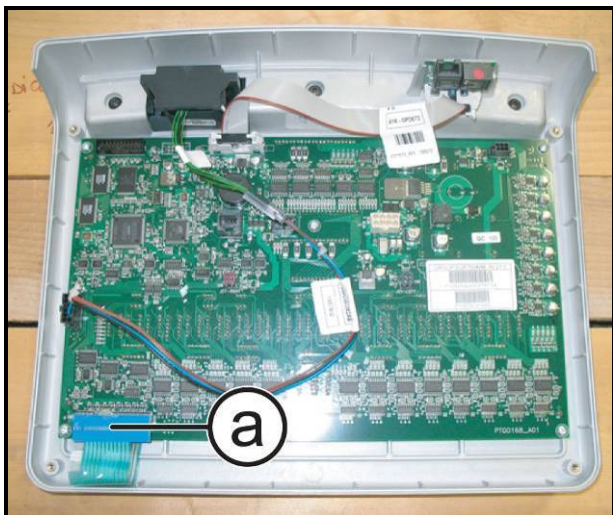


Figure 7.4-1

Carry out the operations in the paragraph: 7.2. "Dismantling the control panel" as far as point (3).

Take the Display to the workbench:

1. Disconnect the connector (a).



After re-fitting the Display Board, fix the connector of the keyboard with a drop of hot-melt glue.

### Model 500



Figure 7.4-2

### Model 700






Figure 7.4-3

2. Using a tool with a fine tip, raise a corner of the keyboard and remove the keyboard.

In order to fit the new keyboard:

1. Take off the film which protects the sticker.
2. Insert the connector in the special hole in the control panel and connect it to the Display Board.
3. Start to stick the adhesive part commencing from the left-hand side going towards the right-hand side without creasing the keyboard.
4. Take off the protective film.

*Continues on the next page...*

-  **Once a keyboard has been removed it cannot be used again, as the tracks and keys get damaged.**
  
  -  **When re-fitting the keyboard, make sure that the keys do not crease and do not remain pressed down.**
  
  -  **After re-fitting the Display, check that the new keyboard functions correctly, as described in the paragraph: 6.1.4.1 “Man. Keyboard Test”.**
-

#### **7.4.2. VISIO/VISIOWEB TOUCH SCREEN**

In order to dismantle the Touch Screen, refer to the dismantling procedure described in the paragraph: 7.3.2.6 “LCD (E) + Touch Screen”.

## 7.5. DISMANTLING THE CARDIO RECEIVER

### 7.5.1. HS/HR RECEIVER (BAND/HAND SENSOR)

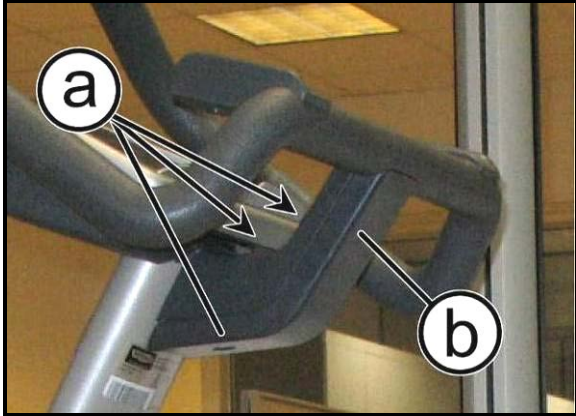


Figure 7.5-1

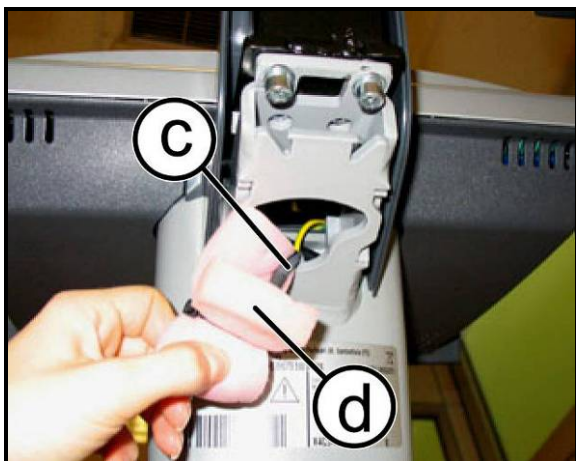


Figure 7.5-2

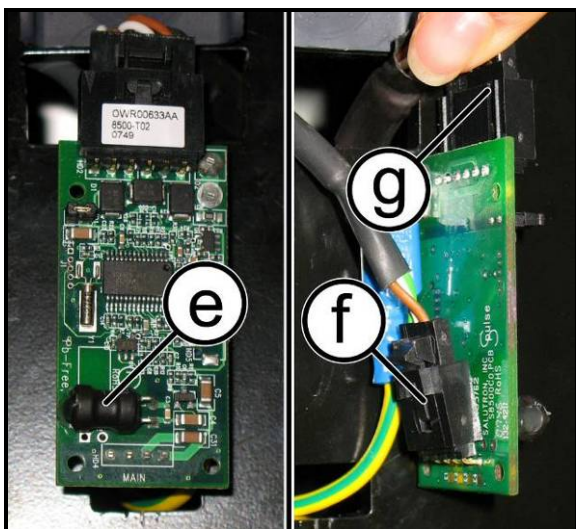


Figure 7.5-3

1. Unscrew the 3 screws (a) using a medium-sized Phillips screwdriver.
2. Remove the bottom guard (b).
3. Remove the receiver (c).
4. Cut the strap and remove the sponge protection (d).
5. Disconnect the receiver from the cables.

In order to re-fit the receiver,

1. On the Cardio Receiver, you can see the coil (e) and the connectors (f) and (g).
2. Connect the cables to the receiver as shown.

*Continues on the next page...*



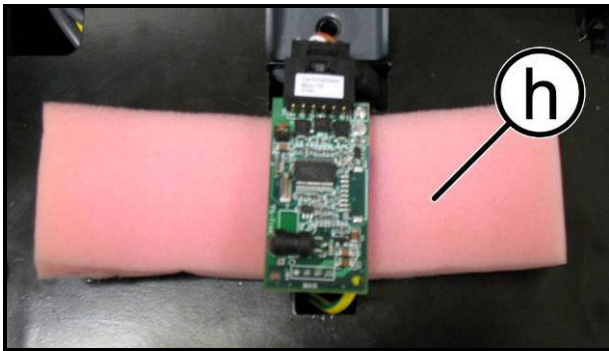


Figure 7.5-4

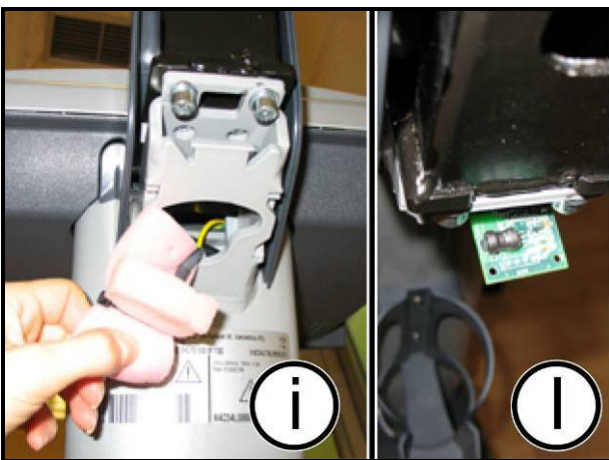


Figure 7.5-5

3. Re-wrap the receiver in the sponge protection (h) and re-apply a strap to bind it.

4. Put the receiver back inside its frame (i).



**WARNING:** Position the receiver so that the coil is turned upwards and towards the user, as in the picture in the figure at the side (l).

*To re-fit the receiver, follow the above operations in reverse.*

## 7.5.2. HR RECEIVER (HR BAND)

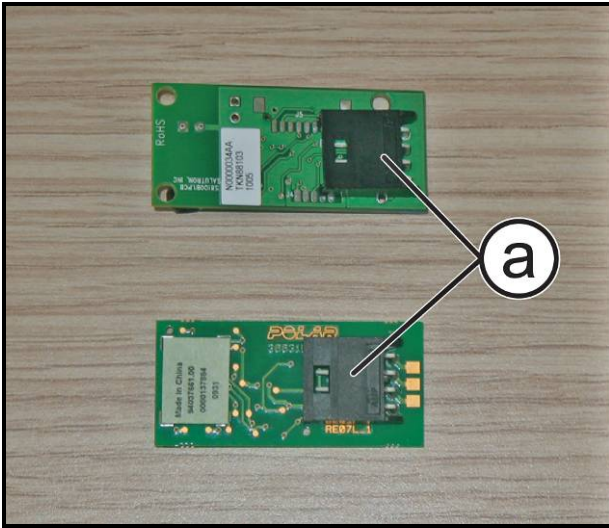


Figure 7.5-6

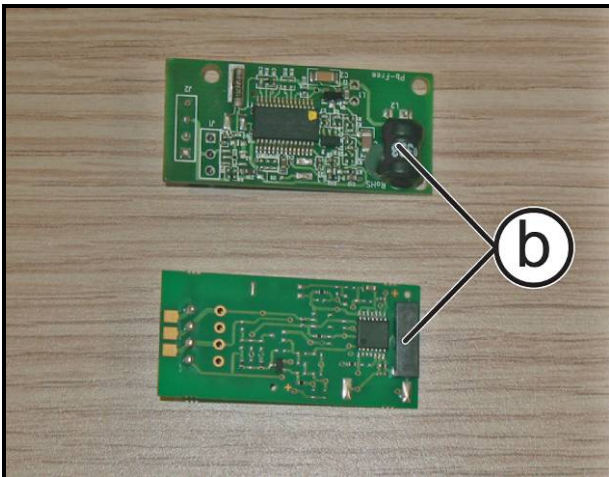


Figure 7.5-7

Carry out the steps described in the paragraph: 7.5.1. “HS/HR Receiver (Band/Hand Sensor)” as far as point (3).

1. Disconnect the cable from the connector (a) on the receiver.

**WARNING:** During re-assembly, position the receiver so that the coil (b), highlighted in the figure, is turned upwards against the guard (f), of Figure 7.5-3.

*In order to re-fit the HR Receiver, carry out the above operations in reverse.*



## 7.6. DISMANTLING THE HANDLEBARS

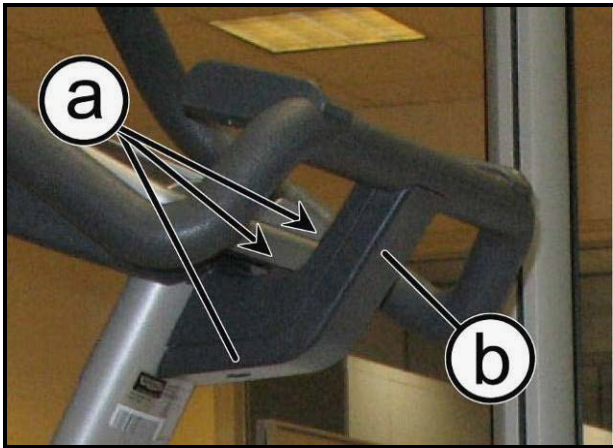


Figure 7.6-1

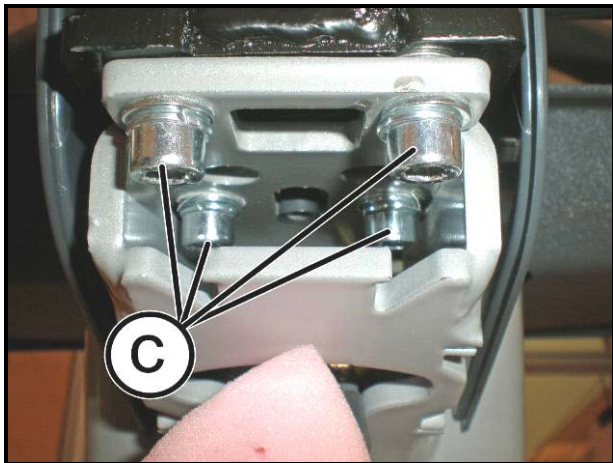


Figure 7.6-2

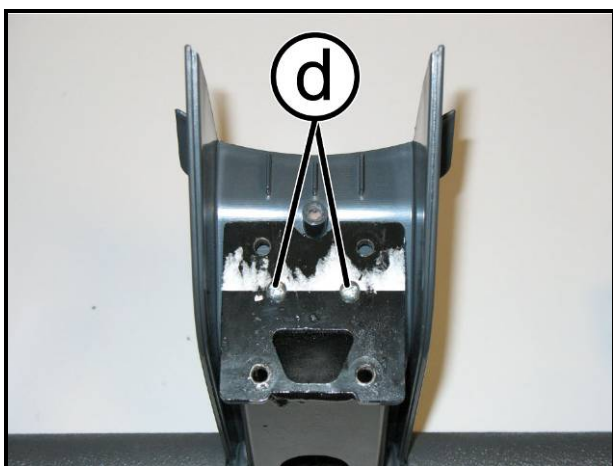


Figure 7.6-3

1. Unscrew the 3 screws (a) using a medium-sized Phillips screwdriver.

2. Remove the bottom guard (b).

3. Unscrew the 4 screws (c) using a 5mm Allen wrench.

**⚠ WARNING:** Support the handlebars before unscrewing the last screw.

4. Remove the handlebars.

**● WARNING:** During re-assembly, tighten the screws (c) using a torque wrench set at 16Nm.

In order to dismantle the top guard, take the handlebars to a workbench:

5. Unscrew the 2 screws (d) using a small Phillips screwdriver.

*In order to re-fit the handlebars, carry out the above operations in reverse.*

## 7.7. DISMANTLING THE HAND SENSOR



Only for the 700, 700SP and 700VISIO/VISIOWEB versions.

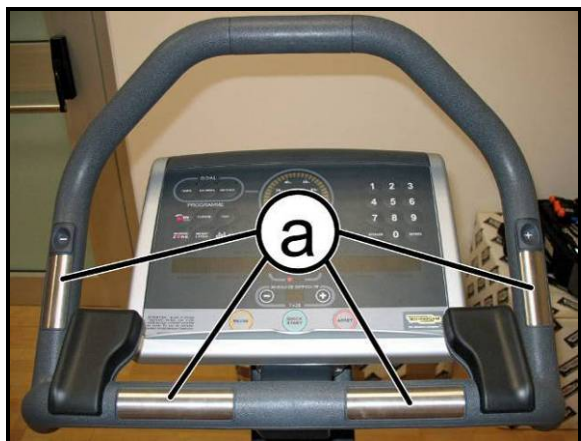


Figure 7.7-1

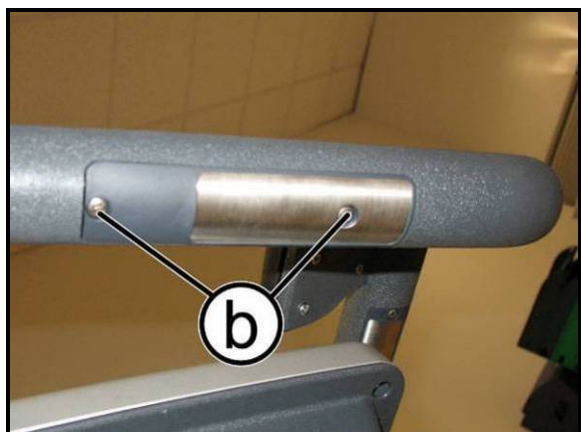


Figure 7.7-2

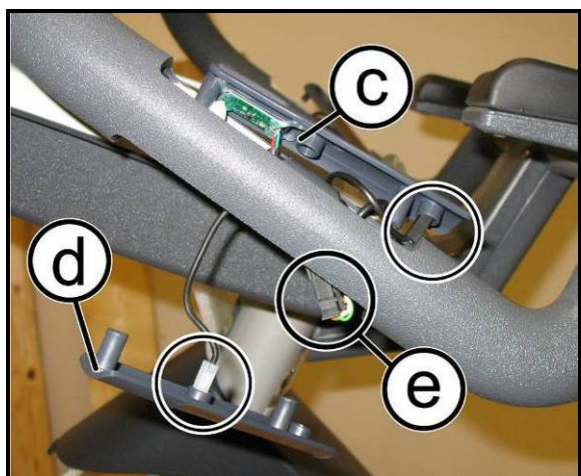


Figure 7.7-3

Switch off the equipment and remove the power supply plug from the wall socket.

**⚠** The following operations are valid for each of the 4 sensors (a).

1. Unscrew the two screws (b) using a small Phillips screwdriver.
2. Lift up the top sensor (c).
3. Remove the bottom sensor (d).
4. Disconnect the two fastons highlighted in the figure at the side.
5. In order to disconnect the Touch Sensors, disconnect the connector (e).

*To re-fit the sensors, carry out the above operations in reverse.*

## 7.8. DISMANTLING THE PEDAL AND THE PEDAL LEVER WITH GUARD



Figure 7.8-1

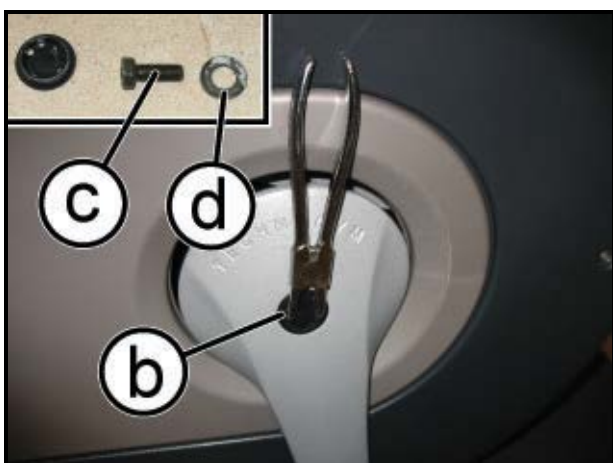


Figure 7.8-2

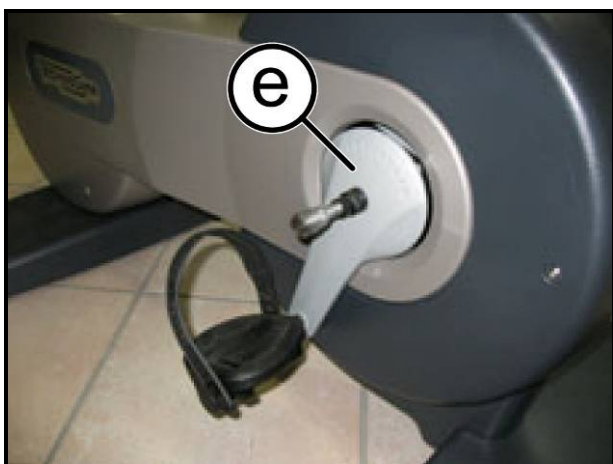


Figure 7.8-3

1. Unscrew the threaded pin (a) using a 15mm wrench and remove the pedal.

**WARNING:** During re-assembly, tighten the screws (a) using a torque wrench set at 32Nm.

*In order to dismantle the pedal lever:*

2. Unscrew the cap (b) using snap ring pliers or with scissors.
3. Unscrew the bolt (c) which you gain access to, using a 13mm socket wrench.
4. Remove the spacer (d).
5. Dismantle the pedal lever (e) using a common bicycle pedal remover as shown in the figure.

**WARNING:** During re-assembly, tighten the pedal lever using a torque wrench set at 40Nm.

*To re-fit the pedal and pedal lever, follow the above operations in reverse.*



## 7.9. DISMANTLING THE GUARD

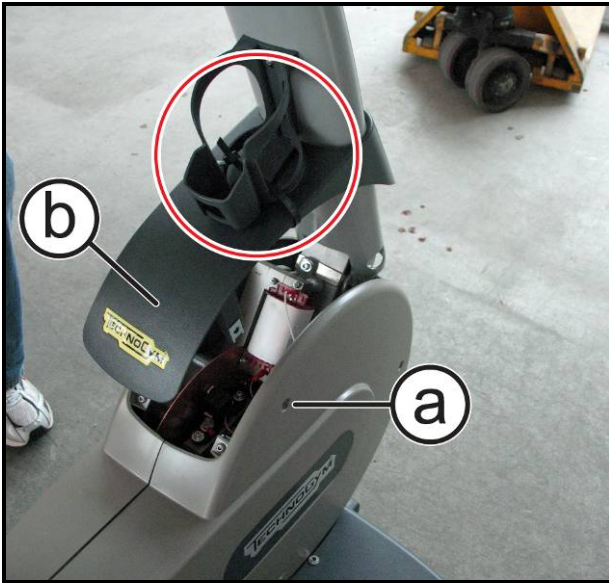


Figure 7.9-1

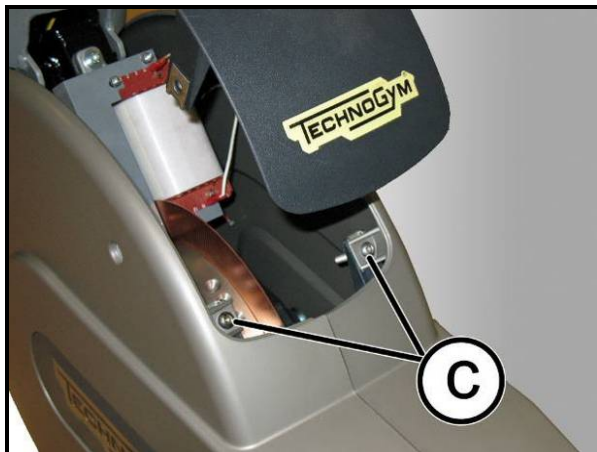


Figure 7.9-2

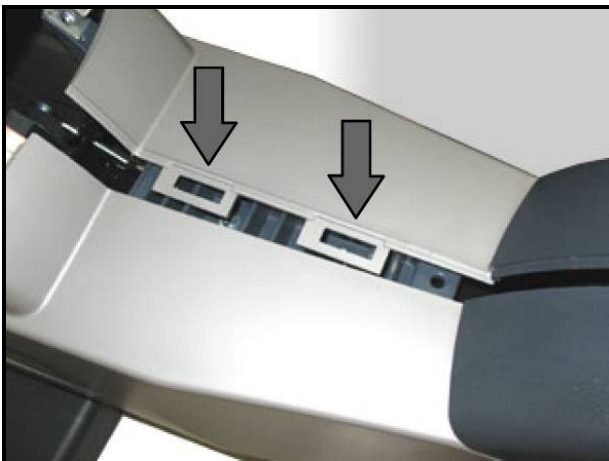


Figure 7.9-3

1. Unscrew the screw (a) using a 4mm Allen wrench.
2. Remove the top guard (b) and fix it with a strap, as shown in the figure at the side.

3. Unscrew the 2 screws (c) using a 4mm Allen wrench.

4. Gently press downwards on the top part of the right-hand guard in order to unhook it from the left-hand one, as shown in the figure.

*Continues on the next page...*

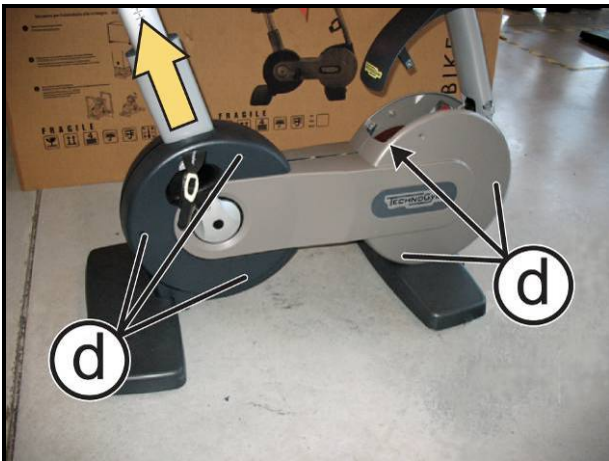


Figure 7.9-4



Figure 7.9-5



Figure 7.9-6

**On the right-hand side:**

5. Unscrew the 6 screws (**d**) using a 4mm Allen wrench.
6. Line up the pedal in line with the saddle support, as indicated by the yellow arrow.
7. Remove the right-hand guard.

**On the left-hand side:**



After removing the right-hand guard, all you need do for the left-hand side is unscrew the corresponding screws as highlighted in the figure at the side.

8. Protect the pedal as far as its base using a cloth, as indicated in the figure at the side.

*Continues on the next page...*

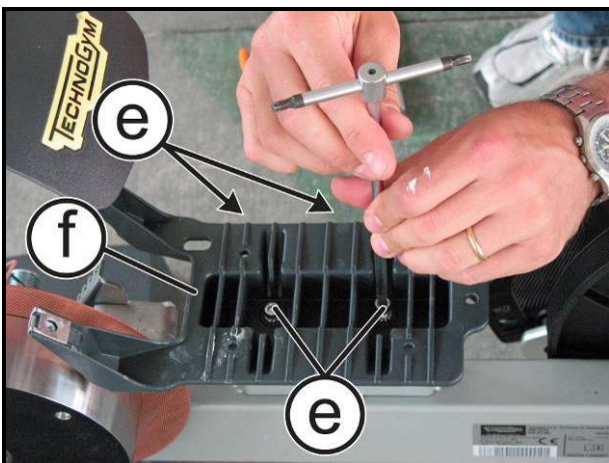


**Figure 7.9-7**



**Figure 7.9-8**

9. With care, lift the guard slightly (**Figure 7.9-7**) in order to pass it through the pedal (**Figure 7.9-8**).



**Figure 7.9-9**

10. Unscrew the 2 top screws (**e**) using a 4mm Allen wrench and loosen the 2 side screws.  
11. Remove the central support (**f**).

*In order to re-fit the guards, carry out the above operations in reverse.*



## 7.10. DISMANTLING THE PULLEY UNIT WITH PEDAL CRANK

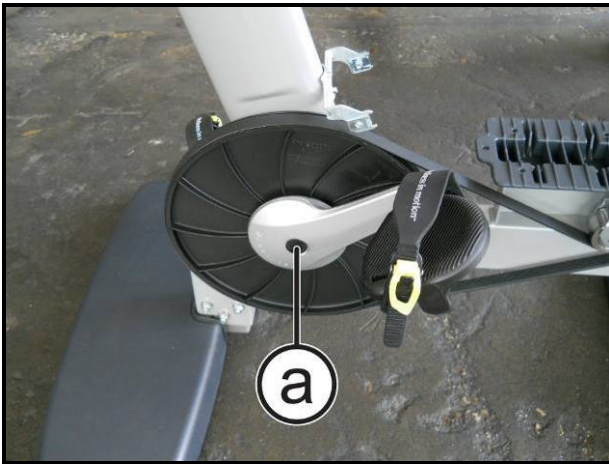


Figure 7.10-1

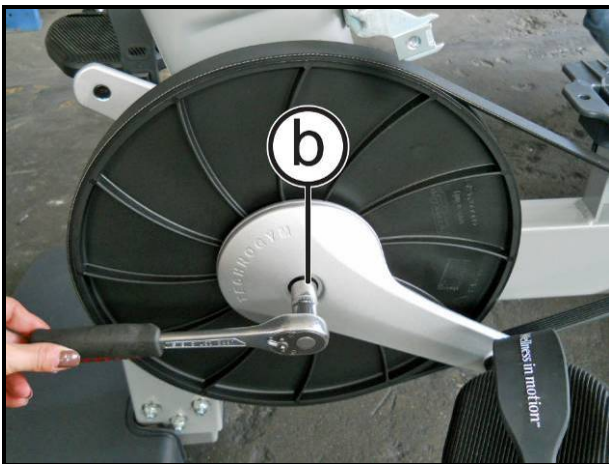


Figure 7.10-2

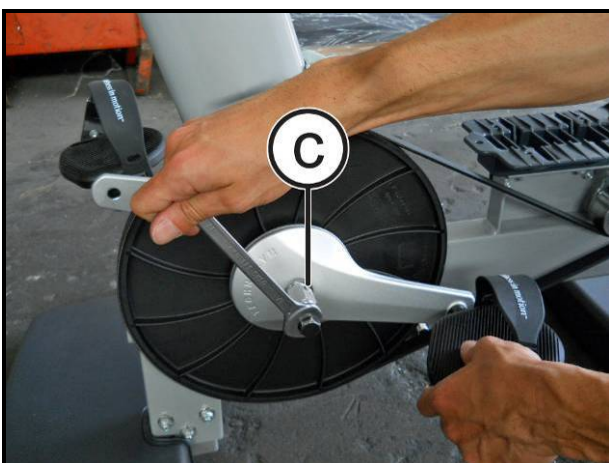


Figure 7.10-3

Carry out the operations in the paragraph: 7.1. “IMPORTANT NOTE ON DISMANTLING” and 7.9. “Dismantling the guard”.

1. Unscrew the cap (a) using snap ring pliers or scissors.

2. Unscrew the bolt (c) using a 13mm socket wrench.

3. Dismantle the pedal lever (c) using a common bicycle pedal remover as shown in the figure.

**WARNING:** During re-assembly, tighten the pedal lever using a torque wrench set at 40Nm.

Continues on the next page...

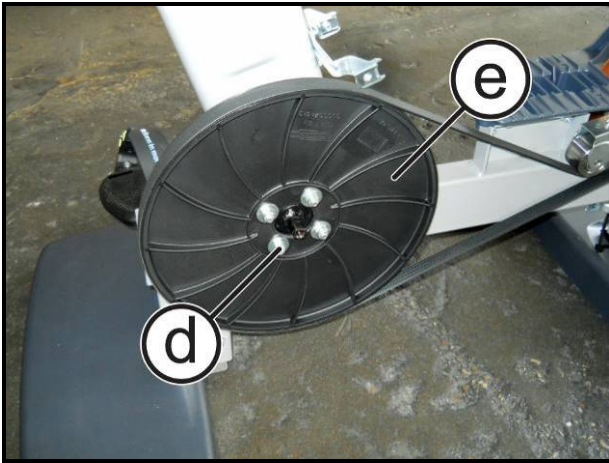


Figure 7.10-4

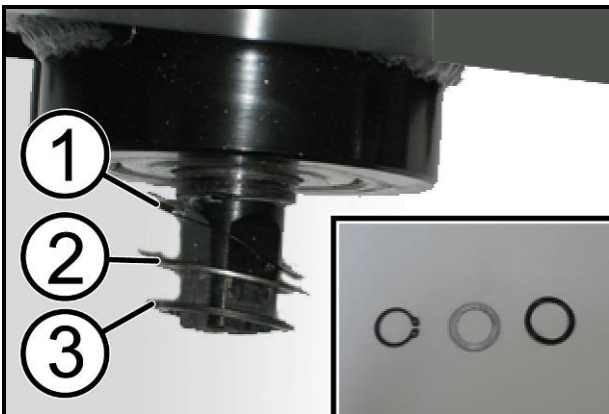


Figure 7.10-5

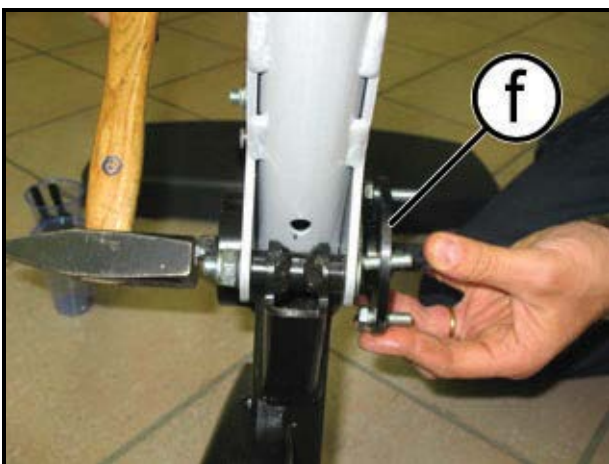


Figure 7.10-6

4. Unscrew the 4 nuts (**d**) using a 13mm wrench, while blocking the screws on the opposite side, using a wrench of the same size.

**WARNING:** During re-assembly, position the screws at the top inside of the flange before refitting the shaft onto the frame.

**WARNING:** During re-assembly, tighten the screws (**d**) using a torque wrench set at 22Nm.

5. On the left-hand side of the equipment, remove the snap ring (**3**), the spacer (**2**) and the elastic spring (**1**).

**WARNING:** During re-fitting, take care to re-insert the components according to the sequence shown in the figure.

6. Remove the pulley shaft (**f**) from the right-hand side, as shown in the figure.

*To re-fit the pulley unit, follow the above operations in reverse.*



## 7.11. DISMANTLING THE SEAT

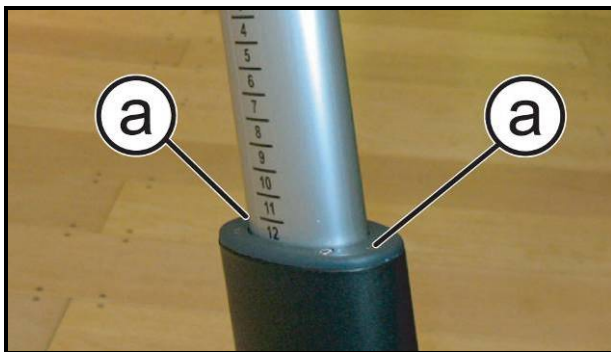


Figure 7.11-1

1. Unscrew the 2 screws (a) using a 4mm Allen wrench and slide off the bush.



Figure 7.11-2

2. Give a gentle knock to the bush of the end-of-run (b), raising the seat above its maximum height, so as to facilitate its removal from the frame.
3. Lift the bush (b) by exerting leverage under the housing of the screws, if necessary.



Figure 7.11-3

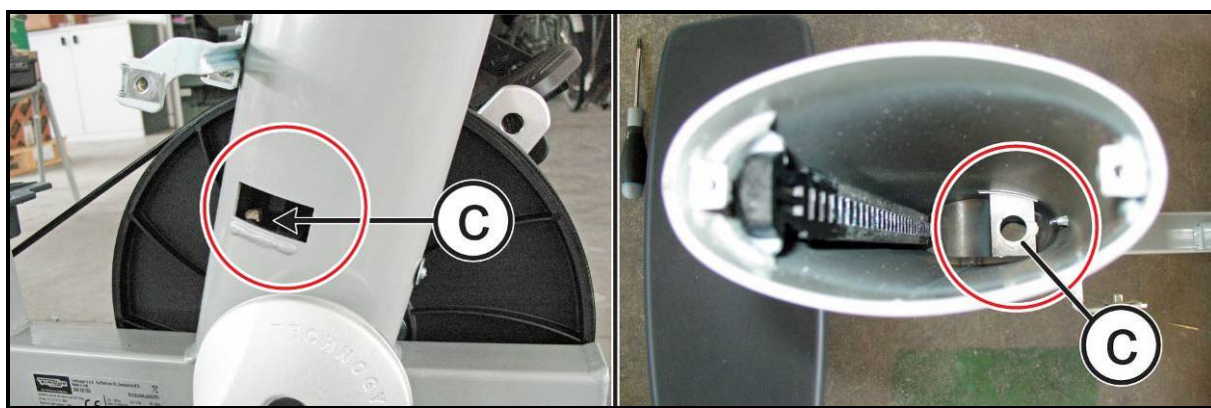
4. Continue to press on the seat adjustment system under the saddle and slide off the Seat Unit.

*Continues on the next page...*

## 7.12. DISMANTLING THE RETAINER BUSHING

### 7.12.1. VERS. 2, MACCHINE VALIDE DA MATRICOLA:

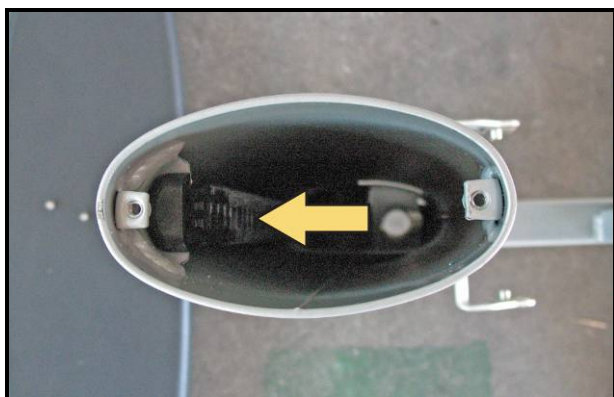
- 500                    DAC23L12000624
- 500SP                DAC24L12000932
- 700                    DAC33L12000403
- 700SP                DAC34L12000487
- 700 VISIO          DAC33W12001927



**Figure 7.12-1**

1. You can remove the bushing (c) and replace it if needed, through the slot in the frame highlighted in the picture above.

*To re-fit the seat group, follow the above operations in reverse considering the following notes:*

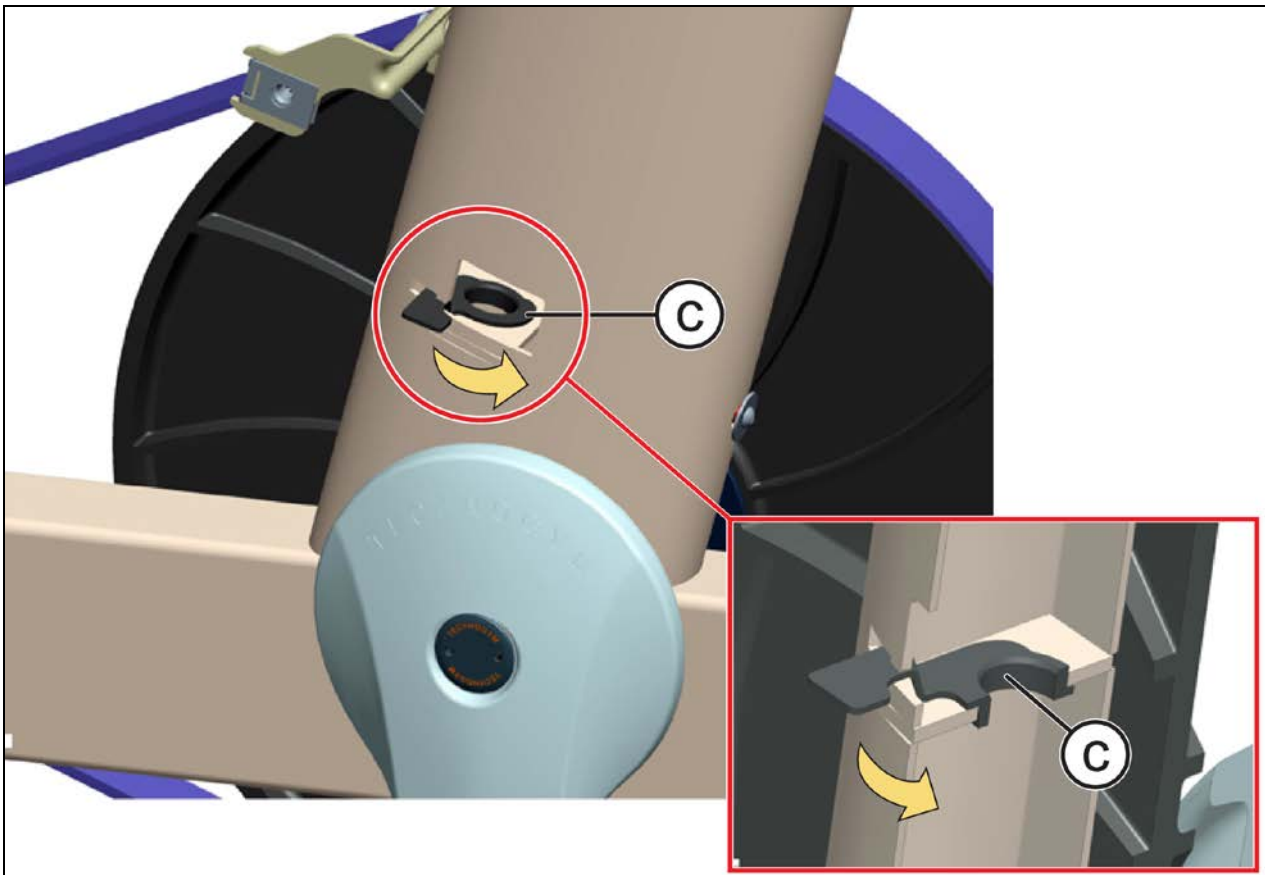


**Figure 7.12-2**

2. When you insert the seat group, keep the adjusting handle (under the seat) pressed.
3. Insert the seat group and place it just on the selecting plate, as indicated by the yellow arrow.
4. Slowly move the seat group downward to centre the bushing on the lower part of the frame.

**7.12.2. VERS. 2, VALID ON EQUIPMENT FROM SERIAL NUMBERS:**

- 500                    DAC23L12000625
- 500SP                DAC24L12000933
- 700                    DAC33L12000404
- 700SP                DAC34L12000488
- 700 VISIO            DAC33W12001928

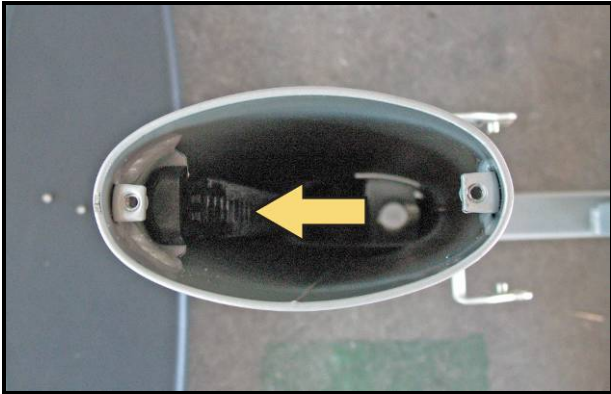


**Figure 7.12-3**

1. Lightly force the bushing (c) lever downward and rotate it in the direction of the yellow arrow, to remove it.

*To re-fit the seat group, follow the above operations in reverse considering the following notes:*

*Continues on the next page...*



**Figure 7.12-4**

2. When you insert the seat group, keep the adjusting handle (under the seat) pressed.
3. Insert the seat group and place it just on the selecting plate, as indicated by the yellow arrow.
4. Slowly move the seat group downward to centre the bushing on the lower part of the frame.

## 7.13. DISMANTLING THE SADDLE

### 7.13.1. VERS. 2, MACCHINE VALIDE DA MATRICOLA:

- 500 DAC23L12000624
- 500SP DAC24L12000932
- 700 DAC33L12000403
- 700SP DAC34L12000487
- 700 VISIO DAC33W12001927

#### 7.13.1.1. Dismantling the saddle padding

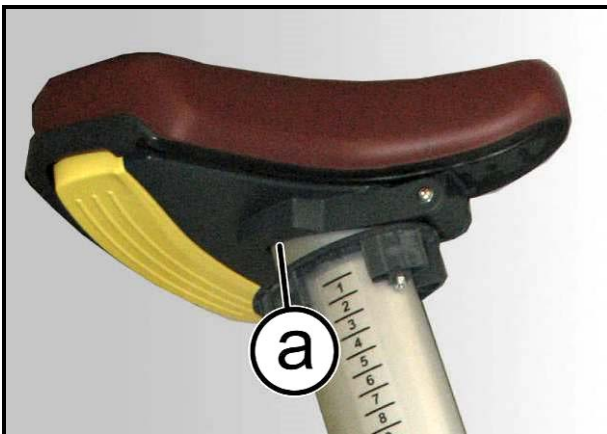


Figure 7.13-1

In order to replace the seat padding:

1. Unscrew the 2 screws (a) using a small Phillips screwdriver.



Figure 7.13-2

2. Unscrew the screw (b), while blocking the pin on the opposite side, with the use of two 3mm Allen wrenches

*Continues on the next page...*



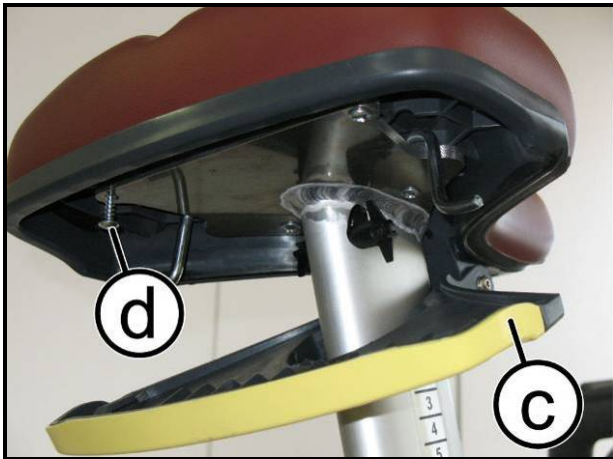


Figure 7.13-3

3. Remove the handle (c) and unscrew the 4 screws (d) using a medium-sized Phillips screwdriver.

4. Remove the padding.

**WARNING:** During re-assembly, tighten the screws using a torque wrench set at 5Nm.

*To re-fit the seat padding, follow the above operations in reverse.*

### 7.13.1.2. Dismantling the saddle selection system

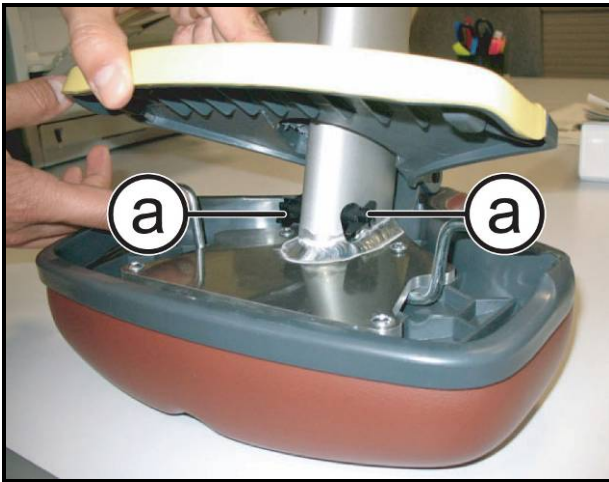


Figure 7.13-4

Carry out the operations in the paragraph:7.11. “Dismantling the seat”, as far as point (4).

With the seat unit on the workbench:

1. Remove the 2 plugs (a) in opposite directions to each other and slide off the spring hooking pin.

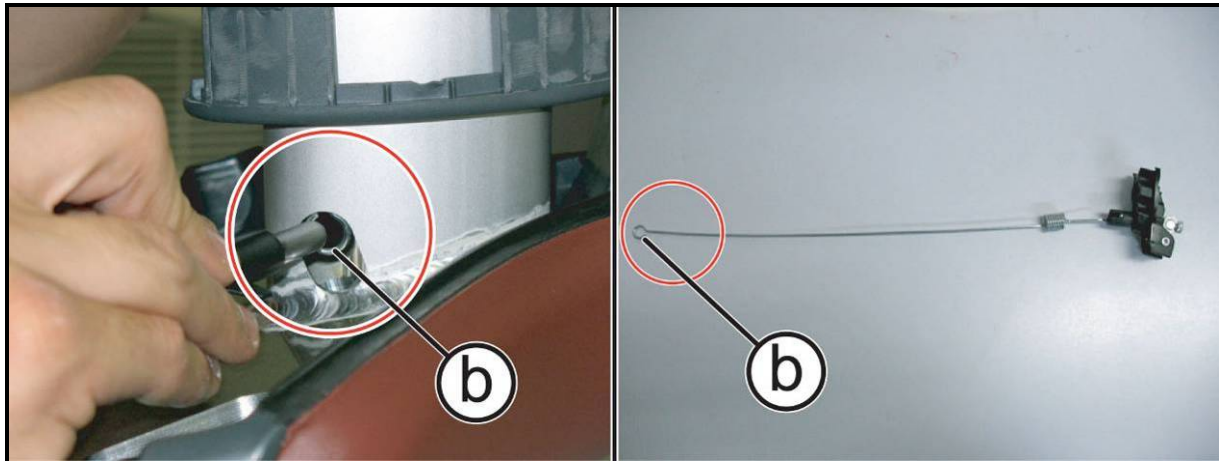


Figure 7.13-5



**WARNING:** During re-fitting, take care to re-insert the pin inside the eyelet of the spring (b) on the selection system, as shown in the figure above.

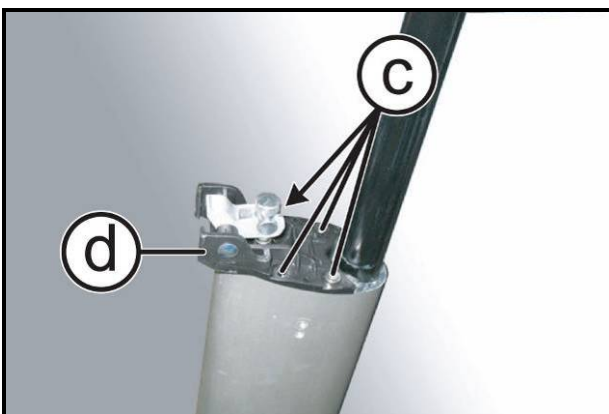


Figure 7.13-6

2. Unscrew the 4 screws (c) using a 3mm Allen wrench and remove the selection system unit (d).

*Continues on the next page...*



**Figure 7.13-7**

**WARNING:** Re-insert the spring in such a way as to prevent it coming off easily, as shown in the figure.

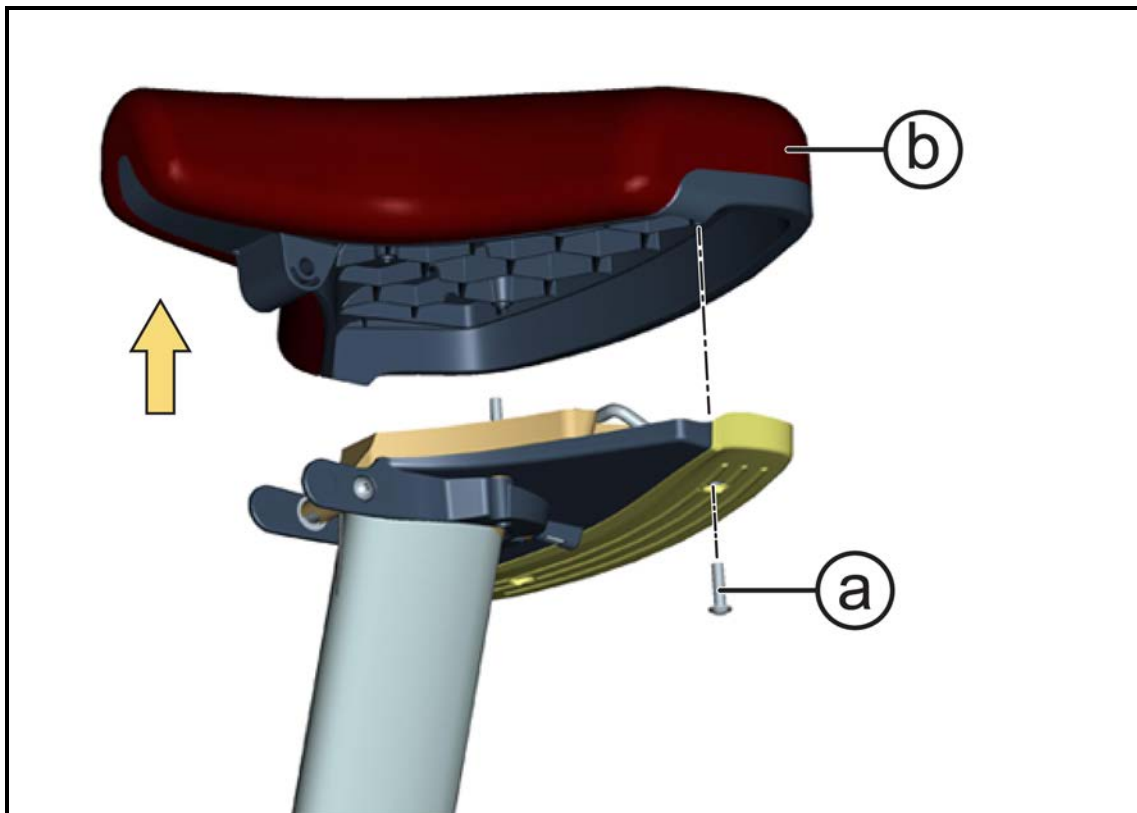
*To re-fit the seat unit, follow the above operations in reverse.*



### 7.13.2. VERS. 2, VALID ON EQUIPMENT FROM SERIAL NUMBERS:

- 500 DAC23L12000625
- 500SP DAC24L12000933
- 700 DAC33L12000404
- 700SP DAC34L12000488
- 700 VISIO DAC33W12001928

#### 7.13.2.1. Dismantling the saddle padding

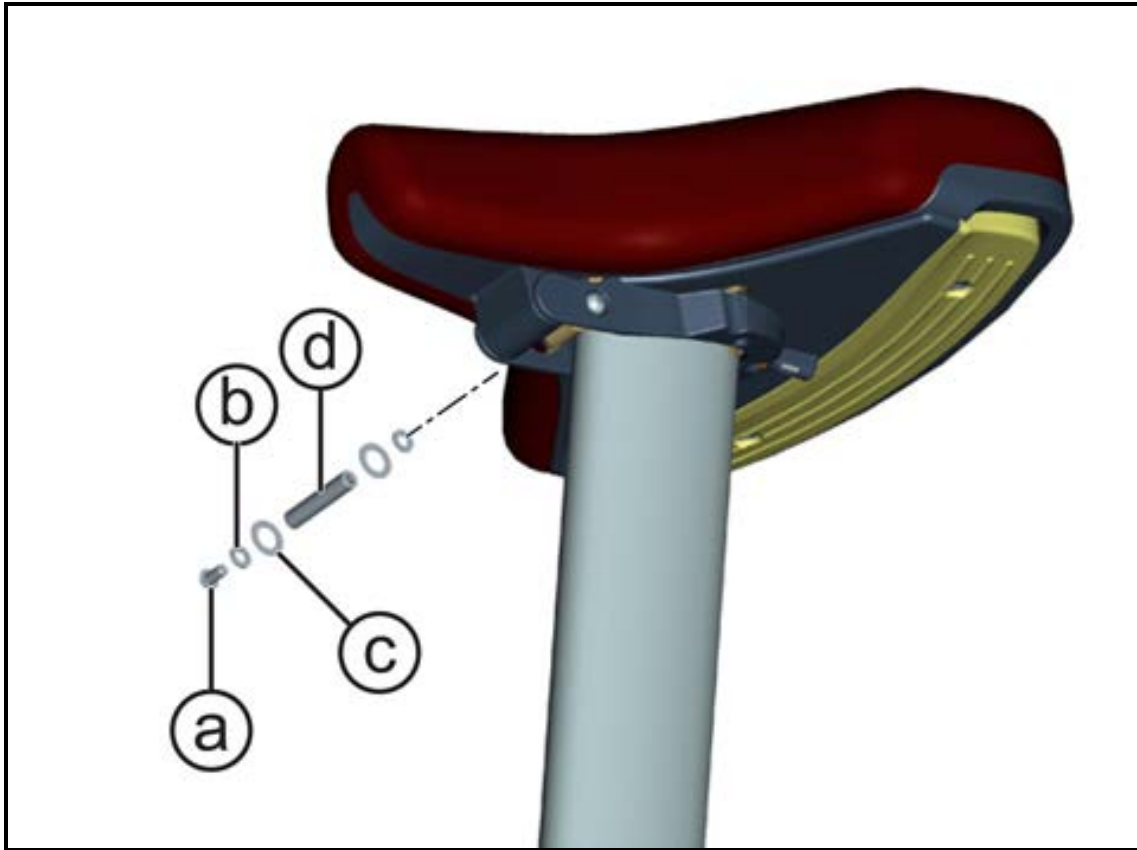


**Figure 7.13-8**

1. Unscrew the 4 screws (a) using a medium size Phillips screwdriver.
2. Remove the seat padding (b).

*To re-fit the seat unit,  
follow the above operations in reverse.*

### 7.13.2.2. Dismantling the saddle handle pin

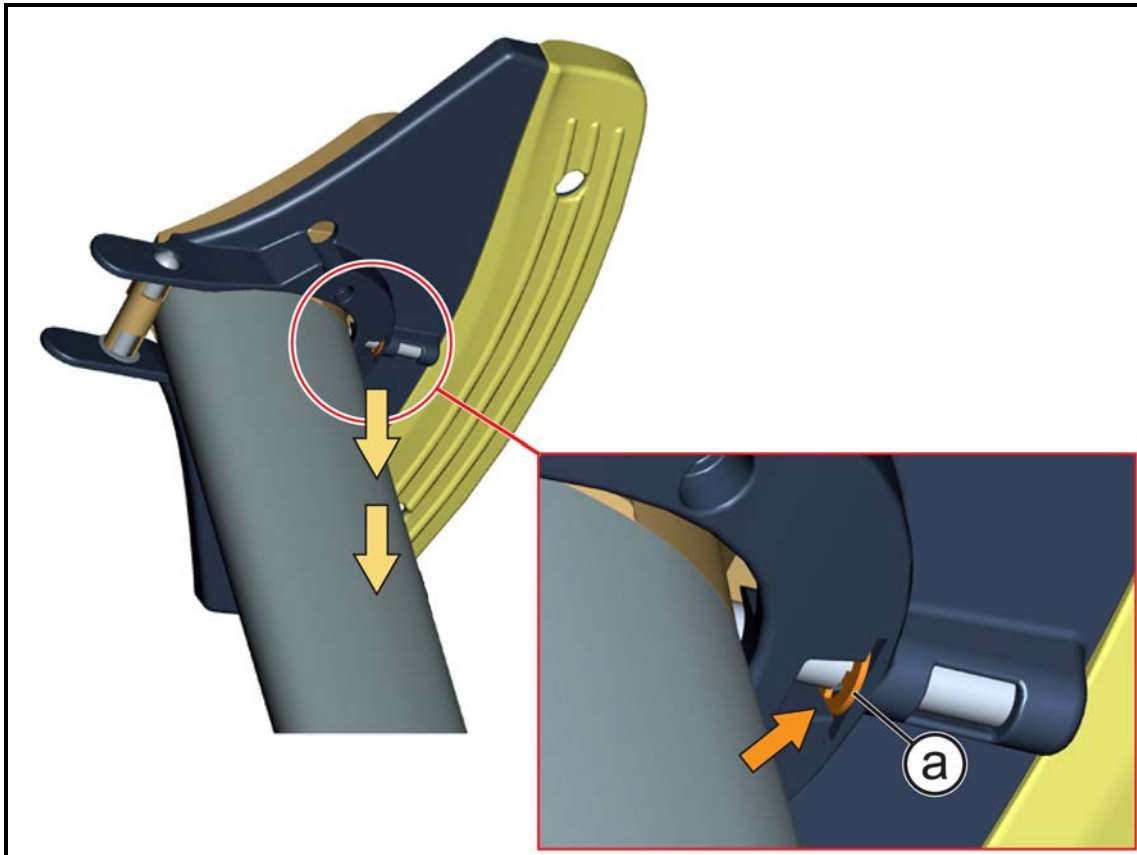


**Figure 7.13-9**

1. On both the sides, unscrew the screw **(a)** using a 3mm Allen wrench.
2. Remove the spacers **(b)** and **(c)** and the pin **(d)**.

*To reassemble the components ,  
carry out the above steps in reverse order.*

### 7.13.2.3. Dismantling the spring pin and the handle

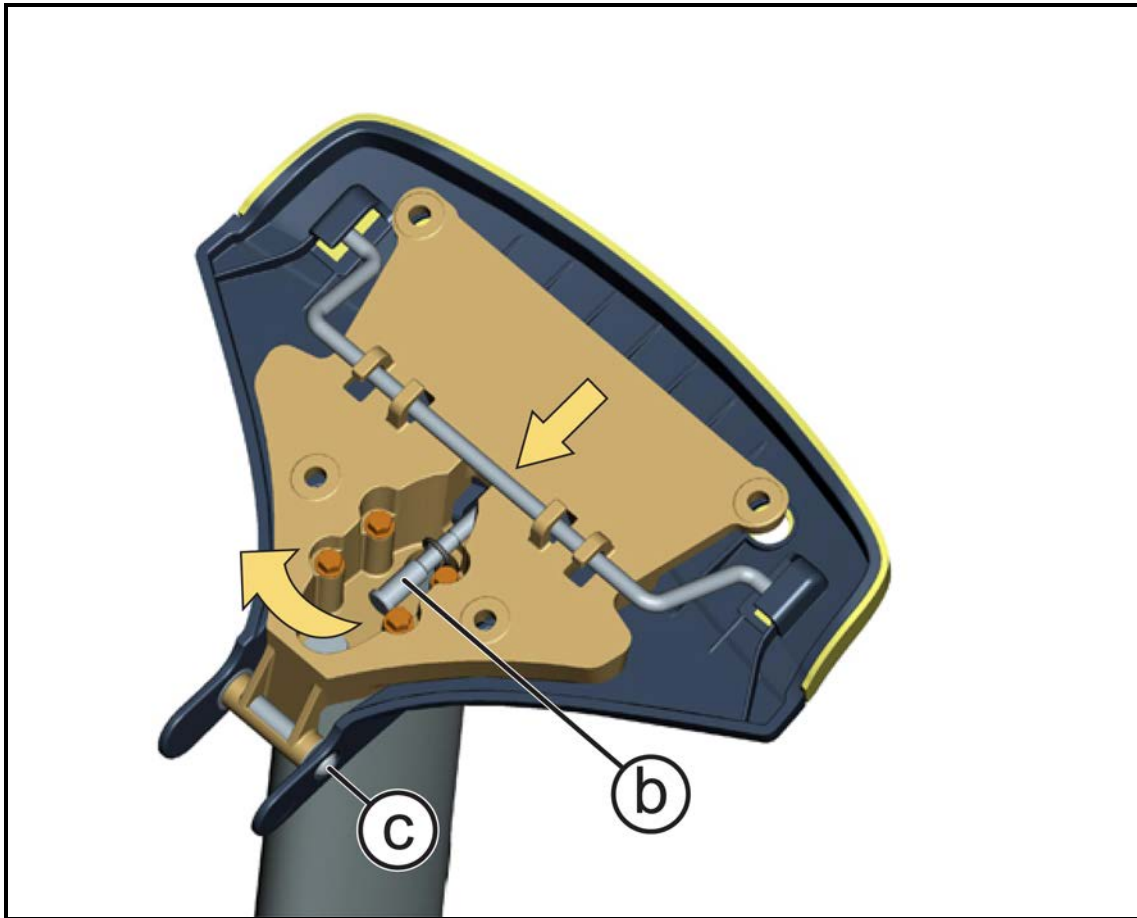


**Figure 7.13-10**

*Carry out the procedure at paragraph: 7.13. “Dismantling the saddle”.*

1. Use a small size flat screwdriver to remove the external snap ring (a), indicated by the orange arrow in the direction of the yellow arrow.

*Continues on the next page...*

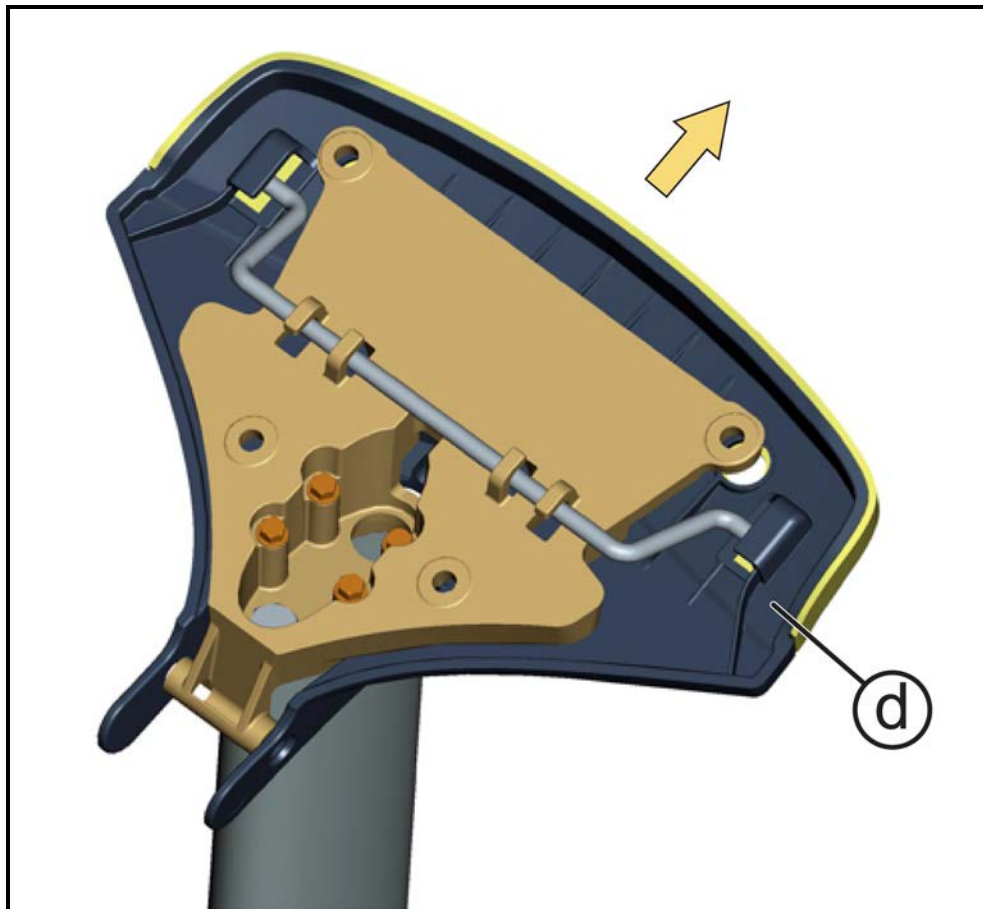


**Figure 7.13-11**

2. Remove the pin (b) in the direction of the yellow arrows.
3. Remove the pin (c) as indicated at paragraph: **7.13.2.2“Dismantling the saddle handle pin”**.

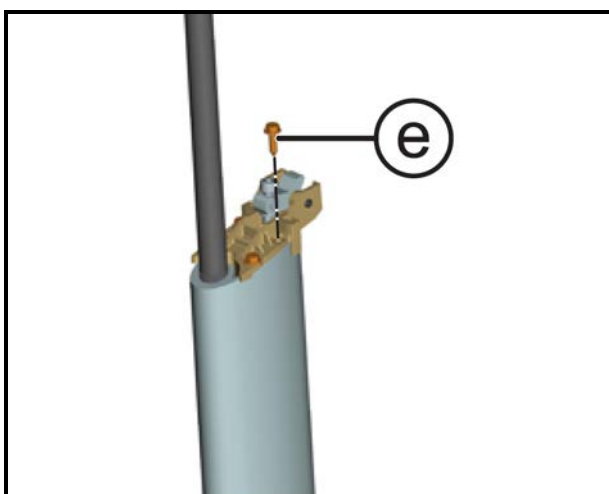
*Continues on the next page...*

To remove the handle:



**Figure 7.13-12**

4. Remove the handle (**d**) in the direction of the yellow arrow.



**Figure 7.13-13**

Bring the seat group on a workbench:

1. Reverse the seat group.
2. Unscrew the 4 screws (**e**) using a 7mm socket wrench.

*Continues on the next page...*

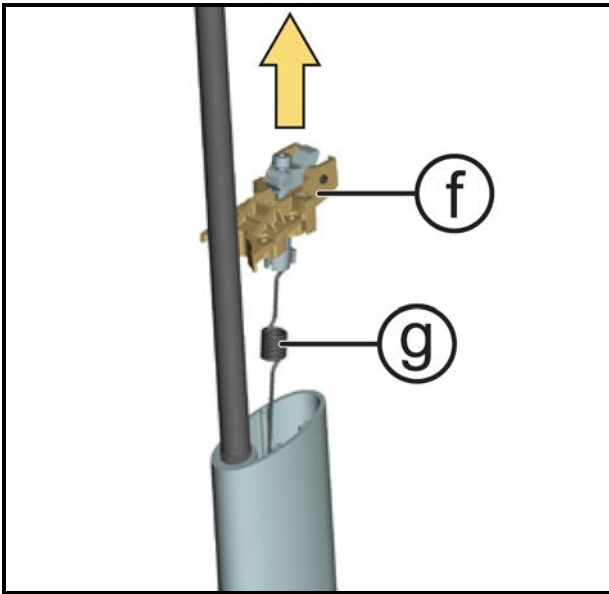


Figure 7.13-14

3. Remove the selecting system group (f) in the direction of the yellow.
4. Remove the spring (g).

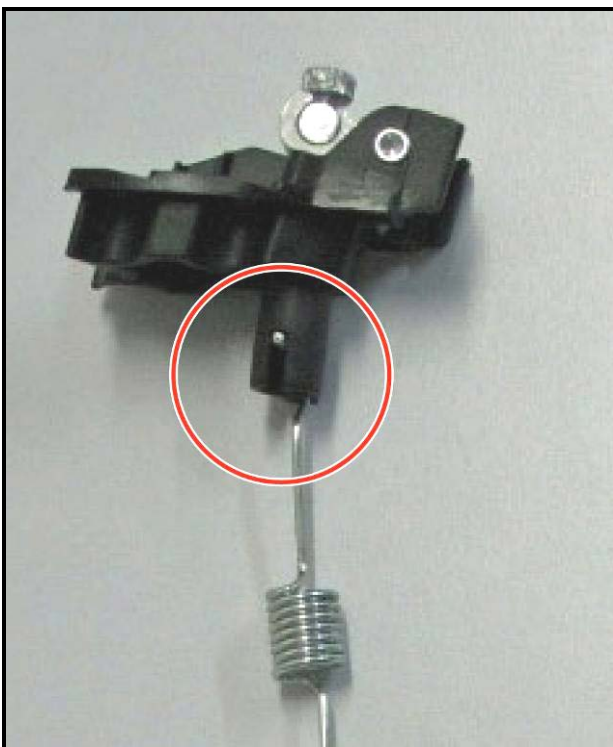
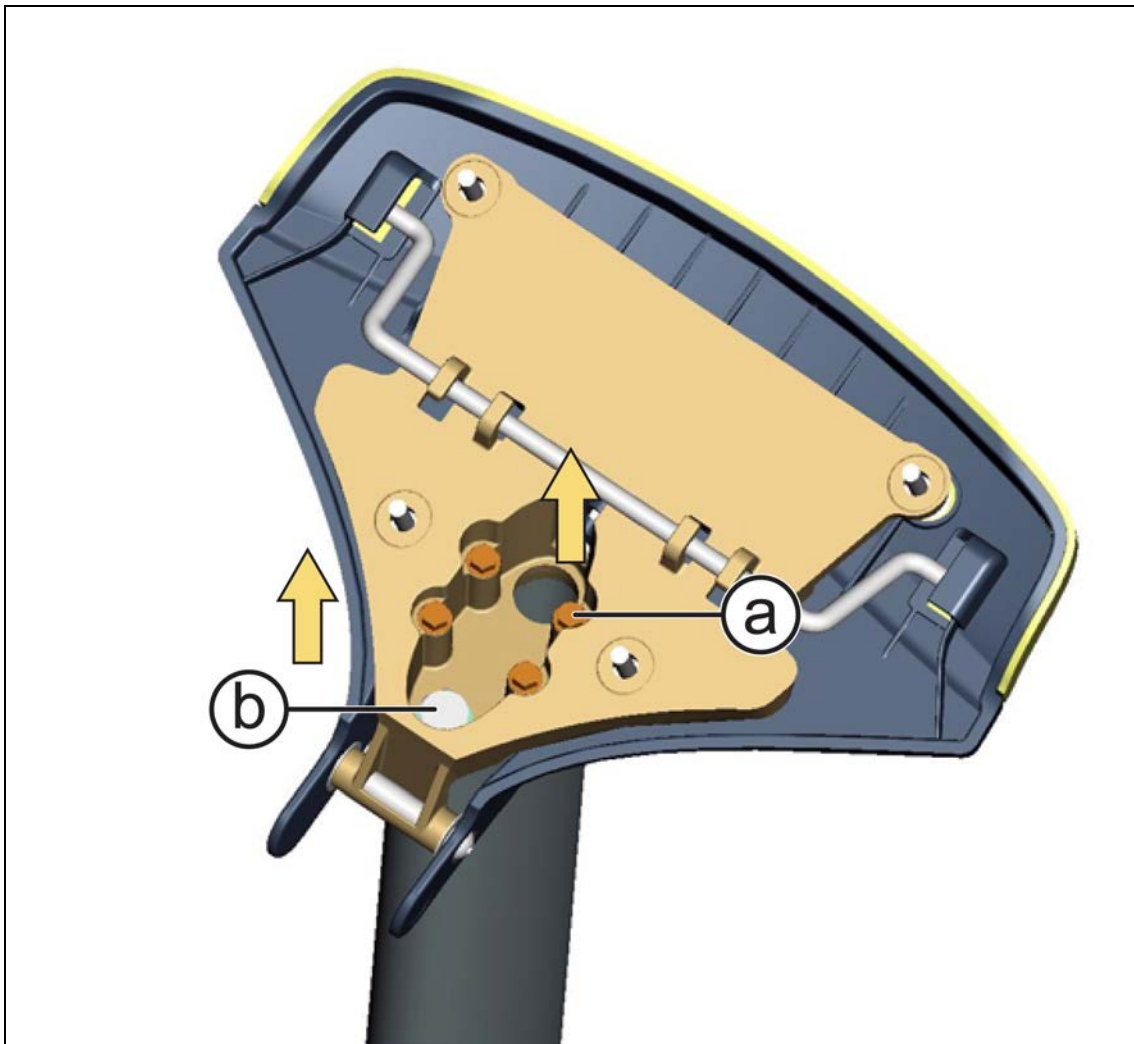


Figure 7.13-15

**WARNING:** insert the spring again as indicated in the figure at side.

*To reassemble the components , carry out the above steps in reverse order.*

#### 7.13.2.4. Dismantling the handle support plate



**Figure 7.13-16**

*Carry out the procedure at paragraph: 7.13.2.3 “Dismantling the spring pin and the handle”.*

1. Unscrew the 4 screws (**a**) using a 7mm socket wrench.
2. Unscrew the screw (**b**) using a 13mm socket wrench.
3. Remove the plate.

*To reassemble the components ,  
carry out the above steps in reverse order.*



### 7.13.2.5. Dismantling the handle pin

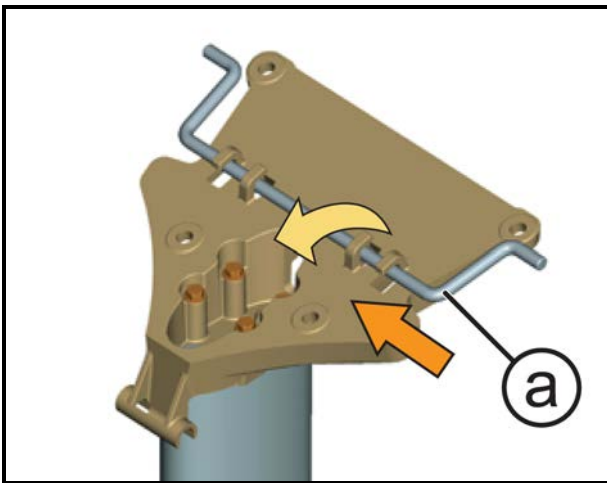


Figure 7.13-17

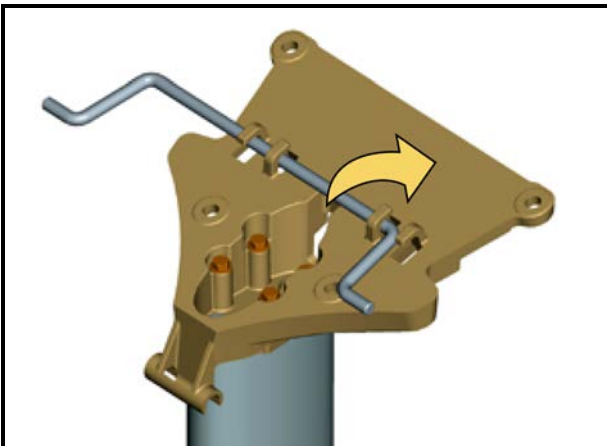


Figure 7.13-18

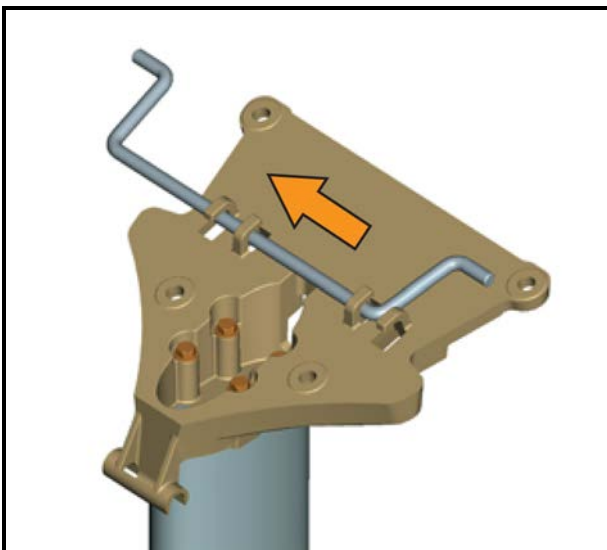


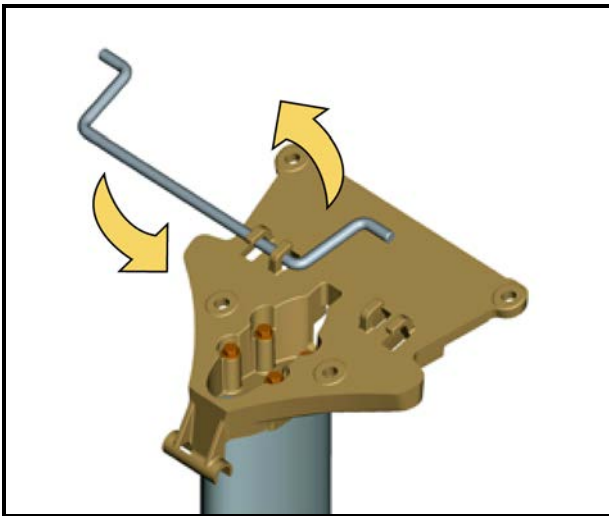
Figure 7.13-19

Carry out the procedure at paragraph:7.13.2.3 “Dismantling the spring pin and the handle”.

1. Rotate the lever (a) 180° in the direction of the yellow arrow.
2. Push the lever on the plate in the direction of the orange arrow and free it from the the first hook.
3. Rotate the lever again of 180° in the direction of the yellow arrow and free it from the second hook.
4. Push the lever on the plate in the direction of the orange arrow.

*Continues on the next page...*





**Figure 7.13-20**

5. Rotate the lever counter-clock wise and free the lever from the plate.
6. Remove the lever (**a**).

*To reassemble the components ,  
carry out the above steps in reverse order.*

## 7.14. DISMANTLING THE RACING SADDLE ACCESSORY

### 7.14.1. DISMANTLING THE RACING SADDLE

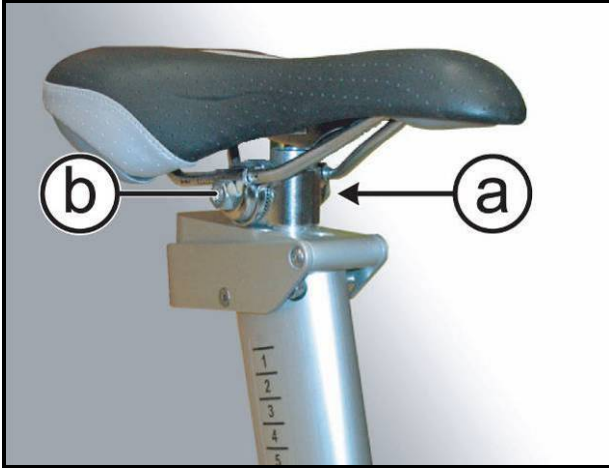


Figure 7.14-1

5. Unscrew the screw (a) using a 17mm wrench, while blocking the nut (b) on the opposite side using a 17mm wrench.
6. Remove the racing saddle.

### 7.14.2. DISMANTLING THE RACING SADDLE SUPPORT UNIT

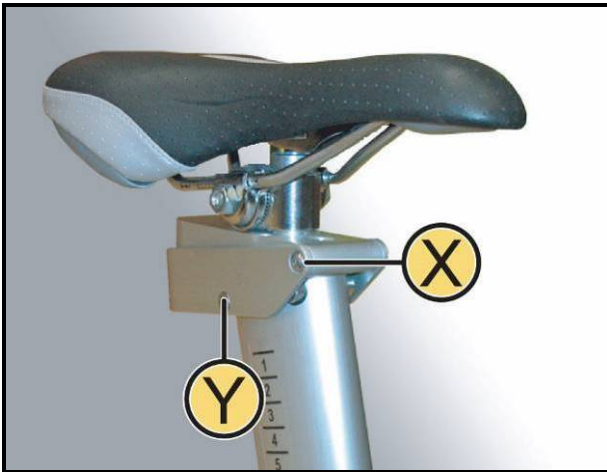


Figure 7.14-2

Carry out the operations in the paragraph: 7.11. Dismantling the seat”.

To remove the handle:



**Remove the pins that fix the handle in its respective positions (X) and (Y) as indicated below.**

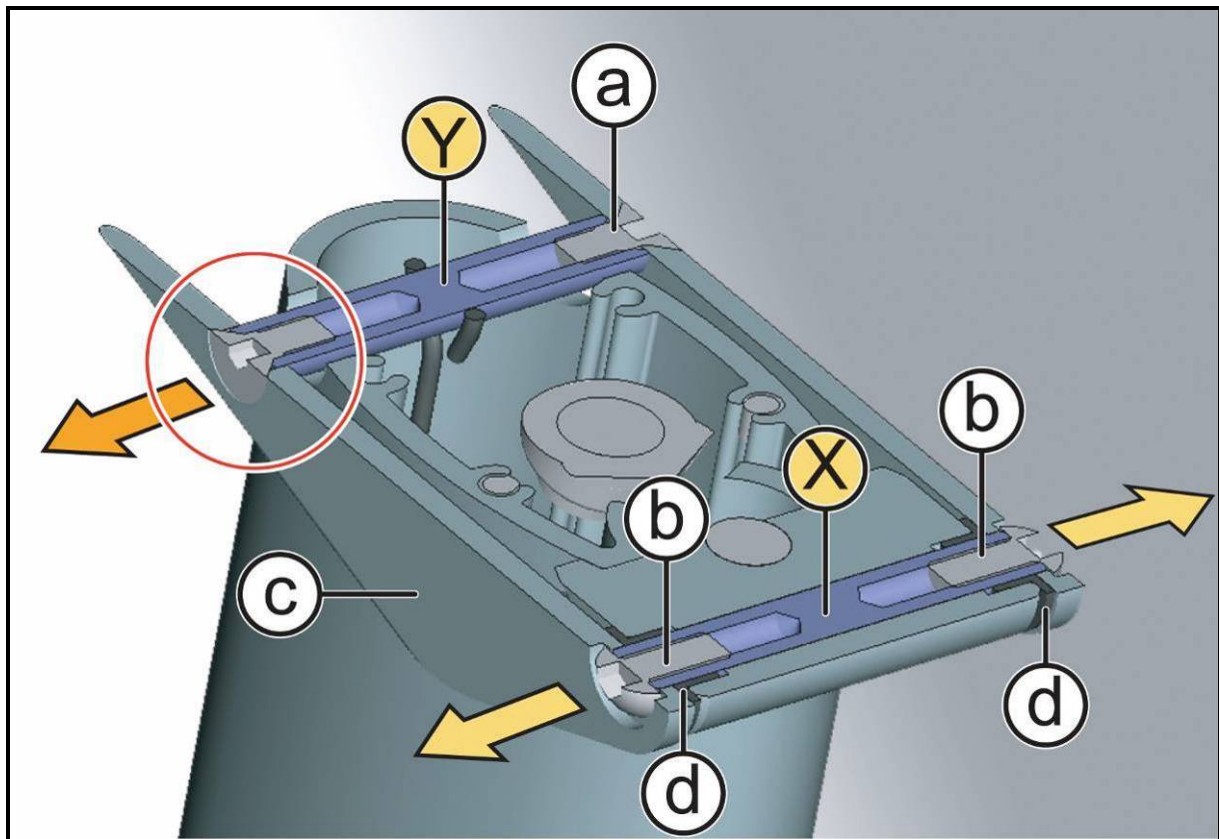
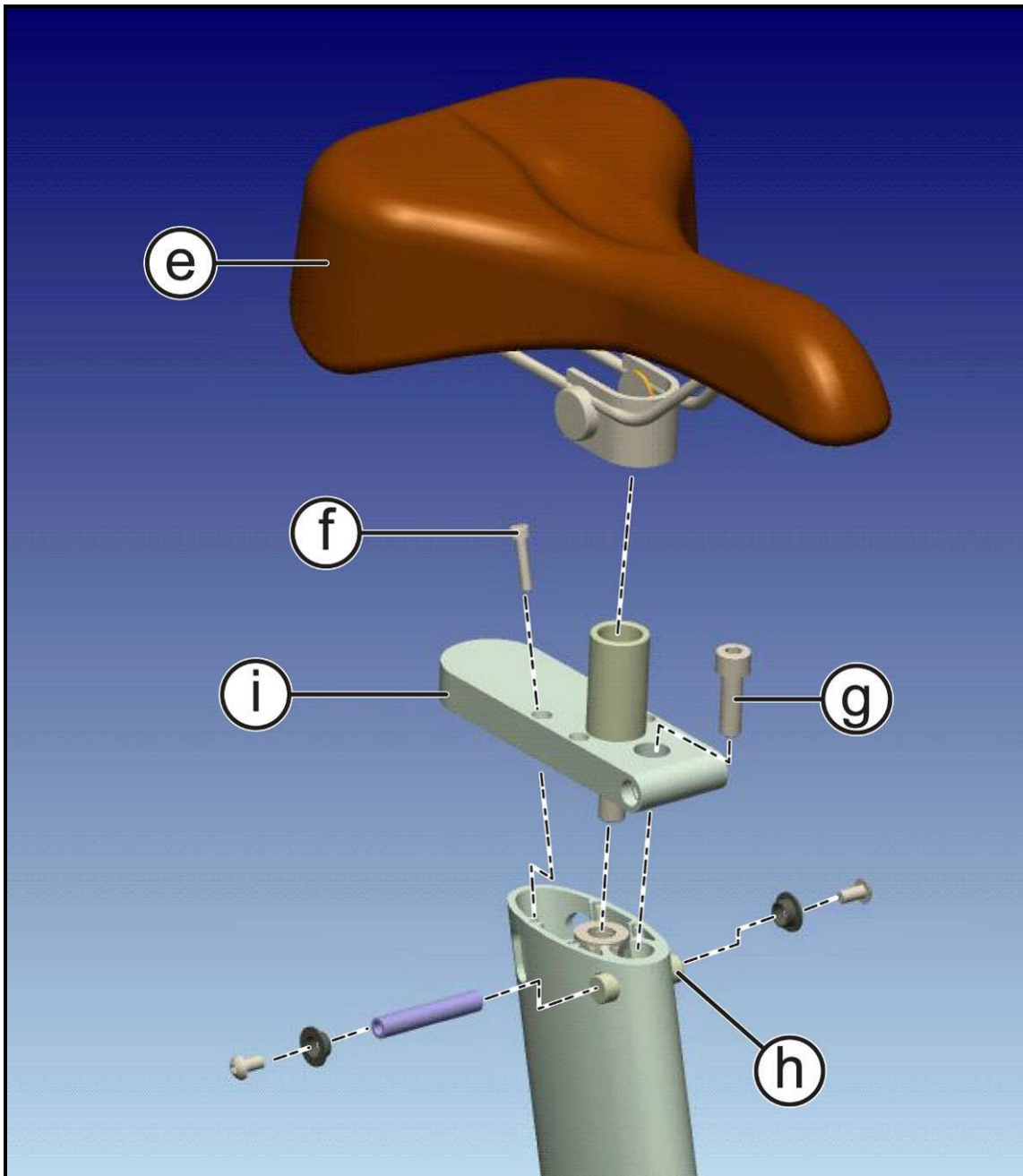


Figure 7.14-3

1. Unscrew the screw **(a)**, on the left-hand side of the equipment using a 3mm Allen wrench, while blocking the screw on the opposite side using the same kind of wrench and slide off the pin **(Y)** from the right-hand side with no stops, as indicated in the figure, in the direction of the orange arrow.
2. Unscrew the 2 screws **(b)** using a 3mm Allen wrench and remove the handle **(c)**.
3. Remove the 2 bushes **(d)** and the pin **(X)**.

*Continues on the next page...*



**Figure 7.14-4**

*To remove the racing saddle support:*

4. Remove the racing saddle (e) as indicated in the paragraph: 7.14.1. “Dismantling the racing saddle”.
5. Using a 3mm Allen wrench, unscrew the 4 screws (f) and with a 6mm Allen wrench, the screw (g).
6. Slide off the pin (h) and remove the racing saddle support (i).

*In order to re-fit the racing saddle unit  
carry out the above operations in reverse.*

## 7.15. DISMANTLING THE BELT AND BELT-TENSIONER

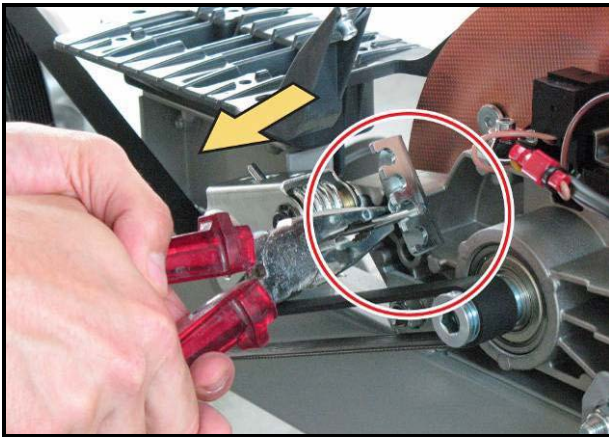


Figure 7.15-1

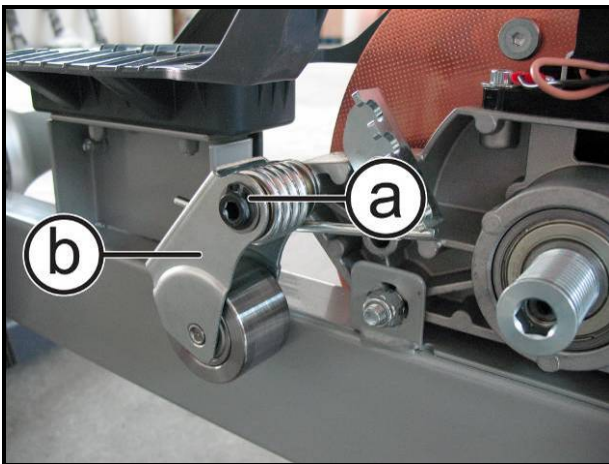


Figure 7.15-2

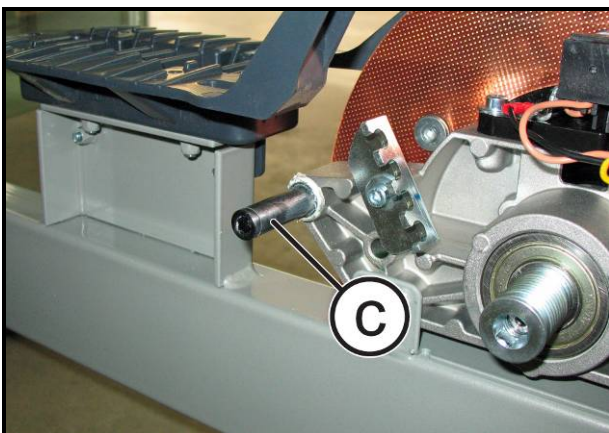




Figure 7.15-3

Carry out the operations in the paragraph: 7.1. "IMPORTANT NOTE ON DISMANTLING" and 7.9. "Dismantling the guard".

1. Make a mark on the initial position.
2. Unhook the spring from the selector.
3. Remove the belt.
4. Remove the snap ring (a) the underlying washer.
5. Remove the belt-tensioner (b).
6. Remove the pin (c) using a 6mm Allen wrench.

 **WARNING:** During re-assembly, tighten the pin (a) using a torque wrench set at 10Nm.

 During re-fitting, place some **LOCTITE 270** on the threaded side of the pin (c) and grease the part in contact with the belt-tensioner, using **MOLYCOTE W2** grease.

*To re-assemble the fitting, follow the above operations in reverse and pay attention to the following notes:*

*Continues on the next page...*



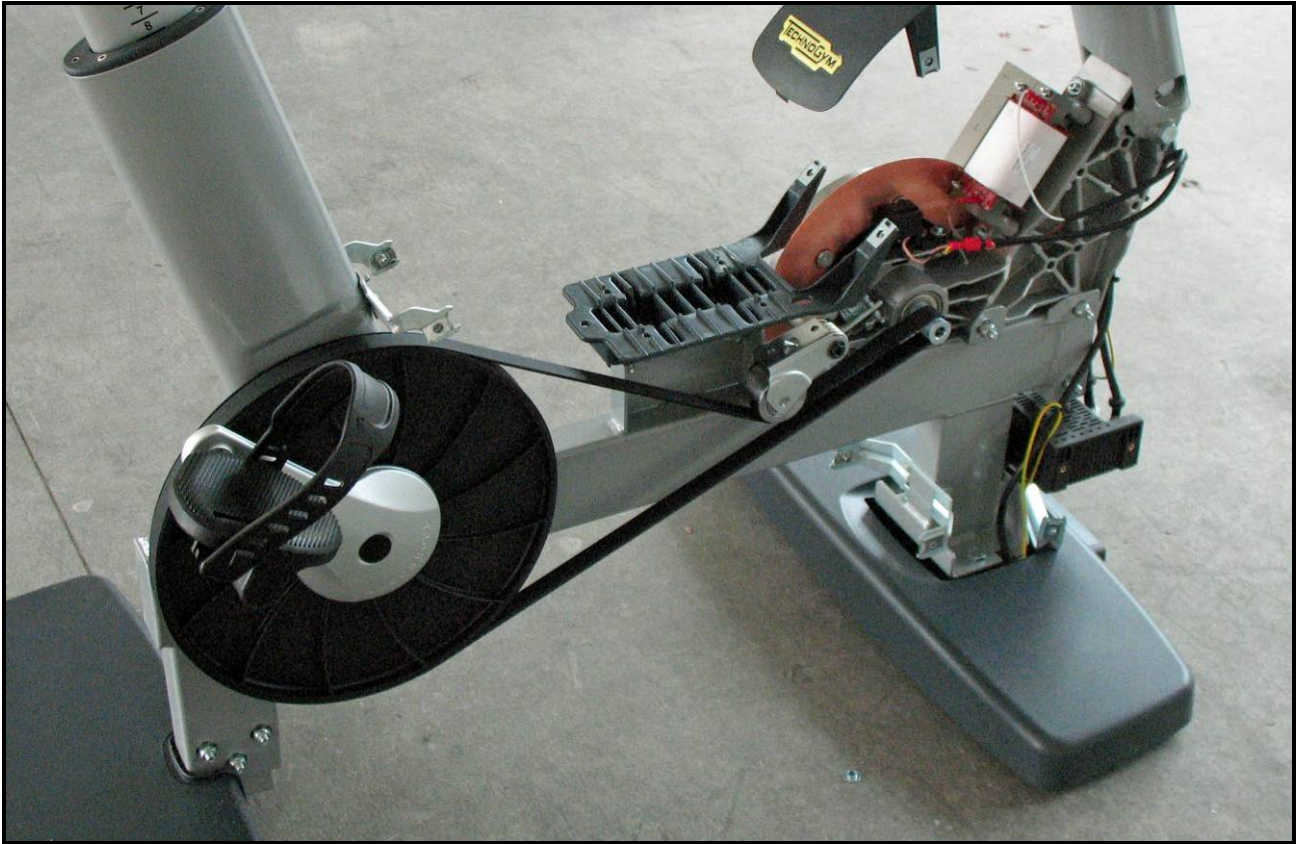


Figure 7.15-4

- **As regards the passage of the belt, refer to the figure at the side.**
  
- **WARNING: At the end of the operation, adjust the tension of the belt as described in the paragraph: 8.1. “Belt tension”**

## 7.16. DISMANTLING THE BRAKE AND THE FLYWHEEL UNIT

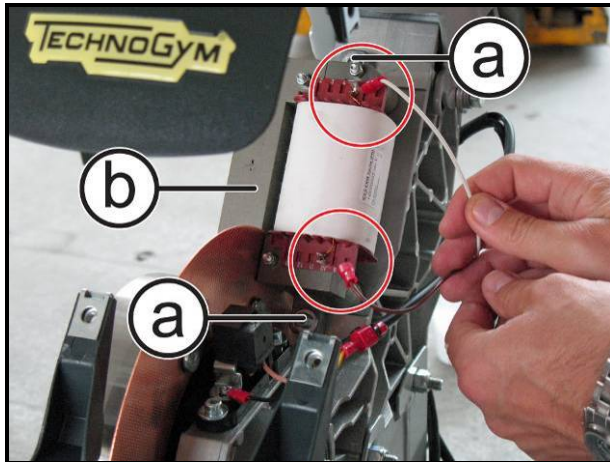


Figure 7.16-1

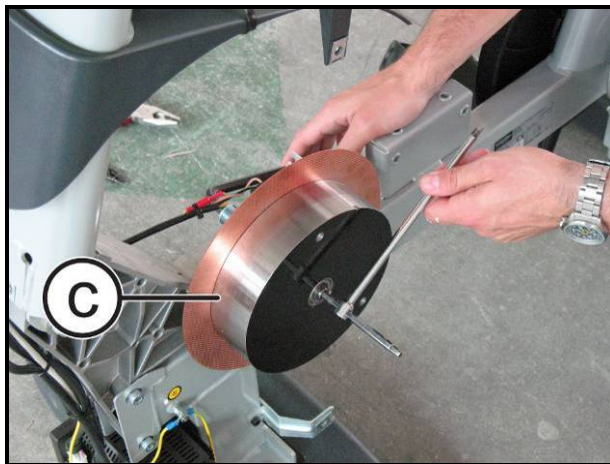


Figure 7.16-2

Carry out the operations in the paragraph: 7.1. “IMPORTANT NOTE ON DISMANTLING” and 7.9. “Dismantling the guard”.

1. Disconnect the two fastons on the brake winding, as highlighted in the figure at the side.
2. Unscrew the 2 stop screws (a) using a 4mm Allen wrench.
3. Remove the brake unit (b) with care.



**WARNING:** Pay particular attention to the copper disk as it could easily buckle.



**WARNING:** During re-assembly, tighten the screws (a) using a torque wrench set at 5Nm.

4. Unscrew the flywheel unit (a) from the central shaft, using a 6mm Allen wrench, while blocking it on the opposite side using a 10mm Allen wrench.
5. With care, remove the flywheel unit from the side opposite the speed sensor.



**WARNING:** After re-fitting the flywheel unit, use a comparator to check for any buckling on the copper disk with a margin of  $\pm 0.15\text{mm}$ .



**WARNING:** During re-assembly, tighten the flywheel using a torque wrench set at 25Nm.

*Continues on the next page...*

**POWERED Version:**

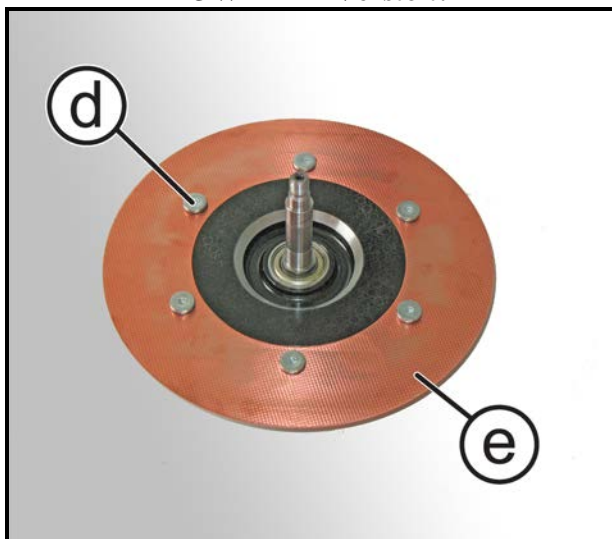


Figure 7.16-3

**SELF-POWERED Version:**

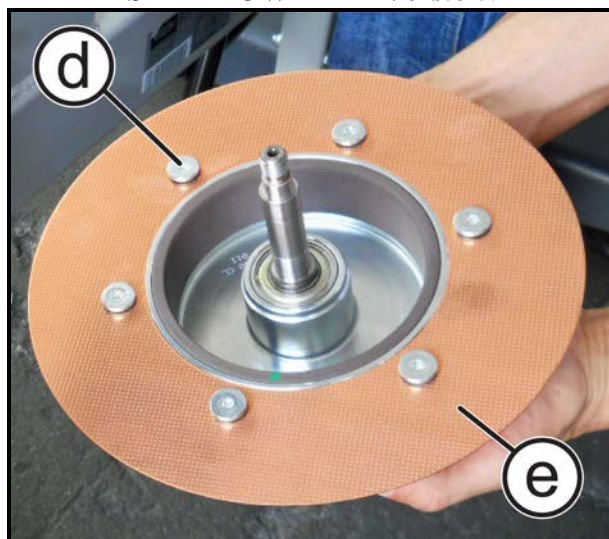


Figure 7.16-4

**In order to remove the copper disk:**

1. Unscrew the 6 screws (d) using a 4mm Allen wrench.
2. Remove the copper disk (e).

**WARNING:** During re-assembly, tighten the screws (d) using a torque wrench set at 6Nm.

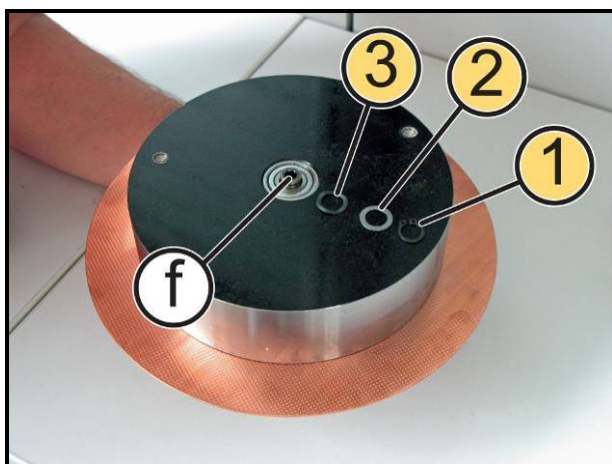


Figure 7.16-5

**To remove the central shaft:**

6. In sequence, remove the snap ring (1), the spacer (2) and the elastic washer (3).
7. Remove the central shaft (f).

*To re-assemble the fitting, follow the above operations in reverse and pay attention to the following note:*

**WARNING:** At the end of the operation, adjust the position of the flywheel, as described in the paragraph: 8.5. "Adjusting the position of the brake unit".



## 7.17. DISMANTLING THE STATOR



Only for 500SP and 700SP versions.



Figure 7.17-1

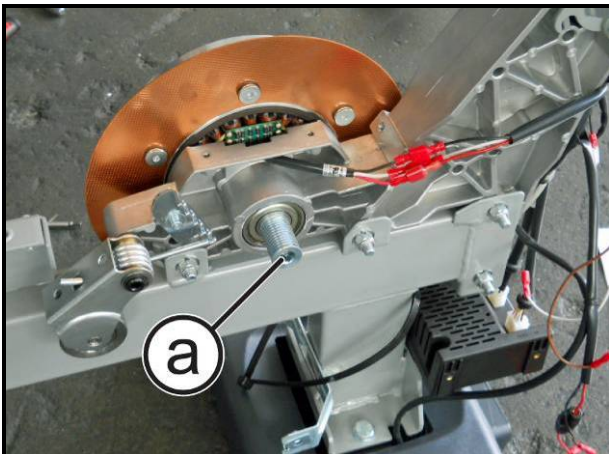


Figure 7.17-2

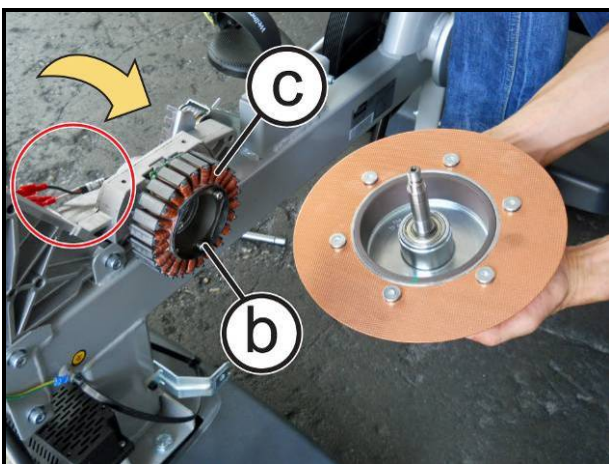


Figure 7.17-3

Carry out the operations in the paragraph: 7.1. "IMPORTANT NOTE ON DISMANTLING", 7.9. "Dismantling the guard" and 7.16. "Dismantling the brake and the Flywheel Unit" as far as point (3).

1. Unscrew the flywheel unit from the central shaft, using a 6mm Allen wrench, while blocking it on the opposite side using a 10mm Allen wrench.
2. Remove the small pulley (a).
3. Remove the Flywheel Unit.
4. Unscrew the 3 screws (b) using a 4mm Allen wrench.
5. Slide the cable off with care, as indicated by the yellow arrow.
6. Remove the stator (c).



**WARNING:** The screws (b) must be tightened using a torque wrench set at 22Nm.

To re-fit the Stator, follow the above operations in reverse.

## 7.18. DISMANTLING THE SPEED SENSOR

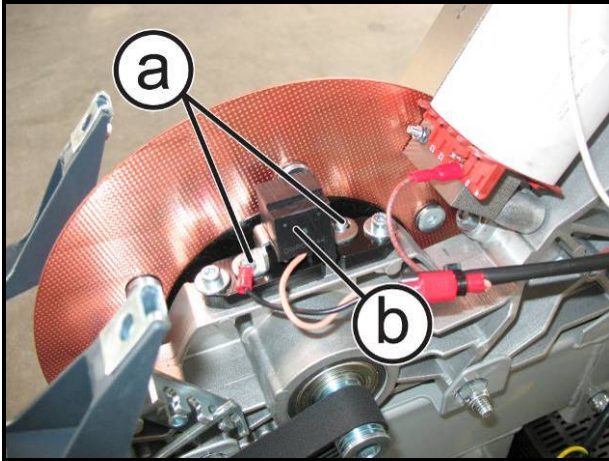


Figure 7.18-1

Carry out the operations in the paragraph: 7.1. “IMPORTANT NOTE ON DISMANTLING” and 7.9. “Dismantling the guard”.

1. Unscrew the 2 screws (a) using a medium-sized Phillips screwdriver.
2. Remove the speed sensor (b).

*To re-fit the speed sensor, follow the above operations in reverse.*



**WARNING:** If you also remove the sensor's plastic support, adjust the position of the sensor, as described in the paragraph: 8.4. “Adjusting the position of the speed sensor”.

## 7.19. DISMANTLING THE BRAKE BOARD

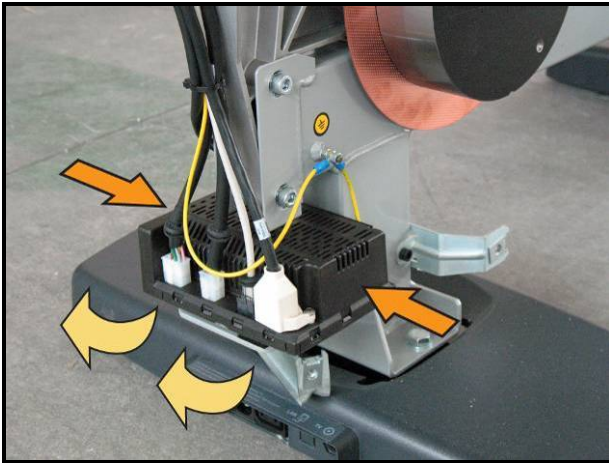


Figure 7.19-1

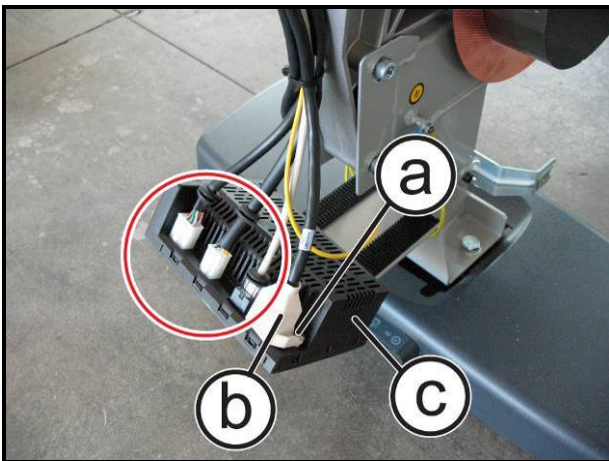


Figure 7.19-2



Figure 7.19-3

Carry out the operations in the paragraph: 7.1. “IMPORTANT NOTE ON DISMANTLING” and 7.9. “Dismantling the guard”.

1. Remove the Brake Board from the equipment, gripping it with your hands as indicated by the orange arrows and pull in the direction of the yellow arrows.
2. Remove the Brake Board from its housing.
3. Disconnect the 3 connectors highlighted in the figure.
4. Unscrew the blocking screw (a) from the mains power supply connector (b) and disconnect it.
5. Remove the Brake Board (c).

*To re-fit the Brake Board, follow the above operations in reverse.*

**WARNING:** If you replace the Brake Board, be careful not to cover the Board details and the SN with the Velcro adhesive strip.

## 7.20. DISMANTLING THE BATTERY



Only for 500SP and 700SP versions.

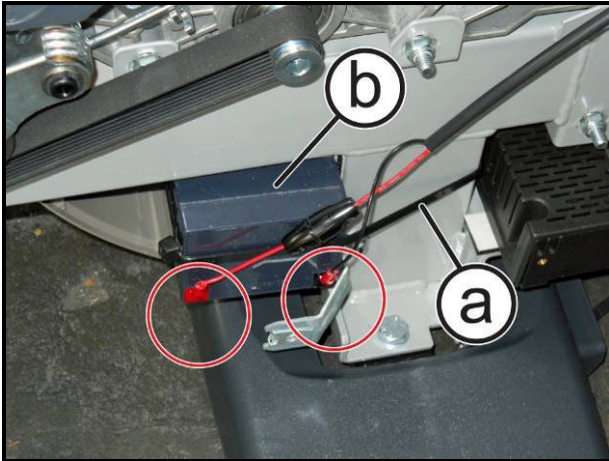


Figure 7.20-1

Carry out the operations in the paragraph: 7.1. “IMPORTANT NOTE ON DISMANTLING” and 7.9. “Dismantling the guard”.

1. Disconnect the fastons highlighted in the figure.
2. Cut the strap (a).
3. Remove the battery (b).

To re-fit the Battery, follow the above operations in reverse.



## 7.21. DISMANTLING THE PLATFORMS

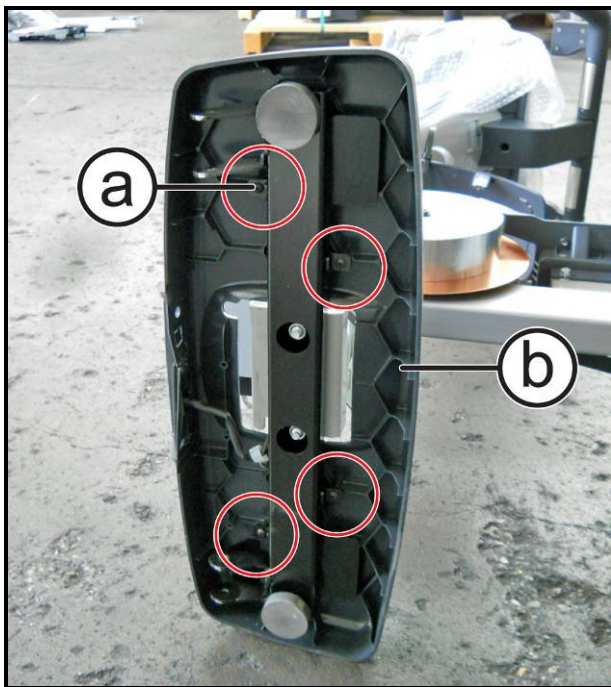


Figure 7.21-1

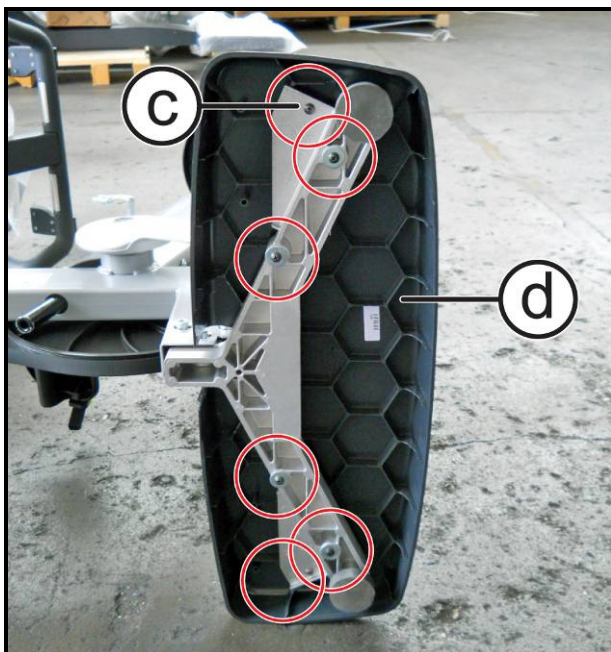


Figure 7.21-2

### Front Platform:

1. Unscrew the 4 screws (a) using a medium-sized Phillips screwdriver.
2. Remove the front platform (b).

### Rear Platform:

3. Unscrew the 6 screws (c) using a medium-sized Phillips screwdriver.
4. Remove the rear platform (d).

*In order to re-fit the Platforms, carry out the above operations in reverse.*

## 7.22. DISMANTLING THE INPUT MODULE



For 500, 700 and 700VISIO/VISIOWEB versions

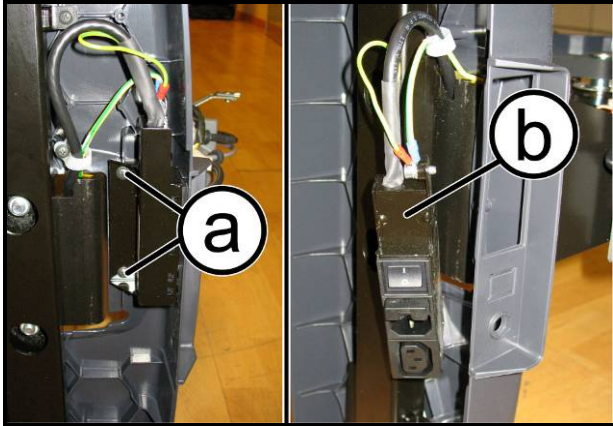


Figure 7.22-1

1. To gain access to the connectors, turn the equipment on its side.
2. Unscrew the 2 screws **(a)** using a medium-sized Phillips screwdriver and remove the input module on the front platform.
3. Disconnect the connector of the cable which goes up to the Brake Board, from its support **(b)**.

*To re-fit the connectors, follow the above operations in reverse.*



For 500SP and 700SP versions.

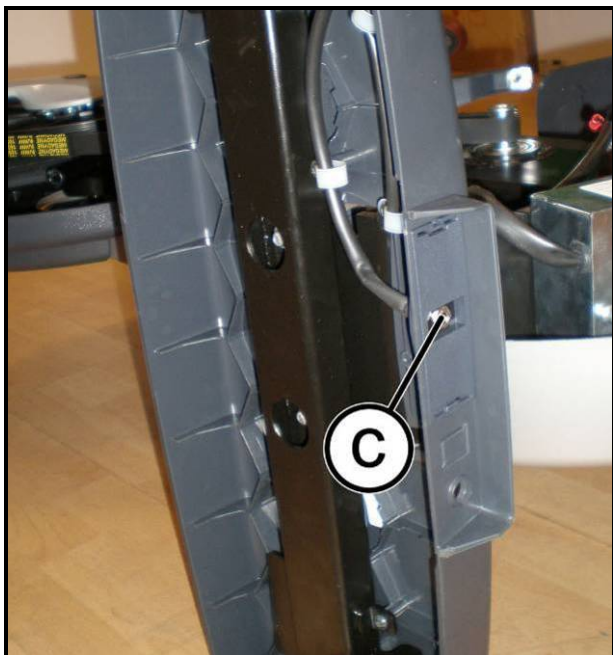


Figure 7.22-2

1. To gain access to the input connector of the battery charger, turn the equipment on its side.
2. Remove the input module for the battery charger **(c)** on the front platform.

*To re-fit the connectors, follow the above operations in reverse.*

*Blank page*





## 8. ADJUSTMENTS

### 8.1. BELT TENSION

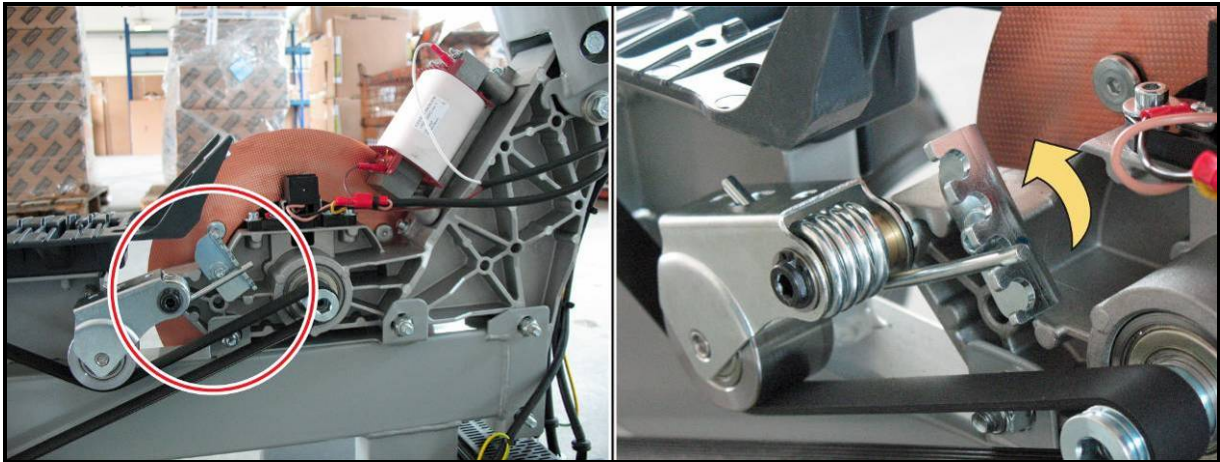


Figure 8.1-1

1. To adjust the belt tension, all you need to do is to choose between the various available positions for the spring (a).



**WARNING: The right tension must be between 50 - 60Hz.**

## 8.2. ALIGNING THE BELT

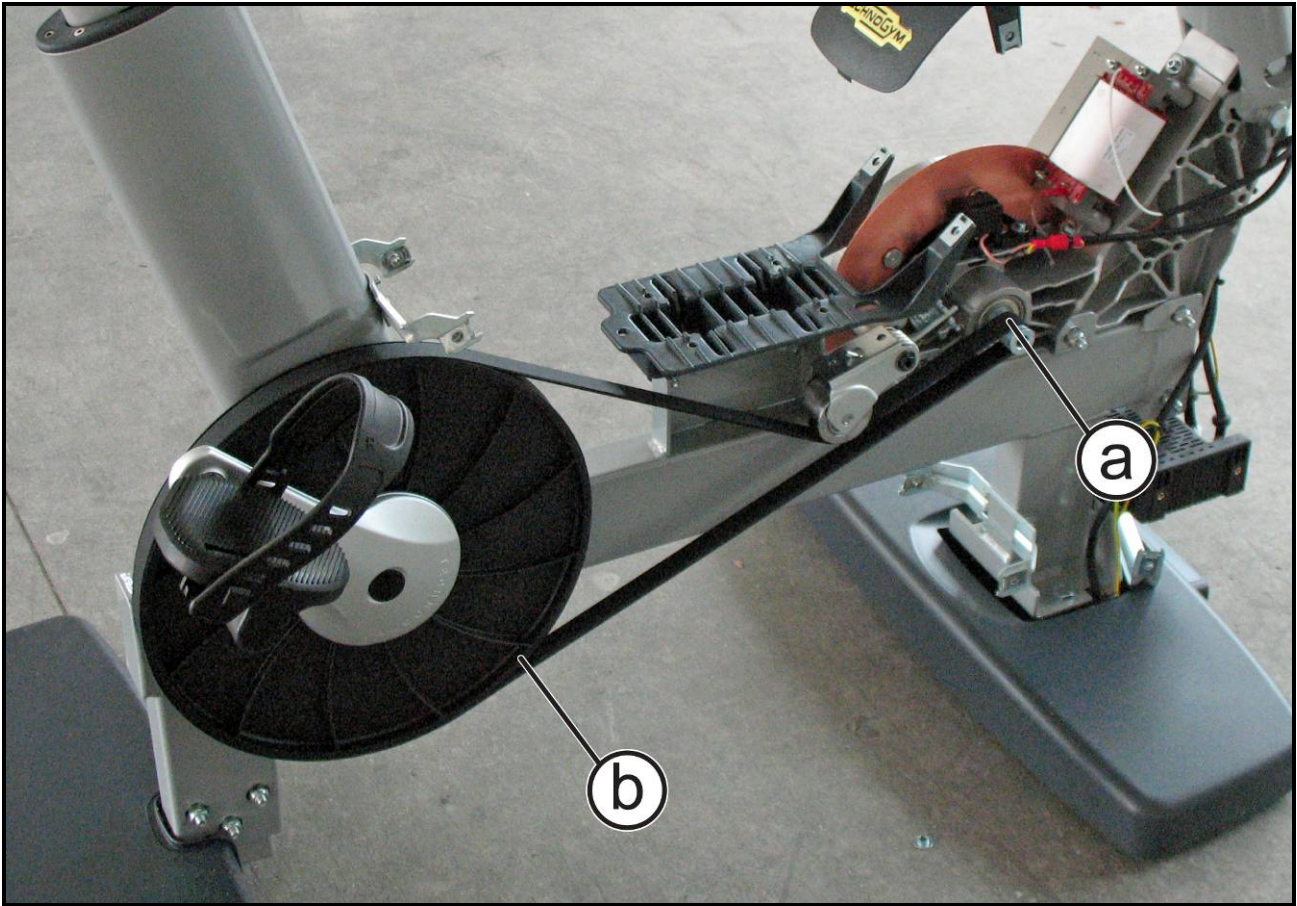


Figure 8.2-1

### To align the belt:

1. Position it correctly in the races of the small pulley of the flywheel (a) and in the races of the pulley of the pedal cranks (b).



**Pedal a few times going forward and in reverse until the belt is positioned in the centre.**

### 8.3. ADJUSTMENT OF THE PLAY ON THE SEAT COLUMN

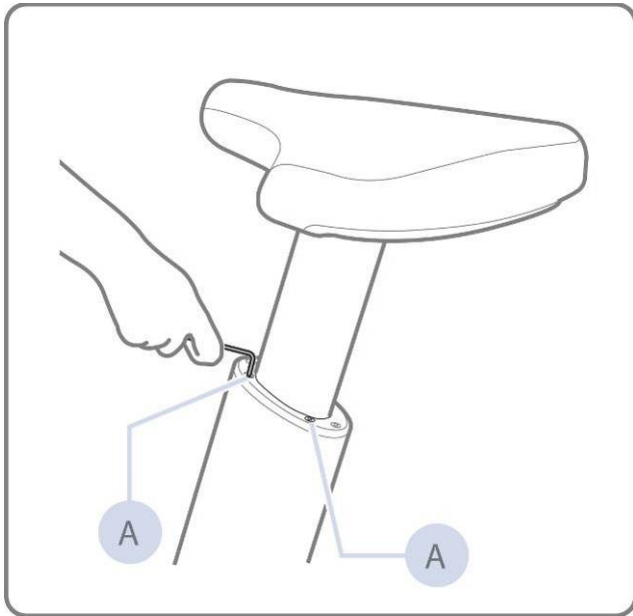


Figure 8.3-1

1. Raise the seat on the equipment so as to gain access to the adjustment bush.
2. Turn the 2 screws (a) on the bush and adjust the play of the seat column, using a 3mm Allen wrench.

## 8.4. ADJUSTING THE POSITION OF THE SPEED SENSOR

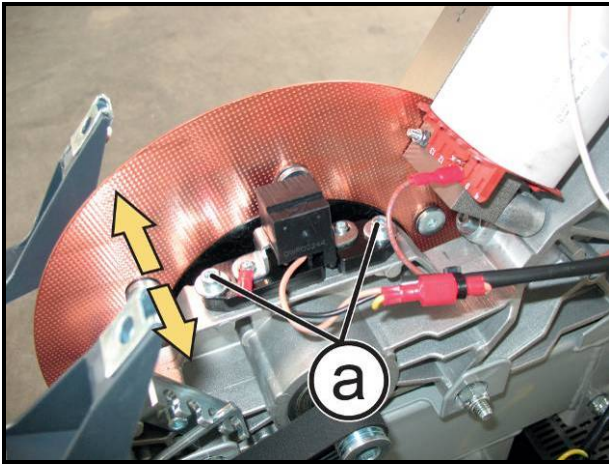


Figure 8.4-1

1. Loosen the 2 screws (**a**) using a 3mm Allen wrench.
2. Move the speed sensor support sideways in the direction of the yellow arrows, moving it closer to or further away from the copper disk up to a distance from the screws of **0.7mm.**
3. Re-tighten the screws (**a**).



## 8.5. ADJUSTING THE POSITION OF THE BRAKE UNIT

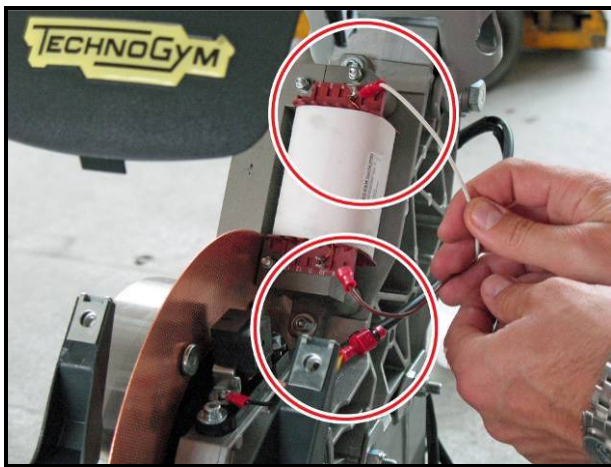


Figure 8.5-1

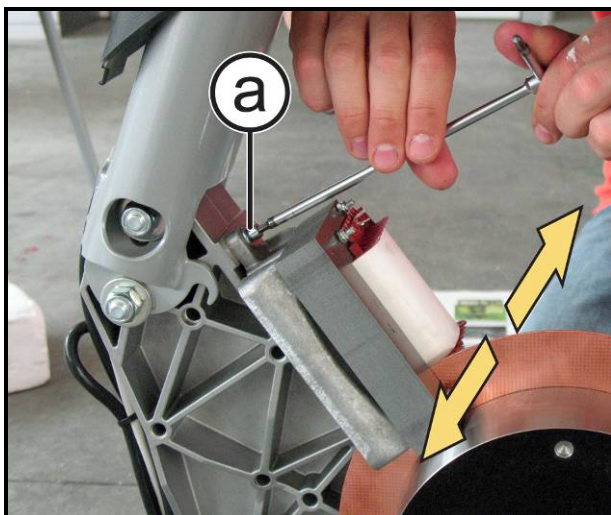




Figure 8.5-2

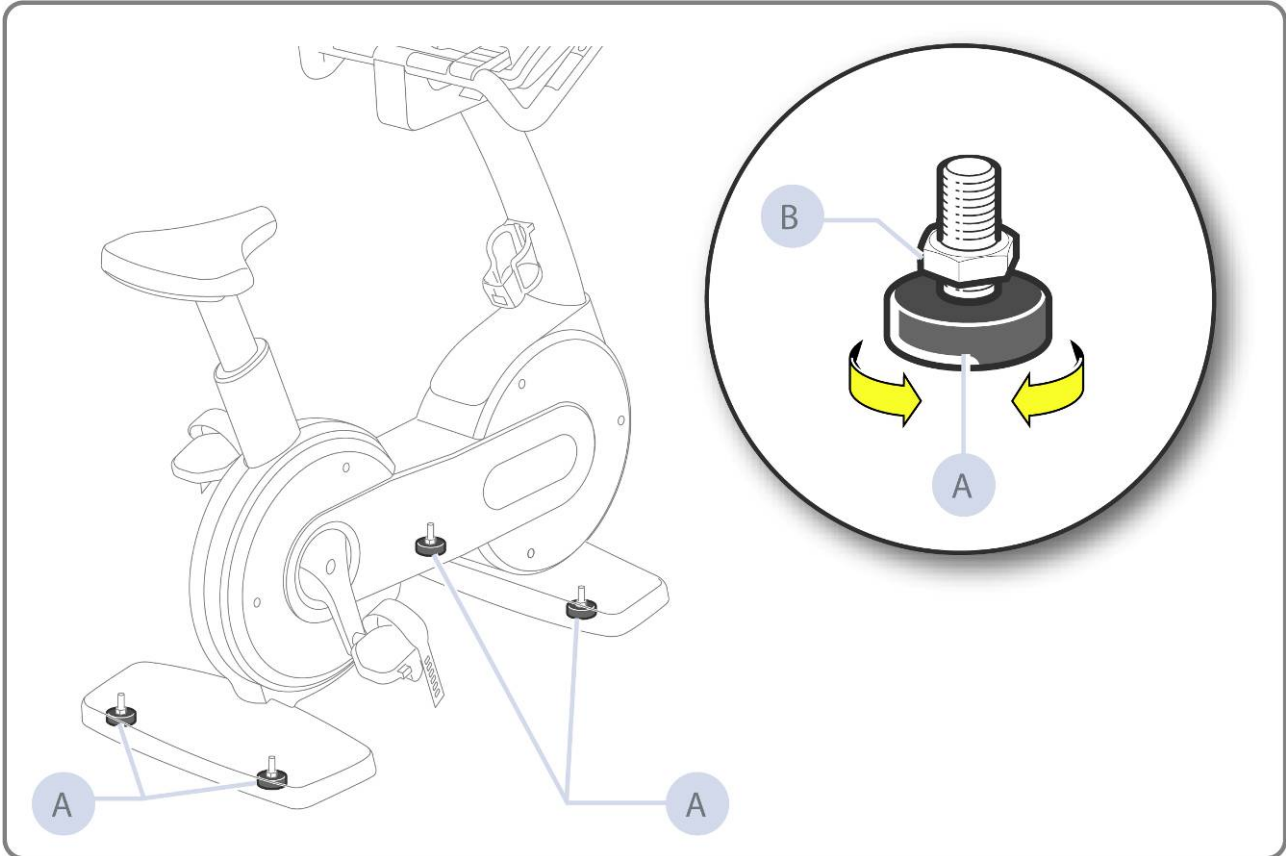
1. Disconnect the 2 fastons highlighted in the figure.
2. Loosen the 2 screws (a) using a 4mm Allen wrench.
3. Move the Brake Unit sideways in the direction of the yellow arrows up to a distance from the disk of **0.6mm**.
4. Re-tighten the screws (a).

 **WARNING:** In order to adjust the brake correctly, do some pedalling at high speed to check that there is no contact with the flywheel.

 **WARNING:** Using a comparator, measure the planarity of the copper disk. It must have a margin of  $\pm 0.15\text{mm}$ .

## 8.6. THE EQUIPMENT IS NOT LEVEL

This problem may be due to the positioning of the equipment on an unflat surface. In order to resolve the problem, you need to regulate the adjustment foot.



**Figure 8.6-1**

*In order to make the equipment level, adjust the two front and rear feet.*

1. Loosen the locknut (**B**), then tighten or unscrew the foot (**A**) until the frame is stable.
2. When you have finished the adjustment, tighten the locknut (**B**).



**WARNING:** During re-assembly, tighten the nuts (b) using a torque wrench set at a maximum of 35Nm.



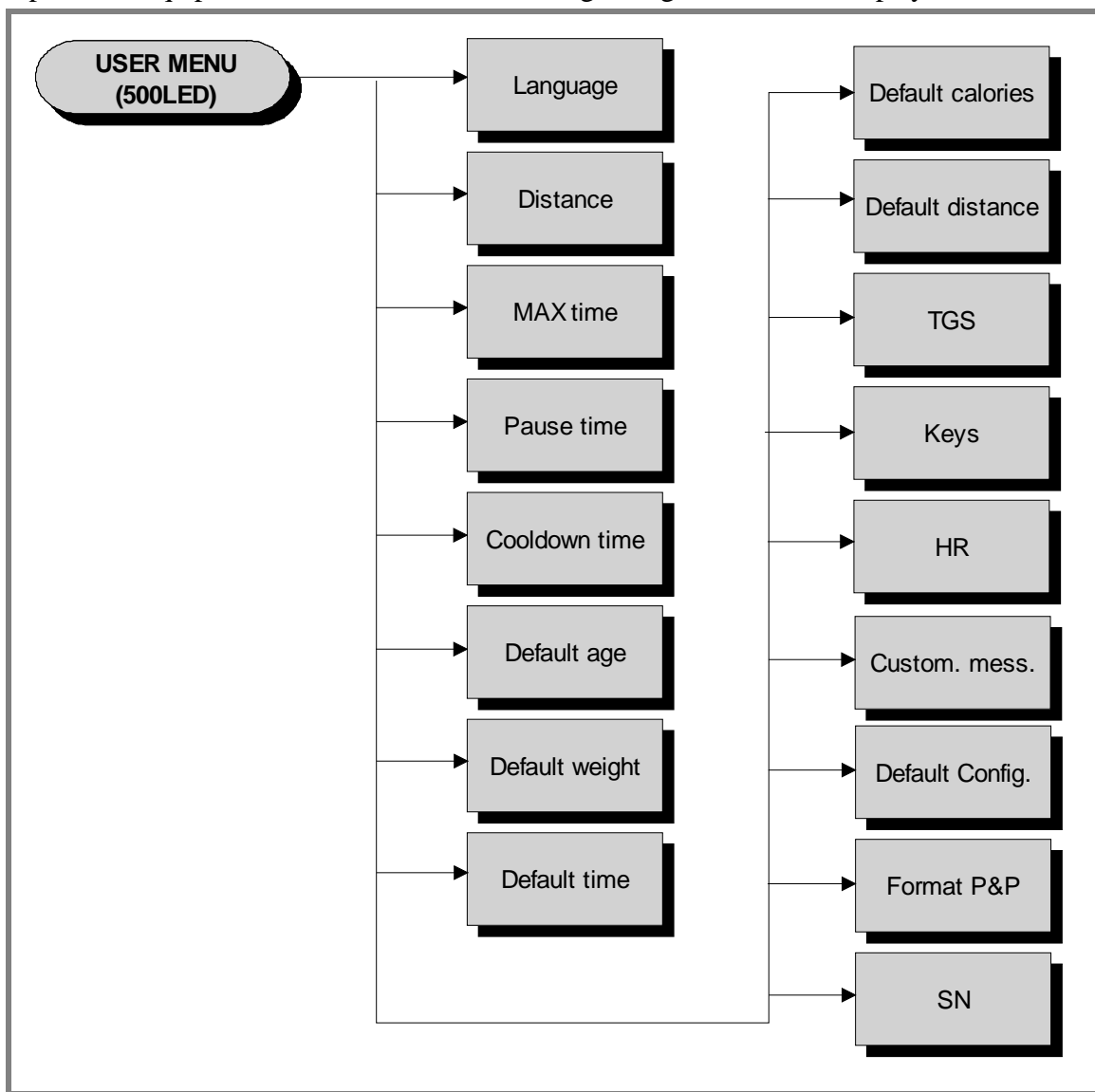
# 9. EQUIPMENT CONFIGURATION

## 9.1. USER MENU: 500 LED

The configuration procedure of the equipment is activated when the equipment is in Stand-By, by pressing the **ENTER**, **↑** and **CANCEL** buttons at the same time. The following will appear on the display:

### ENTER PASSWORD:

In order to access the procedure you need to enter the password **2406** and press the **ENTER** key in order to confirm. To enter the password, the displayed value may be increased or reduced by using the **↑** and **↓** keys, whereas with the **+/- GOAL** keys, it is possible to scroll the numbers and change them individually. At this point, the equipment starts to show the following configuration on the display:



**☛** Use the **ENTER** key to scroll from one parameter to another saving the data if modified, whereas with the **+** and **- speed** keys, you can scroll from one parameter to another without saving data; to cancel the operation, press the **CANCEL** key for a few seconds.

### 9.1.1. LANGUAGE

When a language has been chosen from the list of available languages, all the messages on the equipment's display are shown in the selected language. In order to change the setting, when the display shows the current setting:

**LANGUAGE: xxx**

Press the **+/- GOAL** keys to choose the desired language from among the available options.

### 9.1.2. UNITS OF MEASUREMENT

It is possible to choose the EUROPEAN metric system with kilograms (Kg) and kilometres (Km) or the AMERICAN system with Pounds (lbs) and Miles (ml).

In order to change the setting, when the display shows the current setting:

**MEASURES: xxx**

Press the **+/- GOAL** keys to choose the required unit of measurement from among the options in the following table:

MEASURE:	
KM	<default>
MILES	

### 9.1.3. MAXIMUM EXERCISE TIME

It is possible to set the maximum time of any exercise in minutes, with values ranging from 1 to 9999. In order to change the setting, when the display shows the current maximum time:

**MAX TIME: xxx**

To change the parameter you need to press **ENTER**: the current value of the parameter will be displayed in flashing mode and may be increased or reduced by using the **↑** and **↓** keys, whereas with the **+/- GOAL** keys, it is possible to scroll the numbers and change them individually.

*The default value of this parameter is 9999.*

### 9.1.4. PAUSE TIME

It is possible to set the maximum time of the pause of every exercise in seconds, with values ranging from 10 to 999. In order to change the setting, when the display shows the current maximum time:

**PAUSE TIME: xxx**

To change the parameter you need to press **ENTER**: the current value of the parameter will be displayed in flashing mode and may be increased or reduced by using the **↑** and **↓** keys, whereas with the **+/- GOAL** keys, it is possible to scroll the numbers and change them individually.

*The default value of this parameter is 60.*

### 9.1.5. COOLDOWN TIME

It is possible to set the time of the Cooldown at the end of every exercise in seconds, with values ranging from 5 to 180. In order to change the setting, when the display shows:

**COOLDOWN TIME: xxx**

To change the parameter you need to press **ENTER**: the current value of the parameter will be displayed in flashing mode and may be increased or reduced by using the **↑** and **↓** keys, whereas with the **+/- GOAL** keys, it is possible to scroll the numbers and change them individually.

*The default value of this parameter is 60.*

**☞** When training with the TGS key, the cool-down is interrupted when you pull out the key.

### 9.1.6. DEFAULT AGE

It is possible to set the default age for a generic user, with values ranging from 10 to 99. In order to change the setting, when the display shows the current setting:

**DEFAULT AGE: xxx**

To change the parameter you need to press **ENTER**: the current value of the parameter will be displayed in flashing mode and may be increased or reduced by using the **↑** and **↓** keys, whereas with the **+/- GOAL** keys, it is possible to scroll the numbers and change them individually.

*The default value of this parameter is 30.*

### 9.1.7. DEFAULT WEIGHT

It is possible to set the default weight for a generic user, with values ranging from 10 to 99. In order to change the setting, when the display shows the current setting:

**DEFAULT WEIGHT: KG xx**

To change the parameter you need to press the **ENTER** key: the current value of the parameter will be displayed in flashing mode and may be increased or reduced by using the  $\uparrow$  and  $\downarrow$  keys, whereas with the +/- **GOAL** keys, it is possible to scroll the numbers and change them individually.

*The default value of this parameter is 70.*

### 9.1.8. DEFAULT TIME

It is possible to set the default time of the training session, with values ranging from 1 to 999 min. In order to change the setting, when the display shows the current time:

**DEFAULT TIME: MIN. xxx**

To change the parameter you need to press the **ENTER** key: the current value of the parameter will be displayed in flashing mode and may be increased or reduced by using the  $\uparrow$  and  $\downarrow$  keys, whereas with the +/- **GOAL** keys, it is possible to scroll the numbers and change them individually.

*The default value of this parameter is 15.*

### 9.1.9. DEFAULT CALORIES

It is possible to set the default calories for a training session, with values ranging from 10 to 999. In order to change the setting, when the display shows the current settings:

**DEFAULT CALORIES: xxx**

To change the parameter you need to press the **ENTER** key: the current value of the parameter will be displayed in flashing mode and may be increased or reduced by using the  $\uparrow$  and  $\downarrow$  keys, whereas with the +/- **GOAL** keys, it is possible to scroll the numbers and change them individually.

*The default value of this parameter is 300.*

### 9.1.10. DEFAULT DISTANCE

It is possible to set the default distance for a training session, with values ranging from 1 to 999. In order to change the setting, when the display shows the current setting:

**DEFAULT DISTANCE: KM xxx**

To change the parameter you need to press the **ENTER** key: the current value of the parameter will be displayed in flashing mode and may be increased or reduced by using the **↑** and **↓** keys, whereas with the **+/- GOAL** keys, it is possible to scroll the numbers and change them individually.

*The default value of this parameter is 10.*

### 9.1.11. ENABLING THE TGS

It is possible to enable or disable the use of the TGS reader. In order to change the setting, when the display shows the current setting:

**TGS : xxx**

Press the **+/- GOAL** keys to choose the desired setting from among the options shown in the following table:

TGS	
ENABLED	<i>&lt;default&gt;</i>
DISABLED	

### 9.1.12. ACTIVATING THE KEYBOARD

It is possible to disable the use of the function keys so as to allow the equipment to be used only with the TGS. In order to change the setting, when the display shows the current setting:

**KEYS : xxx**

press the **+/- GOAL** keys to choose the desired setting from among the options shown in the following table:

KEYS	
ENABLED	<i>&lt;default&gt;</i>
DISABLED	

### 9.1.13. MODIFIABILITY OF TARGET HEART RATE

It is possible to allow the target heart rate to be modified or otherwise during the running of a constant heart-rate exercise. In order to change the setting, when the display shows the current setting:

**HR : xxx**

press the +/- **GOAL** keys to choose the desired setting from among the options shown in the following table:

<b>HR</b>
MODIFIABLE <default>
NOT MODIFIABLE

### 9.1.14. ENABLING CUSTOM MESSAGES

It is possible to set the equipment to display or otherwise some personalized messages, when in Stand-By In order to change the setting, when the display shows the current setting:

**CUSTOM MESS. : xxx**

press the numerical +/- **GOAL** keys to choose the required setting from among the options in the following table:

<b>CUSTOM MESS.</b>
YES <default>
NO

### 9.1.15. SETTING THE PARAMETERS TO DEFAULT VALUES

It is possible to set the default values of the user menu. In order to select the function, when the display shows:

**DEFAULT CONFIG.**

Press **ENTER** to confirm the choice, + or - of the difficulty level to move onto the subsequent or previous parameter. If **ENTER** has been pressed, the display shows:

**CONFIRM?**

confirm with **ENTER** or cancel by pressing **CANCEL** for a few seconds.

### 9.1.16. FORMATTING THE P&P KEY

This function allows the formatting of a TGS key for the Plug-&-Play mode. In order to select the function, when the display shows:

#### FORMATTING P&P

confirm with **ENTER** or cancel by pressing **CANCEL** for a few seconds.

At the end of the configuration procedure press the **CANCEL** key for a few seconds to quit.

The **CANCEL** key can be pressed at any time to interrupt the procedure and return to Stand-By.

### 9.1.17. SN

This parameter allows the equipment serial number to be displayed.

**SN:xxxxxx**

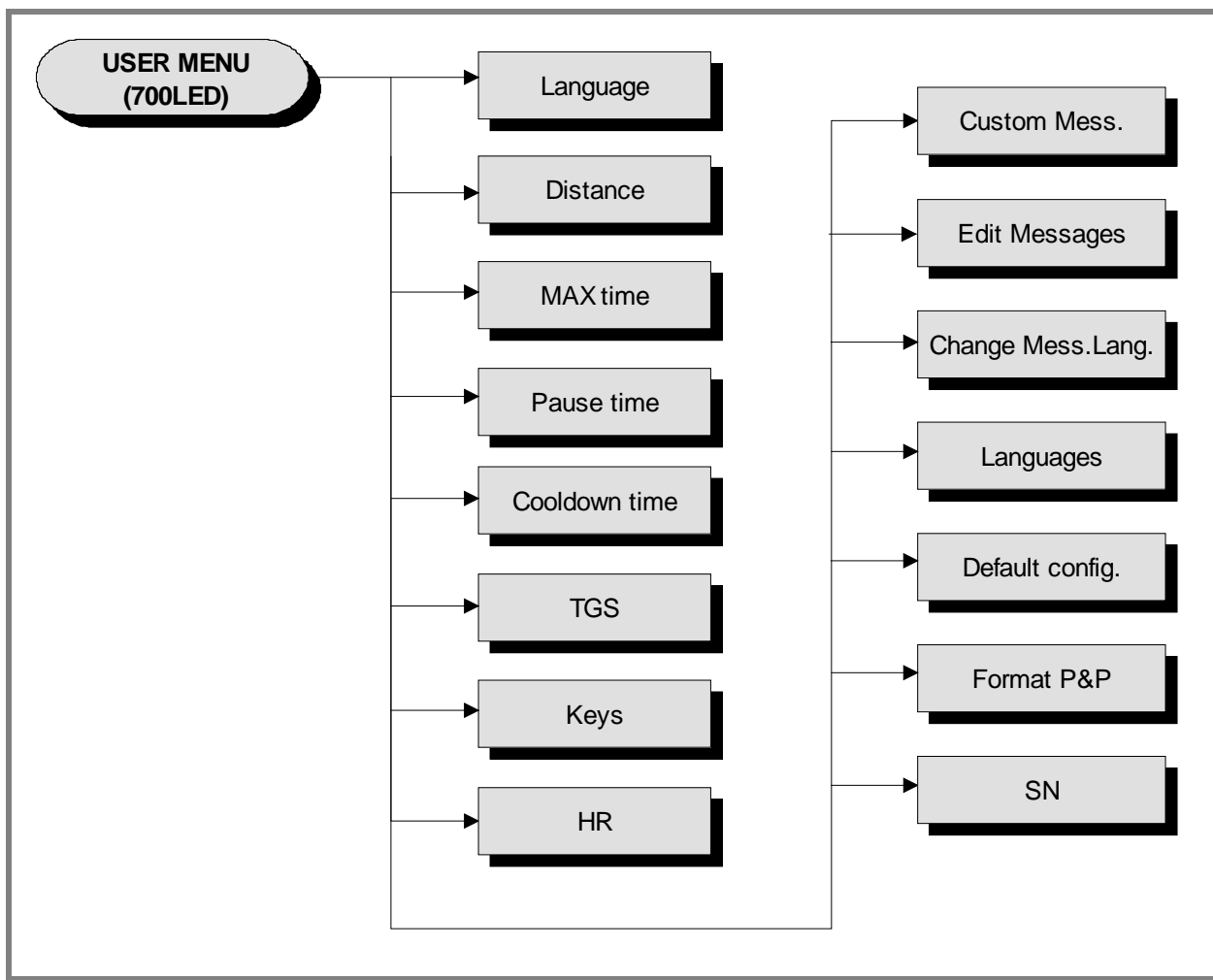


## 9.2. USER MENU: 700 LED

The configuration procedure of the equipment is activated when the equipment is in Stand-By, by pressing the **369** buttons at the same time.

### ENTER PASSWORD:

In order to access the procedure you need to enter the password **2406** and press the **ENTER** key in order to confirm. At this point, the equipment starts to show on the display the current configuration, structured like the following diagram:



**☞** Use the **ENTER** key to scroll from one parameter to another saving the data if modified, whereas with the **+** and **- speed** keys, you can scroll from one parameter to another without saving data; to cancel the operation, press the **CANCEL** key for a few seconds.

### 9.2.1. LANGUAGE

When a language has been chosen from the list of available languages, all the messages on the equipment's display are shown in the selected language. In order to change the setting, when the display shows the current setting:

**LANGUAGE: xxx**

Press the +/- **GOAL** keys to choose the desired language from among the available options.

### 9.2.2. UNITS OF MEASUREMENT

It is possible to choose the EUROPEAN system (Kg and Km) or the AMERICAN system (pounds and miles). In order to change the setting, when the display shows the current setting:

**MEASURES: xxx**

Press the +/- **GOAL** keys to choose the required unit of measurement from among the options in the following table:

MEASURE	
KM	<default>
MILES	

### 9.2.3. MAXIMUM EXERCISE TIME

It is possible to set the maximum time of every exercise in minutes, with values ranging from 1 to 9999.

In order to change the setting, when the display shows the current maximum time:

**MAX TIME: xxx**

To change the parameter you need to press the **ENTER** key: the current value of the parameter will be displayed in flashing mode and it is necessary to press **CANCEL** to cancel the current value and use the numerical keys to enter the desired value.

*The default value of this parameter is 9999.*

### 9.2.4. PAUSE TIME

It is possible to set the maximum time of the pause of every exercise in seconds, with values ranging from 10 to 999. In order to change the setting, when the display shows the current maximum time:

**PAUSE TIME: xxx**

To change the parameter you need to press the **ENTER** key: the current value of the parameter will be displayed in flashing mode and it is necessary to press **CANCEL** to cancel the current value and use the numerical keys to enter the desired value.

*The default value of this parameter is 60.*

### 9.2.5. COOLDOWN TIME

It is possible to set the Time of the Cooldown at the end of every exercise in seconds, with values ranging from 5 to 180. In order to change the setting, when the display shows:

**COOLDOWN TIME: xxx**

To change the parameter you need to press the **ENTER** key: the current value of the parameter will be displayed in flashing mode and it is necessary to press **CANCEL** to cancel the current value and use the numerical keys to enter the desired value.

*The default value of this parameter is 60.*

When training with the TGS key, the cool-down is interrupted when you pull out the key.

### 9.2.6. ENABLING THE TGS

It is possible to enable or disable the use of the TGS reader. In order to change the setting, when the display shows the current setting:

**TGS : xxx**

Press the +/- **GOAL** keys to choose the desired setting from among the options shown in the following table:

<b>TGS</b>	
ENABLED	<default>
DISABLED	

### 9.2.7. ACTIVATING THE KEYBOARD

It is possible to disable the use of the function keys so as to allow the equipment to be used only with the TGS. In order to change the setting, when the display shows the current setting:

**KEYS : xxx**

press the +/- **GOAL** keys to choose the desired setting from among the options shown in the following table:

<b>KEYS</b>	
ENABLED	<default>
DISABLED	



### 9.2.8. MODIFIABILITY OF TARGET HEART RATE

It is possible to allow the target heart rate to be modified or otherwise during the running of a constant heart-rate exercise. In order to change the setting, when the display shows the current setting:

**HR : xxx**

press the numerical +/- **GOAL** keys to choose the required setting from among the options in the following table:

<b>HR</b>
MODIFIABLE <default>
NOT MODIFIABLE

### 9.2.9. ENABLING CUSTOM MESSAGES

It is possible to set the equipment to display or otherwise some personalized messages, when in Stand-By In order to change the setting, when the display shows the current setting:

**CUSTOM MESS. : xxx**

press the numerical +/- **GOAL** keys to choose the required setting from among the options in the following table:

<b>CUSTOM MESS.</b>
YES <default>
NO

### 9.2.10. CHANGING (CUSTOM) MESSAGES

It is possible to change the custom messages. If you press **ENTER** you access a sub-level which displays the first custom message. In order to pass to the second, use the +/- difficulty level keys. To access the message editing phase, press **ENTER** again. To return to the upper level, press **CANCEL** for a few seconds. During the editing phase, move the cursor with +/- **GOAL** . Select the required letter with +/- of the difficulty level and put a space with **CANCEL**.

Press **ENTER** to save the modified message. Press **CANCEL** for a few seconds to cancel and return to the upper level.

### 9.2.11. CHANGING THE MESSAGE LANGUAGE

It is possible to have the Stand-By custom messages in the language set for the previous parameter. To extend the language choice to the predefined custom messages, in Stand-By, when the display shows the current setting:

**CHANGE MESS. LANG.**

### 9.2.12. ENABLING THE MULTI-LANGUAGE MODE

It is possible to set the equipment so as to be able to select the language at each training session. In order to change the setting, when the display shows the current setting:

**LANGUAGE: xxx**

press the +/- **GOAL** keys to choose the desired setting from among the options shown in the following table:

LANGUAGE	
FIXED	<default>
MODIFIABLE	

### 9.2.13. SETTING THE PARAMETERS TO DEFAULT VALUES

It is possible to set the default values of the user menu. In order to select the function, when the display shows:

**DEFAULT CONFIG.**

Press **ENTER** to confirm the choice, + or - of the difficulty level to move onto the subsequent or previous parameter. If **ENTER** has been pressed, the display shows:

**CONFIRM?**

confirm with **ENTER** or cancel by pressing **CANCEL** for a few seconds.

### 9.2.14. FORMATTING THE P&P KEY

This function allows the formatting of a TGS key for the Plug-&-Play mode. In order to select the function, when the display shows:

**FORMATTING P&P**

confirm with **ENTER** or cancel by pressing **CANCEL** for a few seconds.

At the end of the configuration procedure press the **CANCEL** key for a few seconds to quit.

The **CANCEL** key can be pressed at any time to interrupt the procedure and return to Stand-By.

### 9.2.15. SN

This parameter allows the equipment serial number to be displayed.

Press + or - of the difficulty level to move onto the subsequent parameter or the previous one.

**SN:xxxx**

### 9.3. CONFIGURATION OF THE ASSISTANCE MENU: LED MODELS

The configuration procedure for the equipment is activated when the equipment is in Stand-By and differs according to whether you are working on 500 or 700 equipment.

#### 9.3.1. CONFIGURATION ACTIVATION FOR 500 MODELS

Press the **ENTER**, **↑** and **CLEAR** keys at the same time. The following will appear on the display:

#### **ENTER PASSWORD:**

In order to access the procedure you need to enter the password **2501** which protects against unauthorised accesses and press the **ENTER** key in order to confirm. To enter the password, the displayed value may be increased or reduced by using the **↑** and **↓** keys, whereas with the **+/- GOAL** keys, it is possible to scroll the numbers and change them individually.

At this point two choices are offered:

**↑ = Tech Config**  
**↓ = Troubleshooting**

Press the numerical **↑** key to enter the *technical parameter configuration menu*, and the equipment will start to show you on the display the current configuration structure as detailed later on.

#### 9.3.2. CONFIGURATION ACTIVATION FOR 700 MODELS

The configuration procedure for the equipment is activated when the equipment is in Stand-By.

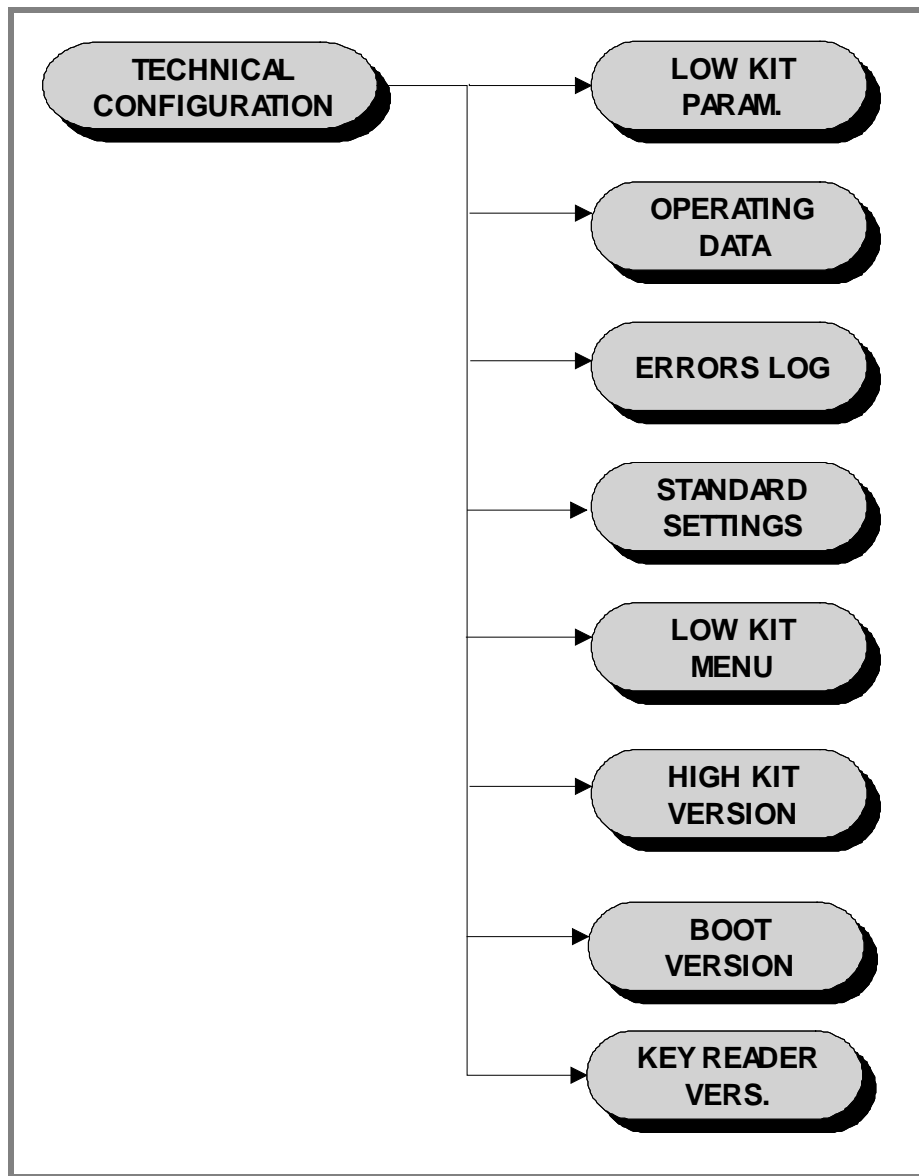
Press the **369** keys at the same time and the Display will show:

#### **ENTER PASSWORD:**

In order to access the procedure you need to enter the password **2501** which protects against unauthorised accesses and press the **ENTER** key in order to confirm. At this point two choices are offered:

**1 = Tech Config**  
**2 = Troubleshooting**

Press the numerical key **1** to enter the *technical parameter configuration menu* and the equipment will start to display the current configuration structure as detailed later on.



To scroll the list of parameters you need to press the + or - keys of the difficulty level so as to display the subsequent or previous parameter.

To change a parameter you need to press the **ENTER** key: the current value of the parameter will be displayed in flashing mode and it is necessary to press **CANCEL** to cancel the current value and use the numerical keys to enter the desired value. Save the change by pressing **ENTER**. To cancel the operation, press on the **CANCEL** key for a few seconds.

The meanings of the parameters are specified below.

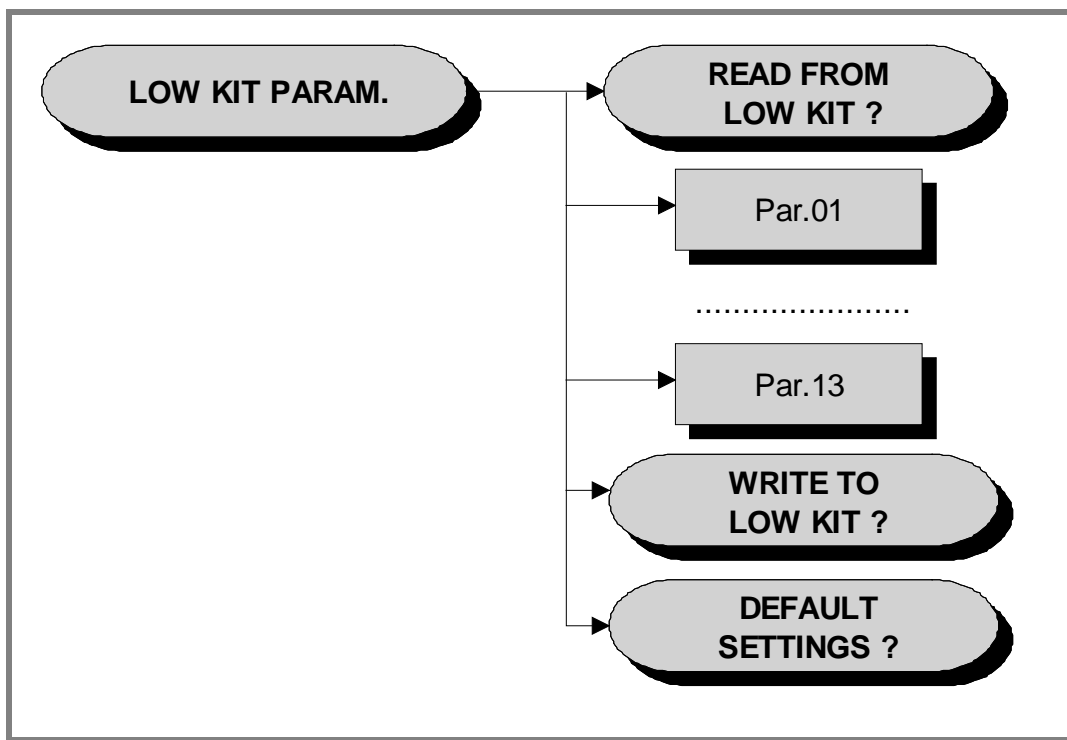


### 9.3.3. LOW KIT PARAMETER

This function allows you to access the parameters with which it is possible to change certain settings on the low kit. In order to access this menu, when the display shows:

#### LOW KIT PARAM.

press **ENTER**. This function is structured in the following way:



Inside this function, in addition to the 13 configuration parameters, described below, we also find the following 3 sub-functions:

#### 9.3.3.1. Read from low kit

To recall the parameters memorized by the low kit and to be able to visualize them on the display, move using the +/- keys of the difficulty level until the display shows:

#### READ FROM LOW KIT ?

press **ENTER** to load the parameters found in the low kit. Return to the upper level by pressing **CANCEL** for a few seconds.

#### 9.3.3.2. Write to low kit

To memorize on the low kit the values of the parameters currently on display, move using the +/- keys of the difficulty level until the display shows:

#### WRITE TO LOW KIT ?

press **ENTER** to transfer the new data to the low kit. Return to the upper level by pressing **CANCEL** for a few seconds.

### 9.3.3.3. Default Setting

To load the default values of the parameters, move using the +/- keys of the difficulty level until the display shows:

**DEFAULT SETTING ?**

press **ENTER**. The following will appear on the display:

**CONFIRM?**

press **ENTER** to recall the low kit default parameters. To return to the upper level press **CANCEL** for a few seconds.



To load these parameters on the low kit, use the “Write to low kit” function.

### 9.3.3.4. Table of Configuration parameters:

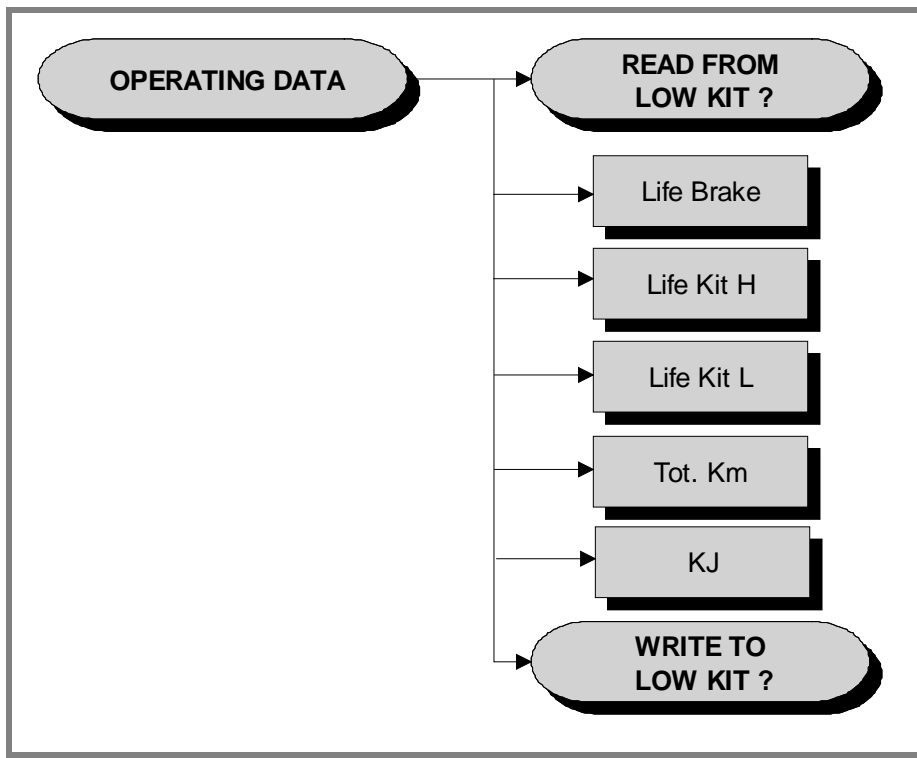
Id (Par.)	Unit of measure	Name	Description	LED	
				Pow.	Self-Pow.
1	decimals	[Rt]	Transmission report	135	141
2		[Rvel]	Speed Ratio (whole part)	9	9
3	mA	[Im]	Minimum Braking	500	0
4	W	[Pmc]	Constant maximum power	200	200
5	in hundredths.	[Km]	Power corrective coefficient	100	100
6	0.1N	[Ca]	User friction torque	13	13
7	°C	[Tea]	Maximum temperature on the coil	125	125
8	Rpm user	[RPMmin ]	minimum Rpm (start cut braking ramp)	30	30
9	type/sec	[RpmF1]	Rpm integration scale	1	1
10	rpm user	[RpmF2]	Rpm filter threshold	30	30
11		[Rvel]	Speed Ratio (decimal part)	0	0
12	0.1N	[D_Ca]	Delta User friction torque	8	8
13	-	-	Enable flag for registers at address ≥ 100	-	-

### 9.3.4. OPERATING DATA

This function allows you to access the operating data of the equipment memorized on the low kit. In order to access this menu, when the display shows:

#### OPERATING DATA

press **ENTER**. This function is structured in the following way:



Inside this function, in addition to the equipment operating data, we also find 2 sub-functions, as described below:

#### 9.3.4.1. Read from low kit

To recall the parameters memorized by the low kit and to be able to visualize them on the display, move using the +/- keys of the difficulty level until the display shows:

#### READ FROM LOW KIT ?

press **ENTER** to load the parameters found in the low kit. Return to the upper level by pressing **CANCEL** for a few seconds.

### 9.3.4.2. Write to low kit

To memorize on the low kit the values of the parameters currently on display, move using the +/- keys of the difficulty level until the display shows:

#### WRITE TO LOW KIT ?

press **ENTER** to transfer the new data to the low kit. Return to the upper level by pressing **CANCEL** for a few seconds.

### 9.3.4.3. Operating data

The equipment operating data as displayed is updated every 10 minutes. This means that every time the equipment is switched off, the data which has been modified since the last saving to memory is lost.

<i>Display Message</i>	<i>Description</i>
<i>Life Brake:</i>	<i>Minutes x 10 of Brake operation (measured by the Low Kit)</i>
<i>Life Kit High:</i>	<i>Minutes x 10 of High Kit operation (measured by the High Kit)</i>
<i>Life Low Kit:</i>	<i>Minutes x 10 of Low Kit operation (measured by the Low Kit)</i>
<i>KJ:</i>	<i>total KJ spent (relating to all the exercises performed) (measured by the High Kit)</i>
<i>Tot Km:</i>	<i>total Km travelled (relating to all the exercises performed) (measured by the Low Kit)</i>

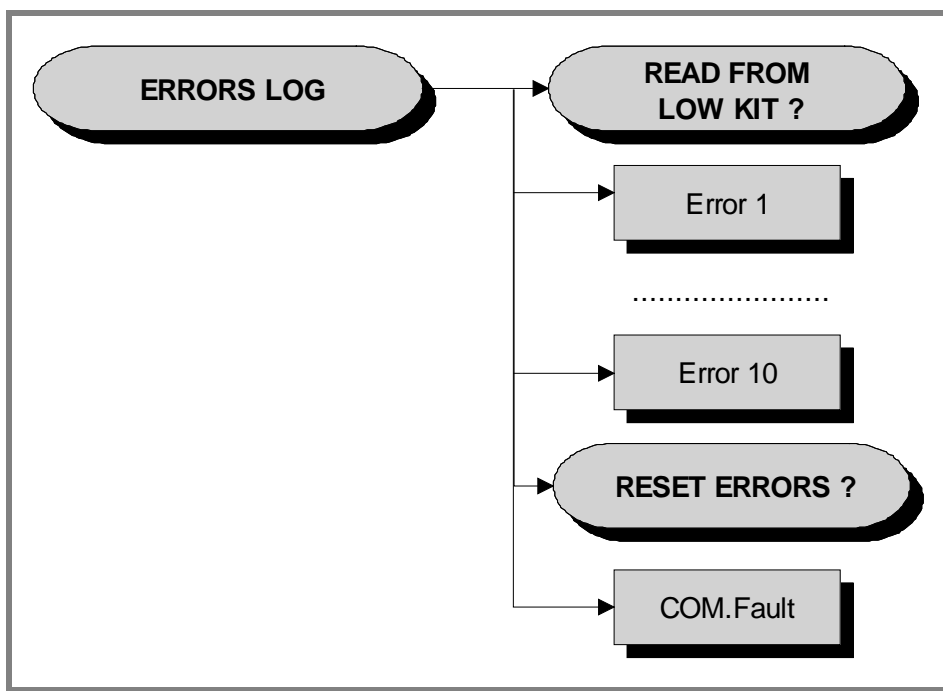
By selecting one of the items in the table above, it is possible to modify its content, but only by resetting its value. When you press **ENTER** the “Reset life...” message appears with the name of the selected item. If you press **ENTER** again, the value of the selected piece of information is reset, whereas if you press **CANCEL** you return to the previous value for the information.

### 9.3.5. ERRORS LOG

This function allows you to access the log of errors generated by the equipment. In order to access this menu, when the display shows:

#### ERRORS LOG

press **ENTER**. This function is structured in the following way:



Inside this function, in addition to the errors recorded by the equipment, we also find 3 sub-functions, as described below:

#### 9.3.5.1. Read from low kit

To recall the errors memorized by the low kit and to be able to visualize them on the display, move using the +/- keys of the difficulty level until the display shows:

#### READ FROM LOW KIT ?

press **ENTER** to load the parameters found in the low kit. Return to the upper level by pressing **CANCEL** for a few seconds.

#### 9.3.5.2. Reset errors

To reset the errors log on the high kit and on the low kit, move using the +/- keys of the difficulty level until the display shows:

#### RESET ERRORS ?

press **ENTER** to reset the errors log. Return to the upper level by pressing **CANCEL** for a few seconds.

### 9.3.5.3. COM.Fault

This is a counter which displays the number of serial communication errors between the high kit and the low kit. It increases every time a communication error is detected. Move using the +/- keys of the difficulty level until the display shows:

## COM.FAULT X

To reset the counter, press **ENTER** and the display will show:

## RESET COM.FAULT?

press **ENTER** to reset. Return to the upper level by pressing **CANCEL** for a few seconds.

### 9.3.5.4. Display errors

The errors log provides a series of information as listed in the following table for every error generated by the equipment.

- *Error Code,*
- *Type of error,*
- *Current at the time of the error*
- *Distance in Km at the time of the error.*

*During movement, the Brake Board is capable of detecting possible faults. The possible detected errors are:*

Error Code	Description
1	<b><i>OVERTEMPERATURE</i></b> : this condition occurs when the temperature measured by the board sensor exceeds 90°C.
8	<b><i>OVERVOLTAGE</i></b> : this condition occurs when the voltage +12Vdc exceeds 13.7Vdc (only on powered models).

You move on to the subsequent error by pressing the + key of the difficulty level. Otherwise the message containing the data of the current error is displayed again.

### 9.3.6. STANDARD SETTINGS

This function allows you to reset the equipment operating data and at the same time to set the default values of the Brake Board parameters. In order to access this menu, when the display shows:

#### STANDARD SETTINGS ?

if you press **ENTER**, the following message will be displayed:

#### CONFIRM ?

By pressing **ENTER** again, all the default values will be re-instated. To return to the upper level press **CANCEL** for a few seconds.



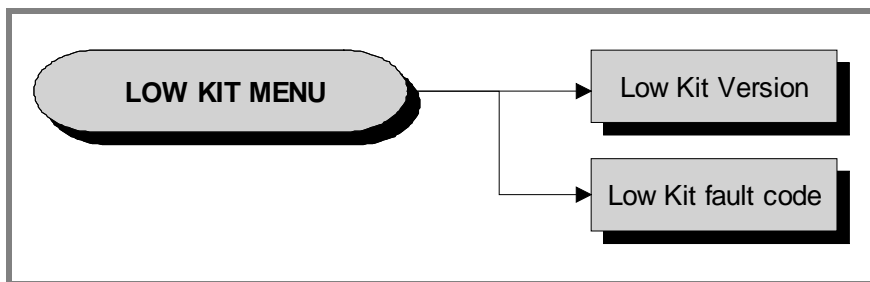
**This function does not change the configured language or television standard.**

### 9.3.7. LOW KIT MENU

This function allows you to directly access Firmware (FW) of the Brake Board. In order to access this menu, when the display shows:

#### LOW KIT MENU

press **ENTER**. This function is structured as follows:



#### 9.3.7.1. Low kit version

This function allows you to display the version of the Firmware (FW) of the Brake Board. In order to access this menu, when the display shows:

#### LOW KIT VERSION

press **ENTER** and the SW numerical sequence will be displayed:

**X.Y.Z**

Where:

- X = *KERNEL*
- Y = *Brake Board*
- Z = *Brake Table*

Which identifies the version of the *Firmware (FW)*.



### 9.3.7.2. Low Kit fault code

This function allows you to display any fault code which is blocking the low kit. In order to access this menu, when the display shows:

#### **LOW KIT FAULT CODE**

if you press **ENTER**, the following message will be displayed:

**FAULT=XX**



**If FAULT=00 is displayed, the Board is not at fault.**

### 9.3.8. HIGH KIT VERSION

This function allows you to display the version of the display SW. In order to display it, when the display shows:

#### **HIGH KIT VERSION**

press **ENTER** and a message will be displayed which identifies the version of the SW.

### 9.3.9. BOOT VERSION

This function allows you to display the BOOT version. In order to display it, when the display shows:

#### **BOOT VERSION**

press **ENTER** and a message will be displayed which identifies the BOOT version.



**The Boot Version parameter refers to the “boot” version relating to the display hardware. The boot is a part of the software which allows you to load the TG application onto the display board. The parameter is used solely as info. It is NOT possible to change the version or update it.**

### 9.3.10. KEY READER VERSION

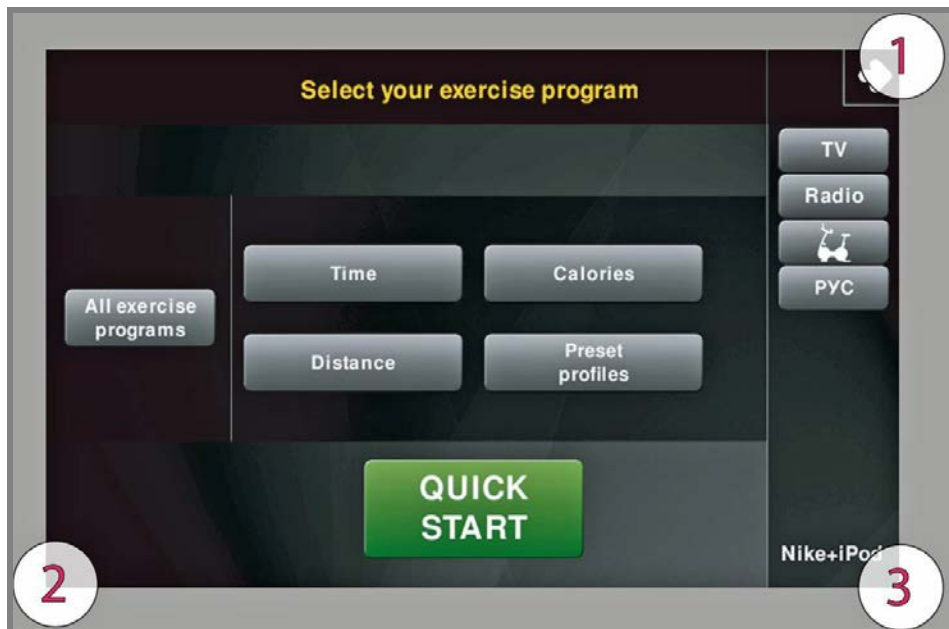
This function allows you to display the *Key Reader Version*. In order to display it, when the display shows:

#### **KEY READER VERSION**

press **ENTER** and a message will be displayed which identifies the version of the KEY READER.

## 9.4. USER MENU: VISIO/VISIOWEB

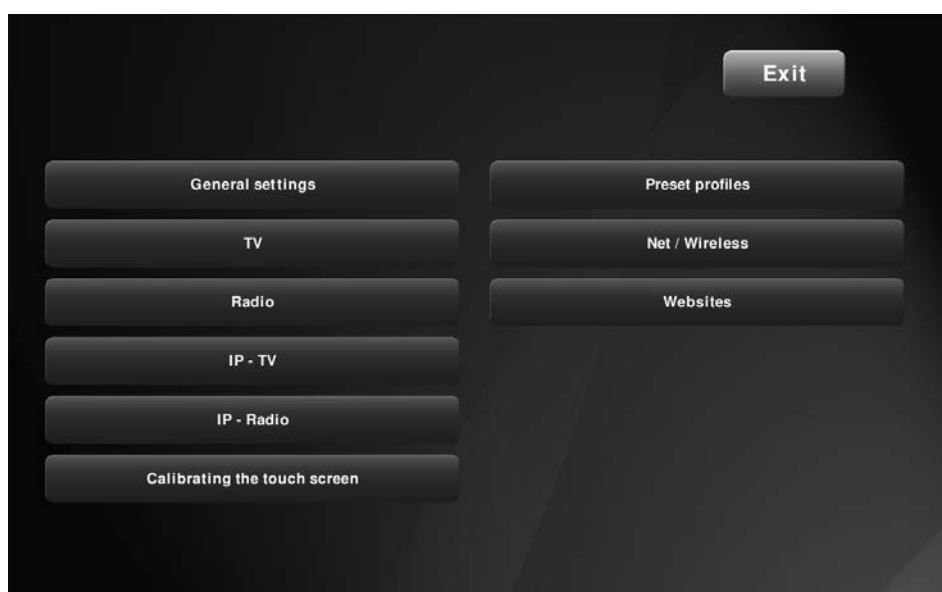
The procedure is activated by pressing the top right-hand corner, the bottom left-hand corner and the bottom right-hand corner of the screen in that sequence, in Stand-By, as shown in the figure below:



A new display will appear from which you can gain access to the various configuration menus, by entering the password on the number keyboard:

Enter the password **2406** and press the **ENTER** key to confirm or **EXIT** to quit.

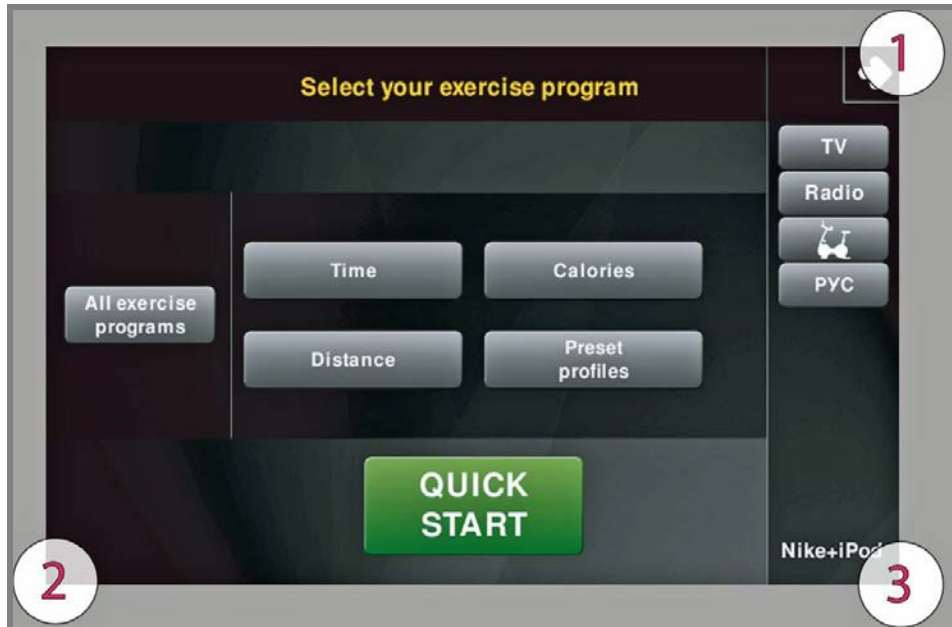
*A menu will then appear which will provide access to the following sub-menus:*



For the following menu, please refer to the relevant chapter in the **VISIO/VISIOWEB** manual.

## 9.5. ASSISTANCE MENU: VISIO/VISIOWEB

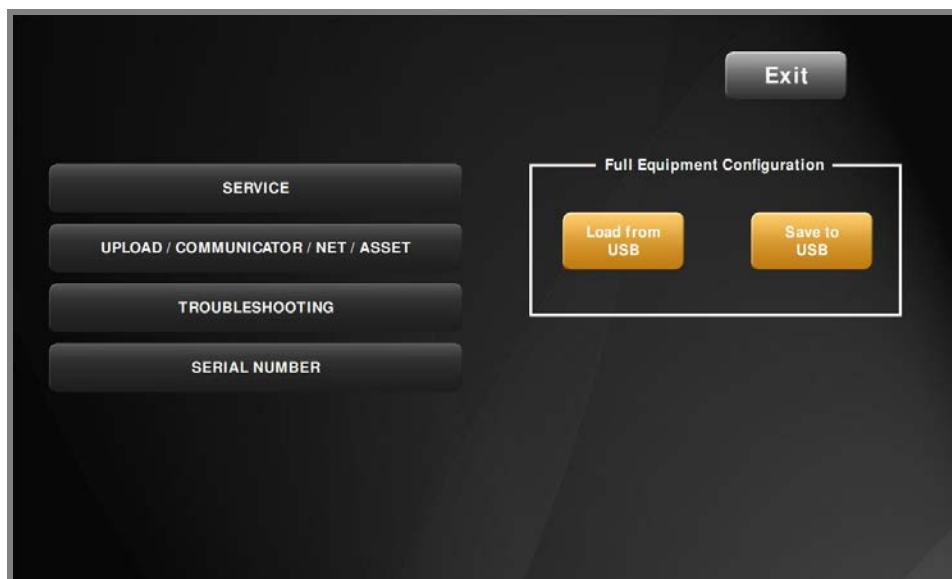
The procedure is activated by pressing the top right-hand corner, the bottom left-hand corner and the bottom right-hand corner of the screen in that sequence, in Stand-By, as shown in the figure below:



A new display will appear from which you can gain access to the various configuration menus, by entering the password on the number keyboard:

Enter the password **2501** and press the **ENTER** key to confirm or **EXIT** to quit.

*A menu will then appear which will provide access to the following sub-menus:*



For the following menu, please refer to the relevant chapter in the VISIO/VISIOWEB manual.

### 9.5.1.1. Table of configuration parameters



To display the parameter values correctly, it is necessary to read them from the Low Kit, using the function “Read from low kit”.



After making any changes to the parameters, it is necessary to write them (save them) on the Low Kit, using the function “Write to low kit”.

Id (Par.)	Unit of measure	Name	Description	VISIO
				Pow.
1	decimals	[Rt]	Transmission report	135
2		[Rvel]	Speed Ratio (whole part)	9
3	mA	[Im]	Minimum Braking	500
4	W	[Pmc]	Constant maximum power	200
5	in hundredths.	[Km]	Power corrective coefficient	100
6	0.1N	[Ca]	User friction torque	13
7	°C	[Tea]	Maximum temperature on the coil	125
8	rpm user	[RPMmin]	Minimum Rpm (start cut braking ramp)	30
9	type/sec	[RpmF1]	Rpm integration scale	1
10	rpm user	[RpmF2]	Rpm filter threshold	30
11		[Rvel]	Speed Ratio (decimal part)	0
12	0.1N	[D_Ca]	Delta User friction torque	8
13	-	-	Enable flag for registers at address $\geq 100$	-

## 9.6. UNITY CONFIGURATION



For the following menu, please refer to the **UNITY Manual (User Interfaces)**.

*Blank page*





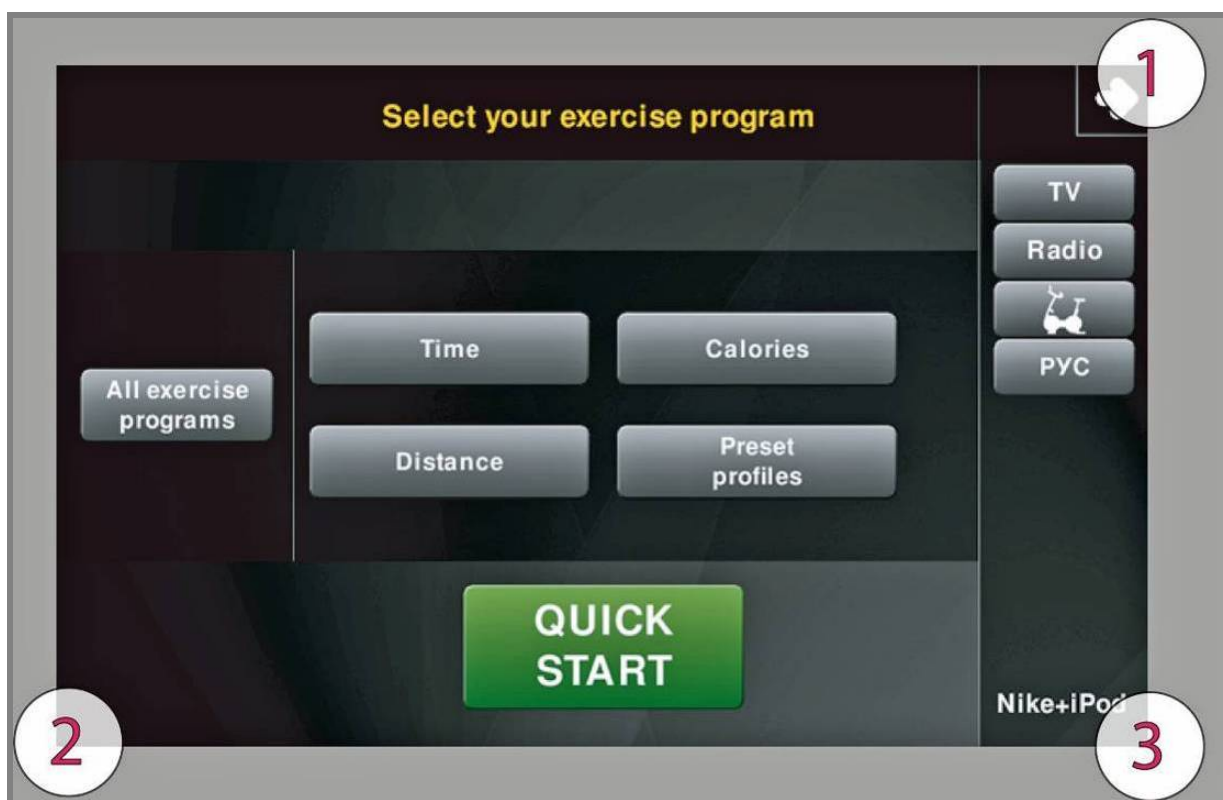
## 10. UPDATING THE SW

### 10.1. VISIO/VISIOWEB



For the following menu, please refer to the VISIO/WISIOWEB Manual.

The procedure is activated by pressing the top right-hand corner, the bottom left-hand corner and the bottom right-hand corner of the screen in that sequence when the equipment is in Stand-By, as shown in the figure below.



A new display will appear from which you can gain access to the various configuration menus, by entering the password on the number keyboard:

In order to access the menu, enter the password **2502** and press the **ENTER** key in order to confirm, **ESCI** in order to quit.

## 10.2. UNITY



For the following menu, please refer to the **UNITY Manual (User Interfaces)**.

*Blank page*



# 11. FUNCTIONAL TESTS FOR THE MD MODELS

After completing any maintenance and/or servicing tasks on the equipment, you need to perform a series of safety **Mechanical Tests** and **Electrical Tests** in order to ensure:

- *The correct functionality of the medical device;*
- *The correct and safe operation of the medical device;*
- *That the exercises are performed in accordance with the bio-medical specifications for which the medical device was designed and manufactured.*

The instruments and activities through which Technogym® guarantees its own safety standards are the following:

- *the Company's ISO 9001/2000 Certification;*
- *Certification that the device complies with the Medical Standards: 60601-1 and 60601-1-2;*
- *Electrical safety tests on every device at the end of production, in accordance with the above-mentioned provisions;*
- *Training of the technical staff who perform maintenance and repair work;*
- *Use of original Technogym® spare parts, which have been checked and tested, for all servicing tasks;*
- *EC Declaration of Conformity.*

## 11.1. ELECTRICAL SAFETY TESTS

On the basis of the risks analysis performed by the after-sales service, regarding the installation and technical servicing activities, it is deemed necessary, nevertheless, to carry out a safety test on the earth ring using a Tester in order to verify that the electrical components are connected up correctly. In particular, this test must guarantee that the earth connection is continuous (*resistance less than  $4\Omega$  (Ohm)*) between the earth pole on the power supply cable (*connected to the equipment*) and the points listed in the figure below:

*Continues on the next page...*

Firstly check that the resistance on the tester tips is close to  $0\Omega$ .



## 11.2. MECHANICAL SAFETY TESTS

### 11.2.1. TEST ON THE ASSEMBLY OF THE MOVEMENT TRANSMISSION SYSTEM AND PLATFORM LEVERAGE

Check that the levers, platforms and brake units are correctly mounted, making sure that:

- *The platforms and levers operate correctly and that they have been fixed and aligned correctly. Do the exercise and check that it is always fluid and silent even at a high level of difficulty.*
- *That the shafts, pulleys and all the transmission components have been correctly fitted. Do the exercise and check that it is always fluid and silent even at a high level of difficulty.*
- *That the flywheel unit and the electromagnet have been correctly fitted. Do the exercise and check that it is always fluid and silent even at a high level of difficulty.*

### 11.2.2. CHECKS ON THE FITTING OF GUARDS

Check on the correct fitting of the guards, making sure that:

- *All the guards have been fitted and in the correct manner, so that there are no unprotected parts on the equipment that might cause injury to the user.*

## 11.3. START-UP TEST

After completing installation and any maintenance work on the equipment, connect it to the power supply and turn the start button to the ON position.

When it is switched on, the equipment performs a *check-Up* between the High Kit and Low Kit. At the end, the equipment goes into *Stand-By* position while waiting for a command from the keyboard.

In order to check that the equipment functions correctly:

- *Get on the equipment;*
- *Start the exercise;*
- *Check that the hardness of the exercise and the level of difficulty varies from 1 to 25, when you press the “+” and “-” difficulty level buttons on the keyboard and on the Fast-Tracks;*
- *Put on the cardio transmitter (band) and check that the equipment reads your heart beat rate correctly;*
- *Grasp the Hand Sensors and check that the equipment reads your heart beat rate correctly (without wearing the chest band).*



## 11.4. LIST OF CRITICAL SPARE PARTS

The Technogym® medical devices are identified by SN labels which allow them to be traceable throughout the life of the device. Just as with the products, there is also a list of **CRITICAL** components, whose traceability is guaranteed with a SN.

*The list of these critical components is shown in the following table:*

<b>Code No.</b>	<b>Component</b>
<b>R0006668XX</b>	<b>Brake Board</b>
<i>OWR00250</i>	<i>Electromagnet</i>
<b>W0003767XX</b>	<b>700 Display Board</b>
<b>W0003778XX</b>	<b>500 Display Board</b>
<i>OWQ00060XX</i>	<i>C-Safe Board</i>
<i>OWR00633XX</i>	<i>HS/HR Cardio Receiver</i>
<i>N0000034XX</i>	<i>HR Cardio Receiver</i>
<i>W0006167XX</i>	<i>Schurter socket</i>
<i>OWR00598XX</i>	<i>N. 2 ferrites RKCF-10-A5 RICHCO</i>
-	<i>Display program - SW version</i>
-	<i>Brake Board program - SW version</i>

**Note:**



**XX = Baan Revision**  
**YY = Language**

If during servicing, maintenance and/or overhauls, any of the critical components listed in the table are replaced, this must be **recorded** in the **JOB REPORT**, by registering the **traceability data** of the new component.

## 12. PLANNED MAINTENANCE

To keep the equipment perfectly efficient, planned maintenance work must be periodically performed to prevent possible problems.

The operations can be divided essentially according to the type of work and to the staff who must do it:

<p><b><i>ROUTINE maintenance to be carried out during the operations of preventive maintenance.</i></b></p>	<p><b><i>MAJOR maintenance</i></b></p>
<p><b><i>ROUTINE</i></b> maintenance operations can be performed by the <b><u>owner of the machine and do not require any particular technical expertise</u></b>; they are simple operations regarding external cleaning, for the purposes of observing good hygiene practices.</p> <p>The maintenance operations must be carried out also by the <b><i>ROUTINE</i></b> technical Technogym during scheduled maintenance.</p>	<p><b><i>MAJOR</i></b> maintenance means operations that can only be performed by a <b><u>Qualified Technician specially trained by Technogym</u></b>; authorised to carry out fine tuning and start-up of the equipment, maintenance and repair work, testing of operation and wear of the mechanical parts in order to ensure perfect and safe operation of the equipment.</p>
<p> <b>Refer to the USER manual.</b></p>	<p> <b>Refer to the PLANNED MAINTENANCE manual, that can be visible from TG DIRECT.</b></p>
<p><b><u>ROUTINE MAINTENANCE:</u></b> No specialisation.</p>	<p><b><u>MAJOR MAINTENANCE:</u></b> Qualified Technician authorised by Technogym and maintenance envisaged in the <u>preventive maintenance contract.</u></p>

*Blank page*

# 13. APPENDIX

## 13.1. TABLE OF PASSWORDS TO ACCESS THE MENUS

The following configuration menus are available together with their respective access passwords:

<b>PASSWORD LIST</b>			<b>INTERFACCIA</b>
<b>Service Menu</b>	<b>2501</b>	Technical configuration;	LED VISIO UNITY
		Upload/ Network page;	VISIO UNITY
		Write Serial Number;	VISIO UNITY
		Access to Windows environment; Windows screen;	VISIO UNITY
		Equipment type selection;	VISIO UNITY
		Troubleshooting;	LED VISIO UNITY
<b>User Menu</b>	<b>2406</b>	IP-TV Configuration;	VISIO UNITY
		IP-Radio Configuration;	VISIO UNITY
		User configuration + Serial Number reading;	LED VISIO UNITY
		Analog and Digital TV channels tuning;	VISIO UNITY
		Analog and Digital Radio channels tuning;	VISIO UNITY
		Touch Screen Calibration;	VISIO UNITY
		Menu for customizing user profile; Training profile menu (to add and customize personal profiles);	LED VISIO UNITY
		Network configuration;	VISIO UNITY
VISIOWEB Bookmarks configuration;	VISIO UNITY		

*Blank page*

## 14. TOOLS

- To make each disassembly operation, adjustment and maintenance on the machines need the tools shown in the **TG SERVICE TOOLS BOX LIST**, available in **TG DIRECT**.







*TECHNOGYM S.p.A.*

*Via G. Perticari, 20 - 47035 Gambettola (FC) - Sede legale*

*Via Calcinaro, 2861 - 47522 Cesena (FC) - Sede operativa*

*ITALIA*

*Tel.: +39-0547-650638*

*Fax: +39-0547-650150*

*e-mail: [service@technogym.com](mailto:service@technogym.com)*