

▶ Visit us at www.TestEquipmentDepot.com

▶ Back to the Extech IRC55 Product Info Page

User's manual

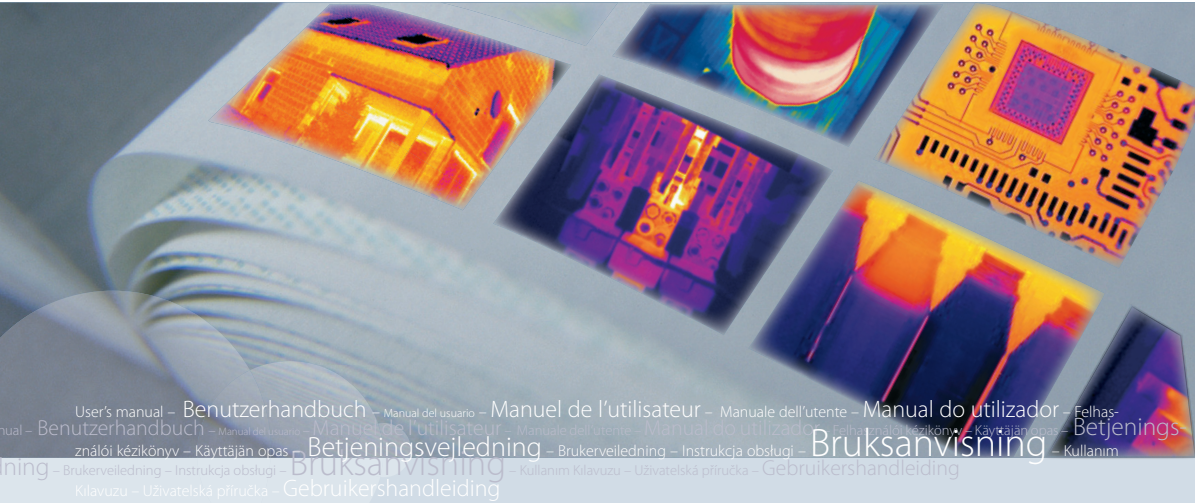

User's manual – Benutzerhandbuch – Manual del usuario – Manuel de l'utilisateur – Manuale dell'utente – Manual do utilizador – Felhasználói kézikönyv – Käyttöään opas – Betjeningsvejledning – Brukerveledning – Instrukcja obsługi – Bruksanvisning – Kullanim Kilavuzu – Uživatelská příručka – Gebruikershandleiding

InfraCAM InfraCAM SD

| | |
|------------|-------------------|
| Publ. No. | 1558299 |
| Revision | a200 |
| Language | English (EN) |
| Issue date | February 12, 2007 |

| | |
|--|-----------|
| Warnings & Cautions | 1 |
| Notice to user | 2 |
| Important note about this manual | 3 |
| Contents of the transport case | 4 |
| Camera parts | 5 |
| Screen elements | 6 |
| Connecting the cables | 7 |
| Operating the camera | 8 |
| Cleaning the camera | 9 |
| Technical data | 10 |
| Dimensional drawings | 11 |
| Introduction to building thermography | 12 |
| Introduction to thermographic inspections of electrical installations | 13 |
| About FLIR Systems | 14 |
| History of infrared technology | 15 |

User's manual

Legal disclaimer

All products manufactured by FLIR Systems are warranted against defective materials and workmanship for a period of one (1) year from the delivery date of the original purchase, provided such products have been under normal storage, use and service, and in accordance with FLIR Systems instruction.

All products not manufactured by FLIR Systems included in systems delivered by FLIR Systems to the original purchaser carry the warranty, if any, of the particular supplier only and FLIR Systems has no responsibility whatsoever for such products.

The warranty extends only to the original purchaser and is not transferable. It is not applicable to any product which has been subjected to misuse, neglect, accident or abnormal conditions of operation. Expendable parts are excluded from the warranty.

In the case of a defect in a product covered by this warranty the product must not be further used in order to prevent additional damage. The purchaser shall promptly report any defect to FLIR Systems or this warranty will not apply.

FLIR Systems will, at its option, repair or replace any such defective product free of charge if, upon inspection, it proves to be defective in material or workmanship and provided that it is returned to FLIR Systems within the said one-year period.

FLIR Systems has no other obligation or liability for defects than those set forth above.

No other warranty is expressed or implied. FLIR Systems specifically disclaims the implied warranties of merchantability and fitness for a particular purpose.

FLIR Systems shall not be liable for any direct, indirect, special, incidental or consequential loss or damage, whether based on contract, tort or any other legal theory.

Copyright

© FLIR Systems, 2007. All rights reserved worldwide. No parts of the software including source code may be reproduced, transmitted, transcribed or translated into any language or computer language in any form or by any means, electronic, magnetic, optical, manual or otherwise, without the prior written permission of FLIR Systems.

This manual must not, in whole or part, be copied, photocopied, reproduced, translated or transmitted to any electronic medium or machine readable form without prior consent, in writing, from FLIR Systems.

Names and marks appearing on the products herein are either registered trademarks or trademarks of FLIR Systems and/or its subsidiaries. All other trademarks, trade names or company names referenced herein are used for identification only and are the property of their respective owners.

Quality assurance

The Quality Management System under which these products are developed and manufactured has been certified in accordance with the ISO 9001 standard.

FLIR Systems is committed to a policy of continuous development; therefore we reserve the right to make changes and improvements on any of the products described in this manual without prior notice.

Patents

This product is protected by patents, design patents, patents pending, or design patents pending.

One or several of the following patents, design patents, patents pending, or design patents pending apply to the products and/or features described in this manual:

| Designation | Status | Reg. No. |
|-------------|---------------|----------------|
| China | Application | 00809178.1 |
| China | Application | 01823221.3 |
| China | Application | 01823226.4 |
| China | Design Patent | 235308 |
| China | Design Patent | ZL02331553.9 |
| China | Design Patent | ZL02331554.7 |
| China | Pending | 200530018812.0 |
| EPC | Patent | 1188086 |
| EPO | Application | 01930377.5 |
| EPO | Application | 01934715.2 |
| EPO | Application | 27282912 |
| EU | Design Patent | 000279476-0001 |
| France | Patent | 1188086 |

| Designation | Status | Reg. No. |
|--------------------|---------------|-----------------|
| Germany | Patent | 60004227.8 |
| Great Britain | Design Patent | 106017 |
| Great Britain | Design Patent | 3006596 |
| Great Britain | Design Patent | 3006597 |
| Great Britain | Patent | 1188086 |
| International | Design Patent | DM/057692 |
| International | Design Patent | DM/061609 |
| Japan | Application | 2000-620406 |
| Japan | Application | 2002-588123 |
| Japan | Application | 2002-588070 |
| Japan | Design Patent | 1144833 |
| Japan | Design Patent | 1182246 |
| Japan | Design Patent | 1182620 |
| Japan | Pending | 2005-020460 |
| PCT | Application | PCT/SE01/00983 |
| PCT | Application | PCT/SE01/00984 |
| PCT | Application | PCT/SE02/00857 |
| PCT | Application | PCT/SE03/00307 |
| PCT | Application | PCT/SE/00/00739 |
| Sweden | Application | 0302837-0 |
| Sweden | Design Patent | 68657 |
| Sweden | Design Patent | 75530 |
| Sweden | Patent | 518836 |
| Sweden | Patent | 522971 |
| Sweden | Patent | 524024 |
| U.S. | Application | 09/576266 |
| U.S. | Application | 10/476,760 |
| U.S. | Design Patent | 466540 |
| U.S. | Design Patent | 483782 |
| U.S. | Design Patent | 484155 |
| U.S. | Patent | 5,386,117 |
| U.S. | Patent | 5,637,871 |
| U.S. | Patent | 5,756,999 |
| U.S. | Patent | 6,028,309 |
| U.S. | Patent | 6,707,044 |
| U.S. | Patent | 6,812,465 |
| U.S. | Patent | 7,034,300 |

| Designation | Status | Reg. No. |
|-------------|---------|------------|
| U.S. | Pending | 29/233,400 |

EULA Terms

- You have acquired a device ("INFRARED CAMERA") that includes software licensed by FLIR Systems AB from Microsoft Licensing, GP or its affiliates ("MS"). Those installed software products of MS origin, as well as associated media, printed materials, and "online" or electronic documentation ("SOFTWARE") are protected by international intellectual property laws and treaties. The SOFTWARE is licensed, not sold. All rights reserved.
- IF YOU DO NOT AGREE TO THIS END USER LICENSE AGREEMENT ("EULA"), DO NOT USE THE DEVICE OR COPY THE SOFTWARE. INSTEAD, PROMPTLY CONTACT FLIR Systems AB FOR INSTRUCTIONS ON RETURN OF THE UNUSED DEVICE(S) FOR A REFUND. **ANY USE OF THE SOFTWARE, INCLUDING BUT NOT LIMITED TO USE ON THE DEVICE, WILL CONSTITUTE YOUR AGREEMENT TO THIS EULA (OR RATIFICATION OF ANY PREVIOUS CONSENT).**
- **GRANT OF SOFTWARE LICENSE.** This EULA grants you the following license:
 - You may use the SOFTWARE only on the DEVICE.
 - **NOT FAULT TOLERANT.** THE SOFTWARE IS NOT FAULT TOLERANT. FLIR Systems AB HAS INDEPENDENTLY DETERMINED HOW TO USE THE SOFTWARE IN THE DEVICE, AND FLIR Systems AB HAS RELIED UPON FLIR Systems AB TO CONDUCT SUFFICIENT TESTING TO DETERMINE THAT THE SOFTWARE IS SUITABLE FOR SUCH USE.
 - **NO WARRANTIES FOR THE SOFTWARE.** THE SOFTWARE is provided "AS IS" and with all faults. THE ENTIRE RISK AS TO SATISFACTORY QUALITY, PERFORMANCE, ACCURACY, AND EFFORT (INCLUDING LACK OF NEGLIGENCE) IS WITH YOU. ALSO, THERE IS NO WARRANTY AGAINST INTERFERENCE WITH YOUR ENJOYMENT OF THE SOFTWARE OR AGAINST INFRINGEMENT. **IF YOU HAVE RECEIVED ANY WARRANTIES REGARDING THE DEVICE OR THE SOFTWARE, THOSE WARRANTIES DO NOT ORIGINATE FROM, AND ARE NOT BINDING ON, FLIR Systems AB.**
 - No Liability for Certain Damages. **EXCEPT AS PROHIBITED BY LAW, FLIR Systems AB SHALL HAVE NO LIABILITY FOR ANY INDIRECT, SPECIAL, CONSEQUENTIAL OR INCIDENTAL DAMAGES ARISING FROM OR IN CONNECTION WITH THE USE OR PERFORMANCE OF THE SOFTWARE. THIS LIMITATION SHALL APPLY EVEN IF ANY REMEDY FAILS OF ITS ESSENTIAL PURPOSE. IN NO EVENT SHALL FLIR Systems AB BE LIABLE FOR ANY AMOUNT IN EXCESS OF U.S. TWO HUNDRED FIFTY DOLLARS (U.S.\$250.00).**
 - **Limitations on Reverse Engineering, Decompilation, and Disassembly.** You may not reverse engineer, decompile, or disassemble the SOFTWARE, except and only to the extent that such activity is expressly permitted by applicable law notwithstanding this limitation.
 - **SOFTWARE TRANSFER ALLOWED BUT WITH RESTRICTIONS.** You may permanently transfer rights under this EULA only as part of a permanent sale or transfer of the Device, and only if the recipient agrees to this EULA. If the SOFTWARE is an upgrade, any transfer must also include all prior versions of the SOFTWARE.
 - **EXPORT RESTRICTIONS.** You acknowledge that SOFTWARE is subject to U.S. export jurisdiction. You agree to comply with all applicable international and national laws that apply to the SOFTWARE, including the U.S. Export Administration Regulations, as well as end-user, end-use and destination restrictions issued by U.S. and other governments. For additional information see <http://www.microsoft.com/exporting/>.

Table of contents

| | | |
|----------|---|-----------|
| 1 | Warnings & Cautions | 1 |
| 2 | Notice to user | 4 |
| 3 | Important note about this manual | 7 |
| 4 | Contents of the transport case | 9 |
| 5 | Camera parts | 11 |
| 5.1 | Front view | 11 |
| 5.2 | Side view | 13 |
| 5.3 | Keypad | 14 |
| 5.4 | Controls & functions | 15 |
| 5.5 | Power indicator | 16 |
| 5.6 | Battery condition indicator | 17 |
| 5.7 | Laser pointer | 18 |
| 6 | Screen elements | 20 |
| 7 | Connecting the cables | 23 |
| 7.1 | Power cable | 23 |
| 7.2 | USB cable | 24 |
| 8 | Operating the camera | 25 |
| 8.1 | Installing the battery | 25 |
| 8.2 | Removing the battery | 26 |
| 8.3 | Charging the battery | 27 |
| 8.3.1 | Using the combined power supply & battery charger to charge the battery when it is inside the camera | 28 |
| 8.3.2 | Using the combined power supply & battery charger to charge the battery when it is outside the camera | 29 |
| 8.3.3 | Using the stand-alone battery charger to charge the battery | 30 |
| 8.4 | Starting the camera | 31 |
| 8.5 | Stopping the camera | 31 |
| 8.6 | Adjusting camera focus | 32 |
| 8.7 | Operating the laser pointer | 33 |
| 8.8 | Saving an image | 34 |
| 8.9 | Auto-adjusting an image | 36 |
| 8.10 | Adjusting an image manually | 37 |
| 8.10.1 | Increasing or decreasing the maximum temperature level | 38 |
| 8.10.2 | Increasing or decreasing the minimum temperature level | 39 |
| 8.10.3 | Changing both the maximum and minimum temperature level at the same time | 40 |
| 8.11 | Measuring a temperature using a spot meter | 41 |
| 8.12 | Measuring a temperature using an area | 42 |
| 8.13 | Changing the colors | 43 |
| 8.14 | Changing emissivity | 44 |
| 8.15 | Changing the reflected apparent temperature | 46 |
| 8.16 | Opening an image | 48 |
| 8.17 | Deleting an image | 49 |
| 8.18 | Deleting all images | 50 |

| | | |
|-----------|--|-----------|
| 8.19 | Changing camera settings | 51 |
| 8.20 | Moving images to a PC | 52 |
| 8.21 | Viewing streaming MPEG4 live video from the camera | 54 |
| 9 | Cleaning the camera | 55 |
| 9.1 | Camera housing, cables & other items | 55 |
| 9.2 | Infrared lens | 56 |
| 10 | Technical data | 57 |
| 11 | Dimensional drawings | 63 |
| 11.1 | Camera | 63 |
| 11.2 | Battery | 67 |
| 11.3 | Stand-alone battery charger | 68 |
| 11.4 | Stand-alone battery charger with battery | 69 |
| 12 | Introduction to building thermography | 71 |
| 12.1 | Important note | 71 |
| 12.2 | Typical field investigations | 71 |
| 12.2.1 | Guidelines | 71 |
| 12.2.1.1 | General guidelines | 71 |
| 12.2.1.2 | Guidelines for moisture detection, mold detection & detection of water damages | 72 |
| 12.2.1.3 | Guidelines for detection of air infiltration & insulation deficiencies ... | 72 |
| 12.2.2 | About moisture detection | 73 |
| 12.2.3 | Moisture detection (1): Low-slope commercial roofs | 73 |
| 12.2.3.1 | General information | 73 |
| 12.2.3.2 | Safety precautions | 74 |
| 12.2.3.3 | Commented building structures | 75 |
| 12.2.3.4 | Commented infrared images | 76 |
| 12.2.4 | Moisture detection (2): Commercial & residential façades | 78 |
| 12.2.4.1 | General information | 78 |
| 12.2.4.2 | Commented building structures | 78 |
| 12.2.4.3 | Commented infrared images | 80 |
| 12.2.5 | Moisture detection (3): Decks & balconies | 80 |
| 12.2.5.1 | General information | 80 |
| 12.2.5.2 | Commented building structures | 81 |
| 12.2.5.3 | Commented infrared images | 83 |
| 12.2.6 | Moisture detection (4): Plumbing breaks & leaks | 83 |
| 12.2.6.1 | General information | 83 |
| 12.2.6.2 | Commented infrared images | 84 |
| 12.2.7 | Air infiltration | 86 |
| 12.2.7.1 | General information | 86 |
| 12.2.7.2 | Commented building structures | 86 |
| 12.2.7.3 | Commented infrared images | 88 |
| 12.2.8 | Insulation deficiencies | 89 |
| 12.2.8.1 | General information | 89 |
| 12.2.8.2 | Commented building structures | 89 |
| 12.2.8.3 | Commented infrared images | 91 |
| 12.3 | Theory of building science | 93 |
| 12.3.1 | General information | 93 |
| 12.3.2 | The effects of testing and checking | 94 |
| 12.3.3 | Sources of disruption in thermography | 95 |
| 12.3.4 | Surface temperature and air leaks | 97 |

| | | | |
|-----------|----------|--|------------|
| | 12.3.4.1 | Pressure conditions in a building | 97 |
| 12.3.5 | | Measuring conditions & measuring season | 103 |
| 12.3.6 | | Interpretation of infrared images | 103 |
| 12.3.7 | | Humidity & dew point | 105 |
| | 12.3.7.1 | Relative & absolute humidity | 105 |
| | 12.3.7.2 | Definition of dew point | 106 |
| 12.3.8 | | Assessing thermal bridging and insulation continuity | 106 |
| | 12.3.8.1 | Credits | 106 |
| | 12.3.8.2 | Introduction | 107 |
| | 12.3.8.3 | Background information | 107 |
| | 12.3.8.4 | Quantitative appraisal of thermal anomalies | 108 |
| | 12.3.8.5 | Conditions and equipment | 112 |
| | 12.3.8.6 | Survey and analysis | 113 |
| | 12.3.8.7 | Reporting | 114 |
| 12.4 | | Disclaimer | 116 |
| | 12.4.1 | Copyright notice | 116 |
| | 12.4.2 | Training & certification | 116 |
| | 12.4.3 | National or regional building codes | 116 |
| 13 | | Introduction to thermographic inspections of electrical installations | 117 |
| 13.1 | | Important note | 117 |
| 13.2 | | General information | 117 |
| | 13.2.1 | Introduction | 117 |
| | 13.2.2 | General equipment data | 118 |
| | 13.2.3 | Inspection | 119 |
| | 13.2.4 | Classification & reporting | 119 |
| | 13.2.5 | Priority | 120 |
| | 13.2.6 | Repair | 120 |
| | 13.2.7 | Control | 121 |
| 13.3 | | Measurement technique for thermographic inspection of electrical installations | 122 |
| | 13.3.1 | How to correctly set the equipment | 122 |
| | 13.3.2 | Temperature measurement | 122 |
| | 13.3.3 | Comparative measurement | 124 |
| | 13.3.4 | Normal operating temperature | 125 |
| | 13.3.5 | Classification of faults | 126 |
| 13.4 | | Reporting | 128 |
| 13.5 | | Different types of hot spots in electrical installations | 130 |
| | 13.5.1 | Reflections | 130 |
| | 13.5.2 | Solar heating | 130 |
| | 13.5.3 | Inductive heating | 131 |
| | 13.5.4 | Load variations | 131 |
| | 13.5.5 | Varying cooling conditions | 132 |
| | 13.5.6 | Resistance variations | 133 |
| | 13.5.7 | Overheating in one part as a result of a fault in another | 133 |
| 13.6 | | Disturbance factors at thermographic inspection of electrical installations | 135 |
| | 13.6.1 | Wind | 135 |
| | 13.6.2 | Rain and snow | 135 |
| | 13.6.3 | Distance to object | 136 |
| | 13.6.4 | Object size | 137 |
| 13.7 | | Practical advice for the thermographer | 139 |
| | 13.7.1 | From cold to hot | 139 |
| | 13.7.2 | Rain showers | 139 |
| | 13.7.3 | Emissivity | 139 |

| | | |
|-----------|---|------------|
| 13.7.4 | Reflected apparent temperature | 140 |
| 13.7.5 | Object too far away | 140 |
| 14 | About FLIR Systems | 141 |
| 14.1 | More than just an infrared camera | 142 |
| 14.2 | Sharing our knowledge | 142 |
| 14.3 | Supporting our customers | 142 |
| 14.4 | A few images from our facilities | 143 |
| 15 | History of infrared technology | 145 |
| | Index | 149 |

WARNING

- This equipment generates, uses, and can radiate radio frequency energy and if not installed and used in accordance with the instruction manual, may cause interference to radio communications. It has been tested and found to comply with the limits for a Class A computing device pursuant to Subpart J of Part 15 of FCC Rules, which are designed to provide reasonable protection against such interference when operated in a commercial environment. Operation of this equipment in a residential area is likely to cause interference in which case the user at his own expense will be required to take whatever measures may be required to correct the interference.
- (Applies only to cameras with laser pointer:) Do not look directly into the laser beam. The laser beam can cause eye irritation.
- Do not disassemble or do a modification to the battery. The battery contains safety and protection devices which, if they become damaged, can cause the battery to become hot, or cause an explosion or an ignition.
- If there is a leak from the battery and the fluid gets into your eyes, do not rub your eyes. Flush well with water and immediately get medical care. The battery fluid can cause injury to your eyes if you do not do this.
- Do not continue to charge the battery if it does not become charged in the specified charging time. If you continue to charge the battery, it can become hot and cause an explosion or ignition.
- Only use the correct equipment to discharge the battery. If you do not use the correct equipment, you can decrease the performance or the life cycle of the battery. If you do not use the correct equipment, an incorrect flow of current to the battery can occur. This can cause the battery to become hot, or cause an explosion and injury to persons.
- Make sure that you read all applicable MSDS (Material Safety Data Sheets) and warning labels on containers before you use a liquid. The liquids can be dangerous.

CAUTION

- Do not point the infrared camera (with or without the lens cover) at intensive energy sources, for example devices that emit laser radiation, or the sun for a long period of time. This can have an unwanted effect on the accuracy of the camera. It can also cause damage to the detector in the camera.
- Do not use the camera in a temperature higher than +50°C (+122°F), unless specified otherwise in the technical data section. High temperatures can cause damage to the camera.
- (Applies only to cameras with laser pointer:) Protect the laser pointer with the protective cap when you do not operate the laser pointer.
- Do not attach the batteries directly to a car's cigarette lighter socket.
- Do not connect the positive terminal and the negative terminal of the battery to each other with a metal object (such as wire).
- Do not get water or salt water on the battery, or permit the battery to get wet.
- Do not make holes in the battery with objects. Do not hit the battery with a hammer. Do not step on the battery, or apply strong impacts or shocks to it.
- Do not put the batteries in or near a fire, or into direct sunlight. When the battery becomes hot, the built-in safety equipment becomes energized and can stop the battery charging process. If the battery becomes hot, damage can occur to the safety equipment and this can cause more heat, damage or ignition of the battery.

- Do not put the battery on a fire or increase the temperature of the battery with heat.
 - Do not put the battery on or near fires, stoves, or other high-temperature locations.
 - Do not solder directly onto the battery.
 - Do not use the battery if, when you use, charge, or store the battery, there is an unusual smell from the battery, the battery feels hot, changes color, changes shape, or is in an unusual condition. Contact your sales office if one or more of these problems occurs.
 - Only use a specified battery charger when you charge the battery.
 - The temperature range through which you can charge the battery is $\pm 0^{\circ}\text{C}$ to $+45^{\circ}\text{C}$ ($+32^{\circ}\text{F}$ to $+113^{\circ}\text{F}$). If you charge the battery at temperatures out of this range, it can cause the battery to become hot or to break. It can also decrease the performance or the life cycle of the battery.
 - The temperature range through which you can discharge the battery is -15°C to $+50^{\circ}\text{C}$ ($+5^{\circ}\text{F}$ to $+122^{\circ}\text{F}$). Use of the battery out of this temperature range can decrease the performance or the life cycle of the battery.
 - When the battery is worn, apply insulation to the terminals with adhesive tape or similar materials before you discard it.
 - Do not use thinner or an equivalent liquid on the camera, the cables and other items. This can cause damage.
 - Be careful when you clean the infrared lens. The lens has an anti-reflective coating.
 - Do not clean the infrared lens too much. This can cause damage to the anti-reflective coating.
-

2 Notice to user

2

Typographical conventions

This manual uses the following typographical conventions:

- **Semibold** is used for menu names, menu commands and labels and buttons in dialog boxes.
- *Italic* is used for important information.
- **Monospace** is used for code samples.
- **UPPERCASE** is used for names on keys and buttons.

Comments & questions

Make a report of errors you find, as well as your suggestions for new revisions. Send an e-mail to:

documentation@flir.se

Technical support

To get technical support, visit this site:

<http://flir.custhelp.com>

To submit a question to the technical support team you must be a registered user. It only takes a few minutes to register online. If you only want to search the knowledgebase for existing questions and answers, you do not need to be a registered user.

When you want to submit a question, make sure that you have the following information on hand:

- The camera model name
- The camera serial number
- The communication protocol, or method, between the camera and your PC (for example, Ethernet, USB, or FireWire)
- Operating system on your PC
- Microsoft® Office version
- Full name, publication number and revision number of the manual

Software updates

FLIR Systems regularly issues software upgrades and service releases on the support pages of the company website:

<http://www.flirthermography.com>

To find the latest upgrades and service releases, make sure you select **USA** in the **Select country** box in the top right corner of the page.

Calibration

(This notice only applies to cameras with measurement capabilities:)

We recommend that you send in the camera for calibration one time per year. Contact your local sales office for instructions where to send the camera.

Accuracy

(This notice only applies to cameras with measurement capabilities:)

For very accurate results, we recommend that you wait 5 minutes after you have started the camera before you measure a temperature.

**Disposal of
electronic waste**



As with most electronic products, this equipment must be disposed of in an environmentally friendly way, and in accordance with existing regulations for electronic waste.

Please contact your FLIR Systems representative for more details.

Training

To read about infrared training, visit this site:

<http://www.infraredtraining.com>

3 Important note about this manual

General

FLIR Systems issues generic manuals that cover several cameras within a model line.

This means that this manual contains descriptions and explanations that may not apply to your particular camera model.

NOTE

FLIR Systems reserves the right to discontinue models, parts or accessories, and other items, or change specifications at any time without prior notice.

3

4

Contents of the transport case

Contents

| Item | Part number |
|--|-------------------------|
| Battery | 1196398 |
| Combined power supply & battery charger | 1910399 |
| InfraCAM/InfraCAM SD infrared camera | Configuration-dependent |
| InfraCAM/InfraCAM SD user's manual | 1558299 |
| Power cable | Configuration-dependent |
| Quick Reference Guide | 1558364 |
| SD Card | 1910472 |
| Stand-alone battery charger (extra option) | 1196474 |
| ThermaCAM™ QuickReport CD-ROM | – |
| ThermaCAM™ QuickReport user's manual | – |
| USB cable | 1910423 |

NOTE

- Contact your local sales office if any item is damaged or missing. You can find the addresses and telephone numbers of local sales offices on the back cover of this manual.
- The contents of the transport case is subject to customer configuration.
- FLIR Systems reserves the right to discontinue models, parts or accessories, and other items, or change specifications at any time without prior notice.
- The stand-alone battery charger is an item that is not included in the standard package.

5 Camera parts

5.1 Front view

Figure

10601703.a2

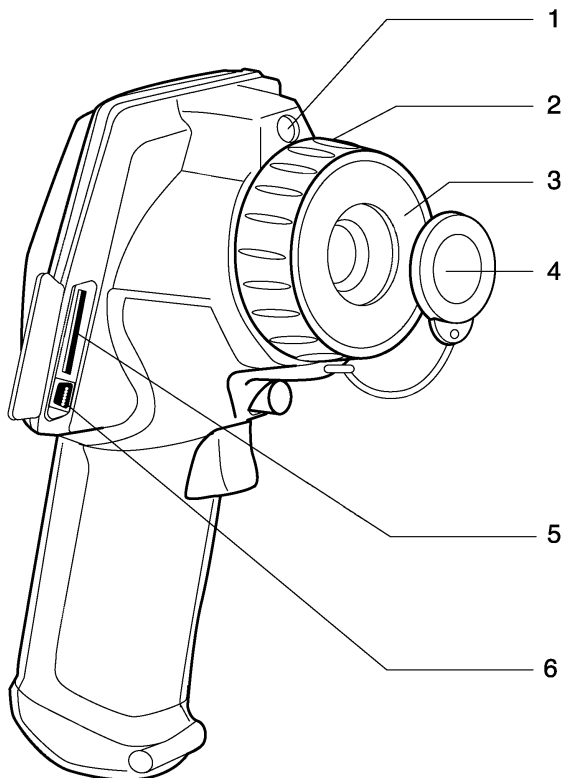

Explanation

This table gives an explanation to the figure above:

| | |
|---|--|
| 1 | Laser pointer with lens cap |
| 2 | Focus ring |
| 3 | Infrared lens |
| 4 | Lens cap for infrared lens. To prevent losing the lens cap, you can attach it to the tripod mount. |

| | |
|----------|---|
| 5 | (Applies only to models with SD Memory Card: Slot for SD Memory Card |
| 6 | USB mini-B connector |

NOTE

The laser pointer may not be enabled in all markets.

5.2

Side view

Figure

10601803.a2

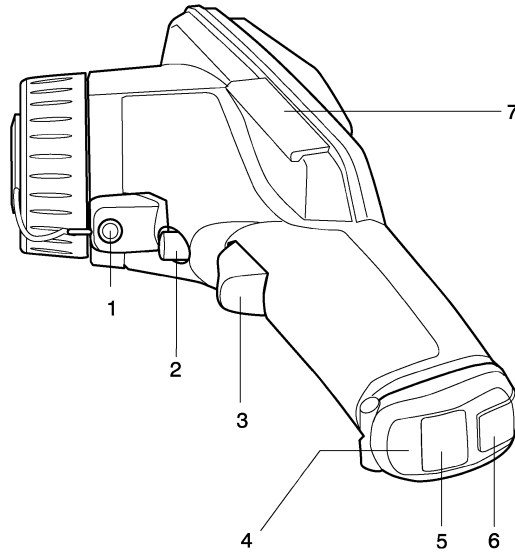

5

Explanation

This table gives an explanation to the figure above:

| | |
|---|---|
| 1 | Tripod mount 1/4"-20 |
| 2 | Top trigger to operate the laser pointer |
| 3 | Bottom trigger to save an image |
| 4 | Battery compartment lid |
| 5 | Rubber lid for power connector |
| 6 | Locking mechanism for battery compartment lid |
| 7 | Camera serial number behind rubber lid |

NOTE

- The laser pointer may not be enabled in all markets.
- When you attach the camera to a tripod, use a tripod ball head where the top part does not prevent the operation of the laser trigger.

5.3 Keypad

Figure

10602903.a2

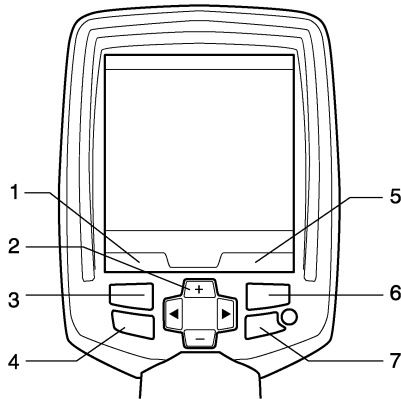

5

Explanation

This table gives an explanation to the figure above:

| | |
|---|--|
| 1 | Text that indicates the current function of the left selection button. |
| 2 | Navigation pad |
| 3 | Left selection button. This button is context-sensitive. |
| 4 | Camera/archive button. This button is used to go between camera mode and archive mode. |
| 5 | Text that indicates the current function of the right selection button. |
| 6 | Right selection button. This button is context-sensitive. |
| 7 | Power button |

5.4 Controls & functions

General

The camera has the following controls:

- Four push-buttons
- One navigation pad
- Two triggers

Explanation

This table gives an explanation to the figures on page 13 and 14:

| Button or trigger | Functions |
|------------------------|--|
| Left selection button | The left selection button has the following context-sensitive functions: <ul style="list-style-type: none"> ■ Menu ■ Select ■ Options ■ Cancel ■ Delete |
| Camera/archive button | Push to go between camera mode and archive mode. |
| Right selection button | The right selection button has the following context-sensitive functions: <ul style="list-style-type: none"> ■ Man/Auto ■ Close ■ Open ■ Overview ■ OK ■ Delete ■ Restore |
| Power button | <ul style="list-style-type: none"> ■ Push the power button to start the camera. ■ Push and hold the power button for more than 0.5 seconds to stop the camera. |
| Navigation pad | <ul style="list-style-type: none"> ■ Push up/down or left/right to navigate on menus and in dialog boxes. ■ Push up/down to change a value. ■ Push left/right to select a menu command in a menu. |
| Top trigger | <ul style="list-style-type: none"> ■ Pull the top trigger to start the laser pointer. ■ Release the top trigger to stop the laser pointer. |
| Bottom trigger | Pull and release the bottom trigger to save one image to the camera memory, or SD Memory Card (depending on camera model). |

NOTE

The laser pointer may not be enabled in all markets.

5.5 Power indicator

General

The camera has two power modes. An indicator shows these modes.

Figure

10715803.a3

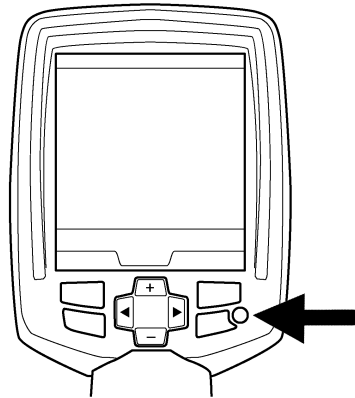

5

Explanation

This table gives an explanation about the indicator:

| Signal type | Explanation |
|--------------------------------|--------------------|
| The green light is continuous. | The camera is on. |
| The green light is off. | The camera is off. |

NOTE

If the green light flashes 10 times per second the camera has a hardware problem. Contact your local sales office for instructions where to send the camera for service.

5.6 *Battery condition indicator*

General The battery has a battery condition indicator.

Figure

10715703.a3

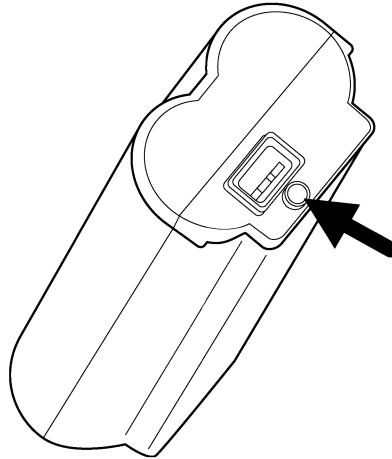

5

Explanation

This table gives an explanation about the battery condition indicator:

| Type of signal | Explanation |
|---|--|
| The green light flashes two times per second. | The power supply or the stand-alone battery charger charges the battery. |
| The green light is continuous. | The battery is fully charged. |
| The green light is off. | The camera uses the battery (instead of the power supply). |

5.7 Laser pointer

General The camera has a laser pointer. When the laser pointer is on, you can see a laser dot approximately 37 mm (1.5 in.) above the target.

Figure This figure shows the difference in position between the laser pointer and the optical center of the infrared lens:

10602503.a2

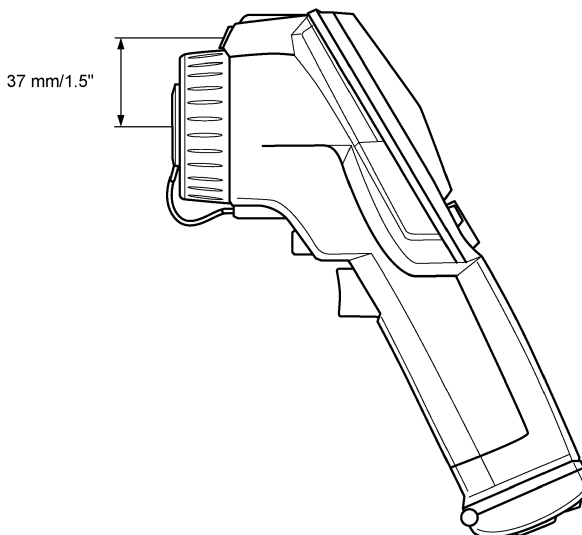

5

WARNING Do not look directly into the laser beam. The laser beam can cause eye irritation.

CAUTION Protect the laser pointer with the protective cap when you do not operate the laser pointer.

NOTE

- The laser pointer may not be enabled in all markets.
- The symbol  is displayed on the screen when the laser pointer is on.
- The distance between the laser beam and the image center changes because of the target distance. Look at the screen to make sure that it displays the correct target.

Laser warning label

This laser warning label is attached to the camera:



Laser rules and regulations

Wavelength: 635 nm. Max. output power: 1 mW.

This product complies with 21 CFR 1040.10 and 1040.11 except for deviations pursuant to Laser Notice No. 50, dated July 26th, 2001.

6 Screen elements

General

You use screen elements—tools, menus and selections in dialog boxes—to control the camera program. This section describes the typical set of screen objects.

Figure

10715503.a5

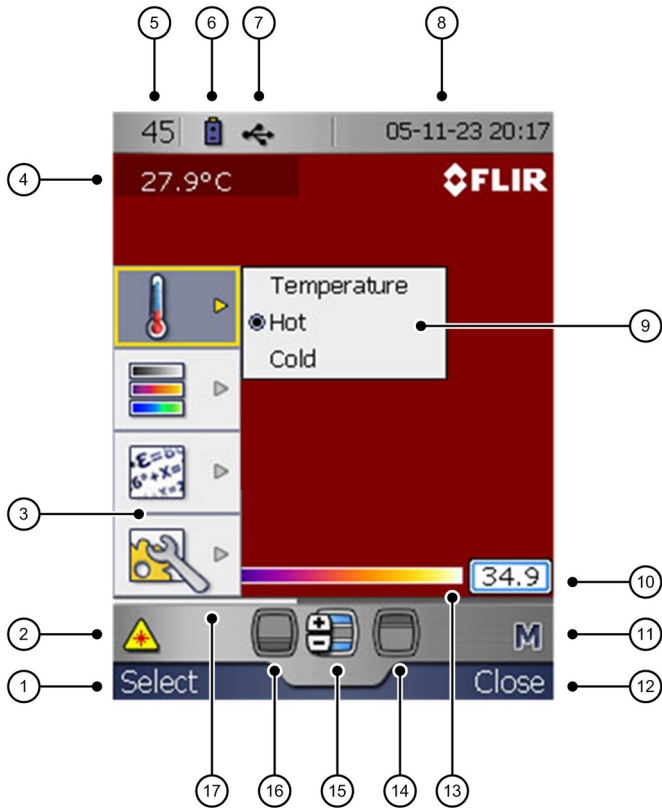

Explanation

This table gives an explanation to the figure above:

| | |
|---|---|
| 1 | Current function of the left selection button of the keypad |
| 2 | Laser symbol |
| 3 | Main menu |

| | |
|----|---|
| 4 | <p>Measured temperature</p> <p>If the symbol > or < precedes the temperature value, the value is above or below the camera's temperature range.</p> |
| 5 | <ul style="list-style-type: none"> ■ The remaining number of images that you can save in the camera memory (applies only to models without SD Memory Card) ■ Free memory on the SD Memory Card in per cent (applies only to models with SD Memory Card) |
| 6 | <p>Indicator that shows battery status and that the camera uses the battery. If the camera uses the power supply, a different indicator is displayed.</p> |
| 7 | <p>Indicator that shows that a USB cable is connected between the camera and a PC</p> |
| 8 | <p>Date and time</p> |
| 9 | <p>Submenu</p> |
| 10 | <p>Maximum temperature in the temperature range. In this figure, the minimum temperature is hidden under the main menu.</p> |
| 11 | <p>Indicator that shows if the camera is in auto-adjust mode (A) or manual adjust mode (M)</p> |
| 12 | <p>Current function of the right selection button of the keypad</p> |
| 13 | <p>Temperature scale</p> |
| 14 | <p>Tool to change the maximum temperature</p> |
| 15 | <p>Tool to change the maximum and minimum temperature at the same time</p> |
| 16 | <p>Tool to change the minimum temperature</p> |
| 17 | <p>Indicator that shows the relative width of the measured temperature span compared to the temperature scale values</p> |

7 Connecting the cables

7.1 *Power cable*

General

You connect a power cable to the camera

- when you charge the battery;
 - when you use the power supply to operate the camera.
-

Figure

10601403.a2

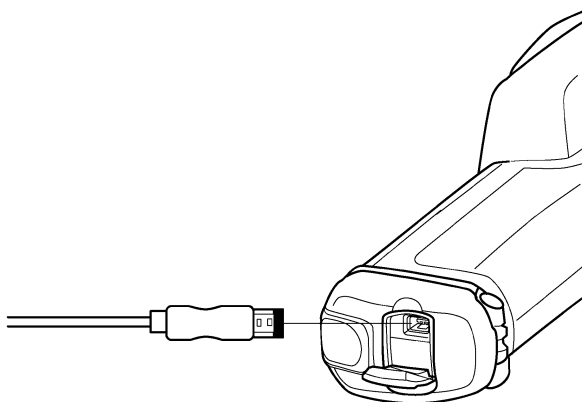

SEE ALSO

For information about pin configuration, see section 10 – Power connector on page 60.

7.2 *USB cable*

General

You connect a USB cable to the camera when you move images from the camera memory to a computer.

Figure

10601303.a3

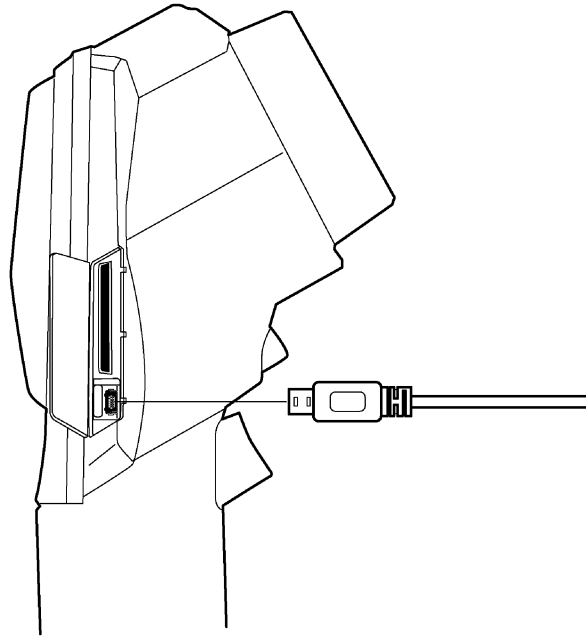

7

SEE ALSO

The camera can stream MPEG4 live video through the USB cable. For more information, see section 8.21 – Viewing streaming MPEG4 live video from the camera on page 54.

8

Operating the camera

8.1

Installing the battery

NOTE

Use a clean and dry cloth to remove any water or moisture on the battery before you install it.

Procedure

Follow this procedure to install the battery:

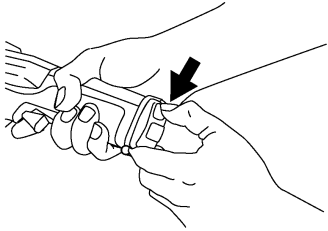
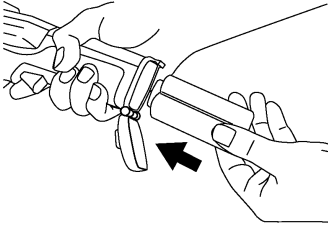
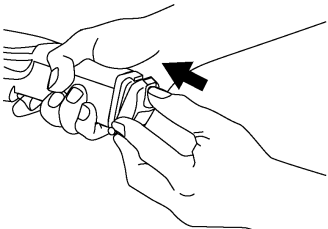
| | |
|------------------------------------|--|
| <p>1</p> <p>10600803.a1</p> | <p>To open the battery compartment lid, push down the locking mechanism.</p>  |
| <p>2</p> <p>10601603.a1</p> | <p>Push the battery into the battery compartment.</p>  |
| <p>3</p> <p>10601103.a1</p> | <p>Push the battery compartment lid into position.</p>  |

8.2 Removing the battery

Procedure

Follow this procedure to remove the battery:

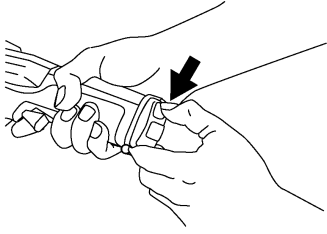
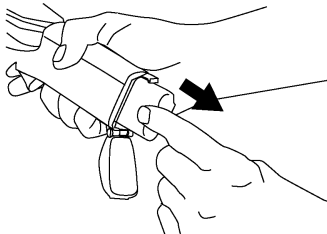
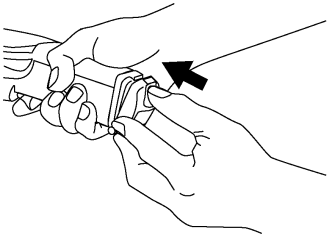
| | |
|-----------------|---|
| <p>1</p> | <p>To open the battery compartment lid, push down the locking mechanism.</p> <p>10600803.a1</p>  |
| <p>2</p> | <p>Pull out the battery from the battery compartment.</p> <p>10601003.a1</p>  |
| <p>3</p> | <p>Push the battery compartment lid into position.</p> <p>10601103.a1</p>  |

8.3 Charging the battery

NOTE You must charge the battery for four hours before you start the camera the first time.

General You must charge the battery when the message **Battery voltage is low!** is displayed on the screen.

Do one of these procedures to charge the battery:

- Use the combined power supply & battery charger to charge the battery when it is inside the camera.
 - Use the combined power supply & battery charger to charge the battery when it is outside the camera.
 - Use the stand-alone battery charger to charge the battery (The stand-alone battery charger is an item that is not included in the standard package.).
-

SEE ALSO For information how to charge the battery, see the following sections:

- Section 8.3.1 – Using the combined power supply & battery charger to charge the battery when it is inside the camera on page 28
 - Section 8.3.2 – Using the combined power supply & battery charger to charge the battery when it is outside the camera on page 29
 - Section 8.3.3 – Using the stand-alone battery charger to charge the battery on page 30
-

8.3.1 Using the combined power supply & battery charger to charge the battery when it is inside the camera

NOTE For the clarity of the procedure, the 'combined power supply & battery charger' is called 'power supply' below.

Procedure Follow this procedure to use the power supply to charge the battery when it is inside the camera:

| | |
|---|---|
| 1 | To open the battery compartment lid, push down the locking mechanism. |
| 2 | Push the battery into the battery compartment. |
| 3 | Push the battery compartment lid into position. |
| 4 | On the battery compartment lid, open the rubber lid to find the connector on the battery. |
| 5 | Connect the power supply cable plug to the connector on the battery. |
| 6 | Connect the power supply wall plug to a wall outlet box. |
| 7 | Disconnect the power supply cable plug when the green light of the battery condition indicator is continuous. |

NOTE The battery has a battery condition indicator. When the green light is continuous, the battery is fully charged.

SEE ALSO

- For information about the battery condition indicator, see section 5.6 – Battery condition indicator on page 17.
- For information about how to install and remove the battery, see section 8.1 – Installing the battery on page 25 and section 8.2 – Removing the battery on page 26.

8.3.2 Using the combined power supply & battery charger to charge the battery when it is outside the camera

NOTE For the clarity of the procedure, the 'combined power supply & battery charger' is called 'power supply' below.

Procedure Follow this procedure to use the power supply to charge the battery when it is outside the camera:

| | |
|----------|---|
| 1 | Put the battery on a flat surface. |
| 2 | Connect the power supply cable plug to the connector on the battery. |
| 3 | Connect the power supply wall plug to a wall outlet box. |
| 4 | Disconnect the power supply cable plug when the green light of the battery condition indicator is continuous. |

NOTE The battery has a battery condition indicator. When the green light is continuous, the battery is fully charged.

SEE ALSO For information about the battery condition indicator, see section 5.6 – Battery condition indicator on page 17.

8.3.3 Using the stand-alone battery charger to charge the battery

Procedure Follow this procedure to use the stand-alone battery charger to charge the battery:

| | |
|----------|---|
| 1 | Put the battery in the stand-alone battery charger. |
| 2 | Connect the power supply cable plug to the connector on the stand-alone battery charger. |
| 3 | Connect the power supply wall plug to a wall outlet box. |
| 4 | Disconnect the power supply cable plug when the green light of the battery condition indicator is continuous. |

NOTE

- The stand-alone battery charger is an item that is not included in the standard package.
- The battery has a battery condition indicator. When the green light is continuous, the battery is fully charged.

SEE ALSO For information about the battery condition indicator, see section 5.6 – Battery condition indicator on page 17.

8.4 *Starting the camera*

Procedure Push the power button to start the camera.

8.5 *Stopping the camera*

Procedure Push and hold the power button for more than 0.5 seconds to stop the camera.

NOTE If you do not use the camera, the power goes off after a time period that you can set in the menu system (See section 8.19 – Changing camera settings on page 51.).

8.6 Adjusting camera focus

Figure

10602803.a1

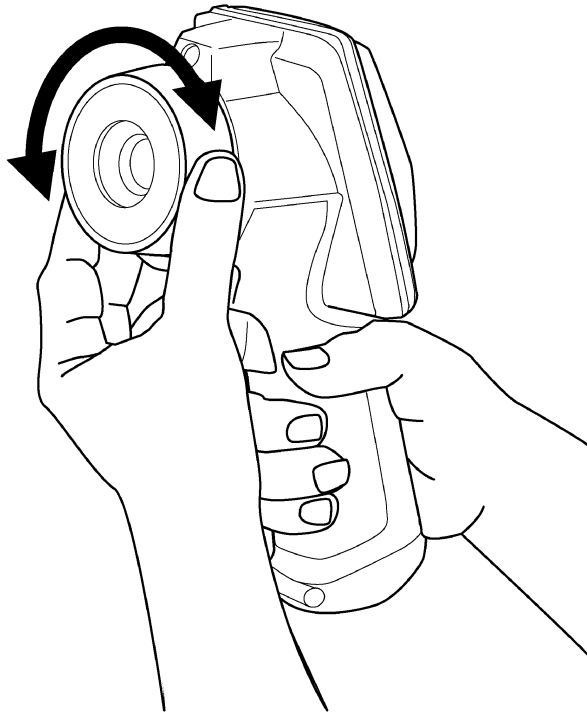

8

Procedure

Follow this procedure to adjust camera focus:

| | |
|---|--|
| 1 | Hold the camera tightly in your hand. |
| 2 | Hold the focus ring with the other hand. |
| 3 | Do one of the following: <ul style="list-style-type: none">▪ Turn the focus ring counter-clockwise for far focus.▪ Turn the focus ring clock-wise for near focus. |

8.7 Operating the laser pointer

Figure

10601203.a3

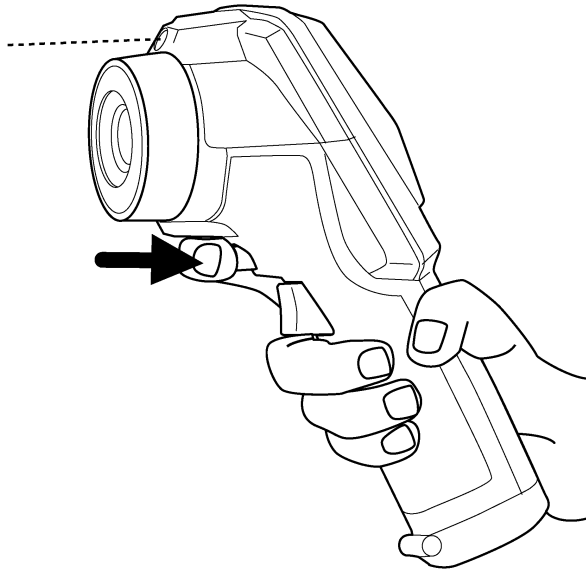

8

Procedure

Follow this procedure to operate the laser pointer:

| | |
|---|--|
| 1 | Pull the top trigger to start the laser pointer. |
| 2 | Release the top trigger to stop the laser pointer. |

NOTE

The laser pointer may not be enabled in all markets.

8.8 Saving an image

General Depending on your camera model, you can save one image or many images to the camera memory, or on the SD Memory Card.

Naming convention The naming convention for images is IR_xxxx.jpg, where xxxx is a unique counter. When you select **Restore default** the camera resets the counter and assigns the first highest free file name for the new file.

Figure

10601503.a1

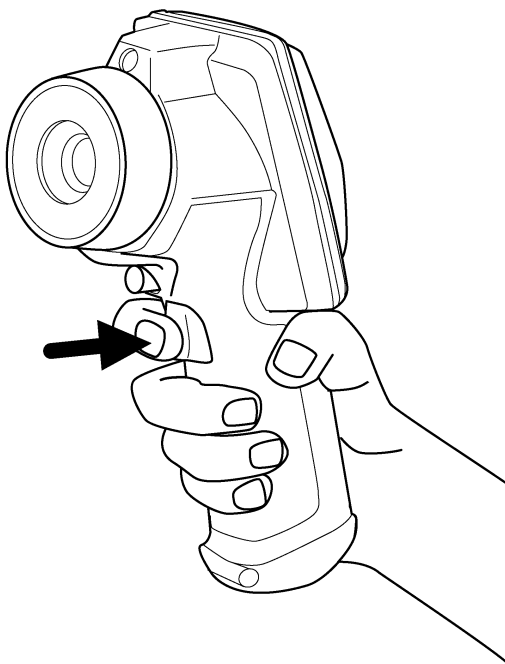

8

Procedure Pull and release the bottom trigger to save one image to the camera memory, or SD Memory Card (depending on camera model).

NOTE

- When you save an image to the camera memory, you save the measured value too.
 - You can save 50 images to the camera memory (applies only to models without SD Memory Card).
 - You can save 1,000 images to the SD Memory Card (applies only to models with SD Memory Card). More than 1,000 images can be saved on larger SD Memory Cards, but this will decrease the performance of the camera.
 - The image file format is compatible with ThermaCAM™ Reporter 8.0 and later (applies only to models with SD Memory Card).
-

8.9 *Auto-adjusting an image*

General For best image brightness and contrast, auto-adjust the camera before you measure a temperature and save an image.

Procedure If the letter **M** is displayed in the bottom right corner of the screen, push **Man/Auto** one time to auto-adjust the image.

NOTE If the letter **A** is displayed in the bottom right corner of the screen, the camera is already auto-adjusted for best image brightness and contrast.

8.10 Adjusting an image manually

General

If you want to analyze an object with many different temperatures, you can use the colors of the scale on different parts of the object.

In the left image below a correct analysis of the left cable is difficult to make if you only auto-adjust the image. You can analyze the left cable more in detail if you increase or decrease

- the **maximum** temperature level;
- the **minimum** temperature level;
- the **maximum and minimum** temperature level at the same time.

Figure

This figure shows two infrared images of cable connection points.

In the image to the left, the image is auto-adjusted. In the right image the maximum and minimum temperature levels have been changed to temperature levels near the object. In the temperature scale to the right of each image you can see how the temperature levels were changed.

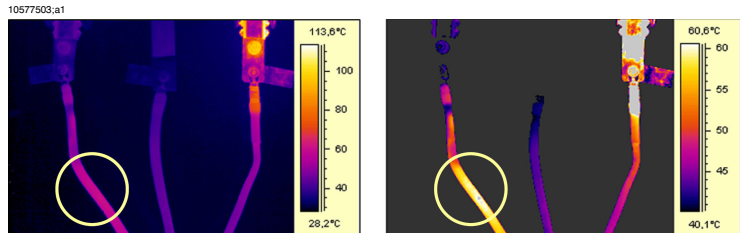

SEE ALSO

For procedures about how to adjust the image manually, see these sections:

- Section 8.10.1 – Increasing or decreasing the maximum temperature level on page 38
- Section 8.10.2 – Increasing or decreasing the minimum temperature level on page 39
- Section 8.10.3 – Changing both the maximum and minimum temperature level at the same time on page 40

8.10.1 Increasing or decreasing the maximum temperature level

Procedure

Follow this procedure to increase or decrease the **maximum** temperature level:

| | |
|---|--|
| 1 | Do one of the following: <ul style="list-style-type: none">■ If the letter A is displayed in the bottom right corner of the screen, push Man/Auto one time.■ If the letter M is displayed in the bottom right corner of the screen, go to the next step below. |
| 2 | To select  , push the navigation pad left/right. |
| 3 | To change the value, push the navigation pad up/down. |

8.10.2 Increasing or decreasing the minimum temperature level

Procedure

Follow this procedure to increase or decrease the **minimum** temperature level:

| | |
|---|--|
| 1 | Do one of the following: <ul style="list-style-type: none">■ If the letter A is displayed in the bottom right corner of the screen, push Man/Auto one time.■ If the letter M is displayed in the bottom right corner of the screen, go to the next step below. |
| 2 | To select  , push the navigation pad left/right. |
| 3 | To change the value, push the navigation pad up/down. |

8.10.3 Changing both the maximum and minimum temperature level at the same time

Procedure Follow this procedure to change both the maximum and minimum temperature at the same time:

| | |
|---|--|
| 1 | Do one of the following: <ul style="list-style-type: none">■ If the letter A is displayed in the bottom right corner of the screen, push Man/Auto one time.■ If the letter M is displayed in the bottom right corner of the screen, go to the next step below. |
| 2 | To select  , push the navigation pad left/right. |
| 3 | To change the value, push the navigation pad up/down. |

8.11 *Measuring a temperature using a spot meter*

General

You can measure the temperature using a fixed spot meter in the middle of the screen.

Procedure

Follow this procedure to measure the temperature using a fixed spot meter:

| | |
|----------|--|
| 1 | To display the main menu, push Menu . |
| 2 | To select  , push the navigation pad up/down. |
| 3 | To enable the menu, push Select . |
| 4 | To select Temperature , push the navigation pad up/down. |
| 5 | To save the changes and close the menu, push Close . |
| 6 | Point the camera at the object you want to measure. The temperature is displayed in the top left corner of the screen. |

NOTE

To display the temperature correctly, the circle in the middle of the spot meter must be completely filled by the object.

8.12 *Measuring a temperature using an area*

NOTE This feature may no be enabled in all camera models.

General You can measure the minimum or maximum temperature using a fixed area in the middle of the screen.

Procedure Follow this procedure to measure the minimum or maximum temperature using a fixed area:

| | |
|----------|--|
| 1 | To display the main menu, push Menu . |
| 2 | To select  , push the navigation pad up/down. |
| 3 | To enable the menu, push Select . |
| 4 | Do one of the following: <ul style="list-style-type: none"> ▪ To create an area for which the minimum temperature is indicated in the top left corner of the screen, push the navigation pad up/down to select Cold and push Select. ▪ To create an area for which the maximum temperature is indicated in the top left corner of the screen, push the navigation pad up/down to select Hot and push Select. |
| 5 | Point the camera at the object you want to measure. |

8.13 Changing the colors

General

You can change the colors that the camera uses to display different temperatures. A different set of colors can make it easier to make an analysis of the image.

Procedure

Follow this procedure to change the color:

| | |
|---|--|
| 1 | To display the main menu, push Menu . |
| 2 | To select  , push the navigation pad up/down. |
| 3 | To enable the menu, push Select . |
| 4 | To select a different color, push the navigation pad up/down. |
| 5 | To close the menu, push Select . |

8.14 Changing emissivity

General

Emissivity is a value that specifies how much radiation an object emits, compared to the radiation of a theoretical reference object of the same temperature (called a 'blackbody').

Except for shiny metals, a value of 0.96 is acceptable for most applications.

Example values

| | |
|--------------------------------|------|
| Asphalt paving | 0.97 |
| Brick, masonry, paint, plastic | 0.93 |
| Copper, heavily oxidized | 0.78 |
| Rubber, concrete | 0.95 |
| Stucco | 0.91 |
| Tape, electrical black | 0.96 |
| Wood | 0.85 |

Procedure

Follow this procedure to change emissivity:

| | |
|----------|---|
| 1 | To display the main menu, push Menu . |
| 2 | To select  , push the navigation pad up/down. |
| 3 | To enable the menu, push Select . |
| 4 | To select Emissivity , push the navigation pad up/down. |
| 5 | To enable the Emissivity menu, push Select . |
| 6 | Do one of the following: <ul style="list-style-type: none"> ■ Select an emissivity value in the menu. ■ Select Set value to set an arbitrary emissivity value. |
| 7 | To close the menu, push Select . |

NOTE

If you set the emissivity to a value lower than 0.5 a warning is displayed on the screen. This is to remind you that the value is unusually low.

8.15 Changing the reflected apparent temperature

General

For very accurate measurements, you must set the reflected apparent temperature. *The reflected apparent temperature compensates for the radiation from the surroundings reflected by the object into the camera.*

If emissivity is low and the object temperature differs very much from the reflected apparent temperature, it is even more important to set the reflected apparent temperature correctly.

Typical examples

It is, for example, important to set the reflected apparent temperature in the following situations:

- When you use the camera to inspect a hot item under a cold winter sky.
- When you use the camera to inspect an item in a room where there are hot furnaces or electrical cabinets at the other end of the room.

Procedure

Follow this procedure to change the reflected apparent temperature:

| | |
|----|--|
| 1 | Do one of the following: <ul style="list-style-type: none"> ■ If you already know the reflected apparent temperature, go to step 7 below. ■ If you do not know the reflected apparent temperature, go to step 2 below. |
| 2 | Crumble up a large piece of aluminum foil. |
| 3 | Uncrumble the aluminum foil and attach it to a piece of cardboard of the same size. |
| 4 | Put the piece of cardboard in front of the object you want to measure. Make sure that the side with aluminum foil points to the camera. |
| 5 | Set the emissivity to 1.0 (See section 8.14 – Changing emissivity on page 44.). |
| 6 | Measure the apparent temperature of the aluminium foil and write it down. You will need this value when you set Reflected temp. in step 12 below. |
| 7 | To display the main menu, push Menu . |
| 8 | To select  , push the navigation pad up/down. |
| 9 | To enable the menu, push Select . |
| 10 | To select Reflected temp. , push the navigation pad up/down. |
| 11 | To enable the Reflected temp. box, push Select . |
| 12 | To select a different value, push the navigation pad up/down. |
| 13 | To close the menu, push OK . |

NOTE

Do not point the infrared camera (with or without the lens cover) at intensive energy sources, for example devices that emit laser radiation, or the sun for a long period of time. This can have an unwanted effect on the accuracy of the camera. It can also cause damage to the detector in the camera.

SEE ALSO

For more information about how to measure reflected apparent temperature, see the ISO standard DIS 18434-1 and the ASTM standard ASTM E1862-97.

8.16 *Opening an image*

General

When you save an image, you store the image in the camera memory, or on the SD Memory Card, depending on your camera model.

To display the image again, you can open the image from the camera memory, or SD Memory Card.

Procedure

Follow this procedure to open an image:

| | |
|----------|---|
| 1 | To open the image archive, push the camera/archive button. |
| 2 | Do one of the following: <ul style="list-style-type: none">■ To find the image you want to open, push the navigation pad left/right.■ To display thumbnails of all images, push Overview, and follow this procedure:<ol style="list-style-type: none">1 To select the image you want to open, push the navigation pad up/down or left/right.2 To open the image, push Open. |
| 3 | To go back to live IR image, push the camera/archive button. |

8.17 *Deleting an image*

General

You can delete an image from the camera memory.

Procedure

Follow this procedure to delete an image:

| | |
|----------|--|
| 1 | To open the image archive, push the camera/archive button. |
| 2 | Do one of the following: <ul style="list-style-type: none"> ■ To delete this image, push Delete. ■ To delete another image, go to Step 3 below. |
| 3 | To display thumbnails of all images, push Overview . |
| 4 | To select the image you want to delete, push the navigation pad up/down or left/right. |
| 5 | Push Options . |
| 6 | Push Delete . |
| 7 | Confirm Delete . |

8.18 *Deleting all images*

General You can delete all images from the camera memory.

Procedure Follow this procedure to delete all images:

| | |
|---|---|
| 1 | To open the image archive, push the camera/archive button. |
| 2 | To display thumbnails of all images, push Overview . |
| 3 | Push Options . |
| 4 | Push Delete all images . |
| 5 | Confirm Delete all images . |

8.19 Changing camera settings

General

Camera settings have an effect on images and how the camera operates.

Applicability

The procedure below is applicable to these settings:

- **Auto off** (to set time period after which the camera power goes off)
- **Display intensity** (to set intensity of the display)
- **Language** (to change language)
- **Unit** (to change units)
- **Time format** (to change time format)
- **Set time** (to set time)
- **Time stamp** (to set time-stamping of images)
- **Restore default** (to restore factory default values)
- **USB cable** (to set USB mode)

Procedure

Follow this procedure to change the camera settings above:

| | |
|---|---|
| 1 | To display the main menu, push Menu . |
| 2 | To select  , push the navigation pad up/down. |
| 3 | To enable the Settings menu, push Select . |
| 4 | To select the setting you want to change, push the navigation pad up/down. |
| 5 | Use the navigation pad and the following buttons to change the setting: <ul style="list-style-type: none"> ■ Select ■ Close ■ OK ■ Cancel |

8.20 Moving images to a PC

General

You can move one or many images from the camera to a computer.

Overview of methods

You can use two different methods when you move images from the camera to a computer:

- **Method 1:** Move images when the camera works as a USB disk. With this method you don't need to install ThermaCAM™ QuickReport on your computer.
- **Method 2:** Move images when the camera is connected to a PC with ThermaCAM™ QuickReport. ThermaCAM™ QuickReport contains features for image handling and creation of PDF reports.
- **Method 3:** Use the SD Memory Card to move images (applies only to models with SD Memory Card).

Equipment

To move the images from the camera, you need this equipment:

- A computer with an IBM-PC, Mac or Linux operating system
- The program ThermaCAM™ QuickReport (**Method 2** only)
- A USB cable

Method 1

Follow this procedure to move images when the camera works as a USB disk:

| | |
|---|--|
| 1 | To display the main menu, push Menu . |
| 2 | To select  , push the navigation pad up/down. |
| 3 | To enable the Settings menu, push Select . |
| 4 | To select USB cable , push the navigation pad up/down. |
| 5 | To select Standard , push the navigation pad up/down. |
| 6 | Click OK . |
| 7 | Connect the camera and use Windows® Explorer to drag-and-drop images from the camera to the computer. |

NOTE

When you select **Standard** a help text is displayed in the camera. Read the help text carefully.

Method 2

Follow this procedure to move images to a PC with ThermaCAM™ QuickReport:

| | |
|----------|--|
| 1 | To display the main menu, push Menu . |
| 2 | To select  , push the navigation pad up/down. |
| 3 | To enable the Settings menu, push Select . |
| 4 | To select USB cable , push the navigation pad up/down. |
| 5 | To select Network disk , push the navigation pad up/down. |
| 6 | Click OK . |
| 7 | Connect the camera to the computer according to ThermaCAM™ QuickReport User's manual, Publ. No. –. |
| 8 | See ThermaCAM™ QuickReport User's manual, Publ. No. – for more instructions. |

NOTE

When you select **Network disk** a help text is displayed in the camera. Read the help text carefully.

SEE ALSO

For information about how to install and use ThermaCAM™ QuickReport, see ThermaCAM™ QuickReport User's manual, Publ. No. –. FLIR Systems ships this manual with your camera.

8.21 Viewing streaming MPEG4 live video from the camera

General The camera can stream MPEG4 live video through the USB cable.

Procedure Follow this procedure to view streaming MPEG4 live video from the camera:

| | |
|---|--|
| 1 | Go to http://www.apple.com/quicktime/download/win.html and download the latest version of Apple® QuickTime. |
| 2 | Install the program according to the instructions. |
| 3 | In the camera, make sure that you select Network disk (USB cable → Network disk) . |
| 4 | Connect your camera to your computer. |
| 5 | Start Apple® QuickTime Player. |
| 6 | On the File menu, click Open URL. |
| 7 | In the text box, type <code>rtsp://192.168.0.2</code> . |
| 8 | Click OK . |

NOTE If `rtsp://192.168.0.2` does not work in step 7 above, try `rtsp://192.168.1.2`.

9 Cleaning the camera

9.1 *Camera housing, cables & other items*

Liquids Use one of these liquids:

- Warm water
 - A weak detergent solution
-

Equipment A soft cloth

Procedure Follow this procedure to clean the camera housing, cables & other items:

| | |
|----------|--|
| 1 | Soak the cloth in the liquid. |
| 2 | Twist the cloth to remove the unwanted liquid. |
| 3 | Clean the part with the cloth. |

CAUTION Do not use thinner or an equivalent liquid on the camera, the cables and other items. This can cause damage.

9.2 *Infrared lens*

Liquids

Use one of these liquids:

- 96% ethanol (C₂H₅OH)
 - A commercial lens cleaning liquid with more than 30% ethanol
-

Equipment

Cotton wool

Procedure

Follow this procedure to use a liquid to clean the infrared lens:

| | |
|----------|---|
| 1 | Soak the cotton wool in the liquid. |
| 2 | Twist the cotton wool to remove the unwanted liquid. |
| 3 | Clean the lens one time only and discard the cotton wool. |

WARNING

Make sure that you read all applicable MSDS (Material Safety Data Sheets) and warning labels on containers before you use a liquid. The liquids can be dangerous.

CAUTION

- Be careful when you clean the infrared lens. The lens has an anti-reflective coating.
 - Do not clean the infrared lens too much. This can cause damage to the anti-reflective coating.
-

10

Technical data

Disclaimer

FLIR Systems reserves the right to discontinue models, parts or accessories, and other items, or change specifications at any time without prior notice.

Imaging performance

| | |
|---------------------|--|
| Spectral range | 7.5–13 μm |
| Detector type | Focal Plane Array (FPA), uncooled microbolometer 120 × 120 pixels |
| Image frequency | 9 Hz |
| Accuracy | $\pm 2.0^{\circ}\text{C}$ ($\pm 3.6^{\circ}\text{F}$) or $\pm 2\%$ of reading |
| Thermal sensitivity | <ul style="list-style-type: none">▪ InfraCAM: 0.20°C (0.36°F)▪ InfraCAM SD: 0.12°C (0.22°F) |

Image presentation

| | |
|---------------|---|
| Screen | 89 mm (3.5 in.) color LCD, 18-bit colors |
| Interpolation | Detector image interpolated to 240 × 240 pixels |

Object temperature ranges

| | |
|---------------------------|---|
| Object temperature ranges | -10 to $+350^{\circ}\text{C}$ ($+14$ to $+662^{\circ}\text{F}$) |
|---------------------------|---|

Laser pointer

| | |
|----------------|---|
| Classification | Class 2 |
| Type | Semiconductor AlGaInP diode laser, 1 mW, 635 nm (red) |

Power system

| | |
|------------------------|--|
| Battery type | Rechargeable Li/Ion battery |
| Battery capacity | 2200 mAh, at +20°C to +25°C (+68°F to +77°F) |
| Battery operating time | Approximately 7 hours at +25°C (+77°F) ambient temperature and typical use |
| Battery charging | <ul style="list-style-type: none"> ■ Use the combined power supply & battery charger to charge the battery when it is inside the camera. ■ Use the combined power supply & battery charger to charge the battery when it is outside the camera. ■ Use the stand-alone battery charger to charge the battery (The stand-alone battery charger is an item that is not included in the standard package.). |
| AC operation | AC adapter, 90–260 VAC, 50/60 Hz, 12 VDC out |
| Voltage | 11–16 VDC |
| Auto off | The camera power goes off after a time period that the user can set. |

Environmental data

| | |
|--------------------------------|---|
| Operating temperature range | –15°C to +50°C (+5°F to +122°F) |
| Storage temperature range | –40°C to +70°C (–40°F to +158°F) |
| Humidity (operating & storage) | IEC 68-2-30/24 h 95% relative humidity +25°C to +40°C (+77°F to +104°F) |
| EMC | EN 61000-6-2:2001 (Immunity) EN 61000-6-3:2001 (Emission) FCC 47 CFR Part 15 Class B (Emission) |
| Encapsulation | IP 54 (IEC 60529) |
| Bump | 25 g (IEC 60068-2-29) |
| Vibration | 2 g (IEC 60068-2-6) |

Physical data

| | |
|-------------------|--|
| Total weight | 0.55 kg (1.21 lb.), including battery |
| Weight of battery | 0.12 kg (0.26 lb.) |
| Size (L × W × H) | 103.0 × 81.2 × 243.0 mm (4.1 × 3.2 × 9.6 in.) |
| Tripod mount | Standard, 1/4"-20 |
| Housing material | Polycarbonate + Acrylonitrile butadiene styrene (PC-ABS) |
| Grip material | TPE Thermoplastic Elastomer Plastics |

Communication

| | |
|-----|--|
| USB | Image transfer to PC USB 1.1 Full Speed (12 Mbps) |
|-----|--|

Power connector

10601903.a1

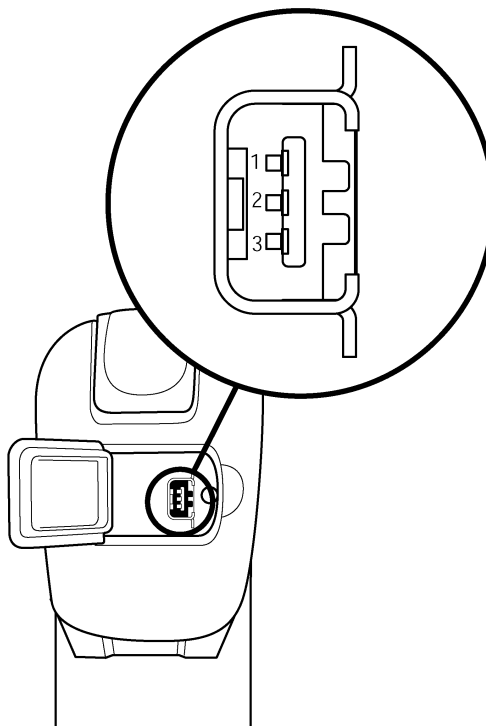

10

| Pin | Signal name |
|-----|-------------|
| 1 | +12V |
| 2 | GND |
| 3 | GND |

Field of view & distance

10602703.a2

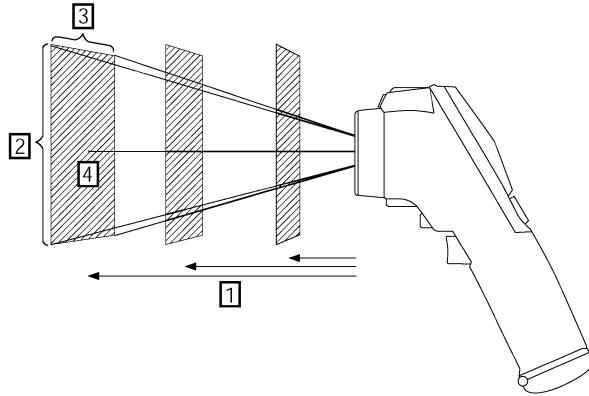

Figure 10.1 Relationship between field of view and distance. **1:** Distance to target; **2:** VFOV = vertical field of view; **3:** HFOV = horizontal field of view; **4:** IFOV = instantaneous field of view (size of one detector element).

This table gives an explanation of field of view at certain distances to targets. D = distance to target.

10603003.a2

| | | | | | | | | | |
|---|------|------|------|-------|-------|-------|--------|--------|-----|
| Focal length: 10.28 mm | | | | | | | | | |
| Resolution: 120 x 120 pixels | | | | | | | | | |
| Field of view in degrees: 25.0 | | | | | | | | | |
| D ---> | 0.50 | 1.00 | 2.00 | 5.00 | 10.00 | 25.00 | 50.00 | 100.00 | m |
| HFOV | 0.22 | 0.44 | 0.89 | 2.22 | 4.44 | 11.09 | 22.18 | 44.36 | m |
| VFOV | 0.22 | 0.44 | 0.89 | 2.22 | 4.44 | 11.09 | 22.18 | 44.36 | m |
| IFOV | 1.85 | 3.70 | 7.39 | 18.48 | 36.96 | 92.41 | 184.82 | 369.65 | mm |
| D ---> | 1.64 | 3.28 | 6.56 | 16.39 | 32.79 | 81.97 | 163.93 | 327.87 | ft. |
| HFOV | 0.73 | 1.45 | 2.91 | 7.27 | 14.54 | 36.36 | 72.72 | 145.44 | ft. |
| VFOV | 0.73 | 1.45 | 2.91 | 7.27 | 14.54 | 36.36 | 72.72 | 145.44 | ft. |
| IFOV | 0.07 | 0.15 | 0.29 | 0.73 | 1.46 | 3.64 | 7.28 | 14.55 | in. |
| Legend: | | | | | | | | | |
| D = Distance to target in meters & feet | | | | | | | | | |
| HFOV = Horizontal field of view in meters & feet | | | | | | | | | |
| VFOV = Vertical field of view in meters & feet | | | | | | | | | |
| IFOV = Instantaneous field of view (size of one detector element) in millimeters & inches | | | | | | | | | |

Optical data

| | |
|-------------------|---------------------|
| Field of view | 25° × 25° |
| Focal length | 10.28 mm (0.40 in.) |
| Close focus limit | 0.125 m (0.409 in.) |
| F-number | 1.5 |

11 Dimensional drawings

11.1 *Camera*

Figure

10602403.a2

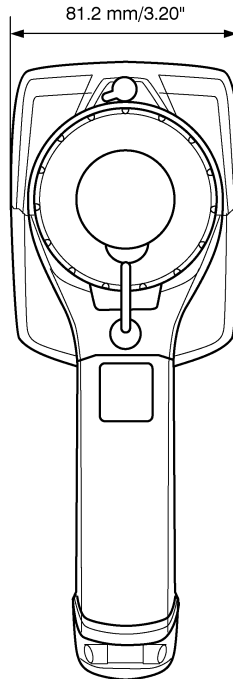

Figure

10602603.a3

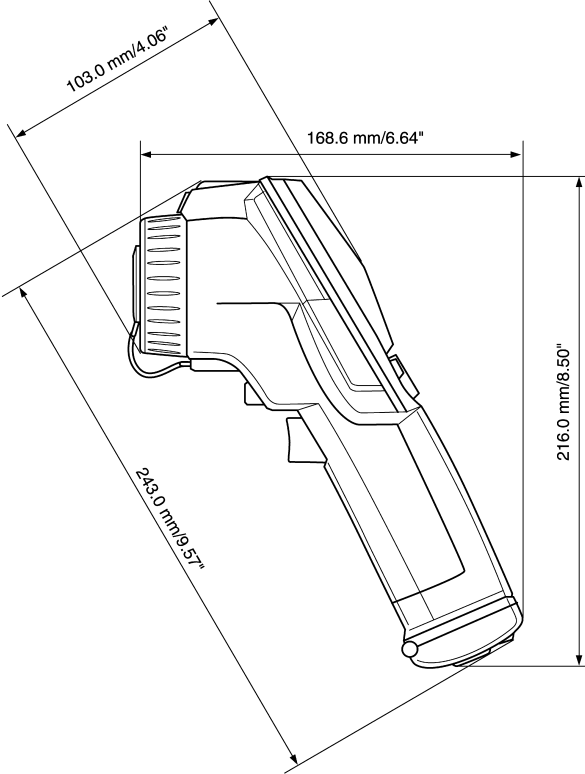

Figure

10726103.a1

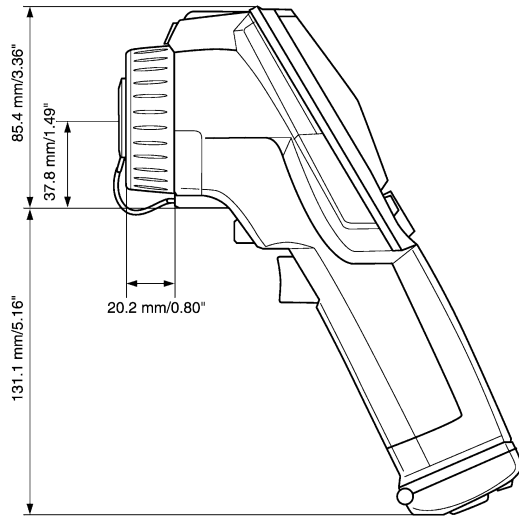

Figure

10726203.a1

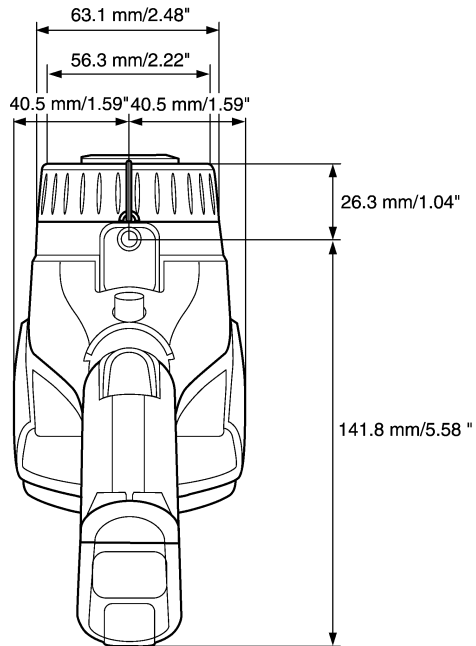

NOTE

The tripod mount thread is 1/4"-20.

11.2

Battery

Figure

10602103.a2

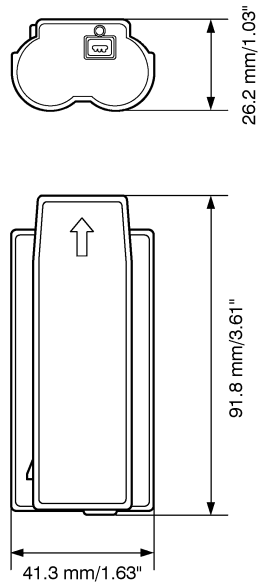
**NOTE**

Use a clean and dry cloth to remove any water or moisture on the battery before you install it.

11.3 Stand-alone battery charger

Figure

10602203.a3

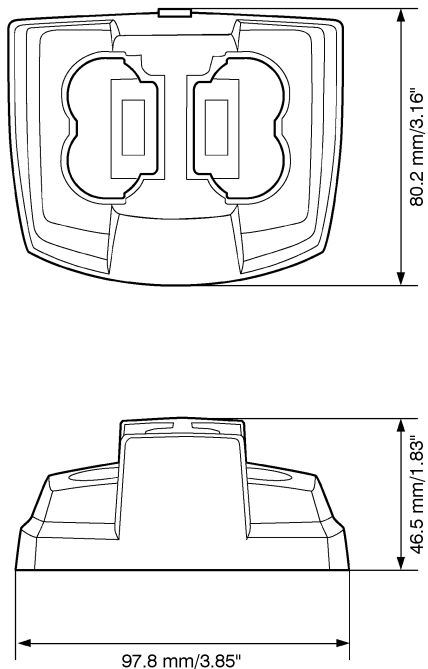

11

NOTE

- The stand-alone battery charger is an item that is not included in the standard package.
- Use a clean and dry cloth to remove any water or moisture on the battery before you put it in the battery charger.

11.4 Stand-alone battery charger with battery

Figure

10602303.a3

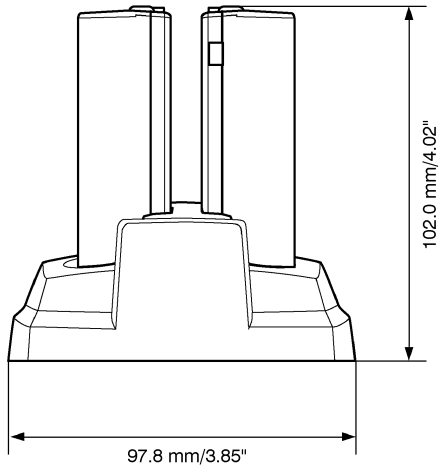
**NOTE**

- The stand-alone battery charger is an item that is not included in the standard package.
- Use a clean and dry cloth to remove any water or moisture on the battery before you put it in the battery charger.

12 Introduction to building thermography

12.1 *Important note*

All camera functions and features that are described in this section may not be supported by your particular camera configuration.

12.2 *Typical field investigations*

12.2.1 Guidelines

As will be noted in subsequent sections there are a number of general guidelines the user should take heed of when carrying out building thermography inspection. This section gives a summary of these guidelines.

12.2.1.1 *General guidelines*

- The emissivity of the majority of building materials fall between 0.85 and 0.95. Setting the emissivity value in the camera to 0.90 can be regarded as a good starting point.
- An infrared inspection alone should never be used as a decision point for further actions. Always verify suspicions and findings using other methods, such as construction drawings, moisture meters, humidity & temperature datalogging, tracer gas testing etc.
- Change level and span to thermally tune the infrared image and reveal more details. The figure below shows the difference between a thermally untuned and a thermally tuned infrared image.

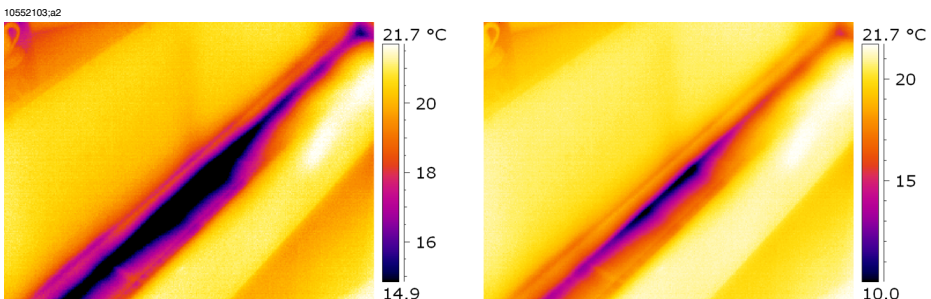

Figure 12.1 LEFT: A thermally untuned infrared image; **RIGHT:** A thermally tuned infrared image, after having changed level and span.

12.2.1.2 Guidelines for moisture detection, mold detection & detection of water damages

- Building defects related to moisture and water damages may only show up when heat has been applied to the surface, e.g. from the sun.
- The presence of water changes the thermal conductivity and the thermal mass of the building material. It may also change the surface temperature of building material due to evaporative cooling. Thermal conductivity is a material's ability to conduct heat, while thermal mass is its ability to store heat.
- Infrared inspection does not directly detect the presence of mold, rather it may be used to find moisture where mold may develop or has already developed. Mold requires temperatures between +4°C to +38°C (+40°F to +100°F), nutrients and moisture to grow. Humidity levels above 50% can provide sufficient moisture to enable mold to grow.

10556003.a1

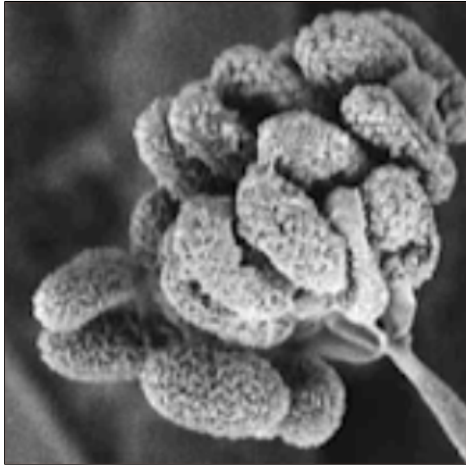

Figure 12.2 Microscopic view of mold spore

12.2.1.3 Guidelines for detection of air infiltration & insulation deficiencies

- For very accurate camera measurements, take measurements of the temperature and enter this value in the camera.
- It is recommended that there is a difference in pressure between the outside and the inside of the building structure. This facilitates the analysis of the infrared images and reveals deficiencies that would not be visible otherwise. Although a negative pressure of between 10 and 50 Pa is recommended, carrying out the inspection at a lower negative pressure may be acceptable. To do this, close all windows, doors and ventilation ducts and then run the kitchen exhaust fan for some time to reach a negative pressure of 5–10 Pa (applies to residential houses only).

- A difference in temperature between the inside and the outside of 10–15°C (18–27°F) is recommended. Inspections can be carried out at a lower temperature difference, but will make the analysis of the infrared images somewhat more difficult.
- Avoid direct sunlight on a part of a building structure—e.g. a façade—that is to be inspected from the inside. The sunlight will heat the façade which will equalize the temperature differences on the inside and mask deficiencies in the building structure. Spring seasons with low nighttime temperatures ($\pm 0^{\circ}\text{C}$ ($+32^{\circ}\text{F}$)) and high daytime temperatures ($+14^{\circ}\text{C}$ ($+57^{\circ}\text{F}$)) are especially risky.

12.2.2 About moisture detection

Moisture in a building structure can originate from several different sources, e.g.:

- External leaks, such as floods, leaking fire hydrants etc.
- Internal leaks, such as freshwater piping, waste water piping etc.
- Condensation, which is humidity in the air falling out as liquid water due to condensation on cold surfaces.
- Building moisture, which is any moisture in the building material prior to erecting the building structure.
- Water remaining from firefighting.

As a non-destructive detection method, using an infrared camera has a number of advantages over other methods, and a few disadvantages:

| Advantage | Disadvantage |
|---|--|
| <ul style="list-style-type: none"> ■ The method is quick. ■ The method is a non-intrusive means of investigation. ■ The method does not require relocation of the occupants. ■ The method features an illustrative visual presentation of findings. ■ The method confirms failure points and moisture migration paths. | <ul style="list-style-type: none"> ■ The method only detects surface temperature differentials and can not see through walls. ■ The method can not detect subsurface damage, i.e. mold or structural damage. |

12.2.3 Moisture detection (1): Low-slope commercial roofs

12.2.3.1 General information

Low-slope commercial roofing is one of the most common roof types for industrial building, such as warehouses, industrial plants, machinery shops etc. Its major advantages over a pitched roof is the lower cost in material and building. However, due to its design where snow and ice will not fall off by itself—as is the case for the majority of pitched roofs—it must be strongly built to support the accumulated weight of both roof structure and any snow, ice and rain.

Although a basic understanding of the construction of low-slope commercial roofs is desirable when carrying out a roof thermography inspection, expert knowledge is not necessary. There is a large number of different design principles for low-slope commercial roofs—both when it comes to material and design—and it would be impossible for the infrared inspection person to know them all. If additional information about a certain roof is needed, the architect or contractor of the building can usually supply the relevant information.

Common causes of roof failure are outlined in the table below (from SPIE Thermosense Proceedings Vol. 371 (1982), p. 177).

| Cause | % |
|------------------|------|
| Poor workmanship | 47.6 |
| Roof traffic | 2.6 |
| Poor design | 16.7 |
| Trapped moisture | 7.8 |
| Materials | 8.0 |
| Age & weathering | 8.4 |

Potential leak locations include the following:

- Flashing
- Drains
- Penetrations
- Seams
- Blisters

12.2.3.2 Safety precautions

- Recommend a minimum of two people on a roof, preferably three or more.
- Inspect the underside of the roof for structural integrity prior to walking on it.
- Avoid stepping on blisters that are common on built up bitumen and gravel roofs.
- Have a cell phone or radio available in case of emergency.
- Inform local police and plant security prior to doing nighttime roof survey.

12.2.3.3 Commented building structures

This section includes a few typical examples of moisture problems on low-slope commercial roofs.

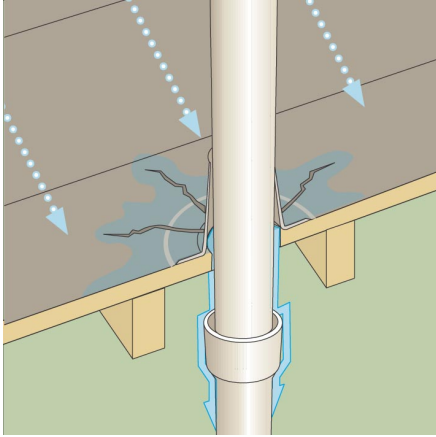
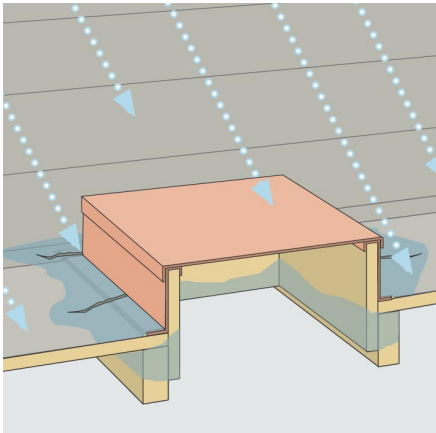
| Structural drawing | Comment |
|---|--|
| <p>10553603,a2</p>  | <p>Inadequate sealing of roof membrane around conduit and ventilation ducts leading to local leakage around the conduit or duct.</p> |
| <p>10553703,a2</p>  | <p>Roof membrane inadequately sealed around roof access hatch.</p> |

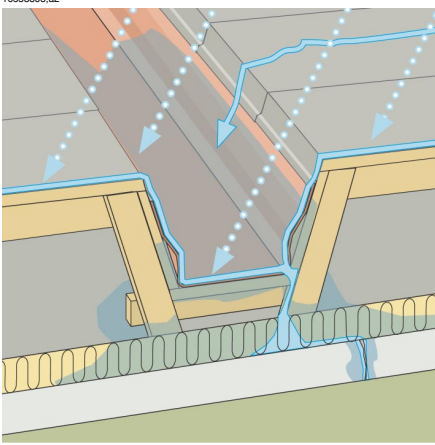
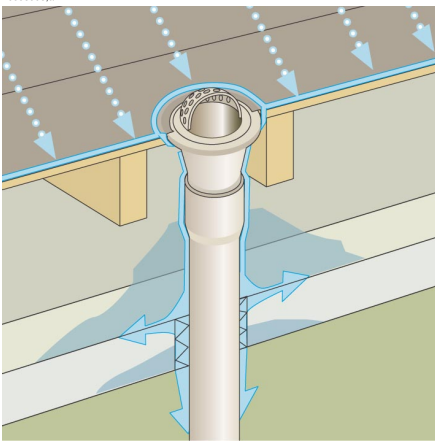
| Structural drawing | Comment |
|---|---|
| <p>10553803.a2</p>  <p>A cross-sectional diagram of a roof drainage channel. The roof surface is shown with a low slope. Blue arrows indicate water flowing into the channel. The channel itself is shallow and wide, and blue arrows show water pooling at the bottom. Below the roof structure, a yellow insulation layer is visible, and blue arrows point downwards from the pooled water, indicating potential leakage.</p> | <p>Drainage channels located too high and with too low an inclination. Some water will remain in the drainage channel after rain, which may lead to local leakage around the channel.</p> |
| <p>10553803.a2</p>  <p>A cross-sectional diagram of a roof outlet. The roof membrane is shown meeting the outlet pipe. Blue arrows indicate water flowing towards the outlet. At the junction, there is a gap between the membrane and the pipe, and blue arrows show water leaking through this gap into the insulation below. The outlet pipe extends downwards through the roof structure.</p> | <p>Inadequate sealing between roof membrane and roof outlet leading to local leakage around the roof outlet.</p> |

12.2.3.4 **Commented infrared images**

12

How do you find wet insulation below the surface of the roof? When the surface itself is dry, including any gravel or ballast, a sunny day will warm the entire roof. Early in the evening, if the sky is clear, the roof will begin to cool down by radiation. Because of its higher thermal capacity the wet insulation will stay warmer longer than the dry and will be visible in the infrared imager (see photos below). The technique is particularly effective on roofs having absorbent insulation—such as wood fiber, fiberglass, and perlite—where thermal patterns correlate almost perfectly with moisture.

Infrared inspections of roofs with nonabsorbent insulations, common in many single-ply systems, are more difficult to diagnose because patterns are more diffuse.

This section includes a few typical infrared images of moisture problems on low-slope commercial roofs:

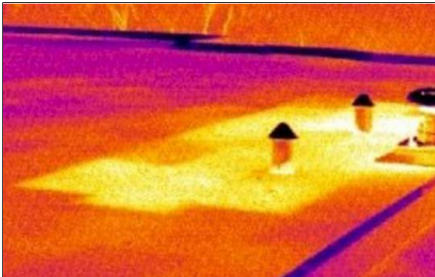
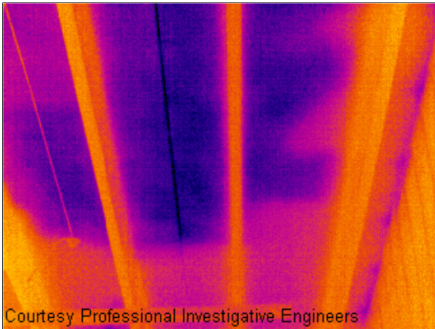
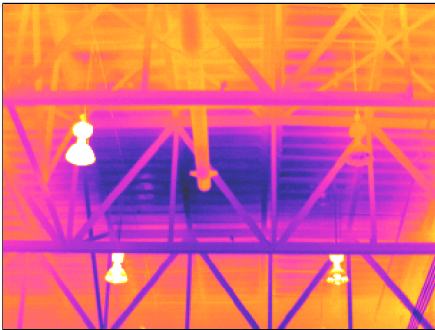
| Infrared image | Comment |
|--|--|
| <p>10554003.a1</p>  | <p>Moisture detection on a roof, recorded during the evening.</p> <p>Since the building material affected by moisture has a higher thermal mass, its temperature decreases slower than surrounding areas.</p> |
| <p>10554103.a1</p>  <p>Courtesy Professional Investigative Engineers</p> | <p>Water-damaged roofing components and insulation identified from infrared scan from the underside of the built-up roof on a structural concrete tee deck.</p> <p>Affected areas are cooler than the surrounding sound areas, due to conductive and/or thermal capacitive effect.</p> |
| <p>10554203.a1</p>  | <p>Daytime survey of built-up low-slope commercial roof.</p> <p>Affected areas are cooler than the surrounding dry areas, due to conductive and/or thermal capacitive effect.</p> |

12.2.4 Moisture detection (2): Commercial & residential façades

12.2.4.1 General information

Thermography has proven to be invaluable in the assessment of moisture infiltration into commercial and residential façades. Being able to provide a physical illustration of the moisture migration paths is more conclusive than extrapolating moisture meter probe locations and more cost-effective than large intrusive test cuts.

12.2.4.2 Commented building structures

This section includes a few typical examples of moisture problems on commercial and residential façades.

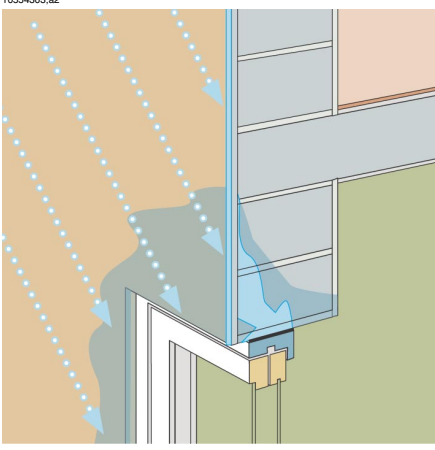
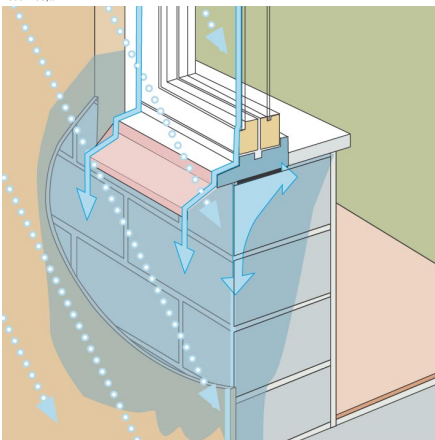
| Structural drawing | Comment |
|--|--|
| <p>10554303.a2</p>  | <p>Pelting rain penetrates the façade due to badly executed bed joints. Moisture builds up in the masonry above the window.</p> |
| <p>10554403.a2</p>  | <p>Pelting rain hits the window at an angle. Most of the rain runs off the window edge flashing but some finds its way into the masonry where the plaster meets the underside of the flashing.</p> |

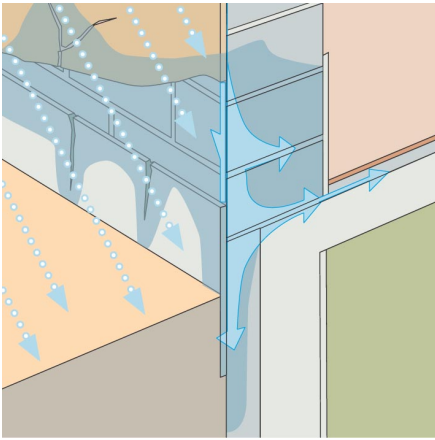
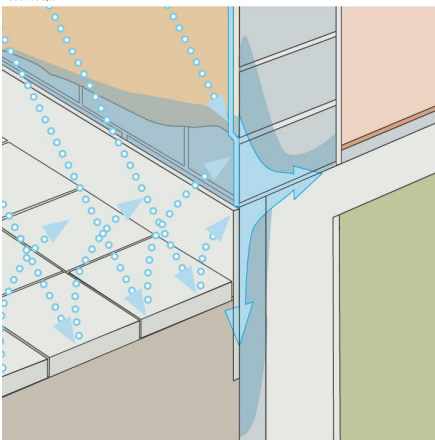
| Structural drawing | Comment |
|---|---|
| <p>10554503,a2</p>  | <p>Rain hits the façade at an angle and penetrates the plaster through cracks. The water then follows the inside of the plaster and leads to frost erosion.</p> |
| <p>10554603,a2</p>  | <p>Rain splashes on the façade and penetrates the plaster and masonry by absorption, which eventually leads to frost erosion.</p> |

12.2.4.3 **Commented infrared images**

This section includes a few typical infrared images of moisture problems on commercial & residential façades.

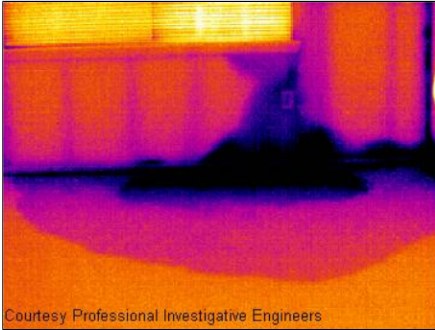
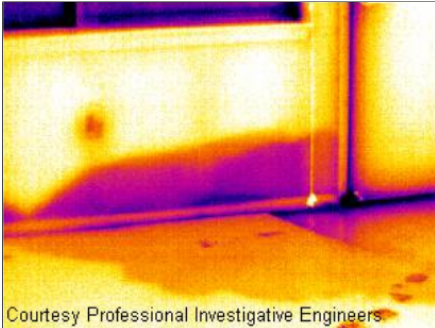
| Infrared image | Comment |
|--|---|
| <p>10554703.a1</p>  <p>Courtesy Professional Investigative Engineers</p> | <p>Improperly terminated and sealed stone veneer to window frame and missing flashings has resulted in moisture infiltration into the wall cavity and interior living space.</p> |
| <p>10554803.a1</p>  <p>Courtesy Professional Investigative Engineers</p> | <p>Moisture migration into drywall from capillary drive and interior finish components from inadequate clearance and slope of grade from vinyl siding façade on an apartment complex.</p> |

12.2.5 **Moisture detection (3): Decks & balconies**

12.2.5.1 **General information**

Although there are differences in design, materials and construction, decks—plaza decks, courtyard decks etc—suffer from the same moisture and leaking problems as low-slope commercial roofs. Improper flashing, inadequately sealed membranes, and insufficient drainage may lead to substantial damage in the building structures below.

Balconies, although smaller in size, require the same care in design, choice of material, and workmanship as any other building structure. Since balconies are usually supported on one side only, moisture leading to corrosion of struts and concrete reinforcement can cause problems and lead to hazardous situations.

12.2.5.2 Commented building structures

This section includes a few typical examples of moisture problems on decks and balconies.

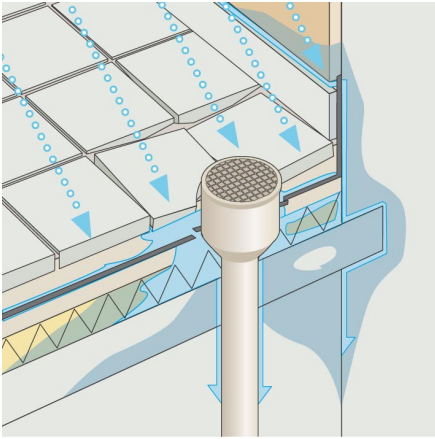
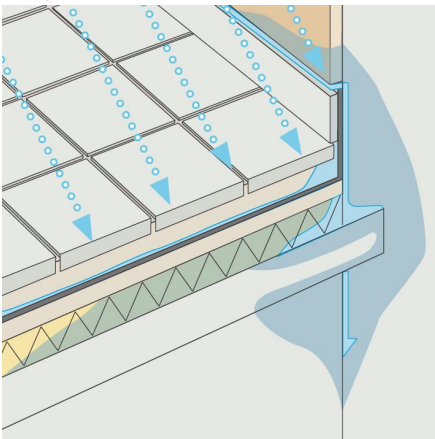
| Structural drawing | Comment |
|---|---|
| <p>10555203.a2</p>  <p>A cross-sectional diagram of a roof edge. A circular roof drain is shown. Blue arrows indicate rainwater flowing from the paving stones towards the drain. However, the waterproofing membrane is not properly sealed around the drain's base, and blue arrows show water leaking through the joint into the structure below.</p> | <p>Improper sealing of paving and membrane to roof outlet, leading to leakage during rain.</p> |
| <p>10555103.a2</p>  <p>A cross-sectional diagram of a deck-to-wall connection. Blue arrows show rainwater flowing down the side of the deck. At the junction with the wall, there is no flashing or proper waterproofing. Blue arrows indicate water penetrating through the joint into the concrete and insulation layers.</p> | <p>No flashing at deck-to-wall connection, leading to rain penetrating the concrete and insulation.</p> |

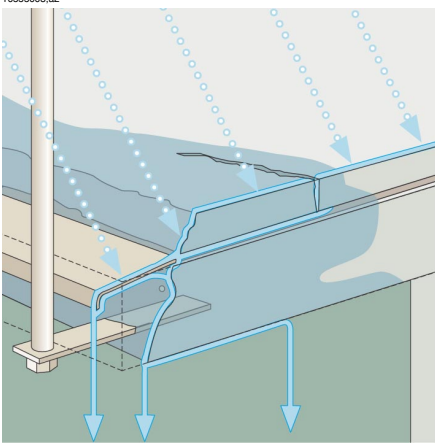
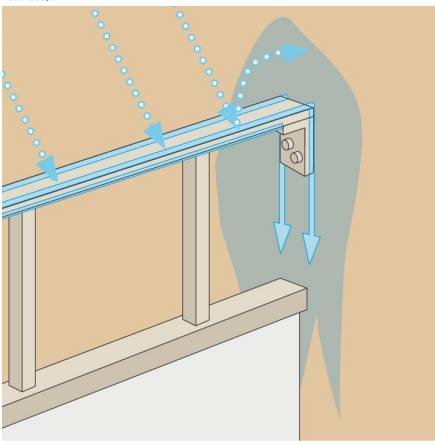
| Structural drawing | Comment |
|---|---|
| <p>10555003.a2</p>  | <p>Water has penetrated the concrete due to inadequately sized drop apron and has led to concrete disintegration and corrosion of reinforcement.</p> <p>SECURITY RISK!</p> |
| <p>10554903.a2</p>  | <p>Water has penetrated the plaster and underlying masonry at the point where the handrail is fastened to the wall.</p> <p>SECURITY RISK!</p> |

12.2.5.3 Commented infrared images

This section includes a few typical infrared images of moisture problems on decks and balconies.

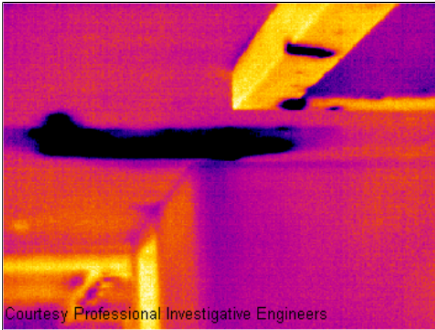
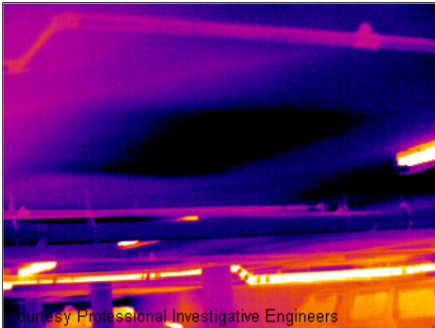
| Infrared image | Comment |
|---|---|
| <p>1055303.a1</p>  <p>Courtesy Professional Investigative Engineers</p> | <p>Improper flashing at balcony-to-wall connections and missing perimeter drainage system resulted in moisture intrusion into the wood framing support structure of the exterior walkway balcony of a loft complex.</p> |
| <p>1055403.a1</p>  <p>Courtesy Professional Investigative Engineers</p> | <p>A missing composite drainage plane or medium on a below-grade parking garage plaza deck structure resulted in standing water between the structural concrete deck and the plaza wearing surface.</p> |

12.2.6 Moisture detection (4): Plumbing breaks & leaks

12.2.6.1 General information

Water from plumbing leaks can often lead to severe damage on a building structure. Small leaks may be difficult to detect, but can—over the years—penetrate structural walls and foundations to a degree where the building structure is beyond repair.

Using building thermography at an early stage when plumbing breaks and leaks are suspected can lead to substantial savings on material and labor.

12.2.6.2 Commented infrared images

This section includes a few typical infrared images of plumbing breaks & leaks.

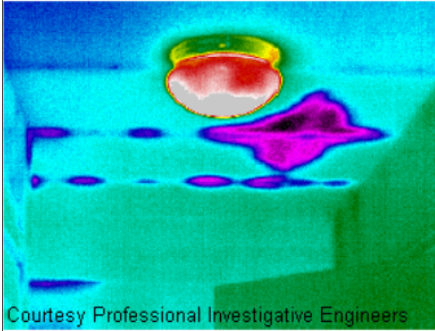
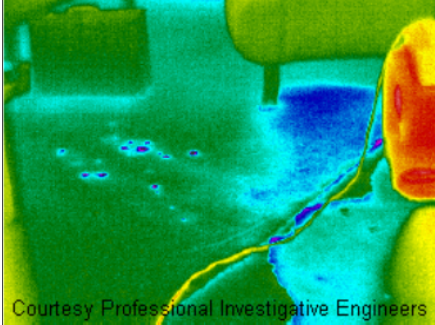
| Infrared image | Comment |
|--|---|
| <p>10555503.a1</p>  <p>Courtesy Professional Investigative Engineers</p> | <p>Moisture migration tracking along steel joist channels inside ceiling of a single family home where a plumbing line had ruptured.</p> |
| <p>10555603.a1</p>  <p>Courtesy Professional Investigative Engineers</p> | <p>Water from plumbing leak was found to have migrated farther than originally anticipated by the contractor during remediation techniques of cutting back carpet and installing dehumidifiers.</p> |

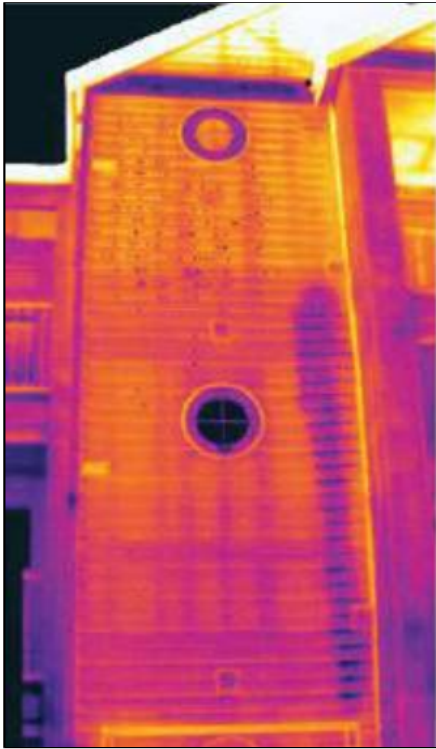
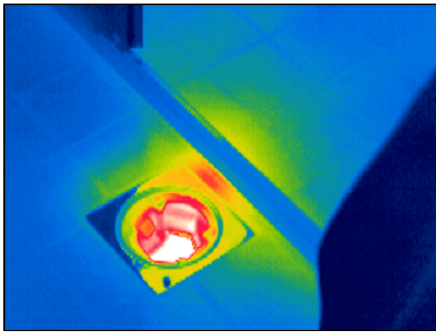
| Infrared image | Comment |
|---|---|
| <p>10555703.a1</p>  | <p>The infrared image of this vinyl-sided 3-floor apartment house clearly shows the path of a serious leak from a washing machine on the third floor, which is completely hidden within the wall.</p> |
| <p>10555803.a1</p>  | <p>Water leak due to improper sealing between floor drain and tiles.</p> |

12.2.7 Air infiltration

12.2.7.1 General information

Due to the wind pressure on a building, temperature differences between the inside and the outside of the building, and the fact that most buildings use exhaust air terminal devices to extract used air from the building, a negative pressure of 2–5 Pa can be expected. When this negative pressure leads to cold air entering the building structure due to deficiencies in building insulation and/or building sealing, we have what is called *air infiltration*. Air infiltration can be expected at joints and seams in the building structure.

Due to the fact that air infiltration creates an air flow of cool air into e.g. a room, it can lead to substantial deterioration of the indoor climate. Air flows as small as 0.15 m/s (0.49 ft./s) are usually noticed by inhabitants, although these air flows may be difficult to detect using ordinary measurement devices.

On an infrared image air infiltration can be identified by its typical ray pattern, which emanates from the point of exit in the building structure—e.g. from behind a skirting strip. Furthermore, areas of air infiltration typically have a lower detected temperature than areas where there is only an insulation deficiency. This is due to the chill factor of the air flow.

12.2.7.2 Commented building structures

This section includes a few typical examples of details of building structures where air infiltration may occur.

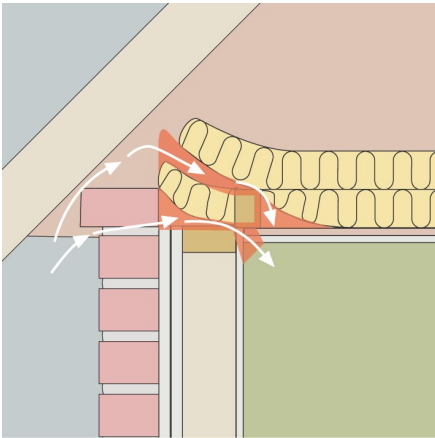
| Structural drawing | Comment |
|---|--|
|  <p>10552503.a2</p> | <p>Insulation deficiencies at the eaves of a brickwall house due to improperly installed fiberglass insulation batts.</p> <p>The air infiltration enters the room from behind the cornice.</p> |

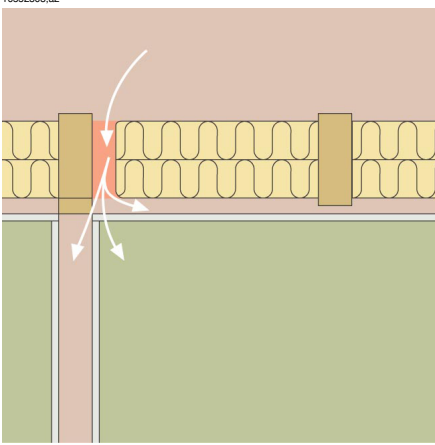
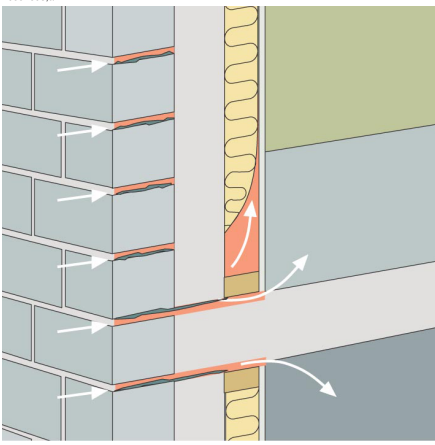
| Structural drawing | Comment |
|---|--|
| <p>10552303.a2</p>  | <p>Insulation deficiencies in an intermediate flow due to improperly installed fiberglass insulation batts.</p> <p>The air infiltration enters the room from behind the cornice.</p> |
| <p>10552603.a2</p>  | <p>Air infiltration in a concrete floor-over-crawl-space due to cracks in the brick wall façade.</p> <p>The air infiltration enters the room beneath the skirting strip.</p> |

12.2.7.3 Commented infrared images

This section includes a few typical infrared images of details of building structures where air infiltration has occurred.

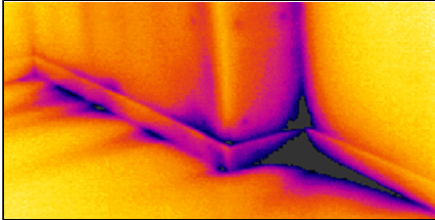
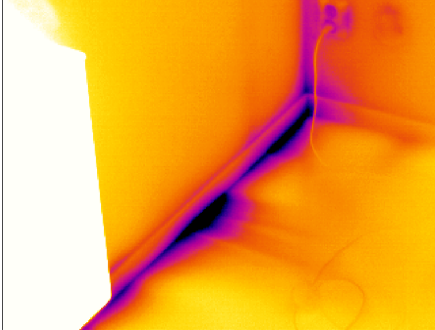
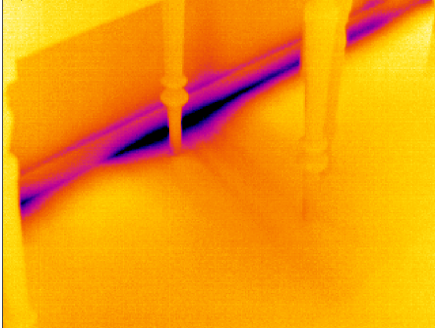
| Infrared image | Comment |
|---|---|
| <p>10552703.a1</p>  | <p>Air infiltration from behind a skirting strip. Note the typical ray pattern.</p> |
| <p>10552803.a1</p>  | <p>Air infiltration from behind a skirting strip. Note the typical ray pattern. The white area to the left is a radiator.</p> |
| <p>10552803.a1</p>  | <p>Air infiltration from behind a skirting strip. Note the typical ray pattern.</p> |

12.2.8 Insulation deficiencies

12.2.8.1 General information

Insulation deficiencies do not necessarily lead to air infiltration. If fiberglass insulation batts are improperly installed air pockets will form in the building structure. Since these air pockets have a different thermal conductivity than areas where the insulation batts are properly installed, the air pockets can be detected during a building thermography inspection.

As a rule of thumb, areas with insulation deficiencies typically have higher temperatures than where there is only an air infiltration.

When carrying out building thermography inspections aimed at detecting insulation deficiencies, be aware of the following parts in a building structure, which may look like insulation deficiencies on the infrared image:

- Wooden joists, studs, rafter, beams
- Steel girders and steel beams
- Water piping inside walls, ceilings, floors
- Electrical installations inside walls, ceilings, floors—such as trunking, piping etc.
- Concrete columns inside timber framed walls
- Ventilation ducts & air ducts

12.2.8.2 Commented building structures

This section includes a few typical examples of details of building structures with insulation deficiencies:

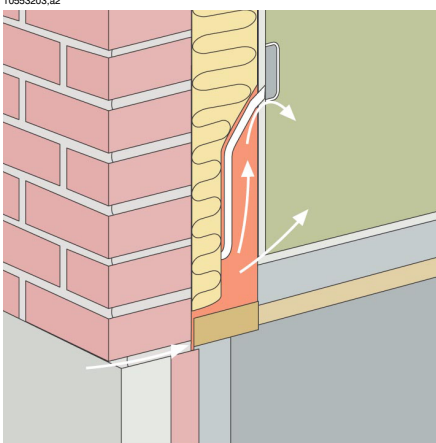
| Structural drawing | Comment |
|---|--|
|  | <p>Insulation deficiencies (and air infiltration) due to improper installation of insulation batts around an electrical mains supply.</p> <p>This kind of insulation deficiency will show up as dark areas on an infrared image.</p> |

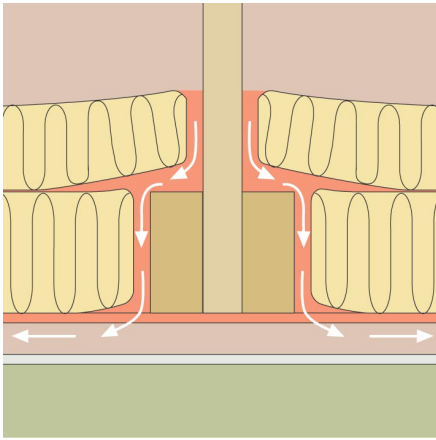
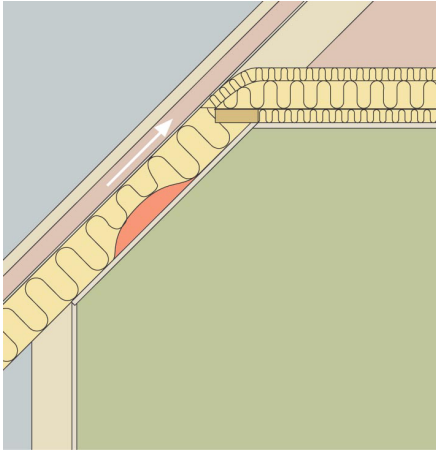
| Structural drawing | Comment |
|---|---|
| <p>10553103;a2</p>  | <p>Insulation deficiencies due to improper installation of insulation batts around an attic floor beam. Cool air infiltrates the structure and cools down the inside of the ceiling.</p> <p>This kind of insulation deficiency will show up as dark areas on an infrared image.</p> |
| <p>10553003;a2</p>  | <p>Insulation deficiencies due to improper installation of insulation batts creating an air pocket on the outside of an inclined ceiling.</p> <p>This kind of insulation deficiency will show up as dark areas on an infrared image.</p> |

12.2.8.3 Commented infrared images

This section includes a few typical infrared images of insulation deficiencies.

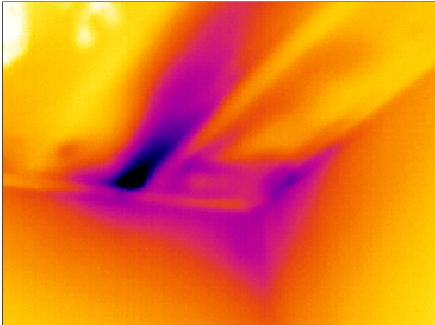
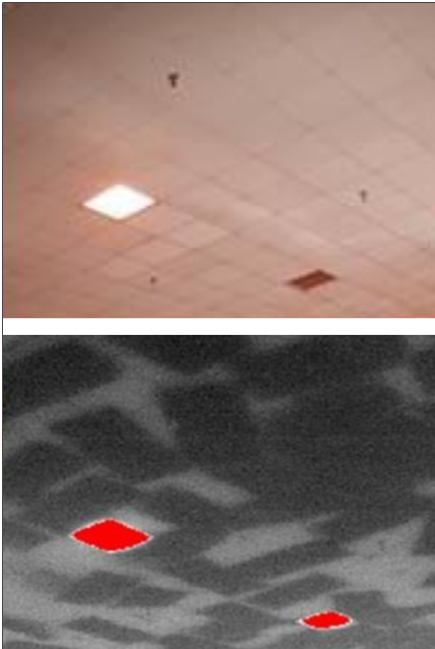
| Infrared image | Comment |
|---|--|
| <p>10553303.a1</p>  | <p>Insulation deficiencies in an intermediate floor structure. The deficiency may be due to either missing insulation batts or improperly installed insulations batts (air pockets).</p> |
| <p>10553403.a1</p>  | <p>Improperly installed fiberglass batts in a suspended ceiling.</p> |

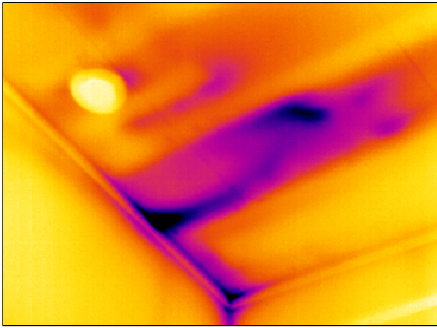
| Infrared image | Comment |
|--|---|
| <p data-bbox="150 199 210 211">10553503.a1</p>  An infrared thermography image showing a floor structure. The image is color-coded by temperature, with yellow and orange representing warmer areas and purple and blue representing cooler areas. A prominent dark purple/blue area in the center indicates a significant temperature drop, suggesting insulation deficiencies. The surrounding areas are warmer, shown in yellow and orange. The image is labeled '10553503.a1' in the top left corner. | <p data-bbox="611 199 1047 305">Insulation deficiencies in an intermediate floor structure. The deficiency may be due to either missing insulation batts or improperly installed insulations batts (air pockets).</p> |

12.3 *Theory of building science*

12.3.1 General information

The demand for energy-efficient constructions has increased significantly in recent times. Developments in the field of energy, together with the demand for pleasant indoor environments, have resulted in ever-greater significance having to be attached to both the function of a building's thermal insulation and airtightness and the efficiency of its heating and ventilation systems.

Defective insulation and tightness in highly insulated and airtight structures can have a great impact on energy losses. Defects in a building's thermal insulation and airtightness do not merely entail risk of excessive heating and maintenance costs, they also create the conditions for a poor indoor climate.

A building's degree of insulation is often stated in the form of a thermal resistance or a coefficient of thermal transmittance (U value) for the various parts of the building. However, the stated thermal resistance values rarely provide a measure of the actual energy losses in a building. Air leakage from joints and connections that are not airtight and insufficiently filled with insulation often gives rise to considerable deviations from the designed and expected values.

Verification that individual materials and building elements have the promised properties is provided by means of laboratory tests. Completed buildings have to be checked and inspected in order to ensure that their intended insulation and airtightness functions are actually achieved.

In its structural engineering application, thermography is used to study temperature variations over the surfaces of a structure. Variations in the structure's thermal resistance can, under certain conditions, produce temperature variations on its surfaces. Leakage of cold (or warm) air through the structure also affects the variation in surface temperature. This means that insulation defects, thermal bridges and air leaks in a building's enclosing structural components can be located and surveyed.

Thermography itself does not directly show the structure's thermal resistance or airtightness. Where quantification of thermal resistance or airtightness is required, additional measurements have also to be taken. Thermographic analysis of buildings relies on certain prerequisites in terms of temperature and pressure conditions across the structure.

Details, shapes and contrasts in the thermal image can vary quite clearly with changes in any of these parameters. The in-depth analysis and interpretation of thermal images therefore requires thorough knowledge of such aspects as material and structural properties, the effects of climate and the latest measuring techniques. For assessing

the results of measurements, there are special requirements in terms of the skills and experience of those taking the measurements, e.g. by means of authorization by a national or regional standardization body.

12.3.2 The effects of testing and checking

It can be difficult to anticipate how well the thermal insulation and airtightness of a completed building will work. There are certain factors involved in assembling the various components and building elements that can have a considerable impact on the final result. The effects of transport, handling and storage at the site and the way the work is done cannot be calculated in advance. To ensure that the intended function is actually achieved, verification by testing and checking the completed building is required.

Modern insulation technology has reduced the theoretical heat requirement. This does mean, however, that defects that are relatively minor, but at important locations, e.g. leaking joints or incorrectly installed insulation, can have considerable consequences in terms both of heat and comfort. Verification tests, e.g. by means of thermography, have proved their value, from the point of view both of the designer and the contractor and of the developer, the property manager and the user.

- For the designer, the important thing is to find out about the function of various types of structures, so that they can be designed to take into account both working methods and functional requirements. The designer must also know how different materials and combinations of materials function in practice. Effective testing and checking, as well as experiential feedback, can be used to achieve the required development in this area.
- The contractor is keen on more testing and inspection in order to ensure that the structures keep to an expected function that corresponds to established requirements in the regulations issued by authorities and in contractual documents. The contractor wants to know at an early stage of construction about any changes that may be necessary so that systematic defects can be prevented. During construction, a check should therefore be carried out on the first apartments completed in a mass production project. Similar checking then follows as production continues. In this way systematic defects can be prevented and unnecessary costs and future problems can be avoided. This check is of benefit both to manufacturers and to users.
- For the developer and the property manager it is essential that buildings are checked with reference to heat economy, maintenance (damage from moisture or moisture infiltration) and comfort for the occupants (e.g. cooled surfaces and air movements in occupied zones).

- For the user the important thing is that the finished product fulfills the promised requirements in terms of the building's thermal insulation and airtightness. For the individual, buying a house involves a considerable financial commitment, and the purchaser therefore wants to know that any defects in the construction will not involve serious financial consequences or hygiene problems.

The effects of testing and checking a building's insulation and airtightness are partly physiological and partly financial.

The physiological experience of an indoor climatic environment is very subjective, varying according to the particular human body's heat balance and the way the individual experiences temperature. The experience of climate depends on both the indoor air temperature and that of the surrounding surfaces. The speed of movement and moisture content of indoor air are also of some significance. Physiologically, a draft produces the sensation of local cooling of the body's surface caused by

- excessive air movements in the occupied zone with normal air temperature;
- normal air movements in the occupied zone but a room temperature that is too low;
- substantial radiated heat exchange with a cold surface.

It is difficult to assess the quantitative effects of testing and checking a building's thermal insulation.

Investigations have shown that defects found in the thermal insulation and airtightness of buildings cause heat losses that are about 20–30% more than was expected. Monitoring energy consumption before and after remedial measures in relatively large complexes of small houses and in multi-dwelling blocks has also demonstrated this. The figures quoted are probably not representative of buildings in general, since the investigation data cannot be said to be significant for the entire building stock. A cautious assessment however would be that effectively testing and checking a building's thermal insulation and airtightness can result in a reduction in energy consumption of about 10%.

Research has also shown that increased energy consumption associated with defects is often caused by occupants increasing the indoor temperature by one or a few degrees above normal to compensate for the effect of annoying thermal radiation towards cooled surfaces or a sensation of disturbing air movements in a room.

12.3.3 Sources of disruption in thermography

During thermography, the risk of confusing temperature variations caused by insulation defects with those associated with the natural variation in U values along warm surfaces of a structure is considered slight under normal conditions.

The temperature changes associated with variations in the U value are generally gradual and symmetrically distributed across the surface. Variations of this kind do of course occur at the angles formed by roofs and floors and at the corners of walls.

Temperature changes associated with air leaks or insulation defects are in most cases more evident with characteristically shaped sharp contours. The temperature pattern is usually asymmetrical.

During thermography and when interpreting an infrared image, comparison infrared images can provide valuable information for assessment.

The sources of disruption in thermography that occur most commonly in practice are

- the effect of the sun on the surface being thermographed (sunlight shining in through a window);
- hot radiators with pipes;
- lights directed at, or placed near, the surface being measured;
- air flows (e.g. from air intakes) directed at the surface;
- the effect of moisture deposits on the surface.

Surfaces on which the sun is shining should not be subjected to thermography. If there is a risk of an effect by sunlight, windows should be covered up (closing Venetian blinds). However, be aware that there are building defects or problems (typically moisture problems) that only show up when heat has been applied to the surface, e.g. from the sun.

For more information about moisture detection, see section 12.2.2 – About moisture detection on page 73.

A hot radiator appears as a bright light surface in an infrared U image. The surface temperature of a wall next to a radiator is raised, which may conceal any defects present.

For maximum prevention of disruptive effects from hot radiators, these may be shut off a short while before the measurement is taken. However, depending on the construction of the building (low or high mass), these may need to be shut off several hours before a thermographic survey. The room air temperature must not fall so much as to affect the surface temperature distribution on the structure's surfaces. There is little timelag with electric radiators, so they cool down relatively quickly once they have been switched off (20–30 minutes).

Lights placed against walls should be switched off when the infrared image is taken.

During thermography there should not be any disruptive air flows (e.g. open windows, open valves, fans directed at the surface being measured) that could affect the surfaces being thermographed.

Any wet surfaces, e.g. as a result of surface condensation, have a definite effect on heat transfer at the surface and the surface temperature. Where there is moisture on a surface, there is usually some evaporation which draws off heat, thus lowering the temperature of the surface by several degrees. There is risk of surface condensation at major thermal bridges and insulation defects.

Significant disruptions of the kind described here can normally be detected and eliminated before measuring.

If during thermography it is not possible to shield surfaces being measured from disruptive factors, these must be taken into account when interpreting and evaluating the results. The conditions in which the thermography was carried out should be recorded in detail when each measurement is taken.

12.3.4 Surface temperature and air leaks

Defects in building airtightness due to small gaps in the structure can be detected by measuring the surface temperature. If there is a negative pressure in the building under investigation, air flows into the space through leaks in the building. Cold air flowing in through small gaps in a wall usually lowers the temperature in adjacent areas of the wall. The result is that a cooled surface area with a characteristic shape develops on the inside surface of the wall. Thermography can be used to detect cooled surface areas. Air movements at the wall surface can be measured using an air velocity indicator. If there is a positive pressure inside the building being investigated, warm room air will leak out through gaps in the wall, resulting in locally warm surface areas around the locations of the leaks.

The amount of leakage depends partly on gaps and partly on the differential pressure across the structure.

12.3.4.1 Pressure conditions in a building

The most important causes of differential pressure across a structural element in a building are

- wind conditions around the building;
- the effects of the ventilation system;
- temperature differences between air inside and outside (thermal differential pressure).

The actual pressure conditions inside a building are usually caused by a combination of these factors.

The resultant pressure gradient across the various structural elements can be illustrated by the figure on page 99. The irregular effects of wind on a building means that in practice the pressure conditions may be relatively variable and complicated.

In a steady wind flow, Bernoulli's Law applies:

$$\frac{\rho v^2}{2} + p = \text{constant}$$

where:

| | |
|--------|----------------------------------|
| ρ | Air density in kg/m ³ |
| v | Wind velocity in m/s |
| p | Static pressure in Pa |

and where:

$$\frac{\rho v^2}{2} + p$$

denotes the dynamic pressure and p the static pressure. The total of these pressures gives the total pressure.

Wind load against a surface makes the dynamic pressure become a static pressure against the surface. The magnitude of this static pressure is determined by, amongst other things, the shape of the surface and its angle to the wind direction.

The portion of the dynamic pressure that becomes a static pressure on the surface (p_{stat}) is determined by what is known as a stress concentration factor:

$$C = \frac{p_{stat}}{\frac{\rho v^2}{2}}$$

If ρ is 1.23 kg/m³ (density of air at +15°C (+59°F)), this gives the following local pressures in the wind flow:

$$p_{stat} = C \times \frac{\rho v^2}{2} = C \times \frac{v^2}{1.63} \text{ Pa}$$

10551803.a1

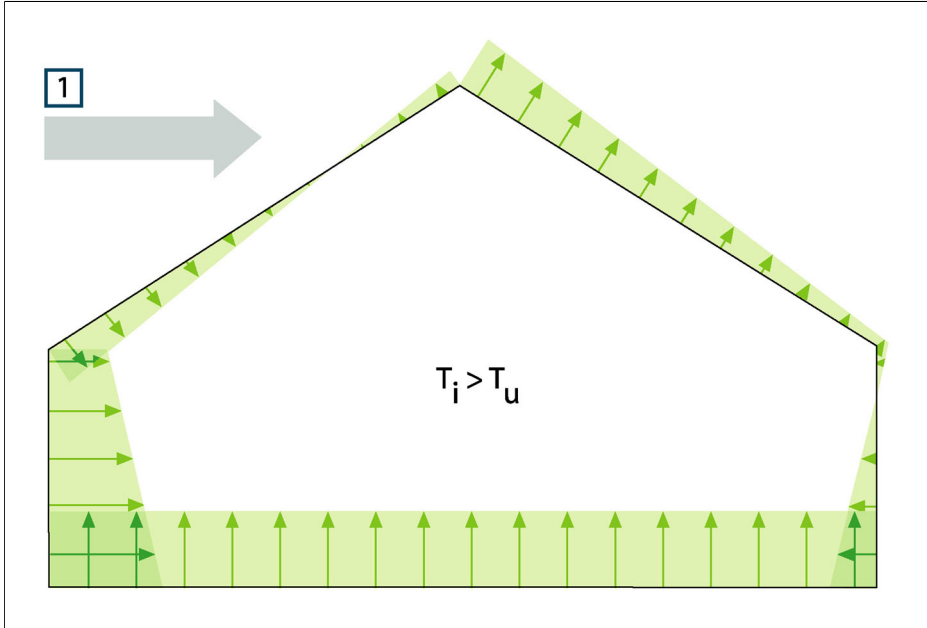

Figure 12.3 Distribution of resultant pressures on a building's enclosing surfaces depending on wind effects, ventilation and internal/external temperature difference. 1: Wind direction; T_u : Thermodynamic air temperature outdoors in K; T_i : Thermodynamic air temperature indoors in K.

If the whole of the dynamic pressure becomes static pressure, then $C = 1$. Examples of stress concentration factor distributions for a building with various wind directions are shown in the figure on page 100.

The wind therefore causes an internal negative pressure on the windward side and an internal positive pressure on the leeward side. The air pressure indoors depends on the wind conditions, leaks in the building and how these are distributed in relation to the wind direction. If the leaks in the building are evenly distributed, the internal pressure may vary by $\pm 0.2 p_{\text{stat}}$. If most of the leaks are on the windward side, the internal pressure increases somewhat. In the opposite case, with most of the leaks on the leeward side, the internal pressure falls.

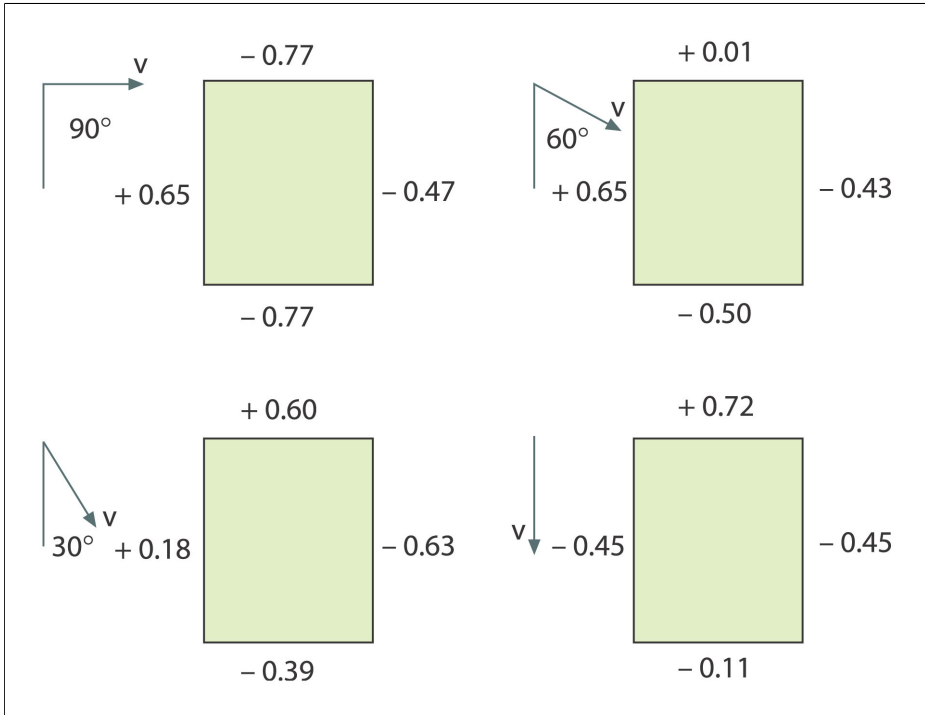

Figure 12.4 Stress concentration factor (C) distributions for various wind directions and wind velocities (v) relative to a building.

Wind conditions can vary substantially over time and between relatively closely situated locations. In thermography, such variations can have a clear effect on the measurement results.

It has been demonstrated experimentally that the differential pressure on a façade exposed to an average wind force of about 5 m/s (16.3 ft/s) will be about 10 Pa.

Mechanical ventilation results in a constant internal negative or positive pressure (depending on the direction of the ventilation). Research has showed that the negative pressure caused by mechanical extraction (kitchen fans) in small houses is usually between 5 and 10 Pa. Where there is mechanical extraction of ventilation air, e.g. in multi-dwelling blocks, the negative pressure is somewhat greater, 10–50 Pa. Where there is so-called balanced ventilation (mechanically controlled supply and extract air), this is normally adjusted to produce a slight negative pressure inside (3–5 Pa).

The differential pressure caused by temperature differences, the so-called chimney effect (airtightness differences of air at different temperatures) means that there is a negative pressure in the building's lower part and a positive pressure in the upper

part. At a certain height there is a neutral zone where the pressures on the inside and outside are the same, see the figure on page 102. This differential pressure may be described by the relationship:

$$\Delta p = g \times \rho_u \times h \left(1 - \frac{T_u}{T_i} \right) \text{ Pa}$$

| | |
|------------|--|
| Δp | Air pressure differential within the structure in Pa |
| g | 9.81 m/s ² |
| ρ_u | Air density in kg/m ³ |
| T_u | Thermodynamic air temperature outdoors in K |
| T_i | Thermodynamic air temperature indoors in K |
| h | Distance from the neutral zone in meters |

If $\rho_u = 1.29 \text{ kg/m}^3$ (density of air at a temperature of 273 K and $\approx 100 \text{ kPa}$), this produces:

$$\Delta p \approx 13 \times h \left(1 - \frac{T_u}{T_i} \right)$$

With a difference of +25°C (+77°F) between the ambient internal and external temperatures, the result is a differential pressure difference within the structure of about 1 Pa/m difference in height (= 3.28 Pa/ft.).

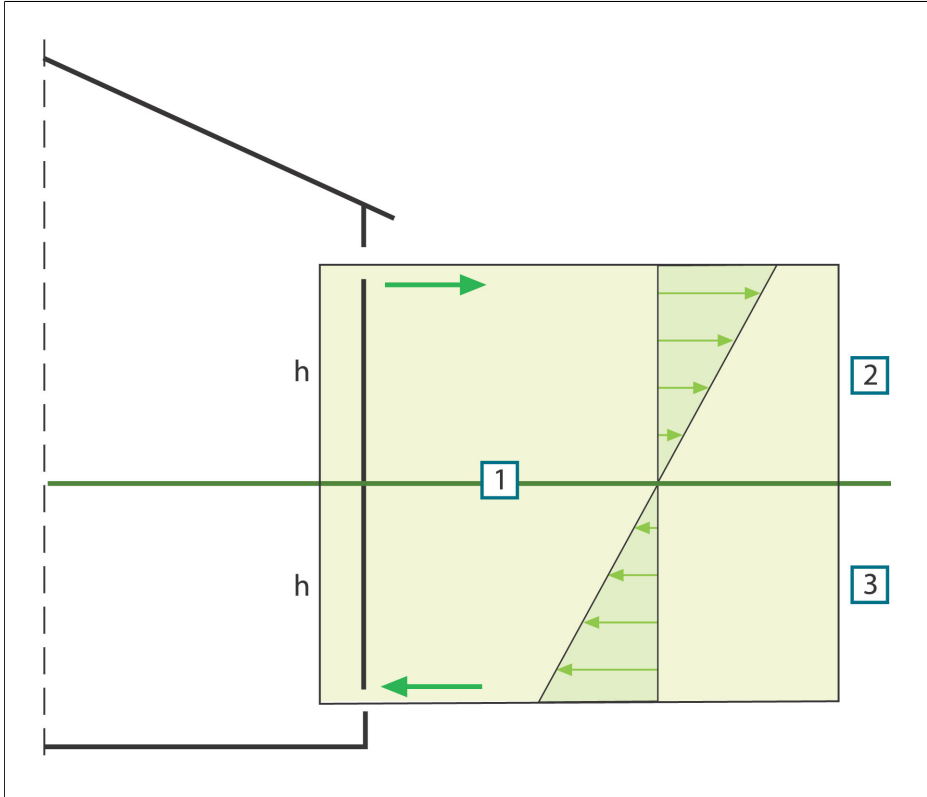

Figure 12.5 Distribution of pressures on a building with two openings and where the external temperature is lower than the internal temperature. 1: Neutral zone; 2: Positive pressure; 3: Negative pressure; **h**: Distance from the neutral zone in meters.

The position of the neutral zone may vary, depending on any leaks in the building. If the leaks are evenly distributed vertically, this zone will be about halfway up the building. If more of the leaks are in the lower part of the building, the neutral zone will move downwards. If more of the leaks are in the upper part, it will move upwards. Where a chimney opens above the roof, this has a considerable effect on the position of the neutral zone, and the result may be a negative pressure throughout the building. This situation most commonly occurs in small buildings.

In a larger building, such as a tall industrial building, with leaks at doors and any windows in the lower part of the building, the neutral zone is about one-third of the way up the building.

12.3.5 Measuring conditions & measuring season

The foregoing may be summarized as follows as to the requirements with regard to measuring conditions when carrying out thermographic imaging of buildings.

Thermographic imaging is done in such a way that the disruptive influence from external climatic factors is as slight as possible. The imaging process is therefore carried out indoors, i.e. where a building is heated, the structure's warm surfaces are examined.

Outdoor thermography is only used to obtain reference measurements of larger façade surfaces. In certain cases, e.g. where the thermal insulation is very bad or where there is an internal positive pressure, outdoor measurements may be useful. Even when investigating the effects of installations located within the building's climatic envelope, there may be justification for thermographic imaging from outside the building.

The following conditions are recommended:

- The air temperature difference within the relevant part of the building must be at least +10°C (+18°F) for a number of hours before thermographic imaging and for as long as the procedure takes. For the same period, the ambient temperature difference must not vary by more than ±30% of the difference when the thermographic imaging starts. During the thermographic imaging, the indoor ambient temperature should not change by more than ±2°C (±3.6°F).
- For a number of hours prior before thermographic imaging and as long as it continues, no influencing sunlight may fall upon the relevant part of the building.
- Negative pressure within the structure ≈ 10–50 Pa.
- When conducting thermographic imaging in order to locate only air leaks in the building's enclosing sections, the requirements in terms of measuring conditions may be lower. A difference of 5°C (9°F) between the inside and outside ambient temperatures ought to be sufficient for detecting such defects. To be able to detect air leaks, certain requirements must however be made with regard to the differential pressure; about 10 Pa should be sufficient.

12.3.6 Interpretation of infrared images

The main purpose of thermography is to locate faults and defects in thermal insulation in exterior walls and floor structures and to determine their nature and extent. The measuring task can also be formulated in such a way that the aim of the thermography is to confirm whether or not the wall examined has the promised insulation and airtightness characteristics. The 'promised thermal insulation characteristics' for the wall according to the design can be converted into an expected surface temperature distribution for the surface under investigation if the measuring conditions at the time when the measurements are taken are known.

In practice the method involves the following:

Laboratory or field tests are used to produce an expected temperature distribution in the form of typical or comparative infrared images for common wall structures, comprising both defect-free structures and structures with in-built defects. Examples of typical infrared images are shown in section 12.2 – Typical field investigations beginning on page 71.

If infrared images of structural sections taken during field measurements are intended for use as comparison infrared images, then the structure's composition, the way it was built, and the measurement conditions at the time the infrared image was taken must be known in detail and documented.

In order, during thermography, to be able to comment on the causes of deviations from the expected results, the physical, metrological and structural engineering prerequisites must be known.

The interpretation of infrared images taken during field measurements may be described in brief as follows:

A comparison infrared image for a defect-free structure is selected on the basis of the wall structure under investigation and the conditions under which the field measurement was taken. An infrared image of the building element under investigation is then compared with the selected infrared image. Any deviation that cannot be explained by the design of the structure or the measurement conditions is noted as a suspected insulation defect. The nature and extent of the defect is normally determined using comparison infrared images showing various defects.

If no suitable comparison infrared image is available, evaluation and assessment are done on the basis of experience. This requires more precise reasoning during the analysis.

When assessing an infrared image, the following should be looked at:

- Uniformity of brightness in infrared images of surface areas where there are no thermal bridges
- Regularity and occurrence of cooled surface areas, e.g. at studding and corners
- Contours and characteristic shapes in the cooled surface area
- Measured temperature differences between the structure's normal surface temperature and the selected cooled surface area
- Continuity and uniformity of the isotherm curve on the surface of the structure. In the camera software the isotherm function is called **Isotherm** or **Color alarm**, depending on camera model.

Deviations and irregularities in the appearance of the infrared image often indicate insulation defects. There may obviously be considerable variations in the appearance of infrared images of structures with insulation defects. Certain types of insulation defects have a characteristic shape on the infrared image. Section 12.2 – Typical field investigations beginning on page 71 shows examples of interpretations of infrared images.

When taking infrared images of the same building, the infrared images from different areas should be taken with the same settings on the infrared camera, as this makes comparison of the various surface areas easier.

12.3.7 Humidity & dew point

12.3.7.1 Relative & absolute humidity

Humidity can be expressed in two different ways—either as *relative humidity* or as *absolute humidity*. Relative humidity is expressed in percent of how much water a certain volume of air can hold at a certain temperature, while absolute humidity is expressed in percent water by weight of material. The latter way to express humidity is common when measuring humidity in wood and other building materials.

The higher the temperature of air, the larger the amount of water this certain volume of air can hold. The following table specifies the maximum amounts of water in air at different temperatures.

Figure 12.6 A: Temperature in degrees Celsius; **B:** Maximum amount of water expressed in g/m³ (at sea level)

| A | B | A | B | A | B | A | B |
|------|-------|------|-------|------|------|------|------|
| 30.0 | 30.44 | 20.0 | 17.33 | 10.0 | 9.42 | 0.0 | 4.86 |
| 29.0 | 28.83 | 19.0 | 16.34 | 9.0 | 8.84 | -1.0 | 4.49 |
| 28.0 | 27.29 | 18.0 | 15.40 | 8.0 | 8.29 | -2.0 | 4.15 |
| 27.0 | 25.83 | 17.0 | 14.51 | 7.0 | 7.77 | -3.0 | 3.83 |
| 26.0 | 24.43 | 16.0 | 13.66 | 6.0 | 7.28 | -4.0 | 3.53 |
| 25.0 | 23.10 | 15.0 | 12.86 | 5.0 | 6.81 | -5.0 | 3.26 |
| 24.0 | 21.83 | 14.0 | 12.09 | 4.0 | 6.38 | -6.0 | 3.00 |
| 23.0 | 20.62 | 13.0 | 11.37 | 3.0 | 5.96 | -7.0 | 2.76 |
| 22.0 | 19.47 | 12.0 | 10.69 | 2.0 | 5.57 | -8.0 | 2.54 |
| 21.0 | 18.38 | 11.0 | 10.04 | 1.0 | 5.21 | -9.0 | 2.34 |

Figure 12.7 A: Temperature in degrees Fahrenheit; **B:** Maximum amount of water in gr/ft³ (at sea level)

| A | B | A | B | A | B | A | B |
|------|-------|------|------|------|------|------|------|
| 86.0 | 13.30 | 68.0 | 7.58 | 50.0 | 4.12 | 32.0 | 2.12 |
| 84.2 | 12.60 | 66.2 | 7.14 | 48.2 | 3.86 | 30.2 | 1.96 |
| 82.4 | 11.93 | 64.4 | 6.73 | 46.4 | 3.62 | 28.4 | 1.81 |
| 80.6 | 11.29 | 62.6 | 6.34 | 44.6 | 3.40 | 26.6 | 1.67 |
| 78.8 | 10.68 | 60.8 | 5.97 | 42.8 | 3.18 | 24.8 | 1.54 |
| 77.0 | 10.10 | 59.0 | 5.62 | 41.0 | 2.98 | 23.0 | 1.42 |
| 75.2 | 9.54 | 57.2 | 5.29 | 39.2 | 2.79 | 21.2 | 1.31 |
| 73.4 | 9.01 | 55.4 | 4.97 | 37.4 | 2.61 | 19.4 | 1.21 |
| 71.6 | 8.51 | 53.6 | 4.67 | 35.6 | 2.44 | 17.6 | 1.11 |
| 69.8 | 8.03 | 51.8 | 4.39 | 33.8 | 2.28 | 15.8 | 1.02 |

Example:

The relative humidity of a certain volume of air at a temperature of +30°C (+86°F) is 40 % RH. Amount of water in 1 m³ (35.31 ft³) of air at +30°C = 30.44 × Rel Humidity = 30.44 × 0.40 = 12.18 g (187.96 gr).

12.3.7.2 Definition of dew point

Dew point can be regarded as the temperature at which the humidity in a certain volume of air will condense as liquid water.

Example:

The relative humidity of a certain volume of air at a temperature of +30°C (+86°F) is 40 % RH. Amount of water in 1 m³ (35.31 ft³) of air at +30°C = 30.44 × Rel Humidity = 30.44 × 0.40 = 12.18 g (187.96 gr). In the table above, look up the temperature for which the amount of water in air is closest to 12.18 g. This would be +14.0°C (+57.2°F), which is the approximate dew point.

12.3.8 Assessing thermal bridging and insulation continuity**12.3.8.1 Credits**

This Technical Note was produced by a working group including expert thermographers, and research consultants. Additional consultation with other persons and organisations results in this document being widely accepted by all sides of industries.

The contents of this Technical Note is reproduced with kind permission from, and fully copyrighted to, United Kingdom Thermography Association (UKTA).

UK Thermography Association
 c/o British Institute of Nondestructive Testing
 1 Spencer Parade
 Northampton NN1 5AA
 United Kingdom

Tel: +44 (0)1604 630124

Fax: +44 (0)1604 231489

12.3.8.1.1 Working group

| | |
|---------------------------|------------------------|
| Ray Faulkner (Chairman) | IRed Ltd |
| Colin Pearson (Secretary) | BSRIA |
| Norman Walker | AWE |
| Stewart Little | IRT Surveys |
| Richard Wallace | Ti Thermal Imaging Ltd |

Consultation with:

Building Control

Stuart Borland Building Sciences

12.3.8.2 Introduction

Over the last few years the equipment, applications, software, and understanding connected with thermography have all developed at an astonishing rate. As the technology has gradually become integrated into mainstream practises, a corresponding demand for application guides, standards and thermography training has arisen.

The UKTA is publishing this technical note in order to establish a consistent approach to quantifying the results for a 'Continuity of Thermal Insulation' examination. It is intended that specifiers should refer to this document as a guide to satisfying the requirement in the Building Regulations, therefore enabling the qualified thermographer to issue a pass or fail report.

12.3.8.3 Background information

Thermography can detect surface temperature variations as small as 0.1 K and graphic images can be produced that visibly illustrate the distribution of temperature on building surfaces.

Variations in the thermal properties of building structures, such as poorly fitted or missing sections of insulation, cause variations in surface temperature on both sides of the structure. They are therefore visible to the thermographer. However, many other factors such as local heat sources, reflections and air leakage can also cause surface temperature variations.

The professional judgement of the thermographer is usually required to differentiate between real faults and other sources of temperature variation. Increasingly, thermographers are asked to justify their assessment of building structures and, in the absence of adequate guidance, it can be difficult to set definite levels for acceptable or unacceptable variation in temperature.

The current Standard for thermal imaging of building fabric in the UK is BS EN 13187:1999 (BS EN 13187:1999, Thermal Performance of Buildings—Qualitative detection of thermal properties in building envelopes—Infrared method (ISO 6781:1983 modified). However, this leaves interpretation of the thermal image to the professional expertise of the thermographer and provides little guidance on the demarcation between acceptable and unacceptable variations. Guidance on the appearance of a range of thermal anomalies can be found in BINDT Guides to thermal imaging (Infrared Thermography Handbook; Volume 1, Principles and Practise, Norman Walker, ISBN 0903132338, Volume 2, Applications, A. N. Nowicki, ISBN 090313232X, BINDT, 2005).

12.3.8.3.1 Requirements

A thermographic survey to demonstrate continuity of insulation, areas of thermal bridging and compliance with Building Regulations should include the following:

- Thermal anomalies.
- Differentiate between real thermal anomalies, where temperature differences are caused by deficiencies in thermal insulation, and those that occur through confounding factors such as localised differences in air movement, reflection and emissivity.
- Quantify affected areas in relation to the total insulated areas.
- State whether the anomalies and the building thermal insulation as a whole are acceptable.

12.3.8.4 Quantitative appraisal of thermal anomalies

A thermographic survey will show differences in apparent temperature of areas within the field of view. To be useful, however, it must systematically detect all the apparent defects; assess them against a predetermined set of criteria; reliably discount those anomalies that are not real defects; evaluate those that are real defects, and report the results to the client.

12.3.8.4.1 Selection of critical temperature parameter

The BRE information Paper IP17/01 (Information Paper IP17/01, Assessing the Effects of Thermal Bridging at Junctions and Around Openings. Tim Ward, BRE, 2001) provides useful guidance on minimum acceptable internal surface temperatures and appropriate values of Critical Surface Temperature Factor, f_{CRsi} . The use of a surface temperature factor allows surveys under any thermal conditions to show areas that are at risk of condensation or mould growth under design conditions.

The actual surface temperature will depend greatly on the temperatures inside and outside at the time of the survey, but a 'Surface Temperature Factor' (f_{Rsi}) has been devised that is independent of the absolute conditions. It is a ratio of temperature drop across the building fabric to the total temperature drop between inside and outside air.

For internal surveys: $f_{Rsi} = T_{si} - T_e / T_i - T_e$

T_{si} = internal surface temperature

T_i = internal air temperature

T_e = external air temperature

A value for f_{CRsi} of 0.75 is considered appropriate across new building as the upper end usage is not a factor considered in testing for 'Continuity of Insulation', or 'Thermal Bridging'. However, when considering refurbished or extended buildings, for example swimming pools, internal surveys may need to account for unusual circumstances.

12.3.8.4.2 Alternative method using only surface temperatures

There are strong arguments for basing thermographic surveys on surface temperatures alone, with no need to measure air temperature.

- Stratification inside the building makes reference to air internal temperatures very difficult. Is it mean air temperature, low level, high level or temperature at the level of the anomaly and how far from the wall should it be measured?
- Radiation effects, such as radiation to the night sky, make use of external air temperature difficult. It is not unusual for the outside surface of building fabric to be below air temperature because of radiation to the sky which may be as low as -50°C (-58°F). This can be seen with the naked eye by the fact that dew and frost often appear on building surfaces even when the air temperature does not drop below the dewpoint.
- It should be noted that the concept of U values is based on 'environmental temperatures' on each side of the structure. This is neglected by many inexperienced analysts.
- The two temperatures that are firmly related to the transfer of heat through building fabric (and any solid) are the surface temperatures on each side.
- Therefore, by referring to surface temperatures the survey is more repeatable.

- The surface temperatures used are the averages of surface temperatures on the same material in an area near the anomaly on the inside and the outside of the fabric. Together with the temperature of the anomaly, a threshold level can be set dependent on these temperatures using the critical surface temperature factor.
- These arguments do not obviate the need for the thermographer to beware of reflections of objects at unusual temperatures in the background facing the building fabric surfaces.
- The thermographer should also use a comparison between external faces facing different directions to determine whether there is residual heat from solar gain affecting the external surfaces.
- External surveys should not be conducted on a surface where $T_{si} - T_{so}$ on the face is more than 10% greater than $T_{si} - T_{so}$ on the north or nearest to north face.
- For a defect that causes a failure under the 0.75 condition of IP17/01 the critical surface factors are 0.78 on the inside surface and 0.93 on the outside surface.

The table below shows the internal and external surface temperatures at an anomaly which would lead to failure under IP17/01. It also shows the deterioration in thermal insulation that is necessary to cause this.

| Example for lightweight built-up cladding with defective insulation | Good area | Failing area |
|---|-----------|--------------|
| Outside temperature in °C | 0 | 0 |
| Surface factor from IP17/01 | 0.95 | 0.75 |
| Outside surface temperature in °C | 0.3 | 1.5 |
| Critical external surface temperature factor, after IP17/01 | | 0.92 |
| Insulation thickness to give this level of performance, mm | 80 | 5.1 |
| Local U value W/m ² K | 0.35 | 1.92 |
| Inside surface temperature in °C | 19.1 | 15.0 |
| UKTA TN1 surface factor | | 0.78 |
| UKTA TN1 surface factor outside | | 0.93 |

Notes to the table

1 Values of surface resistances taken from ADL2 2001, are:

- Inside surface 0.13 m²K/W
- Outside surface 0.04 m²K/W

These originate from BS EN ISO 6946 (BN EN ISO 6946:1997 Building components and building elements - Thermal resistance and thermal transmittance - Calculation method).

- 2 Thermal insulation used here is assumed to have a conductivity of 0.03 W/m K.
 3 The difference in temperature between an anomaly and the good areas is 1.2 degrees on the outside and 4.1 degrees on the inside.

- 4 The UKTA TN1 surface temperature factor for internal surveys is:

$$F_{si} = T_{sia} - T_{so} / T_{si} - T_{so}$$

where:

T_{sia} = internal surface temperature at anomaly

T_{so} = external surface temperature (good area)

T_{si} = internal surface temperature (good area)

- 5 The UKTA TN1 surface temperature factor for external surveys is:

$$F_{so} = T_{soa} - T_{si} / T_{so} - T_{si}$$

where T_{soa} = external surface temperature at anomaly

12.3.8.4.3 *Selecting maximum acceptable defect area*

The allowable area of defect is a quality control issue. It can be argued that there should be no area on which condensation, mould growth or defective insulation will occur and any such anomalies should be included in the report. However, a commonly used value of 0.1% of the building exposed surface area is generally accepted as the maximum combined defect area allowable to comply with the Building Regulations. This represents one square metre in every thousand.

12.3.8.4.4 *Measuring surface temperature*

Measurement of surface temperature is the function of the infrared imaging system. The trained thermographer will recognise, account for and report on the variation of emissivity and reflectivity of the surfaces under consideration.

12.3.8.4.5 *Measuring area of the defects*

Measurement of defect area can be performed by pixel counting in the thermal analysis software or most spreadsheet packages provided that:

- the distance from camera to object is accurately measured probably using a laser measurement system,
- the target distance should take into account the IFOV of the imaging system,
- any angular change between the camera and the object surface from the perpendicular is accounted for.

Buildings consist of numerous construction features that are not conducive to quantitative surveys including windows, roof lights, luminaries, heat emitters, cooling equipment, service pipes and electrical conductors. However, the joints and connections between these objects and the building envelope should be considered as part of the survey.

12.3.8.5 Conditions and equipment

To achieve best results from a thermal insulation survey it is important to consider the environmental conditions and to use the most appropriate thermographic technique for the task.

Thermal anomalies will only present themselves to the thermographer where temperature differences exist and environmental phenomena are accounted for. As a minimum, the following conditions should be complied with:

- Temperature differences across the building fabric to be greater than 10°C (18°F).
- Internal air to ambient air temperature difference to be greater than 5°C (9°F) for the last twentyfour hours before survey.
- External air temperature to be within $\pm 3^{\circ}\text{C}$ ($\pm 5.4^{\circ}\text{F}$) for duration of survey and for the previous hour.
- External air temperature to be within $\pm 10^{\circ}\text{C}$ ($\pm 18^{\circ}\text{F}$) for the preceding twentyfour hours.

In addition, external surveys should also comply with the following:

- Necessary surfaces free from direct solar radiation and the residual effects of past solar radiation. This can be checked by comparing the surface temperatures of opposite sides of the building.
- No precipitation either just prior to or during the survey.
- Ensure all building surfaces to be inspected are dry.
- Wind speed to be less than 10 metres / second (19.5 kn.).

As well as temperature, there are other environmental conditions that should also be taken into account when planning a thermographic building survey. External inspections, for example, may be influenced by radiation emissions and reflections from adjacent buildings or a cold clear sky, and even more significantly the heating effect that the sun may have on surface.

Additionally, where background temperatures differ from air temperatures either internally or externally by more than 5 K, then background temperatures should be measured on all effected surfaces to allow surface temperature to be measured with sufficient accuracy.

For this type of survey infrared cameras must have a sufficiently high resolution to detect small anomalies at a resonable distance. Typically, cameras use detectors with 320×240 (= 76,800) pixels. The total pixel count should be at least 40,000 for good results, and the camera should have a temperature sensitivity of at least 0.2°C (0.36°F) (usually specified as NETD or noise equivalent temperature difference) so that surface anomalies with small temperature differences can be detected.

12.3.8.6 Survey and analysis

The following provides some operational guidance to the thermographic operator.

The survey must collect sufficient thermographic information to demonstrate that all surfaces have been inspected in order that all thermal anomalies are reported and evaluated.

Initially, environmental data must be collected, as with any thermographic survey including:

- Internal temperature in the region of the anomaly.
- External temperature in the region of the anomaly.
- Emissivity of the surface.
- Background temperature.
- Distance from the surface.

By interpolation, determine the threshold temperature to be used.

- For internal surveys the threshold surface temperature (T_{sia}) is $T_{sia} = f_{si}(T_{si} - T_{so}) + T_{so}$. The thermographer will be looking for evidence of surface temperature below this threshold.
- For external surveys the threshold temperature (T_{soa}) is $T_{soa} = f_{so}(T_{so} - T_{si}) + T_{si}$. The thermographer will be looking for evidence of surface temperature above this threshold.

Images of anomalies must be captured in such a way that they are suitable for analysis:

- The image is square to any features of the wall or roof.
- The viewing angle is nearly perpendicular to the surface being imaged. Interfering sources of infrared radiation such as lights, heat emitters, electric conductors, reflective elements are minimised.

The method of analysis will depend somewhat on analysis software used, but the key stages are as follows:

Produce an image of each anomaly or cluster of anomalies.

- Use a software analysis tool to enclose the anomalous area within the image, taking care not to include construction details that are to be excluded.
- Calculate the area below the threshold temperature for internal surveys or above the threshold temperature for external surveys. This is the defect area. Some anomalies that appeared to be defects at the time of the survey may not show defect areas at this stage.
- Add the defect areas from all the images $\sum A_d$.
- Calculate the total area of exposed building fabric. This is the surface area of all the walls and roof. It is conventional to use the external surface area. For a simple shape building this is calculated from overall width, length and height.

$$A_t = (2h(L + w)) + (Lw)$$

- Identify the critical defect area A_c . Provisionally this is set at one thousandth or 0.1% of the total surface area.

$$A_c = A_t/1000$$

- If $\sum A_d < A_c$ the building as a whole can be considered to have 'reasonably continuous' insulation.

12.3.8.7 *Reporting*

Reports should certificate a pass/fail result, comply with customers requirements and as a minimum include the information required by BSEN 13187. The following data is normally required so that survey can be repeated following remedial action.

- Background to the objective and principles of the test.
- Location, orientation, date and time of survey.
- A unique identifying reference.
- Thermographer's name and qualifications.
- Type of construction.
- Weather conditions, wind speed and direction, last precipitation, sunshine, degree of cloud cover.
- Ambient temperatures inside and outside before, at the beginning of survey and the time of each image. Air temperature and radiant temperature should be recorded.
- Statement of any deviation from relevant test requirements.
- Equipment used, last calibration date, any known defects.
- Name, affiliation and qualifications of tester.
- Type, extent and position of each observed defect.
- Results of any supplementary measurements and investigations.
- Reports should be indexed and archived by thermographers.

12.3.8.7.1 *Considerations and limitations*

The choice between internal and external surveys will depend on:

- Access to the surface. Buildings where both the internal and the external surfaces are obscured, e.g., by false ceilings racking or materials stacked against walls may not be amenable to this type of survey.
- Location of the thermal insulation. Surveys are usually more effective from the side nearest to the thermal insulation.
- Location of heavyweight materials. Surveys are usually less effective from the side nearest to the heavyweight material.
- The purpose of the survey. If the survey aims to show risk of condensation and mould growth it should be internal.
- Location of glass, bare metal or other materials that may be highly reflective. Surveys are usually less effective on highly reflective surfaces.

- A defect will usually produce a smaller temperature difference on the outside of a wall exposed to external air movement. However, missing or defective insulation near the external surface can often be more readily identified externally.

12.4 *Disclaimer*

12.4.1 Copyright notice

Some sections and/or images appearing in this chapter are copyrighted to the following organizations and companies:

- FORMAS—The Swedish Research Council for Environment, Agricultural Sciences and Spatial Planning, Stockholm, Sweden
- ITC—Infrared Training Center, Boston, MA, United States
- Stockton Infrared Thermographic Services, Inc., Randleman, NC, United States
- Professional Investigative Engineers, Westminster, CO, United States
- United Kingdom Thermography Association (UKTA)

12.4.2 Training & certification

Carrying out building thermography inspections requires substantial training and experience, and may require certification from a national or regional standardization body. This section is provided only as an introduction to building thermography. The user is strongly recommended to attend relevant training courses.

For more information about infrared training, visit the following website:

<http://www.infraredtraining.com>

12.4.3 National or regional building codes

The commented building structures in this chapter may differ in construction from country to country. For more information about construction details and standards of procedure, always consult national or regional building codes.

13 Introduction to thermographic inspections of electrical installations

13.1 *Important note*

All camera functions and features that are described in this section may not be supported by your particular camera configuration.

Electrical regulations differ from country to country. For that reason, the electrical procedures described in this section may not be the standard of procedure in your particular country. Also, in many countries carrying out electrical inspections requires formal qualification. Always consult national or regional electrical regulations.

13.2 *General information*

13.2.1 Introduction

Today, thermography is a well-established technique for the inspection of electrical installations. This was the first and still is the largest. the largest application of thermography. The infrared camera itself has gone through an explosive development and we can say that today, the 8th generation of thermographic systems is available. It all began in 1964, more than 40 years ago. The technique is now established throughout the whole world. Industrialized countries as well as developing countries have adopted this technique.

Thermography, in conjunction with vibration analysis, has over the latest decades been the main method for fault diagnostics in the industry as a part of the preventive maintenance program. The great advantage with these methods is that it is not only possible to carry out the inspection on installations in operation; normal working condition is in fact a prerequisite for a correct measurement result, so the ongoing production process is not disturbed. Thermographic inspection of electrical installations are used in three main areas:

- Power generation
- Power transmission
- Power distribution, that is, industrial use of electrical energy.

The fact that these controls are carried out under normal operation conditions has created a natural division between these groups. The power generation companies measure during the periods of high load. These periods vary from country to country

and for the climatic zones. The measurement periods may also differ depending on the type of plant to be inspected, whether they are hydroelectric, nuclear, coal-based or oil-based plants.

In the industry the inspections are—at least in Nordic countries with clear seasonal differences—carried out during spring or autumn or before longer stops in the operation. Thus, repairs are made when the operation is stopped anyway. However, this seems to be the rule less and less, which has led to inspections of the plants under varying load and operating conditions.

13.2.2 General equipment data

The equipment to be inspected has a certain temperature behavior that should be known to the thermographer before the inspection takes place. In the case of electrical equipment, the physical principle of why faults show a different temperature pattern because of increased resistance or increased electrical current is well known.

However, it is useful to remember that, in some cases, for example solenoids, ‘overheating’ is natural and does not correspond to a developing defect. In other cases, like the connections in electrical motors, the overheating might depend on the fact that the healthy part is taking the entire load and therefore becomes overheated. A similar example is shown in section 13.5.7 – Overheating in one part as a result of a fault in another on page 133.

Defective parts of electrical equipment can therefore both indicate overheating and be cooler than the normal ‘healthy’ components. It is necessary to be aware of what to expect by getting as much information as possible about the equipment before it is inspected.

The general rule is, however, that a hot spot is caused by a probable defect. The temperature and the load of that specific component at the moment of inspection will give an indication of how serious the fault is and can become in other conditions.

Correct assessment in each specific case demands detailed information about the thermal behavior of the components, that is, we need to know the maximum allowed temperature of the materials involved and the role the component plays in the system.

Cable insulations, for example, lose their insulation properties above a certain temperature, which increases the risk of fire.

13 In the case of breakers, where the temperature is too high, parts can melt and make it impossible to open the breaker, thereby destroying its functionality.

The more the IR camera operator knows about the equipment that he or she is about to inspect, the higher the quality of the inspection. But it is virtually impossible for an IR thermographer to have detailed knowledge about all the different types of equipment that can be controlled. It is therefore common practice that a person responsible for the equipment is present during the inspection.

13.2.3 Inspection

The preparation of the inspection should include the choice of the right type of report. It is often necessary to use complementary equipment such as ampere meters in order to measure the current in the circuits where defects were found. An anemometer is necessary if you want to measure the wind speed at inspection of outdoor equipment.

Automatic functions help the IR operator to visualize an IR image of the components with the right contrast to allow easy identification of a fault or a hot spot. It is almost impossible to miss a hot spot on a scanned component. A measurement function will also automatically display the hottest spot within an area in the image or the difference between the maximum temperature in the chosen area and a reference, which can be chosen by the operator, for example the ambient temperature.

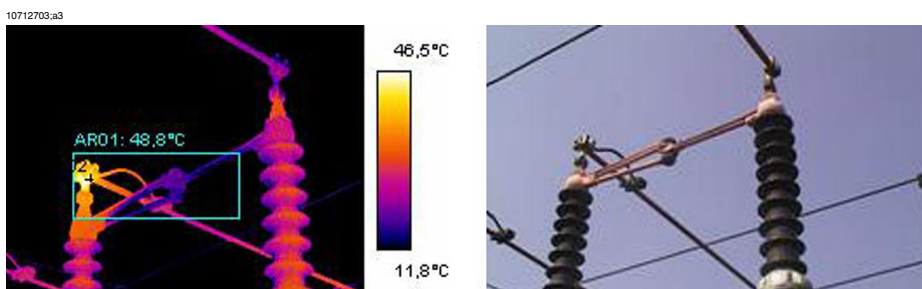

Figure 13.1 An infrared and a visual image of a power line isolator

When the fault is clearly identified and the IR thermographer has made sure that it is not a reflection or a naturally occurring hot spot, the collection of the data starts, which will allow the correct reporting of the fault. The emissivity, the identification of the component, and the actual working conditions, together with the measured temperature, will be used in the report. In order to make it easy to identify the component a visual photo of the defect is often taken.

13.2.4 Classification & reporting

Reporting has traditionally been the most time-consuming part of the IR survey. A one-day inspection could result in one or two days' work to report and classify the found defects. This is still the case for many thermographers, who have chosen not to use the advantages that computers and modern reporting software have brought to IR condition monitoring.

The classification of the defects gives a more detailed meaning that not only takes into account the situation at the time of inspection (which is certainly of great importance), but also the possibility to normalize the over-temperature to standard load and ambient temperature conditions.

An over-temperature of +30°C (+86°F) is certainly a significant fault. But if that over-temperature is valid for one component working at 100% load and for another at 50% load, it is obvious that the latter will reach a much higher temperature should its load increase from 50% to 100%. Such a standard can be chosen by the plant's circumstances. Very often, however, temperatures are predicted for 100% load. A standard makes it easier to compare the faults over time and thus to make a more complete classification.

13.2.5 Priority

Based on the classification of the defects, the maintenance manager gives the defects a repair priority. Very often, the information gathered during the infrared survey is put together with complementary information on the equipment collected by other means such as vibration monitoring, ultrasound or the preventive maintenance scheduled.

Even if the IR inspection is quickly becoming the most used method of collecting information about electrical components safely with the equipment under normal operating conditions, there are many other sources of information the maintenance or the production manager has to consider.

The priority of repair should therefore not be a task for the IR camera operator in the normal case. If a critical situation is detected during the inspection or during the classification of the defects, the attention of the maintenance manager should of course be drawn to it, but the responsibility for determining the urgency of the repair should be his.

13.2.6 Repair

To repair the known defects is the most important function of preventive maintenance. However, to assure production at the right time or at the right cost can also be important goals for a maintenance group. The information provided by the infrared survey can be used to improve the repair efficiency as well as to reach the other goals with a calculated risk.

To monitor the temperature of a known defect that can not be repaired immediately for instance because spare parts are not available, can often pay for the cost of inspection a thousandfold and sometimes even for the IR camera. To decide not to repair known defects to save on maintenance costs and avoid unnecessary downtime is also another way of using the information from the IR survey in a productive way.

However, the most common result of the identification and classification of the detected faults is a recommendation to repair immediately or as soon as it is practically possible. It is important that the repair crew is aware of the physical principles for the identification of defects. If a defect shows a high temperature and is in a critical situation, it is very common that the repair personnel expect to find a highly corroded component. It should also come as no surprise to the repair crew that a connection, which is usually healthy, can give the same high temperatures as a corroded one if it has come loose. These misinterpretations are quite common and risk putting in doubt the reliability of the infrared survey.

13.2.7 Control

A repaired component should be controlled as soon as possible after the repair. It is not efficient to wait for the next scheduled IR survey in order to combine a new inspection with the control of the repaired defects. The statistics on the effect of the repair show that up to a third of the repaired defects still show overheating. That is the same as saying that those defects present a potential risk of failure.

To wait until the next scheduled IR survey represents an unnecessary risk for the plant.

Besides increasing the efficiency of the maintenance cycle (measured in terms of lower risk for the plant) the immediate control of the repair work brings other advantages to the performance of the repair crew itself.

When a defect still shows overheating after the repair, the determination of the cause of overheating improves the repair procedure, helps choose the best component suppliers and detect design shortcomings on the electrical installation. The crew rapidly sees the effect of the work and can learn quickly both from successful repairs and from mistakes.

Another reason to provide the repair crew with an IR instrument is that many of the defects detected during the IR survey are of low gravity. Instead of repairing them, which consumes maintenance and production time, it can be decided to keep these defects under control. Therefore the maintenance personnel should have access to their own IR equipment.

It is common to note on the report form the type of fault observed during the repair as well as the action taken. These observations make an important source of experience that can be used to reduce stock, choose the best suppliers or to train new maintenance personnel.

13.3 Measurement technique for thermographic inspection of electrical installations

13.3.1 How to correctly set the equipment

A thermal image may show high temperature variations:

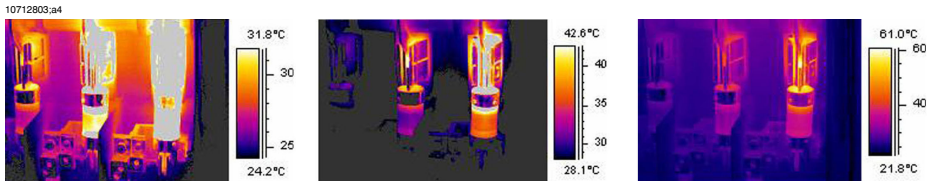

Figure 13.2 Temperature variations in a fusebox

In the images above, the fuse to the right has a maximum temperature of +61°C (+142°F), whereas the one to the left is maximum +32°C (+90°F) and the one in the middle somewhere in between. The three images are different inasmuch as the temperature scale enhances only one fuse in each image. However, it is the same image and all the information about all three fuses is there. It is only a matter of setting the temperature scale values.

13.3.2 Temperature measurement

Some cameras today can automatically find the highest temperature in the image. The image below shows how it looks to the operator.



Figure 13.3 An infrared image of a fusebox where the maximum temperature is displayed

The maximum temperature in the area is +62.2°C (+144.0°F). The spot meter shows the exact location of the hot spot. The image can easily be stored in the camera memory.

The correct temperature measurement depends, however, not only on the function of the evaluation software or the camera. It may happen that the actual fault is, for example, a connection, which is hidden from the camera in the position it happens

to be in for the moment. It might be so that you measure heat, which has been conducted over some distance, whereas the ‘real’ hot spot is hidden from you. An example is shown in the image below.

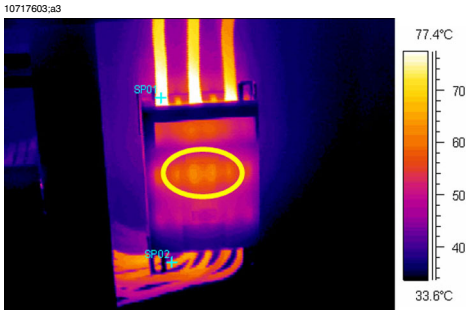

Figure 13.4 A hidden hot spot inside a box

Try to choose different angles and make sure that the hot area is seen in its full size, that is, that it is not disappearing behind something that might hide the hottest spot. In this image, the hottest spot of what the camera can ‘see’, is +83°C (+181°F), where the operating temperature on the cables below the box is +60°C (+140°F). However, the real hot spot is most probably hidden inside the box, see the in yellow encircled area. This fault is reported as a +23.0°C (+41.4°F) excess temperature, but the real problem is probably essentially hotter.

Another reason for underestimating the temperature of an object is bad focusing. It is very important that the hot spot found is in focus. See the example below.

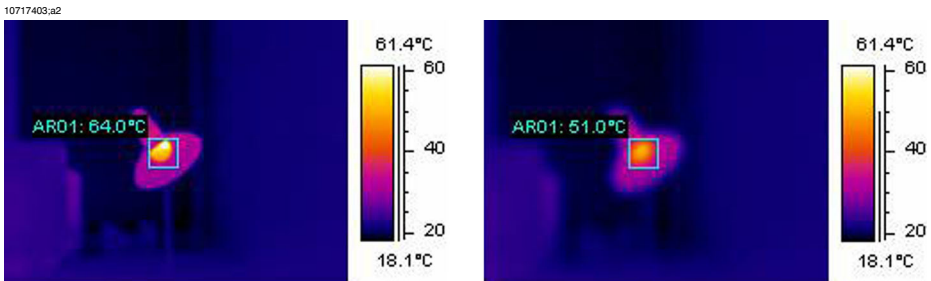

Figure 13.5 LEFT: A hot spot in focus; RIGHT: A hot spot out of focus

In the left image, the lamp is in focus. Its average temperature is +64°C (+147°F). In the right image, the lamp is out of focus, which will result in only +51°C (+124°F) as the maximum temperature.

13.3.3 Comparative measurement

For thermographic inspections of electrical installations a special method is used, which is based on comparison of different objects, so-called *measurement with a reference*. This simply means that you compare the three phases with each other. This method needs systematic scanning of the three phases in parallel in order to assess whether a point differs from the normal temperature pattern.

A normal temperature pattern means that current carrying components have a given operation temperature shown in a certain color (or gray tone) on the display, which is usually identical for all three phases under symmetrical load. Minor differences in the color might occur in the current path, for example, at the junction of two different materials, at increasing or decreasing conductor areas or on circuit breakers where the current path is encapsulated.

The image below shows three fuses, the temperatures of which are very close to each other. The inserted isotherm actually shows less than +2°C (+3.6°F) temperature difference between the phases.

Different colors are usually the result if the phases are carrying an unsymmetrical load. This difference in colors does not represent any overheating since this does not occur locally but is spread along the whole phase.

10713203.a3

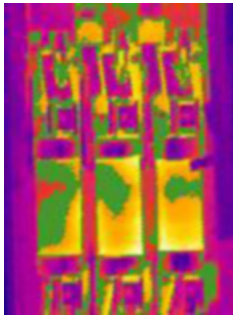

Figure 13.6 An isotherm in an infrared image of a fusebox

A 'real' hot spot, on the other hand, shows a rising temperature as you look closer to the source of the heat. See the image below, where the profile (line) shows a steadily increasing temperature up to about +93°C (+199°F) at the hot spot.

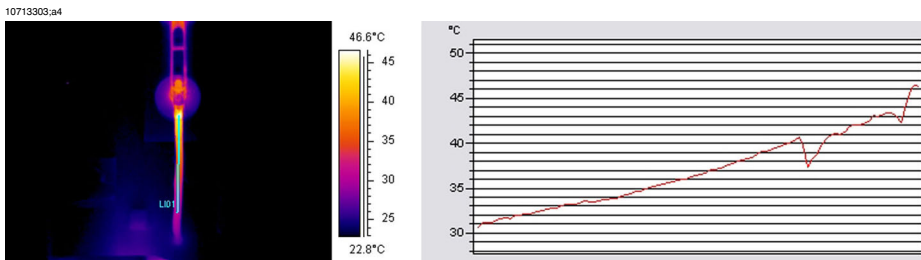

Figure 13.7 A profile (line) in an infrared image and a graph displaying the increasing temperature

13.3.4 Normal operating temperature

Temperature measurement with thermography usually gives the absolute temperature of the object. In order to correctly assess whether the component is too hot, it is necessary to know its operating temperature, that is, its normal temperature if we consider the load and the temperature of its environment.

As the direct measurement will give the absolute temperature—which must be considered as well (as most components have an upper limit to their absolute temperatures)—it is necessary to calculate the expected operating temperature given the load and the ambient temperature. Consider the following definitions:

- **Operating temperature:** the absolute temperature of the component. It depends on the current load and the ambient temperature. It is always higher than the ambient temperature.
- **Excess temperature (overheating):** the temperature difference between a properly working component and a faulty one.

The excess temperature is found as the difference between the temperature of a ‘normal’ component and the temperature of its neighbor. It is important to compare the same points on the different phases with each other.

As an example, see the following images taken from indoor equipment:



Figure 13.8 An infrared image of indoor electrical equipment (1)



Figure 13.9 An infrared image of indoor electrical equipment (2)

The two left phases are considered as normal, whereas the right phase shows a very clear excess temperature. Actually, the operating temperature of the left phase is +68°C (+154°F), that is, quite a substantial temperature, whereas the faulty phase to the right shows a temperature of +86°C (+187°F). This means an excess temperature of +18°C (+33°F), that is, a fault that has to be attended to quickly.

For practical reasons, the (normal, expected) operating temperature of a component is taken as the temperature of the components in at least two out of three phases, provided that you consider them to be working normally.. The ‘most normal’ case is of course that all three phases have the same or at least almost the same temperature. The operating temperature of outdoor components in substations or power lines is usually only 1°C or 2°C above the air temperature (1.8°F or 3.6°F). In indoor substations, the operating temperatures vary a lot more.

This fact is clearly shown by the bottom image as well. Here the left phase is the one, which shows an excess temperature. The operating temperature, taken from the two ‘cold’ phases, is +66°C (+151°F). The faulty phase shows a temperature of +127°C (+261°F), which has to be attended to without delay.

13.3.5 Classification of faults

Once a faulty connection is detected, corrective measures may be necessary—or may not be necessary for the time being. In order to recommend the most appropriate action the following criteria should be evaluated:

- Load during the measurement
- Even or varying load
- Position of the faulty part in the electrical installation
- Expected future load situation
- Is the excess temperature measured directly on the faulty spot or indirectly through conducted heat caused by some fault inside the apparatus?

Excess temperatures measured directly on the faulty part are usually divided into three categories relating to 100% of the maximum load.

| | | |
|-----|-----------------|--|
| I | < 5°C (9°F) | The start of the overheat condition. This must be carefully monitored. |
| II | 5–30°C (9–54°F) | Developed overheating. It must be repaired as soon as possible (but think about the load situation before a decision is made). |
| III | >30°C (54°F) | Acute overheating. Must be repaired immediately (but think about the load situation before a decision is made). |

13.4 Reporting

Nowadays, thermographic inspections of electrical installations are probably, without exception, documented and reported by the use of a report program. These programs, which differ from one manufacturer to another, are usually directly adapted to the cameras and will thus make reporting very quick and easy.

The program, which has been used for creating the report page shown below, is called ThermaCAM™ Reporter. It is adapted to several types of infrared cameras from FLIR Systems.

A professional report is often divided into two sections:

- Front pages, with facts about the inspection, such as:
 - Who the client is, for example, customer's company name and contact person
 - Location of the inspection: site address, city, and so on
 - Date of inspection
 - Date of report
 - Name of thermographer
 - Signature of thermographer
 - Summary or table of contents
- Inspection pages containing IR images to document and analyze thermal properties or anomalies.
 - Identification of the inspected object:
 - What is the object: designation, name, number, and so on
 - Photo
 - IR image. When collecting IR images there are some details to consider:
 - Optical focus
 - Thermal adjustment of the scene or the problem (level & span)
 - Composition: proper observation distance and viewing angle.
 - Comment
 - Is there an anomaly or not?
 - Is there a reflection or not?
 - Use a measurement tool—spot, area or isotherm—to quantify the problem. Use the simplest tool possible; a profile graph is almost never needed in electrical reports.

10713603.a3

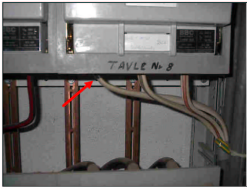
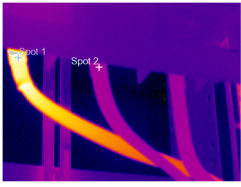
| | | | | | | | | | | | | | | | | |
|---|--|---|------------|--------------|----------------------|-------------------------|--------------|--------------|--------------|------------|--------------------|---------------------|-----|--------------------|--------------------|--|
|  | THERMOGRAPHY INSPECTION for FLIR Systems AB | Date: 2005-10-10 Sign: _____ Contract. : 1708 | | | | | | | | | | | | | | |
| | Photograph | | | | | | | | | | | | | | | |
|  | <table border="1" style="width: 100%; border-collapse: collapse;"> <tr> <td>Place</td> <td>Building 1</td> </tr> <tr> <td>Localization</td> <td>Right panel, group 2</td> </tr> <tr> <td>Equipment</td> <td>Fuse</td> </tr> <tr> <td>Model / type</td> <td>BBC LHBN 250</td> </tr> <tr> <td>Phase / ID</td> <td>Supply for Panel 8</td> </tr> <tr> <td>Room temperature °C</td> <td>15</td> </tr> <tr> <td>Status</td> <td>Over heated</td> </tr> </table> | Place | Building 1 | Localization | Right panel, group 2 | Equipment | Fuse | Model / type | BBC LHBN 250 | Phase / ID | Supply for Panel 8 | Room temperature °C | 15 | Status | Over heated | |
| | Place | Building 1 | | | | | | | | | | | | | | |
| Localization | Right panel, group 2 | | | | | | | | | | | | | | | |
| Equipment | Fuse | | | | | | | | | | | | | | | |
| Model / type | BBC LHBN 250 | | | | | | | | | | | | | | | |
| Phase / ID | Supply for Panel 8 | | | | | | | | | | | | | | | |
| Room temperature °C | 15 | | | | | | | | | | | | | | | |
| Status | Over heated | | | | | | | | | | | | | | | |
| Thermogram | | | | | | | | | | | | | | | | |
|  | <table border="1" style="width: 100%; border-collapse: collapse;"> <tr> <td>Temp. Spot 1</td> <td>34 °C</td> </tr> <tr> <td>Temp. Spot 2</td> <td>17 °C</td> </tr> <tr> <td>TEMPERATURE DIFF</td> <td>17 °C</td> </tr> <tr> <td>Phase</td> <td>L1 L2 L3</td> </tr> <tr> <td>Load (A)</td> <td>45 47 47</td> </tr> <tr> <td>Rated load</td> <td>250</td> </tr> <tr> <td>Fault class</td> <td>2</td> </tr> </table> | Temp. Spot 1 | 34 °C | Temp. Spot 2 | 17 °C | TEMPERATURE DIFF | 17 °C | Phase | L1 L2 L3 | Load (A) | 45 47 47 | Rated load | 250 | Fault class | 2 | |
| | Temp. Spot 1 | 34 °C | | | | | | | | | | | | | | |
| Temp. Spot 2 | 17 °C | | | | | | | | | | | | | | | |
| TEMPERATURE DIFF | 17 °C | | | | | | | | | | | | | | | |
| Phase | L1 L2 L3 | | | | | | | | | | | | | | | |
| Load (A) | 45 47 47 | | | | | | | | | | | | | | | |
| Rated load | 250 | | | | | | | | | | | | | | | |
| Fault class | 2 | | | | | | | | | | | | | | | |
| Comment | | | | | | | | | | | | | | | | |
| <p>Disconnect cable, clean contact surfaces. Check for connectivity between cable shoe and lead. Replace any defective component. Assemble according to directions with correct torque.</p> <p>Note that load is only 18%. Calculated temperature rise at 50% load would be approximately 104°C. $[T50=(T1-T2)*(125/45)^{1.6}+T2]$</p> | | | | | | | | | | | | | | | | |
| Corrected | | | | | | | | | | | | | | | | |
| Measure taken: _____ | | Date: _____ | | | | | | | | | | | | | | |
| Sign: _____ | | Sign.: _____ | | | | | | | | | | | | | | |

Side 1

Figure 13.10 A report example

13.5 Different types of hot spots in electrical installations

13.5.1 Reflections

The thermographic camera sees any radiation that enters the lens, not only originating from the object that you are looking at, but also radiation that comes from other sources and has been reflected by the target. Most of the time, electrical components are like mirrors to the infrared radiation, even if it is not obvious to the eye. Bare metal parts are particularly shiny, whereas painted, plastic or rubber insulated parts are mostly not. In the image below, you can clearly see a reflection from the thermographer. This is of course not a hot spot on the object. A good way to find out if what you see is a reflection or not, is for you to move. Look at the target from a different angle and watch the ‘hot spot.’ If it moves when you do, it is a reflection.

Measuring temperature of mirror like details is not possible. The object in the images below has painted areas which are well suited for temperature measurement. The material is copper, which is a very good heat conductor. This means that temperature variation over the surface is small.

10717503.a2

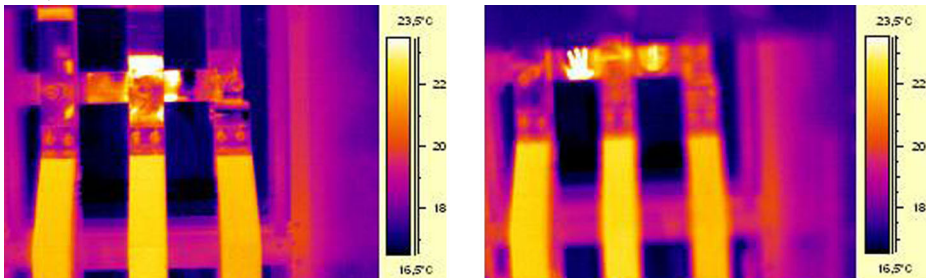

Figure 13.11 Reflections in an object

13.5.2 Solar heating

The surface of a component with a high emissivity, for example, a breaker, can on a hot summer day be heated up to quite considerable temperatures by irradiation from the sun. The image shows a circuit breaker, which has been heated by the sun.

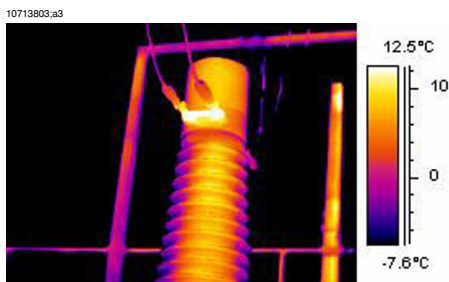

Figure 13.12 An infrared image of a circuit breaker

13.5.3 Inductive heating

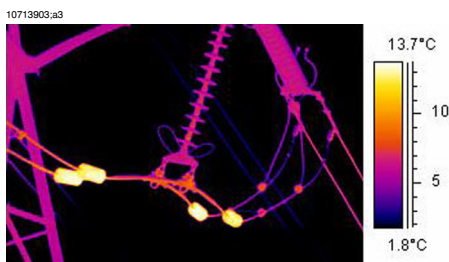

Figure 13.13 An infrared image of hot stabilizing weights

Eddy currents can cause a hot spot in the current path. In cases of very high currents and close proximity of other metals, this has in some cases caused serious fires. This type of heating occurs in magnetic material around the current path, such as metallic bottom plates for bushing insulators. In the image above, there are stabilizing weights, through which a high current is running. These metal weights, which are made of a slightly magnetic material, will not conduct any current but are exposed to the alternating magnetic fields, which will eventually heat up the weight. The overheating in the image is less than +5°C (+9°F). This, however, need not necessarily always be the case.

13.5.4 Load variations

3-phase systems are the norm in electric utilities. When looking for overheated places, it is easy to compare the three phases directly with each other, for example, cables, breakers, insulators. An even load per phase should result in a uniform temperature pattern for all three phases. A fault may be suspected in cases where the temperature of one phase differs considerably from the remaining two. However, you should always make sure that the load is indeed evenly distributed. Looking at fixed ampere meters or using a clip-on ampere meter (up to 600 A) will tell you.

10714003.a3

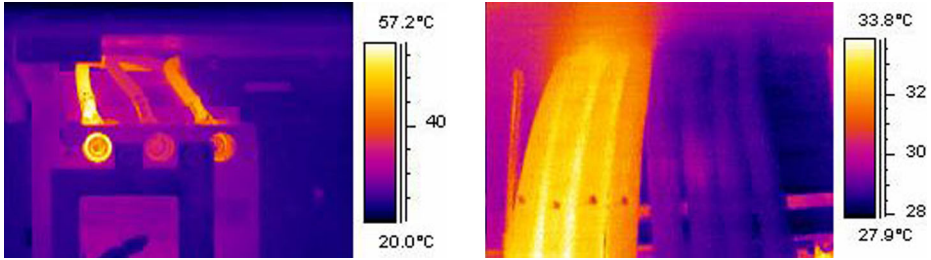

Figure 13.14 Examples of infrared images of load variations

The image to the left shows three cables next to each other. They are so far apart that they can be regarded as thermally insulated from each other. The one in the middle is colder than the others. Unless two phases are faulty and overheated, this is a typical example of a very unsymmetrical load. The temperature spreads evenly along the cables, which indicates a load-dependent temperature increase rather than a faulty connection.

The image to the right shows two bundles with very different loads. In fact, the bundle to the right carries next to no load. Those which carry a considerable current load, are about 5°C (9°F) hotter than those which do not. No fault to be reported in these examples.

13.5.5 Varying cooling conditions

10714103.a3

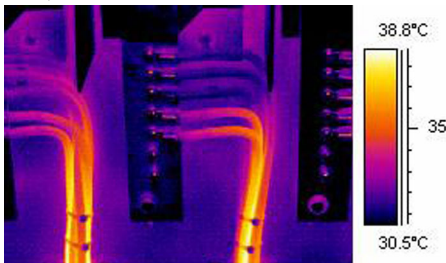

Figure 13.15 An infrared image of bundled cables

When, for example, a number of cables are bundled together it can happen that the resulting poor cooling of the cables in the middle can lead to them reaching very high temperatures. See the image above.

The cables to the right in the image do not show any overheating close to the bolts. In the vertical part of the bundle, however, the cables are held together very tightly, the cooling of the cables is poor, the convection can not take the heat away, and the cables are notably hotter, actually about 5°C (9°F) above the temperature of the better cooled part of the cables.

13.5.6 Resistance variations

Overheating can have many origins. Some common reasons are described below.

Low contact pressure can occur when mounting a joint, or through wear of the material, for example, decreasing spring tension, worn threads in nuts and bolts, even too much force applied at mounting. With increasing loads and temperatures, the yield point of the material is exceeded and the tension weakens.

The image to the left below shows a bad contact due to a loose bolt. Since the bad contact is of very limited dimensions, it causes overheating only in a very small spot from which the heat is spread evenly along the connecting cable. Note the lower emissivity of the screw itself, which makes it look slightly colder than the insulated—and thereby it has a high emissivity—cable insulation.

The image to the right shows another overheating situation, this time again due to a loose connection. It is an outdoor connection, hence it is exposed to the cooling effect of the wind and it is likely that the overheating would have shown a higher temperature, if mounted indoors.

10714203.a3

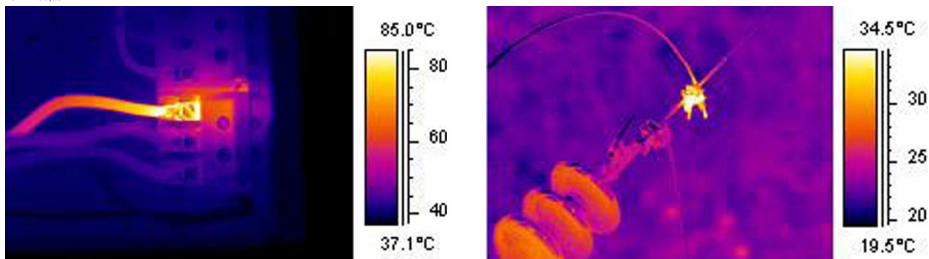

Figure 13.16 LEFT: An infrared image showing bad contact due to a loose bolt; RIGHT: A loose outdoor connection, exposed to the wind cooling effect.

13.5.7 Overheating in one part as a result of a fault in another

Sometimes, overheating can appear in a component although that component is OK. The reason is that two conductors share the load. One of the conductors has an increased resistance, but the other is OK. Thus, the faulty component carries a lower load, whereas the fresh one has to take a higher load, which may be too high and which causes the increased temperature. See the image.

10714303.a3

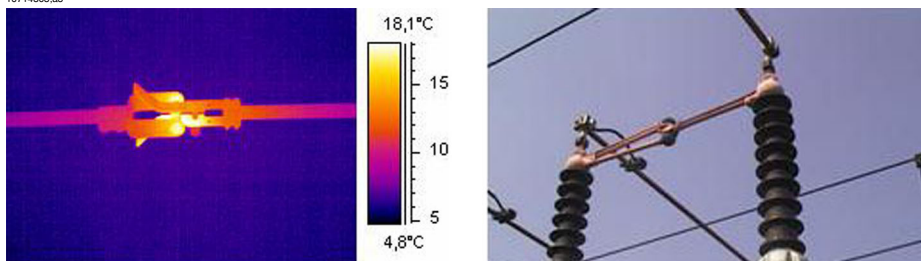

Figure 13.17 Overheating in a circuit breaker

The overheating of this circuit breaker is most probably caused by bad contact in the near finger of the contactor. Thus, the far finger carries more current and gets hotter. The component in the infrared image and in the photo is not the same, however, it is similar).

13.6 *Disturbance factors at thermographic inspection of electrical installations*

During thermographic inspections of different types of electrical installations, disturbance factors such as wind, distance to object, rain or snow often influence the measurement result.

13.6.1 Wind

During outdoor inspection, the cooling effect of the wind should be taken into account. An overheating measured at a wind velocity of 5 m/s (10 knots) will be approximately twice as high at 1 m/s (2 knots). An excess temperature measured at 8 m/s (16 knots) will be 2.5 times as high at 1 m/s (2 knots). This correction factor, which is based on empirical measurements, is usually applicable up to 8 m/s (16 knots).

There are, however, cases when you have to inspect even if the wind is stronger than 8 m/s (16 knots). There are many windy places in the world, islands, mountains, and so on but it is important to know that overheated components found would have shown a considerably higher temperature at a lower wind speed. The empirical correction factor can be listed.

| Wind speed (m/s) | Wind speed (knots) | Correction factor |
|------------------|--------------------|-------------------|
| 1 | 2 | 1 |
| 2 | 4 | 1.36 |
| 3 | 6 | 1.64 |
| 4 | 8 | 1.86 |
| 5 | 10 | 2.06 |
| 6 | 12 | 2.23 |
| 7 | 14 | 2.40 |
| 8 | 16 | 2.54 |

The measured overheating multiplied by the correction factor gives the excess temperature with no wind, that is, at 1 m/s (2 knots).

13.6.2 Rain and snow

Rain and snow also have a cooling effect on electrical equipment. Thermographic measurement can still be conducted with satisfactory results during light snowfall with dry snow and light drizzle, respectively. The image quality will deteriorate in heavy

snow or rain and reliable measurement is no longer possible. This is mainly because a heavy snowfall as well as heavy rain is impenetrable to infrared radiation and it is rather the temperature of the snowflakes or raindrops that will be measured.

13.6.3 Distance to object

This image is taken from a helicopter 20 meters (66 ft.) away from this faulty connection. The distance was incorrectly set to 1 meter (3 ft.) and the temperature was measured to +37.9°C (+100.2°F). The measurement value after changing the distance to 20 meters (66 ft.), which was done afterwards, is shown in the image to the right, where the corrected temperature is +38.8°C (+101.8°F). The difference is not too crucial, but may take the fault into a higher class of seriousness. So the distance setting must definitely not be neglected.

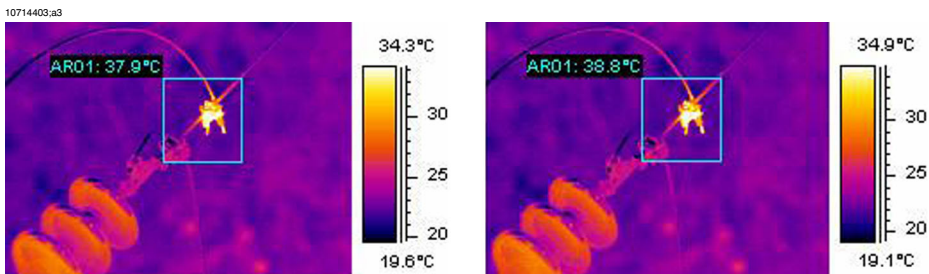

Figure 13.18 LEFT: Incorrect distance setting; RIGHT: Correct distance setting

The images below show the temperature readings from a blackbody at +85°C (+185°F) at increasing distances.

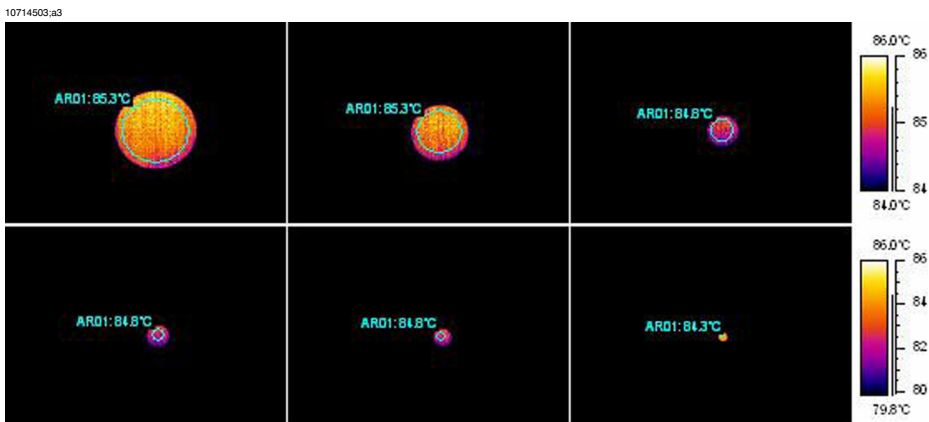

Figure 13.19 Temperature readings from a blackbody at +85°C (+185°F) at increasing distances

The measured average temperatures are, from left to right, +85.3°C (+185.5°F), +85.3°C (+185.5°F), +84.8°C (+184.6°F), +84.8°C (+184.6°F), +84.8°C (+184.6°F) and +84.3°C (+183.7°F) from a blackbody at +85°C (+185°F). The thermograms are taken with a 12° lens. The distances are 1, 2, 3, 4, 5 and 10 meters (3, 7, 10, 13, 16 and 33 ft.). The correction for the distance has been meticulously set and works, because the object is big enough for correct measurement.

13.6.4 Object size

The second series of images below shows the same but with the normal 24° lens. Here, the measured average temperatures of the blackbody at +85°C (+185°F) are: +84.2°C (+183.6°F), +83.7°C (+182.7°F), +83.3°C (+181.9°F), +83.3°C (+181.9°F), +83.4°C (+181.1°F) and +78.4°C (+173.1°F).

The last value, (+78.4°C (+173.1°F)), is the maximum temperature as it was not possible to place a circle inside the now very small blackbody image. Obviously, it is not possible to measure correct values if the object is too small. Distance was properly set to 10 meters (33 ft.).



Figure 13.20 Temperature readings from a blackbody at +85°C (+185°F) at increasing distances (24° lens)

The reason for this effect is that there is a smallest object size, which gives correct temperature measurement. This smallest size is indicated to the user in all FLIR Systems cameras. The image below shows what you see in the viewfinder of camera model 695. The spot meter has an opening in its middle, more easily seen in the detail to the right. The size of the object has to be bigger than that opening or some radiation from its closest neighbors, which are much colder, will come into the measurement

as well, strongly lowering the reading. In the above case, where we have a point-shaped object, which is much hotter than the surroundings, the temperature reading will be too low.

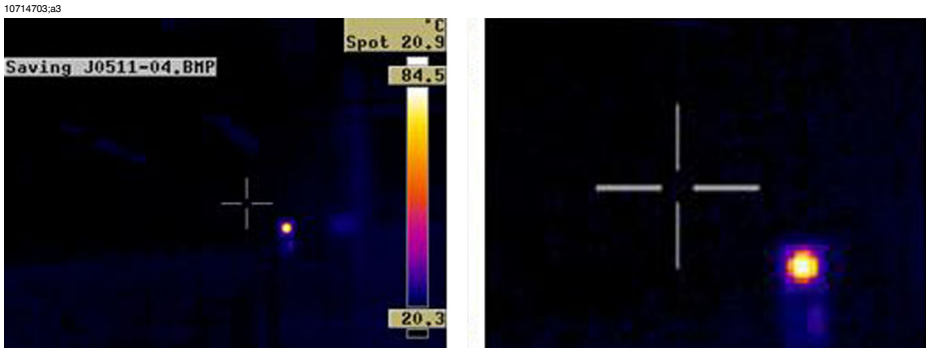

Figure 13.21 Image from the viewfinder of a ThermoCAM 695

This effect is due to imperfections in the optics and to the size of the detector elements. It is typical for all infrared cameras and can not be avoided.

13.7 *Practical advice for the thermographer*

Working in a practical way with a camera, you will discover small things that make your job easier. Here are ten of them to start with.

13.7.1 From cold to hot

You have been out with the camera at +5°C (+41°F). To continue your work, you now have to perform the inspection indoors. If you wear glasses, you are used to having to wipe off condensed water, or you will not be able to see anything. The same thing happens with the camera. To measure correctly, you should wait until the camera has become warm enough for the condensation to evaporate. This will also allow for the internal temperature compensation system to adjust to the changed condition.

13.7.2 Rain showers

If it starts raining you should not perform the inspection because the water will drastically change the surface temperature of the object that you are measuring. Nevertheless, sometimes you need to use the camera even under rain showers or splashes. Protect your camera with a simple transparent polyethylene plastic bag. Correction for the attenuation which is caused by the plastic bag can be made by adjusting the object distance until the temperature reading is the same as without the plastic cover. Some camera models have a separate **External optics transmission** entry.

13.7.3 Emissivity

You have to determine the emissivity for the material, which you are measuring. Mostly, you will not find the value in tables. Use optical black paint, that is, Nextel Black Velvet. Paint a small piece of the material you are working with. The emissivity of the optical paint is normally 0.94. Remember that the object has to have a temperature, which is different—usually higher—than the ambient temperature. The larger the difference the better the accuracy in the emissivity calculation. The difference should be at least 20°C (36°F). Remember that there are other paints that support very high temperatures up to +800°C (+1472°F). The emissivity may, however, be lower than that of optical black.

Sometimes you can not paint the object that you are measuring. In this case you can use a tape. A thin tape for which you have previously determined the emissivity will work in most cases and you can remove it afterwards without damaging the object of your study. Pay attention to the fact that some tapes are semi-transparent and thus are not very good for this purpose. One of the best tapes for this purpose is Scotch electrical tape for outdoor and sub-zero conditions.

13.7.4 Reflected apparent temperature

You are in a measurement situation where there are several hot sources that influence your measurement. You need to have the right value for the reflected apparent temperature to input into the camera and thus get the best possible correction. Do it in this way: set the emissivity to 1.0. Adjust the camera lens to near focus and, looking in the opposite direction away from the object, save one image. With the area or the isotherm, determine the most probable value of the average of the image and use that value for your input of reflected apparent temperature.

13.7.5 Object too far away

Are you in doubt that the camera you have is measuring correctly at the actual distance? A rule of thumb for your lens is to multiply the IFOV by 3. (IFOV is the detail of the object seen by one single element of the detector). Example: 25 degrees correspond to about 437 mrad. If your camera has a 120×120 pixel image, IFOV becomes $437/120 = 3.6$ mrad (3.6 mm/m) and your spot size ratio is about $1000/(3 \times 3.6) = 92:1$. This means that at a distance of 9.2 meters (30.2 ft.), your target has to be at least about 0.1 meter or 100 mm wide (3.9"). Try to work on the safe side by coming closer than 9 meters (30 ft.). At 7–8 meters (23–26 ft.), your measurement should be correct.

14 About FLIR Systems

FLIR Systems was established in 1978 to pioneer the development of high performance infrared imaging systems and is the world leader in the design, manufacturing and marketing of thermal imaging systems for a wide variety of commercial, industrial and government applications. Today, FLIR Systems includes the history of four major companies with outstanding achievements in infrared technology since 1965—the Swedish AGEMA Infrared Systems (formerly AGA Infrared Systems), and the three U.S. companies Indigo Systems, FSI, and Inframetrics.

10722703.a1



Figure 14.1 LEFT: Thermovision® Model 661 from 1969. The camera weighed approximately 25 kg (55 lb.), the oscilloscope 20 kg (44 lb.), the tripod 15 kg (33 lb.). The operator also needed a 220 VAC generator set, and a 10 L (2.6 US gallon) jar with liquid nitrogen. To the left of the oscilloscope the Polaroid attachment (6 kg/13 lb.) can be seen. **RIGHT:** InfraCAM from 2006. Weight: 0.55 kg (1.21 lb.), including battery.

The company has sold more than 40,000 infrared cameras worldwide for applications such as predictive maintenance, R & D, non-destructive testing, process control and automation, machine vision and many others.

FLIR Systems has three manufacturing plants in United States (Portland, OR, Boston, MA, Santa Barbara, CA) and one in Sweden (Stockholm). Direct sales offices in Belgium, Brazil, China, France, Germany, Great Britain, Hong Kong, Italy, Japan, Sweden and USA—together with a world-wide network of agents and distributors—support our international customer base.

FLIR Systems is at the helm of innovation in the infrared camera industry. We anticipate market demand by constantly improving our existing cameras and developing new ones. The company has set milestones in product design and development such as the introduction of the first battery-operated portable camera for industrial inspections, the first uncooled infrared camera, to mention but a few innovations.

FLIR Systems manufactures all vital mechanical and electronic components of the camera systems itself. From detector design and manufacturing over lenses and system electronics, to final testing and calibration, all production steps are done and supervised by our own engineers. The in-depth expertise of these infrared specialists ensures the accuracy and reliability of all vital components that are assembled into your infrared camera.

14.1 *More than just an infrared camera*

At FLIR Systems we recognize that our job is to go beyond just producing the best infrared camera systems. We are committed to enabling all users of our infrared camera systems to work more productively by providing them the most powerful camera-software combination. Especially tailored software for predictive maintenance, R & D and process monitoring is developed in-house. Most software is available in a wide variety of languages.

We support all our infrared cameras with a wide variety of accessories to adapt your equipment to the most demanding infrared applications.

14.2 *Sharing our knowledge*

Although our cameras are designed to be very user-friendly, there is a lot more to thermography than just knowing how to handle a camera. Therefore, FLIR Systems has founded the Infrared Training Center (ITC), a separate business unit, which provides certified training courses. Attending one of the ITC courses will give you a real hands-on learning experience.

The staff of the ITC is also there to provide you with any application support you may need in putting infrared theory into practice.

14.3 *Supporting our customers*

FLIR Systems operates a worldwide service network to keep your camera running at all times. If there should be a problem with your camera, local service centers have all the equipment and know-how to solve it within the shortest possible time. Hence, there is no need to send your camera to the other end of the world or to talk to someone who is not speaking your language.

14.4 A few images from our facilities

10401303.a1

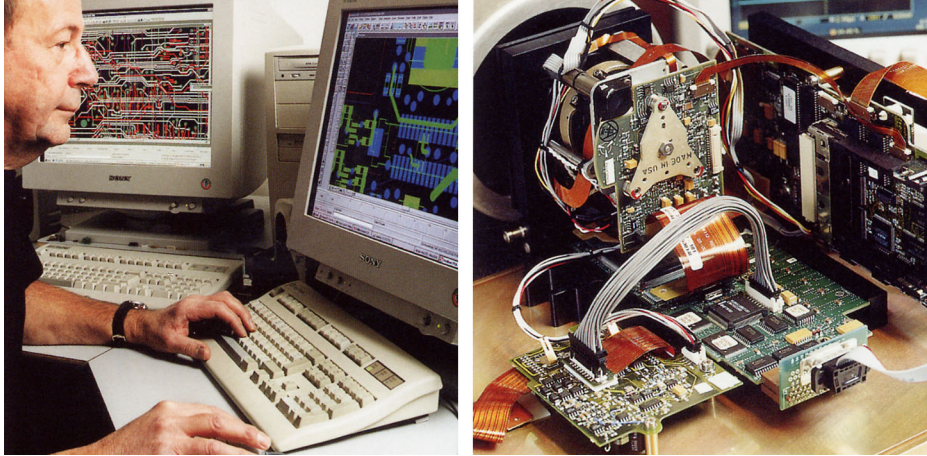

Figure 14.2 LEFT: Development of system electronics; RIGHT: Testing of an FPA detector.

10401403.a1

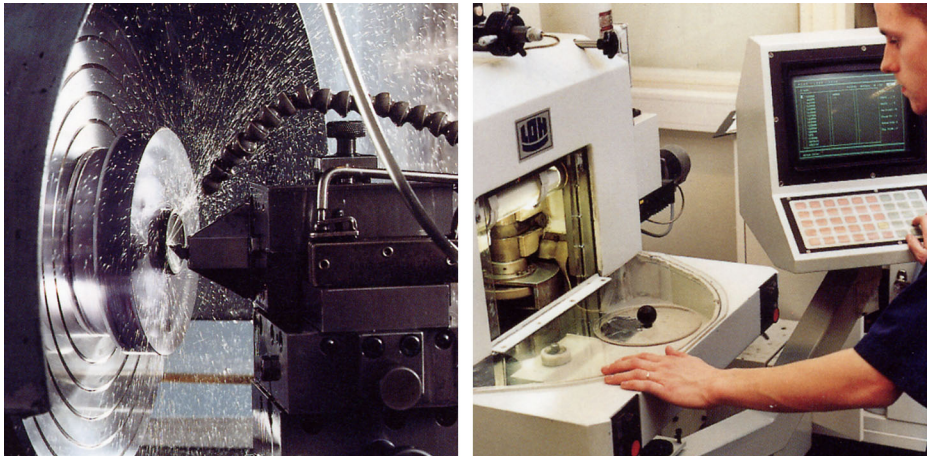

Figure 14.3 LEFT: Diamond turning machine; RIGHT: Lens polishing.

10401503.a1



Figure 14.4 LEFT: Testing of IR cameras in the climatic chamber; **RIGHT:** Robot for camera testing and calibration.

15 History of infrared technology

Less than 200 years ago the existence of the infrared portion of the electromagnetic spectrum wasn't even suspected. The original significance of the infrared spectrum, or simply 'the infrared' as it is often called, as a form of heat radiation is perhaps less obvious today than it was at the time of its discovery by Herschel in 1800.

10388703.a1

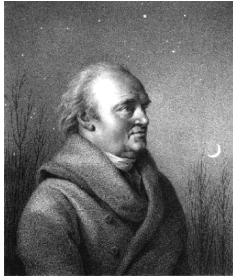

Figure 15.1 Sir William Herschel (1738–1822)

The discovery was made accidentally during the search for a new optical material. Sir William Herschel—Royal Astronomer to King George III of England, and already famous for his discovery of the planet Uranus—was searching for an optical filter material to reduce the brightness of the sun's image in telescopes during solar observations. While testing different samples of colored glass which gave similar reductions in brightness he was intrigued to find that some of the samples passed very little of the sun's heat, while others passed so much heat that he risked eye damage after only a few seconds' observation.

Herschel was soon convinced of the necessity of setting up a systematic experiment, with the objective of finding a single material that would give the desired reduction in brightness as well as the maximum reduction in heat. He began the experiment by actually repeating Newton's prism experiment, but looking for the heating effect rather than the visual distribution of intensity in the spectrum. He first blackened the bulb of a sensitive mercury-in-glass thermometer with ink, and with this as his radiation detector he proceeded to test the heating effect of the various colors of the spectrum formed on the top of a table by passing sunlight through a glass prism. Other thermometers, placed outside the sun's rays, served as controls.

As the blackened thermometer was moved slowly along the colors of the spectrum, the temperature readings showed a steady increase from the violet end to the red end. This was not entirely unexpected, since the Italian researcher, Landriani, in a similar experiment in 1777 had observed much the same effect. It was Herschel,

however, who was the first to recognize that there must be a point where the heating effect reaches a maximum, and that measurements confined to the visible portion of the spectrum failed to locate this point.

10388903.a1



Figure 15.2 Marsilio Landriani (1746–1815)

Moving the thermometer into the dark region beyond the red end of the spectrum, Herschel confirmed that the heating continued to increase. The maximum point, when he found it, lay well beyond the red end—in what is known today as the ‘infrared wavelengths.’

When Herschel revealed his discovery, he referred to this new portion of the electromagnetic spectrum as the ‘thermometrical spectrum.’ The radiation itself he sometimes referred to as ‘dark heat,’ or simply ‘the invisible rays.’ Ironically, and contrary to popular opinion, it wasn’t Herschel who originated the term ‘infrared.’ The word only began to appear in print around 75 years later, and it is still unclear who should receive credit as the originator.

Herschel’s use of glass in the prism of his original experiment led to some early controversies with his contemporaries about the actual existence of the infrared wavelengths. Different investigators, in attempting to confirm his work, used various types of glass indiscriminately, having different transparencies in the infrared. Through his later experiments, Herschel was aware of the limited transparency of glass to the newly-discovered thermal radiation, and he was forced to conclude that optics for the infrared would probably be doomed to the use of reflective elements exclusively (i.e. plane and curved mirrors). Fortunately, this proved to be true only until 1830, when the Italian investigator, Melloni, made his great discovery that naturally occurring rock salt (NaCl)—which was available in large enough natural crystals to be made into lenses and prisms—is remarkably transparent to the infrared. The result was that rock salt became the principal infrared optical material, and remained so for the next hundred years, until the art of synthetic crystal growing was mastered in the 1930’s.

10399103.a1



Figure 15.3 Macedonio Melloni (1798–1854)

Thermometers, as radiation detectors, remained unchallenged until 1829, the year Nobili invented the thermocouple. (Herschel's own thermometer could be read to 0.2°C (0.036°F), and later models were able to be read to 0.05°C (0.09°F). Then a breakthrough occurred; Melloni connected a number of thermocouples in series to form the first thermopile. The new device was at least 40 times as sensitive as the best thermometer of the day for detecting heat radiation—capable of detecting the heat from a person standing 3 meters away (10 ft.).

The first so-called 'heat-picture' became possible in 1840, the result of work by Sir John Herschel, son of the discoverer of the infrared and a famous astronomer in his own right. Based upon the differential evaporation of a thin film of oil when exposed to a heat pattern focused upon it, the thermal image could be seen by reflected light where the interference effects of the oil film made the image visible to the eye. Sir John also managed to obtain a primitive record of the thermal image on paper, which he called a 'thermograph.'

10399003.a2



Figure 15.4 Samuel P. Langley (1834–1906)

The improvement of infrared-detector sensitivity progressed slowly. Another major breakthrough, made by Langley in 1880, was the invention of the bolometer. This consisted of a thin blackened strip of platinum connected in one arm of a Wheatstone bridge circuit upon which the infrared radiation was focused and to which a sensitive galvanometer responded. This instrument is said to have been able to detect the heat from a cow at a distance of 400 meters (1311 ft.).

An English scientist, Sir James Dewar, first introduced the use of liquefied gases as cooling agents (such as liquid nitrogen with a temperature of -196°C (-320.8°F)) in low temperature research. In 1892 he invented a unique vacuum insulating container in which it is possible to store liquefied gases for entire days. The common ‘thermos bottle’, used for storing hot and cold drinks, is based upon his invention.

Between the years 1900 and 1920, the inventors of the world ‘discovered’ the infrared. Many patents were issued for devices to detect personnel, artillery, aircraft, ships—and even icebergs. The first operating systems, in the modern sense, began to be developed during the 1914–18 war, when both sides had research programs devoted to the military exploitation of the infrared. These programs included experimental systems for enemy intrusion/detection, remote temperature sensing, secure communications, and ‘flying torpedo’ guidance. An infrared search system tested during this period was able to detect an approaching airplane at a distance of 1.5 km (0.94 miles), or a person more than 300 meters (984 ft.) away.

The most sensitive systems up to this time were all based upon variations of the bolometer idea, but the period between the two wars saw the development of two revolutionary new infrared detectors: the image converter and the photon detector. At first, the image converter received the greatest attention by the military, because it enabled an observer for the first time in history to literally ‘see in the dark.’ However, the sensitivity of the image converter was limited to the near infrared wavelengths, and the most interesting military targets (i.e. enemy soldiers) had to be illuminated by infrared search beams. Since this involved the risk of giving away the observer’s position to a similarly-equipped enemy observer, it is understandable that military interest in the image converter eventually faded.

The tactical military disadvantages of so-called ‘active’ (i.e. search beam-equipped) thermal imaging systems provided impetus following the 1939–45 war for extensive secret military infrared-research programs into the possibilities of developing ‘passive’ (no search beam) systems around the extremely sensitive photon detector. During this period, military secrecy regulations completely prevented disclosure of the status of infrared-imaging technology. This secrecy only began to be lifted in the middle of the 1950’s, and from that time adequate thermal-imaging devices finally began to be available to civilian science and industry.

Index

–: 9

1

1196398: 9
1196474: 9
1558299: 9
1558364: 9
1910399: 9
1910423: 9
1910472: 9

A

about FLIR Systems: 141
absolute humidity: 105
accuracy: 4, 57
AC operation: 58
address: viii
adjusting camera focus: 32
air infiltration: 86
air movement: 95
airtightness: 95
assessment, correct: 118
auto-adjusting images: 36
auto-adjust mode indicator: 21
auto off: 58

B

balconies: 80
battery: 9
 capacity: 58
 charging: 27, 58
 dimensional drawings: 67
 installing: 25
 operating time: 58
 removing: 26
 type: 58
 weight: 59
battery charger: 9, 28, 29, 30
 dimensional drawings: 68, 69
battery compartment lid: 13
battery condition indicator: 17
battery status indicator: 21
behavior, temperature: 118
blackbody: 44
bottom trigger: 13, 15
breakers: 118
breaks, plumbing: 83

building codes
 national: 116
 regional: 116
building science: 93
building structures, commented: 75, 78, 81, 86, 89
bump: 59
buttons
 camera/archive: 14, 15
 left selection button: 14, 15
 on/off: 14, 15
 power: 14, 15
 right selection button: 14, 15

C

cable insulation: 118
cables
 cleaning: 55
 power: 9, 23
 USB: 9, 24
calibration: 4
camera
 cleaning: 55
 dimensional drawings: 63, 64, 65, 66
 infrared: 9
 starting: 31
 stopping: 31
 switching off: 31
 switching on: 31
 turning off: 31
 turning on: 31
camera/archive button: 14, 15
camera focus
 adjusting: 32
camera parts
 battery compartment lid: 13
 battery condition indicator: 17
 bottom trigger: 13, 15
 buttons
 camera/archive: 14, 15
 left selection button: 14, 15
 navigation pad: 14, 15
 on/off: 14, 15
 power: 14, 15
 right selection button: 14, 15
 focus ring: 11
 front view: 11
 infrared lens: 11
 keypad: 14

- camera parts (*continued*)
 - keys
 - camera/archive: 14, 15
 - left selection button: 14, 15
 - navigation pad: 14, 15
 - on/off: 14, 15
 - power: 14, 15
 - right selection button: 14, 15
 - laser pointer: 11, 18
 - lens cap: 11
 - power indicator: 16
 - rubber lid: 13
 - SD Memory Card slot: 12
 - side view: 13
 - top trigger: 13, 15
 - tripod mount: 13
 - USB mini-B connector: 12
 - camera settings, changing: 51
 - capacity, battery: 58
 - case, transport: 9
 - CAUTION: 1, 2, 18, 47, 55, 56
 - certification: 116
 - changing
 - camera settings: 51
 - emissivity: 44
 - palette: 43
 - reflected apparent temperature: 46
 - charger, battery: 9, 28, 29, 30
 - charging battery: 27, 58
 - checking, effects of: 94
 - classification: 119, 121, 126
 - cleaning
 - camera: 55
 - lens: 56
 - close focus limit: 62
 - colors, changing: 43
 - commented building structures: 75, 78, 81, 86, 89
 - commented infrared images: 76, 80, 83, 84, 88, 91
 - comments: 4
 - commercial façades: 78
 - commercial roofs, low-slope: 73
 - communication: 59
 - conditions
 - cooling: 132
 - measuring: 103
 - pressure: 97
 - wind: 100
 - connecting
 - power cable: 23
 - USB cable: 24
 - connection status indicator: 21
 - connectors
 - power: 60
 - USB mini-B: 12
 - control: 121
 - conventions
 - naming: 34
 - typographical
 - italic*: 4
 - monospace: 4
 - semibold**: 4
 - UPPERCASE: 4
 - cooling conditions: 132
 - copyright: viii
 - correct assessment: 118
 - courses: 5, 116
 - customer support: 4
- D**
- data
 - environmental: 59
 - bump: 59
 - encapsulation: 59
 - vibration: 59
 - optical: 62
 - physical: 59
 - technical: 57
 - decks: 80
 - defect, probable: 118
 - defective parts: 118
 - defects, classification of: 120
 - deficiencies, insulation : 89, 94
 - definition of dew point: 106
 - deleting images: 49, 50
 - detection, moisture: 73
 - detector type: 57
 - deviations: 105
 - Dewar, James: 148
 - dew point, definition of: 106
 - diagnostic mode: 16
 - dimensional drawings
 - battery: 67
 - camera: 63, 64, 65, 66
 - stand-alone battery charger: 68, 69
 - dimensions: 59
 - battery: 67
 - camera: 63, 64, 65, 66
 - stand-alone battery charger: 68, 69
 - disruption, sources of: 95
 - distance: 61, 136
 - disturbance factors
 - distance: 136
 - object size: 137
 - rain: 136

disturbance factors (*continued*)

- snow: 136
- wind: 135

drawings, dimensional

- battery: 67
- camera: 63, 64, 65, 66
- stand-alone battery charger: 68, 69

E

education: 5, 116

effects of

- checking: 94
- testing: 94

elements, screen: 20

EMC: 59

emissivity: 139

- changing: 44
- list of values: 44

encapsulation: 59

environmental data: 59

- bump: 59
- encapsulation: 59
- vibration: 59

equipment data, general: 118

erasing images: 49, 50

excess temperature: 125

external leaks: 73

F

façades, commercial & residential : 78

factors, disturbance

- distance: 136
- object size: 137
- rain: 136
- snow: 136
- wind: 135

faults, classification: 126

field of view: 61

files, moving: 52

FLIR Systems

- copyright: viii
- history: 141
- ISO 9001: viii
- legal disclaimer: viii
- patents: viii
- patents pending: viii
- postal address: viii
- product warranty: viii
- quality assurance: viii
- quality management system: viii
- request for enhancement: 4
- RFE: 4
- trademarks: viii

(continued)

- warranty: viii
- F-number: 62
- focal length: 62
- focus ring: 11
- FOV: 61
- frequency, image: 57

G

general equipment data: 118

grip material: 59

guidelines

- air infiltration: 72
- general: 71
- insulation deficiencies: 72
- moisture detection: 72
- mold detection: 72
- water damage: 72

H

heating

- inductive: 131
- solar: 130

heat picture: 147

Herschel, William: 145

history

- FLIR Systems: 141
- infrared technology: 145

housing material: 59

humidity: 59

- absolute: 105
- relative: 105

I

icons: 20

identification: 121

image

- frequency: 57
- presentation: 57

images

- adjusting manually: 37
- auto-adjusting: 36
- deleting: 49, 50
- erasing: 49, 50
- moving: 52
- number of: 35
- opening: 48
- recalling: 48
- saving: 34

imaging performance: 57

indicators

- auto-adjust mode: 21

indicators (*continued*)
 battery condition: 17
 battery status: 21
 connection status: 21
 manual adjust mode: 21
 power: 16
 temperature span: 21
 inductive heating: 131
 infiltration, air: 86
 InfraCAM/InfraCAM SD user's manual: 9
 infrared
 camera: 9
 lens: 11
 infrared images
 commented: 76, 80, 83, 84, 88, 91
 interpretation of: 103
 infrared technology
 history: 145
 inspection: 119
 installing battery: 25
 insulation, cable: 118
 insulation deficiencies: 89, 94
 internal leaks: 73
 interpolation: 57
 interpretation of infrared images: 103
 irregularities: 105
 ISO 9001: viii
italic: 4

J

James Dewar: 148

K

keypad: 14
 camera/archive: 14, 15
 left selection button: 14, 15
 navigation pad: 14, 15
 on/off button: 14, 15
 power button: 14, 15
 right selection button: 14, 15
 keys
 camera/archive: 14, 15
 left selection button: 14, 15
 navigation pad: 14
 on/off: 14, 15
 power: 14, 15
 right selection button: 14, 15

L

Landriani, Marsilio: 145
 Langley, Samuel P.: 148

laser pointer: 11, 18, 57
 using: 33
 laser trigger: 13, 15
 leaks: 83
 external: 73
 internal: 73
 left selection button: 14, 15
 legal disclaimer: viii
 length, focal: 62
 lens
 cleaning: 56
 infrared: 11
 lens cap: 11
 Leopoldo Nobili: 147
 lids
 battery compartment: 13
 power connector: 13
 rubber: 13
 serial number: 13
 limit, close focus: 62
 list, packing: 9
 live video: 54
 load variations: 131
 low-slope commercial roofs: 73

M

Macedonio Melloni: 146
 manual adjust mode indicator: 21
 manually adjusting images: 37
 Marsilio Landriani: 145
 material
 grip: 59
 housing: 59
 measurement
 comparative: 124
 temperature: 122
 measuring conditions: 103
 measuring season: 103
 measuring temperature: 41, 42
 mechanical ventilation: 100
 Melloni, Macedonio: 146
 modes
 diagnostic: 16
 power: 16
 moisture detection: 73
 commercial & residential façades: 78
 decks & balconies: 80
 low-slope commercial roofs: 73
 plumbing breaks & leaks: 83
 mold: 72
 monospace: 4
 mount, tripod: 13, 59
 movement, air: 95

moving
 files: 52
 images: 52
 MPEG4 live video: 54

N

naming convention: 34
 navigation pad: 14, 15
 Nobili, Leopoldo : 147
 normal operating temperature: 125
 note: 31
 NOTE: 9, 12, 13, 15, 18, 28, 29, 30, 31, 33, 35,
 36, 41, 44, 47, 52, 53, 68, 69
 number, serial: 13
 number of images: 35

O

object size: 137
 object temperature ranges: 57
 on/off button: 14, 15
 opening images: 48
 operating
 battery time: 58
 laser pointer: 33
 temperature ranges: 59
 operating temperature, normal: 125
 operation, AC: 58
 optical data: 62
 overheating: 133

P

packing list: 9
 battery: 9
 battery charger: 9
 InfraCAM/InfraCAM SD user's manual: 9
 infrared camera: 9
 power cable: 9
 power supply: 9
 Quick Reference Guide: 9
 ThermaCAM™ QuickReport CD-ROM: 9
 ThermaCAM™ QuickReport user's manual: 9
 USB cable: 9
 pad, navigation: 14, 15
 palette, changing: 43
 part numbers
 –: 9
 1196398: 9
 1196474: 9
 1558299: 9
 1558364: 9
 1910399: 9
 1910423: 9

part numbers (*continued*)
 1910472: 9
 parts, camera
 battery compartment lid: 13
 battery condition indicator: 17
 bottom trigger: 13, 15
 buttons
 camera/archive: 14, 15
 left selection button: 14, 15
 navigation pad: 14, 15
 on/off: 14, 15
 power: 14, 15
 right selection button: 14, 15
 connectors
 power: 13
 USB mini-B: 12
 focus ring: 11
 front view: 11
 infrared lens: 11
 keypad: 14
 keys
 camera/archive: 14, 15
 left selection button: 14, 15
 navigation pad: 14, 15
 on/off: 14, 15
 power: 14, 15
 right selection button: 14, 15
 laser pointer: 11, 18
 laser trigger: 13, 15
 lens, infrared: 11
 lens cap: 11
 power connector: 13
 power indicator: 16
 rubber lid: 13
 save trigger: 13, 15
 SD Memory Card slot: 12
 serial number: 13
 side view: 13
 top trigger: 13, 15
 trigger, bottom: 13, 15
 trigger, laser: 13, 15
 trigger, save: 13, 15
 trigger, top: 13, 15
 tripod mount: 13
 USB mini-B connector: 12
 parts, defective: 118
 patents: viii
 patents pending: viii
 performance, imaging: 57
 physical data: 59
 plumbing breaks: 83
 postal address: viii
 power button: 14, 15

power cable
 connecting: 23
 power connector: 60
 pin configuration: 60
 power indicator: 16
 power modes: 16
 power supply: 9
 power system: 58
 preparation: 119
 presentation, image: 57
 pressure
 dynamic: 98
 static: 98
 total: 98
 pressure conditions: 97
 priority, repair: 120
 probable defect: 118
 product warranty: viii

Q

quality assurance: viii
 quality management system: viii

R

rain: 136, 139
 ranges
 operating temperature: 59
 spectral: 57
 temperature: 57
 recalling image: 48
 reflected apparent temperature: 140
 reflected apparent temperature, changing: 46
 reflections: 130
 relative humidity: 105
 releases, service: 4
 removing battery: 26
 repair priority: 120
 report: 119
 reporting: 119, 128
 request for enhancement: 4
 residential façades: 78
 resistance variations: 133
 RFE: 4
 right selection button: 14, 15
 roofs, low-slope commercial: 73
 rubber lid: 13

S

safety precautions: 74
 Samuel P. Langley: 148
 save trigger: 13, 15
 saving image: 34

science, building: 93
 screen: 57
 screen elements: 20
 SD Memory Card slot: 12
 season, measuring: 103
 SEE ALSO: 47
semibold: 4
 sensitivity, thermal: 57
 serial number: 13
 service releases: 4
 setting
 emissivity: 44
 Sir James Dewar: 148
 Sir William Herschel: 145
 size
 battery: 67
 camera: 59, 63, 64, 65, 66
 stand-alone battery charger: 68, 69
 snow: 136
 software updates: 4
 solar heating: 130
 solenoids: 118
 sources of disruption: 95
 spectral range: 57
 spectrum
 thermometrical: 146
 speed, wind: 119
 stand-alone battery charger: 9, 30, 68, 69
 starting camera: 31
 stopping camera: 31
 storage temperature ranges: 59
 streaming video: 54
 support, technical: 4
 surface temperature: 97
 switching off camera: 31
 switching on camera: 31
 symbols: 20
 system, power: 58

T

technical data: 57
 technical support: 4
 temperature
 excess: 125
 normal operating: 125
 reflected apparent: 140
 temperature, measuring: 41, 42
 temperature, surface: 97
 temperature behavior: 118
 temperature measurement: 122
 temperature ranges
 object: 57
 operating: 59

temperature ranges (*continued*)

- storage: 59
- temperature span indicator: 21
- temperature variations: 95
- testing, effects of: 94
- ThermaCAM™ QuickReport CD-ROM: 9
- ThermaCAM™ QuickReport user's manual: 9
- thermal sensitivity: 57
- thermograph: 147
- thermometrical spectrum: 146
- thermos bottle: 148
- top trigger: 13, 15
- trademarks: viii
- training: 5, 116
- transport case: 9
 - battery: 9
 - battery charger: 9
 - InfraCAM/InfraCAM SD user's manual: 9
 - infrared camera: 9
 - power cable: 9
 - power supply: 9
 - Quick Reference Guide: 9
 - ThermaCAM™ QuickReport CD-ROM: 9
 - ThermaCAM™ QuickReport user's manual: 9
 - USB cable: 9
- triggers
 - bottom: 13, 15
 - laser: 13, 15
 - top: 13, 15
 - to save image: 13, 15
- tripod mount: 13, 59
- turning off camera: 31
- turning on camera: 31
- type, battery: 58
- type, detector: 57
- typographical conventions
 - italic*: 4
 - monospace: 4
 - semibold: 4
 - UPPERCASE: 4

U

- updates, software: 4
- UPPERCASE: 4
- USB: 59
 - cable: 9
 - connecting cable: 24
- USB mini-B
 - connector: 12
- user's manual
 - InfraCAM/InfraCAM SD: 9
 - ThermaCAM™ QuickReport: 9
- using laser pointer: 33

V

- values, emissivity: 44
- variations
 - load: 131
 - resistance: 133
- ventilation, mechanical: 100
- vibration: 59
- video, streaming: 54
- viewing MPEP4 live video: 54
- voltage: 58

W

- WARNING: 1, 18, 56
- warranty: viii
- weight: 59
- William Herschel: 145
- wind: 135
- wind conditions: 100
- wind speed: 119

A note on the technical production of this manual

This manual was produced using XML – eXtensible Markup Language. For more information about XML, visit the following site:

- <http://www.w3.org/XML/>

Readers interested in the history & theory of markup languages may also want to visit the following sites:

- <http://www.gla.ac.uk/staff/strategy/information/socarcpj/>
- <http://www.renater.fr/Video/2002ATHENS/P/DC/History/plan.htm>

A note on the typeface used in this manual

This manual was typeset using Swiss 721, which is Bitstream's pan-European version of Max Miedinger's Helvetica™ typeface. Max Miedinger was born December 24th, 1910 in Zürich, Switzerland and died March 8th, 1980.

10595503.a1



- 1926-30: Trains as a typesetter in Zürich, after which he attends evening classes at the Kunstgewerbeschule in Zürich.
- 1936-46: Typographer for Globus department store's advertising studio in Zürich.
- 1947-56: Customer counselor and typeface sales representative for the Haas'sche Schriftgießerei in Münchenstein near Basel. From 1956 onwards: freelance graphic artist in Zürich.
- 1956: Eduard Hoffmann, the director of the Haas'sche Schriftgießerei, commissions Miedinger to develop a new sans-serif typeface.
- 1957: The Haas-Grotesk face is introduced.
- 1958: Introduction of the roman (or normal) version of Haas-Grotesk.
- 1959: Introduction of a bold Haas-Grotesk.
- 1960: The typeface changes its name from Neue Haas Grotesk to Helvetica™.
- 1983: Linotype publishes its Neue Helvetica™, based on the earlier Helvetica™.

For more information about Max Miedinger's Helvetica™ typeface, see Lars Muller's book *Helvetica: Homage to a Typeface*, and the following sites:

- <http://www.ms-studio.com/articles.html>
- <http://www.helveticafilm.com/>

The following file identities and file versions were used in the formatting stream output for this manual:

20236703.xml a34
20250403.xml a14
20254903.xml a34a1
20257003.xml a23
20257103.xml a12
20257303.xml a17
20269703.xml a11
20269803.xml a6
20269903.xml a11
20270003.xml a6
20270103.xml a13
20270403.xml a11
20270503.xml a7
20273203.xml a10
20273803.xml a6
20273903.xml a3
20275203.xml a7
20279803.xml a3
R0089.rcp a15
config.xml a5