

GARMIN[®]

G300 Pilot's Guide



SYSTEM OVERVIEW

FLIGHT INSTRUMENTS

EIS

COM INTERFACE

GPS NAVIGATION

FLIGHT PLANNING

HAZARD AVOIDANCE

ADDITIONAL FEATURES

INTEGRATED AUTOPILOT

ANNUNCIATIONS & ALERTS

APPENDIX

INDEX

Copyright © 2009 - 2010, 2012 Garmin Ltd. or its subsidiaries. All rights reserved.

This manual reflects the operation of System Software version 0006.20 or later. Some differences in operation may be observed when comparing the information in this manual to earlier or later software versions.

Garmin International, Inc., 1200 East 151st Street, Olathe, Kansas 66062, U.S.A.
Toll free: 800/800.1020 or 866/739.5687 Tel: 913/397.8200 Fax: 913/397.8282

Garmin AT, Inc., 2345 Turner Road SE, Salem, OR 97302, U.S.A.
Tel: 503/391.3411 Fax 503/364.2138

Garmin (Europe) Ltd, Liberty House, Bulls Copse Road, Hounslow Business Park,
Southampton, SO40 9RB, U.K.
Tel: 44/0870.8501241 Fax: 44/0870.8501251

Garmin Corporation, No. 68, Jangshu 2nd Road, Shijr, Taipei County, Taiwan
Tel: 886/02.2642.9199 Fax: 886/02.2642.9099

Web Site Address: www.garmin.com

Except as expressly provided herein, no part of this manual may be reproduced, copied, transmitted, disseminated, downloaded or stored in any storage medium, for any purpose without the express written permission of Garmin. Garmin hereby grants permission to download a single copy of this manual and of any revision to this manual onto a hard drive or other electronic storage medium to be viewed for personal use, provided that such electronic or printed copy of this manual or revision must contain the complete text of this copyright notice and provided further that any unauthorized commercial distribution of this manual or any revision hereto is strictly prohibited.

Garmin®, FliteCharts®, SafeTaxi®, and MapSource® are registered trademarks of Garmin Ltd. or its subsidiaries. G300™ is a trademark of Garmin Ltd. or its subsidiaries. These trademarks may not be used without the express permission of Garmin.

Jeppesen® is a registered trademark of Jeppesen, Inc.

NavData™ is a trademark of Jeppesen, Inc.

SiriusXM Weather and Radio services are provided by SiriusXM Satellite Radio, Inc.



WARNING: Navigation and terrain separation must NOT be predicated upon the use of the terrain function. The G300 Terrain Proximity feature is NOT intended to be used as a primary reference for terrain avoidance and does not relieve the pilot from the responsibility of being aware of surroundings during flight. The Terrain Proximity feature is only to be used as an aid for terrain avoidance and is not certified for use in applications requiring a certified terrain awareness system. Terrain data is obtained from third party sources. Garmin is not able to independently verify the accuracy of the terrain data.



WARNING: The displayed minimum safe altitudes (MSAs) are only advisory in nature and should not be relied upon as the sole source of obstacle and terrain avoidance information. Always refer to current aeronautical charts for appropriate minimum clearance altitudes.



WARNING: The altitude calculated by G300 GPS receivers is geometric height above Mean Sea Level and could vary significantly from the altitude displayed by pressure altimeters. Always use pressure altitude displayed by the G300 PFD when determining or selecting aircraft altitude.



WARNING: Do not use outdated database information. Databases used in the G300 system must be updated regularly in order to ensure that the information remains current. Pilots using any outdated database do so entirely at their own risk.



WARNING: XM WX Satellite Weather should not be used for hazardous weather penetration. Weather information is approved only for weather avoidance, not penetration.



WARNING: NEXRAD weather data is to be used for long-range planning purposes only. Due to inherent delays in data transmission and the relative age of the data, NEXRAD weather data should not be used for short-range weather avoidance.



WARNING: The illustrations in this guide are only examples. Never use the G300 to attempt to penetrate a thunderstorm. Both the FAA Advisory Circular, Subject: Thunderstorms, and the Aeronautical Information Manual (AIM) recommend avoiding “by at least 20 miles any thunderstorm identified as severe or giving an intense radar echo.”



WARNING: To reduce the risk of unsafe operation, carefully review and understand all aspects of the G300 Pilot’s Guide documentation and the Pilot’s Operating Handbook of the aircraft. Thoroughly practice basic operation prior to actual use. During flight operations, carefully compare indications from the G300 to all available navigation sources, including the information from other NAVAIDs, visual sightings, charts, etc. For safety purposes, always resolve any discrepancies before continuing navigation.



WARNING: Because of variation in the earth’s magnetic field, operating the G300 within the following areas could result in loss of reliable attitude and heading indications. North of 72° North latitude at all longitudes; South of 70° South latitude at all longitudes; North of 65° North latitude between longitude 75° W and 120° W. (Northern Canada); North of 70° North latitude between longitude 70° W and 128° W. (Northern Canada); North of 70° North latitude between longitude 85° E and 114° E. (Northern Russia); South of 55° South latitude between longitude 120° E and 165° E. (Region south of Australia and New Zealand)



WARNING: The Garmin G300 has a very high degree of functional integrity. However, the pilot must recognize that providing monitoring and/or self-test capability for all conceivable system failures is not practical. Although unlikely, it may be possible for erroneous operation to occur without a fault indication shown by the G300. It is thus the responsibility of the pilot to detect such an occurrence by means of cross-checking with all redundant or correlated information available in the cockpit.



WARNING: For safety reasons, G300 operational procedures must be learned on the ground.



WARNING: The United States government operates the Global Positioning System and is solely responsible for its accuracy and maintenance. The GPS system is subject to changes which could affect the accuracy and performance of all GPS equipment. Portions of the Garmin G300 utilize GPS as a precision electronic NAVigation AID (NAVAID). Therefore, as with all NAVAIDs, information presented by the G300 can be misused or misinterpreted and, therefore, become unsafe.



WARNING: The data contained in the terrain and obstacle databases comes from government agencies. Garmin accurately processes and cross-validates the data, but cannot guarantee the accuracy and completeness of the data.



WARNING: Do not use basemap (land and water data) information for primary navigation. Basemap data is intended only to supplement other approved navigation data sources and should be considered as an aid to enhance situational awareness.



CAUTION: The display uses a lens coated with a special anti-reflective coating that is very sensitive to skin oils, waxes, and abrasive cleaners. **CLEANERS CONTAINING AMMONIA WILL HARM THE ANTI-REFLECTIVE COATING.** It is very important to clean the lens using a clean, lint-free cloth and an eyeglass lens cleaner that is specified as safe for anti-reflective coatings.



CAUTION: The Garmin G300 does not contain any user-serviceable parts. Repairs should only be made by an authorized Garmin service center. Unauthorized repairs or modifications could void both the warranty and the pilot's authority to operate this device under FAA/FCC regulations.



NOTE: All visual depictions contained within this document, including screen images of the G300 panel and displays, are subject to change and may not reflect the most current G300 system and aviation databases. Depictions of equipment may differ slightly from the actual equipment.



NOTE: This product, its packaging, and its components contain chemicals known to the State of California to cause cancer, birth defects, or reproductive harm. This notice is being provided in accordance with California's Proposition 65. If you have any questions or would like additional information, please refer to our web site at www.garmin.com/prop65.



NOTE: Interference from GPS repeaters operating inside nearby hangars can cause an intermittent loss of attitude and heading displays while the aircraft is on the ground. Moving the aircraft more than 100 yards away from the source of the interference should alleviate the condition.



NOTE: Use of polarized eyewear may cause the flight displays to appear dim or blank.



NOTE: Temporary Flight Restriction (TFR) data is provided by the FAA and may not be updated outside of normal business hours. Confirm data currency through alternate sources and contact your local FSS for interpretation of TFR data.

Blank Page

Part Number	Change Summary
190-00921-00	Initial release

Rev	Date	Description
A	February, 2009	Production Release
B	August, 2009	Added System Software Version 2.30 parameters
C	August, 2010	<p>System Software Version 2.30 - 2.40 changes:</p> <ul style="list-style-type: none"> • Added Density Altitude to the list of selectable Data Bar Fields • Added an advisory message to indicate when the GDU is in Demo Mode • Added advisory message to indicate anomalous magnetometer data <p>System Software Version 2.40-2.50 changes:</p> <ul style="list-style-type: none"> • Added Altitude Alerter to PFD • Changed PFD to declutter Data Fields in unusual attitudes <p>System Software Version 2.50-2.60 changes:</p> <ul style="list-style-type: none"> • Added message to indicate if config module is missing • Added warning text to Weight & Balance Page <p>System Software Version 2.60-2.70:</p> <ul style="list-style-type: none"> • Added support for Integrated Autopilot control and display via the PFD Page • Added PFD Setup Menu • Added second Bearing Pointer to PFD HSI • Added menu option to XM Page to allow selection of a specific channel number <p>System Software Version 2.70-3.00:</p> <ul style="list-style-type: none"> • Added Synthetic Vision • Added mach number to configurable Data Fields <p>System Software Version 3.00-3.10:</p> <ul style="list-style-type: none"> • Added ability to import/export flight plans using the SD card • Added Softkeys to Nearest Airports Page to quickly show/hide private airports and heliports • Removed ability to adjust Roll Mode reference using the FMS Joystick <p>System Software Version 3.10-3.20:</p> <ul style="list-style-type: none"> • Added ability to display checklist files from SD Card • Added ability to log data to SD Card • Added ability to export Track Log and User Waypoints to SD Card

D	September, 2010	Clerical Changes
E	March, 2012	<p>System Software Version 3.20-4.00:</p> <ul style="list-style-type: none"> • Added support for geo-referenced FliteCharts • Added Softkey to Terrain Page to quickly enabled/disable terrain alerts <p>System Software Version 4.00-4.10:</p> <ul style="list-style-type: none"> • Added support for displaying flight time in databar <p>System Software Version 4.10 - 5.00 :</p> <ul style="list-style-type: none"> • Added persistent sky/ground display to PFD • Added automatic sync of altimeter setting to local terrain elevation • Added display of displaced runway threshold distance to Airport Review Page • Added menu option and softkey to the FPL VNAV Page to force a capture of a VNAV profile • Added Sirius/XM warning text <p>System Software Version 5.10 - 6.00 :</p> <ul style="list-style-type: none"> • Added pathways <p>System Software Version 6.00 - 6.10 :</p> <ul style="list-style-type: none"> • Added baro minimums altitude reference bug and audio alert to PFD • Changed CRS Softkey on PFD Page to indicate which course it controls. <p>System Software Version 6.10 - 6.20 :</p> <ul style="list-style-type: none"> • Added ability to change the layout of PFD1 between full-screen and split-screen in normal mode via the Display Setup Page • Added arrows to PFD terrain messages to indicate terrain alerts which are outside the Synthetic Vision field of view • Added softkey to Terrain page

Section 1 System Overview.....	1
1.1 Line Replaceable Units.....	1
G300 Standard Panel	4
G300 Upgraded Panel	5
1.2 Display Overview	6
1.3 Secure Digital (SD) Cards.....	7
1.4 G300 Controls	8
1.5 System Power-up.....	10
1.6 System Operation.....	12
Display Operation.....	12
G300 System Annunciations	14
AHRS Operation	14
1.7 Accessing System Functionality	16
Menus	16
Data Entry.....	17
Pages.....	19
Main Page Softkeys	24
Flight Planning Softkeys.....	31
Nearest Page Softkeys	32
1.8 Accessing the Information (INFO) Page.....	33
Viewing GPS Receiver Status	33
Position.....	36
Data Fields and Layout (Dual Display - MFD).....	38
1.9 System Settings.....	39
Data Bar Fields.....	40
Display.....	41
Sound	43
Units.....	45
Date & Time	46
Position.....	47
Alarms	47
Setting Airport Criteria.....	49
Section 2 Flight Instruments.....	51
2.1 Flight Instruments.....	51
Airspeed Indicator	53
Attitude Indicator.....	54
Altimeter.....	55
Altitude Alerting.....	59
Vertical Speed Indicator (VSI).....	60
VNAV Indicator	60
Horizontal Situation Indicator (HSI).....	61
Heading Strip and Turn Rate Indicator	66
OBS Mode	66

2.2 Supplemental Flight Data.....	68
Outside Air Temperature	68
Wind Data	68
2.3 Vertical Navigation (VNAV).....	69
Using the VNAV Feature	70
Section 3 Engine Indication System	73
3.1 EIS Display & ENG Page	73
Section 4 COM Interface.....	77
4.1 Auto-tuning Frequencies	77
Section 5 GPS Navigation.....	81
5.1 Introduction	81
Compass Arc	81
5.2 Using Map Displays	82
Map Page Setup	83
Map Range	87
Map Panning	88
Measuring Bearing and Distance	90
Topography	91
Satellite View	92
Map Symbols	92
5.3 Airways.....	93
5.4 Waypoints.....	96
Nearest Information	101
Weather Information	103
Intersections	104
NDBs	105
VORs	106
User Waypoints	107
5.5 Airspace	111
Airspace Alert Messages.....	112
Smart Airspace	113
5.6 Direct-to Navigation	113
Section 6 Flight Planning.....	117
6.1 Introduction	117
Flight Plan Data Fields.....	118
6.2 Flight Plan Creation	119
6.3 Flight Plan Storage.....	121
6.4 Flight Plan Activation.....	122
6.5 Flight Plan Editing.....	123

Adding Waypoints to an Existing Flight Plan.....	123
Editing Flight Plan Speed, Fuel, and/OR Name.....	125
Copying Flight Plans.....	127
Deleting Flight Plans.....	127
Inverting a Flight Plan.....	129
Importing/Exporting Flight Plans.....	130
6.6 Approaches.....	131
Selecting an Approach.....	132
Activating Vectors-to-Final.....	135
6.7 Trip Planning.....	136
Section 7 Hazard Avoidance.....	137
7.1 XM WX Satellite Weather.....	137
XM Datalink Weather Advisory.....	137
XM WX Satellite Weather Products.....	139
Using XM WX Satellite Weather Products.....	150
7.2 Terrain.....	154
Synthetic Vision.....	155
Terrain Information.....	155
Terrain Views.....	156
Terrain Settings.....	158
Terrain Alerts.....	159
Section 8 Additional Features.....	163
8.1 Synthetic Vision (SVX).....	164
Synthetic Vision Operation.....	166
8.2 SafeTaxi.....	175
SafeTaxi Cycle Number and Revision.....	176
8.3 FliteCharts®.....	177
Aircraft Symbol.....	179
Chart Range.....	179
FliteCharts Cycle Number and Expiration Date.....	180
8.4 AOPA Data.....	181
8.5 SIRIUSXM Radio Entertainment (Optional).....	182
Activating SiriusXM Satellite Radio Services.....	182
Using SIRIUSXM Radio.....	184
8.6 Electronic Checklists (Optional).....	188
8.7 Flight Data Logging.....	189
Section 9 Integrated Autopilot (Optional).....	191
9.1 Integrated Autopilot Operation.....	192
Controls.....	192
G300 Autopilot Status BOX.....	196
Integrated Autopilot Modes.....	197

- 9.2 Vertical Modes 198**
 - Pitch Hold Mode (PIT)..... 198
 - Selected Altitude Capture mode (ALTS) 200
 - Altitude Hold Mode (ALT) 201
 - Vertical Speed Mode (VS) 203
 - Vertical Navigation Mode (VNAV) 205
- 9.3 Lateral Modes 209**
 - Roll Hold Mode (ROL)..... 209
 - Heading Mode (HDG)..... 211
 - Navigation Mode (GPS)..... 212
 - Changing the Selected Course (OBS Mode)..... 214
- 9.4 Integrated Autopilot Alerts..... 214**
- Section 10 Annunciations & Alerts 215**
 - 10.1 Miscellaneous Message Advisories..... 215**
 - 10.2 System Status Messages (INFO Page) 217**
 - 10.3 Aural Alerts 221**
 - Terrain 221
 - 10.4 PFD Annunciations and Alerting Functions..... 222**
 - CAS Messages 222
 - Terrain Annunciations 223
 - Integrated Autopilot Alerts (Optional) 224
- Section 11 Appendices 227**
 - Appendix A: Data Field Options 227**
 - Appendix B: Utilities..... 231**
 - Flight Log..... 231
 - Track Log 233
 - Heading Line..... 237
 - Weight & Balance 238
 - EPE Circle 240
 - Proximity Waypoints 241
 - Appendix C: SD Card Use and Databases 243**
 - Installing and Removing SD Cards 243
 - G300 Databases 244
 - Updating G300 Databases 247
 - Exporting Track Logs and User Waypoints..... 249
 - Importing/Exporting Flight Plans..... 250
 - Flight Data Logging..... 250
 - Appendix D: Map Datum and Location Formats 251**
 - Map Datums 251
 - Location Formats..... 251

Appendix E: Abnormal operation.....	253
Loss of GPS Position	253
G300 System Failure Annunciations	254
Reversionary Mode.....	255
Synthetic Vision Troubleshooting	255
Unusual Attitudes.....	256
Appendix F: Display Symbols	257
VFR Symbols	257
IFR Symbols	258
Airspace Symbols	260
Appendix G: Glossary	263
Appendix H: License Agreement and Warranty	269
Contact Garmin.....	269
Software License Agreement.....	269
Limited Warranty	269
AOPA Airport Directory Notice	270
SiriusXM Satellite Radio Service Agreement.....	271
Weather Data Warranty.....	271

Blank Page

SECTION 1 SYSTEM OVERVIEW

The G300 System presents flight instrumentation, position, navigation, communication, and identification information to the pilot using one (single display) or two (dual display) 7" Wide VGA (800x480) flat-panel color display(s).

1.1 LINE REPLACEABLE UNITS

The system is distributed across the following Line Replaceable Units (LRUs):

- **Garmin Display Unit (GDU) 375 (with XM)**
 - Single Display: Split Primary Flight Display (PFD) & Multi Function Display (MFD)
 - Multiple Displays: MFD (recommended)
- **GDU 370 (without XM)**
 - Single Display: Split Primary Flight Display (PFD) & Multi Function Display (MFD)
 - Multiple Displays: MFD, PFD, or split-screen



GDU 37X

- **GSU 73**

- Garmin Sensor Unit sub-system for the G300 (Air Data Computer (ADC), Engine/Airframe Unit, and the Attitude and Heading Reference System (AHRS))
 - ADC: Processes data from the pitot-static system and outside air temperature (OAT) sensor.
 - Engine/Airframe Unit: Receives and processes signals from the engine and airframe sensors.
 - AHRS: Provides aircraft attitude and heading information to the PFD. The AHRS contains advanced sensors (including accelerometers and rate sensors) and interfaces with the Magnetometer to obtain magnetic field information, with the ADC to obtain air data, and with the GDU to obtain GPS information. AHRS operation is discussed later in this section.



GSU 73

- **GMU 44**

- Magnetometer: Measures the local magnetic field and sends data to the AHRS for processing to determine aircraft magnetic heading. This unit receives power directly from the AHRS and communicates with it via an RS-485 digital interface.



GMU 44

- **GTP 59**

- Temperature Probe: Provides raw air temperature data.



GTP 59

G300 STANDARD PANEL

In the standard split-screen configuration, the Primary Flight Display (PFD) and the Multi Function Display (MFD) are displayed in split-screen mode on a single GDU.

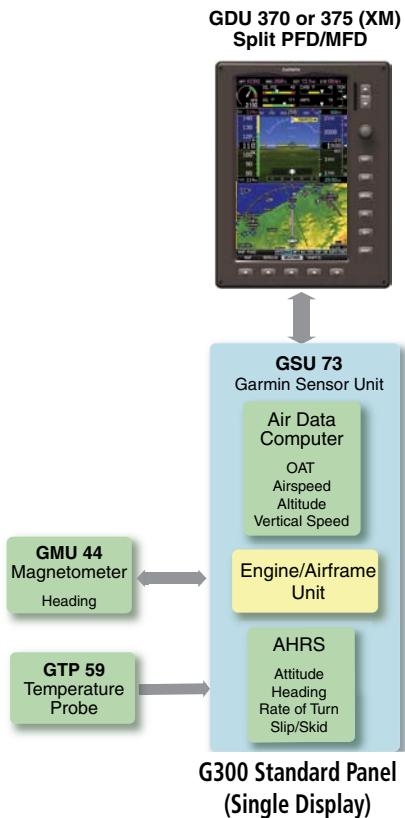

- System Overview
- Flight Instruments
- EIS
- COM Interface
- GPS Navigation
- Flight Planning
- Hazard Avoidance
- Additional Features
- Integrated Autopilot
- Annun/Alerts
- Appendix
- Index

G300 UPGRADED PANEL

With the upgraded 'dual display' configuration the left GDU is configured as a PFD and the right GDU is configured as a MFD.

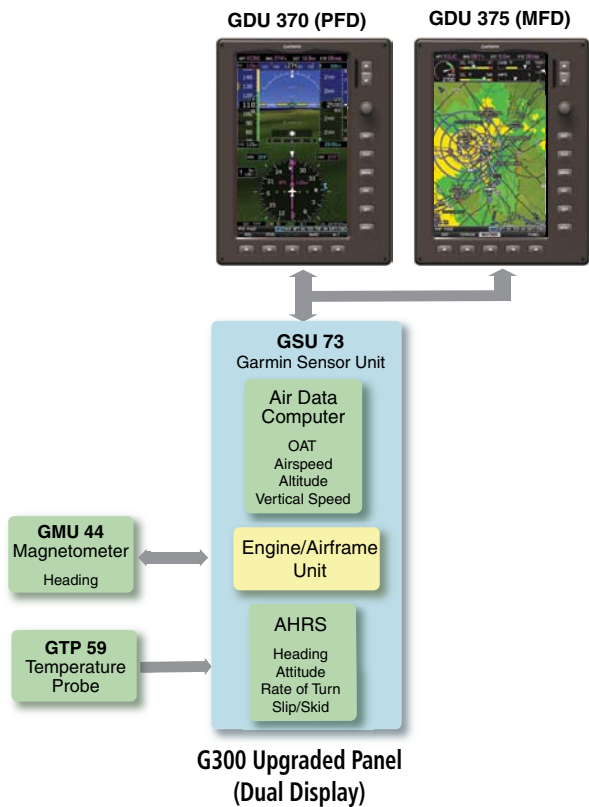

1.2 DISPLAY OVERVIEW



Unit Overview (Single Display Map Page)

- System Overview
- Flight Instruments
- EIS
- COM Interface
- GPS Navigation
- Flight Planning
- Hazard Avoidance
- Additional Features
- Integrated Autopilot
- Annun/Alerts
- Appendix
- Index

1.3 SECURE DIGITAL (SD) CARDS



NOTE: Refer to Appendix C for more information on SD Card use and databases.

The G300 data card slot uses Secure Digital (SD) cards and is located on the upper right side of the display bezel(s). The SD card can be used for software updates, checklist files, flight data logging, exporting Track Logs/User Waypoints, and Importing/Exporting Flight Plans.

Installing an SD Card:

- 1) Insert the SD card in the SD card slot with the card contacts facing the display (the card should be flush with the face of the bezel).
- 2) To eject the card, gently press on the SD card to release the spring latch.

SD Card Slot



Display Bezel SD Card Slot

1.4 G300 CONTROLS

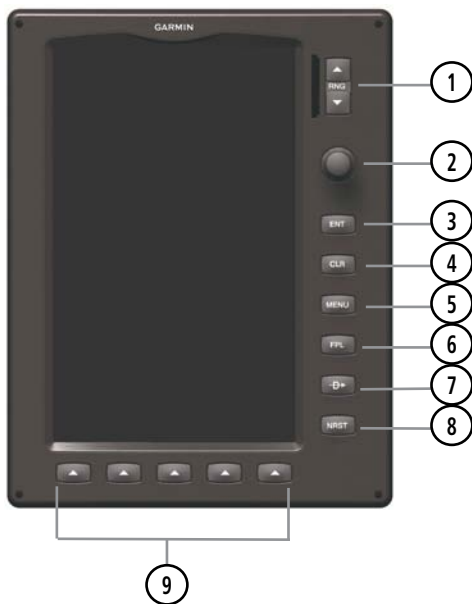

- 1 RNG Key** Press to increase or decrease the viewing range of the map
Press to increase or decrease the HSI Scale on the PFD or PFD Page
- 2 FMS Joystick** Press the **FMS Joystick** to toggle input focus between user interaction with the current page and the page navigation bar
Turn the **FMS Joystick** clockwise to access a drop down menu within the highlighted field
Turn the **FMS Joystick** to change the selected value within the highlighted field
Move the **FMS Joystick** (up, down, left, or right) to highlight a field
Move the **FMS Joystick** (up, down, left, right, or diagonally) to move the map pointer
With the **HDG** or **HDG/ROLL** Softkey selected, press and hold the **FMS Joystick** to sync to the current heading
With the appropriate autopilot mode selected, move the **FMS Joystick** (up/down) to adjust the mode reference for Vertical Speed, Altitude Hold, and Pitch Hold modes, or move the **FMS Joystick** (left/right) to decrease the mode reference for Roll Hold mode.

- System Overview
- Flight Instruments
- EIS
- COM Interface
- GPS Navigation
- Flight Planning
- Hazard Avoidance
- Additional Features
- Integrated Autopilot
- Annun/Alerts
- Appendix
- Index

- 3 ENT Key** Press to confirm menu selection or data entry
 Press to acknowledge messages
 Press and hold to mark a waypoint
- 4 CLR Key** Press to cancel an entry, revert to the previous value in a data entry field or remove menus
 Press and hold to return to the default page
- 5 MENU Key** Press once to view the Page Menu
 Press twice to view the Main Menu
 Press a third time to clear the Main Menu
- 6 FPL Key** Press to display the Flight Plan Page
- 7 Direct-To Key** Press to activate the Direct-To function, enter a destination waypoint and establish a direct course to the selected destination
- 8 NRST Key** Press to display the Nearest Page for viewing the nearest airports, intersections, NDBs, VORs, waypoints, frequencies, and airspace
- 9 Softkey Selection Keys** Press to select softkey shown above the bezel key on the display

1.5 SYSTEM POWER-UP

During system initialization, the AHRS displays the message 'AHRS ALIGN, KEEP WINGS LEVEL' over the attitude indicator. The AHRS should display valid attitude and heading fields typically within the first minute of power-up. The AHRS can align itself both while taxiing and during level flight.



System Initialization

Current database information is displayed during power-up including valid operating dates, cycle number, and database type. When this information has been reviewed for currency (to ensure that no databases have expired), the pilot is prompted to continue.

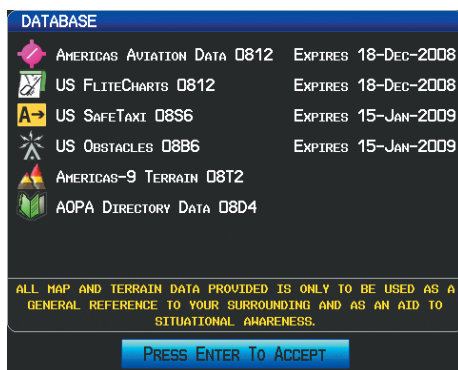

Database Information

Pressing the **ENT** Key acknowledges this information.

After acknowledgement of the database information, the pilot is prompted to acknowledge a datalink weather advisory.

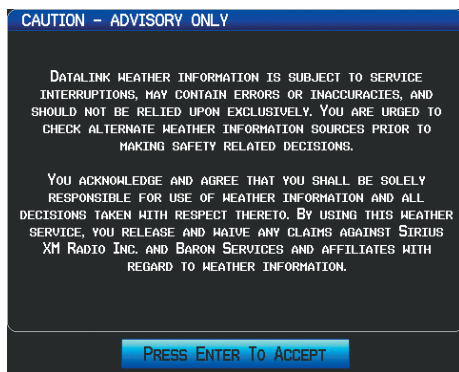

Datalink Weather Advisory

Pressing the **ENT** Key acknowledges this information.

1.6 SYSTEM OPERATION

This section discusses normal and reversionary G300 display operation, G300 System Annunciations, and AHRS Operation.

DISPLAY OPERATION

In normal operating mode, the PFD presents graphical flight instrumentation (attitude, heading, airspeed, altitude, vertical speed), replacing the traditional flight instrument cluster.

• Single Display

- The single display PFD occupies the top portion of the display at all times, and a full display PFD can be accessed by navigating to the PFD Page (see Section 1.6, Accessing System Functionality).
- The single display MFD occupies the bottom portion of the display.



G300 Split-Screen Normal Mode

- **Dual Display (Normal Mode)**

- In normal mode the Dual Display system has a dedicated PFD and MFD.



G300 Dual Display Normal Mode

- **Dual Display (Reversionary Mode)**

In the event of a display failure, the G300 System automatically switches to reversionary (backup) mode. In reversionary mode, all information is presented on the remaining display in the same format as the Single Display system.

If a display failure occurs with the GDU 375, the **WX** and **XM** Pages will no longer be available since the XM receiver resides in the GDU 375.



G300 Dual Display Reversionary Mode (Failed PFD)

G300 SYSTEM ANNUNCIATIONS

When an LRU or an LRU function fails, a large red 'X' is typically displayed over the instrument(s) or data experiencing the failure (Refer to Appendix E, Abnormal Operation). Upon G300 power-up, certain instruments remain invalid as equipment begins to initialize. All instruments should be operational within one minute of power-up. If any instrument remains flagged, the G300 should be serviced by an authorized repair facility.



PFD Initialization

AHRS OPERATION

The Attitude and Heading Reference System (AHRS) performs attitude, heading, and vertical acceleration calculations for the G300 System, utilizing GPS, magnetometer, and air data in addition to information from its internal sensors. Attitude and heading information are updated on the PFD while the AHRS receives appropriate combinations of information from the external sensor inputs.

The AHRS (GSU 73) corrects for shifts and variations in the Earth's magnetic field by applying the Magnetic Field Variation Database. The Magnetic Field Variation Database is derived from the International Geomagnetic Reference Field (IGRF). The IGRF is a mathematical model that describes the Earth's main magnetic field and its annual rate of change. The database is updated approximately every 5 years. Failure to update this database could lead to erroneous heading information being displayed to the pilot. The database can only be updated by an authorized Cessna Service Center.

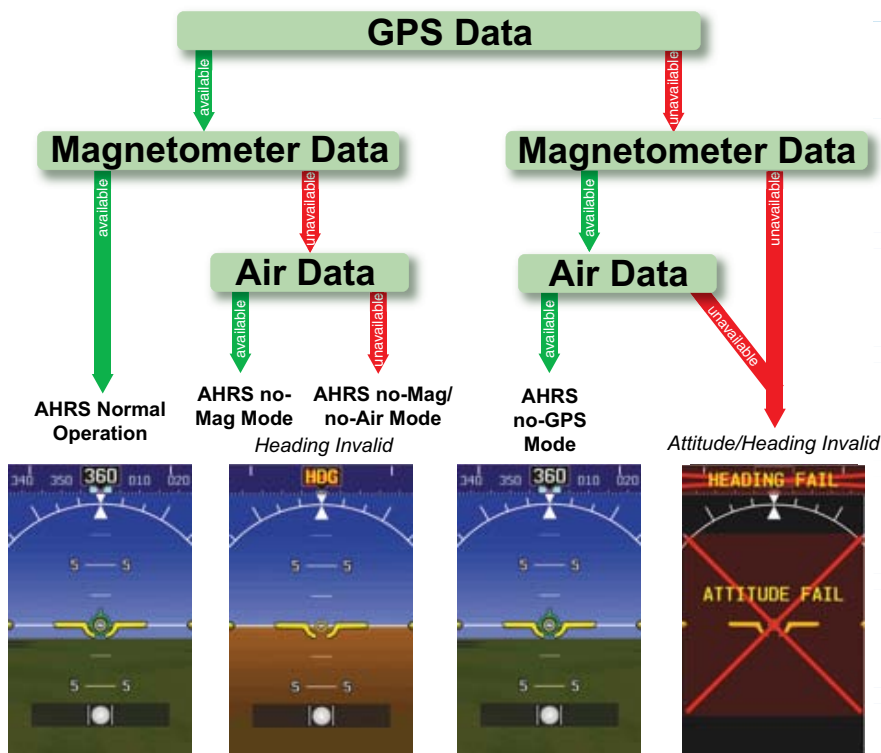

Loss of GPS, magnetometer, or air data inputs is communicated to the pilot by message advisory alerts. Any failure of the internal AHRS inertial sensors results in loss of attitude and heading information (indicated by red 'X' flags over the corresponding flight instruments).

If GPS input fails, the AHRS can continue to provide attitude and heading information to the PFD as long as magnetometer and airspeed data are available and valid.

If the magnetometer input fails, the AHRS continues to output valid attitude information; however, the heading output on the PFD Page is flagged as invalid with a red 'X'.

Failure of the air data input has no effect on the AHRS output while AHRS is receiving valid GPS information. Invalid/unavailable airspeed data in addition to GPS failure results in loss of all attitude and heading information. Likewise, loss of magnetometer (heading) data, in combination with loss of GPS data results in a loss of all attitude and heading information.

1.7 ACCESSING SYSTEM FUNCTIONALITY

MENUS



NOTE: *Flight Log and Track Log Main Menu options must be accessed from the MFD in a multiple display system.*

The G300 has a dedicated **MENU** Key. Press once to display a context-sensitive list of options for the page or the dedicated PFD. Press twice to display the Main Menu.

The Page Menu allows the user to access additional features or make setting changes which specifically relate to the currently displayed page. The menu will display 'No Options' when there are no options for the page selected.

Navigating the page menu:

- 1) Press the **MENU** Key once to display the Page Menu.
- 2) Turn or move the **FMS** Joystick to scroll through a list of available options (a scroll bar always appears to the right of the window/box when the option list is longer than the window/box).
- 3) Press the **ENT** Key to select the desired option.
- 4) Press the **FMS** Joystick, **CLR** Key, or press the **MENU** Key twice to remove the menu and cancel the operation.

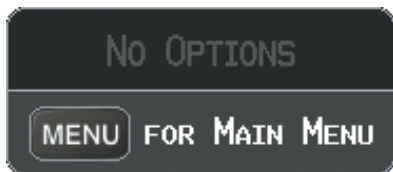

Page Menu (No Options)



TER Page Menu

Navigating the main menu:

- 1) Press the **MENU** Key twice to display the Main Menu.
- 2) Turn or move the **FMS** Joystick to scroll through a list of available options (a scroll bar always appears to the right of the window/box when the option list is longer than the window/box).
- 3) Press the **ENT** Key to select the desired option.

- 4) Press the **FMS** Joystick, **CLR** Key, **EXIT** Softkey, or press the **MENU** Key to remove the menu and cancel the operation.

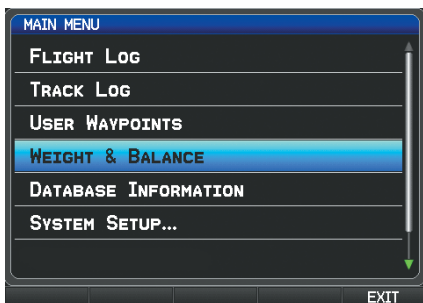

Main Menu (Split-Screen)

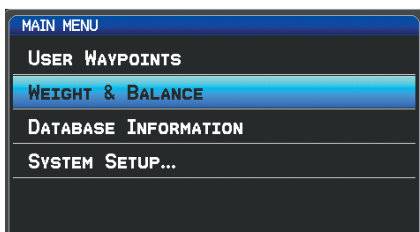

Main Menu (Split-Screen PFD)

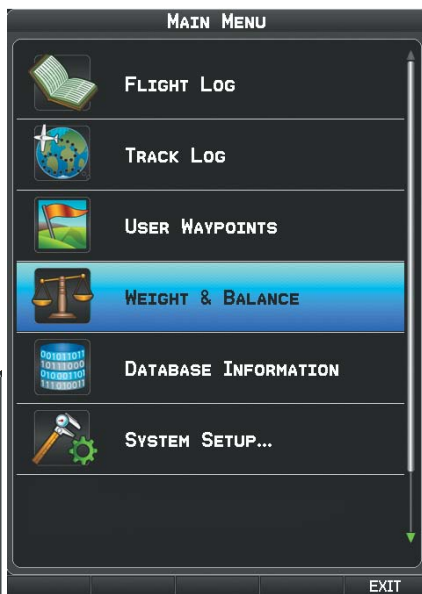

Main Menu (Full-Screen MFD)

DATA ENTRY

The **FMS** Joystick can be used for directly entering alphanumeric data into the G300. In some instances, such as when entering an identifier, the G300 tries to predict the desired identifier based on the characters being entered. In this case, if the desired identifier appears, use the **ENT** Key to confirm the entry without entering the rest of the identifier manually. This can save the pilot from having to enter all the characters of the identifier.

Besides character-by-character data entry, the system also provides a shortcut for entering waypoint identifiers. When the cursor is on a field awaiting entry of a waypoint identifier, turning the **FMS** Joystick counter-clockwise accesses a menu with three different lists of identifiers for quick selections: recent waypoints (RECENT WPTS), nearest airports (NRST APTS), and flight plan waypoints (FPL WPTS). The G300 automatically fills in the identifier, facility, and city fields with the information for the selected waypoint.

Using the FMS Joystick to enter data:

- 1) Press the **FMS** Joystick to activate the cursor.
- 2) Move the **FMS** Joystick to highlight the desired field.
- 3) Begin entering data.
 - a) To quickly enter a waypoint identifier, turn the **FMS** Joystick counter-clockwise to display a list of recent waypoints (RECENT WPTS), nearest airports (NRST APTS) or flight plan waypoints (FPL WPTS).
 - b) Move the **FMS** Joystick to highlight the desired waypoint from the list and press the **ENT** Key.

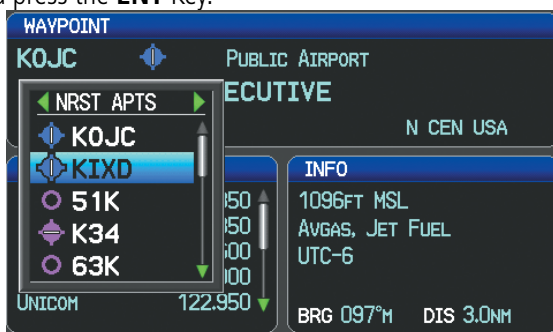

Waypoint Entry (Waypoint Page)

Or:

- a) Turn the **FMS** Joystick clockwise to select a character for the first placeholder.



Data Entry

Turning the **FMS** Joystick clockwise scrolls through the alphabet (where appropriate) toward the letter Z, starting in the middle at K (US only), and the digits zero through nine. Turning the **FMS** Joystick counter-clockwise scrolls in the opposite direction.

- b) Use the **FMS** Joystick to move the cursor to the next placeholder in the field.
- c) Repeat, turning the **FMS** Joystick to select a character and then moving the **FMS** Joystick to move the cursor, until the fields are complete.
- d) Press the **ENT** Key to confirm entry.

Or:

Press the **FMS** Joystick or the **CLR** Key to cancel data entry (the field reverts back to its previous information).

PAGES

The Main Pages, Flight Plan Pages, and Nearest Pages are linked together in a series that you can cycle through using the **FMS** Joystick. A page navigation bar is displayed on the lower portion of the display, directly above the softkey bar. The right side of the page navigation bar shows a list of abbreviated names for each of the pages, and the left side shows the name of the current page.

Press the **FMS** Joystick to toggle input focus between the Page Navigation Bar and interaction with the current page (i.e., turning the page cursor on/off). When the Page Navigation Bar is highlighted blue, the user can cycle through the pages using the **FMS** Joystick. If the Page Navigation Bar is not highlighted blue, the user can interact with the current page (if available).

The Single Display PFD occupies the top portion of the display while the selected page occupies the bottom portion of the display.

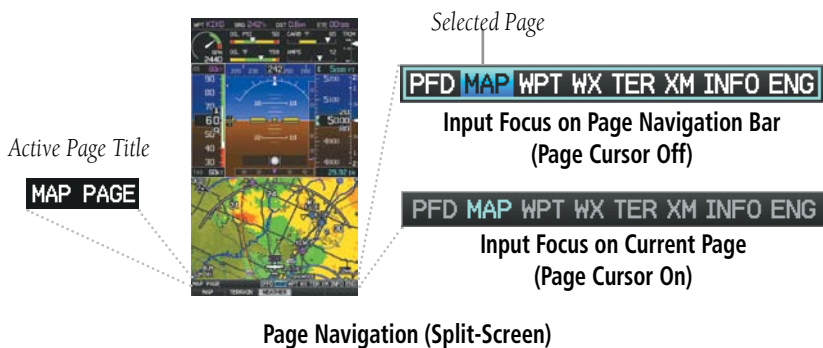

MAIN PAGES



NOTE: In the Dual Display configuration, the Main Pages are only available from the MFD.

There are up to eight Main Pages (seven for the dual display) that can be navigated using the **FMS** Joystick.

Selecting a main page using the FMS Joystick:

- 1) If necessary, press the **FMS** Joystick to begin interaction with the Page Navigation Bar.
- 2) Turn the **FMS** Joystick until the desired page is selected (**PFD** (single display), **MAP**, **WPT**, **WX**, **TER**, **XM**, **INFO**, **ENG**).

- **Main Pages**

PFD Page (PFD) (single display)

Map Page (MAP)

Waypoint Page (WPT)

Weather Page (WX) (optional)

Terrain Page (TER)

XM Audio Page (XM) (optional)

Info Page (INFO)

Engine Page (ENG)

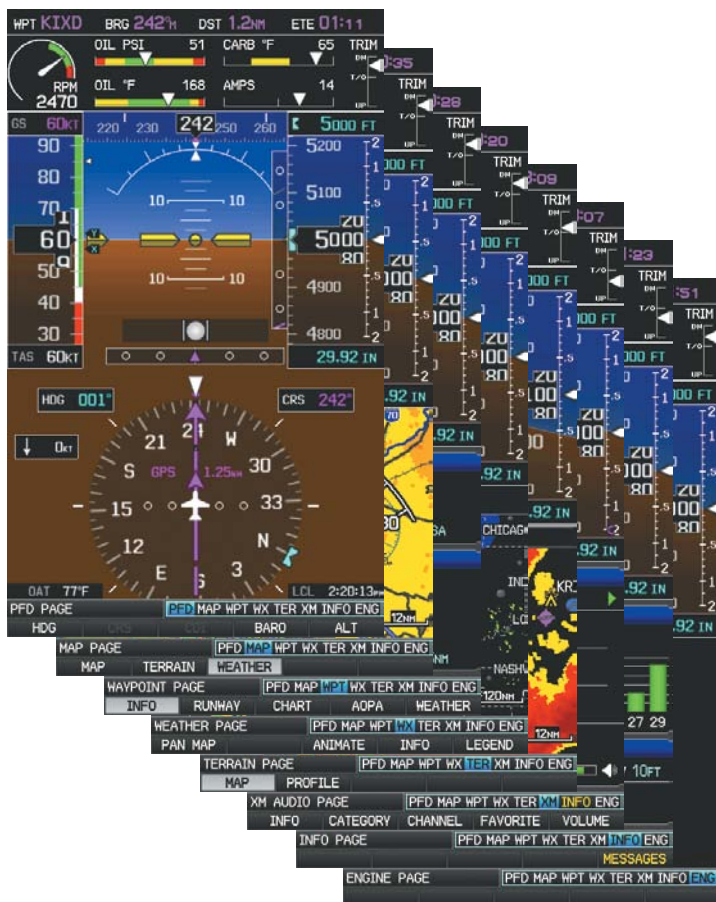

Main Pages (Split-Screen)

FLIGHT PLAN AND NEAREST PAGES

The Flight Plan and Nearest Pages are selected by pressing the **FPL** Key or **NRST** Key.

Selecting the FPL or NRST pages:

- 1) Press the **FPL** or **NRST** Key.
- 2) Turn the **FMS** Joystick until the desired page is selected.
- 3) To return to the Main Pages, press the **EXIT** Softkey.

The Nearest Pages contain the following information.

- APT (Airport)—identifier, bearing, distance, length of the longest runway, and common traffic advisory (CTAF) or tower frequency.
- WX (Airport Weather) (GDU 375 Only)—identifier, bearing, distance, METAR text, and ATIS, AWOS, or ASOS frequency.
- VOR (VHF Omnidirectional Radio Beacon)—identifier, facility type (symbol), bearing, distance, and frequency.
- NDB (Non Directional Beacons)—identifier, facility, type (symbol), bearing, distance, and frequency.
- INT (Intersection)—identifier, bearing, and distance.
- VRP (Visual Reporting Point) (Atlantic)—identifier, bearing, and distance.
- USR (User Waypoints)—name, bearing, and distance.
- CTY (City)—name, bearing, and distance.
- ATC (Air Route Traffic Control Center)—bearing, distance, and frequency.
- FSS (Flight Service Station)—name, bearing, distance, frequency, and VOR (if applicable).
- ASPC (Airspace)—name, time to entry (when applicable), and status.

- **Nearest Pages (NRST)**

Nearest Airports (APT)

Nearest Airport Weather (WX) (GDU 375)

Nearest VORs (VOR)

Nearest NDBs (NDB)

Nearest Intersections (INT)

Visual Reporting Point (VRP) (Atlantic)

Nearest User Waypoints (USR)

Nearest Cities (CTY)

Nearest ARTCC (ATC)

Nearest FSS (FSS)

Nearest Airspace (ASPC)

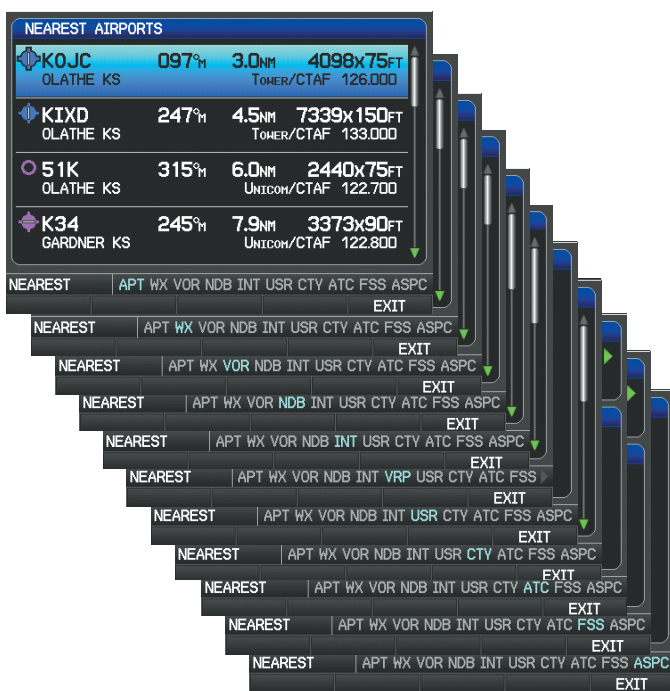

Nearest Pages (Split-Screen)

- **Flight Planning Pages (FPL)**

Active Flight Plan (ACTV)

Vertical Navigation (VNAV)

Flight Plan List (LIST)

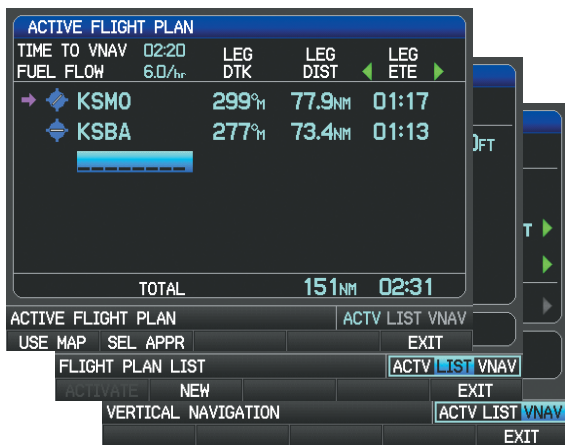

Flight Planning Pages (Split-Screen)

MAIN PAGE SOFTKEYS

The softkeys are located along the bottom of the display(s). The softkeys shown depend on the softkey level or page being displayed. The bezel keys below the softkeys can be used to select the appropriate softkey. When a softkey is selected, its color undergoes a momentary change to black text on blue background then automatically switches to black text on gray background and remains this way until it is turned off, at which time it reverts to white text on black background. When a softkey function is disabled, the softkey label is subdued (dimmed).



Softkeys (WPT Page)

PFD PAGE (SINGLE DISPLAY) & PFD (DUAL DISPLAY) SOFTKEYS

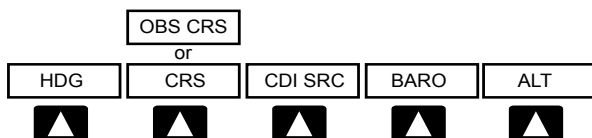

- HDG Allows the pilot to adjust the heading bug with the **FMS** Joystick
- CRS/OBS CRS Allows the pilot to adjust the course in OBS mode
- CDI Not available
- BARO Allows the pilot to adjust the barometric pressure setting and enables the second-level BARO Softkeys
- ALT Allows the pilot to adjust the selected altitude

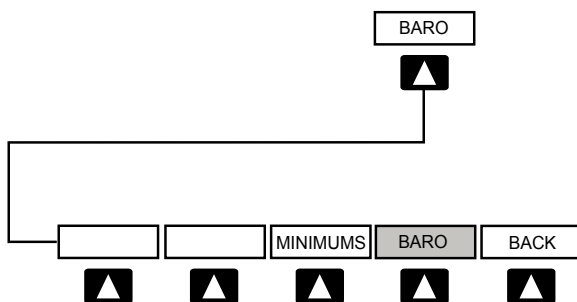

- MINIMUMS Allows the pilot to set or clear the barometric minimums altitude reminder
- BARO Allows the pilot to change the barometric setting
- BACK Returns to top-level softkeys

PFD PAGE (SINGLE DISPLAY) & PFD (DUAL DISPLAY) SOFTKEYS (INTEGRATED AUTOPILOT CONFIGURED)



- HDG/ROLL** Allows the pilot to adjust the heading bug and displays lateral mode softkeys
- CRS/OBS** Allows the pilot to adjust the course in OBS mode
- CDI SRC** Toggles between available NAV sources (when configured)
- BARO** Allows the pilot to adjust the barometric pressure setting
- ALT/PTCH** Allows the pilot to adjust the selected altitude and displays vertical mode softkeys

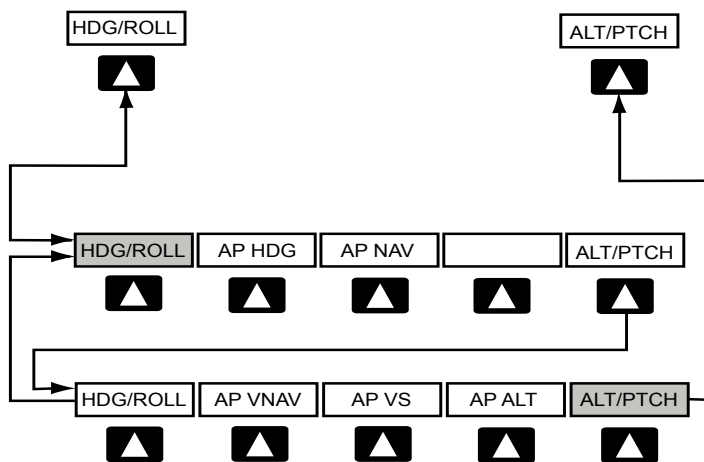

HDG/ROLL Softkey selected

HDG/ROLL Initial press allows the pilot to adjust the heading bug and displays lateral mode softkeys; subsequent press returns to top-level softkeys

AP HDG Selects/deselects heading mode

AP NAV Selects/deselects navigation mode. Cancels GS Mode if LOC Mode is either active or armed. Cancels GP Mode if GPS Mode is either active or armed. Cancels LOC Mode if GPS Mode is active and LOC Mode is armed.

ALT/PTCH Initial press allows the pilot to adjust the selected altitude and displays the vertical mode softkeys; subsequent press returns to top-level softkeys

ALT/PTCH Softkey selected

HDG/ROLL Initial press allows the pilot to adjust the heading bug and displays lateral mode softkeys; subsequent press returns to top-level softkeys

AP VNAV Selects/deselects altitude hold mode

AP VS Selects/deselects vertical speed mode

AP ALT Selects/deselects altitude hold mode

ALT/PTCH Initial press allows the pilot to adjust the selected altitude and displays the vertical mode softkeys; subsequent press returns to top-level softkeys

MAP PAGE SOFTKEYS



MAP Enables second-level Map Page softkeys

TERRAIN Displays/removes terrain awareness information

WEATHER Displays/removes weather information

- System Overview
- Flight Instruments
- EIS
- COM Interface
- GPS Navigation
- Flight Planning
- Hazard Avoidance
- Additional Features
- Integrated Autopilot
- Annun/Alerts
- Appendix
- Index

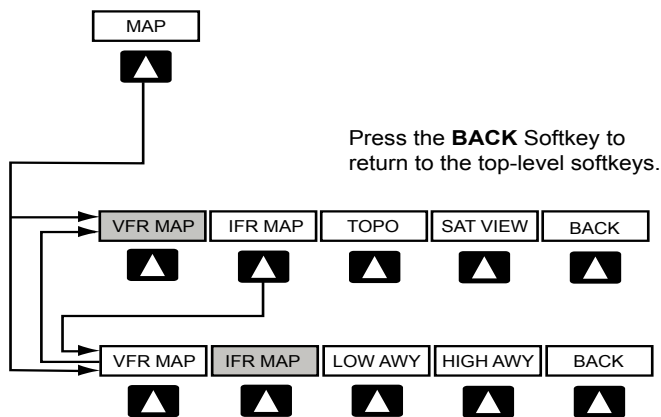

VFR MAP Softkey selected

- IFR MAP Displays IFR map information and softkeys
- TOPO Displays/removes topographical terrain shading
- SAT VIEW Displays/removes satellite imagery (above 20nm scale)
- BACK Returns to top-level softkeys

IFR MAP Softkey selected

- VFR MAP Displays VFR map information and softkeys
- LOW AWY Low Altitude (Victor) Airways displayed
- HIGH AWY High Altitude Airways (Jet Routes) displayed
- BACK Returns to top-level softkeys

WAYPOINT PAGE SOFTKEYS

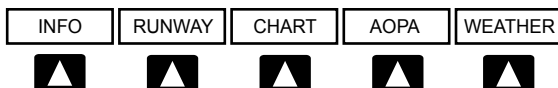

Waypoint (WPT) Page Softkeys
(Split-Screen)



Waypoint (WPT) Page Softkeys
(Full-Screen)

INFO	Displays waypoint information
RUNWAY	Displays runway information (split-screen only)
CHART	Displays optional FliteCharts
AOPA or DIRECTORY	Displays airport directory information
WEATHER	Displays METAR and TAF text (optional)

WEATHER PAGE SOFTKEYS (OPTIONAL)

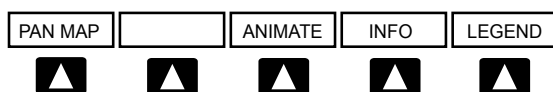

PAN MAP	Activates the map pointer for panning the map
ANIMATE	Animates NEXRAD Radar and Satellite Mosaic weather
INFO	Displays SiriusXM Information
LEGEND	Displays weather legends

TERRAIN PAGE SOFTKEYS



Terrain (TER) Page Softkeys
(Single Screen)



Terrain (TER) Page Softkeys
(Dual Screen)

- MAP Displays the Terrain Page Map View
- PROFILE Displays the Terrain Page Profile View.
- SETTINGS Displays the Terrain Setup Page
- DISABLE Toggles terrain alerts on/off.

XM AUDIO PAGE SOFTKEYS (OPTIONAL)



- INFO Displays SiriusXM Information
- CATEGORY Highlights the Category field
- CHANNEL Highlights the Channels field
- FAVORITE Displays a list of favorite channels
- VOLUME Enables second-level VOLUME softkeys
Press and hold to toggle Mute on/off.

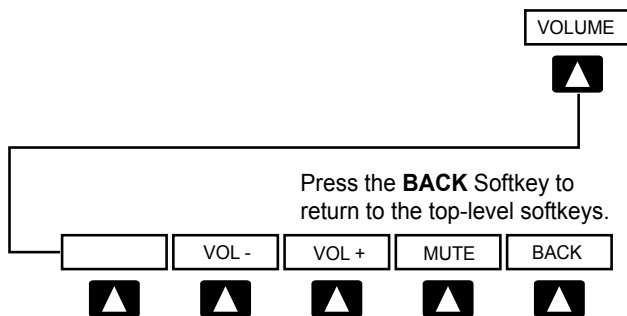

- VOL - Decreases SiriusXM audio volume
- VOL + Increases SiriusXM audio volume
- MUTE Toggles SiriusXM audio on/off
- BACK Returns to top-level softkeys

INFO PAGE SOFTKEY



- MESSAGES Displays system status messages

FLIGHT PLANNING SOFTKEYS

ACTIVE FLIGHT PLAN PAGE SOFTKEYS

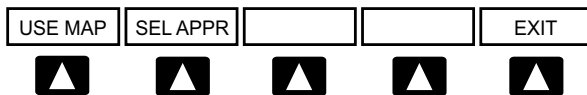

- USE MAP Activates the Map Pointer
- SEL APPR Displays the Select Approach Window
- EXIT Exits the Flight Plan Pages

FLIGHT PLAN LIST PAGE SOFTKEYS



- ACTIVATE Displays the 'Activate Flight Plan?' Window
- NEW Displays the 'New Flight Plan' Window
- IMPORT Displays the available flight plans to import from the SD Card
- EXPORT Exports the selected flight plan
- EXIT Exits the Flight Plan Pages

VERTICAL NAVIGATION (VNAV) PAGE SOFTKEYS



- CAPTURE Captures/cancels VNAV profile
- EXIT Exits the Flight Plan Pages

NEAREST PAGE SOFTKEYS

NEAREST AIRPORT PAGE SOFTKEYS



- PRIVATE Displays/removes the nearest private airports
- HELIPORT Displays/removes the nearest heliports
- EXIT Exits the Nearest Pages

Various softkeys revert to the previous level after 45 seconds of inactivity (e.g., PAN MAP, VOLUME, etc), other softkeys require manual de-selection (e.g., TERRAIN, WEATHER, PANEL, etc.).

1.8 ACCESSING THE INFORMATION (INFO) PAGE

VIEWING GPS RECEIVER STATUS

Internal system checking is performed to ensure the GPS receiver is providing accurate data to the GDU(s).

In the G300 two display system the GPS antenna is connected to the PFD only. The PFD shares its GPS position, velocity, and time data with the MFD. Because the MFD is not using its own GPS receiver, the name of the GDU providing the data (i.e., '3D GPS Location (PFD)') is displayed following the GPS Status text on the INFO Page.

The GPS Status will display one of the following conditions:

- Autolocate—Receiver is looking for any satellite whose almanac has been collected, which can take up to 5 minutes
- Searching the Sky—Receiver is looking for satellites
- Acquiring Satellites—Receiver is looking for and collecting data from satellites visible at its last known or initialized location, but has not acquired a fix
- 2D GPS Location—At least three satellites have been acquired and a two-dimensional location fix has been calculated. "2D Differential" appears when you are receiving DGPS corrections in 2D mode
- 3D GPS Location—At least four satellites have been acquired and a three-dimensional fix has been calculated. "3D Differential" appears when you are receiving DGPS corrections in 3D mode
- Lost Satellite Reception—the receiver is no longer tracking enough satellites for a 2D or 3D fix

GPS Status, Position, and Data Fields (full-screen only) can be accessed from the Information Page.

- System Overview
- Flight Instruments
- EIS
- COM Interface
- GPS Navigation
- Flight Planning
- Hazard Avoidance
- Additional Features
- Integrated Autopilot
- Annun/Alerts
- Appendix
- Index

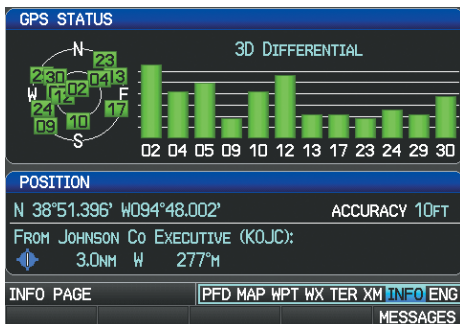

INFO Page (Split-Screen)

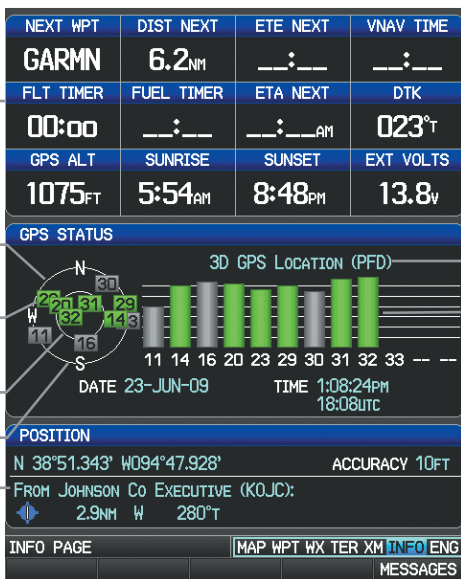

INFO Page (Full-Screen MFD)

Viewing GPS receiver status information:

- 1) If necessary press the **FMS** Joystick to begin interaction with the Navigation Bar.
- 2) Turn the **FMS** Joystick until the Info Page is selected.

NEW LOCATION

The 'New Location' menu option on the **INFO** Page is used when the GPS Receiver is having trouble finding the satellites it expects to be there.

Entering a new location:

- 1) From the **INFO** Page, while the unit is searching for satellites, press the **MENU** Key.
- 2) With 'New Location' menu option highlighted, press the **INFO** Key.
- 3) Move the **FMS** Joystick to highlight 'Use Map' or 'Use Identifier', and press the **ENT** Key.
- 4) After selecting your approximate position using the map pointer or entering an identifier, press the **ENT** Key.
- 5) The GPS Receiver will begin a new search based on the location entered.

ACQUIRING SATELLITES

When the receiver is in the process of acquiring enough satellite signals for navigation, the receiver uses satellite orbital data (collected continuously from the satellites) and last known position to determine the satellites that should be in view. "Acquiring Satellites" is indicated as the solution until a sufficient number of satellites have been acquired for computing a solution.

When the receiver is in the process of acquiring a 3D differential GPS solution, "3D GPS Location" is indicated as the solution until the 3D differential fix has finished acquisition.

SATELLITE INFORMATION

Satellites currently in view are shown at their respective positions on a satellite constellation diagram. The outer circle of the constellation diagram represents the horizon, the inner circle represents 45° above the horizon, and the center point shows the position directly overhead. Each satellite is represented by a square containing the Pseudo-Random Noise (PRN) number (i.e., satellite identification number).

The **INFO** Page can be helpful in troubleshooting weak (or missing) signal levels due to poor satellite coverage or installation problems. As the GPS receiver locks onto satellites, a signal strength bar is displayed for each satellite in view, with the appropriate satellite PRN number (01-32 or 33-64 for WAAS) below each bar. The progress of satellite acquisition is shown in three stages, as indicated by signal bar appearance:

- No bar—Receiver is looking for the indicated satellite
- Gray bar—Receiver has collected the necessary data and the satellite signal can be used
- Green bar—Satellite is being used for the GPS solution

POSITION

The Position box on the **INFO** Page displays latitude, longitude, accuracy (in feet), reference waypoint, type, distance, direction, and bearing. The reference waypoint is designed to display the current position in relation to a prominent landmark. The pilot can change the reference waypoint 'Nearest Type' using the 'Change Nearest Type' page menu option. By default the Nearest Type is set to 'Automatic', which will display the nearest large airport, enroute VOR, or city (in that order).

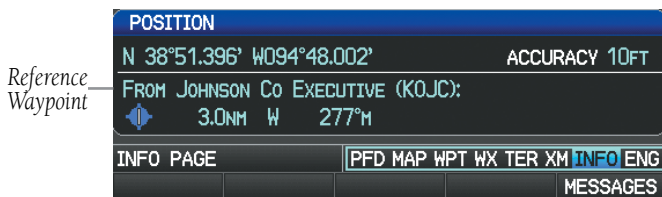

Position Information (INFO Page)

Changing the Nearest Type:

- 1) From the Info Page press the **MENU** Key.
- 2) Turn or move the **FMS** Joystick to highlight 'Change Nearest Type' and press the **ENT** Key.
- 3) Move the **FMS** Joystick to highlight the desired nearest type option (Automatic, Airport, VOR, NDB, Intersection, City, Waypoint), and press the **ENT** Key.

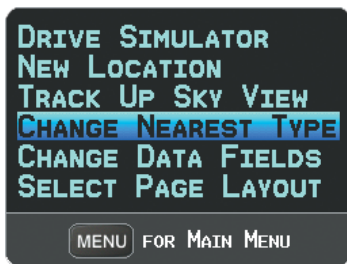

INFO Page Menu



Nearest Type Menu

DISPLAYING/REMOVING LAT/LON ON THE INFO PAGE

If the Location Format selected on the Position Setup Page (refer to Appendix D, Map Datum and Location Formats) is not set to a Lat/Lon format, a new menu option 'Lat/Lon' will appear on the **INFO** Page. Selecting 'Show Lat/Lon' allows simultaneous display of the current position in both the selected location format as well as Lat/Lon format.

DATA FIELDS AND LAYOUT (DUAL DISPLAY - MFD)

The page layout and Data Fields of the full-screen Info Page can be independently configured by the user. Refer to the Annunciations and Alerts Section for a list of available Info Page Data Field options.

Changing the Info Page Data Fields (Full-Screen):

- 1) From the Info Page press the **MENU** Key.
- 2) Turn or move the **FMS** Joystick to highlight 'Change Data Fields' and press the **ENT** Key. The cursor is displayed on the first Data Field.
- 3) Move the **FMS** Joystick to highlight the desired Data Field.
- 4) Turn the **FMS** Joystick to access a list of available Data Field options.
- 5) Turn or move the **FMS** Joystick to highlight the desired Data Field, and press the **ENT** Key.

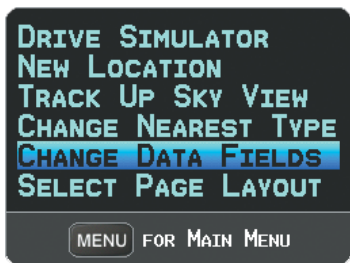

INFO Page Menu

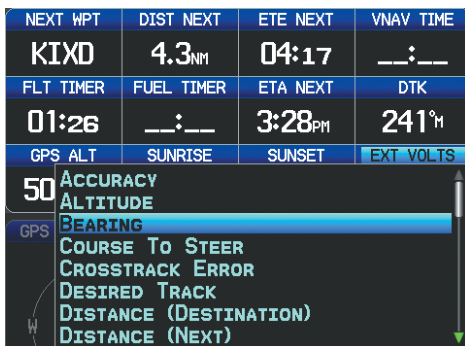

Data Field Options

Changing the Info Page layout:

- 1) From the Info Page press the **MENU** Key.
- 2) Turn or move the **FMS** Joystick to highlight 'Select Page Layout' and press the **ENT** Key.
- 3) Move the **FMS** Joystick to highlight the desired page layout option (1 Row, 2 Rows, 3 Rows), and press the **ENT** Key.

1.9 SYSTEM SETTINGS

The System Setup option in the Main Menu allows management of the following system parameters:

- Data Bar Fields
- Display
- Sound
- Units
- Date & Time
- Position
- Alarms

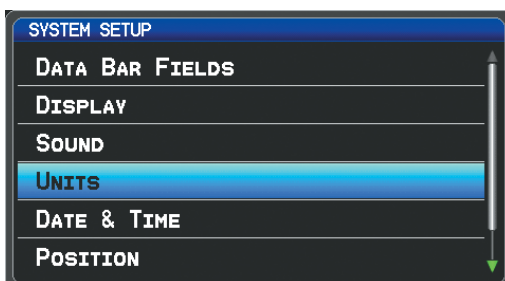

System Setup Menu (Split-Screen)

Restoring system setting defaults:

- 1) Press the **MENU** Key twice to display the Main Menu.
- 2) Turn or move the **FMS** Joystick to highlight 'System Setup...' and press the **ENT** Key.
- 3) Turn or move the **FMS** Joystick to highlight the desired menu option (Data Bar Fields, Display, Date & Time, Position, or Alarms), and press the **ENT** Key.
- 4) Press the **MENU** Key.
- 5) With 'Restore Default' highlighted press the **ENT** Key.

DATA BAR FIELDS

The content of the four data bar fields are independently configured by the user. The full-screen MFD and PFD Data Bar Fields are independently configured from each display.



Data Bar (PFD Page - Split-Screen)

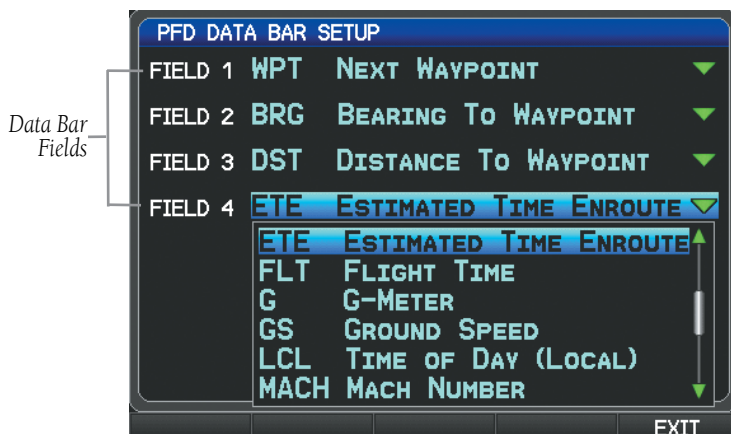

Data Bar Setup Page (Split-Screen)

By default, the split-screen and the full-screen PFD data bar fields are set to display Next Waypoint (WPT), Bearing to Waypoint (BRG), Distance to Waypoint (DST), and Estimated Time Enroute (ETE). The full-screen MFD data bar fields default to Ground Speed (GS), Ground Track (TRK), Minimum Safe Altitude (MSA), and Vertical Speed Required (VSR). These four data fields can be changed to display any of the Data Bar Field Options. Refer to the Annunciations and Alerts Section for a list of available Data Bar Field options.

Changing the information shown in the data bar fields:

- 1) Press the **MENU** Key twice to display the Main Menu.
- 2) Turn or move the **FMS** Joystick to highlight 'System Setup...' and press the **ENT** Key.

- 3) With 'Data Bar Fields' highlighted, press the **ENT** Key.
- 4) Move the **FMS** Joystick to highlight the desired 'Field'.
- 5) Turn the **FMS** Joystick to access the list of options, then turn or move the **FMS** Joystick to highlight the desired option and press the **ENT** Key.
- 6) To restore defaults, press the **MENU** Key. With 'Restore Default' highlighted, press the **ENT** Key.

DISPLAY

The Backlight Intensity (display brightness) can be set to 'Auto' or 'Manual'. 'Auto' sets the Backlight Intensity based on the aircraft's instrument lighting bus voltage. With 'Manual' selected, the pilot can manually adjust the desired backlight intensity (1-10). After each power cycle the Backlight Intensity is set to the default, which is configurable. Refer to the G300 Installation Manual for more information.

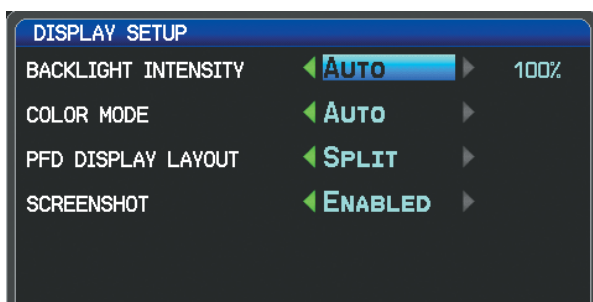

Display Setup Page

Adjusting backlight intensity:

- 1) Press the **MENU** Key twice to display the Main Menu.
- 2) Turn or move the **FMS** Joystick to highlight 'System Setup...' and press the **ENT** Key.
- 3) Turn or move the **FMS** Joystick to highlight 'Display', and press the **ENT** Key.
- 4) Turn the **FMS** Joystick to highlight 'Auto'.

Or:

- a) Turn the **FMS** Joystick to highlight 'Manual'.
 - b) Move the **FMS** Joystick to highlight the desired Backlight Intensity (1-10).
- 5) Press the **FMS** Joystick, the **CLR** Key, the **EXIT** Softkey or the **MENU** Key to return to the previous page.

COLOR MODE

The Color Mode setting is used to adjust the color brightness used on the map and synthetic vision display for day or night use.

Adjusting the color mode:

- 1) Press the **MENU** Key twice to display the Main Menu.
- 2) Turn or move the **FMS** Joystick to highlight 'System Setup...' and press the **ENT** Key.
- 3) Turn or move the **FMS** Joystick to highlight 'Display', and press the **ENT** Key.
- 4) Move the **FMS** Joystick to highlight the Color Mode field.
- 5) Turn the **FMS** Joystick to highlight 'Day', 'Night', or 'Auto'.
- 6) Press the **FMS** Joystick, the **CLR** Key, the **EXIT** Softkey or the **MENU** Key to return to the previous page.

Changing the PFD Display Layout:

- 1) Press the **MENU** Key twice to display the Main Menu.
- 2) Turn or move the **FMS** Joystick to highlight 'System Setup...' and press the **ENT** Key.
- 3) Turn or move the **FMS** Joystick to highlight 'Display', and press the **ENT** Key.
- 4) Move the **FMS** Joystick to highlight the PFD Display Layout field.
- 5) Turn the **FMS** Joystick to highlight 'Auto' or 'Split'.
- 6) Press the **FMS** Joystick, the **CLR** Key, the **EXIT** Softkey or the **MENU** Key to return to the previous page.

Enabling/disabling screenshots:

- 1) Press the **MENU** Key twice to display the Main Menu.
- 2) Turn or move the **FMS** Joystick to highlight 'System Setup...' and press the **ENT** Key.
- 3) Turn or move the **FMS** Joystick to highlight 'Display', and press the **ENT** Key.
- 4) Move the **FMS** Joystick to highlight the Screenshot field.
- 5) Turn the **FMS** Joystick to highlight 'Enabled' or 'Disabled'.

Saving a screenshot:

- 1) With screenshots enabled (see above), navigate to the desired screen.
- 2) Press and hold the **FMS** Joystick until the screen flashes indicating the screenshot was saved to the SD Card.

SOUND

The pilot can manually adjust the desired XM Volume (0-10), Message Volume (Off or 1-10), Altitude Alert (On/Off), and Minimums Alert (On/Off). Message Volume controls the banner message tones (e.g., "Approaching Airspace" or "Arriving at Waypoint"). Alert Volume (e.g., terrain, autopilot, etc.) is set in configuration mode (refer to the G300 Installation Manual for more information).

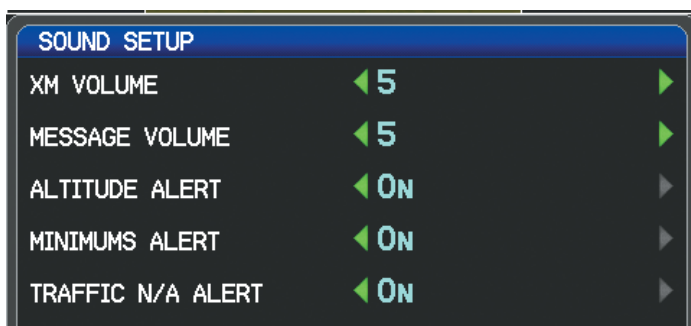

Sound Setup Page (Split-Screen)

Adjusting XM and/or Message Volume:

- 1) Press the **MENU** Key twice to display the Main Menu.
- 2) Turn or move the **FMS** Joystick to highlight 'System Setup...' and press the **ENT** Key.

- 3) Turn or move the **FMS** Joystick to highlight 'Sound', and press the **ENT** Key.
- 4) Move the **FMS** Joystick to highlight the desired field (XM Volume or Message Volume), and select the desired volume by turning the **FMS** Joystick.
- 5) Press the **FMS** Joystick, the **CLR** Key, the **EXIT** Softkey or the **MENU** Key to return to the previous page.

Turning the altitude alert tone on/off:



NOTE: Refer to the *Flight Instruments* section for more information regarding the *Altitude Alert Tone*.

- 1) Press the **MENU** Key twice to display the Main Menu.
- 2) Turn or move the **FMS** Joystick to highlight 'System Setup...' and press the **ENT** Key.
- 3) Turn or move the **FMS** Joystick to highlight 'Sound', and press the **ENT** Key.
- 4) Move the **FMS** Joystick to highlight the Altitude Alert field, and select 'On/Off' by turning the **FMS** Joystick.

Turning the minimums alert tone on/off:



NOTE: Refer to the *Flight Instruments* section for more information regarding the *Minimums Alert Tone*.

- 1) Press the **MENU** Key twice to display the Main Menu.
- 2) Turn or move the **FMS** Joystick to highlight 'System Setup...' and press the **ENT** Key.
- 3) Turn or move the **FMS** Joystick to highlight 'Sound', and press the **ENT** Key.
- 4) Move the **FMS** Joystick to highlight the Minimums Alert field, and select 'On/Off' by turning the **FMS** Joystick.

UNITS

Changing unit settings:

- 1) Press the **MENU** Key twice to display the Main Menu.
- 2) Turn or move the **FMS** Joystick to highlight 'System Setup...' and press the **ENT** Key.
- 3) Turn or move the **FMS** Joystick to highlight 'Units' and press the **ENT** Key.
- 4) Move the **FMS** Joystick to highlight the desired field, and select the desired unit by turning the **FMS** Joystick.
- 5) Press the **FMS** Joystick, the **CLR** Key, the **EXIT** Softkey or the **MENU** Key to return to the previous page.

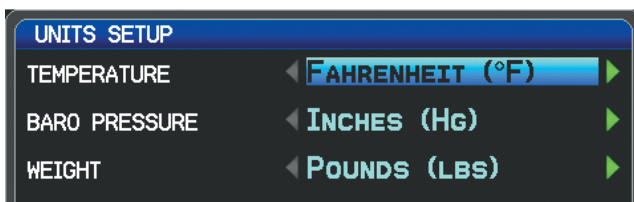

Units Setup Page (Split-Screen)

DATE & TIME

Changing date & time settings:

- 1) Press the **MENU** Key twice to display the Main Menu.
- 2) Turn or move the **FMS** Joystick to highlight 'System Setup...' and press the **ENT** Key.
- 3) Turn or move the **FMS** Joystick to highlight 'Date & Time' and press the **ENT** Key.
- 4) Move the **FMS** Joystick to highlight the desired field, and select the desired option by turning the **FMS** Joystick.
- 5) Press the **FMS** Joystick, the **CLR** Key, the **EXIT** Softkey or the **MENU** Key to return to the previous page.

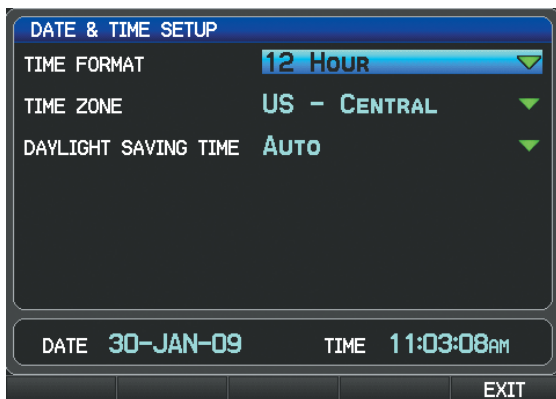

Date & Time Setup Page (Split-Screen)

POSITION



NOTE: Refer to Appendix D for more information on Map Datums and Location Formats.



NOTE: 'Heading' and 'Mag. Variation' settings have no effect on the HSI or the Heading Tape.

Changing position settings:

- 1) Press the **MENU** Key twice to display the Main Menu.
- 2) Turn or move the **FMS** Joystick to highlight 'System Setup...' and press the **ENT** Key.
- 3) Turn or move the **FMS** Joystick to highlight 'Position' and press the **ENT** Key.
- 4) Move the **FMS** Joystick to highlight the desired field, and select the desired option by turning the **FMS** Joystick.
- 5) Press the **FMS** Joystick, the **CLR** Key, the **EXIT** Softkey or the **MENU** Key to remove the menu.

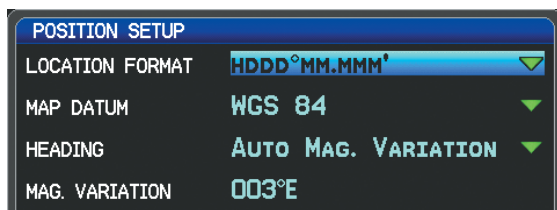

Position Setup Page (Split-Screen)

ALARMS

The Alarms Page allows the pilot to turn airspace alarms On/Off, set an Altitude Buffer, Arrival Alarm, Next Waypoint Alarm, Proximity Alarm, and Fuel Tank Reminder Alarm.

Changing alarm settings:

- 1) Press the **MENU** Key twice to display the Main Menu.
- 2) Turn or move the **FMS** Joystick to highlight 'System Setup...', and press the **ENT** Key.
- 3) Turn or move the **FMS** Joystick to highlight 'Alarms' and press the **ENT** Key. Pressing the **AIRSPACE** Softkey displays the Airspace Alarms Page. Pressing the **NAV** Softkey displays the Arrival Alarm, Next Waypoint Alarm, Proximity Alarm, and Fuel Tank Reminder (split-screen only).
- 4) Move the **FMS** Joystick to highlight the desired field, and select the desired option by turning the **FMS** Joystick.
- 5) Press the **FMS** Joystick, the **CLR** Key, the **EXIT** Softkey or the **MENU** Key to remove the menu.



Airspace Alarms (Split-Screen)



Nav Alarms (Split-Screen)

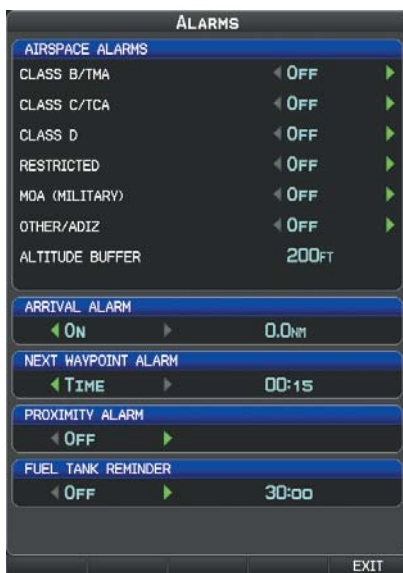

Alarms (Split-Screen MFD)

SETTING AIRPORT CRITERIA

The Page Menu on the Nearest Airports Page allows the pilot to filter out airports that do not meet a defined criteria. Specific surface types and runway lengths can be defined, as well as the option to include private airports and/or heliports.

- **Runway Surface:** Allows the pilot to set criteria for the type of surface on the runway.
 - Any: Shows any runway, regardless of surface type, including water landing facilities.
 - Hard Only: Shows only runways with a concrete, asphalt, or similar sealed surface.
 - Hard or Soft: Shows all runways except water landing facilities.
 - Water Only: Shows only water landing facilities.
- **Minimum Runway Length:** Allows the pilot to enter a specific length for the shortest runway allowed.
- **Include Private Airports:** Allows the pilot include Private Airports in the search criteria.

Entering airport criteria:

- 1) Press the **NRST** Key.
- 2) Turn the **FMS** Joystick to select the Nearest Airports Page.
- 3) Press the **MENU** Key to display the Page Menu.
- 4) Turn or move the **FMS** Joystick to select 'Set Airport Criteria', and then press the **ENT** Key. The Airport Criteria Window appears with the current settings.



Nearest Airports Page Menu

- 5) Move the **FMS** Joystick to highlight the desired field and turn the **FMS** Joystick to select the desired option from the menu. Press the **ENT** Key if necessary to highlight the next field.

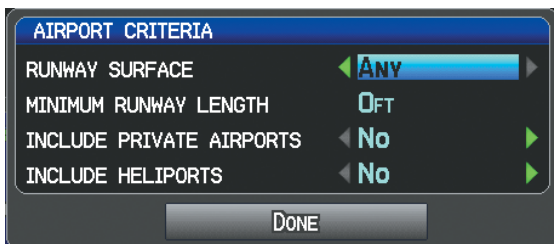

Airport Criteria Window

- 6) With 'Done' highlighted press the **ENT** Key.

Restoring airport criteria defaults:

- 1) Press the **NRST** Key.
- 2) Turn the **FMS** Joystick to select the Nearest Airports Page.
- 3) Press the **MENU** Key to display the Page Menu.
- 4) Turn or move the **FMS** Joystick to select 'Set Airport Criteria', and then press the **ENT** Key. A window appears with the current settings.
- 5) Press the **MENU** Key.
- 6) With 'Restore Default' highlighted press the **ENT** Key.

SECTION 2 FLIGHT INSTRUMENTS

2.1 FLIGHT INSTRUMENTS

Increased situational awareness is provided by replacing the traditional instruments on the panel with an easy-to-scan Primary Flight Display (PFD) that features a horizon, airspeed, attitude, altitude, vertical speed, heading, and course deviation information.

The single display system has a dedicated PFD that occupies the top portion of the display at all times. Select the PFD Page in order to view the Horizontal Situation Indicator (HSI), Outside Air Temperature (OAT), System Time, selected course, and selected heading.



PFD Page (Single Display)



PFD (Dual Display)

Selecting the PFD Page (singly display system):

- 1) Press the **FMS** Joystick if necessary to begin interaction with the Page Navigation Bar.
- 2) Turn the **FMS** Joystick to select the **PFD** Page.

The following flight instruments and supplemental flight data are displayed on the PFD and/or PFD Page (single display system).

- System Overview
- Flight Instruments
- EIS
- COM Interface
- GPS Navigation
- Flight Planning
- Hazard Avoidance
- Additional Features
- Integrated Autopilot
- Annun/Alerts
- Appendix
- Index



- | | | | |
|----|--|----|--|
| 1 | Airspeed Indicator | 16 | Vertical Speed Indicator (VSI) |
| 2 | Lateral Deviation Scale & Course Deviation | 17 | Altimeter |
| 3 | True Airspeed | 18 | Current Vertical Speed |
| 4 | Current Track Indicator (HSI) | 19 | Required Vertical Speed Indicator (RVSI) |
| 5 | Selected Heading | 20 | Vertical Deviation Scale |
| 6 | Wind Data | 21 | Selected Altitude Bug |
| 7 | Selected Heading Bug (HSI) | 22 | Selected Altitude |
| 8 | Course Deviation Indicator (CDI) | 23 | VNAV Indicator |
| 9 | Outside Air Temperature (OAT) | 24 | Heading Strip |
| 10 | System Time | 25 | Turn Rate Indicator |
| 11 | Horizontal Situation Indicator (HSI) | 26 | Current Heading |
| 12 | Course Deviation Indicator (CDI) Scale | 27 | Current Track Indicator (Heading Strip) |
| 13 | Selected Course | 28 | Selected Heading Bug |
| 14 | Slip/Skid Indicator | 29 | Attitude Indicator |
| 15 | Altimeter Barometric Setting | | |

AIRSPEED INDICATOR

The Airspeed Indicator displays airspeed on a rolling number gauge using a moving tape. The true airspeed (TAS) is displayed in knots below the Airspeed Indicator. The numeric labels and major tick marks on the moving tape are marked at intervals of 10 knots. Speed indication starts at 20 knots, with 60 knots of airspeed viewable at any time. The actual airspeed is displayed inside the black pointer. The pointer remains black until reaching never-exceed speed (V_{NE}), at which point it turns red.

A color-coded (red, white, green, yellow, and red/white “barber pole”) speed range strip is located on the moving tape. The colors denote flaps operating range, normal operating range, caution range, and never-exceed speed (V_{NE}). A red range is also present for low speed awareness.

The Airspeed Trend Vector is a vertical, magenta line, extending up or down on the airspeed scale, shown to the right of the color-coded speed range strip. The end of the trend vector corresponds to the predicted airspeed in 6 seconds if the current rate of acceleration is maintained. If the trend vector crosses V_{NE} , the text of the actual airspeed readout changes to yellow. The trend vector is absent if the speed remains constant or if any data needed to calculate airspeed is not available due to a system failure.

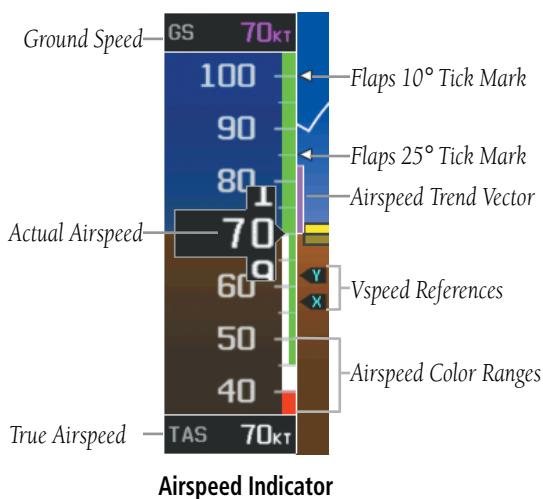

VSPEED REFERENCE

When airspeed is present, the Vs speeds (V_x and V_y) are also displayed at their respective locations to the right of the airspeed scale, otherwise the Vs speeds are displayed at the bottom of the airspeed indicator.

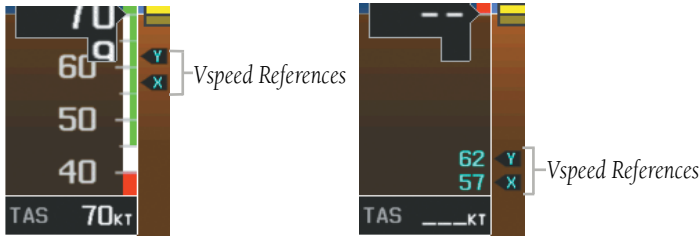

Vspeed References
(with airspeed)

Vspeed References
(without airspeed)

ATTITUDE INDICATOR

Attitude information is displayed over a virtual blue sky and brown ground with a white horizon line. The Attitude Indicator displays the pitch (indicated by the yellow symbolic aircraft on the pitch scale), roll, and slip/skid information.

The horizon line is part of the pitch scale. Pitch markings occur at 2.5° intervals through all pitch ranges.

The inverted white triangle indicates zero on the roll scale. Major tick marks at 30° and 60° and minor tick marks at 10°, 20°, and 45° are shown to the left and right of the zero. Angle of bank is indicated by the position of the pointer on the roll scale.

Slip/skid is indicated by the location of the ball.

- System Overview
- Flight Instruments
- EIS
- COM Interface
- GPS Navigation
- Flight Planning
- Hazard Avoidance
- Additional Features
- Integrated Autopilot
- Annun/Alerts
- Appendix
- Index

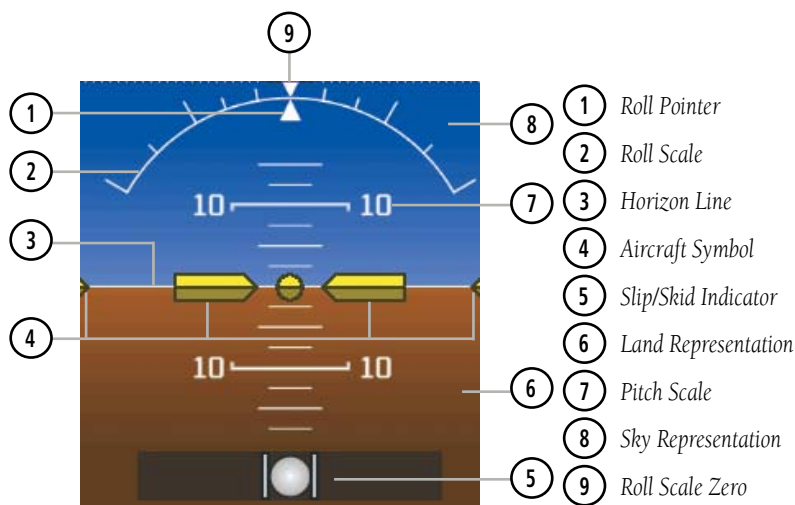

Attitude Indicator

ALTIMETER

The Altimeter displays 400 feet of barometric altitude values at a time on a rolling number gauge using a moving tape. Numeric labels and major tick marks are shown at intervals of 100 feet. Minor tick marks are at intervals of 20 feet. The current altitude is displayed in the black pointer.

The Selected Altitude is displayed above the Altimeter in the box indicated by a selection bug symbol. A bug corresponding to this altitude is shown on the tape; if the Selected Altitude exceeds the range shown on the tape, the bug appears at the corresponding edge of the tape.

- System Overview
- Flight Instruments
- EIS
- COM Interface
- GPS Navigation
- Flight Planning
- Hazard Avoidance
- Additional Features
- Integrated Autopilot
- Annun/Alerts
- Appendix
- Index

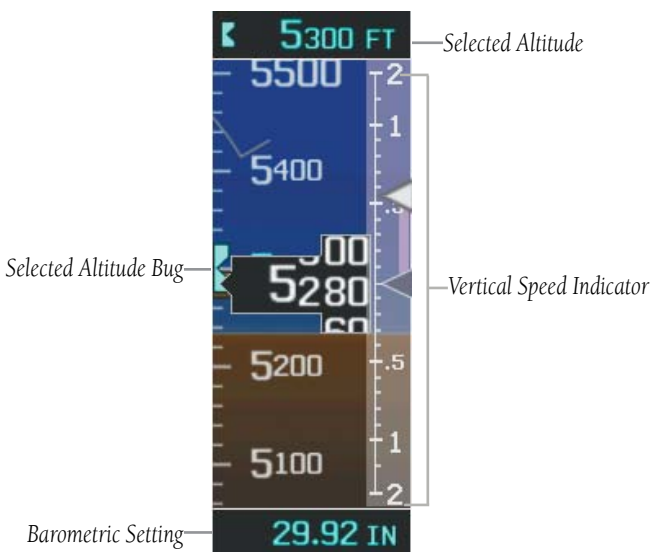

Altimeter

Setting the selected altitude:

- 1) From the PFD Page (one display) or PFD (two display), press the **ALT** Softkey
- 2) Turn the **FMS** Joystick to set the Selected Altitude in 100-ft increments

Syncing to the current altitude:

- 1) From the PFD Page (one display) or PFD (two display), press the **ALT** Softkey
- 2) Press and hold the **FMS** Joystick. The current altitude is now displayed as the Selected Altitude.

BAROMETRIC PRESSURE

The barometric pressure setting is displayed below the Altimeter in inches of mercury (in Hg) or hectopascals (hPa) when metric units are selected.

Selecting the altimeter barometric pressure setting:

- 1) From the PFD Page (one display) or PFD (two display), press the **BARO** Softkey to highlight the barometric pressure setting.
- 2) Turn the **FMS** Joystick to display the desired barometric pressure setting and press the **ENT** Key.

Syncing to the local barometric pressure setting:

- 1) From the PFD Page (one display) or PFD (two display), press the **BARO** Softkey.
- 2) While stationary on the ground, press and hold the **FMS** Joystick.
- 3) Verify indicated altitude matches local field elevation.

BAROMETRIC MINIMUM ALERT

For altitude awareness, a barometric Minimum Descent Altitude (MDA) can be set by the user and is reset when the power is cycled. Once the user-defined altitude is within the range of the tape, a cyan bug appears at the reference altitude on the Altimeter. Once the aircraft reaches the user-defined MDA/DH, the bug and text turn yellow and the aural alert, "Minimums. Minimums", is heard.

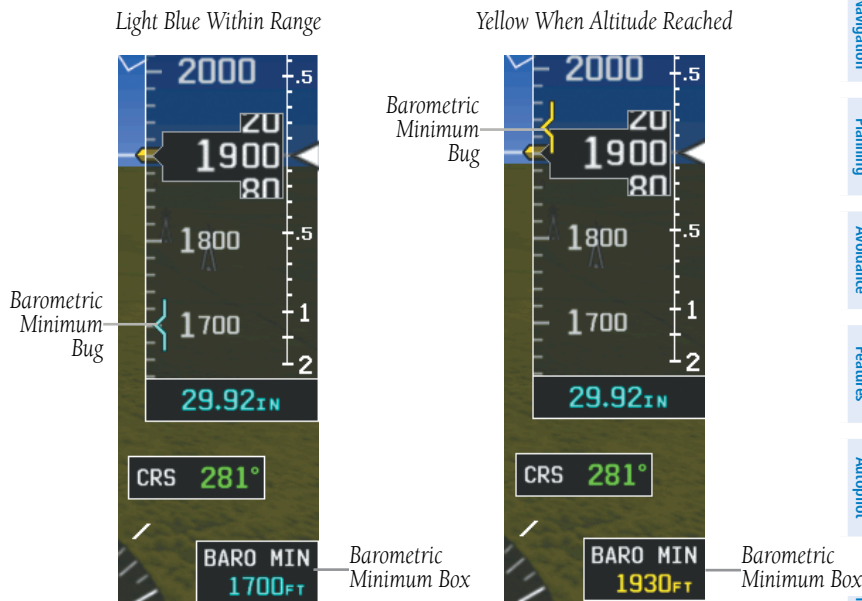

Barometric Minimum Visual Annunciations

Setting the barometric minimum alert bug:

- 1) From the PFD Page (one display) or PFD (two display), press the **BARO** Softkey.
- 2) Press the **MINIMUMS** Softkey.
- 3) Turn the **FMS** Joystick to display the desired alert altitude and press the **ENT** Key.

Canceling the barometric minimum alert bug:

- 1) From the PFD Page (one display) or PFD (two display), press the **BARO** Softkey.
- 2) Press the **MINIMUMS** Softkey.
- 3) Press the **CLR** Key.

Turning the minimums alert tone on/off:

- 1) Press the **MENU** Key twice to display the Main Menu.
- 2) Turn or move the **FMS** Joystick to highlight 'System Setup...' and press the **ENT** Key.
- 3) Turn or move the **FMS** Joystick to highlight 'Sound', and press the **ENT** Key.
- 4) Move the **FMS** Joystick to highlight the Minimums Alert field, and select 'On/Off' by turning the **FMS** Joystick.

ALTITUDE ALERTING

The Altitude Alerting function provides the pilot with visual and aural alerts when approaching the Selected Altitude. Whenever the Selected Altitude is changed, the Altitude Alerter is reset. The following will occur when approaching the Selected Altitude:

- Passing within 1000 feet of the Selected Altitude, the Selected Altitude (shown above the Altimeter) flashes for 5 seconds and an aural tone is generated.
- When the aircraft passes within 200 ft of the Selected Altitude, the Selected Altitude flashes for 5 seconds to indicate that the aircraft is approaching the selected altitude.
- After reaching the Selected Altitude, if the pilot flies outside the deviation band (± 200 Feet of the Selected Altitude), the Selected Altitude changes to yellow text on a black background, flashes for 5 seconds, and an aural tone is generated.

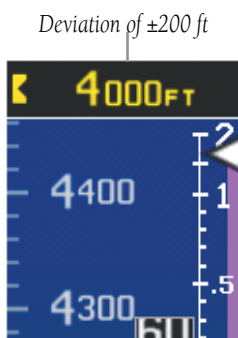

Altitude Alerting Visual Annunciation

Turning the altitude alert tone on/off:

- 1) Press the **MENU** Key twice to display the Main Menu.
- 2) Turn or move the **FMS** Joystick to highlight 'System Setup...' and press the **ENT** Key.
- 3) Turn or move the **FMS** Joystick to highlight 'Sound', and press the **ENT** Key.
- 4) Move the **FMS** Joystick to highlight the Altitude Alert field, and select 'On/Off' by turning the **FMS** Joystick.

VERTICAL SPEED INDICATOR (VSI)

The Vertical Speed Indicator displays the aircraft vertical speed using a non-moving tape labeled at 500, 1000 and 2000 fpm with minor tick marks every 100 feet up to 1000 fpm. The current vertical speed is displayed using a white arrow along the tape.

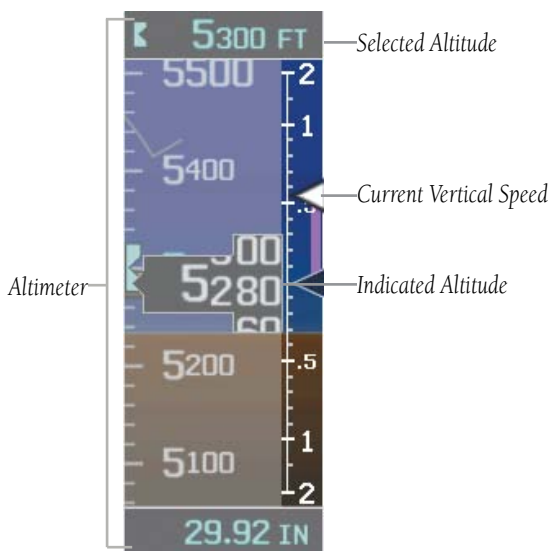

Vertical Speed Indicator

VNAV INDICATOR

When the VNAV profile is defined, the pilot is informed of the progress by message alerts. A magenta chevron (VNAV Indicator) to the left of the altimeter on the Vertical Deviation Scale shows the VNAV profile, and a magenta chevron (Required Vertical Speed Indicator (RVSI)) on the Vertical Speed Indicator indicates the required vertical speed to reach the target altitude. Refer to section 2.3 for more information.

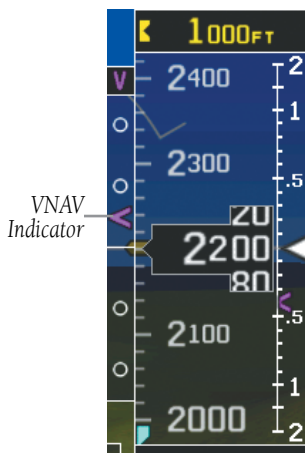

VNAV Indicator

HORIZONTAL SITUATION INDICATOR (HSI)

The Horizontal Situation Indicator (HSI) displays a rotating compass card in a heading-up orientation at the bottom of the page. Letters indicate the cardinal points and numeric labels occur every 30°. Major tick marks are at 10° intervals and minor tick marks at 5° intervals. The current track is represented on the HSI by a magenta triangle and dashed line. The HSI also presents course deviation, bearing, and navigation source information.

The Selected Heading is shown to the left of the HSI. The light blue bug on the compass rose corresponds to the Selected Heading.

Adjusting the selected heading:

- 1) From the PFD Page (one display) or PFD (two display), press the **HDG** Softkey (if necessary). The Heading Box is highlighted.
- 2) Turn the **FMS** Joystick to select the desired heading, and press the **ENT** Key.

The Selected Course is shown to the right of the HSI.

Syncing to the current heading:

- 1) From the PFD Page (one display) or PFD (two display), press the **HDG** Softkey (if necessary).
- 2) Press and hold the **FMS** Joystick. The current heading is now displayed as the Selected Heading.



- | | |
|------------------------------------|--|
| ① Lubber Line | ⑦ To/From Indicator |
| ② Current Track Indicator | ⑧ Aircraft Symbol |
| ③ Course Pointer | ⑨ Lateral Deviation Scales |
| ④ Navigation Source | ⑩ Selected Heading Bug |
| ⑤ Course Deviation Indicator (CDI) | ⑪ Course Deviation & To/From Indicator |
| ⑥ Rotating Compass Rose | |

Horizontal Situation Indicator (HSI)

COURSE DEVIATION INDICATOR (CDI)

The HSI contains a Course Deviation Indicator (CDI), with a Course Pointer, To/From Indicator, and a sliding deviation bar and scale. The course pointer is a single line arrow which points in the direction of the set course. The To/From arrow rotates with the course pointer and is displayed when the active NAVAID is received.

The Course Deviation Indicator (CDI) moves left or right from the course pointer along a lateral deviation scale to display aircraft position relative to the course. If the course deviation data is not valid, the CDI is not displayed.

The full scale limits for the CDI are defined by a GPS-derived distance. If the CDI exceeds the maximum deviation on the scale (two dots), the crosstrack error (XTK) is displayed below the white aircraft symbol.

Another Lateral Deviation Scale and combination Course Deviation and To-From Indicator is located below the slip/skid indicator.

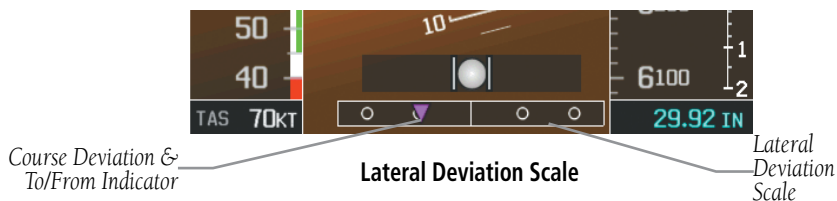

AUTOMATIC CDI SCALE SELECTION (DEFAULT)

Three factors determine the default distance from the center of the CDI to full left or right limits:

- CDI scale = 1.25 nm - within 30 nm of any airport in the active route.
- CDI scale = 0.25 nm - on an approach leg or within 2 nm of the FAF or MAP.
- CDI scale = 5.0 nm - if the previous two conditions do not exist.

MANUAL CDI SCALE SELECTION

The Automatic CDI Scale Selection will resume once the default determining factor for the current phase of flight matches the user-selected CDI scale.

Adjusting the CDI scale:

From the split-screen or full-screen PFD, press the **RNG** Key down arrow to zoom in (decrease CDI scale), or the up arrow to zoom out (increase CDI scale).

The current CDI scale appears in the upper right corner of the HSI.



Horizontal Situation Indicator (HSI)

BEARING POINTERS AND INFORMATION WINDOWS

Two bearing pointers and associated information can be displayed on the HSI for GPS sources. The bearing pointers are light blue and are single-line (Bearing Pointer 1) or double-line (Bearing Pointer 2). A pointer symbol is shown in the information windows to indicate the navigation source. The bearing pointers never override the CDI and are visually separated from the CDI by a white ring (shown when the bearing pointers are selected but not necessarily visible due to data unavailability).

When a bearing pointer is displayed, its associated information window is also displayed. The Bearing Information Windows are displayed at the lower sides of the HSI. The following information may be displayed in the Bearing Information Windows:

- Bearing source (GPS)
- Pointer icon (single lined or double lined)
- Station/waypoint identifier (GPS)
- GPS-derived great circle distance to bearing source

The bearing pointer is removed from the HSI and "NO DATA" is displayed in the information window if GPS is the bearing source and an active waypoint is not selected.



Bearing 1 Information Window
-Identifier
-Bearing Source

Bearing 2 Information Window
-Identifier
-Distance

HSI with Bearing Pointers

Enabling/disabling the bearing pointer and changing sources:

- 1) From the full screen PFD and/or split screen PFD Page, press the **MENU** Key.
- 2) Move the **FMS** Joystick to highlight the desired Bearing Pointer.
- 3) Turn the **FMS** Joystick to highlight the desired source, or to remove the bearing pointer and information window, highlight 'Off'.

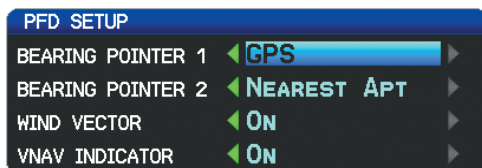

Set Bearing Pointer

HEADING STRIP AND TURN RATE INDICATOR

The Heading Strip displays the Current Heading, Selected Heading Bug, Current Heading, and Current Track Indicator. Numeric labels occur every 10°. Major tick marks are at 5° intervals and minor tick marks at 1° intervals. A digital reading of the current heading appears above the Attitude Indicator.

The Turn Rate Indicator is located above the Heading Strip. Tick marks to the left and right of the displayed heading denote standard turn rates (3 deg/sec). A magenta Turn Rate Trend Vector shows the current turn rate. The end of the trend vector gives the heading predicted in 6 seconds, based on the present turn rate. A standard-rate turn is shown on the indicator by the trend vector stopping at the standard turn rate tick mark, corresponding to a predicted heading of 18° from the current heading. At rates greater than 4 deg/sec, an arrowhead appears at the end of the magenta trend vector and the prediction is no longer valid.



Heading Strip/Turn Rate Indicator

OBS MODE

Enabling Omni-bearing Selector (OBS) Mode suspends the automatic sequencing of waypoints in a GPS flight plan, but retains the current "active-to" waypoint as the navigation reference even after passing the waypoint. 'OBS' is annunciated to the right of the aircraft symbol when OBS Mode is selected.

While OBS Mode is enabled, a course line is drawn through the "active-to" waypoint on the moving map. If desired, the course to/from the waypoint can now be adjusted. When OBS Mode is disabled, the GPS flight plan returns to normal operation with automatic sequencing of waypoints, following the course set in OBS Mode. The flight path on the moving map retains the modified course line.

Extended Course Line



OBS Mode Annunciation

OBS Mode Box



OBS CRS Softkey

Omni-bearing Selector (OBS) Mode (Split-Screen)

Enabling/disabling OBS Mode while navigating a GPS flight plan:

- 1) From the PFD Page (one display) or PFD (two display), press the **FPL** Key.
- 2) On the Active Flight Plan Page while navigating a flight plan or Direct-to, press the **MENU** Key
- 3) With 'Set OBS and Hold' highlighted, press the **ENT** Key. The Course To XXXX box is displayed.
- 4) Turn the **FMS** Joystick to select the desired course to/from the waypoint, and press the **ENT** Key.
- 5) To cancel OBS Mode and return to automatic waypoint sequencing, from the Active Flight Plan Page press the **MENU** Key, with 'Release Hold' highlighted, press the **ENT** Key.

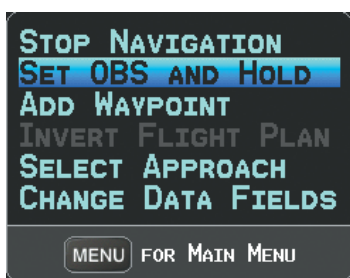

Active Flight Plan Page Menu
(Set OBS Mode)

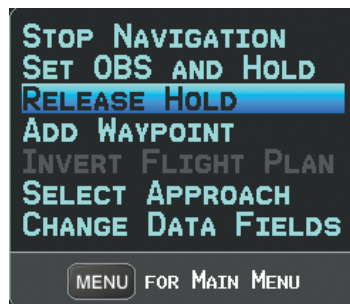

Active Flight Plan Page Menu
(Release OBS Mode)

Syncing to the current aircraft location:

- 1) With OBS Mode enabled, press the **OBS CRS** Softkey (if necessary).
- 2) Press and hold the **FMS** Joystick. The course is now synced to the current aircraft track.

2.2 SUPPLEMENTAL FLIGHT DATA

In addition to the flight instruments, the PFD or PFD Page also displays various supplemental information, including the Outside Air Temperature (OAT), wind data, and Vertical Navigation (VNAV) indications.

OUTSIDE AIR TEMPERATURE

The Outside Air Temperature (OAT) is displayed in degrees Fahrenheit (°F) in the lower left of the PFD or PFD Page.

Outside Air Temperature



Outside Air Temperature (Split-Screen PFD)

WIND DATA

Wind direction/speed or headwind/Crosswind information can be displayed in a window to the upper left of the HSI. When the window is selected for display, but wind information is invalid or unavailable, the window displays "No Wind Data".

Showing/hiding wind data:

- 1) From the full-screen PFD and/or split-screen PFD Page, press the **MENU** Key.
- 2) Move the **FMS** Joystick to highlight the Wind Vector field.
- 3) Turn the **FMS** Joystick to highlight 'Speed/Dir' or 'Head/X-wind'.



Wind Data

2.3 VERTICAL NAVIGATION (VNAV)



CAUTION: VNAV is only a VFR navigation aid and is not intended for instrument approaches.

The Vertical Navigation Page provides settings for the vertical navigation feature. These settings create a three-dimensional profile from the present location and altitude to a final (target) altitude at a specified location.

When the VNAV profile is defined, the pilot is informed of the progress by message alerts. A magenta chevron (VNAV Indicator) to the left of the altimeter on the Vertical Deviation Scale shows the VNAV profile, and a magenta chevron (Required Vertical Speed Indicator (RVSI)) on the Vertical Speed Indicator indicates the required vertical speed to reach the target altitude.

The Vertical Navigation feature is only available when navigating a Direct-to or flight plan, and the ground speed is greater than 35 knots.

One minute prior to the initial descent point the “Approaching VNAV Profile” message appears and the ‘Estimated Time to VNAV’ (on Active Flight Plan Page) goes blank. The descent angle locks to prevent changes in speed from altering the profile. The VNAV feature does not take into account any changes in ground speed that occur during the transition from level flight to descent or climb.

APPROACHING VNAV PROFILE

At 200 ft above the target altitude, the “Approaching Target Altitude” message appears, and the VNAV indicator disappears from the PFD.

System Overview

Flight Instruments

EIS

COM Interface

GPS Navigation

Flight Planning

Hazard Avoidance

Additional Features

Integrated Autopilot

Annun/Alerts

Appendix

Index

APPROACHING TARGET ALTITUDE

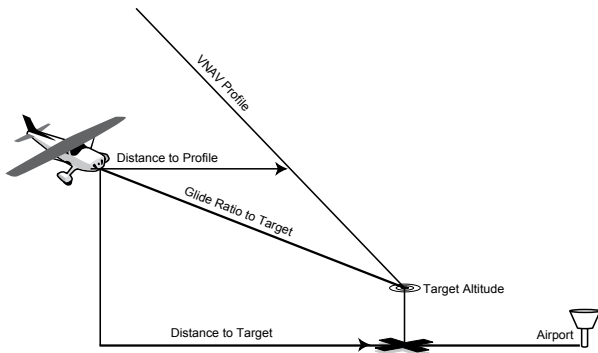

Visual Representation of VNAV

USING THE VNAV FEATURE

Use the VNAV (Vertical Navigation) feature to ensure the aircraft is at the proper altitude. The magenta VNAV Indicator appears on the PFD. A message appears when approaching the VNAV Profile. When the VNAV Indicator is in the vertical center of the Vertical Deviation Scale, the aircraft is at the proper altitude for the VNAV Profile.

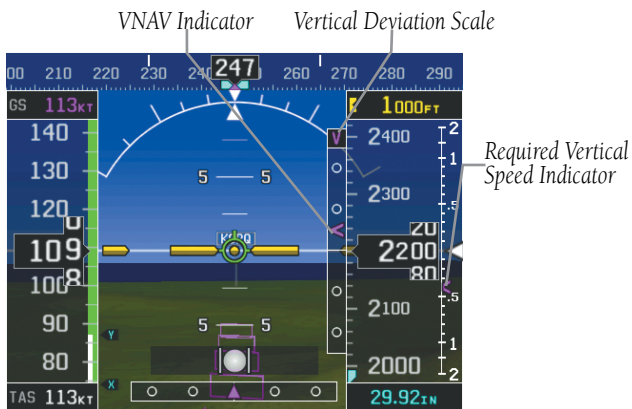

VNAV Indications (PFD)

Configuring a VNAV profile:

- 1) Press the **FPL** Key.
- 2) Turn the **FMS** Joystick to select the Vertical Navigation Page.
- 3) Press the **FMS** Joystick to activate the cursor.
- 4) Enter the desired profile into the fields, and press the **EXIT** Softkey.

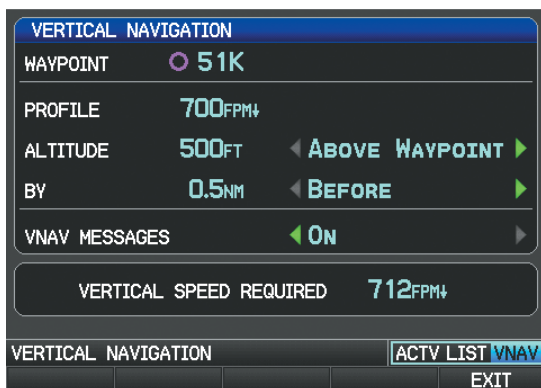

Vertical Navigation Page (Split-Screen)

- Waypoint—Enter any waypoint along the currently active route as the reference waypoint. The reference waypoint defines the target location.
- Profile—Enter the descent rate.
- Altitude—Enter the desired reference waypoint altitude. Select 'Above Waypoint' to use field elevation for airports in the Jeppesen database or 'MSL' to specify an exact MSL altitude target.
- By—Enter the target location with settings of distance 'Before' or 'After' a reference waypoint. To set a target location at a reference waypoint, enter a distance of zero.
- VNAV Messages—Select 'On' or 'Off' to enable/disable VNAV alert messages.

Enabling/disabling the VNAV indicator:

- 1) From the full-screen PFD and/or the split-screen PFD Page, press the **MENU** Key.
- 2) Move the **FMS** Joystick to highlight the VNAV Indicator field.
- 3) Turn the **FMS** Joystick to highlight 'On' or 'Off'.

Force capture of the VNAV profile:

- 1) Enter a valid VNAV profile and begin navigation.
- 2) Press the **FPL** Key.
- 3) Turn the **FMS** Joystick to highlight the Vertical Navigation Page.
- 4) Press the **MENU** Key.
- 5) Turn or move the **FMS** Joystick to highlight 'Capture VNAV Profile' and press the **ENT** Key. Selecting 'Capture VNAV Profile' centers the VNAV indicator (must be navigating a Flight Plan or Direct-to).

Or:

- 1) Enter a valid VNAV profile and begin navigation.
- 2) From the VNAV Page, press (select) the **CAPTURE** Softkey.

Force cancel of the VNAV profile:

- 1) Press the **FPL** Key.
- 2) Turn the **FMS** Joystick to highlight the Vertical Navigation Page.
- 3) Press the **MENU** Key.
- 4) Turn or move the **FMS** Joystick to highlight 'Cancel VNAV Capture' and press the **ENT** Key.

Or:

- 1) Enter a valid VNAV profile and begin navigation.
- 2) From the VNAV Page, press (deselect) the **CAPTURE** Softkey.

SECTION 3 ENGINE INDICATION SYSTEM

3.1 EIS DISPLAY & ENG PAGE

The G300 Engine Indication System (EIS) displays critical engine, electrical, and other system parameters on the top portion of the display (split-screen and full-screen MFD). Additional EIS information can be viewed by selecting the **ENG** Page.

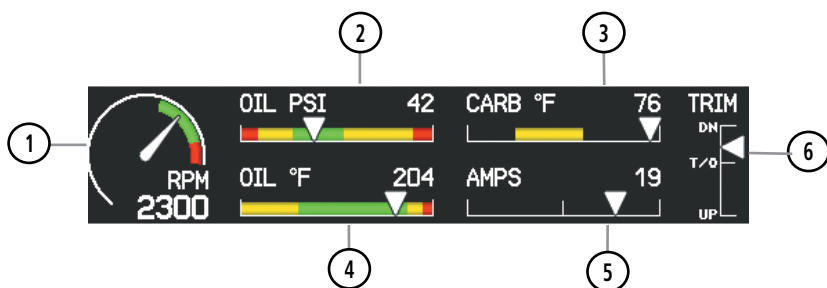

Engine Instrument Display
(Single Display & Dual Display MFD (Except ENG Page))

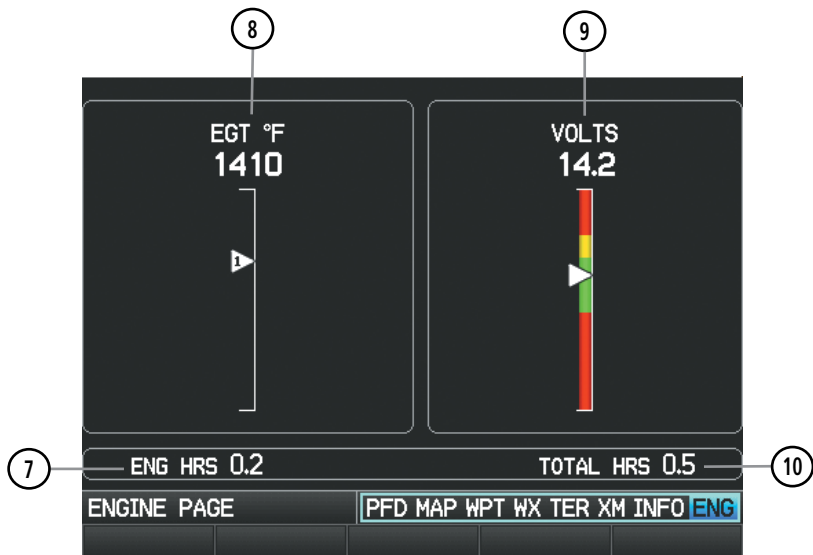

Engine (ENG) Page (Single Display)

- | | | | |
|----------------------|-------|---|---|
| System Overview | 1 15 | Tachometer (RPM) | Displays propeller speed in revolutions per minute (rpm) |
| Flight Instruments | 2 16 | Oil Pressure Indicator (OIL PSI) | Displays oil pressure in pounds per square inch (psi) |
| EIS | 3 13 | Carburetor Temperature Indicator | Displays carburetor temperature in °F; the yellow range indicates where carburetor icing is most likely to occur |
| COM Interface | 4 17 | Oil Temperature Indicator (OIL °F) | Displays oil temperature in degrees Fahrenheit (°F) |
| GPS Navigation | 5 18 | Ammeter | Displays the battery load in amperes |
| Flight Planning | 6 19 | Trim Indicator | Displays trim along a slide bar |
| Hazard Avoidance | 7 11 | Engine Hours (Tach) (ENG HRS) | Counted whenever RPM is > 100. The count is proportional to the current RPM setting. For example, two hours at 1250 RPM will be recorded as one engine hour, and one hour spent at 2500 RPM (normal cruise RPM) will also be recorded as one engine hour. |
| Additional Features | 8 14 | Exhaust Gas Temperature Indicator (EGT °F) | Displays the Exhaust Gas Temperature in °F |
| Integrated Autopilot | 9 12 | Voltmeter | Displays the main bus voltage |
| Annun/Alerts | 10 20 | Total Hours (HRS) | Time is recorded whenever RPM > 600. |

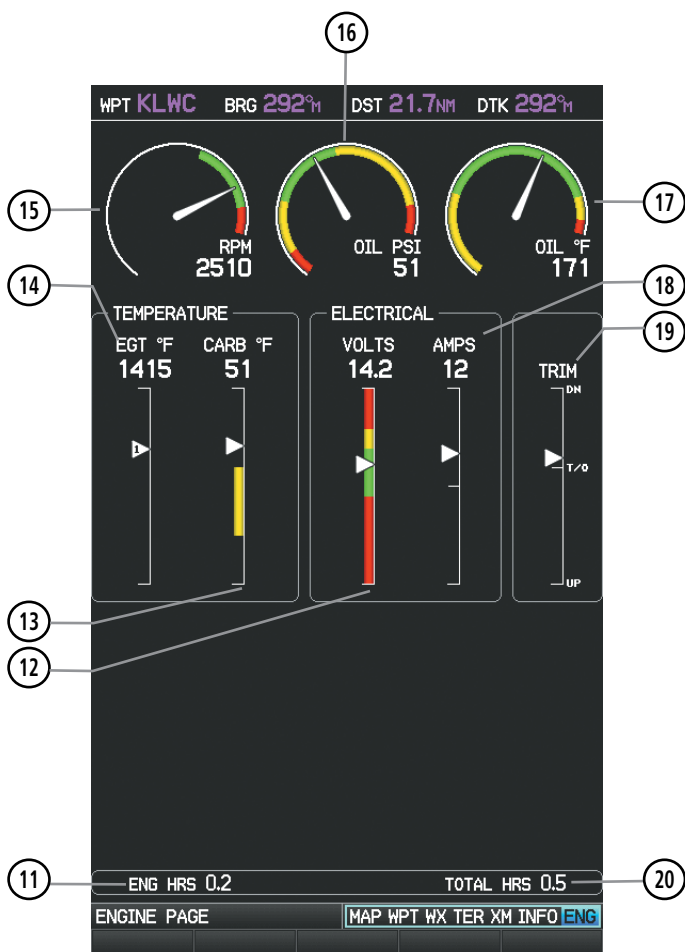

Engine (ENG) Page (Dual Display MFD)

Green bands on the instruments indicate normal ranges of operation; yellow and red bands indicate caution and warning, respectively. When unsafe operating conditions occur, the corresponding caution readout will display solid amber and the warning readout will flash red. If sensory data to an instrument becomes invalid or unavailable, a red "X" is displayed across the instrument.

- System Overview
- Flight Instruments
- EIS**
- COM Interface
- GPS Navigation
- Flight Planning
- Hazard Avoidance
- Additional Features
- Integrated Autopilot
- Annun/Alerts
- Appendix
- Index

Blank Page

SECTION 4 COM INTERFACE

4.1 AUTO-TUNING FREQUENCIES



NOTE: Comprehensive operating instructions for the SL40 VHF Communication Transceiver can be found in the SL40 VHF Comm Pilot's Guide.

Frequencies can be automatically tuned from the following:

- Map Page
- Weather Page
- Waypoint Page
- Nearest Airports Page
- Nearest Airport Weather Page
- Nearest ARTCC Page
- Nearest FSS Page
- Nearest Airspace Page

Auto-tuning a frequency from the Nearest Pages:

- 1) Press the **NRST** Key to display the Nearest Pages.
- 2) Turn the **FMS** Joystick to select the Nearest (Airports, Airport Weather, ARTCC, FSS, or Airspace) Page.
- 3) From the Nearest ARTCC or Nearest FSS, press the **FMS** Joystick, and move the **FMS** Joystick to highlight the desired frequency.



Nearest ARTCC (Single Display)

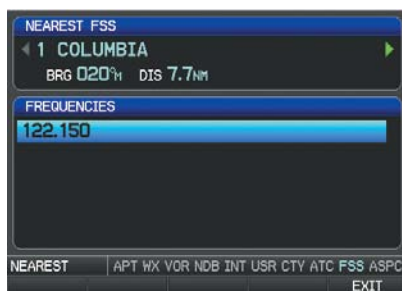

Nearest FSS (Single Display)

Or:

- a) From the Nearest Airport Weather Page, highlight the desired airport weather, and press the **ENT** Key.
- b) With the Weather Information Page displayed, press the **INFO** Softkey.

c) Move the **FMS** Joystick to highlight the desired frequency.

Or:

a) From the Nearest Airspace Page, highlight the desired airspace, and press the **ENT** Key.

b) Press the **FREQS** Softkey.

c) Move the **FMS** Joystick to highlight the desired frequency.

Or:

a) From the Nearest Airport Page, highlight the desired airport and press the **ENT** Key. The Airport Information Page is displayed.

b) Move the **FMS** Joystick to highlight the desired frequency.



Airport Information Page (Single Display)

- 4) Press the **ENT** Key to load the frequency into the standby field of the SL40. If the frequency has an * (additional information available) next to it, press the **ENT** Key a second time with 'Tune' highlighted press the **ENT** Key.

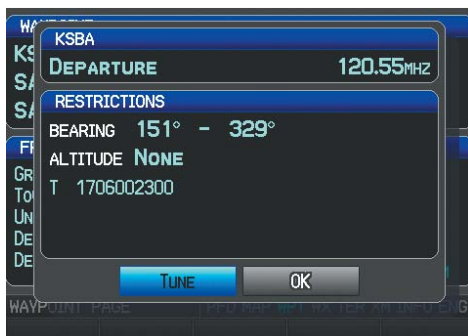

Frequency with Additional Information (Single Display)

Auto-tuning a frequency from the Map Page and Weather Page:

- 1) Press the **FMS** Joystick on the Map Page (or **PAN MAP** Softkey on the Weather (WX) Page) to display the Map Pointer.
- 2) Place the Map Pointer on a map feature (airport, METAR Flag, etc). If multiple map features are present at the Map Pointer position (green arrow in the information box), turn the **FMS** Joystick to cycle through the list.
- 3) Press the **ENT** Key to display the review page for the highlighted feature.
- 4) If necessary, press the **INFO** Softkey to access the Airport Information Page.
- 5) Move the **FMS** Joystick to highlight the desired frequency.
- 6) Press the **ENT** Key to load the frequency into the standby field of the SL40. If the frequency has an * (additional information available) next to it, press the **ENT** Key a second time with 'Tune' highlighted.

Auto-tuning a frequency from the Waypoint Page:

- 1) From the Waypoint Page, enter the desired waypoint using the **FMS** Joystick.
- 2) Move the **FMS** Joystick to highlight the desired frequency.
- 3) Press the **ENT** Key to load the frequency into the standby field of the SL40. If the frequency has an * (additional information available) next to it, press the **ENT** Key a second time with 'Tune' highlighted.

- System Overview
- Flight Instruments
- EIS
- COM Interface**
- GPS Navigation
- Flight Planning
- Hazard Avoidance
- Additional Features
- Integrated Autopilot
- Annun/Alerts
- Appendix
- Index

Blank Page

SECTION 5 GPS NAVIGATION

5.1 INTRODUCTION

The Map Page displays aviation data (e.g., airports, VORs, airways, airspaces), geographic data (e.g., cities, lakes, highways, borders), topographic data (map shading indicating elevation). The Navigation Map can be oriented three different ways: North Up (NORTH UP), Track Up (TRK UP) or Desired Track Up (DTK UP).

An aircraft icon is placed on the Navigation Map at the location corresponding to the calculated present position. The aircraft position and the flight plan legs are accurately based on GPS calculations. The basemap upon which these are placed are from a source with less resolution, therefore the relative position of the aircraft to map features is not exact. The leg of the active flight plan currently being flown is shown as a magenta line on the navigation map. The other legs are shown in white.

The Direct-to Window, the Flight Plan Pages, and the Nearest Airports Pages can be displayed by pressing the corresponding hardkeys.

COMPASS ARC



NOTE: *The compass arc is not available in 'North Up' map orientation.*

A compass arc representing the aircraft's ground track, appears by default on the Map Page. The route line represents the course.

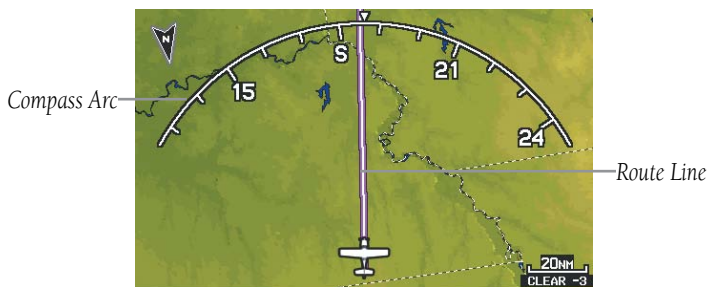

Compass Arc (Map Page)

Removing the Compass Arc from the Map Page:

- 1) With the Map Page displayed, press the **MENU** Key.
- 2) Turn or move the **FMS** Joystick to highlight 'Set Up Map' and press the **ENT** Key.
- 3) Turn the **FMS** Joystick to highlight the 'General' Menu.
- 4) Move the **FMS** Joystick to highlight the 'Compass Arc' field.
- 5) Turn the **FMS** Joystick to access the 'On/Off' drop down list.
- 6) Turn or move the **FMS** Joystick to highlight 'Off', and press the **ENT** Key.

5.2 USING MAP DISPLAYS

Map displays are used extensively in the G300 to provide situational awareness in flight. Most G300 maps can display the following information:

- Airports, NAVAIDs, airspaces, airways, land data (highways, cities, lakes, rivers, borders, etc.) with names
- Map Pointer information (distance and bearing to pointer, location of pointer, name, and other pertinent information)
- Map range
- Aircraft icon (representing present position)
- Flight plan legs
- User waypoints
- Track vector
- Topography data

The information in this section applies to the following maps unless otherwise noted:

- All Map Pages (MAP)
- Waypoint Page (WPT)
 - Single Display System: The Waypoint Page when the **RUNWAY** Softkey is pressed.
 - Dual Display System: The Waypoint Page when the **INFO** Softkey is pressed.

- All Nearest Pages (NRST) (Dual Display)
- Flight Plan Pages (FPL) (Dual Display)
- Direct-to Window (Dual Display)

MAP PAGE SETUP

MAP ORIENTATION

Maps are shown in one of three different orientation options, allowing flexibility in determining aircraft position relative to other items on the map (North Up) or for determining where map items are relative to where the aircraft is going (Track Up), or desired track up (DTK UP).

- North Up aligns the top of the map display to north (default setting).
- Track Up aligns the top of the map display to the current ground track.
- Desired Track (DTK) Up aligns the top of the map display to the desired course.



NOTE: Map orientation can only be changed on the Map Page. Any other pages that show navigation data reflect the orientation selected for the Map Page.

Changing the Navigation Map orientation:

- 1) With the Map Page displayed, press the **MENU** Key.
- 2) Turn or move the **FMS** Joystick to highlight 'Set Up Map' and press the **ENT** Key.
- 3) Turn the **FMS** Joystick to highlight the 'General' Menu.
 - a) Move the **FMS** Joystick to highlight the 'Orientation' field.
 - b) Turn the **FMS** Joystick to access a list of available options.
 - c) Turn or move the **FMS** Joystick to highlight 'North Up', 'Track Up', or 'DTK Up', and press the **ENT** Key.

Or:

- a) Move the **FMS** Joystick to highlight the 'North Up Above' field.
- b) Turn the **FMS** Joystick to access a list of available range options.
- c) Turn or move the **FMS** Joystick to highlight the desired range above which to display North Up orientation.

Or:

- a) Move the **FMS** Joystick to highlight the 'North Up On GRND' field.
- b) Using the **FMS** Joystick highlight 'On' or 'Off', and press the **ENT** Key. When 'North Up On GRND' is 'ON' (default), the map orientation will change to North Up when the aircraft is on the ground.

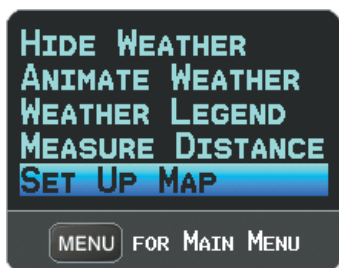

Map Page Menu

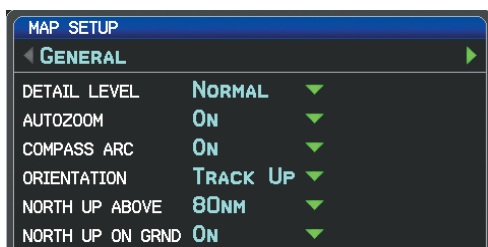

General Menu (Map Setup Page)

AIRPORTS & NAVAIDS

Setting up and customizing airports and NAVAIDs for the map page:

- 1) From the Map Page press the **MENU** Key.
- 2) Turn or move the **FMS** Joystick to highlight 'Set Up Map' and press the **ENT** Key.
- 3) Turn the **FMS** Joystick to select the 'Airport' or 'NAVAID' Category from the horizontal list.
- 4) Move the **FMS** Joystick to highlight the desired feature.
- 5) Turn the **FMS** Joystick to access a list of options for each feature (On/Off, Auto, range settings, text size, etc).
- 6) Using the **FMS** Joystick select the desired option and press the **ENT** Key.
- 7) Press the **FMS** Joystick, the **CLR** Key, or the **EXIT** Softkey to return to the Map Page with the changed settings.

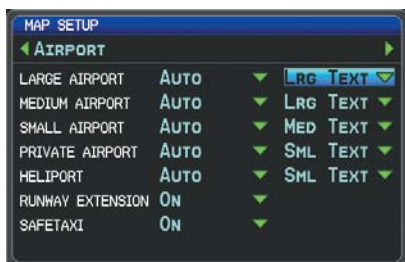

Map Setup Page (Airport Category)



Map Setup Page (NAVAID Category)

CITIES & ROADS

Setting up and customizing cities and roads for the map page:

- 1) From the Map Page press the **MENU** Key.
- 2) Turn or move the **FMS** Joystick to highlight 'Set Up Map' and press the **ENT** Key.
- 3) Turn the **FMS** Joystick to select the 'City' or 'Road' Category from the horizontal list.
- 4) Move the **FMS** Joystick to highlight the desired feature.
- 5) Turn the **FMS** Joystick to access a list of options for each feature (On/Off, Auto, range settings, or text size).
- 6) Using the **FMS** Joystick select the desired option and press the **ENT** Key.
- 7) Press the **FMS** Joystick, the **CLR** Key, or the **EXIT** Softkey to return to the Map Page with the changed settings.



Map Setup Page (City Category)



Map Setup Page (Road Category)

AIRSPACE

Setting up and customizing airspace for the map page:

- 1) From the Map Page press the **MENU** Key.
- 2) Turn or move the **FMS** Joystick to highlight 'Set Up Map' and press the **ENT** Key.
- 3) Turn the **FMS** Joystick to select the 'Airspace' or 'SUA' (Special Use Airspace) Category from the horizontal list.
- 4) Move the **FMS** Joystick to highlight the desired feature.
- 5) Turn the **FMS** Joystick to access a list of options for each feature (On/Off, Auto, range settings, All (Atlantic), or Below (Atlantic)).
- 6) Using the **FMS** Joystick select the desired option and press the **ENT** Key.
- 7) Press the **FMS** Joystick, the **CLR** Key, or the **EXIT** Softkey to return to the Map Page with the changed settings.

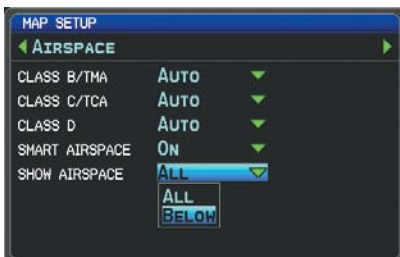

Map Setup Page (Airspace Category) Map Setup Page (Airspace Category - Atlantic)

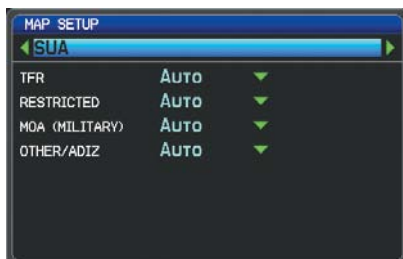

Map Setup Page (SUA Category)

MAP RANGE



NOTE: Refer to the Additional Features section for information on changing the FliteCharts® range.

There are 23 different map ranges available, from 200 feet to 800 nm. The current range is indicated in the lower right corner of the map. The scale bar represents the map scale. To change the map range on any map, use the down arrow on the **RNG** Key to zoom in (decreasing), or the up arrow to zoom out (increasing).

When the selected range exceeds the resolution of the map data, 'overzoom' appears below the map range scale.



Scale Bar Representing a Map Scale of 3.0 nm Per Scale Width.

Map Range/Overzoom (Split-Screen)

Enabling/disabling autozoom:

- 1) With the Map Page displayed, press the **MENU** Key.
- 2) Turn or move the **FMS** Joystick to highlight 'Set Up Map' and press the **ENT** Key.
- 3) Turn the **FMS** Joystick to highlight the 'General' Menu.
- 4) Move the **FMS** Joystick to highlight the 'Autozoom' field.
- 5) Turn the **FMS** Joystick to access the 'On/Off' drop down list.
- 6) Turn or move the **FMS** Joystick to highlight the desired option, and press the **ENT** Key.

MAP PANNING

Map panning allows the pilot to:

- View parts of the map outside the displayed range without adjusting the map range
- Highlight and select locations on the map
- Review information for a selected airport, NAVAID or user waypoint
- Designate locations for use in flight planning
- View airspace and airway information

When the panning function is selected by pressing the **FMS** Joystick (**PAN MAP** Softkey on the Weather Page) the Map Pointer flashes on the map display. A window also appears at the top of the map display showing the latitude/longitude position of the pointer, the bearing and distance to the pointer from the aircraft's present position, the elevation of the land at the position of the pointer, or the object's (airports, obstacles, etc) elevation, if known.

When the Map Pointer is placed on a map feature, the map feature is highlighted and an information box appears (even if the name was not originally displayed on the map).

Pressing the **ENT** Key displays a review page for the highlighted map feature. If multiple features are present at the Map Pointer position, a green arrow will appear in the information box. Turning the **FMS** Joystick will cycle through the list of map features present at that position.

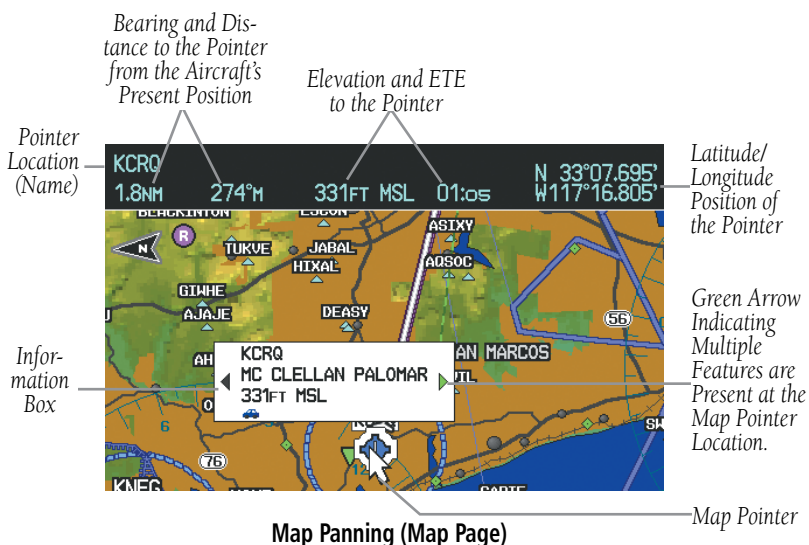

Panning the map:

- 1) Press the **FMS** Joystick (or **PAN MAP** Softkey on the Weather (WX) Page) to display the Map Pointer.
- 2) Move the **FMS** Joystick to move the Map Pointer around the map.
- 3) Press the **FMS** Joystick to remove the Map Pointer and re-center the map on the aircraft's current position.

Reviewing information for a map feature:

- 1) Place the Map Pointer on a map feature. If multiple map features are present at the Map Pointer position (green arrow in the information box), turn the **FMS** Joystick to cycle through the list.
- 2) Press the **ENT** Key to display the review page for the highlighted feature.
- 3) Press the **FMS** Joystick, the **CLR** Key, or the **ENT** Key to exit the review page and return to the Map Page showing the selected waypoint.

MEASURING BEARING AND DISTANCE

Distance and bearing from the aircraft's present position to any point on the viewable navigation map may be calculated using the 'Measure Distance' selection from Map Page menu. The distance tool displays a dashed Measurement Line and a Map Pointer to aid in graphically identifying points to measure. Lat/Long, bearing, distance, and elevation data for the Map Pointer is provided in a window at the top of the Map Page.

Measuring bearing and distance between any two points:

- 1) From the Map Page, press the **MENU** Key.
- 2) Turn or move the **FMS** Joystick to highlight 'Measure Distance' and press the **ENT** Key. A Measure Pointer is displayed on the map at the aircraft's present position.
- 3) Move the **FMS** Joystick to place the reference pointer at the desired location. The bearing and distance are displayed at the top of the map. Elevation at the current pointer position is also displayed. Pressing the **ENT** Key changes the starting point for measuring.
- 4) To exit the Measure Bearing/Distance option, press the **FMS** Joystick; or select 'Stop Measuring' from the Page Menu and press the **ENT** Key.



Map Page Menu

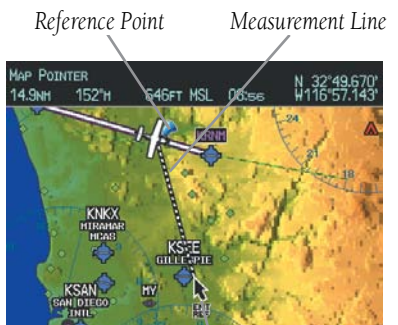

Map Page (Measure Distance)

TOPOGRAPHY

Topographic data can be displayed or removed as described in the following procedures.

Displaying/removing topographic data:

- 1) Press the **MAP** Softkey on the Map Page. Press the **VFR MAP** Softkey (if necessary).
- 2) Press the **TOPO** Softkey. Topographic data is displayed.
- 3) Press the **TOPO** Softkey again to remove topographic data from the Navigation Map.

Or:

- 1) From the Map Page, press the **MENU** Key.
- 2) Turn or move the **FMS** Joystick to highlight 'Set Up Map', and press the **ENT** Key.
- 3) Turn the **FMS** Joystick to highlight the 'Map' Category from the horizontal list.
- 4) Move the **FMS** Joystick to highlight the 'Topo Shading' field.
- 5) Turn the **FMS** Joystick to select 'On' or 'Off', and press the **ENT** Key.

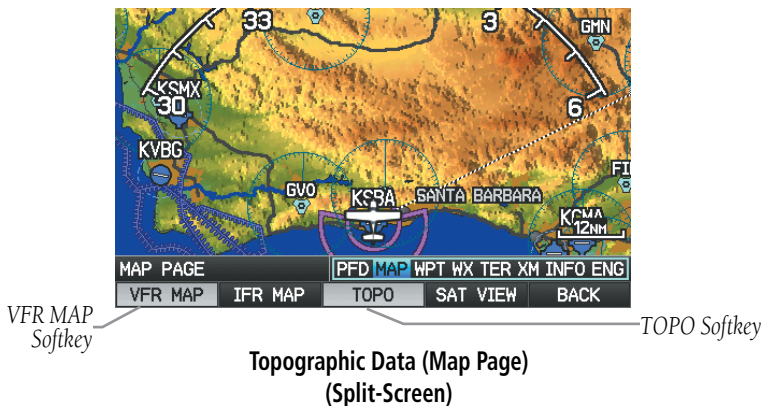

VFR MAP
Softkey

TOPO Softkey

SATELLITE VIEW

The Satellite View displays satellite imagery above 20nm.

Displaying/removing satellite imagery on the map page:

- 1) Press the **MAP** Softkey on the Map Page. Press the **VFR MAP** Softkey (if necessary).
- 2) Press the **SAT VIEW** Softkey. Satellite imagery is displayed on the map.
- 3) Press the **SAT VIEW** Softkey again to remove satellite imagery from the Navigation Map.

Or:

- 1) From the Map Page, press the **MENU** Key.
- 2) Turn or move the **FMS** Joystick to highlight 'Set Up Map', and press the **ENT** Key.
- 3) Turn the **FMS** Joystick to highlight the 'Map' Category from the horizontal list.
- 4) Move the **FMS** Joystick to highlight the 'Satellite View' field.
- 5) Turn the **FMS** Joystick to select 'On' or 'Off', and press the **ENT** Key.



MAP SYMBOLS

Refer to Appendix F for a list of map symbols.

MAP DECLUTTER

The pilot can remove (declutter) unwanted items, such as highways from the map.

To declutter the Map Page:

- 1) From any Map Page, press the **CLR** Key. 'CLEAR-1' appears below the map range. The background map detail (such as highways, cities, rivers, and smaller lakes) are removed from the map.
- 2) Press the **CLR** Key again. 'CLEAR-2' appears below the map range and airspace boundary detail is removed from the map.
- 3) Press the **CLR** Key again. 'CLEAR-3' appears below the map range. Only the waypoints and nav aids that are part of the current flight plan appear on the map.
- 4) Press the **CLR** Key again to return 'ALL' detail to the map.



Map Declutter (Split-Screen)

5.3 AIRWAYS

Low Altitude Airways (or Victor Airways) primarily serve smaller piston-engine, propeller-driven airplanes on shorter routes and at lower altitudes. Airways are eight nautical miles wide and start 1,200 feet above ground level (AGL) and extend up to but not including 18,000 feet mean sea level (MSL). Low Altitude Airways are designated with a "V" before the airway number (hence the name "Victor Airways") since they run primarily between VORs.

High Altitude Airways (or Jet Routes) primarily serve airliners, jets, turboprops, and turbocharged piston aircraft operating above 18,000 feet MSL. Jet Routes start at 18,000 feet MSL and extend upward to 45,000 feet MSL (altitudes above 18,000 feet are called "flight levels" and are described as FL450 for 45,000 feet MSL). Jet Routes are designated with a "J" before the route number.

Low Altitude Airways are drawn in gray. High Altitude Airways are drawn in green. When both types of airways are displayed, high altitude airways are drawn on top of Low Altitude Airways.

When airways are selected for display on the map, the airway waypoints (VORs, NDBs, and Intersections) are also displayed.

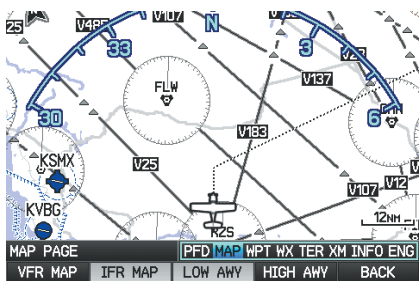

**IFR Map - Low Airways (Victor Airways)
(Single Display)**

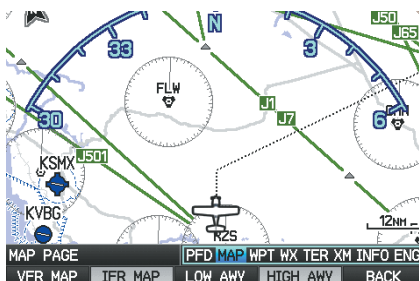

**IFR Map - High Airways (Jet Routes)
(Single Display)**

Airways may be displayed on the map at the pilot's discretion using the **MAP** Softkey on the Map Page.

Displaying/removing airways:

- 1) Press the **MAP** Softkey on the Map Page.
- 2) Press the **IFR MAP** Softkey to display the IFR Map and related softkeys.
- 3) Press the **LOW AWY** Softkey to display/remove the Low Altitude Airways.
- 4) Press the **HIGH AWY** Softkey to display/remove the High Altitude Airways.
- 5) Press the **BACK** Softkey to return to the top-level softkeys.

Reviewing information for an airway:

- 1) From the Map Page, press the **MAP** Softkey.
- 2) Press the **IFR MAP** Softkey (if necessary).
- 3) With the **LOW AWY** and/or **HIGH AWY** Softkeys selected, press the **FMS** Joystick to display the Map Pointer.
- 4) Place the Map Pointer on an airway. The MEA, name of airway, endpoints, distance, and calculated radials are displayed.



Reviewing Airway Information (Map Page)
(Split-Screen)

- 5) Press the **ENT** Key to display the review page for the airway.

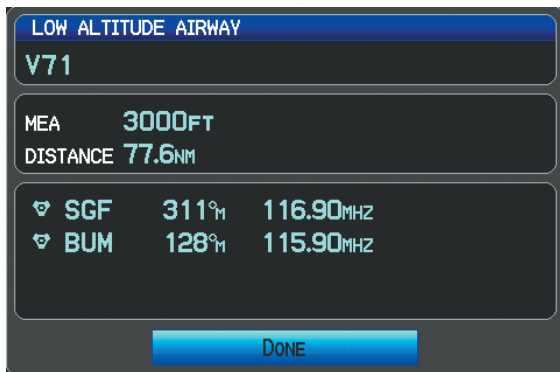

Low Altitude Airway Review Page
(Split-Screen)

- 6) Press the **FMS** Joystick, the **CLR** Key, or the **ENT** Key to exit the review page and return to the Map Page.

- System Overview
- Flight Instruments
- EIS
- COM Interface
- GPS Navigation
- Flight Planning
- Hazard Avoidance
- Additional Features
- Integrated Autopilot
- Annun/Alerts
- Appendix
- Index

5.4 WAYPOINTS

The Waypoint (WPT) Page provides airport and waypoint information.

Waypoints are predetermined geographical positions (internal database) or pilot-entered positions, and are used for all phases of flight planning and navigation.

Waypoints can be selected by entering the ICAO identifier, entering the name of the facility, or by entering the city name. As a waypoint identifier, facility name, or location is entered, the G300's Spell'N'Find™ feature scrolls through the database, displaying those waypoints matching the characters which have been entered up to that point. A direct-to navigation leg to the selected waypoint can be initiated by pressing the Direct-to Key from the Waypoint Page.

The Waypoint Page allows the pilot to review airport information, runway information, frequencies, instrument procedures, AOPA information, and weather information. The pilot can manually enter the identifier or the G300 will choose the most appropriate identifier based on the current position and phase of flight.

The following descriptions and abbreviations are used:

- Usage type: Public, Military, or Private
- Runway surface type: Hard, Turf, Sealed, Gravel, Dirt, Soft, Unknown, or Water
- Runway lighting type: No Lights, Part Time, Full Time, Unknown, or PCL Freq (for pilot-controlled lighting)
- COM Availability: TX (transmit only), RX (receive only), PT (part time), * (additional information available)

Automatic waypoint selection:

Automatic waypoint selection is the system's attempt to deduce what Waypoint to display based on the aircraft's location in relation to the departure airport and/or the waypoints in the Flight Plan.

The pilot can override Automatic Waypoint Selection by manually entering a waypoint. The automatic selection will not resume until such time that the manually entered waypoint and the automatically selected waypoint coincide (does not apply if the **CHART** Softkey is selected). To manually return to Automatic Waypoint Selection, highlight the identifier and press the **CLR** Key.

-Waypoint Identifier/Symbol/Type
 -Facility Name
 -City/Region

COM/NAV
 Freq. Info.
 -Identification
 -Frequency
 -Availability
 -Additional Information

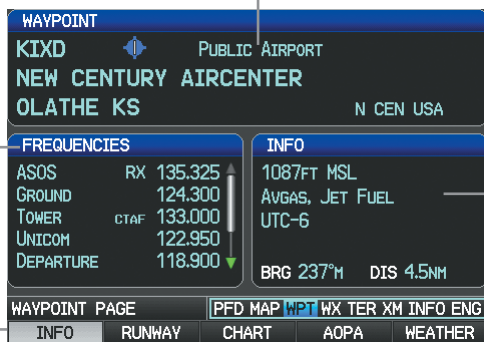

Airport Information
 -Elevation
 -Fuel Available
 -Time Zone (UTC Offset)
 -Lat/Long (Full-Screen)
 -Bearing/Distance

INFO Softkey Selected

Waypoint Page (INFO Softkey Selected)
 (Single Display)

Runway Information
 -Designation
 -Length/Width
 -Surface
 -Lighting
 -Displaced Threshold
 -Traffic Pattern
 -Wind (Full-Screen)

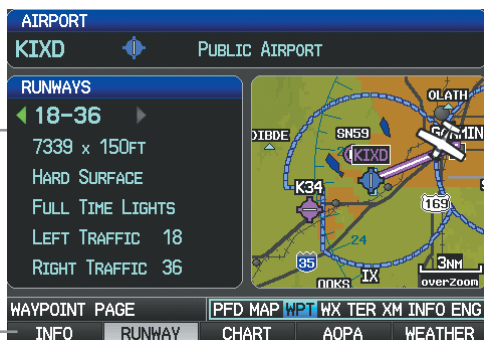

Map Showing Selected Waypoint

RUNWAY Softkey Selected

Waypoint Page (RUNWAY Softkey Selected)
 (Single Display)



Waypoint Page (INFO Softkey Selected)
(Dual Display)

Selecting an airport for review by identifier, facility name, or location:

- 1) From the Waypoint (WPT) Page, press the **INFO** Softkey.
- 2) Press the **FMS** Joystick to activate the cursor.
- 3) Turn the **FMS** Joystick clockwise to begin entering a waypoint identifier (turning it counter-clockwise brings up the waypoint selection submenu - press the **CLR** Key or the **FMS** Joystick to remove it), or move the **FMS** Joystick to select the facility name, or city field.
- 4) Press the **ENT** Key.

If duplicate entries exist for the entered facility name or location, additional entries may be viewed by continuing to turn the **FMS** Joystick during the selection process. If duplicate entries exist for an identifier, a Duplicate Waypoints Window is displayed. Press the **ENT** Key to move the cursor to the Duplicate Waypoints Window.

Duplicate Waypoints Window



Waypoint Information Window-Duplicate Identifier

Selecting a runway:

- 1) With the Waypoint (WPT) Page displayed, press the **INFO** Softkey.
- 2) Press the **FMS** Joystick to activate the cursor.
- 3) Turn the **FMS** Joystick clockwise to begin entering a waypoint identifier for the desired runway (turning it counter-clockwise brings up the waypoint selection submenu - press the **CLR** Key or the **FMS** Joystick to remove it), or move the **FMS** Joystick to select the facility name, or city field.
- 4) Press the **ENT** Key. Full-Screen: continue to **Step 7**.
- 5) Press the **RUNWAY** Softkey (split-screen only).
- 6) Press the **FMS** Joystick to activate the cursor (split-screen only).
- 7) Move the **FMS** Joystick to place the cursor in the 'Runway' Box, on the runway designator.



Runways Box (Waypoint Page)

- Turn the **FMS** Joystick to display the desired runway (if more than one) for the selected airport.

Viewing additional information for a frequency:

The Frequencies Box uses the descriptions and abbreviations listed in the following table:

Communication Frequencies			Navigation Frequencies
Approach *	Control	Pre-Taxi	ILS
Arrival *	CTA *	Radar	LOC
ASOS	Departure *	Ramp	
ATIS	Gate	Terminal*	
AWOS	Ground	TMA *	
Center	Helicopter	Tower	
Class B *	Multicom	TRSA *	
Class C *	Other	Unicom	
Clearance			
* May include Additional Information			

Frequency Abbreviations

- With the Waypoint (WPT) Page displayed, press the **INFO** Softkey.
- Press the **FMS** Joystick to activate the cursor.
- Move the **FMS** Joystick to place the cursor in the 'Frequencies' Box, on the frequency denoted with an *.

FREQUENCIES		
ATIS	RX	132.650
ASOS	RX	132.650
CLEARANCE		132.900
GROUND		121.700
TOWER		119.700
UNICOM		122.950
DEPARTURE	*	120.550

Additional Frequency Information
(Waypoint Page)

- 4) Press the **ENT** Key to view the Additional Information Window.
- 5) To remove the window, press the **FMS** Joystick, **ENT** Key, or **CLR** Key.

NEAREST INFORMATION

The G300 provides a **NRST** Key which gives the pilot quick access to nearest airport, weather, VOR, NDB, intersection, user waypoint, city, ARTCC, FSS, and airspace information. If none are available, "None Within 200 NM" is displayed.

Pressing the **ENT** Key displays the associated 'Information Page' for the highlighted selection (except for the Nearest ARTCC, and Nearest FSS pages), similar to the Waypoint Page. Pressing the **ENT** Key again returns to the Nearest Page.

Viewing nearest information:

- 1) Press the **NRST** Key.
- 2) Turn the **FMS** Joystick to select the desired Nearest Page (APT, WX, VOR, NDB, INT, USR, CTY, ATC, FSS, or ASPC). If none are available, "None Within 200 NM" is displayed.
- 3) Press the **FMS** Joystick to highlight the first selection in the list. Turn or move the **FMS** Joystick to highlight the desired nearest option.
- 4) Press the **ENT** Key to display the associated 'Information Page' (except for the Nearest ARTCC and Nearest FSS pages). From the Airport Information Page, press the **INFO**, **CHART**, **AOPA**, or **WEATHER** Softkeys for additional information. From the User Waypoint Information Page, press the **DELETE**, or **EDIT** softkeys to make changes to the selected user waypoint.
- 5) To return to the Nearest Page, press the **FMS** Joystick, the **ENT** Key, or the **CLR** Key.



Nearest Airports Page
(Single Display)



Airport Information Page
(Single Display)

NEAREST AIRPORT CRITERIA

From the Menu on the Nearest Airports Page the pilot can define the minimum runway length and surface type used when determining the 15 nearest airports to display on the Nearest Airports Page. A minimum runway length and/or surface type can be entered to prevent airports with small runways or runways that are not appropriately surfaced from being displayed. Default settings are 0 feet (or meters) for runway length and "Any" for runway surface type. Private airports and Heliports can also be included.

The Page Menu also allows the pilot to choose between displaying the facility names, city names, bearing, or direction arrows.

To quickly show/hide private airport and heliports from the Nearest Airports Page, press the **PRIVATE** or **HELIPORT** Softkeys.

Setting nearest airport criteria:

- 1) With the Nearest Airports Page displayed, press the **MENU** Key.
- 2) Turn or move the **FMS** Joystick to select 'Set Airport Criteria' from the Page Menu.
- 3) Press the **ENT** Key. The Airport Criteria Window is displayed.
- 4) Move the **FMS** Joystick to select the desired criteria to be defined.
- 5) Turn the **FMS** Joystick to select the desired option.
- 6) Press the **ENT** Key.



Nearest Airports Page Menu

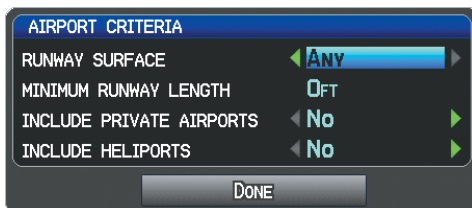

Airport Criteria Window

Restoring nearest airport criteria defaults:

- 1) With the Nearest Airports Page displayed, press the **MENU** Key.
- 2) Turn or move the **FMS** Joystick to select 'Set Airport Criteria' from the Page Menu.
- 3) Press the **ENT** Key. The Airport Criteria Window is displayed.
- 4) Move the **FMS** Joystick to select the desired criteria to be restored.
- 5) Press the **MENU** Key.
- 6) With 'Restore Default' highlighted, press the **ENT** Key.

WEATHER INFORMATION

Textual weather information can be viewed from the Waypoint Page or the Nearest WX Page. Refer to the Hazard Avoidance section for information on XM Weather.

Selecting airport weather information:

- 1) From the Waypoint Page, press the **WEATHER** Softkey.
 - 2) Press the **FMS** Joystick to activate the cursor.
 - 3) Turn the **FMS** Joystick clockwise to begin entering an airport identifier (turning it counter-clockwise brings up the waypoint selection submenu - press the **CLR** Key or the **FMS** Joystick to remove it).
 - 4) Press the **ENT** Key.
- Or:**
- 1) Press the **NRST** Key.
 - 2) Turn the **FMS** Joystick to select the Nearest Airport WX Page. If Nearest Airport Weather is not available, "None Within 200 NM" is displayed.

- 3) Press the **FMS** Joystick to highlight the first airport in the nearest airport weather list. Turn or move the **FMS** Joystick to highlight the desired airport weather.
- 4) Press the **ENT** Key to display the Weather Information Page.
- 5) Turn the **FMS** Joystick to scroll up or down on the page.
- 6) To return to the Nearest Airport Weather Page, press the **FMS** Joystick, the **ENT** Key, or the **CLR** Key.



Nearest Airport Weather Page
(Split-Screen)



Weather Information Page
(Split-Screen)

INTERSECTIONS

Intersections can be viewed from the Waypoint Page or the Nearest Intersections Page. In addition to displaying a map of the currently selected intersection and surrounding area, the Intersection Information Page displays the region, bearing, distance, latitude, and longitude.

Selecting an intersection:

- 1) From the Waypoint Page, press the **INFO** Softkey.
- 2) Press the **FMS** Joystick to activate the cursor.
- 3) Turn the **FMS** Joystick clockwise to begin entering an intersection identifier (turning it counter-clockwise brings up the waypoint selection submenu - press the **CLR** Key or the **FMS** Joystick to remove it), or move the **FMS** Joystick to select the facility name, or city field.
- 4) Press the **ENT** Key.

Or:

- 1) Press the **NRST** Key.
- 2) Turn the **FMS** Joystick to select the Nearest Intersections Page.
- 3) Press the **FMS** Joystick to activate the cursor.
- 4) Turn or move the **FMS** Joystick to highlight the desired intersection.
- 5) Press the **ENT** Key to display the Intersection Information Page.

NDBs

NDBs can be viewed from the Waypoint Page or the Nearest NDBs Page. In addition to displaying a map of the currently selected NDB and surrounding area, the page displays the region, bearing, distance, latitude, longitude, and frequency.

The Nearest NDB Page can be used to quickly find a NDB close to the flight path. The list only includes NDBs that are within 200nm. If there are no NDBs in the list, text indicating that there are no nearest NDBs is displayed. If there are no nearest NDBs in the list, the information and frequency fields are dashed.

Selecting a NDB:

- 1) From the Waypoint Page, press the **INFO** Softkey if necessary.
 - 2) Press the **FMS** Joystick to activate the cursor.
 - 3) Turn the **FMS** Joystick clockwise to begin entering the identifier (turning it counter-clockwise brings up the waypoint selection submenu - press the **CLR** Key or the **FMS** Joystick to remove it), or move the **FMS** Joystick to select the facility name, or city field.
 - 4) Press the **ENT** Key.
- Or:**
- 1) Press the **NRST** Key.
 - 2) Turn the **FMS** Joystick to select the Nearest NDBs Page.
 - 3) Press the **FMS** Joystick to activate the cursor.
 - 4) Turn the **FMS** Joystick to highlight the desired NDB.
 - 5) Press the **ENT** Key to display the NDB Information Page.

VORS

VORs can be viewed from the Waypoint Page or the Nearest VORs Page. In addition to displaying a map of the currently selected VOR and surrounding area, the page displays the region, city, state, bearing, distance, latitude, longitude, frequency, and class (High, Low, or Terminal VOR).

The Nearest VOR Page can be used to quickly find a VOR close to the flight path. The list only includes VORs that are within 200nm. If there are no VORs in the list, text indicating that there are no nearest VORs is displayed. If there are no nearest VORs in the list, the information and frequency fields are dashed.

Localizer information cannot be viewed on the VOR Information Page. If a VOR station is combined with a TACAN station it is listed as a VORTAC on the VOR Information Page and if it includes only DME, it's displayed as VOR-DME.

Selecting a VOR:

- 1) From the Waypoint Page, press the **INFO** Softkey.
- 2) Press the **FMS** Joystick to activate the cursor.
- 3) Turn the **FMS** Joystick clockwise to begin entering identifier (turning it counter-clockwise brings up the waypoint selection submenu - press the **CLR** Key or the **FMS** Joystick to remove it), or move the **FMS** Joystick to select the facility name, or city field.

- 4) Press the **ENT** Key.

Or:

- 1) Press the **NRST** Key.
- 2) Turn the **FMS** Joystick to select the Nearest VOR Page.
- 3) Press the **FMS** Joystick to activate the cursor.
- 4) Turn the **FMS** Joystick to highlight the desired VOR.
- 5) Press the **ENT** Key to display the VOR Information Page.

USER WAYPOINTS

The G300 can create and store up to 3,000 user-defined waypoints. Once a waypoint has been created, it can be renamed, deleted, or moved.

Creating user waypoints:

- 1) To create a user waypoint at the current location, using the Map Pointer, or from the Main Menu:
 - a) To create a user waypoint at the current location, press and hold the **ENT** Key from any page.
 - b) The 'Mark a New User Waypoint?' window appears.
- Or:**
- a) Press the **MENU** Key twice to access the Main Menu.
 - b) Move the **FMS** Joystick to highlight 'User Waypoints' and press the **ENT** Key.

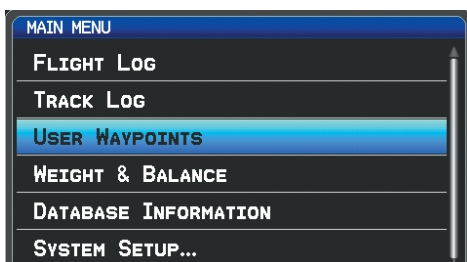

Main Menu (User Waypoints Selected)
(Single Display)

- c) Press the **NEW** Softkey. The message "Create a New User Waypoint?" is displayed.
 - d) Enter a user waypoint name (up to 10 characters). The current aircraft position is the default location of the new waypoint.
- Or:**
- a) From a map page, press the **FMS** Joystick to activate the Map Pointer (on the WX Page, press the **PAN MAP** Softkey).
 - b) Find an empty area without any map features and press the **ENT** Key. The message "Create a New User Waypoint?" is displayed.

Or:

- a) From a map page, press the **FMS** Joystick to activate the Map Pointer (on the WX Page, press the **PAN MAP** Softkey).
 - b) Select a map feature using the Map Pointer and press the **MENU** Key.
 - c) With 'Create User Waypoint' highlighted, press the **ENT** Key. The message "Create a New User Waypoint?" is displayed.
- 2) With 'Yes' highlighted, press the **ENT** Key. The New Waypoint Window is displayed.
 - 3) Move the **FMS** Joystick to the User Waypoint Name Field and enter the waypoint name, if desired.
 - 4) If desired, select the waypoint symbol:
 - a) Move the **FMS** Joystick to highlight the Symbol.
 - b) Turn the **FMS** Joystick to access the 'Select Symbol' Menu.
 - c) Turn or move the **FMS** Joystick to highlight the desired symbol from the menu, and press the **ENT** Key.

Symbol Field (Selected) User Waypoint Name Field



New Waypoint Window (Symbol Selected)

- 5) If desired, press the **POSITION** Softkey and enter the latitude, longitude, name, or altitude for the waypoint **or** press the **REF WPTS** Softkey to enter a bearing and distance from another waypoint or the bearing from two other waypoints to define the new waypoint location.



**New Waypoint Window
(POSITION Softkey Selected)
(Split-Screen)**



**New Waypoint Window
(REF WPTS Softkey Selected)
(Split-Screen)**

- 6) With 'Done' highlighted, press the **ENT** Key.

Selecting and viewing nearest user waypoints:

- 1) Press the **NRST** Key.
- 2) Turn the **FMS** Joystick to select the Nearest USR Page.
- 3) Press the **FMS** Joystick to activate the cursor.
- 4) Turn the **FMS** Joystick to highlight the desired user waypoint.
- 5) Press the **ENT** Key to display the User Waypoint Information Window.

Editing or renaming a user waypoint:

- 1) Press the **MENU** Key twice to access the Main Menu.
- 2) Move the **FMS** Joystick to highlight 'User Waypoints' and press the **ENT** Key.
- 3) Move the **FMS** Joystick to highlight the appropriate waypoint and press the **EDIT** Softkey. The Edit Waypoint Window is displayed.
- 4) Move the cursor to the desired field(s) and make any necessary changes (to edit the Reference Waypoints, press the **REF WPTS** Softkey).
- 5) With 'Done' highlighted, press the **ENT** Key.

Deleting user waypoints:

- 1) Press the **MENU** Key twice to access the Main Menu.
- 2) Turn or Move the **FMS** Joystick to highlight 'User Waypoints' and press the **ENT** Key. If deleting all user waypoints, go to Step 4.
- 3) Highlight a User Waypoint in the User Waypoint List, or enter a waypoint in the User Waypoint field.
- 4) Press the **MENU** Key.

**User Waypoints Page Menu**

- 5) Select 'Delete Waypoint' or 'Delete All'.
- 6) Press the **ENT** Key. 'No' is highlighted in the confirmation window.
- 7) With 'Yes' highlighted in the confirmation window, press the **ENT** Key.

Or:

- 1) Press the **MENU** Key twice to access the Main Menu.
- 2) Turn or Move the **FMS** Joystick to highlight 'User Waypoints' and press the **ENT** Key.
- 3) Highlight a User Waypoint in the User Waypoint List, or enter a waypoint in the User Waypoint field.
- 4) Press the **ENT** Key.
- 5) Press the **DELETE** Softkey. 'No' is highlighted in the confirmation window.
- 6) Highlight 'Yes' and press the **ENT** Key.

User Waypoints can also be deleted by 'Symbol' or 'Distance' from the User Waypoints Page Menu.

Exporting User Waypoints:

- 1) From the split-screen or full-screen MFD, press the **MENU** Key twice.
- 2) Turn or move the **FMS** Joystick to select 'User Waypoints' from the Main Menu, and press the **ENT** Key.
- 3) With an SD card inserted, press the **Menu** Key.
- 4) Turn or move the **FMS** Joystick to select 'Export Waypoints' from the Option Menu, and press the **ENT** Key.

5.5 AIRSPACE

The G300 can display the following types of airspaces: Class B/TMA, Class C/TCA, Class D, Restricted, MOA (Military), Other Airspace, Air Defense Identification Zone (ADIZ), and Temporary Flight Restriction (TFR).

The Nearest Airspace Page and Airspace Alerts provide information about airspaces and the location of the aircraft in relationship to them. The Nearest Airspace Page can be used to quickly find airspaces close to the flight path.

The Nearest Airspace Page displays the class of airspace, controlling agency, vertical boundaries, and status.

Selecting and viewing nearest airspaces:

- 1) Press the **NRST** Key.
- 2) Turn the **FMS** Joystick to select the Nearest Airspace Page.
- 3) Press the **FMS** Joystick to highlight the nearest airspace. Turn or move the **FMS** Joystick to highlight the desired airspace.
- 4) Press the **ENT** Key to display the Airspace Information Page.
- 5) Press the **FREQS** Softkey (if available) to display frequency and additional airport information similar to the Waypoint Information Page.



Nearest Airspace Page
(Single Display)



Airspace Information Page
(Single Display)

The full-screen MFD will also show a map with the nearest airspace highlighted.

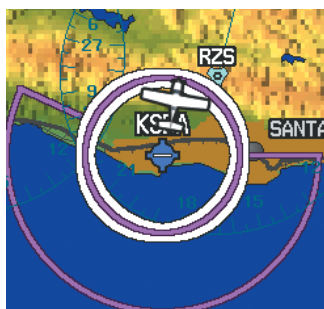

Full-Screen Nearest Airspace Page Map

AIRSPACE ALERT MESSAGES

When an airspace alert appears, press the **NRST** Key to automatically show nearby airspace information on the Nearest Airspace Page. This information includes name, time to entry (if applicable), and status.

There are four types of status information:

- Ahead—Projected to enter the airspace within the next 10 minutes or less
- Near—Within two nautical miles of an airspace but not projected to enter it.
- Near & Ahead—Project to enter the airspace within two nautical miles.
- Inside Airspace—Within the boundaries of the airspace.

SMART AIRSPACE

Smart Airspace shows airspace at and immediately surrounding the aircraft's current altitude in bold. Airspaces at all other altitudes are de-emphasized.

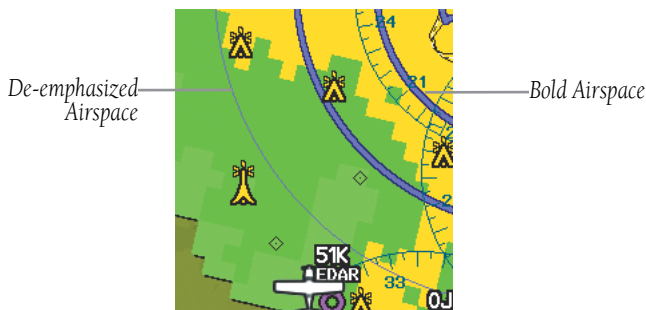

Smart Airspace

5.6 DIRECT-TO NAVIGATION

The Direct-to method of navigation, initiated by pressing the **Direct-to** Key is quicker to use than a flight plan when the desire is to navigate to a single point such as a nearby airport.

Once a direct-to is activated, the G300 establishes a point-to-point course line from the present position to the selected direct-to destination. Course guidance is provided until the direct-to is replaced with a new direct-to or flight plan, or cancelled.

Entering a waypoint identifier, facility name, or city as a direct-to destination:

- 1) Press the **Direct-to** Key. The Direct-to Window is displayed (with the active flight plan waypoint as the default selection or a blank waypoint field if no flight plan is active).
- 2) Turn the **FMS** Joystick clockwise to begin entering a waypoint identifier (turning it counter-clockwise brings up the waypoint selection submenu - press the **CLR** Key or the **FMS** Joystick to remove it), press the **RECENT** Softkey to display a list of recent waypoints, or move the **FMS** Joystick to select the facility name, or city field.
- 3) Press the **ENT** Key.
- 4) With 'Activate' highlighted, press the **ENT** Key.



Direct-to Window (Single Display)

Selecting RECENT WPTS, NRST APTS, or FPL WPTS as a direct-to destination:

- 1) Press the **Direct-to** Key. The Direct-to Window is displayed (with the active flight plan destination as the default selection or a blank destination if no flight plan is active).
- 2) Press the **RECENT** Softkey to display a list of recent waypoints (RECENT WPTS) only or turn the **FMS** Joystick counter-clockwise to display a list of recent waypoints (RECENT WPTS), nearest airports (NRST APTS), and flight plan waypoints (FPL WPTS).
- 3) Move the **FMS** Joystick to select the desired waypoint.
- 4) Press the **ENT** Key.
- 5) With 'Activate' highlighted, press the **ENT** Key.



Direct-to Window (Flight Plan Waypoints Selected)
(Single Display)

Selecting a nearby airport as a direct-to destination:

- 1) Press the **NRST** Key.
- 2) Select the desired airport (the nearest one is already selected).
- 3) Press the **Direct-to** Key.
- 4) Press the **ENT** Key.
- 5) With 'Activate' highlighted, press the **ENT** Key.

Direct-to destinations may also be selected by using the pointer on the navigation map pages. If no airport, NAVAID, or user waypoint exists at the desired location, a temporary waypoint named 'MAP POINTER' is automatically created at the location of the map arrow.

Selecting a waypoint as a direct-to destination using the pointer:

- 1) From a navigation map page, press the **FMS** Joystick to display the pointer.
- 2) Move the **FMS** Joystick to place the pointer at the desired destination location.
- 3) If the pointer is placed on an existing airport, NAVAID, or user waypoint, the waypoint name is highlighted.

- 4) Press the **Direct-to** Key to display the Direct-to Window with the selected point entered as the direct-to destination.
- 5) Press the **ENT** Key.
- 6) With 'Activate' highlighted, press the **ENT** Key.

Canceling or resuming a direct-to:

- 1) Press the **Direct-to** Key to display the Direct-to Window.
- 2) Move the **FMS** Joystick to highlight 'Stop Navigation' or 'Resume Flight Plan' if a flight plan was active.
- 3) Press the **ENT** Key. If a flight plan is still active, the G300 resumes navigating the flight plan.

Or:

- 1) Press the **FPL** Key.
- 2) Press the **Menu** Key.
- 3) Turn or move the **FMS** Joystick to highlight 'Stop Navigation' or 'Resume Flight Plan' if a flight plan was active.
- 4) Press the **ENT** Key. If a flight plan is still active, the G300 resumes navigating the flight plan.

SECTION 6 FLIGHT PLANNING

6.1 INTRODUCTION



WARNING: *The approaches provided are for monitoring purposes only. Only the final course segment (final approach fix (FAF) to missed approach point (MAP)) of the published approach is available for monitoring.*



NOTE: *The Saved Flight Plan Page is not available from the full-screen PFD.*

Flight planning on the G300 consists of building a flight plan by entering waypoints one at a time and inserting approaches as needed. The flight plan is displayed on maps using different line widths, colors, and types, based on the type of leg and the segment of the flight plan currently being flown.

Up to 50 flight plans with up to 300 waypoints each can be created and stored in memory. One flight plan can be activated at a time and becomes the active flight plan. The active flight plan is erased when the destination is reached and the system is turned off. When storing flight plans with an approach, the G300 uses the waypoint information from the current database to define the waypoints. If the database is changed or updated, the G300 automatically updates the information if the procedure has not been modified. If an approach is no longer available, the procedure is deleted from the affected stored flight plan(s), and an alert is displayed.

Whenever an approach is loaded into the active flight plan it replaces the destination airport with a sequence of waypoints for the selected approach. The airport must have a published instrument approach and only the final course segment (usually from final approach fix to missed approach point) of the published approach is available in the G300.

FLIGHT PLAN DATA FIELDS

By default, the Data Fields on the Active and Saved Flight Plan Pages are set to display Leg Desired Track (DTK), Leg Distance (DIST), and Leg Estimated Time En Route (ETE). The first two Data Fields can be changed using the Page Menu. The last Data Field can be changed using the **FMS** Joystick.

Changing the information shown in the flight plan data fields:

From the Active Flight Plan Page or the Saved Flight Plan Page, move the **FMS** Joystick (right or left) to quickly change the third data field.

Or:

- 1) From the Active Flight Plan Page or the Saved Flight Plan Page, press the **MENU** Key.
- 2) Turn or move the **FMS** Joystick to highlight 'Change Data Fields' and press the **ENT** Key. The cursor is displayed on the first Data Field.
- 3) If desired, move the **FMS** Joystick to highlight the second Data Field.
- 4) Turn the **FMS** Joystick to access the list of available Data Fields.
- 5) Turn or Move the **FMS** Joystick to highlight the desired option from the list and press the **ENT** Key.

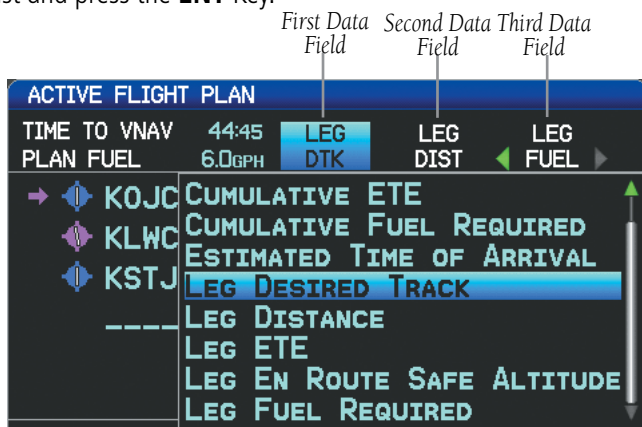

Data Field Selection (Active Flight Plan Page)

Viewing fuel remaining at each waypoint:

From the Active Flight Plan Page, move the **FMS** Joystick (right or left) to quickly change the third data field to Fuel Remaining (FUEL REM).

6.2 FLIGHT PLAN CREATION

The active flight plan is listed on the Active Flight Plan Page. It is the flight plan to which the G300 is currently providing guidance, and is shown on the navigation maps. Stored flight plans are listed on the Flight Plan List Page, and are available for activation (becomes the active flight plan).



Active Flight Plan Page (Single Display)

Map Page (Single Display)

Creating an active flight plan:

- 1) Press the **FPL** Key.
- 2) Press the **FMS** Joystick to activate the cursor.
- 3) Turn the **FMS** Joystick to display the Insert Waypoint Window. (Turning it clockwise displays a blank Insert Waypoint Window, turning it counter-clockwise displays a list of recent waypoints (RECENT WPTS), nearest airports (NRST APTS), or flight plan waypoints (FPL WPTS)).



Insert Waypoint Window (Single Display)

- 4) Enter the identifier, facility, or city name of the departure waypoint or select a waypoint from the submenu of waypoints and press the **ENT** Key. The active flight plan is modified as each waypoint is entered.
- 5) Repeat step numbers 3 and 4 to enter each additional flight plan waypoint.
- 6) When all waypoints have been entered, press the **FMS** Joystick to remove the cursor.

Creating a stored flight plan:

- 1) Press the **FPL** Key.
- 2) Turn the **FMS** Joystick to display the Flight Plan List Page.
- 3) Press the **NEW** Softkey; or press the **MENU** Key, highlight 'New Flight Plan', and press the **ENT** Key to display a blank flight plan for the first empty storage location.
- 4) Turn the **FMS** Joystick to display the Insert Waypoint Window (Turning it clockwise displays a blank Insert Waypoint Window, turning it counter-clockwise displays a list of recent waypoints (RECENT WPTS), nearest airports (NRST APTS), or flight plan waypoints (FPL WPTS)).
- 5) Enter the identifier, facility, or city name of the departure waypoint or select a waypoint from the submenu of waypoints and press the **ENT** Key.
- 6) Repeat steps 4 and 5 to enter each additional flight plan waypoint.
- 7) When all waypoints have been entered, press the **FMS** Joystick to return to the Flight Plan List Page. The new flight plan is now in the list.

6.3 FLIGHT PLAN STORAGE

The G300 can store up to 50 flight plans. The active flight plan is erased when another flight plan is activated. Details about each stored flight plan can be viewed on the Flight Plan List Page

Viewing information about a stored flight plan:

- 1) Press the **FPL** Key.
- 2) Turn the **FMS** Joystick to display the Flight Plan List Page.
- 3) Press the **FMS** Joystick to activate the cursor and turn or move the **FMS** Joystick to highlight the desired flight plan.
- 4) Press the **ENT** Key. The Saved Flight Plan Page is displayed showing departure, destination, total distance, and enroute safe altitude information for the selected Flight Plan.
- 5) Press the **FMS** Joystick or **DONE** Softkey to exit the Saved Flight Plan Page.



Flight Plan List Page (Split-Screen)



Saved Flight Plan Page (Split-Screen)

Storing an active flight plan from the Active Flight Plan Page:

- 1) Press the **FPL** Key.
- 2) Turn the **FMS** Joystick to select the Active Flight Plan Page.
- 3) Press the **MENU** Key. The Active Flight Plan Page Menu is displayed.
- 4) Turn or move the **FMS** Joystick to Highlight 'Save Flight Plan'.
- 5) Press the **ENT** Key.
- 6) With 'Yes' highlighted, press the **ENT** Key. A copy of the flight plan is stored in the next available position in the flight plan list on the Flight Plan List Page.

6.4 FLIGHT PLAN ACTIVATION

Activating a stored flight plan erases the active flight plan and replaces it with a copy of the flight plan being activated. Inverting a stored flight plan reverses the waypoint order, and replaces it with the flight plan being activated (the stored flight plan is not changed).

Activating a stored flight plan:

- 1) Press the **FPL** Key and turn the **FMS** Joystick to display the Flight Plan List Page.
- 2) Press the **FMS** Joystick to activate the cursor, and turn or move the **FMS** Joystick to highlight the desired flight plan.
- 3) Press the **ACTIVATE** Softkey; or press the **MENU** Key, highlight 'Activate Flight Plan', and press the **ENT** Key. The 'Activate XXXXX-XXXXX' confirmation window appears (only if already navigating a flight plan).
- 4) With 'Yes' highlighted, press the **ENT** Key. To cancel the request, press the **CLR** Key, the **FMS** Joystick, or highlight 'No' and press the **ENT** Key.

Activating a Flight Plan Leg:

- 1) Press the **FPL** Key.
- 2) Turn the **FMS** Joystick to display the Active Flight Plan Page.
- 3) Press the **FMS** Joystick to activate the cursor and move the **FMS** Joystick to highlight the waypoint leg to be activated.
- 4) Press the **Direct-to** Key twice. The "Activate Leg XXXXX - XXXXX?" window is displayed.



Activate Leg Window

- 5) With 'Yes' highlighted, press the **ENT** Key. To cancel the request, press the **CLR** Key, the **FMS** Joystick, or highlight 'No' and press the **ENT** Key.

6.5 FLIGHT PLAN EDITING

ADDING WAYPOINTS TO AN EXISTING FLIGHT PLAN

Waypoints can be added to the active flight plan or any stored flight plan. Choose the flight plan, select the desired point of insertion, enter the waypoint, and it is added in front of the selected waypoint. Flight plans are limited to 300 waypoints (including approach waypoints).

Adding a waypoint to a stored flight plan:

- 1) On the Flight Plan List Page, press the **FMS** Joystick to activate the cursor.
- 2) Turn or move the **FMS** Joystick to highlight the desired flight plan.
- 3) Press the **ENT** Key.
- 4) Move the **FMS** Joystick select the point in the flight plan to add the new waypoint. The new waypoint is placed directly in front of the highlighted waypoint.
- 5) Turn the **FMS** Joystick to display the Insert Waypoint Window. Turning it clockwise displays a blank Insert Waypoint Window, turning it counter-clockwise displays the a list of recent waypoints (RECENT WPTS), nearest airports (NRST APTS), or flight plan waypoints (FPL WPTS).

Or:

Press the **MENU** Key, highlight 'Insert Waypoint', and press the **ENT** Key.

- 6) Enter the identifier, facility, or city name of the departure waypoint or select a waypoint from the submenu of waypoints.
- 7) Press the **ENT** Key.

Adding a waypoint to the active flight plan:

- 1) Press the **FPL** Key.
- 2) Press the **FMS** Joystick to activate the cursor.
- 3) Using the **FMS** Joystick select the point in the flight plan before which to add the new waypoint. The new waypoint is placed directly in front of the highlighted waypoint.

- Turn the **FMS** Joystick to display the Insert Waypoint Window. Turning it clockwise displays a blank Insert Waypoint Window, turning it counter-clockwise displays the a list of recent waypoints (RECENT WPTS), nearest airports (NRST APTS), or flight plan waypoints (FPL WPTS).

Or:

Press the **MENU** Key, highlight 'Insert Waypoint', and press the **ENT** Key.

- Enter the identifier, facility, or city name of the departure waypoint or select a waypoint from the submenu of waypoints and press the **ENT** Key. The active flight plan is modified as each waypoint is entered.

Adding a waypoint to the active or saved flight plan using the map:

- Press the **FPL** Key
- From the Active Flight Plan Page or from the Saved Flight Plan Page, press the **USE MAP** Softkey to activate the map pointer.
- Move the **FMS** Joystick to highlight the desired flight plan leg to be modified.

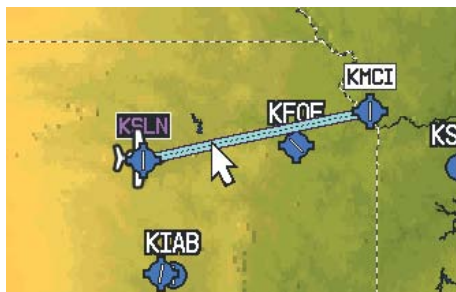

Active Flight Plan Page (Flight Plan Leg Highlighted with Map Pointer)

- With the desired flight plan leg highlighted (blue), press the **ENT** Key (the flight plan leg turns magenta). This will split the flight plan leg.
- Using the **FMS** Joystick, drag the flight plan leg to highlight the desired waypoint to be added.



Active Flight Plan Page (Waypoint Selected with Map Pointer)

- 6) With the desired waypoint highlighted, press the **ENT** Key. The flight plan is now modified to include the added waypoint.
- 7) Press the **DONE** Softkey (from the Flight Plan List Page only).

EDITING FLIGHT PLAN SPEED, FUEL, AND/OR NAME

Adjusting the Active Flight Plan fuel:

- 1) Press the **FPL** Key and turn the **FMS** Joystick to display the Active Flight Plan Page.
- 2) Press the **FMS** Joystick to activate the cursor, and move the **FMS** Joystick to highlight the 'Plan Fuel' field.
- 3) Using the **FMS** Joystick, enter the desired plan fuel, and press the **ENT** Key.

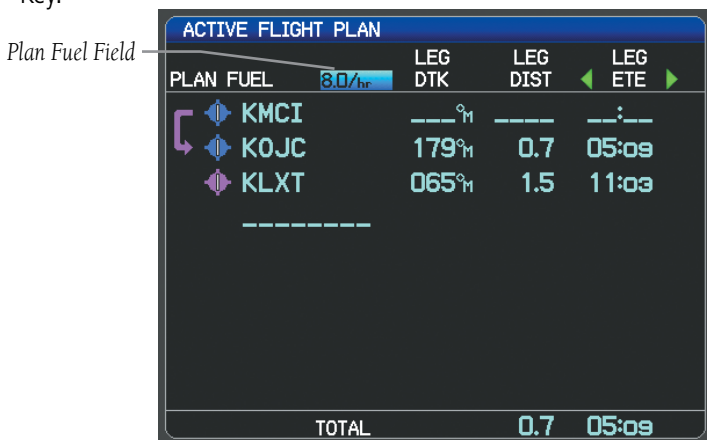

Plan Fuel (Active Flight Plan Page)

Adjusting the Saved Flight Plan speed and fuel:

- 1) Press the **FPL** Key and turn the **FMS** Joystick to display the Flight Plan List Page.
- 2) Press the **FMS** Joystick to activate the cursor, and turn or move the **FMS** Joystick to highlight the desired flight plan, and press the **ENT** Key. The Saved Flight Plan Page is displayed.
- 3) Move the **FMS** Joystick to the 'Plan Speed' field.
- 4) Using the **FMS** Joystick, enter the desired speed, and press the **ENT** Key.
- 5) Repeat steps 3 and 4 for 'Plan Fuel', and press the **DONE** Softkey.

Fuel Flow Field — *Plan Speed Field*



Flight Plan Speed and Fuel (Saved Flight Plan Page)

Editing the Saved Flight Plan name:

- 1) Press the **FPL** Key and turn the **FMS** Joystick to display the Flight Plan List Page.
- 2) Press the **FMS** Joystick to activate the cursor, and turn or move the **FMS** Joystick to highlight the desired flight plan, and press the **ENT** Key. The Saved Flight Plan Page is displayed.
- 3) Move the **FMS** Joystick to highlight the Flight Plan Name field.
- 4) Using the **FMS** Joystick, enter the flight plan name, and press the **ENT** Key.



Editing the Saved Flight Plan Name

COPYING FLIGHT PLANS

The G300 allows copying a flight plan into a new flight plan memory slot, allowing editing, etc., without affecting the original flight plan. This can be used to duplicate an existing stored flight plan for use in creating a modified version of the original stored flight plan.

Copying a stored flight plan:

- 1) Press the **FPL** Key and turn the **FMS** Joystick to display the Flight Plan List Page.
- 2) Press the **FMS** Joystick to activate the cursor, and turn or move the **FMS** Joystick to highlight the desired flight plan.
- 3) Press the **MENU** Key, using the **FMS** Joystick highlight 'Copy Flight Plan', and press the **ENT** Key.

DELETING FLIGHT PLANS

Individual or all stored flight plans can be deleted from the G300 memory.

Deleting a stored flight plan:

- 1) Press the **FPL** Key and turn the **FMS** Joystick to display the Flight Plan List Page.
- 2) Press the **FMS** Joystick to activate the cursor, and turn or move the **FMS** Joystick to highlight the desired flight plan.
- 3) Press the **CLR** Key; or press the **MENU** Key, highlight 'Delete Flight Plan', and press the **ENT** Key.

- 4) With 'Yes' highlighted, press the **ENT** Key to delete the flight plan. To cancel the request, press the **CLR** Key, the **FMS** Joystick, or highlight 'No' and press the **ENT** Key.

Deleting all stored flight plans:

- 1) Press the **FPL** Key and turn the **FMS** Joystick to display the Flight Plan List Page.
- 2) Press the **MENU** Key, highlight 'Delete All', and press the **ENT** Key.
- 3) With 'Yes' highlighted, press the **ENT** Key to delete all saved flight plans. To cancel the request, press the **CLR** Key, the **FMS** Joystick, or highlight 'No' and press the **ENT** Key.



NOTE: The changes made to the active flight plan affect navigation as soon as they are entered. Editing the active flight plan does not affect any saved flight plans. Waypoints in the final approach segment (such as the FAF or MAP) can not be deleted individually.

Deleting the Active Flight Plan:

- 1) Press the **FPL** Key to display the Active Flight Plan Page.
- 2) Press the **MENU** Key
- 3) With 'Stop Navigation' highlighted, press the **ENT** Key.

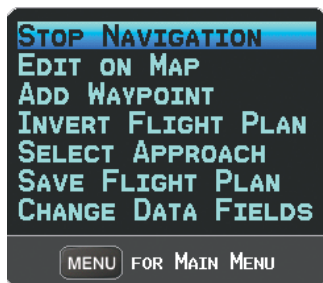

Active Flight Plan Page Menu

Deleting an individual waypoint from the active flight plan:

- 1) Press the **FPL** Key to display the Active Flight Plan Page.
- 2) Press the **FMS** Joystick to activate the cursor and turn or move the **FMS** Joystick to highlight the waypoint to be deleted.

- 3) Press the **CLR** Key or press the **MENU** Key and highlight 'Remove Waypoint'. The 'Remove XXXXX From Flight Plan?' window is displayed.



Remove Waypoint Window

- 4) With 'Yes' highlighted, press the **ENT** Key. To cancel the request, press the **CLR** Key, the **FMS** Joystick, or highlight 'No' and press the **ENT** Key.

Deleting an individual waypoint from a saved flight plan:

- 1) Press the **FPL** Key.
- 2) Turn the **FMS** Joystick to display the Flight Plan List Page if necessary.
- 3) Press the **FMS** Joystick to activate the cursor and turn or move the **FMS** Joystick to highlight the flight plan to be edited and press the **ENT** Key.
- 4) Move the **FMS** Joystick to highlight the waypoint to be deleted.
- 5) Press the **CLR** Key or press the **MENU** Key and highlight 'Remove Waypoint'. The 'Remove XXXXX From Flight Plan?' window is displayed.
- 6) With 'Yes' highlighted, press the **ENT** Key. To cancel the request, press the **CLR** Key, the **FMS** Joystick, or highlight 'No' and press the **ENT** Key.

INVERTING A FLIGHT PLAN

Any flight plan may be inverted (reversed) for navigation back to the original departure point.

Inverting the active flight plan:

- 1) Press the **FPL** Key to display the Active Flight Plan Page.
- 2) Press the **MENU** Key, turn or move the **FMS** Joystick to highlight 'Invert Flight Plan', and press the **ENT** Key. An "Invert the Active Flight Plan?" confirmation window is displayed.

- 3) With 'Yes' highlighted, press the **ENT** Key to invert the active flight plan. To cancel, press the **CLR** Key, the **FMS** Joystick, or highlight 'No' and press the **ENT** Key.

Inverting a saved flight plan:

- 1) Press the **FPL** Key and turn the **FMS** Joystick to display the Flight Plan List Page.
- 2) Press the **FMS** Joystick to activate the cursor.
- 3) Move the **FMS** Joystick to highlight the desired flight plan, and press the **ENT** Key. The Saved Flight Plan Page is displayed.
- 4) Press the **MENU** Key, highlight 'Invert Flight Plan?', and press the **ENT** Key.
- 5) With 'Yes' highlighted, press the **ENT** Key. To cancel the request, press the **CLR** Key, the **FMS** Joystick, or highlight 'No' and press the **ENT** Key.

IMPORTING/EXPORTING FLIGHT PLANS

Importing flight plans:

- 1) With a flight plan saved to the SD Card, press the **FPL** Key and turn the **FMS** Joystick to display the Flight Plan List Page.
- 2) Press the **IMPORT** Softkey.
- 3) Using the **FMS** Joystick highlight the desired flight plan to import.
- 4) Press the **IMPORT** Softkey again and press the **ENT** Key.

Exporting flight plans:

- 1) Press the **FPL** Key and turn the **FMS** Joystick to display the Flight Plan List Page.
- 2) Press the **FMS** Joystick to activate the cursor, and turn or move the **FMS** Joystick to highlight the desired flight plan.
- 3) Press the **EXPORT** Softkey and press the **ENT** Key.

6.6 APPROACHES



WARNING: The G300 is not designed to be independently used for flight into instrument meteorological conditions (IMC) or other conditions in which aircraft control is based solely upon flight instruments. The approaches provided are for monitoring purposes only. Only the final course segment (final approach fix (FAF) to missed approach point (MAP)) of the published approach is available for monitoring.

An approach can be loaded at any airport that has one available, and provides situational awareness for non-precision and precision approaches to airports with published instrument approach procedures. Only one approach can be loaded at a time in a flight plan. If an approach is loaded when another approach is already in the active flight plan, the new approach replaces the previous approach.

Whenever an approach is selected, the choice to either “Load Approach” or “Activate Approach” is given. “Load Approach” adds the approach to the end of the flight plan without immediately using it for navigation guidance. This allows continued navigation via the intermediate waypoints in the original flight plan, but keeps the procedure available on the Active Flight Plan Page for quick activation when needed. “Activate Approach” also adds the procedure to the end of the flight plan but immediately begins to navigate to the first waypoint in the approach.



Select Approach Window (Split-Screen)

SELECTING AN APPROACH

When selecting an approach, it replaces the destination airport with the sequence of waypoints for the selected approach. Keep in mind that the airport must have a published approach (GPS, RNAV, VOR, NDB, localizer, or ILS) and only the final course segment (final approach fix to missed approach point) of the published approach is available in the G300.

An approach can be selected from the Direct-to Window, Waypoint (WPT) Page, Active Flight Plan Page, and the Saved Flight Plan Page.

Loading an approach from the active or saved flight plan page:

- 1) Press the **FPL** Key.
- 2) Turn the **FMS** Joystick to display the Active Flight Plan Page or Saved Flight Plan Page.
- 3) Press the **SEL APPR** Softkey; or press the **MENU** Key, highlight 'Select Approach' by turning or moving the **FMS** Joystick, and press the **ENT** Key. The Select Approach Window is displayed.
- 4) Turn the **FMS** Joystick to access a list of available approaches. Turn or move **FMS** Joystick to highlight the desired approach and press the **ENT** Key.
- 5) With 'Load Approach' highlighted, press the **ENT** Key. To cancel the request, press the **CLR** Key or the **FMS** Joystick.

Viewing a chart for the selected approach:

- 1) With an approach selected in the Select Approach Window, press the **MENU** Key. The Show Chart Menu is displayed.



Select Approach Menu

- 2) Press the **ENT** Key. A chart displaying the selected approach is displayed.
- 3) Press the **EXIT** Softkey to return to the Select Approach Window.

Activating an approach on the Active Flight Plan Page:

- 1) Press the **FPL** Key.
- 2) Turn the **FMS** Joystick to display the Active Flight Plan Page (if necessary).
- 3) Press the **SEL APPR** Softkey; or press the **MENU** Key, highlight 'Select Approach' by turning or moving the **FMS** Joystick, and press the **ENT** Key. The Select Approach Window is displayed.
- 4) Turn the **FMS** Joystick to access a list of available approaches. Turn or move the **FMS** Joystick to highlight the desired approach and press the **ENT** Key.
- 5) With 'Activate Approach' highlighted, press the **ENT** Key. To cancel the request, press the **CLR** Key or the **FMS** Joystick.

Or:

- 1) With an approach loaded on the Active Flight Plan Page, press the **MENU** Key.
- 2) Turn or move the **FMS** Joystick to highlight 'Activate Approach', and press the **ENT** Key.

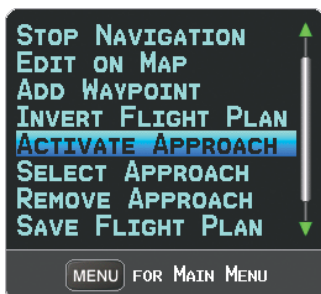

Active Flight Plan Page Menu

Or:

- 1) With an approach loaded on the Active Flight Plan Page, press the **FMS** Joystick to activate the cursor.
- 2) Move the **FMS** Joystick to highlight the approach, and press the **ENT** Key. "Activate XXXXX Approach?" window is displayed.
- 3) With 'Yes' highlighted, press the **ENT** Key.

Loading/Activating an approach from the Direct-to Window or Waypoint Page:

- 1) Press the **Direct-to** Key or select the Waypoint Page.
- 2) Press the **MENU** Key.
- 3) Turn or move the **FMS** Joystick to highlight 'Select Approach', and press the **ENT** Key. If an approach is not already loaded or activated, the cursor is displayed in the Approach Field. If an approach is already loaded or activated, 'Activate' is highlighted.
- 4) With 'Activate' highlighted press the **ENT** Key, or select an approach, highlight 'Load Approach' or 'Activate Approach', and press the **ENT** Key.

Removing an approach:

- 1) Press the **FPL** Key.
- 2) Turn the **FMS** Joystick to display the Active Flight Plan Page or Saved Flight Plan Page.
- 3) Press the **RMV APPR** Softkey; or press the **MENU** Key, highlight 'Remove Approach' by turning or moving the **FMS** Joystick, and press the **ENT** Key.

ACTIVATING VECTORS-TO-FINAL

After an approach has been activated, the **VECTORS** Softkey is used when being vectored to the final approach course by Air Traffic Control (ATC).

If the **VECTORS** Softkey is pressed, the G300 creates an extension of the final course, beyond the final approach waypoint in the database (final approach fix [FAF]). On the Active Flight Plan Page, a Vector to Final symbol appears beside the first approach waypoint.

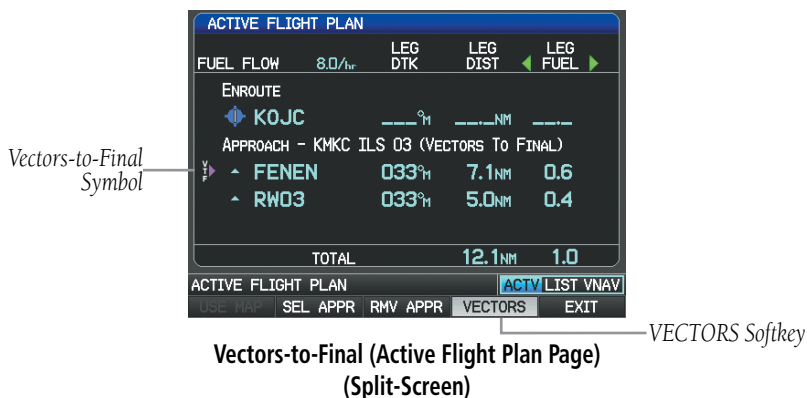

Vectors-to-Final (Active Flight Plan Page)
(Split-Screen)



Vectors-to-Final (Map Page)
(Split-Screen)

The G300 does not provide guidance to the inbound course. The course deviation needle on the graphic HSI remains off-center until established on the final approach course. The map shows an extension of the final approach course using a bold magenta line.

If the **VECTORS** Softkey is not pressed, the G300 creates a straight-line course directly to the first waypoint in the approach.

Loading the approach cancels the Direct-to and initiates a route to the FAF.

Canceling Vectors-to-Final:

From the Active Flight Plan Page (with an approach activated), press the **VECTORS** Softkey.

Or:

- 1) From the Active Flight Plan Page, press the **MENU** Key.
- 2) Turn or move the **FMS** Joystick to highlight 'Cancel Vectors-to-Final' and press the **ENT** Key.

6.7 TRIP PLANNING

Refer to Appendix B (Utilities) for information on Flight Log and Track Log.

SECTION 7 HAZARD AVOIDANCE

7.1 XM WX SATELLITE WEATHER



NOTE: XM WX Satellite Weather is only available with the optional GDU 375.

XM DATALINK WEATHER ADVISORY

Each time the system powers-up, the pilot is prompted to acknowledge an XM datalink weather advisory.

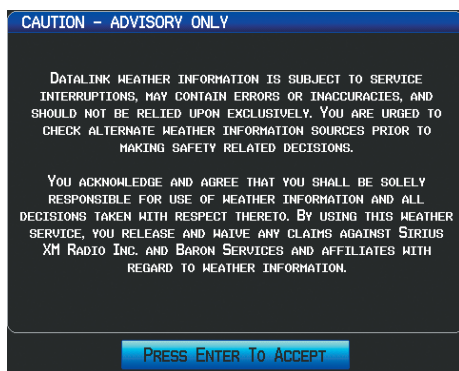

Datalink Weather Advisory

Press the **ENT** Key to acknowledge this information.

Before XM WX Satellite Weather can be used, the service must be activated by calling SiriusXM at 1.800.985.9200. Service is activated by providing SiriusXM Satellite Radio with a Radio ID. SiriusXM Satellite Radio uses the Radio ID to send an activation signal that allow the G300 to display weather data and/or entertainment programming. SiriusXM service should activate in 45 to 60 minutes.

Activating XM WX Satellite Weather (GDU 375 only):

- 1) The Radio ID can be displayed by accessing the XM Audio Page, and pressing the **INFO** Softkey. Record the Radio ID for reference during XM Activation.

- 2) Make sure that the aircraft's XM antenna has an unobstructed view of the southern sky. It is highly recommended that the aircraft be outside of and at least 25 feet away from the hangar.
- 3) Hook up the aircraft to external power if available. The complete activation process may take 45-60 minutes or more, depending on the demand on the XM activation system.
- 4) Power on the avionics and allow the G300 to power up. Do not power cycle the units during the activation process.
- 5) Go to the XM Info Page. During the activation process the unit may display several different activation levels, this is normal and should be ignored. When the service class (Aviator Lite, Aviator, or Aviator Pro) and all the weather products for the class that you subscribed to are displayed, the activation is complete. Wait 30 seconds to allow the GDU 375 to store the activation before removing power.



NOTE: During the SiriusXM activation process do not change channels or pages.

If the XM receiver will not receive, an Activation Refresh may resolve the issue. An Activation Refresh may be performed by visiting the link https://care.siriusxm.com/retailrefresh_view.action and following the instructions.

XM WX SATELLITE WEATHER INFORMATION

- Radio ID—Eight-digit ID number used for activation.
- Service Level—XM Weather subscription plan purchased.
- Weather Products—List of weather features and age of weather data in minutes.

Accessing XM Weather information:

From the Weather (WX) Page press the **INFO** Softkey.

Or:

From the (XM) Audio Page press the **INFO** Softkey.

XM WX SATELLITE WEATHER PRODUCTS

NEXRAD

NEXRAD (NEXt-generation RADar), is a network of 158 high-resolution Doppler radar systems that are operated by the National Weather Service (NWS). NEXRAD data provides centralized meteorological information for the continental United States and selected overseas locations. The maximum range of a single NEXRAD radar site is 250 nm. In addition to a wide array of services, the NEXRAD network provides important information about severe weather and air traffic safety.

NEXRAD data is not real-time. The lapsed time between collection, processing, and dissemination of NEXRAD images can be significant and may not reflect the current radar synopsis. Due to the inherent delays and the relative age of the data, it should be used for long-range planning purposes only. Never use NEXRAD data or any radar data to penetrate hazardous weather. Rather, use it in an early-warning capacity of pre-departure and enroute evaluation.

Composite data from all the NEXRAD radar sites in the United States is shown. This data is composed of the maximum reflectivity from the individual radar sweeps. The display of the information is color-coded to indicate the weather severity level.

The display of radar coverage is always active when NEXRAD is selected. Areas where NEXRAD radar coverage is not currently available or is not being collected are indicated in grayish-purple (Weather (WX) Page Only). Radar capability exists in these areas, but it is not active or is off-line.

NEXRAD ABNORMALITIES

There are possible abnormalities regarding displayed NEXRAD images. Some, but not all, of those include:

- Ground clutter
- Strokes and spurious radar data
- Sun strobes, when the radar antenna points directly at the sun
- Military aircraft deploy metallic dust (chaff) which can cause alterations in radar scans
- Interference from buildings or mountains, which may cause shadows

NEXRAD LIMITATIONS

Certain limitations exist regarding the NEXRAD radar displays. Some, but not all, are listed for the user's awareness:

- NEXRAD base reflectivity does not provide sufficient information to determine cloud layers or precipitation characteristics (hail vs. rain). For example, it is not possible to distinguish between wet snow, wet hail, and rain.
- NEXRAD base reflectivity is sampled at the minimum antenna elevation angle. An individual NEXRAD site cannot depict high altitude storms at close ranges, and has no information about storms directly over the site.
- Radar coverage only extends to 55°N.
- Any precipitation displayed between 52°N and 55°N is unknown.

NEXRAD INTENSITY

Colors are used to identify the different NEXRAD echo intensities (reflectivity) measured in dBZ (decibels of Z). "Reflectivity" (designated by the letter Z) is the amount of transmitted power returned to the radar receiver. The dBZ values increase as returned signal strength increases. Precipitation intensity is displayed using colors corresponding to the dBZ values.

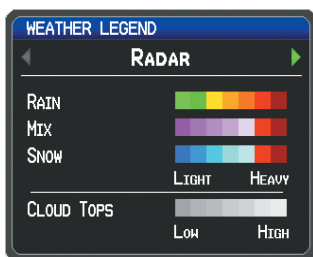

RADAR Legend

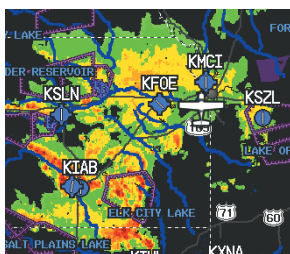

NEXRAD Data

SATELLITE MOSAIC

Satellite Mosaic displays infrared composite images of cloud cover taken by geostationary weather satellites. The Satellite Mosaic provides up to seven levels of cloud cover.

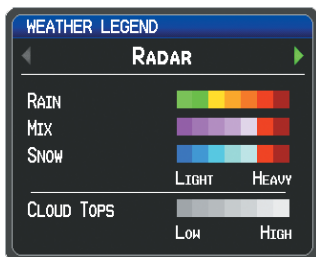

RADAR Legend

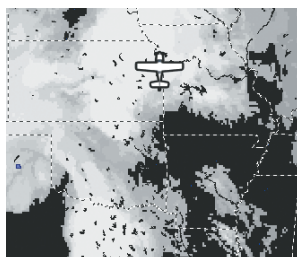

Satellite Mosaic/Cloud Tops Data

ECHO TOPS

Echo Tops are derived from NEXRAD radar and indicate the highest altitude at which precipitation is falling. Echo Tops at or above the altitude you select are displayed, in 5,000 foot increments up to 70,000 ft. Echo Tops can be helpful in determining the severity of thunderstorms.

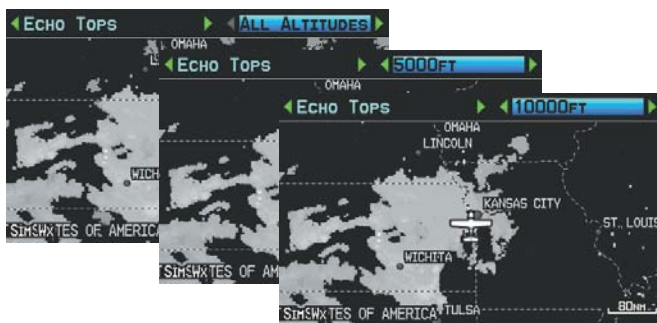

Echo Tops Data (Single Display)

WINDS ALOFT

Winds Aloft data shows the forecasted wind speed and direction at the surface and at selected altitudes. Altitudes can be displayed in 3,000-foot increments up to 42,000 feet MSL.

Winds Aloft are displayed using wind barbs or a wind streamline depending on the selected range. The wind barbs indicate wind speed and direction. The wind streamline indicates wind direction with arrows.

The wind barbs always point in the direction that the wind is coming from. The wind speed is depicted using flags at the end of the wind barb. A short wind flag is 5 knots, a long wind flag is 10 knots, and a triangle flag is 50 knots.

- System Overview
- Flight Instruments
- EIS
- COM Interface
- GPS Navigation
- Flight Planning
- Hazard Avoidance
- Additional Features
- Integrated Autopilot
- Annun/Alerts
- Appendix
- Index



Winds Aloft Data (Single Display)

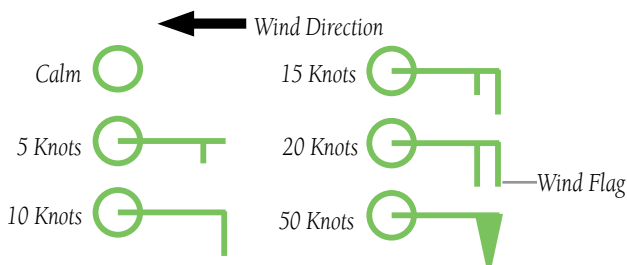

Winds Barbs

SURFACE PRESSURE

This feature displays pressure isobars and pressure centers. The isobars connect points of equal pressure. Pressure readings can help determine weather and wind conditions. High pressure areas are generally associated with fair weather. Low pressure areas are generally associated with clouds and the chance of precipitation. Isobars that are packed closely together show a strong pressure gradient. Strong gradients are associated with areas of stronger winds. Pressure units can be displayed in Millibars (mb) and Inches of Mercury (in).

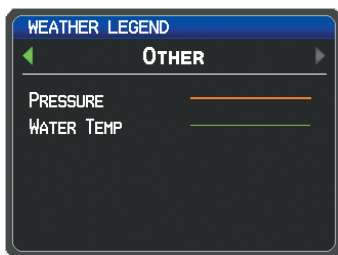

Other Legend

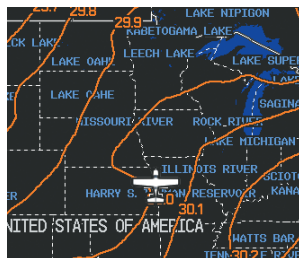

Surface Pressure Data

XM LIGHTNING

Lightning data shows the approximate location of cloud-to-ground lightning strikes. A strike icon represents a strike that has occurred within a two-kilometer region and within the last seven minutes. The exact location of the lightning strike is not displayed.



Lightning Data (Single Display)

STORM CELLS

The Storm Cells feature displays storms as well as the storm’s projected path in the immediate future.

The direction of the storm is displays by an arrow (at a range of 20 nm or less). The tip of the arrow indicates where the storm should be in 15 minutes. Critical information about the storm cell (tops and intensity) can be viewed by selecting the storm cell with the map pointer. Pressing the **ENT** Key will display additional information.



Storm Cell Data (Single Display)

METARS AND TAFS



NOTE: METAR information is only displayed within the installed aviation database service area.

METAR (METeorological Aerodrome Report) is an international code used for reporting weather observations. METARs are updated hourly or as needed. METARs typically contain information about the temperature, dewpoint, wind, precipitation, cloud cover, cloud heights, visibility, and barometric pressure. They can also contain information on precipitation amounts, lightning, and other critical data. If METAR data is available for an airport, a color-coded flag is shown next to the airport.

TAF (Terminal Area Forecast) is the standard format for 24-hour weather forecasts. TAFs may contain some of the same code as METAR data. It typically forecasts significant weather changes, temporary changes, probable changes, and expected changes in weather conditions.

METAR and TAF text data is displayed on the Map Page and the Weather (WX) Page. An abbreviated version can be viewed by panning over the METAR flag. Pressing the **ENT** Key will display additional information. METAR and TAF data can be displayed as raw or decoded text.





Changing METAR and TAF text:

- 1) Using the Map Pointer, select the desired METAR and press the **ENT** Key; or from the Waypoint (WPT) Page press the **WEATHER** Softkey. The Weather Information Page is displayed.
- 2) Press the **MENU** Key.
 - a) Select 'Show Decoded Text' or 'Show Raw Text'.
 - b) Press the **ENT** Key.

Or:

 - a) Select 'Change Text Size' and press the **ENT** Key.
 - b) Select 'Small', 'Medium', or 'Large' and press the **ENT** Key.

The METAR flag color is determined by the information in the METAR text.

-  VFR (ceiling greater than 3000 feet AGL and visibility greater than 5 miles)
-  Marginal VFR (ceiling 1000-3000 feet AGL and/or visibility 3-5 miles)
-  IFR (ceiling 500 to below 1000 feet AGL and/or visibility 1 mile to less than 3 miles)
-  Low IFR (ceiling below 500 feet AGL or visibility less than 1 mile)
-  METAR text does not contain adequate information to determine flight conditions

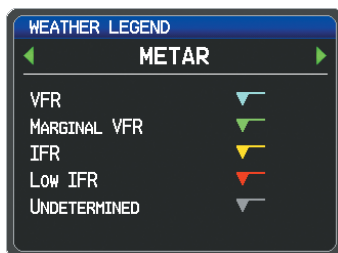

METAR Legend



METAR Selected With Map Pointer

AIRMETS

An AIRMET (AIRmen's METeoroological Information) can be especially helpful for pilots of light aircraft that have limited flight capability or instrumentation. An AIRMET must affect or be forecast to affect an area of at least 3,000 square miles at any one time. AIRMETS are routinely issued for six-hour periods and are amended as necessary due to changing weather conditions. AIRMETS are displayed as colored, dashed lines.

SIGMETS

A SIGMET (SIGnificant METeorological Information) advises of weather that is potentially hazardous to all aircraft. In the contiguous United States, the following items are covered: severe icing, severe or extreme turbulence, volcanic ash, dust storms, and sandstorms that lower visibility to less than three statute miles.

A Convective SIGMET is issued for the following conditions: thunderstorms, isolated severe thunderstorms, embedded thunderstorms, hail at the surface, and tornadoes.

A SIGMET is widespread and must affect or be forecast to affect an area of at least 3,000 square miles. SIGMETs are displayed as a yellow-dashed line.

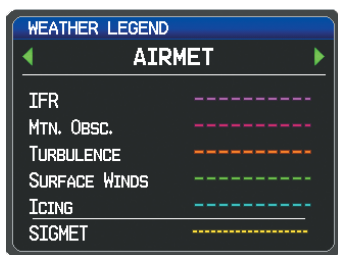

AIRMET/SIGMET Legend

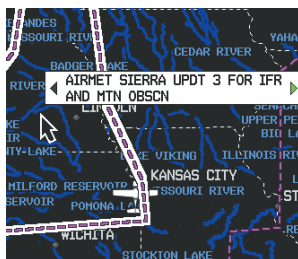

AIRMET Selected With Map Pointer

TEMPORARY FLIGHT RESTRICTIONS (TFRS)

Temporary Flight Restrictions or TFRs temporarily restrict all aircraft from entering the selected airspace unless a waiver has been issued. TFRs are routinely issued for occurrences such as sporting events, dignitary visits, military depots, and forest fires. TFRs are represented as an area highlighted by red (active) or yellow (not yet active).



TFR Data

PIREPS

Pilot Weather Reports (PIREPs) provide timely weather information for a particular route of flight. When significant weather conditions are reported or forecast, Air Traffic Control (ATC) facilities are required to solicit PIREPs. A PIREP may contain unforecast adverse weather conditions, such as low in-flight visibility, icing conditions, wind shear, and turbulence. PIREPs are issued as either Routine (UA) (blue) or Urgent (UUA) (yellow).

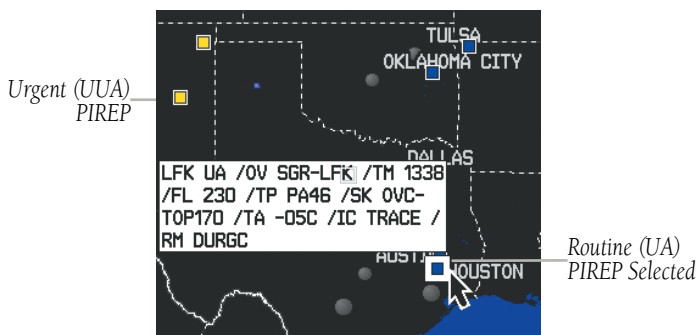

PIREP Data

FREEZING LEVELS

Freezing Level shows contours for the lowest forecast altitude where icing conditions are likely to occur.

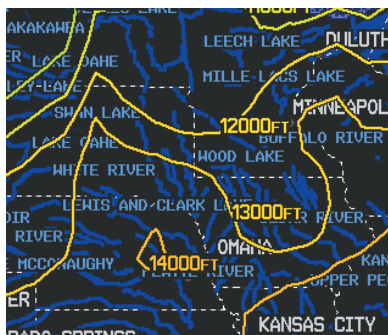

Freezing Level Data

TURBULENCE FORECAST

Turbulence data identifies the potential for erratic movement of high-altitude air mass associated winds. Turbulence is classified as light, moderate, severe, or extreme. Turbulence data is intended to supplement AIRMETs and SIGMETs.

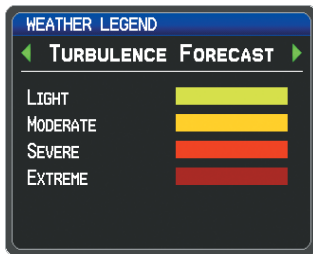

Turbulence Forecast Legend



Severe Turbulence Selected With Map Pointer (Single Display)

ICING FORECAST (CIP & SLD)

Current Icing Product (CIP) data shows a graphical view of the current icing environment. Icing severity is displayed in four categories: light, moderate, severe, and extreme (not specific to aircraft type). The CIP product is not a forecast, but a representation of the current conditions at the time of the analysis.

Supercooled Large Droplet (SLD) icing conditions are characterized by the presence of relatively large, super cooled water droplets indicative of freezing drizzle and freezing rain aloft. SLD threat areas are depicted as magenta dots over the CIP colors.

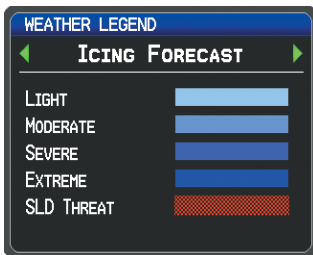

Icing Forecast Legend

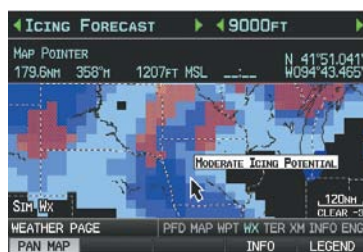

Moderate Icing Selected With Map Pointer (Single Display)

FORECAST

Forecast information is available for current and forecast weather conditions. Forecasts are available for intervals of 12, 24, 36, and 48 hours.

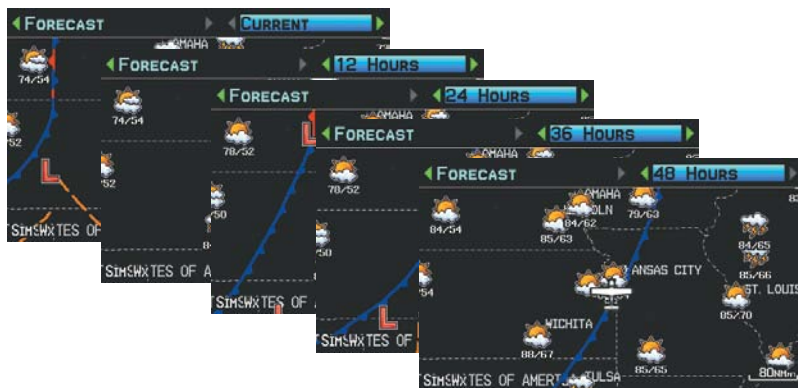

Forecast Data (Single Display)

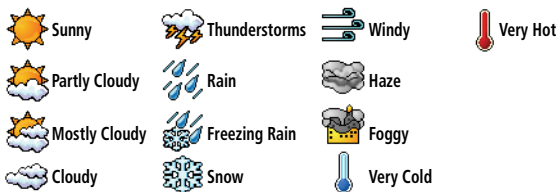

Forecast Legend

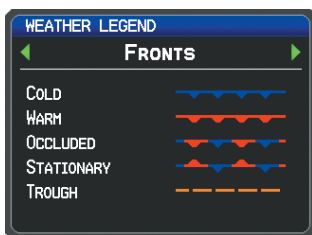

Fronts Legend

- System Overview
- Flight Instruments
- EIS
- COM Interface
- GPS Navigation
- Flight Planning
- Hazard Avoidance
- Additional Features
- Integrated Autopilot
- Annun/Alerts
- Appendix
- Index

WATER TEMPERATURE

The surface temperatures of coastal and large inland bodies of water are displayed.

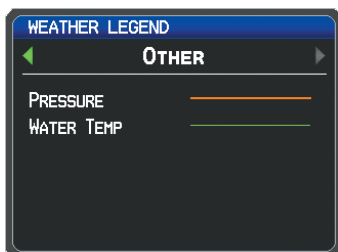

Other Legend



Water Temperature Data (Single Display)

USING XM WX SATELLITE WEATHER PRODUCTS

XM Weather Products can be displayed on the Map Page and individually on the Weather (WX) Page.

The setup menu for the Map Page controls the map range settings above which weather products are decluttered from the display. If a map range larger than the weather product map range setting is selected, the weather product data is removed from the map. For weather products such as Lightning, and Storm Cells, the weather product is displayed when a map range “smaller” than the weather product map range setting is selected (Satellite Mosaic works inversely). The menu also provides a means for enabling/disabling display of ‘Airmets’, ‘Sigmet’s’, ‘Weather Data’, ‘NEXRAD’, and/or ‘Fronts’ on the Map Page.

Additional information about the following can be displayed by panning over the display on the Weather Page and the Map Page:

- Storm Cells
- SIGMETs
- AIRMETs
- METARs
- TFRs

Additional information is also available for the following weather products on the Weather Page (not displayed on the Map Page):

- Forecast
- PIREPs

Viewing XM WX Satellite Weather products on the Map Page:

- 1) Select the Map Page.
- 2) Select the **WEATHER** Softkey to display the XM WX weather products.
Or:
 - a) Press the **MENU** Key.
 - b) Select 'Show Weather' and press the **ENT** Key.
- 3) Press the **FMS** Joystick to activate the Map Pointer.
- 4) Use the **FMS** Joystick to highlight the desired weather product with the Map Pointer.
- 5) With the desired weather product highlighted, press the **ENT** Key to get detailed information (if available).

Viewing XM WX Satellite Weather products on the Weather (WX) Page:

- 1) From the WX Page press the **FMS** Joystick to highlight the weather product field.
- 2) Turn the **FMS** Joystick to select and automatically display the desired weather product.
- 3) If necessary, move the **FMS** Joystick to highlight the type field and turn the **FMS** Joystick to scroll through a list of available options.
- 4) Press the **PAN MAP** Softkey to get abbreviated information about the selected weather product or map feature (if available).
- 5) With the desired weather product selected press the **ENT** Key to get detailed information (if available).

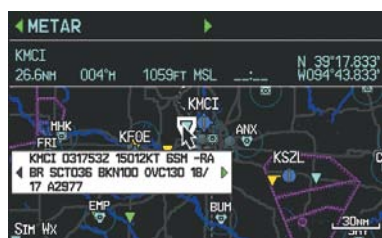

Abbreviated Weather Product Information (Single Display)



Detailed Weather Product Information (Single Display)

Viewing plain-language PIREP text on the Weather (WX) Page:

- 1) From the WX Page press the **FMS** Joystick to highlight the weather product field.
- 2) Turn the **FMS** Joystick to select the 'PIREP' weather product.
- 3) Press the **PAN MAP** Softkey and move the **FMS** Joystick to highlight the desired PIREP.
- 4) With the desired PIREP selected press the **ENT** Key to get the plain-language PIREP text.

Setting up and customizing weather data for the Map Page:

- 1) From the Map Page press the **MENU** Key.
- 2) Turn or move the **FMS** Joystick to highlight 'Set Up Map' and press the **ENT** Key.
- 3) Turn the **FMS** Joystick to select the 'Weather' or 'WX Reports' Category from the horizontal list.
- 4) Move the **FMS** Joystick to select the desired weather product.
- 5) Turn the **FMS** Joystick to access a list of options for each product (On/Off, Auto, range settings).
- 6) Press the **ENT** Key to select an option.
- 7) Press the **FMS** Joystick, the **CLR** Key, or the **EXIT** Softkey to return to the Map Page with the changed settings.

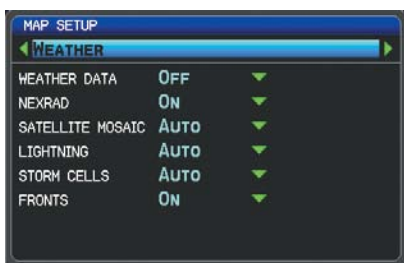

Map Setup Page (Weather Category)



Map Setup Page (WX Report Category)

Restoring default weather data for the Map Page:

- 1) From the Map Page press the **MENU** Key.
- 2) Turn or move the **FMS** Joystick to highlight 'Set Up Map' and press the **ENT** Key.
- 3) Turn the **FMS** Joystick to select 'Weather' or 'WX Reports'.

- 4) Move the **FMS** Joystick to select the desired weather product.
- 5) Press the **MENU** Key.
- 6) With 'Restore Default' or 'Restore All Map Defaults' selected, press the **ENT** Key.
- 7) Press the **FMS** Joystick, the **CLR** Key, or the **EXIT** Softkey to return to the Map Page with the restored settings.

Viewing legends for displayed weather products:

- 1) From the Map Page press the **MENU** Key to access the Map Page Menu.
- 2) Turn or move the **FMS** Joystick to select 'Weather Legend' and press the **ENT** Key to display the Weather Legend Window.
- 3) Turn the **FMS** Joystick to view the desired weather legend (Radar, Fronts, METAR, AIRMET, Turbulence Forecast, Icing Forecast, or Other).
- 4) With '**DONE**' highlighted, press the **ENT** Key to return to the Map Page.
Or:
 - 1) From the Weather (WX) Page press the **LEGEND** Softkey to display the Weather Legend Window.
 - 2) Turn the **FMS** Joystick to view the desired weather legend (Radar, Fronts, METAR, AIRMET, Turbulence Forecast, Icing Forecast, or Other).
 - 3) Press the **FMS** Joystick, **CLR** Key, or **LEGEND** Softkey to return to the Weather (WX) Page.

Animating XM WX weather:

- 1) From the Map Page press the **MENU** Key to access the Map Page Menu.
- 2) Turn or move the **FMS** Joystick to select 'Animate Weather' and press the **ENT** Key.
- 3) To stop animation, press the **MENU** Key again, turn or move the **FMS** Joystick to select 'Stop Animation', and press the **ENT** Key.
Or:
 - 1) Select the Weather (WX) Page.
 - 2) Using the **FMS** Joystick select either the 'NEXRAD Radar' or 'Satellite Mosaic' weather product.
 - 3) Select the **ANIMATE** Softkey to begin animation

Or:

- a) Press the **MENU** Key.
- b) Select 'Animate Weather' and press the **ENT** Key to begin animation.

- 4) To stop animation, deselect the **ANIMATE** Softkey.

Or:

Press the **MENU** Key, turn or move the **FMS** Joystick to select 'Stop Animation', and press the **ENT** Key.

7.2 TERRAIN



WARNING: Do not use Terrain information for primary terrain avoidance. Terrain information is intended only to enhance situational awareness.



NOTE: Terrain data is not displayed when the aircraft latitude is greater than 75° North or 60° South.



NOTE: Terrain depicted in the Profile View is always "ahead" of the aircraft, and will change as ground track changes.

The Terrain Page displays altitudes of terrain and obstructions relative to the aircraft position and altitude with reference to a database that may contain inaccuracies. Terrain and obstructions are shown only if they are in the database. Terrain and obstacle information should be used as an aid to situational awareness. They should never be used to navigate or maneuver around terrain.

Note that all obstructions may not be available in the terrain and obstacle database. No terrain and obstacle information is shown without a valid 3-D GPS position.

The G300 GPS receiver provides the horizontal position and altitude of the aircraft. Aircraft GPS altitude is derived from satellite position. GPS altitude is then converted to a mean sea level (MSL)-based altitude (GPS-MSL altitude) and is used to determine terrain and obstacle proximity. GPS-MSL altitude accuracy is affected by satellite geometry, but is not subject to variations in pressure and temperature that normally affect pressure altitude sensors. GPS-MSL altitude does not require local altimeter settings to determine MSL altitude. It is a widely-used MSL altitude source.

Terrain and obstacle databases are referenced to MSL. Using the GPS position and altitude, the Terrain feature portrays a 2-D picture of the surrounding terrain and obstacles relative to the position and altitude of the aircraft. GPS position and GPS-MSL altitude are used to calculate and predict the aircraft's flight path in relation to the surrounding terrain and obstacles. In this way, the pilot can view predicted dangerous terrain and obstacle conditions.

Alert windows appear on all pages (except the Terrain (TER) Page) to inform the pilot of proximity to the terrain and obstacles, as well as an unsafe descent rate. These alerts depend on user-defined parameters in the Terrain Page setup.

SYNTHETIC VISION

Terrain is integrated within Synthetic Vision (when active) to provide land contours (colors are consistent with those of the topographical map display), large water features, towers, obstacles over 200' AGL, as well as visual and auditory alerts to indicate the presence of terrain and obstacle threats relevant to the projected flight path. Synthetic Vision terrain information is displayed in red and yellow shading on the PFD. Refer to section 8.1 (Synthetic Vision) for more information.

TERRAIN INFORMATION

The areas of the terrain shaded red are predicted to be within 100 feet below or above the aircraft. The yellow terrain areas are between the user-defined Caution Elevation and 100 feet below the aircraft. By default, the Caution Elevation is 1,000 feet; therefore, the areas in yellow are between 1,000 feet and 100 feet below the aircraft. The black areas are further than the Caution Elevation. A projected point of impact is marked with an "X" symbol.

Enabling/Disabling Terrain Shading on the Map Page:

From the Map Page with the VFR Map displayed, press the **TERRAIN** Softkey.

Or:

- 1) From the Map Page, press the **MENU** Key.
- 2) Turn or move the **FMS** Joystick to highlight 'Set Up Map', and press the **ENT** Key.
- 3) Turn the **FMS** Joystick to highlight the 'Map' Category from the horizontal list.
- 4) Move the **FMS** Joystick to highlight the 'Terrain Shading' field.
- 5) Turn the **FMS** Joystick to select 'On' or 'Off', and press the **ENT** Key.

TERRAIN VIEWS

Two views are displayed on the Terrain (TER) Page: the Map View, and the Profile View.

Press the **MAP** or **PROFILE** Softkeys to toggle between views (split-screen only).

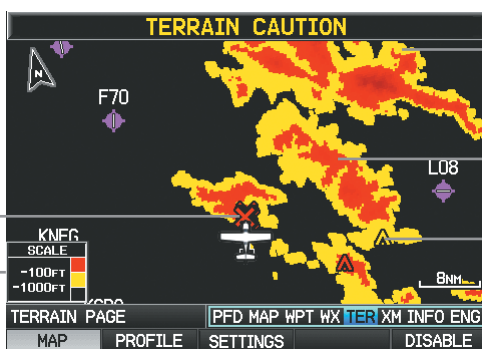

Yellow Terrain is Between the User-defined Caution Elevation and 100 ft Below the Aircraft

Red Terrain is above the aircraft, or within 100 ft below the aircraft.

Obstacle

Terrain (TER) Page (Map View) (Single Display)

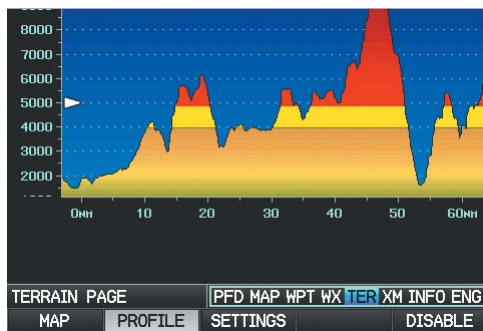

Terrain (TER) Page (Profile View) (Single Display)

OBSTACLE INFORMATION

Obstacles are shown on the Terrain Page at or below the map range of 12 nm. Obstacles are also shown on the Map Page when the map range is set to 3 nm or below.

Standard aeronautical chart symbols are used for lighted or unlighted obstacles taller than 200 feet Above Ground Level (AGL). Refer to the Obstacle Icons legend below.

Each obstacle is labeled with the altitude of the top of the obstacle, or Mean Sea Level (MSL). Each obstacle also lists, in parentheses, the actual height of the obstacle, or Above Ground Level (AGL).

Unlighted Obstacle		Lighted Obstacle		Potential Impact Points	Obstacle Location
< 1000' AGL	> 1000' AGL	< 1000' AGL	> 1000' AGL		
					WARNING: Red obstacle is above or within 100' below current aircraft altitude
					CAUTION: Yellow obstacle is between 100' and 1000' (default) below current aircraft altitude

Terrain Obstacle Colors and Symbology

TERRAIN SETTINGS

Use the terrain settings to set levels for terrain alerts as well as obstacles in or near your flight path.

- Caution Elevation—The G300 will provide an alert if the terrain or obstacle is within the default Caution Elevation or user-defined Caution Elevation.
- Look Ahead Time—Determines the maximum time when an alert annunciation occurs. For example, if 120 seconds is selected, the G300 provides an alert up to 120 seconds before you reach the terrain or obstacle.
- Alert Sensitivity—The three Alert Sensitivity settings (Terrain, Obstacle, and Descent Rate) determine what level of alerts are annunciated. The G300 defaults to 'High' sensitivity, which annunciates all red and yellow alerts at the time set in Look Ahead Time. 'Medium' sensitivity annunciates all of the red and the highest priority of yellow alerts. 'Low' only annunciates red alerts. 'Off' disables the alert.

Accessing the terrain settings:

- 1) On the Terrain Page, press the **SETTINGS** Softkey.
- 2) Move the **FMS** Joystick to highlight the desired field.
- 3) Turn the **FMS** Joystick to make changes to the highlighted field.
- 4) With 'Done' highlighted press the **ENT** Key, or press the **CLR** Key to accept the changes and exit the Terrain Setup window.

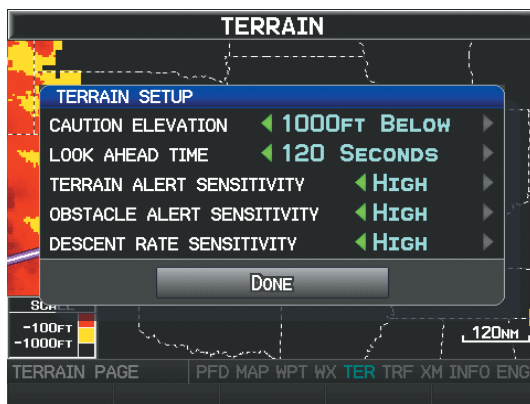

Terrain Setup

TERRAIN ALERTS

Terrain, Obstacle, and Descent Rate Alerts are issued when flight conditions meet parameters that are set within the software algorithms. Terrain alerts typically employ a CAUTION or a WARNING alert severity level, or both. When an alert is issued, visual annunciations are displayed and aural alerts are simultaneously issued. When the aircraft descends through 500 feet above the destination airport an audible "Five Hundred" altitude reminder occurs.

If the Terrain Page is not displayed, a pop-up alert appears in the lower left corner of the page. The Range Rings on the pop-up alert are spaced every whole mile/kilometer/nautical mile. Press the **CLR** Key to acknowledge the pop-up and/or aural alert.

Terrain and obstacle annunciations appear on the PFD and PFD Page in the upper left corner of the Attitude Indicator. Arrows are depicted on the terrain and obstacle annunciations if terrain is outside the Synthetic Vision field of view.

Arrows indicate the terrain is outside the Synthetic Vision field of view.



Terrain Annunciation on PFD

Enabling/Disabling terrain alerts:

From the Terrain Page, press the **DISABLE** Softkey.

Or:

- 1) From the Terrain Page, press the **MENU** Key to access the Page Menu.
- 2) Turn or move the **FMS** Joystick to highlight 'Disable Alerts' or 'Enable Alerts' and press the **ENT** Key. Disabling terrain alerts is only temporary. Terrain alerts are automatically enabled when the unit is powered on.

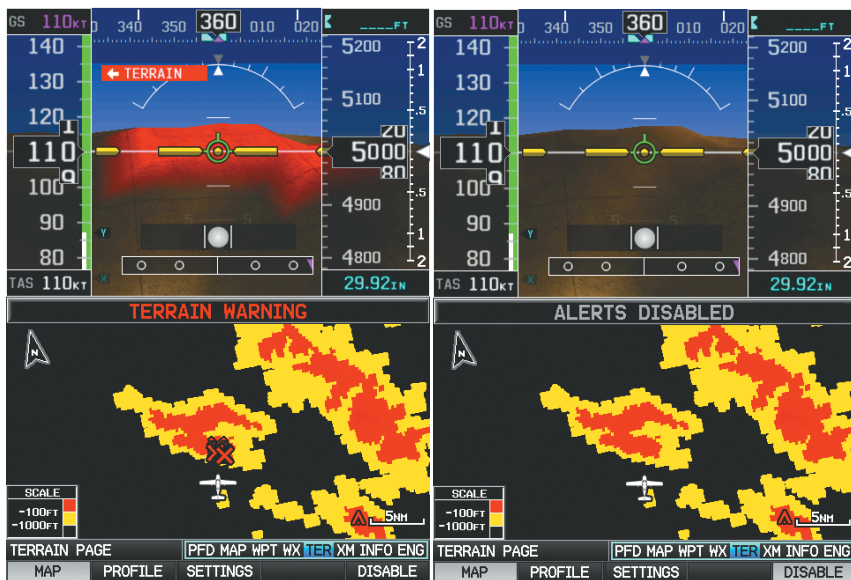

Terrain Page - Alerts Enabled
(Single Display)

Terrain Page - Alerts Disabled
(Single Display)

AURAL ALERTS

- “Five Hundred”—when the aircraft descends through 500 feet above the destination airport.

The following aural terrain alerts are issued when flight conditions meet parameters that are set within the software algorithms, and are dependent on the sensitivity level set in the Terrain Setup Menu.

Alert Severity	Terrain	Obstacle	Descent Rate
Caution	“caution, terrain” “caution, terrain ahead”	“caution, obstacle” “caution, obstacle ahead”	“caution, sink rate”
Warning	“terrain ahead! pull up!” “terrain! terrain! pull up! pull up!”	“obstacle ahead! pull up!” “obstacle! obstacle! pull up! pull up!”	“sink rate, pull up!” “pull up!”

Aural Alerts Summary



PFD Page Terrain Alerts

- System Overview
- Flight Instruments
- EIS
- COM Interface
- GPS Navigation
- Flight Planning
- Hazard Avoidance**
- Additional Features
- Integrated Autopilot
- Annun/Alerts
- Appendix
- Index

Blank Page

SECTION 8 ADDITIONAL FEATURES



NOTE: With the availability of SafeTaxi, and FliteCharts in electronic form, it is still advisable to carry another source of charts on board the aircraft.

Additional features of the system include the following:

- Synthetic Vision (SVX)
- SafeTaxi®
- FliteCharts® electronic charts
- Airport Directory Data (AOPA)
- SiriusXM Radio entertainment (Optional)
- Electronic Checklists (Optional)
- Flight Data Logging

Synthetic Vision provides a three-dimensional forward view of terrain features on the PFD. Synthetic Vision imagery shows the pilot's view of relevant features in relation to the aircraft attitude, as well as the flight path pertaining to the active flight plan.

SafeTaxi diagrams provide detailed taxiway, runway, and ramp information at more than 700 airports in the United States.

FliteCharts provide on-board electronic terminal procedure charts. Electronic charts offer the convenience of rapid access to essential information.

The AOPA Airport Directory contains airport statistics such as pattern altitudes, noise abatement information, FBO phone numbers, hours of operation, local attractions, ground transportation, lodging, and services.

The optional SiriusXM Radio entertainment audio feature offers more than 170 channels of music, news, and sports.

Optional checklists help to quickly find the proper procedure on the ground or during flight.

The Flight Data Logging feature automatically stores critical flight and engine data on an SD data card. A 2 GB SD card can store over 1,000 hours of flight data or up to 1,000 files (whichever comes first).

8.1 SYNTHETIC VISION (SVX)



WARNING: Use appropriate primary systems for navigation, and for terrain and obstacle avoidance. Synthetic Vision is intended as an aid to situational awareness only and may not provide either the accuracy or reliability upon which to solely base decisions and/or plan maneuvers to avoid terrain or obstacles.

Synthetic Vision is a visual enhancement to the G300. Synthetic Vision depicts a forward-looking attitude display of the topography immediately in front of the aircraft. Synthetic Vision information is shown on the Primary Flight Display (PFD). The depicted imagery is derived from the aircraft attitude, heading, GPS three-dimensional position, and databases of terrain, obstacles, and other relevant features. Loss of any of the required data, including temporary loss of the GPS signal, will cause Synthetic Vision to be disabled until the required data is restored.

The Synthetic Vision terrain display shows land contours (colors are consistent with those of the topographical map display), large water features, towers, and other obstacles over 200' AGL that are included in the obstacle database. Cultural features on the ground such as roads, highways, railroad tracks, cities, and state boundaries are not displayed even if those features are found on the Navigation Map. The terrain display also includes a north-south east-west grid with lines oriented with true north.

Terrain is integrated within Synthetic Vision to provide visual and auditory alerts to indicate the presence of terrain and obstacle threats relevant to the projected flight path. Terrain alerts are displayed in red and yellow shading on the PFD.

The terrain display is intended for situational awareness only. It may not provide the accuracy or fidelity on which to base decisions and plan maneuvers to avoid terrain or obstacles. Navigation must not be predicated solely upon the use of the terrain or obstacle data displayed by Synthetic Vision.

The following Synthetic Vision enhancements appear on the PFD:

- Flight Path Marker
- Terrain Alerting
- Airport Signs
- Obstacle Alerting
- Runway Display
- Zero-Pitch Line



Synthetic Vision Imagery (PFD or PFD Page)

SYNTHETIC VISION OPERATION

Synthetic Vision is activated from the PFD or PFD Page Option Menu. When Synthetic Vision is enabled, the pitch scale increments are reduced.

Activating and deactivating synthetic vision:

- 1) From the full-screen PFD and/or split-screen PFD Page, press the **MENU** Key.
- 2) Move the **FMS** Joystick to highlight the 'Synthetic Vision' field.
- 3) Turn the **FMS** Joystick to highlight 'On' or 'Off'.
- 4) Turn the **FMS** Joystick to highlight 'On' or 'Off'.



Synthetic Vision on PFD

PATHWAYS



NOTE: Pathways and terrain features are not a substitute for standard course and altitude deviation information provided by the CDI, VSI, and VDI.



NOTE: Pathways boxes may not be displayed for holding patterns, procedure turns and certain portions of the flight plan being received from an external GPS navigator.

Pathways provide a three-dimensional perspective view of the selected route of flight shown as colored rectangular boxes representing the horizontal and vertical flight path of the active flight plan. The box size represents 700 feet wide by 200 feet tall during enroute, oceanic, and terminal flight phases. During an approach, the box width is 700 feet or one half full scale deviation on the HSI, whichever is less. Other than the descending portion of an ILS or WAAS GPS approach (starting from the leg leading into the FAF), pathways boxes are shown at the level of the altitude bug.

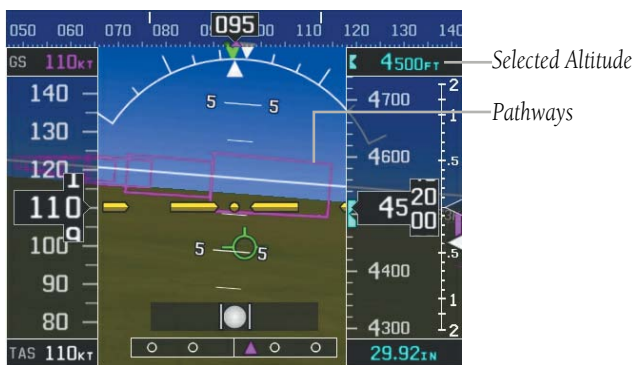

Pathways (PFD or PFD Page)

The color of the rectangular boxes may be magenta, green, or white depending on the route of flight and navigation source selected. The active GPS or GPS overlay flight plan leg is represented by magenta boxes that correspond to the Magenta CDI. A localizer course is represented by green boxes that correspond to a green CDI. An inactive leg of an active flight plan is represented by white boxes corresponding to a white line drawn on the Navigation Map indicated an inactive leg.

Pathways provide supplemental glidepath information on an active ILS, LPV, LNAV/VNAV, and some LNAV approaches. Pathways are intended as an aid to situational awareness and should not be used independent of the CDI, VDI, glide path indicator, and glide slope indicator. They are removed from the display when the selected navigation information is not available. Pathways are not displayed beyond the active leg when leg sequencing is suspended and are not displayed on any portion of the flight plan leg that would lead to intercepting a leg in the wrong direction.

- System Overview
- Flight Instruments
- EIS
- COM Interface
- GPS Navigation
- Flight Planning
- Hazard Avoidance
- Additional Features
- Integrated Autopilot
- Annun/Alerts
- Appendix
- Index

Activating and deactivating pathways:

- 1) From the full-screen PFD and/or the split-screen PFD Page, press the **MENU** Key.
- 2) Move the **FMS** Joystick to highlight the 'Pathways' field.
- 3) Turn the **FMS** Joystick to highlight 'On' or 'Off'.

DEPARTURE AND ENROUTE

Prior to intercepting an active flight plan leg, pathways are displayed as a series of boxes with pointers at each corner that point in the direction of the active waypoint. Pathways are not displayed for the first leg of the flight plan if that segment is a Heading-to-Altitude leg. The first segment displaying pathways is the first active GPS leg or active leg with a GPS overlay. If this leg of the flight plan route is outside the SVX field of view, pathways will not be visible until the aircraft has turned toward this leg. While approaching the center of the active leg and prescribed altitude, the number of pathway boxes decreases to a minimum of four.

Pathways are displayed along the flight plan route at the selected altitude for the leg. Climb profiles cannot be displayed due to the variables associated with aircraft performance. Flight plan legs requiring a climb are indicated by pathways displayed at a level above the aircraft at the altitude selected.

DESCENT AND APPROACH



NOTE: During the final segment of an ILS or WAAS GPS approach, the pathways boxes automatically adjust to correspond with the localizer/glideslope (ILS).

When an approach providing vertical guidance is activated, Pathways are shown level at the selected altitude. Pathways are shown level at the selected altitude up to the point along the final approach course where the altitude intercepts the extended vertical descent path or glideslope. From the vertical path descent or glideslope intercept point, the pathways are shown inbound to the Missed Approach Point (MAP) along the published lateral and vertical descent path.

During an ILS approach, the initial approach segment is displayed in magenta at the segment altitudes if GPS is selected as the navigation source on the CDI. When

switching to the localizer inbound with LOC selected as the navigation source on the CDI, pathways are displayed in green along the localizer and glideslope.

If GPS is the selected navigation source on the HSI, the pathways boxes are magenta. If LOC is the selected navigation source on the HSI, the pathways boxes are green for the ILS. Pathways boxes are not displayed for segments such as heading legs or VOR radials.

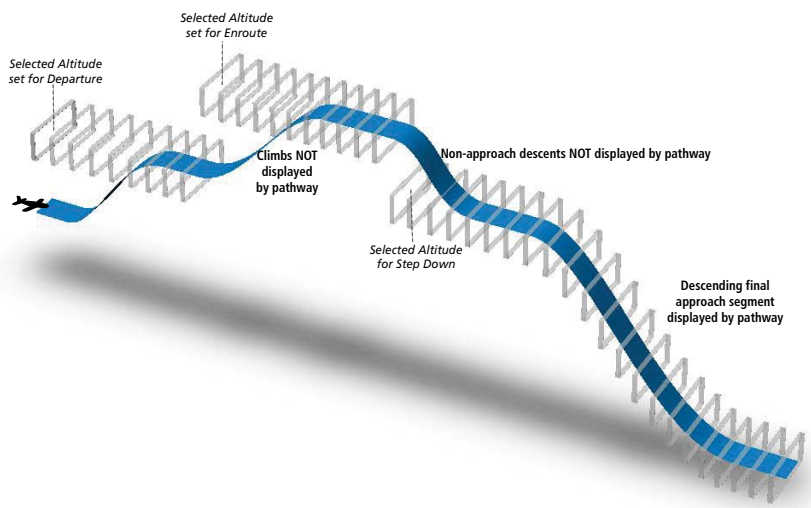

Pathways - Enroute, Descent, and Approach

MISSED APPROACH

Pathways are displayed at the selected altitude upon activating the missed approach on the external GPS navigator.

FLIGHT PATH MARKER

The Flight Path Marker (FPM), also known as a Velocity Vector, is displayed on the PFD at groundspeeds above 30 knots. The FPM depicts the approximate projected path of the aircraft accounting for wind speed and direction relative to the three-dimensional terrain display.

The FPM is always available when the Synthetic Terrain feature is in operation. The FPM represents the direction of the flight path as it relates to the terrain and obstacles on the display, while the airplane symbol represents the aircraft heading.

The FPM may be used to identify a possible conflict with the aircraft flight path and distant terrain or obstacles. Displayed terrain or obstacles in the aircraft's flight path extending above the FPM could indicate a potential conflict, even before a terrain alert is issued. However, decisions regarding terrain and/or obstacle avoidance should not be made using only the FPM.

Activating and deactivating the flight path marker:

- 1) From the full-screen PFD and/or split-screen PFD Page, press the **MENU** Key.
- 2) Move the **FMS** Joystick to highlight the 'Flight Path Marker' field.
- 3) Turn the **FMS** Joystick to highlight 'On' or 'Off'.



Flight Path Marker (PFD or PFD Page)

- System Overview
- Flight Instruments
- EIS
- COM Interface
- GPS Navigation
- Flight Planning
- Hazard Avoidance
- Additional Features
- Integrated Autopilot
- Annun/Alerts
- Appendix
- Index

ZERO PITCH LINE

The Zero Pitch Line is drawn completely across the display and represents the aircraft attitude with respect to the horizon. It may not align with the terrain horizon, particularly when the terrain is mountainous or when the aircraft is flown at high altitudes.

AIRPORT SIGNS

Airport Signs provide a visual representation of airport location and identification on the synthetic terrain display. Airport Signs appear on the display when the aircraft is approximately 15 nm from an airport and disappear at approximately 4.5 nm. Airport signs are shown without the identifier until the aircraft is approximately eight nautical miles from the airport. Airport signs are not shown behind the airspeed or altitude display.



Airport Signs

RUNWAYS



WARNING: Do not use Synthetic Vision runway depictions as the sole means for determining the proximity of the aircraft to the runway or for maintaining the proper approach path angle during landing.



NOTE: Not all airports have runways with endpoint data in the database, therefore, these runways are not displayed.

Runway data provides improved awareness of runway location with respect to the surrounding terrain. All runway thresholds are depicted at their respective elevations as defined in the database. In some situations, where threshold elevations differ significantly, crossing runways may appear to be layered. As runways are displayed, those within 45 degrees of the aircraft heading are outlined in white. Other runways (those NOT aligned with the aircraft heading) are outlined in gray. When an approach for a specific runway is active, that runway appears brighter and is outlined with a white box, regardless of the runway orientation as related to aircraft heading. As the aircraft gets closer to the runway, more detail such as runway numbers and centerlines are displayed.

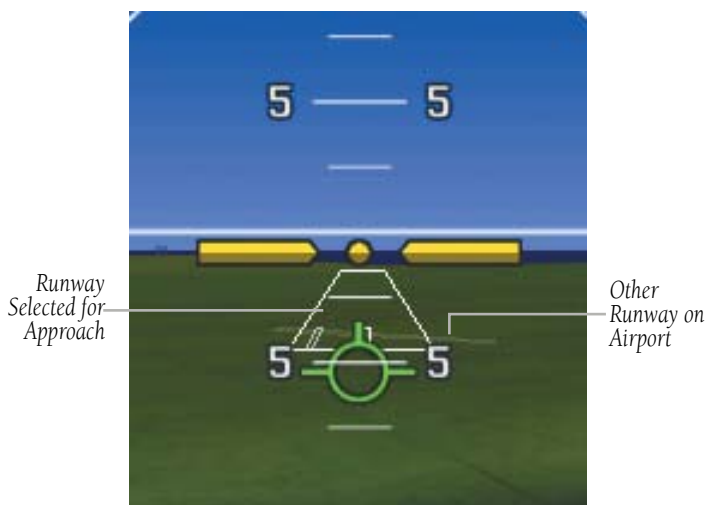

Airport Runways

terrain alert. Obstacles greater than 1000 feet below the aircraft altitude are not shown. Obstacles are shown behind the airspeed and altitude displays.

- System Overview
- Flight Instruments
- EIS
- COM Interface
- GPS Navigation
- Flight Planning
- Hazard Avoidance
- Additional Features
- Integrated Autopilot
- Annun/Alerts
- Appendix
- Index



Obstacle Annunciation

Obstacle Caution

Potential Impact Point

Synthetic Vision Obstacle Alerts

Arrows indicate the obstacle is outside the Synthetic Vision field of view.



Obstacle Outside the Synthetic Vision Field of View

During unusual attitude conditions or when the terrain gradient is great enough to completely fill the display, a brown (earth) or blue (sky) colored bar at the top or bottom of the screen is displayed to prevent the pilot from losing sight of the horizon.



Blue Sky Bar with Full Display Terrain

8.2 SAFETAXI

SafeTaxi is an enhanced feature that gives greater map detail when viewing airports at close range. When viewing at ranges close enough to show the airport detail, the map reveals taxiways with identifying letters/numbers, runway incursion "Hot Spots", and airport landmarks including ramps, buildings, control towers, and other prominent features. Resolution is greater at lower map ranges. The SafeTaxi feature can be seen on the Map Page and the Waypoint Page

Designated Hot Spots are recognized at airports with many intersecting taxiways and runways, and/or complex ramp areas. Airport Hot Spots are outlined to caution pilots of areas on an airport surface where positional awareness confusion or runway incursions happen most often. Hot Spots are defined by a red shaded area.

During ground operations the aircraft's position is displayed in reference to taxiways, runways, and airport features. When panning over the airport, features such as runway holding lines and taxiways are shown at the cursor.

System Overview

Flight Instruments

EIS

COM Interface

GPS Navigation

Flight Planning

Hazard Avoidance

Additional Features

Integrated Autopilot

Annun/Alerts

Appendix

Index

- System Overview
- Flight Instruments
- EIS
- COM Interface
- GPS Navigation
- Flight Planning
- Hazard Avoidance
- Additional Features
- Integrated Autopilot
- Annun/Alerts
- Appendix
- Index

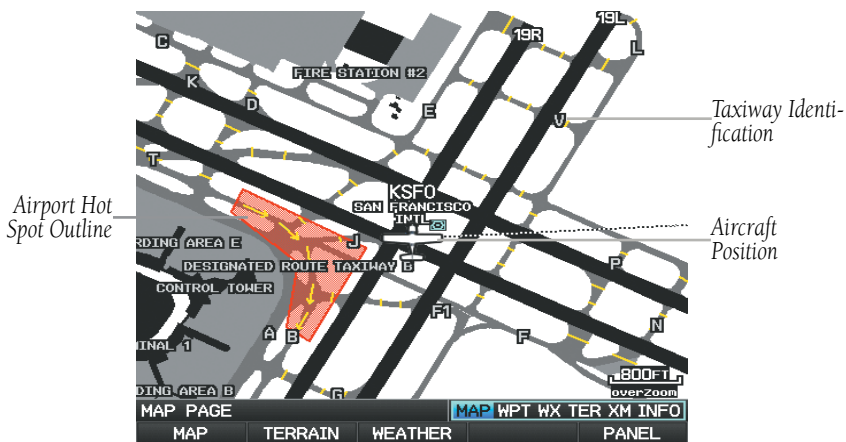

SafeTaxi Depiction on the Map Page

Enabling/disabling SafeTaxi:

- 1) With the Map Page displayed, press the **Menu** Key. The Map Page Menu is displayed.
- 2) Turn or move the **FMS** Joystick to highlight 'Set Up Map' and press the **ENT** Key.
- 3) Turn the **FMS** Joystick to highlight the 'Airport' Category from the horizontal list.
- 4) Move the **FMS** Joystick to highlight the 'Safe Taxi' Field.
- 5) Turn the **FMS** Joystick to access the menu options.
- 6) Turn or move the **FMS** Joystick to select 'On' or 'Off', and press the **ENT** Key.

SAFETAXI CYCLE NUMBER AND REVISION

SafeTaxi database is revised every 56 days. SafeTaxi is always available for use after the expiration date. The Power-up Page indicates whether the databases are current, out of date, or not available. The Power-up Page shows the SafeTaxi database is current when the SafeTaxi Expires date is shown in white. When the SafeTaxi cycle has expired, the SafeTaxi Expires date appears in yellow.

The SafeTaxi Region, Version, Cycle, Effective date, and Expiration date of the database cycle can also be found in the Main Menu, under 'Database Information'.

The SafeTaxi database is provided by Garmin. Refer to Appendix C for instructions on updating the SafeTaxi database.

8.3 FLITECHARTS®



WARNING: Do not use the approach information provided by the VFR navigation database residing within the G300 as a means of navigating any instrument approach. The G300 VFR navigation database is limited to present only the waypoints for the final approach leg of a published procedure. These waypoints and associated course line are made available for monitoring purposes only.

FliteCharts resemble the paper version of National Aeronautical Charting Office (NACO) terminal procedures charts. The charts are displayed with high-resolution and in color for applicable charts. FliteCharts database subscription is available from Garmin. Available data includes:

- Arrivals (STAR)
- Departure Procedures (DP)
- Approaches
- Airport Diagrams
- Takeoff Minimums
- Alternate Minimums

Displaying FliteCharts:

- 1) With the Waypoint (WPT) Page displayed, press the **CHART** Softkey.
- 2) Press the **FMS** Joystick to activate the cursor.
- 3) Move the **FMS** Joystick to highlight the Airport Identifier Field and use the **FMS** Joystick to begin entering the desired airport.

Or:

- a) Move the **FMS** Joystick to highlight the Chart Field.
- b) Turn the **FMS** Joystick to access a drop-down menu of available charts.
- c) Turn or move the **FMS** Joystick to select the desired chart, and press the **ENT** Key.

Or:

- 1) From the Active Flight Plan Page (with a waypoint entered), press the **SEL APPR** Softkey. The 'Select Approach Window' is displayed.
- 2) Press the **MENU** Key.
- 3) Turn or move the **FMS** Joystick to select 'Show Chart', and press the **ENT** Key. The selected chart is displayed.
- 4) Press the **EXIT** Softkey to return to the previous page.

Or:

- 1) From the Map Page or Active Flight Plan Page, use the Map Pointer to highlight the desired airport and press the **ENT** Key. The Airport Information Window is displayed.
- 2) Press the **CHART** Softkey.
- 3) With the 'Chart' Field highlighted, turn the **FMS** Joystick to access a drop-down menu of available charts.
- 4) Turn or move the **FMS** Joystick to select the desired chart, and press the **ENT** Key.

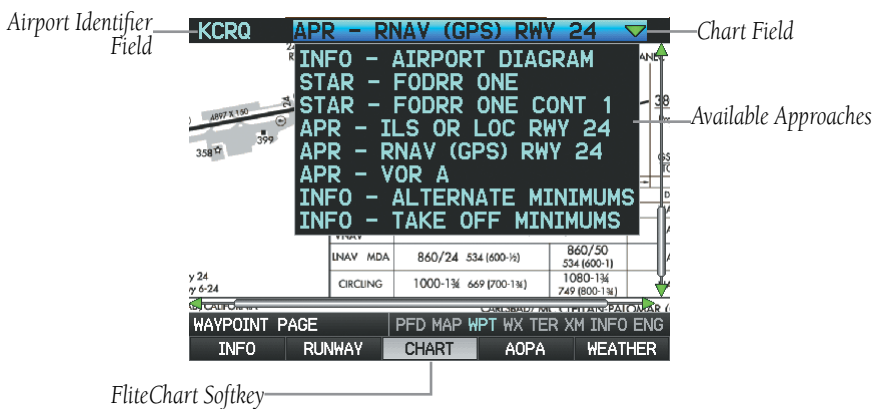

FliteCharts (Waypoint Page)
(Single Display)

When a terminal procedure chart is not available for the requested airport or there is an error rendering the data, the banner "CHART NOT AVAILABLE" appears on the screen. The "CHART NOT AVAILABLE" banner does not refer to the FliteCharts subscription, but rather the availability of a particular airport chart selection or procedure for a selected airport.

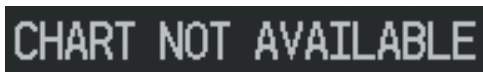
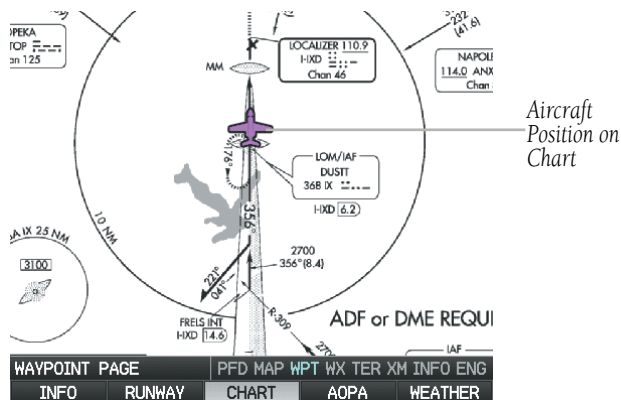

Chart Not Available Banner

AIRCRAFT SYMBOL

The aircraft symbol is shown in magenta on the chart only if the chart is to scale and the aircraft position is within the boundaries of the chart. The aircraft symbol is not displayed when the Aircraft Not Shown Icon appears. The Aircraft Not Shown Icon may appear at certain times, even if the chart is displayed to scale.



Aircraft Symbol Displayed on Chart (Waypoint Page)
(Single Display)

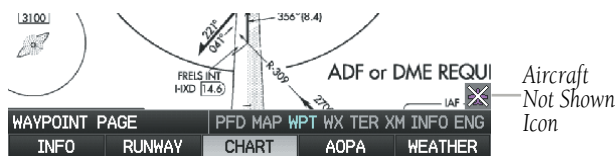

Aircraft Not Shown Icon (Waypoint Page)
(Single Display)

CHART RANGE

Changing the chart range:

Use the down arrow on the **RNG** Key to zoom in (decreasing), or the up arrow to zoom out (increasing). Move the **FMS** Joystick to scroll the chart up, down, left, or right.

Or:

To quickly zoom all the way out, press the **CHART** Softkey. Press it again to return to the previous range (only available from the Waypoint Page).

- System Overview
- Flight Instruments
- EIS
- COM Interface
- GPS Navigation
- Flight Planning
- Hazard Avoidance
- Additional Features
- Integrated Autopilot
- Annun/Alerts
- Appendix
- Index

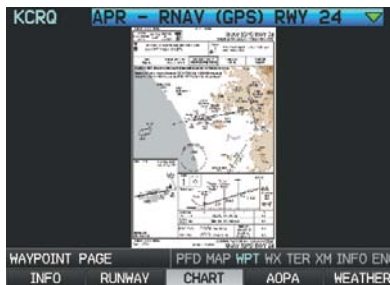

FliteCharts (Zoomed Out)
(Single Display)

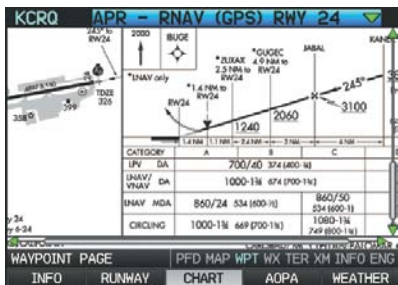

FliteCharts (Zoomed In)
(Single Display)

Scroll Arrow

Scroll Bar

FLITECHARTS CYCLE NUMBER AND EXPIRATION DATE

FliteCharts data is revised every 28 days. FliteCharts do not expire and will remain viewable after the expiration date. The Power-up Page indicates any of four different possible criteria for chart availability. These indications are whether the databases are not configured, not available, current or out of date.

8.4 AOPA DATA

The AOPA Airport Directory contains airport statistics such as pattern altitudes, noise abatement information, FBO phone numbers, hours of operation, local attractions, ground transportation, lodging, and services.

Viewing AOPA Airport Directory information:



From the Waypoint (WPT) Page, press the **AOPA** Softkey.

Or:

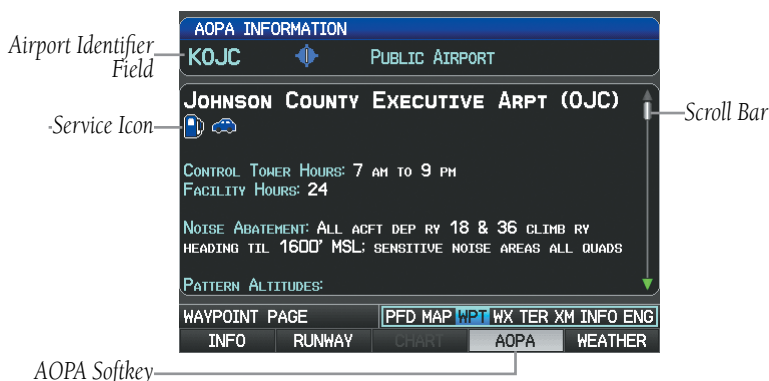
- 1) From any map highlight an airport using the Map Pointer, and press the **ENT** Key. The Airport Information Window is displayed.
- 2) Press the **AOPA** Softkey.
- 3) To return to the map, press the **ENT** Key, the **CLR** Key, or the **FMS** Joystick.



AOPA (Waypoint (WPT) Page)
(Single Display)

Icon	Description
	Restaurant on Field
	Self Serve Fuel
	Courtesy Car

AOPA Directory Service Icons

8.5 SIRIUSXM RADIO ENTERTAINMENT (OPTIONAL)



NOTE: SiriusXM Radio is only available with the optional GDU 375.



NOTE: Refer to the Hazard Avoidance Section for information about XM WX Satellite Weather products.

SiriusXM Satellite Radio offers a variety of radio programming over long distances without having to constantly search for new stations. Based on signals from satellites, coverage far exceeds land-based transmissions. SiriusXM Satellite Radio services are subscription-based.

ACTIVATING SIRIUSXM SATELLITE RADIO SERVICES

Before SiriusXM Satellite Radio can be used, the service must be activated by calling SiriusXM at 1.800.985.9200. Service is activated by providing SiriusXM Satellite Radio with a Radio ID. SiriusXM Satellite Radio uses the Radio ID to send an activation signal that allows the G300 to display weather data and/or entertainment programming. SiriusXM service should activate in 45 to 60 minutes.

Activating SiriusXM Satellite Radio (GDU 375 only):

- 1) The Radio ID can be displayed by accessing the XM Audio Page, and pressing the **INFO** Softkey. Record the Radio ID for reference during XM Activation.
- 2) Make sure that the aircraft's XM antenna has an unobstructed view of the southern sky. It is highly recommended that the aircraft be outside of and at least 25 feet away from the hangar.
- 3) Hook up the aircraft to external power if available. The complete activation process may take 45-60 minutes or more, depending on the demand on the XM activation system.
- 4) Power on the avionics and allow the G300 to power up. Do not power cycle the units during the activation process.

- Go to the XM Info Page. During the activation process the unit may display several different activation levels, this is normal and should be ignored. When the service class (Aviator Lite, Aviator, or Aviator Pro) and all the weather products for the class that you subscribed to are displayed, the activation is complete. Wait 30 seconds to allow the GDU 375 to store the activation before removing power.



NOTE: During the XM activation process do not change channels or pages.

If the XM receiver will not receive, an Activation Refresh may resolve the issue. An Activation Refresh may be performed by visiting the link <http://www.xmradio.com/refresh/rapidrefresh.xmc> and following the instructions.

Accessing the Radio ID:

From the XM Audio Page press the **INFO** Softkey.

Or:

From the XM Audio Page select Channel '0' in the 'All Channels' Category.

Or:

- From the WX Page press the **MENU** Key to display the WX Page Menu.
- Turn or move the **FMS** Joystick to highlight 'Weather Products' and press the **ENT** Key.

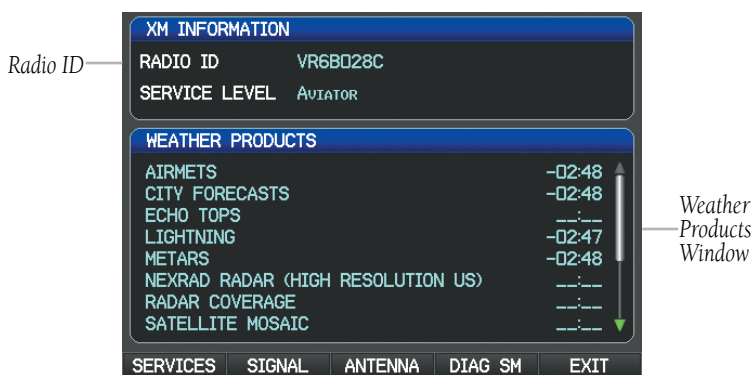

XM Information Page
(Split-Screen)

USING SIRIUSXM RADIO

The XM Audio Page provides information and control of the audio entertainment features of the SiriusXM Satellite Radio.

Selecting the XM Audio Page:

- 1) If necessary, press the **FMS** Joystick to interact with the page navigation bar.
- 2) Turn the **FMS** Joystick to select the XM Audio Page.



XM Audio Page (Split-Screen)

CATEGORY

The Category Field of the XM Audio Page cycles through a horizontal list of categories such as jazz, rock, or news.

Selecting a category:

- 1) Press the **CATEGORY** Softkey on the XM Audio Page. The Category Field is highlighted.



Category Field (Split-Screen)

- 2) Turn the **FMS** Joystick to highlight the desired category.

Or:

- 1) Press the **FMS** Joystick to activate the cursor. Move the **FMS** Joystick to highlight the Category Field (if necessary).
- 2) Turn the **FMS** Joystick to highlight the desired category.

Press and hold the **CATEGORY** Softkey to view the 'All Channels' Category.

ACTIVE CHANNEL AND CHANNEL LIST

The Channels List of the XM Audio Page shows a list of the available channels for the selected category. The currently selected channel will flash blue. The Active Channel is denoted by an arrow.

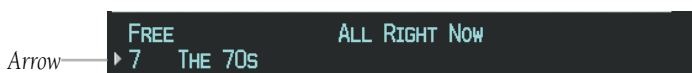

Active Channel

The Active Channel Box (split-screen only) or the Now Playing Box (full-screen) shows the currently selected channel, signal strength, and volume.

Selecting a channel:

- 1) From the XM Audio Page, press the **CHANNEL** Softkey. The Channel Field is highlighted.
- 2) Turn the **FMS** Joystick to highlight the desired channel and press the **ENT** Key.

Or:

- 1) Press the **FMS** Joystick. Move the **FMS** Joystick to highlight the Channel Field (if necessary).
- 2) Turn the **FMS** Joystick to highlight the desired channel and press the **ENT** Key.

Or:

- 1) From the XM Audio Page, press the **MENU** Key.
- 2) Turn or move the **FMS** Joystick to highlight 'Enter Channel' and press the **ENT** Key.
- 3) Turn the **FMS** Joystick to enter the desired channel and press the **ENT** or **CLR** Key.

USING FAVORITES

Favorites is a customized category of up to 30 of your SiriusXM Radio favorites.

Adding a channel to Favorites:

- 1) With the favorites channel selected, press the **MENU** Key.
- 2) With 'Add To Favorites' selected, press the **ENT** Key.
- 3) With 'Yes' selected, press the **ENT** Key.



Adding a Channel to Favorites

Selecting Favorites:

- 1) Press the **FAVORITE** Softkey on the XM Audio Page. The Favorites category is displayed.
- 2) Press the **FMS** Joystick to activate the cursor.
- 3) Move the **FMS** Joystick to select the desired channel and press the **ENT** Key.

Or:

- 1) Press the **FMS** Joystick to activate the cursor. Move the **FMS** Joystick to highlight the Category Field (if necessary).
- 2) Turn the **FMS** Joystick to highlight the Favorites category.
- 3) Move the **FMS** Joystick to select the desired channel and press the **ENT** Key.

Deleting a channel from Favorites:

- 1) With the Favorites channel selected, press the **MENU** Key.
- 2) With 'Remove Favorite' selected, press the **ENT** Key.

Or:

Highlight 'Remove All Favorites' and press the **ENT** Key to delete all channels from your Favorites list.

VOLUME

Radio volume is shown in the Now Playing Box in the lower right corner of the display. Volume level is controlled by pressing the **VOLUME** Softkey, which brings up the **MUTE** Softkey, and the volume increase (**VOL +**) and decrease (**VOL -**) softkeys.

Adjusting the volume:

- 1) With the XM Audio Page displayed, press the **VOLUME** Softkey.
- 2) Press the **VOL -** Softkey to reduce volume or press the **VOL +** Softkey to increase volume.
- 3) Press the **MUTE** Softkey to mute the audio. Press the **MUTE** Softkey again to unmute the audio.

Or:

Press and hold the **VOLUME** Softkey to mute and unmute the audio.

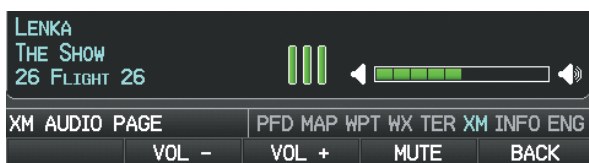

Volume Control (Split-Screen)

8.6 ELECTRONIC CHECKLISTS (OPTIONAL)



NOTE: The information described in this section is not intended to replace the checklist information described in the AFM.



NOTE: Garmin is not responsible for the availability or content of checklists. G300 checklists are created, modified, and updated by the aircraft manufacturer.



NOTE: Checklists cannot be edited from within the system.

The G300 is capable of displaying checklists (if available from the aircraft manufacturer) which allow a pilot to quickly find the proper procedure on the ground and during each phase of flight. The G300 accesses the checklist file (*.ace) from the root directory (/*.ace) of the SD card. If a checklist file is available on the SD card, the 'Checklists' Main Menu Option will appear.

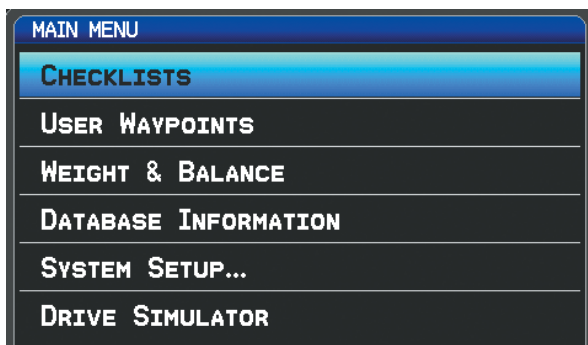

Main Menu w/ Checklists (Split-Screen)

8.7 FLIGHT DATA LOGGING

The flight data logging feature automatically stores flight and engine data to an SD card. Data is recorded to the SD card every second. A data file is created each time the system is powered on with an SD card inserted, or each time an SD card is inserted after power on. A 2 GB SD card can store over 1,000 hours of flight data or up to 1,000 files (whichever comes first). The data files stored on the SD card have an extension of .csv. This file format can be opened using a spread sheet application on a personal computer. Garmin recommends using a 2 GB SanDisk or Toshiba SD card.

- System Overview
- Flight Instruments
- EIS
- COM Interface
- GPS Navigation
- Flight Planning
- Hazard Avoidance
- Additional Features**
- Integrated Autopilot
- Annun/Alerts
- Appendix
- Index

Blank Page

SECTION 9 INTEGRATED AUTOPILOT (OPTIONAL)



NOTE: The approved Pilot's Operating Handbook (POH) always supersedes the information in this Pilot's Guide.



NOTE: Refer to the approved Pilot's Operating Handbook (POH) for emergency procedures.



NOTE: This section covers the operation of the G300 when configured with an optional external autopilot unit. Refer to the external autopilot vendor documentation for additional information.

The G300 can communicate with an optional external autopilot unit. The G300 issues pitch and roll steering commands to the external autopilot unit. The external autopilot unit is then responsible for moving the flight controls.

This section contains the following terminology:

- External Autopilot Unit: Refers to the third-party autopilot box.
- Integrated Autopilot: Refers to the functionality available when the External Autopilot Unit and the G300 are working together.



NOTE: In a multiple display configuration, the external autopilot unit is connected to a single GDU (most likely the PFD). In the event that the GDU connected to the external autopilot unit fails, the integrated autopilot capability will be lost.

9.1 INTEGRATED AUTOPILOT OPERATION

CONTROLS

INTEGRATED AUTOPILOT PFD PAGE (SINGLE DISPLAY) & PFD (DUAL DISPLAY) SOFTKEYS



NOTE: Unless otherwise specified, all mode softkeys are alternate action (i.e., press on, press off).

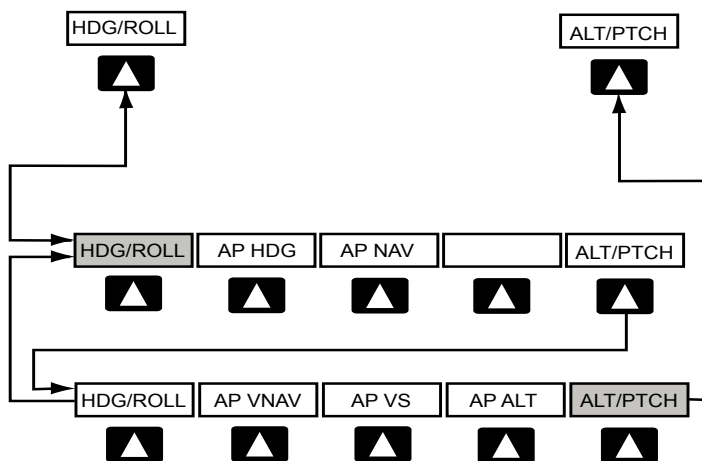

HDG/ROLL Softkey selected

HDG/ROLL	Initial press allows the pilot to adjust the heading bug and displays lateral mode softkeys; subsequent press returns to top-level softkeys
AP HDG	Selects/deselects heading mode
AP NAV	Selects/deselects navigation mode
ALT/PTCH	Initial press allows the pilot to adjust the selected altitude and displays the vertical mode softkeys; subsequent press returns to top-level softkeys

ALT/PTCH Softkey selected

HDG/ROLL	Initial press allows the pilot to adjust the heading bug and displays lateral mode softkeys; subsequent press returns to top-level softkeys
AP VNAV	Selects/deselects altitude hold mode
AP VS	Selects/deselects vertical speed mode
AP ALT	Selects/deselects altitude hold mode
ALT/PTCH	Initial press allows the pilot to adjust the selected altitude and displays the vertical mode softkeys; subsequent press returns to top-level softkeys

FMS JOYSTICK

Moving the **FMS** Joystick up/down adjusts the mode reference for Vertical Speed (VS), Altitude Hold (ALT), and Pitch Hold (PIT) modes.

Moving the **FMS** Joystick left/right adjusts the mode reference for Roll Hold (ROL) mode.

ENGAGING THE INTEGRATED AUTOPILOT

An initial press of a softkey or button listed below (when the Integrated Autopilot is not engaged) will engage the Integrated Autopilot with the listed lateral and vertical modes:

Control Pressed	Modes Selected			
	Lateral		Vertical	
	Mode/Annunciation		Mode/Annunciation	
CWS Button (press and hold)	Roll Hold *	ROL	Pitch Hold *	PIT
AP HDG Softkey	Heading	HDG	Pitch Hold *	PIT
AP NAV Softkey	Navigation **	GPS	Pitch Hold *	PIT
AP ALT Softkey	Roll Hold *	ROL	Altitude Hold	ALT
AP VS Softkey	Roll Hold *	ROL	Vertical Speed	VS
AP VNAV Softkey	Roll Hold *	ROL	Vertical Navigation	VNAV ***

* Default

** Requires an active flight plan.

*** Requires an active flight plan and VNAV must be enabled.

Engaging the Integrated Autopilot

The **AP NAV** Softkey must have an active GPS course to activate the integrated autopilot.

The **AP VNAV** Softkey must have an active flight plan and VNAV enabled to activate the integrated autopilot.

DISENGAGING THE INTEGRATED AUTOPILOT

The Integrated Autopilot is manually disengaged by pressing the autopilot disconnect button on the control stick or yoke. Manual disengagement is indicated by a five-second flashing yellow 'AP' annunciation and an aural alert.

Automatic disengagement is indicated by a flashing red 'AP' annunciation and an aural alert. The flashing indication continues until acknowledged by pressing the **ENT** Key. Automatic disengagement occurs due to:

- System failure
- Invalid sensor data
- Inability to compute default autopilot modes

CONTROL WHEEL STEERING (CWS)

Control Wheel Steering allows the aircraft to be hand-flown without disengaging the Integrated Autopilot. Press and hold the external autopilot unit's CWS Button to temporarily disengage the pitch and roll servos from the flight control surfaces and hand-fly the aircraft. The G300 autopilot control is synchronized to the aircraft attitude during Control Wheel Steering. The green 'AP' annunciation is temporarily replaced by a white 'CW' for the duration of Control Wheel Steering maneuvers.

In most scenarios, releasing the CWS Button reengages the Integrated Autopilot with a new reference. Refer to Sections 9.2 (Vertical Modes) and 9.3 (Lateral Modes) for Control Wheel Steering behavior in each mode.

G300 AUTOPILOT STATUS BOX

Autopilot (AP) status and Integrated Autopilot mode annunciators are displayed on the G300 Autopilot Status Box, located on the PFD. When the external autopilot unit is engaged and the G300 is issuing commands to it, lateral and/or vertical modes are displayed. When the external autopilot unit is engaged but it is operating in a standalone mode (i.e., not responding to the G300 commands), the Autopilot status (AP) is displayed; however, the lateral/vertical modes are not displayed.

Autopilot (AP) status is displayed on the far left of the G300 Autopilot Status Box. Lateral modes are displayed in the center, and vertical modes are displayed on the right. Armed modes are displayed in white and active in green.

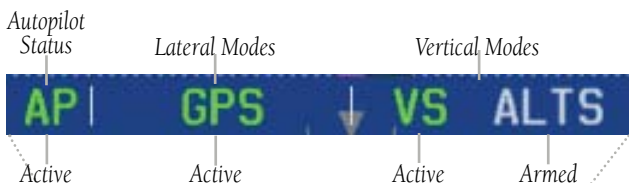

Autopilot Status Box



Autopilot Display (PFD)

INTEGRATED AUTOPILOT MODES

Integrated Autopilot modes are normally selected independently for the pitch and roll axes. Unless otherwise specified, all mode keys are alternate action (i.e., press on, press off). In the absence of a specific mode selection, the Integrated Autopilot reverts to the default pitch and/or roll mode(s).

Armed modes are annunciated in white and active modes are annunciated in green on the G300 Autopilot Status Box. Under normal operation when the softkey for the active mode is pressed, the Integrated Autopilot reverts to the default mode(s) for the axis(es). Automatic transition from armed to active mode is indicated by the white armed mode annunciation moving to the green active mode field and flashing for 10 seconds.

If the information required to compute a mode becomes invalid or unavailable, the Integrated Autopilot automatically reverts to the default mode for that axis. A flashing yellow mode annunciation and annunciator light indicate loss of sensor (AHRS/air data) or navigation data (GPS, WAAS) required to compute commands. When such a loss occurs, the system automatically begins to roll the wings level (i.e., enters Roll Hold Mode) or maintains the pitch angle (i.e., enters Pitch Hold Mode), depending on the affected axis. The flashing annunciation stops when the **ENT** key is pressed or another mode for the axis is selected. If after 10 seconds no action is taken, the flashing annunciation stops.

The Integrated Autopilot is automatically disabled if the attitude information required to compute the default lateral/vertical modes becomes invalid or unavailable.



Integrated Autopilot Manually Disengaged

- System Overview
- Flight Instruments
- EIS
- COM Interface
- GPS Navigation
- Flight Planning
- Hazard Avoidance
- Additional Features
- Integrated Autopilot
- Annun./Alerts
- Appendix
- Index

9.2 VERTICAL MODES

The following table lists the vertical modes with their corresponding controls and annunciations.

Vertical Mode	Description	Control	Annunciation
Pitch Hold	Holds the current aircraft pitch attitude; may be used to climb/descend to the Selected Altitude	(default)	PIT
Selected Altitude Capture	Captures the Selected Altitude	*	ALTS
Altitude Hold	Holds current Altitude Reference	AP ALT Softkey	ALT nnnnn FT
Vertical Speed	Holds aircraft vertical speed; may be used to climb/descend to the Selected Altitude	AP VS Softkey	VS nnnn FPM
Vertical Navigation	Captures and tracks the Vertical Navigation (VNAV) profile.	AP VNAV Softkey	VNAV
VNAV Target Altitude Capture	Captures the Vertical Navigation (VNAV) Target Altitude**	**	ALTV

* *ALTS is armed automatically when PIT or VS is active, and under VNAV when the Selected Altitude is to be captured instead of the VNAV Target Altitude.*

***ALTV is armed automatically under VNAV when the VNAV Target Altitude is to be captured instead of the Selected Altitude*

Integrated Autopilot Vertical Modes

PITCH HOLD MODE (PIT)

When the Integrated Autopilot is activated, Pitch Hold Mode is selected by default. Pitch Hold Mode is indicated as the active vertical mode by the green annunciation 'PIT'. This mode may be used for climb or descent to the Selected Altitude (shown above the altimeter), since Selected Altitude Capture Mode is automatically armed when Pitch Hold Mode is activated.

In Pitch Hold Mode, a constant pitch attitude (the pitch reference) is maintained. The pitch reference is set to the aircraft pitch attitude at the moment of mode selection. If the aircraft pitch attitude exceeds the configured pitch command limitations, a pitch angle equal to the nose-up/down limit is maintained.

Changing the pitch reference while in Pitch Hold (PIT) Mode:

Move and hold the **FMS Joystick** (use the PFD **FMS Joystick** if using a full-screen PFD) up or down. This causes the nose of the aircraft to slowly pitch in the direction that the **FMS Joystick** is held. The current pitch attitude is held when the joystick is released.

Or:

Hold the Control Wheel Steering (CWS) Button, establish the desired pitch attitude, then release the CWS Button.

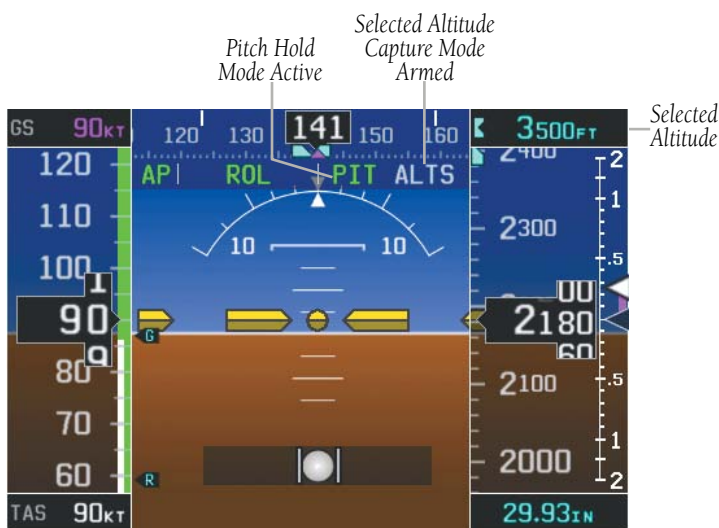

Pitch Hold & Selected Altitude Capture Modes

- System Overview
- Flight Instruments
- EIS
- COM Interface
- GPS Navigation
- Flight Planning
- Hazard Avoidance
- Additional Features
- Integrated Autopilot
- Annun/Alerts
- Appendix
- Index

SELECTED ALTITUDE CAPTURE MODE (ALTS)



NOTE: Selected Altitude Capture Mode is not armed if the Selected Altitude has not been set.

- 1 Selected Altitude Capture Mode is automatically armed with the activation of Pitch Hold, Vertical Speed, or VNAV (if the Selected Altitude is to be captured instead of the VNAV Target Altitude) Modes. The white 'ALTS' annunciation indicated Selected Altitude Capture Mode is armed.
- 2 As the aircraft nears the Selected Altitude, Selected Altitude Capture Mode is automatically activated with Altitude Hold Mode armed. The green 'ALTS' annunciation flashes for up to 10 seconds and a white 'ALT' annunciation appears.
- 3 At 50 feet from the Selected Altitude, Altitude Hold Mode is automatically activated and the Selected Altitude is held (shown as the Altitude Reference). As Altitude Hold Mode becomes active, the white 'ALT' annunciation moves to the active pitch mode field and flashes green for 10 seconds to indicate the automatic transition. The Altitude Reference is displayed beside the 'ALT' annunciation.



Automatic transition to ALTS Mode with ALT Mode armed



Automatic transition from ALTS to ALT Mode

Altitude Reference



CHANGING THE SELECTED ALTITUDE



NOTE: Holding the CWS Button while in Selected Altitude Capture Mode does not cancel the mode.

Setting the selected altitude:

- 1) From the PFD Page (one display) or PFD (two display), press the **ALT/PTCH** Softkey.
- 2) Turn the **FMS** Joystick to set the Selected Altitude in 100-ft increments

Use of the **FMS** Joystick to change the Selected Altitude while Selected Altitude Capture Mode is active causes the Integrated Autopilot to revert to Pitch Hold Mode with Selected Altitude Capture Mode armed for the new Selected Altitude.

ALTITUDE HOLD MODE (ALT)

Altitude Hold Mode can be activated by pressing the **AP ALT** Softkey; the Integrated Autopilot maintains the current aircraft altitude (to the nearest 10 feet) as the Altitude Reference. The Altitude Reference, shown in the G300 Autopilot Status Box, is independent of the Selected Altitude, displayed above the Altimeter. Altitude Hold Mode active is indicated by a green 'ALT' annunciation in the G300 Autopilot Status Box.

Altitude Hold Mode is automatically armed when in Selected Altitude Capture Mode. Selected Altitude Capture Mode automatically transitions to Altitude Hold Mode when within 50 feet of the Selected Altitude. In this case, the Selected Altitude becomes the Altitude Reference.

CHANGING THE ALTITUDE REFERENCE

When operating in Altitude Hold Mode, the Altitude Reference can be adjusted in the following ways:

- The Altitude Reference can be adjusted up or down in 10-foot increments by pressing the **FMS** Joystick up or down. Using this method, up to 200 feet of altitude change can be commanded. To change the Altitude Reference by more the 200 feet, use the CWS button as described below, or climb/descend using another vertical mode (PIT, VS) to capture the desired Selected Altitude.
- Pressing the CWS Button allows the aircraft to be hand-flown to a new Altitude Reference. When the CWS Button is released at the desired altitude, the new altitude is established as the Altitude Reference.



NOTE: While operating in Altitude Hold Mode, using the **FMS** Joystick to change the Selected Altitude does not change the Altitude Reference, and does not cancel the mode.



HGD/ROLL	AP VNAV	AP VS	AP ALT	ALT/PTCH
----------	---------	-------	--------	----------

Altitude Hold Mode

VERTICAL SPEED MODE (VS)

In Vertical Speed Mode, the Integrated Autopilot acquires and maintains a Vertical Speed Reference. Current aircraft vertical speed (to the nearest 100 fpm) becomes the Vertical Speed Reference at the moment of Vertical Speed Mode activation. This mode may be used for climb or descent to the Selected Altitude (shown above the altimeter) since Selected Altitude Capture Mode is automatically armed when Vertical Speed Mode is selected.

When Vertical Speed Mode is activated by pressing the **AP VS** Softkey, 'VS' is annunciated in green in the G300 Autopilot Status Box. The current Vertical Speed Reference is displayed in the G300 Autopilot Status Box for 10 seconds after a change is made. The Vertical Speed Reference is also displayed on the vertical speed indicator with a light blue vertical speed bug whenever Vertical Speed mode is active.

CHANGING THE VERTICAL SPEED REFERENCE

The Vertical Speed Reference may be adjusted in the following ways:

- Move the **FMS** Joystick up or down to adjust the Vertical Speed Reference in increments of 100 fpm. The current Vertical Speed Reference is displayed in the G300 Autopilot Status Box for 10 seconds after a change is made. To dismiss the Vertical Speed Reference display, press **ENT**.
- Press the CWS Button and hand-fly the aircraft to a new Vertical Speed Reference. When the CWS Button is released, the aircraft's vertical speed (to the nearest 100 fpm) is established as the new Vertical Speed Reference.

- System Overview
- Flight Instruments
- EIS
- COM Interface
- GPS Navigation
- Flight Planning
- Hazard Avoidance
- Additional Features
- Integrated Autopilot
- Annun/Alerts
- Appendix
- Index

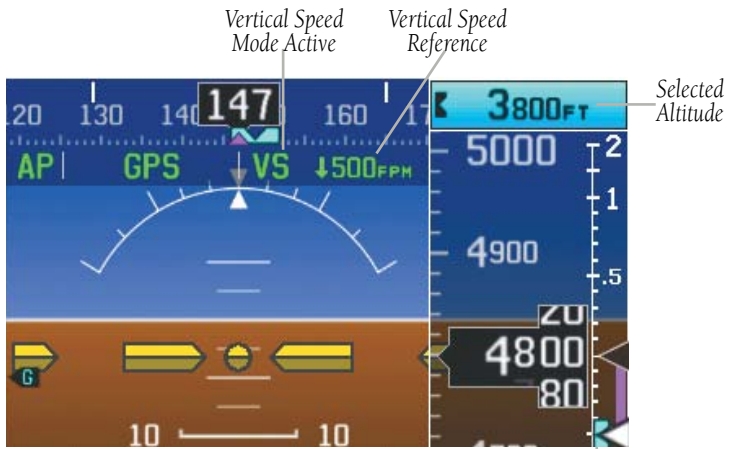

Vertical Speed Mode Active

Vertical Speed Reference

Selected Altitude

Vertical Speed Mode Softkey

Vertical Speed Reference Bug

HDG/ROLL	AP VNAV	AP VS	AP ALT	ALT/PTCH
----------	---------	-------	--------	----------

Vertical Speed Mode

VERTICAL NAVIGATION MODE (VNAV)

NOTE: If another pitch mode softkey is pressed while VNAV Mode is selected, VNAV Mode reverts to armed.

NOTE: Pressing the CWS Button while VNAV Mode is active does not cancel the mode. The Integrated Autopilot guides the aircraft back to the descent path upon release of the CWS Button.

Vertical Navigation (VNAV) Mode is available anytime that the G300's internal VFR GPS is being used for navigation, and VNAV data for the active flight plan is available. Refer to Section 2.3 (Vertical Navigation) for more information.

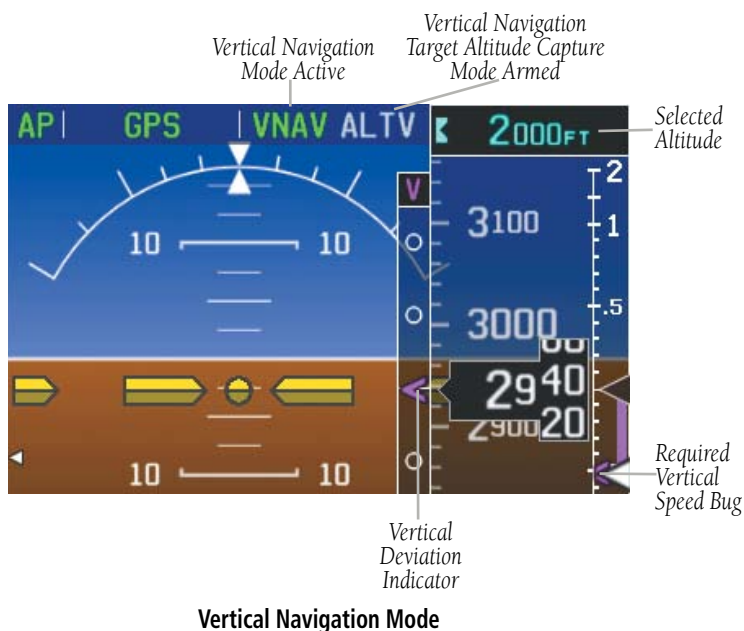

Activating Vertical Navigation Mode:

1 When a flight plan is active, VNAV data is valid, and the **AP VNAV** Softkey is pressed, VNAV mode is armed in preparation for descent path capture. 'VNAV' is annunciated in white in the G300 Autopilot Status Box. If applicable, the appropriate altitude capture mode is armed for capture of the VNAV Target Altitude (ALTV) or the Selected Altitude (ALTS), whichever is greater.

2 Prior to descent path interception, the Selected Altitude must be set below the current aircraft altitude by at least 75 feet. For transition from Altitude Hold to VNAV Mode to take place, acknowledgement is required within 5 minutes of descent path interception by pressing the **AP VNAV** Softkey or Adjusting the Selected Altitude.

If acknowledgement is not received within 1 minute of descent path interception, the white 'VNAV' annunciation starts to flash. Flashing continues until acknowledged or the descent path is intercepted. If the descent is not confirmed by the time of interception, VNAV Mode remains armed and the descent is not captured.

3 When a descent leg is captured (i.e., vertical deviation becomes valid), VNAV Mode is activated and tracks the descent profile. An altitude capture mode (ALTS or ALTV) is armed as appropriate.

4 When approaching the VNAV Target Altitude (or Selected Altitude) the system automatically transitions to ALTS or ALTV Mode with ALT Mode armed.



If the altimeter's barometric setting is adjusted while VNAV mode is active, the Integrated Autopilot increases/decreases the descent rate by up to 500 fpm to re-establish the aircraft on the descent path (without commanding a climb). For large changes, it may take several minutes for the aircraft to reestablish on the descent path. If the change is made while nearing the VNAV waypoint, the aircraft may not reestablish on the descent path in time to level off at the VNAV Target Altitude. In this case, the Integrated Autopilot will revert to Pitch Hold mode upon passing the VNAV waypoint, and Selected Altitude Capture (ALTV) mode will be automatically armed.

AUTOMATIC REVERSION TO PITCH HOLD MODE

Several situations can occur while VNAV Mode is active which cause the Integrated Autopilot to revert to Pitch Hold Mode:

- Vertical deviation exceeds 200 feet during an overspeed condition.
- Vertical deviation becomes invalid (the Deviation Indicator is removed from the PFD).

Following a reversion to Pitch Hold Mode, VNAV Mode and the appropriate altitude capture mode become armed to allow for possible profile recapture.

VNAV TARGET ALTITUDE CAPTURE MODE (ALTV)

VNAV Target Altitude Capture is analogous to Selected Altitude Capture Mode and is armed automatically after the **AP VNAV** Softkey is pressed if the VNAV Target Altitude is to be intercepted before the Selected Altitude. The annunciation 'ALTV' indicates that the VNAV Target Altitude is to be captured. Refer to Section 2.3 (Vertical Navigation) for more information on setting up the VNAV target altitude.

As the aircraft nears the VNAV Target Altitude, the Integrated Autopilot automatically transitions to VNAV Target Altitude Capture Mode with Altitude Hold Mode armed. This automatic transition is indicated by the green 'ALTV' annunciation flashing for up to 10 seconds and the appearance of the white 'ALT' annunciation.

At 50 feet from the VNAV Target Altitude, the Integrated Autopilot automatically transitions from VNAV Target Altitude Capture to Altitude Hold Mode and selects the VNAV target altitude as the new Integrated Autopilot Altitude Reference. As Altitude Hold Mode becomes active, the white 'ALT' annunciation moves to the active vertical mode field and flashes green for 10 seconds to indicate the automatic transition.

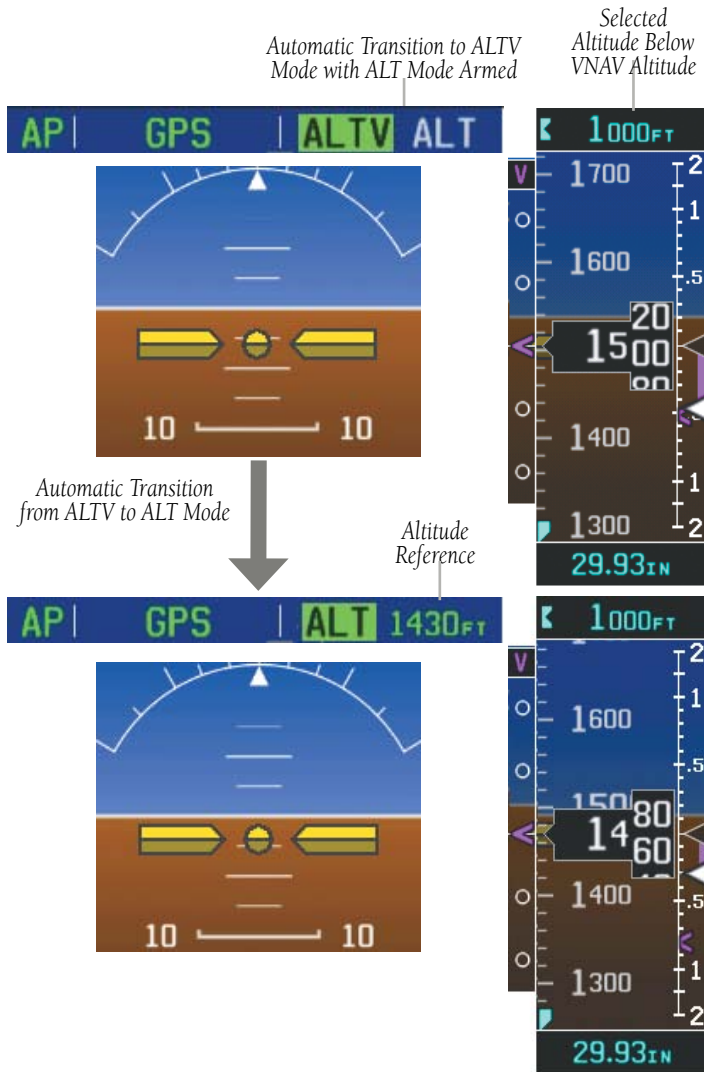

Automatic Mode Transitions During Altitude Capture

9.3 LATERAL MODES

The following table lists the lateral modes with their corresponding controls and annunciations:

Lateral Mode	Description	Control	Annunciation
Roll Hold	Holds the current aircraft roll attitude or rolls the wings level, depending on the commanded bank angle	(default)	ROL
Heading	Captures and tracks the Selected Heading (heading bug)	AP HDG Softkey	HDG
Navigation	Captures and tracks the selected GPS navigation source	AP NAV Softkey	GPS

Lateral Modes

The CWS Button does not change lateral references for HDG or NAV modes. The Integrated Autopilot guides the aircraft back to the Selected Heading/Course upon release of the CWS Button.

ROLL HOLD MODE (ROL)



NOTE: If Roll Hold Mode is activated as a result of a mode reversion, the Integrated Autopilot rolls the wings level.

When the Integrated Autopilot is activated, Roll Hold Mode is selected by default. This mode is annunciated as 'ROL' in the G300 Autopilot Status Box. Roll Mode maintains a constant bank angle, the roll reference, which is subject to the following bank angle conditions:



Roll Hold Mode Annunciation

Initial Bank Angle	Autopilot Roll Reference
Less than 6°	Rolls wings level
6° to Maximum Bank Setting	Maintains current aircraft bank angle
Greater than Maximum Bank Setting	Limits bank angle to maximum bank setting

Roll Hold Mode Responses

CHANGING THE ROLL REFERENCE

When operating in Roll Hold Mode, the roll reference can be adjusted in the following ways:

- To decrease the roll reference, move **FMS** Joystick (PFD) to the left or right and hold. The Integrated Autopilot slowly decreases the bank angle. The current bank angle as the **FMS** Joystick is released is held (if the bank angle exceeds 6°). If the bank angle is less than 6° as the **FMS** Joystick is released, the Integrated Autopilot will roll the aircraft wings level. The roll reference cannot be increased using the **FMS** Joystick.
- Hold the CWS Button (if equipped), establish the desired bank angle, then release the CWS Button.

HEADING MODE (HDG)

Heading Mode is activated by pressing the **AP HDG** Softkey. Heading Mode acquires and maintains the Selected Heading. The Selected Heading is shown by a light blue bug on the HSI and Heading Tape and in the box to the upper left of the HSI.



Heading Mode Annunciation

CHANGING THE SELECTED HEADING



NOTE: Press and hold the **FMS** Joystick (on the PFD or PFD Page) to synchronize the Selected Heading to the current heading.

Changing the selected heading (integrated autopilot configured):

- 1) From the PFD Page (one display) or PFD (two display), press the **HDG/ROLL** Softkey (if necessary). The Heading Box is highlighted.
- 2) Turn the **FMS** Joystick to select the desired heading, and press the **ENT** Key. The Selected Heading is shown to the left of the HSI.

Holding the CWS Button and hand-flying the aircraft does not change the Selected Heading. The Integrated Autopilot guides the aircraft back to the Selected Heading upon release of the CWS Button.

Turns are commanded in the same direction as Selected Heading Bug movement, even if the Bug is turned more than 180° from the present heading (e.g., a 270° turn to the right). However, Selected Heading changes of more than 330° at a time result in turn reversals.

NAVIGATION MODE (GPS)



NOTE: A valid GPS course must be active for the Integrated Autopilot to enter Navigation Mode.



NOTE: When intercepting a flight plan leg, the Integrated Autopilot gives commands to capture the active leg at approximately a 45° angle to track between the waypoints defining the active leg. The Integrated Autopilot does not give commands to fly to the starting waypoint of the active leg unless a direct-to course to the first flight plan waypoint is entered.

Pressing the **AP NAV** Softkey selects Navigation Mode. Navigation Mode acquires and tracks the selected navigation source using GPS roll steering.

If the Course Deviation Indicator (CDI) shows greater than one dot when the **AP NAV** Softkey is pressed, the selected mode is armed. If the CDI is less than one dot, Navigation Mode is automatically captured when the **AP NAV** Softkey is pressed. The armed annunciation appears in white to the left of the active lateral mode.

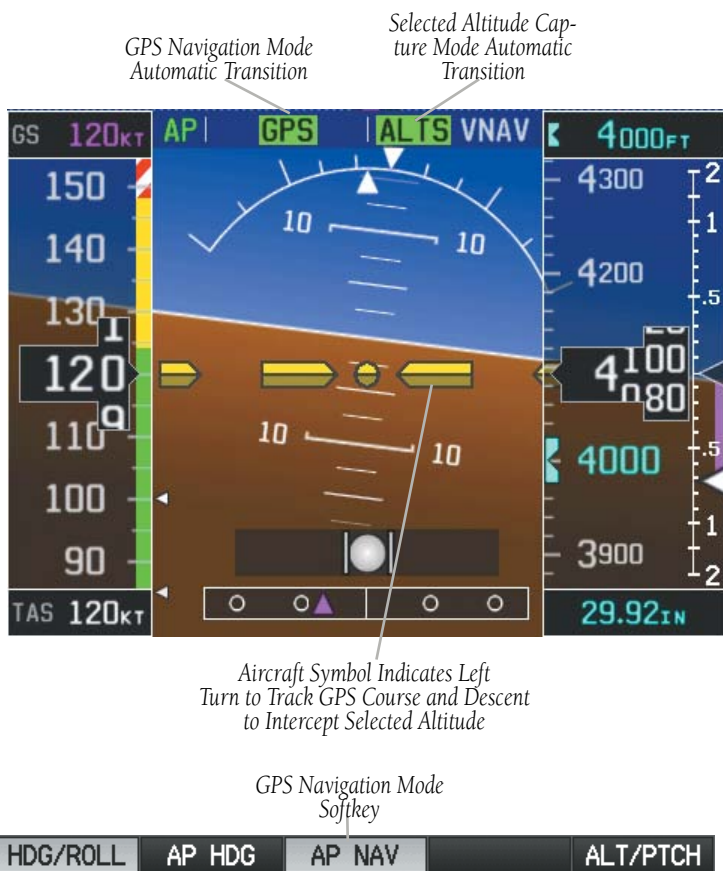

GPS Navigation Mode (PFD)

If Navigation Mode is active and either of the following occur, the Integrated Autopilot reverts to Roll Hold Mode (wings rolled level):

- Active flight plan is deleted
- GPS reception is lost

- System Overview
- Flight Instruments
- EIS
- COM Interface
- GPS Navigation
- Flight Planning
- Hazard Avoidance
- Additional Features
- Integrated Autopilot
- Annun/Alerts
- Appendix
- Index

CHANGING THE SELECTED COURSE (OBS MODE)

In OBS Mode the Selected Course is controlled using the **OBS CRS** Softkey. Or press **XPDR/CRS** > **OBS CRS** when a transponder is configured.

Enabling/disabling OBS Mode:

- 1) From the Active Flight Plan Page, press the **MENU** Key while navigating a flight plan or Direct-to.
- 2) With 'Set OBS and Hold' highlighted, press the **ENT** Key. The OBS Mode Box is highlighted.
- 3) Turn the **FMS** Joystick to select the desired course to/from the waypoint.
- 4) To cancel OBS Mode and return to automatic waypoint sequencing, press the **MENU** Key, with 'Release Hold' highlighted, press the **ENT** Key.

Holding the CWS Button and hand-flying the aircraft does not change the Selected Course while in Navigation Mode. The Integrated Autopilot guides the aircraft back to the flight plan course when the CWS Button is released.

9.4 INTEGRATED AUTOPILOT ALERTS

Refer to Section 10.4, 'PFD Annunciations and Alerting Functions'.

SECTION 10 ANNUNCIATIONS & ALERTS

10.1 MISCELLANEOUS MESSAGE ADVISORIES

Message	Comments
Approaching Target Altitude	Within 200 feet of final VNAV target altitude.
Approaching VNAV Profile	The aircraft is within one minute of reaching the initial VNAV decent point.
Arriving at XXX	The aircraft is nearing the destination.
Can't Unlock Maps	No applicable unlock code for one or more maps was found. All MapSource maps are not accessible.
Database Error	Internal problem with the system. Contact your dealer or Garmin Product Support to have the unit repaired.
Fuel Tank	A reminder for switching fuel tanks. The reminder message repeats at the specified interval after the beginning of each trip.
Lost Satellite Reception	The system is unable to receive satellite signals.
Memory Full	System memory is full, no further data can be saved.
Proximity Alarm XXXXX	You have reached the distance set for a proximity waypoint.
Next DTK XXX	The aircraft is nearing a turn in a route.
No XM Signal	The XM antenna is not receiving a signal.
Proximity Alarm Memory Full	No additional proximity waypoints can be saved.
Proximity Waypoints Overlap	The radius of two proximity waypoints overlap.
Route Already Exists	A route name that already exists has been entered.
Route Memory Full	No additional routes can be saved.

System Overview

Flight Instruments

EIS

COM Interface

GPS Navigation

Flight Planning

Hazard Avoidance

Additional Features

Integrated Autopilot

Annun/Alerts

Appendix

Index

MISCELLANEOUS MESSAGE ADVISORIES (CONT.)

Message	Comments
Route Truncated	Uploaded route from another device has more than 300 waypoints.
Route Waypoint Memory Full	No additional route waypoints can be saved.
Saving XM Program Information	An XM Radio channel lineup change has occurred and the unit is saving the channel lineup to memory.
Steep Turn Ahead	Approaching a turn that requires a bank angle in excess of 25 degrees to stay on course.
Track Already Exists	A saved track with the same name already exists.
Track Log Full	The track log is full and track recording was turned off. To record more track points, you need to clear the track log and turn track recording on.
Track Memory Full	No more track data can be stored. Delete the old track data to store the new data.
Track Truncated	A complete uploaded track will not fit in memory. The oldest track log points have been deleted.
Transfer Complete	Data transfer was completed.
VNAV Cancelled	VNAV function has been cancelled due to a change in the active route.
Waypoint Already Exists	A waypoint with the same name already exists.
Waypoint Memory Full	The unit has stored the maximum number of waypoints.

AIRSPACE MESSAGES

Message	Comments
Inside Airspace	Inside the boundaries of the airspace.
Airspace Near and Ahead	Within two nautical miles of an airspace and your current course takes you inside the airspace.

AIRSPACE MESSAGES (CONT.)

Message	Comments
Airspace Ahead, Within 10 Minutes	The projected course takes you inside an airspace within the next 10 minutes or less.
Near Airspace, Within 2 nm	Within two nautical miles of an airspace but not projected to enter it.

10.2 SYSTEM STATUS MESSAGES (INFO PAGE)

The 'INFO' Page on the Navigation Bar will flash yellow if there is a System Status Message.

A yellow **MSG** (Message) alert will flash in the bottom right corner of the split-screen or full-screen PFD to alert the pilot of System Status Messages on the **INFO** Page.



System Status Message Alert (Split-Screen or Full-Screen PFD)



System Status Message Alert (Split-Screen or Full-Screen MFD)

Accessing the Info Page system status messages:

- 1) When the 'INFO' Page on the Page Navigation Bar is flashing, use the **FMS** Joystick to access the Info Page.
- 2) Press the yellow **MESSAGES** Softkey. The Messages Page is displayed.



System Status Message Alert (Info Page) (Split-Screen)

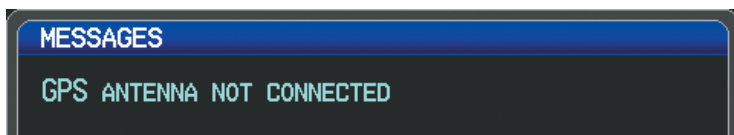

Messages Page (Split-Screen)

- 3) To return to the Info Page, press the **FMS** Joystick, **CLR** Key, or **EXIT** Softkey. The Info Page will stop flashing, but remain yellow until the message is resolved.

The following system status messages may appear on the Info Page.

SYSTEM STATUS MESSAGES

Message	Comments
AHRS extended operation in no-GPS mode	The AHRS is operating exclusively in no-GPS mode. The G300 system should be serviced.
AHRS fault detected	A fault has been detected in the AHRS. The G300 system should be serviced.
AHRS magnetic-field model out of date	The AHRS Earth magnetic field model is out of date. The G300 system should be serviced.
AHRS not calibrated	The AHRS is either not calibrated or requires post installation calibration procedures to be conducted. The G300 system should be serviced.
AHRS not receiving airspeed data	The AHRS is not receiving true airspeed from the air data computer. The AHRS relies on GPS information in the absence of true airspeed. The G300 system should be serviced.
AHRS not receiving GPS information	The AHRS is not receiving any or any useful GPS information. The G300 system should be serviced.
AHRS too far north/south for magnetic heading	The aircraft is outside geographical limits for approved AHRS operation. Heading is flagged as invalid.
Autopilot fault detected	The remote autopilot unit has detected an internal fault and needs service.

SYSTEM STATUS MESSAGES (CONT.)

Message	Comments
Check XM antenna	The display that is configured for a XM antenna connection does not have an XM signal.
Config module error	The GDU has encountered unexpected configuration settings. The G300 system should be serviced.
Config module missing	The PFD config module is not connected.
Demo Mode - Do not use for navigation	The system is in demo mode, do not use for navigation.
GDU software version mismatch	The PFD and MFD do not have the same software version installed. Display crosstalk is disabled. Ensure all installed display software matches.
GPS antenna not connected	The display that is configured for a GPS antenna connection does not detect any antenna current draw from the GPS antenna RF connector.
GPS antenna shorted to ground	The display that is configured for a GPS antenna connection detects the GPS antenna RF connector is shorted to ground.
GSU 73 configuration error	The GSU configuration settings do not match the configuration settings stored in backup memory. The G300 system should be serviced.
GSU 73 needs service	The GSU should be serviced when possible.
GSU 73 not responding	The GDU has lost communication with the GSU.
GSU 73 software update available	A software update for the GSU 73 is available. Consult the install manual for instructions on performing a GSU 73 software update..
GSU 73 temperature too low	The GSU temperature is too low. If the problem persists, the G300 system should be serviced.
GSU 73 temperature too high	The GSU temperature is too high. If the problem persists, the G300 system should be serviced.

System Overview

Flight Instruments

EIS

COM Interface

GPS Navigation

Flight Planning

Hazard Avoidance

Additional Features

Integrated Autopilot

Annun/Alerts

Appendix

Index

SYSTEM STATUS MESSAGES (CONT.)

Message	Comments
Magnetic anomaly - Check mag installation	An anomaly has been detected in the magnetometer data. Heading may or may not be flagged invalid.
Check XM antenna	The display that is configured for a XM antenna connection does not have an XM signal.
Check XM antenna	The display that is configured for a XM antenna connection does not have an XM signal.
Magnetometer failure	Communication has been lost or a fault has been detected in the GMU. Heading is flagged invalid and the AHRS will use GPS for backup mode operation. The G300 system should be serviced.
Navigation database mismatch	The PFD and MFD have different navigation database versions installed. Install the correct navigation database on all displays.
Network fault - Duplicate GDU detected	A duplicate GDU has been detected on the CAN bus. If the problem persists, the G300 system should be serviced.
Not receiving autopilot RS-232 data	Not receiving RS-232 data from integrated autopilot unit.
Obstacle database mismatch	The PFD and MFD have different obstacle database versions installed. Install the correct obstacle database on all displays.
Obstacle database missing	The obstacle database is missing. Install the correct obstacle database on all displays.
Terrain database mismatch	The PFD and MFD have different terrain database versions installed. Install the correct terrain database on all displays.
Terrain database missing	The terrain database is missing. Install the correct terrain database on all displays.
XM receiver needs service	The display should be serviced when possible.

10.3 AURAL ALERTS

TERRAIN

- “Five Hundred”—when the aircraft descends through 500 feet above the destination airport.

The following aural terrain alerts are issued when flight conditions meet parameters that are set within the software algorithms, and are dependent on the sensitivity level set in the Terrain Setup Menu.

Severity	Terrain	Obstacle	Descent Rate
Caution	“caution, terrain” “caution, terrain ahead”	“caution, obstacle” “caution, obstacle ahead”	“caution, sink rate”
Warning	“terrain ahead! pull up!” “terrain! terrain! pull up! pull up!”	“obstacle ahead! pull up!” “obstacle! obstacle! pull up! pull up!”	“sink rate, pull up!” “pull up!”

Aural Alerts Summary

10.4 PFD ANNUNCIATIONS AND ALERTING FUNCTIONS

The following annunciations and alerting functions are displayed on the PFD.

CAS MESSAGES

The G300 Crew Alerting System (CAS), as installed in the Cessna SkyCatcher, uses two alert levels.

- **WARNING:** This level of alert requires immediate attention.

Warning annunciation text is shown in red in the CAS Annunciation Window on the PFD.

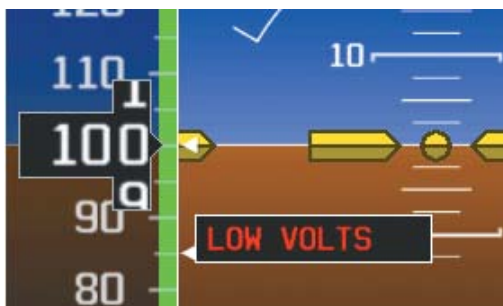

Low Voltage Warning

- **ADVISORY**—This Level of alert provides general information.

Advisory annunciation text is shown in white in the CAS Annunciation Window.



Set Baro Advisory

TERRAIN ANNUNCIATIONS

In addition to the Terrain Pop-up Alert in the lower left corner of the page, terrain and obstacle annunciations appear on the PFD in the upper left corner of the Attitude Indicator. Refer to the Hazard Avoidance Section for more information.



Terrain Alerts
(PFD or PFD Page)

INTEGRATED AUTOPILOT ALERTS (OPTIONAL)

Integrated Autopilot Alert



Integrated Autopilot Alerts

STATUS ALERTS

If the commanded operation cannot be achieved, the following messages are displayed over the pitch ladder. The annunciation is removed once the condition is resolved.

Alert Condition	Annunciation	Description
Up-elevator Trim Required	↑ TRIM UP ↑	The autopilot does not have the required elevator authority.
Down-elevator Trim Required	↓ TRIM DOWN ↓	

Status Alerts

The following messages are displayed in the G300 Autopilot Status Box.

Alert Condition	Annunciation	Description
System Failure	AP	Autopilot inoperative
Manual Disengagement	AP	Autopilot Disengaged

Integrated Autopilot System Alerts

SPEED ALERTS

If the airspeed limitations have been reached, the following messages are displayed over the pitch ladder. The annunciation is removed once the condition is resolved.

Alert	Annunciation	Description
Overspeed Protection	MAX SPEED	External autopilot unit will raise the nose to limit the aircraft's speed.
Underspeed Protection	MIN SPEED	External autopilot unit will lower the nose to prevent the aircraft's speed from decreasing.

Speed Alerts

- System Overview
- Flight Instruments
- EIS
- COM Interface
- GPS Navigation
- Flight Planning
- Hazard Avoidance
- Additional Features
- Integrated Autopilot
- Annun. Alerts**
- Appendix
- Index

Blank Page

SECTION 11 APPENDICES

APPENDIX A: DATA FIELD OPTIONS

DATA BAR FIELD OPTIONS

Data Bar Field	Definition
BRG - Bearing to Waypoint	The compass direction from the present position to the next waypoint.
DA - Density Altitude	Pressure altitude corrected for non-standard temperature variations.
DST - Distance to Waypoint	The distance to the next waypoint in the Active Flight Plan.
DTK - Desired Track	The desired course between the active "from" and "to" waypoints.
ESA - En Route Safe Altitude	The recommended minimum altitude within ten miles left or right of the desired course on an active flight plan or direct-to.
ETA - Estimated Time of Arrival	The estimated time at which the aircraft should reach the next waypoint, based upon current ground speed and track.
ETE - Estimated Time En Route	The estimated time it takes to reach the next waypoint from the present position, based upon current ground speed.
FLT - Flight Time	Total time in-flight (HH:MM).
G - G-Meter	The amount of positive or negative G's.
GS - Ground Speed	The velocity that the aircraft is traveling relative to a ground position.
LCL - Time of Day(Local)	The current time and date in 12-hour or 24-hour format.
MACH - Mach Number	A unit of speed that measures the ratio of the speed of an airplane to the speed of sound in the same atmospheric conditions.
MSA - Minimum Safe Altitude	Uses Grid MORAs to determine a safe altitude within ten miles of the aircraft's present position.

DATA BAR FIELD OPTIONS (CONT.)

Data Bar Field	Definition
TRK - Ground Track	Direction of aircraft movement relative to a ground position.
UTC - Time	The current time and date in Universal (UTC) time.
VSR - Vertical Speed Required	The vertical speed necessary to descend/climb from the current position and altitude to the previously selected VNAV position and altitude, based upon current ground speed.
WPT - Next Waypoint	The next waypoint in the flight plan or direct-to route.
XTK - Crosstrack Error	The distance the aircraft is from a desired course in either direction, left or right.

INFO PAGE DATA FIELD OPTIONS (DUAL DISPLAY)

Info Page Data Field Option	Definition
Accuracy	The current accuracy of the GPS determined location.
Altitude (GPS ALT)	The current altitude in geometric height above Mean Sea Level (MSL).
Bearing (BRG)	The compass direction from the present position to a destination waypoint.
Course to Steer (CTS)	The recommended direction to steer in order to reduce cross-track error and return to the course line.
Crosstrack Error (XTK)	The distance the aircraft is off a desired course in either direction, left or right.
Density Altitude (DENSITY ALT)	Pressure Altitude adjusted for non-standard temperature.
Desired Track (DTK)	The desired course between the active "from" and "to" waypoints.
Distance (Destination) (DIST DEST)	The distance to the destination waypoint in the Active Flight Plan

INFO PAGE DATA FIELD OPTIONS (DUAL DISPLAY) (CONT.)

Info Page Data Field Option	Definition
Distance (Next) (DIST NEXT)	The distance to the next waypoint in the Active Flight Plan.
En Route Safe Altitude (ESA)	The recommended minimum altitude within ten miles left or right of the desired course on a active flight plan or direct-to.
Estimated Time En Route (Destination) (ETE DEST)	The estimated time it takes to reach the destination waypoint from the present position, based upon current ground speed.
Estimated Time En Route (Next) (ETE NEXT)	The estimated time it takes to reach the next waypoint form the present position, based upon current ground speed.
Estimated Time of Arrival (Destination) (ETA DEST)	The estimated time at which the aircraft should reach the destination waypoint, based upon current speed and track.
Estimated Time of Arrival (Next) (ETA NEXT)	The estimated time at which the aircraft should reach the next waypoint, based upon current speed and track.
Estimated Time to VNAV (VNAV TIME)	The estimated time it takes to reach the VNAV waypoint form the present position, based upon current ground speed.
Flight Timer (FLT TIMER)	Total time in-flight (HH:MM).
Fuel Timer (FUEL TIMER)	Elapsed time since the Fuel Tank Reminder Alarm was last issued (HH:MM).
Glide Ratio (G/R)	The estimated distance an aircraft will move forward for any given amount of lost altitude.
Ground Speed	The velocity that the aircraft is traveling relative to a ground position.
Ground Track (TRK)	The direction of aircraft movement relative to a ground position.

System Overview

Flight Instruments

EIS

COM Interface

GPS Navigation

Flight Planning

Hazard Avoidance

Additional Features

Integrated Autopilot

Annun/Alerts

Appendix

Index

INFO PAGE DATA FIELD OPTIONS (DUAL DISPLAY) (CONT.)

Info Page Data Field Option	Definition
Mach Number (MACH)	A unit of speed that measures the ratio of the speed of an airplane to the speed of sound in the same atmospheric conditions.
Minimum Safe Altitude (MSA)	Uses Grid MORAs to determine a safe altitude within ten miles of the aircraft's present position.
Next Waypoint	The next waypoint in the flight plan or direct-to route.
Sunrise	The time at which the sun rises on this day (current location).
Sunset	The time at which the sun sets on this day (current location).
Time (UTC)	The current time and date in Universal (UTC) time.
Time of Day (Local)	The current time and date in 12-hour or 24-hour format.
Vertical Speed (VS)	The rate of climb or descent (GPS-derived).
Vertical Speed Required (VSR)	The vertical speed necessary to descend/climb from the current position and altitude to the previously selected VNAV position and altitude, based upon current ground speed.
Weather (Altimeter) (WX ALTIM)	The altimeter setting at the nearest METAR reporting station.
Weather (Dew Point) (WX DEW PT)	The dew point at the nearest weather reporting station.
Weather (Rel. Humidity) (WX HUMIDITY)	The relative humidity at the nearest weather reporting station.
Weather (Temperature) (WX TEMP)	The temperature at the nearest weather reporting station.
Weather (Wind) (WX WIND)	The wind speed and direction at the nearest weather reporting station.

APPENDIX B: UTILITIES



NOTE: The *Flight Log* option is not available from the full-screen PFD Main Menu.

FLIGHT LOG

The Flight Log shows a list of any recorded flights, including date, route of flight, and flight time. The G300 saves up to 50 recorded flights. Entries on this list are automatically created for each flight.

Recording begins when the aircraft reaches 250 feet of altitude. When the aircraft's groundspeed drops below 30 knots, the flight entry is saved and a new entry is recorded when departing the airport. A touch-and-go or brief stop of less than 10 minutes appends to the current flight record, rather than starting a new entry.

VIEWING THE FLIGHT LOG

Select any listed entry in the log to view additional information, including a map displaying the actual path flown.

Viewing details for a flight:

- 1) From the split-screen or full-screen MFD, press the **MENU** Key twice to display the Main Menu. (The 'Flight Log' option is not available from the full-screen PFD Main Menu).
- 2) Turn or move the **FMS** Joystick to select 'Flight Log', and press the **ENT** Key. (Hours and minutes can be displayed by pressing the **MENU** Key and selecting 'Show Hours and Minutes').
- 3) Turn or move the **FMS** Joystick to select the desired flight from the list, and press the **ENT** Key. Route, date, hours, distance, and actual flight path are displayed (full-screen). Use the **MAP** and **INFO** Softkeys to toggle between the Flight Log Map Page and the Flight Log Information Page (split-screen).

- 4) With 'Done' selected, press the **ENT** Key to return to the previous page.

FLIGHT LOG		
11-JUN	KMCI-KSTJ	0.2 HOURS
11-JUN	K50-KEGT	0.1 HOURS
11-JUN	51K-K34	0.4 HOURS
10-JUN	KOJC-KLWC	0.2 HOURS

Flight Log List (Single Display)

FLIGHT LOG	
FROM	KLWC - LAWRENCE MUN
TO	(LOCAL)
DATE	03-SEP-08
HOURS	1.2
DISTANCE	124.8NM
DONE	
INFO	MAP

Flight Log Information
(Single Display)



Flight Log Map
(Single Display)

DELETING FLIGHT RECORDS

You can delete the highlighted flight record or delete all flight records from the Flight Log.

Deleting flight records:

- 1) From the split-screen or full-screen MFD, press the **MENU** Key twice to display the Main Menu. (The 'Flight Log' option is not available from the full-screen PFD Main Menu).
- 2) Turn or move the **FMS** Joystick to select 'Flight Log', and press the **ENT** Key.
- 3) Select the desired flight (if applicable), and press the **MENU** Key.
- 4) Turn or move the **FMS** Joystick to select 'Delete Flight' or 'Delete All', and press the **ENT** Key.

TRACK LOG



NOTE: The Track Log option is not available from the full-screen PFD Main Menu.

The G300 draws an electronic breadcrumb trail or "track log" on the Map Page. The track log contains points along its path, including time and location for each point.

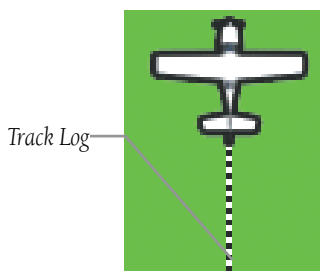

Track Log (Map Page)

The track log starts recording as soon as the G300 gets a location fix. For the best results, clear the track log before each flight. When the track log is full, new track points overwrite the oldest track points (if set to 'Wrap' in the Track Log Settings).

The percentage of memory used by the current track log appears at the top of the Track Log Window. After the track log is cleared, it shows zero percent. When the screen reaches 100%, the most recent track points start to overwrite the least recent track points (if 'Wrap' is selected in the Record Mode Field). To avoid losing track points, save the track log when it approaches the 99% mark.

The Save feature allows storage of up to 15 track logs.

Displaying/removing the track log on the Map Page:

- 1) From the Map Page, press the **MENU** Key. The Map Page Menu is displayed. (The 'Track Log' option is not available from the full-screen PFD Main Menu).
- 2) Turn or move the **FMS** Joystick to select 'Set Up Map' from the Map Page Menu, and press the **ENT** Key.
- 3) Turn the **FMS** Joystick to highlight the 'Line' options from the horizontal list.
- 4) Move the **FMS** Joystick to highlight the 'Track Log' field.
- 5) Turn the **FMS** Joystick to select 'On' or 'Off', and press the **ENT** Key.
- 6) Press the **FMS** Joystick, the **CLR** Key, or the **EXIT** Softkey to return to the Map Page.



Map Page Menu
(Single Display)

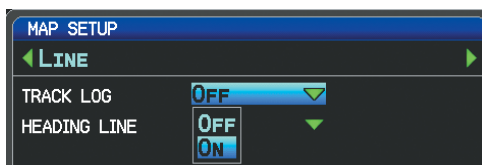

Map Setup Page

Changing track log settings:

- 1) From the split-screen or full-screen MFD, press the **MENU** Key twice. (The 'Track Log' option is not available from the full-screen PFD Main Menu).
- 2) Turn or move the **FMS** Joystick to select 'Track Log' from the Main Menu, and press the **ENT** Key.
- 3) Move the **FMS** Joystick to highlight the desired field.

- 4) Turn the **FMS** Joystick to select the desired setting.

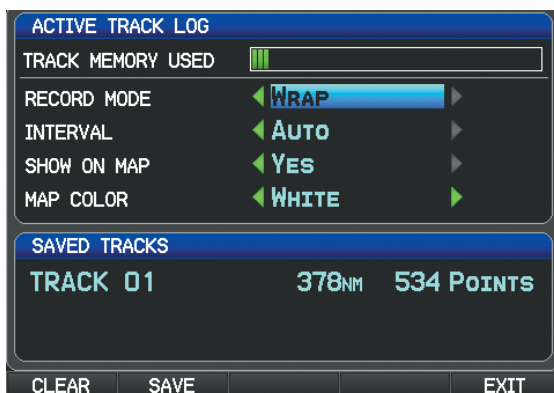

Track Log Window (Single Display)

- Record Mode—‘Wrap’ records over the oldest tracks when the track log reaches 100%. ‘Fill’ records a track log until the track log is full (100%).
- Interval—‘Distance’ records track points after a specified distance has been traveled. ‘Time’ creates track points after a specified time has elapsed.
- Show On Map—Select ‘Yes’ to display the track log on the map.
- Map Color—Select a color for the track when it appears on the map.

Clearing the track log:

- 1) From the split-screen or full-screen MFD, press the **MENU** Key twice. (The ‘Track Log’ option is not available from the full-screen PFD Main Menu).
- 2) Turn or move the **FMS** Joystick to select ‘Track Log’ from the Main Menu, and press the **ENT** Key.
- 3) Move the **FMS** Joystick to highlight the desired saved track, and press the **CLEAR** Softkey. (Or press the **MENU** Key, with ‘Clear Active Track’ selected, press the **ENT** Key.) The ‘Clear Active Track Log?’ window is displayed.
- 4) With ‘Yes’ selected, press the **ENT** Key.

Saving a track log:

- 1) From the split-screen or full-screen MFD, press the **MENU** Key twice. (The 'Track Log' option is not available from the full-screen PFD Main Menu).
- 2) Turn or move the **FMS** Joystick to select 'Track Log' from the Main Menu, and press the **ENT** Key.
- 3) Press the **SAVE** Softkey. (Or press the **MENU** Key, with 'Save Active Track' selected, press the **ENT** Key.) The 'Save Active Track?' window is displayed.
- 4) Turn the **FMS** Joystick to select 'Entire Active Track', 'Past 24 Hours', 'Past 7 Days', or 'Specify Dates'.
- 5) Move the **FMS** Joystick to highlight 'Save' and press the **ENT** Key.

Editing a track log:

- 1) From the split-screen or full-screen MFD, press the **MENU** Key twice. (The 'Track Log' option is not available from the full-screen PFD Main Menu).
- 2) Turn or move the **FMS** Joystick to select 'Track Log' from the Main Menu, and press the **ENT** Key.
- 3) Move the **FMS** Joystick to highlight the desired saved track, and press the **ENT** Key.
- 4) Move the **FMS** Joystick to highlight the desired field.
- 5) Turn the **FMS** Joystick to make the desired changes.
- 6) With 'Done' selected, press the **ENT** Key.

Exporting a track log:

- 1) From the split-screen or full-screen MFD, press the **MENU** Key twice. (The 'Track Log' option is not available from the full-screen PFD Main Menu).
- 2) Turn or move the **FMS** Joystick to select 'Track Log' from the Main Menu, and press the **ENT** Key.
- 3) Using the **FMS** Joystick highlight the desired track log to export.
- 4) With an SD card inserted, press the **EXPORT** Softkey.

HEADING LINE

The G300 draws an electronic “heading line” on the Map Page. The heading line can be set to time or distance.

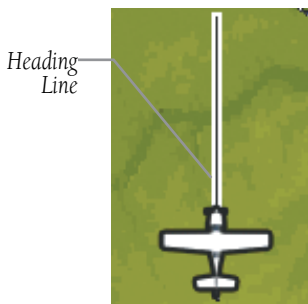

Heading Line (Map Page)

Changing the heading line settings on the Map Page:

- 1) From the Map Page, press the **MENU** Key. The Map Page Menu is displayed.
- 2) Turn or move the **FMS** Joystick to select 'Set Up Map' from the Map Page Menu, and press the **ENT** Key.
- 3) Turn the **FMS** Joystick to highlight the 'Line' options from the horizontal list.
- 4) Move the **FMS** Joystick to highlight the 'Heading Line' field.
- 5) Turn the **FMS** Joystick to select 'On/Off', 'Distance', or 'Time' and press the **ENT** Key. If necessary, move the **FMS** Joystick to set the desired time or distance, and press the **ENT** Key.

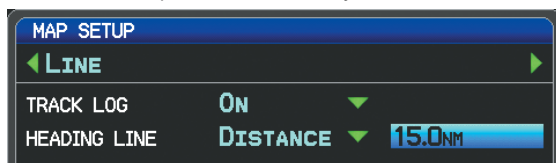

Heading Line Settings (Map Setup Page)

- 6) Press the **FMS** Joystick, the **CLR** Key, or the **EXIT** Softkey to return to the Map Page.

WEIGHT & BALANCE

Weight & Balance may be used during pre-flight preparations to verify the weight and balance conditions of the aircraft. By entering the weight values on this page, the G300 can calculate the total weight, moment, and center of gravity (CG).



Weight & Balance Page (C.G. in Range)
(Single Display)



Weight & Balance Page (C.G. Out of Range)
(Single Display)



NOTE: This information is only for flight planning purposes. Consult the aircraft's pilot operating handbook for the official weight and balance data.

To perform weight and balance calculations:

- 1) Press the **MENU** Key twice to open the Main Menu.
- 2) Turn or move the **FMS** Joystick to highlight 'Weight & Balance', and press the **ENT** Key.
- 3) Move the **FMS** Joystick to select the desired station.
- 4) Turn the **FMS** Joystick to enter the desired weight and press the **ENT** Key.
- 5) Repeat steps 3 and 4 using the **FMS** Joystick to enter the desired weights. Press the **ENT** Key after each entry. The calculated moment, weight, and CG figures appear at the bottom of the page.
- 6) To empty the aircraft, press the **MENU** Key and select 'Empty Aircraft', or press the **EMPTY** Softkey.

To reset weight & balance page:

- 1) From the Weight & Balance page, press the **MENU** Key.
- 2) Turn or move the **FMS** Joystick to highlight 'Empty Aircraft', and press the **ENT** Key. "Empty All Stations?" window is displayed.



Weight & Balance Page Menu

Or:

Press the **EMPTY** Softkey. "Empty All Stations?" window is displayed.



Empty Stations Window

- 3) With 'Yes' highlighted, press the **ENT** Key.

If the Loading Limit for a particular station is exceeded, the station name will turn yellow.

	WEIGHT	ARM
AIRCRAFT EMPTY	829.1LBS	+131.70
FUEL	20.0GAL	+144.00
PILOT	165.0LBS	+142.10
CO-PILOT	125.0LBS	+142.10
BAGGAGE	55.0LBS	+172.00

Loading Limit Exceeded

EPE CIRCLE

Estimated Position Error (EPE) indicates the accuracy of the position fix. EPE uses Dilution of Precision (DOP) and other factors to calculate a horizontal position error. DOP measures satellite geometry quality (i.e., number of satellites received and where they are relative to each other).

Setting up and customizing the EPE circle for the map page:

- 1) From the Map Page press the **MENU** Key.
- 2) Turn or move the **FMS** Joystick to highlight 'Set Up Map' and press the **ENT** Key.
- 3) Turn the **FMS** Joystick to select the 'Miscellaneous' from the horizontal list.
- 4) Move the **FMS** Joystick to highlight the desired feature.
- 5) Turn the **FMS** Joystick to select 'On' or 'Off', and press the **ENT** Key.

PROXIMITY WAYPOINTS

The Proximity Waypoints Page allows the pilot to define an alarm circle around a waypoint location.

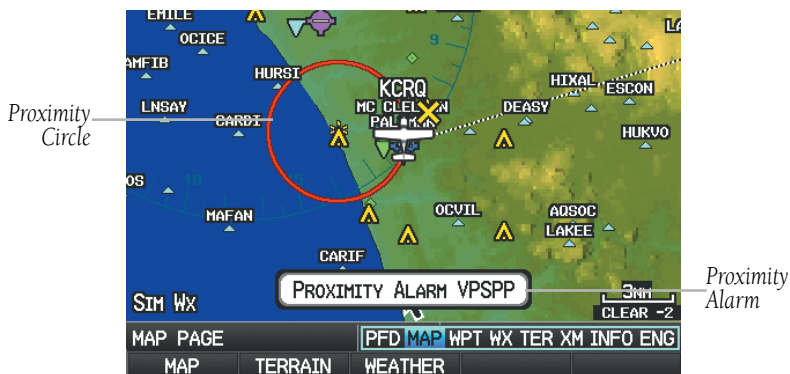

Proximity Waypoint Alarm

Defining proximity waypoints:

- 1) Press the **MENU** Key twice to open the Main Menu.
- 2) Turn or move the **FMS** Joystick to highlight 'User Waypoints', and press the **ENT** Key.
- 3) Press the **PROXIMITY** Softkey. The Proximity Waypoints Page is displayed.
- 4) Press the **NEW** Softkey. The New Proximity Waypoint Window is displayed.
- 5) Select 'Use Map' or 'Use Identifier', and press the **ENT** Key.
- 6) Select the desired waypoint using the Map or Select Waypoint Window, and press the **ENT** Key. The 'Distance' field is highlighted.
- 7) Using the **FMS** Joystick, enter the desired distance and press the **ENT** Key.

Setting up and customizing proximity waypoints for the map page:

- 1) Press the **MENU** Key twice to open the Main Menu.
- 2) Turn or move the **FMS** Joystick to highlight 'User Waypoints', and press the **ENT** Key.

- 3) Press the **PROXIMITY** Softkey. The Proximity Waypoints Page is displayed.
- 4) Turn the **FMS** Joystick to select 'On' or 'Off', and press the **ENT** Key.
Or:
 - 1) Press the **MENU** Key twice to open the Main Menu.
 - 2) Turn or move the **FMS** Joystick to highlight 'System Setup...', and press the **ENT** Key.
 - 3) Turn or move the **FMS** Joystick to highlight 'Alarms', and press the **ENT** Key.
 - 4) Move the **FMS** Joystick to highlight the 'Proximity Alarm' Field.
 - 5) Turn the **FMS** Joystick to select 'On' or 'Off', and press the **ENT** Key.
Or:
 - 1) From the Map Page press the **MENU** Key.
 - 2) Turn or move the **FMS** Joystick to highlight 'Set Up Map' and press the **ENT** Key.
 - 3) Turn the **FMS** Joystick to select the 'Point' from the horizontal list.
 - 4) Move the **FMS** Joystick to highlight the 'Proximity Circle' Field.
 - 5) Turn the **FMS** Joystick to access a list of options for each feature (On/Off, Auto, or range settings).
 - 6) Highlight the desired setting and press the **ENT** Key.

Deleting proximity waypoints:

- 1) Press the **MENU** Key twice to open the Main Menu.
- 2) Turn or move the **FMS** Joystick to highlight 'User Waypoints', and press the **ENT** Key.
- 3) Press the **PROXIMITY** Softkey. The Proximity Waypoints Page is displayed.
- 4) Select the desired waypoint to be deleted.
- 5) Press the **CLR** Key or the **MENU** Key and select 'Remove Selected Waypoint' or 'Remove All Waypoints'.
- 6) Press the **ENT** Key. The 'Remove Proximity Waypoint for XXXX' Window is displayed
- 7) With 'Yes' highlighted, press the **ENT** Key.

APPENDIX C: SD CARD USE AND DATABASES

The G300 uses an SD Card for software updates, database updates, MapSource® data, checklist files, Flight Data Logging, exporting Track Logs/User Waypoints, importing/exporting Flight Plans and user-downloaded vehicles. Garmin recommends using a 2 GB SanDisk or Toshiba SD Card.

Refer to the Garmin website (www.garmin.com) for instructions on downloading and installing software updates.

INSTALLING AND REMOVING SD CARDS



NOTE: SD Cards are not waterproof. They should not be exposed to moisture or excessive static charges, and should be stored in the case supplied with the card.



SD Card Slot(s)

Installing an SD Card:

- 1) Insert the card into the slot on the top, right, front of the bezel. Be sure the SD Card contacts are facing the display.
- 2) Firmly push the card into the unit. It is not necessary to force the card.
- 3) The unit takes a few seconds to read the card. When the data card has been properly installed and accepted, a summary screen noting the card details appears. Press **ENT** Key to acknowledge.

If you insert an SD Card and get a card format not recognized message, try removing the card and reinserting it. If the card is still not recognized, contact Garmin Product Support or your Garmin dealer.

Removing an SD Card:

- 1) Push the card into the unit until it stops.
- 2) Release the card. The card should eject for easy removal.
- 3) With the card ejected, pull the card out of the slot.

G300 DATABASES

The following databases are included with the G300 depending on the unit (Americas, Atlantic, or Pacific). See the Additional Feature section for information on AOPA Airport Directory, FliteCharts®, and SafeTaxi®. See the Hazard Avoidance section for information on Obstacles and Terrain.

Database	G300
Basemap	+
AOPA Airport Directory	+
Jeppesen® Navigation Database (NavData™)	+
FliteCharts®	+
SafeTaxi®	+
Obstacle	+
Terrain	+

Databases

BASEMAP

The basemap database contains data for the topography and land features, such as river, lakes, and towns. It is updated only periodically, with no set schedule. There is no expiration date.

AOPA AIRPORT DIRECTORY

The AOPA Airport Directory provides data on airports and heliports throughout the U.S. and it is updated on a 56-day cycle. Detailed information for over 5,300 U.S. airports, along with the names and phone numbers of thousands of FBOs can be viewed. This service allows the pilot to plan an overnight, choose fuel stops, find ground transportation, etc.

JEPPESEN® NAVIGATION DATABASE (NAVDATA™)



NOTE: After performing a Jeppesen database update, verify all flight plans (routes) are current. If there is an obsolete Jeppesen aviation point in a saved route, the route is locked and unusable. A new route with current Jeppesen database points will need to be created.

The Jeppesen Navigation Database (NavData) is updated on a 28-day cycle. The following information is provided from the Jeppesen database:

- Airport—identifier, facility name, city/state/country, latitude/longitude, field elevation, available fuel types, runway designations and layout, runway surface, runway length, runway width, runway lighting, communication frequencies, and published approaches.
- Weather—frequencies associated with an airport (ASOS, ATIS, and AWOS).
- VORs—identifier, facility name, city/state/country, location (latitude/longitude), frequency, service volume (high, low, terminal), and type (such as VOR-DME, TACAN, and VORTAC).
- NDBs—identifier, facility name, city/state/country, location (latitude/longitude), and frequency.
- Intersections—identifier, nearest VOR, radial and distance from nearest VOR, location (latitude/longitude), and region/country.

- ARTCC—Air Route Traffic Control Centers.
- Airspace—boundaries (Class B, Class C, Control Zones, SUAs, and MOAs), controlling agency, and vertical boundaries.
- FSS—Flight Service Stations.

FLITECHARTS

The FliteCharts database contains procedure charts for the United States only. This database is updated on a 28-day cycle.

SAFETAXI

The SafeTaxi database contains detailed airport diagrams for selected airports. These diagrams aid in following ground control instructions by accurately displaying the aircraft position on the map in relation to taxiways, ramps, runways, terminals, and services. This database is updated on a 56-day cycle.

OBSTACLE

The obstacle database contains data for obstacles, such as towers, that pose a potential hazard to aircraft. Obstacles 200 feet and higher are included in the obstacle database. It is very important to note that not all obstacles are necessarily charted and therefore may not be contained in the obstacle database. This database is updated on a 56-day cycle.

TERRAIN



NOTE: The data contained in the terrain and obstacle databases comes from government agencies. Garmin accurately processes and cross-validates the data, but cannot guarantee the accuracy and completeness of the data.

The terrain database is updated periodically and has no expiration date.

UPDATING G300 DATABASES

The G300 database updates can be obtained by visiting the 'flyGarmin' website (www.fly.garmin.com). After the databases have been updated, check that the appropriate databases are initialized and displayed on the splash screen during power-up.



NOTE: The databases are stored internally on each GDU. When updating a two display system, each GDU will need to be updated individually using the same SD card.

The G300 database updates can be obtained by visiting the 'flyGarmin' website (www.fly.garmin.com). The 'flyGarmin' website requires the unit's System ID to update databases. This allows the databases to be encrypted with the unit's unique System ID when copied to the SD Card.

Obtaining the System ID:

- 1) Press the **MENU** Key twice to access the Main Menu.
- 2) Select 'System Setup' and press the **ENT** Key.

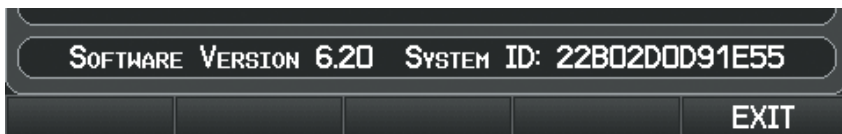

System Setup Page

Or:

Select 'Database Information' and press the **ENT** Key.

System ID



Database Information Page

Updating G300 Databases:

Equipment required to perform the update:

- Windows-compatible PC computer (Windows 2000 or XP recommended)
 - SanDisk SD Card Reader or equivalent
 - Updated database obtained from the flyGarmin website
 - SD Card, 2 GB recommended (Garmin recommends SanDisk or Toshiba)
- 1) After the data has been copied to the SD Card, insert the SD card in the SD card slot of the display.
 - 2) Power on the display. The Update Databases Page is displayed. A green checkbox indicates that the database already installed on the G300 is up to date. An empty checkbox indicates that the database on the SD card is more current and should be installed.



Update Databases Page

- 3) With 'Update All' highlighted, press the **ENT** Key. The database status is updated.



Update Databases Page

Or:

Move the **FMS** Joystick to highlight a single database to update, and

press the **ENT** Key. The database status is updated.



**Update Databases Page
(Database Status Updated)**

- 4) Press the **RESTART** Softkey. Once the database(s) have been successfully updated, the SD Card can be removed from the unit.



Update Databases Page

- 5) Repeat steps 1-4 for the remaining GDU if applicable.

EXPORTING TRACK LOGS AND USER WAYPOINTS

Exporting a track log:

- 1) From the split-screen or full-screen MFD, press the **MENU** Key twice. (The 'Track Log' option is not available from the full-screen PFD Main Menu).
- 2) Turn or move the **FMS** Joystick to select 'Track Log' from the Main Menu, and press the **ENT** Key.
- 3) Using the **FMS** Joystick highlight the desired track log to export.
- 4) With an SD card inserted, press the **EXPORT** Softkey.

Exporting User Waypoints:

- 1) From the split-screen or full-screen MFD, press the **MENU** Key twice.
- 2) Turn or move the **FMS** Joystick to select 'User Waypoints' from the Main Menu, and press the **ENT** Key.
- 3) With an SD card inserted, press the **Menu** Key.
- 4) Turn or move the **FMS** Joystick to select 'Export Waypoints' from the Option Menu, and press the **ENT** Key.

IMPORTING/EXPORTING FLIGHT PLANS

Importing flight plans:

- 1) With a flight plan saved to the SD Card, press the **FPL** Key and turn the **FMS** Joystick to display the Flight Plan List Page.
- 2) Press the **IMPORT** Softkey.
- 3) Using the **FMS** Joystick highlight the desired flight plan to import.
- 4) Press the **IMPORT** Softkey again and press the **ENT** Key.

Exporting flight plans:

- 1) Press the **FPL** Key and turn the **FMS** Joystick to display the Flight Plan List Page.
- 2) Press the **FMS** Joystick to activate the cursor, and turn or move the **FMS** Joystick to highlight the desired flight plan.
- 3) Press the **EXPORT** Softkey and press the **ENT** Key.

FLIGHT DATA LOGGING

The G300 also has the ability to log flight data. Refer to the Additional Features section for more information.

APPENDIX D: MAP DATUM AND LOCATION FORMATS

MAP DATUMS

A datum is a mathematical model of the Earth that approximates the shape of the Earth and enables calculations to be carried out in a consistent and accurate manner. The datum is physically represented by a framework of ground monuments (such as trig. stations) whose locations have been accurately measured and calculated on this reference surface. Lines of latitude and longitude on a chart are referenced to a specific map datum. Every chart has a map datum reference and the G300 can be set to match most of those commonly used.

LOCATION FORMATS

Your current location can be viewed on the GPS in the form of coordinates. Since different charts use different location formats, Garmin GPS units allow you to choose the correct coordinate system for the type of chart you are using. The most common format is latitude and longitude, which is used by all Garmin units. You can change the location format to use with other coordinate systems.

Map Datum and Location Format selection can be performed on the Position Setup Page.

Changing position settings:

- 1) Press the **MENU** Key twice to display the Main Menu.
- 2) Turn or move the **FMS** Joystick to highlight 'System Setup...' and press the **ENT** Key.
- 3) Turn or move the **FMS** Joystick to highlight 'Position' and press the **ENT** Key.
- 4) Move the **FMS** Joystick to highlight the desired field, and select the desired option by turning the **FMS** Joystick.
- 5) Press the **FMS** Joystick, the **CLR** Key, the **EXIT** Softkey or the **MENU** Key to remove the menu.

- System Overview
- Flight Instruments
- EIS
- COM Interface
- GPS Navigation
- Flight Planning
- Hazard Avoidance
- Additional Features
- Integrated Autopilot
- Annun/Alerts
- Appendix**
- Index

Blank Page

APPENDIX E: ABNORMAL OPERATION

LOSS OF GPS POSITION

When the G300 loses the GPS signal for any reason, the following will occur:

- A blinking red question mark will appear over the airplane icon on the map.
- The 'Lost Satellite Reception' message will display.
- Any GPS dependent data fields will not be available.



GPS Signal Lost

HAZARD DISPLAY WITH LOSS OF GPS POSITION

If the Terrain Page doesn't have at least a 3D fix (i.e. altitude unknown), a Red X will be displayed.



Terrain Page Red X (Single Display)

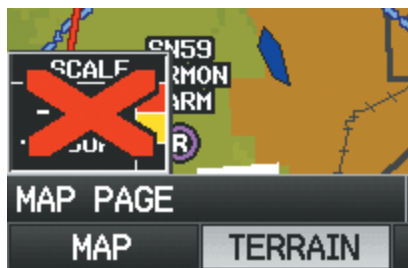

Map Page Red X (Terrain) (Single Display)

G300 SYSTEM FAILURE ANNUNCIATIONS

When an LRU or an LRU function fails, a large red 'X' is typically displayed over the instrument(s) or data experiencing the failure. Upon G300 power-up, certain instruments remain invalid as equipment begins to initialize. All instruments should be operational within one minute of power-up. If any instrument remains flagged, the G300 should be serviced by an authorized repair facility.



NOTE: Refer to the Pilot's Operating Handbook for additional information regarding pilot responses to these annunciations.



G300 System Failure Annunciations
(Single Display)

REVERSIONARY MODE

In the event of a display failure, the G300 System automatically switches to reversionary (backup) mode. In reversionary mode, all flight information is presented on the remaining display in the same format as the split-screen system.

If a display failure occurs with the GDU 375, the **WX** and **XM** Pages will no longer be available since the XM receiver resides in the GDU 375.



G300 Reversionary Mode (Failed PFD)

SYNTHETIC VISION TROUBLESHOOTING

Synthetic Vision is intended to be used with traditional attitude, heading, obstacle, and terrain inputs (in most areas). Synthetic Vision is disabled when valid attitude or heading data is not available for the display. In case of invalid Synthetic Vision data, the PFD display reverts to the standard blue-over-brown attitude display.

Synthetic Vision becomes disabled without the following data resources:

- Attitude data
- Heading data
- GPS position data
- Terrain data
- The position of the aircraft exceeds the range of the terrain database

REVERSIONARY MODE

Synthetic Vision can be displayed on the remaining display(s) in Reversionary Mode. If it is enabled when the system switches to Reversionary Mode, Synthetic Vision will take up to 30 seconds to display. The standard display will be shown in the interim.

UNUSUAL ATTITUDES

When the aircraft enters an unusual pitch attitude, red chevrons pointing toward the horizon warn of extreme pitch and data fields are decluttered (removed) from the display. The chevrons are displayed on the Attitude Indicator, starting at 50° above and 30° below the horizon line.



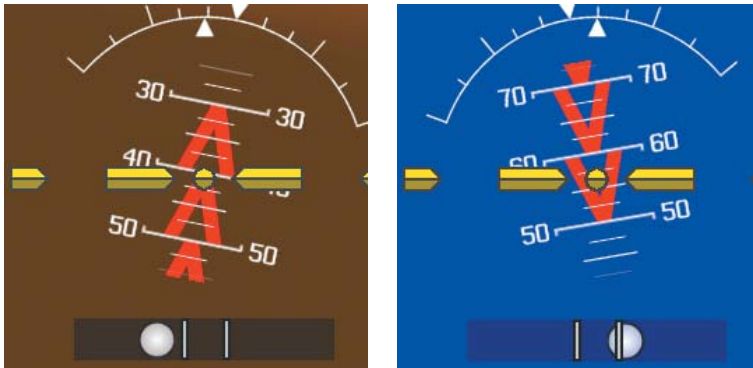







Also during unusual attitude conditions or when the terrain gradient is great enough to completely fill the display, a brown (earth) or blue (sky) colored bar at the top or bottom of the screen is displayed to prevent the pilot from losing sight of the horizon.









Pitch Attitude Warnings

APPENDIX F: DISPLAY SYMBOLS

VFR SYMBOLS

Item	Symbol
Unknown	
Non-towered, Non-serviced	
Towered, Non-serviced	
Non-towered, Serviced	
Towered, Serviced	
Soft Surface, Non-serviced	
Soft Surface, Serviced	
Soft Surface, Private	
Paved, Private	
Seaplane Base	
Heliport	

Americas/Pacific Database Airports

Item	Symbol
Civilian, Non-serviced	
Military, Non-serviced	
Civilian, Serviced	
Military, Serviced	
Civilian, Soft/Unknown Surface, Non-serviced	
Civilian, Soft/Unknown Surface, Serviced	

Atlantic Database Airports

- System Overview
- Flight Instruments
- EIS
- COM Interface
- GPS Navigation
- Flight Planning
- Hazard Avoidance
- Additional Features
- Integrated Autopilot
- Annun/Alerts
- Appendix
- Index

Item	Symbol
Intersection	
Visual Reporting Point	
LOM (compass locator at outer marker)	
NDB (non-directional radio beacon)	
VOR	
VOR/DME	
ILS/DME or DME only	
VORTAC	
TACAN	

Nav aids

Item	Symbol
Interstate Highway	
US Highway	
State Highway	
National Highway	
Small City	
Medium City	
Large City	

Miscellaneous











IFR SYMBOLS

Item	Symbol
VFR, Soft/unknown Surface, Non-serviced	
VFR, Soft/unknown Surface, Serviced	









Atlantic Database Airports

Item	Symbol
Low-Altitude	
High-Altitude	

Airways

Item	Symbol
Unknown	
VFR Airport, Non-serviced	
IFR Airport, Non-serviced	
VFR Airport, Serviced	
IFR Airport, Serviced	
VFR, Soft Surface, Non-serviced	
VFR, Soft Surface, Serviced	
VFR, Soft Surface, Private	
VFR, Paved, Private	
VFR Seaplane Base	
VFR Heliport	

Americas/Pacific Database Airports

Item	Symbol
Intersection	
LOM (compass locator at outer marker)	
NDB (non-directional radio beacon)	
VOR	
VOR/DME	
ILS/DME or DME Only	
VORTAC	
TACAN	

Nav aids

System Overview

Flight Instruments

EIS

COM Interface

GPS Navigation

Flight Planning

Hazard Avoidance

Additional Features

Integrated Autopilot

Annun/Alerts

Appendix

Index

AIRSPACE SYMBOLS



Item	Symbol
Class B, Class E, CTA	
Class A, Class C, TMA	
Class D	
Mode C Veil	
TRSA	
MOA	
Danger, Alert, or Training Area	
Restricted, Prohibited, or Warning Area	
Radar Area	
ATZ, TIZ	
MATZ	
ADIZ	
Misc/Unknown	

VFR Americas/Pacific Database

Item	Symbol
Class B, Class E, CTA	
Class A, Class C, TMA, TRSA	
Class D	
MOA	
Danger, Alert, or Training Area	
Restricted, Prohibited, or Warning Area	
Radar Area	
ATZ, TIZ	
Misc/Unknown	

IFR Americas/Pacific Database

- System Overview
- Flight Instruments
- EIS
- COM Interface
- GPS Navigation
- Flight Planning
- Hazard Avoidance
- Additional Features
- Integrated Autopilot
- Annun/Alerts
- Appendix
- Index

Item	Symbol
Danger or Alert Area	
Restricted, Prohibited, or Warning Area	
Training Area	

VFR Atlantic Database Exceptions

Item	Symbol
Training Area	

IFR Atlantic Database Exceptions

- System Overview
- Flight Instruments
- EIS
- COM Interface
- GPS Navigation
- Flight Planning
- Hazard Avoidance
- Additional Features
- Integrated Autopilot
- Annun/Alerts
- Appendix**
- Index

Blank Page

APPENDIX G: GLOSSARY

ADIZ	Air Defense Identification Zone
AGL	Above Ground Level
AIM	Airman's Information Manual
AIRMET	Airman's Meteorological Information
APT	airport
ASPC	airspace
ARTCC	Air Route Traffic Control Center
ASOS	Automated Surface Observing System
ATC	Air Traffic Control
ATIS	Automatic Terminal Information Service
AWOS	Automated Weather Observing System
Bearing	The compass direction from the present position to a destination waypoint.
°C	degrees Celsius
Calibrated Airspeed	Indicated airspeed corrected for installation and instrument errors.
cm	centimeter
COM	communication radio
Course	The line between two points to be followed by the aircraft.
Course to Steer	The recommended direction to steer in order to reduce course error or stay on course. Provides the most efficient heading to get back to the desired course and proceed along the flight plan.
Crosstrack Error	The distance the aircraft is off a desired course in either direction, left or right.
CTS	Course to Steer

System Overview	dBZ	decibels 'Z' (radar return)
	deg	degree
Flight Instruments	Desired Track	The desired course between the active "from" and "to" waypoints.
	DIS	distance
EIS	Distance	The 'great circle' distance from the present position to a destination waypoint.
	DME	Distance Measuring Equipment
COM Interface	DTK	Desired Track
GPS Navigation	Enroute Safe Altitude	The recommended minimum altitude within ten miles left or right of the desired course on an active flight plan or direct-to.
	ENT	enter
Flight Planning	ESA	Enroute Safe Altitude
	Estimated Time of Arrival	The estimated time at which the aircraft should reach the destination waypoint, based upon current speed and track.
Hazard Avoidance	Estimated Time Enroute	The estimated time it takes to reach the destination waypoint from the present position, based upon current ground speed.
Additional Features	ETA	Estimated Time of Arrival
	ETE	Estimated Time Enroute
Integrated Autopilot	°F	degrees Fahrenheit
Annun/Alerts	FAA	Federal Aviation Administration
	FAF	Final Approach Fix
Appendix	FCC	Federal Communication Commission
	FPL	flight plan
Index	fpm	feet per minute
	FSS	Flight Service Station
	ft	foot/feet

gal	gallon(s)	
Glide Ratio, G/R	The estimated distance an aircraft will move forward for any given amount of lost altitude.	System Overview
GND	ground	Flight Instruments
gph	gallons per hour	
GPS	Global Positioning System	EIS
Grid MORA	Grid Minimum Off-Route Altitude; one degree latitude by one degree longitude in size and clears the highest elevation reference point in the grid by 1000 feet for all areas of the grid	COM Interface
Groundspeed	The velocity that the aircraft is travelling relative to a ground position.	Navigation
Ground Track	see Track	GPS
GS	Ground speed	Flight Planning
Heading	The direction an aircraft is pointed, based upon indications from a magnetic compass or a properly set directional gyro.	Hazard Avoidance
Hg	mercury	Additional Features
hPa	hectopascal	Integrated Autopilot
hr	hour	Annun/Alerts
HSI	Horizontal Situation Indicator	Appendix
Hz	Hertz	Index
IAF	Initial Approach Fix	
IAT	Indicated Air Temperature	
ICAO	International Civil Aviation Organization	
IFR	Instrument Flight Rules	
ILS	Instrument Landing System	
IMC	Instrument Meteorological Conditions	
in	inch	

System Overview	Indicated	Information provided by properly calibrated and set instrumentation on the aircraft panel.
	in HG	inches of mercury
Flight Instruments	kg	kilogram
	kHz	kilohertz
EIS	km	kilometer
	kt	knot
COM Interface	LAT	latitude
	lb	pound
GPS Navigation	Leg	The portion of a flight plan between two waypoints.
	LON	longitude
Flight Planning	m	meter
	MAP	Missed Approach Point
Hazard Avoidance	METAR	Meteorological Aviation Routine
	MHz	megahertz
Additional Features	Minimum Safe Altitude	Uses Grid MORAs to determine a safe altitude within ten miles of the aircraft present position.
	MOA	Military Operations Area
Integrated Autopilot	MSA	Minimum Safe Altitude
	MSL	Mean Sea Level
Annun/Alerts	NAVAID	NAVigation AID
	NDB	Non-directional Beacon
Appendix	NEXRAD	Next Generation Radar
	nm	nautical mile(s)
Index	NRST	nearest

OAT	Outside Air Temperature
OBS	Omni Bearing Selector
psi	pounds per square inch
QTY	quantity
rpm	revolutions per minute
SBAS	Satellite-Based Augmentation System
SD	Secure Digital
sec	second(s)
SIGMET	Significant Meteorological Information
TACAN	Tactical Air Navigation System
TAF	Terminal Aerodrome Forecast
TAS	True Airspeed
TER	terrain
TFR	Temporary Flight Restriction
TOPO	topographic
Track	Direction of aircraft movement relative to a ground position; also 'Ground Track'
TRSA	Terminal Radar Service Area
UTC	Coordinated Universal Time
VFR	Visual Flight Rules
VHF	Very High Frequency
VNAV	vertical navigation
VOL	volume

System Overview

Flight Instruments

EIS

COM Interface

GPS Navigation

Flight Planning

Hazard Avoidance

Additional Features

Integrated Autopilot

Annun/Alerts

Appendix

Index

System Overview	VOR	VHF Omni-directional Range
	VORTAC	very high frequency omnidirectional range station and tactical air navigation
Flight Instruments	VSI	Vertical Speed Indicator
	VSR	Vertical Speed Required
EIS	VTF	vector to final
	WAAS	Wide Area Augmentation System
COM Interface	WPT	waypoint
	WX	weather
GPS Navigation		
Flight Planning		
Hazard Avoidance		
Additional Features		
Integrated Autopilot		
Annun/Alerts		
Appendix		
Index		

APPENDIX H: LICENSE AGREEMENT AND WARRANTY

CONTACT GARMIN

Contact Garmin if you have any questions while using your G300. In the USA contact Garmin Product Support by phone: (913) 397-8200 or (800) 800-1020, Monday–Friday, 8 AM–5 PM Central Time; or go to www.garmin.com/support.

In Europe, contact Garmin (Europe) Ltd. at +44 (0) 870.8501241 (outside the UK) or 0808 2380000 (within the UK).

SOFTWARE LICENSE AGREEMENT

BY USING THE G300, YOU AGREE TO BE BOUND BY THE TERMS AND CONDITIONS OF THE FOLLOWING SOFTWARE LICENSE AGREEMENT. PLEASE READ THIS AGREEMENT CAREFULLY.

Garmin grants you a limited license to use the software embedded in this device (the “Software”) in binary executable form in the normal operation of the product. Title, ownership rights, and intellectual property rights in and to the Software remain with Garmin.

You acknowledge that the Software is the property of Garmin and is protected under the United States of America copyright laws and international copyright treaties. You further acknowledge that the structure, organization, and code of the Software are valuable trade secrets of Garmin and that the Software in source code form remains a valuable trade secret of Garmin. You agree not to decompile, disassemble, modify, reverse assemble, reverse engineer, or reduce to human readable form the Software or any part thereof or create any derivative works based on the Software. You agree not to export or re-export the Software to any country in violation of the export control laws of the United States of America.

LIMITED WARRANTY

The Garmin G300 LRU's that comply with TSO (Technical Standard Order) requirements for certification (GMU 44 and GTP 59) are warranted to be free from defects in materials or workmanship for two years from the date of purchase. The Garmin G300 LRU's that do not comply with TSO requirements for certification (GDU 370, GDU 375, and the GSU 73) are warranted to be free from defects in materials or workmanship for one year from the date of purchase. Within the specified period, Garmin will, at its sole option, repair or replace any components that fail in normal use. Such repairs or replacement will be made at no charge to the customer for parts and labor, provided that the customer shall be responsible for any transportation cost. This warranty does not cover failures due to abuse, misuse, accidents, or unauthorized alterations or repairs. In addition, Garmin reserves the right to refuse warranty claims against products or services that are obtained and/or used in contravention of the laws of the country.

THE WARRANTIES AND REMEDIES CONTAINED HEREIN ARE EXCLUSIVE AND IN LIEU OF ALL OTHER WARRANTIES EXPRESS OR IMPLIED OR STATUTORY, INCLUDING ANY LIABILITY ARISING UNDER ANY WARRANTY OF MERCHANTABILITY OR FITNESS FOR A PARTICULAR PURPOSE, STATUTORY OR OTHERWISE. THIS WARRANTY GIVES YOU SPECIFIC LEGAL RIGHTS, WHICH MAY VARY FROM STATE TO STATE.

IN NO EVENT SHALL GARMIN BE LIABLE FOR ANY INCIDENTAL, SPECIAL, INDIRECT OR CONSEQUENTIAL DAMAGES, WHETHER RESULTING FROM THE USE, MISUSE, OR INABILITY TO USE THIS PRODUCT OR FROM DEFECTS IN THE PRODUCT. Some states do not allow the exclusion of incidental or consequential damages, so the above limitations may not apply to you.

Garmin retains the exclusive right to repair or replace the unit or software, or to offer a full refund of the purchase price, at its sole discretion. SUCH REMEDY SHALL BE YOUR SOLE AND EXCLUSIVE REMEDY FOR ANY BREACH OF WARRANTY.

Products sold through online auctions are not eligible for rebates or other special offers from Garmin. On-line auction confirmations are not accepted for warranty verification. To obtain warranty service, an original copy of the sales receipt from the original retailer is required. Garmin will not replace missing components from any package purchased through an online auction.

To obtain warranty service, contact your local Garmin Authorized Service Center. For assistance in locating a Service Center, visit the Garmin website at www.garmin.com or contact Garmin Customer Service at one of the numbers listed below.

Garmin International, Inc., 1200 East 151st Street, Olathe, Kansas 66062, U.S.A.

Toll free: 800/800.1020 or 866/739.5687

Tel: 913/397.8200

Fax: 913/397.8282

Garmin AT, Inc., 2345 Turner Road SE, Salem, OR 97302, U.S.A.

Toll free: 800/525.6726

Tel: 503/391.3411

Fax: 503/364.2138

Garmin (Europe) Ltd., Liberty House, Bulls Copse Road, Hounslow Business Park, Southampton, SO40 9RB, U.K.

Toll free (within U.K.): 0808 238 0000

Tel: 44/0870.8501241

Fax: 44/0870.8501251

AOPA AIRPORT DIRECTORY NOTICE

AOPA MEMBERSHIP PUBLICATIONS, INC. AND ITS RELATED ORGANIZATIONS (HEREINAFTER COLLECTIVELY "AOPA") EXPRESSLY DISCLAIM ALL WARRANTIES, WITH RESPECT TO THE AOPA INFORMATION INCLUDED IN THIS DATA, EXPRESS OR IMPLIED, INCLUDING, BUT NOT LIMITED TO, THE IMPLIED WARRANTIES OF MERCHANTABILITY AND FITNESS FOR A PARTICULAR PURPOSE. THE INFORMATION IS PROVIDED "AS IS" AND AOPA DOES NOT WARRANT OR MAKE ANY REPRESENTATIONS REGARDING ITS ACCURACY, RELIABILITY, OR OTHERWISE. UNDER NO CIRCUMSTANCES INCLUDING NEGLIGENCE, SHALL AOPA BE LIABLE FOR ANY INCIDENTAL, SPECIAL OR CONSEQUENTIAL DAMAGES THAT RESULT FROM THE USE OR INABILITY TO USE THE SOFTWARE OR RELATED DOCUMENTATION, EVEN IF AOPA OR AN AOPA AUTHORIZED REPRESENTATIVE HAS BEEN ADVISED OF THE POSSIBILITY OF SUCH DAMAGES. USER AGREES NOT TO SUE AOPA AND, TO THE MAXIMUM EXTENT ALLOWED BY LAW, TO RELEASE AND HOLD HARMLESS AOPA FROM ANY CAUSES OF ACTION, CLAIMS OR LOSSES RELATED TO ANY ACTUAL OR ALLEGED INACCURACIES IN THE INFORMATION ARISING OUT OF GARMIN'S USE OF THE INFORMATION IN THE DATASETS. SOME JURISDICTIONS DO NOT ALLOW THE LIMITATION OR EXCLUSION OF IMPLIED WARRANTIES OR LIABILITY FOR INCIDENTAL OR CONSEQUENTIAL DAMAGES SO THE ABOVE LIMITATIONS OR EXCLUSIONS MAY NOT APPLY TO YOU.

SIRIUSXM SATELLITE RADIO SERVICE AGREEMENT

SiriusXM Satellite Radio Inc.

Hardware and required monthly subscription sold separately. Subscription fee is consumer only. Other fees and taxes, including a one-time activation fee may apply. All programming fees and weather data subject to change. XM WX weather data displays and individual product availability vary by hardware equipment. Reception of the SiriusXM signal may vary depending on location. Subscriptions subject to Customer Agreement included with the SiriusXM Welcome Kit and available at siriusxm.com. Available only in the 48 contiguous United States. XM WX is a trademark of SiriusXM Satellite Radio Inc.

Contact SiriusXM Satellite Radio by phone at 800.985.9200 to subscribe to XM WX Weather and/or SiriusXM Radio.

WEATHER DATA WARRANTY

THE WEATHER DATA SOFTWARE PRODUCT IS PROVIDED "AS IS." ALL OTHER WARRANTIES, EXPRESSED OR IMPLIED, INCLUDING ANY WARRANTY OF MERCHANTABILITY OR FITNESS FOR A PARTICULAR PURPOSE OR OF NON-INFRINGEMENT ARE HEREBY EXCLUDED.

USER SAFETY

If you use SiriusXM Services it is your responsibility to exercise prudent discretion and observe all safety measures required by law and your own common sense. You assume the entire risk related to your use of the Services. SiriusXM and Garmin assume no responsibility for accidents resulting from or associated with use of the Services. Your Radio Service includes traffic and weather information, and you acknowledge that such information is not for "safety for life", but is merely supplemental and advisory in nature, and therefore cannot be relied upon as safety-critical in connection with any aircraft, sea craft or automobile usage. This information is provided "as is" and SiriusXM and Garmin disclaim any and all warranties, express and implied, with respect thereto or the transmission or reception thereof. SiriusXM and Garmin further do not warrant the accuracy, reliability, completeness or timeliness of the traffic and weather information disclosed on the Radio Service. In no event will SiriusXM and Garmin, their data suppliers, service providers, marketing/distribution, software or Internet partners or hardware manufacturers be liable to you or to any third party for any direct, indirect, incidental, consequential, special, exemplary or punitive damages or lost profits resulting from use of or interruptions in the transmission or reception of the Services.

LIMITS ON OUR RESPONSIBILITY

a) DISCLAIMERS.

EXCEPT AS EXPRESSLY PROVIDED HEREIN, WE MAKE NO WARRANTY OR REPRESENTATION, EITHER EXPRESS OR IMPLIED, REGARDING THE RADIO SERVICE. YOUR USE OF THE SERVICE IS AT YOUR SOLE RISK. THE CONTENT AND FUNCTIONALITY OF THE SERVICE IS PROVIDED "AS IS" WITHOUT ANY WARRANTY OF ANY KIND, EXPRESS OR IMPLIED. ALL SUCH WARRANTIES OR REPRESENTATIONS (INCLUDING, WITHOUT LIMITATION, THE IMPLIED WARRANTIES OF MERCHANTABILITY, FITNESS FOR A PARTICULAR PURPOSE, TITLE AND NON-INFRINGEMENT) ARE HEREBY DISCLAIMED.

b) LIMITATIONS OF LIABILITY.

WE ARE NOT RESPONSIBLE FOR ANY SPECIAL, INCIDENTAL, OR CONSEQUENTIAL DAMAGES OR LOSSES RELATING TO THE USE OF THE RADIO SERVICE, WHETHER BASED ON NEGLIGENCE OR OTHERWISE. OUR TOTAL LIABILITY TO YOU AND ANY OTHER PERSONS RECEIVING OUR SERVICES, REGARDLESS OF THE CAUSE, WILL IN NO EVENT EXCEED THE AMOUNTS THAT YOU HAVE PAID TO US FOR THE SERVICE THAT YOU RECEIVED DURING THE SIX (6) MONTH PERIOD IMMEDIATELY PRIOR TO THE SPECIFIC EVENT THAT GAVE RISE TO THE APPLICABLE DAMAGE OR LOSS. THIS ALLOCATION OF RISK IS REFLECTED IN OUR PRICES. YOU MAY HAVE GREATER RIGHTS THAN DESCRIBED ABOVE UNDER YOUR STATE'S LAWS

This product was developed using DAFIF™, a product of the National Geospatial-Intelligence Agency.

This product has not been endorsed or otherwise approved by the National Geospatial-Intelligence Agency, or the United States Department of Defense (10 U.S.C. 425)

a. Under 10 U.S.C. 456, no civil action may be brought against the United States on the basis of the content of a navigational aid prepared or disseminated by either the former Defense Mapping Agency (DMA), National Imagery and Mapping Agency (NIMA), or the National Geospatial-Intelligence Agency (NGA).

b. The DAFIF™ product is provided "as is," and no warranty, express or implied, including, but not limited to the implied warranties of merchantability and fitness for particular purpose or arising by statute or otherwise in law or from a course of dealing or usage in trade, is made by NGA as to the accuracy and functioning of the product.

c. Neither NGA nor its personnel will be liable for any claims, losses, or damages arising from or connected with the use of this product. The user agrees to hold harmless the United States National Geospatial-Intelligence Agency. The user's sole and exclusive remedy is to stop using the DAFIF product.

A

- Acquiring Satellites 35
- Air Data Computer (ADC) 2
- Airport
 - Criteria 49
- Airports 84
- Airport Signs 171
- Airspace 86
 - Alert Messages 112
 - Smart Airspace 113
- Airspeed Indicator 53, 53–54
- Airways 93
- Alarms 47
- Alerts 215
- Altimeter 55
- Altimeter barometric setting 52
- Altitude Hold Mode (ALT) 201
- Animating 153
- Approach
 - Activating 134
 - Loading 132, 133, 134
 - Removing 134, 137, 182
 - Selecting 132
- Attitude and Heading Reference
 - System (AHRS) 2, 14
- Attitude Indicator 54, 54–55
- Aural Alerts 221
- Automatic Reversion 207
- Automatic waypoint selection 97
- Autopilot 191
- Autopilot Status BOX 196
- Auto-tuning 77

B

- Barometric setting, Altimeter 52, 56–57
- Basemap 245
- Bearing 66

- Bearing Pointers 64
- Bearing source 64

C

- CDI scale 64
- Chart Not Available 178
- CIP 148
- Color Mode 42
- COM 77
- Compass Arc 81
- Control Wheel Steering (CWS) 195
- Course Deviation Indicator (CDI) 63
- Current Icing Product 148
- Customizing 85

D

- Data Bar Fields 40
- Databases 243, 244
- Data Entry 17–18
- Data Fields 227
- Date & Time 43, 46
- Declutter 93
- Delete
 - Flight plans 127
 - Flight Records 233
 - Individual waypoint 128, 129
- Direct-to 113
- Display
 - Backlighting 39
 - Color Mode 42

E

- Echo Tops 141
- Editing 123
 - Fuel Flow 125
 - Speed 125
- EIS Display 73
- Engine/Airframe Unit 2
- Engine Indication System (EIS) 73

System Overview

Flight Instruments

EIS

COM Interface

GPS Navigation

Flight Planning

Hazard Avoidance

Additional Features

Abnormal Operation

Annun/Alerts

Appendix

Index

System Overview
 ENG Page 73
 EPE Circle 240

F

Flight Instruments
 Failure Annunciations 254
 Flight Instruments 51
 Flight Log 231
 Flight path Marker 169
 Flight Plan
 Activation 122
 Copying 127
 Creation 119
 Data Fields 118
 Deleting 127
 Fuel Flow 125
 Inverting 129
 Waypoints, Adding 123
 Flight Plan (FPL) Pages 22
 FliteCharts 177
 Expiration 180
 Range 179
 FMS Joystick 8
 Forecast 149
 FPL Key 9
 Freezing Levels 147
 Frequencies 77
 Fuel Flow 125

G

Garmin Display Unit (GDU) 49
 Garmin Sensor Unit (GSU) 2
 GDU 370 1
 GMU 44 3
 GSU 73 2
 GTP 59 3

H

Hazard Display 192, 196, 197, 198,
 200, 201, 203, 253
 Heading 52
 Heading Line 237
 Heading Mode (HDG) 211
 Heading Strip 66
 Horizontal Situation Indicator (HSI)
 61

I

Icing Forecast 148
 INFO Page 33
 Information Window 64
 Information Windows 64
 Integrated Autopilot 191
 Alerts 224
 Disengaging 195
 Engaging 194
 Modes 197
 Intersections 104
 Inverting a Flight Plan 129

J

Jeppesen® Aviation Database 245

L

Legends 153
 Lightning 143
 Limited Warranty 269
 Line Replaceable Unit (LRU) 1
 Location Format 251
 Loss of GPS 192
 Low Voltage Warning 222

M

Magnetometer 3
 Main Pages 20

Map 251, 253
 Panning 89
 Range 87
 Symbols 92, 93
 Map Declutter 93
 Map Displays 82
 Map Orientation 83
 Measuring Bearing and Distance 90
 MENU Key 9
 Menus 16
 Main Menu 16
 Navigating 42
 Page Menu 16
 Messages 215
 Airspace 221

N

NAVAIDS 84
 Navigation 81
 Navigation Mode (GPS) 212
 NDBs 105
 Nearest
 Airspace 111, 112
 NDB 105, 106
 VORs 106
 Nearest Airport Criteria 102
 Nearest Information 101
 Nearest (NRST) Pages 22
 New Location 35
 NEXRAD 139, 140
 Normal Mode 13
 NRST Key 9

O

OBS Mode 66
 Obstacles 157
 Outside Air Temperature (OAT) 52, 68

P

Pages 19
 Flight Plan (FPL) 22
 MAIN 20
 Nearest (NRST) 22
 Panning 88, 89
 PFD
 Annunciations 222
 PFD Page 51
 Pilot Weather Reports 147
 PIREPs 147
 Pitch Hold Mode (PIT) 198
 Position 36, 47
 Power-up 10
 Proximity Waypoints 241

R

Range 87
 Red X 14, 253
 Reversionary Mode 13, 214
 RNG Key 8
 Roll Hold Mode (ROL) 209
 Runway 99

S

SafeTaxi 164, 175
 Satellite Information 36
 Satellite Mosaic 140
 Satellite View 92
 SD Cards 7, 243
 Secure Digital Cards 7
 Selected Altitude 52
 Selected Altitude Bug 52
 Selected Altitude Capture mode
 (ALTS) 200
 Selected Heading 61
 Set Baro Advisory 222

Settings 39
SiriusXM 137, 138, 163, 182, 184
SLD 148
Softkeys 24, 31
Softkey Selection Keys 9
Sound 43
Standard Panel 4
Storm Cells 143
Supercooled Large Droplet 148
Supplemental Flight Data 68
Surface Pressure 142
Symbols 92, 257
Synthetic Vision 164
Synthetic Vision (SVX) 163
System
 Controls 8
 Initialization 10
 Power-up 10
System ID 247
System Status Messages 217
System Time 52

T

Temperature Probe 3
Temporary Flight Restrictions 146
Terrain 154
 Alerts 158, 159
 Annunciations 223
 Views 156
Topography 91
Track Log 233
Traffic Information Service (TIS)
 Annunciations 224
Trip Planning 136
True Airspeed (TAS) 52, 53
Turbulence Forecast 148
Turn Rate Indicator 66

U

Unit Overview 6
Upgraded Panel 5
User Waypoints 107
Utilities 231

V

Vectors-to-Final 135
Vertical Modes 198, 209
Vertical Navigation Mode (VNAV)
 205
Vertical Navigation (VNAV) 69
 Capturing 72
 Configuring 71
 Indicator 72
Vertical Speed Indicator (VSI) 59
Vertical Speed Mode (VS) 203
VNAV Target Altitude Capture Mode
 (ALTV) 207
VORs 106
Vspeed Reference 42, 54

W

Warranty 269
Water Temperature 150
Waypoints 96, 111
Weather Information 103
Weight & Balance 238
Winds Aloft 141
Wings level 210

X

X symbol on terrain 155

Z

Zero Pitch Line 171



Garmin International, Inc.
1200 East 151st Street
Olathe, KS 66062, U.S.A.
Toll free: 800.800.1020 or
866.739.5687
p: 913.397.8200
f: 913.397.8282

Garmin AT, Inc.
2345 Turner Road SE
Salem, OR 97302, U.S.A.
Toll free: 800.525.6726
p: 503.391.3411
f: 503.364.2138

Garmin (Europe) Ltd
Liberty House, Bulls Copse Road
Hounslow Business Park
Southampton, SO40 9RB, U.K.
Toll free (within U.K.) 0808.2380000
p: 44/0870.8501241
f: 44/0870.8501251

Garmin Corporation
No. 68, Jangshu 2nd Road
Shijr, Taipei County, Taiwan
p: 886/2.2642.9199
f: 886/2.2642.9099

www.garmin.com