



User's Guide

This software User's Guide is your on-screen guide to your printer. By clicking the links on this screen, you can get information on the following topics.



Getting to Know Your Printer

Background information about your printer.



Paper Handling

How to load various types of paper.



Printer Software

How to print using the printer software.



Control Panel

Information about the control panel functions.



Problem Solver

Solutions to problems you may encounter.



Options and Consumables

How to use options and informations about consumables.



Product Information

Information about the printer parts and features.

- › Safety
- › Copyright and Trademarks
- › Glossary

[Home](#) > [Getting to Know Your Printer](#)

Getting to Know Your Printer

[Features](#)

[Home](#) > Paper Handling

Paper Handling

[Printing on Continuous Paper](#)

[Printing on Single Sheets](#)

[Printing on Special Paper](#)

Home > Printer Software

Printer Software

[Operating System Versions](#)

[About Your Printer Software](#)

[Using the Printer Driver](#)

[Printer Driver Settings Overview](#)

[Using EPSON Status Monitor 3](#)

[Using Bi-D Adjustment](#)

[Using Printer Setting](#)

[Setting Up Your Printer on a Network](#)

[Canceling Printing](#)

[Uninstalling the Printer Software](#)

[Home](#) > [Control Panel](#)

Control Panel

[Using the Control Panel](#)

[Lock-Out Mode](#)

[About Your Printer's Default Settings](#)

[Home](#) > [Problem Solver](#)

Problem Solver

Troubleshooting

[Using the Error Indicators](#)

[Problems and Solutions](#)

[Correcting USB Problems](#)

[Clearing a Paper Jam](#)

[Printing a Self Test](#)

Where To Get Help

[Technical Support Web Site](#)

[Contacting Customer Support](#)

[Home](#) > [Options and Consumables](#)

Options and Consumables

[Installing and Using Options](#)

[Replacing the Ribbon Cartridge](#)

[Home](#) > [Product Information](#)

Product Information

[Printer Parts](#)

[Printer Specifications](#)

[Command Lists](#)

[Standards and Approvals](#)

[Cleaning the Printer](#)

[Transporting the Printer](#)

[Home](#) > [Safety](#)

Safety Instructions

- [Warnings, Cautions, and Notes](#)
- [Hot Parts Caution Symbol](#)
- [Important Safety Instructions](#)
- [For United Kingdom users](#)
- [For German users](#)
- [For Turkish users](#)
- [For Ukrainian users](#)
- [For Brazilian users](#)

Warnings, Cautions, and Notes

Warnings

must be followed carefully to avoid bodily injury.

Cautions

must be observed to avoid damage to your equipment.

Notes

contain important information and useful tips on the operation of your printer.

[Top](#) 

Hot Parts Caution Symbol



This symbol is placed on the print head and other parts to indicate that they may be hot. Never touch those parts just after the printer has been used. Let them cool for a few minutes before touching them.

[Top](#) 

Important Safety Instructions

Read all of these safety instructions before using the printer. In addition, follow all warnings and instructions marked on the printer itself.

When setting up the printer

- Do not place the printer on an unstable surface or near a radiator or heat source.

- Place the printer on a flat, stable surface. The printer will not operate properly if it is tilted or placed at an angle.
- Do not place this product on a soft, unstable surface like a bed or a sofa, or a small, enclosed area, as this restricts ventilation.
- Do not block or cover the slots and openings in the printer's cabinet, and do not insert objects through the slots.
- Leave adequate room around the printer for easy operation and maintenance.
- Place the printer where you can easily connect it to a network interface cable, if necessary.
- Use only the type of power source indicated on the printer's label. If you are not sure of the power supply specifications in your area, contact your local power company or consult your dealer.
- Connect all equipment to properly grounded electrical outlets. Avoid using outlets on the same circuit as photocopiers or air control systems that regularly switch on and off.
- Do not use a damaged or frayed power cord.
- The power cord should be placed to avoid abrasions, cuts, fraying, crimping, kinking, and other damage.
- If you use an extension cord with the printer, make sure the total ampere rating of all devices plugged into the extension cord does not exceed the cord's ampere rating. Also, make sure the total ampere of all devices plugged into the electrical outlet does not exceed the electrical outlet's ampere rating.
- Use only the power cord that comes with this product. Use of another cord may result in fire or electric shock.
- This product's power cord is for use with this product only. Use with other equipment may result in fire or electric shock.
- Be sure the AC power cord meets the relevant local safety standards.
- Avoid using or storing the printer in places subject to rapid changes in temperature and humidity. Also keep it away from direct sunlight, strong light, heat sources, or excessive moisture or dust.
- Avoid places subject to shocks and vibrations.
- Place the printer near a wall outlet where you can easily unplug the power cord.
- Keep the entire computer system away from potential sources of electromagnetic interference, such as loudspeakers or the base units of cordless telephones.
- Avoid electrical outlets controlled by wall switches or automatic timers. An interruption in power can erase information in the memory of your printer or computer. Also avoid outlets on the same circuit as large motors or other appliances that can cause voltage fluctuations.
- Use a grounded power outlet; do not use an adapter plug.
- If you plan to use a printer stand, follow these guidelines:
 - Use a stand that can support at least twice the weight of the printer.
 - Never use a stand that tilts the printer. The printer should always be kept level.
 - Position your printer's power cord and interface cable so they do not interfere with paper feeding. If possible, secure the cables to a leg of the printer stand.

When maintaining the printer

- Unplug the printer before cleaning it, and always clean it with a piece of damp cloth only.
- Do not spill liquid onto the printer.
- Do not attempt to service the printer yourself except as specifically explained in this guide.
- Unplug the printer and refer servicing to qualified service personnel under the following conditions:
 - i. If the power cord or plug is damaged.
 - ii. If liquid has entered the printer.
 - iii. If the printer has been dropped or the cabinet damaged.
 - iv. If the printer does not operate normally or exhibits a distinct change in performance.
- Do not use aerosol blowers which contain flammable gas inside or around this product. Doing so may cause fire.
- Adjust only those controls that are covered by the operating instructions.
- If you plan to use the printer in Germany, observe the following:
To provide adequate short-circuit protection and over-current protection for this printer, the building installation must be protected by a 16-amp circuit breaker.
Bei Anschluss des Druckers an die Stromversorgung muss sichergestellt werden, dass die Gebäudeinstallation mit einer 16 A-Sicherung abgesichert ist.
- Do not touch the white cable inside the printer.

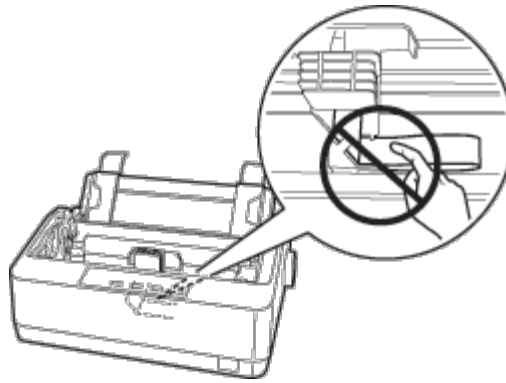

When handling the paper

- Do not load paper that is curled or has been folded.

When operating the printer

- Adjust only those controls that are covered in the user documentation. Improper adjustment of other controls may result in damage requiring extensive repair by a qualified technician.
- Whenever you turn off the printer, wait at least five seconds before turning it back on; otherwise, you may damage the printer.
- Do not turn off the printer while it is printing the self test. Always press the **Pause** button to stop printing and then turn off the printer.
- Do not reconnect the power cord to an electrical outlet that has the wrong voltage for your printer.
- Never replace the print head yourself; you may damage the printer. Also, other parts of the printer must be checked when the print head is replaced.
- You need to move the print head by hand to replace the ribbon cartridge. If you have just used the printer, the print head may be hot; let it cool for a few minutes before touching it.

Restriction of use

When this product is used for applications requiring high reliability/safety such as transportation devices related to aviation, rail, marine, automotive etc.; disaster prevention devices; various safety devices etc.; or functional/precision devices etc., you should use this product only after giving consideration to including fail-safes and redundancies into your design to maintain safety and total system reliability.

Because this product was not intended for use in applications requiring extremely high reliability/safety such as aerospace equipment, main communication equipment, nuclear power control equipment, or medical equipment related to direct medical care etc., please make your own judgment on this product's suitability after a full evaluation.

[Top](#)

For United Kingdom users

Use of options

Epson (UK) Limited shall not be liable against any damages or problems arising from the use of any options or consumable products other than those designated as Original Epson Products or Epson Approved Products by Epson (UK) Limited.

Safety information

 **Warning:**

This appliance must be earthed. Refer to the rating plate for voltage and check that the appliance voltage

corresponds to the supply voltage.

Important:

The wires in the mains lead fitted to this appliance are coloured in accordance to the following code:

Green and yellow — Earth

Blue — Neutral

Brown — Live

If you have to fit a plug:

As the colours of the mains lead of this appliance may not match coloured markings used to identify the terminals in a plug, please proceed as follows:

The green and yellow wire must be connected to the terminal in the plug which is marked with the letter E or the Earth symbol (⏏).

The blue wire must be connected to the terminal in the plug marked with the letter N.

The brown wire must be connected to the terminal in the plug marked with the letter L.

If damage occurs to the plug, replace the cord set or consult a qualified electrician.

Replace fuses only with a fuse of the correct size and rating.

[Top](#) 

For German users

Maschinenlärminformations-Verordnung 3. GPSGV: Der höchste Schalldruckpegel beträgt 70 dB(A) oder weniger gemäss EN ISO 7779.

Das Gerät ist nicht für die Benutzung im unmittelbaren Gesichtsfeld am Bildschirmarbeitsplatz vorgesehen. Um störende Reflexionen am Bildschirmarbeitsplatz zu vermeiden, darf dieses Produkt nicht im unmittelbaren Gesichtsfeld platziert werden.

Importeur

Epson Europe B.V.

Azië building, Atlas ArenA, Hoogoorddreef 5, 1101 BA Amsterdam, The Netherlands

[Top](#) 

For Turkish users

EEE Yönetmeliğine Uygundur.

[Top](#) 

For Ukrainian users

Обладнання відповідає вимогам Технічного регламенту обмеження використання деяких небезпечних речовин в електричному та електронному обладнанні.

[Top](#) 

For Brazilian users

A Epson preocupa-se com o meio ambiente e sabe que o planejamento para o futuro requer um forte compromisso ambiental. Para isso, nos empenhamos em criar produtos inovadores que são confiáveis, recicláveis e eficientes. Produtos melhores

utilizando menos recursos naturais para ajudar a garantir um futuro melhor para todos.

As embalagens deste produto - papelão, plástico, isopor e espuma - são recicláveis e podem ser entregues a cooperativas de reciclagem, postos de recolhimento de resíduos ou empresas recicladoras.

Os materiais que compõem o produto - plástico, metais, placa eletrônica e cartucho - são recicláveis. O produto não deve ser desmontado, deve ser encaminhado para os Centros de Serviços Autorizados que darão o destino ambientalmente adequado. Consulte em nosso site - <http://global.latin.epson.com/br> os Centros de Serviços Autorizados.

Todos os Centros de Serviços Autorizados podem receber equipamentos da marca Epson destinados para reciclagem.

Conheça nossas ações ambientais e o Programa de Coleta de Cartuchos (<http://www.epson.com.br/coleta>) em nosso site.

Top 

[Home](#) > Copyright and Trademarks

Copyright and Trademarks

No part of this publication may be reproduced, stored in a retrieval system, or transmitted in any form or by any means, electronic, mechanical, photocopying, recording, or otherwise, without the prior written permission of Seiko Epson Corporation. The information contained herein is designed only for use with this Epson printer. Epson is not responsible for any use of this information as applied to other printers.

Neither Seiko Epson Corporation nor its affiliates shall be liable to the purchaser of this product or third parties for damages, losses, costs, or expenses incurred by the purchaser or third parties as a result of: accident, misuse, or abuse of this product or unauthorized modifications, repairs, or alterations to this product, or (excluding the U.S.) failure to strictly comply with Seiko Epson Corporation's operating and maintenance instructions.

Seiko Epson Corporation shall not be liable for any damages or problems arising from the use of any options or any consumable products other than those designated as Original Epson Products or Epson Approved Products by Seiko Epson Corporation.

EPSON, EXCEED YOUR VISION, and ESC/P are registered trademarks of Seiko Epson Corporation in Japan and other countries/regions.

Microsoft[®], Windows[®], and Windows Vista[®] are registered trademarks of Microsoft Corporation in the United States and/or other countries.

IBM[®] is a registered trademark of International Business Machines Corporation.

General Notice: Other product names used herein are for identification purposes only and may be trademarks of their respective owners. Epson disclaims any and all rights in those marks.

The contents of this manual are subject to change without notice.

Copyright © 2012 Seiko Epson Corporation. All rights reserved.

[Home](#) > [Glossary](#)

Glossary

ASCII

American Standard Code for Information Interchange. A standardized coding system for assigning numerical codes to letters and symbols.

auto line feed

When this setting is turned on using the default-setting mode, each carriage return (CR) code is automatically followed by a line feed (LF) code.

bidirectional printing

Printing in which the print head prints in both directions (bidirectionally). This increases the print speed but may reduce precise vertical alignment. Bidirectional printing is this printer's standard printing mode.

buffer

The portion of the printer's memory used to store data before it is printed.

character table

A collection of letters, numbers, and symbols that constitute the set of characters used in a particular language.

characters per inch (cpi)

A measurement of the size of text characters.

compress printing

This function reduces the size of the data. You can compress your printing data to the ratio of 75%.

continuous paper

Paper that has sprocket-feed holes on both sides, is perforated between pages, and is supplied in a folded stack. Also called fanfold paper.

control code

A special code used to control a printer function such as performing a carriage return or line feed.

cpi

A measurement of the size of text characters.

data dump

A troubleshooting method that helps identify the cause of communication problems between the printer and the computer. When the printer is in hex dump mode, it prints each code that it receives in hexadecimal notation and ASCII characters. Also called hex dump.

default

A value that takes effect when the equipment is turned on, reset, or initialized.

dithering

A way of arranging dots on a page to simulate a shade or tone.

dot matrix

A method of printing in which each letter or symbol is formed by a pattern (matrix) of individual dots.

draft

The print mode used by your printer when you select Draft as the font. The Draft font uses less dots per character for faster printing.

driver

A software program that sends commands from the computer for using the functions of a particular printer.

ESC/P®

Abbreviation for Epson Standard Code for Printers. This is the system of commands your computer uses to control your printer. It is standard for all Epson printers and supported by most application software for personal computers.

ESC/P 2™

The enhanced version of the ESC/P printer command language. Commands in this language produce laser-like results, such as scalable fonts and enhanced graphics.

fanfold paper

Paper that has sprocket-feed holes on both sides, is perforated between pages, and is supplied in a folded stack. Also called continuous paper.

font

A style of type designated by a name such as Roman or Sans Serif.

form feed (FF)

A control code and control panel button that advances the paper to the next top-of-form position.

halftoning

A method of using dot patterns to represent an image. Halftoning makes it possible to produce varying shades of gray using only black dots, or a nearly infinite array of colors using only a few colors of dots.

hex dump

A troubleshooting method that helps identify the cause of communication problems between the printer and the computer. When the printer is in hex dump mode, it prints each code that it receives in hexadecimal notation and ASCII characters. Also called data dump.

high speed draft

A mode of draft printing you can select using the default-setting mode. High speed draft uses a minimum number of dots per character to produce extremely high-speed printing.

interface

The connection between the computer and the printer over which print data is transmitted to the printer.

landscape

Printing that is oriented sideways on the page. This orientation gives you a page that is wider than it is high and is useful for printing spreadsheets.

letter quality (LQ)

The print mode used by your printer when a font other than Draft is selected. Printing with letter-quality fonts provides better readability and appearance at a reduced print speed.

line feed (LF)

A control code and control panel button that advances the paper one line space.

loading position

The position to which the paper is automatically loaded.

micro adjust

A printer feature that allows you to precisely adjust the tear-off and top-of-form positions.

near letter quality (NLQ)

The print mode used by your printer when a font other than Draft is selected. Printing with NLQ fonts provides better readability and appearance at a reduced print speed.

paper positions

There are three paper positions for continuous paper printing: standby, tear-off, and top-of-form. For single sheet printing, there is only the top-of-form position.

pitch

The size of the font, which is measured in the number of characters per inch (cpi). The standard is 10 cpi.

platen

The black flat part that provides a backing for the paper during printing.

portrait

Printing that is oriented upright on the page (as opposed to landscape, in which printing is sideways on the page). This is the standard orientation for printing letters or documents.

printer driver

A software program that sends commands from the computer for using the functions of a particular printer.

printing start position

The horizontal position on the paper that the printer recognizes as the first printable column. You can adjust the printing start position with the control panel.

proportional font

A font whose characters take up varying amounts of horizontal space depending on the width of the character. Thus the uppercase M takes up more horizontal space than the lowercase l.

recommended printable area

The area of a page on which the printer can print. It is smaller than the physical size of the page due to margins.

reset

To return a printer to its default settings.

resolution

A measure of the amount of detail that can be represented. Resolution of printed images is measured in number of dots per inch (dpi).

self test

A method for checking the operation of the printer. When you run the self test, the printer prints the characters stored in its ROM (Read Only Memory).

standby position

The position of your continuous paper when it is attached to the tractor but not loaded in the printer.

tear off

A control panel button that feeds the perforation of continuous paper to the tear-off position and then feeds the paper back to the top-of-form position.

tear-off position

The position the printer feeds the paper to when the auto tear-off mode is on. Using the Micro Adjust function, you can adjust the position so that the paper's perforation meets the printer's tear-off edge.

top-of-form position

The position on the paper that the printer recognizes as the first printable line. This is the default top-margin position.

unidirectional printing

Printing in which the print head prints in one direction only. Unidirectional printing is useful for printing graphics because it provides precise vertical alignment. You can select unidirectional printing using the printer's default-setting mode.

[Home](#) > [Getting to Know Your Printer](#)

■ Features

Your EPSON® LX-350 9-pin dot matrix printer provides high-quality printing and superior performance in a compact design. Its features include:

- The ability to handle a wide range of paper types, including continuous paper, multipart forms (with one original and up to four copies), single sheets, envelopes, and roll paper.
- High-speed printing of up to 347 cps (characters per second) at 10 cpi (characters per inch).

Your printer comes packaged with the printer driver and other software, including the EPSON Status Monitor 3 utility for Microsoft Windows 7, Vista, XP, and 2000. The EPSON Status Monitor 3 utility lets you check the status of your printer quickly and easily.

Printing on Continuous Paper

- ▾ Printing with the push tractor
- ▾ Removing a printed document from the push tractor
- ▾ Switching back to single sheets
- ▾ Adjusting the top-of-form position
- ▾ Advancing the paper to the tear-off edge

Your printer can handle continuous paper with the push tractor.

Printing with the push tractor

When using the push tractor, it is a good idea to set the Auto tear off feature in the Default Setting mode to **On**. See [About Your Printer's Default Settings](#).

Follow these steps to load continuous paper using the push tractor:

- 1** Make sure the printer is turned off. Remove the paper guide and place the paper release lever in the continuous paper position.

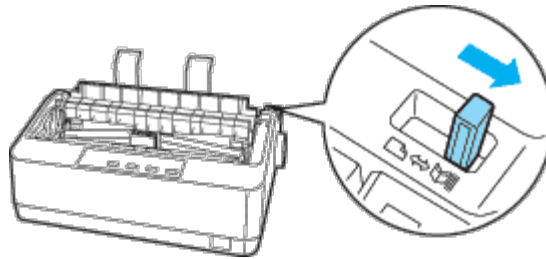

 **Note:**

Printer cover is removed in the illustration to show details; however, there is no need to remove it.

- 2** Release the sprocket units by pulling the sprocket locks forward.

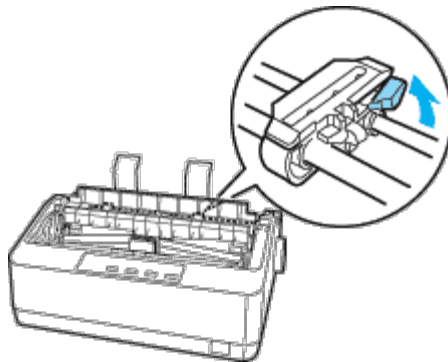

- 3** Slide the left sprocket using the arrow mark on the printer as a guide. The printer prints to the right of the arrow mark. Push the sprocket lock lever back to lock it in place. Then slide the right sprocket unit to match the width of your paper, but do not lock it. Move the paper support so it is midway between the sprocket units.

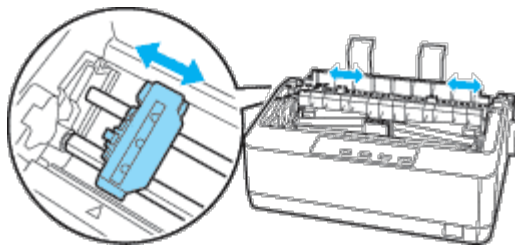

- 4 Make sure your paper has a clean, straight leading edge. Open the sprocket covers. Fit the first holes of the paper over the sprocket pins and then close the sprocket covers. Slide the right sprocket unit to remove any slack in the paper and lock it in place. Now the paper is in the paper-park position.

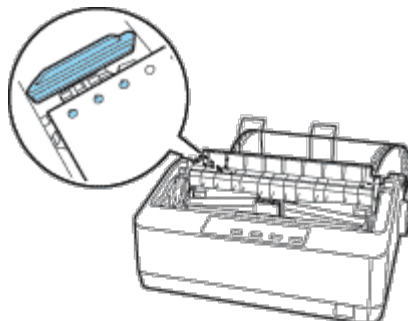

 **Note:**

If continuous paper becomes saggy or too tense, adjust the position of the right sprocket.

 **Caution:**

Use the paper feed knob on the right side of the printer only to clear paper jams and only when the printer is turned off. Otherwise, you may damage the printer or cause it to lose the top-of-form position.

- 5 To prevent printed paper from getting caught, attach the paper guide by fitting its notches over the printer's mounting posts as shown below. Then slide the paper guide toward the front of the printer until you feel it click and move the edge guides to the sides.

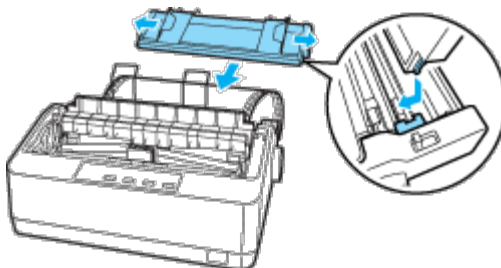

- 6 Turn on the printer.

- 7 Make sure the printer cover is closed. Press the **Load/Eject** button to feed the paper to the loading position. When the printer receives data, it begins printing automatically.

- 8 After you finish printing, follow the steps in the next section to tear off your printed document. If the first printed line on your page appears too high or low, you can change its position by using the Micro Adjust feature. See [Adjusting the top-of-form position](#).

 **Caution:**

Never use the paper feed knob to adjust the top-of-form position; this may damage the printer or cause it to lose the top-of-form position.

When you send more data, the paper automatically feeds back to the loading position.

Top 

Removing a printed document from the push tractor

Follow these steps to remove the printed document:

- 1 Press the **Tear Off (Font)** button. Make sure the **Tear Off (Font)** light is flashing. (This indicates that your paper is at the current tear-off position.)
- 2 Open the paper guide cover, then tear off the printed document using the tear-off edge of the paper tension unit.

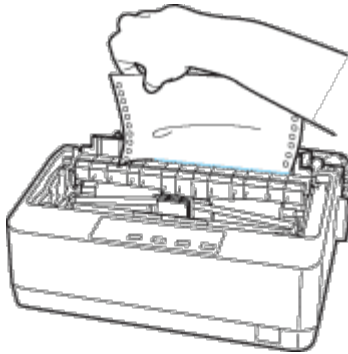

 **Note:**

If your paper's perforation is not properly aligned with the tear-off edge, you can adjust the tear-off position using the Micro Adjust feature. See [Adjusting the tear-off position](#).

 **Caution:**

Never use the paper feed knob to adjust the tear-off position; this may damage the printer or cause it to lose the tear-off position.

- 3 Close the paper guide cover.

When you resume printing, the printer automatically feeds the paper back to the top-of-form position and starts printing.

To feed continuous paper to the standby position where you can remove the paper, press the **Load/Eject** button. Then open the sprocket covers of the tractor and remove the paper.

 **Caution:**

Always tear off your printed document before you press the **Load/Eject** button. Reverse feeding several pages at a time may cause a paper jam.

Top 

Switching back to single sheets

To switch to single sheets, press the **Load/Eject** button; the printer feeds the paper backwards into the standby position. Then, follow the steps in [Loading single sheets](#).

Caution:

Always tear off your printed document before you press the **Load/Eject** button. Reverse feeding several pages at a time may cause a paper jam.

[Top](#) 

Adjusting the top-of-form position



The top-of-form position is the position on the page where the printer starts printing. If your printing appears too high or low on the page, you can use the micro adjust feature to adjust the top-of-form position. Follow these steps:

Caution:

Never use the paper feed knob to adjust the top-of-form position; this may damage the printer or cause it to lose the top-of-form position.

Note:

- Your top-of-form position setting remains in effect until you change it, even if you turn off the printer.
- The top margin setting made in some application software overrides the top-of-form position setting you make with the Micro Adjust feature. If necessary, adjust the top-of-form position in your software.

- 1 Make sure the printer is turned on.
- 2 If necessary, load paper as described in this chapter.
- 3 Remove the printer cover.
- 4 Hold down the **Pause** button for about three seconds. The **Pause** light starts flashing and the printer enters the Micro Adjust mode.
- 5 Press the **LF/FF**  button to move the top-of-form position down on the page, or press the **Load/Eject**  button to move the top-of-form position up on the page.

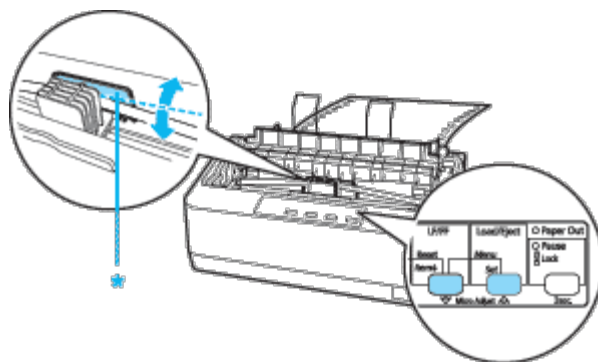

* plastic ribbon cover

Note:

- The printer has a minimum and a maximum top-of-form position. If you try to adjust it beyond these limits, the printer beeps and stops moving the paper.
- When the paper reaches the default top-of-form position, the printer also beeps and stops moving the paper briefly. You can use the default position as a reference point when adjusting the top-of-form position.

6 After you set the top-of-form position, press the **Pause** button to exit the Micro Adjust mode.

Top 

Advancing the paper to the tear-off edge

If you use the push tractor, you can use the tear-off feature to advance your continuous paper to the printer's tear-off edge when you finish printing. You can then easily tear off the printed document. When you resume printing, the printer automatically feeds the paper back to the top-of-form position so that you can save the paper normally lost between documents.

As described below, you can use the tear-off feature in two ways: manually, by pressing the printer's **Tear Off (Font)** button, or automatically, by turning on the auto tear-off mode.



Caution:

Never use the tear-off feature (as described below) to feed continuous paper with labels backwards; they may come off their backing sheet and jam the printer.

Using the Tear Off button

After the printer finishes printing your document, check that the **Tear Off (Font)** light is not flashing. Then press the **Tear Off (Font)** button. The printer advances the paper to the tear-off edge.



Note:

If the **Tear Off (Font)** light is flashing, the paper is in the tear-off position. If you press the **Tear Off (Font)** button again, the printer feeds your paper to the next top-of-form position.

Advancing the paper to the tear-off position automatically

To automatically advance your printed documents to the tear-off position, you need to turn on the auto tear-off mode and select the appropriate page length for continuous paper in the Default Setting mode. For instructions, see [Changing default settings](#).

When auto tear-off is on, the printer automatically advances the paper to the tear-off position whenever it receives a full page of data or a form feed command followed by no more data.

Adjusting the tear-off position

If your paper's perforation is not aligned with the tear-off edge, you can use the Micro Adjust feature to move the perforation to the tear-off position.

Follow these steps to adjust the tear-off position:





Caution:

Never use the paper feed knob to adjust the tear-off position; this may damage the printer or cause it to lose the tear-off position.

 **Note:**

Your tear-off position setting remains in effect until you change it, even if you turn off the printer.

- 1 Make sure the **Tear Off (Font)** light is flashing (the paper is at the current tear-off position). You may need to press the **Tear Off (Font)** button to advance the paper to the tear-off position.
- 2 Open the paper guide cover.
- 3 Hold down the **Pause** button for about three seconds. The **Pause** light begins to flash and the printer enters the Micro Adjust mode.
- 4 Press the **LF/FF**  button to feed the paper backwards, or press the **Load/Eject**  button to feed the paper forwards, until the paper perforation is aligned with the tear-off edge.

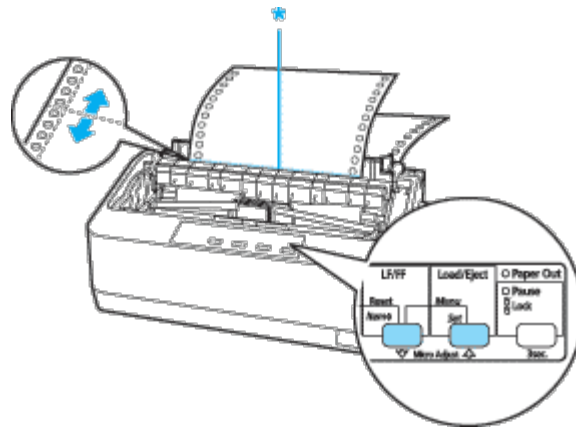

* tear-off edge

 **Note:**

- When the paper reaches the default position, the printer beeps and stops moving the paper.
- The printer has a minimum and a maximum tear-off position. If you try to adjust the tear-off position beyond these limits, the printer beeps and stops moving the paper.

- 5 After you set the tear-off position, press the **Pause** button to exit the Micro Adjust mode.
- 6 Tear off the printed pages.

When you resume printing, the printer automatically feeds the paper back to the top-of-form position and begins printing.

Printing on Single Sheets

Loading single sheets

You can load single-sheet paper one sheet at a time using the paper guide of the printer. For specifications on the type of single-sheet paper you can use, see [Paper](#).

Before printing on single-sheet multipart forms, envelopes, or other special paper, be sure to set the paper thickness lever to the appropriate position. See [Paper](#) for details.

 **Note:**

- For detailed specifications on the types of single-sheet paper you can use, see [Paper](#).
- You can use the paper guide to load single-sheet carbonless multipart forms that are fastened at the top by line gluing.
- Insert multipart forms in the paper guide, bound edge first and printable side down.

Loading single sheets

Follow these steps to load single sheets:

- 1 Make sure the printer is turned off. Also make sure that the paper release lever is pushed back to the single-sheet position and the paper guide is in the upright position, as shown below.

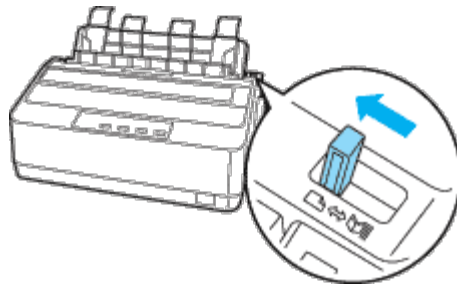

- 2 Slide the left edge guide to 0 position. Next, adjust the right edge guide to match the width of your paper.

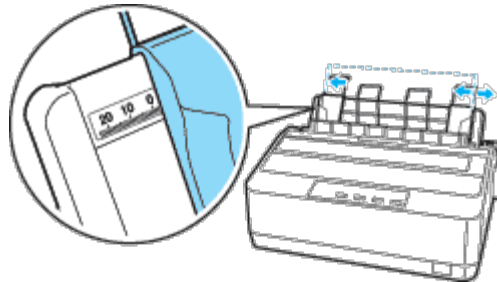

- 3 Slide a sheet of paper down firmly between the edge guides until it meets resistance.

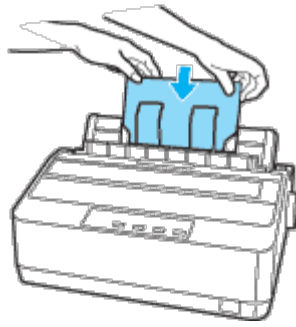

For normal use, turn on the printer without pressing any other buttons. When the printer receives data, it begins to print.



Caution:

Use the paper feed knob on the right side of the printer only to clear paper jams and only when the printer is off. Otherwise, you may damage the printer or cause it to lose the top-of-form position.

Top 

Printing on Special Paper

- ▾ Adjusting the paper thickness lever
- ▾ Multipart forms
- ▾ Envelopes

Your printer can also print on a wide variety of paper types, including multipart forms and envelopes.

For multipart forms, you should not print any closer than 13 mm (0.5 inch) from either side of the paper. For information on the recommended printable area of envelopes, see [Recommended printable area](#).

⚠ Caution:

When printing on multipart forms, thicker-than-normal paper or envelopes, make sure your application software settings keep the printing entirely within the recommended printable area. Printing past the edge of these papers can damage the print head.

Adjusting the paper thickness lever

Before printing on special paper, you need to change the paper thickness setting.

Follow these steps to adjust the paper thickness setting:

- 1** Open the printer cover. The paper thickness lever is on the left side of the printer. The numbers next to the lever indicate the thickness setting.

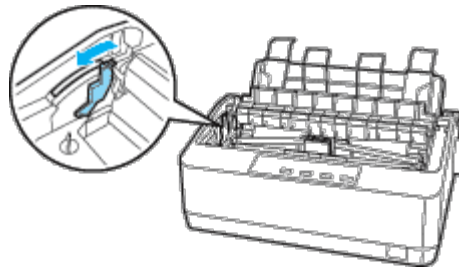

- 2** Use the table below to select the appropriate paper thickness.

Paper type		Paper-thickness lever position
Ordinary paper	Single sheets	-1 or 0
	Continuous paper	
Multipart forms	2 parts (original + 1 copy)	1
	3 parts (original + 2 copies)	2
	4 parts (original + 3 copies)	3
	5 parts (original + 4 copies)	4
Envelopes		3 to 5

- 3** Close the printer cover.

Multipart forms

You can use continuous or single-sheet carbonless multipart forms of up to five parts (one original plus four copies). Before you print on the forms, set the paper thickness lever as described in the previous section. The following tips will help you get good results:

- Use only continuous multipart forms that are joined by point glue or paper staple. Never load continuous multipart forms joined by metal staples, tape, or continuous gluing.
- Use only single-sheet multipart forms that are line-glued only at the top. Insert the forms glued edge first into the printer.
- Use only multipart forms that are free of wrinkles and waves.
- If you need to adjust the loading position, use your application software or change the loading position as described on [Adjusting the top-of-form position](#).
- When you use side-crimped continuous multipart forms, the copies may not align with the original. If this happens, raise the paper guide.

Top 

Envelopes

You can feed envelopes individually using the paper guide. Keep the following tips in mind:

- Before loading an envelope, set the paper thickness lever to the proper position. See [Adjusting the paper thickness lever](#).
- To load an envelope, follow the steps in [Loading single sheets](#). Insert the wide edge of the envelope into the printer first, printable-side down. When you insert the envelope between the paper guides, push it firmly and hold it until it feeds into the printer.
- Use envelopes only under normal temperature and humidity conditions.
- Make sure the printing stays entirely within the recommended printable area.
- The print head must not go past the left or right edge of the envelope or other thick paper. (See [Printer Specifications](#) for specifications.) It's a good idea to print a test sample using a normal single sheet of paper before you print on envelopes.

Top 

[Home](#) > [Printer Software](#)

Operating System Versions

In this manual, the following abbreviations are used.

Windows refers to Microsoft Windows 7, Vista, XP, and 2000.

- Windows 7 refers to Windows 7 Home Basic, Windows 7 Home Premium, Windows 7 Professional, Windows 7 Enterprise, and Windows 7 Ultimate.
- Windows Vista refers to Windows Vista Home Basic Edition, Windows Vista Home Premium Edition, Windows Vista Business Edition, Windows Vista Enterprise Edition, and Windows Vista Ultimate Edition.
- Windows XP refers to Windows XP Home Edition, Windows XP Professional x64 Edition, and Windows XP Professional.
- Windows 2000 refers to Windows 2000 Professional.

[Home](#) > [Printer Software](#)

About Your Printer Software

The Epson software includes the printer driver software and EPSON Status Monitor 3.

The printer driver is software that allows your computer to control the printer. You need to install the printer driver so your Windows software applications can take full advantage of the printer's capabilities.

EPSON Status Monitor 3 program allows you to monitor the status of your printer, alerts you when errors occur, and provides you with troubleshooting tips. EPSON Status Monitor 3 is automatically installed when you install the printer driver.



Note:

Before proceeding, make sure you have installed the printer driver on your computer described in the *Start Here* or the *Setup Guide*.

Using the Printer Driver

- Accessing the printer driver from Windows applications
- Accessing the printer driver from the Start menu
- Changing the printer driver settings

You can access the printer driver from your Windows applications or from the Start menu.

- When you access the printer driver from a Windows application, any settings you make apply only to the application you are using. See [Accessing the printer driver from Windows applications](#) for more information.
- When you access the printer driver from the Start menu, the printer driver settings you make apply to all your applications. See [Accessing the printer driver from the Start menu](#) for more information.

See [Changing the printer driver settings](#) to check and change printer driver settings.

 **Note:**

While many Windows applications override the settings made with the printer driver, some do not, so you must verify that the printer driver settings match your requirements.

Accessing the printer driver from Windows applications

Follow these steps to access the printer driver from a Windows application:

- 1 Select **Print Setup** or **Print** from the File menu of your application software. In the Print or Print Setup dialog box displayed, make sure that your printer is selected in the Name drop-down list.

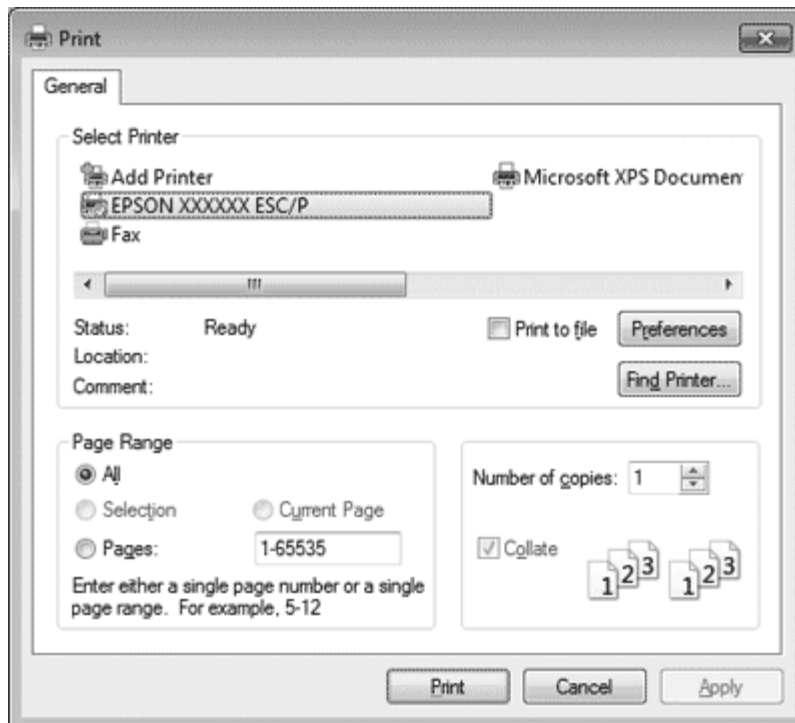

- 2 Click **Printer**, **Setup**, **Properties**, **Options** or **Preferences**. (The button you click depends on your application and you may need to click a combination of these buttons.) The Printing Preferences window appears, and you see the Layout,

Paper/Quality, User Defined Paper and Extension Settings menus. These menus contain the printer driver settings.

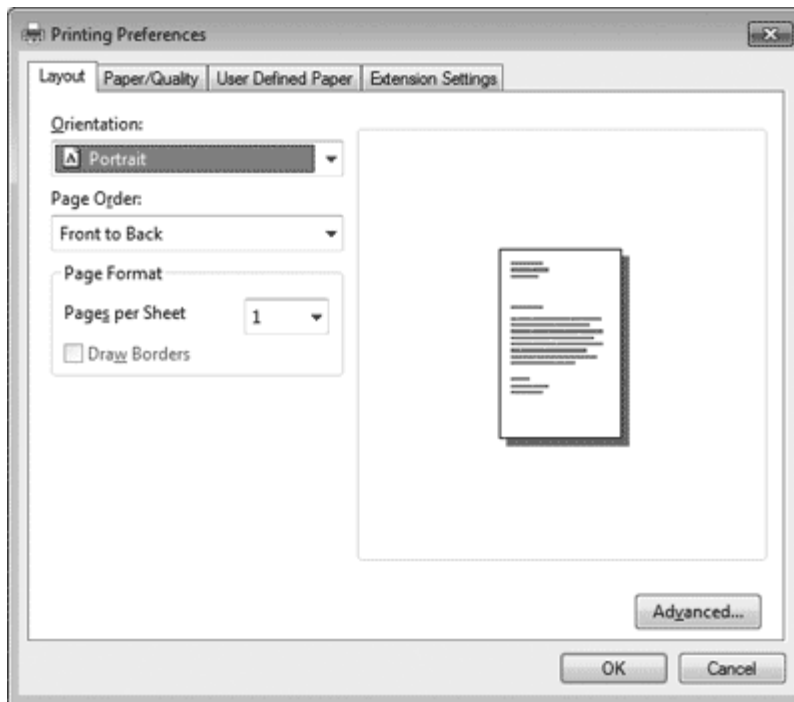

- 3 To view a menu, click the corresponding tab at the top of the window. See [Changing the printer driver settings](#) to change the settings.

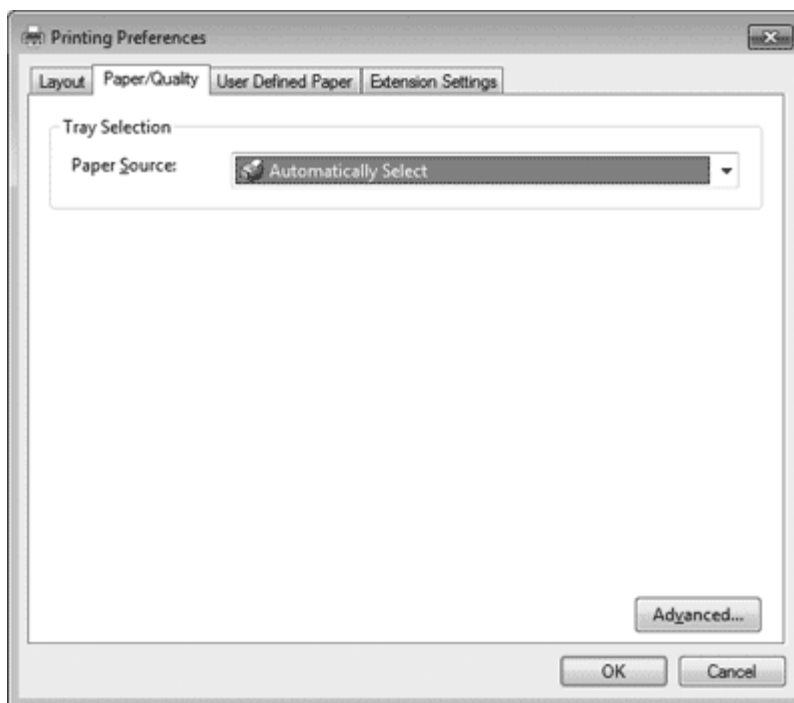

[Top](#)

Accessing the printer driver from the Start menu

Follow these steps to access the printer driver from the Start menu:

1 For Windows 7:
Click **Start**, and click **Devices and Printers**.

For Windows Vista:
Click **Start**, click **Control Panel**, click **Hardware and Sound**, and then click **Printers**.

For Windows XP Professional edition:
Click **Start**, and click **Printers and Faxes**.

For Windows XP Home edition:
Click **Start**, click **Control Panel**, and then click **Printers and Faxes**.

For Windows 2000:
Click **Start**, point to **Settings**, and then click **Printers**.

2 Right-click your printer icon, and click **Printing Preferences**. The screen displays the Printing Preferences window, which contains the Layout, Paper/Quality, User Defined Paper and Extension Settings menus. These menus display the printer driver settings.

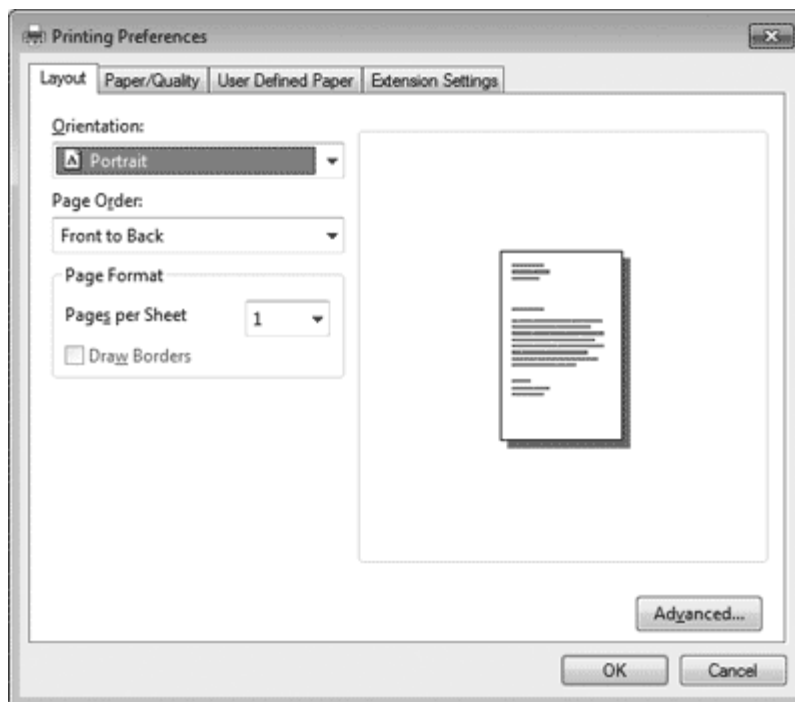

When you click **Properties** (Windows Vista, XP, and 2000) or **Printer properties** (Windows 7) in the menu displayed by right-clicking the printer icon, the Properties window appears, which includes menus used to make the printer driver settings.

 **Note:**

Do not click **Properties** though both **Properties** and **Printer properties** are displayed in the menu of Windows 7.

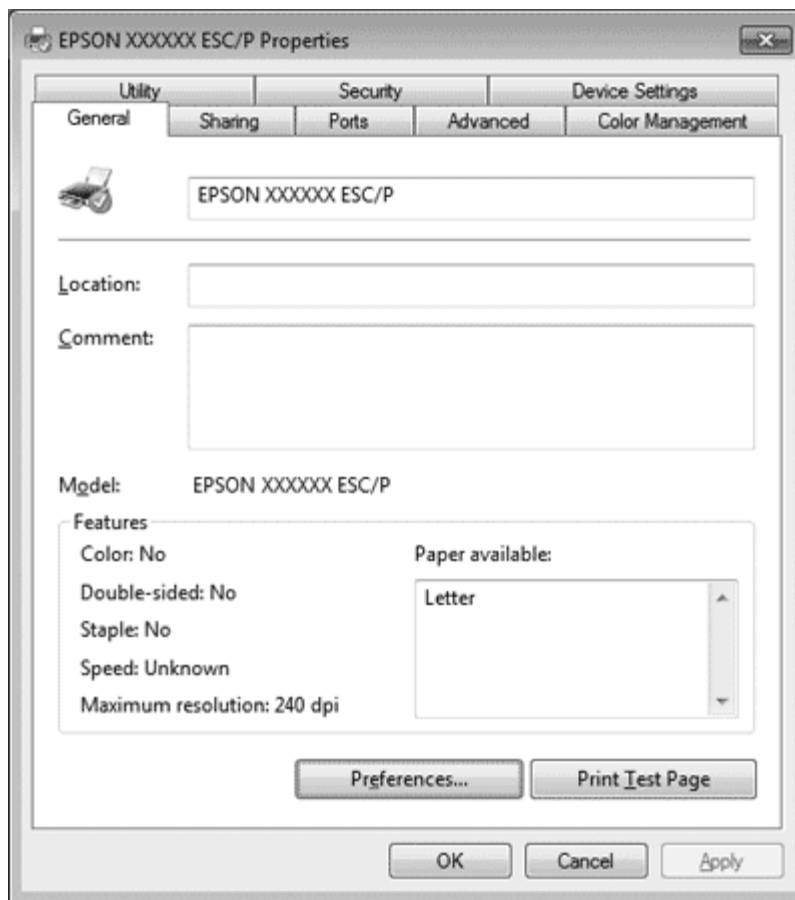

- 3 To view a menu, click the corresponding tab at the top of the window. See [Printer Driver Settings Overview](#) for information on how to change the settings.

[Top](#) 

Changing the printer driver settings

Your printer driver has four menus from which you can change the printer driver settings: Layout, Paper/Quality, User Defined Paper, and Extension Settings. You can also change settings on the Utility menu in the printer software. For an overview of the available settings, see [Printer Driver Settings Overview](#). If you are using Windows XP or 2000, you can also view online help by right-clicking items in the driver and selecting **What's this?**.

Click the **Help** button on the Printer Driver screen.

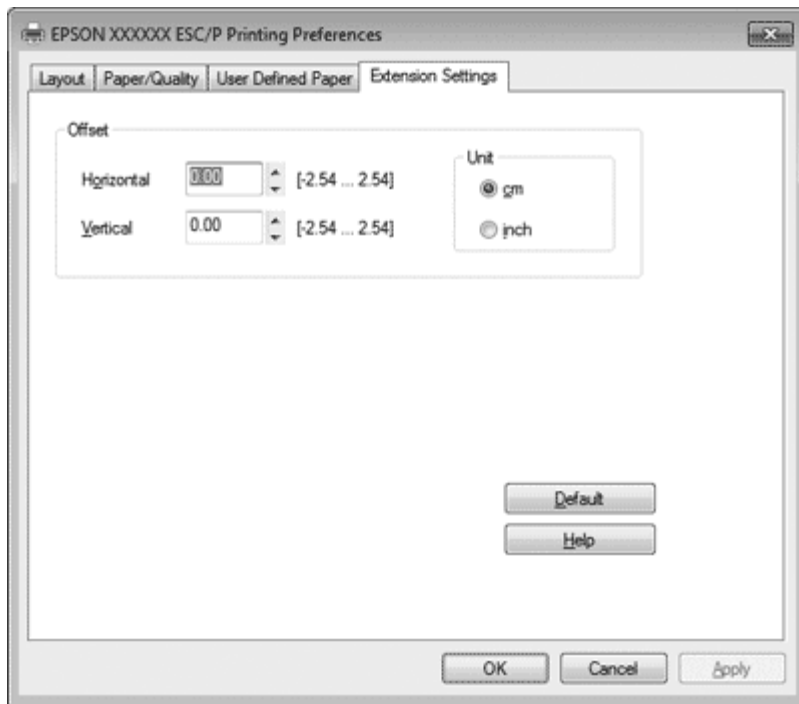

When you finish making your printer driver settings, click **OK** to apply the settings, or click **Cancel** to cancel your changes. Once you have checked your printer driver settings and changed them if necessary, you are ready to print.

Printer Driver Settings Overview

Printer settings

Monitoring settings

Setting Utility

The following tables show the Windows printer driver settings. Note that not every setting is available in all versions of Windows. For more details, see **Help** for the printer driver.

Printer settings

Settings	Explanations
Paper Size	Select the size of the paper you want to use. If you do not see your paper size, use the scroll bar to scroll through the list. If your paper size is not included in the list, see Definition of Custom Paper Size for instructions.
Orientation	Select Portrait or Landscape .
Paper Source	Select the paper source you want to use.
Graphic - Print Quality	Select the printing resolution you want. The higher the resolution you select, the more detailed your printout will be; however, increasing the resolution slows printing.
Halftoning	Select the type of halftoning to use when printing graphics. To let the printer determine the best halftone quality, use Auto Select .
Printer Font Setting	Select a character table group to use. You can select one of three character table groups, Standard , Expanded , and None (bit image printing). When Standard or Expanded is selected, the printer uses the device fonts. Expanded includes more fonts than Standard. When None is selected, the printer uses bit map images instead of the device fonts. For details on the fonts which are included in each table, see your printer's documentation.
Page Order*	Select whether to print from front to back or back to front.
Pages Per Sheet*	Select the number of pages that you want to print onto a single page.
Copy Count*	When you select more than one in the Number of copies box, this check box appears and you can select whether to collate the pages of the copies.
Advanced Printing Features*	Select Enable or Disable for the metafile Spooling.
Print Optimizations*	Select Disable when the printer does not use the device fonts and select Enable when the printer uses the device fonts.
Printable Area	If Standard is selected, the normal printable area for Epson impact printers is used. If Maximum is selected, the printer's maximum printable area is used.
Top Margin Priority	Select which setting for the print-start position is to be used; driver setting or printer setting. For more details, see Help for the printer driver.
Packet Mode	Ordinarily, there is no need to change this setting. If you change the printer's Packet Mode settings, change this setting to match. If the printer and printer driver settings are different, you may not be able to print correctly. For more details, see Help for the printer driver.
User Defined Paper	If your paper is not included in the Paper Size drop-down list, you can add the size to the list. For more details, see Help for the printer driver.
Offset	This setting allows you to offset the image on the page. That is, you can adjust the position of the printed image. If the offset you specify moves a portion of the

	image out of the printer's printable area, that portion will not be printed.
Print Speed	This setting allows you to select print speed. Select Printer Setting when you want to print using the settings stored in the printer. When Standard is selected, prints in standard printing mode. When High Speed is selected, prints in high-speed printing mode.
Print Direction	This setting allows you to select bidirectional printing. Selecting the Printer Setting will use the setting stored in the printer. Selecting Bidirectional will print in bidirectional printing mode. Selecting Unidirectional will print in unidirectional printing mode.

* For details, see Windows help.

Definition of Custom Paper Size

If your paper is not included in the Paper Size drop-down list, you can add the size to the list.

- 1 For Windows 7:
Click **Start**, and click **Devices and Printers**.

For Windows Vista:

Click **Start**, click **Control Panel**, click **Hardware and Sound**, and then click **Printers**.

For Windows XP Professional x64 Edition:

Click **Start**, and click **Printers and Faxes**.

For Windows XP Professional:

Click **Start**, and click **Printers and Faxes**.

For Windows XP Home Edition:

Click **Start**, click **Control Panel**, and then click **Printers and Faxes**.

For Windows 2000:

Click **Start**, point to **Settings**, and then click **Printers**.

- 2 Right click your printer icon, and click **Printing Preferences**.

- 3 Select the **User Defined Paper** menu.

- 4 Enter the paper size in the Paper Size fields.

- 5 Click **Apply** and then click **OK**.

Note:

For more details, see Help for the printer driver.

Top 

Monitoring settings

Settings	Explanations
EPSON Status Monitor 3	You can access EPSON Status Monitor 3 when you click this button. To monitor the printer, make sure the Monitor the printing status check box is selected.
Monitoring Preferences	Click this button to open the Monitoring Preferences dialog box where you can make settings for EPSON Status Monitor 3. See Setting up EPSON Status Monitor 3 for more information.

Top 

Setting Utility

Settings	Explanations
Bi-D Adjustment	Click this button to open the Bi-D Adjustment dialog box where you can adjust misalignment in vertical lines.
Printer Setting	Click this button to open the Printer Settings utility dialog box where you can change the printer settings.

[Top](#) 

Using EPSON Status Monitor 3

[Setting up EPSON Status Monitor 3](#)

[Accessing EPSON Status Monitor 3](#)

EPSON Status Monitor 3 allows you to monitor your printer's status, alerts you when printer errors occur, and provides troubleshooting instructions when needed.

EPSON Status Monitor 3 is available when:

- The printer is connected directly to the host computer via the parallel port [LPT1] or the USB port.
- Your system is configured to support bidirectional communication.

EPSON Status Monitor 3 is installed when the printer is connected directly and you install the printer driver as described in the *Start Here* or the *Setup Guide*. When sharing the printer, be sure to set EPSON Status Monitor 3 so that the shared printer can be monitored on the printer server and clients. See [Setting up EPSON Status Monitor 3](#) and [Setting Up Your Printer on a Network](#).



Caution:

Although you can print to the printer directly connected to the computer in a remote location by using Remote Desktop function* of Windows 7, Vista, or XP, communication error may occur.

* Remote Desktop function: Function which enables a user to access applications or files in a computer connected to the office network from a mobile computer at a remote location.



Note:

- If you are using a computer running Windows 7, Vista, or XP with multiple users are logged on, a communication error message may be displayed when monitoring printers at the same time.
- If EPSON Status Monitor 3 is installed with the Windows Firewall feature turned on (recommended), the shared printer may not be able to be monitored. This problem can be resolved by adding EEBAgent.exe to Exceptions of the firewall function.

Setting up EPSON Status Monitor 3

Follow these steps to set up EPSON Status Monitor 3:

- 1** For Windows 7:
Click **Start**, and click **Devices and Printers**.

For Windows Vista:
Click **Start**, click **Control Panel**, click **Hardware and Sound**, and then click **Printers**.

For Windows XP Professional edition:
Click **Start**, and click **Printers and Faxes**.

For Windows XP Home Edition:
Click **Start**, click **Control Panel**, and then click **Printers and Faxes**.

For Windows 2000:
Click **Start**, point to **Settings**, and then click **Printers**.
- 2** Right-click your printer icon, click **Printer properties** (Windows 7) or **Properties** (Windows Vista, XP, and 2000), and then click the **Utility** tab.
- 3** Click the **Monitoring Preferences** button. The Monitoring Preferences dialog box appears.

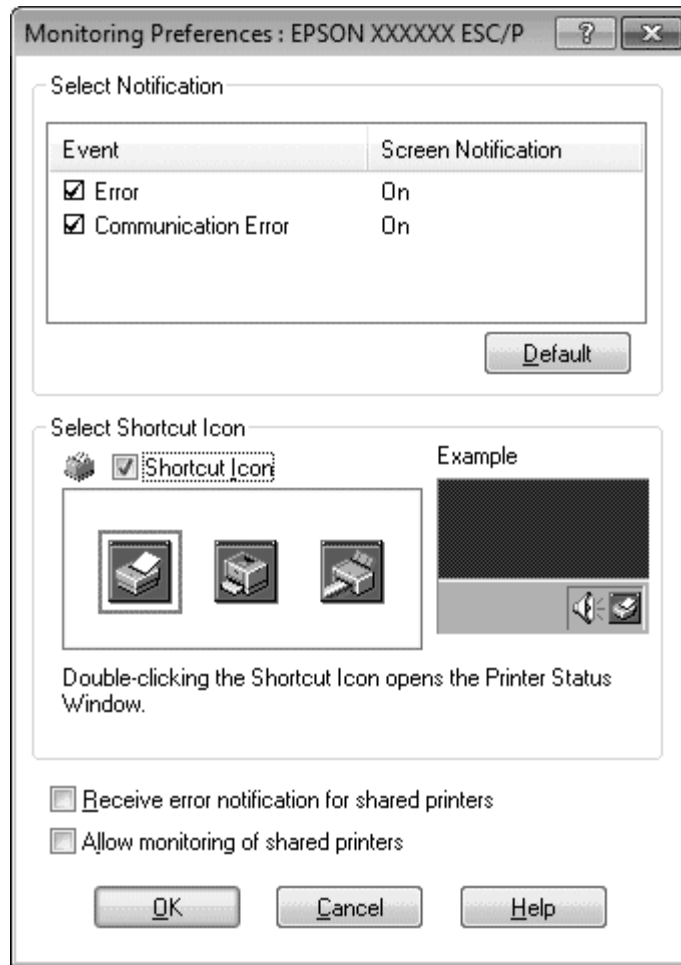

4 The following settings are available:

Select Notification	Displays the error item check box On/Off status. Turn on this check box to display the selected error notification.
Select Shortcut Icon	The selected icon is displayed on the taskbar. The setting's example is shown on the right window. By clicking the shortcut icon, you can access the Monitoring Preferences dialog box easily.
Receive error notification for shared printers	Error notification for a shared printer can be received when this check box is selected.
Allow monitoring of shared printer	When this check box is selected, a shared printer can be monitored by other PCs. Note: You must access Windows as the Administrator.

 **Note:**

Click the **Default** button to revert all items to the default settings.

Top 

Accessing EPSON Status Monitor 3

Do one of the following to access EPSON Status Monitor 3:

- Double-click the printer-shaped shortcut icon on the taskbar. To add a shortcut icon to the taskbar, go to the Utility menu and follow the instructions.

- Open the Utility menu, then click the **EPSON Status Monitor 3** icon. To find out how to open the Utility menu, see [Using the Printer Driver](#).

When you access EPSON Status Monitor 3 as described above, the following printer status window appears.

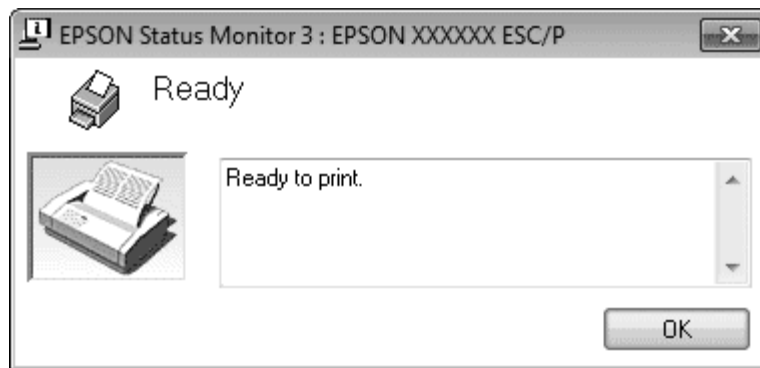

You can view printer status information in this window.

 **Note:**

It might not be possible to retrieve the printer status during printing. In this situation, click the **EPSON Status Monitor 3** button in the Utility tab, and use the printer with the status window left open.

[Top](#) 

Using Bi-D Adjustment

Making adjustment with Bi-D Adjustment

This utility tool allows you to make adjustment when you find a misalignment in vertical line.

Making adjustment with Bi-D Adjustment

To make Bi-D Adjustment, follow the steps below.

 **Caution:**

- Do not turn off the printer while the printer is printing adjustment pattern. Doing so may cause the printer to store incorrect settings. If you turned off the printer during the adjustment process, restart Bi-D Adjustment again.
- Do not turn off Packet Mode setting.
- Network connection is not supported.
- Make sure that the printer's status is ready before making Bi-D Adjustment.
- If Bi-D Adjustment is not printed properly, set the printer's font setting to default and try again.

- 1 Open the **Utility** menu, then click the **Bi-D Adjustment** icon. To find out how to open the **Utility** menu, see [Using the Printer Driver](#). The Bi-D Adjustment window appears.
- 2 Click **Next**.
- 3 Click **Print**. The printer prints three sets of adjustment pattern.
- 4 Look at the adjustment patterns and find the vertical line that is aligned the best. Then, select the corresponding line number in the Bi-D Adjustment window.
- 5 Click **Set**. The adjustment pattern will be stored in the printer.

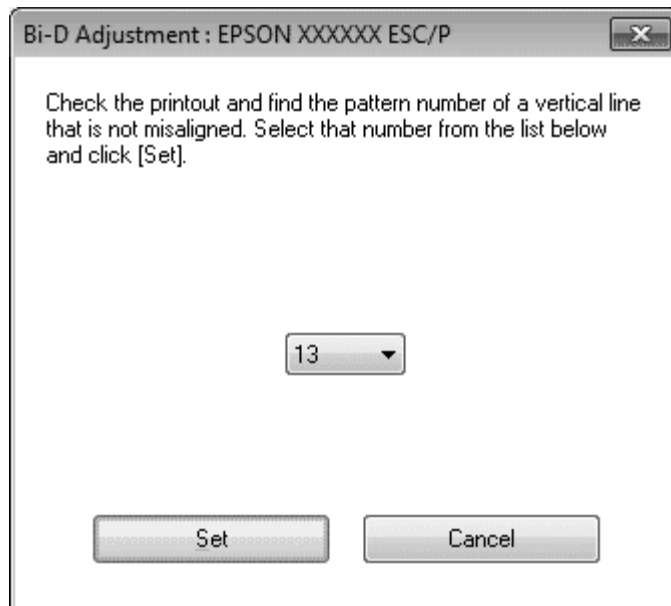

Using Printer Setting

Changing printer settings

This utility tool allows you to display current settings stored in the printer, change settings of the printer, and read settings stored in the file or save settings to the file.

 **Caution:**

- Do not turn off Packet Mode setting.
- Network connection is not supported.
- Make sure that the printer's status is ready before getting setting from the printer or updating the printer settings.

Changing printer settings

To change printer settings, follow the steps below.

- 1 Open the **Utility** menu, then click the **Printer Setting** icon. To find out how to open the Utility menu, see [Using the Printer Driver](#). The Printer Setting windows appears.

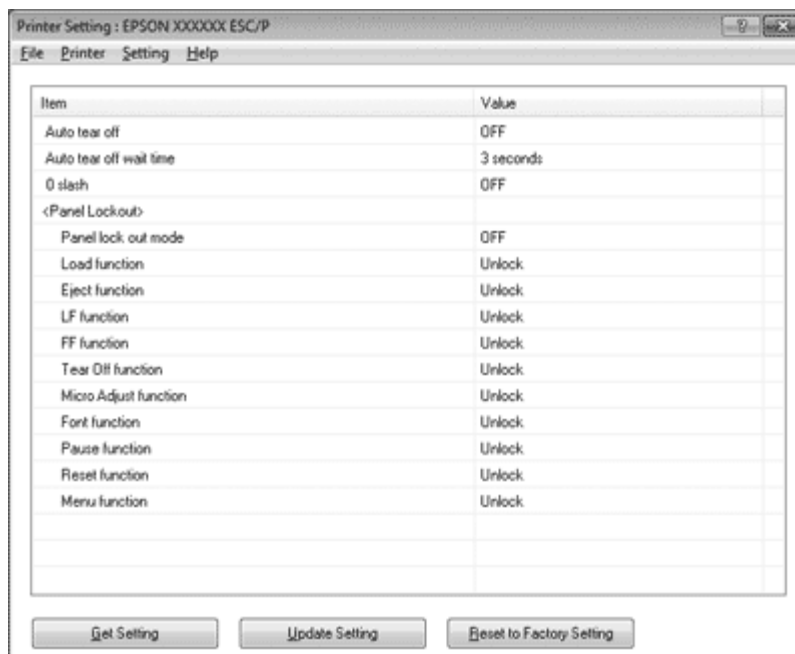

- 2 Change the necessary printer settings. For details on how to use this tool, refer to the printer driver Help.

 **Note:**

For a printer that is connected via USB in Windows 2000, after the message "Updated printer settings." is displayed, turn the power to the printer back on.

[Home](#) > [Printer Software](#)

Setting Up Your Printer on a Network

- [Sharing the printer](#)
- [Setting up your printer as a shared printer](#)
- [Setting for the clients](#)

Sharing the printer

This section describes how to share the printer on a standard Windows network.

The computers on a network can share a printer that is directly connected to one of them. The computer that is directly connected to the printer is the printer server, and the other computers are the clients which need permission to share the printer with the printer server. The clients share the printer via the printer server.

According to the versions of Windows OS and your access rights on the network, perform the appropriate settings of the printer server and clients.

See [Setting Up Your Printer on a Network](#).

See [Setting for the clients](#).

 **Note:**

- When sharing the printer, be sure to set EPSON Status Monitor 3 so that the shared printer can be monitored on the printer server and clients. See [Setting up EPSON Status Monitor 3](#).
- When connecting to a Windows XP shared printer, error and warning notifications do not appear during printing. Installing Windows XP Service Pack 1 or later will solve this problem.
- When connecting to a shared printer beyond a router, error and warning notification for shared printers during printing is not available in some cases because of the router's settings.
- The printer server and clients should be set on the same network system, and they should be under the same network management beforehand.
- The on-screen displays on the following pages may differ depending on the version of Windows OS.

[Top](#) 

Setting up your printer as a shared printer

Follow these steps to set the printer server.

 **Note:**

You must access as the Administrators of the local machine.

- 1 For a Windows 7 printer server:
Click **Start**, and click **Devices and Printers**.

For a Windows Vista printer server:
Click **Start**, click **Control Panel**, click **Hardware and Sound**, and then click **Printers**.

For a Windows XP Professional printer server:
Click **Start**, and click **Printers and Faxes**.

For Windows XP Home Edition printer server:
Click **Start**, click **Control panel**, and then click **Printers and Faxes**.

For a Windows 2000 printer server:
Click **Start**, point to **Settings**, and then click **Printers**.

2 For Windows 7:
Right-click your printer icon, click **Printer Properties**, and then click the **Sharing** tab in the appearing screen.

For Windows Vista, XP, or 2000:
Right-click your printer icon, and click **Sharing** in the menu that appears.

For Windows XP, if the following menu appears, click either **Network Setup Wizard** or **If you understand the security risks but want to share printers without running the wizard, click here**.

In either case, follow the on-screen instructions.



3 For a Windows 2000 printer server, select **Shared as**, then type the name in the Share name box and click **OK**.

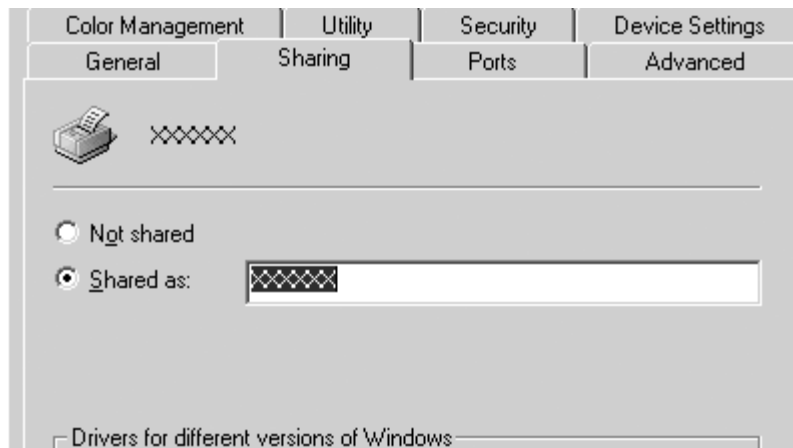

For a Windows 7, Windows Vista, or XP printer server, select **Share this printer**, then type the name in the Share name box and click **OK**.

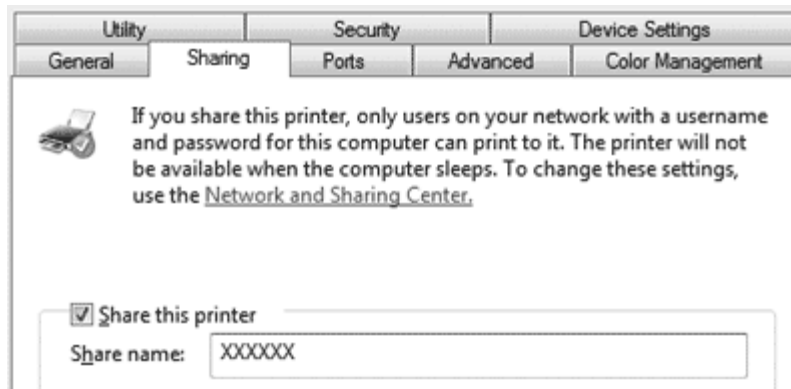

 **Note:**

- Do not use spaces or hyphens for the share name, or an error may occur.
- In Windows 7 or Vista, you cannot select **share this printer** until you click the **Change sharing options** button.

You need to set the client computers so that they can use the printer on a network. See the following pages for details: See [Setting for the clients](#).

Sharing the printer when the firewall is on

 **Note:**

To share files and printers when Windows Firewall is on, perform the following procedure.

Windows 7

- 1 Click **Start**, click **Control Panel**, click **System and Security**, and then click **Windows Firewall**.
- 2 Click **Turn Windows Firewall on or off** in the window on the left. Make sure that **Block all incoming connections, including those in the list of allowed programs** is not selected, and then click **OK**.
- 3 Click **Allow a program or feature through Windows Firewall** in the window on the left.
- 4 Select **Share file and printer**, and then click **OK**.

Windows Vista

- 1 Click **Start**, and then click **Control Panel**.
- 2 Click **Security**, and then click **Windows Firewall** to open the **Windows Firewall** window.
- 3 Click **Turn Windows Firewall on or off** in the window on the left. When the **User Account Control** screen is displayed, click **Continue**.
- 4 Make sure that **Block all incoming connections** is not selected from the **General** tab.
- 5 Open the **Exceptions** tab, select **File and Printer Sharing**, and then click **OK**.

Windows XP

- 1 Click **Start**, and then click **Control Panel**.
- 2 Click **Security Center**.
- 3 Click **Windows Firewall** to open the **Windows Firewall** window.
- 4 Make sure that **Don't allow exceptions** is not selected from the **General** tab.
- 5 Open the **Exceptions** tab, select **File and Printer Sharing**, and then click **OK**.

Top 

Setting for the clients

This section describes how to install the printer driver by accessing the shared printer on a network.

Note:

- To share the printer on a Windows network, you need to set the printer server. For details, see [Setting up your printer as a shared printer](#).
- This section describes how to access the shared printer on a standard network system using the server (Microsoft workgroup). If you cannot access the shared printer due to the network system, ask the administrator of the network for assistance.
- When you want to use the EPSON Status Monitor 3 at clients, you have to install both of the printer driver and the EPSON Status Monitor 3 in each client from the Software Disc.
- If the printer drivers are not already installed on the client, please install them before performing these settings.

- 1 On the Windows **Start** menu, open the **Device and Printers**, **Printers** or **Printers and Faxes**.

For Windows 7 clients:

Click **Start**, and click **Devices and Printers**.

For Windows Vista clients:

Click **Start**, click **Control Panel**, click **Hardware and Sound**, and then click **Printers**.

Windows XP Professional clients:

Click **Start** and click **Printers and Faxes**.

Windows XP Home Edition clients:

Click **Start**, click **Control Panel**, and then click **Printers and Faxes**.

For Windows 2000 clients:

Click **Start**, click **Settings**, and then click **Printers**.

- 2 Right-click the icon for the printer you wish to change the settings for, and then click **Properties** (Windows Vista, XP, and 2000) or **Printer properties** (Windows 7).



- 3 Click the **Ports** tab and then click **Add Port**.

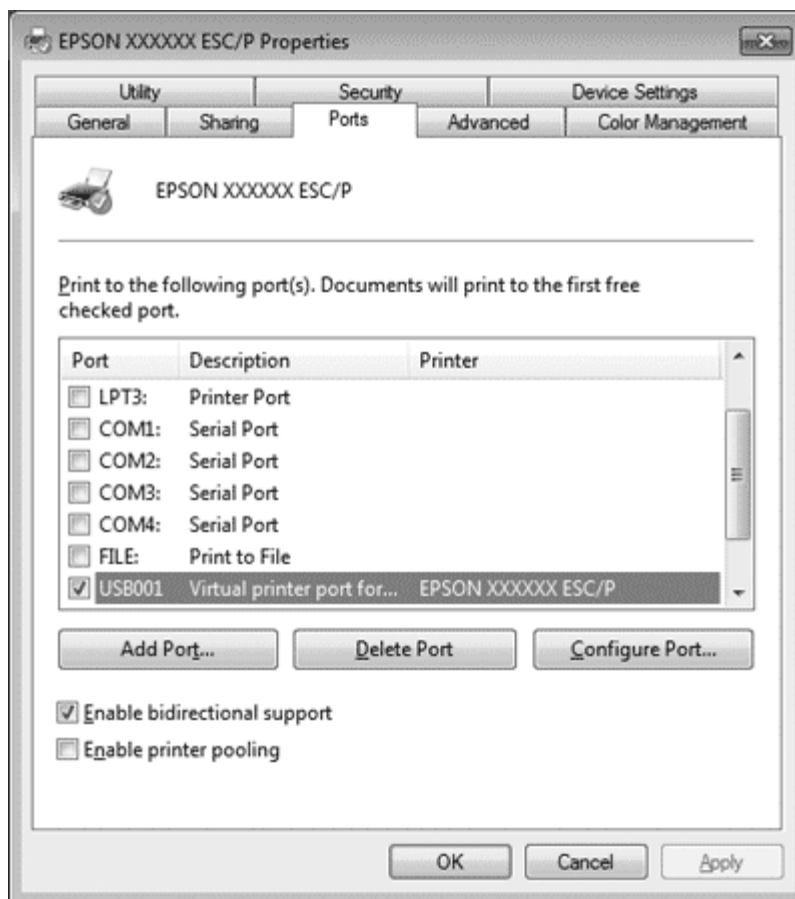

- 4 When the **Printer Ports** window appears, select **Local Port**, and then click **New Port**.

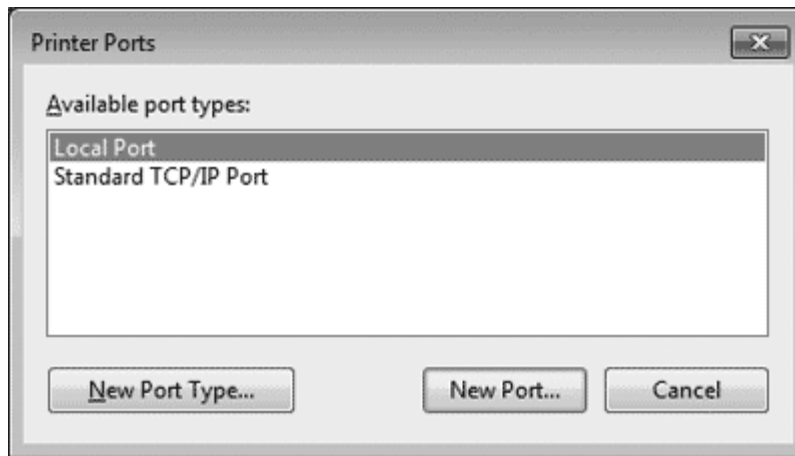

- 5 Enter the following information for the port name and then click **OK**.

`\\Name of computer connected to the target printer\name of shared printer`

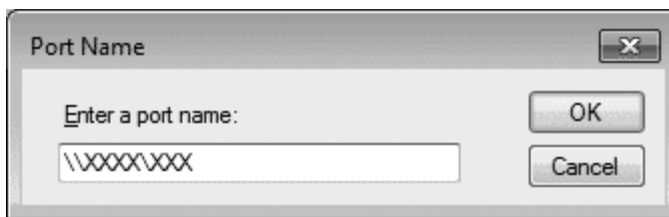

- 6 After returning to the **Printer Ports** window, click **Close**.
- 7 Check that the name you entered for the port has been added and selected, and then click **Close**.

Home > Printer Software

Canceling Printing

If the printouts are not what you expected and display incorrect or garbled characters or images, you may need to cancel printing. When the printer icon is displayed on the taskbar, follow the instructions below to cancel printing.

- 1 Double-click the printer icon on the task bar.



- 2 When canceling all printing documents, select **Cancel All Documents** on the Printer menu.

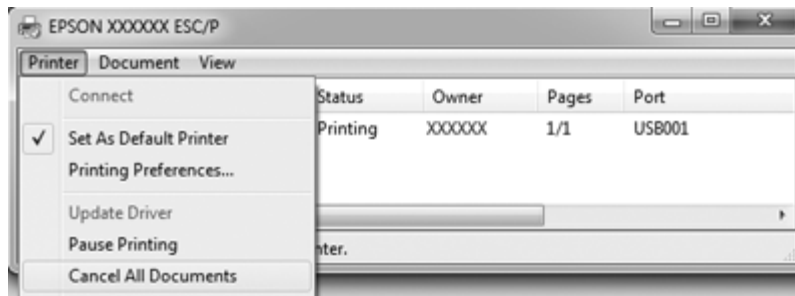

When canceling a specified document, select a document you want to cancel and select **Cancel** on the Document menu. The printing job is canceled.

Uninstalling the Printer Software

Uninstalling the printer driver and EPSON Status Monitor 3

When you wish to reinstall or upgrade the printer driver, uninstall the printer driver that has been installed already.

 **Note:**

When uninstalling EPSON Status Monitor 3 from a multi-user Windows XP or 2000 environment, remove the shortcut icon from all clients before uninstalling. You can remove the icon by clearing the Shortcut Icon check box in the Monitoring Preferences dialog box.

Uninstalling the printer driver and EPSON Status Monitor 3

- 1 Quit all applications.
- 2 For Windows 7, Vista, or XP:
Click **Start**, and then select **Control Panel**.

For Windows 2000:
Click **Start**, point to **Settings**, and click **Control Panel**.
- 3 Click **Uninstall a program** (Windows 7 or Vista) or double-click the **Add or Remove Programs** icon (Windows XP or 2000).

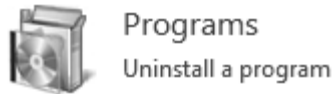

- 4 Click **Change or Remove Programs** (Windows XP or 2000 only), select the **EPSON XXXXXX ESC/P Printer Utility Uninstall**, then click **Uninstall/Change** (Windows 7) or **Change/Remove** (Windows Vista, XP, or 2000).

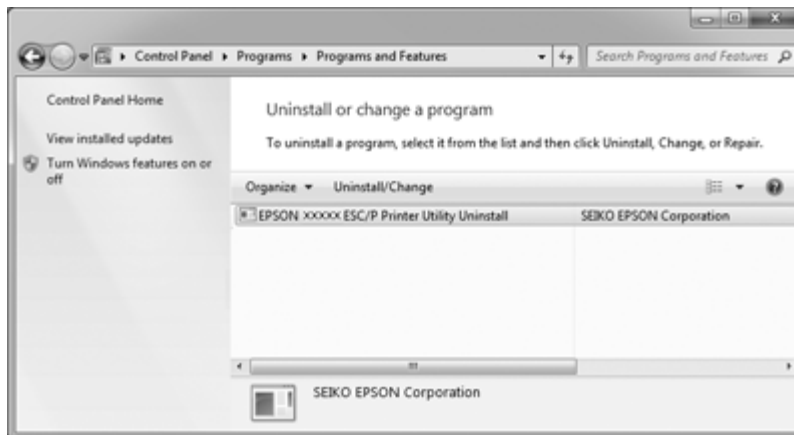

- 5 Click the **Printer Model** tab, select the icon of the printer you want to uninstall, then click **OK**.

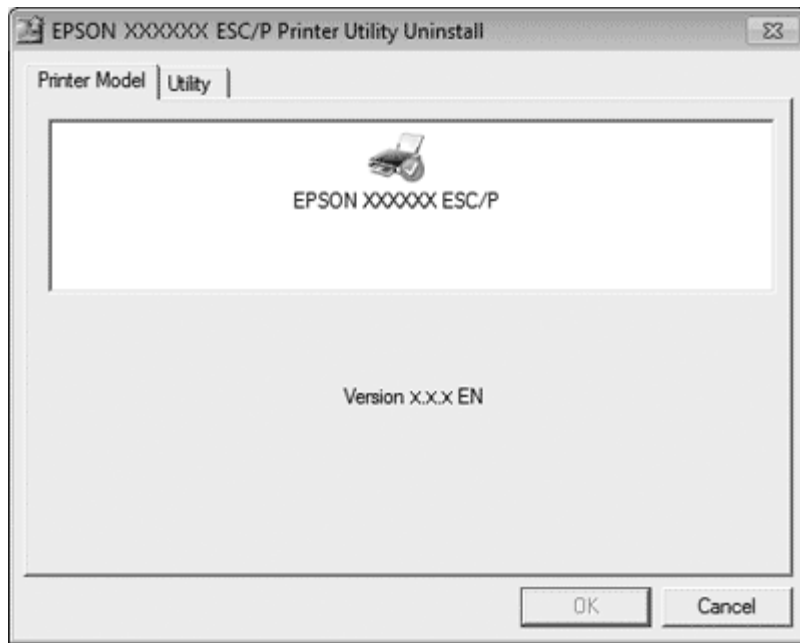

 **Note:**

Make sure that nothing is selected in the Printer Model tab. Click the **Utility** tab and select **EPSON Status Monitor 3(for EPSON XXXXXX ESC/P)** and click **OK**. You can uninstall only the EPSON Status Monitor 3.

- 6 Follow the on-screen instructions.

Using the Control Panel

- ▾ Control Panel Buttons and Lights
- ▾ Selecting a built-in font
- ▾ Panel operations during sleep mode

You can control simple printer operations—such as line feeding, form feeding, loading and ejecting paper, and selecting fonts—with the buttons on the control panel. The control panel lights show the printer's status.

Control Panel Buttons and Lights

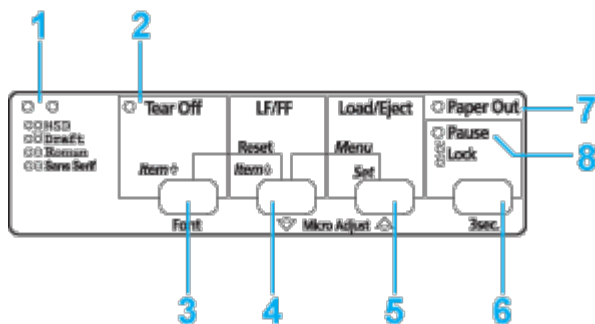

1. Font selection lights

Indicates the current font selection setting.

● ○	High Speed Draft
● ◐	Draft
○ ●	Roman
○ ○	Sans Serif

○ = on, ● = off, ◐ = flashing

Lights up and continues under the default settings.

2. Tear Off (Font) light

Flashes when continuous paper is in the tear-off position.

3. Tear Off (Font) button *

- Advances continuous paper to the tear-off position.
- Feeds continuous paper backward from the tear-off position to the top-of-form position.

4. LF/FF button **

- Feeds paper line by line when pressed and released.
- Ejects a single sheet or advances continuous paper to the next top-of-form position when held down.

5. Load/Eject button **

- Loads a single sheet of paper.
- Ejects a single sheet of paper if a sheet is loaded.
- Loads continuous paper from the standby position.

- Feeds continuous paper backwards to the standby position.

6. Pause button

Stops printing temporarily, and resumes printing when pressed again. When pressed for three seconds, turns on the Micro Adjust mode**. To turn off, press again.

7. Paper Out light

- On when no paper is loaded in the selected paper source or when paper is not loaded correctly.
- Flashes when paper has not been fully ejected or a paper jam has occurred.
- Flashes for three seconds along with the **Pause** light when the lock-out mode is turned on.

8. Pause light

- On when the printer is paused.
- Flashes when the printer is in the Micro Adjust mode**.
- Flashes when the print head has overheated.
- Flashes for three seconds along with the **Paper Out** light when the lock-out mode is turned on.
- Only this light is on in sleep mode. All other lights are off.

* Font select: In the Micro Adjust mode, you can select the font to use for printing by pressing the **Tear Off (Font)** button. The font selection lights turn on, off or flash to indicate the selected font.

** Micro Adjust mode: When you hold down the **Pause** button for three seconds, the printer enters the micro adjust mode. In this mode, you can press the **LF/FF** ↓ and **Load/Eject** ↑ buttons to adjust the top-of-form or tear-off position. See [Adjusting the top-of-form position](#).

[Top](#) 

Selecting a built-in font

Follow these steps to select a built-in font using the buttons on the printer's control panel:

- 1** Make sure that the printer is not printing. If it is, wait until printing is complete.
- 2** Hold down the **Pause** button for three seconds to enter the Micro Adjust mode. The **Pause** light begins to flash. The two font selection lights show the current font selection.
- 3** Press the **Tear Off (Font)** button repeatedly to cycle through all of the available selections; then stop when you reach the desired font with a pattern shown on the control panel. Your selection stays in effect until you change it again.

Note:

- Settings you make in your application programs usually override settings you make from the printer's control panel. For best results, use your application to select a font and pitch.
- Bar code fonts cannot be selected via the control panel.

[Top](#) 

Panel operations during sleep mode

The printer enters sleep mode if 4 minutes and 30 seconds has passed since the previous operation and no errors have occurred. The following operations return the printer from sleep mode.

- Sending print data.
- Pressing a control panel button. Pressing a button once returns the printer from sleep mode and shows the current status using the control panel lights. To use the normal button functions, press a button one more time.

Note:

Pressing a button only once returns the printer from sleep mode. It returns to sleep mode again if more than 20 seconds pass without any additional operations being made.

Home > Control Panel

Lock-Out Mode



 [Changing the lock-out mode setting](#)

You can restrict the use of buttons on the control panel by using the lock-out mode.

Changing the lock-out mode setting

You can turn lock-out mode on or off or change locked functions from lock-out setting mode.

The following table shows the basic function of each button in the lock-out setting mode.

Button	Basic function
Item  button	Selects the next menu parameter.
Item  button	Selects the previous menu parameter.
Set button	Changes the value in the selected menu.

You can select the printer functions to be locked while the lock-out mode is on according to your needs.

 **Note:**

- Before entering the lock-out setting mode, you need to load A4 or letter size single-sheet paper or continuous paper that is at least 210 mm (8.3 inches) wide. See [Printing on Continuous Paper](#) and [Printing on Single Sheets](#) for instructions on loading continuous paper and single sheets.
- For your safety, Epson recommends operating the printer with the printer cover closed. The printer will function with the printer cover open or removed, but for maximum safety keep the cover closed.

Follow these steps to change the lock-out mode setting:



- 1 Make sure the printer is turned off.

 **Caution:**





Whenever you turn off the printer, wait at least five seconds before turning it back on; otherwise, you may damage the printer.

- 2 Turn on the printer while holding down both the **LF/FF** and **Pause** buttons.

The printer enters the lock-out setting mode and prints a message asking if you wish to print all of the current settings.

- 3 If you want to print the current settings, press the **Set** button. If you want to bypass printing of the current settings, press the **Item  button** or the **Item  button**.

The printer prints the first menu and the current value of the menu.

- 4 Press the **Item  button** or the **Item  button** to select the menu parameters which you wish to change. Press the **Set** button to scroll through the values within the selected parameter until you find the desired setting. After setting the selected parameter to the desired setting, you may continue to make changes to other parameters by pressing the **Item  button** or the **Item  button**.

- 5 Turn off the printer and exit the lock-out setting mode.



Note:

You may exit the lock-out setting mode by turning off the printer at any time. Any settings you have made remain in effect until you change them again.

[Top](#)

[Home](#) > [Control Panel](#)

About Your Printer's Default Settings

[Default Setting mode](#)

[Changing default settings](#)

The default settings control many printer functions. While you can often set these functions through your software or printer driver, you may sometimes need to change a default setting from the printer's control panel using the Default Setting mode.

Default Setting mode

The following table lists the default settings and the options you can select in the Default Setting mode. The settings are explained in detail after the table. For instructions on changing the default settings, see [Changing default settings](#).

Item	Setting / value *1
Page length for tractor	3inch, 3.5inch, 4inch, 5.5inch, 6inch, 7inch, 8inch, 8.5inch, 11inch , 70/6inch, 12inch, 14inch, 17inch
Skip over perforation	Off , On
Auto tear off	Off , On
Auto line feed	Off , On
Print direction	Bi-D , Uni-D
Software	ESC/P , IBM PPDS
0 slash	0 , 
I/F mode	Auto , Parallel, Serial, USB
Auto I/F wait time	10 seconds , 30 seconds
Baud rate	19200 , 9600, 4800, 2400, 1200, 600, 300 BPS
Parity	None , Odd, Even, Ignore
Data length	8 bit , 7 bit
Parallel I/F bidirectional mode	Off, On
Packet mode	Auto , Off
Character table *2	Standard model: Italic, PC 437 , PC 850, PC 860, PC 865, PC 861, PC 863, BRASCII, Abicomp, Roman 8, ISO Latin 1, PC 858, ISO 8859-15 All other models: Italic, PC 437 , PC 850, PC 437 Greek, PC 853, PC 855, PC 852, PC 857, PC 866, PC 869, MAZOWIA, Code MJK, ISO 8859-7, ISO Latin 1T, Bulgaria, PC 774, Estonia, ISO 8859-2, PC 866 LAT, PC 866 UKR, PC APTEC, PC 708, PC 720, PC AR864, PC 860, PC 865, PC 861, PC 863, BRASCII, Abicomp, Roman 8, ISO Latin 1, PC 858, ISO 8859-15, PC 771, PC437 Slovenia, PC MC, PC1250, PC1251, KZ1048
International character set for Italic table	Italic U.S.A. , Italic France, Italic Germany, Italic U.K., Italic Denmark1, Italic Sweden, Italic Italy, Italic Spain1
Pitch	10CPI , 12CPI, 15CPI, 17CPI, 20CPI, Proportional
Auto CR (IBM PPDS) *3	Off , On
Manual feed wait time	0.5 second, 1 second, 1.5 seconds , 2 seconds
Buzzer	Off, On
Low-noise mode	Off , On

IBM character table (IBM PPDS) *3	Table2 , Table1
Power off timer	Off , 1 hours, 2 hours, 4 hours, 8 hours, 12 hours

*1 Settings with bold weight mean the standard factory settings. Settings may vary depending on the country.

*2 The options available vary depending on the country.

*3 These settings take effect only when IBM PPDS emulation is selected.

Page length for tractor

This setting allows you to set the page length (in inches) for continuous paper.

Skip over perforation

This feature is available only when continuous paper is selected. When you select **On**, the printer provides a one-inch (25.4 mm) margin between the last line printed on one page and the first line printed on the next page. Because the program margin settings in most applications override margin settings made from the control panel, you should use this setting only if you cannot set your top and bottom margins using your application.

Auto tear off

When auto tear off is on and you are using continuous paper with the push tractor, the printer automatically advances the paper perforation to the tear-off position, where you can easily tear off the printed pages. When the printer receives the next print job, it automatically moves the unused paper back to the top-of-form position and starts printing, so you can use all of the next page.

Auto tear off is available under the following conditions.

- No print data is sent for more than three seconds after entering a page break by holding down the **LF/FF** button.
- No print data is sent for more than three seconds after sending an FF command.

When auto tear off is off, you need to move the perforation to the tear-off position by pressing the control panel button. See [Using the Tear Off button](#) for more information.

Auto line feed

When auto line feed is on, the printer accompanies each carriage return (CR) code received with a line feed code, and the print position moves to the next line. If the printer adds an extra line after every carriage return, select **Off**.

Print direction

You can select bidirectional printing (**Bi-D**) or unidirectional printing (**Uni-D**). Printing is normally bidirectional for faster printing; however, unidirectional printing allows for precise vertical printing alignment, which is useful for printing graphics.

Software

When you select **ESC/P**, the printer operates in the EPSON ESC/P mode. When you select **IBM PPDS**, the printer emulates an IBM printer.

O slash

The zero character has a slash (0) when **0** is selected. There is no slash (0) when **O** is selected. The slash allows you to easily distinguish between the uppercase letter *O* and a zero.

I/F (interface) mode

The printer comes with three kinds of interfaces; a parallel interface, a serial interface and a USB interface.

If your printer is connected to only one computer, choose **Parallel**, **Serial**, or **USB** for the interface mode, depending on the interface you use. If your printer is connected to two computers, select **Auto** (automatic) to allow the printer to automatically switch between interfaces depending on which one is receiving data.

Auto I/F (interface) wait time

This setting takes effect only when I/F mode is set to **Auto**. This setting determines how long the printer waits when it no longer receives data from an interface before it checks whether a print job is being sent through the other interface. You can specify **10 seconds** or **30 seconds** for the auto interface wait time.

Baud rate

Use this option to set the data transfer rate (baud) for the serial interface. The baud rate is measured in bits per second (bps). See your computer manual and software documentation for the proper setting.

Parity

When this option is set to **None**, parity checking is disabled. The parity bit, if used, provides a basic form of error detection. See your computer manual and software documentation for the proper setting.

Data length

Set the data length of the serial interface to **7 bit** or **8 bit**. See your computer manual and software documentation for the proper setting.

Parallel I/F bidirectional mode

The parallel interface bidirectional transfer mode is used when this feature is turned on. If bidirectional transfer mode is unnecessary, turn this off.

Packet mode

Make sure to select **Auto** to print from Windows applications using the printer driver included in the software CD-ROM that comes with the printer. Turn off this mode if you encounter connection problems when you are printing from applications based on other operating systems such as DOS.

Character table

You can select among various character tables.

International character set for Italic table

You can select among several international character sets for the Italic character table. Each character set contains eight characters that vary depending on the country or language, so you can customize the Italic table to suit your printing needs.

Pitch

You can select the character pitch from among six settings.

Auto CR (carriage return)

This setting is available only in the IBM PPDS emulation mode. When auto carriage return is on, each line feed (LF) code or ESC J code is accompanied by a carriage return code. This moves the print position to the beginning of the next line.

Manual feed wait time

This sets the amount of wait time between the time paper is inserted into the paper guide and when it is fed. If the paper feeds before you can adjust its position to your satisfaction, you can increase the wait time.

Buzzer (beeper)

The printer beeps when an error occurs or a panel operation is made. (See [Using the Error Indicators](#) for more information on printer errors.) If you do not want the printer to beep, turn off this setting.

Low -noise mode

When you choose **On**, the noise is reduced, but the printing speed is slower.

IBM character table

This setting is available only in IBM PPDS emulation mode. When you select **Table1**, hex codes 80H to 90H of the character tables are used for the control codes. When you select **Table 2**, hex codes 80H to 90H are used for characters.



Power off timer

When a time is set, the printer automatically turns off after the set time has passed while in standby status. To turn on the printer again, turn off the power switch and then turn it back on.

[Top](#) 

Changing default settings

The following table shows the basic function of each button in the default setting mode.

Button	Basic function
Menu (LF/FF and Load/Eject) buttons	Enters or exits the default setting mode.
Item  button	Selects the next menu parameter.
Item  button	Selects the previous menu parameter.
Set button	Changes the value in the selected menu.

Follow these steps to enter the default-setting mode and change the printer's default settings:

Note:

- Before entering the default-setting mode, you need to load A4 or letter size single-sheet paper or continuous paper that is at least 297 mm (11 inches) long and 210 mm (8.27 inches) wide.
- If you use single sheets, you need to load a new sheet of paper each time the printer ejects a printed sheet.
- If you turn off the printer prior to exiting default-setting mode, any changes you may have made are canceled and not saved.

1 Make sure paper is loaded.

Press the **Menu (LF/FF and Load/Eject)** buttons until the printer beep once.

2

The printer enters the default-setting mode and prints a message prompting you to select the language for the default-setting menu. The language which is underlined indicates the current setting.

 **Note:**

Depending on the model, language may not be selected.

3 If the language you want is not selected, press the **Item** ↓ (**Tear Off**) button until the printout indicates the language you want.

 **Note:**

You cannot change the language by the **Item** ↑ (**LF/FF**) button.

4 Press the **Set** (**Load/Eject**) button to select the desired language.

The printer prints a message asking if you wish to print all of the current settings.

 **Note:**

The language you select is also effective when you are entering the lock-out setting mode or bidirectional adjustment mode.

5 If you want to print the current settings, press the **Set** button. If you want to bypass printing of the current settings, press the **Item** ↓ button or the **Item** ↑ button.

The printer prints the first menu and the current value of the menu.

6 Press the **Item** ↓ button or the **Item** ↑ button to select the menu parameters which you wish to change. Press the **Set** button to scroll through the values within the selected parameter until you find the desired setting. After setting the selected parameter to the desired setting, you may either continue to make changes to other parameters by pressing the **Item** ↓ button or the **Item** ↑ button, or exit the default-setting mode by pressing the **Menu** (**LF/FF** and **Load/Eject**) buttons.

 **Note:**

You cannot change the setting value to the previous item. You have to press the **Set** button until the value you want is selected.

7 When you finish making settings, press the **Menu** (**LF/FF** and **Load/Eject**) buttons.

Release the buttons when all the lights turn on. The printer exits the default-setting mode.







The settings you made is saved as new default value.

 **Note:**

If you turn off the printer prior to exiting default-setting mode, any changes you may have made are canceled and not saved.

Using the Error Indicators

You can identify many common printer problems using the lights on the control panel. If your printer stops working and one or more control panel lights are on or flashing or the printer beeps, use the following table to diagnose and fix the problem. If you cannot fix your problem using this table, see [Problems and Solutions](#).

Panel light state	Beep pattern	Problem
		Solution
 Pause	–	The printer is paused. Press the Pause button to resume printing.
	• • •	Paper from another paper source is currently in the paper path. Move the paper release lever back to the appropriate position and press the Load/Eject button to clear the paper from the paper path. Then set the lever to the position you want to use. Press the Pause button to turn off the Pause light, if necessary.
 Paper Out  Pause	• • •	No paper is loaded in the selected paper source. Load paper in the printer. Then press the Pause button to turn off the Pause light, if necessary.
	• • •	The paper is not loaded correctly. Remove your paper and reload it. See Printing on Continuous Paper for instructions on loading paper. Then press the Pause button to turn off the Pause light, if necessary.
	• • •	Paper is jammed in the printer. Clear the paper jam as described in Clearing a Paper Jam .
 Paper Out  Pause	• • •	Continuous paper is not fed back to the standby position. Tear off the printed document at the perforation; then press the Load/Eject button. The printer feeds the paper to the standby position. Press the Pause button to turn off the Pause light, if necessary.
	• • •	A single sheet of paper is not fully ejected. Press the Load/Eject button to eject the sheet. Then press the Pause button to turn off the Pause light, if necessary.
	• • •	Paper is jammed in the printer. Clear the paper jam as described in Clearing a Paper Jam .
 Pause	–	The print head is overheated. Wait a few minutes; the printer resumes printing automatically once the print head has cooled.
 All the lights on the control panel	• • • • •	An unknown printer error has occurred. Turn off the printer and leave it off for several minutes; then turn on the printer again. If the error recurs, contact your dealer.

 = on,  = flashing

• • • = short series of beeps (three beeps)

• • • • • = long series of beeps (five beeps)

 **Note:**

The printer beeps once if you press a control panel button when the corresponding function is not available.

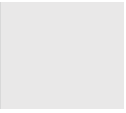

Problems and Solutions

- ▾ Power supply
- ▾ Printing
- ▾ Paper handling
- ▾ Network problems

Most problems you may encounter while operating your printer have simple solutions.

You can check the operation of your printer using the self test. See [Printing a Self Test](#). If the self test works properly the problem probably lies in the computer, the application software, or the interface cable. If the self test does not work, contact your dealer or a qualified service person for assistance.

 **Note:**

If you are an experienced user or a programmer, you can print a hexadecimal dump to isolate communication problems between the printer and computer. To print a hex dump, turn off the printer. Next, hold down the **Load/Eject** and **LF/FF** buttons while you turn on the printer. Then send data from your computer. The printer prints all the codes it receives in hexadecimal format.

Power supply

Power is not being supplied

The lights on the control panel do not go on.	
Cause	What to do
The power cord may be unplugged.	Check that the power cord is properly plugged into the electrical outlet.
The outlet may not be operating.	If the electrical outlet is controlled by an outside switch or automatic timer, use a different outlet. Plug another electrical device, such as a lamp, into the outlet to determine whether the outlet is operating properly.
The power switch is not in the ON position.	Check the status of the power switch. When Power off timer is enabled, the printer turns off even if the power switch is in the ON position. See Default Setting mode .
The lights come on briefly and then go off. The lights stay off even when the power is turned on again.	
Cause	What to do
The voltage ratings of the printer and electrical outlet may not match.	Check that the printer's voltage rating matches the voltage of your electrical outlet. If the voltages do not match, unplug the printer and contact your dealer immediately. Do not reconnect the power cord to an electrical outlet.

Printing

The printer does not print

The Pause light is off but nothing is printed.	
Cause	What to do
The software may not be installed properly.	Check that the software is installed properly for your printer, as described in the <i>Start Here</i> or the <i>Setup Guide</i> . Check the software's printer settings.
The interface cable may not match the specifications of the printer or computer.	Check both ends of the interface cable. Make sure the cable meets both the printer and computer specifications.
The printer port may not be set correctly.	For Windows 2000, click Start , point to Settings , then click Printers . For Windows XP, click Start , Control Panel , then click Printers and Faxes . For Windows Vista, click Start , Control Panel , then click Printer . For Windows 7, click Start , Control Panel , Hardware and Sound , then click Device and Printer . When the icon of the printer you are using appears, right-click it and select Properties (Windows Vista, XP, and 2000) or Printer Properties (Windows 7). Then, click the Ports or Details tab and select the appropriate port.
The printer has been turned off using the Power off timer function.	When Power off timer is enabled, the printer turns off even if the power switch is in the ON position. Turn off the power switch and then turn it back on. See Default Setting mode .
The Paper Out and Pause lights are on and the printer beeps three times.	
Cause	What to do
The printer may be out of paper.	Load paper in the printer.
The printer sounds like it is printing, but nothing is printed.	
Cause	What to do
The ribbon cartridge may not be installed properly.	See the <i>Start Here</i> or the <i>Setup Guide</i> .
The ribbon may be worn out.	Replace the ribbon cartridge.
The printer makes a strange noise, the beeper sounds five times, and the printer stops abruptly.	
Cause	What to do
The paper or ribbon may be jammed.	Turn off the printer and check for a paper jam, a ribbon jam or other problems.
The printer may have overheated.	Let the printer cool. Then try to print again. If the printer still does not print correctly contact your dealer.
The beeper sounds five times and all the lights blink.	
Cause	What to do
An error has occurred.	Turn off the printer and turn it on again. If the problem persists, check for a paper jam or ribbon jam. If there is no jam, contact your dealer or a qualified service person. (If an error occurs when you switch between single sheets and continuous paper, make sure the paper release lever is in the correct position.)

The print is faint or uneven

Printed characters have parts missing at the bottom.	
Cause	What to do
The ribbon cartridge may not be installed properly.	See Replacing the Ribbon Cartridge .
The printout is faint.	
Cause	What to do
The ribbon may be worn out.	Replace the ribbon cartridge as described in Replacing the Ribbon Cartridge .

Dots are missing in printed characters or graphics

A line of dots is missing in the printout.	
Cause	What to do
The print head is damaged.	Stop printing and contact your dealer to have the print head replaced.
Dots are missing in random positions.	
Cause	What to do
Either there is too much slack in the ribbon or the ribbon has come loose.	Reinstall the ribbon cartridge as described in Replacing the Ribbon Cartridge .

Printed characters are not what you expected

The typestyles or characters you sent with your software did not print.	
Cause	What to do
The software may not be properly configured.	Check that the software is correctly configured for your printer.
The font selected on the control panel does not print.	
Cause	What to do
Your software may be overriding your control panel setting.	Check the font setting in your application software.

The print position is not what you expected

Printing starts too high or too low on the page, or the bottom part of one page is printed at the top of the next page.	
Cause	What to do
Your application software settings may be incorrect.	Check the margin or top-of-form position setting in your application software.
Page length does not match the length of the paper.	
Cause	What to do
The page length setting in your application may be incorrect.	Check the page length set by your application software and adjust it if necessary.
The printer's page length setting for the tractor may not match the size of the continuous paper you are using.	Check Page length for tractor of the printer's default settings. See About Your Printer's Default Settings .
Regular gaps occur in the printout.	
Cause	What to do
One-inch skip-over-perforation may be set.	Set Skip over perforation to Off in the Default Setting mode. See About Your Printer's Default Settings .

Top 

Paper handling

Single sheets do not feed properly

Paper does not feed.	
Cause	What to do
Continuous paper may be left in the printer.	Remove the continuous paper. Set the paper release lever to the single-sheet position. Insert a new sheet.
The printer cannot detect the paper on the paper guide as it is positioned too far to the left or right.	Move the paper (and the edge guides) a little to the left or right.
Paper feeding is crooked or the paper jams.	
Cause	What to do
The paper was not fed correctly or is of the wrong type.	Turn off the printer and pull out the paper. Insert a new sheet straight into the paper guide. Make sure you're using the right type of paper. See the paper specifications under Paper .
Paper does not eject completely.	
Cause	What to do
The paper may be too long.	Press the LF/FF button to eject the page. Use paper that is within the specified range. See the paper specifications under Paper .

Continuous paper does not feed properly

The tractor does not feed the paper.	
Cause	What to do
The paper release lever may be in the wrong position.	Check that the paper release lever is pulled forward to the continuous-paper position. If not, turn off the printer, move the lever, and turn it on again.
The paper may have come off the tractor.	Reattach the paper to the tractor.
Paper feeding is crooked or the paper jams.	
Cause	What to do
The paper supply is obstructed.	Make sure the paper supply is not obstructed by a cable or some other object.
The paper supply is too far away from the printer.	Make sure that your paper supply is within 1 meter (3 feet) of the printer.
The printer cover may be opened.	Close the printer cover.
The edge guide positions may be incorrect.	Position the edge guides at the diamond-shaped guide marks.
The holes on the sides of the paper are misaligned.	Check that the holes on the sides of the paper are aligned with each other. Also make sure the sprocket units are locked and their covers are closed.
Your paper may be the wrong size or thickness for the printer.	Make sure that the paper size and thickness are within the specified ranges. See Paper for information on the continuous paper specifications.
When you use side-crimped multipart forms, the copies may not align with the original.	Raise the paper guide to keep the printing position accurate.
The paper does not eject properly.	
Cause	What to do
The page may be too long.	Tear off the fresh supply of paper and eject the page from the printer. Use only paper that is within the specified length range described under Paper .
When you switch between single sheets and continuous paper, the beeper sounds three times and the Pause light comes on.	
Cause	What to do
You may have tried to change the paper release lever position while paper remained in the printer.	Return the paper release lever to the previous position and eject the paper. Then change the paper release lever position.

Network problems

A communication error occurs	
Cause	What to do
Are multiple users logged into a single computer at the same time?	<p>On a Windows XP/Vista/7 system with multiple users, a communication error may occur when switching to a new user and starting a new print job while the previous user is still printing.</p> <p>Make sure that the print job for the first user is complete and that user is logged off before switching to a new user and starting a new print job.</p>

[Home](#) > [Problem Solver](#)

Correcting USB Problems

- [Make sure that your computer is a Windows 7, Vista, XP, or 2000 pre-installed model](#)
- [Printer does not work correctly with the USB cable](#)

If you are having difficulty using your printer with a USB connection, read the information in this section.

Make sure that your computer is a Windows 7, Vista, XP, or 2000 pre-installed model

Your computer must be a Windows 7, Vista, XP, or 2000 pre-installed model. You may not be able to install or run the USB printer driver on a computer which is not equipped with a USB port or which has been upgraded from Windows 95 to Windows Vista, XP, or 2000.

For details about your computer, contact your dealer.

[Top](#) 

Printer does not work correctly with the USB cable

If your printer does not work correctly with the USB cable, try one or more of these solutions:

- Make sure that the cable you are using is a standard, shielded USB cable.
- If you are using a USB hub, connect the printer to the first tier of the hub, or connect the printer directly to the computer's USB port.

[Top](#) 

[Home](#) > [Problem Solver](#)

Clearing a Paper Jam

Follow these steps to clear a paper jam.

 **Caution:**

Do not touch the white cable inside the printer.

- 1 Turn off the printer.
- 2 If a single-sheet of paper is stuck on the paper guide, gently remove it.
- 3 Open the printer cover. If you are loading continuous paper, remove the paper guide.
- 4 If continuous paper is jammed in the printer, tear off the fresh supply at the perforation.
- 5 Turn the knob on the right side of the printer away from you to eject the paper in the printer. Remove any remaining pieces of paper.

 **Caution:**

Use the knob on the right side of the printer only to clear paper jams when the printer is off. Otherwise, you may damage the printer or lose the top-of-form or tear-off position.

 **Note:**

The control panel lights may flash when turning the knob by hand while the printer is off. This is not a malfunction.

- 6 Replace the paper guide if necessary, and close the printer cover.
- 7 Turn on the printer. Make sure the **Paper Out** and **Pause** lights are off.

If any paper still remains inside the printer, follow the steps below to remove the remaining paper.

- 1 Turn off the printer.
- 2 Open the printer cover, and then set the paper release lever to the continuous paper position.
- 3 Remove the paper tension unit.
- 4 Remove the jammed paper.
- 5 Reset the paper release lever to match the paper being used.
- 6 Turn on the printer, load the paper, and then close the printer cover.

Printing a Self Test

Running the printer's self test helps you determine whether the printer or the computer is causing the problem:

- If the self test results are satisfactory, the printer is working properly and the problem is probably caused by your printer driver settings, application settings, computer, or interface cable. (Be sure to use a shielded interface cable.)
- If the self test does not print properly, there is a problem with the printer. See [Problems and Solutions](#) for possible causes and solutions to the problem.

You can print the self test using either single sheets or continuous paper. See [Printing on Continuous Paper](#) or [Printing on Single Sheets](#) for paper-loading instructions.

 **Caution:**

You should use paper at least 210 mm (8.27 inches) wide to run the self test; otherwise, the print head prints directly on the platen.

Follow these steps to perform a self test:

- 1 When using continuous paper, make sure paper is loaded, and the paper release lever is set to the correct position. Then turn off the printer.

 **Caution:**

Whenever you turn off the printer, wait at least five seconds before turning it back on; otherwise you may damage the printer.

- 2 To run the test, turn on the printer while holding down the **LF/FF** button or **Load/Eject** button.

Self test is printed in Draft characters when the **LF/FF** button is held, or in NLQ characters when the **Load/Eject** button is held.

- 3 When using single-sheet paper, load paper in the printer.

After a few seconds, the printer loads the paper automatically and begins printing the self test. A series of characters is printed.

 **Note:**

To temporarily stop the self test, press the **Pause** button. To resume the test, press the **Pause** button again.

- 4 To end the self test, press the **Pause** button to stop printing. If paper remains in the printer, press the **LF/FF** button to eject the printed page. Then turn off the printer.

 **Caution:**

Do not turn off the printer while it is printing the self test. Always press the **Pause** button to stop printing and the **LF/FF** button to eject the printed page before you turn off the printer.

[Home](#) > [Problem Solver](#)

■ Technical Support Web Site

Epson's Technical Support Web Site provides help with problems that cannot be solved using the troubleshooting information in your product documentation. If you have a Web browser and can connect to the Internet, access the site at:

<http://support.epson.net/>

If you need the latest drivers, FAQ's, manuals, or other downloadables, access the site at:

<http://www.epson.com>

Then, select the support section of your local Epson Web site.

[Home](#) > [Problem Solver](#)

Contacting Customer Support

- [Before Contacting Epson](#)
- [Help for Users in Australia](#)
- [Help for Users in Europe](#)
- [Help for Users in North America](#)
- [Help for Users in Latin America](#)

Before Contacting Epson

If your Epson product is not operating properly and you cannot solve the problem using the troubleshooting information in your product documentation, contact customer support services for assistance. If customer support for your area is not listed below, contact the dealer where you purchased your product.

Customer support will be able to help you much more quickly if you give them the following information:

- Product serial number
(The serial number label is usually on the back of the product.)
- Product model
- Product software version
(Click **About**, **Version Info**, or similar button in the product software.)
- Brand and model of your computer
- Your computer operating system name and version
- Names and versions of the software applications you normally use with your product

[Top](#) 

Help for Users in Australia

Epson Australia wishes to provide you with a high level of customer service. In addition to your product documentation, we provide the following sources for obtaining information:

Your Dealer

Don't forget that your dealer can often help identify and resolve problems. The dealer should always be the first call for advise on problems; they can often solve problems quickly and easily as well as give advise on the next step to take.

Internet URL <http://www.epson.com.au>

Access the Epson Australia World Wide Web pages. Worth taking your modem here for the occasional surf! The site provides a download area for drivers, Epson contact points, new product information and technical support (e-mail).

Epson Helpdesk

Epson Helpdesk is provided as a final backup to make sure our clients have access to advise. Operators on the Helpdesk can aid you in installing, configuring and operating your Epson product. Our Pre-sales Helpdesk staff can provide literature on new Epson products and advise where the nearest dealer or service agent is located. Many types of queries are answered here.

The Helpdesk numbers are:

Phone: 1300 361 054
Fax: (02) 8899 3789

We encourage you to have all the relevant information on hand when you ring. The more information you prepare, the faster we can help solve the problem. This information includes your Epson product documentation, type of computer, operating system, application programs, and any information you feel is required.

[Top](#) 

Help for Users in Europe

Check your **Pan-European Warranty Document** for information on how to contact Epson Customer support.

[Top](#) 

Help for Users in North America

Epson provides the technical support services listed below.

Internet Support

Visit Epson's support website for your printer (U.S. or Canada) for solutions to common problems. You can download drivers and documentation, get FAQs and troubleshooting advice, or e-mail Epson with your questions.

Speak to a Support Representative

Before you call Epson for support, please have the following information ready:

- Product name
- Product serial number (located on the back of product)
- Proof of purchase (such as a store receipt) and date of purchase
- Computer configuration
- Description of the problem

Then call:

- U.S.: (562) 276-4322, 6 am to 8 pm, Pacific Time, Monday through Friday, and 7 am to 4 pm, Saturday.
- Canada: (905) 709-2170, 6 am to 8 pm, Pacific Time, Monday through Friday, and 7 am to 4 pm, Saturday.

Days and hours of support are subject to change without notice. Toll or long distance charges may apply.

Purchase Supplies and Accessories

You can purchase Epson ribbons at <http://www.epson.com> (U.S. sales) or <http://www.epson.ca> (Canadian sales). You can also purchase supplies from an Epson authorized reseller. To find the nearest one, call 800-GO-EPSON (800-463-7766).

[Top](#) 

Help for Users in Latin America

Epson provides the technical support services listed below.

Internet Support

Visit Epson's support web site for your printer for solutions to common problems. You can download drivers and documentation, get FAQs and troubleshooting advice, or e-mail Epson with your questions.

Speak to a Support Representative

Before you call Epson for support, please have the following information ready:

- Product name
- Product serial number (located on the back of product)
- Proof of purchase (such as a store receipt) and date of purchase
- Computer configuration
- Description of the problem

Then call:

Country	Telephone
Argentina	(54 11) 5167-0300
Brazil	0800-880-0094
Bolivia *	800-100-116
Chile	(56 2) 484-3400
Colombia	(57 1) 523-5000
Costa Rica	800-377-6627
Dominican Republic *	1-888-760-0068
Ecuador *	1-800-000-044
El Salvador *	800-6570
Guatemala *	1-800-835-0358
Honduras **	800-0122 Code: 8320
Mexico	Mexico City (52 55) 1323-2052 Other cities 01-800-087-1080
Nicaragua *	00-1-800-226-3068
Panama *	00-800-052-1376
Peru	Lima (51 1) 418-0210 Other cities 0800-10126
Uruguay	00040-5210067
Venezuela	(58 212) 240-1111

* Contact your local phone company to call this toll free number from a mobile phone.

** Dial first 7 digits, wait for a message, then enter code.

If your country is not on the list, please contact your nearest Epson office. May be subject to additional local or long distance calling costs.

Purchase supplies and accessories

You may purchase Epson original ribbons at an authorized Epson reseller. To find your nearest reseller, please contact Epson as described above.

Installing and Using Options

[Roll paper holder](#)

Roll paper holder

The optional roll paper holder (C81114*) allows you to use your printer with 216 mm (8.5 inch) roll paper like that used with telex machines. This option is not available in all countries.

Follow these steps to install and use the roll paper holder:

- 1 Turn off the printer and remove the paper guide.
- 2 Position the roll paper holder beneath the printer as shown below. Fit the two holes in the base onto the two positioning pegs on the bottom of the printer.

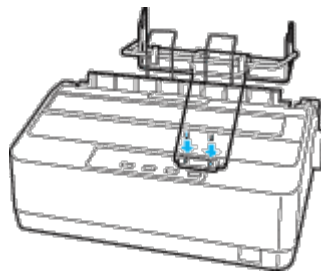

Caution:

Be careful to avoid dropping the roll paper holder when lifting the printer. Only the printer's weight holds it in place.

- 3 Push the paper release lever to the single-sheet position.
- 4 Cut the leading edge of the roll paper straight across. Slide the roll paper holder shaft through the center of the paper roll.

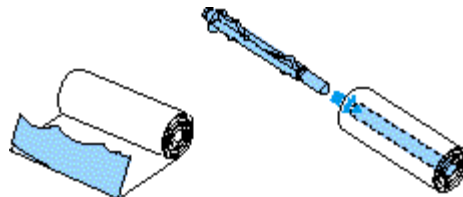

- 5 Set the shaft and paper roll onto the roll paper holder. Orient the roll so that paper feeds from the bottom of the roll. Then turn on the printer.
- 6 Bring the leading edge of the paper up over the paper path guide for single sheets and insert it into the printer path for single sheets until you feel resistance.

Install the paper guide. Slide the left edge guide to the center until it stops at the guide mark. Then slide the right edge

7

guide to the opposite guide mark.

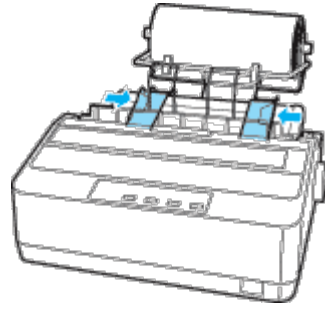

Top 

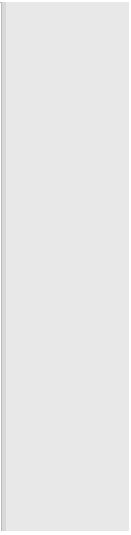

[Home](#) > [Options and Consumables](#)

Replacing the Ribbon Cartridge

[Genuine Epson ribbon cartridge](#)

[Replacing the ribbon cartridge](#)

Genuine Epson ribbon cartridge

When printing becomes faint, you need to replace the ribbon cartridge. Genuine Epson ribbon cartridges are designed and manufactured to work properly with your Epson printer. They ensure proper operation and long life of the print head and other printer parts. Other products not manufactured by Epson may cause damage to your printer, which is not covered by Epson's warranties.

Your printer uses the following ribbon cartridge:

Epson black ribbon cartridge:

S015631

[Top](#) 

Replacing the ribbon cartridge

Follow these steps to install or replace the ribbon cartridge:

- 1 Make sure the printer is turned off.
- 2 Open the printer cover to the upright position, then pull it up to remove it.

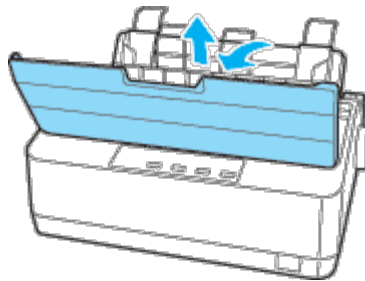

 **Warning:**

If you have just used the printer, the print head may be hot; let it cool for a few minutes before replacing the ribbon cartridge.

- 3 Remove the tension unit by squeezing the tension unit's lock tabs gently and pulling the tension unit away from the printer.
- 4 Make sure that the print head is in the middle of the printer.
If it is not, turn on the printer and then turn off again. Then remove the ribbon cartridge from the printer.
- 5 Remove the new ribbon cartridge from its package.

- 6 Turn the ribbon-tightening knob in the direction of the arrow to remove any slack from the ribbon so it is easier to install.

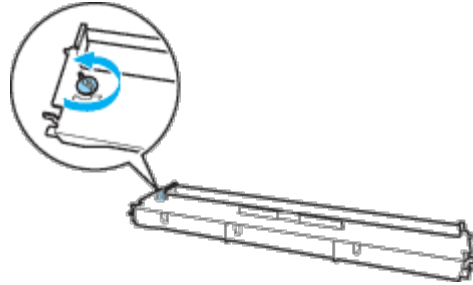

- 7 Insert the ribbon cartridge into the printer as shown; then press both sides of the cartridge firmly to fit the plastic hooks into the printer slots.

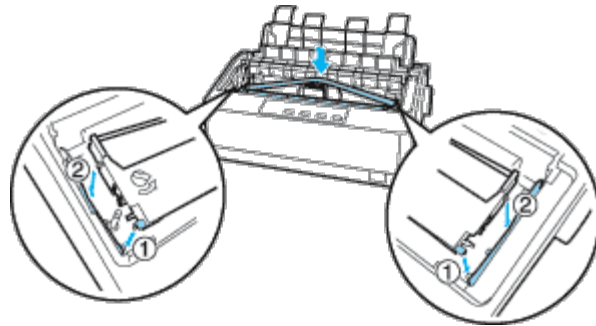

 **Note:**

Do not touch the white cable inside the printer.

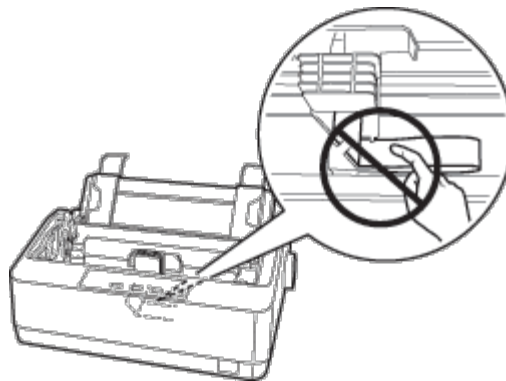

- 8 Use a pointed object, such as a ball point pen, to guide the ribbon between the print head and ribbon guide.

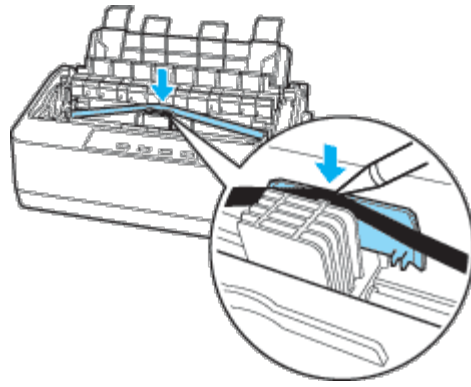

- 9 Turn the ribbon-tightening knob in the direction of the arrow to help feed the ribbon into place; it should not be twisted or creased.

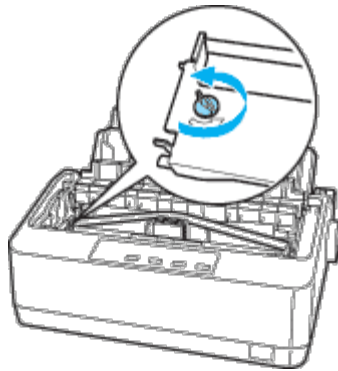

- 10 Reinstall the paper tension unit.
- 11 Reinstall and close the printer cover.

Home > Product Information

Printer Parts

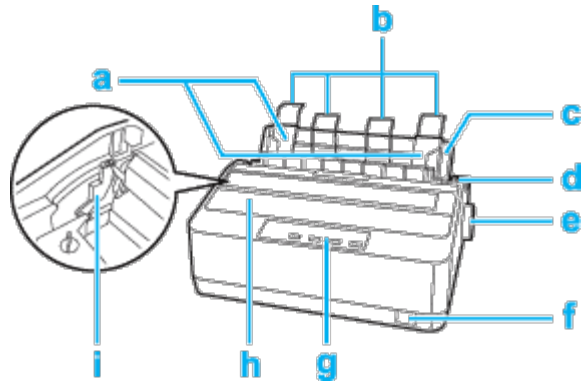

- a. edge guides
- b. paper supports
- c. paper guide
- d. paper release lever
- e. knob
- f. power switch
- g. control panel
- h. printer cover
- i. paper thickness lever

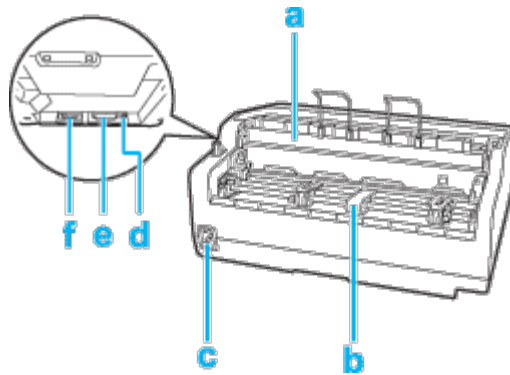

- a. paper tension unit
- b. push tractor
- c. power plug
- d. USB interface
- e. parallel interface
- f. serial interface

Printer Specifications

- [Mechanical](#)
- [Electronic](#)
- [Electrical](#)
- [Environmental](#)
- [Paper](#)
- [Recommended printable area](#)
- [Paper alignment](#)

Mechanical

Printing method:	9-pin impact dot matrix	
Printing speed:	High speed draft	347 cps at 10 cpi 357 cps at 12 cpi 390 cps at 15 cpi
	High speed draft condensed	383 cps at 17cpi 298 cps at 20 cpi
	Draft	260 cps at 10 cpi 312 cps at 12 cpi 223 cps at 15 cpi
	Draft condensed	222 cps at 17 cpi 260 cps at 20 cpi
	Draft emphasized	130 cps at 10 cpi
	NLQ	65 cps at 10 cpi 78 cps at 12 cpi 55 cps at 15 cpi 47 cps at 17 cpi 56 cps at 20 cpi
Printing direction:	Bidirectional logic seeking for text and graphics printing. Unidirectional text or graphics printing can be selected using software commands.	
Line spacing:	4.23 mm (1/6-inch) or programmable in 0.118 mm (1/216-inch) increments	
Printable columns:	80 columns (at 10 cpi)	
Resolution:	240 × 144 dpi maximum	
Feeding method:	Friction feed (rear paper entry) Push tractor feed (rear paper entry)	
Feeder:	Rear push tractor Roll paper holder (Optional)	
Paper feed speed:	Continuous	63 mm/second (2.5 inches/second)
	Intermittent	63 msec/line at 1/6-inch line spacing
Reliability:	Total print volume	20 million lines (except print head) MTBF 10,000 POH (25% duty)
	Print head life	400 million strokes per wire
Dimensions and weight:	When using continuous paper:	
	Height	199 mm (7.8 inches)
	Width	362 mm (14.3 inches)

	Depth	335 mm (13.2 inches)
	(including the paper supports and knob.)	
	When using single sheets:	
	Height	199 mm (7.8 inches)
	Width	362 mm (14.3 inches)
	Depth	307 mm (12.1 inches)
	(including the paper supports and knob.)	
	Weight	approx. 4 kg (8.8 lb)
Ribbon:	Black ribbon cartridge (S015631)	
Ribbon life (Draft, 10 cpi, 14 dots/ character)	Black ribbon	4 million characters
Acoustic noise:	Approx. 53 db (A) (ISO 7779 pattern)	

[Top](#) 

Electronic

Interfaces:	One standard bidirectional, 8-bit, parallel interface with IEEE-1284 nibble mode support, one EIA-232D serial interface, and one USB (ver. 2.0) interface
Buffer:	128 KB
Built-in fonts:	<p>Bitmap fonts:</p> <p>EPSON Draft 10, 12, 15 cpi</p> <p>EPSON Roman 10, 12, 15 cpi, proportional</p> <p>EPSON Sans Serif 10, 12, 15 cpi, proportional</p> <p>Bar code fonts:</p> <p>EAN-13, EAN-8, Interleaved 2 of 5, UPC-A, UPC-E, Code 39, Code 128, POSTNET</p>
Character tables:	<p>Standard:</p> <p>One Italic and 12 graphical character tables:</p> <p>Italic table, PC 437 (US, Standard Europe), PC 850 (Multilingual), PC 860 (Portuguese), PC 861 (Icelandic), PC 865 (Nordic), PC 863 (French-Canadian), BRASCII, Abicomp, ISO Latin 1, Roman 8, PC 858, ISO 8859-15</p> <p>Expanded:</p> <p>One Italic and 42 graphical character tables:</p> <p>Italic table, PC 437 (US, Standard Europe), PC 850 (Multilingual), PC 860 (Portuguese), PC 861 (Icelandic), PC 865 (Nordic), PC 863 (French-Canadian), BRASCII, Abicomp, ISO Latin 1, Roman 8, PC 858, ISO 8859-15, PC 437 Greek, PC 852 (Eastern Europe), PC 853 (Turkish), PC 855 (Cyrillic), PC 857 (Turkish), PC 866 (Russian), PC 869 (Greek), MAZOWIA (Poland), Code MJK (CSFR), ISO 8859-7 (Latin/Greek), ISO Latin 1T (Turkish), Bulgaria (Bulgarian), PC 774 (LST 1283: 1993), Estonia (Estonian), PC 771 (Lithuanian), ISO 8859-2, PC 866 LAT. (Latvian), PC 866 UKR (Ukrainian), PC APTEC (Arabic), PC 708 (Arabic), PC 720 (Arabic), PC AR 864 (Arabic), Hebrew7, Hebrew8, PC862 (Hebrew), PC437 Slovenia, PC MC, PC1250, PC1251, KZ1048 (Kazakhstan)</p>
Character sets:	<p>13 international character sets:</p> <p>USA, France, Germany, UK, Denmark 1, Sweden, Italy, Spain 1, Japan, Norway, Denmark 2, Spain 2, Latin America</p>

[Top](#) 

Electrical

This product will enter sleep mode after a period of nonuse. The time interval has been set at the factory to ensure that the product meets Energy Star standards of energy efficiency and cannot be modified by the consumer.

	120 V Model	220 to 240 V Model
--	--------------------	---------------------------

Input voltage range	AC 99 to 132 V	AC 198 to 264 V
Rated frequency range	50 to 60 Hz	
Input frequency range	49.5 to 60.5 Hz	
Rated current	0.8 A (maximum 1.5 A depending on the character type)	0.4 A (maximum 0.7 A depending on the character type)
Power consumption	Approx. 27 W (ISO/IEC 10561 letter pattern) Approx. 10 W in standby mode Approx. 1.1 W in sleep mode* Approx. 0.5 W in auto off mode 0 W in power off	

* sleep mode: When 4 minutes and 30 seconds pass in the following condition, the printer enters sleep mode.

- No operation
- No error
- There is no data in input buffer

 **Note:**

Check the label on the back of the printer for the voltage of your printer.

[Top](#) 

Environmental

	Temperature (without condensation)	Humidity (without condensation)
Operation	5 to 35 °C (41 to 95 °F)	10 to 80% RH
Storage	-30 to 60 °C (-22 to 140 °F)	0 to 85% RH

[Top](#) 

Paper

 **Note:**

- Use recycled paper, envelopes, and single-sheet multipart forms only under normal temperature and humidity conditions, as follows:
 Temperature: 15 to 25 °C (59 to 77 °F)
 Humidity: 30 to 60% RH
- Do not load paper that has been folded or is damaged, wrinkled, or curled.

Single sheets (standard): paper guide entry

Width	100 to 257 mm (3.9 to 10.1 inches)
Length	100 to 364 mm (3.9 to 14.3 inches)
Thickness	0.065 to 0.14 mm (0.0025 to 0.0055 inch)
Weight	52 to 90 g/m ² (14 to 24 lb)

Single-sheet multipart forms: paper guide entry

Width	100 to 257 mm (3.9 to 10.1 inches)
Length	100 to 364 mm (3.9 to 14.3 inches)
Copies	1 original + up to 4 copies

Thickness	0.12 to 0.39 mm (0.0047 to 0.015 inch)
Weight	40 to 58 g/m ² (12 to 15 lb)
Binding	Line-glued at the top of form

Envelopes: paper guide entry

Size	No. 6: 165 × 92 mm (6.5 × 3.6 inches) No. 10: 241 × 105 mm (9.5 × 4.1 inches)
Thickness	0.16 to 0.52 mm (0.0063 to 0.0205 inch)
Weight	45 to 90 g/m ² (12 to 24 lb)

Continuous paper (standard and multipart): rear entry

Width	101.6 to 254 mm (4.0 to 10.0 inches)
Length (one page)	101.6 to 558.8 mm (4.0 to 22.0 inches)
Copies	1 original + up to 4 copies
Thickness	0.065 to 0.39 mm (0.0025 to 0.015 inch)
Weight (not multipart)	52 to 82 g/m ² (14 to 22 lb)
Weight (one sheet of multipart)	40 to 58 g/m ² (12 to 15 lb)
Binding	Point glue or paper staple on both sides

Roll paper: rear entry with optional roll paper holder

Width	216 mm (8.5 inches)
Thickness	0.07 to 0.09 mm (0.0028 to 0.0035 inch)
Weight	52 to 82 g/m ² (14 to 22 lb)

Top 

Recommended printable area

Note:

For best results, print within the recommended printable area. The printer may not print outside this area.

Single sheets and envelopes:



- A The minimum top margin is 4.2 mm (0.17 inch).
- B The minimum left and right margins are 3.0 mm (0.12 inch) each.
For single sheets the maximum paper width is 257 mm (10.1 inches).
The maximum printable width is 203.2 mm (8.0 inches). If the paper size is substantially wider than this, the side margins will be wider than the minimum, but the printable width does not increase beyond 203.2 mm (8.0 inches).
- C The minimum bottom margin is 4.2 mm (0.17 inch).

Continuous paper:

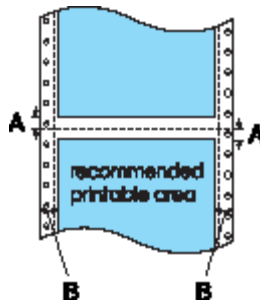

- A The minimum top and bottom margins above and below the perforation are 4.2 mm (0.17 inch) each.
- B The minimum left and right margins are 13 mm (0.51 inch) each.
The maximum paper width is 254 mm (10.0 inches).
The maximum printable width is 203.2 mm (8.0 inches). If the paper size is substantially wider than this, the side margins will be wider than the minimum, but the printable width does not increase beyond 203.2 mm (8.0 inches).

Roll paper:



- A The minimum top margin is 4.2 mm (0.17 inch).
- B The minimum left and right margins are 3.0 mm (0.12 inch) each.
The maximum printable width is 203.2 mm (8.0 inches).

[Top](#)

Paper alignment

For continuous paper, printing starts at the arrow mark on the printer. The unprintable area is to the left of the arrow mark.

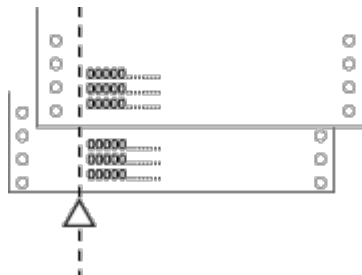

For single sheets, printing starts at "0" on the paper guide scale. The unprintable area is to the left of the "0."

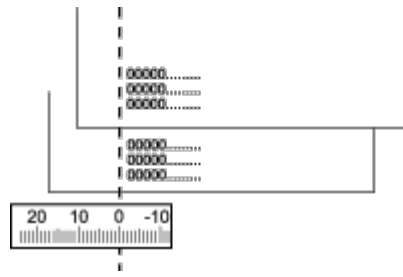

[Top](#) 

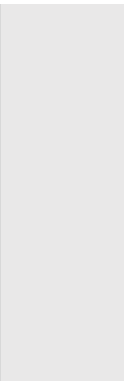

[Home](#) > [Product Information](#)

Command Lists

[EPSON ESC/P control codes](#)

[IBM PPDS emulation control codes](#)

Your printer supports the EPSON ESC/P control codes and IBM PPDS emulation control codes listed below.

EPSON ESC/P control codes

Selecting an EPSON ESC/P printer in your software allows you to use advanced fonts and graphics.

General operation:

ESC @, ESC U

Paper feeding:

FF, LF, ESC 0, ESC 1, ESC 2, ESC 3, ESC A, CR

Page format:

ESC (C, ESC C, ESC C 0, ESC Q, ESC I, ESC (c, ESC N, ESC O, ESC (U

Print position motion:

ESC \$, ESC \, ESC D, HT, ESC B, VT, ESC J

Font selection:

ESC k, ESC x, ESC y, ESC P, ESC M, ESC g, ESC p, ESC 4, ESC 5, ESC E, ESC F, ESC !

Font enhancement:

ESC W, DC4, SO, DC2, SI, ESC w, ESC G, ESC H, ESC T, ESC S, ESC -

Spacing:

ESC Space

Character handling:

ESC t, ESC (t, ESC R, ESC %, ESC &, ESC :, ESC I, ESC 6,
ESC 7

Bit image:

ESC K, ESC L, ESC Y, ESC Z, ESC *, ESC ^

Bar code:

ESC (B

[Top](#) 

IBM PPDS emulation control codes

This printer emulates the IBM Proprinter using the commands below. For detailed information, see the IBM PPDS reference manual.

General operation:

NUL, DC3, ESC j, BEL, CAN, DC1, ESC Q, ESC [K, ESC U

Paper feeding:

FF, LF, ESC 5, ESC A, ESC 0, ESC 1, ESC 2, ESC 3, CR, ESC]

Page format:

ESC C, ESC C0, ESC X, ESC N, ESC O, ESC 4

Print position motion:

ESC d, ESC R, ESC D, HT, ESC B, VT, ESC J

Font selection:

DC2, ESC P, ESC :, ESC E, ESC F, ESC I, ESC [d, ESC [I

Font enhancement:

DC4, SO, ESC SO, ESC W, ESC [@, SI, ESC SI, ESC G, ESC H, ESC T,
ESC S, ESC -, ESC _

Spacing:

BS, SP

Character handling:

ESC 6, ESC 7, ESC [T, ESC ^, ESC ¥

Bit image:

ESC K, ESC L, ESC Y, ESC Z

Bar code:

ESC [f, ESC [p

Download:

ESC =

[Top](#) 

[Home](#) > [Product Information](#)

Standards and Approvals

[Safety approvals](#)[CE marking](#)[FCC compliance statement for United States users](#)[For Canadian users](#)**WARNING:**

- This is a Class A product. In a domestic environment this product may cause radio interference in which case the user may be required to take adequate measures.
- The connection of a non-shielded printer interface cable to this printer will invalidate the EMC standards of this device.
- You are cautioned that changes or modifications not expressly approved by Seiko Epson Corporation could void your authority to operate the equipment.

Safety approvals

120 V model:

Safety standards	UL60950-1 CAN/CSA C22.2 No.60950-1
EMI	FCC part 15 subpart B Class A ICES-003 Class A

230 V model:

Safety standards	IEC/EN60950-1
EMI	AS/NZS CISPR22 class A

[Top](#) 

CE marking

230 V model:

Low Voltage Directive 2006/95/EC	EN60950-1
EMC Directive 2004/108/EC	EN55022 class A EN61000-3-2 EN61000-3-3 EN55024

[Top](#) 

FCC compliance statement for United States users

This equipment has been tested and found to comply with the limits for a Class A digital device, pursuant to Part 15 of the FCC Rules. These limits are designed to provide reasonable protection against harmful interference when the equipment is operated in a commercial environment. This equipment generates, uses, and can radiate radio frequency energy and, if not installed and used in accordance with the instruction manual, may cause harmful interference to radio communications. Operation of this equipment in a residential area is likely to cause harmful interference, in which case the user will be required

to correct the interference at his own expense.

This device complies with Part 15 of the FCC Rules. Operation is subject to the following two conditions:

- (1) this device may not cause harmful interference, and
- (2) this device must accept any interference received, including interference that may cause undesired operation.

[Top](#) 

For Canadian users

This Class A digital apparatus complies with Canadian ICES-003.

Cet appareil numérique de la classe A est conforme à la norme NMB-003 du Canada.

[Top](#) 

[Home](#) > [Product Information](#)

Cleaning the Printer

To keep your printer operating at its best, you should clean it thoroughly several times a year.

Follow these steps to clean your printer:

- 1 Remove any paper loaded in the printer. Make sure the printer is turned off.
- 2 Remove the paper guide.
- 3 Use a soft brush to carefully brush away all dust and dirt from the outer case and paper guide.
- 4 If the outer case or paper guide is still dirty or dusty, clean them with a soft, clean cloth dampened with a mild detergent dissolved in water. Keep the printer cover in place and lower it until it lies flat on the top of the printer to prevent water from getting inside the printer.



Caution:

- Never use alcohols or thinners to clean the printer; these chemicals can damage the printer components as well as the case.
- Be careful not to get water onto the printer mechanism or electronic components.
- Do not use a hard or abrasive brush.
- Do not spray the inside of the printer with lubricants; unsuitable lubricants can damage the printer mechanism. Contact an Epson dealer if you think lubrication is needed.

[Home](#) > [Product Information](#)

■ Transporting the Printer

If you need to transport your printer for some distance, carefully repack it using the original box and packing materials.

Follow these steps to repack the printer in its original packing materials:



Warning:

- When transporting the printer, hold the bottom left and right sides of the printer firmly to lift it.
- You need to move the print head by hand to remove the ribbon cartridge. If you have just used the printer, the print head may be hot; let it cool for a few minutes before touching it.

- 1** Remove any paper loaded in the printer. Make sure the printer is turned off.
- 2** Unplug the power cord from the electrical outlet; then disconnect the interface cable from the printer.
- 3** Lower the paper guide. Remove the paper supports.
- 4** If any options are installed, remove them and pack them in their original boxes.
- 5** Make sure that the print head is not hot. Then remove the ribbon cartridge as described in [Replacing the Ribbon Cartridge](#).
- 6** Make sure the tractor that comes with your printer is installed in the push position.
- 7** Repack the printer, ribbon cartridge, paper supports, and power cord in their original packing materials and place them in the printer's original box.