

TIFFIN MOTORHOMES, INC.

105 2nd Street NW ♦ Red Bay, Alabama 35582 U.S.A.

2021 PowerGlide[®] Owner's Manual



WARNING: Breathing diesel engine exhaust exposes you to chemicals known to the State of California to cause cancer and birth defects or other reproductive harm.

- Always start and operate the engine in a well-ventilated area.
- If in an enclosed area, vent the exhaust to the outside.
- Do not modify or tamper with the exhaust system.
- Do not idle the engine except as necessary.

For more information go to www.P65warnings.ca.gov/diesel.

TIFFIN MOTORHOMES, INC.

Allegro Phaeton Chassis Owner's Manual

2021

© Tiffin Motorhomes, Inc.
105 2nd Street NW, Red Bay, AL 35582 U.S.A.
Telephone 256.356.8661 • Facsimile 256.356.8219
E-Mail: info@tiffinmotorhomes.com

DISCLAIMER

Many of the features and appliances described in this manual may or may not be reflected in the actual motor home purchased, depending on the options and models selected by the motorhome owner. All items, materials, instructions, and guidance described in this manual are as accurate as possible at the time of printing. However, because of Tiffin Motorhomes' ongoing and dedicated commitment to excellence, improvement of Tiffin motorhomes is a continuing process. Consequently, Tiffin Motorhomes reserves the right to make substitutions and improvements in its makes and models of motorhomes without prior notification. Substitutions of comparable or better materials, finishes, appliances, instrumentation, and instruction may be made at any time it is deemed prudent to provide the customer with the best possible motorhome meeting the customer's requirements.

Copyright © 2020 by Tiffin Motorhomes, Inc. -- all rights reserved

Printed in the United States of America: Sixth U.S. Printing: May 2020
[20200501]

**Tiffin Allegro Phaeton - PowerGlide Chassis
Customer Support
256-356-0261
Monday-Friday
6 a.m. - 4:30 p.m. CST**

If you should require chassis service, *you should first contact your nearest Tiffin Powerglide® Chassis service center.* Use https://tiffinmotorhomes.com/locate_dealer/map.php to locate an authorized warranty service facility. If for some reason this is not possible or if you would like to call the manufacturers direct, you can contact them at the following telephone numbers:

TIFFIN POWERGLIDE CHASSIS

256-356-0261

(Please have your VIN# ready)

SAFE RIDE

(Nights and weekends)

1-877- 276-0619

CUMMINS ENGINE COMPANY

1-800-CUMMINS (800-286-6467)

ALLISON TRANSMISSIONS

1-800-524-2303

MICHELIN TIRE

800-TIRE-HELP (800-847-3435)

Visit our website at www.tiffinmotorhomes.com

Table of Contents

Chapter 1		Engine Shutdown	4-14
Tire Care		Diagnostic Fault Codes	4-15
Tire Care	1-2	Towing Hitch	4-15
Correct Tire Pressure	1-3		
Chapter 2		Chapter 5	
Allison Transmission Operation		Scheduled Maintenance	
Driving Considerations	2-2	Scheduled Maintenance Chart	5-2
Fluid Level Check	2-3	Fluids	5-5
		Lubrication Points	5-8
		Maintenance Parts	5-11
		Tiffin Assistance	5-12
Chapter 3		Chapter 6	
Brake System		Pre-Trip Inspection	
Brake System	3-2	Pre-Trip Inspection	6-2
Compressed Air System	3-4		
Air Dryer	3-6		
Engine Compression Brake	3-7		
Chapter 4			
Cummins Engines			
EPA Mandates	4-3		
ATS Warning Lamps	4-3		
DPF Maintenance	4-4		
Aftertreatment Operation	4-5		
Engine Indicator Lamps	4-7		
Engine Starting	4-11		
Cold-Weather Starting	4-12		
Engine Braking (optional)	4-12		
Cruise Control	4-13		

Chapter 7

Instruments & Controls

Safety Instructions	4
Overview	5
Indicator quick reference	6
Gauge Quick Reference	7
Navigation	8
Indicators	9
Gauges	13
Selectable Display	17
Alarm Messages	21
Menu Map	26
Tire Pressure Monitor	28
Diagnostics	33
Smart Wheel Steering Wheel	35

Chapter 8

Air Supply

Air Supply	8-2
-------------------	------------

Chapter 9

Tag Axle

Tag Axle Operation	9-2
---------------------------	------------

Chapter 10

Warranty

Chassis Warranties	10-2
---------------------------	-------------

Chapter 11

Allegro Club

Allegro Club Information	11-2
---------------------------------	-------------

TIRE CARE

TIRE CARE

- What is the most important component of tire care?

- ✓ TIRE PRESSURE

- Why?
 - ✓ Improved Ride
 - ✓ Improved Tire Wear
 - ✓ Improved Road Handling
 - ✓ Improved Braking



Tire Care

Maintaining the proper tire inflation pressure is the most important thing you can do to maximize the life of your tires. An under-inflated tire can build up excessive heat that may go beyond the prescribed limits of endurance of the rubber and the radial cords. Over-inflation will reduce the tire's footprint on the road, reducing the traction, braking capacity, and handling of your vehicle. An over-inflated tire will also cause a harsh ride, uneven tire wear, and will be more susceptible to impact damage.

Keep in mind that the pressure rating on the side wall of your tire is the *maximum* pressure for that tire. This is not necessarily the *correct* pressure for the tires when installed on *your* vehicle. Maintaining the correct tire pressure for *your vehicle's loaded weight* is extremely important and must be a part of regular vehicle maintenance.

Correct Tire Pressure

- How to determine the correct pressure
 - ✓ Weigh each wheel position
 - ✓ Set tire pressure according to chart



* This Chart Shows Cold Inflation Pressures

295/80 R22.5 LRH Energy XZA2

Load per Wheel-end
22.5 X 9.00" Wheel

		PSI=>	80	85	90	95	100	105	110	115	120	Max Load per Tire
		KPA=>	550	590	620	660	690	720	760	790	830	
Single	LBS		5,660	5940	6,220	6,495	6,770	7,040	7,300	7,570	7,830	7,830
Dual	LBS		10,030	10,530	11,030	11,510	12,000	12,470	12,950	13,420	13,880	6,940
Single	KG		2,550	2,700	2,810	2,960	3,060	3,170	3,310	3,410	3,550	3,550
Dual	KG		4,540	4,800	4,980	5,240	5,440	5,620	5,880	6,060	6,380	3,150

TIRE CARE

To determine the correct air pressure for your tires, load your motor home as you would normally travel, including water and fuel. Go to a truck scale as found at most major truck stops and weigh **each wheel position** independently, with driver and passenger(s) in the vehicle as described in the *Michelin Recreational Vehicle Tire Guide* (MWL43146 Rev. 03/12) to determine the correct air pressure for the weight on each wheel position. Then use the charts in the guide and adjust the pressure accordingly when the tires are cool or have not been driven for more than one mile. You may call 1-800-847-3435 for a copy of the *Michelin Recreational Vehicle Tire Guide*.

NOTE: Never reduce the air pressure in a hot tire.

REMEMBER: For control of your RV, it is critical that the tire pressure be the same on both sides of the axle.

Emissions and Fuel Efficiency Compliance

Your chassis was designed, and built, with components including, but not limited to, low rolling resistance tires specifically designed and manufactured to exacting standards for regulatory fuel efficiency and greenhouse gas emissions compliance. The vehicle owner is responsible for being sure these components are replaced with the same or equivalent components that maintain compliance with federal and local regulations.

For help with determining tires that are the same or equal in regards to rolling resistance for maintaining compliance with the regulatory standards, please contact Michelin at 1-800-947-3435.

Allison Transmission Operation

Operation

The display screen on the shift control pad will indicate the highest selected gear for the transmission. When mountainous or up-and-down terrain conditions are encountered, you should **manually select a lower gear**, preferably lower than 5th gear. This can be done at any road speed by pressing the down arrow repeatedly until the desired gear is indicated in the window of the shifter pad. When your road speed decreases to a safe point, the transmission will downshift at a higher **RPM** than normal. This will decrease the use of overdrive while pulling hills, which can result in excessive heat build-up in the transmission, and keeps the engine operating at peak horse power and performance.

When ascending a grade, maintain engine speed to within **400-500 RPM** of governed engine speed. Governed speed will be **2200 RPM** on the Cummins ISL engine model. Road speed may decrease, but the engine will be at its peak in the power curve.

It is especially pertinent to monitor your water temperature gauge when climbing steep grades. Keep in mind that it is not uncommon for the temperature to increase, especially in hot weather. If the gauge reaches 225°F or if the temperature warning light on the gauge panel should come on, reduce your road speed, shift to the next lower gear and keep your tachometer within **500 RPM** of engine governed speed. In many cases this will stabilize the water temperature. If the temperature gauge continues to rise, or if the stop engine light comes on, pull to the side of the road and shift the transmission into neutral. Bring the engine **RPM** to **1,700—2,000 RPM** until the temperature drops down into the normal range. This should occur in a relatively short period of time. If the temperature gauge does not begin to drop, stays in the red zone, or continues to rise, shut down the engine and allow it to cool. After the engine is allowed to cool check the fluid level in the reservoir and add coolant if needed.

A good “**rule of thumb**” for descending grades is to never use a higher gear than was used to climb the same or similar grade. Try to keep the engine within **500 RPM** of governed speed. This will give the best engine braking and reduce the need to use the service brakes. Select a gear that will keep you at a safe speed with minimal brake application. Never ride your brakes when descending a grade since excessive brake heat will build up and your brakes could fade, leaving you with little or no braking power.

Your vehicle is equipped with an engine brake. The engine brake will assist in slowing your vehicle on a downhill grade. With the engine brake switch in the on position, release the accelerator and depress the service brake to activate the engine brake. When the engine brake is activated the transmission will pre-select a lower gear to aid in braking. This is indicated by a “2” in the left hand pane of the transmission shift selector. The transmission will begin to down-shift as soon as the road and engine speed will safely allow. This will produce a slowing effect and will remain engaged until either the exhaust brake switch is turned off, the accelerator is pressed, or the engine speed drops to 800 RPM. If your initial speed is high, you may have to step on the brake to slow the vehicle before the transmission will down-shift from 6th gear to 5th gear. This is normal.

Always select (N) neutral on the transmission shift pad prior to turning off the vehicle engine.

Mode Button

The mode button is located on the keypad pushbutton shift selector. The mode button can be pressed at any time after engine start to activate the alternate shift schedule. There are two shift schedules, a primary and a secondary.

The primary shift schedule is normally used each time the vehicle is started and is specified in such a way to accommodate **“NORMAL”** vehicle operation. This shift schedule is also known as **“PERFORMANCE”** mode.

The secondary shift schedule is an alternate shift schedule that the TCM only uses upon request. This shift schedule is also known as **“ECONOMY”** mode.

“ECONOMY” mode will allow the transmission to make shift changes at a lower engine RPM, thus making it possible to get better fuel mileage. Factors such as terrain, driving habits, vehicle weight and towing will still have an impact on mileage.

Fluid Level Check





Use the transmission shift pad for best results in checking the transmission fluid level. The transmission will not reach operating temperature until the coach has been driven for at least 15 miles. Therefore it may be best to check transmission fluid level at the end of your driving day.

Transmissions do not consume fluid. If your transmission shows to be low of fluid it should be inspected for leaks.





Check the transmission fluid level with the following steps:

Conditions that must be met

- **Be sure transmission is at operating temperature (104° to 220° F)**
- **Vehicle is parked on level ground with the parking brake is set**
- **Transmission in neutral and engine at idle**
- **Wait until vehicle has been stationary for two minutes**

- Simultaneously press the up and down arrow keys 

- Correct fluid level will be indicated by 
- Low fluid level will be indicated by 
- High fluid level will be indicated by 

If conditions are not met one of the following messages will be displayed

- Oil temp too low 
- Not in neutral 
- Not stationary for two minutes 
- Engine not at idle 

Brake System

Brake System



Figure 3-1: Rear Brakes

- Front brakes are 17” air applied disc
- Rear brakes (Figure 3-1) double as parking brake
 - Park brakes are spring applied – air released
 - Two large 16.5 x 7” drum brakes
 - Park brake remains applied even if air pressure is lost
- If air pressure is lost
 - A buzzer and warning lamp will alert you
- Chassis is equipped with automatic slack adjusters (Figure 3-2)
 - No brake adjustment required



Figure 3-2: Automatic Slack Adjuster

The rear brakes on the PowerGlide chassis are also used as the parking brakes. This provides you the holding power of two large drum brakes to prevent your coach from rolling, even when fully loaded on a 20% grade.

A decrease in air pressure while driving will **not** cause an immediate loss of brakes. If a significant leak develops in the air system, at approximately **60 PSI** you will be alerted by a lamp on the instrument panel, and by an audible alarm. As you apply the brakes, the air supply holding the park brakes in the released position will gradually be depleted. When system pressure drops to approximately **40 PSI** the rear brakes will set. This allows you sufficient time to pull over to the side of the road.

BRAKE SYSTEM

NOTE: The rear brakes have dual chambers – one for the service brakes and one for the park brake. The service brakes are air applied and spring released. The park brake is spring applied and air released.

The brake system is equipped with automatic slack adjusters that avoid the need to manually adjust your brakes. Each time you step on the brake pedal, if adjustment is needed, the adjusters will take up the slack.

Compressed Air System

40' Non-Tag Tank Drains



44' Tag Tank Drains



Compressed Air System

The compressed air system is comprised of **multi-air storage tanks**. The **primary tank** stores and supplies air for the **rear brakes**, the secondary tank stores and supplies air for the **front brakes**.

When air is compressed it becomes hot. As it cools, condensed moisture forms in the system. The air system is equipped with an air dryer to remove most of this moisture. The dryer has an automatic moisture ejector that releases the trapped moisture back into the atmosphere. However, some moisture will form in the system beyond the dryer, and make its way into the storage tanks. As moisture collects in the **primary** and **secondary** tanks, it displaces the area needed for air storage, thus requiring that the tanks be **drained periodically**.

The air system is equipped with **air tank drains** conveniently located in the compartment with the DEF tank. Each drain is attached to a different tank. These drains should be **opened regularly** for a few seconds to **remove** any moisture trapped in the tanks.

Air Dryer



Figure 3-3: Haldex Purest Air Dryer

The Tiffin PowerGlide chassis air brake system features a Haldex Purest air dryer (Figure 3-3), which removes the condensed moisture from compressed air. The air dryer is equipped with a desiccant cartridge that needs to be changed **every 36 months**. The dryer is located on the driver's side (LH) frame rail (behind the rear axle).

Warning

Air tanks should be bled of all pressure any time you perform work on the air system.

Engine Compression Brake



Figure 3-4: Compression Brake

The engine compression brake (Figure 3-4):

- Improves braking power
- Reduces the chance of overheating brakes on steep grades
- Works in conjunction with the transmission to help slow the vehicle
- Has two stages (low and high) for varying terrain

All brakes will build up heat when being used due to friction – this is normal. However, excessive use of the brakes when descending a grade can result in excessive heat and can cause “**brake fade**” or a loss of braking power, even with disc brakes. The proper way to use your brakes is to go slowly enough that a fairly light, occasional use of the brakes will keep your speed from increasing.

NOTE: DO NOT maintain continual brake pedal pressure when descending a hill with any type of brake system.

Rather, down-shift the transmission to slow the vehicle and make light, intermittent brake applications to control downhill speeds. By utilizing the transmission gears and compression brake, continual use of the brakes will not be necessary. When using the transmission’s lower gears to slow the vehicle on hills, be careful not to exceed the governed speed of your engine. If engine-governed speed is exceeded, the transmission will shift up to the next range, rapidly increasing the speed of your vehicle. If you find that you are continually using the brakes to maintain a safe speed and to keep the **RPM** within this range, slow the vehicle down even further and shift the transmission to a **lower gear**.

Warning

DO NOT USE the compression brake on wet roads, hazardous, or slippery conditions.
As with any motorized vehicle, practice safety when on the road.

BRAKE SYSTEM

Cummins ISL Engine

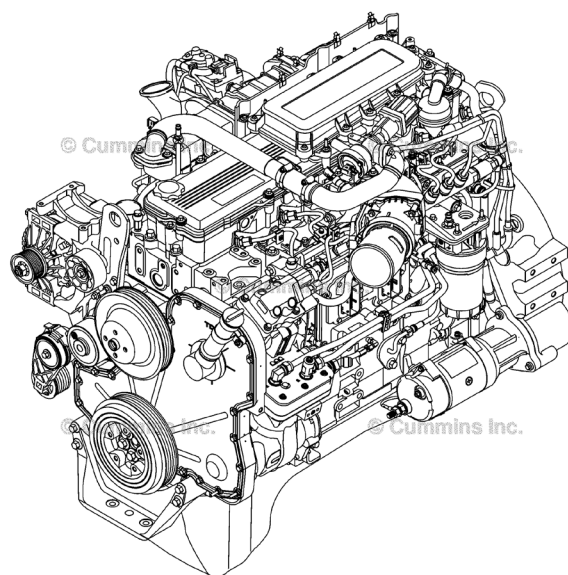

0000018

EPA Mandates

The Environmental Protection Agency (EPA) mandates that all engines built after December 31, 2009 must reduce the level of emissions exhausted by the engine to the following levels.

Nitrous Oxides (NO_x) – 0.2 g/bhp-hr

Particulate Matter (PM)- .01 g/bhp-hr

To meet EPA guidelines, diesel engines installed in Tiffin Motorhomes PowerGlide chassis for domicile in Canada and the USA use an after treatment system (ATS) with a diesel particulate filter (DPF) to reduce particulate matter, and selective catalytic reduction (SCR) technology to reduce NO_x downstream of the engine.

Notice

Using non-specification fluids can result in serious damage to the ATS. It is extremely important that the following guidelines be met for vehicles with EPA10 thru EPA2017 compliant engines, or damage may occur to the ATS, and the warranty may be compromised.

- Use "ultra-low sulfur diesel (ULSD)" with 15 ppm sulfur content or less.
- Do not use fuel blended with used engine lube oil or kerosene.
- Engine lube oil must have a sulfated ash level less than 1.0 wt %, currently referred to as CJ-4 oil.
- Use only API certified diesel exhaust fluid (DEF) in the DEF tank.

The ATS is comprised of a diesel oxidation catalyst (DOC), and a diesel particulate filter (DPF). The DPF traps soot particles, and exhaust heat converts the soot to ash in the DPF in a process called regeneration (re-gen). The harder an engine works, the better it disposes of soot. When the engine is running under load and re-gen occurs without input, it is called passive re-gen. If the engine isn't running hot enough, the electronic controls may initiate an active re-gen, whereby extra fuel is injected into the exhaust stream before the DPF, to superheat the soot trapped in the filter and burn it to ash. Both types of re-gen occur without driver input.



Operating at reduced engine load will allow soot to accumulate in the DPF. When this occurs, the DPF lamp  illuminates, indicating that a re-gen **must** be performed, and the driver **must** bring the vehicle up to highway speed to increase the load. Driving at highway speeds for 20 minutes should allow for a re-gen to take place, and turn off the DPF lamp.

After the exhaust stream passes through the DPF, it flows through a second canister housing which is the SCR device. A controlled quantity of diesel exhaust fluid (DEF) is injected into the exhaust stream where

heat converts it to ammonia (NH₃) gas. This mixture flows through the SCR device where the ammonia gas reacts with the NO_x in the exhaust to produce harmless nitrogen (N₂) and water vapor (H₂O), which then exits out of the tailpipe.

ATS Warning Lamps

Warning lamps in the driver's message center alert you of situations with the after-treatment system.

- An illuminated DPF lamp indicates a re-gen is needed.  Driving at highway speeds for 20 minutes should correct this condition.
 - A blinking DPF lamp indicates the need for a re-gen is more urgent. Again, driving the vehicle at highway speeds for 20 minutes should correct this condition.
 - A blinking DPF lamp along with a check engine light indicates that the engine is unable to effectively regenerate, and you should **immediately** seek service at the nearest Cummins Authorized Dealer.
- An illuminated High Exhaust Temperature (HEST) lamp alerts the operator of elevated exhaust temperatures while the engine is performing an active re-gen.  Do not operate, or park the vehicle near flammable objects while the HEST lamp is illuminated.
- An illuminated DEF warning lamp indicates that the DEF tank should be refilled at the next opportunity.  This light will illuminate when the tank level is at approximately 10%.
 - A blinking DEF warning lamp indicates the tank level has dropped to approximately 5%.
 - A blinking DEF lamp along with the check engine lamp indicates the tank level has dropped to approximately 2.5%. A 25% reduction in engine torque will be applied with this condition.
 - When the tank is empty the Stop Engine Light will be illuminated and the vehicle speed will be limited to 5 MPH. Filling the tank with new DEF will remedy this condition.

DPF Maintenance

Eventually ash will accumulate in the DPF and the filter will require servicing. DPF servicing must be performed by an authorized technician, following the engine manufacturer's instructions. DPF cleaning will be required at approximately 200,000 miles of service. A record must be maintained for warranty purposes, which includes:

- Date of cleaning or replacement
- Vehicle mileage
- Particulate filter part number and serial number

Aftertreatment Operation

Diesel Particulate Filter

Soot is composed of the partially burned particles of fuel that occur during normal engine operation (black smoke).

Ash is composed of the partially burned particles of engine oil that occur during normal engine operation.

Over time, both soot and ash accumulate in the DPF and must be removed. Soot is removed by a process called regeneration. Ash is removed by removing the DPF and cleaning it at specified intervals.

A vehicle with an ATS has up to four additional indicator lamps on the dashboard. These additional lamps, along with the check engine lamp, alert the operator of the status of the ATS.

Ultra low sulfur diesel fuel is required for an engine equipped with a DPF. If ultra low sulfur diesel is not used, the engine might not meet emissions regulations, and the DPF or DOC can be damaged.

To maximize the maintenance intervals of the DPF, Cummins Inc. recommends the use of a lubricating engine oil meeting Cummins Engineering Standard 20081. The use of oil meeting CES 20081 also requires the use of ultra low sulfur diesel fuel to maintain the specified oil drain interval without risk of engine damage.

Regeneration

Regeneration is the process of converting the soot collected in the DPF into ash.

Under some operating conditions, such as low speed, low load, or stop and go duty cycles, the engine may not have enough opportunity to regenerate the DPF during normal vehicle operation. When this occurs, the engine will illuminate the DPF lamp to inform the vehicle operator that assistance is required, typically in the form of operating the vehicle at highway speeds for approximately 20 minutes.

Heat is required for the regeneration process to occur. Regeneration can be classified into two different types: passive regeneration and active regeneration.

Passive Regeneration

Passive regeneration occurs when the exhaust temperatures are naturally high enough to oxidize the soot collected in the DPF faster than the soot is collected.

Passive regeneration typically occurs when the vehicle is driven at normal highway speeds and/or under heavy loads.

Active Regeneration

Active regeneration occurs when the exhaust temperatures are not naturally high enough to oxidize the soot in the DPF faster than it's collected.

Active regeneration requires assistance from the engine in to increase the exhaust temperature. This is typically accomplished by the engine injecting a small amount of diesel fuel into the exhaust stream, which is then oxidized by the DOC, and creates the heat needed to regenerate the DPF.

Active regeneration will occur more frequently in vehicles operated at low speed, low load, or stop and go duty cycles. Active regeneration only occurs if the engine ECM has detected that the DPF restriction has reached a specified limit, and may only occur if the vehicle is moving above a preset speed threshold. The engine ECM will activate and de-activate active regeneration as needed.

Active regeneration is largely transparent to the vehicle operator, the vehicle operator may notice an increase in turbocharger noise during an active regeneration event, and may notice that the high exhaust temperature lamp is illuminated, if the vehicle is so equipped.

During active regeneration, the exhaust temperature can be hotter than when the engine is operating at full load. The exhaust temperature during a normal active regeneration event could reach 1100°F, and possibly 1500°F under certain conditions.

Warning

Active regeneration can occur any time the vehicle is moving, and the exhaust temperature can remain hot after the vehicle has stopped moving. The exhaust temperature could reach 1500°F, which is hot enough to ignite or melt common materials, or to burn people. If the HEST lamp is illuminated do not operate or park the vehicle with the exhaust near people, or flammable materials.

Aftertreatment Warm-up

The ATS warm up function is used to help prevent the buildup of water condensation in the ATS during extended idle operation.

After approximately four hours of engine idle operation, the engine speed will increase to around 1100 RPM, and remain at this speed for 10 minutes. During this time the ATS is warmed up enough to evaporate any water that has condensed in the system.

The ATS warm-up function can be stopped by depressing the throttle, clutch, or brake pedal. If the engine continues to idle, the ATS warm-up function will try to raise the idle speed until the ATS temperatures are suitable.

Engine Indicator Lamps

General Information

The following engine indicator lamps cover only the lamps controlled by the engine ECM.

Wait to Start Lamp

The WAIT TO START lamp illuminates when the intake air heater needs to warm the intake air prior to starting the engine. The WAIT TO START lamp on time will vary depending on the ambient air temperature.

The WAIT TO START lamp is amber and looks similar to this:



Check Engine Lamp

The CHECK ENGINE lamp illuminates when the engine needs to be serviced at the first available opportunity.

The CHECK ENGINE lamp is amber, and looks similar to this:



Another function of the CHECK ENGINE lamp is to flash for 30 seconds at key-on when one of the following occurs. This flashing function is referred to as the MAINTENANCE lamp. The MAINTENANCE lamp could flash for any of the following reasons:

- Maintenance required (if the Maintenance Monitor is enabled).
- Water-in-fuel is detected.
- Coolant level is low.

Stop Engine Lamp

The STOP ENGINE lamp indicates, when illuminated, the need to stop the engine as soon as it can be safely done. The engine must remain shut down until the engine can be repaired.

For engines with the Engine Protection shutdown feature enabled, if the STOP ENGINE lamp begins to flash, the engine will automatically shut down after 30 seconds. The flashing STOP engine lamp alerts the operator to the impending shut down.

The STOP ENGINE lamp is red in color, and looks similar to this:



Malfunction Indicator Lamp (MIL)

The engine in this vehicle is required to conform to EPA Heavy Duty On-Board Diagnostic (OBD) regulations. OBD exist to make sure the engine is operating within the prescribed emissions limits. The OBD system monitors the ATS to detect malfunctions that adversely affect emissions. If a malfunction is detected the malfunction indicator lamp (MIL) will illuminate, and a diagnostic fault code will be logged in the engine control module.

The MIL lamp is amber, and looks similar to this:



Diesel Particulate Filter (DPF) Lamp

The DPF lamp indicates, when illuminated or flashing, that the DPF needs to be regenerated.

The DPF lamp is amber, and looks similar to this:



An illuminated DPF lamp indicates that the DPF needs to be regenerated at the next possible opportunity. This can be accomplished by:

1. Changing to a more challenging duty cycle, such as highway driving, for at least 20 minutes.
2. Have a Cummins authorized repair location perform a stationary regeneration.

NOTE: Stationary regeneration is considered a normal maintenance practice and is not covered by Cummins Inc. warranty.

A flashing DPF lamp indicates that the DPF needs to be regenerated at the next possible opportunity. Engine power may be reduced automatically.

When the DPF lamp is flashing, the operator should:

1. Change to a more challenging duty cycle, such as highway driving, for at least 20 minutes.
2. Have a Cummins authorized repair location perform a stationary regeneration.

A flashing DPF lamp combined with an illuminated CHECK ENGINE lamp indicates that the DPF needs to be regenerated immediately. Engine power will be reduced automatically. When these lamps are illuminated together you should **immediately** seek service from a Cummins authorized repair location.

NOTE: If the engine is unable to complete a DPF regeneration cycle, the STOP ENGINE lamp will illuminate and the vehicle will have to be towed to a Cummins authorized repair location.

High Exhaust Temperature (HEST) Lamp



The HEST lamp is amber, and looks similar to this:

The HEST lamp indicates, when illuminated, that exhaust temperatures are high due to regeneration of the DPF. The lamp could illuminate during normal engine operation or during stationary regeneration.

NOTE: The OEM determines whether or not the HEST lamp is installed on the vehicle. The OEM also specifies the temperatures, vehicle speeds, and other conditions at which the lamp illuminates. Refer to the OEM service manual for additional information regarding this lamp.

When this lamp is illuminated, make sure the exhaust pipe outlet is not directed at any surface or material that will melt, burn, or explode.

- Keep the exhaust outlet away from people, and anything that can burn, melt, or explode.
- Nothing within 0.6 m [2ft] of the exhaust outlet
- Nothing that can burn, melt, or explode within 1.5 m [5ft] (such as gasoline, wood, paper, plastics, fabric, compressed gas containers, or hydraulic lines).
- In an emergency, turn off the engine to stop the flow of exhaust.

NOTE: The HEST lamp does not signify the need for any kind of vehicle or engine service; it merely alerts the vehicle operator to high exhaust temperatures, it will be common for the HEST lamp to illuminate on and off during normal vehicle operation as the engine completes regeneration.

Diesel Exhaust Fluid (DEF) Lamp



The DEF lamp is amber, and looks similar to this:

The DEF lamp indicates, when illuminated or flashing, that the diesel exhaust fluid level is low.

Diesel Exhaust Fluid (DEF) Lamp (cont.)

An illuminated DEF lamp indicates that the DEF level has fallen below the initial warning level. This can be corrected by filling the DEF tank with diesel exhaust fluid.

NOTE: It is recommended that the DEF tank be filled completely full of diesel exhaust fluid in order to correct any fault conditions.

A flashing DEF lamp indicates that the DEF level has fallen below the critical warning level. This can be corrected by filling the diesel exhaust fluid tank with diesel exhaust fluid.

NOTE: It is recommended that the DEF tank be filled completely full of diesel exhaust fluid in order to correct any fault conditions.

A flashing DEF lamp combined with an illuminated WARNING or CHECK ENGINE lamp indicates that the DEF level has fallen below the initial derate level. The engine power will be limited automatically. This can be corrected by filling the DEF tank with diesel exhaust fluid.

NOTE: It is recommended that the diesel exhaust fluid tank be filled completely full of diesel exhaust fluid in order to correct any fault conditions.

If the engine has been shut down, idled for 1 hour, or if fuel has been added after the DEF tank has been emptied, the STOP ENGINE lamp will also be illuminated along with the flashing DEF lamp and illuminated CHECK ENGINE lamp. The engine vehicle speed will also be limited to 5 mph.

NOTE: In order to remove the 5 mph speed limit, the diesel exhaust fluid tank must be filled to at least 10 percent volume of the tank.

NOTE: It is recommended that the DEF tank be filled completely full of diesel exhaust fluid in order to correct any fault conditions.

Engine Starting

Warning

Do not use starting fluids with this engine. This engine is equipped with an intake air heater. Use of starting fluids could cause an explosion, fire, personal injury, severe damage to the engine, and property damage.

NOTE: For cold-weather starting, see “Cold-Weather Operation” in Section 1 of the Cummins Engine Owner’s Manual.

NOTE: Cummins electronic engines are run on a dynamometer before being shipped from the factory. They do not require a break-in period.

IMPORTANT: Special break-in oils are not recommended for new or rebuilt Cummins engines.

NOTICE

If a vehicle does not start on the first attempt, make sure that the engine has completely stopped rotating before reapplying the starter switch. Failure to do so can cause the pinion to release and re-engage, which could cause ring gear and starter pinion damage.

IMPORTANT: Ring gear and starter pinion damage caused by improper starting procedures is not warrantable.

NOTICE

Do not crank the engine for more than 30 seconds at a time. Wait two minutes after each try to allow the starter to cool. Failure to do so could cause starter damage.

NOTICE

If the engine is equipped with a turbocharger, protect the turbocharger during start-up by not opening the throttle or accelerating the engine above 1000 rpm until normal engine idle oil pressure registers on the gauge.

Starting

Set the parking brake.

1. Place the transmission in neutral.
2. Turn the key to the ON position.
3. Wait a minimum of 10 seconds. If the “Wait-to-Start” lamp is still illuminated after 10 seconds, continue to wait until the lamp is no longer illuminated. The wait to start lamp may stay illuminated for up to 30 seconds depending on ambient temperature.
4. Start the engine.
5. NOTE: See the Cummins Operation and Maintenance Manual for detailed information on starting procedures.

Cold-Weather Starting

Turn the ignition switch to the on position. If the Wait-To-Start lamp  is illuminated, wait until it goes out before trying to start the engine. The Wait-To-Start lamp will stay on for up to 30 seconds. The length of time it remains illuminated depends on the ambient temperature. Once the Wait-To-Start lamp goes off, turn the key to the start position. If the engine doesn't start after 30 seconds of cranking, turn the key to the off position and wait two minutes; then repeat the starting procedure. Once the engine is started, let it run at idle for 3 to 5 minutes before driving. If normal engine oil pressure doesn't show on the gauge within 15 seconds of starting, shut the engine off and contact your nearest Cummins authorized repair location for assistance.

If the unit is equipped with a block heater, start the block heater 2 to 4 hours before travel.

Engine Braking

Important: The engine brake is a vehicle slowing device, not a vehicle stopping device. It is not a substitute for the vehicle service brakes. Use of the engine brake for vehicle downhill control, and slowing down on level terrain will help the service brakes to remain cool and ready for an emergency.

Warning

Do not use the engine brake on wet, icy, or snow-covered roads. Using the engine brake could result in loss of vehicle control, possibly causing personal injury, death, or property damage.

Engine brakes are devices that use the energy of engine compression to provide vehicle retardation. Engine brakes provide maximum retardation while the engine is at rated speed. Therefore, the engine works in conjunction with the transmission to automatically select the best gear for maximum braking efficiency.

The Allison transmission provides for optimum retarding downshift operation. When the engine brake is turned ON, your foot is removed from the throttle pedal, and the service brake is depressed, the transmission will immediately pre-select a lower gear. The transmission then starts to down-shift through gears to reach the pre-selected gear. When the engine brake is active, down-shifting occurs at higher speeds than when it is not active. This allows the engine brake to provide the maximum retarding power.

The engine brake switch in your coach has three positions; off (center position) low, and high. In the low position the engine uses only three cylinders to provide braking effort. In the high position the engine uses all six cylinders to provide braking effort.

The engine brake is activated when the following conditions are satisfied:

1. The engine brake switch is in the low or high position
2. The accelerator pedal is released
3. The service brake is depressed

Cruise Control

Warning

Do not use the cruise control system when driving conditions do not permit maintaining a constant speed, such as in heavy traffic or on roads that are winding, icy, snow covered, slippery, or roads with a loose driving surface. Failure to follow this precaution could cause a collision or loss of vehicle control, possibly resulting in personal injury, death, or property damage.

NOTICE

Cruise control allows you to automatically control the speed of the vehicle above 32 MPH (50 km/h).

Do not shift to Neutral (N) when using cruise control. This will cause the engine to over-speed, which can damage the engine.

Cruise On/Off

Press the cruise control ON/OFF switch to activate the cruise control or to turn it off.

Cruise Set

Press the cruise control SET switch to set the desired cruising speed.

Cruise Resume

Press the cruise control RESUME switch to resume cruise control activation.

Disengage Cruise

Disengage the cruise control by depressing the service brake, or by switching the cruise on/off switch to the off position.

Engine Shutdown

1. With the vehicle stopped, place the transmission in the Neutral (N) position, and set the parking brake using the parking brake control knob.
2. It is important to idle an engine for 3 to 5 minutes before shutting it down. This allows the lubricating oil and the water to carry heat away from the combustion chambers, bearings, shafts, etc. This is especially important with turbo-charged engines.
3. Do not idle the engine for long periods.
4. If the engine is not being used, shut it down by turning the ignition key to the OFF position.
5. Allow a minimum of 3 minutes after the engine is turned off before switching off the chassis battery disconnect.

Diagnostic Fault Codes

The engine control (ECM) monitors the engine sensors and parameters while the engine is in operation. The ECM can detect certain conditions that are outside of the normal operating parameters. The ECM will log diagnostic fault information, and illuminate the check engine light, stop engine light, or the malfunction indicator light to inform the operator of a problem. It will also log diagnostic fault information in the form of numeric codes to assist a technician in troubleshooting the concern.

Diagnostic fault codes fall into two categories; active faults, and historic faults. Active faults indicate the condition causing the fault is still present. Historic faults indicate the condition causing the fault is no longer present, but remain in the ECM memory to assist the technician when diagnosing the concern.

Active fault codes can be retrieved by the operator using the dash instrumentation. This can be helpful in determining if the condition is serious, and needs immediate attention, or if it is safe to continue operating the engine until it is convenient for the operator to have the service work performed.

Retrieve active fault codes using the following steps:

Refer to page 33 in the Instruments & controls section of this manual, follow the illustration on page 27 and navigate to the OBD section and retrieve the information listed below.

The desired screen will look like this:

On Board Diagnostics (DM1)		
Status	SPN	FMI ADDR Description
Active	96	3-Volt Above Norm 33 Fuel Level 1
Inactive	241	18-Data Below Norm MS 51 Tire Pressure

Two pieces of information will be displayed

- a. SPN followed by a 3 or 4 digit number
- b. FMI followed by a 1 or 2 digit number

Provide these two pieces of information to a Tiffin phone tech, or the nearest Cummins authorized repair location for guidance on how you should proceed.

Towing

The Allegro Phaeton is capable of towing typical motor vehicles or trailers up to 10,000 lbs. The motor home is equipped with a 10,000-pound towing hitch, and associated wiring connector. The total weight of the motor home and any vehicle towed must not exceed the Gross Combined Weight Rating (GCWR). When the motor home is weighed, remember to account for passengers and their locations in the motor home. Any vehicles or trailers to be towed by the motor home should have adequate active braking.

CUMMINS ENGINES

Scheduled Maintenance

SCHEDULED MAINTENANCE

Scheduled Maintenance

SERVICE INTERVAL (Miles x 1,000)	Annually	5	10	15	20	50	Required Fluids, Lubricants, and Procedures
Air System:							
Air Dryer		X					Inspect for leaks and blockage of purge valve (7)
Air Intake Screen		X					Inspect for blockage
Primary Air Tank Reservoir		X					Open drain to release excess moisture before and after each trip
Secondary Air Tank Reservoir		X					Open drain to release excess moisture before and after each trip
Brake Systems:							
ABS Sensors						X	Clean sensors & adjust into hub rings
Brake Pads, Rotors, Shoes & Drums					X		Inspect pads, shoes, rotors & drums for wear and cracks (1)
Slack Adjusters					X		Inspect slack adjuster for proper adjustment – lubricate w/ NGLI #2 grease
Brake Hoses/Whips, Front & Rear			X				Inspect for leaks, & cracking.
Cooling Systems:							
A/C Condenser Fins			X				Inspect for blockage and wash clean every 10k or as needed
Charge Air Cooler Fins			X				Inspect for blockage and wash clean every 10k or as needed
Fan & Fan Shroud					X		Inspect for blockage and cracks.
Radiator Fins/Grill			X				Inspect for blockage and wash clean every 10k or as needed
Radiator Hoses & Pipes			X				Inspect for kinks, chaffing wear and leaks.
Surge Tank Cap		X					Inspect for leak
Surge Tank Vent Lines		X					Inspect for kinks and leaks daily
Fan Drive Belt					X		Inspect fan belt. Replace if cracks appear across belt section
Electrical Systems:							
Rear Electrical Compartment		X					Check for loose fuses and cables
Front Electrical Compartment		X					Check for loose fuses and cables
Generator Cables		X					Check for loose red & black cables connected to generator
Alternator Belt					X		Check for correct tension and wear (1)
Batteries		X					Inspect for leaks / check for loose lugs / remove any corrosion

SCHEDULED MAINTENANCE

SERVICE INTERVAL (Miles x 1,000)	Annually	5	10	15	20	50	Required Fluids, Lubricants, and Procedures
Engine Systems:							
Engine Oil Filter	X				X		Replace engine oil filter per engine manual (1)
Engine Oil	X				X		Change engine oil per engine manual (1)
Exhaust Muffler & Piping			X				Inspect for pinholes, rust and leaks
Engine Air Filter	X	X					Check restriction indicator - replace filter as needed (6)
Fuel Tank Vent Lines					X		Inspect for "P" traps that may cause air locks and slow filling
Fuel Tank & Lines			X				Inspect for leaks around fuel inlet nipples and hoses
Engine Coolant		X					Test coolant inhibitor level and freeze protection every 6 months (10)
Primary Fuel Filter	X				X		Replace fuel filter per engine manual (1)
Secondary Fuel Filter	X				X		Replace fuel filter per engine manual (1)
Air Intake Piping (filter to turbo)		X					Inspect for rubbing, holes, broken or loose clamps. Repair any problems immediately
Engine Crankcase Breather							Replace every 60,000 miles
Steering Systems:							
Steering Gear			X				Inspect mount bolts for looseness & hydraulic hoses for leaks
Steering Gear Pump			X				Inspect for hydraulic hose leaks at fittings
Steering Shaft U-Joints			X				Inspect for loose fasteners
Steering Shaft Boot			X				Inspect for clearance between boot & shaft, lubricate w/ NGLI #2 grease
Steering Fluid			X				Check fluid level and inspect for leaks
Steering Fluid Change						X	Change fluid at 5 years or 50,000 miles (8)
Suspension & Axles:							
Coach Alignment				X			Align coach as needed (4)
Front Ride Height Adjust					X		Adjust to 10" measuring bag height from top plate to bottom of piston
Rear Ride Height Adjust					X		Adjust to 7" from bottom of rail to centerline of axle
Ride Height Valve Linkages					X		Grease linkage grommets w/D.A. Stewart Aqualube
Air Suspension Bags			X				Inspect for leaks at fittings and inspect bags for leaks or cracks
Front Axle Bearings					X		Inspect seals for leakage and repair as necessary (11)
Front Axle Tie Rods - Inspect					X		Inspect for looseness
Front Axle King Pins	X				X		Lubricate W/NGLI #2 grease or annually
Front & Rear Shocks			X				Inspect for leaks on shock tube, replace as needed
Drive Axle Lube					X		Inspect for leaks & check fluid level. Use synthetic oil only 75W90 (3)
Wheel Lug Torque			X				Re-torque all wheels nuts - Torque 450-500 lbs (2)
Tag Axle			X				Inspect for leaks and check fluid level in hubs. Use 80W90 non-synthetic gear oil (9)

SCHEDULED MAINTENANCE

SERVICE INTERVAL (Miles x 1,000)	Annually	5	10	15	20	50	Required Fluids, Lubricants, and Procedures
Suspension & Axles:							
Automatic Slack Adjusters	X				X		Lubricate W/NGLI #2 grease (1)
Slack Adjuster Cam Shafts	X				X		Lubricate W/NGLI #2 grease (1)
Slack Adjuster Clevis Pins					X		Inspect for wear in clevis pin and cotter pins. Replace as necessary
Transmission & Driveline:							
Drive Shaft					X		Inspect u-joints for loose bolts & wear, lubricate w/NGLI #2 grease (1)
Transmission Fluid							Replace fluid every 5 years or when indicated by transmission shift pad (5)
Transmission Filters							Replace filters every 5 years or when indicated by transmission shift pad (5)

- (1) Replace / inspect at stated mileage interval or every 12 months, whichever occurs first.
- (2) Re-torque all wheel nuts after the first 100 miles, then every 10K miles thereafter.
- (3) Factory filled with synthetic oil. Do not mix with mineral oils. Change fluid every 3 years or 50K miles.
- (4) For best tire life and handling, alignment of front axle is recommended every 15K miles.
- (5) Factory filled with Allison approved TES-295 fluid. To maintain these service intervals, fluid must not be mixed with Dexron or other fluids.
- (6) Replace filter when indicator shows 25 inches or every 12 months, whichever occurs first.
- (7) Replace desiccant cartridge every 36 months.
- (8) Change fluid every 5 years or 50K miles.
- (9) Factory filled with 80W90 mineral oil. Do not mix with synthetic. Change fluid every 3 years or 50K miles.
- (10) Drain, flush, and refill with new antifreeze/coolant every 5 years. Only use coolants that meet or exceed Cummins requirements. Refer to appropriate Cummins literature for specifications. 2009 - 2016 model year coaches were factory filled with Shell Rotella ELC. 2017 -current models are factory filled with Old World Final Charge Global.
- (11) Vehicles with RL80 front suspensions require no hub maintenance for 600,000 miles. Vehicles with RL67, and RL77 front axles require no hub maintenance for 300,000 miles.

Fluids

Engine Oil

The primary oil recommendation for the ISL / ISX engine is a high-quality SAE 15W-40 oil with API classification CJ-4 that meets CES-20081 standards. If the engine is to be consistently operated in extreme cold temperatures, -15°C (5°F), an SAE 5W-40 full synthetic oil is recommended. The Cummins engine in your coach was factory filled with Shell Rotella 15W-40 motor oil.

Cummins does not recommend special break-in oils for this engine. The factory fill oil can be run until the first oil change interval is reached.

Cummins does not recommend the use of aftermarket oil additives in their engines. High-quality 15W-40 engine oils with API classification CJ-4 meeting CES-20081 standards are precisely blended with the necessary additives. Additional additives are not necessary to enhance the oil performance.

Please refer to your Cummins ISL / ISX Owner's Manual for more details on engine oils, and other engine maintenance.

Engine Coolant

The engine cooling system in your coach was factory filled with Old World Final Charge Global, Nitrite-Free Coolant. Old World Final Charge Global is a fully formulated, organic acid technology (OAT) coolant designed to protect all metals within the cooling system.

Do not mix or dilute the coolant in your coach with water, or other non-compatible coolants. If you need to top off your cooling system use only Old World Final Charge Global 50/50 premixed coolant. If the coolant does become diluted with water, or another non-compatible coolant a complete drain, flush, and refill of the cooling system is required.

Test the coolant in your coach for freeze protections, and inhibitors every 5000 miles, or at least twice annually. Test strips can be purchased from Old World Industries or one of its distributors.

The engine coolant in your coach should be replaced every 5 years. Drain, flush, and refill with new coolant. Be sure to use a coolant that meets or exceeds Cummins Engineering Standard, CES-14603. Please refer to your Cummins ISL / ISX Owner's Manual for more details on the required coolant specifications.

IMPORTANT! When refilling the cooling system follow these instructions:

- 1) Remove surge tank lid/ radiator cap. (located on the surge tank)
- 2) Fill radiator through the surge tank (5 GPM max)

SCHEDULED MAINTENANCE

- 3) Once coolant is visible and halfway up the sight glass on the surge tank, start and run engine at idle for one minute, then at high idle for an additional two minutes.
- 4) Return engine to idle and if necessary, top off surge tank until coolant is visible halfway up the sight glass and close lid tightly.



NOTE: A complete drain, flush, and refill should be done at an authorized service center.

Diesel Exhaust Fluid (DEF)

DEF (diesel exhaust fluid) is used to reduce the NO_x (nitrogen oxides) emissions from your engine exhaust system. DEF is non-flammable, non-toxic, and non-polluting. DEF can be corrosive to certain materials. If DEF is spilled, rinse and clean the area immediately with clear water.

It is recommended that you only use DEF certified by the American Petroleum Institute (API) in your vehicle. Look for this symbol on the container, or dispensing system to identify the fluid has been certified by the API.



DEF has a limited shelf life. Normal shelf life is around 18 months if stored in a sealed container at temperatures between 23°F and 77°F. DEF should not be stored in direct sunlight as this will reduce the shelf life of the product. If your coach is in storage for a period of 6 months or longer you should have the condition of the DEF tested before use. Testing should be done using a DEF refractometer. The DEF should show 32.5% Urea concentration, +/- 1.5%. If the DEF test outside of this parameter the tank should be drained, flushed with distilled water, and filled with new DEF.

DEF consumption will vary depending on your driving habits, and operating conditions. Generally DEF consumption will be 2 to 4 gallons for every 100 gallons of diesel fuel burned for the ISL engine. Consumption on the ISX engine will be higher. ISX engines will consume 3 to 6 gallons of DEF for every 100 gallons of fuel burned.

DEF freezes around 12°F. The DEF system on your vehicle is designed to accommodate this condition and does not require any intervention from the operator.

NEVER add anything other than new or known good DEF to the tank. If the tank is accidentally contaminated by another fluid the tank should be drained, flushed with distilled water, and filled with new DEF.

Differential Oil

The differential in your coach was factory filled with Shell Spirax 75W-90 full synthetic lubricant. The fluid level should be checked every 10K miles. If make-up oil is required use only full synthetic 75W-90 lubricants. Never mix mineral oils with synthetic lubricants.

The differential oil should be changed every 3 years or 50,000 miles, whichever occurs first.

Transmission Fluid

The transmission in your coach was factory filled with Shell Spirax S6 A295 synthetic fluid. Spirax S6 A295 is an Allison approved TES-295 fluid. Allison approved TES-295 fluids extend both the service intervals, and the warranty for your transmission. Continued use of TES-295 fluid provides extended warranty coverage up to 5 years or 200,000 miles whichever occurs first.

Transmission fluid should be checked on a regular basis. It is recommended to check fluid at the end of the day when the transmission is at full operating temperature. Fluid should be checked with the park brake set, the engine running at idle, the transmission in neutral, and the transmission temperature above 140°F.

Transmissions do not consume fluid. If you find the need to regularly add fluid to your transmission a leak has developed and you should seek service from an Allison authorized dealer as soon as possible.

Change the transmission fluid and filter when indicated by the illumination of the transmission “wrench icon” on the shift selector, or every 5 years, whichever occurs first.

Please refer to your Allison Transmission Operators Manual for additional information on transmission fluids, and other transmission maintenance.

Lubrication Points

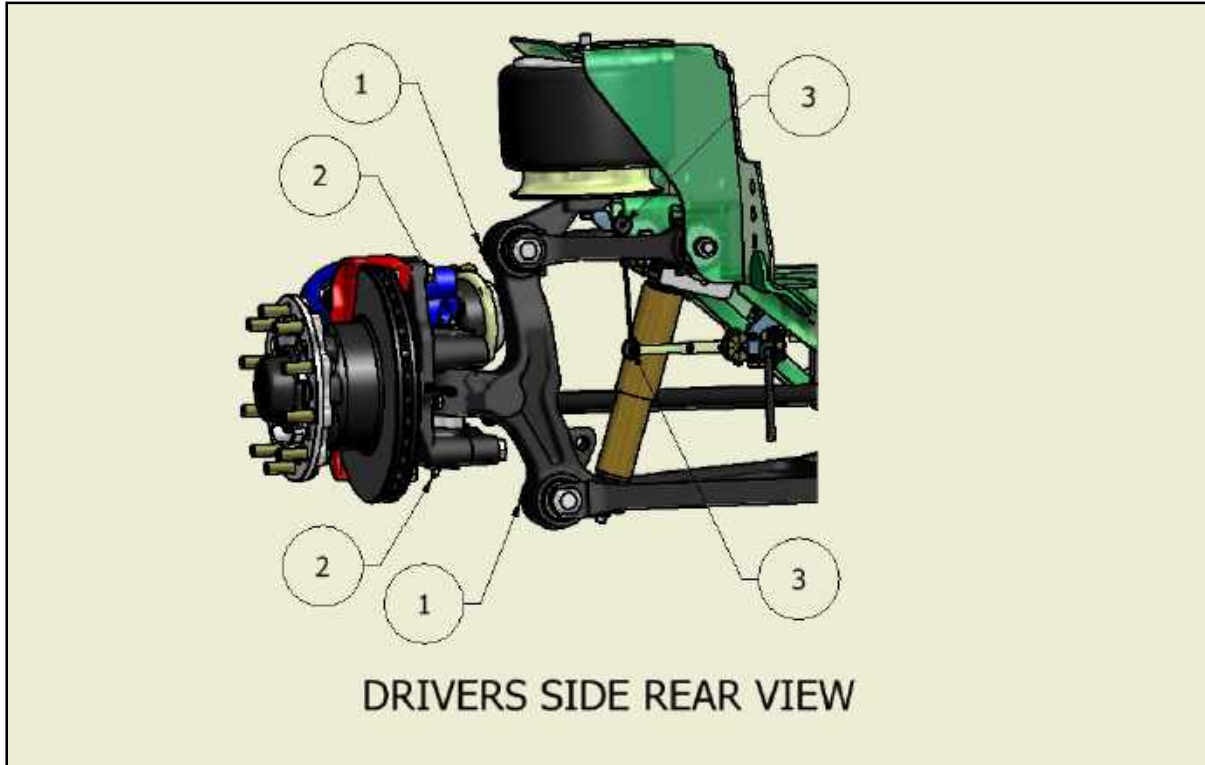

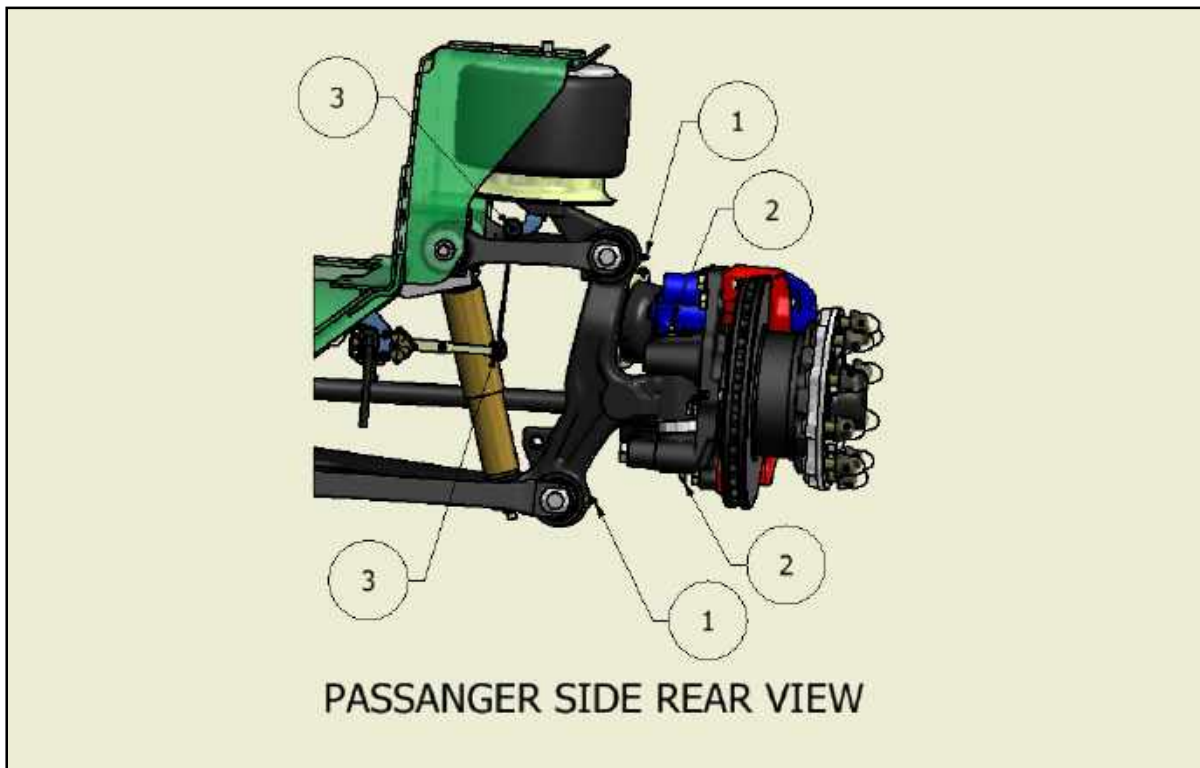

Lubrication Points

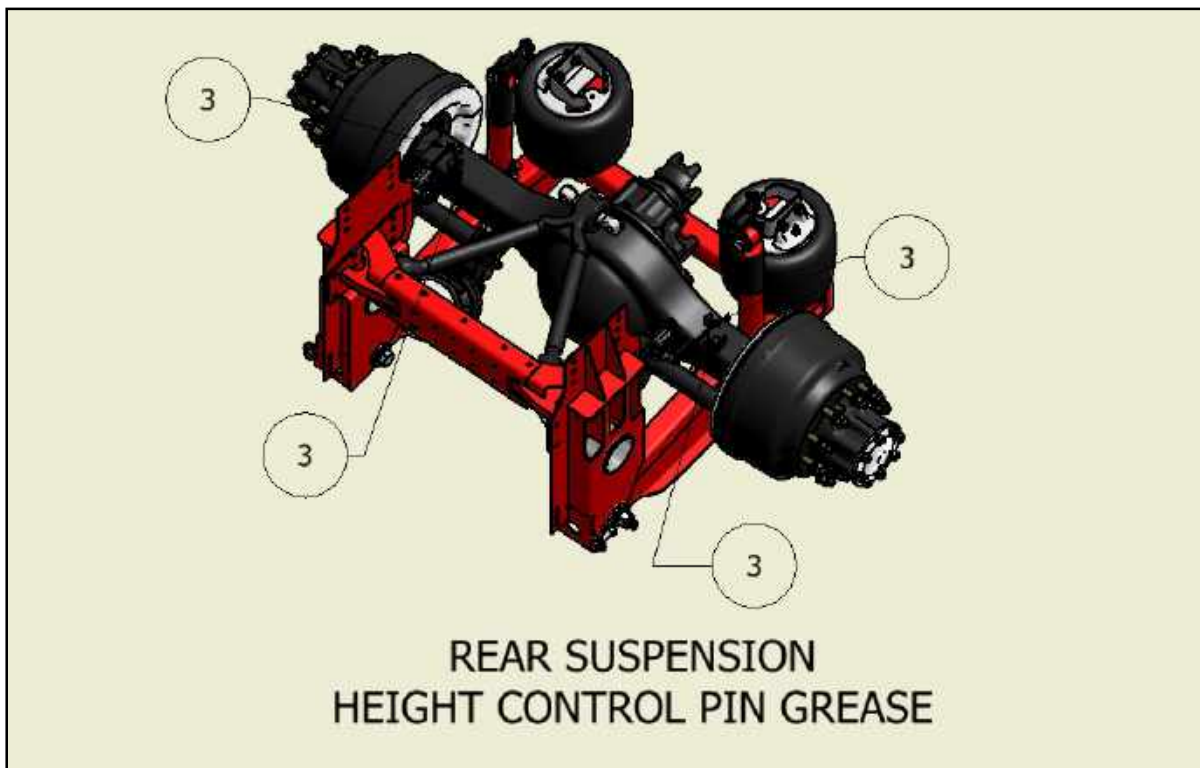

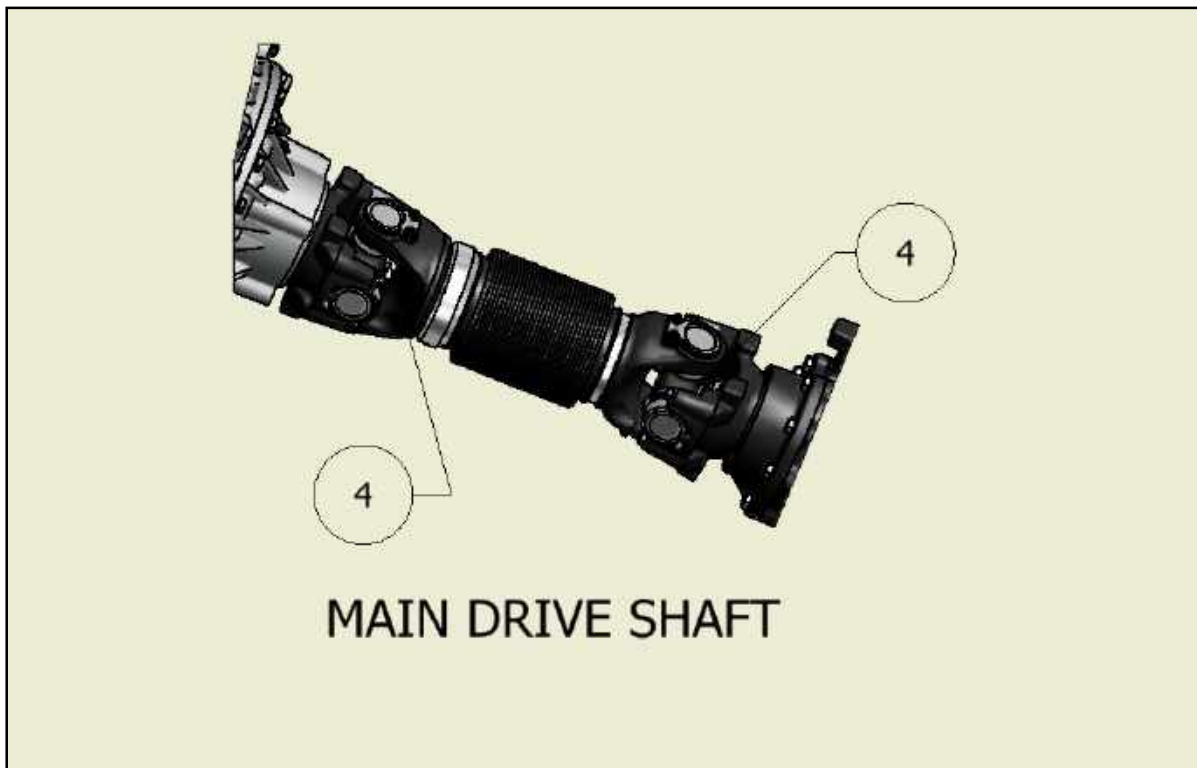

Lubrication Points

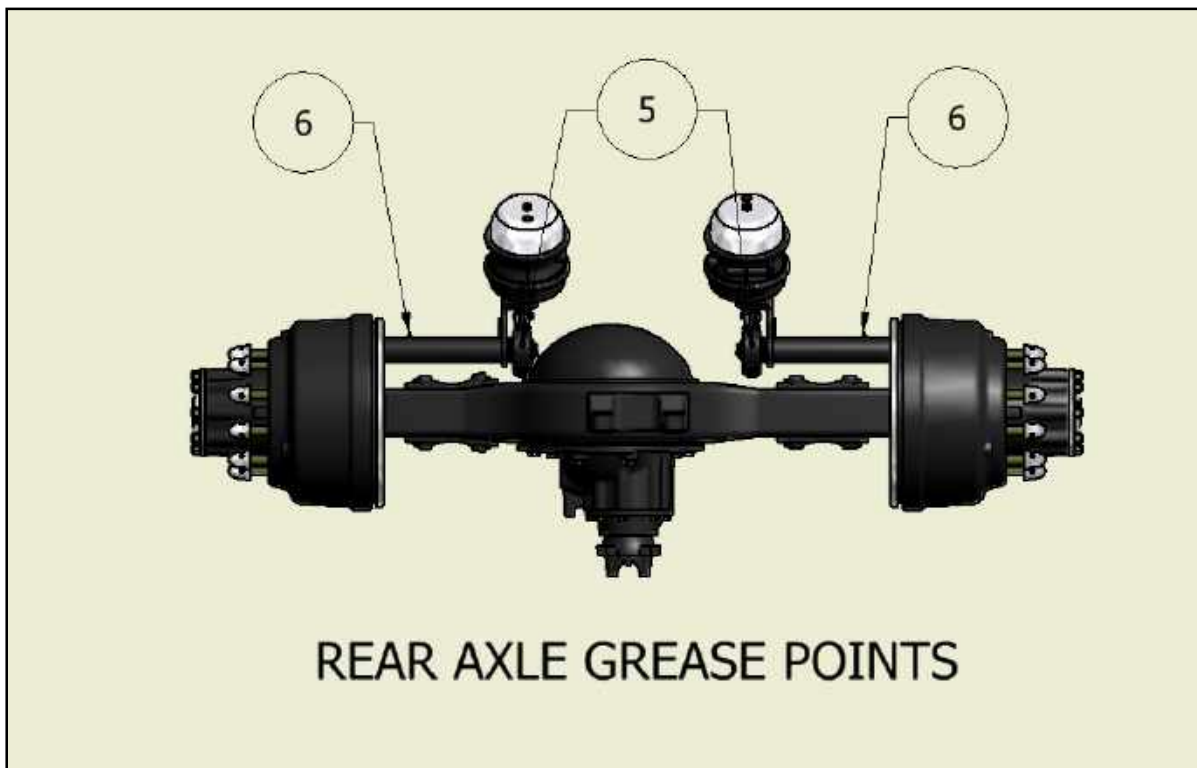

Maintenance Parts

Primary Fuel Filter/Water Sep W/WIF sensor

Cummins Filtration part # FS1003

Tiffin part # 31647

Secondary Fuel Filter

Cummins Filtration part # FF63009

Tiffin part # 5059830

Engine Oil Filter

Cummins Filtration part # LF9009

Tiffin part # 5024652

Engine Air Filter

Parker/Racor # 062891010

Tiffin part # 5028577

Serpentine Belt

Cummins part # 4937693

Tiffin part # 5042760

AC Belt

Gates part #K080435

Tiffin part # 5027678

**For assistance with your
Tiffin PowerGlide Chassis**

Please contact one of the following
chassis specialists at Tiffin Motorhomes, Inc.

256-356-8661

Service

Greg Dees

Billy Payne, extension 3862

Ricky Brown, extension 3861

Parts

Heath Thorne, extension 3860

Mechanical Engineering

Corbette Davis, extension 2125

Electrical Engineering

Chris Struzik, extension 2363

Plant Manager

Gary Harris, extension 2288

Please have your **Chassis VIN #** ready
when you call.

SCHEDULED MAINTENANCE

Pre-Trip Inspection

Pre-Trip Inspection

- Check fluid levels & add as necessary
- Check tire inflation pressure
- Look for fluid leaks

Before starting your motor home daily, a few things must be checked. By doing so, you ensure that a safe trip is in order and lessen your chances of experiencing difficulties while on the road.

- Check the tires for proper inflation pressure and any damage. Also check the inner duals. Refer to the air pressure charts in this manual for proper inflation pressures.
- Look for fluid leaks under the motor home. This can prevent any serious problems from occurring later.
- Check the coolant level in the reservoir and add Old World Final Charge Global coolant if necessary. This reservoir can be found on the rear of your vehicle.
- Check SCA (supplemental coolant additive) and freeze point every 6 months, or sooner if coolant has been diluted with water.

Caution

If the water temperature in your engine is greater than 120 degrees, do not remove the radiator cap! You could be severely burned.

- Approximate COOLING SYSTEM CAPACITIES – does not include the heater core or other auxiliary systems.
- Cummins ISL – Rear Radiator 52 qt. or 13 gallons
- Check transmission fluid level
- Check engine oil level
- Check for small animals in engine compartment, such as squirrels and cats
- Check the power steering fluid reservoir

Check fuel/water separator

ISL

- Check fuel/water separator and drain any water or contamination that may be present. This must be done with the engine off.

After you have completed your inspection, you may now start your engine. Turn the key to the run position and wait for the wait to start light to turn off. You may now start the engine. ***Never use ether or any other starting fluids to start the electronic engine. The inlet heater can ignite the fumes and cause an explosion in the air inlet system.*** Once you have started the engine, monitor your gauges carefully. Make sure that the oil pressure rises within 15 seconds. If it does not, shut down the engine and call a repair facility to determine the cause.



Figure 6-1: Filter Restriction Indicator

- Check air filter restriction indicator (Figure 6-1)

Brand New Air Cleaner
10" to 12" of Vacuum

- **Change the engine air filter element when the air inlet restriction indicator reaches 25 inches of vacuum or once a year, whichever occurs first.**

Instruments & Controls



GRAPHICAL INSTRUMENT CLUSTER

OPERATION MANUAL

VDC00249

TIFFIN, 12.3" DISPLAY

Rev E 27-Feb-20 MW

Copyright © 2020 Valid Manufacturing Ltd. All rights reserved.

Information in this document is subject to change without notice. No part of this document may be reproduced or transmitted, in whole or in part, in any form, or by any means, electronic or mechanical, for any purpose, without the express written permission of Valid Manufacturing Ltd.

CONTENTS

Safety Instructions	4	Outside Temperature	16
Overview	5	Time.....	16
Cleaning your GIC screen	5	Selectable Display.....	17
Indicator Quick Reference	6	Trip 1, Trip 2 and Fuel Economy.....	17
Gauge Quick Reference.....	7	TPMS (Coach Tire Pressure)	17
Navigation	8	TPMS Trailer (Trailer Tire Pressure) ...	18
Joystick Knob	8	Information Gauges	19
Indicators	9	Pre-Drive.....	20
Gauges	13	Brightness.....	20
Engine Coolant Temperature	13	Settings	20
Engine Oil Pressure	13	Alarm Messages – Information.....	21
Speedometer.....	13	Alarm Messages - Caution	22
Fuel Level – Engine & Generator	14	Alarm Messages - Critical.....	25
Message Center	14	Menu Map – Selectable Display Menu	26
Trip Meter/Fuel Economy	15	Menu Map - Settings Menu	27
Tachometer	15	Menu Map - Tire Pressure (TPMS) Setup	
Diesel Exhaust Fluid (DEF) Level.....	15	Menu	28
Chassis Battery Voltage.....	16	Tire Pressure (TPMS) Sensor Display	29
Front and Rear Air Tank Pressure	16	Tire Pressure (TPMS) Configuration	30
Compass.....	16	Diagnostics.....	33

SAFETY INSTRUCTIONS

WARNING

- ▶ *Driving while distracted can result in loss of vehicle control.*
- ▶ *Do not make adjustments in the selectable display on the graphical instrument cluster under conditions that will affect your safety or the safety of others.*

CAUTION

Your graphical instrument cluster system should be serviced only by qualified personnel.

OVERVIEW

The Graphical Instrument Cluster (GIC) is primarily a display device that communicates electronically with multiple pieces of equipment on the coach.

To familiarize yourself with the indicators and gauges, refer to the quick reference guide on pages 6 and 7.

The display will automatically dim for nighttime driving when the headlights are activated.

A selectable display within the tachometer gauge provides a menu system which is navigated by rotating and pressing a joystick knob. Refer to page 26 for the menu selections:

- Speedometer
- Display brightness
- Pre-drive item reminders
- Selectable gauges
- Tire pressure and temperature for coach & trailer
- Trip 1 and Trip 2

With the coach stopped and the park brake applied, the <Settings> menu also provides the following items:

- Choice of towable trailer/vehicle for the tire pressure monitoring system (TPMS).
- Sound volume for alerts.
- Measurement units for speed/distance, temperature and pressure.
- Background image and brightness.
- Gauge needle color.
- Vertical position of screen display.
- Diagnostics for system, onboard diagnostics (OBD) and controller area network (CAN-Bus).

Cleaning your GIC screen

The glass on the GIC screen is treated with an optical coating to prevent glare and reflection. It should be cleaned with a product that is designed for this, such as the optical wipes included with the screen, or optical cleaner and a microfiber cloth.

WARNING: *The screen surface can be damaged if not treated with care.*

INDICATOR QUICK REFERENCE

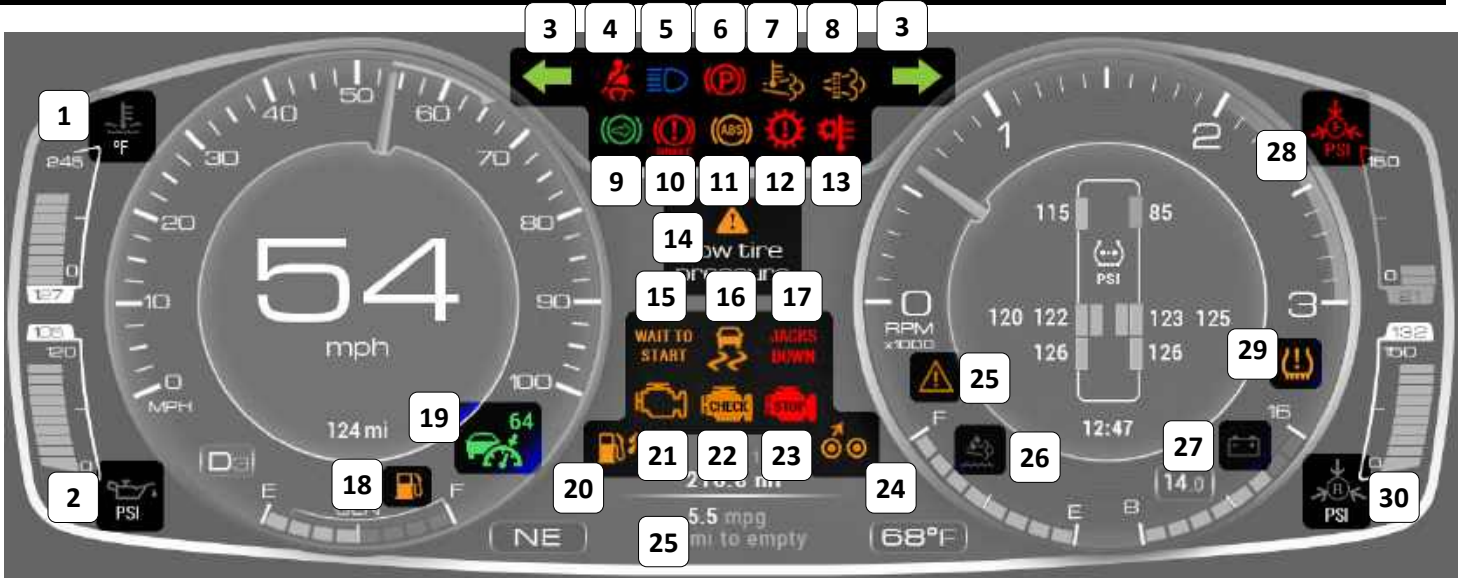

ID	Symbol	Description	Page
1		High Engine Coolant Temp	9
2		Low Engine Oil Pressure	9
3		Left, Right Turn Signal	9
4		Seat Belt	9
5		Headlights High Beam	9
6		Park Brake On	9
7		High Exhaust Temperature	9
8		Diesel Particulate Filter	10
9		Engine Brake	10
10		Electronic Brake Controller	10
11		Anti-Lock Brake System	10
12		Check Transmission	10
13		High Transmission Oil Temp	11
14		Info, Caution or Critical Alarm	9
15		Wait to Start	11

ID	Symbol	Description	Page
16		Automatic Traction Control	11
17		Jacks Down	11
18		Low Fuel	14
19		Cruise Control	11
20		Water in Fuel	11
21		Malfunction Indicator	9
22		Check Engine	11
23		Stop Engine	11
24		Tag Axle Dumped	11
25		DM1 Fault	11
26		Low Diesel Exhaust Fluid	12
27		Low Battery	12
28		Low Secondary (Front) Tank Air Pressure	12
29		Low Tire Pressure	12
30		Low Primary (Rear) Tank Air Pressure	12

GAUGE QUICK REFERENCE

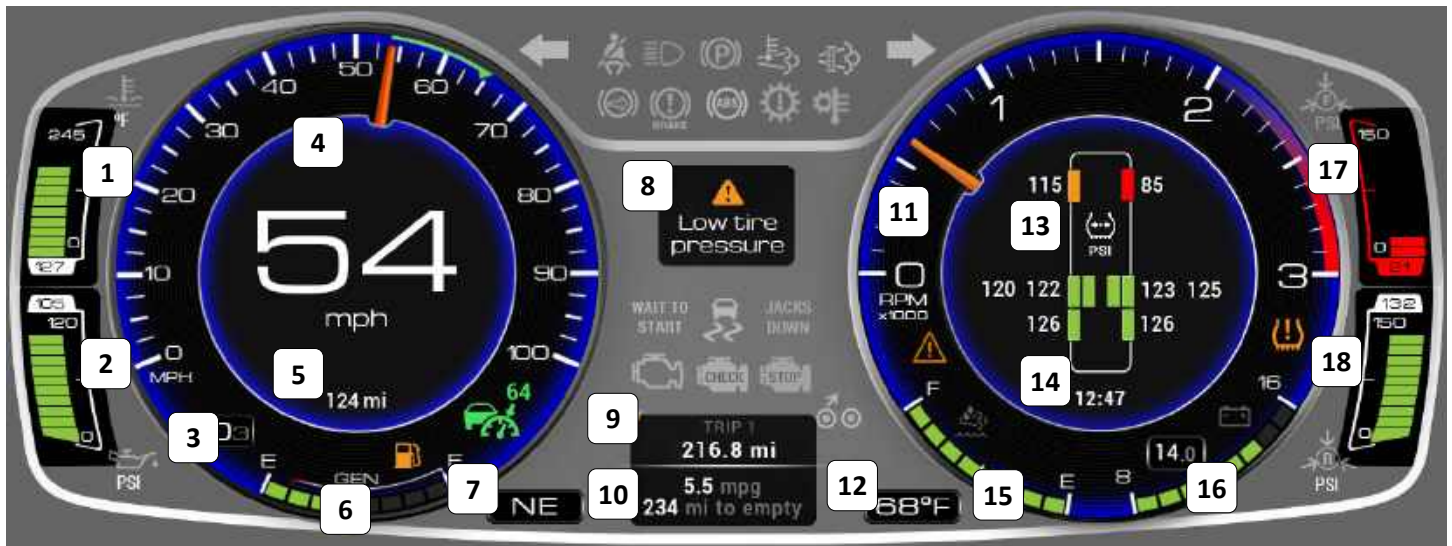

ID	Description	Page #
1	Engine coolant temperature	13
2	Engine oil pressure	13
3	Current gear	13
4	Speedometer	13
5	Odometer	14
6	Fuel level	14
7	Compass	16
8	Message center	14
9	Trip meter	15
10	Fuel economy	15
11	Tachometer	15
12	Outside temperature	16
13	Informational display - selectable	17
14	Time	16
15	Diesel exhaust fluid (DEF) level	15
16	Chassis battery voltage level	16
17	Front air tank pressure	16
18	Rear air tank pressure	16

NAVIGATION

Joystick Knob



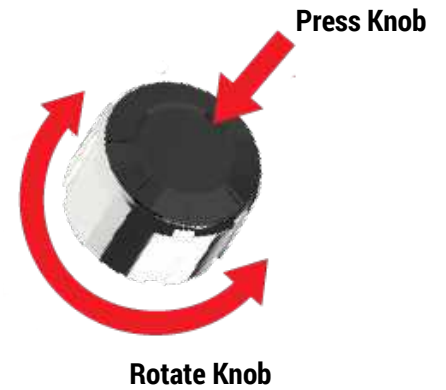

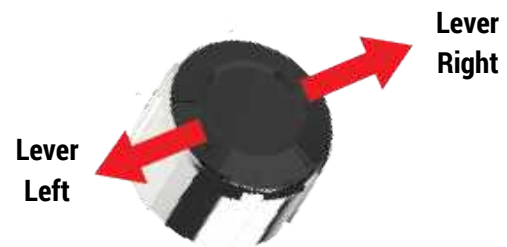

The joystick knob is connected directly to the GIC and is primarily used to navigate the selectable display by **rotating** the knob to scroll the menu or view and **pressing** to select that item (refer to page 17).



In addition to being pressed or rotated, the top can be levered sideways to the left or right. Do this to toggle between the selectable displays for the speedometer and tachometer.











INDICATORS















ID	Indicator	Name	Description
1		High Engine Coolant Temp	A high engine coolant temperature may indicate that your engine is overheating or that you could be losing coolant. Seek service.
2		Low Engine Oil Pressure	Low engine oil pressure can cause engine damage. Stop driving and seek service at the first opportunity.
3		Left Turn Signal, Right Turn Signal	Displays when the left turn signal or right turn signal is activated. Both left and right turn signals display when Hazard Flasher is activated.
4		Seat Belt	After ignition, the seat belt light will flash momentarily.
5		Headlights High Beam	Headlights are in high beam mode.
6		Park Brake On	The park brake is applied.
7		High Exhaust System Temperature (HEST)	Indicates that high exhaust temperatures may exist due to <u>active regeneration</u> (soot burn-off) in the diesel particulate filter (DPF). This is normal and does not signify the need for any kind of vehicle or engine service. When this lamp is illuminated, ensure that the exhaust pipe outlet is not directed at any combustible surface or material.

(Continued on next page)

INDICATORS















ID	Indicator	Name	Description				
8		Diesel Particulate Filter (DPF)	<p>The exhaust diesel particulate filter (DPF) has excessive soot levels and requires passive or active regeneration (regen) to burn off the soot to prevent a clogged filter.</p> <p>Passive regeneration occurs when the vehicle is driven at a challenging duty cycle, such as highway driving for at least 20 minutes, to increase exhaust temperatures.</p> <p>Active regeneration supplements soot burn-off by injecting diesel fuel to increase exhaust temperature.</p>				
			INDICATORS				
			DPF 	Check Engine 	Stop Engine 	Soot Level	Action Required
			Solid	-	-	Low	Provide regen opportunity:
			Flashing	-	-	Medium	<ul style="list-style-type: none"> ➤ Alter duty cycle. ➤ Initiate a parked manual regen.
			Flashing	Solid	-	High	<p>Provide regen opportunity:</p> <ul style="list-style-type: none"> ➤ Initiate a parked manual regen. ➤ Seek service.
-	-	Solid	Extreme	<ul style="list-style-type: none"> ➤ Stop engine at earliest opportunity. ➤ Seek service. 			
9		Engine Brake	The vehicle's engine exhaust brake system is enabled. The exhaust brake is more effective in the lower gears and at higher engine speeds.				
10		Electronic Brake Controller	The Electronic Brake Controller has detected a fault.				
11		Anti-lock Brake System	The electronic brake controller has detected a fault with the anti-lock brake system (ABS) and has disabled this feature.				
12		Check Transmission	Transmission over temp / Check transmission.				

INDICATORS

ID	Indicator	Name	Description
13		High Transmission Oil Temp	Indicates that the engine oil temperature is higher than the warning level threshold.
14		Info Alarm	Refer to page 21 for a list of INFORMATION alarms
		Caution Alarm	Refer to page 22 for a list of CAUTION alarms
		Critical Alarm	Refer to page 25 for a list of CRITICAL alarms
15		Wait to Start	The vehicle's glow plugs must heat up before the vehicle is started. This indicator will remain lit until the glow plugs are ready (approximately 15 seconds, or longer in colder weather). Once the indicator is off, the vehicle can be started.
16		Automatic Traction Control	The electronic brake controller (EBC) has detected a fault with the automatic traction control (ATC) and has disabled this feature.
17		Jacks Down	If any of the hydraulic jacks are not fully stowed (no matter what gear the vehicle is in), this indicator will be displayed along with a critical alarm message.
18		Low Fuel	Fuel level is below the low fuel threshold.
19		Cruise Control	Cruise control is active – a fixed vehicle speed is set by the operator.
20		Water in Fuel	Water has been detected in the fuel supply.
21		Malfunction Indicator	Malfunction related to the emissions control system. The after-treatment system should be diagnosed and serviced at your next available opportunity.
22		Check Engine	Scheduled maintenance due. It will flash for 30 seconds after engine ignition and remain illuminated, indicating that the engine needs service at the first available opportunity.
23		Stop Engine	The vehicle must be stopped as soon as it is safe to do so.
24		Tag Axle Dumped	Tag axle weight has been reduced.
25		DM1 Fault	Indicates an active diagnostic trouble code.

(Continued on next page)

INDICATORS

ID	Indicator	Name	Description																																
26		Low Diesel Exhaust Fluid	<p>This symbol indicates that the diesel exhaust fluid (DEF) is low. The fluid creates a catalytic reaction that removes particles from the exhaust. When low, the fluid must be topped up.</p> <table border="1"> <thead> <tr> <th colspan="3">INDICATORS</th> <th rowspan="2">Fluid Level</th> <th rowspan="2">Action Required</th> </tr> <tr> <th>DEF</th> <th>Check Engine</th> <th>Stop Engine</th> </tr> </thead> <tbody> <tr> <td></td> <td></td> <td></td> <td></td> <td></td> </tr> <tr> <td>Solid</td> <td>-</td> <td>-</td> <td>Low</td> <td rowspan="2">Refill the diesel exhaust fluid (DEF) tank.</td> </tr> <tr> <td>Flashing</td> <td>-</td> <td>-</td> <td>Critical</td> </tr> <tr> <td>Flashing</td> <td>Solid</td> <td>-</td> <td>Critically Low</td> <td>Engine power loss will occur. This will be restored after refilling the DEF tank.</td> </tr> <tr> <td>Flashing</td> <td>Solid</td> <td>Solid</td> <td>Empty</td> <td>The vehicle will be limited to a speed of 5 mph (8 km/h). Normal engine power and vehicle speed will be restored after refilling the DEF tank.</td> </tr> </tbody> </table>	INDICATORS			Fluid Level	Action Required	DEF	Check Engine	Stop Engine						Solid	-	-	Low	Refill the diesel exhaust fluid (DEF) tank.	Flashing	-	-	Critical	Flashing	Solid	-	Critically Low	Engine power loss will occur. This will be restored after refilling the DEF tank.	Flashing	Solid	Solid	Empty	The vehicle will be limited to a speed of 5 mph (8 km/h). Normal engine power and vehicle speed will be restored after refilling the DEF tank.
			INDICATORS			Fluid Level			Action Required																										
			DEF	Check Engine	Stop Engine																														
																																			
			Solid	-	-	Low	Refill the diesel exhaust fluid (DEF) tank.																												
			Flashing	-	-	Critical																													
Flashing	Solid	-	Critically Low	Engine power loss will occur. This will be restored after refilling the DEF tank.																															
Flashing	Solid	Solid	Empty	The vehicle will be limited to a speed of 5 mph (8 km/h). Normal engine power and vehicle speed will be restored after refilling the DEF tank.																															
27		Low Battery	The battery indicator turns red when the voltage goes below a set level.																																
28		Low Secondary (Front) Tank Air Pressure	Pressure in the front (secondary) air tank is low.																																
29		Low Tire Pressure	<p>The tire pressure monitoring system (TPMS) has indicated there is a tire with low pressure.</p> <p>Rotate the joystick knob to view coach and trailer tire pressure screens on the selectable display. Press the knob to switch between tire pressure and tire temperature.</p>																																
30		Low Primary (Rear) Tank Air Pressure	Pressure in the rear (primary) air tank is low.																																

GAUGES

Engine Coolant Temperature

This gauge measures the temperature of the engine coolant fluid.

The message center will display a warning and sound an alert when the temperature is higher than the red warning level.



Green - Normal



Orange - High



Red - Warning

Engine Oil Pressure

This gauge measures the pressure of the engine oil, which is required to ensure efficient lubrication of the internal engine parts. The oil pressure will increase as the engine RPM is increased from idle to normal driving speed. An oil pressure warning is an indication to seek service at the earliest opportunity.

The message center will display a warning and sound an alert when the pressure is less than the red warning level.

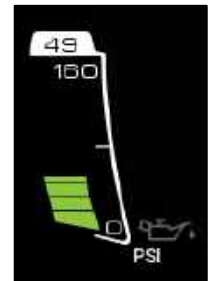

Green - Normal

Speedometer

The speedometer displays the speed of the vehicle in miles or kilometers per hour, both with a needle and as a digital readout.

Also found on the speedometer is the fuel gauge, generator gauge, cruise control indicator, and current gear.

With the coach stopped and the park brake applied, you can change the display units between miles and kilometers with the Selectable Display selection *Settings > Units > Speed / Dist.*

The color of the gauge needle can be configured in *Settings > Needle Color.*

Cruise Control

The Cruise Control indicator is gray when the feature is enabled. It is green when the feature is active and a fixed vehicle speed has been set by the operator.



GAUGES

Odometer

The odometer displays the lifetime mileage of the vehicle from when it was manufactured.

Fuel Level – Engine & Generator

The fuel level is displayed at the bottom of the speedometer. When fuel falls below the factory programmed low level, the fuel indicator will turn red and an alert will sound. The generator gauge is a static gauge that indicates the point at which the generator will run out of fuel.

The GIC is connected directly to the fuel tank level sender. Provided the chassis battery level is greater than the factory-configured 'Power Off' level, it continues to send fuel level messages over the RV-C network with the ignition off. This allows the fuel level to be viewed on the Coach Management System for operation of the coach generator.

Note that the generator will run out of fuel before the engine does. As indicated on the gauge, the generator will stop running while there is still an eighth of a tank of fuel left. This provides the operator with the opportunity to drive to a fuelling station.



Fuel level normal



Fuel level low – generator will run out of fuel

Message Center

The message center is between the speedometer and the tachometer. During normal operation, this area displays the vehicle logo. When necessary, the message area shows three categories of alarms:



INFORMATION: These relate to normal operation of the coach. Refer to page 21.



CAUTION: These indicate items which require your attention. Refer to page 22. A chime may also sound when an alarm occurs.



CRITICAL: These indicate items which require your immediate attention. Refer to page 25. A chime may also sound when an alarm occurs.

When an alarm occurs it is immediately displayed. After a short delay, the display will then continue to cycle through each active alarm.

GAUGES

Trip Meter/Fuel Economy

Trip 1 or Trip 2 are items in the Selectable Display. Rotate the knob to display the item. Press the knob to switch between Trip 1 and Trip 2. Hold the knob to reset. Refer to the menu map on page 26.

The odometer displays the lifetime mileage of the vehicle from when it was manufactured.

The average fuel economy and distance to empty can be configured in miles or kilometers. This changes the display between miles per gallon / miles and liters per 100 kilometers / kilometers. Refer to the menu map: *Settings > Units > Speed / Dist.*

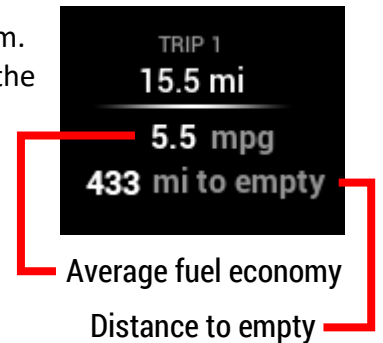

Tachometer

The gauge displays engine revolutions per minute (RPM).

The color of the gauge needle can be configured in *Settings > Needle Color.*

Gauge
needle



Diesel Exhaust Fluid (DEF) Level

The diesel exhaust fluid (DEF) level is displayed on the lower left of the tachometer. When the DEF level falls below the factory-programmed low level, the DEF indicator will turn amber and an alert will sound.

The low Diesel Exhaust Fluid (DEF) indicator is illuminated by a message from the engine controller. It has four low level thresholds which determine if the DEF indicator is solid or flashing. Refer to the description on page 12.



GAUGES

Chassis Battery Voltage

This gauge measures the chassis batteries, which are used when driving the coach; for example, starting the engine.

When the voltage falls below 11.5V, the battery indicator will turn red and an alert will sound.

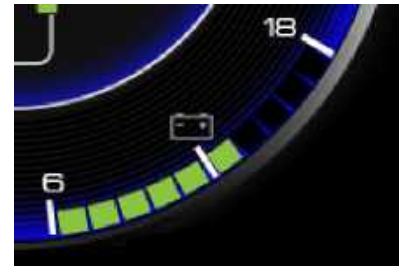

Front and Rear Air Tank Pressure

The bar gauge color on the front and rear air pressure gauges indicates the following levels:

- Green is normal.
- Orange is slightly low.
- Red is critically low. A warning sound will also occur.

The front air pressure gauge is shown; however, the levels are the same for the rear air pressure gauge.



Green - High

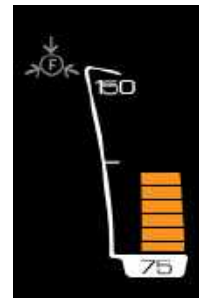

Orange - Low



Red - Warning

Compass

The compass displays the direction in which the vehicle is heading.



Outside Temperature

The outside temperature is displayed according to data collected by either RVC (Spyder) or the engine ECU. Units can be changed from Fahrenheit to Celsius in the Settings menu (see page 27).



Time

The time is displayed in the selectable display area of the tachometer.



SELECTABLE DISPLAY

The center of the tachometer can display a variety of information as desired by the user. This information can be selected with the use of the joystick knob. Rotate the knob clockwise and counter-clockwise to scroll up and down the menu items. Press the top button to select that menu item.

The following information is available:

- Trip information (Trip 1, Trip 2, fuel economy)
- TPMS (Tire Pressure Monitoring System)
- TPMS Trailer (if enabled)
- Information Gauges
- Pre-Drive List
- Brightness
- Settings

Refer to the menu maps on pages 26 & 28 for all available menu options.

Trip 1, Trip 2 and Fuel Economy

The fuel economy is calculated by the engine controller. 'Inst. Economy' is the instantaneous fuel economy of the vehicle. For example, when driving uphill, a higher value will be displayed than when driving downhill.

Note: Refer to page 15 for information on the the average fuel economy display.

With the coach stopped and the park brake applied, you can also change the display units between miles and kilometers with the Selectable Display selection *Settings > Units > Speed / Dist.*

Note: With miles selected, fuel information displayed in US gallons and miles per gallon. With kilometers selected, fuel information is displayed in liters and in liters per 100 kilometers.

Press knob to make selection



Rotate knob to scroll up and down



Press knob to toggle between Trip 1 & Trip 2

TPMS (Coach Tire Pressure)

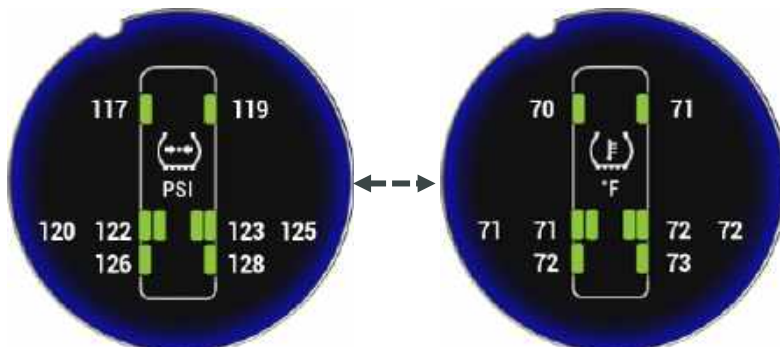

Press knob to toggle between pressure and temperature

SELECTABLE DISPLAY

Tire Pressure (Coach) is an item in the Selectable Display. Rotate the knob to display the item. Press the button to toggle between tire pressure and tire temperature. With the park brake set, press the button for 5 seconds to display the Tire Pressure Monitor (TPMS) screen. Refer to the menu map on page 26. *Note that the bracketed items pertain to the coach tire pressure.*

The status of each tire is represented by a color:

Pressure

- Critical High: ■ (Red)
- Normal : ■ (Green)
- Warning Low: ■ (Orange)
- Critical Low: ■ (Red)

Temperature

- High : ■ (Red)
- Normal: ■ (Green)

The thresholds for pressure and temperature are set at the factory. However, the pressure thresholds are around the 'normal' pressure which is established when the pressure sensor is screwed onto the tire valve.

TPMS Trailer (Trailer Tire Pressure)

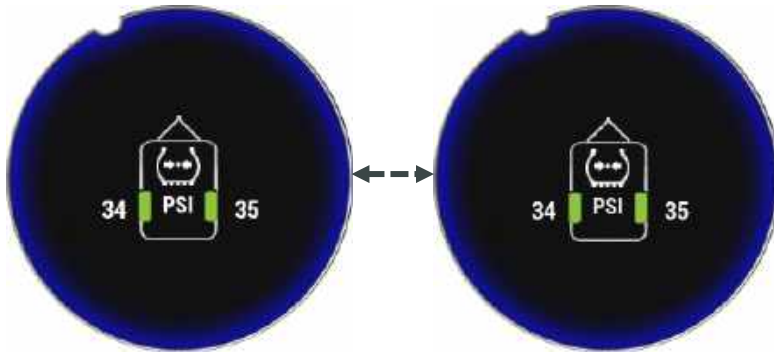

Press knob to toggle between pressure and temperature

Tire Pressure (Trailer) is an item in the Selectable Display. Rotate the knob to display the item. Press the button to toggle between tire pressure and tire temperature. With the park brake set, press the button for 5 seconds to display the Tire Pressure Monitor (TPMS) screen. Refer to the menu map on page 26. *Note that the bracketed items pertain to the trailer tire pressure.*

This example shows a 2 wheel configuration.

The status of each tire is represented by a color:

Pressure

- Critical High: ■ (Red)
- Normal : ■ (Green)
- Warning Low: ■ (Orange)
- Critical Low: ■ (Red)

Temperature

- High : ■ (Red)
- Normal: ■ (Green)

The thresholds for pressure and temperature are set at the factory. However, the pressure thresholds are around the 'normal' pressure which is established when the pressure sensor is screwed onto the tire valve.

SELECTABLE DISPLAY

Information Gauges

Information gauges do **not** have any warning threshold levels.

You may choose to display a single gauge, or select the <Scan> item to continuously scan through each gauge every five seconds. Scan mode is indicated by the symbol: 

Gauge	Description
Accelerator Position	Displays the position of the accelerator foot pedal. 100% is fully depressed.
Engine Load	At any given speed the engine has a maximum torque rating. Engine load is the current output torque as a ratio of this maximum torque.
Transmission Shaft Speed	Displays the revolutions-per-minute (rpm) of the transmission shaft (drive shaft) which is the output of the transmission (gearbox). Note: The tachometer (refer to page 15) displays engine drive shaft RPM, which is the input to the transmission (gearbox). The difference relates to the current gear selection.
DEF Temperature	Displays the temperature of the fluid in the Diesel Exhaust Fluid (DEF) tank. During vehicle operation, Selective Catalytic Reduction (SCR) systems are designed to provide heating for the Diesel Exhaust Fluid (DEF) tank and supply lines. If DEF freezes when the vehicle is shut down, startup and normal operation of the vehicle will not be inhibited. The SCR heating system is designed to quickly return the DEF to liquid form and the operation of the vehicle will not be impacted. The freezing and unthawing of DEF will not cause degradation of the product.
Transmission Temperature	Displays the transmission oil temperature.
House Batteries	The house batteries provide power to interior lights and appliances, thermostats, water pump, etc. They are charged by the engine alternator, generator or shore power. Refer to page 17 for information on the chassis battery gauge.
Generator	Indicates whether the generator is running, and/or other status information.
Inverter Status	Provides the status of the inverter.
Engine Coolant Temperature	Displays the temperature of the engine coolant fluid.
Engine Oil Pressure	Displays the pressure of the engine oil, which is required to lubricate the internal engine parts.

SELECTABLE DISPLAY

Pre-Drive

Pre-Drive is an item in the Selectable Display. Use the knob rotation and button press to choose this. Refer to the menu map on page 26.

This is an auto-scrolling list which displays **active** items requiring attention prior to vehicle travel.

After viewing, rotate the knob to select another menu item.



Brightness

The display **Brightness** is an item in the Selectable Display. Use the knob rotation and button press to choose this. Refer to the menu map on page 26.

Different brightness levels can be set for daytime or nighttime driving. If the headlights are off when the brightness is adjusted, the brightness level will be saved for driving with the headlights off (daytime). If the headlights are on when the brightness is adjusted, that level will be saved for driving with the headlights on (nighttime).

Rotate the knob to adjust the brightness and then press the knob to save for that mode and return to the previous menu.

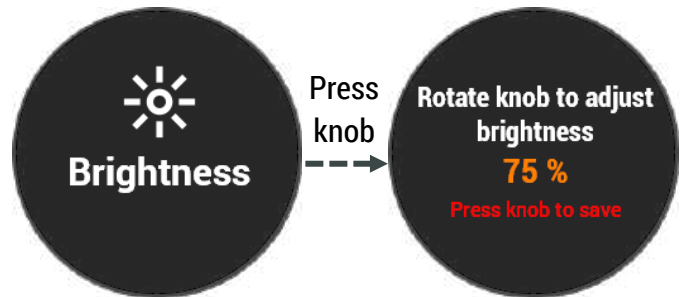

Settings

The coach must be stopped with the park brake set for this menu item to be available.

Settings is an item in the Selectable Display. Use the knob rotation and button press to choose this. Refer to the menu map on page 26.

Rotate the knob to scroll through the available menu items and press the knob to select. To return to the previous menu choose Back.

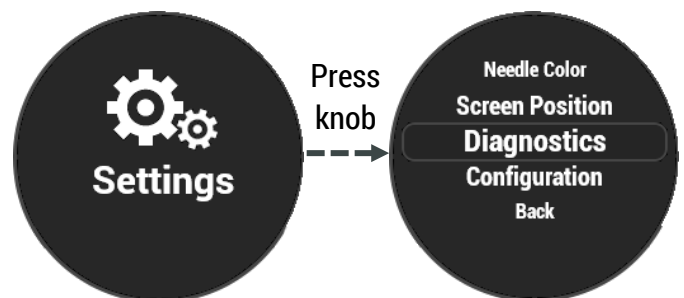

ALARM MESSAGES – INFORMATION



INFORMATION messages relate to normal activities of the coach.

MESSAGE	DESCRIPTION
Tag Axle Dumped	Tag axle weight has been reduced.

ALARM MESSAGES - CAUTION



CAUTION messages relate to items that require your attention.

MESSAGE	DESCRIPTION
No Cluster Data	The Graphical Instrument Cluster has an internal error – the graphics application has reported it has not received data from the cluster task within the last 15 seconds.
No J1939-I Data	No messages have been received on the J1939 network within the last 15 seconds. Check to confirm the J1939 connector is plugged into the Graphical Instrument Cluster or if there is a problem with the J1939 network.
No Serial-I Data	The Graphical Instrument Cluster has an internal error – the I/O board has not received a valid serial message from the cluster task within the last 15 seconds.
No J1939 C Data	Not receiving any J1939 messages from the Engine Controller.
No Serial-C Data	The Graphical Instrument Cluster has an internal error – the cluster task has not received a valid serial message from the I/O board within the last 15 seconds.
Low Tire Pressure	The Tire Pressure Monitoring System (TPMS) has indicated there is a tire with low pressure. This same message is displayed for both Warning and Critical low pressures. Rotate the joystick knob to view coach and trailer tire pressure screens on the Selectable Display. Press the knob to switch between tire pressure and tire temperature.
High Tire Pressure	The Tire Pressure Monitoring System (TPMS) has indicated there is a tire with a Critical high pressure. Unlike low pressure, a ‘Warning’ alarm does not exist for high pressure. Rotate the joystick knob to view coach and trailer tire pressure screens on the Selectable Display. Press the knob to switch between tire pressure and tire temperature. Refer to pages 17 and 18.
High Tire Temp.	The Tire Pressure Monitoring System (TPMS) has indicated there is a tire with high temperature. Rotate the joystick knob to view coach and trailer tire pressure screens on the Selectable Display. Press the knob to switch between tire pressure and tire temperature.
Low Fuel	The vehicle fuel tank is low – refer to the ‘Distance to empty’ display.
Regen in Process	Indicates that Active Regeneration is in progress (see below).
High Exhaust Temp.	Indicates that high exhaust temperatures may exist due to Active Regeneration (soot burn-off) in the diesel particulate filter (DPF). This is normal and does not signify the need for vehicle or engine service. Ensure the exhaust pipe outlet is not directed at any combustible surface or material.

ALARM MESSAGES - CAUTION

MESSAGE	DESCRIPTION
ABS Warning	The Anti-Lock Brake System (ABS) has detected a fault and has disabled this feature.
Check Engine	J1939 message received. The engine needs service at the first available opportunity.
MIL Check Engine	J1939 message received. There is a general fault (not necessarily with the engine) that must be diagnosed.
DPF Filter Warning	The exhaust Diesel Particulate Filter (DPF) has excessive soot levels and requires passive or active regeneration (regen) to burn off the soot to prevent a clogged filter. Initiate a parked manual regen or seek service at the first available opportunity.
Low DEF	The diesel exhaust fluid (DEF) is low. The fluid creates a catalytic reaction that removes particles from the exhaust. When low, the fluid must be topped up.
Front Press. Fault	The pressure reading for the front air tank is out of range. This may be caused by a bad pressure transducer or faulty wiring.
Rear Press. Fault	The pressure reading for the rear air tank is out of range. This may be caused by a bad pressure transducer or faulty wiring.
Pre-Drive Items	Refer to the Pre-Drive list shown in the Selectable Display for active pre-drive item(s) which require attention prior to vehicle travel. Refer to the menu map on page 26. The Pre-Drive list on the Selectable Display will automatically scroll up and down as necessary to display all currently active items: <ul style="list-style-type: none"> • Antenna Up • Shore Power Connected • Entry Step Out • Fridge Unlocked • Baggage Door Open • Slide Overridden • Not at Ride Height • FD Slide Not Secure • RD Slide Not Secure • RP Slide Not Secure • FP Slide Not Secure • Engine Preheat On • Generator On • Emergency Start On
No RVC Data	The GIC communicates with both RV-C and J1939 communication networks on the coach. The GIC I/O board has not received any RV-C message within the last 15 seconds.
Trans. Over Temp.	Signal from transmission indicating that its fluid temperature is above normal acceptable limits, and as a result, transmission operation may be altered or restricted.
High Coolant Temp.	The coolant fluid temperature is high.
Low Eng. Oil Press.	The engine oil pressure is low.

ALARM MESSAGES - CAUTION

MESSAGE	DESCRIPTION
ATC Warning	The electronic brake controller (EBC) has detected a fault with the automatic traction control (ATC) and has disabled this feature.
Water in Fuel	Signal which indicates the presence of water in the fuel.
Battery Over Volt	The engine control module (ECM) battery measurement is above the factory-configured high battery threshold.
Battery Under Volt	The engine control module (ECM) battery measurement is below the factory-configured low battery threshold.
Check Trans.	Signal from transmission indicating that some aspect of its operation is not functioning correctly, and as a result, transmission operation may be altered or restricted.
No CCVS Data	The GIC application has not received any cruise control vehicle speed (CCVS) data over the J1939 network within the last 15 seconds.
Comm. Error - Engine	There has been a loss of communication between the GIC and the engine.
Comm. Error - ABS	There has been a loss of communication between the GIC and the anti-lock brake system.
Comm. Error - Trans	There has been a loss of communication between the GIC and the transmission.
ESC Warning	This parameter is controlled by the Vehicle Dynamic Stability Control System. The warning is accompanied by an illuminated ATC indicator.

ALARM MESSAGES - CRITICAL



CRITICAL messages relate to items that require your immediate attention.

MESSAGE	DESCRIPTION
EBS Error	The Electronic Braking System (EBS) has reported a critical error. The EBS controls normal braking in addition to the Anti-Lock Braking System (ABS) and Automatic Traction Control (ATC).
Stop Engine	J1939 message received. The vehicle needs to be stopped as soon as it is safe to do so. An alert tone will sound continuously.
DPF Filter Error	The exhaust diesel particulate filter (DPF) has a critical soot level. Stop engine as soon as possible. Seek service at the first available opportunity.
Extreme Low DEF	The diesel exhaust fluid (DEF) is low. Engine power loss will occur. This will be restored after refilling the DEF tank.
Low Air	The front tank pressure is below the 'red' threshold level. The warning buzzer does not sound when the transmission gear is in neutral.
Low Air	The rear tank pressure is below the 'red' threshold level. The warning buzzer does not sound when the transmission gear is in neutral.
Tire Overspeed	Tires are rated for maximum speeds. If the vehicle goes faster than this speed, this alarm will display.
Trans. Over Temp.	Signal from transmission indicating that its fluid temperature is above normal acceptable limits, and as a result, transmission operation may be altered or restricted.
Check Trans.	Signal from transmission indicating that some aspect of its operation is not functioning correctly, and as a result, transmission operation may be altered or restricted.
Rolling Alarm!	If the vehicle is in neutral gear and the brake pedal is not depressed, nor the park brake engaged, this alarm will display.
*Jacks Down!	If any of the hydraulic jacks are not fully stowed (no matter what gear the vehicle is in), this indicator will be displayed along with a critical alarm message.
*Shore Power Connected	This indicates that the vehicle is still connected to shore power with the park brake released.
Shore Power Unknown	This message displays when the generator is running.

*These messages are accompanied by a red blinking bezel border if the park brake is not set and the vehicle speed is less than 5mph.

MENU MAP – SELECTABLE DISPLAY MENU

Selectable Display Menu (Tachometer)

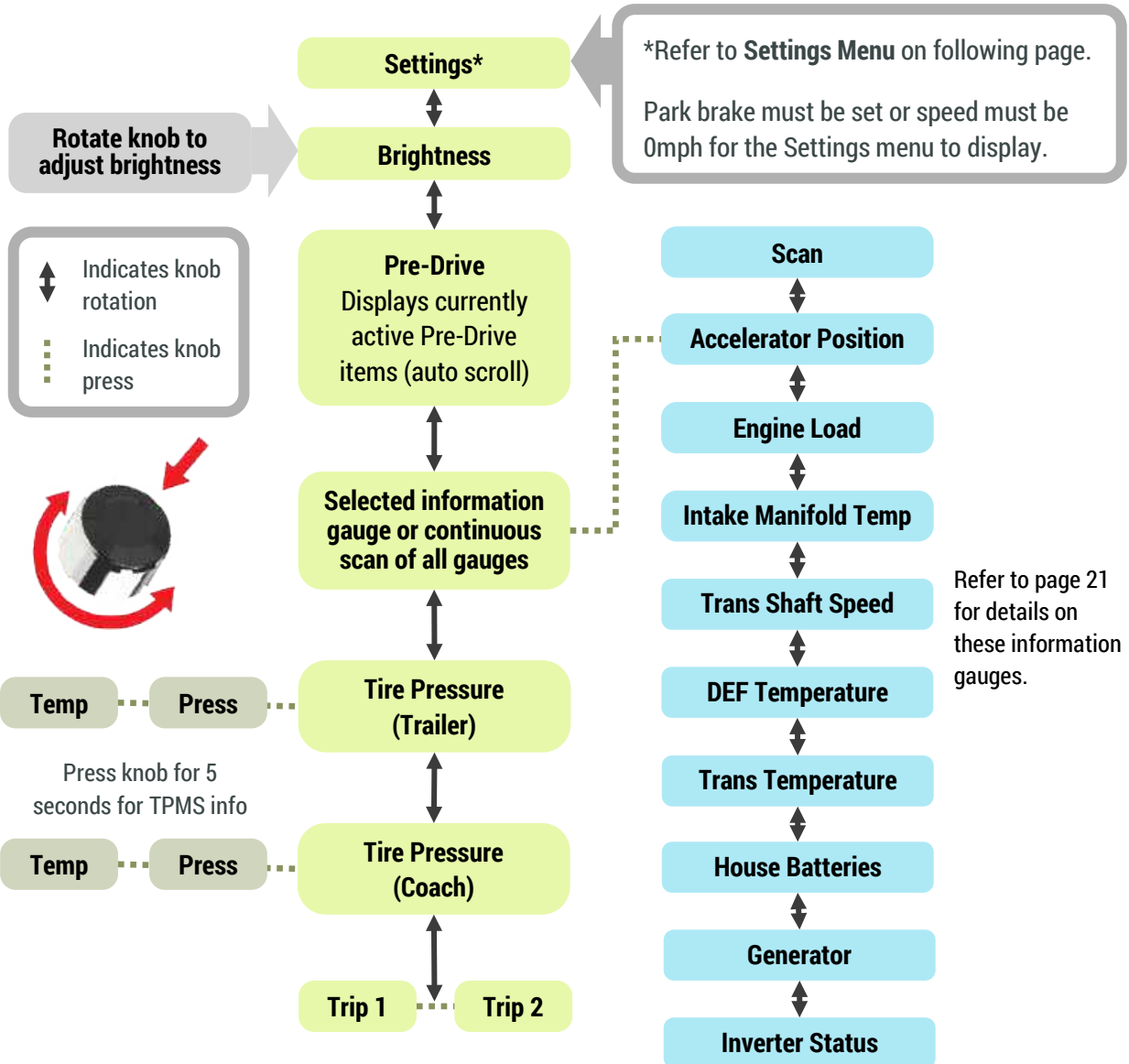

MENU MAP - SETTINGS MENU

Settings Menu

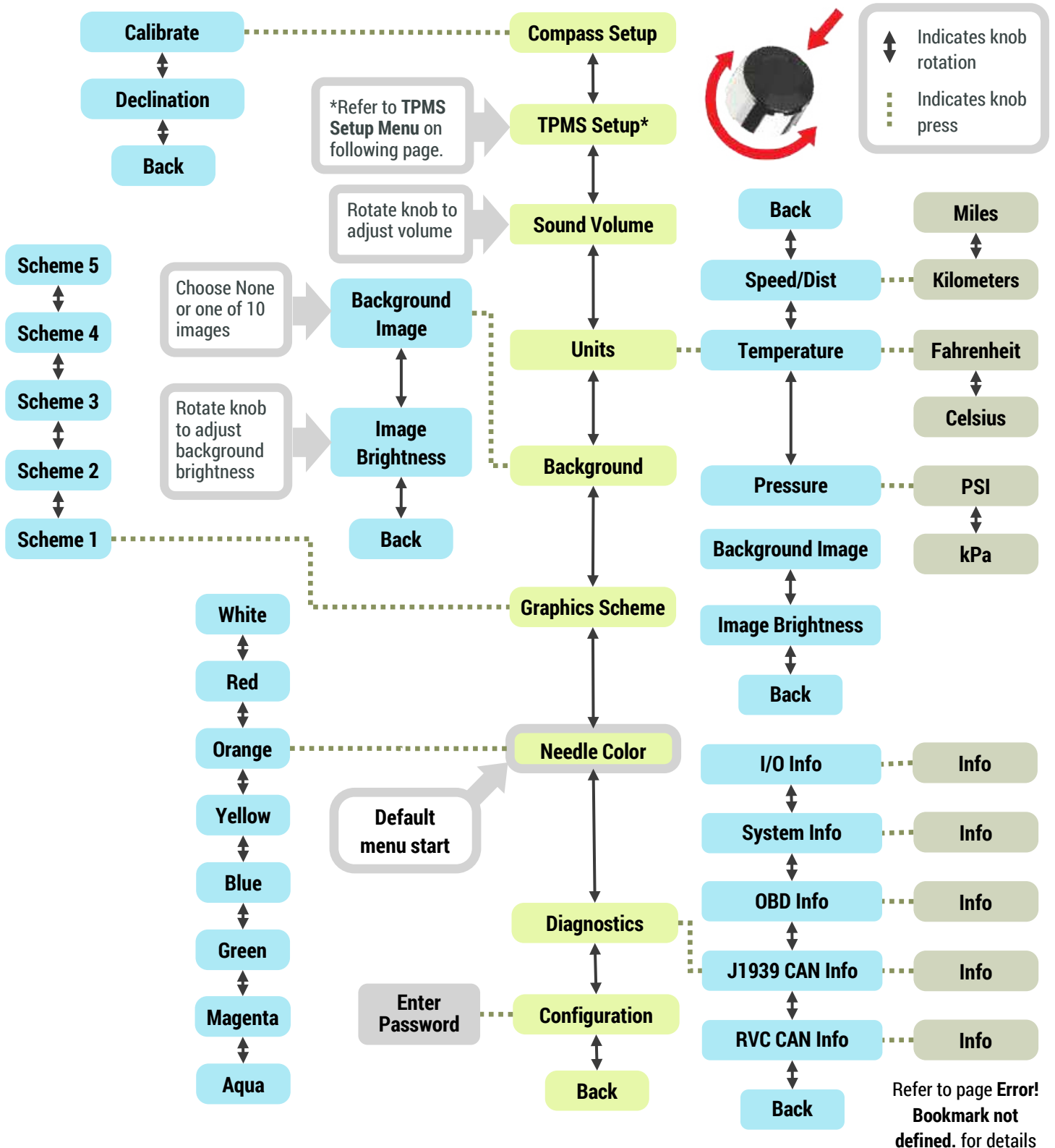

MENU MAP - TIRE PRESSURE (TPMS) SETUP MENU

TPMS Setup Menus

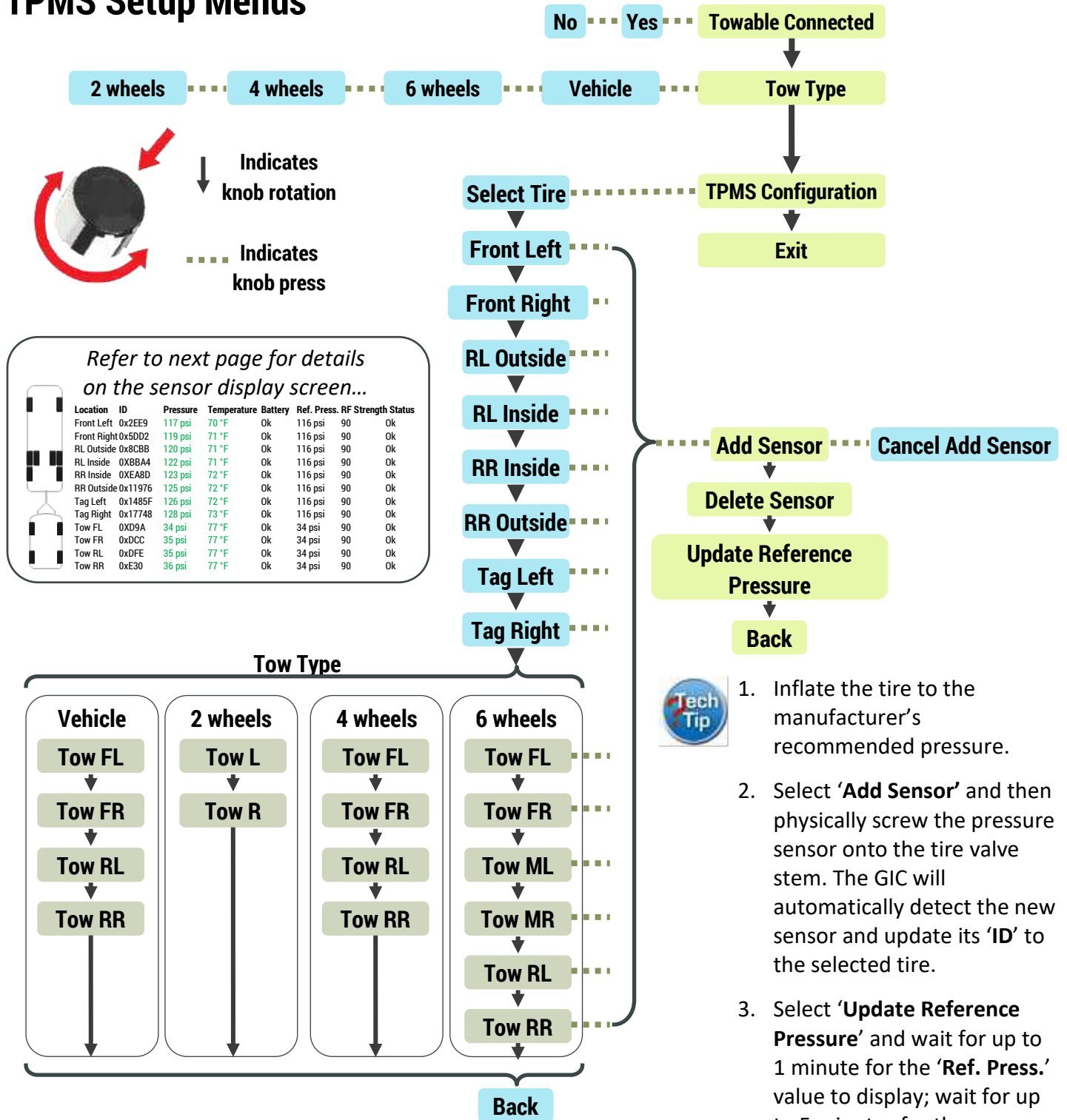

TIRE PRESSURE (TPMS) SENSOR DISPLAY

Location	ID	Pressure	Temperature	Battery	Ref. Press.	RF Strength	Status
Front Left	0x2EE9	117 psi	70 °F	Ok	116 psi	90	Ok
Front Right	0x5DD2	119 psi	71 °F	Ok	116 psi	90	Ok
RL Outside	0x8CBB	120 psi	71 °F	Ok	116 psi	90	Ok
RL Inside	0XBBA4	122 psi	71 °F	Ok	116 psi	90	Ok
RR Inside	0XE8D	123 psi	72 °F	Ok	116 psi	90	Ok
RR Outside	0x11976	125 psi	72 °F	Ok	116 psi	90	Ok
Tag Left	0x1485F	126 psi	72 °F	Ok	116 psi	90	Ok
Tag Right	0x17748	128 psi	73 °F	Ok	116 psi	90	Ok
Tow FL	0XD9A	34 psi	77 °F	Ok	34 psi	90	Ok
Tow FR	0xDCC	35 psi	77 °F	Ok	34 psi	90	Ok
Tow RL	0xDFE	35 psi	77 °F	Ok	34 psi	90	Ok
Tow RR	0xE30	36 psi	77 °F	Ok	34 psi	90	Ok
---	---	---	---	---	---	---	---
---	---	---	---	---	---	---	---

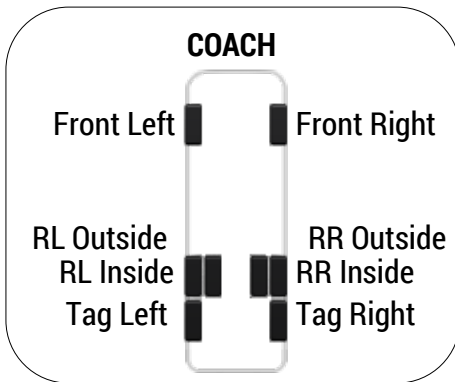

The 'reference pressure' (**Ref. Press.**) is established from the current tire pressure.

In early versions of the Pressure-Pro system, the 'reference pressure' was set as soon as the tire sensor was screwed onto the valve stem. However, in later versions, it is necessary to use the '**Update Reference Pressure**' menu selection, refer to page 32.

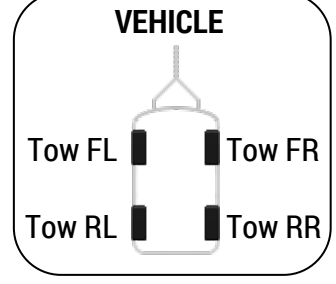
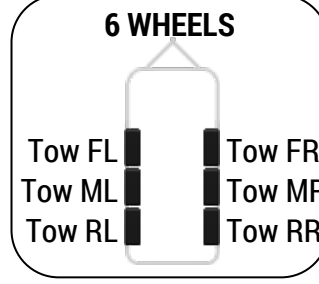
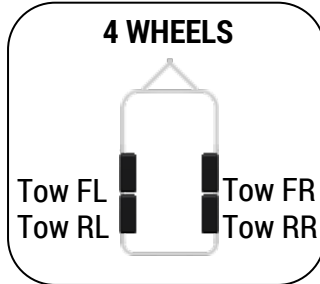
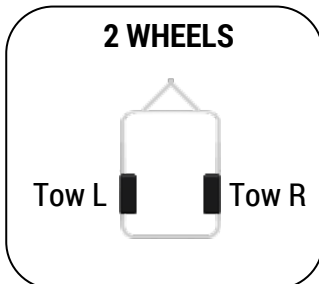

If tire pressure sensors are moved between towable vehicles with a different number of wheels, it is suggested that only the **common front wheel sensors** are moved. This allows them to be moved without having to delete and add sensors. However, it may still be necessary to '**Update Reference Pressure,**' depending on the manufacturers recommend pressures.

TIRE PRESSURE (TPMS) CONFIGURATION

The Tire Pressure Monitoring System (TPMS) consists of multiple sensors which screw onto tire valve stems and communicate to a central module. This module puts the data onto the J1939 network, where it is read by the GIC. The low tire pressure threshold is factory programmed within the TPMS central module. There is an ID printed on each tire pressure sensor, for example OB5A53. Each ID is displayed once it has been added in the TPMS configuration screen.

The TPMS configuration displays 14 tire locations. The last six (6) are for the towable vehicle, where any unused tire locations are shown in a light gray color. This allows all configured tire sensors to be displayed, regardless of the tow vehicle type. This is particularly useful if a tire needs to be moved from a currently unused location to another tire location, because it cannot be added until it is first removed from the original location.

Towable Connected

Refer to the TPMS setup menus on page 28.

Press the button knob to toggle between 'Yes' and 'No'

Parameter	Default	Configuration choices
Towable Connected	No	Yes or No

Tow Type

Refer to the TPMS setup menus on page 28.

Press the button knob repeatedly to select the number of wheels.

Parameter	Default	Configuration choices
Tow Type	2 wheels	2 wheels, 4 wheels, 6 wheels or vehicle

Add Sensor

Select 'Add Sensor' just prior to screwing a sensor onto a tire valve stem.

Note 1: If an existing sensor is to be moved to another tire, it must first be removed from the original tire using 'Delete Sensor'. Refer to page 31.

Note 2: It is not necessary to use 'Add Sensor' if a sensor is removed to manually inflate the tire, provided the same sensor is replaced.

Refer to the TPMS setup menus on page 28 (*password may be required*). Rotate the knob to highlight a menu item and then press the knob to make a selection.

To add a tire pressure sensor:

1. The 'Towable Connected' parameter must be set to **Yes**.
2. The 'Tow Type' parameter must be chosen for the relevant number of wheels.
3. If required, enter the password.

TIRE PRESSURE (TPMS) CONFIGURATION

Note: This is an independent password entry screen compared to that used for the other configurations.

4. Rotate the knob to select a tire.
5. Choose 'Add Sensor.'
6. Screw the tire pressure monitor onto the valve stem and wait until its ID is detected.

(If required, press the knob to 'Cancel Add Sensor')

7. Select 'Back' and repeat from step 4 to add additional tire sensors.
8. Refer to page 32 for instructions on updating the reference pressure for each sensor added.



Tire Sensor

Delete Sensor

'Delete Sensor' will remove a sensor from the selected tire location. This is required if a sensor is to be relocated to a different tire.

Refer to the TPMS setup menus on page 28 (*OEM or service password may be required*).

Rotate the knob to highlight a menu item and then press the knob to make a selection.

To delete a tire pressure sensor:

1. The 'Towable Connected' parameter must be set to **Yes**.
2. The 'Tow Type' parameter must be chosen for the relevant number of wheels.
3. If required, enter the password.

Note: This is an independent password entry screen compared to that used for the other configurations.

4. Rotate the knob to select a tire.
5. Choose 'Delete Sensor'.
6. Repeat from step 4 to delete additional tire sensors.

TIRE PRESSURE (TPMS) CONFIGURATION

Update Reference Pressure

Prerequisites: This procedure requires the tire to be inflated to the manufacturer's recommended pressure because the reference pressure is established from the current tire pressure. It may also be necessary to wait for up to 5 minutes for a pressure sensor to transmit its current tire pressure.

Refer to the TPMS setup menus on page 28 (password may be required).

Rotate the knob to highlight a menu item and then press the knob to make a selection.

To update the reference pressure for a tire pressure sensor:

1. The 'Towable Connected' parameter must be set to **Yes**.
2. The 'Tow Type' parameter must be chosen for the relevant number of wheels.
3. If required, enter the password.

Note: This is an independent password entry screen compared to that used for the other configurations.

4. Rotate the knob to select a tire.
5. Choose 'Update Reference Pressure'.

Note: Wait for up to 1 minute for the '**Ref. Press.**' value to display and then wait for up to 5 minutes for the pressure sensor to transmit its next reading for the '**Pressure**' to display an accurate value.

6. Repeat from Step 4 to update the reference pressure for additional tire sensors.

DIAGNOSTICS

The diagnostic screens are found in the System menu. They provide information that is helpful for service staff when troubleshooting any issues, and are discussed in greater detail in the Service Manual.

Screen	Description
I/O Info	Shows the status of the discrete inputs and outputs connected directly to the rear connectors on the GIC.
System Info	Displays the status of any alert message received since the ignition was turned on. The part numbers, firmware revisions and serial number are also shown.
OBD Info	Displays the status of any diagnostic message (DM1) received since the ignition was turned on.
J1939 CAN Info	Displays all devices communicating on the vehicle's J1939 Controller Area Network (CAN).
RVC CAN Info	Displays all devices communicating on the vehicle's RVC Controller Area Network (CAN).



5320 48 Ave. SE • Salmon Arm, BC, Canada V1E 1X2

Phone: 250-832-6477 • 24-hour Emergency Technical Support: 250-804-1247

Fax: 250-832-7746 • sales@validmanufacturing.com

www.validmanufacturing.com

Smart Wheel Steering Wheel

The **SmartWheel** Steering Wheel offers control of the horn, headlamp and marker lamp flash, cruise control, and wiper functions from switches mounted on the steering wheel. The system consists of electronic switch pods attached to the wheel and the Control Module mounted in the Front Junction Box. Communication between the steering wheel and the Control Module is accomplished via four wires which utilize a clock-spring in the steering column as a connecting path to allow for wheel rotation. As each switch is closed, the Switch Pod generates a unique signal which is transmitted to the Control Module. The Control Module decodes that signal to determine which switch is closed and operates the corresponding outputs for that function. The same four wires provide power for back-lighting the steering wheel switches.

This section illustrates and briefly describes the switches/buttons mounted on the steering wheel:

- 1. HORN:** Pressing the horn pad on the steering wheel will send the appropriate signal to the Control Module to cause the HORN output to be activated while the switch is pressed.
- 2. HEADLAMP FLASH:** If the headlamps are turned on, pressing the switch will cause them to go off while the switch is pressed. In like manner, if the headlamps are turned off, pressing the switch will cause them to go on while the switch is pressed.
- 3. MARKER LAMP FLASH:** If the marker lamps are turned on, pressing the switch will cause them to go off while the switch is pressed. In like manner, if the marker lamps are turned off, pressing the switch will cause them to go on while the switch is pressed.

CRUISE FUNCTIONS

- 4. CRUISE CANCEL:** Operation of this switch signals the cruise system to disengage without losing the current speed setting.
- 5. CRUISE RESUME:** Operation of this switch actuates the Cruise Resume function of the engine controller.
- 6. CRUISE ON/OFF:** Operation of this switch cycles the Cruise system from On to Off and back again. When the switch is in the on position, the green cruise indicator lamp will illuminate.
- 7. CRUISE SET:** Operation of this switch actuates the Cruise Set function of the engine controller.

WIPER FUNCTIONS

- 8. WIPER OFF:** Operation of this switch causes all operation of the wipers to be canceled. This mode is also entered any time that the ignition is turned off. Activation of any wiper function generates a “Headlamp On” signal from the Master which will only be reset by turning off the ignition, or by activating, then deactivating the dashboard headlamp switch.

Smart Wheel Steering Wheel

9. WIPER WASH: Operation of this switch activates the wash pump relay while the switch is pressed. In addition, if none of the latching wiper functions (Wiper Lo/Hi or Variable) had been previously selected, the Low Speed Wiper will be activated for a period of approximately 3 wiper cycles after the switch is released. If any of the latching wiper functions (Wiper Lo/Hi or Variable) had been previously selected, the wipers will continue to run in the selected mode after the wash switch is released.

10. WIPER LO/HI: Operation of this switch initially causes the Low Speed Wiper function to activate. If the switch is pressed again the High Speed Wiper function will be activated. Subsequent presses of this switch will cause alternate operation of the wipers in the low or high speed mode.

11. WIPER VARIABLE: Operation of this switch initially causes the Low Speed Wiper function to activate for one wipe. If the switch is pressed again within approximately 30 seconds, the Low Speed Wiper function will be activated again and will repeat at an interval determined by the time between the last two operations of the switch. Additional switch operations will shorten the cycle. Activation of any other wiper mode cancels the variable mode. For example, in light rain or mist conditions the driver presses the switch once when the windshield first needs clearing. When the windshield again requires clearing the driver presses the button again – setting the time period between subsequent wipes to that required by current conditions.

RADIO CONTROLS

12. Radio Power

13. Press UP: TOGGLES INPUTS -- PRESS DOWN: RADIO PRESETS

14. (UP/DOWN) RADIO VOLUME

15. (UP/DOWN) RADIO TUNE

Smart Wheel Steering Wheel



1



12

13

2

7

4

5

6

3

11

9

8

10



14

15

- 1 - HORN
- 2 - HEADLAMP
- 3 - MARKER LAMP FLASH
- 7 - CRUISE SET
- 4 - CRUISE CANCEL
- 5 - CRUISE RESUME
- 6 - CRUISE ON/OFF
- 7 - CRUISE SET
- 8 - WIPER OFF

- 9 - WIPER WASH
- 10 - WIPER HI/LO
- 11 - WIPER VARIABLE
- 12 - RADIO POWER
- 13 - UP: TOGGLES INPUTS - DOWN: RADIO PRESETS
- 14 - (UP/DOWN) RADIO VOLUME
- 15 - (UP/DOWN) RADIO TUNE

Smart Wheel Steering Wheel

Air Supply

Air Supply

Two auxiliary air sources are provided for customer use. One in the front electrical compartment, and one at the rear of the coach near the air tank drains. These air supply connections can supply up to 120psi, although the volume of air at these connections is low. For maximum air pressure at these connections, start and run the engine at 1000 rpm during use. These connections are on a pressure protected manifold, no air will be available at these connections when tank air pressure is below 85psi.



Figure 8-1: Front Customer Air Supply



Figure 8-2: Rear Customer Air Supply

- Manifold provided for auxiliary air source
 - Up to 120 psi
 - Quick connect fittings already installed at rear
- Can be used for:
 - Air horn supply
 - Fill tires
 - Etc.

Note: All unused ports must be plugged.

Warning

Air tanks should be bled of all pressure before any work is done on the air system!

AIR SUPPLY

Tag Axle

Tag Axle Operation

A tag axle is installed on coaches longer than 40' to distribute weight, improve ride, and add stability to the vehicle.

The tag axle is not a “lift” style axle. However, air pressure in the tag axle is controlled while making sharp turns, and when backing up, to reduce vehicle turning radius and prevent excessive wear on the tag axle tires.

While driving, tag axle air pressure is regulated by the drive axle height control valve. This allows weight on the tag axle to vary based on weight applied to the drive axle. When the turn signal is activated, **and** vehicle speed is below 20 MPH, pressure in the tag axle air bags is reduced to provide a tighter turning radius, and to prevent “scuffing” of the tag axle tires. Once the vehicle speed is above 20 MPH the tag axle air bags will return to their normal operating pressure.

When the transmission is placed in reverse gear, pressure in the tag axle air bags is also reduced to allow for tighter turns while backing the vehicle. Once the vehicle is driven above 20 MPH the tag axle air bags will return to their normal operating pressure.

Warranty

Warranty

- **Engine**

- Cummins ISL/ISX: 5 Years or 100,000 miles

- **Transmission**

- Allison 3000/4000 MH Series: 5 Years or 200,000 miles

- **Chassis**

- 3 Years or 50,000 miles

- **Drive Train**

- 3 Years or 50,000 miles

- **Suspension**

- 3 Years or 50,000 miles

- **GHG Emission Components**

- **Tires:** Tiffin Motor Homes, Inc. warrants that its vehicles are designed, built and equipped with tires that conform, at the time of sale, with requirements of vehicle manufactures whose vehicles are designed to meet applicable 2014 - 2019 U.S. Environmental Protection Agency and National Highway Traffic and Safety Administration greenhouse gas and fuel efficiency standards, and those tires are free from defects in material and workmanship which cause the vehicle to fail to conform with the vehicle manufacture's requirements for a period of 2 years or 24,000 miles, whichever occurs first. Claims for failures under this coverage are filed directly to the tire manufacture.

WARRANTY



902-A Gates Street, Red Bay AL 35582 (256) 356-8522

The Tiffin Allegro Club is the owner's club for all owners of any Tiffin built motorhome. The Club maintains an office near the Tiffin service center/campground and is open Monday – Friday. You will find a great supply of logo wear here, a small customer lounge, and friendly staff to make your visit to Red Bay more enjoyable.

Club members benefit from attending Tiffin rallies held across the nation, receive discounts from various vendors such as Michelin Tires, Passport America, Enterprise, etc., and develop comradery and friendship with other owners. With the purchase of a new, untitled coach, the first year's membership is complimentary from Tiffin Motorhomes. Renewals are very reasonable and discounts are offered for multiple years. You may join or renew memberships online at www.TiffinMotorhomes.com in the OWNERS section or by calling/visiting the Tiffin Allegro Club office at (256) 356-8522. News about the Club can be found at our online news blog, www.TiffinSideroads.com. Enter your email address in order to receive notices about upcoming events.

You must be a current member of the Tiffin Allegro Club in order to participate in our very popular Tiffin rallies. Rallies are usually four nights and include live entertainment, informative seminars, catered meals, and social activities such as craft shows, ice cream get-togethers, and swap meets. As a 'thank you' for your brand loyalty, Tiffin Motorhomes often sends a group of service technicians to the rallies to perform minor repairs and adjustments on your coach. A local dealer is present with a display of the newest and latest Tiffin coaches. Rallies sell out quickly! Registration information can be found at www.TiffinMotorhomes.com for all upcoming events.

In addition to the international Tiffin Allegro Club, Tiffin also has local chapters across the USA and in some Canadian provinces. These local chapters get together regularly for outings and activities. Check out the local chapter in your area by visiting the CHAPTERS page at www.Tiffinmotorhomes.com for contact information.

Membership in the Tiffin Allegro Club can play a vital part in maximizing the enjoyment you receive from owning a Tiffin built coach. For more information, please contact the Tiffin Allegro Club at (256) 356-8522. Wherever you go, we go!