



**NONRESIDENT
TRAINING
COURSE**



September 1995

Aerographer's Mate 1 & C

NAVEDTRA 14010

Although the words “he,” “him,” and “his” are used sparingly in this course to enhance communication, they are not intended to be gender driven or to affront or discriminate against anyone.

PREFACE

By enrolling in this self-study course, you have demonstrated a desire to improve yourself and the Navy. Remember, however, this self-study course is only one part of the total Navy training program. Practical experience, schools, selected reading, and your desire to succeed are also necessary to successfully round out a fully meaningful training program.

THE COURSE: This self-study course is organized into subject matter areas, each containing learning objectives to help you determine what you should learn along with text and illustrations to help you understand the information. The subject matter reflects day-to-day requirements and experiences of personnel in the rating or skill area. It also reflects guidance provided by Enlisted Community Managers (ECMs) and other senior personnel, technical references, instructions, etc., and either the occupational or naval standards, which are listed in the *Manual of Navy Enlisted Manpower Personnel Classifications and Occupational Standards*, NAVPERS 18068.

THE QUESTIONS: The questions that appear in this course are designed to help you understand the material in the text.

VALUE: In completing this course, you will improve your military and professional knowledge. Importantly, it can also help you study for the Navy-wide advancement in rate examination. If you are studying and discover a reference in the text to another publication for further information, look it up.

*1995 Edition Prepared by
AGCM B. J. Bauer and
AGC(AW) T. Howlett*

Published by
NAVAL EDUCATION AND TRAINING
PROFESSIONAL DEVELOPMENT
AND TECHNOLOGY CENTER

**NAVSUP Logistics Tracking Number
0504-LP-026-6930**

Sailor's Creed

“I am a United States Sailor.

I will support and defend the Constitution of the United States of America and I will obey the orders of those appointed over me.

I represent the fighting spirit of the Navy and those who have gone before me to defend freedom and democracy around the world.

I proudly serve my country's Navy combat team with honor, courage and commitment.

I am committed to excellence and the fair treatment of all.”

CONTENTS

CHAPTER	Page
1. Convergence, Divergence, and Vorticity	1-1
2. Forecasting Upper Air Systems	2-1
3. Forecasting Surface Systems	3-1
4. Forecasting Weather Elements	4-1
5. Forecasting Severe Weather Features	5-1
6. Sea Surface Forecasting	6-1
7. Meteorological Products and Tactical Decision Aids	7-1
8. Oceanographic Products and Tactical Decision Aids	8-1
9. Operational Oceanography	9-1
10. Special Observations and Forecasts	10-1
11. Tropical Forecasting	11-1
12. Weather Radar	12-1
13. Meteorological and Oceanographic Briefs	13-1
14. Administration and Training	14-1
APPENDIX	
I. References Used to Develop the TRAMAN	AI-1
INDEX	INDEX-1

INSTRUCTIONS FOR TAKING THE COURSE

ASSIGNMENTS

The text pages that you are to study are listed at the beginning of each assignment. Study these pages carefully before attempting to answer the questions. Pay close attention to tables and illustrations and read the learning objectives. The learning objectives state what you should be able to do after studying the material. Answering the questions correctly helps you accomplish the objectives.

SELECTING YOUR ANSWERS

Read each question carefully, then select the BEST answer. You may refer freely to the text. The answers must be the result of your own work and decisions. You are prohibited from referring to or copying the answers of others and from giving answers to anyone else taking the course.

SUBMITTING YOUR ASSIGNMENTS

To have your assignments graded, you must be enrolled in the course with the Nonresident Training Course Administration Branch at the Naval Education and Training Professional Development and Technology Center (NETPDTC). Following enrollment, there are two ways of having your assignments graded: (1) use the Internet to submit your assignments as you complete them, or (2) send all the assignments at one time by mail to NETPDTC.

Grading on the Internet: Advantages to Internet grading are:

- you may submit your answers as soon as you complete an assignment, and
- you get your results faster; usually by the next working day (approximately 24 hours).

In addition to receiving grade results for each assignment, you will receive course completion confirmation once you have completed all the

assignments. To submit your assignment answers via the Internet, go to:

<http://courses.cnet.navy.mil>

Grading by Mail: When you submit answer sheets by mail, send all of your assignments at one time. Do NOT submit individual answer sheets for grading. Mail all of your assignments in an envelope, which you either provide yourself or obtain from your nearest Educational Services Officer (ESO). Submit answer sheets to:

COMMANDING OFFICER
NETPDTC N331
6490 SAUFLEY FIELD ROAD
PENSACOLA FL 32559-5000

Answer Sheets: All courses include one “scannable” answer sheet for each assignment. These answer sheets are preprinted with your SSN, name, assignment number, and course number. Explanations for completing the answer sheets are on the answer sheet.

Do not use answer sheet reproductions: Use only the original answer sheets that we provide—reproductions will not work with our scanning equipment and cannot be processed.

Follow the instructions for marking your answers on the answer sheet. Be sure that blocks 1, 2, and 3 are filled in correctly. This information is necessary for your course to be properly processed and for you to receive credit for your work.

COMPLETION TIME

Courses must be completed within 12 months from the date of enrollment. This includes time required to resubmit failed assignments.

PASS/FAIL ASSIGNMENT PROCEDURES

If your overall course score is 3.2 or higher, you will pass the course and will not be required to resubmit assignments. Once your assignments have been graded you will receive course completion confirmation.

If you receive less than a 3.2 on any assignment and your overall course score is below 3.2, you will be given the opportunity to resubmit failed assignments. **You may resubmit failed assignments only once.** Internet students will receive notification when they have failed an assignment--they may then resubmit failed assignments on the web site. Internet students may view and print results for failed assignments from the web site. Students who submit by mail will receive a failing result letter and a new answer sheet for resubmission of each failed assignment.

COMPLETION CONFIRMATION

After successfully completing this course, you will receive a letter of completion.

ERRATA

Errata are used to correct minor errors or delete obsolete information in a course. Errata may also be used to provide instructions to the student. If a course has an errata, it will be included as the first page(s) after the front cover. Errata for all courses can be accessed and viewed/downloaded at:

<http://www.advancement.cnet.navy.mil>

STUDENT FEEDBACK QUESTIONS

We value your suggestions, questions, and criticisms on our courses. If you would like to communicate with us regarding this course, we encourage you, if possible, to use e-mail. If you write or fax, please use a copy of the Student Comment form that follows this page.

For subject matter questions:

E-mail: n315.products@cnet.navy.mil
Phone: Comm: (850) 452-1001, Ext. 1713
DSN: 922-1001, Ext. 1713
FAX: (850) 452-1370
(Do not fax answer sheets.)
Address: COMMANDING OFFICER
NETPDTC (CODE 315)
6490 SAUFLEY FIELD ROAD
PENSACOLA FL 32509-5237

For enrollment, shipping, grading, or completion letter questions

E-mail: fleetservices@cnet.navy.mil
Phone: Toll Free: 877-264-8583
Comm: (850) 452-1511/1181/1859
DSN: 922-1511/1181/1859
FAX: (850) 452-1370
(Do not fax answer sheets.)
Address: COMMANDING OFFICER
NETPDTC (CODE N331)
6490 SAUFLEY FIELD ROAD
PENSACOLA FL 32559-5000

NAVAL RESERVE RETIREMENT CREDIT

If you are a member of the Naval Reserve, you will receive retirement points if you are authorized to receive them under current directives governing retirement of Naval Reserve personnel. For Naval Reserve retirement, this course is evaluated at 8 points. (Refer to *Administrative Procedures for Naval Reservists on Inactive Duty*, BUPERSINST 1001.39, for more information about retirement points.)

COURSE OBJECTIVES

The objective of this course is to provide Aerographer's Mates with occupational information on the following areas: convergence, divergence, and vorticity; the forecasting of upper air systems; the forecasting of surface systems; the forecasting of weather elements; the forecasting of severe weather features; sea surface forecasting; meteorological products and tactical decision aids; oceanographic products and tactical decision aids; operational oceanographic products and tactical decision aids.

graphy; tropical forecasting; weather radar; meteorological and oceanographic briefs; and administration and training.

Student Comments

Course Title: Aerographer's Mate 1 & C

NAVEDTRA: 14010 **Date:** _____

We need some information about you:

Rate/Rank and Name: _____ SSN: _____ Command/Unit _____

Street Address: _____ City: _____ State/FPO: _____ Zip _____

Your comments, suggestions, etc.:

<p>Privacy Act Statement: Under authority of Title 5, USC 301, information regarding your military status is requested in processing your comments and in preparing a reply. This information will not be divulged without written authorization to anyone other than those within DOD for official use in determining performance.</p>
--

NETPDTC 1550/41 (Rev 4-00)

CHAPTER 1

CONVERGENCE, DIVERGENCE, AND VORTICITY

In your reading of the *AG2* manual, volume 1, you became familiar with the terms *convergence*, *divergence*, and *vorticity* when used in relation to surface lows and highs. You were also presented with a basic understanding of the principles involved. In this section, we will cover the terms, the motions involved in upper air features and surface features, and the relationship of these processes to other meteorological applications.

We will first discuss convergence and divergence, followed by a discussion of vorticity.

NOTE

The World Meteorological Organization adopted "hectopascals" (hPa) as its standard unit of measurement for pressure. Because the units of hectopascals and millibars are interchangeable (1 hPa = 1 mb), hectopascals have been substituted for millibars in this TRAMAN.

CONVERGENCE AND DIVERGENCE

LEARNING OBJECTIVES: Define the terms *convergence* and *divergence*. Recognize directional and velocity wind shear rules. Recognize areas of mass divergence and mass convergence on surface pressure charts. Identify the isopycnic level. Retail the effects that convergence and divergence have on surface pressure systems and features aloft. Identify rules associated with divergence and convergence.

As mentioned in the *AG2* manual, volume 1, unit 8, convergence is the accumulation of air in a region or layer of the atmosphere, while divergence is the depletion of air in a region or layer. The layer of maximum convergence and divergence occurs between

the 300- and 200-hPa levels. Coincidentally, this is also the layer of maximum winds in the atmosphere; where jet stream cores are usually found. These high-speed winds are directly related to convergence and divergence. The combined effects of wind direction and wind speed (velocity) is what produces convergent and divergent airflow.

CONVERGENCE AND DIVERGENCE (SIMPLE MOTIONS)

Simply stated, convergence is defined as the increase of mass within a given layer of the atmosphere, while divergence is the decrease of mass within a given layer of the atmosphere.

Convergence

For convergence to take place, the winds must result in a net inflow of air into that layer. We generally associate this type of convergence with low-pressure areas, where convergence of winds toward the center of the low results in an increase of mass into the low and an upward motion. In meteorology, we distinguish between two types of convergence as either horizontal or vertical convergence, depending upon the axis of the flow.

Divergence

Winds in this situation produce a net flow of air outward from the layer. We associate this type of divergence with high-pressure cells, where the flow of air is directed outward from the center, causing a downward motion. Divergence, too, is classified as either horizontal or vertical.

DIRECTIONAL WIND SHEAR

The simplest forms of convergence and divergence are the types that result from wind direction alone. Two flows of air need not be moving in opposite directions to induce divergence, nor moving toward the same point to induce convergence, but maybe at any angle to each other to create a net inflow of air for convergence or a net outflow for divergence.

WIND SPEED (VELOCITY) SHEAR

Convergence is occurring when wind speeds are decreasing downstream; that is, mass is accumulating upstream. Conversely, divergence is occurring when wind speeds are increasing downstream; that is, mass is being depleted upstream.

DIRECTIONAL AND SPEED WIND SHEAR

Wind speed in relation to the wind direction is also a valuable indicator. For example, on a streamline analysis chart we can analyze both wind direction and wind speed, variations in wind speed along the streamlines, or the convergence or divergence of the streamlines.

The following are some of the combinations or variations of wind speed and direction:

- In a field of parallel *streamlines* (wind flow), if the wind speed is decreasing downstream (producing a net inflow of air for the layer), convergence is taking place. If the flow is increasing downstream (a net outflow of air from the layer), divergence is occurring.

- In an area of uniform wind speed along the streamlines, if the streamlines diverge (fan out), divergence is occurring; if the streamlines converge (come together), convergence is taking place.

- Normally, the convergence and divergence components are combined. The fact that streamlines converge or diverge does not necessarily indicate convergence or divergence. We must also consider the wind speeds—whether they are increasing or decreasing downstream in relation to whether the streamlines are spreading out or coming together.

- If, when looking downstream on the streamlines, the wind speed increases and the streamlines diverge, divergence is taking place. On the other hand, if the wind speed decreases downstream and the streamlines come together, convergence is taking place.

There are other situations where it is more difficult to determine whether divergence or convergence is occurring, such as when the wind speed decreases downstream and the wind flow diverges, as well as when wind speed increases downstream and the wind flow converges. A special evaluation then must be made to determine the net inflow or outflow.

DIVERGENCE AND CONVERGENCE (COMPLEX MOTIONS)

In this section we will be discussing high-level convergence and divergence in relation to downstream contour patterns and the associated advection patterns. Low tropospheric advection (and also stratospheric advection) certainly play a large role in pressure change mechanisms.

Since the term *divergence* is meant to denote depletion of mass, while *convergence* is meant to denote accumulation of mass, the forecaster is concerned with the mass divergence or mass convergence in estimating pressure or height changes. Mass divergence in the entire column of air produces pressure or height falls, while mass convergence in the entire column of air produces pressure or height rises at the base of the column.

Mass Divergence and Mass Convergence

Mass divergence and mass convergence involve the density field as well as the velocity field. However, the mass divergence and mass convergence of the atmosphere are believed to be largely stratified into two layers as follows:

- Below about 600 hPa, velocity divergence and convergence occur chiefly in the friction layer, which is about one-eighth of the weight of the 1,000-to 600-hPa advection stratum, and may be disregarded in comparison with density transport in estimating the contribution to the pressure change by the advection stratum.

- Above 600 hPa, mass divergence and convergence largely result from horizontal divergence and convergence of velocity. However, on occasion, stratospheric advection of density may be a modifying factor.

The stratum below the 400-hPa level may be regarded as the ADVECTION stratum, while the stratum above the 400-mb level maybe regarded as the significant horizontal divergence or convergence stratum. Also, the advection stratum maybe thought of as the zone in which compensation of the dynamic effects of the upper stratum occurs.

The Isopycnic Level

At about 8km (26,000 ft) the density is nearly constant. This level, which is near the 350-hPa pressure surface, is called the *isopycnic level*. This level is the

location of constant density, with mass variations above and below.

Since the density at 200 hPa is only four-sevenths the density at the isopycnic level, the height change at 200 hPa would have to be twice that at the isopycnic level (350 hPa) for the same pressure/height change to occur. Thus, height changes in the lower stratosphere tend to be a maximum even though pressure changes are a maximum at the isopycnic level.

Pressure changes occur at the isopycnic level, and in order to maintain constant density a corresponding temperature change must also occur. Since the density is nearly constant at this level, the required temperature variations must result from vertical motions. When the pressures are rising at this level, the temperature must also rise to keep the density constant. A temperature rise can be produced by descending motion. Similarly falling pressures at this level require falling temperatures to keep the density constant. Falling temperatures in the absence of advection can be produced by ascent through this level.

Thus, rising heights at the isopycnic level are associated with subsidence, and falling heights at the isopycnic level are associated with convection.

The 350-hPa to 200-hPa Stratum

Subsidence at 350 hPa can result from horizontal convergence above this level, while convection here would result from horizontal divergence above this level.

Since rising heights in the upper troposphere result in a rising of the tropopause and the lower stratosphere, the maximum horizontal convergence must occur between the isopycnic level (350 hPa) and the average level of the tropopause (about 250 hPa). This is due to the reversal of the vertical motion between the tropopause and the isopycnic level. Thus, the level of maximum horizontal velocity convergence must be between 300 hPa and 200 hPa and is the primary mechanism for pressure or height rises in the upper air. Similarly, upper height falls are produced by horizontal velocity divergence with a maximum at the same level. The maximum divergence occurs near or slightly above the tropopause and closer to 200 hPa than to 300 hPa. Therefore, it is more realistic to define a layer of maximum divergence and convergence as occurring between the 300- and 200-hPa pressure surfaces. The 300- to 200-hPa stratum is also the layer in which the core of the jet stream is usually located. It is also at this level that the cumulative effects of the mean temperature

field of the troposphere produce the sharpest horizontal contrasts in the wind field.

The level best suited for determination of convergence and divergence is the 300-hPa level. Because of the sparsity of reports at the 300-hPa level, it is frequently advantageous to determine the presence of convergence and divergence at the 500-hPa level.

Divergence/Convergence and Surface Pressure Systems

The usual distribution of divergence and convergence relative to moving pressure systems is as follows:

- In advance of the low, convergence occurs at low levels and divergence occurs aloft, with the level of nondivergence at about 600 hPa.
- In the rear of the low, there is usually convergence aloft and divergence near the surface.

The low-level convergence ahead of the low occurs usually in the stratum of strongest warm advection, and the low-level divergence in the rear of the low occurs in the stratum of strongest cold advection. The low-level divergence occurs primarily in the friction layer (approximately 3,000 ft) and is thought to be of minor importance in the modification of thickness advection compared with heating and cooling from the underlying surfaces.

Divergence/Convergence Features Aloft

In advance of the low, the air rises in response to the low-level convergence, with the maximum ascending motion at the level of nondivergence eventually becoming zero at the level of maximum horizontal divergence (approximately 300 hPa). Above this level, descending motion is occurring. In the rear of the low, the reverse is true; that is, descending motion in the surface stratum and ascending motion in the upper troposphere above the level of maximum horizontal convergence. In deepening systems, the convergence aloft to the rear of the low is small or may even be negative (divergence). In filling systems, the divergence aloft in advance of the low is small or even negative (convergence).

Thus, in the development and movement of surface highs and surface lows, two vertical circulations are involved, one below and one above the 300-hPa level. The lower vertical circulation is upward in the cyclone

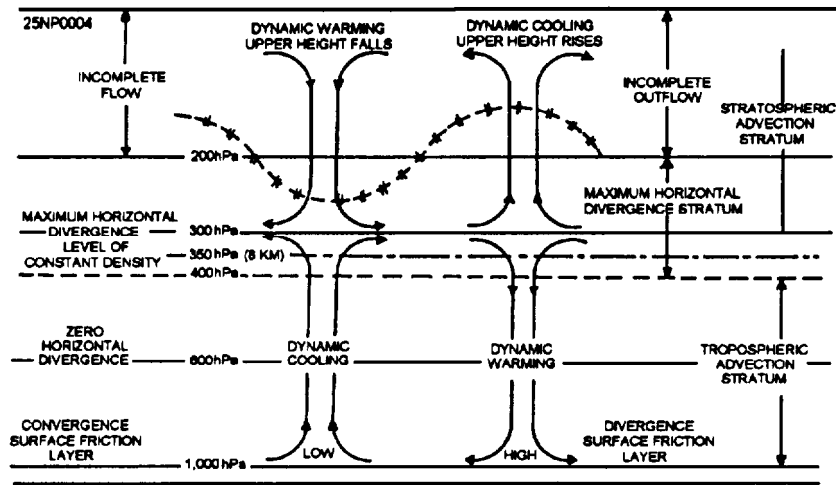

Figure 1-1.-Generalized vertical circulation overdeveloping highs and lows.

and downward in the anticyclone. The upper vertical circulation involves downward motion in the stratosphere of the developing cyclone and upward motion in the upper troposphere and lower stratosphere of the developing anticyclone. See figure 1-1.

Divergence and upper-height falls are associated with high-speed winds approaching weak contour gradients which are cyclonically curved. Figure 1-2 illustrates contour patterns associated with height falls,

Convergence and upper-height rises are associated with the following:

- Low-speed winds approaching straight or cyclonically curved strong contour gradients. See figure 1-3, view (A).
- High-speed winds approaching anticyclonically curved weak contour gradients. See figure 1-3, view (B).

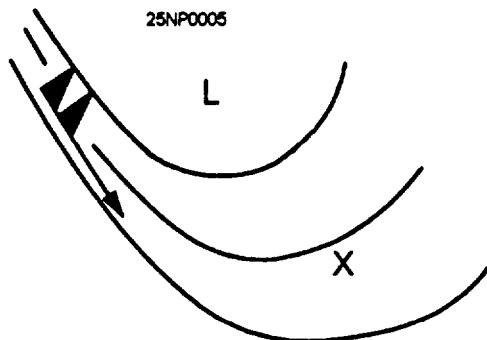
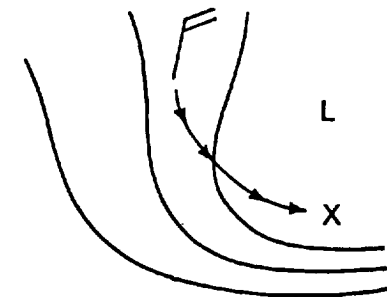
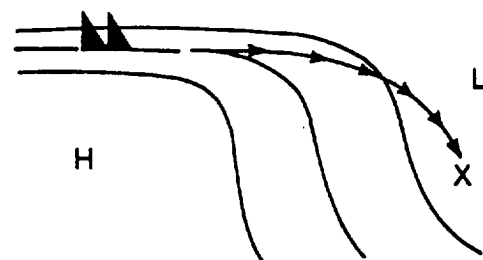

Figure 1-2.-Divergence Illustrated.



(A)



(B)

Figure 1-3.-Convergence Illustrated.

Note that the associated height rises or falls occur downstream and to the left of the flow, as illustrated in figure 1-3.

Divergence Identification (Downstream Straightline Flow)

The technique for determining the areas of divergence consists in noting those areas where winds of high speed are approaching weaker downstream gradients that are straight. When inertia carries a high-speed parcel of air into a region of weak gradient, it possesses a Coriolis force too large to be balanced by the weaker gradient force, It is thus deflected to the right. This results in a deficit of mass to the left. The parcels that are deflected to the right must penetrate higher pressure/heights and are thus slowed down until they are in balance with the weaker gradient. Then they can be steered along the existing isobaric or contour channels.

Divergence Identification (Weak Downstream Cyclonically Curved Flow)

If the weak downstream gradients are cyclonically curved, the divergence resulting from the influx of high-speed wind is even more marked due to the additional effect of centrifugal forces.

Divergence Identification (Downstream Anticyclonically Curved Flow)

The effect of centrifugal forces on anticyclonically curving high-speed parcels is of extreme importance in producing overshooting of high-speed air from sharply curved ridges into adjacent troughs, causing pressure rises in the west side of the troughs.

Divergence Identification (Strong Winds)

If high-speed parcels approach diverging cyclonically curved contours, large contour falls will occur downstream to the left of the high-speed winds. Eventually a strong pressure gradient is produced downstream, to the right of the high-speed winds, chiefly as a result of pressure falls to the left of the direction of high-speed winds in the cyclonically curved contours with weak pressure gradient. Usually the deflection of air toward higher pressure is so slight that it is hardly observable in individual wind observations. However, when the pressure field is very weak to the right of the incoming high-speed stream, noticeable angles between the wind and contours may be observed,

especially at lower levels, due to transport of momentum downward as a result of subsidence, where the gradients are even weaker. This occurs sometimes to such an extent that the wind flow is considerably more curved anticyclonically than the contours. In rare cases this results in anticyclonic circulation centers out of phase with the high-pressure center. This is a transitory condition necessitating a migration of the pressure center toward the circulation center. In cases where the high-pressure center and anticyclonic wind flow center are out of phase, the pressure center will migrate toward the circulation center (which is usually a center of mass convergence).

It is more normal, however, for the wind component toward high pressure to be very slight, and unless the winds and contours are drawn with great precision, the deviation goes unnoticed.

Overshooting

High-speed winds approaching sharply curved ridges result in large height rises downstream from the ridge due to overshooting of the high-speed air. It is known from the gradient wind equation that for a given pressure gradient there is a limiting curvature to the trajectory of a parcel of air moving at a given speed. Frequently on upper air charts, sharply curved stationary ridges are observed with winds of high speed approaching the ridge. The existence of a sharply curved extensive ridge usually means a well-developed trough downstream, and frequently a cold or cutoff low exists in this trough. The high-speed winds approaching the ridge, due to centrifugal forces, are unable to make the sharp turn necessary to follow the contours. These winds overshoot the ridge anticyclonically, but with less curvature than the contours, resulting in their plunging across contours toward lower pressure/heights downstream from the ridge. This may result in any one of a number of consequences for the downstream trough, depending on the initial configuration of the ridge and trough, but all of these consequences are based on the convergence of mass into the trough as a result of overshooting of winds from the ridge.

Four effects of overshooting areas follows:

1. Filling of the downstream trough. This happens if the contour gradient is strong on the east side of the trough; that is, a blocking ridge to the east of the trough.
2. Acceleration of the cutoff low from of its stationary position. This usually occurs in all cases.

3. Radical reorientation of the trough. This usually happens where the trough is initially NE-SW, resulting in a N-S and in some cases a NW-SE orientation after sufficient time (36 hours).

4. This situation may actually cut off a low in the lower area of the trough. This usually happens when the high-speed winds approaching the ridge are southwesterly and approach the ridge at a comparatively high latitude relative to the trough. This frequently reorients the trough line towards a more NE-SW direction. Usually, the reorientation of the trough occurs simultaneously with 1 and 2.

Sharply Curved Ridges

Closely related to the previously mentioned situation are cases of sharply curved ridges where the gradient in the sharply curved portion (usually the northern portions of a north-south ridge) has momentarily built up to a strength that is incompatible with the anticyclonic curvature. Such ridges often collapse with great rapidity prior to the development of such excessive gradients, causing rapid filling of the adjacent downstream trough, and large upper contour falls. The gradient wind relation implies that subsequent trajectories of the high-speed parcels generated in the strong ridge line gradient must be less anticyclonically curved than the contours in the ridge.

It can also be shown from the gradient wind equation that the anticyclonic curvature increases as the difference between the actual wind and the geostrophic wind increases, until the actual wind is twice the geostrophic wind, when the trajectory curvature is at a maximum. This fact can be used in determining the trajectory of high-speed parcels approaching sharply curved stationary ridges or sharply curved stationary ridges with strong gradients. By measuring the geostrophic wind in the ridge, the maximum trajectory curvature can be obtained from the gradient wind scale. This trajectory curve is the one that an air parcel at the origin point of the scale will follow until it intersects the correction curve from the geostrophic speed to the displacement curve of twice the geostrophic speed.

Actual Wind Speeds

If actual wind speed observations are available for parcels approaching the ridge, comparison can be made with the geostrophic winds (pressure gradient) in the ridge. If the actual speeds are more than twice the measured geostrophic wind in the ridge, the anticyclonic curvature of these high-speed parcels will be less than

the maximum trajectory curvature obtained from the gradient wind scale, and even greater overshooting of these high-speed parcels will occur across lower contours. Convergence in the west side of the downstream trough results in lifting of the tropopause with dynamic cooling and upper-level contour rises.

Subgradient Winds

Low-speed winds approaching an area of stronger gradient become subject to an unbalanced gradient force toward the left due to the weaker Coriolis force. These subgradient winds are deflected toward lower pressure, crossing contours and producing contour rises in the area of cross-contour flow. This cross-contour flow accelerates the air until it is moving fast enough to be balanced by the stronger pressure gradient. Due to the acceleration of the slower oncoming parcels of air, the contour rises propagate much faster than might be expected on the basis of the slow speed of the air as it initially enters the stronger pressure gradient.

The following two rules summarize the discussion of subgradient winds:

- High-speed winds approaching low-speed winds with weak cyclonically curved contour gradients are indicative of divergence and upper-height falls downstream to the left of the current.
- Low-speed winds approaching strong, cyclonically curved contour gradients or high-speed winds approaching low-speed winds with weak anticyclonically curved contour gradients are indicative of convergence and upper height rises downstream and to the left and right of the current, respectively.

IMPORTANCE OF CONVERGENCE AND DIVERGENCE

Convergence and divergence have a pronounced effect upon the weather occurring in the atmosphere. Vertical motion, either upward or downward, is recognized as an important parameter in the atmosphere. For instance, extensive regions of precipitation associated with extratropical cyclones are regions of large-scale upward motion. Similarly, the nearly cloud-free regions in large anticyclones are regions in which air is subsiding. Vertical motions also affect temperature, humidity, and other meteorological elements.

Changes in Stability

When convergence or divergence occurs, whether on a large or small scale, it may have a very pronounced effect on the stability of the air. For example, when convection is induced by convergence, air is forced to rise without the addition of heat. If this air is unsaturated, it cools first at the dry adiabatic rate; or if saturated at the moist rate. The end result is that the air is cooled, which will increase the instability of that air column due to a net release of heat. Clouds and weather often result from this process.

Conversely, if air subsides, and this process is produced by convergence or divergence, the sinking air will heat at the dry adiabatic lapse rate due to compression. The warming at the top of an air column will increase the stability of that air column by reducing the lapse rate. Such warming often dissipates existing clouds or prevents the formation of new clouds. If sufficient warming due to the downward motion takes place, a subsidence inversion is produced.

Effect on Weather

The most important application of vertical motion is the prediction of rainfall probability and rainfall amount. In addition, vertical motion affects practically all meteorological properties, such as temperature, humidity, wind distribution, and particularly stability. In the following section the distribution of large-scale and small-scale vertical motions are considered.

Since cold air has a tendency to sink, subsidence is likely to be found to the west of upper tropospheric troughs, and rising air to the east of the troughs. Thus, there is a good relation between upper air meridional flow and vertical flow.

In the neighborhood of a straight Northern Hemisphere jet stream, convergence is found to the north of the stream behind centers of maximum speed as well as to the south and ahead of such centers. Divergence exists in the other two quadrants. Below the regions of divergence the air rises; below those of convergence there is subsidence.

These general rules of thumb are not perfect, and only yield a very crude idea about distribution of vertical motion in the horizontal. Particularly over land in summer, there exists little relation between large-scale weather patterns and vertical motion. Rather, vertical motion is influenced by local features and shows strong diurnal variations. Large-scale vertical motion is of small magnitude at the ground (zero if the ground is flat).

Above ground level, it increases in magnitude to at least 500 hPa and decreases in the neighborhood of the tropopause. There have been several studies of the relation between frontal precipitation and large-scale vertical velocities, computed by various techniques. In all cases, the probability of precipitation is considerably higher in the 6 hours following an updraft than following subsidence. Clear skies are most likely with downdrafts. On the other hand, it is not obvious that large-scale vertical motion is related to showers and thunderstorms caused during the daytime by heating. However, squall lines, which are formed along lines of horizontal convergence, show that large-scale vertical motion may also play an important part in convective precipitation.

Vertical Velocity Charts

Vertical velocity charts are currently being transmitted over the facsimile network and are computed by numerical weather prediction methods. The charts have plus signs indicating upward motion and minus signs indicating downward motion. The figures indicate vertical velocity in centimeters per second (cm/sec). With the larger values of upward motions (plus values) the likelihood of clouds and precipitation increases. However, an evaluation of the moisture and vertical velocity should be made to get optimum results. Obviously, upward motion in dry air is not as likely to produce precipitation as upward motion in moist air.

Studies have shown that surface cyclones and anticyclones are not independent of developments in the upper atmosphere, rather, they work in tandem with one another. The relationship of the cyclone to the large-scale flow patterns aloft must therefore be a part of the daily forecast routine.

Many forecasters have a tendency to shy away from the subject of vorticity, as they consider it too complex a subject to be mastered. By not considering vorticity and its effects, the forecaster is neglecting an important forecasting tool. The principles of vorticity are no more complicated than most of the principles of physics, and can be understood just as readily. In the following section we will discuss the definition of vorticity, its evaluation, and its relationships to other meteorological parameters.

VORTICITY

LEARNING OBJECTIVES: Recognize the two components of relative vorticity. Define the term *absolute vorticity*. Determine vorticity impacts on weather processes.

Vorticity measures the rotation of very small air parcels. A parcel has vorticity when it spins on its axis as it moves along its path. A parcel that does not spin on its axis is said to have zero vorticity. The axis of spinning or rotation can extend in any direction, but for our purposes, we are mainly concerned with the rotational motion about an axis that is perpendicular to the surface of the Earth. For example, we could drop a chip of wood into a creek and watch its progress. The chip will move downstream with the flow of water, but it may or may not spin as it moves downstream. If it does spin, the chip has vorticity. When we try to isolate the cause of the spin, we find that two properties of the flow of water cause the chip to spin: (1) If the flow of water is moving faster on one side of the chip than the other, this is shear of the current; (2) if the creek bed curves, the path has curvature. Vorticity always applies to extremely small air parcels; thus, a point on one of our upper air charts may represent such a parcel. We can examine this point and say that the parcel does or does not have vorticity. However, for this discussion, larger parcels will have to be used to more easily visualize the effects. Actually, a parcel in the atmosphere has *three* rotational motions at the same time: (1) rotation of the parcel about its own axis (*shear*), (2) rotation of the parcel about the axis of a pressure system (*curvature*), and (3) rotation of the parcel due to the atmospheric rotation. The sum of the first two components is known as *relative vorticity*, and the sum total of all three is known as *absolute vorticity*.

RELATIVE VORTICITY

Relative vorticity is the sum of the rotation of the parcel about the axis of the pressure system (curvature) and the rotation of the parcel about its own axis (shear).

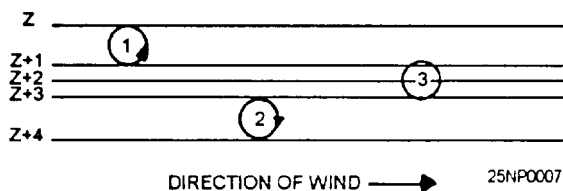

Figure 1-4. Illustration of vorticity due to the shear effect.

The vorticity of a horizontal current can be broken down into two components, one due to curvature of the streamlines and the other due to shear in the current.

Shear

First, let us examine the shear effect by looking at small air parcels in an upper air pattern of straight contours. Here the wind shear results in each of the three parcels having different rotations (fig. 1-4).

Refer to figure 1-4. Parcel No. 1 has stronger wind speeds to its right. As the parcel moves along, it will be rotated in a counterclockwise direction. Parcel No. 2 has the stronger wind speeds to its left; therefore, it will rotate in a clockwise direction as it moves along. Parcel No. 3 has equal wind speeds to the right and left. It will move, but it will not rotate. It is said to have zero vorticity.

Therefore, to briefly review the effect of shear—a parcel of the atmosphere has vorticity (rotation) when the wind speed is stronger on one side of the parcel than on the other.

Now let's define positive and negative vorticity in terms of clockwise and counterclockwise rotation of a parcel. The vorticity is positive when the parcel has a counterclockwise rotation (cyclonic, Northern Hemisphere) and the vorticity is negative when the parcel has clockwise rotation (anticyclonic, Northern Hemisphere).

Thus, in figure 1-4, parcel No. 1 has positive vorticity, and parcel No. 2 has negative vorticity.

Curvature

Vorticity can also result due to curvature of the airflow or path. In the case of the wood chip flowing with the stream, the chip will spin or rotate as it moves along if the creek curves.

To demonstrate the effect of curvature, let us consider a pattern of contours having curvature but no shear (fig. 1-5).

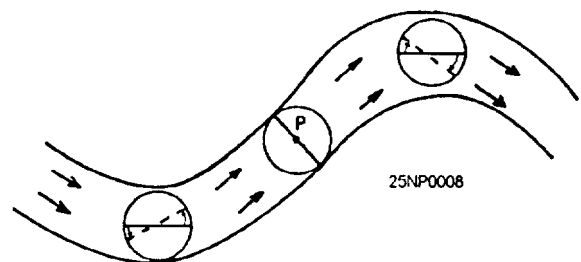

Figure 1-5. Illustration of vorticity due to curvature effect.

Place a small parcel at the trough and ridge lines and observe the way the flow will spin the parcel, causing vorticity. The diameter of the parcel will be rotated from the solid line to the dotted position (due to the northerly and southerly components of the flow on either side of the trough and ridge lines).

Note that we have counterclockwise rotation at the trough (positive vorticity), and at the ridge line we have clockwise rotation (negative vorticity). At the point where there is no curvature (inflection point), there is no turning of the parcel, hence no vorticity. This is demonstrated at point P in figure 1-5.

Combined Effects

To find the relative vorticity of a given parcel, we must consider both the shear and curvature effects. It is quite possible to have two effects counteract each other; that is, where shear indicates positive vorticity but curvature indicates negative vorticity, or vice versa (fig. 1-6).

To find the net result of the two effects we would measure the value of each and add them algebraically. The measurement of vorticity will be discussed in the next section.

It must be emphasized here that relative vorticity is observed instantaneously. Relative vorticity in the atmosphere is defined as the instantaneous rotation of very small particles. The rotation results from wind shear and curvature. We refer to this vorticity as being relative, because all the motion illustrated was relative to the surface of the Earth.

ABSOLUTE VORTICITY

When the relative vorticity of a parcel of air is observed by a person completely removed from the Earth, he or she observes an additional component of vorticity created by the rotation of the Earth. Thus, this

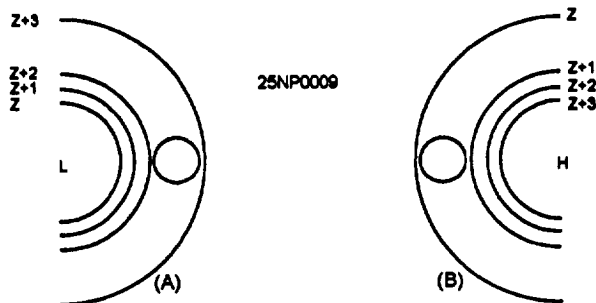

Figure 1-6-Illustration of shear effect opposing the curvature effect in producing vorticity. (A) Negative shear and positive curvature; (B) positive shear and negative curvature.

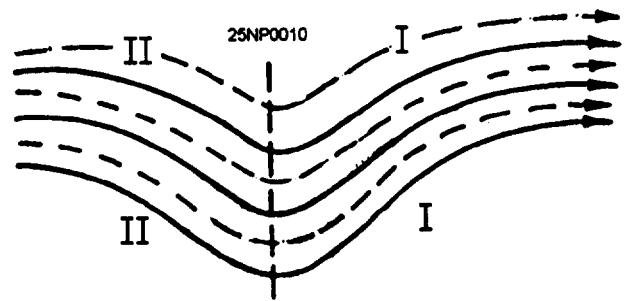

Figure 1-7-Contour-isotach pattern for shear analysis.

person sees the total or absolute vorticity of the same parcel of air.

The total vorticity, that is, relative vorticity plus that due to the Earth's rotation, is known as the absolute vorticity. As was stated before, for practical use in meteorology, only the vorticity about an axis perpendicular to the surface of the Earth is considered. In this case, the vorticity due to the Earth's rotation becomes equal to the Coriolis parameter. This is expressed as $2\omega \sin \theta$, where ω is the angular velocity of the Earth and θ is the latitude. Therefore, the absolute vorticity is equal to the Coriolis parameter plus the relative vorticity. Writing this in equation form gives: (Za = absolute vorticity)

$$Za = 2\omega \sin \theta + Zr$$

EVALUATION OF VORTICITY

In addition to locating the areas of convergence and divergence, we must also consider the effects of horizontal wind shear as it affects the relative vorticity, and hence the movement of the long waves and deepening or falling associated with this movement.

The two terms *curvature* and *shear*, which determine the relative vorticity, may vary inversely to each other. Therefore, it is necessary to evaluate both of them. Figures 1-7 through 1-10 illustrate some of the possible combinations of curvature and shear. Solid

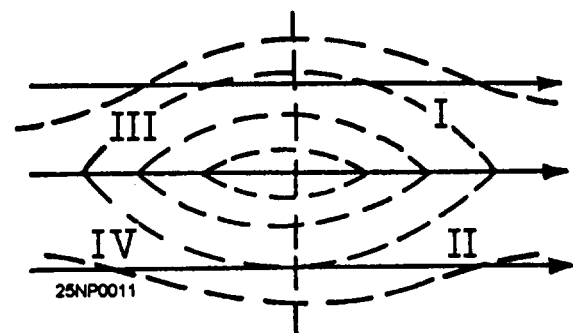

Figure 1-8-Contour-isotach pattern for shear analysis.

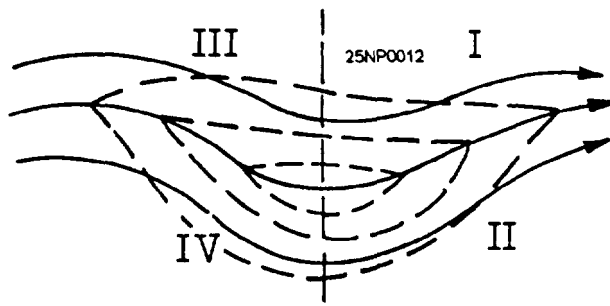

Figure 1-9.-Contour-isotach pattern for shear analysis.

lines are streamlines or contours; dashed lines are isotachs.

Figure 1-7 represents a symmetrical sinusoidal streamline pattern with isotachs parallel to contours. Therefore, there is no gradient of shear along the contours. In region I, the curvature becomes more anticyclonic downstream, reaching a maximum at the axis of the downstream ridge; that is, relative vorticity decreases from the trough to a minimum at the downstream ridge. The region from the trough to the downstream ridge axis is favorable for deepening.

The reverse is true west of the trough, region II. This region is unfavorable for deepening.

In figure 1-8 there is no curvature of streamlines; therefore, the shear alone determines the relative vorticity. The shear downstream in regions I and IV becomes less cyclonic; in regions II and III, it becomes more cyclonic. Regions I and IV are therefore favorable for deepening downstream.

In region I of figure 1-9 both cyclonic shear and curvature decrease downstream and this region is highly favorable for deepening. In region III both cyclonic shear and curvature increase downstream and this region is unfavorable for deepening. In region II the cyclonic curvature decreases downstream, but the cyclonic shear increases. This situation is indeterminate without calculation unless one term predominates. If the curvature gradient is large and the shear gradient small, the region is likely to be favorable for deepening.

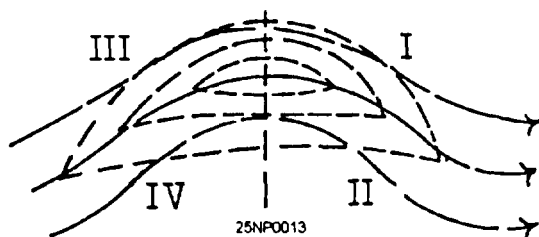

Figure 1-10.-Contour-isotach pattern for shear analysis.

In region IV, the cyclonic curvature increases downstream, but the cyclonic shear decreases, so that this region is also indeterminate unless one of the two terms predominates.

In region I of figure 1-10 the cyclonic shear decreases downstream and the cyclonic curvature increases. The region is indeterminate; however, if the shear gradient is larger than the curvature gradient, deepening is favored. Region II has increasing cyclonic shear and curvature downstream and is quite unfavorable. In region III, the shear becomes more cyclonic downstream and the curvature becomes less cyclonic. This region is also indeterminate unless the curvature term predominates. In region IV, the shear and curvature become less cyclonic downstream and the region is favorable for deepening.

RELATION OF VORTICITY TO WEATHER PROCESSES

Vorticity not only affects the formation of cyclones and anticyclones, but it also has a direct bearing on cloudiness, precipitation, pressure, and height changes. Vorticity is used primarily in forecasting cloudiness and precipitation over an extensive area. One rule states that when relative vorticity decreases downstream in the upper troposphere, convergence is taking place in the lower levels. When convergence takes place, cloudiness and possibly precipitation will prevail if sufficient moisture is present.

One rule using vorticity in relation to cyclone development stems from the observation that when cyclone development occurs, the location, almost without exception, is in advance of an upper trough. Thus, when an upper level trough with positive vorticity advection in advance of it overtakes a frontal system in the lower troposphere, there is a distinct possibility of cyclone development at the surface. This is usually accompanied by deepening of the surface system. Also, the development of cyclones at sea level takes place when and where an area of positive vorticity advection situated in the upper troposphere overlies a slow moving or quasi-stationary front at the surface.

The relationship between convergence and divergence can best be illustrated by the term shear. If we consider a flow where the cyclonic shear is decreasing downstream (stronger wind to the right than to the left of the current), more air is being removed from the area than is being fed into it, hence a net depletion of mass aloft, or divergence. Divergence aloft is associated with surface pressure falls, and since this is

the situation, the relative vorticity is decreasing downstream. We may state that surface pressure falls where relative vorticity decreases downstream in the upper troposphere, or where advection of more cyclonic vorticity takes place aloft. The converse of this is in the case of convergence aloft.

SUMMARY

In this chapter we expanded on the subjects of convergence, divergence, and vorticity, which were first presented in the AG2 manual, volume 1. Our discussion

first dealt with convergence and divergence as simple motions. The dynamics of convergent and divergent flow was covered, along with a discussion of wind directional shear and wind speed shear. Convergence and divergence as complex motions were then presented. Rules of thumb on convergence and divergence relative to surface and upper air features were covered. The last portion of the chapter dealt with vorticity. Definitions of relative vorticity and absolute vorticity were covered. Vorticity effects on weather processes was the last topic of discussion.

CHAPTER 2

FORECASTING UPPER AIR SYSTEMS

To prepare surface and upper air prognostic charts, we must first make predictions of the weather systems for these charts. Inasmuch as the current surface and upper air charts reveal the current state of the weather, so should the prognostic charts accurately reveal the future state of the weather.

Preparing upper air and surface prognostic charts dictates that the Aerographer's Mate first begin with the upper levels and then translate the prognosis downward to the surface. The two are so interrelated that consideration of the elements on one should not be made independently of the other.

Prognostic charts are constructed at the Fleet Numerical Meteorology and Oceanography Center (FNMOC). The resultant products are transmitted over their respective facsimile networks.

Overseas Meteorology and Oceanography (METOC) units also construct and transmit prognostic charts. We are all too often inclined to take these products at face value. Since these prognostic charts are generally for large areas, this practice could lead to an erroneous forecast.

It is important that you, the Aerographer's Mate, not only understand the methods by which prognostic charts are constructed, but you should also understand their limitations as well. In this chapter we will discuss some of the more common methods and rules for forecasting upper air features. In the following chapter, methods and techniques for propping upper air charts will be considered. These methods can be used in constructing your own prognostic charts where data are not available and/or to check on the prognostic charts made by other sources.

Before you read this chapter, you may find it beneficial to review the *AG2 TRAMAN*, NAVEDTRA 10370, volume 1, unit 8, which discusses upper air analysis concepts.

GENERAL PROGNOSTIC CONSIDERATIONS

LEARNING OBJECTIVES: Evaluate features on upper level charts, and be familiar with the various meteorological products available to the forecaster in preparing upper level prognostic charts.

The forecaster must consider all applicable forecasting rules, draw upon experience, and consult all available objective aids to produce the best possible forecast from available data.

Forecasters should examine all aspects of the weather picture from both the surface and aloft before issuing their forecasts. Some conditions are deemed less important, while others are emphasized. Forecasters must depend heavily upon their knowledge and experience as similar conditions yield similar consequences. Some forecasters may decide to discard a parameter, such as surface pressure, because through their experience, or the experience of others, they may decide that it is not a decisive factor.

An objective system of forecasting certain atmospheric parameters may often exceed the skill of an experienced forecaster. However, the objective process should not necessarily take precedence over a subjective method, but rather the two should be used together to arrive at the most accurate forecast.

HAND DRAWN ANALYSIS

Methods and procedures used in the analysis of upper air charts were covered in the *AG2 TRAMAN*, volume 1. Accurately drawn analyses provide the forecaster with the most important tool in constructing an upper air prognostic chart. Such information as windspeed and direction, temperature, dew point depression, and heights are readily available for the forecaster to integrate into any objective method for producing a prognostic chart.

COMPUTER PRODUCTS

FNMOCC provides a large number of charts for dissemination to shore and fleet units. These include analysis and prognostic charts ranging from subsurface oceanographic charts to depictions of the troposphere, as well as a number of specialized charts. A complete listing of these charts is contained in *The Numerical Environmental Products Manual*, volume III (*Environmental Products*), FLENUMMETOCENINST 3145.2.

APPLICATION OF SATELLITE IMAGERY

As a further aid, satellite imagery can also be used in preparing prognostic charts. The availability of useful satellite data will vary with time and area.

OBJECTIVE FORECASTING TECHNIQUES

LEARNING OBJECTIVES: Evaluate various objective forecasting techniques, including extrapolation and isotherm-contour relationships for the movement of troughs and ridges. Forecast intensity of troughs and ridges. Forecast the movement of upper level features. Forecast the intensity of upper level and associated surface features. Lastly, forecast the formation of upper level and associated surface features.

Experience in itself is not always enough to forecast the movement and/or intensity of upper air systems, but, couple the forecasters experience with basic objective techniques and a more accurate product will be prepared.

FORECASTING THE MOVEMENT OF TROUGH AND RIDGES

Techniques covered in this section apply primarily to long waves. Some of the techniques will be applicable to short waves as well. A long wave is by definition a wave in the major belt of westerlies, which is characterized by large length and significant amplitude. (See the *AG2 TRAMAN*, volume 1, for a discussion of long and short waves.) Therefore, the first step in propping the movement and intensity of long waves is to determine their limits. There are several basic approaches to the propping of both long and

short waves. Chiefly, these are extrapolation, isotherm-contour relationship, and the location of the jet maximum in relation to the current in which it lies.

Extrapolation

The past history of systems affecting an area of interest is *fundamental* to the success of forecasting. Atmospheric systems usually change slowly, but, continuously with time. That is, there is continuity in the weather patterns on a sequence of weather charts. When a particular pressure system or height center exhibits a tendency to continue without much change, it is said to be *persistent*. These concepts of persistence and continuity are *fundamental* forecast aids.

The extrapolation procedures used in forecasting may vary from simple extrapolation to the use of more complex mathematical equations and analog methods based on theory. The forecaster should extrapolate past and present conditions to obtain future conditions. Extrapolation is the simplest method of forecasting both long and short wave movement.

Simple extrapolation is merely the movement of the trough or ridge to a future position based on past and current movement and expected trends. It is based on the assumption that the changes in speed of movement and intensity are slow and gradual. However, it should be noted that developments frequently occur that are not revealed from present or past indications. However, if such developments can be forecast by other techniques, allowances can be made.

Extrapolation for short periods on short waves is generally valid. The major disadvantage of extrapolating the long period movement of short waves or long waves is that past and present trends do not continue indefinitely. This can be seen when we consider a wave with a history of retrogression. The retrogression will not continue indefinitely, and we must look for indications of its reversal; that is, progressive movement.

Isotherm-Contour Relationships

The forecaster should always examine the long waves for the isotherm-contour relationships, and then apply the rules for the movement of long waves. These rules are covered in the *AG2 TRAMAN*, volume 1. These rules are indicators only, but if they confirm or parallel other applied techniques, they have served their purpose. A number of observations and rules are stated regarding the progression, stationary characteristics, or

retrogression of long waves. These rules are discussed in the following text.

PROGRESSION OF LONG WAVES.— Progression (eastward movement) of long waves is usually found in association with relatively short wave lengths and well defined major troughs and ridges. At the surface, there are usually only one or two prominent cyclones associated with each major trough aloft. Beneath the forward portion of each major ridge there is usually a well developed surface anticyclone moving toward the east or southeast. The 24-hour height changes at upper levels usually have a one-to-one association with major troughs and ridges; that is, motion of maximum height fall and rise areas associated with major trough and ridge motion. The tracks of the height change centers depend on the movement and changes in intensity of the long waves.

STATIONARY LONG WAVE PATTERNS.— Once established, stationary long wave patterns usually persist for a number of days. The upper airflow associated with the long wave pattern constitutes a steering pattern for the smaller scale disturbances (*short waves*). These short waves, with their associated height change patterns and weak surface systems, move along in the flow of the large scale, long wave pattern. Short wave troughs deepen as they move through the troughs of the long waves, and fill as they move through the ridges of the long waves. The same changes in intensity occur in sea level troughs or pressure centers that are associated with minor troughs aloft. Partly as a result of the presence of these smaller scale systems, the troughs and ridges of the stationary long waves are often spread out and hard to locate exactly.

RETROGRESSION OF LONG WAVES.— A continuous retrogression of long wave troughs is a rare event. The usual type of retrogression takes place in a discontinuous manner; a major trough weakens, accelerates eastward, and becomes a minor trough, while a major wave trough forms to the west of the former position of the old long wave trough. New major troughs are generally formed by the deepening of minor troughs into deep, cold troughs.

Retrogression is seldom a localized phenomenon, but appears to occur as a series of retrogressions in several long waves. Retrogression generally begins in a quasi-stationary long wave train when the stationary wavelength shows a significant decrease. This can happen as a result of a decrease in zonal wind speed, or of a southward shift in the zonal westerlies. Some characteristics of retrogression are as follows:

- Trajectories of 24-hour height change patterns at 500-hPa deviate from the band of maximum wind.
- New centers appear, or existing ones rapidly increase in intensity.
- Rapid intensification of surface cyclones occurs to the west of existing major trough positions.

Location Of The Jet Stream

The *AG2 TRAMAN*, volume 1, discusses the migration of the jet stream both northward and southward. Some general considerations can be made concerning this migration and the movement of waves in the troposphere:

- In a northward migrating jet stream, a west wind maximum emerges from the tropics and gradually moves through the lower midlatitudes. Another maximum, initially located in the upper midlatitudes, advances toward the Arctic Circle while weakening. Open progressive wave patterns with pronounced amplitude and a decrease in the number of waves due to cutoff centers exist. The jet is well organized and troughs extend into low latitudes.

- As the jet progresses northward, the amplitude of the long waves decrease and the cutoff lows south of the westerlies dissipate. By the time the jet reaches the midlatitudes, a classical *high zonal index* (*AG2 TRAMAN*, volume 1) situation exists. Too, we have weak, long waves of large wavelength and small amplitude, slowly progressive or stationary. Few extensions of troughs into the low latitudes are present, and in this situation, the jet stream is weak and disorganized.

- As the jet proceeds farther northward, there will often be a sharp break of high zonal index with rapidly increasing wave amplitudes aloft. Long waves retrograde. As the jet reaches the upper midlatitudes and into the sub-Arctic region, it is still the dominant feature, while a new jet of the westerlies gradually begins to form in the subtropical regions. Long waves now begin to increase in number, and there is a reappearance of troughs in the tropics. The cycle then begins again.

With a southward migrating jet, the processes are reversed from that of the northward moving jet. It should be noted that shortwaves are associated with the jet maximum and move with about the same speed as these jet maximums.

FORECASTING THE INTENSITY OF TROUGHS AND RIDGES

Forecasting the intensity of long wave troughs and ridges often yields nothing more than an indication of the expected intensity; that is, greater than or less than present intensity. For instance, if deepening or falling is indicated, but the extent of deepening or tilling is not definite, the forecaster is forced to rely on experience and intuition in order to arrive at the amount of deepening or tilling. FNMOC upper level charts forecast the intensity of upper waves with a great deal of success. If available, you should check your intensity and movement predictions against these prognoses.

Extrapolation

Patterns on upper level charts are more persistent than those on the surface. Therefore, extrapolation gives better results on the upper air charts than on surface charts. When you use height changes aloft, the procedure is to extrapolate height change and add or subtract the change to the current height values.

Use of Time Differentials

The time differential chart is discussed in the *AG2 TRAMAN*, volume 1.

The time differential chart constructed for the 500-hPa level shows the history of changes that have taken place at the 500-hPa level at 24-hour intervals. In considering the information on the time differential chart, those centers with a well defined history of movement will be of greatest value. Take into consideration not only the amount of movement, but also the changes in intensity of the centers. Centers with no history should be treated with caution, especially with regard to their direction of movement which is usually downstream from the current position. Information derived from the time differential chart should be used to supplement information obtained from previous considerations, and when in agreement, used as a guide for the amount of change.

Normally, the 24-hour height rise areas can be moved with the speed of the associated short wave ridges, and the speed of the fall centers with the speed of the associated short wave troughs. It must be remembered that height change centers may be present due to convergence or divergence factors and may not have an associated short wave trough or ridge. Be

cautious not to move a height change center with the contour flow if it is due primarily to convergence or divergence. However, with short wave indications, a change center will appear and move in the direction of the contour flow.

Once you have progged the movement of the height change centers and determined their magnitude, apply the change indicated to the height on the current 500-mb chart. You should use these points as guides in constructing prognostic contours.

Isotherm-Contour Relationship

In long waves, deepening of troughs is associated with cold air advection on the west side of the trough and filling of troughs with warm air advection on the west side of the trough. The converse is true for ridges. Warm air advection on the western side of a ridge indicates intensification, and cold air advection indicates weakening. This rule is least applicable immediate yeast of the Continental Divide in the United States, and probably east of any high mountain range where westerly winds prevail aloft. In short waves, deepening of troughs is associated with cold air advection on the west side of the trough and falling of troughs with warm air advection, particularly if a jet maximum is in the northerly current of the trough and tilling is indicated by warm air advection on the western side.

In reference to the above paragraph, the advection is not the cause of the intensity changes, but rather is a "sign" of what is occurring. High level convergence/divergence is the cause.

Effect of Super Gradient Winds

Figure 2-1, views (A) through (D), shows the effect of the location of maximum winds on the intensity of troughs and ridges.

Explanation of figure 2-1 is as follows:

- When the strongest winds aloft are the westerlies on the western side of the trough, the trough deepens [fig. 2-1, view (A)].
- When the strongest winds aloft are the westerlies at the base of the trough, the trough moves rapidly eastward and does not change in intensity [fig. 2-1, view (B)].
- When the strongest winds are on the east side of the trough, the trough fills [fig. 2-1, view (C)].

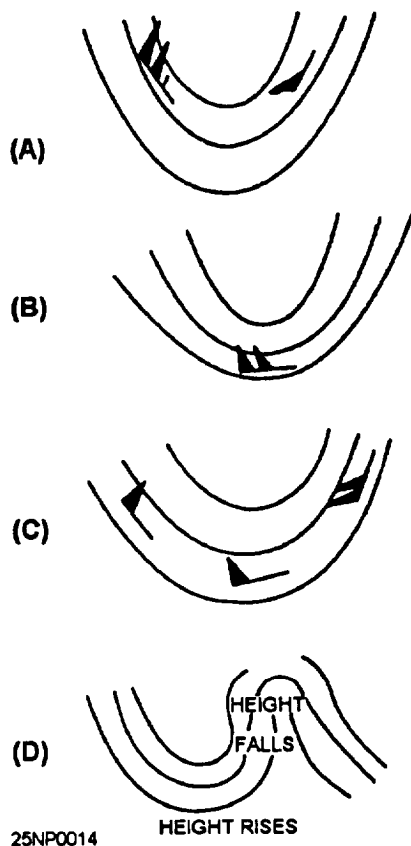

25NP0014

Figure 2-1.—Effect of super gradient winds on the deepening and filling of troughs. (A) Strongest winds on the west side of trough; (B) strongest winds in southern portion of trough; (C) strongest winds on east side of trough; (D) excessive contour gradients.

- Sharply curved ridges with excessive contour gradients are unstable and rotate rapidly clockwise, causing large height rises and filling in the trough area downstream, and large height falls in the left side of the strong gradient ridge [fig. 2-1, view (D)].

Convergence and Divergence Above 500 Millibars

Study the 300-mb (or 200-mb) chart to determine areas of convergence and divergence. Note these areas of convergence and divergence.

Convergence and divergence are covered in chapter 1 of this TRAMAN, and also in the *AG2 TRAMAN*, volume 1. As a review of the effects of convergence and divergence, and the changes in intensity of troughs and ridges, we have the following rules:

Refer to chapter 1 for illustrations of these rules.

- Divergence and upper height falls are associated with high-speed winds approaching cyclonically curved

weak contour gradients. Divergence results in height falls to the left of the high-speed current.

- Convergence and upper height rises are associated with low-speed winds approaching straight or cyclonically curved strong contour gradients and with high-speed winds approaching anticyclonically curved weak contour gradients.

FORECASTING THE MOVEMENT OF UPPER LEVEL FEATURES

The movement of upper level features is discussed in the following text.

Movement of Highs

Areas of high pressure possess certain characteristics and traits. The following text discusses these indicators for areas of high pressure.

SEMIPERMANENT HIGHS.— The semipermanent, subtropical highs are ordinarily not subject to much day-to-day movement. When a subtropical high begins to move, it will move with the speed and in the direction of the associated long wave ridge. The movement of the long wave ridge has already been discussed. Also, seasonal movement, though slower and over a longer period of time, should be considered. These highs tend to move poleward and intensify in the summer, and move equatorward and decrease in intensity in the winter.

BLOCKS.— Blocks will ordinarily persist in the same geographic location. Movement of blocks will be in the direction of the strongest winds; for example, eastward when the westerlies are strongest, and westward when the easterlies are strongest. The speed of movement of these systems can usually be determined more accurately by extrapolation. Extrapolation should be used in moving the highs under any circumstance, and the results of this extrapolation should be considered along with any other indications.

Some indications of intensity changes that are exhibited by lower tropospheric charts (700-500 hPa) are as follows:

- Intensification will occur with warm air advection on the west side; weakening and decay will occur with cold air advection on the west side; and there is little or no change in the intensity if the isotherms are symmetric with the contours. This low tropospheric advection is not the cause of the intensity change but is only a indicator. The cause is at higher levels; for

example, intensification is caused by high-level cold advection and/or mass convergence.

- Under low zonal index situations, a blocking high will normally exist at a northern latitude and will have a pronounced effect on the systems in that area; in general it will slow the movement

- Under high zonal index situations, there is a strong west to east component to the winds, and systems will move rapidly.

Movement of Closed Lows

The semipermanent Icelandic and Aleutian lows undergo little movement. These semipermanent lows will decrease or increase in area of coverage; occasionally split, or elongate east-west during periods of high zonal index. North-south displacements are due primarily to seasonal effects. The movement of these semipermanent lows is derived primarily from extrapolation.

EXTRAPOLATION.— Extrapolation can be used at times to forecast both the movement and the intensity of upper closed lows. This method should be used in conjunction with other methods to arrive at the predicted position and intensity. Figure 2-2 shows some examples

of simple extrapolation of both movement and intensity. Remember, there are many variations to these patterns, and each case must be treated individually.

Figure 2-2, view (A), illustrates a forecast in which a low is assumed to be moving at a constant rate and filling. Since the low has moved 300 nautical miles in the past 24 hours, it may be assumed that it will move 300 nautical miles in the next 24-hour period. Similarly, since the central height value has increased by 30 meters in the past 24 hours, you would forecast the same 30 meter increase for the next 24 hours. While this procedure is very simple, it is seldom sufficiently accurate. It is often refined by consulting a sequence of upper air data to determine a rate of change.

This principle is illustrated in figure 2-2, view (B). By consulting the previous charts, we find the low is filling at a rate of 30 meters per 24 hours; therefore, this constant rate is predicted to continue for the next 24 hours. However, the rate of movement is decreasing at a constant rate of change of 100 nautical miles in 24 hours. Hence, this constant rate of change of movement is then assumed to continue for the next 24 hours, so the low is now predicted to move just 200 nautical miles in the next 24 hours.

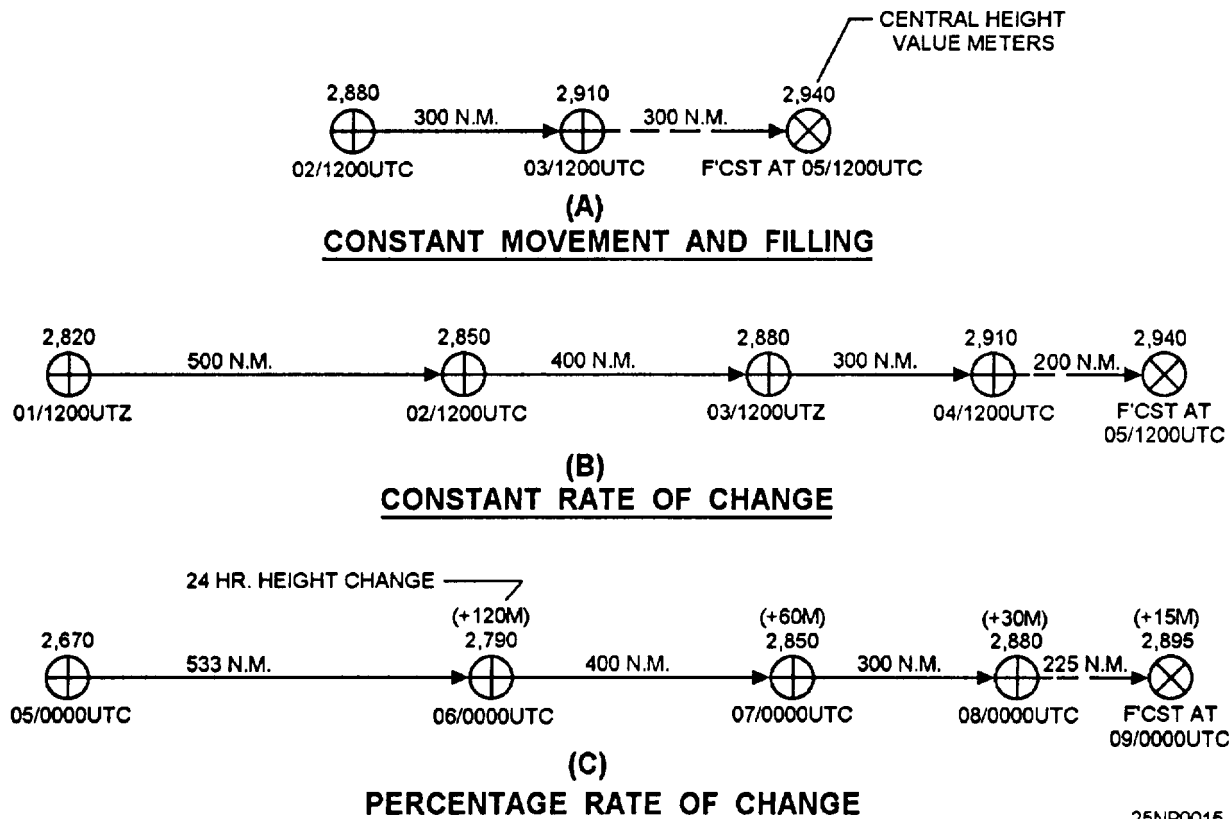

25NP0015

Figure 2-2.-Simple extrapolation of the movement and Intensity of a closed low on the 700-mb chart. (A) Constant movement and filling (B) constant rate of change, (C) percentage rate of change.

Frequently neither of these two situations exist, and both the change in movement and the height center change occur at a proportional rate. This is illustrated in figure 2-2, view (C). From a sequence of charts 24 hours apart, it is shown that the low is filling at a decreasing rate and also moving at a decreasing rate. The height change value is 50 percent of the value 24 hours previously on the successive charts, and the rate of movement is 75 percent. We then assume this constant percentage rate to continue for the next 24 hours, so the low is forecast to move 225 nautical miles and fill only 15 meters.

Accelerations may be handled in a similar manner as the decelerations shown in figure 2-2. Also, a sequence of 12-hour charts could be used in lieu of 24-hour charts to determine past trends.

CRITICAL ECCENTRICITY.— When a migratory system is unusually intense, the system may extend vertically beyond the 300-hPa level. Advection considerations, contour-isotherm relationships, convergence and divergence considerations, and the location of the jet max will yield the movement vector. These principles are applied in the same manner as when the movement of long waves are determined. The eccentricity formula may be applied to derive a movement vector, but only when a nearly straight eastward or westward movement is apparent. Migratory lows also follow the steering principle and the mean climatological tracks. The climatological tracks must be used cautiously for the obvious reasons. The rise and fall centers of the time differential charts are of great aid in determining an extrapolated movement vector, and extrapolation is the primary method by which the movement of a closed low is determined.

Certain cutoff lows and migratory dynamic cold lows lend themselves to movement calculation by the eccentricity formula. The conditions under which this formula may be applied are:

- The low must have one or more closed contours (nearly circular in shape).
- The strongest winds must be directly north or south of the center. The location of the max winds determines the direction of movement. When the strongest winds are the easterlies north of the low, the low moves westward; when the strongest winds are the westerlies south of the low, the low will move eastward. The low will also move toward the weakest diverging cyclonic gradient and parallel to the strongest current. Systems moving eastward must have a greater speed in

order to overcome convergence upstream—there is normally convergence east of a low system.

The eccentricity formula is written:

$$E_c = V - V' - 2C$$

or

$$2C = V - V' - E_c$$

where

E_c is the critical eccentricity value.

V is the wind speed south of the closed low.

V' is the wind speed north of the closed low.

C is the speed of the closed low (in knots).

To obtain the value of C , it is necessary to determine the latitude of the center of the low and the spread (in degrees latitude) between the strongest winds in the low and the center of the low. Apply these values to table 2-1 to determine the tabular value. Apply the tabular value to the critical eccentricity formula to obtain $2C$, thus C . In determining the critical eccentricity of a system, it is necessary to interpolate both for latitude and the spread. A negative value for C indicates westward movement; a positive value indicates eastward movement.

LOCATION OF THE JET STREAM.— As long as a jet maximum is situated, or moves to the western side of a low, this low will not move. When the jet center has rounded the southern periphery of the low, and is not followed by another center upstream, the low will move rapidly and fill.

Table 2-1.-Critical Eccentricity Value

Latitude (degrees)	Spread (degrees latitude)				
	1°	3°	5°	10°	20°
80	.1	.9	2.5	--	--
70	.2	1.8	4.9	19.5	80.0
60	.3	2.6	7.1	27.0	115.0
50	.4	3.3	9.1	37.0	150.0
40	.4	4.0	10.9	43.5	175.0
30	.5	4.5	12.3	50.0	200.0
20	.5	4.9	13.3	53.0	--
10	.6	5.2	14.0	56.0	--

ISOTHERM-CONTOUR RELATIONSHIP.—

Little movement will occur if the isotherms and contours are symmetrical (no advection). Lows will intensify and retrogress if cold air advection occurs to the west and fill and progress eastward if warm air advection occurs to the west.

FORECASTING THE INTENSITY OF UPPER LEVEL AND ASSOCIATED SURFACE FEATURES

Many of the same considerations used in the movement of closed centers aloft may also apply to forecasting their intensity. Extrapolation and the use of time differentials aid in forecasting the change and magnitude of increases and decreases. Again, rise and fall indications must be used in conjunction with advection considerations, divergence indications, and other previously discussed factors.

Intensity Forecasting Principles (Highs)

The following text discusses how atmospheric conditions affect the forecasted intensity of high pressure systems.

- Highs undergo little or no change in intensity when isotherms and contours are symmetrical
- Highs intensify when warm air advection occurs on the west side of the high.
- Highs weaken when cold air advection occurs on the west side of the high.
- Blocking highs *usually* intensify during westward movement and weaken during eastward movement.
- Convergence and height rises occur in the downstream trough when high-speed winds with a strong gradient approach low-speed winds with an anticyclonic weak gradient. This is often the case in ridges where the west side contains the high-speed winds; the ridge intensifies due to this accumulation of mass. This situation has also been termed *overshooting*. This situation can be detected at the 500-hPa level, but the 300-hPa level is better suited because it is the addition or removal of mass at higher levels that determines the height of the 500-hPa contours.
- Rise and fall centers on the time differential chart indicate the changes in intensity, both sign (increasing, decreasing) and magnitude of change, if any, in

decimeters. The magnitude of the height rises or falls can be adjusted if other indications reveal that a slowing down or a speeding up of the processes is occurring, and expected to continue.

Intensity Forecasting Principles (Lows)

The following text discusses how atmospheric conditions affect the forecasted intensity of low-pressure systems.

- Lows and cutoff lows deepen when cold air advection occurs on the west side of the trough.
- Lows fill when warm air advection occurs on the west side of the low.
- Lows fill when a jet maximum rounds the southern periphery of the low.
- Lows fill when the jet maximum is on the east side of the low, if another jet max does not follow.
- Lows deepen when the jet max remains on the west side of the low, provided the jet max to the west of the low is not preceded by another on the southern periphery or eastern periphery of the low, for this indicates no change in intensity.
- The 24-hour rise and fall centers aid in extrapolating both the change and the magnitude of falls in moving lows. Again, these rise and fall indications must be considered along with advection factors, divergence indications, and the indications of the contour-isotherm relationships.

FORECASTING THE FORMATION OF UPPER LEVEL AND ASSOCIATED SURFACE FEATURES

The following text deals with the formation of upper level and associated surface features, and how atmospheric features affect them.

Formation Forecasting Principles (Highs)

The following are atmospheric condition indicators that are relevant to the formation of highs.

- Cold air masses of polar and Arctic origin generally give no indication of the formation of highs at the 500-hPa level or higher, as these airmasses normally do not extend to this level.
- The shallow anticyclones of polar or Arctic origin give indications of their genesis primarily on the

surface and the 850-mb charts. The area of genesis will show progressively colder temperatures at the surface and aloft; however, the drop in the 850-mb temperatures does not occur at the same rate as at the surface. This is an indication that a very strong inversion is in the process of forming. The air in the source region must be relatively stagnant.

- High-level anticyclogenesis is indicated when low-level warm air advection is accompanied by stratospheric cold air advection. This situation has primary application to the formation of blocks, as high-level anticyclogenesis is primarily associated with the formation of blocks and the intensification of the ridges of the subtropical highs.

- Blocks should normally be forecast to form only over the eastern portion of the oceans in the middle and high latitudes. Warm air is normally present to the north and northwest.

Formation Forecasting Principles (Lows)

There are certain conditions required in the atmosphere, as well as certain atmospheric indicators, for cyclogenesis to occur. The greater the number of these indicators/conditions in agreement, the greater the success in forecasting cyclogenesis. Some of them are listed below:

- An area of divergence exists aloft.
- A jet maximum on the west side of a low indicates deepening and southward movement.
- Cold air advection in the lower troposphere and warming in the lower stratosphere is associated with the formation of or deepening of lows.

Formation Forecasting Principles (Cutoff Lows)

Another task in forecasting is that of the formation of cutoff lows. Some of the indicators are as follows:

- They generally form only off the southwestern coast of the United States and the northwestern coast of Africa.
- The upstream ridge intensifies greatly. This intensifying upstream ridge contains an increasing, strong, southwesterly flow.
- Strong northerlies on the west side of the trough.
- Height falls move south or southeastward.

- Strong cold air advection occurs on the west side of the upper trough.

Constructing Upper Level Prognostic Charts

The constant pressure prognostic chart is about to take form. The forecasted position of the long wave troughs and ridges have been determined and depicted on the tentative prognostic chart. The position of the highs, lows, and cutoff centers were then determined and depicted on the tentative prognostic chart. Short waves were treated in a similar fashion. Contours are then depicted. The height values of the contours are determined by actual changes in intensity of the systems. The pattern of the contours is largely determined by the position of the long waves, short waves, and closed pressure systems. Contours are drawn in accordance with the following eight steps:

1. Outline the areas of warm and cold advection in the stratum between 500 and 200 hPa, and move the thickness lines at approximately 50 percent of the indicated thickness gradient in the direction of the thermal wind.

2. Tentatively note, at several points on the chart, the areas of height changes on the constant pressure surface above the existing height values.

3. Move the areas of 24-hour height rises and falls at the speed of the short waves, and note at several key points the amount and direction of the height change from the current chart.

4. Adjust the advected height changes, and, in turn, adjust these for positions of the long waves, pressure systems, and short waves.

5. Extrapolate heights for selected points at 500 hPa on the basis of the 24-hour time differential indications and advection considerations, provided that they are justified by the indications of high-level convergence and divergence. When the contributions from advection and time differentials are not in agreement with convergence and divergence, adjust the contribution of each and use accordingly.

6. Adjust the height values to the forecasted intensities of the systems. These adjustments can lead to the following:

- All factors point toward intensification (deepening of lows and filling of highs).
- One factor washes away the contribution made by another, and the system remains at or near its present state of intensity.

- All factors point toward weakening of the system.

7. Sketch the preliminary contours, connecting the forecast positions of the long waves, short waves, and the pressure systems with the values determined by steps 1 through 5 above.

8. The last step in the construction of a constant pressure prognostic chart is to check the chart for the following points:

- The chart should follow continuity from the existing pattern.

- The chart should be vertically consistent and rational in the horizontal.

- The chart should not deviate from the seasonal pattern unless substantiated beyond a doubt.

- Unless indicators dictate otherwise, it should follow the normal patterns.

Now draw the smooth contours, troughs, ridges, highs, and lows; and adjust the gradients.

Application of Satellite Imagery

Satellite imagery provides the forecaster with information that may be used in conjunction with previously discussed techniques in forecasting movement and intensity of troughs, ridges, and systems aloft. As discussed in the *AG2 TRAMAN*, volume 1, satellite imagery should be compared with the analyzed charts and products to ensure they reflect a true picture of the atmosphere. As with the analyses, satellite imagery should also be used in preparation of your forecast products.

The following features can be useful to the forecaster in producing prognostic upper-air charts:

- Positive vorticity advection maximum (PVA maximum) cloud patterns associated with the upper-air troughs and ridges

- Cloud patterns indicative of the wind flow aloft

Computer Products

Upper-level prognostic charts with varying valid times are uploaded to the Naval Oceanographic and Data Distribution System (NODDS) daily. Items included on the charts will vary on an individual basis, with respect to the contours for the particular height, isotachs, and isotherms.

The forecaster may use these charts directly for preparing forecasts, or in conjunction with their own prepared products. A complete listing of charts available with descriptions is found in the Navy *Oceanographic Data Distribution System Products Manual*, FLENUMMETOCCENINST 3147.1.

The Fleet Numerical Meteorology and Oceanography Center prepares a large number of computer products for upper air forecasting. The *Numerical Environmental Products Manual*, volume 3 (*Environmental Products*), FLENUMMETOCCENINST 3145.2, lists available products.

SUMMARY

In this chapter we first discussed general prognostic considerations. The value of an accurate, hand drawn analysis was addressed, along with a discussion of available aids, including computer products and satellite imagery. The majority of this chapter deals with objective forecasting techniques used in the preparation of upper level charts. The first topic discussed was that of forecasting the movement of troughs and ridges, followed by a discussion on forecasting the intensity of troughs and ridges. Lastly, forecasting of the movement, intensity, and the formation of upper level systems and associated features were covered.

CHAPTER 3

FORECASTING SURFACE SYSTEMS

With the upper air prognosis completed, the next step is to construct the surface prognostic chart. Since more data is available for the surface chart, and this chart is chiefly the one on which you, the Aerographer's Mate, will base your forecast, you should carefully construct the prognosis of this chart to give the most accurate picture possible for the ensuing period. The surface prognosis may be constructed for periods up to 72 hours, but normally the period is 36 hours or less. In local terminal forecasting, the period may range from 1 to 6 hours.

Construction of the surface prognosis consists of the following three main tasks.

1. Propping the formation, dissipation, movement, and intensity of pressure systems.
2. Propping the formation, dissipation, movement, and intensity of fronts.
3. Propping the pressure pattern; that is, the isobaric configuration and gradient.

From an accurate forecast of the foregoing features, you should be able to forecast the weather phenomena to be expected over the area of interest for the forecast period.

FORECASTING THE FORMATION OF NEW PRESSURE SYSTEMS

LEARNING OBJECTIVES Recognize features on satellite imagery and upper air charts conducive to the formation of new pressure systems.

The central problem of surface prognosis is to predict the formation of new low-pressure centers. This problem is so interrelated to the deepening of lows, that both problems are considered simultaneously when and where applicable. This problem mainly evolves into two categories. One is the distribution of fronts and air masses in the low troposphere, and the other is the velocity distribution in the middle and high troposphere. The rules applicable to these two conditions are discussed when and where appropriate.

For the principal indications of cyclogenesis, frontogenesis, and windflow at upper levels, refer to the *AG2 TRAMAN*, volume 1.

The use of hand drawn analyses and prognostic charts in forecasting the development of new pressure systems is in many cases too time-consuming. In most instances, the forecaster will generally rely on satellite imagery or computer drawn prognostic charts.

SATELLITE IMAGERY — THE FORMATION OF NEW PRESSURE SYSTEMS

To most effectively use satellite imagery, the forecaster must be thoroughly familiar with imagery interpretation. Also, the forecaster must be able to associate these images with the corresponding surface phenomena.

The texts, *Satellite Imagery Interpretation in Synoptic and Mesoscale Meteorology*, NAVEDTRA 40950, and *A Workbook on Tropical Cloud Systems Observed in Satellite Imagery*, volume 1, NAVEDTRA 40970, contain useful information for the forecaster on the subject of satellite interpretation. The Naval Technical Training Unit at Keesler AFB, Mississippi, also offers the supplemental 2-week course, Weather Satellite Systems and Photo Interpretation (SAT INTERP).

The widespread cloud patterns produced by cyclonic disturbances represent the combined effect of active condensation from upward vertical motion and horizontal advection of clouds. Storm dynamics restrict the production of clouds to those areas within a storm where extensive upward vertical motion or active convection is taking place. For disturbances in their early stages, upward vertical motion is the predominant factor that controls cloud distribution. The comma-shaped cloud formation that precedes an upper tropospheric vorticity maximum is an example. Here, the clouds are closely related to the upward motion produced by positive vorticity advection (PVA). In

many cases this cloud may be referred to as the PVA Max. See figure 3-1.

Wave or low development along an already existing front may be detected from satellite imagery. In figure 3-2, a secondary vorticity center is shown approaching a frontal zone.

The cloud mass at A (fig. 3-2) is associated with a secondary vorticity center that has moved near the front. Interaction between this vorticity center and the front will result in the development of another wave near B.

By recognizing the vorticity center and determining its movement from successive satellite passes, the forecaster should be able to accurately predict the formation of a second low-pressure system.

UPPER AIR CHARTS — THE FORMATION OF NEW PRESSURE SYSTEMS

Computer drawn charts also provide the forecaster with another tool for forecasting the development of new pressure systems. These prognostic charts may be used to directly prepare a forecast, or the forecaster may use a sequence of them to construct other charts.

A very beneficial chart used in determining changes in surface pressure, frontogenesis, frontolysis, and development of new pressure systems is the advection chart. The normal methods of

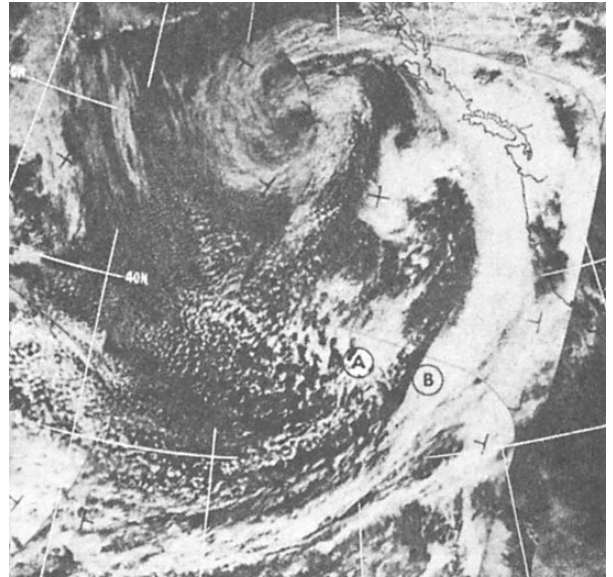

Figure 3-2.-Frontal wave development.

construction are time-consuming; however, by using computer charts, the chart may be more readily constructed.

The 700-hPa, 1000-hPa, and 500-hPa thickness charts should be used in construction of the advection chart. The 700-hPa contours approximate the mean wind vector between the 1000- and 500-hPa levels. On a 1000- to 500-hPa thickness chart, the contours depict thermal wind, which blows parallel to the thickness lines. Meteorologically speaking, we know that lines of greater thickness represent relatively warmer air than lines of less thickness. If the established advection pattern is replacing higher thickness values with lower thickness values, then it must be advecting cooler air (convergence and divergence not considered). The opposite of this is also true. The changing of thickness values can be determined by the mean wind vector within the layer of air. The 700-hPa contours will be used as the mean wind vectors.

The advection chart should be constructed in the following manner:

1. Place the thickness chart over the 700-mb chart and line it up properly.
2. Remember that the 700-hPa contours represent the mean wind vector. Place a red dot indicating warm air at all intersections where the mean wind vector is blowing from higher to lower thickness values.
3. Use the same procedure to place a blue dot at all intersections where the mean wind vector is blowing from lower to higher thickness values.

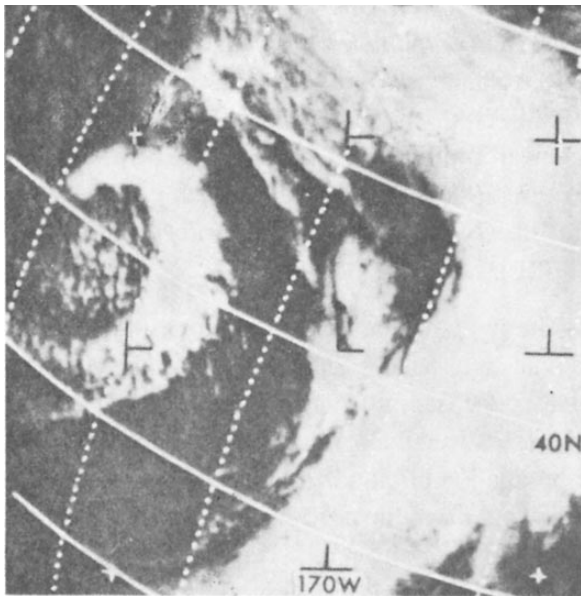

Figure 3-1.-A well developed, comma-shaped cloud is the result of a moving vorticity center to the rear of the polar front. The comma cloud is composed of middle and high clouds over the lower-level cumulus and is preceded by a clear slot.

You need not place red and blue dots for the entire chart-only for the area of interest.

Now, to use this advection chart, it should be compared against the chart from the preceding 12 hours. From comparison of the red and blue dots, you can determine if there has been an increase or decrease in the amount of warm or cold air advection in a particular area, as well as any change in the intensity of advection.

Then, the advection type and amount, as well as change, can be applied to determine the possibility of new pressure system development.

FORECASTING THE MOVEMENT OF SURFACE PRESSURE SYSTEMS

LEARNING OBJECTIVES Forecast the movement of surface low- and high-pressure systems by extrapolation, isallobaric indications, relation to warm sector isobars, relation to frontal movement, thickness lines, relation to the jetstream, and statistical techniques.

Whether you move the high- or low-pressure areas first is a matter of choice for the forecaster. Most forecasters prefer to move the low-pressure areas first, and then the high-pressure areas.

MOVEMENT OF LOW-PRESSURE SYSTEMS

Lows determine, to a large extent, the frontal positions. They also determine a portion of the isobaric configuration in highs because gradients readjust between the two. As a result of knowing the interplay of energy between the systems, meteorologists have evolved rules and methods for propping the movement, formation, intensification, and dissipation of lows.

Extrapolation

First and foremost in forecasting the movement of lows should be their past history. This is a record of the pressure centers, attendant fronts, their direction and speed of movement, and their intensification/weakening. From this past history, you can draw many valid conclusions as to the future behavior of the systems and their future motion. This technique is valid for both highs and lows for short periods of time.

The general procedure for the extrapolation of low-pressure areas is outlined below. Although only movement is covered, the central pressures with anticipated trends could be added to obtain an intensity forecast.

1. Trace in at least four consecutive past positions of the centers.

2. Place an encircled X over each one of these positions, and connect them with a dashed line, (See fig. 3-3.) If you know the speed and direction of movement, as obtained from past charts, the forecasted position can be calculated. One word of *caution*, straight linear extrapolation is seldom valid beyond 12 hours. Beyond this 12-hour extrapolated position, deepening/filling, acceleration/deceleration, and changes in the path must be taken into consideration. It is *extremely important* that valid history be followed from chart to chart, *Systems do not normally appear out of nowhere, nor do they just disappear*

3. An adjustment based on a comparison between the present chart and the preceding chart must be made. For example, the prolonged path of a cyclone center must not run into a stationary or quasi-stationary anticyclone, notably the stationary anticyclones, over continents in winter. When the projected path points toward such anticyclones, it will usually be found that the speed of the cyclone center decreases and the path curves northward. This path will continue northward until it becomes parallel to the isobars around the quasi-stationary high. The speed of the center will be least where the curvature of the path is greatest. When the center resumes a more or less straight path, the speed again increases.

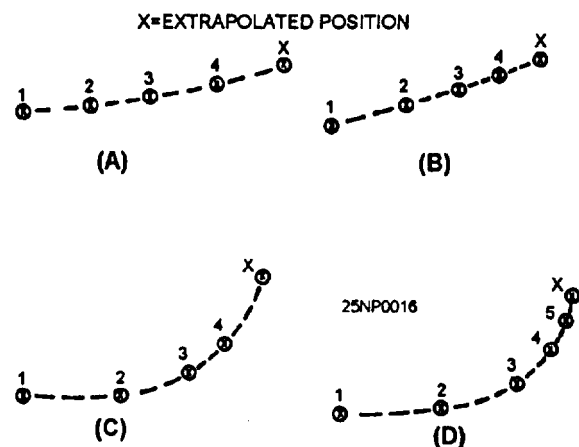

Figure 3-3.-Example of extrapolation procedure. X is the extrapolated position.

Isallobaric Indications

Lows tend to move toward the center of the largest 3-hour pressure falls. This is normally the point where the maximum warm air advection is occurring.

Figure 3-4 shows the movement of an occluding wave cyclone through its stages of development in relation to the surface pressure tendencies. This one factor cannot be used alone, but, compared with other indications, you may arrive at the final forecasted position of the lows. Too, you should remember that the process depicted in this illustration takes place over several days, and many other factors enter into the subsequent movement.

Circular, or nearly circular, cyclonic centers generally move in the direction of the greatest pressure falls. Anticyclone centers move in the direction of the greatest pressure rises.

Troughs move in the direction of the greatest pressure falls, and ridges move in the direction of the greatest pressure rises. See figure 3-5.

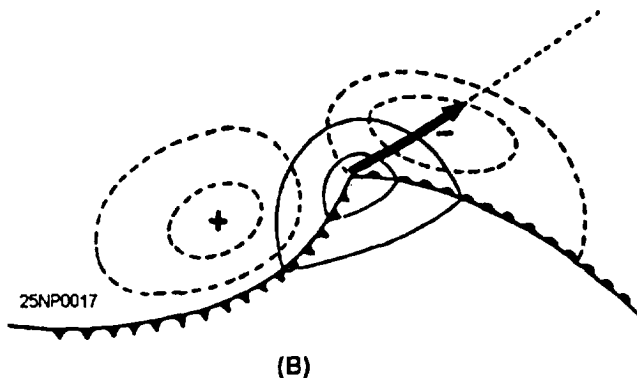
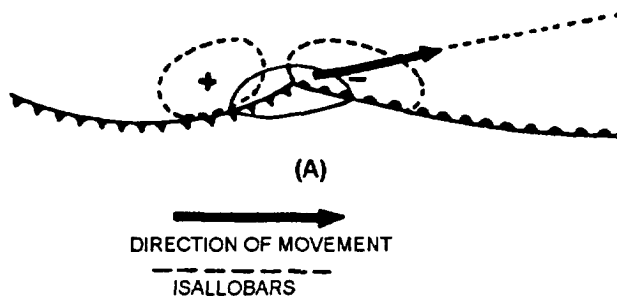

Relative to Warm Sector Isobars

Warm, unoccluded lows move in the direction of the warm sector isobars, if those isobars are straight. These lows usually have straight paths (fig. 3-6, view A), whereas old occluded cyclones usually have paths that are curved northward (fig. 3-6, view B). The speed of the cyclones approximates the speed of the warm air.

Whenever either of these rules is in conflict with upper air rules, it is better to use the upper air rules.

Relative to Frontal Movement

The movement of the pressure systems must be reconciled with the movement of the associated fronts if the fronts are progged independently of the pressure systems. Two general rules are in use regarding the relationship of the movement of lows to the movement of the associated fronts: First, warm core lows are steered along the front if the front is stationary or nearly so; and second, lows tend to move with approximately the warm front speed and somewhat slower than the cold front speed.

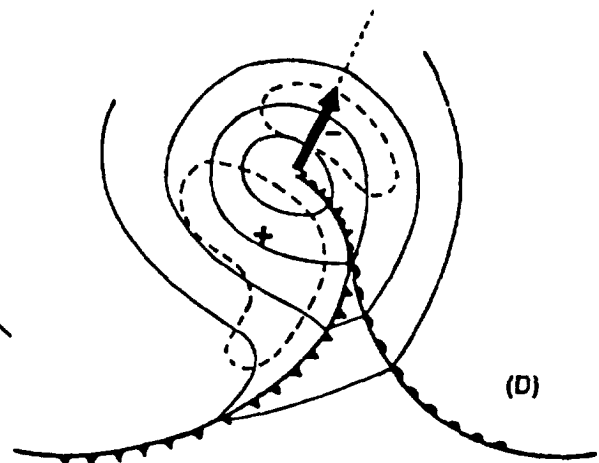
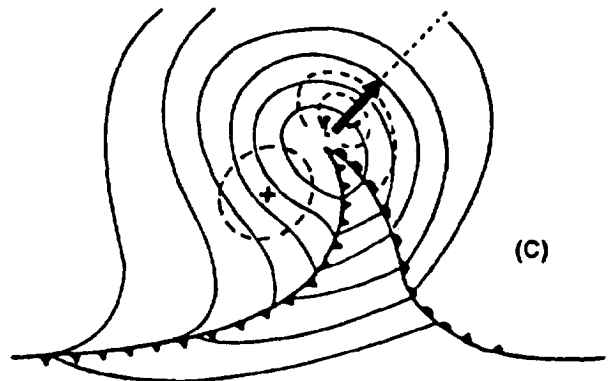

Figure 3-4. Movement of occluding wave cyclone in relation to isallobaric centers.

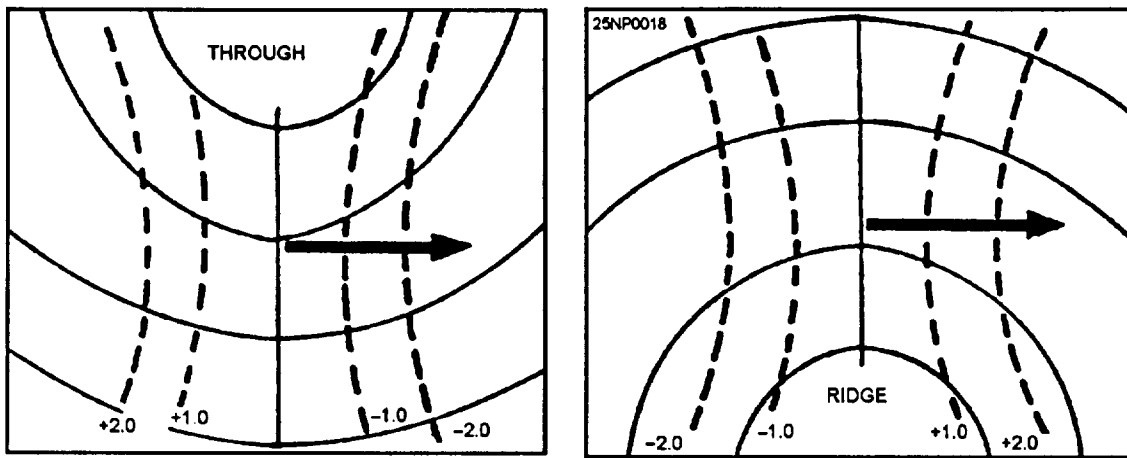

Figure 3-5.-Movement of troughs and ridges in relation to the isallobaric gradient.

Steering

Surface pressure systems move with the upper-level steering current. This principle is based on the concept that pressure systems are moved by the external forces operating on them. Thus, a surface pressure system tends to be steered by the isotherms, contour lines, or streamlines aloft, by the warm sector isobars, or by the orientation of a warm front. This principle is nearly always applied to the relationship between the velocity of a cyclone and the velocity of the basic flow in which it is embedded.

The method works best when the flow pattern changes very slowly, or not at all. If the upper flow pattern is expected to change greatly during the forecast period, you must first forecast the change in this pattern prior to forecasting the movement of the surface pressure systems. *Do not attempt to steer a surface system by the flow of an upper level that has closed contours above the surface system.* When using the steering method, you must first consider the systems that are expected to have little or no movement; namely, warm highs and cold lows. Then, consider movement of migratory highs and lows; and finally, consider the changes in the intensity of the systems.

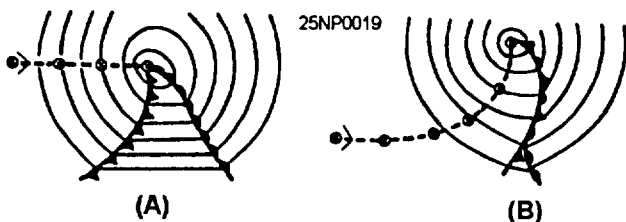

Figure 3-6.-Movement of lows in relation to warm sector isobars. (A) Movement of warm sector lows; (B) movement of old occluded cyclones.

Studies that used the steering technique have found, in most cases, that there was a displacement of the lows poleward and the highs equatorward of the steering current. Therefore, expect low-pressure centers, especially those of large dimension, to be deflected to the left and high-pressure areas deflected to the right of a westerly steering current. Over North America the angle of deflection averages about 15°, although deviations range from 0° to 25° or even 30°.

CAUTION

The steering technique should not be attempted unless the closed isallobaric minimum is followed by a closed isallobaric maximum some distance to the rear of the low.

THE STEERING CURRENT.— The steering flow or current is the basic flow that exerts a strong influence upon the direction and speed of movement of disturbances embedded in it. The steering current or layer is a level, or a combination of levels, in the atmosphere that has a definite relationship to the velocity of movement of the embedded lower level circulations. The movement of surface systems by this flow is the most direct application of the steering technique. Normally, the level above the last closed isobar is selected. This could be the 700-, 500-, or 300-hPa level. However, in practice, it is better to integrate the steering principle over more than one level. The levels most often used are the 700- and 500-hPa levels.

For practical usage, the present 700- or 500-mb chart should be used in conjunction with the 24- or

36-hour prognostic charts for these levels. In this way, changes both in space and time can be considered. For a direct application for a short period of time, transfer the position of the low center to the concurrent 700-mb chart. For direction, move the center in the direction of the contours downstream and slightly inclined to the left for low-pressure areas. Experience with moving systems of this type will soon tell you how much deviation should be made. For speed of the surface cyclone, average the basic current downstream over which the cyclone will pass (take into consideration changes in direction and speed of flow over the forecast period). Take 70 percent of this value for the mean speed for 24 hours. Move the low center along the contours, as described above, for this speed for 24 hours. This should be your position at that time.

For the 500-mb chart, follow the same procedure, except use 50 percent of the wind speed for movement. If these two are not in agreement, take a mean of the two. There may be cases where the 500-mb chart is the only one used. In this case, you will not be able to check the movement against the 700-mb chart.

FORECASTING PRINCIPLES.— The following empirical relationships and rules should be taken into account when you use the steering technique:

- Warm, unoccluded lows are steered by the current at the level to which the closed low does not extend. When so steered, lows tend to move slightly to the left of the steering current.

- Warm lows (unoccluded) are steered with the upper flow if a well-defined jet is over the surface center or if there is no appreciable fanning of the contours aloft. Low-pressure systems, especially when large, tend to move slightly to the left of the steering current.

- Rises and falls follow downstream along the 500-hPa contours; the speed is roughly half of the 500-hPa gradient. The 3-hour pressure rises and pressure falls seem to move in the direction of the 700-hPa flow; while 24-hour pressure rises and pressure falls move with the 500-hPa flow.

- Cold lows, with newly vertical axes, are steered with the upper low (in the direction of upper height falls), parallel to the strongest winds in the upper low, and toward the weakest contour gradient.

- Occluded lows, the axes of which are not vertical, are steered partly in the direction of the warm air advection area.

- A surface low that is becoming associated with a cyclone aloft will slow down, become more regular, and follow a strongly cyclonic trajectory.

- Surface lows are steered by jet maximums above them, and deviate to the left as they are so steered. They move at a slower rate than the jet maximum, and are soon left behind as the jet progresses.

- During periods of northwesterly flow at 700 hPa from Western Canada to the Eastern United States, surface lows move rapidly from the northwest to the southeast, bringing cold air outbreaks east of the Continental Divide.

- If the upper height fall center (24 hour) is found in the direction in which the surface cyclone will move, the cyclone will move into the region or just west of it in 24 hours.

Direction of Mean Isotherms (Thickness Lines)

A number of rules have been compiled regarding the movement of low-pressure systems in relation to the mean isotherms or thickness lines. These rules are outlined as follows:

- Unoccluded lows tend to move along the edge of the cold air mass associated with the frontal system that precedes the low; that is, it tends to move along the path of the concentrated thickness lines. When using this method, you should remember that the thickness lines will change position during the forecast period. If there is no concentration of thickness lines, this method cannot be used.

- When the thickness gradient (thermal wind) and the mean windflow are equal, the low moves in a direction midway between the two. This rule is more reliable when both the thermal wind and the mean windflow are strong.

- When the mean windflow gradient is stronger than the thickness gradient, the low will move more in the direction of the mean windflow.

- When the thickness gradient is stronger than the mean windflow gradient, the low will move more in the direction of the thickness lines.

- With warm lows, the mean isotherms show the highest temperature directly over the surface low, which is about halfway between the 700-hPa trough and ridge line. This indicates the mean isotherm and 700-hPa isoheights are 90 degrees out of phase. Since warm

lows move with the mean speed of the warm air above them, they will be rapidly moving systems.

- If the highest mean temperatures occur under the 700-hPa ridge (isotherms and contours in phase), the ridge itself is warm while the low is cold; therefore, the low will move slowly.

- Lows move with a speed of approximately 50 percent of the thermal wind for the 1,000- to 500-hPa stratum, and approximately 75 percent of the thermal wind of the 1,000- to 700-hPa stratum.

Movement of Lows in Relation to the Jetstream

Some of the rules for moving lows in relation to the jetstream position were mentioned previously. One basic rule however, states that “highs and lows situated under or very near the jetstream behave regularly and follow the steering indications.” Minimum deviations occur when the upper flow does not change with time.

Forecasting the Movement of Lows by Statistical Techniques

Since it requires many years of experience and a photographic memory to develop a mental catalog of weather patterns, a weather type or normal path classification is a boon to the inexperienced forecaster in identifying situations from the past for application to the present. There are many normal and average conditions to regulate behavior patterns of future movement and development. However, there are also many deviations from the norm. The season of the year and topographical influences are factors to be considered. If we could catalog weather types or average types, and the systems would obey these rules, it would greatly simplify the art of forecasting. However, as a rule, this does not occur. Use these statistical techniques, but do not rely too heavily on them.

Normal Tracks

In 1914, Bowie and Weightman published climatological tables of the average, by month, of the 24-hour speed and direction of cyclonic centers in the United States. The storms were classified with respect to the point of origin and the current location of the centers. Although these tables appear to be antiquated, some of them resemble relatively recent classifications; therefore, they are of some value to the present-day forecaster.

The *Marine Climatic Atlas* also contains average storm tracks for each month of the year for areas over the oceans of the world. Other publications are available that give average or normal tracks for other areas of the world.

Prediction of Maritime Cyclones

This method is an empirically derived method for objectively predicting the 24-hour movement and change in intensity of maritime cyclones. The technique requires only measurement of the 500-hPa height and temperature gradients above the current surface center, and determination of the type of 500-hPa flow within which the surface system is embedded. Full details of this method are described in *The Prediction of Maritime Cyclones*, NAVAIR 50-1P-545.

The deepening prediction should be made first, as this will often give a good indication of movement.

The explosive intensification of maritime cyclones is a fairly common phenomenon, but is presently among the most difficult problems to forecast. Conversely, there are many situations in which it is important to predict the rapid filling of cyclones. This technique gives an objective method for predicting the 24-hour central change in pressure of those maritime cyclones whose initial positions lie north of 30 degrees north latitude. Further, the technique applies to the winter months only (November through March), although it may be used with some degree of confidence in other months.

The following factors are considered the most important:

- The location of the surface cyclone center with respect to the 500-hPa pattern.
- The strength of the 500-hPa flow above the cyclone center.
- The 500-hPa temperature gradient to the northwest of the surface center.

Of the lows that deepened, the deepening was in general greater, the stronger the 500-hPa contour and isotherm gradient. The study also indicated that the preferred location for filling cyclones is inside the closed 500-hPa contours, and that deepening cyclones favor the region under open contours in advance of the 500-hPa trough. The remaining portions of the pattern indicate areas of relatively little change, except lows located under a 500-hPa ridge line fill.

MOVEMENT OF HIGH-PRESSURE SYSTEMS

In general, the methods for extrapolation of low-pressure areas are applicable to the movement of high-pressure areas.

The following are general considerations in forecasting the movement of high-pressure systems:

- A surface high, or that portion situated under a blocking high aloft, remains very nearly stationary.
- A high situated under or very near a jetstream is steered by the current aloft.
- Cold, shallow highs are steered more easily than the larger ones. The Canadian and Siberian highs move little when there is no jet max in their vicinity or above them, and they move rapidly when the jet max is present.
- Progressive warm highs move with a speed consistent with that of the major ridges aloft.
- With straight westerly currents aloft, surface highs are displaced equatorward.
- Highs tend to move in the direction of, and with the speed of, the isallobaric centers; however, this rule is not very reliable because the isallobaric rises often follow the low rather than lead the high.

Steering is not used for high-pressure systems as widely as for lows because high-pressure cells do not have as great a vertical extent as low-pressure systems. However, steering seems to work about 75 percent of the time for cold highs.

FORECASTING THE INTENSITY OF SURFACE PRESSURE SYSTEMS

LEARNING OBJECTIVES: Forecast the intensity of surface low- and high-pressure centers by using extrapolation, isallobaric indications, relation to frontal movement, aloft indications, weather type, and in relation to normal storm tracks.

The changes in intensity of pressure systems at the surface are determined, to a large extent, by events occurring above the system.

EXTRAPOLATION

The 3-hour pressure tendencies reported in a synoptic plot indicate the sum of the pressure change due to movement of the system, plus that due to deepening and filling. If the exact amount of pressure change due to movement could be determined, it could be assumed that the system would continue to deepen or fill at that rate. However, it is not normally prudent to assume that the current rate of change will continue, nor just how much of the pressure change is due to movement.

ISALLOBARIC INDICATIONS

Isallobaric analyses at the surface show the following relationships between the isallobars and the change in intensity of pressure systems:

- When the 3-hour pressure falls extend to the rear of the low, the low is deepening.
- When the 3-hour pressure rises extend ahead of the low, the low tends to fill.
- When the 3-hour pressure rises extend to the rear of the high or ridge, the high or ridge tends to fill.
- Since low-pressure systems usually move in a direction parallel to the isobars in the warm sector, and since the air mass in the warm sector is homogeneous, it is possible to assume that the pressure tendencies in the warm sector are an indication of the deepening or filling of the system. The effects of frontal passages must be removed. Therefore, if a low moves parallel to warm sector isobars, the 3-hour pressure tendency in the warm sector is equal to the deepening or falling of the system.

Remember that when you use the present 3-hour pressure tendency values for any of the above rules, they are merely an indication of what has been happening, and not necessarily what will be taking place in the future. Consequently, if you use the tendencies for indication of deepening or filling, you will need to study the past trend of the tendencies.

RELATIVE TO FRONTAL MOVEMENT

Wave cyclones form most readily on stationary or slow moving fronts. A preferred position is along a decelerating cold front in the region of greatest deceleration. Normally, the 700-hPa winds are parallel to the front along this area.

Under conditions characteristic of the eastern Pacific, a secondary wave cyclone may rapidly develop (fig. 3-7, step 1). As the secondary wave forms on the

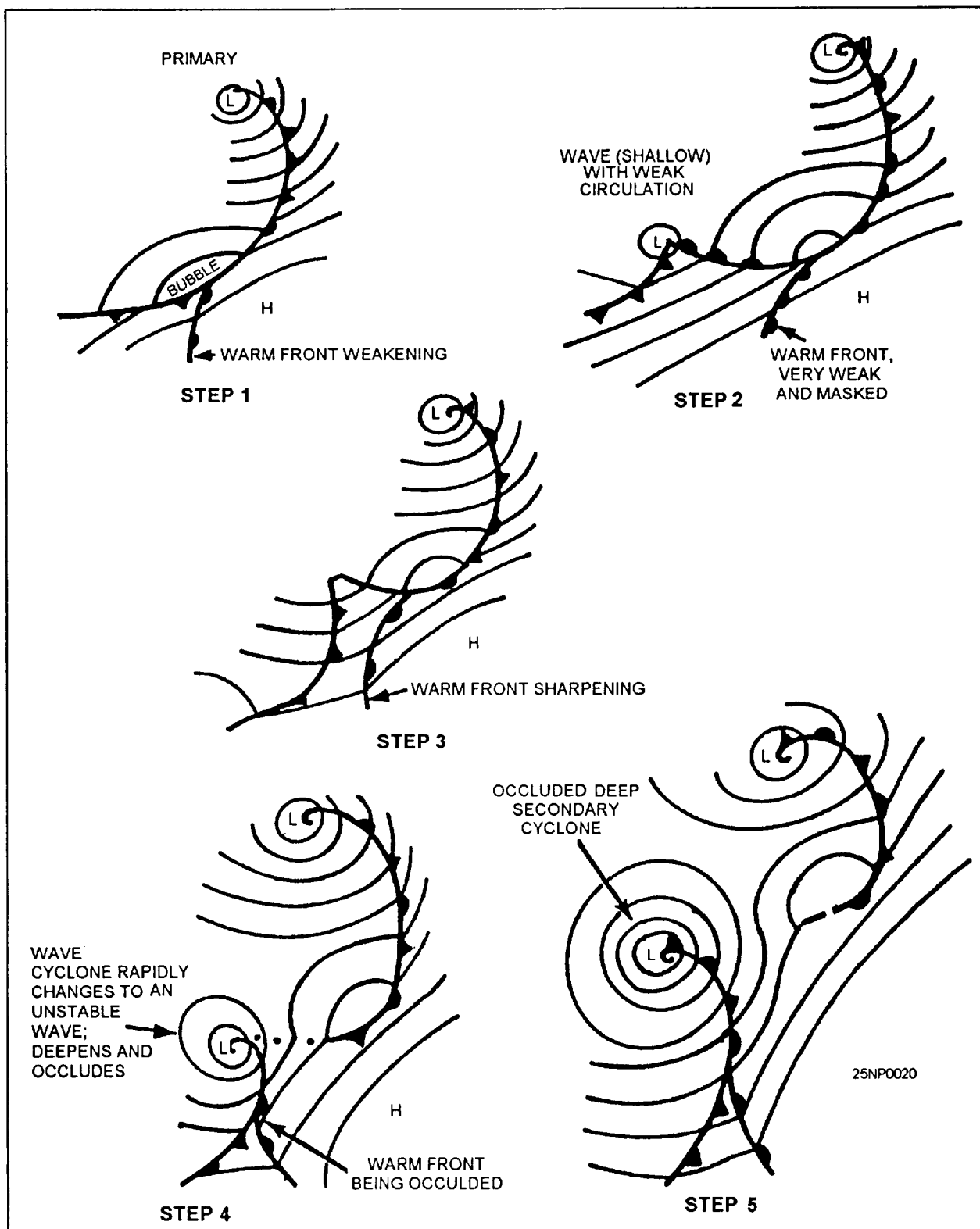

Figure 3-7.-Illustration of secondary cyclone development over the eastern Pacific.

retarded portion of the cold front, the original warm front associated with the primary cyclone tends to wash out, or become masked in the more or less parallel flow between the returning cold air from the high to the east and the original warm feeding current. In this stage of

development, the new secondary wave cyclone is rapidly moving, but with no appreciable deepening as it moves along the front and few, if any, indications of occluding (fig. 3-7, step 2). As this new low moves eastward along the front, the pressure gradients

surrounding it will tighten and tend to intensify the old masked warm front (fig. 3-7, step 3). Later, as the wave moves rapidly eastward, it will pick up this intensified warm front and begin to occlude (fig. 3-7, step 4).

This occlusion deepens as much as 10 to 15 hPa in 12 hours. The resultant rapid deepening and increase in cyclonic circulation results in a portion of the original polar front discontinuity between the new and the old cyclone being washed out (fig. 3-7, step 5).

INDICATIONS ALOFT FOR DEEPENING AND FILLING OF SURFACE LOWS

There are numerous atmospheric factors aloft that affect the central pressure of surface lows. The following text discusses a few of these factors.

Temperature Advection Changes

The role of temperature advection in contributing to the pressure or height changes can be misleading. On the one hand, low-level (usually the 1,000- to 500-hPa stratum) warm air advection is frequently cited as responsible for the surface pressure falls ahead of moving surface lows (the converse for cold air advection); on the other hand, warm air advection is frequently associated with rising heights in the upper levels.

The pressure change at the SURFACE is equal to the pressure change at some UPPER LEVEL, plus the change in mass of the column of air between the two. That is, if the pressure at some upper level remains UNCHANGED and the intervening column is replaced with warmer air, the mass of the whole atmospheric column (and consequently the surface pressure) decreases, and so does the height of the 1,000-hPa surface.

As an example, assume that warm air advection is indicated below the 500-hPa surface (5,460 meters) above a certain station. If no change in mass is expected above this level, the height of the 500-hPa level (5,460 meters) will remain unchanged. Suppose the 1,000- to 500-hPa advection chart indicates that the 5,400-meter thickness line is now over the station in question and will be replaced by the 5,490-meter thickness line in a given time interval; that is, warm air advection of 90 meters. The consequence is that the 1,000-hPa surface, which is now 60 meters above sea level, will lower 90 meters to 30 meters below sea level, and the surface pressure will decrease a corresponding amount, about 11 hPa (7.5 hPa approximately equals 60 meters). Whenever the surface pressure is less than 1,000 hPa,

the 1,000-hPa surface is below the ground and is entirely fictitious. In view of the above description of advective temperature changes, the following rules may apply:

- Warm air advection between 1,000 and 500 hPa induces falling surface pressures.
- Cold air advection between 1,000 and 500 hPa induces rising surface pressures.

Indications of Deepening From Vorticity

Cyclogenesis and deepening are closely related to cyclonic flow or cyclonic vorticity aloft. If you recall from the discussion of vorticity in chapter 1, vorticity is the measure of the path of motion of a parcel plus the wind shear along the path of motion. Thus, we have the following rules for the relationship of vorticity aloft to the deepening or falling of surface lows:

- Increasing cyclonic (positive) relative vorticity induces downstream surface pressure falls.
- Increasing anticyclonic (negative) relative vorticity induces downstream surface pressure rises.
- A wave will be unstable and deepen if the 700-hPa wind field over it possesses cyclonic relative vorticity.
- A wave will be stable if the 700-hPa wind over it possesses anticyclonic vorticity.
- If there are several waves along a front, the one with the most intense cyclonic vorticity aloft will develop at the expense of the others. This is usually the one nearest the axis of the trough.

Deepening of Lows Relative to Upper Contours

The amount of deepening of eastern United States lows moving northeastward into the Maritime Provinces of Canada frequently can be predicted by estimating the number of contours at the 200- or 300-hPa level that would be traversed by the surface low during the forecast period. For a close approximation, multiply the 200-hPa current height difference in *tens of meters* by $3/4$ to obtain the surface pressure change in hectopascals. For example: a 240-meter height difference at 200 hPa results in a pressure change of 18 hPa at the surface.

$$24 \times 3/4 = 18 \text{ hPa pressure change}$$

If FALLING heights are indicated aloft, the AMOUNT of fall need not be estimated. The deepening of the surface low and greater advective cooling, associated with the occlusion process, appear to compensate for the upper height falls.

If FUSING heights are indicated aloft over the expected low position, the AMOUNT MUST BE ESTIMATED to determine the ACTUAL height difference to which the rule will apply. In some cases the height rises aloft over the expected position of the low may be quite large, indicating the development of a high-latitude ridge aloft, which tends to block the eastward progress of the low. This may result in rapid deceleration of the low, with falling and/or recurvature to the north. In such a case, the forecast position of the low is revised in light of the changing circulation aloft.

The above technique works *only* when lows are expected to move northeastward out of a heat source, such as the Southern Plains. When a low moves into the Southern Plains from the west or northwest, there is frequently no accompanying cooling in the low troposphere, since the low is moving toward the heat source.

Some rules for the falling and deepening of surface lows in relation to upper contours areas follows:

- Filling is indicated when a surface low moves into or ahead of the major ridge position of the 500-hPa level.

- Surface lows tend to fill when the associated upper-level trough weakens.
- Surface lows tend to fill when they move toward values of higher thickness lines.
- When the associated upper trough deepens, the surface low also deepens.
- Surface lows deepen when they move toward lower thickness values.
- Waves develop along fronts when the 700-hPa windflow is parallel to the front, or nearly so.
- During periods of southerly flow at 700 hPa along the east coast of the United States, secondary storms frequently develop in the vicinity of Cape Hatteras.

High Tropospheric Divergence in Developing Lows

In the case of developing (dynamic) cyclones, horizontal divergence is at a maximum in the 400- to 200-hPa stratum, and the air above must sink and warm adiabatically to maintain equilibrium. See figure 3-8.

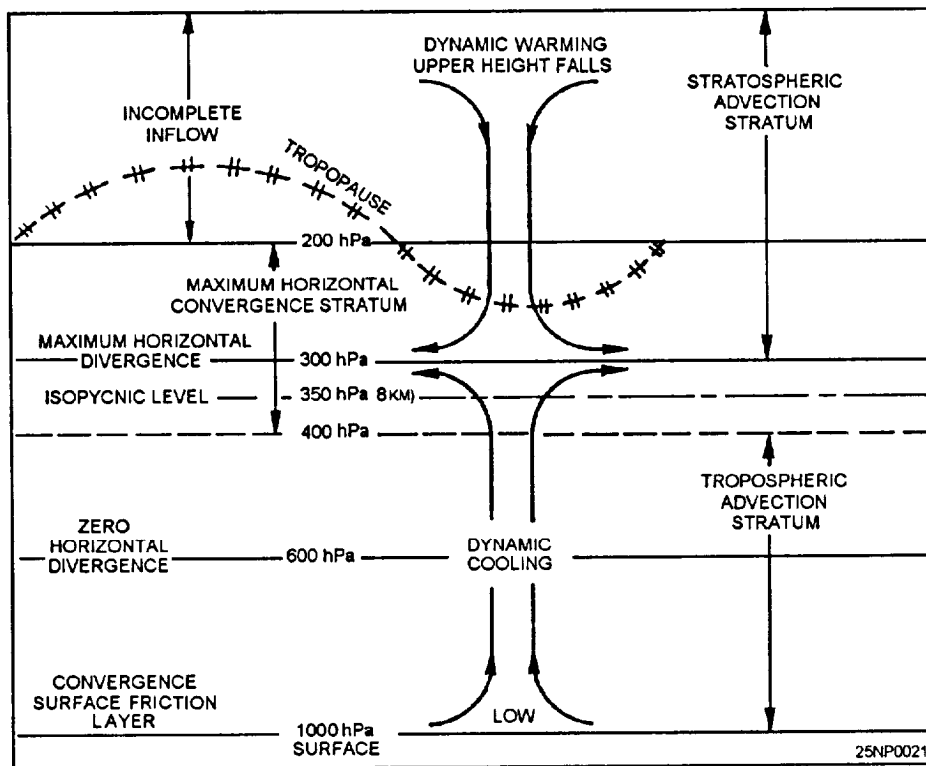

Figure 3-8.-Vertical circulation over developing low.

Using the Current 500-hPa Chart

In the deepening of lows there must be removal of air at high levels due to divergence in the 400- to 200-hPa stratum, resulting in stratospheric warming. Insufficient inflow at very high levels to compensate the subsidence results in 500-hPa contour falls.

This is roughly the mechanism thought to be responsible for the development of low-pressure systems. The high-level decrease in mass overcompensates the low tropospheric increase in density; the high-level effect thus determines the reduction of pressure at the surface when lows are intensifying.

Stratospheric and Upper Tropospheric Decrease in Mass

The chief cause of deepening lows is the decrease in mass in the upper troposphere and the lower stratosphere. With rapidly deepening lows, it is known that the change in mass in the stratosphere contributes as much to the local surface pressure change as do the tropospheric changes in density, if not more. Warming is frequently observed in the stratosphere over deepening surface lows, pointing to subsidence in the lower stratosphere. This warming is accompanied by lowering heights of constant pressure surfaces in the lower stratosphere, indicating a decrease in mass at high levels. See figure 3-8.

Deepening, to a large extent is controlled by mass changes in the upper atmosphere. For example, it has been shown that the lower two-thirds (below about 300-hPa level) of the central column become colder and denser as the areas of low pressure deepen, while the upper one-third of the column becomes warmer. The upper mass decreases by an amount sufficient to counteract the cooling in the lower layers, plus an additional amount to deepen the low. The preferred region for deepening of lows is in the top third of the atmospheric column or, roughly, the stratosphere. See figure 3-8.

Using Facsimile and NODDS Products

Facsimile and NODDS products currently contain prognostic 500 mb, 1000- to 500-mb thickness, and 500-mb vorticity charts. These charts can be used in making predictions of advective changes, thickness patterns, and subsequent changes to the surface pattern.

DEEPENING OF LOWS RELATIVE TO WEATHER TYPES

Weather types were discussed previously under the section Movement of Low-Pressure Systems. This method can also be used to forecast changes in intensity of pressure systems, as each system or type has its own average movement plus average deepening or filling.

DEEPENING OF LOWS IN RELATION TO NORMAL STORM TRACK

Lows whose tracks deviate to the left of the normal track frequently deepen. In general, the normal track of a low is parallel to the upper flow. If a low deviates to the left of normal, it crosses upper contours (assuming an undisturbed upper current) and becomes superimposed by less mass aloft, resulting in deepening of the low. As long as this crossing of upper contours is unaccompanied by sufficient compensatory cooling at the surface low center, the system will deepen.

RELATION BETWEEN DEEPENING LOWS AND MOVEMENT

There is little basis for the rule that deepening storms move slowly and filling storms move rapidly. The speed of movement of a low, whatever its intensity, is dependent upon the isallobaric gradient and other factors. The magnitude of the surface isallobaric gradients depends upon the low-level advection, the magnitude of the upper-level height changes, and the phase relation between the two levels.

FORECASTING THE INTENSITY OF SURFACE HIGHS

The following section will deal with atmospheric factors aloft and how they affect surface anticyclogenesis. This section will also discuss rules for forecasting the intensity of surface highs.

Anticyclogenesis Indicators

In the case of developing dynamic anticyclones, cooling takes place at about 200 hPa and above. This cooling is due to the ascent of air, resulting from convergence in the 400- to 200-hPa stratum. Incomplete outflow at very high levels causes piling up of air above fixed upper levels, resulting in high-level pressure rises. At the same time, warming occurs in the lower troposphere. This warming sometimes occurs very rapidly in the lower troposphere above the surface

levels, which may remain quite cold. A warming of 10°C per day at the 500-hPa level is not unusual. Such a rate of warming is not entirely due to subsidence but probably has a considerable contribution from warm advection. However, continuity considerations suggest that the convergence in the 400- to 200-hPa stratum produces some sinking and adiabatic warming in the lower troposphere. See figure 3-9.

Thus, in the building of anticyclones, there must be a piling up of air at high levels due to horizontal velocity convergence in the 400- to 200-hPa stratum, which results in the stratospheric cooling observed with developing anticyclones. Insufficient outflow at very high levels results in an accumulation of mass. This is roughly the mechanism thought to be responsible for the development of high-pressure systems. The high-level increase of mass overcompensates the low tropospheric decrease of density, and the high-level effect thus

determines the sign of increase of pressure at the surface when highs are intensifying. See figure 3-9.

The development of anticyclones appears to be just the reverse of the deepening of cyclones. Outside of cold source regions, and frequently in cold source regions, high-level anticyclogenesis appears to be associated with an accumulation of mass in the lower stratosphere accompanied by cooling. In many cases this stratospheric cooling maybe advective, but more frequently the cooling appears to be clearly dynamic; that is, due to the ascent of air resulting from horizontal convergence in the upper troposphere.

Studies of successive soundings accompanying anticyclogenesis outside cold source regions show progressive warming throughout the troposphere. This constitutes a negative contribution to anticyclogenesis. In other words, outside of cold source regions, during anticyclone development, the decrease in DENSITY in the troposphere is overcompensated by an increase in

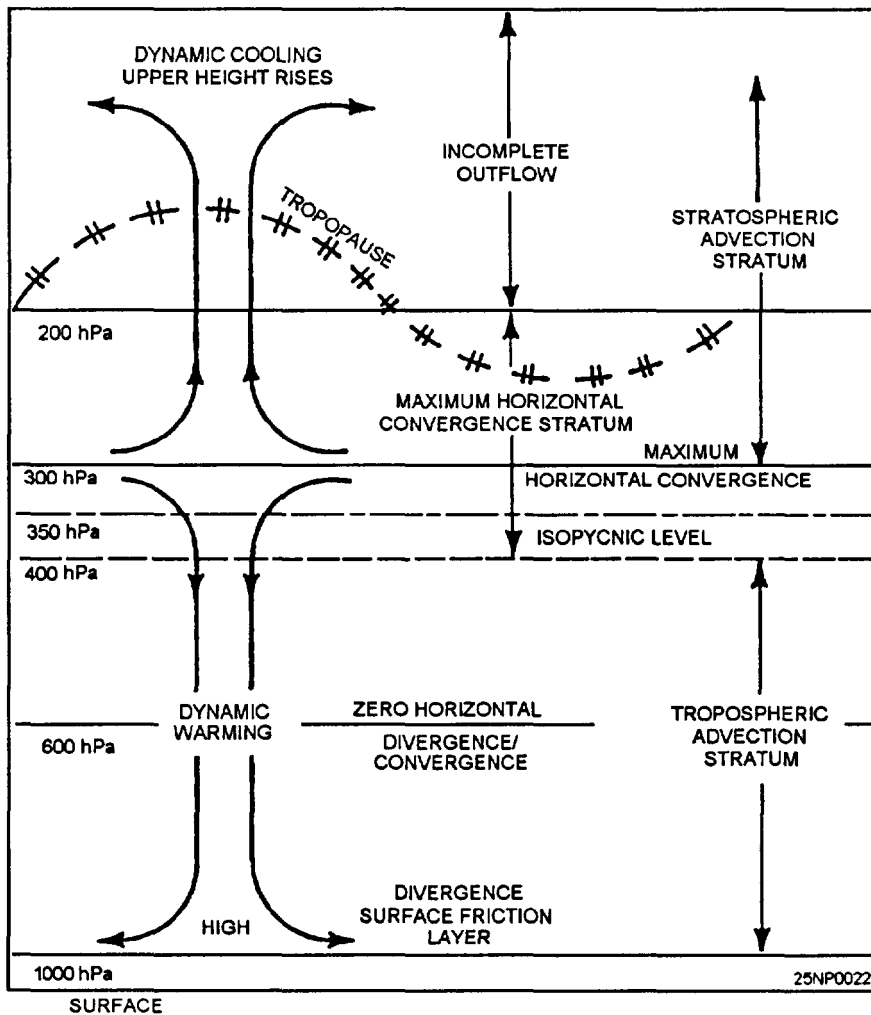

Figure 3-9.-Vertical circulation over developing high.

mass, and generally accompanied by cooling in the stratosphere. This is analogous to the deepening of lows where the decrease in mass, generally accompanied by warming at high levels, overcompensates the cooling in the troposphere.

The evidence, therefore, indicates that high-level changes, undoubtedly due to dynamic mechanisms in the upper troposphere, are largely responsible for deepening and filling of surface pressure systems. This fact is of considerable prognostic value if the dynamic processes that induce these mass and density changes can be detected on the working charts.

Rules for Forecasting the Intensity of Highs

The following rules are for forecasting the intensity of surface highs:

- Intensification of surface highs is indicated, and should be forecasted, when cold air advection is occurring in the stratum between 1,000 hPa and 500 hPa when either no height change is

occurring or forecasted at 500 hPa, when convergence is indicated at and above 500 hPa or both, and when the cold advection is increasing rapidly. A high also intensifies when the 3-hour pressure tendency rises are occurring near the center, and in the rear quadrants of the high. When a moving surface high that is not subjected to heating from below is associated with a well-defined upper ridge, the change in intensity is largely governed by changes in intensity of the upper-level ridge.

- Weakening of surface highs is indicated and should be forecasted when the cold air advection is decreasing, or is replaced by warm air advection in the lower tropospheric stratum, with either no height change at 500 hPa or when divergence is occurring or forecasted at and above 500 hPa, or when both are occurring at the same time.

- When warm air and low tropospheric advection is coupled with convergence aloft, or when cold air and low tropospheric advection is coupled with divergence aloft, the contribution of either maybe canceled by the

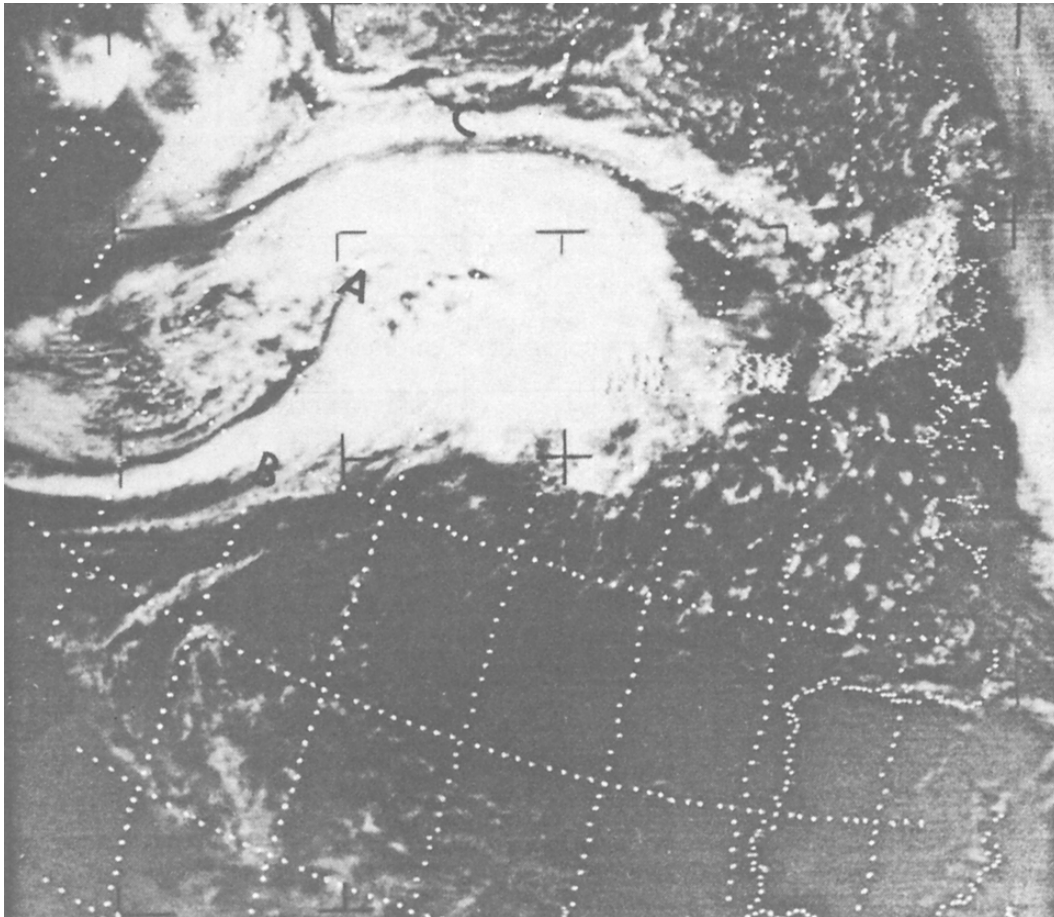

Figure 3-10.—Visual, local noon, first day.

other. An estimate of the effects of each must be made before a decision is reached.

- When surface pressure falls occur near the center and in the forward quadrants of the high, the high will weaken.

- When a cold high that is moving southward is being heated from below, it will weaken, unless the heating is compensated by intensification of the ridge aloft. The amount of intensification can be determined by correlating the contributions of height change at the 500-hPa level as progged and the change in thickness as advected.

SATELLITE IMAGERY

The *AG2 TRAMAN*, volume 1, provides a detailed discussion of satellite imagery analysis. It may be beneficial to review Unit 10 before you read this chapter.

Satellite imagery provides the forecaster with an aid in forecasting the deepening of surface low-pressure systems. In the following series of illustrations, both visual and infrared imagery depicts the cloud features over a 60-hour period during the deepening of a low-pressure system. See figures 3-10 through 3-15.

In figure 3-10, the visual pass at noon local time shows a large cloud mass with a low level vortex centered near A. A frontal band, B, extends to the southwest from the large cloud mass. The beginning of a dry tongue is evident. An interesting cloud band, C, which appears just north of the cloud mass, is of about the same brightness as the major cloud mass.

The infrared scan for midnight, figure 3-11, shows the further development of the vortex with penetration of the dry tongue. Low-level circulation is not visible, but the brightness (temperature) distribution differs from the visual picture. The detail within the frontal band is apparent, with a bright cold line, DE, along the upstream edge of the band. In all probability, this is the cirrus generated by the convection near the polar jetstream. The cloud band, C, from the previous (daylight) picture is seen in the IR, and is composed of lower clouds than would be anticipated from the video.

By the second noon (fig. 3-12), the vortex is clearly defined, but again the spiral arm of the frontal band is nearly saturated, with a few shadows to provide detail on cloud layering. The National Meteorological Center (NMC) operational surface analysis during this period shows that the cyclone has deepened.

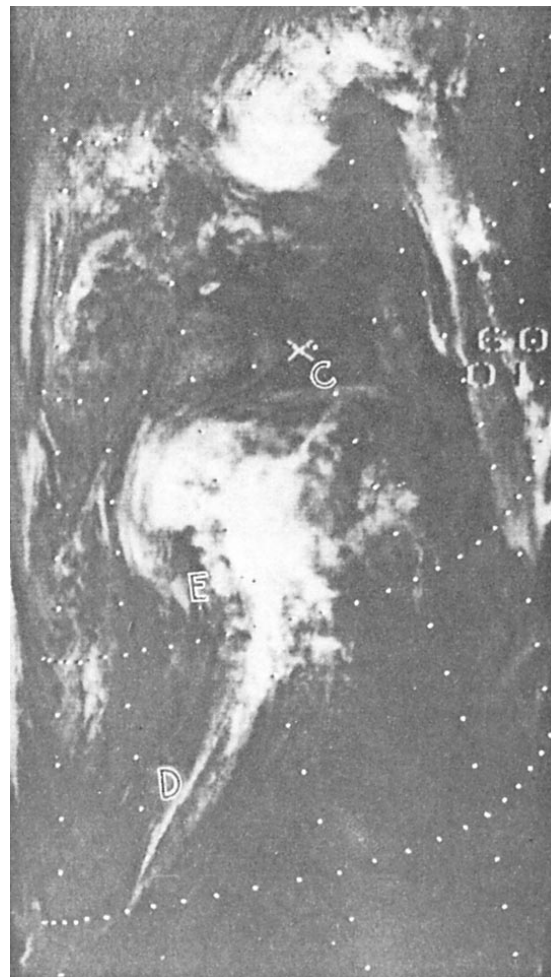

Figure 3-11.-Infrared, local midnight, first night.

In figure 3-13, the pass for the second midnight shows the coldest temperatures form a hooked-shaped pattern with the highest cloudiness still equatorward of the vortex center at F. The granular gray-to-light-gray temperature within the dry tongue area, G, suggests cells that consist of cumulus formed from stratocumulus, and small white blobs indicating cumulus congestus.

The visual pass for the third noon (fig. 3-14) shows the vortex to be tightly spiraled, indicating a mature system. The frontal band is narrower than it was 24 hours earlier, with some cloud shadows present to aid in determining the cloud structure. Surface analysis indicates that the lowest central pressure of the cyclone was reached approximately 6 hours prior to this picture.

The final pass in this series (fig. 3-15) shows the coldest temperatures completely surrounded the vortex. The frontal band also shows the segmented nature of the active weather areas within the band. A typical vorticity

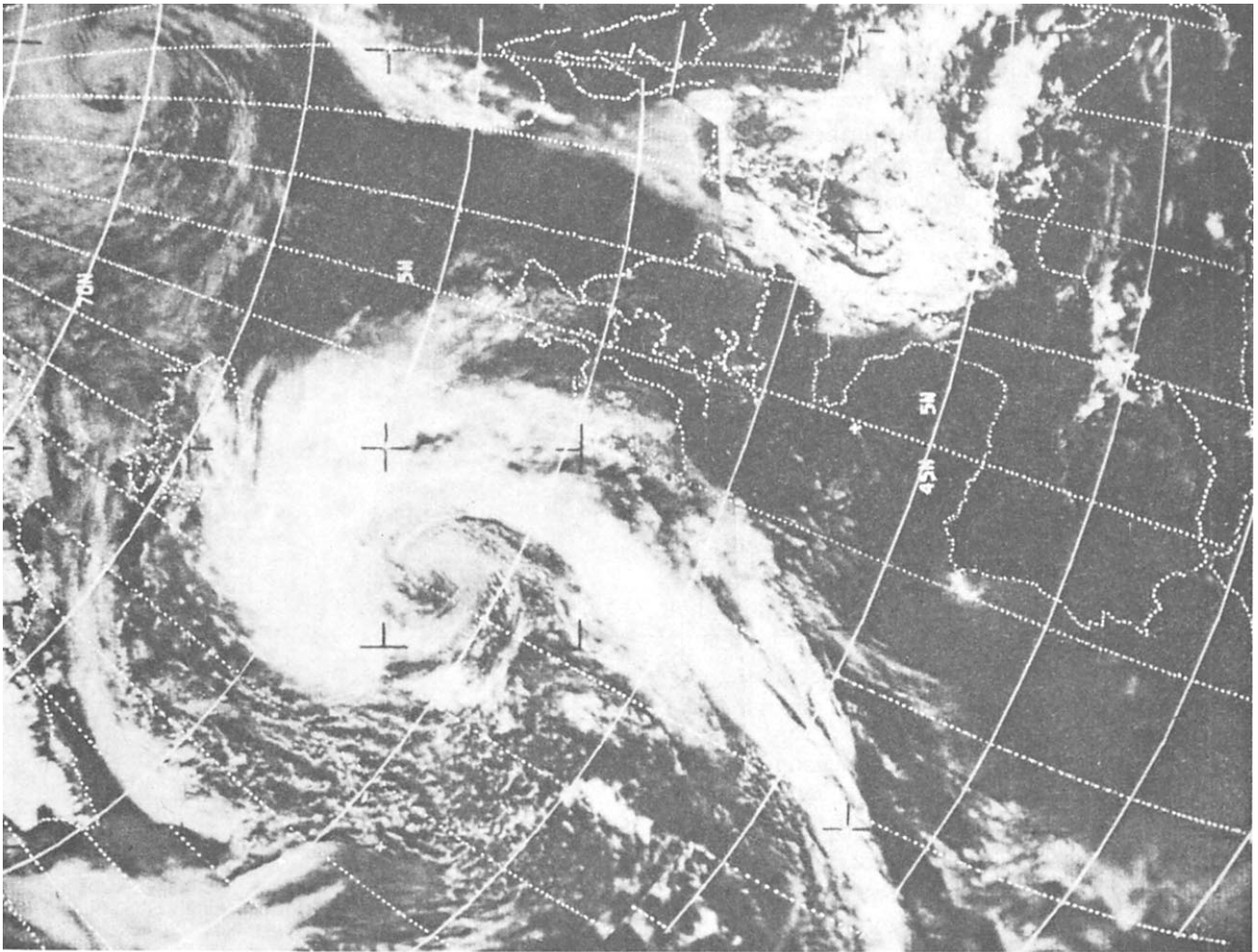

Figure 3-12.-Visual, loud noon, second day.

center at H shows the cold temperatures of cumulus congestus and cumulonimbus cloud tops. The same vorticity center is apparent in the previous (daylight) picture (fig. 3-14) west of the frontal blind.

SATELLITE IMAGERY PRINCIPLES

The forecaster may use the following general conclusions in adapting satellite imagery to forecasting the change in intensity of surface cyclones:

- The use of nighttime IR data together with daytime data yields 12-hour continuity with respect to cyclone development or decay.
- A hook-shaped cloud mass composed of cold temperatures, (high cloud tops) indicates an area of strong upward vertical motion with attendant surface pressure falls.
- As the dry tongue widens, the cyclone continues to deepen.

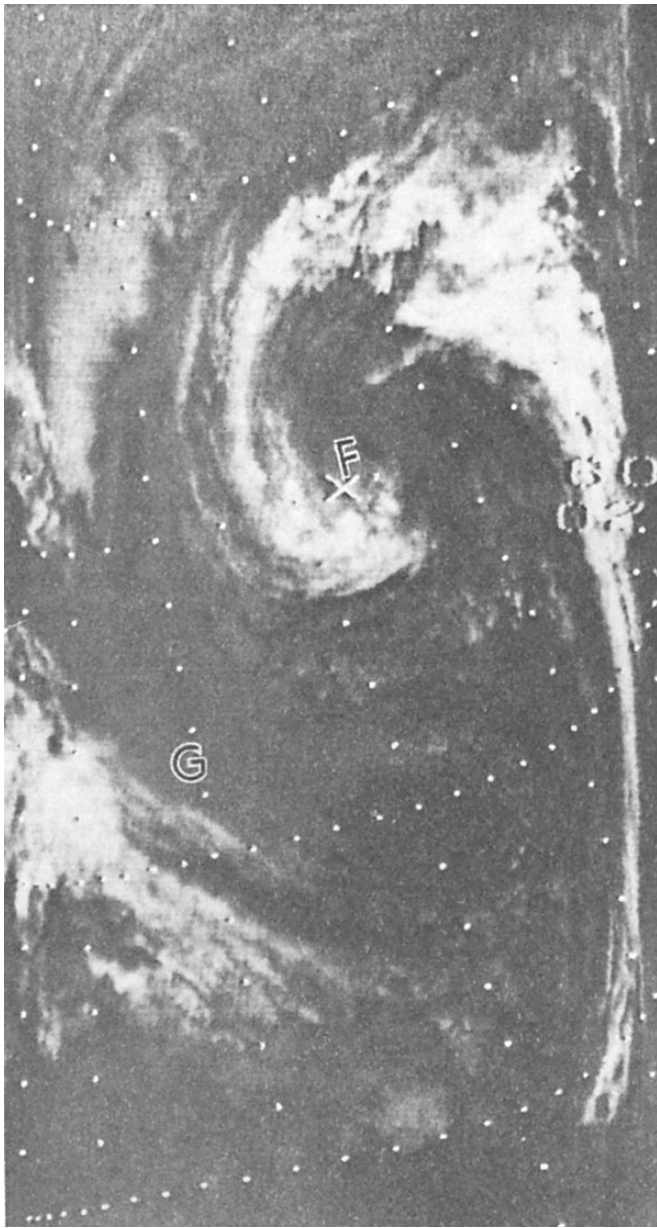

Figure 3-13.-Infrared, local midnight, second day.

- When high or middle clouds completely surround the vortex center, the cyclone has reached maturity and can be expected to fill. This generally indicates the advection of cold, dry air into the cyclone has ceased.

FORECASTING THE MOVEMENTS AND INTENSITY OF FRONTS

LEARNING OBJECTIVES Forecast the movement and intensity of fronts by using extrapolation and the geostrophic wind method.

The following text discusses various rules for the movement of fronts, as well as the effects upper air features have on fronts.

MOVEMENT OF FRONTS

Fronts are ordinarily forecasted after the pressure systems have been forecasted. However, there may be cases for short-range forecasting where movement of all of the systems is unnecessary. Extrapolation is perhaps the simplest and most widely used method of moving fronts for short periods. When moving fronts for longer periods, other considerations must be taken into account.

The following text discusses a simple extrapolation method, as well as the geostrophic wind method, and considerations based on upper air influences.

Extrapolation

When fronts are moved by extrapolation, they are merely moved based on past motion. Of course such factors as occluding, frontogenesis, frontolysis, change in position, intensity of air masses and cyclones, and orographic influences must be taken into account. Adjustments to the extrapolation frontal positions are made on the basis of the above considerations.

You should keep in mind that the adjacent air masses and associated cyclones are the mechanisms that drive the fronts.

You should also keep in mind the upper air influences on fronts; for example, the role the 700-hPa winds play in the movement and modification of fronts. Finally, you should remember that past motion is not a guarantee of future movement, and the emphasis should be on considering the changes indicated, and incorporating these changes into an extrapolated movement.

Geostrophic Wind Method

Frontal movement is forecasted by the geostrophic wind at the surface, and at the 700-hPa level at several points along the front. The basic idea is to determine the component of the wind at the surface and aloft, which is normal (perpendicular) to the front and, therefore, drives the front. Determination of the component normal to the front is made by triangulation.

THE PROCEDURE.— The steps are as follows:

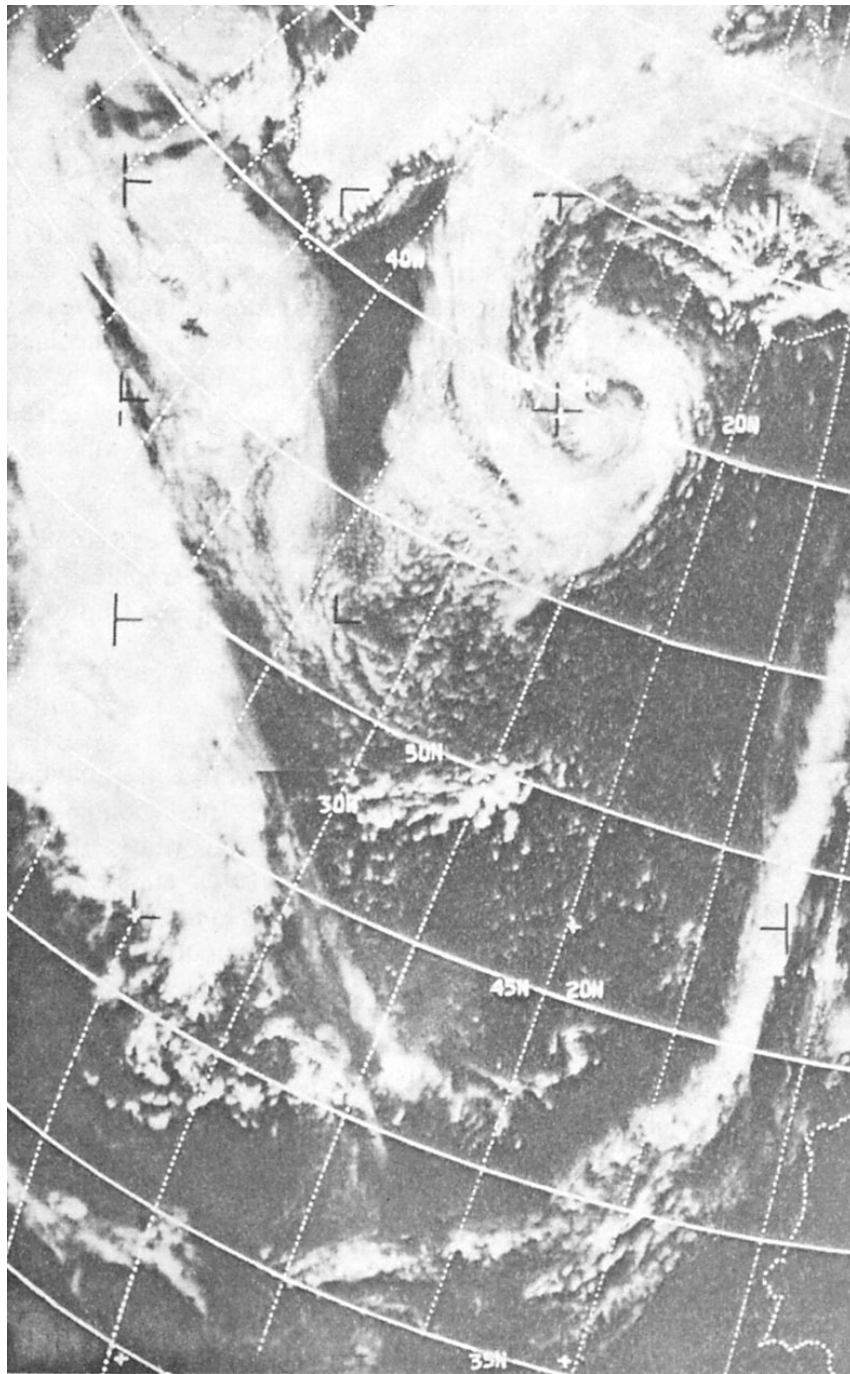

Figure 3-14.-Visual, local noon, third day.

1. Select two to four points along the front where a regular and reliable pressure gradient exists, and determine the geostrophic wind by use of the geostrophic wind scale. (NOTE: Do not use the observed wind.) The wind speed should be determined a short distance behind a cold front and a short distance ahead of the warm front where a representative gradient can be found. The points on the isobars in figure 3-16 serve as a guide to the proper selection of the geostrophic wind measurements.

2. Draw a vector toward the front, parallel to the isobars from where the geostrophic wind was determined. The vectors labeled "y" in figure 3-16 illustrate this step.

3. Draw a vector perpendicular to the front originating at the point where the "y" vector intersects the front, and label this vector "x," as illustrated in figure 3-16.

4. At a convenient distance from the intersection, along the "x" vector, construct a perpendicular to the "x"



Figure 3-15.-Infrared, local midnight, third night.

vector, letting it intersect the "y" vector. This is line c in figure 3-16.

5. The angle formed at the intersection of the "y" vector and the perpendicular originating from the "x" vector is labeled θ (theta). Measure angle θ to the nearest degree with a protractor, and determine the value of its sine by using trigonometric tables or a slide rule.

6. Let side a of the right triangle formed in step 4 represent the value of the geostrophic wind obtained in step 1, and call it "Cgs." Solve the triangle for side b by multiplying the sine of θ by the value of Cgs. The resulting value of b is the component of the wind normal to the front, giving it its forward motion. The formula is

$$b = C_{gs} \times \sin \theta$$

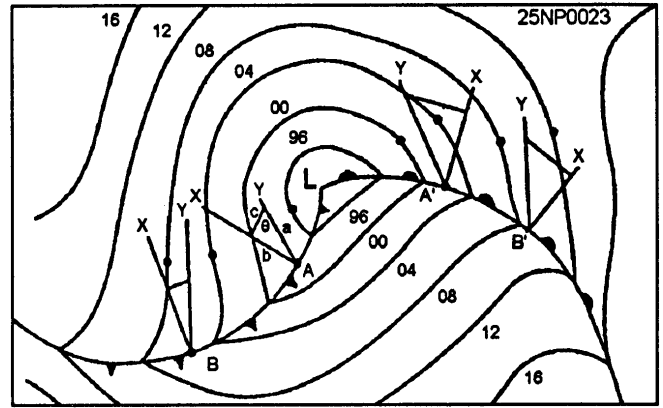

Figure 3-16.-Geostrophic wind method.

In the sample problem, if the Cgs was determined to be 25 knots and angle θ to be 40° , b is 19.1 knots, since the sine of angle θ is 0.643.

As you can see, the components normal to the front should be equal on both sides of the front, and that in reality, it would matter very little where the component is computed in advance of or to the rear of the front. In cold fronts the reason that the component to the rear is chosen is that this flow, as well as this air mass, is the flow supplying the push for the forward motion. In the case of a warm front, the receding cold air mass under the warm front determines the forward motion, because the warm air mass is merely replacing the retreating cold air, not displacing it.

OTHER CONSIDERATIONS.— The foregoing discussion neglected to discuss the effects of cyclonic and anticyclonic curvature on the isobars, and the effect of vertical motion along the frontal surfaces. The upslope motion along the frontal surfaces reduces the effective component normal to the front. Furthermore, the cyclonic curvature in the isobars indicates convergence in the horizontal and divergence in the vertical, further reducing the effective component normal to the front. For these reasons, the component normal to the front is reduced at the surface only by the following amounts for the different types of fronts and isobaric curvature:

- Slow moving cold front,
anticyclonic curvature 0%
- Fast moving cold front,
cyclonic curvature 10-20%
- Warm front 20-40%
- Warm occluded fronts 20-40%
- Cold occluded fronts 10-30%

- If the pressure gradient is forecast to increase, decrease the component by the least percentage.

- If the pressure gradient is forecast to decrease, decrease the component normal to the front by the highest percentage value.

- If the pressure gradient is forecast to remain static, decrease the component normal to the front by the middle percentage value as listed above.

Upper Air Influences on the Movement of Surface Fronts

A number of the rules relating the upper air contours to the movement of fronts were discussed in the AG2 TRAMAN, volume 1. You saw that a slow moving cold front has parallel contours behind the front, and in a fast moving cold front, the contours were at an angle to the front, and at times normal to the front.

Some additional rules are stated below:

- During periods of strong, continued westerly flow aloft (high index) over North America, surface fronts move rapidly eastward. A rule of thumb, the front will move eastward at a speed that is 50 percent of the 500-hPa flow and 70 percent of the 700-hPa flow.

- Cold fronts associated with cP outbreaks are closely dependant on the vertical extent of the northerly winds. The following relationships are evident: For cP air to push southward into the Great Basin from British Columbia, strong northerlies must exist to at least 500 hPa over the area; for cP air to push southward into the Gulf of Mexico, northerly and/or northwesterly winds must extend, or be expected to extend, to at least 500 hPa as far south as Texas; for cP air to push southward over Florida to Cuba, northerlies must extend to at least 500 hPa as far south as the Gulf States.

FORECASTING THE INTENSITY OF FRONTS

The following text deals with the forecasting of the intensity of fronts, as well as indicators of frontogenesis and frontolysis.

Frontogenesis

Surface fronts generally intensify when one of the following three conditions and/or combination occurs:

1. The mean isotherms (thickness lines) become packed along the front.

2. The fronts approach deep upper troughs.

3. Either or both air masses move over a surface that strengthens their original properties.

Frontogenesis occurs when two adjacent air masses exhibit different temperatures and density, and prevailing winds bring them together. This condition, however, is the normal permanent condition along the polar front zone; therefore, the polar front is semipermanent.

Generation of a new front, or the intensifying of an existing front, occurs during the winter months along the eastern coasts of the American and Asian Continents. During this time the underlying surface (ocean) is much warmer than the overlying air mass.

Frontolysis

Weakening or dissipation of fronts occurs when:

- The mean isotherms become more perpendicular to the front or more widely spaced.
- The surface front moves out ahead of the associated pressure trough.
- Either or both air masses modify.
- The front(s) meet with orographic barriers.

FORECASTING ISOBARIC CONFIGURATION

LEARNING OBJECTIVES: Evaluate isobaric configuration in preparation of surface charts.

Isobars may be constructed on the surface prognosis either by computing the central pressures for the high and low centers and numerous other points on the surface prognosis chart and drawing the isobars, or by moving the isobars in accordance with the surface pressure 3-hour tendencies and indications.

A thickness prognosis is used in constructing the isobaric configuration on your forecast. The steps for constructing forecasted isobaric configuration by using the thickness chart are as follows:

1. At a selected point, determine the difference between the present 500-hPa height and the forecasted 500-hPa height. A forecasted rise at the 500-hPa level is positive; a forecasted fall is negative.

2. At the same selected point, determine the difference between the current and the forecasted thickness value.

3. Algebraically subtract the difference of the forecasted thickness value from the forecast difference of the 500-hPa level.

4. Convert this difference in meters to hectopascals by using the expression 60 meters equal 7 1/2 hPa. Be sure to assign the proper sign.

5. Add (or subtract if the value is negative) this value to the current sea level pressure. This is the progged sea-level pressure.

6. Repeat steps 1 through 5 for all the points selected, and sketch the isobars.

EXTENDED WEATHER FORECASTS

LEARNING OBJECTIVES: Recognize the need for extended weather forecasts.

While most routine forecasting does cover a short period of time, generally 12 to 36 hours, the forecaster will, upon occasion, be required to provide outlooks for extended periods of up to 7 days or longer.

Fleet Numerical Meteorology and Oceanography Center (FNMOC) and the National Weather Service prepare facsimile products to aid the forecaster in providing extended forecasts.

Of major importance to the forecaster in preparing an extended outlook without the benefit of facsimile prognostic charts is the determination of the type of flow (zonal or meridional) that can be expected to persist

during the outlook period. With a zonal flow, a steady progression of pressure systems moving regularly can be anticipated. With the change to a meridional flow, the introduction of cold polar or arctic air into the lower latitudes and mixing with the warmer air will create a number of problems to be considered. Among these will be the development of new pressure systems, deepening or filling of present systems, and movement of the systems.

The forecaster should also become familiar with the particular areas that tend to trigger cyclogenesis and/or frontogenesis, and use this information when preparing his/her outlook. Many of the climatological publications that are readily available make note of these areas.

Many local area forecaster's handbooks contain detailed information on how various weather situations approaching the station affect the station weather well in advance. These should be used when available.

SUMMARY

In this chapter we first discussed the formation of new pressure systems, and available tools used for their interpretation. The next topic discussed was that of the forecasting of the movement of surface pressure systems; lows followed by high-pressure centers. We also discussed forecasting the intensity of surface pressure systems. Topics discussed were extrapolation, isalobaric indications, relation to frontal movements, and lastly, aloft indications of deepening and filling. We then discussed forecasting the movement and intensity of fronts by using extrapolation and the geostrophic wind methods. We also discussed the importance of and the procedures used in the construction of the isobaric configuration on forecasts. Lastly, we discussed extended weather forecasts.

CHAPTER 4

FORECASTING WEATHER ELEMENTS

Cloudiness, precipitation, and temperature are among the most important elements of any weather forecast. Cloudiness and precipitation may be subdivided into two main categories: occurrences associated with frontal activity and occurrences in air masses not associated with fronts.

There are many factors that influence the daily heating and cooling of the atmosphere. Some of these factors are cloudiness, humidity, nature of the undeying surface, surface winds, latitude, and the vertical temperature lapse rate. Cloudiness is quite obvious in its influence on heat gain at the earth's surface during daylight hours, and also heat loss due to radiational cooling at night.

This chapter discusses the forecasting of middle and upper cloudiness, precipitation, and local temperature. The forecasting of convective clouds and associated precipitation, along with fog and stratus is covered in chapter 5 of this manual.

CONDENSATION AND PRECIPITATION PRODUCING PROCESSES

LEARNING OBJECTIVES: Evaluate the processes necessary for condensation and precipitation to occur.

We will begin our discussion by identifying the conditions that must be present for condensation and precipitation to take place.

CONDENSATION PRODUCING PROCESSES

The temperature of a parcel of air must be lowered to its dewpoint for condensation to occur. Condensation depends upon two variables—the amount of cooling and the moisture content of the parcel. Two conditions must be met for condensation to occur; first, the air must be at or near saturation, and second, hygroscopic nuclei must be present. The first condition may be brought about by evaporation of additional moisture into the air, or by the cooling of the air to its dewpoint temperature.

The first process (evaporation of moisture into the air) can occur only if the vapor pressure of the air is less than the vapor pressure of the moisture source. The second condition (cooling) is the principal condensation producer.

Nonadiabatic cooling processes (radiation and conduction associated with advection) primarily result in fog, light drizzle, dew or frost.

The most effective cooling process in the atmosphere is adiabatic lifting of air. It is the only process capable of producing precipitation in appreciable amounts. It is also a principal producer of clouds, fog, and drizzle. The meteorological processes that result in vertical motion of air are discussed in the following texts. None of the cooling processes are capable of producing condensation by themselves; moisture in the form of water vapor must be present.

PRECIPITATION PRODUCING PROCESSES

Precipitation occurs when the products of condensation and/or sublimation coalesce to form hydrometers that are too heavy to be supported by the upward motion of the air. A large and continuously replenished supply of water droplets, ice crystals, or both is necessary if appreciable amounts of precipitation are to occur.

Adiabatic lifting of air is accomplished by orographic lifting, frontal lifting, or vertical stretching (or horizontal convergence). All of these mechanisms are the indirect results of horizontal motion of air.

Orographic Lifting

Orographic lifting is the most effective and intensive of all cooling processes. Horizontal motion is converted into vertical motion in proportion to the slope of the inclined surface. Comparatively flat terrain can have a slope of as much as 1 mile in 20 miles.

The greatest extremes in rainfall amount and intensity occur at mountain stations. For this reason, it is very important that the forecaster be aware of this potential situation.

Frontal Lifting

Frontal lifting is the term applied to the process represented on a front when the inclined surface represents the boundary between two air masses of different densities. In this case, however, the slope ranges from 1/20 to 1/100 or even less. The steeper the front, the more adverse and intense its effects, other factors being equal. These effects were discussed in detail in the *AG2 TRAMAN*, volume 1.

Vertical Stretching

Since it is primarily from properties of the horizontal wind field that vertical stretching is detectable, it is more properly called *convergence*. This term will be used hereafter.

The examples of convergence and divergence, explained in the foregoing, are definite and clear cut, associated as they are with the centers of closed flow patterns. Less easily detected types of convergence and divergence are associated with curved, wave-shaped, or straight flow patterns, where the air is moving in the same general direction. Variations in convergence and divergence are indicated in figures 4-1, 4-2, 4-3, and 4-4 by means of the following key:

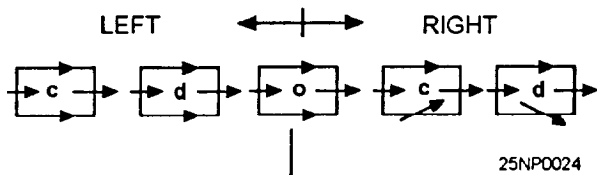
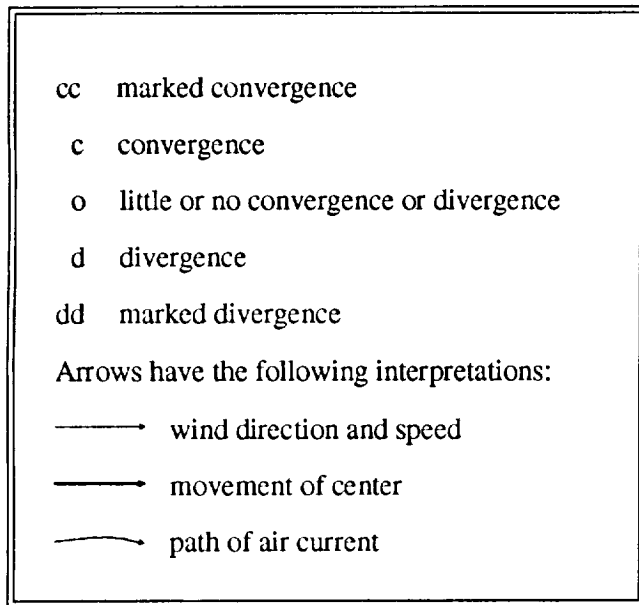

Figure 4-1.-Longitudinal and lateral convergence and divergence.

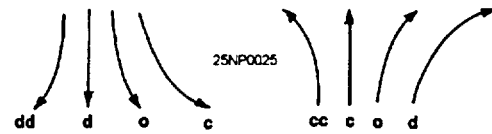

Figure 4-2.-Convergence and divergence in meridional flow.

The left side of figure 4-1 illustrates longitudinal convergence and divergence; the right side illustrates lateral convergence and divergence. Many more complicated situations can be analyzed by separation into these components.

It can be shown mathematically and verified synoptically that a fairly deep layer of air moving with a north-south component has associated convergence or divergence, depending on its path of movement. In figure 4-2 the arrows indicate paths of meridional flow in the Northern Hemisphere. In general, equatorward flow is divergent unless turning cyclonically, and poleward flow is convergent unless turning anticyclonically.

The four diagrams of figure 4-3 represent the approximate distribution of convergence and divergence in Northern Hemispheric cyclones and anticyclones. For moving centers, the greatest convergence or divergence occurs on or near the axis along which the system is moving. The diagrams of figure 4-3 show eastward movement, but they apply regardless of the direction of movement of the center.

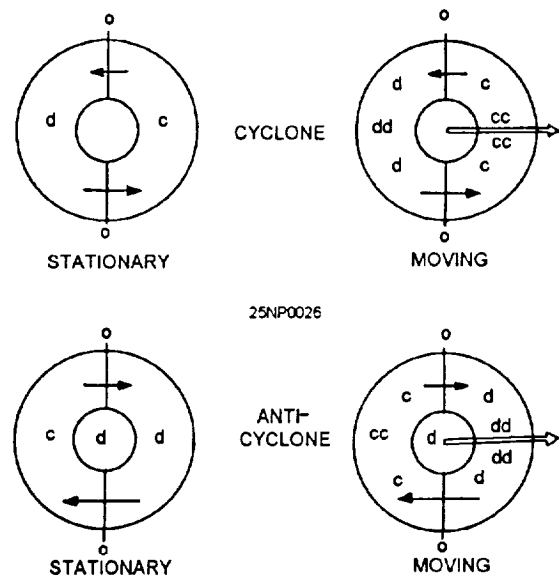

Figure 4-3.-Convergence and divergence in lows and highs.

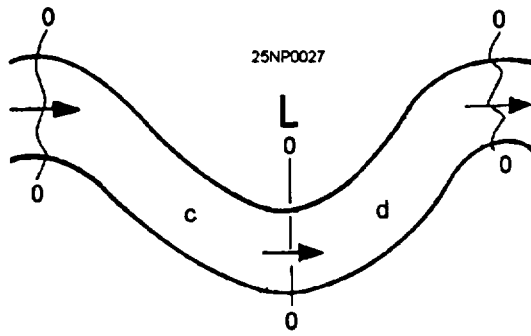

Figure 4-4.-Convergence and divergence in waves.

Convergence and divergence are not quite so easily identified in wave-shaped flow patterns because the wave speed of movement is often the factor that determines the distribution. The most common distribution for waves moving toward the east is illustrated in figure 4-4. There is relatively little divergence at the trough and ridge lines, with convergence to the west and divergence to the east of the trough lines.

This chapter devotes more time to a discussion of convergence because it is the most difficult characteristic to assess. Its extent ranges from the extremely local convergence of thunderstorm cells and tornadoes to the large-scale convergence of the broad and deep currents of poleward- and equatorward-moving air masses.

The amount, type, and intensity of the weather phenomena resulting from any of the lifting processes described in this chapter depend on the stability or convective stability of the air being lifted.

All of the lifting mechanisms (orographic, frontal, vertical stretching) can occur in any particular weather situation. Any combination, or all three, are possible, and even probable. For instance, an occluded cyclone of maritime origin moving onto a mountainous west coast of a continent could easily have associated with it warm frontal lifting, cold frontal lifting, orographic lifting, lateral convergence, and convergence in the southerly flow. All fronts have a degree of convergence associated with them.

WEATHER DISSIPATION PROCESSES

LEARNING OBJECTIVES: Identify processes leading to the dissipation of weather.

Each of the processes described in the preceding text has its counterpart among the condensation-preventing or weather-dissipating processes. Downslope flow on the lee side of orographic barriers results in adiabatic warming. If the air mass above and in advance of a frontal surface is moving with a relative component away from the front, downslope motion with adiabatic warming will occur. Divergence of air from an area must be compensated for by subsiding air above the layer, which is warmed adiabatically. These mechanisms have the common effect of increasing the temperature of the air, thus preventing condensation.

Likewise, these processes occur in combination with one another, and they may also occur in combination with the condensation-producing processes. This may lead to situations that require careful analysis. For instance, a current of air moving equatorward on a straight or anticyclonically curved path (divergence indicated) encounters an orographic barrier; if the slope of this orographic barrier is sufficiently steep or the air is sufficiently moist, precipitation will occur in spite of divergence and subsidence associated with the flow pattern. The dry, sometimes even cloudless, cold front that moves rapidly from west to east in winter is an example of upper level, downslope motion, which prevents the air being lifted by the front from reaching the condensation level.

The precipitation process itself opposes the mechanism that produces it, both by contributing the latent heat of vaporization and by exhausting the supply of water vapor.

FORECASTING FRONTAL CLOUDS AND WEATHER

LEARNING OBJECTIVES: Evaluate surface and upper level synoptic data in the analysis of frontal clouds and weather.

Cloud and weather regimes most difficult to forecast are those associated with cyclogenesis. It is well known that falling pressure, precipitation, and an expanding shield of middle clouds indicate that the cyclogenetic process is occurring and, by following these indications, successful forecasts can often be made for 6 to 48 hours in advance. Most of the winter precipitation of the lowlands in the middle latitudes is chiefly cyclonic or frontal in origin, though convection is involved when the displaced air mass is unstable.

Cyclones are important generators of precipitation in the Tropics as well as in midlatitudes.

Factors to be considered in arriving at an accurate forecast are listed below; these factors are not listed in any order of importance:

- The source region of the parent air mass.
- Nature of the underlying surface.
- The type and slope of the front(s).
- Wind and contour patterns aloft.
- Past speed and direction of movement of the low or front(s).
- Familiarization with the *normal* weather patterns.

As pointed out earlier, a thorough understanding of the physical processes by which precipitation develops and spreads is essential to an accurate forecast.

FRONTAL AND OROGRAPHIC CLOUDINESS AND PRECIPITATION

There are unique cloud and precipitation features and characteristics associated with the cold and warm fronts, as well as orographic barriers. The following text discusses these features and characteristics.

Cold Front

You will find it helpful to use constant pressure charts in conjunction with the surface synoptic situation in forecasting cold frontal cloudiness and precipitation. When the contours at the 700-hPa level are perpendicular to the surface cold front, the band of weather associated with the front is narrow. This situation occurs with a fast-moving front. If the front is slow moving, the weather and precipitation will extend as far to the rear of the front as the winds at the 700-hPa level are parallel to the front. In both of the above cases, the flow at 700 hPa also indicates the slope of the front. Since the front at the 700-hPa level lies near the trough line, it is apparent that when the flow at 700 hPa is perpendicular to the surface front, the 700-hPa trough is very nearly above the surface trough; hence, the slope of the front is very steep. When the 700-hPa flow is parallel to the surface front, the 700-hPa trough lies to the rear of the surface front and beyond the region in which the flow continues parallel to the front. Consequently, the frontal slope is more gradual, and lifting is continuing between the surface and the 700-hPa level at some distance to the rear of the surface front.

Another factor that contributes to the distribution of cloudiness and precipitation is the curvature of the flow aloft above the front. Cyclonic flow is associated with horizontal convergence, and anticyclonic flow is associated with horizontal divergence.

Very little weather is associated with a cold front if the mean isotherms are perpendicular to the front. When the mean isotherms are parallel to the front, weather will occur with the front. This principle is associated with the contrast of the two air masses; hence, with the effectiveness of lifting.

Satellite imagery provides a representative picture of the cloud structure of frontal systems. Active cold fronts appear as continuous, well-developed cloud bands composed of low, middle, and high clouds. This is caused by the upper wind flow, which is parallel, or nearly parallel, to the frontal zone (fig. 4-5).

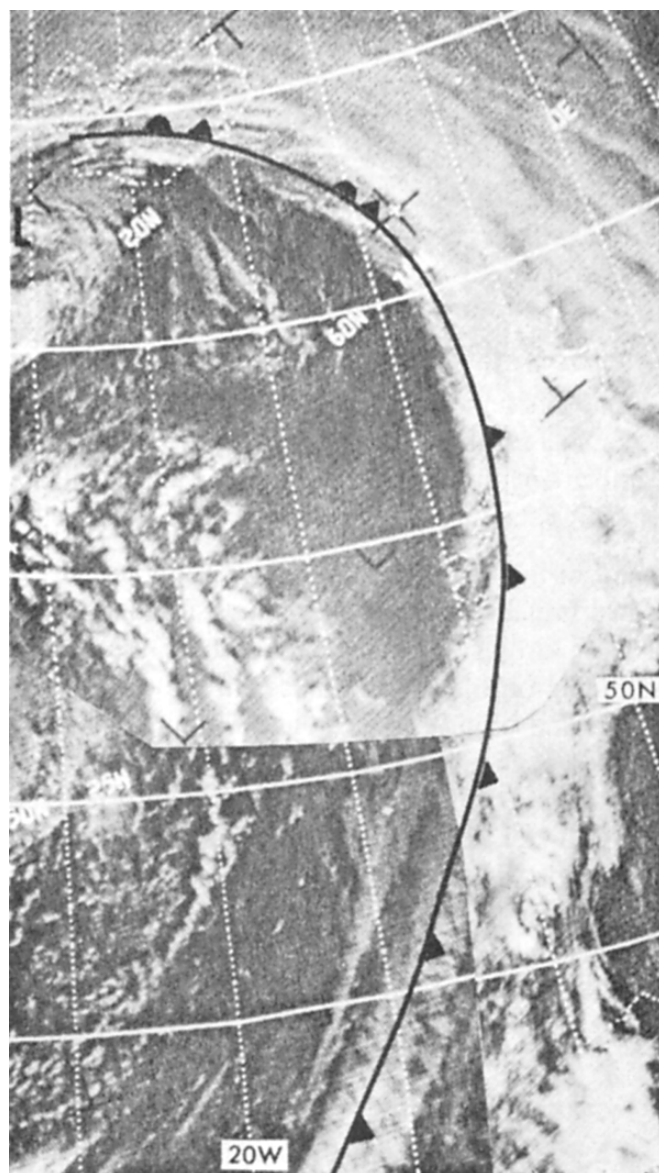

Figure 4-5.—An active cold front.

The perpendicular component of the upper winds associated with the inactive cold front causes the cloud bands to appear as narrow, fragmented, or discontinuous. The band of clouds is comprised mainly of low-level cumulus and stratiform clouds, but some cirriform may be present. Occasionally, inactive cold fronts over water will have the same appearance as active fronts over land, while overland they may have few or no clouds present. Figure 4-6 depicts the fragmented clouds associated with an inactive cold front in the lower portion, while a more active cold front cloud presentation is shown in the upper portion.

Warm Front

As with cold fronts, the use of constant pressure charts in conjunction with the surface synoptic situation is helpful in forecasting warm-frontal cloudiness and precipitation.

Cloudiness and precipitation occur where the 700-hPa flow across the warm front is from the warm air to the cold air, and is moving in a cyclonic path or in a straight line. This implies convergence associated with the cyclonic curvature. Warm fronts are accompanied by no weather and few clouds if the 700-hPa flow above them is anticyclonic. This is due to horizontal divergence associated with anticyclonic curvature.

The 700-hPa ridge line ahead of a warm front may be considered the forward limit of the prewarm frontal cloudiness. The sharper the ridge line, the more accurate the rule.

When the slope of the warm front is gentle near the surface position, and is steep several hundred miles to the north, the area of precipitation is situated in the region where the slope is steep. There may be no precipitation just ahead of the surface frontal position.

Warm fronts are difficult to locate on satellite imagery. An active warm front maybe associated with a well organized cloud band, but the frontal zone is difficult to locate. An active warm front maybe placed somewhere under the bulge of clouds that are associated with the peak of the warm sector of a frontal system. The clouds are a combination of stratiform and cumuliform beneath a cirriform covering. See figure 4-7.

You must remember that no one condition represents what could be called typical, as each front presents a different situation with respect to the air masses involved. Therefore, each front must be treated as a separate case, by using present indications, geographical location, stability of the air masses, moisture content, and intensity of the front to determine its precipitation characteristics.

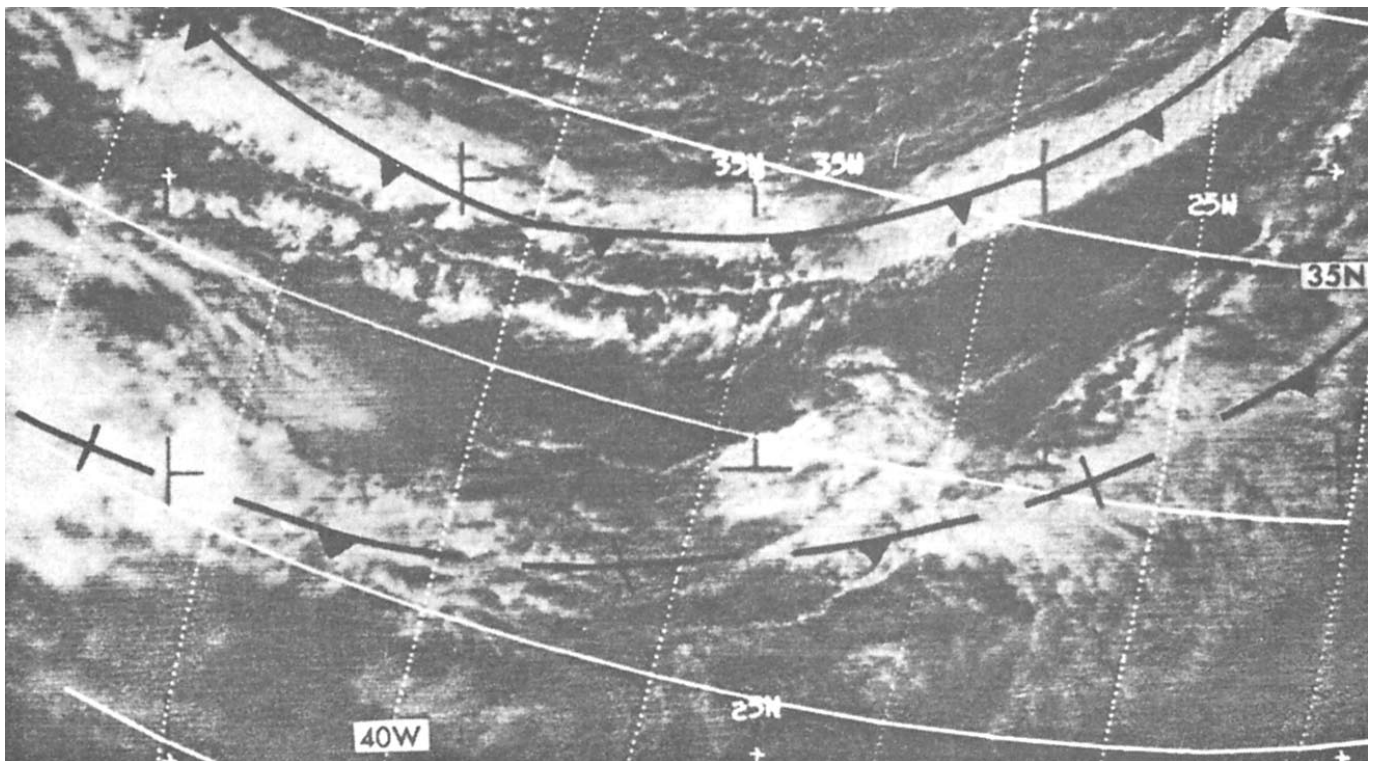

Figure 4-6.-Inactive and active cold front satellite imagery.

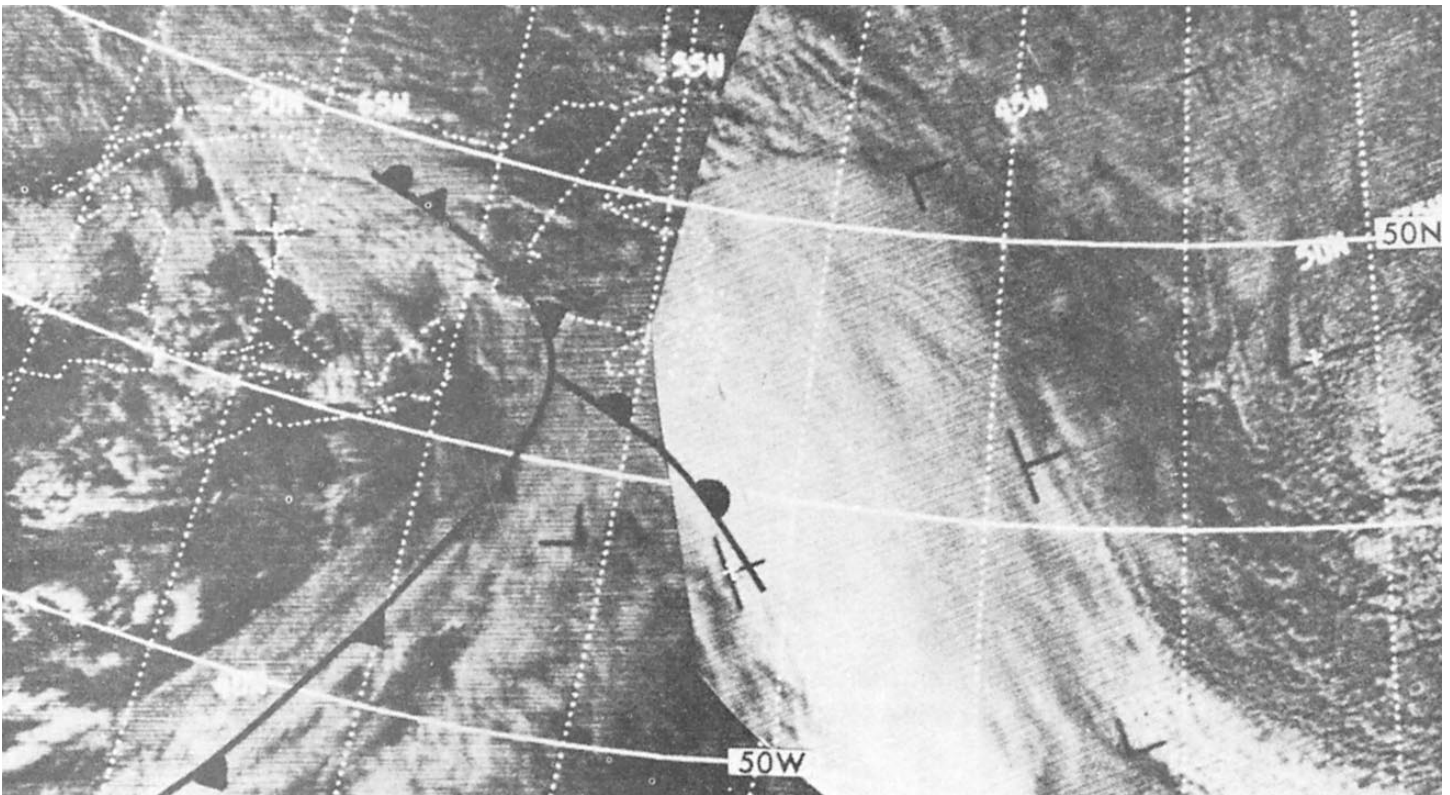

Figure 4-7.-Warm front satellite cloud imagery.

Orographic Barriers

In general, an orographic barrier increases the extent and duration of cloudiness and precipitation on the windward side, and decreases it on the leeward side.

AIR MASS CLOUDINESS AND PRECIPITATION

If an air mass is lifted over an orographic barrier, and the lifting is sufficient for the air to reach its lifting condensation level, cloudiness of the convective type occurs. If the air is convectively unstable and has sufficient moisture, showers or thunderstorms occur. The preceding situations occur on the windward side of the barrier.

Curvature (path of movement) of the flow aloft also affects the occurrence of cloudiness and precipitation. In a cool air mass, showers and cumulus and stratocumulus clouds are found in those portions of the air mass that are moving in a cyclonically curved path. In a warm air mass, cloudiness and precipitation will be abundant under a current turning cyclonically or moving in a straight line. Clear skies occur where a current of air is moving from the north in a straight line or in an anticyclonically curved path. Also, clear

skies are observed in a current of air moving from the south if it is turning sharply anticyclonically. Elongated V-shaped troughs aloft have cloudiness and precipitation in the southerly current in advance of the troughs, with clearing at and behind the trough. These rules also apply in situations where this type of low is associated with frontal situations.

Cellular cloud patterns (open or closed), as shown by satellite imagery, will aid the forecaster in identifying regions of cold air advection, areas of cyclonic, anticyclonic, and divergent wind flow.

Open Cellular Cloud Patterns

Open cellular cloud patterns are most commonly found to the rear of cold fronts in cold, unstable air. These patterns are made up of many individual cumuliform cells. The cells are composed of cloudless, or less cloudy, centers surrounded by cloud walls with a predominant ring or U-shape. In the polar air mass, the open cellular patterns that form in the deep, cold air are predominately cumulus congestus and cumulonimbus. The open cells that form in the subtropical high are mainly stratocumulus, cumulus, or cumulus congestus clusters. For open cells to form in a polar high, there must be moderate to intense heating of the air mass from below.



Figure 4-8.-Open cells on satellite Imagery.

When this polar air mass moves out over the water, the moist layer is shallow and capped by a subsidence inversion near the coast. Further downstream the vertical extent of the moist layer and the height of the clouds increases due to air mass modifications by the underlying surface. In figure 4-8, the open cells behind a polar front over the North Atlantic indicate cold air advection and cyclonic curvature of the low-level wind flow. Vertical thickness of the cumulus at A is small, but increases eastward toward B.

Figure 4-9 shows a large area of the subtropical high west of Peru covered with open cells. These are not associated with low-level cyclonic flow or steady cold air advection.

Closed Cellular Cloud Patterns

Closed cellular cloud patterns are characterized by approximately polygonal cloud-covered areas bounded by clear or less cloudy walls. Atmospheric conditions necessary for the formation of closed cells are weak convective mixing in the lower levels, with a cap to this mixing aloft. The convective mixing is the result of surface heating of the air or radiational cooling of the cloud tops. This type of convection is not as intense as that associated with open cells. The cap to the instability associated with closed cellular cloud patterns is in the form of a subsidence inversion in both polar and subtropical situations. Closed cellular cloud patterns are made up of stratocumulus elements in both the polar and subtropical air masses. In

addition to the stratocumulus elements, trade-wind cumulus may also be present with the subtropical highs. When associated with the subtropical highs, closed cellular clouds are located in the eastern sections of the high-pressure area. Closed cells are associated with limited low-level instability below the subsidence inversion. Extensive

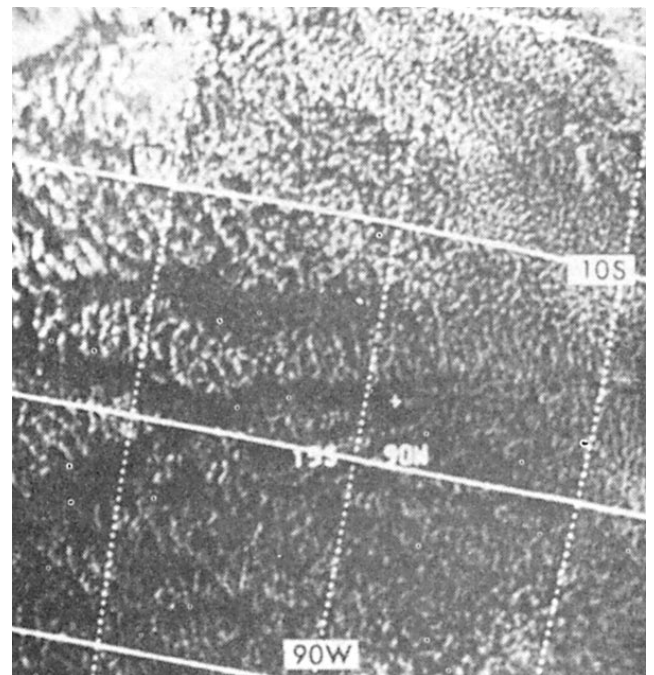

Figure 4-9.-Open cells in the subtropical high.

vertical convective activity is not likely. Figure 4-10 shows closed cells in the southeastern portion of a polar high near A.

Figure 4-11 shows closed cells in the eastern portion of a subtropical high in the South Pacific. West of A, the closed cells are composed of stratocumulus with some clear walls, and east of the walls, the cells are composed of thinner clouds.

The practical training publications, *Satellite Imagery Interpretation in Synoptic and Mesoscale Meteorology*, NAVEDTRA 40950, and *Tropical Clouds and Cloud Systems Observed in Satellite Imagery*, Volume 1, NAVEDTRA 40970, offer further information on the subject of satellite interpretation.

VERTICAL MOTION AND WEATHER

Upward vertical motion (convection) is associated with increasing cloudiness and precipitation, and downward vertical motion (subsidence) with improving weather.

Vertical motion analyses and prognostic charts are currently transmitted by the NWS and FNMOC. The values are computed and are on the charts. Plus values represent upward vertical motion

(convection), and minus values represent downward vertical motion (subsidence).

VORTICITY AND PRECIPITATION

Vorticity was discussed in chapter 1 of this manual, as well as the *AG2 TRAMAN*, volume 1. We have seen that relative vorticity is due to the effects of both curvature and shear. Studies have led to the following rules:

- Cloudiness and precipitation should prevail in regions where the relative vorticity decreases downstream.
- Fair weather should prevail where relative vorticity increases downstream.

The fact that both shear and curvature must be considered when relative vorticity changes are investigated results in a large number of possible combinations on upper air charts. When both terms are in agreement, we can confidently predict precipitation or fair weather. When the two are in conflict, a closer examination is required.

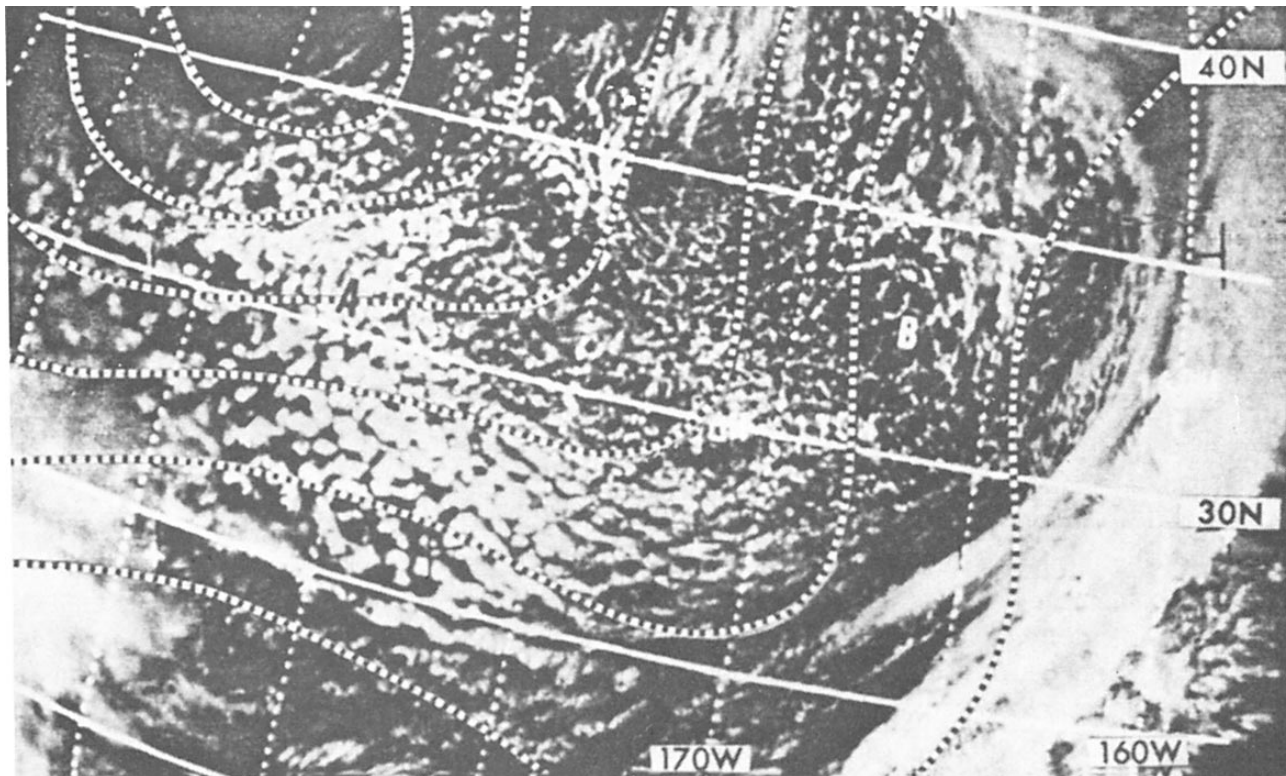

Figure 4-10.-Closed cells in polar high.

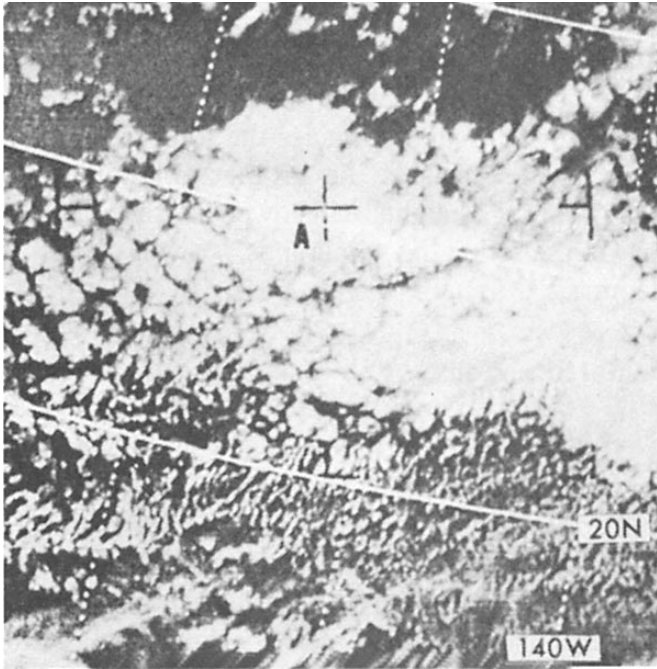

Figure 4-11.-Closed cells in a subtropical high.

NEPHANALYSIS

Nephanalysis may be defined as any form of analysis of the field of cloud cover and/or type. Cloud observations received in synoptic codes permit only a highly generalized description of the actual structure of the cloud systems.

Few forecasters make full use of the cloud reports plotted on their surface charts, and often, the first consideration in nephanalysis is to survey what cloud information is transmitted, and to make sure that everything pertinent is plotted. For very short-range forecast, the charts at 6-, 12-, and 24-hour intervals are apt to be insufficient for use of the extrapolation techniques explained in this chapter. Either nephanalysis or surface charts should then be plotted at the intermediate times from 3-hourly synoptic reports or even from hourly sequences. An integrated system of forecasting ceiling, visibility, cloud cover, and precipitation should be considered simultaneously, as these elements are physically dependent upon the same synoptic processes.

With present-day satellite capabilities, it is rare that a nephanalysis would be manually performed. Instead, the surface analysis and satellite imagery will be used together.

FRONTAL PRECIPITATION

For short-range forecasting, the question is often not whether there will be any precipitation, but when will it begin or end.

This problem is well suited to extrapolation methods. For short-range forecasting, the use of hourly nephanalyses often serve to "pickup" new precipitation areas forming upstream in sufficient time to alert a downstream area. Also, the thickening and lowering of middle cloud decks generally indicate where an outbreak of precipitation may soon occur.

Forecasting the Movement of Precipitation Areas by Isochrones

The areas of continuous, intermittent, and showery precipitation can be outlined on a large-scale 3-hourly or hourly synoptic chart in a manner similar to the customary shading of precipitation areas on ordinary synoptic surface weather maps. Different types of lines, shading, or symbols can distinguish the various types of precipitation. Isochrones of several hourly past positions of the lines of particular interest can then be added to the chart, and extrapolations for several hours

MIDDLE CLOUDS IN RELATION TO THE JETSTREAM

Jets indicate as much individuality with respect to associated weather as do fronts. Because of the individuality of jetstreams, and also because of the individuality of each situation with respect to humidity distribution and lower level circulation patterns, statistically stated relationships become somewhat vague and are of little value in forecasting.

SHORT-RANGE EXTRAPOLATION

LEARNING OBJECTIVES: Compare short-range extrapolation techniques for the movement of frontal systems and associated weather.

The purpose of this section is to outline several methods that are particularly suited to preparing forecasts for periods of 6 hours or less. The techniques presented are based on extrapolation. Extrapolation is the estimating of the future value of some variable based on past values. Extrapolation is one of the most powerful short-range forecasting tools available to the forecaster.

made from them if reasonably regular past motions are in evidence. A separate isochrone chart (or acetate overlay) may be easier to use. Lines for the beginning of continuous precipitation are illustrated in figure 4-12. The isochrones for showery or intermittent precipitation usually give more uncertain and irregular patterns, which result in less satisfactory forecasts. When large-scale section surface weather maps are regularly drawn, it maybe sufficient and more convenient to make all precipitation area analyses and isochrones on these maps.

Forecasting the Movement of Precipitation by Using a Distance versus Time (x-t) Diagram

The idea of plotting observations taken at different times on a diagram that has horizontal or vertical distance in the atmosphere as one coordinate and time as the other has been used in various forms by forecasters for years. The time cross section that was discussed in the *AG2 TRAMAN*, volume 1, unit 9, lesson 2. is a special case of this aid, where successive information at only one station is plotted.

LOWERING OF CEILING IN CONTINUOUS RAIN AREAS

One of the many obstacles the forecaster faces in preparing forecasts is the problem of determining “when” ceilings heights will lower in areas expecting rain. In the following paragraphs, we will discuss this dilemma.

Frontal Situations

The lowering of ceiling with continuous rain or snow in warm frontal and upper trough situations is a familiar problem to the forecaster in many regions. In very short-range forecasting, the question as to whether or not it will rain or snow, and when the rain or snow will begin, is not so often the critical question. Rather, the problem is more likely to be (assuming the rain/snow has started) how much will the ceiling lower in 1,2, and 3 hours, or will the ceiling go below a certain minimum in 3 hours. The visibility in these situations generally does not reach an operational minimum as soon as the ceiling. It has been shown that without sufficient convergence, advection, or turbulence, evaporation of rain into a layer does not lead to saturation, and causes no more than haze or light fog.

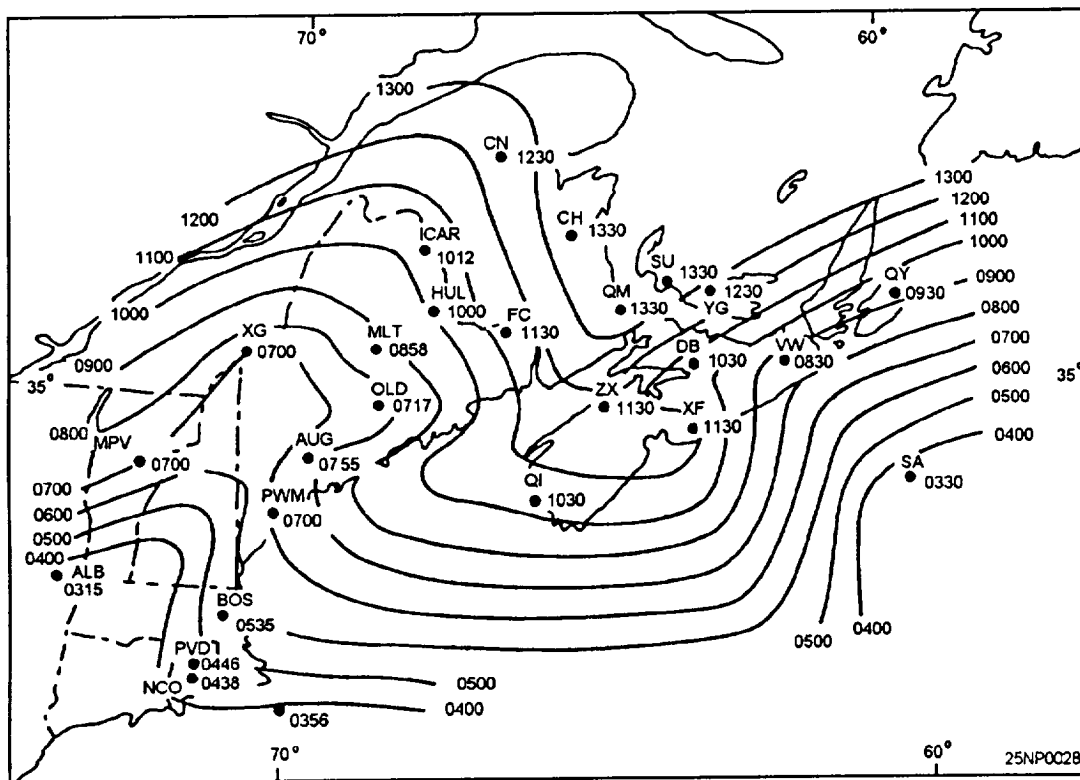

Figure 4-12. Isochrones of beginning of precipitation, an early winter situation.

It is important to recognize the difference between the behavior of the actual cloud base height and the variation of the ceiling height, as defined in airway reports. The ceiling usually drops rapidly, especially during the first few hours after the rain or snow begins. However, if the rain or snow is continuous, the true base of the cloud layer descends gradually or steadily. The reason for this is that below the precipitation frontal cloud layer there are usually shallow layers in which the relative humidity is relatively high and which soon become saturated by the rain. The cloud base itself has small, random fluctuations in height superimposed on the general trend.

Time of Lowering of Ceiling

Forecasting the time when a given ceiling height will be reached during rain is a separate problem. Nomograms, tables, air trajectories, and the time air will become saturated can all be resolved into an objective technique tempered with empirical knowledge and subjective considerations. This forecast can be developed for your individual station.

Extrapolation of Ceiling Trend by Means of the x-t Diagram

The x-t diagram, as mentioned previously in this chapter, can be used to extrapolate the trend of the ceiling height in rain. The hourly observations should be plotted for stations near a line parallel to the probable movement of the general rain sea, originating at your terminal and directed toward the oncoming rain area. Ceiling-time curves for given ceiling heights may be drawn and extrapolated. There may be systematic geographical differences in the ceiling between stations due to local (topographic) influences. Such differences sometimes can be anticipated from climatological studies, or experience. In addition, there may be a diurnal ceiling fluctuation, which will become evident in the curve. Rapid and erratic up-and-down fluctuations also must be dealt with. In this case, a smoothing of the curves may be necessary before extrapolation can be made. A slightly less accurate forecast may result from this process.

In view of the previous discussion of the precipitation ceiling problem, it is not expected that mere extrapolation can be wholly satisfactory at a station when the ceiling lowers rapidly during the first hours of rain, as new cloud layers form beneath the front. However, by following the ceiling trend at surrounding stations, patterns of abrupt ceiling changes may be

noted. These changes at nearby stations where rain started earlier may give a clue to a likely sequence at your terminal.

THE TREND CHART AS AN EXTRAPOLATION AID

The trend chart can be a valuable forecasting tool when it is used as a chronological portrayal of a group of related factors. It has the added advantage of helping the forecaster to become "current" when coming on duty. At a glance, the relieving duty forecaster is able to get the picture of what has been occurring. Also, the forecaster is able to see the progressive effect of the synoptic situation on the weather when the trend chart is used in conjunction with the current surface chart.

The format of a trend chart should be a function of what is desired; consequently, it may vary in form from situation to situation. It should, however, contain those elements that are predictive in nature.

The trend chart is a method for graphically portraying those factors that the forecasters generally attempt to store in their memory. Included in this trend chart is a list of key predictor stations. The forecaster uses the hourly and special reports from these stations as aids in making short forecasts for his/her station. Usually, the sequences from these predictor stations are scanned and committed to memory. The method is as follows:

1. Determine the direction from which the weather will be arriving; i.e., upstream.
2. Select a predictor station(s) upstream and watch for the onset of the critical factor; for example, rain.
3. Note the effect of this factor on ceiling and visibility at predictor station(s).
4. Extrapolate the approach of the factor to determine its onset at your station.
5. Consider the effect of the factor at predictor station(s) in forecasting its effect at your station.

The chief weakness of this procedure is its subjectivity. The forecaster is required to mentally evaluate all of the information available, both for their station and the predictor station(s).

A question posed, "How many trend charts do I need?" The answer depends on the synoptic situation. There are times when keeping a graphic record is unnecessary; and other times, the trend for the local

station may suffice. The trend chart format, figure 4-13, is but one suggested way of portraying the weather record. Experimentation and improvisation are encouraged to find the best form for any particular location or problem.

TIME-LINER AS AN EXTRAPOLATION AID

In the preceding sections of this chapter, several methods have been described for “keeping track of the weather” on a short-term basis. Explanations of time-distance charts, isochrone aids, trend charts, etc., have been presented. It is usually not necessary to use all, or even most of these aids simultaneously. The aid described in this section is designed for use in combination with one or several of the methods

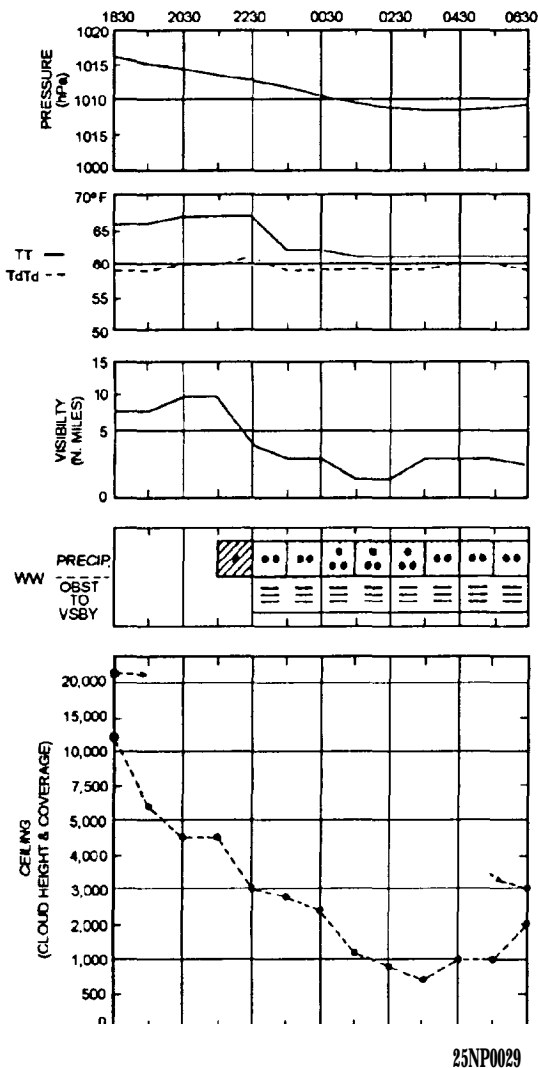

Figure 4-13.-Trend chart suggested format.

previously described. Time-liners are especially useful for isochrone analysis and follow-on extrapolation.

Inasmuch as a majority of incorrect short-range forecasts result from poor timing of weather already upstream, an aid, such as described below, may improve this timing.

Construction of the Time-Liner

The time-liner is simply a local area map that is covered with transparent plastic and constructed as follows:

1. Using a large-scale map of the local area, construct a series of concentric circles centered on your station, and equally spaced from 10 to 20 miles apart. This distance from the center to the outer circle depends on your location, but in most cases, 100 to 150 miles is sufficient.

2. Make small numbered or lettered station circles for stations located at varying distances and direction from your terminal. Stations likely to experience your future weather should be selected. In addition to the station circle indicators, significant topographical features, such as rivers or mountains, maybe indicated on the base diagram. (Aeronautical charts include these features.)

3. Cover and bind the map with transparent plastic.

Plotting and Analysis of the Time-Liner

By inspection of the latest surface chart, and other information, you can determine a quadrant, semicircle, or section of the diagram and the parameters to be plotted. This should be comprised of stations in the direction from which the weather is approaching your station. Then, plot the hourly weather SPECIALS for those stations of interest. Make sure to plot the time of each special observation.

Overlay the circular diagram with another piece of transparent plastic, and construct isochrones of the parameter being forecast; for example, the time of arrival of the leading or trailing edge of a cloud or precipitation shield. The spacing between isochrones can then be extrapolated to construct “forecast isochrones” for predicting the time of arrival of occurrence of the parameter at your terminal. Refer to figure 4-14 for an example.

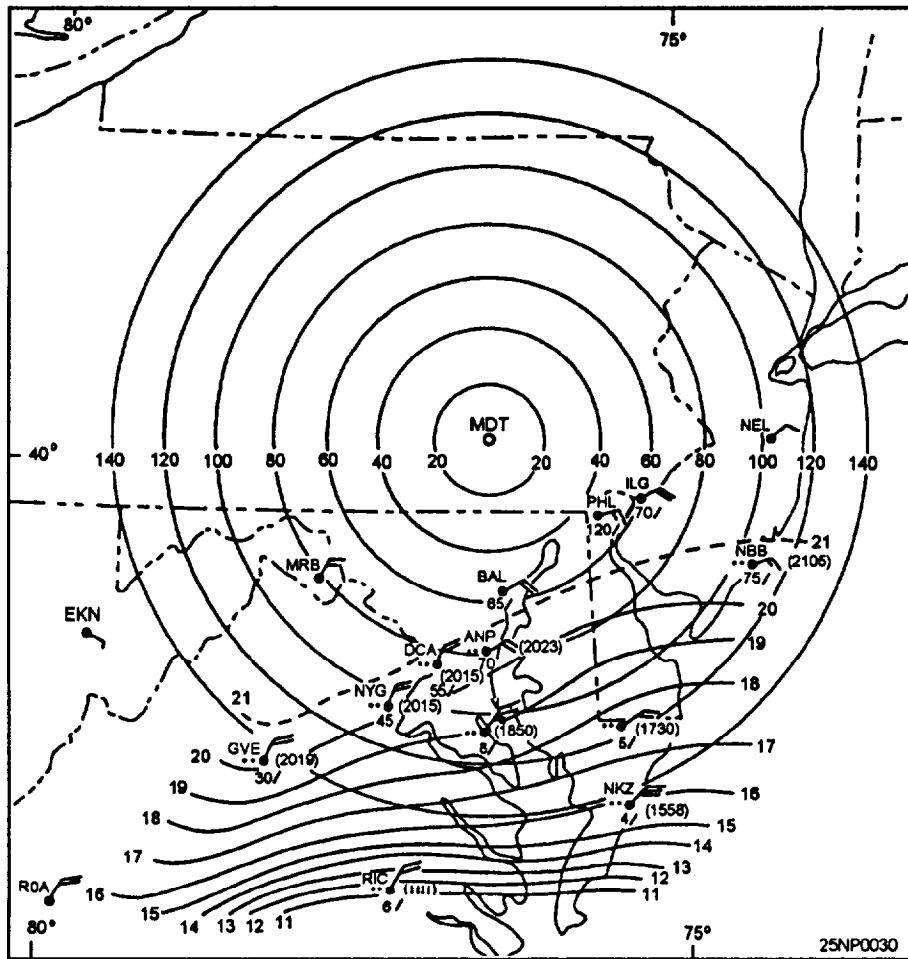

Figure 4-14.-Large-scale sample time-liner (Isochrones show advance of precipitation field).

Use of Doppler Radar in Cloud and Precipitation Forecasting

Doppler radar is very useful in determining weather phenomena approaching your station and estimating the probability of precipitation at your station, Refer to chapter 12 of this manual and the *Federal Meteorological Handbook No. 11, Part B*, for information on analysis of weather conditions and Doppler radar theory.

CLOUD ANALYSIS AND FORECASTING

LEARNING OBJECTIVES: Recognize upper air data and its value in forecasting. Recognize moisture features aloft and their significance to the forecaster.

Forecasters are frequently called upon to make forecasts of clouds over areas where synoptic observations are not readily available, or over areas where clouds above the lowest layer are obscured by a lower cloud deck. This section is designed to acquaint the forecaster with the principles of detection and analysis of clouds from rawinsonde data. A complete discussion of this problem is beyond the scope of this training manual. Further information on this subject may be found in the practical training publication, *Use of the Skew T Log P Diagram in Analysis and Forecasting*, NAVAIR 50-1P-5.

IMPORTANCE OF RAWINSONDE OBSERVATIONS (RAOB) IN CLOUD ANALYSIS

Cloud observations regularly available to forecasters in surface synoptic reports leave much to be desired as a basis for cloud forecasting.

Rawinsondes, which penetrate cloud systems, reflect, to some extent (primarily in the humidity trace), the vertical distribution of clouds. If the humidity element were perfect, there would usually be no difficulties in locating cloud layers penetrated by the instrument. Because of the shortcomings in the instrument, however, the relationship between indicated humidity and cloud presence is far from definite, and an empirical interpretation is necessary. Nevertheless, rawinsonde reports give valuable evidence that, when compared with other data, aids greatly in determining a coherent picture of stratiform and frontal cloud distributions. Their value in judging air mass cumulus and cumulonimbus distribution is negligible.

INFERRING CLOUDS FROM RAOB

Theoretically, we should be able to infer from the humidity data of RAOBs the layers where the rawinsonde penetrates cloud layers. In practice, the determination that can be made from temperature and dewpoint curves are often less exact and less reliable than desired. Nevertheless, RAOBs give clues about cloud distribution and potential areas of cloud formation. These clues generally cannot be obtained from any other source.

DEWPOINT AND FROST POINT IN CLOUDS

The temperature minus the dewpoint depression yields the dewpoint, which is defined as the temperature to which the air must be cooled at a constant vapor pressure for saturation to occur. The FROST POINT (that is, the temperature to which the air has to be cooled or heated adiabatically to reach saturation with respect to ice) is higher than the dewpoint except at 0°C, where the two coincide. In the graph shown in figure 4-15, the difference between dewpoint and frost point is plotted as a function of the dewpoint itself.

In a cloud with the temperature above freezing, the true dewpoint will coincide closely with the true air temperature, indicating that the air between the cloud droplets is practically saturated. Minor discrepancies may occur when the cloud is not in a state of equilibrium (when the cloud is dissolving or forming rapidly, or when precipitation is falling through the cloud with raindrops of slightly different temperature than the air); but these discrepancies are very small. In the subfreezing portion of a cloud, the true temperature is between the true dewpoint and the true frost point, depending on the ratio between the quantities of frozen

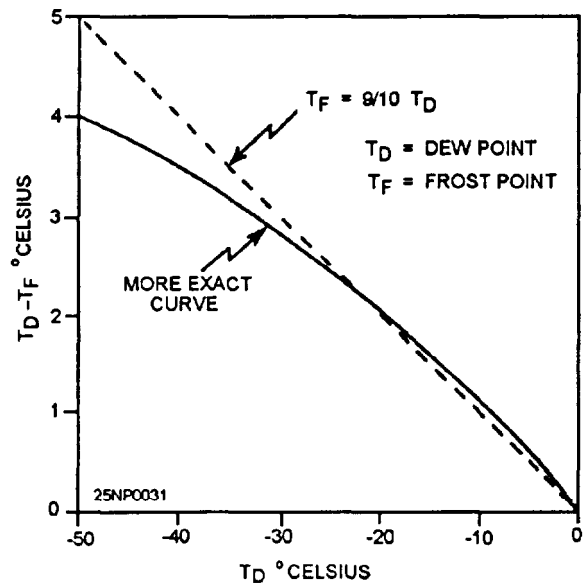

Figure 4-15.-Difference between frost point and dewpoint as a function of the dewpoint.

and liquid cloud particles. If the cloud consists entirely of supercooled water droplets, the true temperature and the true dewpoint will, more or less, coincide. If the cloud consists entirely of ice, the temperature should coincide with the frost point. Therefore, we cannot look for the coincidence of dewpoint and temperatures as a criterion for clouds at subfreezing temperatures. At temperatures below -12°C, the temperature is more likely to coincide with the frost point than the dewpoint.

The graph shown in figure 4-15 indicates that the difference between the dewpoint and frost point increases roughly 1°C for every 10°C that the dewpoint is below freezing. For example, when the dewpoint is -10°C, the frost point equals -9°C; when the dewpoint is -20°C, the frost point is -18°C; and when the dewpoint is -30°C, the frost point is -27°C. Thus, for a cirrus cloud that is in equilibrium (saturated with respect to ice) at a (frost point) temperature of -40°C, the correct dewpoint would be -44°C, (to the nearest whole degree).

We can state, in general, that air in a cloud at temperatures below about -12°C is saturated with respect to ice, and that as the temperature of the cloud decreases (with height), the true frost point/dewpoint difference increases. Any attempt to determine the height of cloud layers from humidity data of a RAOB is, therefore, subject to error. It is possible to overcome

some of these errors by a subjective interpretation of the Rawinsonde Observations (RAOBs), as discussed in the following sections.

INTERPRETATION OF RAOB LAYERS WITH RESPECT TO CLOUD LAYERS

The following diagrams (figs. 4-16, 4-17, and 4-18) illustrate the behavior of a rawinsonde during cloud penetration. These diagrams are correlated with aircraft observations or the heights of cloud bases and tops from aircraft flying in the vicinity of an ascending rawinsonde. The difference in time and distance between the aircraft and sounding observations was usually less than 2 hours and 30 miles, respectively. Some of the aircraft reported only the cloud observed above 15,000

feet; others reported all clouds. In figure 4-16 through 4-18, the aircraft cloud observations are entered in the lower left corner of each diagram under the heading cloud; the surface weather report is entered under the aircraft cloud report. Where the low cloud was not reported by the aircraft, the height of the cloud base may be obtained from the surface reports, Aircraft height reports are expressed in thousands of feet, pressure-altitude. The temperature, frost point, and dewpoint curves are indicated by T, T_f and T_D respectively.

In figure 4-16, a marked warm front is approaching from the south. Moderate continuous rain fell 2 hours later. At 1830 UTC, an aircraft reported solid clouds from 1,000 to 44,000 feet (tropopause). The 1500 UTC sounding shows an increasing dewpoint depression with height and no discontinuity at the reported cloud top of 15,000 feet. A definite dry layer is indicated between

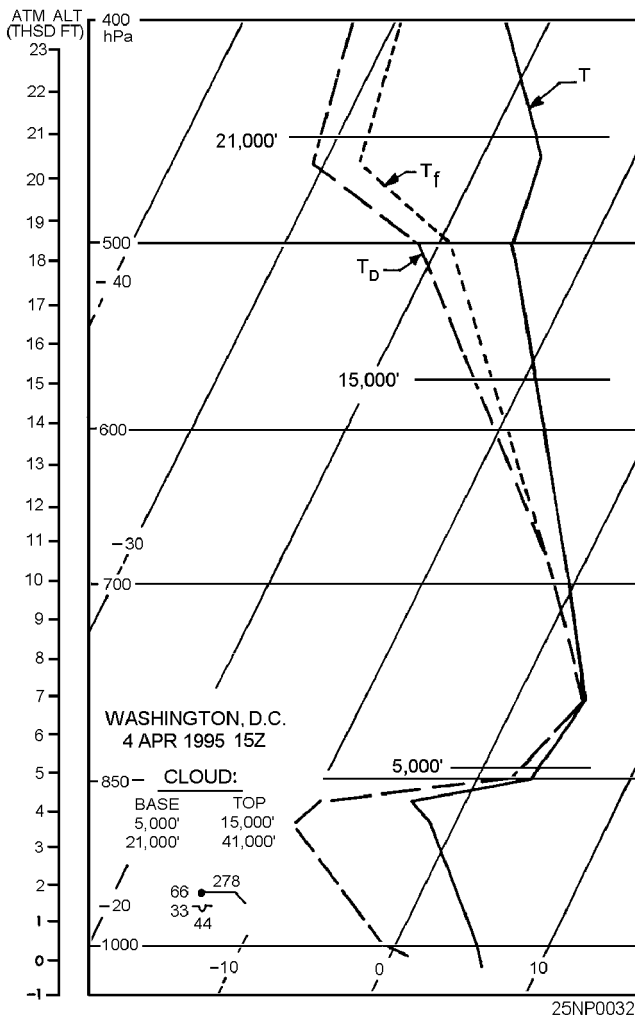

Figure 4-16.-Example of inferring clouds from a RAOB with an active warm front approaching from the south.

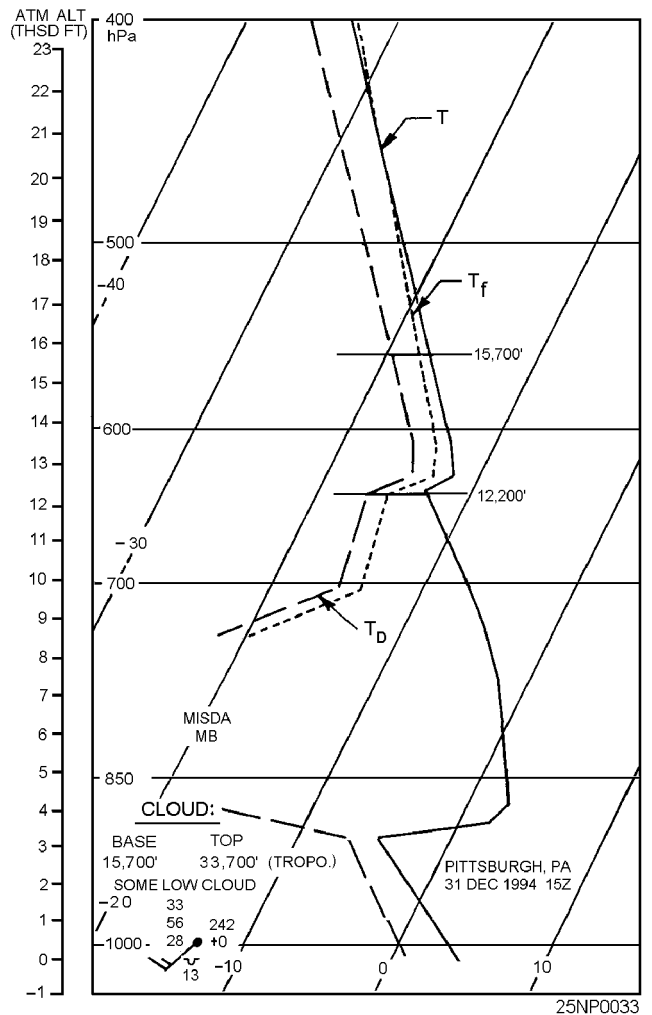

Figure 4-17.-Example of inferring clouds from a RAOB with a middle layer and no precipitation reaching the surface

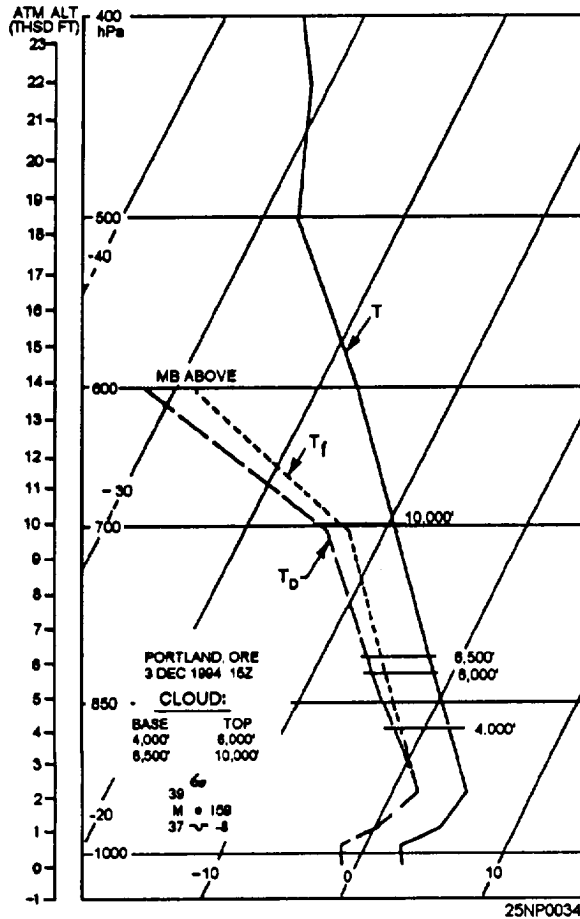

Figure 4-18. Example of inferring clouds from a RAOB showing layer clouds with their intermediate clear layers not showing in the humidity trace.

18,300 and 20,000 feet. The second reported cloud layer is indicated by a decrease in dewpoint depression, but the humidity element is obviously slow in responding. The dewpoint depression at the base of the cloud at 21,000 feet is 14°C and at 400-hPa; after about a 3-minute climb through the cloud, it is still 10°C. From the sounding, clouds should have been inferred to be from about 4,500 feet (base of the rapid humidity increase) to 500-hPa and a second layer from 20,000 feet up. In view of the rapid falling of the cloud free gap between 15,000 and 21,000 feet that followed as the warm front approached, the agreement between reported and inferred conditions is good.

Figure 4-17 shows a middle cloud layer with no precipitation reaching the surface. This is a case of a cloud in the 500-hPa surface with no precipitation reaching the surface; the nearest rain reaching the surface was in Tennessee. The evidence from the sounding for placing the cloud base at 12,200 feet is

strong, yet the base is inexplicably reported at 15,700 feet. The reported cloud base of 15,000 feet was probably not representative, since altostratus, with bases 11,000 to 14,000 feet, was reported for most stations over Ohio and West Virginia.

Figure 4-18 shows layered clouds with their intermediate clear layers not showing in the humidity trace. There is good agreement between the sounding and the aircraft report. The clear layer between 6,000 and 6,500 feet is not indicated on the sounding. Thin, clear layers, as well as thin cloud layers, usually cannot be recognized on the humidity trace.

Comparisons between soundings and cloud reports provide us with the following rules:

1. A cloud base is almost always found in a layer, indicated by the sounding, where the dewpoint depression decreases.

2. You should not always associate a cloud with a layer of decreasing dewpoint, but only when the decrease leads to minimum dewpoint depressions from 6°C to 0°C. However, at temperatures below -25°C, dewpoint depressions in clouds are often higher than 6°C.

3. The dewpoint depression in a cloud is, on the average, smaller in clouds that have higher temperatures. typical dewpoint depressions are 1°C to 2°C at temperatures of 0°C and above, and 4°C between -10°C and -20°C.

4. The base of a cloud should be located at the base of the layer of decreasing dewpoint depression, if the decrease is sharp.

5. If a layer of decreasing dewpoint depression is followed by a layer of a stronger decrease, the cloud base should be associated with the base of the strongest decrease.

6. The top of a cloud layer is usually indicated by an increase in dewpoint depression. Once a cloud base is determined, the cloud is extended up to a level where a significant increase in dewpoint depression starts. The gradual increase of dewpoint depression with height in a cloud is not significant.

In addition to the above analysis, another study was made to determine how reliable the dewpoint depression is as an indicator of clouds. The results are summarized in figure 4-19. Each graph shows the percent probability of the existence of a cloud layer in January for different values of dewpoint depression. On each graph one curve shows the probability of clear or

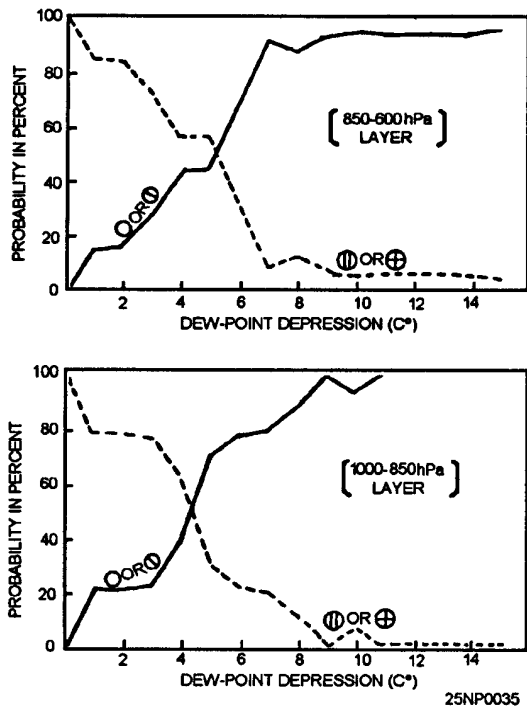

Figure 4-19.-Percent probability of existence of cloud layer bases for different values of dewpoint depression (degrees C). Solid lines represent probability of clear or scattered conditions; dashed lines, the probability of broken or overcast conditions with the cloud layer bases between 1,000-hPa and 600-hPa.

scattered conditions as a function of the dewpoint depression; the other curve shows that of broken or overcast conditions. Separate graphs are based on 1,027 observations, which are enough to indicate the order of magnitude of the dewpoint depressions at the base of winter cloud layers. Minor irregularities in the curves were not smoothed out because it is not certain that they are all due to insufficient data. The graphs are applicable without reference to the synoptic situation. For a given winter sounding, you can estimate from the graph the probability of different sky cover conditions with cloud bases between 1,000-hPa and 600-hPa for layers of given minimum dewpoint depressions.

HUMIDITY FIELD IN THE VICINITY OF FRONTAL SYSTEMS

Studies of the humidity field throughout frontal zones indicate there is a tongue of dry air extending downward in the vicinity of the front, and sloping in the same direction as the front. One study found that such a dry tongue was more or less well developed for all frontal zones investigated. This dry tongue was best

developed near warm fronts; it extended, on the average, down to 700-hPa in cold fronts and to 800-hPa in warm fronts. In about half the fronts, the driest air was found within the frontal zone itself on occasion it was found on both the cold and warm sides of the zone. About half the flights through this area showed a sharp transition from moist to dry air, and the change in frost point on these flights averaged about 20°C in 35 miles. Some flights gave changes of more than 20°C in 20 miles.

As a frontal cloud deck is approached, the dewpoint or frost point depression starts diminishing rapidly. At distances beyond 10 to 15 nm, this variation is much less. You should keep this fact in mind when attempting to locate the edge of a cloud deck from rawinsonde data. Linear extrapolation or interpolation of dewpoint depressions cannot be expected to yield good results. For instance, when one station shows a dewpoint depression of 10°C and the neighboring station shows saturation, the frontal cloud may be anywhere between them, except within about 10 nm of the driest station.

Since the frontal cloud masses at midtropospheric levels is usually surrounded by relatively dry air, it is possible to locate the edge of the cloud mass from humidity data on constant pressure charts. This is so because the typical change in dewpoint depression in going from the cloud edge into cloudfree air is considerably greater than the average error in the reported dewpoint depression.

500-hPa ANALYSIS OF DEWPOINT DEPRESSION

Figure 4-20 shows an analysis of the 500-hPa dewpoint depression field superimposed upon an analysis of areas of continuous precipitation, and of areas of overcast middle clouds. The 500-hPa dewpoint depression isopleths were drawn independently of the surface data. The analysis shows the following:

1. The regions of high humidity at the 500-hPa level coincide well with the areas of middle clouds and the areas of precipitation.
2. The regions of high humidity at the 500-hPa level are separated from the extensive dry regions by strong humidity gradients. These gradients are, in all probability, much stronger than those shown on this analysis.
3. A dewpoint depression of 4°C or less is characteristic of the larger areas of continuous

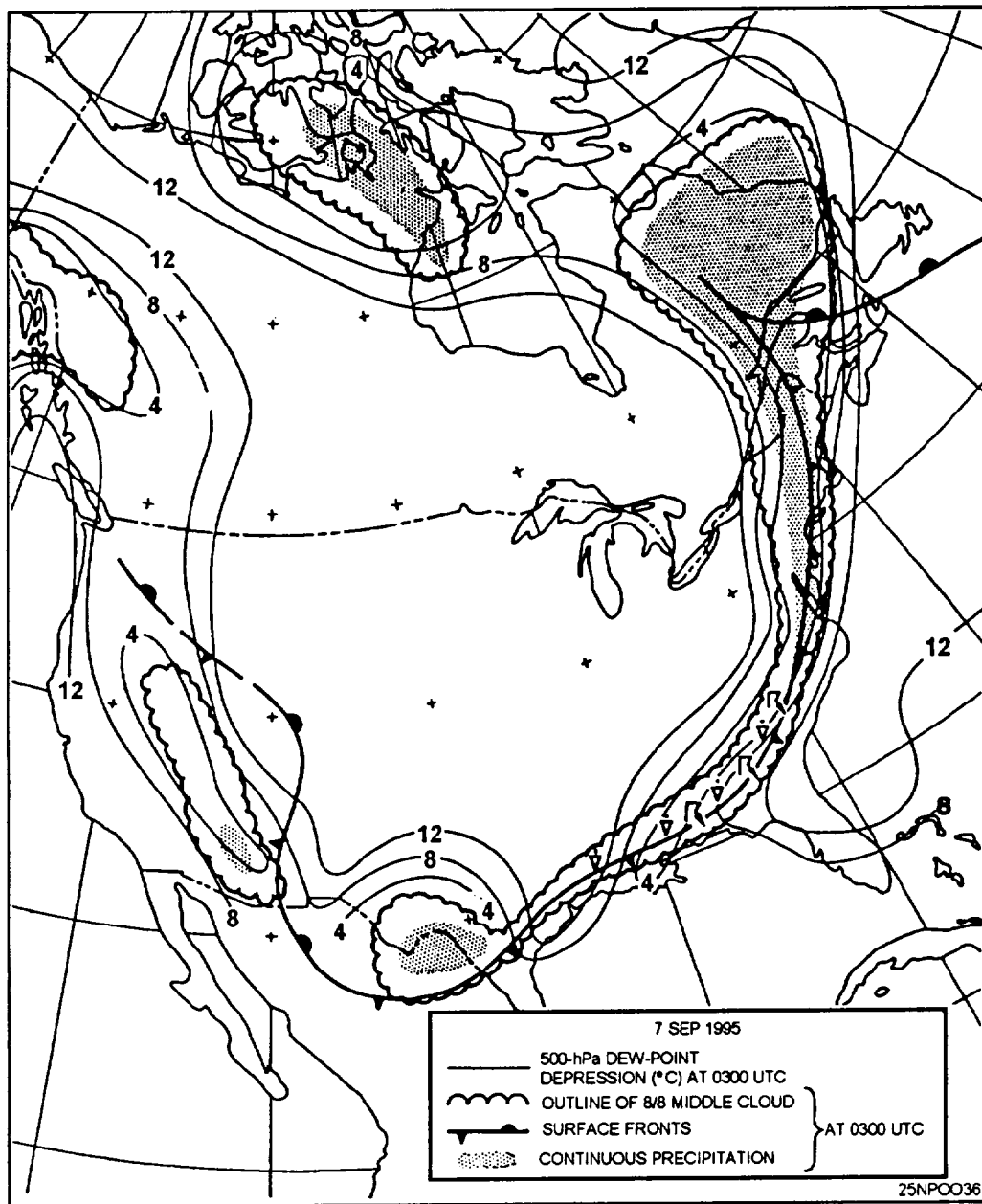

Figure 4-20. Surface fronts, areas of continuous precipitation, areas covered by 8/8 middle clouds, and isolines of 500-hPa dewpoint depression at 0300 UTC, 7 September 1995.

precipitation, and also of the larger areas of overcast middle clouds.

Since the 500-hPa level dewpoint depression analysis agrees well with the surface analysis of middle cloud and precipitation, the possibility exists of replacing or supplementing one of these analyses with the other.

The characteristics of the 500-hPa level dewpoint depression analysis, outlined above, make it a valuable adjunct to the surface analysis. These analyses can be

compared and, by cross-checking, each can be completed with greater accuracy than if they were done independently.

THREE-DIMENSIONAL HUMIDITY ANALYSIS—THE MOIST LAYER

Using a single level (for example, the 500-hPa level dewpoint depression analysis) to find probable cloud areas does not indicate clouds above or below that level. For example, if the top of a cloud system reached only

to 16,000 feet, and there was dry air above at 500-hPa (approximately 18,000 feet), you wouldn't suspect, from the 500hPa analysis, the existence of clouds below the 500-hPa level.

However, an analysis of the extension of the moist layers in three dimensions can be obtained simply by scrutinizing individual RAOBs. Those selected should be in the general vicinity of, and the area 500 to 1,200 miles upstream of, the area of interest, depending on the forecast period. The heights of the bases and tops can be indicated, though there is little advantage in indicating a dry layer 2,000 to 3,000 feet thick sandwiched between thicker moist layers. Usually, it is sufficient to indicate the entire moist layer, without bothering about any finer stratums. A survey of the cloud field is made easier by writing the heights of the bases and tops in different colors.

A moist layer for the sake of simplicity may be defined as a layer having a frost point depression of 3°C or less (i.e., a dewpoint depression of 4°C at -10°C; 5°C at -20°C; 6°C at -30°C).

PRECIPITATION AND CLOUDS

The type and intensity of precipitation observed at the surface is related to the thickness of the cloud aloft, and particularly to the temperatures in the upper portion of the cloud.

The results of a study relating cloud-top temperatures to precipitation type and intensity are as follows:

- From aircraft ascents through stratiform clouds, along with simultaneous surface observations of precipitation, it was found that 87 percent of the cases where drizzle occurred, it fell from clouds whose cloud-top temperatures were warmer than -5°C. The frequency of rain or snow increased markedly when the cloud-top temperature fell below -12°C.
- When continuous rain or snow fell, the temperature of the coldest part of the cloud was below -12°C in 95 percent of the cases.
- Intermittent rain was mostly associated with cold cloud-top temperatures.
- When intermittent rain was reported at the surface, the cloud-top temperature was colder than -12°C in 81 percent of the cases, and colder than -20°C in 63 percent of the cases. From this, it appears that when minor snow (continuous or intermittent) reaches the ground from stratiform clouds, the clouds (solid or

layered) extend in most cases to heights where the temperature is well below -12°C, or even -20°C.

This rule cannot be reversed. When rain or snow is not observed at the surface, middle clouds may well be present in regions where the temperature is below -12°C or -20°C. Whether or not precipitation reaches the ground will depend on the cloud thickness, height of the cloud base, and the dryness of the air below the base.

INDICATIONS OF CIRRUS CLOUDS IN RAOB

Cirrus clouds form at temperatures of -40°C or colder. At these temperatures, as soon as the air is brought to saturation, the condensate immediately freezes. The ice crystals often descend in altitude slowly, to levels that have air temperatures of -30°C, and persist if the humidity below the formation level is high enough to support saturation. In general, cirrus clouds are found in layers that are saturated, or supersaturated, with respect to ice at temperatures colder than 0°C.

OBSERVATION AND FORMATION OF CIRRUS

Cirrus, or cirriform clouds, are divided into three general groups: cirrus (proper), cirrostratus, and cirrocumulus. Cirrus clouds, detached or patchy, usually do not create a serious operational problem. Cirrostratus and extensive cirrus haze, however, may be troublesome in high-level jet operations, aerial photography, interception, rocket tracking, and guided missile navigational systems. Therefore, a definite requirement for cirrus cloud forecasting exists.

The initial formation of cirrus clouds normally requires that cooling take place to saturation, and to have temperatures near -40°C. Under these conditions, water droplets are first formed, but most of them immediately freeze. The resulting ice crystals persist as long as the humidity remains near saturation with respect to ice. There is some evidence that the speed of the cooling, and the kind and abundance of freezing nuclei, may have an important effect on the form and occurrence of cirrus clouds. Slow ascent starts crystallization at humidities substantially below saturation; this is presumably the case in extensive cirrostratus clouds associated with warm frontal altostratus clouds. If slow ascent occurs in air that has insufficient freezing nuclei, a widespread haze may result, which at -30° to -40°C is predominantly composed of water droplets. In the case of more rapid

cooling, there is a tendency for the initial condensation to contain a higher proportion of water droplets, which leads to a "mixed cloud" that will convert to ice or snow in time. Presumably, dense cirrus, fine cirrus, cirrocumulus, and anvil cirrus clouds are of this type. It is assumed that fine cirrus clouds (proper) are formed in shallow layers that are undergoing rapid convection due to advection of colder air at the top of the shear layer.

On the other hand fine cirrus and cirrostratus clouds are so often associated, and cirrostratus clouds are so often reported by pilots as developing from the merging of fine cirrus clouds, that there is a question whether the process of formation in cirrus and cirrostratus clouds are essentially different. Nevertheless, the prevailing crystal types in cirrus and cirrostratus clouds seem to differ, though this may not be universal, or may merely represent different stages in cirrus cloud evolution.

Horizontal visibilities within cirrostratus clouds are generally between 500 feet and 2 nm. Thin cirrus haze, invisible from the ground, often reduces the visibility to 3 nm.

A rule of thumb for forecasting or estimating the visibility within thin cirrus or other high cloud (temperatures below -30°C) follows:

Visibility = $1/2$ nm times dewpoint depression in degrees C. For example; temperature is -35°C , dewpoint is -38°C , and visibility = $1/2 \times 3 = 1\ 1/2$ nm. This rule has been used successfully only in the Arctic where poor visibility in apparently cloudfree air is often encountered.

THE CIRRUS CLOUD FORECASTING PROBLEM

Many forecasters have attempted to forecast cirrus clouds by using frontal or cyclone models. This procedure is not always satisfactory. There are a number of parameters, both surface and aloft, that have been correlated with cirrus cloud formation. A few of the more prominent parameters are mentioned in the following text.

Surface Frontal Systems

Frontal and cyclone models have been developed that embody an idealized cloud distribution. In these models, the cirrus clouds are lowering and thickening to form altostratus clouds, which indicates an advancing warm front.

Fronts Aloft

Above 500-hPa the concepts of air masses and fronts have little application. Most of the fine cirrus clouds observed ahead of and above warm fronts or lows initially form independent of the frontal middle cloud shield, though later it may trail downward to join the altostratus and altostratus cloud shields. With precipitation occurring in advance of a warm front, a 60-percent probability exists that cirrus clouds are occurring above. Cirrus clouds observed with the cold front cloud shield either originate from cumulonimbus along and behind the front or from convergence in the vicinity of the upper trough. In many cases there is no post cold front cirrus clouds, probably due to marked subsidence aloft.

Contour Patterns Aloft

One forecasting rule used widely states that "the ridge line at 20,000 feet, about 500 hpa, preceding a warm front marks the forward edge of the cirrus cloud shield."

For a typical 500-hPa wave pattern, the following information applies:

- No extensive cirrostratus clouds will occur before the surface ridge line arrives.
- Extensive cirrostratus clouds follow the passage of the surface ridge line.
- No middle clouds appear before the arrival of the 500-hPa ridge line.
- Middle clouds tend to obscure the cirrus clouds after passage of the 500-hPa ridge line.
- When the 500-hPa wave has a small amplitude, the cirrus cloud arrival is delayed and the clouds are thinner.
- The greater the 500-hPa convergence from trough to ridge, the more cirrus clouds between the surface and 500-hPa ridge lines.

Cirrus Clouds in Relation to the Tropopause

Experiences of pilots have confirmed that the tops of most cirrus clouds are at or below the tropopause. In the midlatitudes, the tops of most cirrus cloud layers are at or within several thousand feet of the polar tropopause. Patchy cirrus clouds are found between the polar tropopause and the tropical tropopause. A small percentage of cirrus clouds, and sometimes extensive

cirrostratus, may be observed in the lower stratosphere above the polar tropopause, but mainly below the level of the jetstream core. The cirrus clouds of the equatorial zone also generally extend to the tropopause. There is a general tendency for the mean height of the bases to increase from high to low latitudes more or less paralleling the mean tropopause height, ranging from 24,000 feet at 70° to 80° latitude to 35,000 to 4,000 feet or higher in the vicinity of the equator. The thickness of individual cirrus cloud layers are generally about 800 feet in the midlatitudes. The mean thickness of cirrus clouds tends to increase from high to low latitudes. In polar continental regions in winter, cirrus clouds are virtually based at the surface. In the midlatitudes and in the tropics, there is little seasonal variation.

Cirrus Clouds in Relation to the Jetstream

A discussion of cloud types associated with the jetstream is contained in the *AG2 TRAMAN*, volume 1. In addition to this information, we will discuss a few studies pertaining to cloud types. All of these studies agree that most of the more extensive and dense clouds are on the equatorward of the jet axis. The observed frequency of high clouds poleward of the jet axis can be accounted for as the upper reaches of a cold front, or cold lows, not directly related to the jetstream. In some parts of a trough, these high clouds may tend to be dense, and in other areas thin.

PREDICTION OF SNOW VS RAIN

LEARNING OBJECTIVES: Evaluate the surface and upper-level synoptic situations in determining the form of precipitation in your forecast.

Typically, an inch or so of precipitation in the form of rain will cause no serious inconvenience. On the other hand the same amount of precipitation in the form of snow, sleet, or freezing rain can seriously interfere with naval operations. In such cases, the snow versus rain problem may become a factor of operational significance.

Sleet and freezing rain, which often may occur in the intermediate period between snow and rain, are generally grouped with snow in our discussion. Any decision arrived at for the snow versus rain problem would, naturally, have to be modified, dependant on

your geographical location. This should be easily accomplished through a local study of the optimum conditions. The various techniques and systems presented here will often complement each other. The approach used here is a discussion of the general synoptic patterns and the thermal relationship; that is, the use of temperatures at the surface and aloft, and the presentation of an objective technique to distinguish the types of precipitation.

GEOGRAPHICAL AND SEASONAL CONSIDERATIONS

The forecasting problem of snow versus rain arises, naturally, during the colder months of the year. In midwinter when the problem is most serious in the northern states, the southern states may not be concerned.

PHYSICAL NATURE OF THE PROBLEM

The type of precipitation that reaches the ground in a borderline situation is essentially dependent on two conditions. There must be a stratum of above-freezing temperatures between the ground and the level at which precipitation is forming, and this stratum must be sufficiently deep to melt all of the falling snow prior to striking the surface. Thus, a correct prediction of rain or snow at a given location depends largely on the accuracy with which the vertical distribution of the temperature, especially the height of the freezing level, can be predicted. On the average, it is generally satisfactory to assume that the freezing level must be at least 1,200 feet above the surface to ensure that most of the snow will melt before reaching the surface.

Effects of Advection

In the lower troposphere, above the surface, horizontal advection is usually the dominant factor affecting local temperature changes. In most precipitation situations, particularly in borderline situations, warm air advection and upward motion are occurring simultaneously, giving rise to the fact that warming generally accompanies precipitation. However, this effect is frequently offset when there is weak warm advection, or even cold advection, in the cold air mass in the lower layers.

In situations where precipitation is occurring in association with a cold upper low, upward motion is accompanied by little, if any, warm advection. In such borderline cases, precipitation may persist as snow, or

tend to turn to snow, due to cooling, as a result of upward motion or advection.

Nonadiabatic Effects

The most important of the nonadiabatic effects taking place during the precipitation process is the cooling, which takes place due to evaporation as the precipitation falls through unsaturated air between the clouds and the surface. This effect is especially pronounced when very dry air is present in the lower levels, with wet-bulb temperatures at or below freezing. Then, even if the dry-bulb temperature is above freezing in a layer deeper than 1,200 feet in the lower levels, the precipitation may still fall as snow, since the evaporation of the snow will lower the temperatures in the layer between the cloud and the surface until the below-freezing wet-bulb temperatures are approached.

The actual cooling that occurs during the period when evaporation is taking place may often be on the order of 5° to 10°F within an hour. After the low-level stratum becomes saturated, evaporation practically ceases, and advection brings a rise in temperature in the low levels. However, reheating often comes too late to bring a quick change to rain since the temperatures may have dropped several degrees below freezing, and much snow may have already fallen. The lower levels may be kept cool through the transfer of any horizontally transported heat to the colder, snow-covered surface.

Melting of Snow

Melting snow descending through layers that are above freezing is another process which cools a layer. To obtain substantial temperature changes due to melting, it is necessary to have heavy amounts of precipitation falling, and very little warm air advection. As cooling proceeds, the temperature of the entire stratum will reach freezing, so that a heavy rainstorm could transform into a heavy snowstorm,

Incidents of substantial lowering of the freezing level due to melting are relatively rare. The combination of heavy rain, and little, if any, warm advection is an infrequent occurrence.

Combined Effects

The combined effects of horizontal temperature advection, vertical motion, and cooling due to evaporation are well summarized by observations of the behavior of the bright band on radar (approximately 3,000 ft). Observers have found that within the first

1 1/2 hours after the onset of precipitation, the bright band lowers by about 500 to 1,000 feet. This is attributable primarily to evaporational cooling, and probably secondary to melting. Since evaporational cooling ceases as saturation is reached, warm air advection, partially offset by upward motion, again becomes dominant, and the bright band ascends to near its original level. The bright band will ascend to its original level approximately 3 hours after the onset of precipitation, and may ascend a few thousand additional feet.

Other nonadiabatic effects, such as radiation and heat exchange with the surface, probably play a relatively smaller role in the snow-rain problem. However, it is likely that the state of the underlying surface (snow-covered land versus open water) may determine whether the lower layers would be above or below freezing. Occasionally, along a seacoast in winter, heat from the open water keeps temperatures offshore above freezing in the lower levels. Along the east coast of the United States, for example, coastal areas may have rain, while a few miles inland snow predominates. This situation is associated with low-level onshore flow, which is typical of the flow associated with many east coast cyclones. Actually, this situation cannot be classified as a purely nonadiabatic effect since the warmer ocean air is being advected on shore.

GENERAL SYNOPTIC CONSIDERATIONS

The snow versus rain problem usually depends upon relatively small-scale synoptic considerations, such as the exact track of the surface disturbance, whether the wind at a coastal station has an onshore component, the position of the warm front, and the orientation of a ridge east of the low.

In the larger sense, the snow versus rain zone is directly related to the position of the polar front. The location of the polar front is, in turn, closely related to the position of the belt of strong winds in the middle and upper troposphere. When the westerlies extend farther to the south, storm tracks are similarly affected, and the snow-rain zone may be farther to the south. As the westerlies shift northward of their normal position, the storm tracks develop across Canada. Concurrent with this northward shift, the United States has above normal temperatures, and the snow-rain problem exists farther to the north.

With a high zonal index situation aloft, the snow-rain zone will extend in a narrower belt, often well

ahead of the surface perturbation and will undergo little north-south displacement. Those areas with precipitation occurring will not undergo a change from one form to another since there is relatively little advection of warm or cold air with a high zonal condition.

When the upper-level wave is of large or increasing amplitude (low zonal index), it is difficult to generalize about the characteristics of the snow versus rain problem without considering the surface perturbation.

Up to this point, we have discussed the snow-rain pattern in association with an active low of the classical type. The rate of precipitation accumulation here is rapid, and the transition period of freezing rain or sleet is short, usually on the order of a few hours or less. Another situation in which there is frequently a snow versus rain problem is that of a quasi-stationary front in the southern states, with a broad west-southwest to southwest flow aloft, and a weak surface low. The precipitation area in this case tends to become elongated in the direction of the upper-level current. The precipitation rate may be slow, but it occurs over a longer period. Often a broad area of sleet and freezing rain exists between belts of snow and rain, leading to a serious icing condition over an extensive region for a period of several hours or more. This pattern of precipitation changes either as an upper trough approaches from the west and initiates cyclogenesis on the front or as the flow aloft veers and precipitation ceases.

FORECASTING TECHNIQUES AND AIDS

Approaches to the snow versus rain forecasting problem have generally fallen into three broad categories. The first category depends on the use of observed flow patterns and parameters to predict the prevalent form of precipitation for periods as much as 36 hours in advance. The second category consists of studies relating local parameters to the occurrence of rain or snow at a particular station, or area. In this approach, it is assumed thermal parameters will be obtainable from prognoses. This approach tends to have its greatest accuracy for periods of 12 hours, or less, since longer periods of temperature predictions for the boundary zone between rain and snow are very difficult to make with sufficient precision. A third category used involves the use of one of the many objective techniques available. A number of stations have developed objective local techniques. The method presented here is applicable to the eastern half of the United States. Thus, the general procedure in making a snow versus

rain forecast at present is to use a synoptic method for periods up to 24 or 36 hours, and then consider the expected behavior of thermal parameters over the area to obtain more precision for periods of about 12 hours or less.

A number of methods based on synoptic flow patterns applicable to the United States are described in the U.S. Department of Commerce's publication. *The Prediction of Snow vs Rain, Forecasting Guide No. 2*. These methods are mostly local in application and are beyond the scope of this manual.

Prognostic charts from the National Meteorological Center and other sources should be used whenever and wherever available, not only to determine the occurrence and extent of precipitation, but for the prediction of the applicable thermal parameters as well.

Methods Employing Local Thermal Parameters

The following text discusses methods of employing surface temperature, upper-level temperatures, 1000- to 700-hPa and 1000- to 500-hPa thicknesses, the height of the freezing level, and combined parameters for the prediction of snow versus rain. All of these are interdependent, and should be considered simultaneously.

SURFACE TEMPERATURE.— Surface temperature considered by itself is not an effective criterion. Its use in the snow versus rain problem has generally been used in combination with other thermal parameters. One study for the Northeastern United States found that at 35°F snow and rain occurred with equal frequency, and by using 35°F as the critical value (predict snow at 35°F and below, rain above 35°F), 85 percent of the original cases could be classified. Another study based on data from stations in England suggested a critical temperature of 34.2°F, and found that snow rarely occurs at temperatures higher than 39°F. However, it is obvious from these studies that even though surface temperature is of some value in predicting snow versus rain, it is often inadequate. Thus, most forecasters look to upper-level temperatures as a further aid to the problem.

UPPER-LEVEL TEMPERATURES.— Two studies of the Northeastern United States found that temperatures at the 850-hPa level proved to be a good discriminating parameter, and that including the surface temperature did not make any significant contribution. The discriminating temperatures at the 850-hPa level were -2° to -4°C. Another study found that the area

bounded by the 0°C isotherm at 850-hPa level and the 32°F isotherm at the surface, when superimposed upon the precipitation area, separated the snow-rain precipitation shield in a high percentages of cases. A range of -2° to -4°C at the 850-hPa level should be used along coastal areas, and also behind deep cold lows, At mountain stations a higher level would have to be used.

A technique that uses temperatures at mandatory levels (surface, 1000-, 850-, 700-, and 500-hPa, etc.) is advantageous because of the availability of charts at these levels. There is, however, the occasional problem where temperature inversions are located near the 850- or 700-hPa levels, so that the temperature of one level may not be indicative of the layer above or below. This difficulty can be overcome by using thickness, which is a measure of the mean temperature of the layer.

THICKNESS.— The National Weather Service has examined both the 1,000- to 700-hPa and 1,000- to 500-hPa thickness limits for the eastern half of the United States.

A generalized study of 1,000- to 500-hPa thickness as a predictor of precipitation forms in the United States was made by A. J. Wagner, More complete details on this study can be found in *The Prediction of Snow vs Rain, Forecasting Guide No. 2*.

Wagner's data was taken from a study of 40 locations in the United States for the colder months of a 2-year period. Cases were limited to surface temperatures between 10°F and 50°F. The form of precipitation in each case was considered as belonging in one of two categories-frozen which includes snow, sleet, granular snow, and snow crystals; and unfrozen, which includes rain, rain and snow mixed, drizzle, and freezing rain and drizzle.

Equal probability, or critical thickness values, were obtained from the data at each location. From this study it was clear that the critical thickness values increase with increasing altitude. This altitude relationship is attributable to the fact that a sizable portion of the thickness stratum is nonexistent for high-altitude stations, and obviously does not participate in the melting process. To compensate for this, the equal probability thickness values must increase with station elevation. For higher altitude stations, thickness values between the 850- to 500-hPa or 700- to 500-hPa stratums, as appropriate, should prove to be better dated to precipitation form.

The Wagner equal probability chart is reproduced in figure 4-21.

Wagner's study also indicates that the form of precipitation can be specified with a certainty of 75 percent at plus or minus 30 meters from the equal probability value, increasing to 90 percent certainty at plus or minus 90 meters from this value. Stability is the parameter that accounts for the variability of precipitation for a given thickness at a given point. This fact is taken into account in the following reamer: if the forecast precipitation is due to a warm front that is more stable than usual, the line separating rain from frozen precipitation is shifted toward higher thickness values. Over the Great Lakes, where snow occurs in unstable, or stable conditions, the equal probability thickness is lower than that shown in figure 4-21 for snow showers, and higher than that shown in figure 4-21 for warm frontal snow.

HEIGHT OF THE FREEZING LEVEL.— The height of the freezing level is one of the most critical thermal parameters in determining whether snow can reach the ground. It was pointed out earlier that theoretical and observational evidence indicates that a freezing level averaging 1,200 feet or more above the surface is usually required to ensure that most of the snow will melt before reaching the surface. This figure of 1,200 feet can thus be considered as a critical or equal probability value of the freezing level.

COMBINED THERMAL PARAMETERS.— From the foregoing discussion, you can conclude that no one method, when used alone, is a good discriminator in the snow versus rain forecasting problem. Therefore, you should use a combination of the surface temperature, height of the freezing level, 850-hPa temperature, and the 1,000-to 700-hPa and /or 1,000- to 500-hPa thicknesses to arrive at the forecast. There is generally a high correlation between the 850-hPa temperature, and the 1,000- to 700-hPa thickness and between the 700-hPa temperature and the 1,000- to 500-hPa thickness. Certainly an accurate temperature forecast for these two levels would yield an approximate thickness value for discriminating purposes.

Additional Snow versus Rain Techniques

The determining factor in the form of precipitation in this study was found to be the distribution of temperature and moisture between the surface and the 700-hPa level at the time of the beginning of precipitation. The median level of 850-hPa was studied in conjunction with the precipitation area and the 32°F

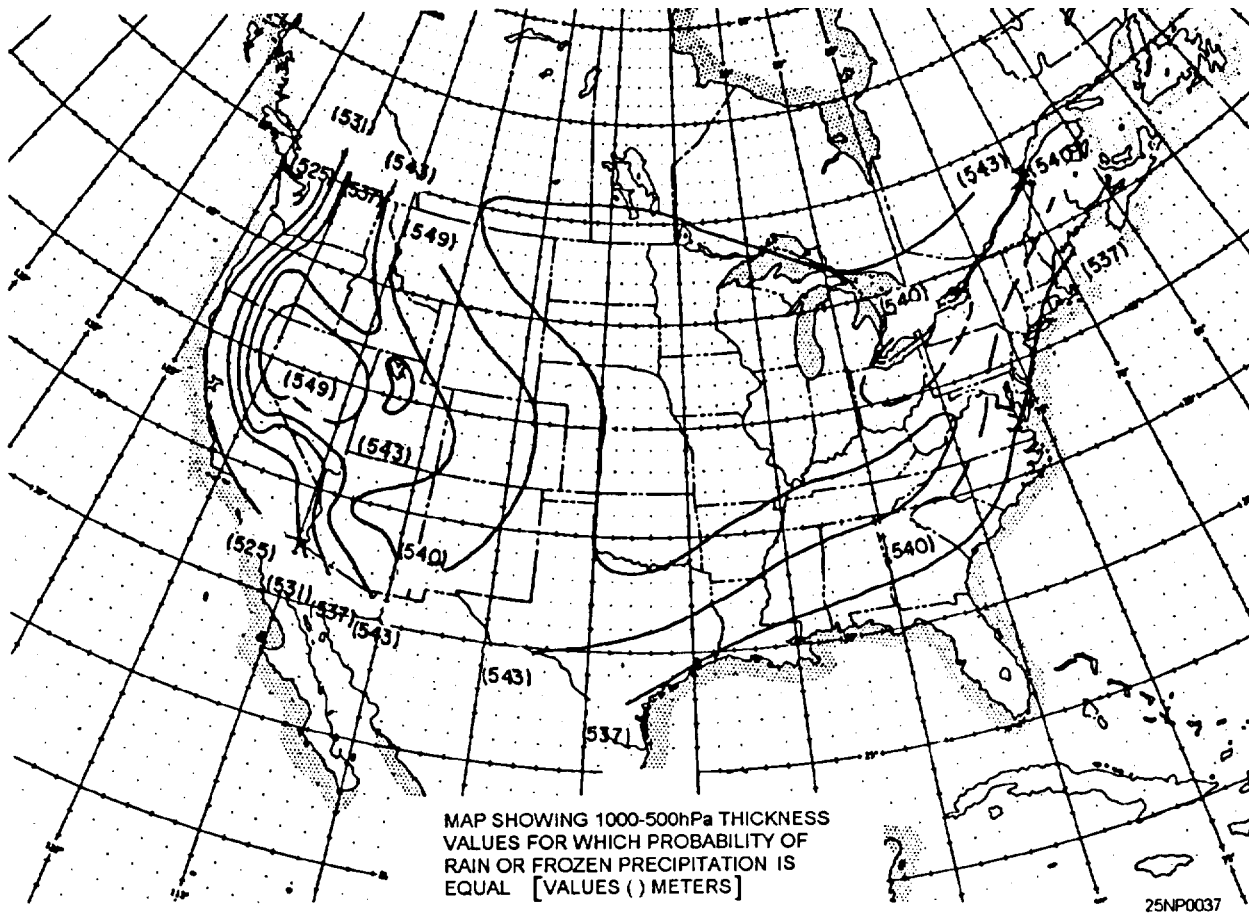

Figure 4-21.-Map showing 1,000- to 500-hPa thickness values for which probability of rain or frozen precipitation is equal (after Wagner).

isotherm sketched on the surface chart. This method presents an objective and practical method by which the forecaster can make a decision on whether the precipitation in winter will be rain, snow, freezing rain, sleet, or some combination of these.

The following objective techniques can be applied to the land areas south of 50° north latitude and east of a line drawn through Williston, North Dakota; Rapid City, South Dakota; Goodland, Kansas; and Amarillo, Texas.

The area outlined by the 0°C isotherm at 850-hPa and the 32°F isotherm on the surface chart, when superimposed upon the precipitation area, generally separates the forms of precipitation. Most of the pure rain was found on the warm side of the 32°F isotherm, and most of the pure snow on the cold side of 0°C isotherm, with intermediate types falling generally within the enclosed area between these two isotherms. It was also observed that in a large majority of situations,

evaporation and condensation was a sizable factor, both at 850-hPa and at the surface level in its affect upon temperature. With this in mind, the wet-bulb temperature was selected for investigation because of its conservative properties with respect to evaporation and condensation, and also because of its ease of computation directly from the temperature and dewpoint. The surface chart is used for computations of the 1,000-hPa level because the surface chart approximates the 1,000-hPa level for most stations during a snow situation; therefore, little error is introduced. *IT MUST BE REMEMBERED THAT ALL PREDICTIONS ARE BASED ON FORECAST VALUES.*

MOVEMENT OF THE 850-hPa 0°C ISOTHERM.— A reasonably good approximation for forecasting the 0°C isotherm at the 850-hPa level can be made subjectively by use of a combination of extrapolation and advection, considerations of synoptic developments, and the rules listed in the following

paragraphs. (See figure 4-22, views (A) and (B), for typical warm and cold air advection patterns at 850-hPa.)

The following rules for the movement of the 24-hour, 850-hPa level temperature change areas have been devised

- Maximum cooling takes place between the 850-hPa contour trough and the 850-hPa isotherm ridge east of the trough.
- Maximum warming takes place between the 850-hPa contour ridge and the 850-hPa isotherm trough east of the contour ridge.
- Changes are slight with ill-defined isotherm/contour patterns.
- Usually, little change occurs when isotherms and contours are in phase at the 850-hPa level.
- The temperature falls at the 850-hPa level tend to replace height falls at the 700-hPa level in an average of 24 hours. Conversely, temperature rises replace height rises.

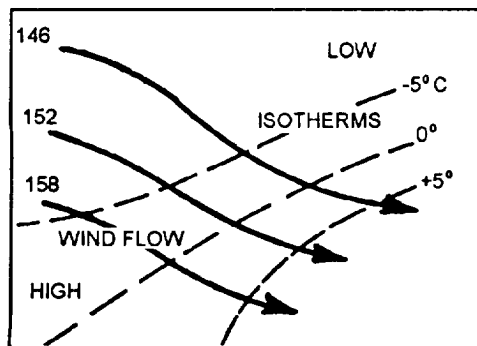

(A) COLD AIR ADVECTION (850 hPa)

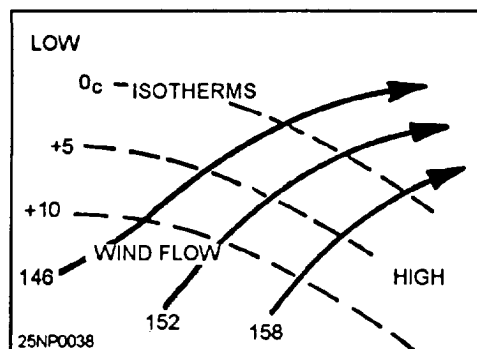

(B) WARM AIR ADVECTION (850 hPa)

Figure 4-22. Typical cold and warm air advection patterns at 850-hPa. (A) Cold; (B) Warm.

- With filling troughs or northeastward moving lows, despite northwest flow behind the trough, 850-hPa level isotherms are seldom displaced southward, but follow the trough toward the east or northeast

- Always predict temperature falls immediately following a trough passage.

- Do not forecast temperature rises of more than 10 to 2°F in areas of light or sparse precipitation in the forward areas of the trough. If the area of precipitation is widespread and moderate or heavy, forecast no temperature rise.

- With eastward moving systems under normal winter conditions (trough at the 700-hPa level moving east about 10° per day), a distance of 400 nautical miles to the west is a good point to locate the temperature to be expected at the forecasting point 24 hours later. A good 850-hPa temperature advection speed seems to be about 75 percent of the 700-hPa trough displacement.

The following is step-by-step procedures for moving the 850-hPa 0°C isotherm:

1. Extrapolate the movement of the thermal ridge and troughs for 12 and 24 hours. If poorly defined, this step may be omitted. The amplitude of the thermal wave may be increased or decreased subjectively if, during the past 12 hours, there has been a corresponding increase or decrease in the height of the contours at 500-hPa.

2. The thermal wave patterns will maintain their approximate relative position with the 850-hPa level contour troughs and ridges. Therefore, the 12- and 24-hour prognostic positions of the contour troughs and ridges should be made, and the extrapolated positions of the thermal points checked against this contour prognosis. Adjustments of these thermal points should be made.

3. Select points on the 0°C isotherm that lie between the thermal ridge and trough as follows: one or two points in the apparent warm advection area, and one or two points in the apparent cold advection area. Apply the following rules to these selected points.

- Warm advection area. If the points lie in a near saturated or precipitation area, they will remain practically stationary with respect to the contour trough. If the points lie in a nonsaturated area, but one that is expected to become saturated or to lie in precipitation area, then it will remain stationary or move upwind slightly to approximate y the prognostic position of the 0°C wet-bulb. If the point does not fall in the above two

categories, it will be advected with about 50 percent of the wind component normal to the isotherm. Note in all three cases above, the movement is related to the contour pattern.

- Cold Advection area. Advect the point with approximately 75 to 80 percent of the wind component normal to it.

In the case of a slow moving, closed low at the 850-hPa level, the 0°C isotherm will move eastward with respect to the closed low as cold air is advected around the low.

MOVEMENT OF THE 850-hPa 0°C WET-BULB ISOTHERM.— The wet-bulb temperature can be forecast by the above procedures and rules. Remember that the wet-bulb temperature is dependent upon dewpoint as well as the temperature. The dewpoint will be advected with the winds at nearly the full velocity, whereas the temperature under nonsaturated conditions moves slower. The following observations with respect to the 0°C wet-bulb isotherm *after* saturation is reached may help:

- The 0°C wet-bulb isotherm does not move far offshore in the Gulf and the Atlantic because of upward vertical motion in the cold air over the warmer water.

- If the 0°C wet-bulb isotherm lies in a ribbon of closely packed isotherms, movement is slow.

- Extrapolation works well on troughs and ridges.

After the forecast of the surface and 850-hPa level temperature and dewpoint values are made, you are ready to convert these values to their respective wet-bulb temperature. The following procedures are recommended

- Use figure 4-23, views (A) and (B), to compute the wet-bulb temperatures for the 1,000- and 850-hPa levels, respectively. (The surface chart may be used for the 1,000-hPa level.) Admittedly, the wet-bulb temperatures at just these two levels do not give a complete picture of the actual distribution of moisture and temperature, and error is introduced when values are changing rapidly, but these are values the forecaster can work with and predict with reasonable accuracy.

- Refer to figure 4-24. From the surface wet-bulb temperature at the bottom, go up vertically until you intersect the computed 850-hPa level wet-bulb temperature to the left. This intersection indicates the form of precipitation that can be expected. A necessary assumption for use of this graph is that the wet-bulb temperatures at these two levels can be predicted with

reasonable accuracy. Known factors affecting the wet-bulb temperature at any particular station should be carefully considered before entering the graph. Some of the known factors are elevation, proximity to warm bodies of water, known layers of warm air above or below the 850-hPa level, etc. Area “A” on the graph calls for a rain forecast, area “B” for a freezing rain forecast, and area “C” for a snow forecast. Area “D” is not so clear cut because it is an overlap portion of the graph; however, wet snow or rain and snow mixed predominate in this area. Sleet occurring by itself for more than 1 or 2 hours is rare, and should be forecast with caution.

FORECASTING THE AREA OF MAXIMUM SNOWFALL

The intent of this section is to introduce the patterns associated with maximum snowfall and to present techniques for predicting the areas where snowstorms are likely to appear.

Synoptic Types

There are four distinct types of synoptic patterns with associated maximum snow area.

BLIZZARD TYPE.— The synoptic situation features an occluding low. In the majority of cases, the “wrapped around” high pressure and ridges are present. The track of the low is north of 40°N, and its speed, which initially may be average or about 25 knots, decreases into the slow category during the occluding process. In practically all cases, a cold closed low at the 500-hPa level is present and captures the surface low in 24 to 36 hours.

The area of maximum snowfall lies to the left of the track. At any particular position, the area is located from due north to west of the low-pressure center. When this type occurs on the east coast with its large temperature contrast and high moisture availability, heavy snowfall may occur. The western edge of the maximum area is limited by the 700-hPa level trough, or low center, and the end of all snow occurs with the passage of the 500-hPa level trough or low center.

MAJOR STORM AND NONOCCLUDING LOWS.— The synoptic situation consists of a nonoccluding wave-type low. The track of the low or wave is south of 40° latitude, and its speed is at least the average of 25 knots, often falling into the fast-moving category. The upper-air picture is one of fast-moving troughs, generally open, but on occasion could have a

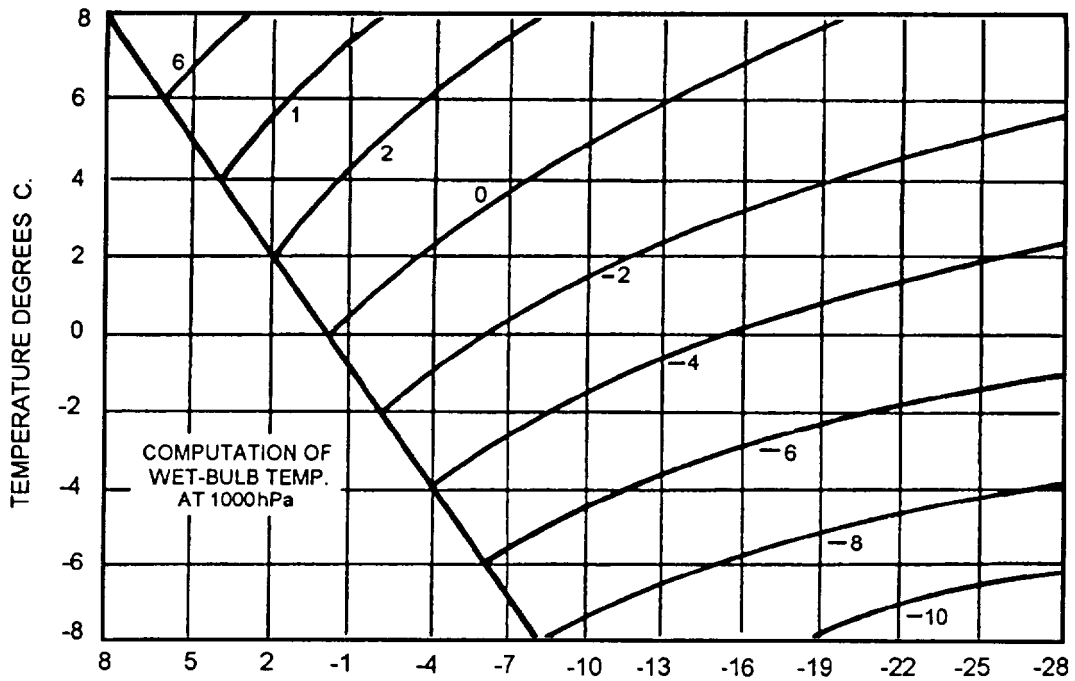

(A) DEW POINTS, DEGREES C. GRAPH I

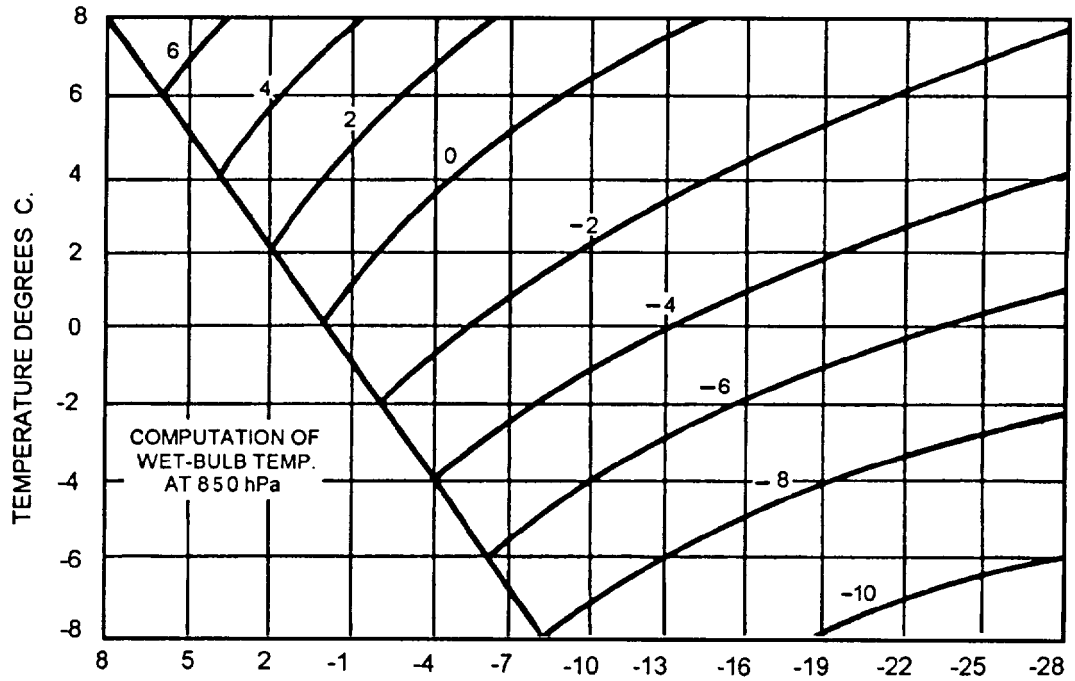

(B) DEW POINTS, DEGREES C. GRAPH II

25NP0039

Figure 4-23.-Graphs for computing wet-bulb temperatures. (A) Computation of 1,000-hPa level wet-bulb temperature; (B) computation of 850-hPa level wet-bulb temperature.

minor closed center for one or two maps in the bottom of the trough.

The area of maximum snowfall lies in the cold air to the left of the track and usually describes a narrow belt oriented east-west or northeast-southwest about 100

to 200 miles wide. At any position, the area is parallel to the warm front and north of the low-pressure center. Within the maximum area, the rate of snowfall is variable from one case to another, depending upon available moisture, amount of vertical shear, etc. However, it is not uncommon for heavy snow (1 inch

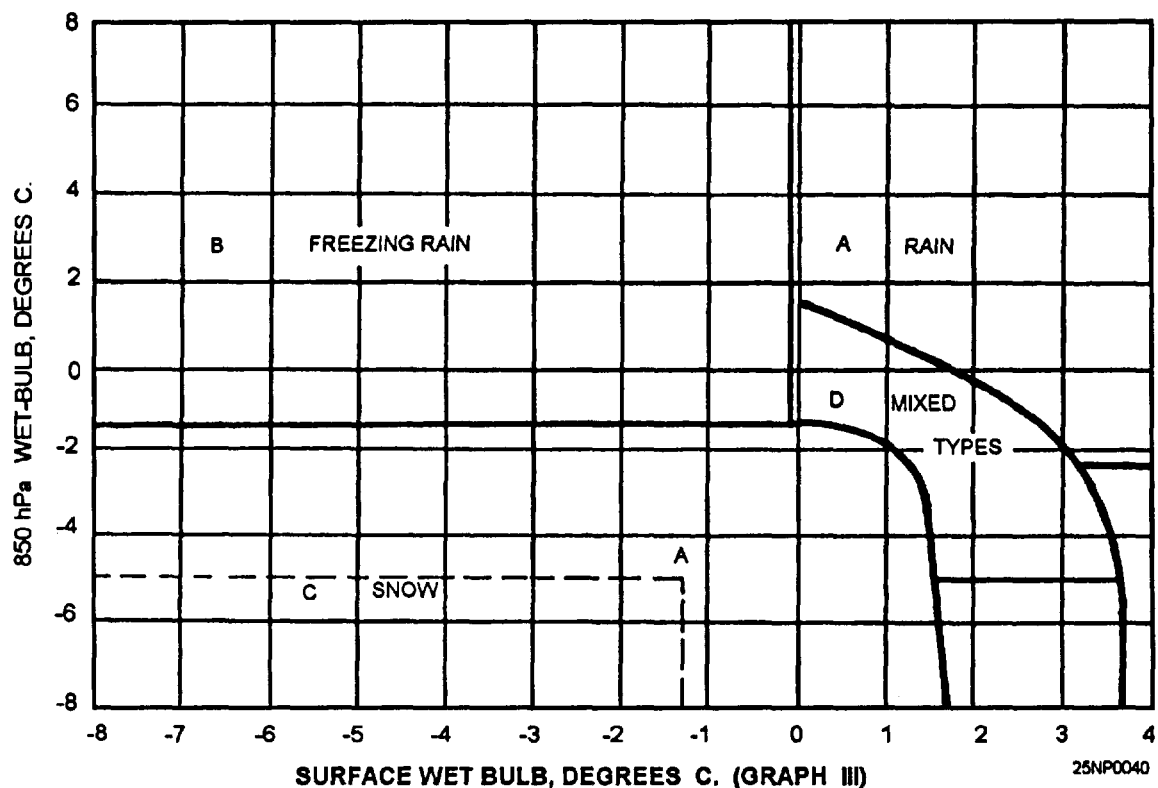

Figure 4-24.-Graph for delineating the form of precipitation.

per hour or greater) to occur. You must remember that even though heavy snow occurs, the duration is short. This means that a location could lie in the maximum snow area only 4 to 8 hours; whereas, in the case of the blizzard type, it usually remains in the area in excess of 10 hours.

WARM ADVECTION TYPE.— This type was separated from the other types because of the absence of an active low in the vicinity of the maximum snow area. A blocking high or ridge is located ahead of a sharp warm front. The overrunning warm air is a steady current from the south to southwest. The area of maximum snowfall is a narrow band parallel to the warm front and moves north or northeast. A rate of fall of moderate to heavy for a 6- to 12-hour duration may occur. The usual history is a transition to freezing rain, and then rain.

POST-COLD FRONTAL TYPE.— The synoptic situation consists of a sharp cold front oriented nearly north-south in a deep trough. A minor wave may form on the front and rapidly travel to the north or northeast. Strong cold advection from the surface to the 850-hPa level is present west of the front. The troughs at the 700-hPa and 500-hPa levels are sharp and displaced to the west of the surface trough 200 to 300 miles. Ample

moisture is available at the 850-hPa and 700-hPa levels. This type of heavy snow may occur once or twice per season.

The area of maximum snowfall is located between the 850-hPa and 700-hPa troughs, where moisture at both levels is available. The rate of fall is moderate, although for a brief period of an hour or less, it may be heavy. The duration is short, on the order of 2 to 4 hours at anyone location. The area as a whole generates and dissipates in a 12- to 18-hour period. The normal history is one of a general area of light snow within the first 200 miles of a strong outbreak of cold air. After the cold air moves far enough south and the cold front becomes oriented more north to south and begins moving steadily eastward, the troughs aloft and moisture distribution reach an ideal state, and a maximum snow area appears. After 12 to 18 hours, the advection of dry air at the 700-hPa level decreases the rate of fall in the area, and soon thereafter, the area, as a whole, dissipates.

Locating the Area of Maximum Snowfall

The various parameters and characteristics that may be of benefit in locating areas of maximum snowfall are discussed in the following text.

TEMPERATURE.— The 0°C (-3°C east coast) isotherm at the 850-hPa level is used as a basis for snow-rain areas. This isotherm should be carefully analyzed by using all data at 850 hpa. It should then be checked against the surface chart. Keep in mind the following two points:

1. In areas of precipitation, locations reporting snow should lie on the cold side of the 0°C (-3°C east coast) isotherm; for locations reporting mixed types of precipitation (e.g., rain and snow, sleet and snow), the 0°C (-3°C) isotherm will lie very close to or through the location.

2. In areas of no precipitation, the 0°C (-3°C east coast) isotherm will roughly parallel the 32°F isotherm at the surface. In cloudy areas, the separation will be small, and in clear areas, the separation will be larger.

At the 850-hPa level, the 0°C wet-bulb temperature should be sketched in, particularly in the area where precipitation may be anticipated within the next 12 to 24 hours. This line will serve as the first approximation of the future position of the 0°C isotherm.

MOISTURE.— At the 850-hPa level, the -5°C dewpoint line is used as the basic defining line; at the 700-hPa level, the -10°C dewpoint line is used as the basic defining line. The area at 850 hpa that lies within the overlap of the 0°C isotherm and the -5°C dewpoint line is the first approximation of the maximum snowfall area. All locations within this area have temperatures less than 0°C and spreads of 5°C or less. This area is further refined by superimposing the sketched -10°C dewpoint line at 700 hPa upon the area. Now the final area is defined by the 0°C isotherm and the overlapped minimum dewpoint lines from both levels. This final area becomes the area where moderate or heavy snow will be reported, depending upon the particular synoptic situation. See figure 4-25,

MOVEMENT.— The first basic rule for moving the area of maximum snowfall is that it maintains the same relative position to the other synoptic features of the 850-hPa level and surface charts. However, in order to forecast the expansion or contraction of the area, it is necessary to forecast the lines that define it. The 0°C isotherm should be forecast according to the roles set forth in the section treating this particular phase. The moisture lines may be advected with the winds. The 0°C isotherm should also be moved with rules stated previously in this chapter.

The area of maximum snowfall can be forecast for 12 hours with considerable accuracy, and for 24 hours with fair accuracy, provided a reasonable amount of care

is exercised according to rules and subjective ideas mentioned previously.

TEMPERATURE

LEARNING OBJECTIVES: Analyze synoptic features in determining temperature forecasts.

Temperature ranks among the most important forecast elements. Temperatures are not only important in the planning and execution of operational exercises, but also are of keen interest to all of us in everyday life.

FACTORS AFFECTING TEMPERATURES

Many factors are involved in the forecasting of temperatures. These factors include air mass characteristics, frontal positions and movement, amount and type of cloudiness, season, nature and position of pressure systems, and local conditions.

Temperature, which is subject to marked changes from day to night, is not considered a conservative property of an air mass. Too, it does not always have a uniform lapse rate from the surface up through the atmosphere. This means that the surface air temperature will not be representative because of the existence of inversions, which may be a condition particularly prevalent at night. Usually, the noonday surface air temperature is fairly representative,

Let's look at factors that cause temperature variations. These factors include insolation and terrestrial radiation, lapse rate, advection, vertical heat transport, and evaporation and condensation.

Insolation and Radiation

In forecasting temperatures, insolation and terrestrial radiation are two very important factors. Low latitudes, for instance, receive more heat during the day than stations at high latitudes. More daytime heat can be expected in the summer months than in the winter months, since during the summer months the sun's rays are more direct and reach the earth for a longer period of time. Normally, there is a net gain of heat during the day and a net loss at night. Consequently, the maximum temperature is usually reached during the day, and the minimum at night. Cloudiness will affect insolation and terrestrial radiation. Temperature forecasts must be made only after the amount of cloudiness is determined. Clouds reduce insolation and terrestrial radiation,

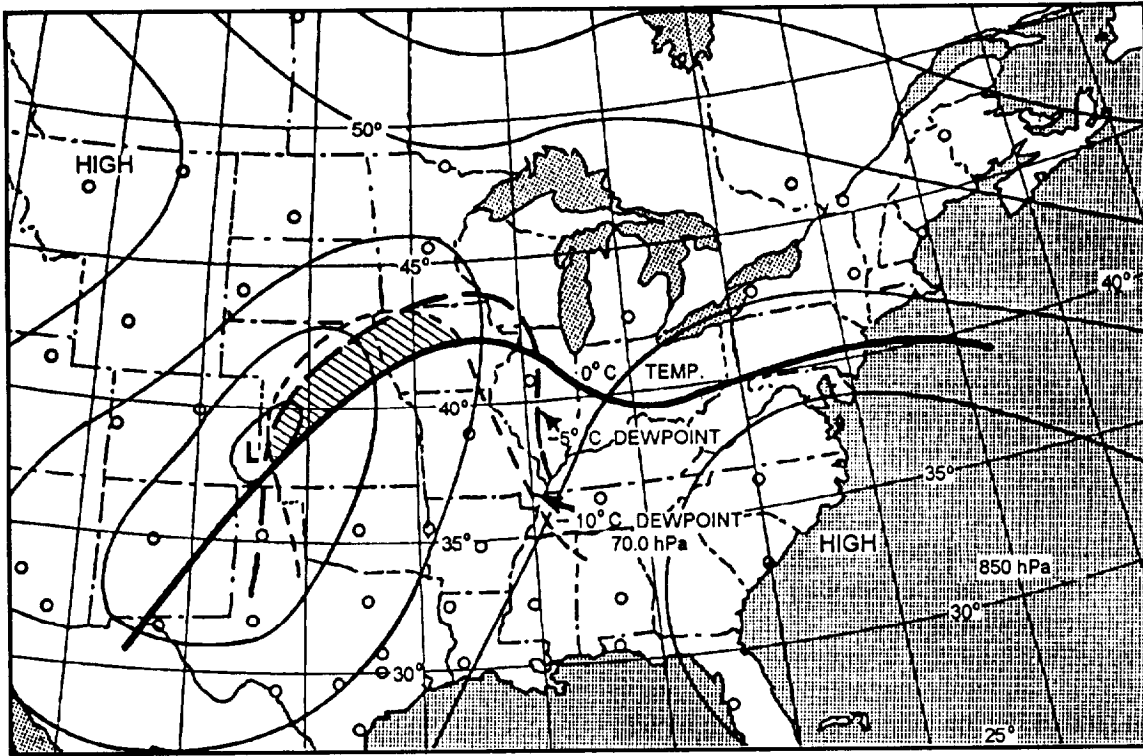

25NP0041

Figure 4-25.-Illustration of the location of the maximum snow area. The low center moved to Iowa in 24 hours, and the maximum snow area spread northeast along the area 50 to 75 miles either side of a line through Minneapolis to Houghton, Michigan.

causing daytime temperature readings to be relatively lower than normally expected, and nighttime temperatures to be relatively higher. The stability of the lapse rate has a marked effect on insolation and terrestrial radiation. With a stable lapse rate, there is less vertical extent to heat; therefore, surface heating takes place more rapidly. With an unstable lapse rate, the opposite is true. If there is an inversion, there is less cooling, since the surface temperature is lower than that of the inversion layer; that is, at some point the energy radiated by the surface is balanced by that radiated by the inversion layer.

Advection

One of the biggest factors affecting temperature is the advection of air. Advection is particularly marked in its effect on temperature with frontal passage. If a frontal passage is expected during the forecast period, the temperature must be considered. Advection within an air mass may also be important. This is particularly true of sea and land breezes and mountain breezes. They affect the maximum and minimum temperatures and their time of occurrence.

Vertical Heat Transport

Vertical heat transport is a temperature factor. It is considerably affected by the windspeed. With strong wind there is less heating and cooling than with light wind or a calm because the heat energy gained or lost is distributed through a deeper layer when the turbulence is greater.

Evaporation and Condensation

Evaporation and condensation affect the temperature of an air mass. When cool rainfalls through a warmer air mass, evaporation takes place, taking heat from the air. This often affects the maximum temperature on a summer day on which afternoon thundershowers occur. The temperature may be affected at the surface by condensation to a small extent during fog formation, raising the temperature a degree or so because of the latent heat of condensation.

FORECASTING SPECIAL SITUATIONS

The surface and aloft situations that are indicative of the onset of cold waves and heat waves are discussed in the following text.

Cold Wave

A forecast of a cold wave gives warning of an impending severe change to much colder temperatures. In the United States, it is defined as a net temperature drop of 20°F or more in 24 hours to a prescribed minimum that varies with geographical location and time of the year. Some of the prerequisites for a cold wave over the United States are continental Polar, or Arctic air with temperatures below average over west central Canada, movement of a low eastward from the Continental Divide that ushers in the cold wave, and large pressure tendencies on the order of 3 to 4 hPa occurring behind the cold front. Aloft, a ridge of high pressure develops over the western portion of the United States or just off the coast. An increase in intensity of the southwesterly flow over the eastern Pacific frequently precedes the intensifying of the ridge. Frequently, retrogression of the long waves takes place. In any case, strong northerly to northwesterly flow is established aloft and sets the continental Polar or Arctic air mass in motion. When two polar outbreaks rapidly follow one another, the second outbreak usually moves faster and overspreads the Central States. It also penetrates farther southward than the first cold wave. In such cases, the resistance of the southerly winds ahead of the second front is shallow. At middle and upper levels, winds remain west to northwest, and the long wave trough is situated near 80° west.

Most cold waves do not persist. Temperatures moderate after about 48 hours. Sometimes, however, the upper ridge over the western portion of the United States and the trough over the eastern portion are quasi-stationary, and a large supply of very cold air remains in Canada. Then, we experience successive outbreaks with northwest steering that hold temperatures well below normal for as long as 2 weeks.

Heat Wave

In the summer months, heat wave forecasts furnish a warning that very unpleasant conditions are impending. The definition of a heat wave varies from place to place. For example, in the Chicago area, a heat wave is said to exist when the temperature rise above 90°F on 3 successive days. In addition, there are many summer days that do not quite reach this requirement, but are highly unpleasant because of humidity.

Heat waves develop over the Midwestern and eastern portions of the United States when along wave

trough stagnates over the Rockies or the Plains states, and along wave ridge lies over or just off the east coast. The belt of westerlies are centered far to the north in Canada. At the surface we observe a sluggish and poorly organized low-pressure system over the Great Plains or Rocky Mountains. Pressure usually is above normal over the South Atlantic, and frequently the Middle Atlantic states. An exception occurs when the amplitude of the long wave pattern aloft becomes very great. Then, several anticyclonic centers may develop in the eastern ridge, both at upper levels and at the surface. Frequently, they are seen first at 500 hPa. Between these highs we see formation of east-west shear lines situated in the vicinity of 38° to 40°N. North of this line winds blow from the northeast and bring cool air from the Hudson Bay into the northern part of the United States. A general heat wave continues until the long wave train begins to move.

SUMMARY

In this chapter we discussed condensation and precipitation producing processes. Following a discussion on condensation and precipitation producing processes, we then covered condensation and precipitation dissipation processes. Forecasting of frontal clouds and weather was then discussed, including the topics of frontal cloudiness and precipitation, air mass cloudiness and precipitation, vertical motion and weather, vorticity and precipitation, and middle clouds in relation to the jetstream. We then covered short-range extrapolation techniques, which included use of the nephanalysis, frontal precipitation, lowering of ceilings in continuous rain areas, the trend chart as an aid, and the time-liner as an aid. A discussion of cloud layer analysis and forecasting was then presented along with the importance of RAOB use in cloud analysis and identification, the humidity field, a 500-hPa level analysis of the dewpoint depression, a three-dimensional analysis of the moist layer, precipitation and clouds, and cirrus indications. A discussion of the prediction of snow versus rain followed. Topics presented were geographical and seasonal considerations, the physical nature of the problem, general synoptic considerations, forecasting techniques, and areas of maximum snowfall. The last topics of discussion were factors affecting temperature, and the forecasting of temperatures during special situations.

CHAPTER 5

FORECASTING SEVERE WEATHER FEATURES

The paramount responsibilities of the forecaster include providing forecasts of severe weather conditions and timely warnings to aircraft and ships to ensure the safety of their operations, as well as the safety of their personnel.

This chapter discusses some of these phenomena and methods that may be used to forecast severe weather conditions.

THUNDERSTORMS

LEARNING OBJECTIVES: Recognize phenomena associated with thunderstorm activity. Forecast the movement and intensity of thunderstorms.

The thunderstorm represents one of the most formidable weather hazards in temperate and tropical zones. The turbulence, high winds, heavy rain, and occasionally hail that accompany thunderstorms are a definite threat to the safety of flight and to the security of naval installations. It is important that the forecaster be acquainted with the structure of thunderstorms and their associated weather, as well as the knowledge to accurately predict their formation and movement.

The *AG2 TRAMAN*, volume 1, covered thunderstorm formation and movement. Therefore, in this chapter, we will discuss, in more detail, the weather phenomena associated with thunderstorms and various methods of forecasting their intensity and movement.

THUNDERSTORM TURBULENCE AND WEATHER

Thunderstorms are characterized by turbulence, moderate to extreme updrafts and downdrafts, hail, icing, lightning, precipitation, and, under most severe conditions (in certain areas), tornados.

Turbulence (Drafts and Gusts)

Downdrafts and updrafts are currents of air that may be continuous over many thousands of feet in the vertical, and horizontally as large as the extent of the

thunderstorm. The velocity of the downdrafts and updrafts is relatively constant as contrasted to gusts. Gusts are primarily responsible for the bumpiness (turbulence) normally encountered in cumuliform clouds. A downdraft or updraft maybe compared to a river flowing at a fairly constant rate, whereas a gust is comparable to an eddy or other type of random motion of water in a river.

Studies of the structure of the thunderstorm cell indicate that during the cumulus stage of development, the updrafts may cover a horizontal area as large as 6 miles. In the cumulus stage, the updraft may extend from below the cloud base to the cloud top, a height greater than 25,000 feet. During the mature stage, the updrafts cease in the lower levels of the cloud, although they continue in the upper levels where cloud tops may exceed 60,000 feet. These drafts are of considerable importance in aviation because of the change in altitude that may occur when an aircraft flies through them.

In general, the maximum number of high velocity gusts are found at altitudes of 5,000 to 10,000 feet below the top of the thunderstorm cloud, while the least severe turbulence is encountered near the base of the thunderstorm. The characteristic response of an aircraft intercepting a series of gusts is a number of sharp accelerations or "bumps" without an accompanying change in altitude. The degree of bumpiness or turbulence experienced in flight is related to both the number of such abrupt changes encountered in a given distance and the strength of the individual changes.

Hail

Hail is regarded as one of the worst hazards of flying in thunderstorms. It usually occurs during the mature stage of cells that have updrafts of more than average intensity, and is found with the greatest frequency between 10,000 and 15,000 feet. As a general rule, the greater the vertical extent of the thunderstorm, the more likely hail will occur.

Although encounters by aircraft with large hail are not too common, hail can severely damage an aircraft in a very few seconds. The general conclusion regarding hail is that most midlatitude storms contain hail sometime during their cycle. Most hail will occur

during the mature stage. In subtropical and tropical thunderstorms, hail seldom reaches the ground. It is generally believed that these thunderstorms contain less hail aloft than do midlatitude storms.

Rain

Thunderstorms contain considerable quantities of moisture that may or may not be falling to the ground as rain. These water droplets may be suspended in, or moving with, the updrafts. Rain is encountered below the freezing level in almost all penetrations of fully developed thunderstorms. Above the freezing level, however, there is a sharp decline in the frequency of rain.

There seems to be a definite correlation between turbulence and precipitation. The intensity of turbulence, in most cases, varies directly with the intensity of precipitation. This relationship indicates that most rain or snow in thunderstorms is held aloft by updrafts.

Icing

Where the air temperatures are at or below freezing, icing should be expected in flights through thunderstorms. In general, icing is associated with temperatures from 0° to -20°C. Most severe icing occurs from 0°C to -10°C. The heaviest icing conditions usually occur in that region above the freezing level where the cloud droplets have not yet turned to ice crystals. When the thunderstorm is in the cumulus stage, severe icing may occur at any point above the freezing level. However, because of the formation of ice crystals at high levels and the removal of liquid water by precipitation, icing conditions are usually somewhat less in the mature and dissipating stage.

THUNDERSTORM ELECTRICITY AND LIGHTNING

The thunderstorm changes the normal electrical field, in which the earth is negative with respect to the air above it, by making the upper portion of the thunderstorm cloud positive and the lower portion negative. This negative charge then induces a positive charge on the ground. The distribution of the electric charges in a typical thunderstorm is shown in figure 5-1. The lightning first occurs between the upper positive charge area and the negative charge area immediately below it. Lightning discharges are considered to occur most frequently in the area roughly bounded by the 0°C and the -9°C temperature levels. However, this does

not mean that all discharges are confined to this region, for as the thunderstorm develops, lightning discharges may occur in other areas, and from cloud to cloud, as well as cloud to ground. Lightning can do considerable damage to aircraft, especially to radio equipment.

THUNDERSTORMS IN RELATION TO THE WIND FIELD

During all stages of a cell, air is being brought into the cloud through the sides of the cloud. This process is known as *entrainment*. A cell entrains air at a rate of 100 percent per 500 hPa; that is, it doubles its mass in an ascent of 500 hPa. The factor of entrainment is important in establishing a lapse rate within the cloud that is greater than the moist adiabatic rate, and in maintaining the downdraft.

When there is a marked increase with height in the horizontal wind speed, the mature stage of the cell may be prolonged. In addition, the increasing speed of the wind with height produces considerable tilt to the updraft of the cell, and in fact, to the visible cloud itself. Thus, the falling precipitation passes through only a small section of the rising air; it falls thereafter through the relatively still air next to the updraft, perhaps even outside the cell boundary. Therefore, since the drag of the falling water is not imposed on the rising air currents within the thunderstorm cell, the updraft can continue until its source of energy is exhausted. Tilting of the thunderstorm explains why hail is sometimes encountered in a cloudless area just ahead of the storm.

RADAR DETECTION

Radar, either surface or airborne, is the best aid in detecting thunderstorms and charting their movements. A thunderstorm's size, direction of movement, shape and height, as well as other significant features, can be determined from a radar presentation. Radar interpretation is mentioned in chapter 12 of this manual, and for a more detailed discussion, refer to the *Federal Meteorological Handbook No. 7, Part B*, and the *Federal Meteorological Handbook No. 11, Part B*.

THUNDERSTORM FLIGHT HAZARDS

Thunderstorms are often accompanied by extreme fluctuations in ceiling and visibility. Every thunderstorm has turbulence, sustained updrafts and downdrafts, precipitation, and lightning. Icing conditions, though quite localized, are quite common in thunderstorms, and many contain hail. The flight

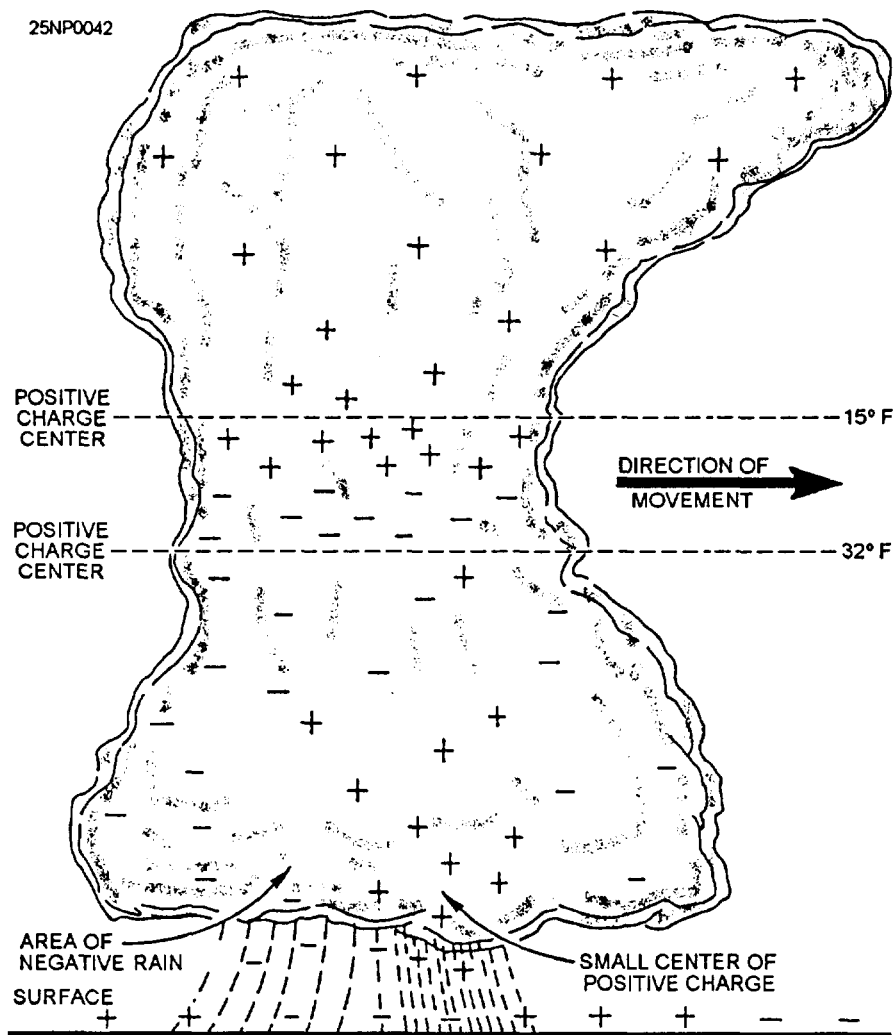

Figure 5-1.-Location of electric charges inside a typical thunderstorm cell.

conditions listed below are generally representative of many (but not necessarily all) thunderstorms.

- The chance of severe or extreme turbulence within thunderstorms is greatest at higher altitudes, with most cases of severe and extreme turbulence about 8,000 to 15,000 feet above ground level (AGL). The least turbulence may be expected when flying at or just below the base of the main thunderstorm cloud. (The latter rule would not be true over rough terrain or in mountainous areas where strong eddy currents produced by strong surface winds would extend the turbulence up to a higher level.)

- The heaviest turbulence is closely associated with the areas of heaviest rain.

- The strongest updrafts are found at heights of about 10,000 feet AGL or more; in extreme cases, updrafts in excess of 65 feet per second occur.

Downdrafts are less severe, but downdrafts on the order of 20 feet per second are quite common.

- The probability of lightning strikes occurring is greatest near or slightly above the freezing level.

Because of the potential hazards of flying in a thunderstorm, it is obviously nothing short of folly for pilots to attempt to fly in thunderstorms, unless operationally necessary.

THUNDERSTORM SURFACE PHENOMENA

The rapid change in wind direction and speed immediately before thunderstorm passage is a significant surface hazard associated with thunderstorm activity. The strong winds that accompany thunderstorm passage are the result of horizontal spreading of downdraft currents from within the storm as it approaches the ground.

Figure 5-2 shows the nature of the wind outflow and indicates how it is formed from the settling dome of cold air that accompanies the rain core during the mature stage of the thunderstorm. The arrival of this outflow results in a radical and abrupt change in the wind speed and direction. It is an important consideration for aircraft that are landing or taking off.

Wind speeds at the leading edge of the thunderstorm are ordinarily far greater than those at the trailing edge. The initial wind surge observed at the surface is known as the first gust. The speed of the first gust is normally the highest recorded during thunderstorm passage, and it may vary as much as 180 degrees in direction from the surface wind direction that previously existed. The mass of cooled air spreads out from downdrafts of neighboring thunderstorms (especially in squall lines), and often becomes organized into a small, high-pressure area called a *bubble high*, which persists for some time as an entity that can sometimes be seen on the surface chart. These highs may be a mechanism for controlling the direction in which new cells form.

The speed of the thunderstorm winds depends upon a number of factors, but local surface winds reaching 50 to 75 miles per hour for a short time are not uncommon. Because thunderstorm winds can extend several miles in advance of the thunderstorm itself, the thunderstorm wind is a highly important consideration for pilots preparing to land or take off in advance of a storm's arrival. Also, many thunderstorm winds are strong enough to do considerable structural damage, and are capable of overturning or otherwise damaging even medium-sized aircraft that are parked and not adequately secured.

The outflow of air ahead of the thunderstorm sets up considerable low-level turbulence. Over relatively level ground, most of the significant turbulence associated with the outrush of air is within a few hundred feet of the ground, but it extends to progressively higher levels as the roughness of the terrain increases.

THUNDERSTORM ALTIMETRY

During the passage of a thunderstorm, rapid and marked surface pressure variations generally occur. These variations usually occur in a particular sequence characterized as follows.

- An abrupt fall in surface pressure as the storm approaches.
- An abrupt rise in surface pressure associated with rain showers as the storm moves overhead (often associated with the first gust).
- A gradual return to normal surface pressure after thunderstorm passage, and the rain ceases.

Such pressure changes may result in significant pressure altitude errors on landing.

Of greater concern to the pilot are pressure altitude readings that are too high. If a pilot used an altimeter setting computed during the maximum pressure, and then landed after the pressure had fallen, the altimeter still could read 60 feet or more above the true altitude after landing.

Here is where you, as a forecaster, can make certain that timely and accurate altimeter settings are furnished to the tower for transmission to pilots during

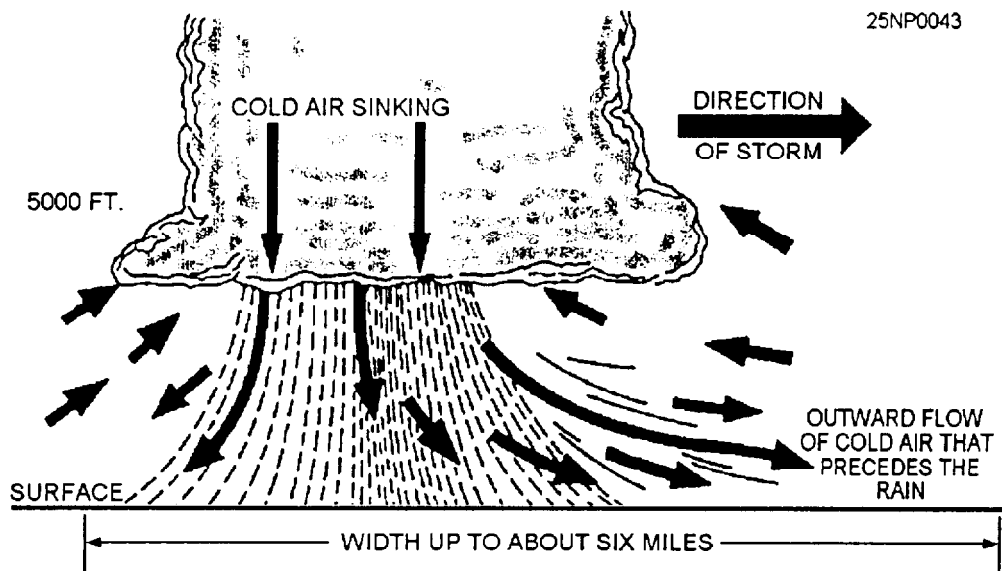

Figure 5-2.-Cold dome of air beneath a thunderstorm cell in the mature stage. Arrows represent deviation of windflow. Dashed lines indicate rainfall.

thunderstorm conditions. If the data are old and inaccurate, an aircraft mishap could result.

THUNDERSTORM FORECASTING

The standard method of forecasting air mass thunderstorms has long consisted primarily of an analysis of rawinsonde data with particular emphasis on the so-called "positive areas."

Many times conditions are favorable for thunderstorm development, with a large positive energy area showing up on the sounding, with no ensuing thunderstorm activity. At other times, thunderstorms may occur when they are not forecasted. Clearly, factors other than instability are important, and, at times, of overriding importance.

A number of thunderstorm forecasting methods have been developed, but many of these are beyond the scope of this manual. The forecasting of convective clouds by using variations of the parcel method are covered in this section. Further, a method for the prediction of these storms that enables the forecaster to arrive at a fairly accurate, reasonably objective forecast will be discussed.

For a more detailed discussion of the determinations of instability, stability, the convective condensation level (CCL), the level of free convection (LFC), and the lifting condensation level (LCL), refer to the *AG2 TRAMAN*, volume 2.

THE PARCEL METHOD

The temperature of a minute parcel of air is assumed to change adiabatically as the parcel is displaced vertically from its original position. If, after vertical displacement, the parcel has a higher virtual temperature than the surrounding atmosphere, the parcel is subjected to a positive buoyancy force and will be further accelerated upwards; conversely, if its virtual temperature has become lower than that of the surrounding air, the parcel will be denser, and eventually return to its initial or equilibrium position,

Formation of Clouds by Heating From Below

The first step is to determine the convection temperature or the surface temperature that must be reached to start the formation of convection clouds by solar heating of the surface air layer. The procedure is to first determine the CCL on the plotted sounding and, from the CCL point on the T curve, proceed downward along the dry adiabat to the surface pressure isobar. The

temperature read at this intersection is the convection temperature.

Figure 5-3 shows an illustration of forecasting afternoon convective cloudiness from a plotted sounding. The dewpoint curve was not plotted to avoid confusion. The dashed line with arrowheads indicates the path the parcel of air would follow under these conditions. You can see that the sounding was modified at various times during the day.

To determine the possibility of thunderstorms by the use of this method and from an analysis of the sounding, the following conditions must exist:

- Sufficient heating must occur.
- The positive area must exceed the negative area. The greater the excess, the greater the possibility of thunderstorms.
- The parcel must rise to the ice crystal level. Generally, this level should be -10°C and below.
- There must be sufficient moisture in the lower troposphere. This is the most important single factor in thunderstorm formation.
- Climatic and seasonal conditions should be favorable.
- A weak inversion (or none at all) should be present in the lower levels.
- An approximate height of the cloud top may be determined by assuming that the top of the cloud will extend beyond the top of the positive area by a distance equal to one-third of the height of the positive area.

Formation of Clouds by Mechanical Lifting

When using this method, it is assumed that the type lifting will be either orographic or frontal. Here we will be concerned with the Lifting Condensation Level (LCL) and the Level of Free Convection (LFC).

The LCL is the height at which a parcel of air becomes saturated when it is lifted dry adiabatically. The LCL for a surface parcel is always found at, or below, the CCL. The LFC is the height at which a parcel of air is lifted dry adiabatically until saturated, and thereafter would first become warmer than the surrounding air. The parcel will then continue to rise freely above this level until it becomes colder than the surrounding air.

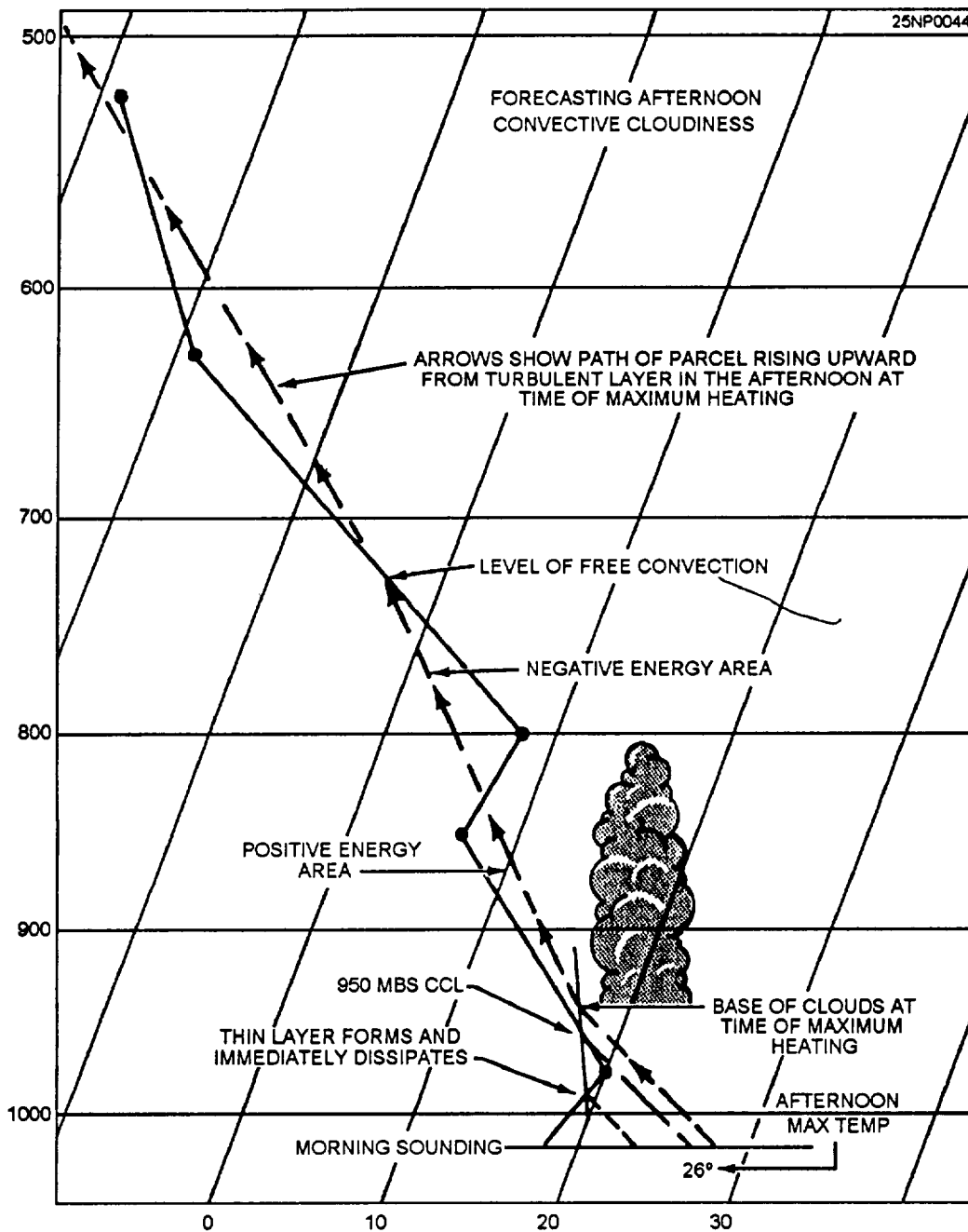

Figure 5-3. Forecasting afternoon convective cloudiness.

Figure 5-4 shows the formation of clouds due to mechanical lifting. This figure shows the formation of a stratified layer of clouds above the LCL, and to the LFC. At the LFC and above, the clouds would be turbulent. The tops of the clouds extend beyond the top of the positive area due to overshooting, just as clouds formed due to heating.

To determine the possibility of thunderstorms from this method, the following conditions should be met:

- The positive area must exceed the negative area; the greater the excess, the greater the possibility of thunderstorms,
- There must be sufficient lifting for the parcel to reach the LFC, The frontal slope or the orographic barriers can be used to determine how much lifting can be expected,
- The parcel must reach the ice crystal level (-10°C and below).

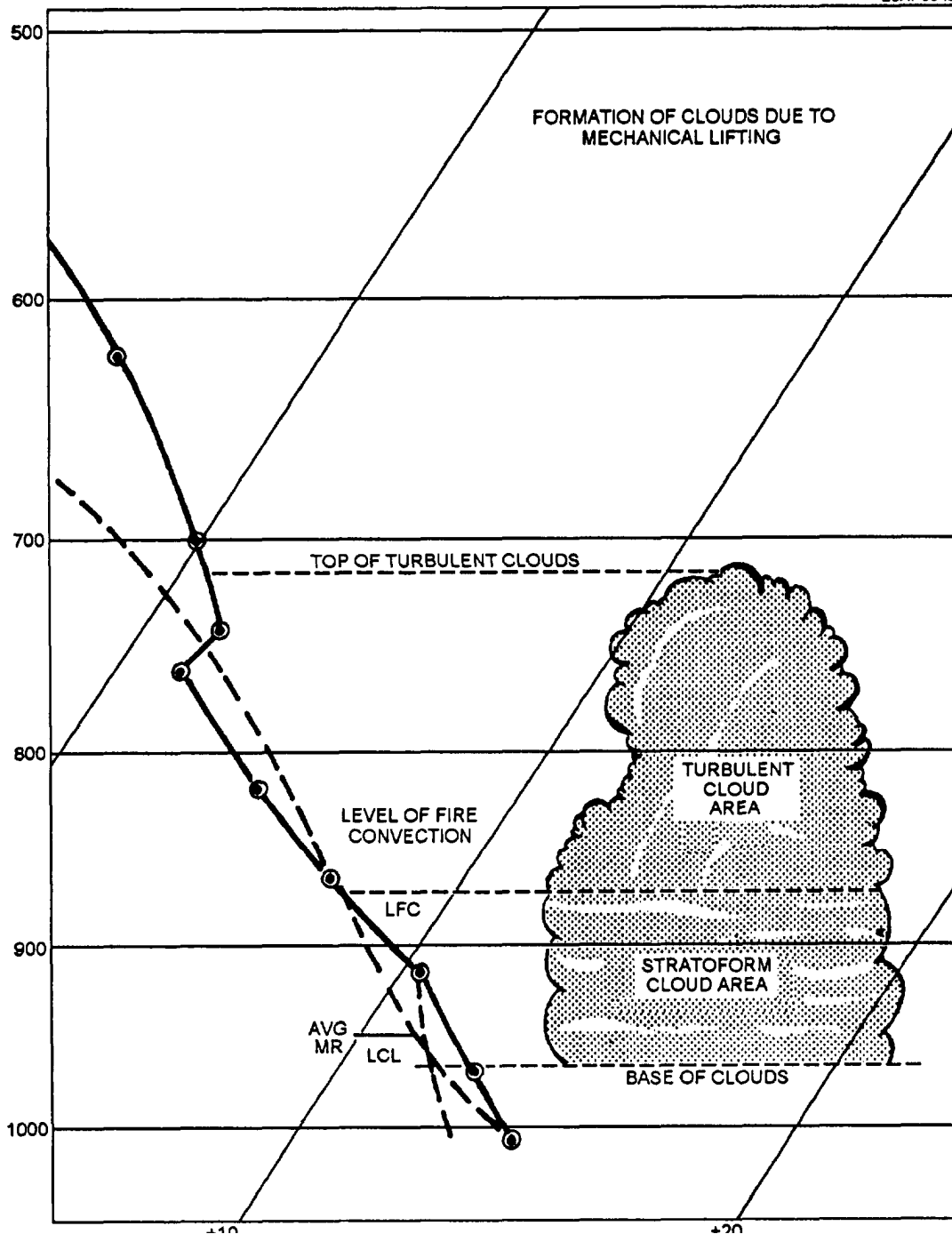

Figure 5-4. Formation of clouds due to mechanical lifting.

- Even though the positive area does not exceed the negative area, cloudiness occurs after the parcel passes the LCL, and precipitation may occur after the parcel passes the ice crystal level.

One main advantage of this method is that it can be done quickly and with relative ease. A major disadvantage is that it assumes that the parcel does not change its environment, and that it overestimates or underestimates the stability and instability conditions.

INSTABILITY INDICATIONS FROM THE WET-BULB CURVE

A layer of the atmosphere is potentially unstable if the potential wet-bulb temperature decreases with altitude. Potential instability refers to a layer that is lifted as a whole. The wet-bulb temperature may be found by lifting each individual point on the sounding dry adiabatically to saturation, and then back to its

original level moist adiabatically. By connecting the points on a sounding, a wet-bulb curve can be constructed.

If the wet-bulb curve slopes to the right with increasing altitude, the potential wet-bulb temperature increases with height, and the layer is potentially stable. If it slopes to the left with increasing height, more than the saturation adiabats, the layer is potentially unstable. If none of the potential curves intersect the sounding, thunderstorms are not likely to occur.

AIR-MASS THUNDERSTORMS

This method is a reasonably simple method for forecasting air-mass thunderstorms in the Eastern United States. It does require prediction of short-range changes in the vertical distribution of temperature and moisture.

- The first consideration is to eliminate those areas whose soundings disclosed one or more of the following moisture inadequacies:

- The Dewpoint depression is 13°C or more at any level from 850 through 700 hPa.

- The Dewpoint depression sum is 28°C or more at 700- and 600-hPa levels.

- There is dry or cool advection at low levels.

- The surface dewpoint is 60°F or less at 0730 local with no substantial increase expected before early afternoon.

- There is a lapse rate of 21°C or less from 850 to 500 hPa.

- There is a freezing level below 12,000 feet in an unstable cyclonic flow, producing only light showers.

After eliminating all soundings that meet one or more of the previous six conditions, you should use the following parameters to make the forecast.

- The lapse rate between 850 and 500 hPa.

- The sum of the dewpoint depressions at 700 and 600 hPa in degrees C.

NOTE: The lapse rate is the difference in temperature between these two pressure levels. For example, if the temperature at 850 hpa was 15°C and at 500hPa it was -10°C, the difference would equal 25°.

These two computations are used as arguments for the graph in figure 5-5.

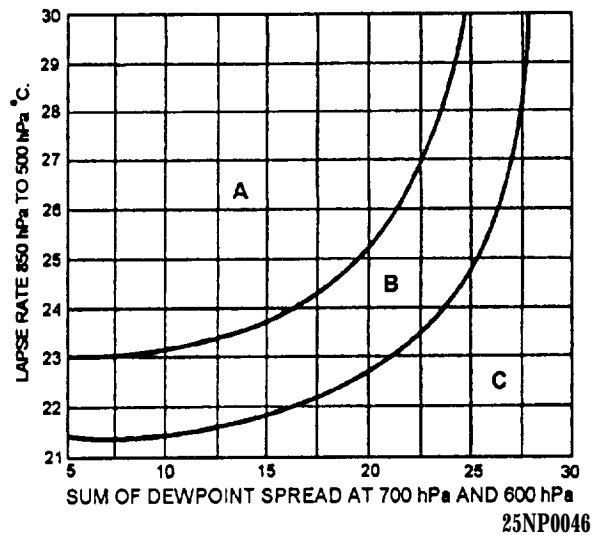
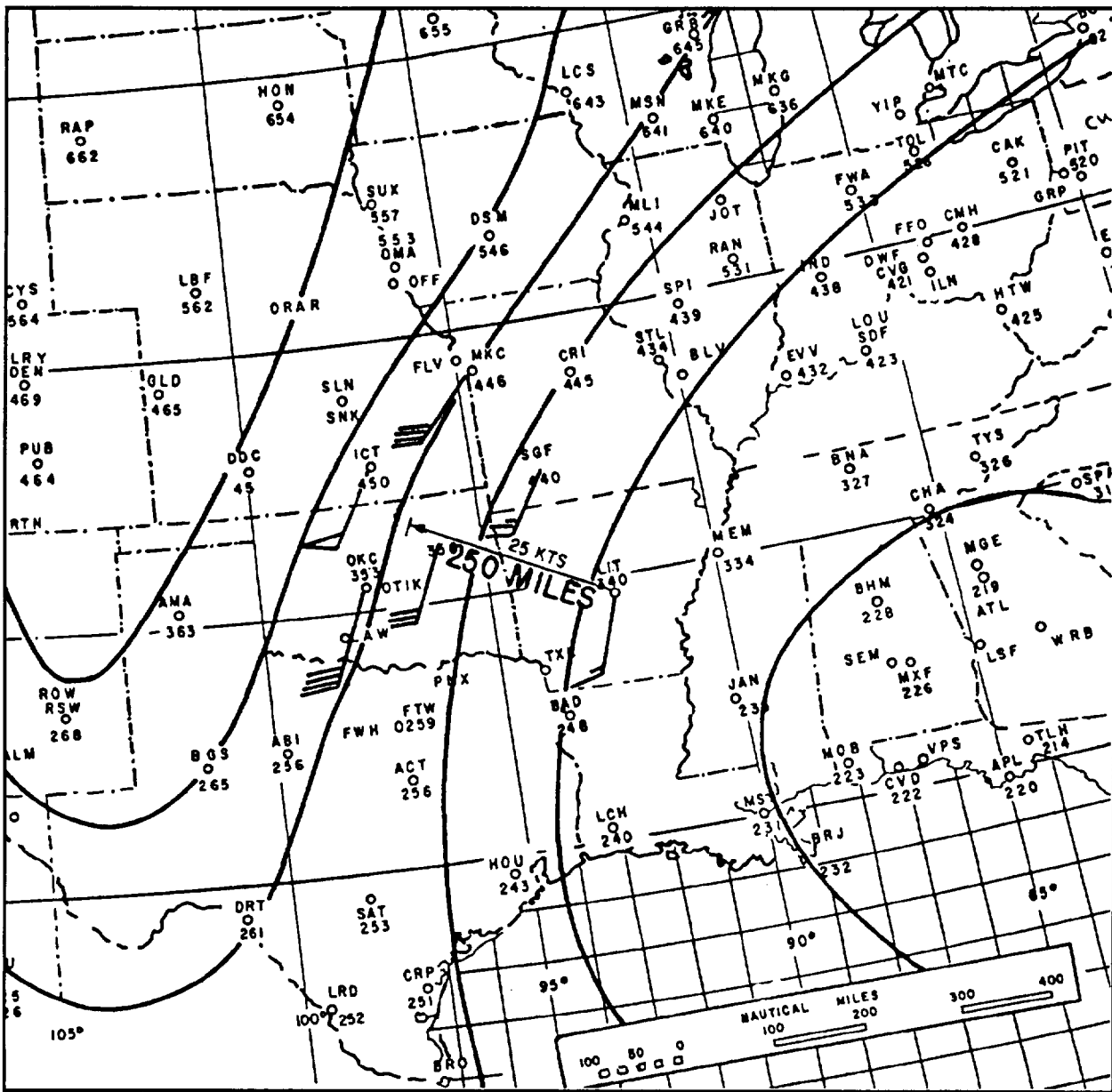

Figure 5-5.-Local area thunderstorm graph. Area “A” is isolated thunderstorms, with a 12 to 1 chance of at least one rain gauge in dense network receiving rain. Area “B” is scattered thunderstorms, with a 4 to 1 chance of reported rain. Area “C” is no rain.

One further condition for the development of thunderstorms is the absence of large anticyclonic wind shear, which is measured at 850 hPa. No horizontal shear at this level may exceed 20 knots in 250 miles measured toward the low-pressure area from the sounding station. Figure 5-6 illustrates how this measurement is made.

STABILITY INDEXES AS AN INDICATION OF INSTABILITY

The overall stability or instability of a rawinsonde sounding is sometimes conveniently expressed in the form of a single numerical value called the stability index. Such indexes have been introduced mainly as aids in connection with particular forecasting techniques. Most of the indexes take the form of a difference in temperature, dewpoint, wet-bulb temperature, or potential temperature in height or pressure between two arbitrarily chosen surfaces. These indexes are generally useful only when combined, either objectively or subjectively, with other data and synoptic considerations. Used alone, they are less valuable than when plotted on stability index charts and analyzed for large areas. In this respect they have the value of alerting the forecaster to those soundings, routes, or areas that should be more closely examined by other procedures.



25NP0047

Figure 5-6.-Example of anticyclonic shear and curvature at 850 hPa preventing thunderstorms, with otherwise favorable air mass conditions present in the Little Rock area.

There are a number of methods that maybe used for determining stability or instability. Among these methods are the Showalter Stability Index (SSI), the Lifted Index (LI), the Fawbush-Miller Stability Index (FMI), and the Martin Index (MI). Only the SSI method will be discussed in this TRAMAN.

The National Weather Service currently uses the (LI) method for producing their facsimile products. All current methods are discussed in detail in NAVAIR

50- IP-5, *Use of the Skew T, Log P Diagram in Analysis and Forecasting.*

For more information on the SSI, the forecasting of peak wind gusts, and the forecasting of hail, refer to the AG2 TRAMAN, volume 2, unit 6. These subjects are covered in an abbreviated form in this chapter.

The SSI is the most widely used of the various types of indexes.

Figure 5-7 shows the computation of the SSI.

For forecasting purposes, the significance of the index values to forecasting is as follows:

- When the index is $+3^{\circ}\text{C}$ or less, showers are probable, and some thunderstorms may be expected in the area.
- The chance of thunderstorms increases rapidly for index values in the range of $+1^{\circ}\text{C}$ to -2°C .
- Index values of -3°C or less are associated with severe thunderstorms.
- When the value of the index is below -6°C , the forecaster should consider the possibility of tornado occurrence. However, the forecasting value of all index categories must, in each case, be evaluated in the light of the moisture content of the air and of other synoptic conditions.

FORECASTING MOVEMENT OF THUNDERSTORMS

Radar can be an invaluable aid in determining the speed and the direction of movement of the thunderstorm. Sometimes it is desirable and necessary to estimate the movement from winds aloft. There is no completely reliable relationship between speed or direction of the winds aloft in forecasting thunderstorm movement. However, one study reveals that there is a marked tendency for large convective rainstorms to move to the right of the wind direction in the mean cloud layer from 850 to 500 hPa (or the 700-hPa wind) with a deviation of about 25 degrees. There appears to be little correlation between wind speed and speed of movement at any level, although the same study mentioned above revealed that 82 percent of the storms move within plus or minus 10 knots of a mean speed of 32 knots.

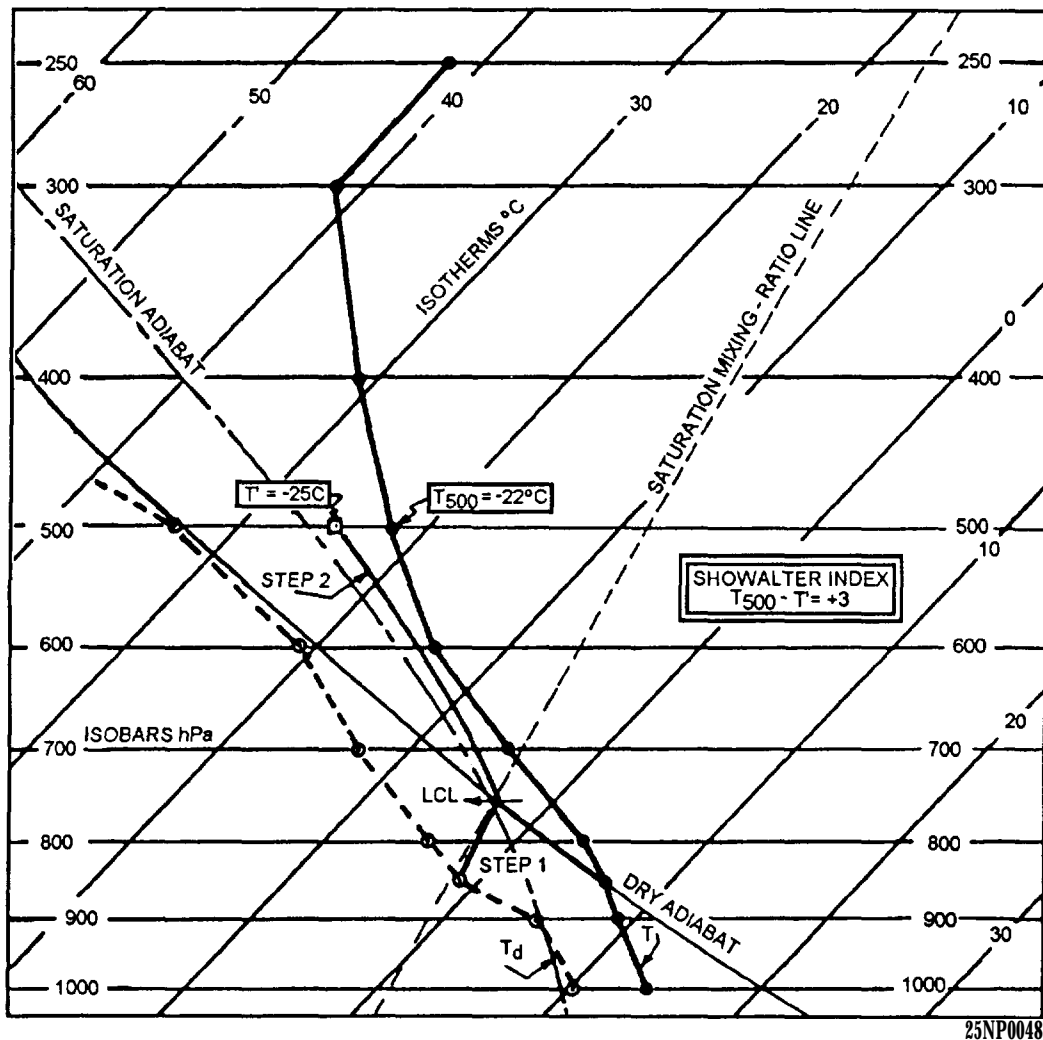

Figure 5-7.-Computation of the Showalter Stability Index (SSI).

FORECASTING MAXIMUM GUSTS WITH NONFRONTAL THUNDERSTORMS

Maximum gusts associated with thunderstorms occur over a very small portion of the area in which the thunderstorm exists, and usually occur immediately before the storm's passage. Nevertheless, the possibility of damage to aircraft and installations on the surface is so great that every available means should be used to make the best and most accurate forecast possible to forewarn the agencies concerned.

Estimation of Gusts From Climatology and Storm Intensity

The forecaster is aware that the season of the year and the station location have a great bearing upon the maximum winds to be expected. Certain areas of the United States, and the world, have a history of severe thunderstorm occurrence with associated strong winds during the most favorable seasons of the year. For this reason you should have the thunderstorm climatology for your station, as well as for the general area, available as to time of occurrence, season of occurrence, and the associated conditions.

The storm's intensity and reports from neighboring stations can give you a good indication of conditions to expect at your station.

Forecasting Peak Wind Gusts Using the USAF Method

Refer to the AG2 TRAMAN, volume 2, unit 6, for an explanation of two methods for forecasting maximum wind gusts of convective origin. One involves the use of the Dry Stability Index (T_1) and the other the downrush temperature subtracted from the dry-bulb temperature (T_2).

FORECASTING HAIL

Hail, like the maximum wind gusts in thunderstorms, usually takes place in a narrow shaft that is seldom wider than a mile or 2 and usually less than a mile wide. The occurrence of hail in thunderstorms was discussed earlier in this chapter. However, a few additional facts concerning the occurrence and frequency of hail in flight should be discussed at this point.

- Since hail is normally associated with thunderstorms, the season of the maximum occurrence

of hail is coincident with the season of maximum occurrence of thunderstorms.

- When the storm is large and well developed, an assumption should be made that it contains hail.

- Encounters of hail below 10,000 feet show the hail distribution to be equally divided between the clear air alongside the thunderstorm, in the rain area beneath the storm, and within the thunderstorm itself.

- From 10,000 to 20,000 feet, the percentages range from 40 percent in the clear air alongside the storm to 60 percent in the storm, with 82 percent of the encounters outside the storm beneath the overhanging cloud.

- Above 20,000 feet, the percentages reflect 80 percent of the hail is encountered in the storm with 20 percent in the clear air beneath the anvil or other cloud extending from the storm.

Climatology is of vital importance in predicting hail occurrence, as well as hail size. Good estimations of the size of hail can be gleaned from reports of the storm passage over nearby upstream stations. Here too, modifying influences must be taken into account.

Hail Frequency as Related to Storm Intensity and Height

Fifty percent hail frequencies may be expected in storms exceeding 46,000 feet, based on radar reports. With a maximum echo height of 52,000 feet, a 67 percent hail frequency can be expected; and only 33 percent at 35,00 feet. Mean echo heights are 42,000 feet for hail and 36,000 feet for rain.

A Yes-No Hail Forecasting Technique

The technique presented in this section of the chapter is an objective method of hail forecasting. It uses the parameters of the ratio of cloud depth below the freezing level and height of the freezing level. The data used in this study were derived from 70 severe convective storms (34 hail-producing and 36 nonhail-producing storms) over the Midwestern States. Severe thunderstorms, as used in the development of this technique, were defined as those thunderstorms causing measurable property damage due to strong winds, lightning, or heavy rain. Severe thunderstorms with accompanying hail were defined as those thunderstorms accompanied by hail where hail was listed as the prime cause of property damage, even though other phenomena may also have occurred. All

tornadoes were excluded from consideration to avoid confusion.

METHOD OF ANALYSIS.— Plot representative upper air soundings (0000 UTC and 1200 UTC) on the Skew T diagram. Then analyze the following parameters:

- Convective condensation level (CCL).

- Equilibrium level (EL). The EL is found at the top of the positive area on the sounding where the temperature curve and the saturation adiabat through the CCL again intersect. This gives a measure of the extent of the cloud's vertical development, and thus an estimate of its top or maximum height.

- Freezing level. This is defined as the height of the zero degree isotherm.

NOTE: All three heights are expressed in units of hectopascals (hPa).

Next determine the following two parameters:

1. The ratio of the cloud depth below the freezing level (distance in hectopascals from the CCL to the freezing level) to the cloud's estimated vertical

development (distance from the CCL to the EL in hectopascals) is defined as the cloud depth ratio. For example, if the CCL was at 760 hpa, the freezing level at 620 hPa, and the EL at 220 hpa, then the cloud depth ratio would be computed as follows:

$$\text{Cloud depth ration} = \frac{140}{540} = .26$$

2. Height of the freezing level in hectopascals (620 hpa).

With step 1 as the vertical axis and step 2 as the horizontal axis, use figure 5-8 for occurrence or nonoccurrence of hail. In this case, hail would be forecast if the value falls in the hail forecast area.

EVALUATION.— Using the data in 70 dependent cases, the correct percent for prediction of hail or no hail was 83 percent. This technique combines the two parameters relating hail to convective activity into a single predictor. Although the data used in this study were from the Midwest, the application need not be confined to that area. With some modification of this diagram, this method could serve as a basis for a local forecasting tool for other areas.

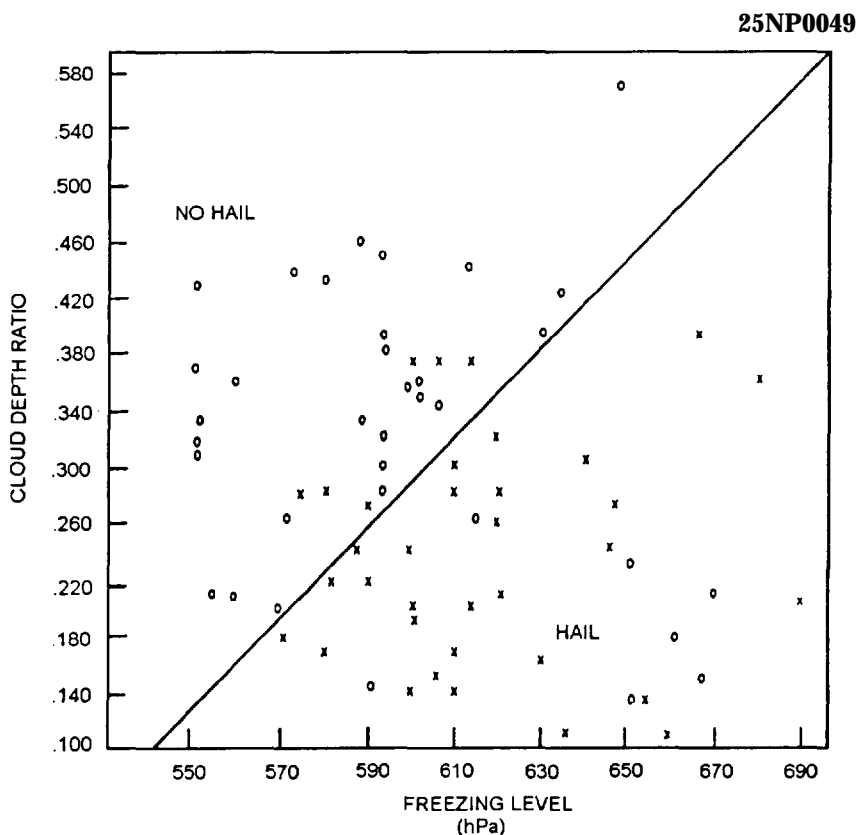

Figure 5-8.-Scattered diagram showing the distribution of selected hail occurrences at certain Midwestern stations during the spring and summer of 1994 and 1995. The freezing level is plotted against the cloud depth ratio. (X = hail reported. 0 = no hail reported.)

Hail Size Forecasting

Once the forecaster has determined that the probability of hail exists, as previously outlined, the next logical question will relate to the size of the hail that may be anticipated. The following text discusses the method that uses the Skew T Log P diagram.

The first step in forecasting hail is to determine the convective condensation level (CCL). This parameter is evaluated on the adiabatic chart by finding the mean mixing ratio in the moist layer of the lowest 150 hPa.

and following this saturation, mixing ratio line to its intersection with the sounding dry-bulb temperature curve. Next, the moist adiabat through the CCL is traced up to the pressure level where the dry-bulb temperature is -5°C . This pressure level, the dry-bulb temperature curve, and the moist adiabat through the CCL form a triangle, outlining a positive area. Figure 5-9 illustrates this procedure. The horizontal coordinate in figure 5-9 is the length of the horizontal side of the triangle in degrees Celsius. The length is measured from the pressure at the base of the triangle.

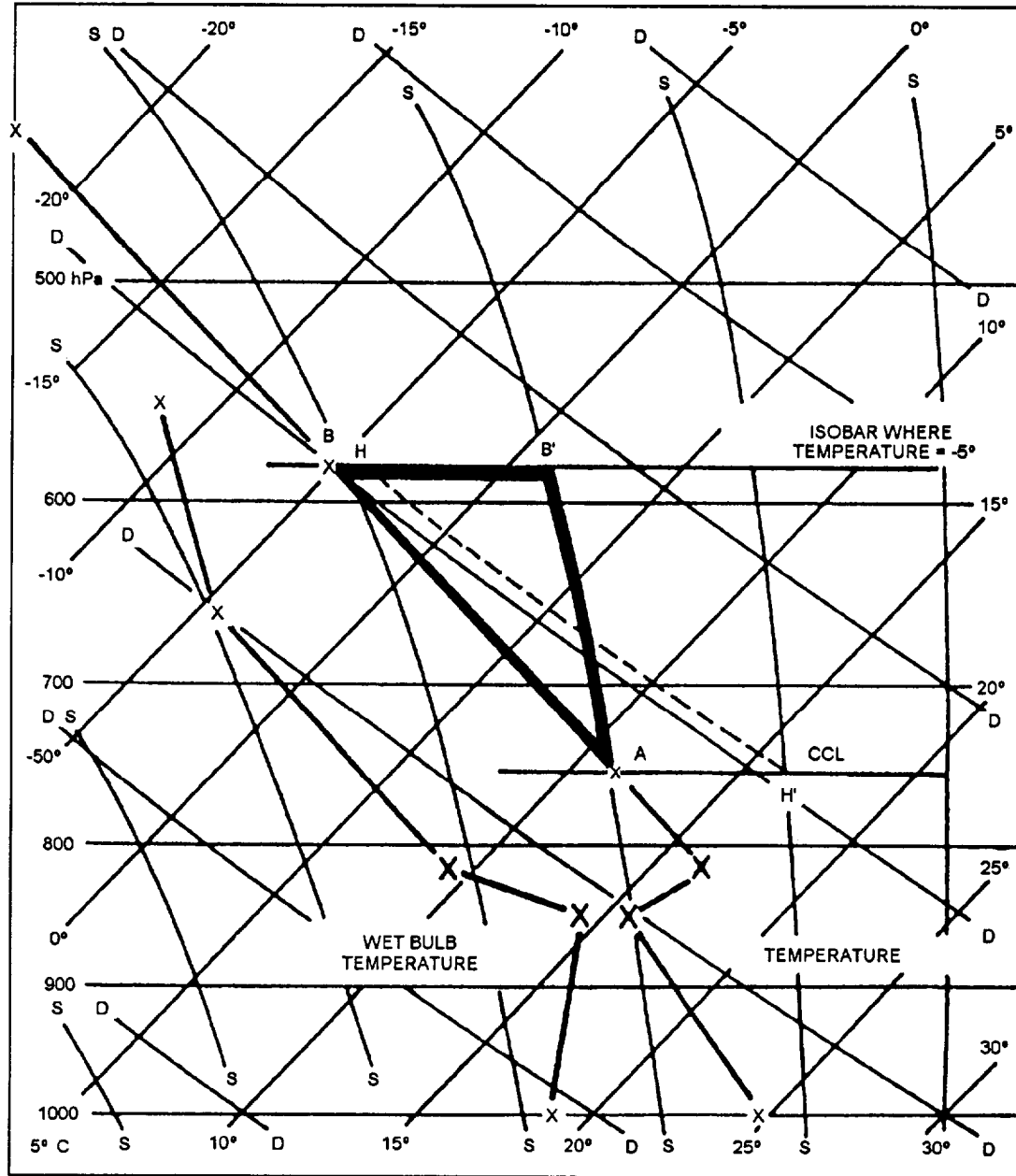

25NP0050

Figure 5-9. Example of hail size forecast sounding.

These computations for the horizontal length in degrees and altitude in degrees are used on the graph in figure 5-10, and for the forecast of hailstone diameter.

EXAMPLE OF TECHNIQUE.— In the sounding shown in figure 5-9, the CCL is point A. The moist adiabat from the CCL to the pressure level, where the temperature is -5°C , is the line AB' . The isobar from the point where the air temperature is -5°C to its intersection with the moist adiabat is the line BB' . The

dry adiabat from the isobar BB' through the triangle to the pressure of the CCL is the line HH' . The base of the triangle in degrees Celsius is 6°C (from plus 1 to minus 5). The length of the dry adiabat through the triangle is 21°C (from minus 4 to plus 17).

EVALUATION.— The value on the graph in figure 5-10, with a horizontal coordinate of 6 and a vertical coordinate of 21, is a forecast of 1-inch hail.

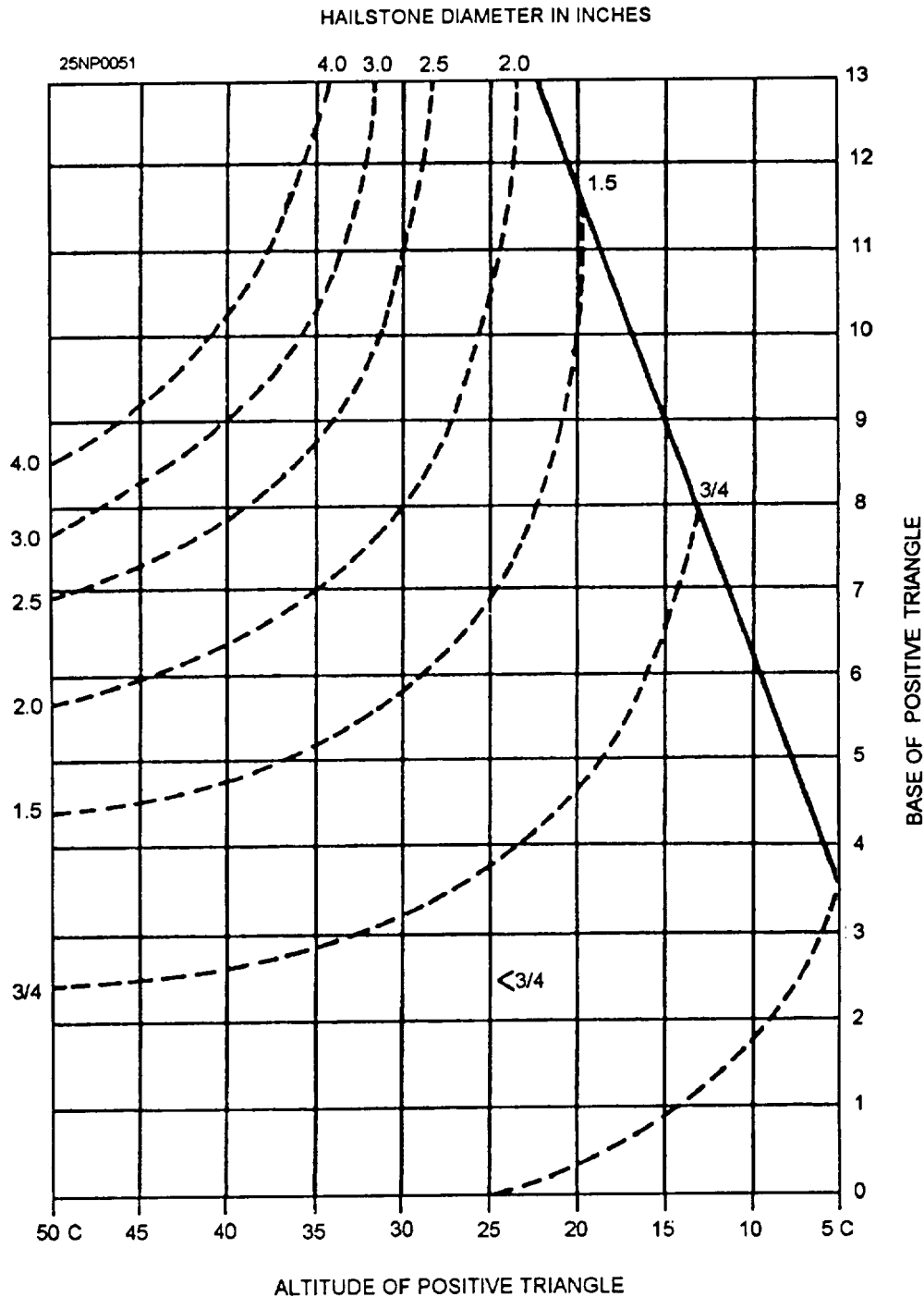

Figure 5-10.-Fawbush-Miller Hail Graph showing forecast hailstone diameter in inches.

To more accurately forecast hail size in conjunction with thunderstorms along the Gulf Coast or in any air mass where the Wet-Bulb-Zero height is above 10,500 feet, it is necessary to refer to the graph in figure 5-11. The hail size derived from figure 5-10 is entered on the horizontal coordinate of figure 5-11, and the corrected hail size read off is compatible with the height of the Wet-Bulb-Zero temperature.

LEARNING OBJECTIVES: Analyze areas conducive to tornadic activity. Identify the three general types of tornadoes. Recognize the difference between tornadoes and waterspouts.

A Thunderstorm Checklist

Regardless of where you are forecasting, the factors and parameters favorable for thunderstorm, hail, and gust forecasting should be systematized into some sort of checklist to determine the likelihood and probability of thunderstorms and the attendant weather. Figure 5-12 is a suggested format and checklist to ensure that all parameters have been given due consideration.

Tornadoes are violently rotating columns of air extending downward from a cumulonimbus cloud. They are nearly always observed as funnel clouds. Their relatively small size ranks them as second in the severity of the damage they cause, with tropical cyclones ranking first. They occur only in certain areas of the world, and are most frequent in the United States in the area bounded by the Rockies to the west and the Appalachians to the east. Tornadoes also occur during certain preferred seasons of the year in the United States,

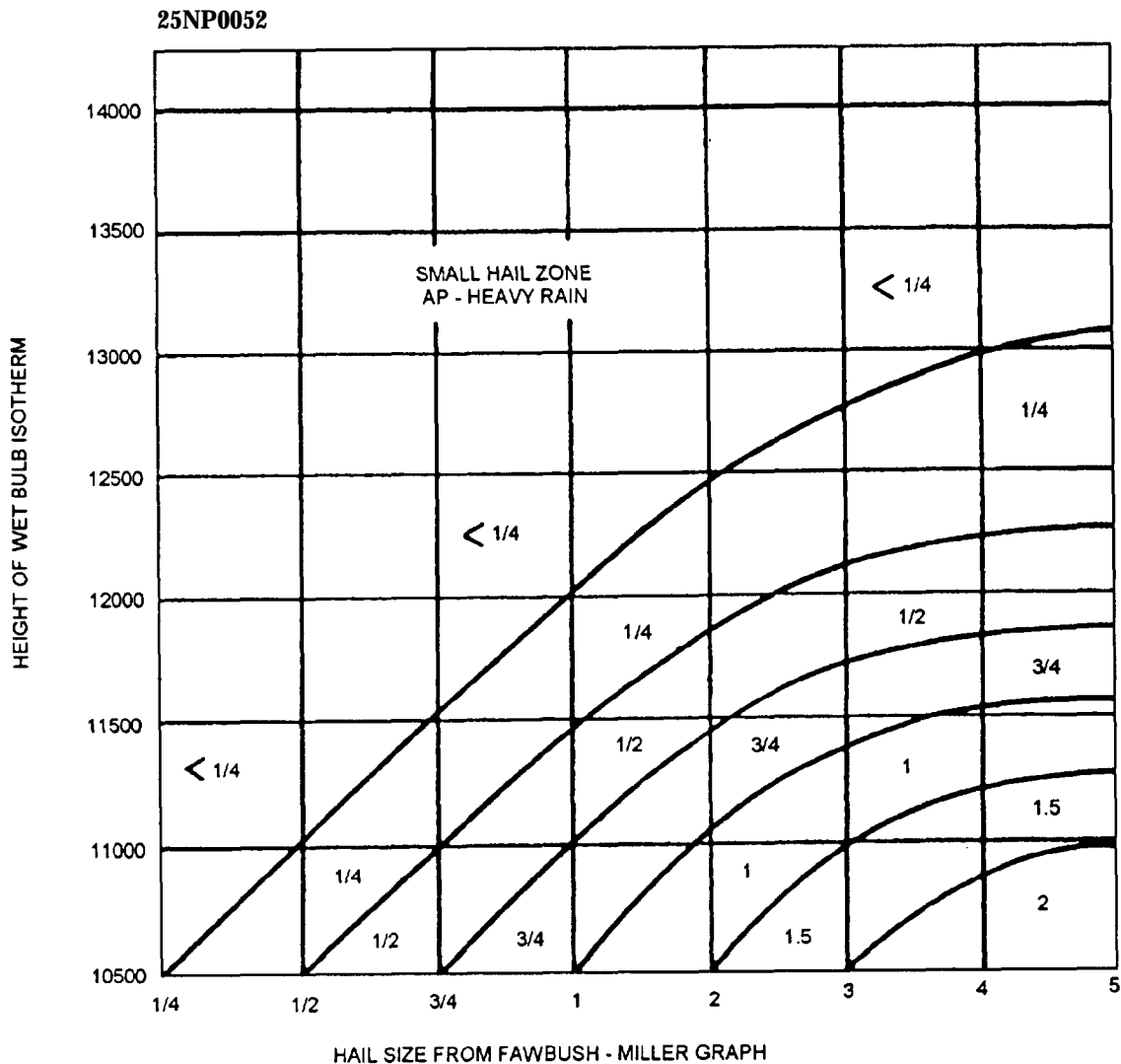

Figure 5-11.-Hail size at surface expected from tropical air mass thunderstorm.

WORKSHEET

SUGGESTED CHECKLIST FOR THE DETERMINATION OF AIR MASS THUNDERSTORM ACTIVITY

I. Analyze the Skew T Logo P Diagram using the closest sounding & parcel methods

1. Determine the following

- | | |
|---|--------------------------|
| a. Convective condensation level (CCL) | <u>5,000'</u> |
| b. Temperature necessary for convection | <u>+28°C (82.4°F)</u> |
| c. Maximum temperature forecast | <u>+30°C (86°F)</u> |
| d. Is temperature necessary for convection expected to be reached? | <u>YES</u> |
| e. Inversions present? (Stg/Weak/Mdt/Height) | <u>NONE</u> |
| f. Inversions strong enough to prevent or retard convection activity | <u>NO</u> |
| g. Positive energy area favorable/unfavorable | <u>FAV</u> |
| h. Does positive energy area extend well above the freezing level? (Preferably above the -10° C isotherm) | <u>YES</u> |
| i. Does moist layer extend to 10,000 ft? | <u>YES</u> |
| j. At least 3 gr/kg moisture 12,000 ft | <u>YES (4.5)</u> |
| k. Conditionally unstable air extent to 16,000' | <u>YES</u> |
| l. Stability index (fav/unfav) | <u>-1 (FAV)</u> |
| m. Were thunderstorms or clouds of vertical development present previous day? If so, has there been any change at lower or upper levels to retard further development today | <u>YES - NO CHANGE</u> |
| n. Is month and time of year favorable climatologically for thunderstorm development? | <u>YES (6.4 PER MO.)</u> |
| 2. Forecast from consideration of a thru n. | <u>AFTN TSTMS</u> |

Note: The most important single predictor of daytime thunderstorms is moisture in the lower troposphere in the morning.

Determination of f. is of prime consideration. You must decide if heating and lift is sufficient to overcome the inversion.

25NP0053

Figure 5-12.-Suggested checklist for the determination of air mass thunderstorm activity.

II. Forecast from using the Bailey Graph

ScTD TSTMJ

III. Final forecast from all of the above considerations

ScTD AFTN

AIR MASS TSTMJ BETWEEN 14-1800 LOCAL

IV. Gusts

1. T₁ Manual Method

40 KT

2. Estimated from reports or
expected intensity of storm

38 KT

3. Final Forecast

39 KTS

V. Hail (SURFACE)

1. Yes-No Method

YES

2. Fawbush-Miller Method
Note if wet bulb zero above
10,500 ft.

1/2-1"

3. Estimated

1/2"

4. Forecast

1/2"

Figure 5-12.-Suggested checklist for the determination of air mass thunderstorm activity—Continued.

with their most frequent occurrence during May. The season of occurrence varies with the locality. In the United States, 80 percent of the tornadoes have occurred between noon and 2100 local time.

Complete details on the forecasting of these phenomena are beyond the scope of this training manual. You should consult the *U.S. Department of Commerce, Forecasting Guide No. 1, Forecasting Tornadoes and Severe Thunderstorms*, and the many other excellent texts and publications for a complete understanding of this problem. The senior Aerographer's Mate should have a basic understanding of the factors leading to the formation of such severe phenomena, to recognize potential situations, and to be able to forecast such phenomena.

SURFACE THERMAL PATTERNS AS A FORECASTING AID

This method indicates that thermal tongues averaging 50 miles or less in width are favored locations for tornado activity within the area of convective storm activity. These thermal tongues can be located quite readily on the surface synoptic chart. Use the following technique to supplement the existing tornado forecast.

The procedures to locate areas of potentially severe convective activity with reference to the synoptic surface thermal pattern are as follows:

1. Draw isotherms for every 2°C to locate thermal tongues.
2. Within the general area in which convective storms are forecast, locate the axis of all pronounced

thermal tongues oriented nearly parallel to the gradient flow.

3. On this axis, locate the point with the greatest temperature gradient within 50 to 100 miles to the right, and normal to the flow.

4. From this reference point, a rectangle is constructed with its left side along the axis of the thermal tongue by locating corner points on the axis 25 miles upstream and 125 miles downstream from the reference point. The rectangle is 150 miles long and 50 miles wide.

5. This is the forecast area for possible tornado or funnel cloud development.

TORNADO TYPES

There are three distinct tornadic types over the United States. They are the Great Plains type, the Gulf Coast type, and West Coast type.

Great Plains Type

This type of tornado will generally form on the squall line in advance of a fast moving cold front, hence its prediction involves timely forecasting of the squall line formation along, or in advance of, a cold front, upper cold front, or trough. Conditions must favor a downrush of air from aloft.

Gulf Coast Type

In contrast to the air mass type (Great Plains type), tornadoes also form in equatorial type air masses that are moist to great heights. Such storms are most common on the coasts of the Gulf of Mexico and produce the waterspouts often reported over Florida. Tornadoes are triggered in this air mass primarily by lifting at the intersection of a thunderstorm line with a warm front, and less frequently by frontal and prefrontal squall lines.

West Coast Type

Tornadoes also form in relatively cold moist air. This air mass tornado is the Pacific or West Coast type. It is responsible for waterspouts on the West Coast. Tornadoes in this type of air mass are normally in a rather extensive cloudy area with scattered rain showers and isolated thunderstorms. Clouds are mostly stratocumulus. Favorable situations for tornado development in this air mass type include the rear of

Maritime Polar (mP) cold fronts—well cooled air behind squall lines.

WATERSPOUTS

Waterspouts fall into two classes—tornadoes over water and fair weather waterspouts. The fair weather waterspout is comparable to a dust devil. It may rotate in either direction, whereas the other type of waterspout rotates cyclonically. In general, waterspouts are not as strong as tornadoes, in spite of the large moisture source and the reduced friction of the underlying surface. The water surface beneath a waterspout is either raised or lowered, depending on whether it is affected more by the atmospheric pressure reduction or the wind force. There is less inflow and upflow of air in a waterspout than in a tornado. The waterspout does not lift a significant amount of water from the surface. Ships passing through waterspouts have mostly encountered fresh water.

FORECASTING FOG AND STRATUS

LEARNING OBJECTIVES: Be familiar with the effects of air-mass stability on fog formation. Identify the procedures used in the forecasting of fog. Recognize conditions favorable for the formation of the various types of fog. Calculate fog parameters by using the Skew T Log P Diagram.

Fog and stratus clouds are hazardous conditions for both aircraft and ship operations. You will frequently be called upon to forecast formation, lifting, or dissipation of these phenomena. To provide the best information available, we will discuss the various factors that influence the formation and dissipation of fog and stratus.

EFFECT OF AIR MASS STABILITY ON FOG

Fog and stratus are typical phenomena of a warm air mass. Since a warm air mass is warmer than the underlying surface, it is stable, especially in the lower layers.

Through the use of upper air soundings, measurements can be made of temperature and relative humidity, from which stability characteristics can be determined. Refer to the publication, *Use of the Skew T, Log P in Analysis and Forecasting*, NAVAIR 50-IP-5, for complete information on analyzing upper air soundings.

GENERAL PROCEDURE FOR FORECASTING FOG

The synoptic situation, time of year, climatology of the station, air-mass stability, amount of cooling expected, strength of the wind, dewpoint-temperature spread, and trajectory of the air over favorable types of underlying surfaces are basic considerations you should take into account when forecasting fog.

Consideration of Geography and Climatology

Certain areas are more favorable climatologically for fog formation during certain periods of the year than others. All available information pertaining to climatology should be compiled for your station or operating area to determine the times and periods most favorable for fog formation.

You should also determine the location of the station with respect to air drainage or upslope conditions. Next, determine the type of fog to which your location would be exposed. For example, inland stations would be more likely to have radiation fog and shore coastal stations advection fog. A determination should then be made of air trajectories favorable for fog formation at your station.

Frontal Fog

Frontal fogs are associated with the forecasting of the movement of fronts and their attendant precipitation areas. For example, fogs can form in advance of a warm front, in the warm air section behind the warm front (when the warm air dewpoint is higher than the cold air temperature), or behind a slow moving cold front when the air becomes saturated.

Air-mass Fog

The first step in the forecasting of air-mass fogs is to determine the trajectory of the air mass and estimate the changes that are expected to occur during the night. If the air mass has been heated during the day and there was no fog the preceding morning, no

marked cloud cover during the day, and no overwater trajectory, fog will not form during the night. However, during fall and winter, nights are long and days are short, and conditions are generally stable. When a fog situation has been in existence, the same conditions tend to remain night after night, and the heating during the day is insufficient to effectively raise the temperature above saturation. Also, determine if the air has had a path over extensive bodies of water, and whether this path was sufficient to raise the humidity or lower the temperature sufficiently to form fog. Then construct nomograms, tables, etc., by using dewpoint depression against time of fog formation for various seasons and winds; modify these in the light of each particular synoptic situation.

FACTORS TO BE CONSIDERED IN FOG AND STRATUS FORMATION

Wind, saturation of the air mass, nocturnal cooling, and air-mass trajectories have a role in the formation of fog or stratus clouds.

Wind

Wind velocity is an important consideration in the formation of fog and/or low ceiling clouds.

When the temperature and dewpoint are near one another at the surface and eddy currents are 100 feet or more in vertical thickness, adiabatic cooling in the upward portion of the eddy could give the additional cooling needed to bring about saturation. Any additional cooling would place the air in a temporary supersaturated state. The extra moisture will then condense out of the air, producing a low ceiling cloud. Adiabatic heating in the downward portion of the eddy will usually evaporate the cloud particles. If all cloud particles evaporate before reaching the ground, the horizontal visibility should be good. However, if many particles reach the ground before evaporation, the horizontal visibility will be restricted by moderate fog. Clouds that form in eddy areas may at first be patchy and then become identified as *ragged stratus*. If the cloud forms into a solid layer, it will be a layer of stratus. When conditionally unstable air is present in the eddy, or if the frictional eddy currents are severe enough,

stratocumulus clouds will form in the area. See figure 5-13.

Saturation of the Air Mass

The saturation curve in figure 5-14 shows the amount of moisture in grams per kilogram the air will hold at various temperatures.

The air along the curve is saturated and is at its dewpoint. Any further cooling will yield water as a result of condensation; hence, fog or low ceiling clouds (depending upon the wind velocity) will form.

Nocturnal Cooling

Nocturnal cooling begins after the temperature reaches its maximum during the day. Cooling will continue until sunrise, or shortly thereafter. This cooling affects only the lower limits of the atmosphere. If nocturnal cooling reduces the temperature to a value near the dewpoint, fog or low clouds will develop. The wind velocity and terrain roughness will control the depth of the cooled air. Calm winds will allow a patchy

type of ground fog or a shallow, continuous ground fog to form. Winds of 5 to 10 knots will usually allow the fog to thicken vertically. Winds greater than 10 knots will usually cause low stratus or stratocumulus to form. See figures 5-15 and 5-16 for examples of fog and stratus formation.

The amount of cooling at night is dependent on soil composition, vegetation, cloud cover, ceiling, and other factors. Cloud cover based below 10,000 feet has a greenhouse effect on surface temperatures, absorbing some terrestrial radiation and reradiating a portion of this heat energy back to be absorbed by the land. This causes a reduction in nocturnal cooling. Nocturnal cooling between 1530 local and sunrise will vary from as little as 5° to 10° (with an overcast sky condition based around 1,000 feet), to 25° or 30°F with a clear sky or a cloud layer above 10,000 feet. Other factors and exceptions must also be considered. If a front is expected to pass the station during the night, or onshore winds are expected to occur during the night, the amount of cooling expected would have to be modified in light of these developments.

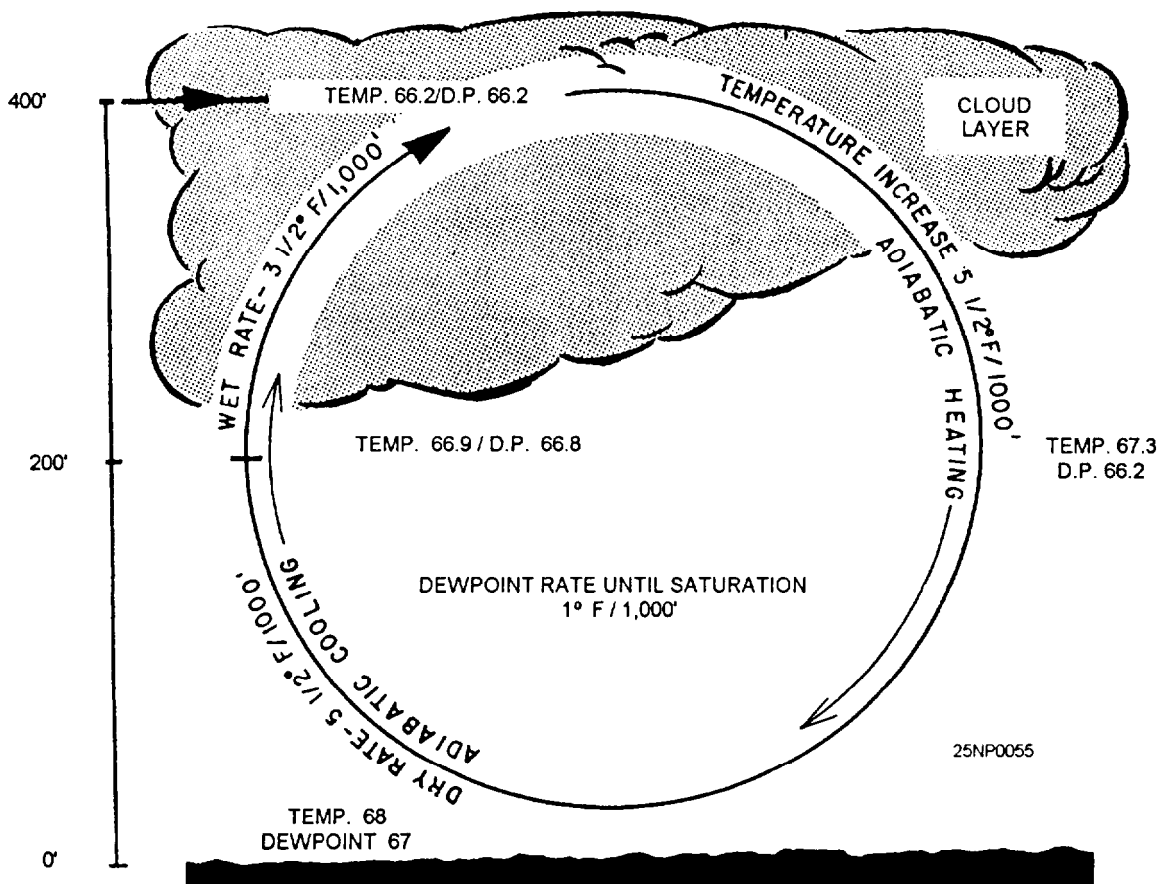

Figure 5-13. How wind velocity can cause a low cloud layer.

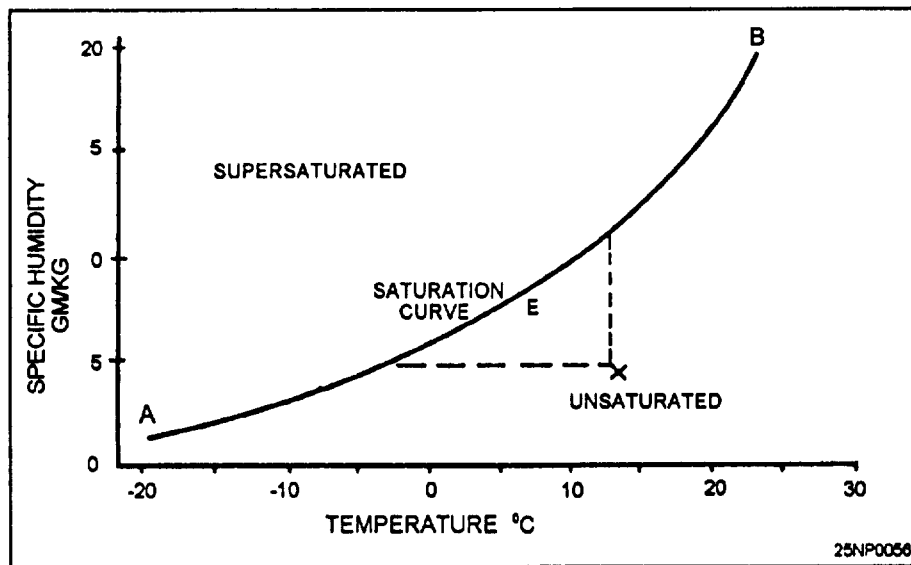

Figure 5-14.-Saturation curve.

An estimate of the formation time of fog, and possibly stratus, can be aided greatly if some type of saturation time chart, such as that illustrated in figure 5-17, can be constructed on which the forecasted temperature versus the forecasted dewpoint can be plotted. To use this diagram, note the maximum temperature and consider the general sky condition from the surface chart, forecasts, or sequence reports. By projecting the temperature and dewpoint temperature, an estimated time of fog formation can be forecast. If smoke is observed in the area, fog will normally form about 1 hour earlier than the formation line indicates on the charts because of the abundance of condensation nuclei.

Air-mass Trajectories

The trajectory of an air mass during the forecast period can be another important factor in fog formation. Warm air moving over a colder surface is a primary fog producer. This can happen when a station is in the warm sector, following a warm frontal passage. Cooling of the air mass takes place, allowing condensation and widespread fog or low stratus to form. To determine the probabilities of condensation behind a warm front, compare the temperature ahead of the front with the dewpoint behind the front. If the temperature ahead of the warm front is lower than the dewpoint behind the front, the air mass behind the front will cool to a temperature near the temperature ahead of the front, causing condensation and the formation of fog or low stratus.

Over water areas, warm air passing over cold water may cause enough cooling to allow condensation and the production of low clouds.

Another instance in which trajectory is important is when cold air moves over a warmer water surface, marsh land, or swamp, producing *steam fog*. In addition, air passing over a wet surface will evaporate a portion of the surface moisture, causing an increase in the dewpoint. Whenever there is a moisture source present, air will evaporate a portion of this moisture, unless the vapor pressure of the air is as great, or greater, than the vapor pressure of the water. A dewpoint increase may be enough to allow large eddy currents, nocturnal cooling, or terrain lifting to complete the saturation process and allow condensation to occur.

CONDITIONS FAVORABLE FOR GROUND OR RADIATION FOG

For the formation of ground or radiation fog, ideally, the air mass should be stable, moist in the lower layers, dry aloft, and under a cloud cover during the day, with clear skies at night. Winds should be light, nights long, and the underlying surface wet.

A stationary, subsiding, high-pressure area furnishes the best requirements for light winds, clear skies, stability, and dry air aloft. If the air in the high has been moving over a body of water, or if it lies over ground previously moistened by an active precipitating front, the wet surface will cause an increase in the dewpoint of the lowest layers of the air. In addition, long

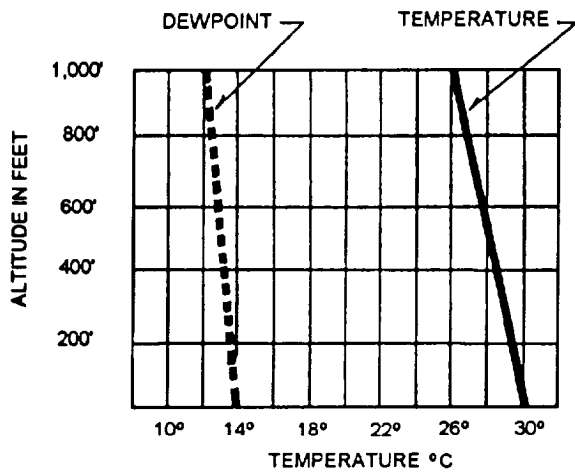

25NP0057

(A) 1530 LST - MAXIMUM SURFACE TEMPERATURE

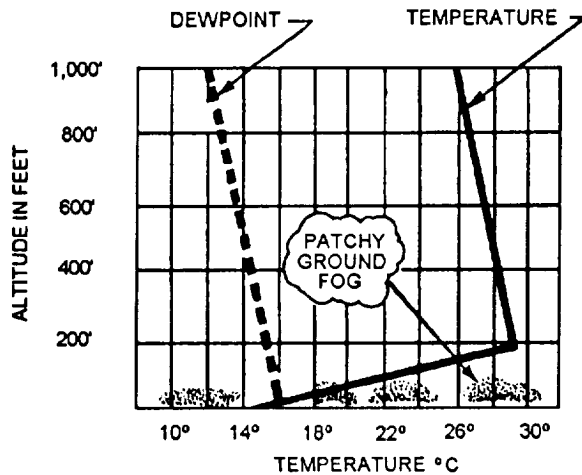

(B) SUNRISE - MINIMUM SURFACE TEMPERATURE

Figure 5-15.-Nocturnal cooling over a land area producing patchy ground fog (calm winds). (A) 1530 Local maximum surface temperature; (B) sunrise-minimum surface temperature.

nights versus short days in fall and winter are favorable for the formation of radiation fog.

CONDITIONS FAVORABLE FOR ADVECTION-RADIATION FOG

Cold and moist are apt descriptions of air masses that form in the late summer and early fall in the western quadrants of the Bermuda High. Cyclogenesis off the east coast of the United States, as well as the southerly flow associated with continental polar highs that have moved out over the ocean, are also cold and moist. If

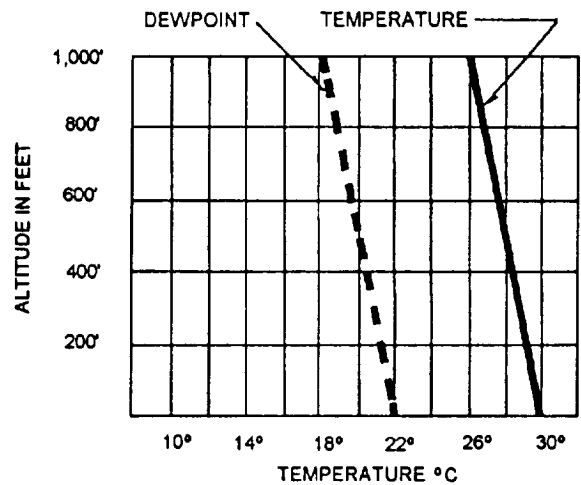

25NP0058

(A) 1530 LST - MAXIMUM SURFACE TEMPERATURE

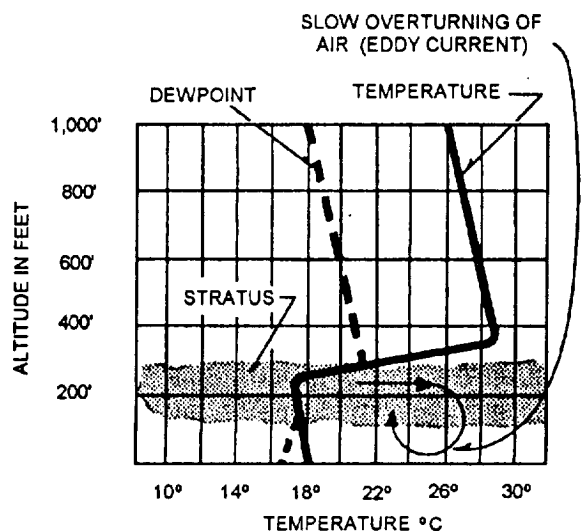

(B) SUNRISE - MINIMUM SURFACE TEMPERATURE

Figure 5-16.-Nocturnal cooling over a land area producing stratus (10- to 15-knot wind). (A) 1530 local maximum surface temperature; (B) sunrise-minimum surface temperature.

this air mass moves inland (replacing warm, dry, land air), it may be cooled to saturation due to radiational cooling during the long autumn nights with consequent formation of fog or stratus. The fog is limited to the coastal areas, extending inland between 150 and 250 miles, depending on the wind speed. On the east coast, it is limited to the region between the Appalachian Mountains and the Atlantic Ocean.

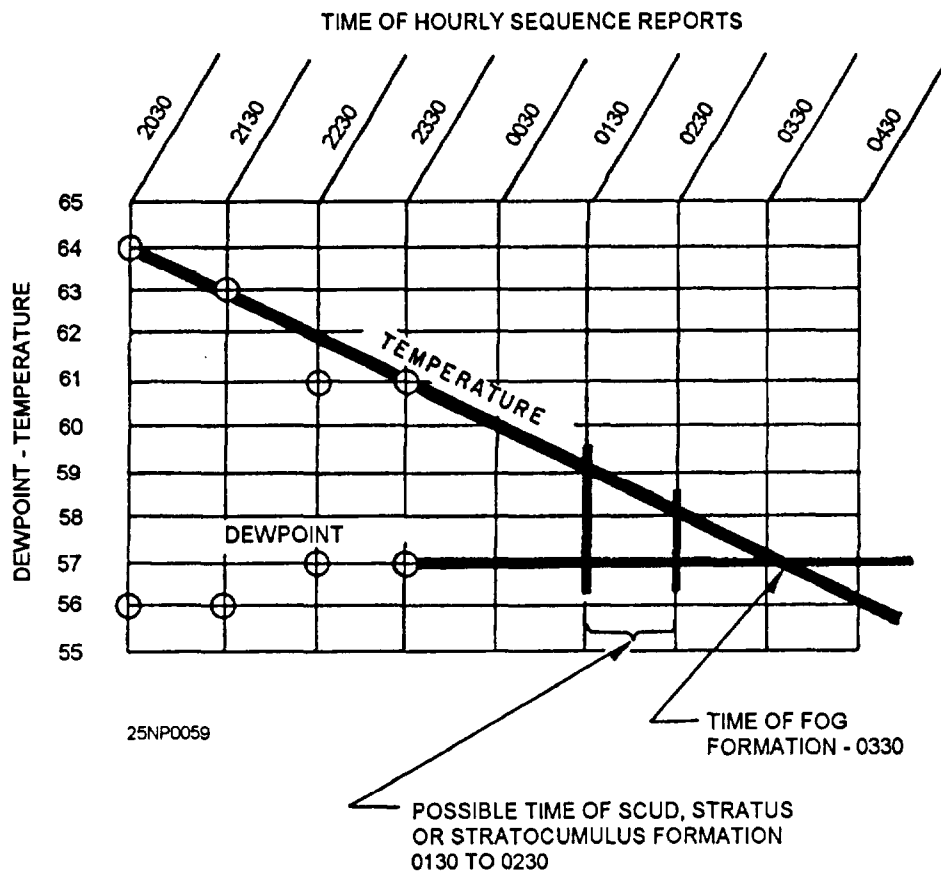

Figure 5-17.-Saturation time chart. (0's indicate actual temperature and dewpoint observations. Straight line is forecast temperature-dewpoint trends.)

In late fall and winter, when continental temperature gradients have intensified, and the land temperature has become colder than the adjacent water, poleward moving air is cooled by advection over colder ground, as well as by radiation. If the air is sufficiently moist, fog or stratus may form. During daytime, heating may dissipate the fog or stratus entirely. If not, the heating, together with the wind, which is advecting the air, sets up a turbulence inversion and stratus or stratocumulus layers form at the base of the inversion. At night if the air is cooled again and the surface pressure gradient is weak, a surface inversion may replace the turbulence inversion, and fog again occurs at the surface. However, if the pressure gradient is strong, cooling will intensify the inversion. Under these conditions stratus or stratocumulus clouds occur just as in the daytime, except with lower cloud bases.

Late fall and winter advection-radiation fogs can occur any place over the continent that can be reached by maritime air or modified returning continental air. Mainly, this occurs over the eastern half of the United States. However, since tropical air masses do not reach as high a latitude in winter as in summer, the frequency

of such fogs are much less in the northern regions of the country. With large, slow-moving, continental warm highs over the eastern half of the country, however, the fogs may extend all the way from the Gulf of Mexico to Canada.

CONDITIONS FAVORABLE FOR UPSLOPE FOG AND STRATUS

Upslope fog and stratus occur in those regions in which the land slopes gradually upward, and those areas accessible to humid, stable air masses. In North America, the areas best meeting these conditions are the Great Plains of the United States and Canada and the Piedmont region east of the Appalachians.

The synoptic conditions necessary for formation of this type of fog or stratus are the presence of humid air and a wind with an upslope component. The stratus is not advected over the station as a solid sheet. It forms gradually overhead. The length of time between the first signs of stratus and a ceiling usually ranges from 1/2 hour to 2 hours; although at times, the stratus may not form a ceiling at all. A useful procedure is to check the

hourly observations of surrounding stations, especially those southeastward. If one of these stations starts reporting stratus, the chances of stratus formation at your station are high.

CONDITIONS FAVORABLE FOR FRONTAL FOG

Frontal fogs are of three types: prefrontal (warm front), postfrontal (cold front), and frontal passage.

Prefrontal Fog

Prefrontal (warm front) fogs occur in stable continental polar (cP) air masses when precipitating warm air overrides the colder air. The rain raises the dewpoint in the cP air mass sufficiently for fog formation. Generally, the wind speeds are light, and the area most conducive to the formation of this type of fog is one between a nearby secondary low and the primary low-pressure center. The northeastern area of the United States is probably the most prevalent region for this type of fog. Prefrontal fog is also of importance along the Gulf and Atlantic coastal plains, the Midwest, and in the valleys of the Appalachians.

A rule of thumb for forecasting ceiling during prefrontal fog is as follows: If the gradient winds are greater than 25 knots, the ceiling will usually remain 300 feet or higher during the night.

Postfrontal Fog

As with the prefrontal fog, postfrontal (cold front) fogs are caused by falling precipitation. Fogs of this type are common when cold fronts with east-west orientations have become quasi-stationary and the continental polar air behind the front is stable. This type of fog is common in the Midwest. Fog, or stratiform clouds, may be prevalent for considerable distances behind cold fronts if the cold fronts produce precipitation.

Frontal Passage Fog

During the passage of a front, fog may form temporarily if the winds accompanying the front are very light and the two air masses are near saturation. Also, temporary fog may form if the air is suddenly cooled over moist ground with the passage of a precipitating cold front. In low latitudes, fog may form in the summer if the surface is cooled sufficiently by evaporation of rain that fell during a frontal passage,

provided that the moisture addition to the air and the cooling are great enough to allow for fog formation.

CONDITIONS FAVORABLE FOR SEA FOG

Sea fogs are advection fogs that form in warm moist air cooled to saturation as it moves over colder water. The colder water may occur as a well-defined current, or as gradual latitudinal cooling. The dewpoint and the temperature undergo a gradual change as the air mass moves over colder and colder water. The surface air temperature falls steadily, and tends to approach the water temperature. The dewpoint also tends to approach the water temperature, but at a slower rate. If the dewpoint of the air mass is initially higher than the coldest water to be crossed, and if the cooling process continues sufficiently long, the temperature of the air ultimately falls to the dewpoint, and fog results. However, if the initial dewpoint is less than the coldest water temperature, the formation of fog is unlikely. Generally, in northward moving air masses or in air masses that have previously traversed a warm ocean current, the dewpoint of the air is initially higher than the cold water temperature to the north, and fog will form, provided sufficient fetch occurs.

The rate of temperature decrease is largely dependent on the speed at which the air mass moves across the sea surface, which, in turn, is dependent both on the spacing of the isotherms and the velocity of the air normal to them.

The dissipation of sea fog requires a change in air mass (a cold front). A movement of sea fog to a warmer land area leads to rapid dissipation. Upon heating, the fog first lifts, forming a stratus deck; then, with further heating, this cloud deck breaks up into a stratocumulus layer, and eventually into convective type clouds or evaporates entirely. An increase in wind velocity can lift sea fog, forming a stratus deck, especially if the air/sea temperature differential is small. Over very cold water, dense sea fog may persist even with high winds.

CONDITIONS FAVORABLE FOR ICE FOG

When the air temperature is below about -25°F , water vapor in the air that condenses into droplets is quickly converted into ice crystals. A suspension of ice crystals based at the surface is called "ice fog." Ice fog occurs mostly in the Arctic regions, and is mainly an artificial fog produced by human activities. It occurs locally over settlements and airfields where hydrocarbon fuels are burned—the burning of hydrocarbon fuels produces water vapor.

When the air temperature is approximately -30°F or lower, ice fog frequently forms very rapidly in the exhaust gases of aircraft, automobiles, or other types of combustion engines.

When there is little or no wind, it is possible for an aircraft to generate enough ice fog during landing or takeoff to cover the runway and a portion of the airfield. Depending on the atmospheric conditions, ice fogs may persist for periods of a few minutes to several days.

There is also a fine arctic mist of ice crystals that persists as a haze over wide expanses of the arctic basin during winter; this fine mist may extend upward through much of the troposphere, similar to a cirrus cloud with the base reaching the ground.

USE OF THE SKEW T LOG P DIAGRAM IN FORECASTING THE FORMATION AND DISSIPATION OF FOG

One of the most accepted methods for forecasting the formation and dissipation of fog makes use of an upper air sounding plotted on the Skew T Log P Diagram. The plotting of an upper air sounding is useful in forecasting both the formation and dissipation of fog, but it can be used more objectively in forecasting fog dissipation.

The use of an upper air sounding to determine the possibility of fog formation must be subjective. A study of the existing lapse rate should be made to determine the stability or instability of the lower layers. The surface layer must be stable before fog can form. If it is not found to be stable, the cooling expected during the forecast period must be considered, and this modification should be applied to the sounding to determine if the layer will be stable with the additional cooling.

The difference between the temperature and the dewpoint must be considered. If the air temperature and the dewpoint are expected to coincide during the period covered by the forecast, a formation of fog is very likely.

The expected wind speed must be considered. If the wind speed is expected to be strong, the cooling will not result in a surface inversion favorable for the formation of fog, but may result in an inversion above the surface, which is favorable for the formation of stratus clouds.

DETERMINATION OF FOG HEIGHT

An upper air sounding taken during the time fog is present will show a surface inversion. The fog will not necessarily extend to the top of the inversion. If the temperature and dewpoint have the same value at the

top of the inversion, you can assume that the fog extends to the top of the inversion. However, if they do not have the same value, you can determine the depth of the fog by averaging the mixing ratio at the surface and the mixing ratio at the top of the inversion. The intersection of this average mixing ratio with the temperature curve is the top of the fog layer.

Two methods that may be used to find the height of the top of the fog layer, in feet, are reading the height directly from the pressure-height curve on the Skew T Log P Diagram or by using the dry adiabatic method.

1. In using the pressure-height curve method, locate the point where the temperature curve and the average mixing ratio line intersect on the Skew T Log P Diagram. Move this point horizontally until the pressure-height curve is intersected. Determine the height of the fog layer from the value of the pressure-height curve at this intersection.

2. The dry adiabatic method is based on the fact that the dry adiabatic lapse rate is 1°C per 100 m, or 1°C per 328 ft. Using this method, follow the dry adiabat from the intersection of the average mixing ratio line with the temperature curve to the surface level. Find the temperature difference between the point where the dry adiabat reaches the surface and the point of intersection of the dry adiabat and the average mixing ratio. For example, in figure 5-18, the dry adiabat at the surface is 25°C. The temperature at the intersection of the dry adiabat and the average mixing ratio is 20°C. By applying the dry adiabatic method with a lapse rate of 1°C per 328 ft, we find the height of the top of the fog layer as follows:

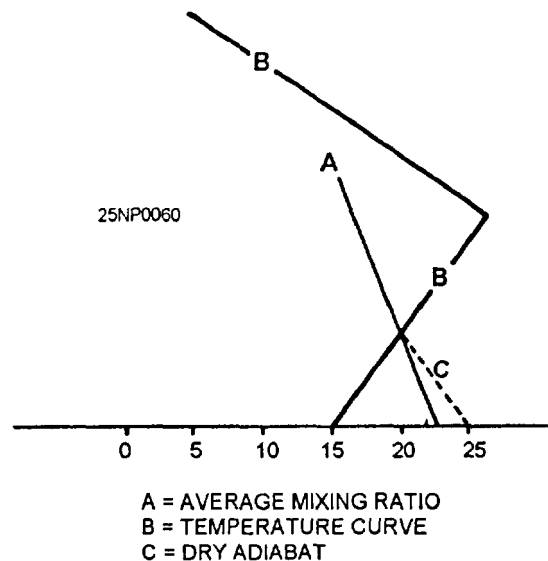

Figure 5-18.-Dry adiabatic method of determining fog height.

$$\frac{1}{328} = \frac{5}{x}$$

$$x = 1,640 \text{ ft}$$

DISSIPATION

To determine the surface temperature necessary for the dissipation of fog by using the Skew T Log P Diagram, trace dry adiabatically from the intersection of the average mixing ratio line and the temperature curve to the surface level. The temperature of the dry adiabat at the surface level is the temperature necessary for dissipation. This temperature is known as the CRITICAL TEMPERATURE. This temperature is an approximation, since it assumes no changes will take place in the stratum from the time of observation to the time of dissipation. This temperature should be modified on the basis of local conditions. See figure 5-18.

In considering the dissipation of fog and low clouds, you should consider the rate at which the surface temperature will increase after sunrise. Vertically thick fog, or multiple cloud layers, will slow up the morning heating at the surface. If advection fog is present, the fog may be lifted off the ground to a height where it is classified as stratus. If ground fog is present, the increase in surface air temperature will cause the fog particles to evaporate, thus dissipating the fog. Further heating may evaporate advection fog and low clouds.

FORECASTING ADVECTION FOG OVER THE OCEANS

In the absence of actual temperature and dewpoint data and with a stationary high (a southerly flow is assumed), use the following method to forecast advection fog over the ocean.

1. Pick out the point on an isobar at which the highest sea temperature is present (either from the surface chart or a mean monthly sea temperature chart). Assume that at this point, the air temperature is equal to that of the water and has a dewpoint 2 degrees lower.
2. Find the point on the isobar northward where the water is 2 degrees colder. From this point on, patchy light fog should occur.
3. From a saturation curve chart (fig. 5-14), find how much further cooling would have to occur to give an excess over saturation of 0.4 GM/KG, and also 2.0 GM/KG. The first represents the beginning of moderate fog and the second represents drizzle.

4. As the air continues around the northern ridge of the high, it will reach its lowest temperature, and from then on will be subject to warming. The pattern will then be drizzle until the excess is reduced to 2.0 GM/KG, and moderate fog until 0.4 GM/KG is reached.

If actual water and temperature data are available, use these in preference to climatic mean data. If the high is moving, trajectories will have to be calculated.

The fog is usually less widespread than calculated, and drizzle is less extensive. Also, clearing and lifting on the east side of the high is slightly faster. This method appears to work well in the summer over the Aleutian areas where such fog is frequent.

FORECASTING UPSLOPE FOG

Orographic lifting of the air will cause adiabatic cooling at the dry adiabatic rate of 5.5°F per 1,000 feet. If an adequate amount of lifting occurs, fog or low clouds will form. This process can create challenges for the forecaster.

The procedures for determining the probability of fog or low clouds during nighttime hours at stations having upslope winds are as follows:

1. Forecast the amount of nocturnal cooling,
2. Determine the expected amount of upslope cooling by using the following steps:
 - a. Determine the approximate number of hours between sunset and sunrise.
 - b. Estimate the expected wind velocity during the nighttime hours.
 - c. Multiply a by b. This will give the distance the upslope wind will move during the period of the day when daylight heating cannot counteract upslope cooling.
 - d. Determine the approximate terrain elevation difference between the station and the distance computed in c. Elevation difference should be in feet. (Example, 2.5 thousand feet.)
 - e. Multiply the elevation difference by the dry adiabatic rate of cooling. (Example, 2.5 times 5.5 = 13.75°F of upslope cooling.)
3. Add the expected amount of upslope cooling to the expected nocturnal cooling to arrive at the total amount of cooling.
4. Determine the late afternoon temperature dewpoint spread at the station under consideration. If

the expected cooling is greater than the late afternoon spread, either fog or low clouds should be expected. Wind velocity will determine which of the two conditions will form.

FORECASTING STRATUS FORMATION AND DISSIPATION

Fog and stratus forecasting are so closely tied together that many of the fog forecasting rules and conditions previously mentioned also apply to the forecasting of stratus clouds.

Determining the Base and Top of a Stratus Layer

One of the first steps in forecasting the dissipation of stratus is to determine the thickness of the stratus layer. The procedure is as follows:

1. Determine a representative mixing ratio between the surface and the base of the inversion.
2. Project this mixing ratio line upward through the sounding.
3. The intersection of the average mixing ratio line with the temperature curve gives the approximate base

and maximum top of the stratus. Point A in figure 5-19 is the base of the stratus layer, and point B is the maximum top of the layer. Point A is the initial base of the layer; but as heating occurs during the morning, the base will lift. Point B represents the maximum top of the stratus layer; although in the very early morning, it might lie closer to the base of the inversion. However, as heating occurs during the day, the top of the stratus layer will also rise and will be approximated by point B. If the temperature and the dewpoint are the same at the top of the inversion, the stratus will extend to this level.

To determine the height of the base and the top of the stratus layer, use either the method previously outlined for fog, or the pressure altitude scale.

Determining Dissipation Temperatures

To determine the temperature necessary for the dissipation of a stratus layer, the following steps are provided:

1. From point A in figure 5-19, follow the dry adiabat to the surface level. The temperature of the dry adiabat at the surface level is the temperature required to be reached for stratus dissipation to begin. This is point C.

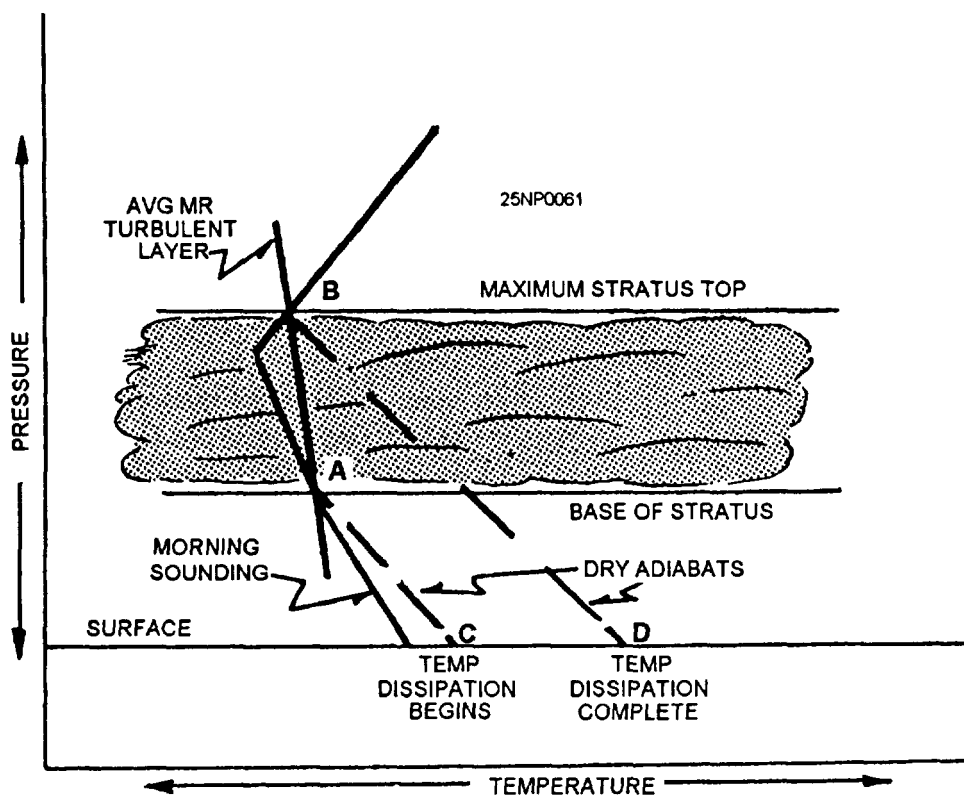

Figure 5-19.-Sounding showing the base and the top of stratus layers. Also note temperature at which dissipation begins and temperature when dissipation is complete.

2. From point B in figure 5-19, follow the dry adiabat to the surface level. The temperature of the dry adiabat at the surface level is the surface temperature required for the dissipation of the stratus layer to be complete. This is point D.

Determining Time of Dissipation

After determination of the temperatures necessary for stratus dissipation to begin and to be completed, a forecast of the time these temperatures will be reached must be made. Estimate the length of time for the required amount of heating to take place; and on the basis of this estimate, the time of dissipation may be forecasted. Remember to take into consideration the absence or the presence of cloud layers above the stratus deck. In addition, consider the trajectory of the air over the station. If the trajectory is from a water surface, temperatures will be held down for a longer than normal period of time.

One rule of thumb used widely in forecasting the dissipation of the stratus layer is to estimate the thickness of the layer; and if no significant cloud layers are present above and normal heating is expected, forecast the dissipation of the layer with an average of 360 feet per hour of heating. In this way an estimate can be made of the number of hours required to dissipate the layer.

AIRCRAFT ICING

LEARNING OBJECTIVES: Recall factors conducive to aircraft icing. Be familiar with icing hazards at the surface. Analyze aircraft icing forecasts by using synoptic data. Prepare aircraft icing forecasts by using the -8D method.

Aircraft icing is another of the weather hazards to aviation. It is important that the pilot be advised of icing because of the serious effects it may have on aircraft performance. Ice on the airframe decreases lift and increases weight, drag, and stalling speed. In addition, the accumulation of ice on exterior movable surfaces affects the control of the aircraft. If ice begins to form on the blades of the propeller, the propeller's efficiency is decreased, and still further power is demanded of the engine to maintain flight. Today, most aircraft have sufficient reserve power to fly with a heavy load of ice; airframe icing is still a serious problem because it results

in greatly increased fuel consumption and decreased range. Further, the possibility always exists that engine-system icing may result in loss of power.

The total effects of aircraft icing are a loss of aerodynamic efficiency; loss of engine power; loss of proper operation of control surfaces, brakes, and landing gear; loss of aircrew's outside vision; false flight instrument indications; and loss of radio communication. For these reasons, it is important that you, the forecaster, be alert and aware of the conditions conducive to ice formation. It is also important that you accurately forecast icing conditions during flight weather briefings.

This chapter will cover icing intensities, icing hazards near the ground, operational aspects of aircraft icing, and icing forecasts. For a discussion of the types of icing, physical factors affecting aircraft icing, and the distribution of icing in the atmosphere, refer to the *AG2 TRAMAN*, volume 2, unit 6, as well as *Atmospheric Turbulence and Icing Criteria*, NAVMETOCCOMINST 3140.4, which discusses associated phenomena, as well as a common set of criteria for the reporting of icing.

SUPERCOOLED WATER IN RELATION TO ICING

Two basic conditions must be met for ice to form on an airframe in significant amounts. First, the aircraft surface temperature must be colder than 0°C. Second, supercooled water droplets, or liquid water droplets at subfreezing temperatures, must be present. Water droplets in the free air, unlike bulk water, do not freeze at 0°C. Instead, their freezing temperature varies from an upper limit near -10°C to a lower limit near -40°C. The smaller and purer the droplets, the lower their freezing point. When a supercooled droplet strikes an object, such as the surface of an aircraft, the impact destroys the internal stability of the droplet and raises its freezing temperature. In general, the possibility of icing must be anticipated in any flight through supercooled clouds or liquid precipitation at temperatures below freezing. In addition, frost sometimes forms on an aircraft in clear, humid air if both the aircraft and air are at subfreezing temperatures.

PROCESS OF ICE FORMATION ON AIRCRAFT

The first step in ice formation is when the supercooled droplets strike the surface of the aircraft. As the droplet, or portion of it, freezes, it liberates the

heat of fusion. Some of this liberated heat is taken on by the unfrozen portion of the drop; its temperature is thereby increased, while another portion of the heat is conducted away through the surface in which it lies. The unfrozen drop now begins to evaporate due to its increase in temperature, and in the process, it uses up some of the heat, which, in turn, cools the drop. Due to this cooling process by evaporation, the remainder of the drop is frozen. Icing at 0°C will occur only if the air is not saturated because the nonsaturated condition is favorable for evaporation of part of the drop. Evaporation cools the drop below freezing, and then ice formation can take place.

INTENSITIES OF ICING

There are three intensities of aircraft icing—light, moderate, and severe.

Light

The rate of accumulation may create a problem if flight is prolonged in this environment (over 1 hour). Occasional use of deicing/anti-icing equipment removes/prevents accumulation. It does not present a problem if the deicing/anti-icing equipment is used.

Moderate

The rate of accumulation is such that even short encounters become potentially hazardous, and the use of deicing/anti-icing equipment or diversion is necessary.

Severe

The rate of accumulation is such that deicing/anti-icing fails to reduce or control the hazard. Immediate diversion is necessary.

ICING HAZARDS NEAR THE GROUND

Certain icing hazards exist on or near the surface. One hazard results when wet snow is falling during takeoff. This situation can exist when the air temperature at the surface is at or below 0°C. Wet snow sticks tenaciously to aircraft components, and it freezes if the aircraft encounters markedly colder temperatures during takeoff.

If not removed before takeoff, frost, sleet, freezing rain, and snow accumulation on parked aircraft become operational hazards. Another hazard arises from the presence of puddles of water, slush, and/or mud on

airfields. When the temperature of the airframe is colder than 0°C, water blown by the propellers or splashed by wheels can form ice on control surfaces and windows. Freezing mud is particularly dangerous because the dirt may clog controls and cloud the windshield.

OPERATIONAL ASPECTS OF AIRCRAFT ICING

Due to the large number of types and different configurations of aircraft, this discussion is limited to general aircraft types, rather than specific models.

Turbojet Aircraft

These high speed aircraft generally cruise at altitudes well above levels where severe icing exists. The greatest problem will be on takeoff, climb, and approach because of the greater probability of encountering supercooled water droplets at low altitudes. Also, the reduced speeds result in a decrease of aerodynamic heating.

Turbojet engines experience icing both externally and internally. All exposed surfaces are subject to external airframe icing.

Internal icing may pose special problems to turbojet aircraft engines. In flights through clouds that contain supercooled water droplets, air intake duct icing is similar to wing icing. However, the ducts may ice when skies are clear and temperatures are above freezing. While taxiing and during takeoff and climb, reduced pressure exists in the intake system, which lowers temperatures to a point that condensation and/or sublimation takes place, resulting in ice formation. This temperature change varies considerably with different types of engines. Therefore, if the free air temperature is 10°C or less (especially near the freezing point) and the relative humidity is high, the possibility of induction icing definitely exists.

Turboprop Aircraft

The problems of aircraft icing for this type of aircraft combine those of conventional aircraft and turbojet aircraft. Engine icing problems are similar to those encountered by turbojet aircraft, while propeller icing is similar to that encountered by conventional aircraft.

Propeller icing is a very dangerous form of icing because of the potential for a tremendous loss of power and vibrations. Propeller icing varies along the blade due to the differential velocity of the blade, causing a

temperature increase from the hub to the propeller tip. Today's turboprop aircraft have deicers on the propellers. However, these deicers are curative, not preventive, and the danger remains.

Rotary-Wing Aircraft

When helicopters encounter icing conditions, the icing threat is similar, but potentially more hazardous than with fixed-wing aircraft. When icing forms on the rotor blades while hovering, conditions become hazardous because the helicopter is operating near peak operational limits. Icing also affects the tail rotor, control rods and links, and air intakes and filters.

PRELIMINARY CONSIDERATIONS

The first phase in the preparation of an aircraft icing forecast consists of making certain preliminary determinations. These are essential regardless of the technique employed in making the forecast.

Clouds

Determine the present and forecast future distribution, type, and vertical extent of clouds along the flight path. The influence of local effects, such as terrain features, should not be overlooked.

Temperature

Determine those legs of the proposed flight path that will be in clouds colder than 0°C. A reasonable estimate of the freezing level can be made from the data contained on freezing level charts, constant-pressure charts, rawinsonde observations, and airways reports (AIREP) observations, or by extrapolation from surface temperatures.

Precipitation

Check surface reports for precipitation along the proposed flight path, and forecast the precipitation character and pattern during the flight. Special consideration should be given to the possibility of freezing precipitation.

Note that each of the following methods and forecast rules assumes that two basic conditions must exist for the formation of icing. These assumptions are

1. the surface of the aircraft must be colder than 0°C, and
2. supercooled liquid-water droplets, clouds, or precipitation must be present along the flight path.

THE ICING FORECAST

The following text discusses icing intensity forecasts by using upper air data, surface data, and precipitation data, as well as icing formed due to orographic and frontal lifting.

Intensity Forecasts From Upper Air Data

Check upper air charts, pilot reports, and rawinsonde reports for the dewpoint spread at the flight level. Also check the upper air charts for the type of temperature advection along the route. One study, which considered only the dewpoint spread aloft, found that there was an 84 percent probability that there would be no icing if the spread were greater than 3°C, and an 80 percent probability that there would be icing if the spread were less than 3°C.

When the dewpoint spread was 3°C or less in areas of warm air advection at flight level, there was a 67 percent probability of no icing and a 33 percent probability of light or moderate icing. However, with a dewpoint spread of 3°C or less in a cold frontal zone, the probability of icing reached 100 percent. There was also a 100-percent probability of icing in building cumuliform clouds when the dewpoint spread was 3°C or less. With the spread greater than 3°C, light icing was probable in about 40 percent of the region of cold air advection with a 100-percent probability of no icing in regions of warm or neutral advection. However, it appears on the basis of further experience that a more realistic spread of 4°C at temperatures near -10° to -15°C should be indicative of probable clouds, and that spreads of about 2° or 3°C should be indicative of probable icing. At other temperatures use the values in the following rules:

- If the temperature is:
 - 0° to -7°C and the dewpoint spread is greater than 2°C, there is an 80-percent probability of no icing.
 - -8° to -15°C and the dewpoint spread is greater than 3°C, forecast no icing with an 80-percent chance of success.
 - -16° to -22°C and the dewpoint spread is greater than 1°C, a forecast of no icing would have a 90-percent chance of success.
 - Colder than -22°C, forecast no icing regardless of what the dewpoint spread is with 90-percent probability of success.
- If the dewpoint spread is 2°C or less at temperatures of 0° to -7°C, or is 3°C or less at -8° to -15°C:
 - In zones of neutral, or weak cold air advection, forecast light icing with a 75-percent probability of success.
 - In zones of strong cold air advection, forecast moderate icing with an 80-percent probability of success.
 - In areas with vigorous cumulus buildups due to insolation surface heating, forecast moderate icing.

Intensity Forecasts From Surface Chart Data

If upper air data is not available, check the surface charts for locations of cloud shields associated with fronts, low-pressure centers, and precipitation areas along the route.

Intensity Forecasts From Precipitation Data

Within clouds not resulting from frontal activity or orographic lifting, and over areas with steady nonfreezing precipitation, forecast little or no icing. Over areas not experiencing precipitation, but having cumuliform clouds, forecast moderate icing.

Intensity Forecasts Based on Clouds Due To Frontal or Orographic Lifting

Within clouds resulting from frontal, or orographic lifting, neither the presence, nor the absence of precipitation can be used as indicators of icing. The following observations have proven to be accurate:

- Within clouds up to 300 miles ahead of the warm front surface position, forecast moderate icing.
- Within clouds up to 100 miles behind the cold front surface position, forecast severe icing.
- Within clouds over a deep, almost vertical low-pressure center, forecast severe icing.
- In freezing drizzle, below or in clouds, forecast severe icing.
- In freezing rain, below or in clouds, forecast severe icing.

ICING TYPE FORECASTS

The following rules apply to the forecasting of icing types:

- Forecast rime icing when the temperatures at flight level are colder than -15°C, or when between -1° and -15°C in stable stratiform clouds.
- Forecast clear icing when temperatures are between 0° and -8°C in cumuliform clouds and freezing precipitation.
- Forecast mixed rime and clear icing when temperatures are between -9° and -15°C in cumuliform clouds.

EXAMPLE OF ICING FORECASTS USING THE SKEW T LOG P DIAGRAM

It has been previously pointed out how the thickness of clouds, as well as the top of the overcast, may be estimated with accuracy from the dewpoint depression and changes in the lapse rate.

The analysis of cloud type and icing type from the Skew T Log P Diagram is illustrated in figure 5-20. First, look at the general shape of the curve. The most prominent feature is the inversion, which shows a very stable layer between 2,500 and 3,000 feet. Note that the dewpoint depression is less than 1 degree at the base of the inversion. Moisture exists in a visible format this dewpoint depression, so expect a layer of broken or overcast clouds whose base will be approximately 2,000 feet and will be topped by the base of the inversion. The next most prominent feature is the high humidity, as reflected by the dewpoint depressions, at 8,000 feet. Since the dewpoint depression is 2°C, a probability of clouds exists at this level. There is a rapid increase in the dewpoint depression at 17,000 feet, indicating that the top of the cloud layer is at this level. You would then assume the cloud layer existed between 8,000 and 17,000 feet.

The next step is to determine, if possible, the type of clouds in between these levels. If this sounding were plotted on the Skew T Log P Diagram, you would be able to see that the slope of the lapse rate between 8,000

and 12,000 feet is shown to be unstable by comparison to the nearest moist adiabat. The clouds will then display unstable cumuliform characteristics. Above 12,000 feet, the lapse rate is shown by the same type of comparison to be stable, and the clouds there should be altostratus.

Now determine the freezing level. Note that the lapse rate crosses the 0°C temperature line at approximately 9,500 feet. Since you have determined that clouds exist at this level, the temperatures are between 0° and -8°C, and the clouds are cumuliform, forecast clear ice in the unstable cloud up to 12,000 feet. Above 12,000 feet, the clouds are stratiform, so rime icing should be forecast. The intensity of the icing would have to be determined by the considerations given in the previous section of this chapter.

Icing Forecasts Using the -8D Method

When surface charts, upper air charts, synoptic and airway reports, and pilot reports are not clear as to the presence and possibility of icing, it may be determined

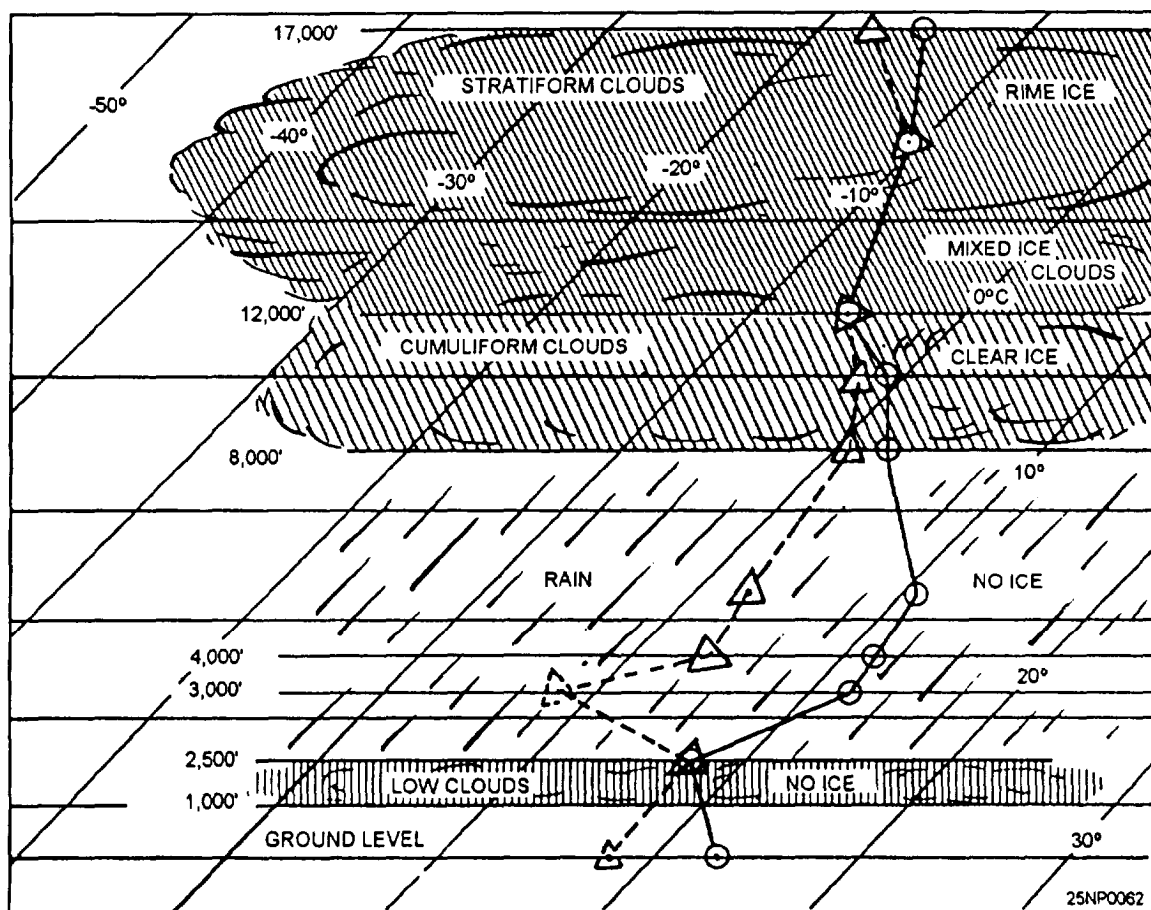

Figure 5-20.-An illustration of the analysis of cloud type and icing type from a Skew T Log P Diagram.

from the Skew T Log P Diagram by using the following 7 steps:

1. Plot the temperature against pressure as determined from a RAOB sounding.
2. Record the temperature and dewpoint in degrees and tenths to the left of each plotted point.
3. Determine the difference (in degrees and tenths) between the temperature and dewpoint for each level. This difference is D, the dewpoint deficit; it is always taken to be positive.
4. Multiply D by -8 and plot the product (which is in degrees Celsius) opposite the corresponding temperature point at the appropriate place.
5. Connect the points plotted by step 4 with a dashed line in the manner illustrated in figure 5-21.
6. The icing layer is outlined by the area enclosed by the temperature curve on the left and the $-8D$ curve on the right. In this outlined area, supersaturation with respect to ice exists. This is the hatched area, as shown in figure 5-21.
7. The intensity of icing is indicated by the size of the area enclosed by the temperature curve and the $-8D$ curve. In addition, the factors given in the following

section should be considered when formulating the icing forecast. The cloud type and the precipitation observed at the RAOB time or the forecast time maybe used to determine whether icing is rime or glaze.

Conclusions arrived at by using the-SD method for forecasting icing:

- When the temperature and dewpoint coincide in the RAOB sounding, the $-8D$ curve must fall along the 0°C isotherm. In a subfreezing layer, the air would be saturated with respect to water and supersaturated with respect to ice. Light rime icing would occur in the altostratus/nimbostratus clouds in such a region, and moderate rime icing would occur in cumulonimbus clouds in such a region. Severe clear ice would occur in the stratocumulus virga, cumulus virga, and stratus.
- When the temperature and dewpoint do not coincide but the temperature curve lies to the left of the $-8D$ curve in the subfreezing layer, the layer is supersaturated with respect to cloud droplets. If the clouds in this layer are altostratus, altocumulus, cumulogenitus, or altocumulus virga, only light rime will be encountered. If the clouds are cirrus, cirrocumulus, or cirrostratus, only light hoarfrost will be sublimated on the aircraft. In cloudless regions, there

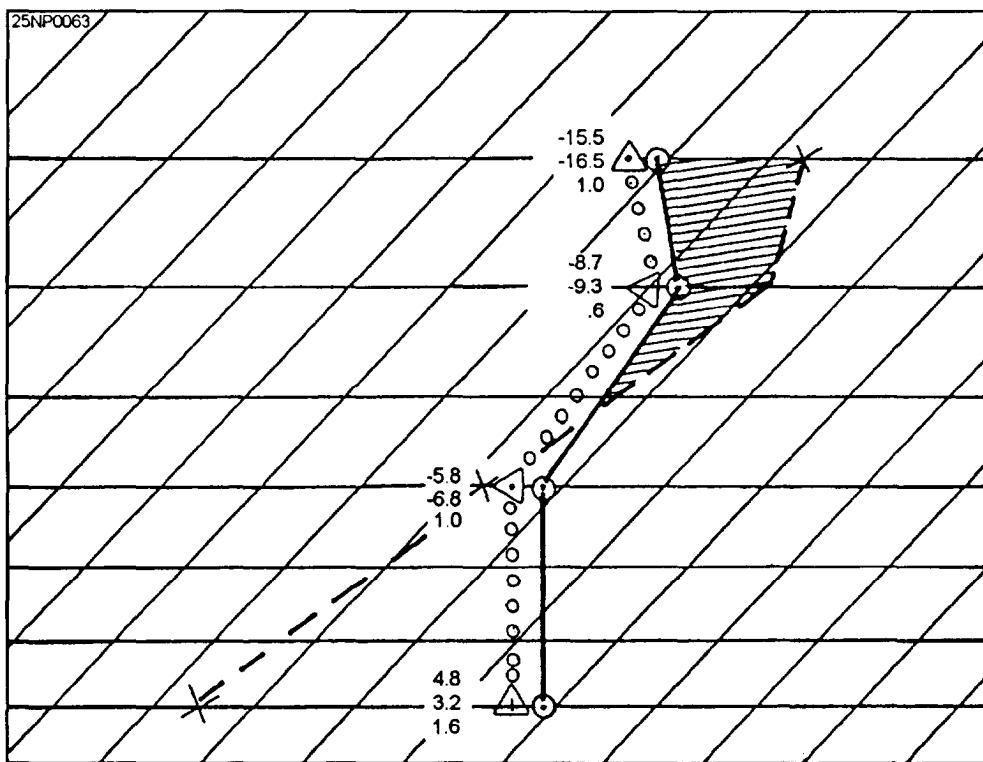

Figure 5-21.-The $-8D$ ice forecast method.

will be no supercooled droplets, but hoarfrost will form on the aircraft through direct sublimation of water vapor.

- When the temperature curve lies to the right of the $-8D$ curve in a subfreezing layer, the layer is subsaturated with respect to both ice and water surface. No icing will occur in this region.

Modification of the Icing Forecast

The final phase is to modify your icing forecast. This is essentially a subjective process. The forecaster should consider the following items: probable intensification or weakening of synoptic features, such as low-pressure centers, fronts, and squall lines during the time interval between the latest analysis and the forecast; local influences, such as geographic location, terrain features, and proximity to ocean coastlines or lake shores, and radar weather observations and pilot reports of icing. The forecaster should be cautious in either underforecasting or overforecasting the amount and intensity of icing. An overforecast results in a reduced payload for the aircraft due to increased fuel load, while an underforecast may result in an operational emergency.

TURBULENCE

LEARNING OBJECTIVES: Recall characteristics associated with turbulence. Determine the four intensities of turbulence. Forecast surface, in-cloud, and clear air turbulence (CAT). Recognize the advantages of the use of Doppler radar in turbulence forecasting.

Turbulence is of major importance to pilots of all types of aircraft; therefore, it is also of importance to the forecaster, whose duty it is to recognize situations where turbulence may exist, and to forecast both the areas and intensity of the turbulence. The following text discusses the classification and intensity of turbulence, the forecasting of turbulence near the ground, the forecasting of turbulence in convective clouds, and the forecasting of clear air turbulence (CAT).

Refer to the *AG2 TRAMAN*, volume 2, unit 6, for a discussion of the types and properties of turbulence.

TURBULENCE CHARACTERISTICS

Turbulence may be defined as irregular and instantaneous motions of air that are made up of a number of small eddies that travel in the general air current. Atmospheric turbulence is caused by random fluctuations in the windflow. Given an analyzed wind field with both streamlines and isotachs smoothly drawn, any difference between an actual wind and this smooth field is attributed to turbulence.

To an aircraft in flight, the atmosphere is considered turbulent when irregular whirls or eddies of air affect the motion of the aircraft, and a series of abrupt jolts or bumps is felt by the pilot. Although a large range of sizes of eddies exists in the atmosphere, those causing bumpiness are roughly of the same size as the aircraft dimensions, and usually occur in an irregular sequence imparting sharp translation or angular motions to the aircraft. The intensity of the disturbances to the aircraft varies not only with the intensity of the irregular motions of the atmosphere but also with aircraft characteristics, such as flight speed, weight stability, and size.

Wind Shear and CAT

A relatively tight gradient, either horizontal or vertical, produces churning motions (eddies), which result in turbulence. The greater the change of wind speed and/or direction, the more severe the turbulence. Turbulent flight conditions are often found in the vicinity of the jetstream, where large shears in the horizontal and vertical are found. Since this type of turbulence may occur without any visual warning, it is often referred to as CAT.

The term *clear air turbulence* is misleading because not all high-level turbulence included in this classification occurs in clear air. However, the majority (75 percent) is found in a cloud-free atmosphere. CAT is not necessarily limited to the vicinity of the jetstream; it may occur in isolated regions of the atmosphere. Most frequently, CAT is associated with the jetstream or mountain waves. However, it may also be associated with a closed low aloft, a sharp trough aloft, or an advancing cirrus shield. A narrow zone of wind shear, with its accompanying turbulence, is sometimes encountered by aircraft as it climbs or descends through a temperature inversion. Moderate turbulence may also be encountered momentarily when passing through the wake of another aircraft.

The criteria for each type of CAT areas follows:

- Mountain wave CAT. Winds 25 knots or greater, normal to terrain barriers, and significant surface pressure differences across such barriers.

- Trough CAT. That portion of a trough that has horizontal shear on the order of 25 knots, or more, in 90 nautical miles.

- Closed low aloft CAT. If the flow is merging or splitting, moderate or severe CAT maybe encountered. Also, to the northeast of a cutoff low aloft, significant CAT may be experienced. As with the jetstream CAT, the intensity of this type of turbulence is related to the strength of the shear.

- Wind shear CAT. Those zones in space in which wind speeds are 60 knots or greater, and both horizontal and vertical shear exists, as indicated in table 5-1.

No provision is made for light CAT because light turbulence serves only as a flight nuisance. Any of the above situations can produce moderate to severe CAT. However, the combination of two or more of the above conditions is almost certain to produce severe or even extreme CAT. A jetstream may be combined with a mountain wave or be associated with a merging or splitting low.

Turbulence on the Lee Side of Mountains

When strong winds blow approximately perpendicular to a mountain range, the resulting turbulence may be quite severe. Associated areas of steady updrafts and downdrafts may extend to heights from 2 to 20 times the height of the mountain peaks. Under these conditions when the air is stable, large waves tend to form on the lee-side of the mountains, and may extend 150 to 300 miles downwind. They are referred to as *mountain waves*. Some pilots have

reported that flow in these waves is often remarkably smooth, while others have reported severe turbulence. The structure and characteristics of the *mountain wave* were presented in volume 2 of the *AG2 TRAMAN*. Refer to figure 6-1-5 in volume 2 for an illustration of a *mountain wave*.

The windflow normal to the mountain produces a primary wave, and, generally less intense, additional waves farther downwind. The characteristic cloud patterns may or may not be present to identify the wave. The pilot, for the most part, is concerned with the primary wave because of its more intense action and proximity to the high mountainous terrain. Severe turbulence frequently can be found 150 to 300 miles downwind, when the winds are greater than 50 knots at the mountaintop level. When winds are less than 50 knots at the mountaintop level, a lesser degree of turbulence may be experienced.

Some of the most dangerous features of the mountain wave are the turbulence in and below the roll cloud, the downdrafts just to the lee side of the mountain peaks, and to the lee side of the roll clouds. The *cap cloud* must always be avoided because of turbulence and concealed mountain peaks.

The following five rules have been suggested for flights over mountain ranges where waves exist:

1. The pilot should, if possible, fly around the area when wave conditions exist. If this is not feasible, he/she should fly at a level that is at least 50 percent higher than the height of the mountain range.
2. The pilot should avoid the roll clouds, since these are the areas with the most intense turbulence.
3. The pilot should avoid the strong downdrafts on the lee side of the mountain.

Table 5-1. Wind Shear CAT with Wind Speed 60 Knots or Greater

HORIZONTAL SHEAR (NAUT/MI)	VERTICAL SHEAR (PER 1,000 FT)	CAT INTENSITY
25k/90	9-12k	Moderate
25k/90	12-15k	Moderate, at times severe
25k/90	above 15k	Severe

4. He/she should also avoid high lenticular clouds, particularly if their edges are ragged

5. The pressure altimeter may read as much as 1,000 feet lower near the mountain peaks.

CLASSIFICATION AND INTENSITY OF TURBULENCE

The *Airman's Information Manual*, chapter 7, contains a turbulence reporting criteria table, which describes the meteorological characteristics with which the respective classes of turbulence are associated.

Terminal Aerodrome Forecast (TAF) Code, NAVMETOCCOMINST 3143.1, lists code figures for turbulence type and intensity.

The Turbulence Reporting Criteria Table, table 5-2, has been adopted as the standard. All NAVMETOCCOM units must adopt these as standards as a guide in forecasting turbulence.

The following is a guide to the classification of turbulence.

Extreme Turbulence

This rarely encountered condition is usually confined to the strongest forms of convection and wind shear, such as the following:

- Mountain waves in or near the rotor cloud, usually found at low levels, leeward of the mountain ridge when the wind normal to the mountain ridge exceeds 50 knots.

- In severe thunderstorms where the production of large hail (three-fourths inch or more) is indicated. It is more frequently encountered in organized squall lines than in isolated thunderstorms.

Severe Turbulence

Severe turbulence may also be found in the following:

- In mountain waves:

- When the wind normal to the mountain ridge exceeds 50 knots. The turbulence may extend to the tropopause, and at a distance of 150 miles leeward. A reasonable mountain wave turbulence layer is about 5,000 feet thick.

- When the wind normal to the mountain ridge is 25 to 50 knots, the turbulence may extend up to

50 miles leeward of the ridge, and from the mountain ridge up to several thousand feet above.

- In and near mature thunderstorms, and occasionally in towering cumuliform clouds.

- Near jetstreams within layers characterized by horizontal wind shears greater than 40 knots/150 run, and vertical wind shears in excess of 6 knots/1,000 feet. When such layers exist, favored locations are below and/or above the jet core, and from roughly the vertical axis of the jet core to about 50 to 100 miles toward the cold side.

Moderate Turbulence

Moderate turbulence may be found in the following:

- In mountain waves:

- When the wind normal to the mountain ridge exceeds 50 knots. Moderate turbulence may be found from the ridge line to as much as 300 miles leeward.

- When the wind normal to the ridge is 25 to 50 knots, moderate turbulence maybe found from the ridge line to as much as 150 miles leeward.

- In, near, and above thunderstorms, and in towering cumuliform clouds.

- Near jetstreams and in upper level troughs, cold lows, and fronts aloft where vertical wind shears exceed 6 knots/1,000 feet, or horizontal wind shears exceed 10 knots per 100 miles.

- At low altitudes, usually below 5,000 feet, when surface winds exceed 25 knots, or the atmosphere is unstable due to strong insolation or cold advection.

Light Turbulence

In addition to the situations where more intense classes of turbulence occur, the relatively common class of light turbulence maybe found:

- In mountainous areas, even with light winds.

- In and near cumulus clouds.

- Near the tropopause.

- At low altitudes when winds are under 15 knots, or the air is colder than the underlying surface.

Table 5-2.-Turbulence Reporting Criteria Table

Intensity	Aircraft Reaction	Reaction Inside Aircraft	Reporting Term-Definition
Light	<p>Turbulence that momentarily causes slight, erratic changes in altitude and/or attitude (pitch, roll, yaw). Report as Light Turbulence;</p> <p>or</p> <p>Turbulence that causes slight, rapid, and somewhat rhythmic bumpiness without appreciable changes in altitude or attitude. Report as Light Chop.</p>	<p>Occupants may feel a slight strain against seat belts or shoulder straps. Unsecured objects may be displaced slightly. Food service may be conducted and little or no difficulty is encountered in walking.</p>	<p>Occasional—Less than 1/3 of the time.</p> <p>Intermittent—1/3 to 2/3.</p> <p>Continuous—More than 2/3.</p>
Moderate	<p>Turbulence that is similar to Light Chop but of greater intensity. It causes rapid bumps or jolts without appreciable changes in aircraft altitude or attitude. Report as Moderate Chop.¹</p>	<p>Occupants feel definite strain against seat belts or shoulder straps. Unsecured objects are dislodged. Food service and walking are difficult.</p>	<p>NOTE:</p> <ol style="list-style-type: none"> 1. Pilots should report location(s), time (UTC), intensity, whether in or near clouds, altitude, type of aircraft and, when applicable, duration or turbulence. 2. Duration may be based on time between two locations or over a single location. All locations should be readily identifiable.
Severe	<p>Turbulence that causes large, abrupt changes in altitude and/or attitude. It usually causes large variations in indicated airspeed. Aircraft may be momentarily out of control. Report as Severe Turbulence.¹</p>	<p>Occupants are forced violently against seat belts or shoulder straps. Unsecured objects are tossed about. Food service and walking are impossible.</p>	<p>EXAMPLES:</p> <ol style="list-style-type: none"> a. Over Omaha. 1232 UTC, moderate turbulence, in cloud, flight level 310, B707. b. From 50 miles south of Albuquerque to 30 miles north of Phoenix, 1210 UTC to 1250 UTC, occasional moderate chop, flight level 330, DC8.
Extreme	<p>Turbulence in which the aircraft is violently tossed about and is practically impossible to control. It may cause structural damage. Report as Extreme Turbulence.¹</p>		
<p>¹High level turbulence (normally above 15,000 feet ASL) not associated with cumuliform cloudiness, including thunderstorms, should be reported as CAT (clear air turbulence) preceded by the appropriate intensity, or light or moderate chop.</p>			

FORECASTING TURBULENCE NEAR THE SURFACE

Over land during nighttime hours there is very little turbulence near the surface. The only exception is that of high wind speeds over rough terrain. This type of turbulence decreases with increasing height.

During the daylight hours, turbulence near the surface depends on the radiation intensity, the lapse rate, and the wind speed. Turbulence intensity tends to increase with height throughout the unstable and neutral layers above the surface to the first inversion, or stable layer. Similar turbulence occurs in fresh polar outbreaks over warm waters.

Vertical gustiness increases with height more rapidly than horizontal gustiness.

Situations for violent turbulence near the surface occur shortly after a cold frontal passage, especially over rough terrain. Other examples of turbulence occur over deserts on hot days and during thunderstorms.

Peak gusts at the surface can be estimated to be essentially equal to the wind speeds at the gradient level, except in thunderstorms.

FORECASTING TURBULENCE IN CONVECTIVE CLOUDS

In the absence of any dynamic influences that might serve to drastically modify the vertical temperature and moisture distribution, on-hand rawinsonde data may be used to evaluate the turbulence potential of convective clouds or thunderstorms for periods up to 24 hours. The following is one procedure for predicting turbulence in such clouds. This method is often referred to as the *Eastern Airlines Method*:

The technique is as follows:

- Determine the CCL.
- From the CCL, proceed along the moist adiabat to the 400-hPa level. This curve is referred to as the *updraft curve*.
- Compare the departure of the updraft curve with the free air temperature (T) curve at the 400-hPa level. For positive values, the updraft curve should be warmer than the (T) curve. That is, the updraft curve would be to the right of the (T) curve. The value of the maximum positive departure obtained in this step is referred to as ΔT .

Table 5-3 is based on several years relating AT values to commercial pilot reports of thunderstorm turbulence, and can be used to predict the degree of turbulence in air mass thunderstorms.

This method of forecasting thunderstorm turbulence is almost exclusively confined to the warmer months when frontal cyclonic activity is at a minimum. During the cooler months, frontal and cyclonic influences may cause rapid changes in the vertical distribution of temperatures and moisture, and some other methods have to be used.

FORECASTING CLEAR AIR TURBULENCE (CAT)

Clear air turbulence is one of the more common in-flight hazards encountered by high-altitude, high-performance aircraft.

Not all high-level turbulence occurs in clear air. However, a rough, bumpy ride may occur in clear air, without visual warning. This turbulence may be violent enough to disrupt tactical operations, and possibly cause serious airframe stress and/or damage.

Most cases of CAT at high altitudes can be attributed to the jetstream, or more specifically, the abrupt vertical wind shear associated with the jetstream. CAT is experienced most frequently during the winter months when the jetstream winds are the strongest.

The association of CAT with recognizable synoptic features has become better understood over the last few years. The following are general areas where CAT may occur:

- In general, in any region along the jetstream axis where wind shear appears to be strong horizontally, vertically, or both.
- In the vicinity of traveling jet maxima, particularly on the cyclonic side.
- In the jetstream below and to the south of the core.
- Near 35,000 feet in cold, deep troughs.

The instruction *Atmospheric Turbulence and Icing Criteria*, NAVMETOCCOMINST 3140.4, sets forth associated phenomena, as well as a common set of criteria for the reporting of turbulence.

Table 5.3.-Relation of Maximum Positive Departure to Thunderstorm Turbulence

ΔT (°C)	TURBULENCE
0-3	Light
4-6	Moderate
7-9	Severe
Above 9	Extreme

OBSERVATION OF SEVERE WEATHER FEATURES USING DOPPLER RADAR

Doppler radar (WSR - 88D) is proving to be a boon to the forecasting of severe weather features, such as wind shear, turbulence, and microbursts. For a discussion of these topics, refer to the *Federal Meteorological Handbook No. 11, Doppler Radar Meteorological Observations, Part D*, as well as chapter 12 of this manual.

SUMMARY

In this chapter we first discussed phenomena associated with thunderstorms; and then followed with a discussion of associated hazards aloft and at the surface. Methods used in the forecasting of thunderstorm movement and intensity were discussed. Following the discussion of thunderstorms, we covered tornadoes, tornado types, and waterspouts. A discussion on fog formation, types of fog, conditions necessary for various types of fog, and the use of the Skew T Log P Diagram in determining various fog parameters were presented. Next, we covered the processes involved in aircraft icing, intensities of icing, icing hazards near the surface, and aloft. Operational aspects of aircraft icing were then discussed, followed by types of icing and icing intensity forecasts. The last topics presented were turbulence characteristics, classification and intensities, the forecasting of turbulence near the surface, in-cloud, and CAT, as well as a discussion of the benefits of Doppler radar in forecasting turbulence.

CHAPTER 6

SEA SURFACE FORECASTING

The task of forecasting various elements of the sea surface is the responsibility of senior Aerographer's Mates filling a variety of billets.

Aboard carriers, sea condition forecasts for flight operations, refueling, or underway replenishment must be provided on a routine basis. Staffs of larger facilities will generally provide surf forecasts for amphibious operations, while at air stations that support search and rescue (SAR) units, you may be called upon to provide forecasts of sea conditions and surface currents. Therefore, it is important that you be familiar with these elements and be able to provide forecasts as necessary.

In this chapter, we will discuss sea surface characteristics and the forecasting of sea waves, swell waves, surf, and surface currents. Now let's consider sea surface characteristics.

SEA SURFACE CHARACTERISTICS

LEARNING OBJECTIVES: Describe the basic principles of ocean waves. List and describe the properties that all waves have in common. Define additional terms used in sea surface forecasting. Explain wave spectrum in terms of wave frequency, energy, and wind speed.

To accurately forecast sea conditions it is necessary to understand the process of wave development, the action that takes place as the energy moves, and to have an understanding of the various properties of waves.

In this section, we will discuss this background information and the terminology used. A complete understanding of these terms is necessary to produce the most usable and accurate sea condition forecast.

BASIC PRINCIPLES OF OCEAN WAVES

Ocean waves are advancing crests and troughs of water propagated by the force of the wind. When winds start to blow, the frictional effect of the wind on the water creates ripples that form more or less regular arcs of long radii. As the wind continues to blow, the ripples increase in height and become waves.

A wave is visible evidence of energy moving in an undulating motion through a medium, such as water. As the energy moves through the water, there is little mass motion of the water in the direction of travel of the wave. This can best be illustrated by tying one end of a rope to a pole or other stationary object. When the free end of the rope is whipped up and down, a series of waves moves along the rope toward the stationary end. There is no mass motion of the rope toward the stationary end, only the energy traveling through the medium, in this case the rope.

A *sine wave* is a true rhythmic progression. The curve along the centerline can be inverted and superimposed upon the curve below the centerline. The amplitude of the crest is equal to the amplitude of the trough, and the height is twice that of the amplitude. Sine waves are a theoretical concept seldom observed in reality. They are used primarily in theoretical groundwork so that other properties of sine waves may be applied to other types of waves such as ocean waves. Principles of other types of waves are modified according to the extent of deviation of their properties from those of sine waves.

Waves that have been created by the local wind are known as *sea waves*. These waves are still under the influence of the local wind and are still in the generating area. They are composed of an infinite number of sine waves superimposed on each other, and for this reason they have a large spectrum, or range of frequencies.

Sea waves are very irregular in appearance. This irregularity applies to almost all their properties. The reason for this is twofold: first, the wind in the generating area (fetch) is irregular both in direction and speed; second, the many different frequencies of waves generated have different speeds. Figure 6-1 is a typical illustration of sea waves. The waves found in this aerial photograph are irregular in direction, wave length, and speed.

As the waves leave the generating area (fetch) and no longer come under the influence of the generating winds they become *swell waves*. Because swell waves are no longer receiving energy from the wind, their spectrum of frequencies is smaller than that of sea waves. Swell waves are also smoother and more regular

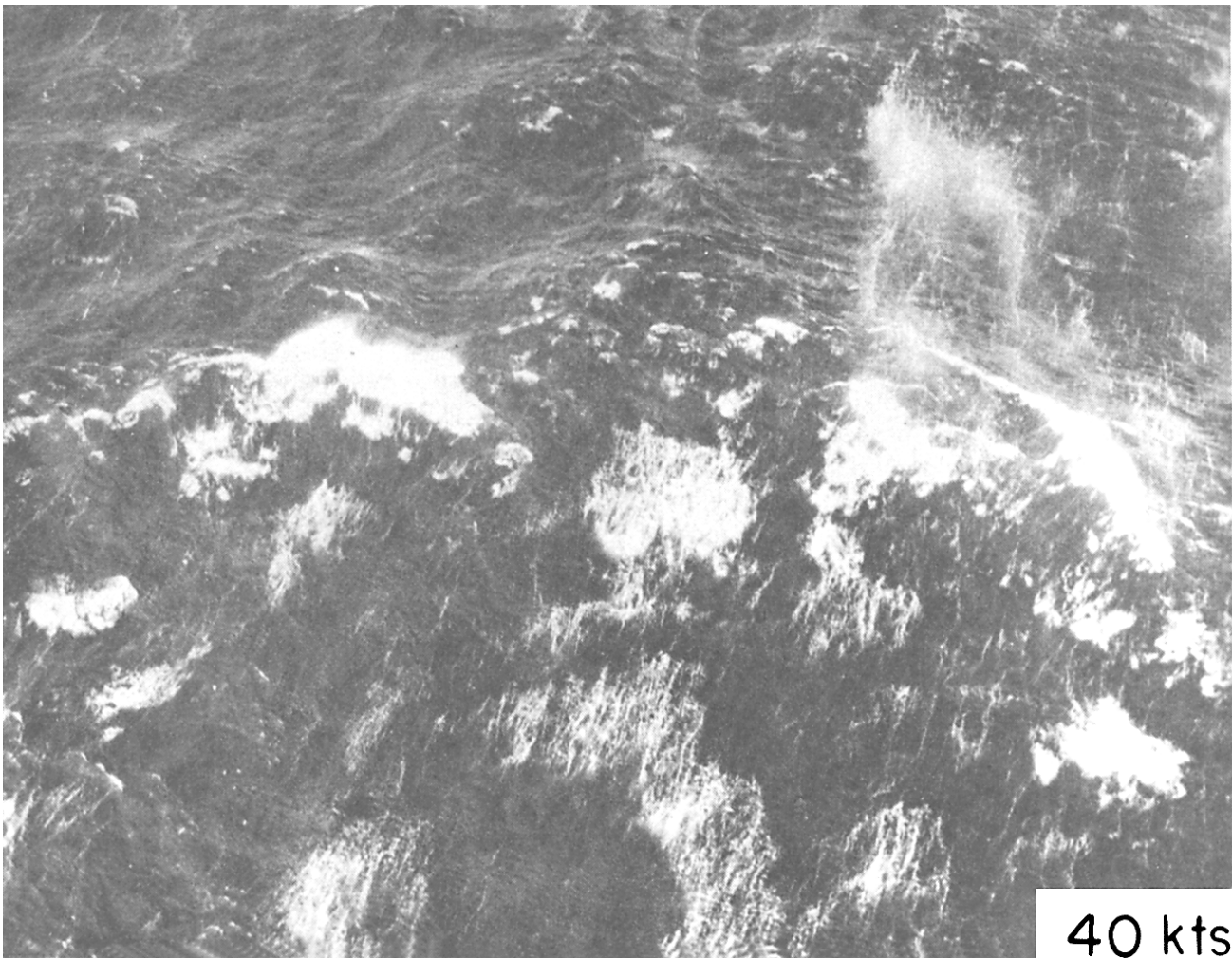

Figure 6-1.-Aerial photo of sea waves.

in appearance than sea waves. Figure 6-2 illustrates typical swell wave conditions.

PROPERTIES OF WAVES

All waves have the following properties in common:

- **Amplitude.** The amplitude of a wave is the maximum vertical displacement of a particle of the wave from its rest position. In the case of ocean waves, the rest position is sea level.

- **Wave Height (H).** Wave height is the vertical distance from the top of the crest to the bottom of the trough. Wave height is measured in feet. Four values for wave height are determined and forecast. They are:

1. H_{avg} (the average height of the waves). This average includes all the waves from the smallest ripple to the largest wave.

2. H_{sig} or $H_{1/3}$ (the average height of the highest one-third of all waves). This significant height of waves seems to represent the wave heights better than the other values, and this value will be used most often for this reason

3. $H_{1/10}$ (the average height of the highest one-tenth of all waves). $H_{1/10}$ is used to indicate the extreme roughness of the sea.

4. H_{max} - high wave.

- **Period (T).** The period of a wave is the time interval between successive wave crests, and it is measured in seconds.

- **Frequency (f).** The frequency of waves is the number of waves passing a given point during 1 second. It is the reciprocal of the period. In general, the lower the frequency, the longer the wave period; the larger the frequency, the shorter the wave period.

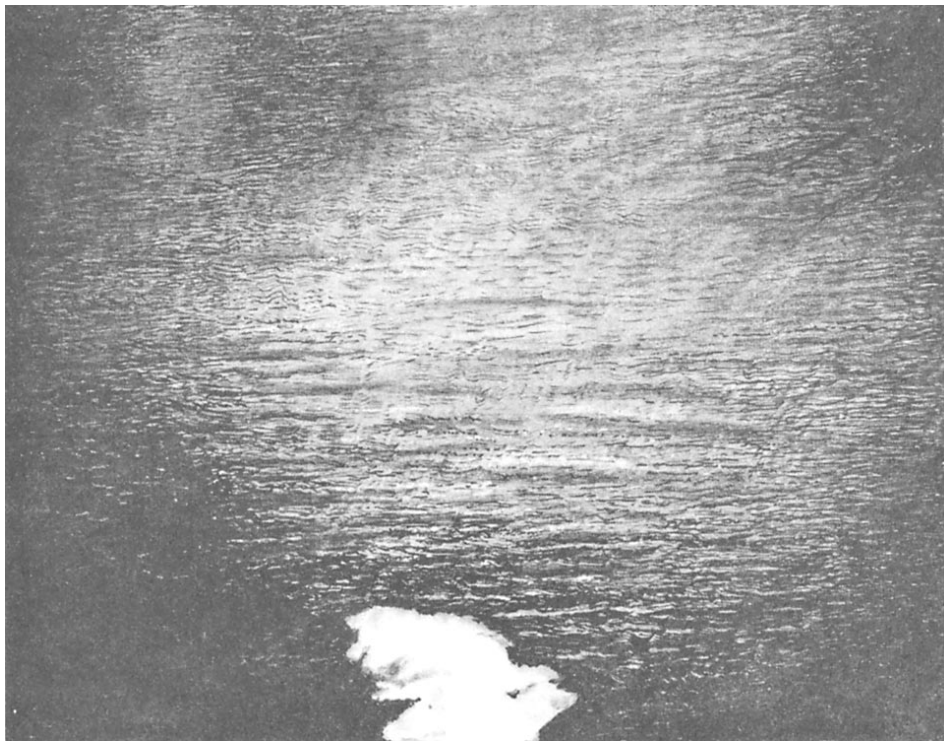

Figure 6-2.-Swell waves.

- **Wave Length (L).** The wave length is the horizontal distance between two successive crests or from a point on one wave to the corresponding point on the succeeding wave. Wave length is measured in feet, and it is found by the formula: $L = 5.12 T^2$.

- **Wave Speed (C).** The wave speed is the rate that a particular phase of motion moves along through the medium. It is the rate that a wave crest moves through the water. There are two speeds used in ocean wave forecasting: group speed and individual speed. The group speed of waves is approximately one-half that of the individual speed. The individual wave speed in knots is found by the formula $C = 3.03 T$. The group wave speed is found by the formula $C = 1.515 T$.

Definitions of Other Terms

Other definitions that the Aerographer's Mate should be familiar are as follows:

- **Deep water.** Water that is greater in depth than one-half the wave length.

Shallow water. Water that is less in depth than one-half the wave length.

- **Fetch (F).** An area of the sea surface over which a wind with a constant direction and speed is blowing, and generating sea waves. The fetch length is measured in nautical miles and has definite boundaries.

- **Duration time (t).** The time that the wind has been in contact with the waves within a fetch.

- **Fully developed state of the sea.** The state the sea reaches when the wind has imparted the maximum energy to the waves.

- **Nonfully developed state of the sea.** The state of the sea reached when the fetch or duration time has limited the amount of energy imparted to the waves by the wind.

- **Steady state.** The state reached when the fetch length has limited the growth of the waves. Once a steady state has been reached, the frequency range produced will not change regardless of the wind.

- **Wind field.** A term that refers to the fetch dimensions, wind duration, and wind speed, collectively.

- **Effective duration time.** The duration time that has been modified to account for the waves already

present in the fetch or to account for waves generated by a rapidly changing wind.

- **E value.** E is equal to the sum of the squares of the individual amplitudes of the individual sine waves that make up the actual waves. Since it is proportional to the total energy accumulated in these waves, it is used to describe the energy present in them and in several formulas involving wave energy.

- **Co-cumulative spectra.** The co-cumulative spectra are graphs in which the total accumulated energy is plotted against frequency for a given wind speed. The co-cumulative spectra have been devised for two situations: a fetch limited wind and a duration time limited wind.

- **Upper limit of frequencies (f_u).** The upper limit of frequencies represents the lowest valued frequencies produced by a fetch or that are present at a forecast point. This term gets its name from the fact that the period associated with this frequency is the period with the highest value. The waves associated with this frequency are the largest waves.

- **Lower limit of frequencies (f_L).** The lower limit of frequencies represents the highest value frequencies produced by a fetch or that are present at a forecast point. This term gets its name from the fact that the period associated with this frequency is the period with the lowest value. The waves associated with this frequency are the smallest waves.

- **Filter area.** That area between the fetch and the forecast point through which swell waves propagate. This area is so termed because it filters the frequencies and permits only certain ones to arrive at a forecast point at a forecast time.

- **Significant frequency range.** The significant frequency range is the range of frequencies between the upper limit of frequencies and the lower limit of frequencies. The term significant range is used because those low-valued frequencies whose E values are less than 5 percent of the total E value and those high-valued frequencies whose E values are less than 3 percent of the total E value are eliminated because of insignificance. The significant range of frequencies is used to determine the range of periods present at the forecast point.

- **Propagation.** Propagation as applied to ocean waves refers to the movement of the swell through the area between the fetch and the forecast point.

- **Dispersion.** The spreading out effect caused by the different group speeds of the spectral frequencies in the original disturbance at the source. Dispersion can be understood by thinking of the different speeds of the different frequencies. The faster wave groups will get ahead of the slower ones; the total area covered is thereby extended. The effect applies to swell only.

- **Angular spreading.** Angular spreading results from waves traveling radially outward from the generating area rather than in straight lines or banks because of different wind direction in the fetch. Although all waves are subject to angular spreading, the effect of such spreading is compensated for only with swell waves because the spreading effect is negligible for sea waves still in the generating area. Angular spreading dissipates energy.

Wave Spectrum

The wave spectrum is the term that describes mathematically the distribution of wave energy with frequency and direction. The wave spectrum consists of a range of frequencies.

Remember that ocean waves are composed of a multitude of *sine waves*, each having a different frequency. For purposes of explanation, these frequencies are arranged in ascending order from left to right, ranging from the low-valued frequencies on the left to the high-valued frequencies on the right, as illustrated in figure 6-3.

A particular range of frequencies, for instance, from 0.05 to 0.10 does not, however, represent only six different frequencies of sine waves, but an infinite number of sine waves whose frequencies range between 0.05 and 0.10. Each sine wave contains a certain amount of energy, and the energy of all the sine waves added together is equal to the total energy present in the ocean waves. The total energy present in the ocean waves is not distributed equally throughout the range of frequencies; instead, in every spectrum, the energy is concentrated around a particular frequency (f_{max}), that corresponds to a certain wind speed. For instance, for a wind speed of 10 knots (kt) f_{max} is 0.248; for 20 kt, 0.124; for 30 kt, 0.0825; for 40 kt, 0.0619. For more

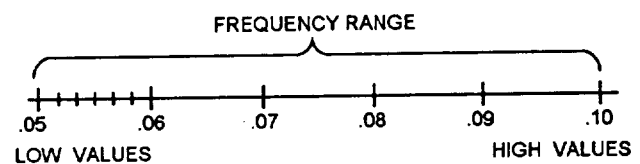

Figure 6-3.-A typical frequency range of a wave spectrum.

information refer to the publication *Practical Methods for Observing and Forecasting Ocean Waves* (H.O. Publication 603), which gives the complete range of f_{\max} values and the corresponding periods for wind speeds, starting from 10 kt, at 2-kt intervals, Notice that the frequency decreases as the wind speed increases, This suggests that the higher wind speeds produce higher ocean waves. The table mentioned above can be graphed for each wind speed, An example of such a graph can also be found in H.O. publication 603.

It is difficult to work with actual energy values of these sine waves; for this reason the square of the wave amplitude has been substituted for energy. This value is proportional to wave energy.

The square of the wave amplitude plotted against frequency for a single value of wind speed constitutes the spectrum of waves. Thus, a graph of the spectrum is needed for each wind speed, and the energy associated with each sine wave can be determined from these graphs. Each wind speed produces a particular spectrum; and the higher the wind speed, the larger the spectrum.

FORECASTING SEA WAVES

LEARNING OBJECTIVES: Describe the generation and growth of sea waves. Explain the formation of fully developed seas. Recognize the factors associated with nonfully developed seas, and determine and analyze features associated with sea waves. Define sea wave terms and describe an objective method of forecasting sea waves.

Since sea waves are in the generating area, forecasting of them will be most important when units are deployed in areas close to storm centers.

Problems encountered in providing these forecasts will include accurately predicting the storm track and the intensity of the winds that develop the sea waves. Now let's look at the generation and growth of sea waves.

GENERATION AND GROWTH

When the wind starts to blow over a relatively calm stretch of water, the sea surface becomes covered with tiny ripples. These ripples increase in height and decrease in frequency value as long as the wind continues to blow or until a maximum of energy has

been imparted to the water for that particular wind speed. These tiny waves are being formed over the entire length and breadth of the fetch. The waves formed near the windward edge of the fetch move through the entire fetch and continue to grow in height and period, so that the waves formed at the leeward edge of the fetch are superimposed on the waves that have come from the windward edge and middle of the fetch. This description illustrates that at the windward edge of the fetch the wave spectrum is small; at the leeward edge of the fetch the spectrum is large.

These waves are generated and grow because of the energy transfer from the wind to the wave. The energy is transferred to the waves by the pushing and dragging forces of the wind. Since the speed of the generated waves is continually increasing, these waves will eventually be traveling at nearly the speed of the wind. When this happens the energy transfer from the wind to the wave ceases, When waves begin to travel faster than the wind, they meet with resistance and lose energy because they are then doing work against the wind. This then explains the limitation of wave height and frequency that a particular wind speed may create.

Fully Developed Sea

When the wind has imparted its maximum energy to the waves, the sea is said to be fully developed. The maximum frequency range for that wind will have been produced by the fetch, and this maximum frequency range will be present at the leeward edge of the fetch. Once the sea is fully developed, no frequency is produced with a value lower than that of the minimum frequency value for the wind speed in question, no matter how long the wind blows. In brief, the waves cannot grow any higher than the maximum value for that wind speed.

When the sea is fully developed, the area near the windward edge is said to be in a steady state, because the frequency range does not increase any more. If the wind continues to blow at the same speed and from the same direction for a considerable period of time, the major portion of the fetch reaches the steady state.

Nonfully Developed Sea

When the wind is unable to impart its maximum energy to the waves, the sea is said to be nonfully developed. This can happen under two circumstances. First, when the distance over which the wind is blowing is limited or when the fetch is limited. Second, when the wind has not been in contact with the sea for a

sufficient length of time, or when the duration time is limited. Now let's look at each situation.

FETCH LIMITED SEA.— When the fetch length is too short, the wind is not in contact with the waves over a distance sufficient to impart the maximum energy to the waves. The ranges of frequencies and wave heights are therefore limited, and the wave heights are less than those of a fully developed sea. The process of wave generation is cut off before the maximum energy has been imparted to the waves and the fetch is in a steady state. This leads to the conclusion that for every wind speed, a minimum fetch distance is required for the waves to become fully developed, and that if this minimum fetch requirement is not met, the sea is fetch limited.

DURATION TIME LIMITED SEA.— When the wind has not been in contact with the waves long enough, it has had insufficient time to impart the maximum energy to the waves, and the growth of the frequency range and wave heights ceases before the fully developed state of the sea has commenced. Such a situation is known as a duration time limited sea. This leads to the conclusion that for every wind speed, a minimum duration time is required for the waves to become fully developed; and that if this minimum duration time requirement is not met, the sea is duration time limited. The state of the sea, then, is one of three conditions: fully developed, fetch limited, or duration time limited.

Table 6-1 shows the various wind speeds, fetch lengths and minimum wind duration times needed to generate a fully developed state of the sea. When conditions do not meet these minimum requirements, the properties of the waves must be determined by means of graphs and formulas.

DETERMINING THE WIND FIELD

As we have discussed, wind is the cause of waves. It therefore stands to reason that in order to accurately predict sea conditions, it is necessary to determine wind properties as accurately as possible. Miscalculation of fetch, wind speed, or duration will lead to inaccuracies in predicted wave conditions.

In this section, we present methods of determining the wind properties as accurately as possible with the available data.

Table 6-1.-Minimum Wind Speed (V), Minimum Fetch Length (F), and Minimum Duration Time (t) Needed to Generate a Fully Developed Sea

V WIND SPEED (KT)	F FETCH LENGTH (NMI)	t DURATION (HR)
10	10	2.4
12	18	3.8
14	28	5.2
16	40	6.6
18	55	8.3
20	75	10
22	100	12
24	130	14
26	180	17
28	230	20
30	280	23
32	340	27
34	420	30
36	500	34
38	600	38
40	710	42
42	830	47
44	960	52
46	1,100	57
48	1,250	63
50	1,420	69
52	1,610	75
54	1,800	81
56	2,100	88

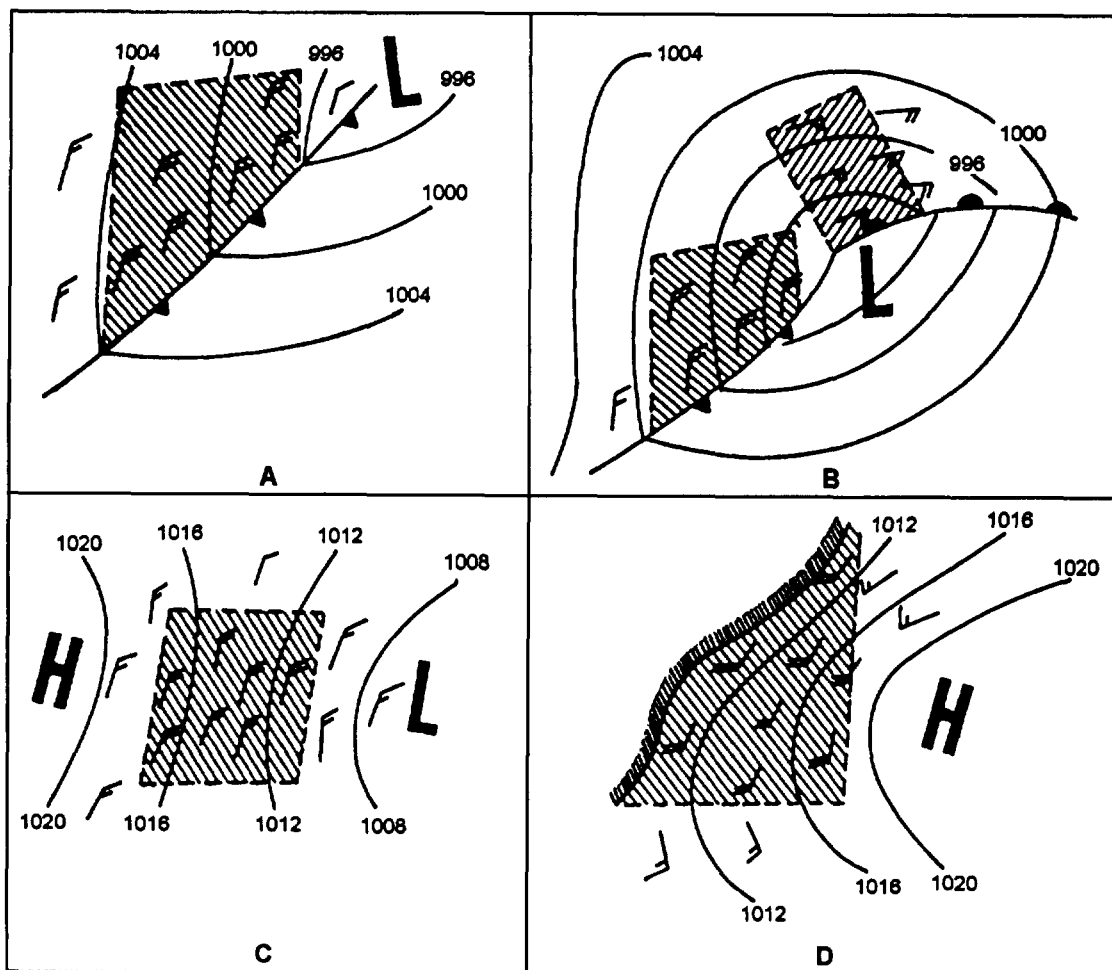

25NP0065

Figure 6-4.-Typical fetch areas.

Location of Fetch

In all cases, the first step toward a wave forecast is locating a fetch. A fetch is an area of the sea surface over which a wind with a constant direction and speed is blowing. Figure 6-4 shows some typical fetch areas. The ideal fetch over an open ocean is rectangular shaped, with winds that are constant in both speed and direction. As shown in figure 6-4, most fetch areas are

bounded by coastlines, frontal zones or a change in isobars. In cases where the curvature of the isobars is large, it is a good practice to use more than one fetch area, as shown in figure 6-4(B).

Although some semipermanent pressure systems have stationary fetch areas, and some storms may move in such a manner that the fetch is practically stationary, there are also many moving fetch areas. Figure 6-5

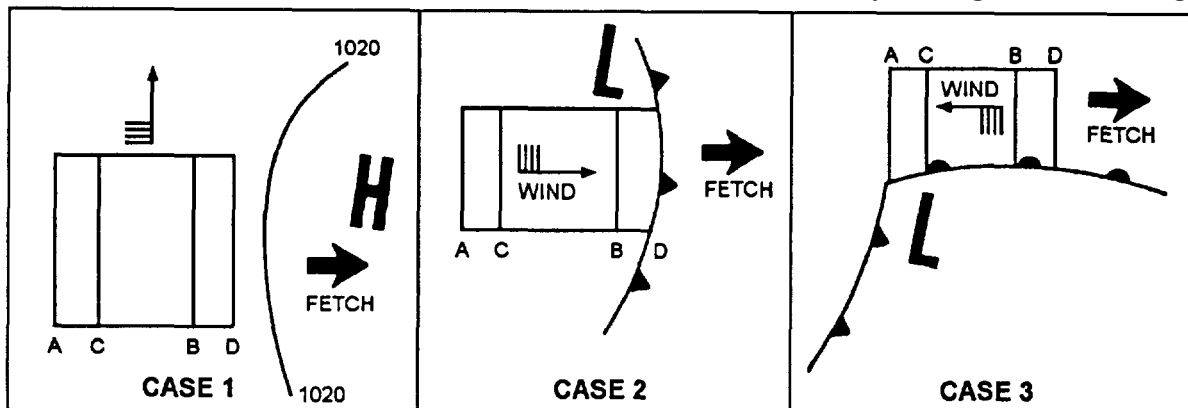

25NP0066

Figure 6-5.-Examples of moving fetches.

shows three cases where a fetch AB has moved to the position CD on the next map 6 hours later. The problem is determining what part of the moving fetch area to consider as the average fetch for the 6-hour period.

In figure 6-5, Case 1, the fetch moves perpendicular to the wind field. The best approximation is fetch CB. Therefore, in a forecast involving this type of fetch, use only the part of the fetch that appears on two consecutive maps. The remaining fetch does contain waves, but they are lower than those in the overlap area.

In figure 6-5, Case 2, the fetch moves to leeward (in the same direction as the wind). Since waves are moving forward through the fetch area, the area to be used in this case is fetch CD.

Case 3, figure 6-5, depicts the fetch moving windward (against the wind). Since the waves move toward A, the region AC will have higher waves than the area BD. Experience has shown that in this case AB is the most accurate choice for a fetch,

Determining Accurate Wind Speed

The most obvious and accurate way to determine wind speed over a fetch is to average the reported values from ships. This method has the advantage of not requiring a correction for gradients or stability. But often there are only a few ship reports available, and ship reports are subject to error in observation, encoding, or transmission.

A second way to determine wind speed is to measure the geostrophic wind from the isobaric spacing and then correct it for curvature and stability. At first it would seem this would be less desirable due to the extra time necessary for corrections. However, barometric pressure is probably the most reliable of the parameters reported by ships, and a reasonably accurate isobaric analysis can be made from a minimum number of reports. For these reasons the corrected geostrophic wind is considered to be the best measure of wind speed over the fetch, except of course in cases where there is a dense network of ship reports where wind direction and speed are in good agreement.

The reason for correction to geostrophic wind is that the isobars must be straight for a correct measure of the wind. When the isobars curve, other forces enter into the computations. The wind increases or decreases depending on whether the system is cyclonic or anticyclonic in nature. The stability correction is a measure of turbulence in the layer above the water. Cold air over warmer water is unstable and highly turbulent,

making the surface wind more nearly equal to the geostrophic wind. Conversely, warm air over colder water produces a stable air mass and results in the surface wind being much smaller than the geostrophic wind.

Three rules for an approximation of the curvature correction are as follows:

1. For moderately curved to straight isobars-no connection is applied.
2. For great anticyclonic curvature-add 10 percent to the geostrophic wind speed.
3. For great cyclonic curvature-subtract 10 percent from the geostrophic wind speed.

In the majority of cases the curvature correction can be neglected since isobars over a fetch area are relatively straight. The gradient wind can always be computed if more refined computations are desired.

In order to correct for air mass stability, the sea air temperature difference must be computed. This can be done from ship reports in or near the fetch area aided by climatic charts of average monthly sea surface temperatures when data is too scarce. The correction to be applied is given in table 6-2. The symbol T_s stands for the temperature of the sea surface, and T_a for the air temperature.

Determination of Wind Duration

Once a fetch has been determined and the wind speed has been found, the next step is to determine the duration of that wind over the fetch. It is highly unlikely that the wind will begin and end at one of the 6-hour map times. Therefore an accurate value must be interpolated. In most cases a simple interpolation of the successive maps will be sufficient to locate the bounds of the wind field in space and time.

Table 6-2.-Air-Sea Temperature Difference Correction

$(T_s - T_a)$ Algebraically Subtracted	Percent of Geostrophic Wind
0 or negative	60
0 to 10	65
10 to 20	75
20 or above	90

Determining how long the wind has blown is relatively simple when the wind speed has been constant for the entire duration. If this does not occur, a representative duration must be selected.

SLOWLY VARYING WIND.— Suppose the wind has been blowing for 24 hours, with velocities of 10 knots for 6 hours, 15 knots for 12 hours, and 20 knots for 6 hours. The duration is 24 hours but the speed value is in question. The most consistent solution is to use three durations with the corresponding wind speeds and work up three successive states.

MORE RAPID VARIATIONS.— Suppose the wind blows for 12 hours and during that time it increases in velocity from 10 to 20 knots. Studies and experience have shown that in cases of variable winds a single value may be assigned for wind speed if the change has been relatively small. The following rules can be applied under these conditions:

- Average the speeds when the change is gradual or increasing or decreasing. Apply the average to the entire duration.
- Use the last wind speed when the speed changes in the first few hours, then remains constant. Apply that speed to the entire duration.

OBJECTIVE METHODS FOR FORECASTING SEA WAVES

There are a number of different methods for forecasting sea waves. Some of the methods are too technical or time consuming to be of practical use of Aerographer's Mates.

A relationship between wave velocity (c), wave length (L), and period (T) maybe indicated using the equation $C = 3.03 T$. The length in feet of a deep-water wave (L) may be computed using the equation $L = 5.12 T$. The period of a wave in seconds (T) may be calculated using the equation $T = 0.33 C$, where (C) is the wave velocity.

Sea state forecasts are divided into four categories: significant wave height ($H_{1/3}$), average wave height (H_{AVG}), one-tenth average wave height ($H_{1/10}$), and high wave (H_{MAX}).

For more information, refer to the practical training publication *Sea and Swell Forecasting*, NAVEDTRA 40560, published by the Naval Oceanographic Office. This publication presents a method for forecasting sea waves, and a brief summary follows.

In order to prepare an accurate sea state forecast one must first determine wind speed over the fetch (U), length of the fetch (F), and the length of time the wind speed (u) has remained unchanged within the fetch (t_d).

These parameters are determined using current and/or previous surface charts. Using these parameters and the tables in NAVEDTRA 40560, an accurate sea state forecast may be obtained.

FORECASTING SWELL WAVES

LEARNING OBJECTIVES: Explain swell wave generation and recognize the two fundamental modifications that sea waves undergo as they leave the fetch area. Define the terms associated with swell waves, and explain the five rules used to determine how much of the swell will reach the forecast point. Prepare an objective swell wave forecast.

In the preceding portion of this chapter, we have discussed the principles of sea waves and methods of forecasting them. With sea wave forecasting we are considering the point that we are forecasting to be within the generating area, with the wind still blowing. This, however, will not be the problem in the majority of the forecasts that will be required. Normally the forecast point will be outside the fetch area; therefore, it will be necessary to determine what effect the distance traveled is going to have on the waves. In this section we will discuss the basic principles of swell waves as well as an objective method of determining what changes will take place in the spectrum of waves as they traverse from the generating area to the forecast point.

GENERATION OF SWELL WAVES

After a sea state has been generated in a fetch, there are many different wave trains present with different periods, and most of them are moving out of the fetch in slightly different directions. Because of these different periods and slight differences in direction, the propagation of swell waves follows two fundamental processes. These processes are dispersion and angular spreading.

Dispersion

An accepted fact about wave travel is that the waves with longer periods move faster than waves with shorter

periods. The actual formula for the speed of the wave train is

$$C = 1.515T$$

where C is the speed of the wave train and T is the wave period in the wave train.

All of the different wave trains (series of waves all having the same period and direction of movement) in the fetch can be compared to a group of long distance runners at a track and field meet. At first all of the runners start out at the starting line at the same time. As they continue on, however, the faster runners move ahead and the slower runners begin to fall behind. Thus the field of runners begins to string out along the direction of travel. The wave trains leaving a fetch do the same thing. The stringing out of the various groups of waves is called dispersion.

In a swell forecast problem it is necessary to determine what wave trains have already passed the forecast point and which have not yet arrived. After this

has been determined, the wave trains that are left are the ones that are at the forecast point at the time of observation.

Angular Spreading

As the wave trains leave the fetch, they may leave at an angle to the main direction of the wind in the fetch. Thus, swell waves may arrive at a forecast point though it may lie to one side of the mainline of direction of the wind. This process of angular spreading is depicted in figure 6-6.

The problem in swell forecasting is to determine how much of the swell will reach the forecast point after the waves have spread out at angles. This is accomplished by measuring the angles from the leeward edge of the fetch to the forecast point. These angles must be measured as accurately as possible, figure 6-7, and are determined by the following five rules:

1. Draw the rectangular fetch.

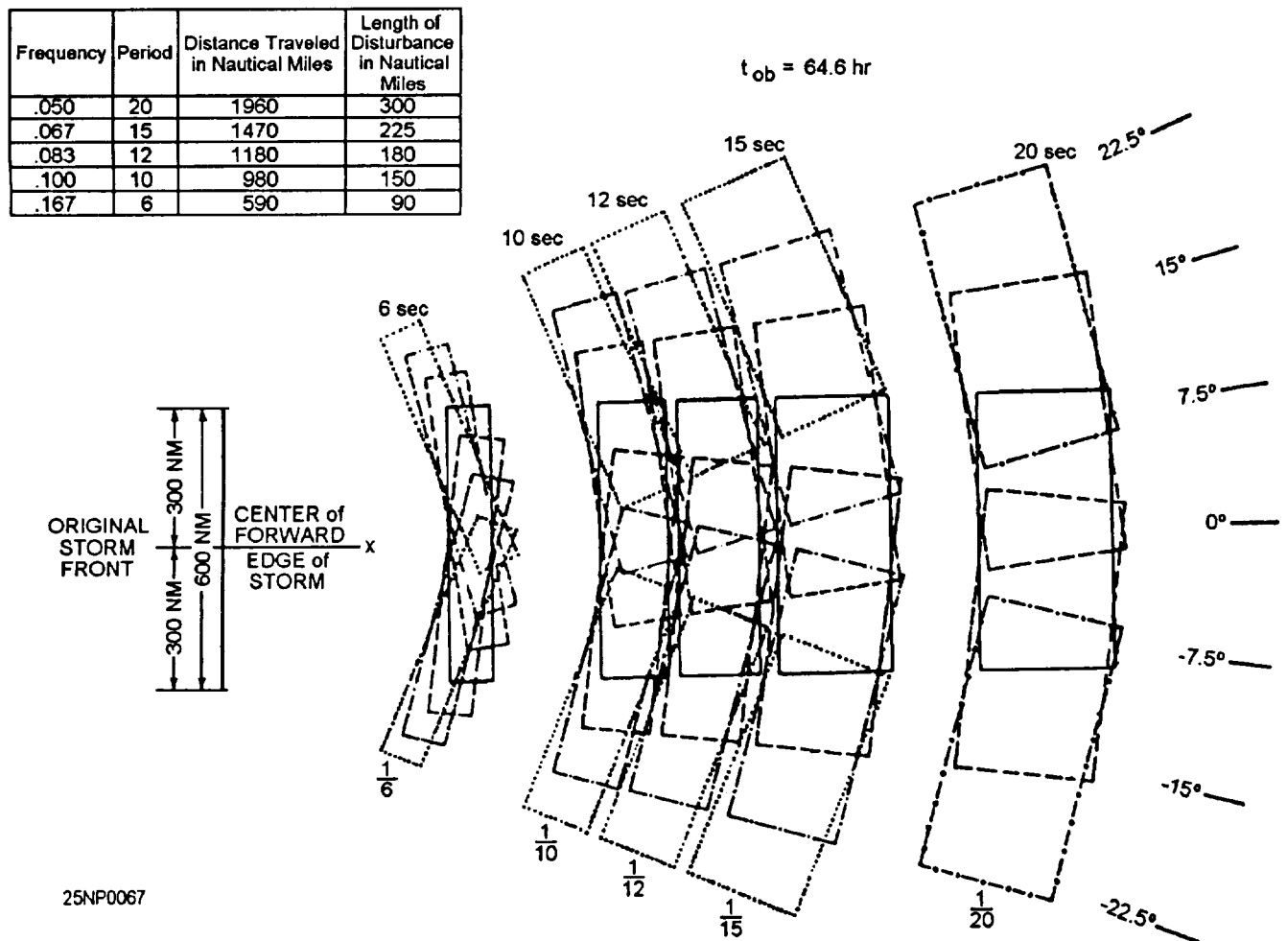

Figure 6-6.-Angular spreading.

25NP0088

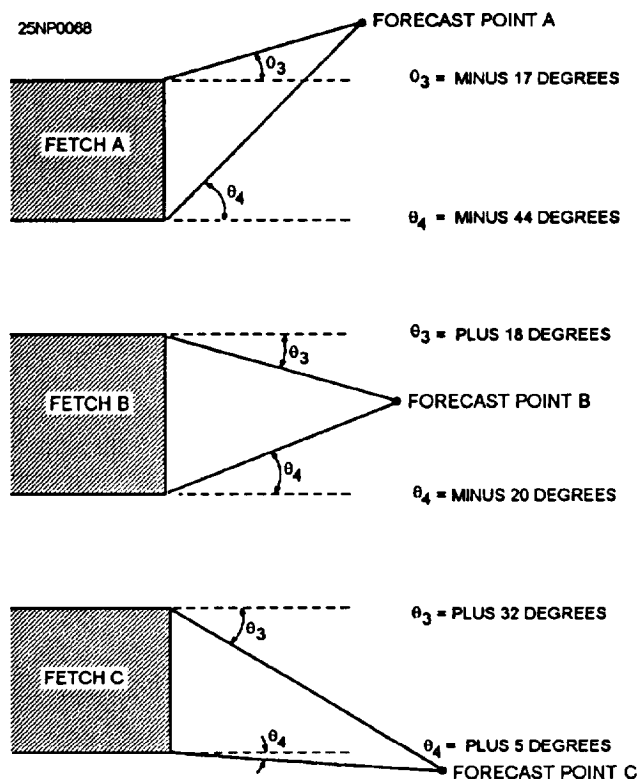

Figure 6-7.-Measurements of angles for angular spreading.

2. Extend the top and bottom edge of the fetch outward parallel to the main direction of the wind. This is shown as dashed lines in figure 6-7.

3. Draw lines from the top and bottom edges of the fetch to the forecast point.

4. The angles to the forecast point are designated Theta 3 (θ_3) and Theta 4 (θ_4). Theta 3 is measured from the top edge of the fetch and Theta 4 from the bottom edge.

5. Any angle that lies above the dashed line is negative while any angle that lies below the dashed line is positive.

After the angles Theta 3 and 4 have been measured they are converted to percentages of the swell that will reach the forecast point. This conversion is made by entering sea and swell graph 7, figure 6-8, with the positive or negative angles and reading the corresponding percentages directly. The percentages are then subtracted ignoring the plus or minus to find the angular spreading.

OBJECTIVE METHOD FOR FORECASTING SWELL WAVES

A number of terms used in dealing with forecasting sea waves will be used again in this process; however, a number of new terms will be introduced. Table 6-3 lists most of these terms with their associated symbol and definition.

As with objective forecasting of sea waves there are a number of different methods for forecasting swell waves. Some of the methods are too technical or time consuming to be of practical use.

When ship operations are conducted outside a fetch area it becomes necessary to forecast swell conditions at that location. Prior to computing swell conditions the height and period of the significant waves departing the fetch area must be determined. For more details refer to *Sea and Swell Forecasting*, NAVEDTRA 40560.

FORECASTING SURF

LEARNING OBJECTIVES: Explain the generation of surf and describe the two changes that occur upon entering intermediate water. Recognize the characteristics of the three types of breakers. Define the terms associated with surf. Describe an objective method for surf forecasting and the calculations of the modified surf index.

Thus far we have discussed the generation of sea waves, their transformation to swell waves, some of the changes that occur as they move, and objective methods of forecasting both waves.

The Navy is greatly involved in amphibious operations, which requires the forecasting of another sea surface phenomena: surf. Senior Aerographer's Mates will occasionally be called upon to provide forecasts for amphibious operations, and accurate and timely forecasts can greatly decrease the chance of personnel injury or equipment damage. Therefore, it is important that forecasters have a thorough understanding of the characteristics of surf and a knowledge of surf forecasting techniques.

GENERATION OF SURF

The breaking of waves in either single or multiple lines along the beach or over some submerged bank or reef is referred to as surf.

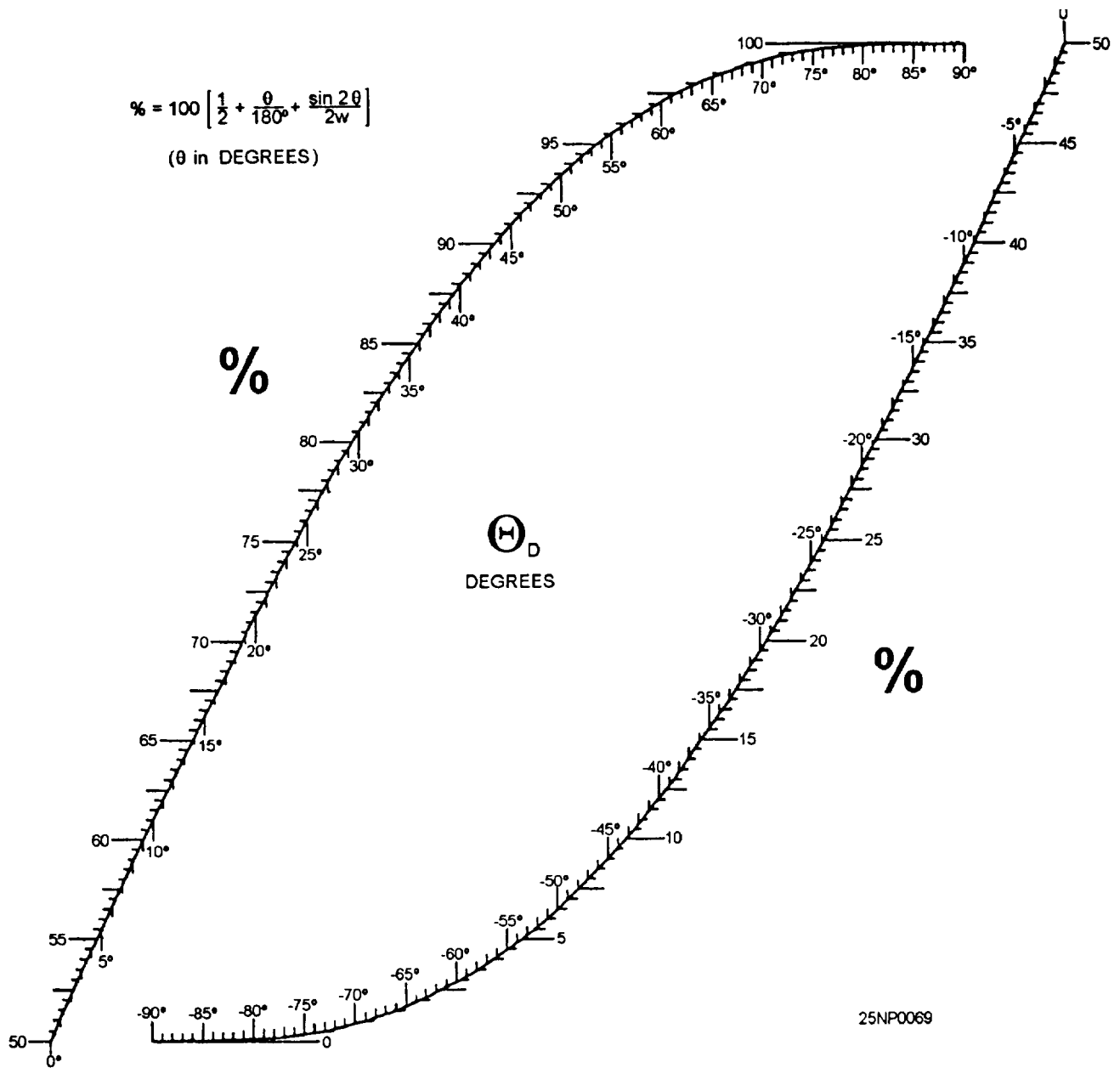

Figure 6-8.-Sea and swell graph 7.

Table 6-3.-Sea Wave Terminology

NAME	SYMBOL AND DIMENSION	DEFINITION
Decay distance	(D) Miles	Distance from point of forecast to the leeward (downwind) edge of the fetch.
Decay index	(H_o/H_f)	Ratio of deep water wave height to fetch wave height.
Deep water wave height	(H_o) Feet	Height of waves after leaving the generating fetch but before reaching shallow water to become surf. (Swell height).
Travel time	(t_o) Hours	Length of time necessary for waves to travel decay distance (D).

The energy that is being expended in producing this phenomenon is the energy that was given to the sea surface when the wind developed the sea waves. This energy is diminished as the swell waves move from the fetch area to the area of occurrence of the surf.

The surf zone is the extent from the water up-rush on the shore to the most seaward breaker. It will be within this area that the forecast will be prepared.

When waves enter an area where the depth of the bottom reaches half their wave length, the waves are said to “feel bottom.” This means that the wave is no longer traveling through the water unaltered, but is entering intermediate water where changes in wave length, speed, direction, and energy will occur. There will be no change in period. These changes are known as shoaling and refraction. Shoaling affects the height of the waves, but not direction, while refraction effects both. Both shoaling and refraction result from a change in wave speed in shallow water. Now let’s look at shoaling and refraction in more detail.

Shoaling

The shoaling effect is caused by two factors. The first is a result of the shortening of the wave length. Wave length is shortened as the wave slows down and the crests move closer together. Since the energy between crests remains constant the wave height must increase if this energy is to be carried in a shorter length of water surface. Thus, waves become higher near shore than they were in deep water. This is particularly true with swell since it has along wavelength in deep water and travels fast. As the swell speed decreases when approaching shore, the wave length shortens, and along swell that was barely perceptible in deep water may reach a height of several feet in shallow water.

The second factor in shoaling has an opposite effect (decreasing wave height) and is due to the slowing down of the wave velocity until it reaches the group velocity. AS the group velocity represents the speed that the energy of the wave is moving, the height of the individual wave will decrease with its decreasing speed until the wave and group velocity are equal. The second factor predominates when the wave first feels bottom, decreasing the wave height to about 90 percent of its deep water height by the time the depth is one-sixth of the wave length. Beyond that point, the effect of the decreased distance between crests dominates so that the wave height increases to quite large values close to shore.

Refraction

When waves arrive from a direction that is perpendicular to a straight beach, the wave crests will parallel the beach. If the waves are arriving from a direction other than perpendicular or the beach is not straight, the waves will bend, trying to conform to the bottom contours. This bending of the waves is known as refraction and results from the inshore portion of the wave having a slower speed than the portion still in deep water. This refraction will cause a change in both height and direction in shallow water.

Surf Development

When a wave enters water that is shallower than half its wave length, the motion of the water near the bottom is retarded by friction. This causes the bottom of the wave to slow down. As the water becomes more shallow the wave speed decreases, the wave length becomes shorter, and the wave crest increases in height. This continues until the crest of the wave becomes too high and is moving too fast. At this point the crest of the wave becomes unstable and crashes down into the preceding wave trough; when this happens the wave is said to be breaking. The type of breaker (that is, whether spilling, plunging, or surging) is determined by the steepness of the wave in deep water and the slope of the beach. Figure 6-9 depicts the general characteristics of the three types of breakers.

SPILLING BREAKER.— Spilling breakers occur with shallow beach slopes. The water at the crest of a wave may create foam as it spills down the face of the wave. Spilling breakers also occur more frequently when deepwater sea waves approach the beach. This is because the shorter wavelength of a sea wave means that the wave is steeper in the deep water and that the water spills from the crest as the waves begin to feel bottom. Because the water constantly spills from the crest in shorter wavelength (shorter period) waves, the height of spilling waves rarely increases as dramatically when the wave feels bottom, as do the longer period waves forming at the crest and expanding down the face of the breaker.

PLUNGING BREAKER.— Plunging breakers occur with a moderately steep bottom. In this type of breaker, a large quantity of water at the crest of a wave curls out ahead of the wave crest, temporarily forming a tube of water on the wave face before the water plunges down the face of the wave in a violent tumbling action. Plunging breakers are characterized by a loud, explosive sound made when the air trapped in the curl

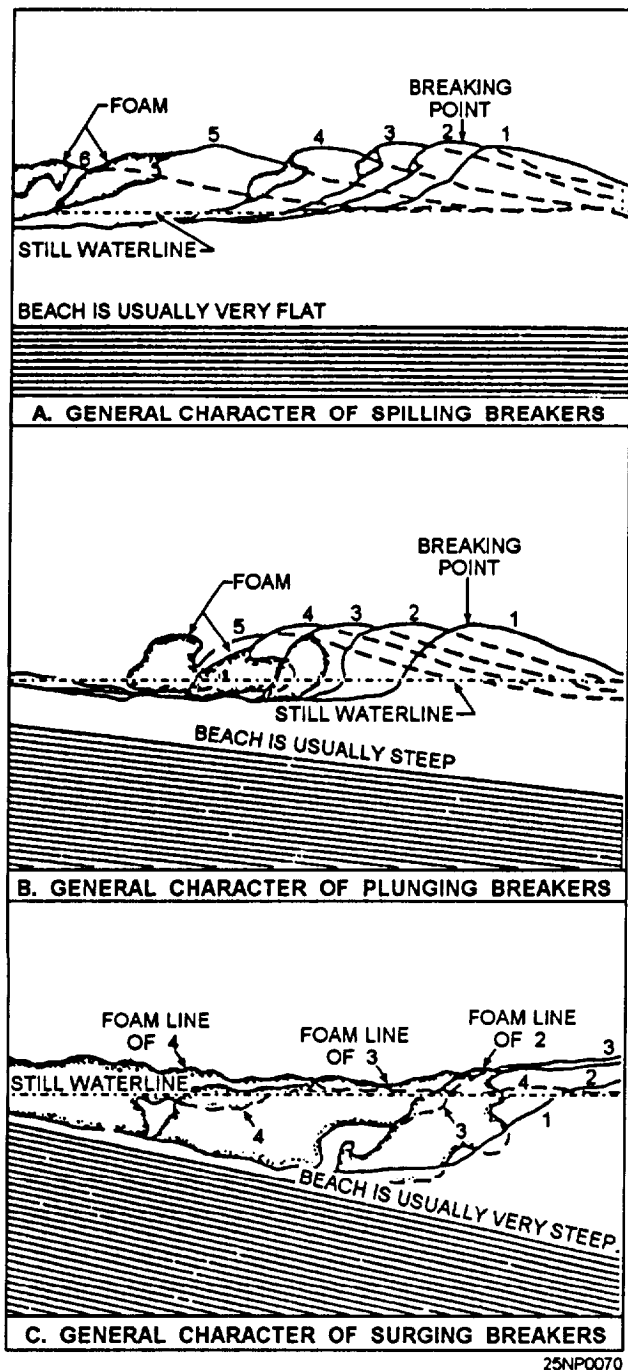

Figure 6-9.-General characteristics of spilling, plunging, and surging breakers.

is released Plunging breakers are more commonly associated with swell waves that approach the beach with much longer wavelengths. The shortening of the wavelength as the wave feels bottom causes a great mass of water to build up in the crest in a short time. Longer period swell waves may double in height when feeling bottom.

SURGING BREAKER.— Surging breakers are normally seen only with a very steep beach slope. This

type of breaker is often described as creating the appearance that the water level at the beach is suddenly rising and falling. The entire face of the wave usually displays churning water and produces foam, but an actual curl never develops.

Littoral Current

Remember that refraction occurs when a wave train strikes a beach at an angle, and this action causes a mass transport of water parallel to the beach in the same direction as the wave train. This mass transports called the longshore current or littoral current.

Many of the craft used in amphibious operations are small and, because they are designed to land upon the beach are not sea-worthy. Owing to the size of landing craft, significant breaker height, maximum breaker height, breaker period, breaker type, the angle of breakers to the beach, the longshore (littoral) current speed and the number of lines of surf can have a dramatic effect on amphibious operations and are of vital importance.

Definition of Terms

The following are some terms that will be used extensively in surf discussions and should be understood by the forecaster:

- Breaker height - the vertical distance in feet between the crest of the breaker and the level of the trough ahead of the breaker.
- Breaker wave length - the horizontal distance in feet between successive breakers.
- Breaker period - the time in seconds between successive breakers. This is always the same as the deepwater wave period.
- Depth of breaking - the depth of the water in feet at the point of breaking.
- Surf zone - the horizontal distance in yards between the outermost breakers and the limit of wave uprush on the beach.
- Number of lines of surf - the number of lines of breakers in the surf zone.
- Deep water wave angle - the angle between the bottom contours and the deep water swell wave crests.
- Breaker angle - the angle between the beach and the lines of breakers. It is always less than the deep water wave angle.

- Wave steepness index - ratio of the deep water wave height to deep water wave period squared
- Breaker height index - ratio of breaker height to deep water wave height.
- Breaker type - classification of breaker as to spilling, plunging, or surging.
- Breaker depth index - ratio of depth of breaking to deep water wave height.
- Width of surf zone - horizontal distance in yards between the outermost breakers and the limit of wave uprush on the beach.
- Refraction index - ratio of depth of breaking to the deep water wave length.
- Coefficient of refraction - percent of breaker height that will actually be seen on the beach after refraction occurs.
- Longshore current - current parallel to beach due to breaker angle, height, period, and beach slope.

OBJECTIVE TECHNIQUE FOR FORECASTING SURF

Figure 6-10 provides an example of the surf worksheet that may be used in a surf forecasting procedure. The steps in the method conform to steps on the worksheet.

Equipped with an understanding of the terms discussed above, the surf forecast worksheet, figure 6-10, and the step-by-step procedures listed in *Surf Forecasting*, NAVEDTRA 40570, the Aerographer's Mate can prepare accurate surf forecasts.

The presentation to the user can be made in any manner that is agreed upon; however, figure 6-11 illustrates one of the most commonly used methods.

FORECASTING THE MODIFIED SURF INDEX

The Modified Surf Index is a dimensionless number that provides a measure of likely conditions to be encountered in the surf zone. The Modified Surf Index provides a guide for judging the feasibility of landing operations for various types of landing craft.

The Modified Surf Index Calculation Sheet, breaker, period, and wave angle modification tables are listed in the *Joint Surf Manual*, COMNAVSURFPAC/COMNAVSURFLANTINST

3840.1. By following the listed procedures on the Modified Surf Index Calculation Sheet the Aerographer's mate obtains an objective tool to be used by on-scene commanders.

The *Joint Surf Manual* also lists modified surf limits for various propeller driven landing craft. The modified surf index is not applicable for the Landing Craft Air Cushion (LCAC). LCAC operations use the significant breaker height.

For more information on amphibious operations, see *Environmental Effects on Weapon's Systems and Naval Warfare (U)*, (S)RP1.

FORECASTING SURFACE CURRENTS

LEARNING OBJECTIVES: Distinguish between tidal and nontidal currents. Define the terms associated with currents. Classify currents as wind driven, coastal, or tidal. Identify publications available to obtain tidal and current information.

Although the forecasting of surface currents has been performed by aerographers for a number of years, the prominence of such forecasting became more evident when a number of incidents involving large sea-going oil tankers occurred. Collisions and grounding involving tankers caused great amounts of pollutants, mainly oil, to be spilled on the water surface. The movement, both direction and speed, of such contaminants is directly controlled by the surface currents in the affected area. More concerned emphasis has now been placed on the ability of forecasters to predict the movement of such contaminated areas.

In the past, NAVMETOC units have provided forecasts to assist in the location of personnel or boats adrift in the open sea as well as forecasts used in estimating ice flow.

With the growing concern about pollution and contamination of ocean waters, it is anticipated that more requests for current and drift forecasts will be directed to NAVMETOC units.

In this section, we will discuss the general characteristics of currents, how they form, and the different types of currents. There are presently no hard and fast rules or techniques that are universally

SURF FORECAST WORKSHEET

BEACH NAME _____ BEACH SLOPE _____ ETA SURF _____

FROM OBSERVED OR FORECAST SWELL

- | | |
|--|-------------------|
| 1. Deep water wave height | $H_o =$ _____ ft |
| 2. Deep water wave period | $T_o =$ _____ sec |
| 3. Angle between deep water waves and depth contours | $a_o =$ _____ deg |

SURF CALCULATIONS			
Step	Enter SWELL GRAPH	With	And Read
4	1	H_o from step 1 and T_o from step 2	H_o/T_o^2
5	2	H_o/T_o^2 from step 4	H_b/H_o
6	3	H_o from step 1 and H_b/H_o from step 5	H_b ft
7	4	H_o/T_o^2 from step 4 and Beach Slope from heading	Breaker Type
8	5	H_o/T_o^2 from step 4. If $H_o/T_o^2 < .01$ go to next step	d_b/H_o
9	6	H_o from step 1 and d_b/H_o from step 8 or use $d_b = 1.3 H_o$ if $H_o/T_o^2 < .01$	d_b ft
10	7	d_b from step 9 and Beach Slope from heading	Width of Surf Zone yd
11	8	d_b from step 9 and T_o from step 2	L_b ft
12	9	L_b from step 11 and Width of Surf Zone from step 10	No. Lines of Surf
13	10	d_b from step 9 and T_o from step 2.	d_b/L_o
14	11	a_o from step 3 and d_b/L_o from step 13	a_b deg K_d
15	12	H_b from step 6 and K_d from step 14	H_b corrected for refraction cor H_b ft
16	13	a_b from step 14 and Beach Slope from heading. H_b from step 15 and T_o from step 2	Longshore Current kt

Figure 6-10.-Sample surf worksheet.

SURFCST	(Beach)	(Time)
ALPHA	BRAVO	CHARLIE
DELTA	ECHO	FOXTROT
GOLF	HOTEL	
ALPHA	= Significant Breaker Height (ft)	
BRAVO	= Maximum Breaker Height (ft)	
CHARLIE	= Period of Breakers (sec)	
DELTA	= Type of Breakers	
ECHO	= Angle Breakers Make with Beach (deg)	
FOXTROT	= Longshore Current (kt)	
GOLF	= Number of Lines of Surf, Width of Surf Zone (yd)	
HOTEL	= Remarks	

Figure 6-11. Example of final forecast form.

followed. Most units involved in surface current forecasts have their own innovations and methods.

CURRENTS

Aerographer's Mates have a knowledge of the major ocean currents and the meteorological results of the interaction of sea and air. Oceanic circulation (currents) plays a major role in the production and distribution of weather phenomena. Principal surface current information such as direction, speed, and temperature distribution is relatively well known.

Tidal and Nontidal currents

Currents in the sea are generally produced by wind, tide, differences in density between water masses, sea level differences, or runoff from the land. They may be roughly classed as tidal or nontidal currents. Tidal currents are usually significant in shallow water only, where they often become the strong or dominant flow. Nontidal currents include the permanent currents in the general circulatory systems of the oceans; geopotential currents, those associated with density difference in water masses; and temporary currents, such as wind-driven currents that are developed from meteorological conditions. The system of currents in the oceans of the world keeps the water continually circulating. The positions shift only slightly with the seasons except in the Southeast Asia area where monsoonal effects actually reverse the direction of flow

from summer to winter. Currents appear on most charts as continuous streams defined by clear boundaries and with gradually changing directions. These presentations usually are smoothed patterns that were derived from averages of many observations.

Drift

The speed of a current is known as its drift. Drift is normally measured in knots. The term velocity is often interchanged with the term speed in dealing with currents although there is a difference in actual meaning. Set, the direction that the current acts or proceeds, is measured according to compass points or degrees. Observations of currents are made directly by mechanical devices that record speed and direction, or indirectly by water density computations, drift bottles, or visually using slicks and watercolor differences.

Ocean currents are usually strongest near the surface and sometimes attain considerable speed, such as 5 knots or more reached by the Florida Current. In the middle latitudes, however, the strongest surface currents rarely reach speeds above 2 knots.

Eddies

Eddies, which vary in size from a few miles or more in diameter to 75 miles or more in diameter, branch from the major currents. Large eddies are common on both sides of the Gulf Stream from Cape Hatteras to the Grand Banks. How long such eddies persist and retain their characteristics near the surface is not well known, but large eddies near the Gulf Stream are known to persist longer than a month. The surface speeds of currents within these eddies, when first formed, may reach 2 knots. Smaller eddies have much less momentum and soon die down or lose their surface characteristics through wind stirring.

WIND DRIVEN CURRENTS

Wind driven currents are, as the name implies, currents that are created by the force of the wind exerting stress on the sea surface. This stress causes the surface water to move and this movement is transmitted to the underlying water to a depth that is dependent mainly on the strength and persistence of the wind. Most ocean currents are the result of winds that tend to blow in a given direction over considerable amounts of time. Likewise, local currents, those peculiar to an area, will arise when the wind blows in one direction for some time. In many cases the strength of the wind may be used as a rule of thumb for determining the speed of the

local current; the speed is figured as 2 percent of the wind's force. Therefore, if a wind blows 3 or 4 days in a given direction at about 20 knots, it maybe expected that a local current of nearly 0.4 knot is being experienced.

A wind-driven current does not flow in exactly the same direction as the wind, but is deflected by Earth's rotation. The deflecting force (Coriolis force) is greater at high latitudes and more effective in deep water. It is to the right of the wind direction in the Northern Hemisphere and to the left in the Southern Hemisphere. At latitudes between 10N and 10S the current usually sets downwind. In general the angular difference in direction between the wind and the surface current varies from about 10 degrees in shallow coastal areas to as much as 45 degrees in some open ocean areas. Each layer of moving water sets the layer below in motion. And the layer below is then deflected by the Coriolis effect, causing the below layer to move to the right of the overlying layer. Deeper layers move more slowly because energy is lost in each transfer between layers.

We can plot movements of each layer using arrows whose length represents the speed of movement and whose direction corresponds to the direction of the layer's movements. The idealized pattern for a surface current set in motion by the wind in the Northern Hemisphere is called the EKMAN SPIRAL. Each layer is deflected to the right of the overlying layer, so the direction of water movement shifts with increasing depth. The angle increases with the depth of the current, and at certain depths the current may flow in the opposite direction to that of the surface.

Some major wind-driven currents are the West Wind Drift in the Antarctic, the North and South Equatorial Currents that lie in the trade wind belts of the ocean, and the seasonal monsoon currents of the Western Pacific.

Chapters 6 and 7 of *Oceanography, Sixth Edition*, by M. Grant Gross, contain additional information on the subjects of waves, tides, coasts, and the coastal oceans.

COASTAL AND TIDAL CURRENTS

Coastal currents are caused mainly by river discharge, tide, and wind. However, they may in part be produced by the circulation in the open ocean areas. Because of tides or local topography, coastal currents are generally irregular.

Tidal currents, a factor of little importance in general deepwater circulation, are of great influence in coastal waters. The tides furnish energy through tidal currents, which keep coastal waters relatively well stirred. Tidal currents are most pronounced in the entrances to large tidal basins that have restricted openings to the sea. This fact often accounts for steerage problems experienced by vessels.

WIND DRIVEN CURRENT PREDICTION

Attempts at current prediction in the past have only been moderately successful. There has been a tendency to consider ocean currents in much the same manner as wind currents in the atmosphere, when in actuality it appears that ocean currents are affected by an even greater number of factors. It therefore requires different techniques to be used.

In order to predict current information, it must be understood that currents are typically unsteady in direction and speed. This has been well documented in a number of studies. The reasons for this variability have been attributed to the other forces, besides wind and tides, that affect the currents.

Climatological surface charts have been constructed for nearly all the oceans of the world using data from ship's drifts. However, this data has been shown to have limitations and should be used as a rough estimate only.

Synoptic Analysis and Forecasting of Surface Currents, NWRP 36-0667-127, provides a composite method of arriving at current forecasts. This method uses portions of other methods that have been used. Forecasters should make themselves aware of the information contained in this publication.

COASTAL AND TIDAL CURRENT PREDICTION

Prediction of tidal currents must be based on specific information for the locality in question. Such information is contained in various forms in many navigational publications.

Tidal Current Tables, issued annually, list daily predictions of the times and strengths of flood and ebb currents and the time of intervening slacks. Due to lack of observational data, coverage is considerably more limited than for tides. The Tidal Current Tables do include supplemental tidal data that can be determined for many places in addition to those for where daily predictions are given.

SUMMARY

In this chapter, we discussed the basic principles and properties of ocean waves, associated terms, and wave spectrum. Next we considered forecasting of sea waves, generation and growth, and the characteristics of fully and nonfully developed seas. Wind field and fetch areas were also covered followed by an objective method of forecasting sea waves. We also covered the

generation, dispersion and angular spreading of swell waves, as well as an objective method for forecasting swell waves. The generation of surf and associated characteristics, the three breaker types, definition of terms, and an objective technique for forecasting surf were also considered, followed by an explanation of the modified surf index. Finally, we looked at forecasting surface currents, wind driven currents, coastal and tidal currents.

CHAPTER 7

METEOROLOGICAL PRODUCTS AND TACTICAL DECISION AIDS

The tasks of the Aerographer have expanded tremendously in recent years. Aerographers provide on-scene commanders with a multitude of forecast aids that greatly influence the success of surface and airborne evolutions.

In this chapter we will discuss various computer-generated products that support the planning and execution of successful surface and land-based operations. We will be describing TESS 3 products that are useful as tactical decision aids, but other products of benefit as tactical decision aids may be found in the *Navy Oceanographic Data Distribution System (NODDS) Products Manual*, the *Naval Integrated Tactical Environmental Sub-System (NITES)*, the *National Oceanography Data Distribution Exchange System (NODDES)*, and the *Joint Maritime Combat Information System (JMCIS)*.

The intent of this chapter is to provide the forecaster with an introduction to forecaster aids. The applications, limitations, assumptions, and functional descriptions of various aids to the forecaster will be discussed. For operator guidelines, functional descriptions, and technical references refer to the respective operator's manual or NAVMETOCCOM instructions.

First, we will discuss computer-generated aids that are referenced in the *Tactical Environmental Support System (TESS (3)) and Shipboard Meteorological and Oceanographic Observing System (SMOOS) Operator's Manuals*.

ELECTRONIC COUNTERMEASURES (ECM) EFFECTIVENESS

LEARNING OBJECTIVES: Interpret ECM effectiveness display parameters. Recognize optimum locations and flight paths. Identify applications, limitations, and assumptions. Analyze an example output display.

This program provides the capability to determine the optimum locations and flight paths of attack and tactical jamming aircraft by evacuating the effectiveness of a jamming device against a victim radar (user specified) under given atmospheric conditions. Mission planners use this program to determine optimum placement, and ECM outputs are also used to prepare aircrew briefs.

APPLICATION

The ECM effectiveness display program provides airborne jammer effectiveness against surface-based radars. Signal strength is calculated and displayed with respect to height for five equally spaced ranges. Input to the program consists of the victim radar and jammer of interest and a refractivity data set from the refractivity data file (RDF).

The victim radar and jamming characteristics are entered/edited using the platform and jammer options, respectively, from the electromagnetic system file (EMFILE). The refractivity data are entered via the Environmental Status option of the electromagnetic (EM) propagation suite of programs.

LIMITATIONS AND ASSUMPTIONS

The restrictions as well as the principles taken for granted in using the ECM program areas follows:

- The ECM program assumes horizontal homogeneity of the atmosphere (horizontal changes in the refractivity structure of the atmosphere are not accounted for).
- The use of this program is valid only for radars and jammers with frequencies between 100 MHz and 20 GHz.
- Effects produced by sea or land clutter are not accounted for.
- No account is made for absorption of oxygen, water vapor, fog, rain, snow, or other atmospheric particulate matter. In general, the contribution of

absorption to propagation loss is small compared to refractive effects.

- ECM accounts for the ducting in evaporative ducts, surface-based ducts, and low-elevated ducts, provided the victim radar antennas are within the elevated duct. The program does not, however, properly account for the over-the-horizon region for low-elevated ducts when the bottom of the duct is above the antenna height.

- The victim radar must be surface-based.

- Prior to running this program, a primary refractivity data set must be selected.

- Output from this program is classified and labeled corresponding to the classification of the radar or jammer.

FUNCTIONAL DESCRIPTION

The ECM display program provides a plot of signal strength relative to the free-space value versus height for five equally spaced discrete ranges.

Figure 7-1 shows an example output of the ECM effectiveness display. The ECM output consists of five displays. The displays suggest optimum altitude at each

range for most effective jamming. Jamming is most effective where the plotted line is farthest to the right on each display.

D-VALUES (DVAL)

LEARNING OBJECTIVES: Define the DVAL program. Recognize program inputs. Identify applications, limitations, and assumptions. Explain an example of the D-value profile.

The DVAL program is used to compute profiles of D-values. A D-value is defined as the difference between the actual height above mean sea level (MSL) of a particular isobaric surface and the height of the same pressure surface in the U.S. Standard Atmosphere. Program input consists of temperature and geopotential height profiles with respect to pressure, output altitude increment, and specification of units for which the output is desired.

APPLICATION

D-values are used by naval aviators to make pressure-bomb detonation altitude corrections.

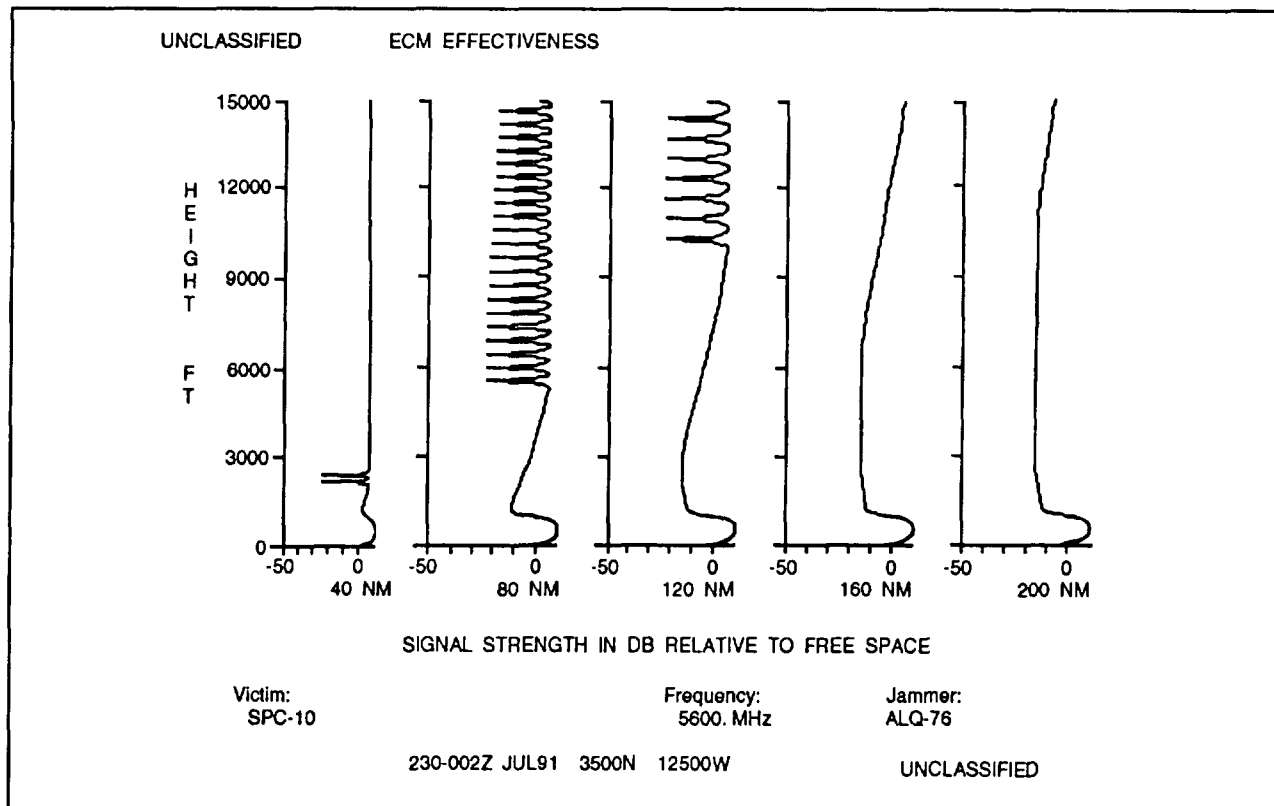

86NP0071

Figure 7-1. Example output of the ECM effectiveness display.

LIMITATIONS AND ASSUMPTIONS

The restrictions as well as the principles taken for granted in using the DVAL program areas follows:

- The algorithm used by this program applies to a maximum altitude of 11,000 geopotential meters.
- The D-value for MSL is determined by extrapolating the pressure and temperature data to MSL by using the data for the first two levels of the entered environmental profile. Caution should be exercised in

determining over-water surface D-values using radiosonde data from a coastal location when the balloon-release height is >50 meters.

FUNCTIONAL DESCRIPTION

AD-value is defined as a difference in the observed height of a particular isobaric surface and the height associated with that isobaric surface in the U.S. Standard Atmosphere. Table 7-1 shows an example of the D-value profile.

Table 7-1.-Example Output of the D-Value Profile

UNCLASSIFIED		D-VALUE PROFILE			
ALT.(F)	D-VALUE(F)	ALT.(F)	D-VALUE(F)	ALT.(F)	D-VALUE(F)
.0	1.4	9500.0	28.8	19000.0	42.4
500.0	3.1	10000.0	29.7	19500.0	43.1
1000.0	4.8	10500.0	30.1	20000.0	44.0
1500.0	6.6	11000.0	30.6	20500.0	45.0
2000.0	8.3	11500.0	31.0	21000.0	46.1
2500.0	10.1	12000.0	31.5	21500.0	47.4
3000.0	11.9	12500.0	32.0	22000.0	48.9
3500.0	13.7	13000.0	32.6	22500.0	50.5
4000.0	15.5	13500.0	33.2	23000.0	52.3
4500.0	17.4	14000.0	33.8	23500.0	54.2
5000.0	18.9	14500.0	34.5	24000.0	56.1
5500.0	20.1	15000.0	35.2	24500.0	57.8
6000.0	21.2	15500.0	36.0	25000.0	59.4
6500.0	22.2	16000.0	36.9	25500.0	61.0
7000.0	23.3	16500.0	37.8	26000.0	62.5
7500.0	24.4	17000.0	38.8	26500.0	63.9
8000.0	25.5	17500.0	39.8	27000.0	65.2
8500.0	26.6	18000.0	40.9	27500.0	66.4
9000.0	27.7	18500.0	41.8	28000.0	67.6
171255 UTC AUG86 3500N 01500E					
UNCLASSIFIED					

BATTLE GROUP VULNERABILITY (BGV)

LEARNING OBJECTIVES: Interpret BGV graphic depictions and identify their uses. Identify applications, limitations, and assumptions. Analyze an example of the BGV display.

BGV provides estimates of the vulnerability of the various platforms in a battle group to a specified electronic support measure (ESM) system under varying environmental conditions. The vulnerability estimate for an individual platform is expressed as the maximum intercept range of all active emitters on the platform. A graphic depicting the vulnerability of the battle group is displayed. Intercept ranges for surface-to-air, air-to-air, and air-to-surface can be calculated.

APPLICATION

The emission control (EMCON) planner uses BGV to assess the effectiveness of EMCON plans and to optimize platform position. The object is to minimize the battle group's vulnerability to counterdetection.

LIMITATIONS AND ASSUMPTIONS

The restrictions as well as the principles taken for granted in running the BGV program are as follows:

- Make sure the environment selected from the refractivity data set is indicative of the location and time of interest. BGV is range- and time-independent.
- The maximum intercept range output is limited to 1000 km (541 nmi). The atmosphere is usually not horizontally homogeneous over these great distances.
- BGV doesn't account for absorption of electromagnetic (EM) energy. In general, the absorption of EM energy by things such as oxygen, water vapor, fog, rain, snow, and soon, adds little to the propagation loss. Refraction is considered the main factor in transmission.
- BGV is valid for frequencies between 100 MHz and 20 GHz.
- Sea-reflected interference is also considered only if the receiver or emitter is below 100 m.

- The effects of surface-based ducts are considered to dominate any contributions from the evaporative duct.

- BGV assumes the emitters are radiating at peak power.

- The probability of detection associated with the output ranges depend upon the probability of detection associated with receiver sensitivities.

- If you are attempting to verify ESM intercept ranges achieved by your own receiver, remember that BGV outputs maximum intercept range. If a platform's emitters are not turned on at that range, there will be nothing to intercept.

FUNCTIONAL DESCRIPTION

BGV computes the maximum ESM intercept range (ESMR) of an emitter. ESMR is computed only if the emitter's frequency falls within one of the frequency bands of the receiver.

Figure 7-2 shows an example of the BGV display. The center of axis corresponds to the formation center, and the top of the screen is north. Each platform's location is marked by an X. The shaded circle around each platform has a radius equal to the longest ESMR associated with that platform. The shaded area as a whole represents the battle group's area of vulnerability to ESM counterdetection.

ELECTROMAGNETIC PATH LOSS VERSUS RANGE (LOSS)

LEARNING OBJECTIVES: Interpret LOSS display parameters. Recognize optimum locations and flight paths. Identify limitations and assumptions. Explain functional description.

The LOSS program provides a display of one-way path loss vs. range or path loss for ESM intercept vs. range. The ESM systems, radar, communication, or sonobuoys are prepared for LOSS by the EMFILE maintenance program. The EM system's transmitter heights (if airborne) and the target or receiver heights are entered during the program run. The RDF is presented for refractive environment selection each time LOSS is run.

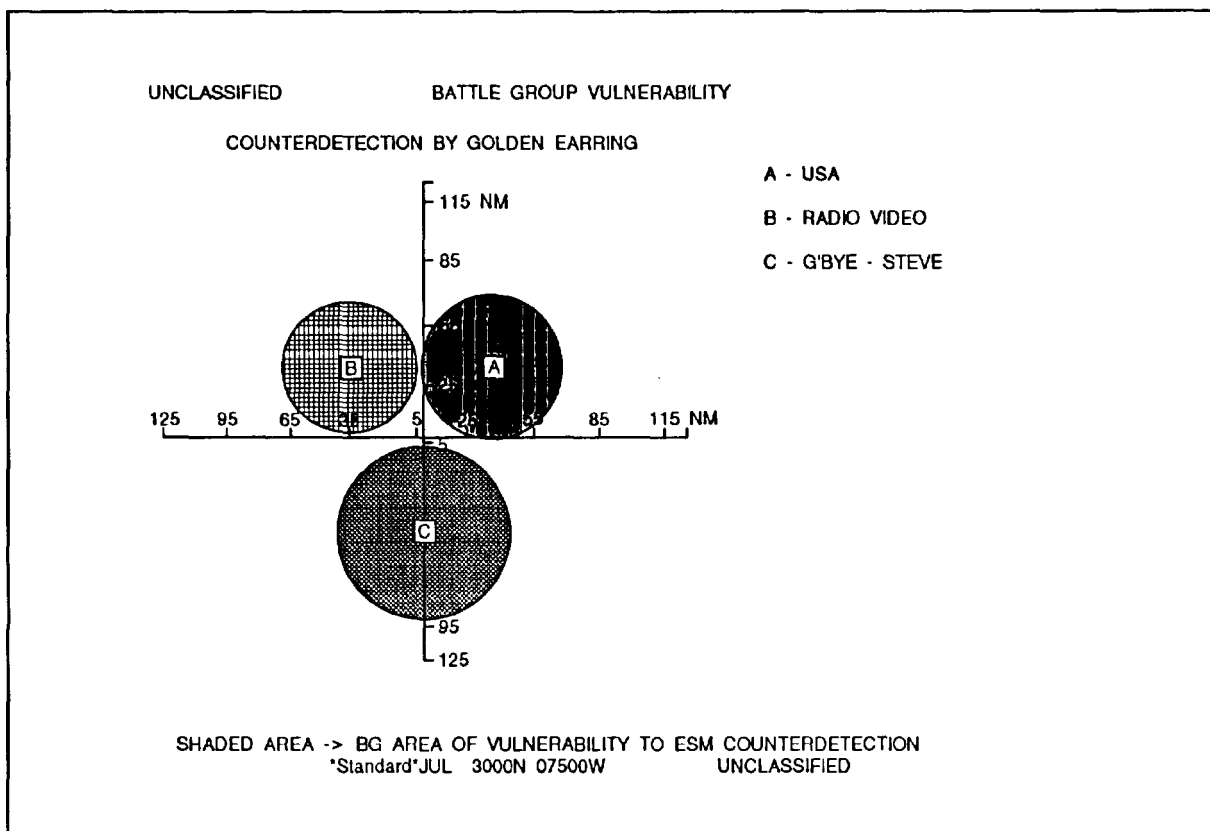

Figure 7-2.-Example output of the BGV display.

APPLICATION

The LOSS program is used to assess the performance of a user-specified EM system under given atmospheric conditions. Path loss vs. range is displayed with the system's path-loss thresholds (calculated from the user-specified freespace ranges if not entered), allowing the determination of maximum detection, communication, or intercept range.

LIMITATIONS AND ASSUMPTIONS

The restrictions as well as the principles taken for granted in using the LOSS program are as follows:

- LOSS assumes horizontal homogeneity (horizontal changes in the refractivity structure of the atmosphere are not accounted for).
- LOSS is valid only for EM systems with frequencies between 100 MHz and 20 GHz.
- LOSS does not include any effects produced by sea or land clutter in the calculation of detection or communication ranges. This shortcoming may be

important to air-search radars in the detection of targets flying above surface-based ducts or strong evaporation ducts, but it is not expected to significantly affect the predicted enhanced detection ranges within a duct. Specifically, for surface-based ducts, the actual detection capability at some ranges maybe reduced for air targets flying above the duct.

- The model that calculates the LOSS display for surface-based systems is valid only for antenna heights between 1 and 200 m inclusive, and the program will not accept heights outside these bounds, except in the case of sonobuoys where the height is nominally 0.5 m.
- The airborne-loss display model does not include sea-reflected interference effects, which could cause both reduced and enhanced path loss for low-flying radar or radar targets. The surface-loss display model does not account for sea-reflected interference effects. Only the minimum path loss within each lobe of the interference region is plotted when the spacing between lobes becomes very close.
- There is no account made for absorption of EM energy from oxygen, water vapor, fog, rain, snow, or

other particulate matter in the atmosphere. In general, the contribution of absorption to propagation loss is small.

- LOSS accounts for ducting in evaporation ducts, surface-based ducts, and low-elevated ducts, provided the transmitter of the radar antenna is within the duct. The program does not properly account for the over-the-horizon region for low-elevated ducts when the bottom of the duct is above the transmitter or radar antenna height. The calculated path-loss values for the LOSS display will generally be greater than the corresponding actual values. The errors become less the higher the elevated duct is above the transmitter or radar antenna height and should be insignificant when the separation exceeds a few thousand feet.

- The LOSS display can be used for the following applications:

- Long-range air-search radars, surface-based or airborne.
- Surface-search radars when employed against low-flying air targets and surface-based combatants that are large in comparison to the sea state.
- To determine the intercept range of radar, sonobuoy, or communications systems by an ESM receiver. The ESM receiver used in this application is chosen during preparation of the ESM system for LOSS.
- Airborne surface-search radars when the surface radar target is large in comparison to the sea clutter. The target should also beat a considerable distance from the radar. LOSS considers targets as point sources. Close in-range targets are seen by the radar as distributed targets.
- Surface-to-air or air-to-air communications systems.

- The LOSS display should not be used for the following applications:

- Most types of gun or missile fire-control radar.
- Small surface targets, for example, periscopes.

- Prior to running this program, a primary refractivity data set must be selected.

- Output from this program is classified and should be labeled corresponding to the classification of the EM system used to produce the display.

- Effects of wave splash, wave shadowing, bobbing, and rolling are not taken into account for sonobuoy output.

FUNCTIONAL DESCRIPTION

LOSS produces an EM path loss with respect to range display, and it plots the path-loss thresholds (computed using the user-specified free-space ranges if not entered) as horizontal lines on the display. The program is structured so that two processing paths exist, and the path taken depends upon the type of system used (surface-based or airborne).

Figure 7-3 shows an example of the LOSS display. The LOSS display is a graph of energy loss (dB) plotted along range (nmi or km). There can be up to four horizontal dotted lines present on the graph. These lines correspond to the computed or entered free-space ranges for the EM system. The intersections of the plotted line and the horizontal lines indicate the path-loss threshold values along the vertical axis and the range at which they occur on the horizontal axis. The path-loss threshold is the minimum amount of energy necessary for the EM system to detect, communicate, or be detected. The plotted line may crisscross the horizontal lines due to interference effects.

ELECTRONIC SUPPORT MEASURE (ESM) PROGRAM

LEARNING OBJECTIVES: Describe the necessary data for the ESM program and interpret the output. Identify limitations and assumptions. Interpret the ESM range tables.

The ESM program is used to calculate and display the maximum intercept ranges of U.S. and Russian surface emitters by user-specified ESM receivers. Input to the program consists of receiver and emitter characteristics from the data base file and a refractivity data set from the environmental data files (EDFs). The refractivity data set consists of a modified refractive index (M-unit) profile with respect to height, the height of the evaporation duct, and the surface wind speed.

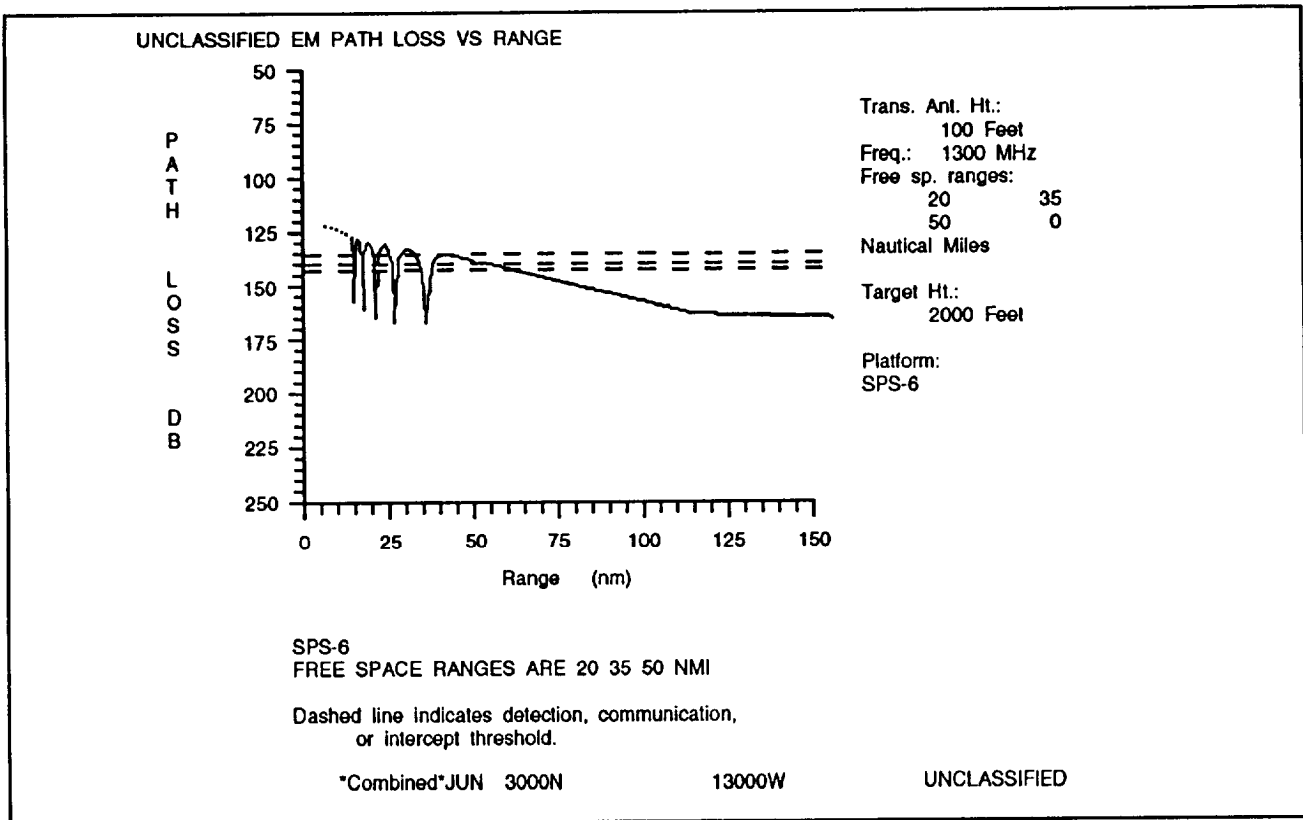

86NP0073

Figure 7-3.-Example output of the LOSS display.

APPLICATION

ESM range tables provide the capability to determine the probable effectiveness of various ESM receivers against a predefined set of both U.S. and Russian emitters. This allows the development of an ESM employment plan that maximizes the potential for detecting target emitters.

LIMITATIONS AND ASSUMPTIONS

The restrictions as well as the principles taken for granted in using the ESM program areas follows:

- Make sure the environment selected from the refractivity data set is indicative of the location and time of interest. The ESM program is range- and time-independent.
- The maximum intercept range output is limited to 1000 km (541 nmi). The atmosphere is usually not horizontally homogeneous over these great distances.
- Emitters are limited to a preset list. If you wish to find the ESM intercept range of some other emitter, use the Platform Vulnerability (PV) program.

- Emitter frequencies are nominal frequencies. Intercept ranges of zero indicate that this nominal frequency does not fall within the prescribed receiver's bandwidth.

- The ESM program does not account for absorption of EM energy. In general, the absorption of EM energy by things such as oxygen, water vapor, fog, rain, or snow adds little to the propagation loss. Refraction is considered the main factor in transmission.

- The ESM program is valid for frequencies between 100 Mhz and 20 GHz.

- Sea-reflected interference is considered.

- ESM accounts for ducting in evaporation ducts, surface-based ducts, and low-elevated ducts, provided the antenna is within the elevated duct. This program does not properly account for the over-the-horizon region for low-elevated ducts when the bottom of the duct is above the antenna. Errors are small and should be insignificant when the separation exceeds a few thousand feet.

- The effects of a surface-based duct are considered to dominate any contributions from the evaporation duct.

- The ESM program assumes the emitters are radiating at peak power.

- The probability of detection associated with the output ranges depends upon the receiver sensitivities.

- If you are attempting to verify ESM intercept ranges achieved by your own receiver, remember that PV outputs maximum intercept ranges. If a platform's emitters aren't turned on at that range, there will be nothing to intercept.

PLATFORM VULNERABILITY (PV)

LEARNING OBJECTIVES Interpret PV outputs to assess vulnerability of various emitters. Identify limitations and assumptions. Interpret an example output of the PV program.

FUNCTIONAL DESCRIPTION

ESM computes the maximum ESMR of an emitter. ESMR is computed only if the emitter's frequency falls within one of the frequency bands of the receiver. Table 7-2 shows an example of ESM range tables.

PV provides estimates of the vulnerability of the various emitters on a platform to a specified ESM system under varying environmental conditions. ESM estimate is expressed as the maximum intercept range for each emitter. Intercept ranges for surface-to-air, air-to-air, and air-to-surface can be calculated.

Table 7-2.-Example Output of ESM Range Tables

CLASS						ESM RANGE TABLES					
*** ESM INTERCEPT RANGE TABLE ***											
RECEIVER: ESM receiver											
EMITTERS' COUNTRY: Country											
EMITTER	FREQ Mhz	INT RNG (max) km	EMITTER	FREQ Mhz	INT RNG (max) km	EMITTER	FREQ Mhz	INT RNG (max) km	EMITTER	FREQ Mhz	INT RNG (max) km
Emitter 1	150		Emitter 13	3082	117						
Emitter 2	208		Emitter 14	3082	139						
Emitter 3	840		Emitter 15	3923	129						
Emitter 4	870		Emitter 16	3938	180						
Emitter 5	920		Emitter 17	3950	180						
Emitter 6	2442	197	Emitter 18	6530	229						
Emitter 7	2770	175	Emitter 19	7092	191						
Emitter 8	2798	223	Emitter 20	7800	463+						
Emitter 9	2828	175	Emitter 21	8050	182						
Emitter 10	2995	126	Emitter 22	8100	218						
Emitter 11	2998	139	Emitter 23	8125	229						
Emitter 12	3000	463+	Emitter 24	8136	214						
Press "RETURN" for next page						031200 UTC APR85 2500N 09000W CLASS					

APPLICATION

The EMCON planner can use PV to assess the relative vulnerability of the various emitters on a platform versus their value in surveillance or communication. The object is to minimize the platform's vulnerability to counterdetection.

LIMITATIONS AND ASSUMPTIONS

The restrictions as well as the principles taken for granted in listing the PV program areas follows:

- Make sure the environment selected from the refractivity data set is indicative of the location and time of interest. PV is range- and time-independent.
- The maximum intercept range output is limited to 1000 km (541 nmi). The atmosphere is usually not horizontally homogeneous over these great distances.
- PV doesn't account for absorption of EM energy. In general, the absorption of EM energy by things such as oxygen, water vapor, fog, rain, or snow adds little to the propagation loss. Refraction is considered the main factor in transmission.
- PV is valid for frequencies between 100 MHz and 20 GHz.

- Sea-reflected interference is also considered only if the receiver or emitter is below 100 m.
- The effects of a surface-based duct are considered to dominate any contributions from the evaporation duct.
- PV assumes the emitters are radiating at peak power.
- The probability of detection associated with the output ranges depends upon the probability of detection associated with the receiver sensitivities.
- If you are attempting to verify ESM intercept ranges achieved by your own receiver, remember that PV outputs maximum intercept range. If a platform's emitters aren't turned on at that range, there will be nothing to intercept.

FUNCTIONAL DESCRIPTION

PV computes the maximum ESMR of an emitter. ESMR is computed only if the emitter's frequency falls within one of the frequency bands of the receiver.

Table 7-3 shows an example output of the PV program. The bar graph shows the maximum range that

Table 7-3.-Example Output of the PV Program

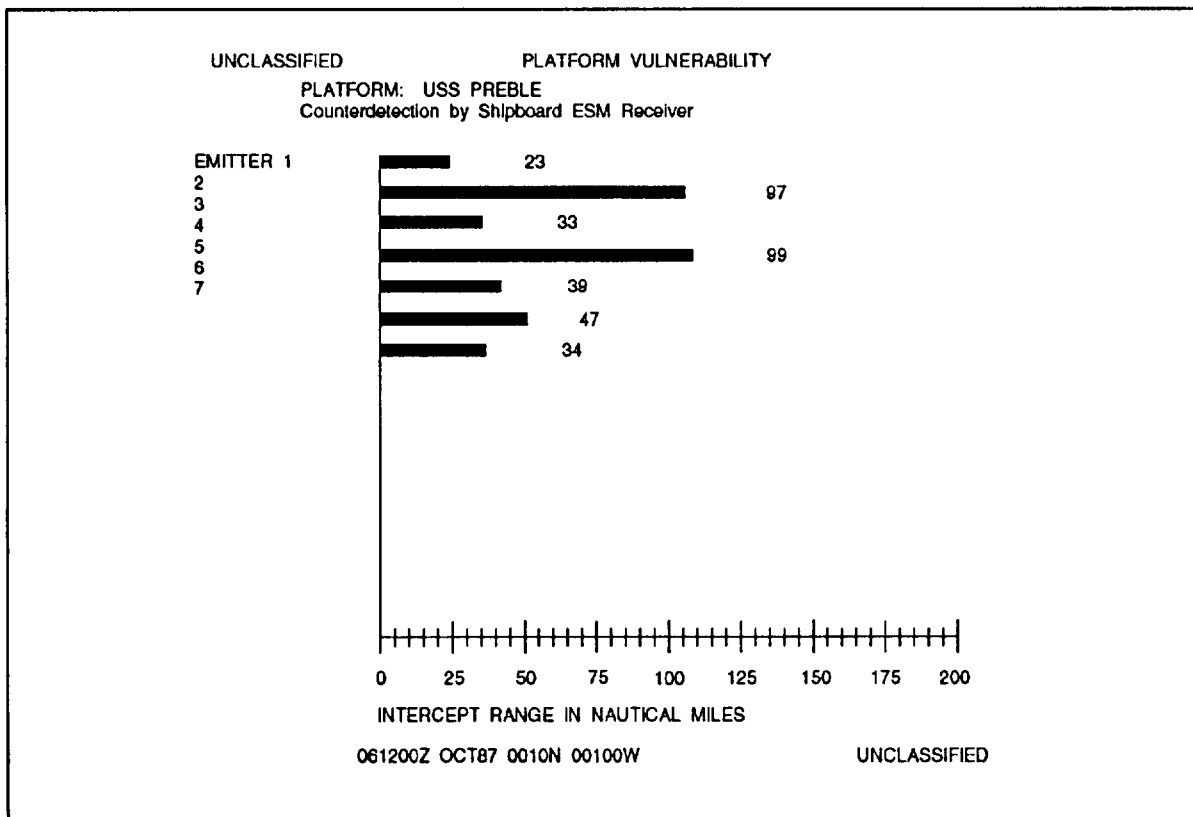

25NP0074

the specified receiver can detect these emitters under the environmental conditions specified.

SURFACE-SEARCH RADAR RANGE (SSR)

LEARNING OBJECTIVES Interpret SSR tables to determine detection ranges of surface-search radars. Identify limitations and assumptions. Describe how the output of the SSR program is displayed.

The SSR program determines the effectiveness of a surface-search radar against a variety of ship classes. Input to the program consists of a user-specified radar antenna height, surface-search radar parameters from the data base (PDB) file, and a refractivity data set from the RDF. The retrieved surface-search radar ranges incorporate the characteristics of the user selected, surface-search radar and the targets' radar cross section. The refractivity data set is composed of a profile of a modified refractive index (M-unit) with respect to height, the height of the evaporation duct, and the surface wind.

APPLICATION

SSR determines the probable effectiveness of surface-search radar against different size targets. The determination is based on given atmospheric refractivity conditions. The detection ranges that are determined represent a 90 percent probability of detection. Based on the information output by this program, the tactical commander can alter the disposition of his or her forces, as necessary, to maximize the effectiveness of his or her surface-search effort.

LIMITATIONS AND ASSUMPTIONS

The restrictions as well as the principles taken for granted in using the SSR program areas follows:

- The SSR Range Tables program assumes horizontal homogeneity of the atmosphere. (The program does not account for horizontal changes in the refractivity structure of the atmosphere.)

- There is no account made for the absorption of EM energy by oxygen, water vapor, fog, rain, snow, or other atmospheric particulate matter.

- This program accounts for ducting in evaporation ducts, surface-based ducts, and low-elevated ducts, provided the radar antenna is within

the elevated duct. The program does not properly account for the over-the-horizon region for low-elevated ducts when the bottom of the duct is above the radar antenna height. Errors are small and should be insignificant when the separation between the base of the low-elevated duct and the radar antenna exceeds a few thousand feet.

- Prior to running this program, a primary refractivity data set must be selected.

FUNCTIONAL DESCRIPTION

Output from this program consists of a SSR table for the user-selected, surface-search radar. Output is provided in the user-selected units (metric or English), and is displayed on two screens. Detection ranges are represented by MIN, AVG, and MAX where MIN is the range expected if detecting from a bow or stem aspect, MAX is a broadside aspect, and AVG is a quartering aspect. Output from this program is classified and should be labeled as required.

ELECTROMAGNETIC COVER DIAGRAM (COVER)

LEARNING OBJECTIVES: Interpret COVER displays of radar detection or communication coverage. Identify limitations and assumptions. Interpret an example of a surface-system COVER diagram.

The COVER program provides a display of radar detection or communication coverage in the vertical plane. Input to the program consists of the radar or communication system of interest, the height of the system (if airborne), and a refractivity data set from the RDF.

The EM system is entered/edited using the platform option of the EMFILE maintenance program. The refractivity profile is entered via the environmental status option of the EM propagation suite of programs.

APPLICATION

COVER provides the capability to determine how a given EM system will perform under given atmospheric conditions in detecting or communicating with a given target or receiver. It provides the information necessary to plan flight profiles for airborne systems to achieve maximum probability of detecting

targets. It is also used to plan the flight profile of attacking aircraft against a surface target to minimize the probability of the aircraft being detected by the target. Another use is to alert surface units to holes in their radar coverage against attacking aircraft or missiles. This capability provides the information on which to plan the disposition of surface units and to base requirements for airborne coverage.

LIMITATIONS AND ASSUMPTIONS

The restrictions as well as the principles taken for granted in using the COVER program areas follows:

- COVER assumes horizontal homogeneity (horizontal changes in the refractivity structure of the atmosphere are not accounted for).

- COVER is valid only for EM systems with frequencies between 100 MHz and 20 GHz.

- COVER does not include any effects produced by sea or land clutter in the calculation of detection or communication ranges. This shortcoming may be important to air-search radars in the detection of targets flying above surface-based ducts or strong evaporation ducts, but it is not expected to significantly affect the predicted enhanced detection ranges within a duct. Specifically y, for surface-based ducts, the actual detection capability at some ranges may be reduced for air targets flying above the duct.

- The model that calculates the coverage display for surface-based systems is valid only for antenna heights between 1 and 100 m, and the program will not accept heights outside these bounds. The antenna heights for airborne systems are limited to the maximum height of the selected coverage system in the EM system data file.

- The airborne coverage display model does not include sea-reflected interference effects, which could cause both reduced and enhanced coverage for low-flying aircraft or radar targets. The surface coverage display model does account for sea-reflected interference effects. Only the maximum range within each lobe of the interference region is plotted when the spacing between lobes becomes very close.

- There is no account made for the absorption of EM energy by oxygen, water vapor, fog, rain, snow, or other particulate matter in the atmosphere. In general, the contribution of absorption to propagation loss is small compared to refractive effects.

- COVER accounts for ducting in evaporation ducts, surface-based ducts, and low-elevated ducts, provided the transmitter or radar antenna is within the elevated duct. The program does not properly account for the over-the-horizon region for low-elevated ducts when the bottom of the duct is above the transmitter or radar antenna height. The calculated ranges for the coverage display will generally be less than the corresponding actual ranges. The errors become less the higher the elevated duct is above the transmitter or radar antenna height and should be insignificant when the separation exceeds a few thousand feet.

- The coverage display can be used for the following applications:

- Long-range air-search radars, surface-based or airborne
- Surface-search radars when employed against low-flying air targets
- Surface-to-air or air-to-air communication systems
- Sonobuoys (only with the proper antenna height and frequency)

- The coverage display should not be used for the following applications:

- Airborne or surface-based surface-search radars employed against surface targets
- Most types of gun- or missile-fire control radar

- It is not the intent of the coverage display model to calculate the maximum radar range for a given radar and target, but rather to show the relative performance of a radar (or communications) system at different altitudes as affected by the environment. *It is up to the user to use free-space ranges that are appropriate for the application at hand.*

- Output from this program is classified and should be labeled corresponding to the classification of the EM system used to produce the display.

- Effects of wave splash, wave shadowing, bobbing, and rolling are not taken into account for sonobuoy output.

FUNCTIONAL DESCRIPTION

COVER diagrams are contours of constant electric field strength information in the vertical plane that indicates areas where radar targets might be detected.

The contours chosen for display represent radar receiver thresholds against a particular size (radar cross section) target. COVER diagrams are also used to assess very high frequency (VHF) or ultra high frequency (UHF) communications coverage.

The method used to construct the COVER diagram depends on whether the EM system is surface-based or airborne. Both methods employ raytracing, but for surface-based systems, coherent interference between direct and sea-reflected paths, sea-surface roughness, and diffraction effects are considered.

Figure 7-4 shows an example output of a surface-system COVER diagram. A surface-system COVER diagram is composed of up to four coverage lobes. A COVER diagram for an airborne system has one lobe, drawn by straight lines, emanating from the antenna height.

A lobe describes the vertical and horizontal limits of the radar coverage. The shape and size of the lobes are dependent on the antenna type and the computed or entered free-space ranges or path-loss thresholds. Each lobe is where the particular radar device would detect a certain size target at a specified probability of detecting that target. Also involved is whether the target is steady

or fluctuating and the probability of receiving a false alarm on the radar screen.

SHIP ICE ACCRETION (SHIP ICE)

LEARNING OBJECTIVES: Interpret SHIP ICE program tabular displays. Identify limitations and assumptions. Explain how ice accretion rates are determined by the SHIP ICE program.

The SHIP ICE program provides estimates of ship ice accretion rates vs. time given the wind speed and the air and sea-surface temperatures at various forecast times. Ice accretion from sea spray upon the ship's superstructure can impair the operational capability and safety of the ship.

APPLICATION

This program can be used to predict the ice accretion on a ship's superstructure due to sea spray. It can assist in planning by considering the icing effects along an

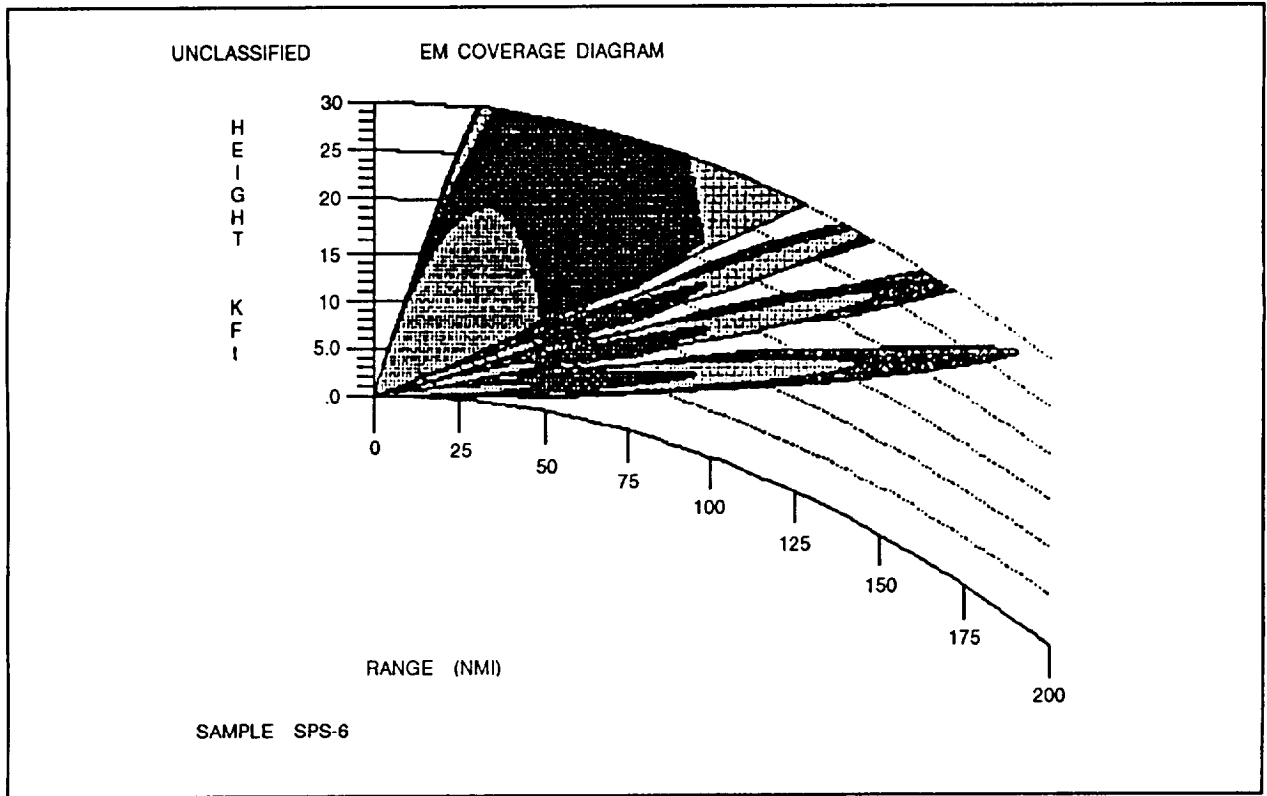

Figure 7-4. Example output of the EM coverage diagram.

intended route, or determining how frequently the superstructure ice should be cleared.

LIMITATIONS AND ASSUMPTIONS

The restrictions as well as the principles taken for granted in using the SHIP ICE program are as follows:

- The methods described here are best applied to smaller ships. Ship's characteristics, such as freeboard, waterline length, hull response, and ship's course and speed are not considered.

- Information relating to ice accretion thresholds is not available and must be developed independently by each user.

- Air temperature is entered in whole degrees (Celsius). For temperatures $< -21^{\circ}\text{C}$, the SHIP ICE model assumes a constant accretion rate based on -21°C . The algorithm considers temperatures from -2°C to -21°C .

- Sea temperature is entered in whole degrees Celsius. The algorithm considers temperatures from 10°C to -2°C .

- Wind speed is entered in whole knots. The algorithm considers winds from 22 to 71 kt by the following categories:

- Beaufort Force 6 and 7 (winds 22 to 33 kt)
- Beaufort Force 8 (winds 34 to 40 kt)
- Beaufort Force 9 and 10 (winds 41 to 56 kt)
- Beaufort Force 11 and 12 (winds 57 to 71 kt)

- If the air temperature is $> -2^{\circ}\text{C}$, then the ice accretion is considered to be 0.

- If the wind is < 22 kt (BF 6) and the temperature is $< -2^{\circ}\text{C}$, then the ice accretion is considered to be 1.5 cm per day.

FUNCTIONAL DESCRIPTION

The SHIP ICE program determines the ice accretion rates from look-up tables based on the wind category. For each category, there is an ice accretion matrix with an accretion rate for each combination of air-sea temperature (where the air temperatures are between -2°C and -21°C , and sea temperatures between 10 and -2°C .) Figure 7-5 shows an example of a SHIP ICE ACCRETION program.

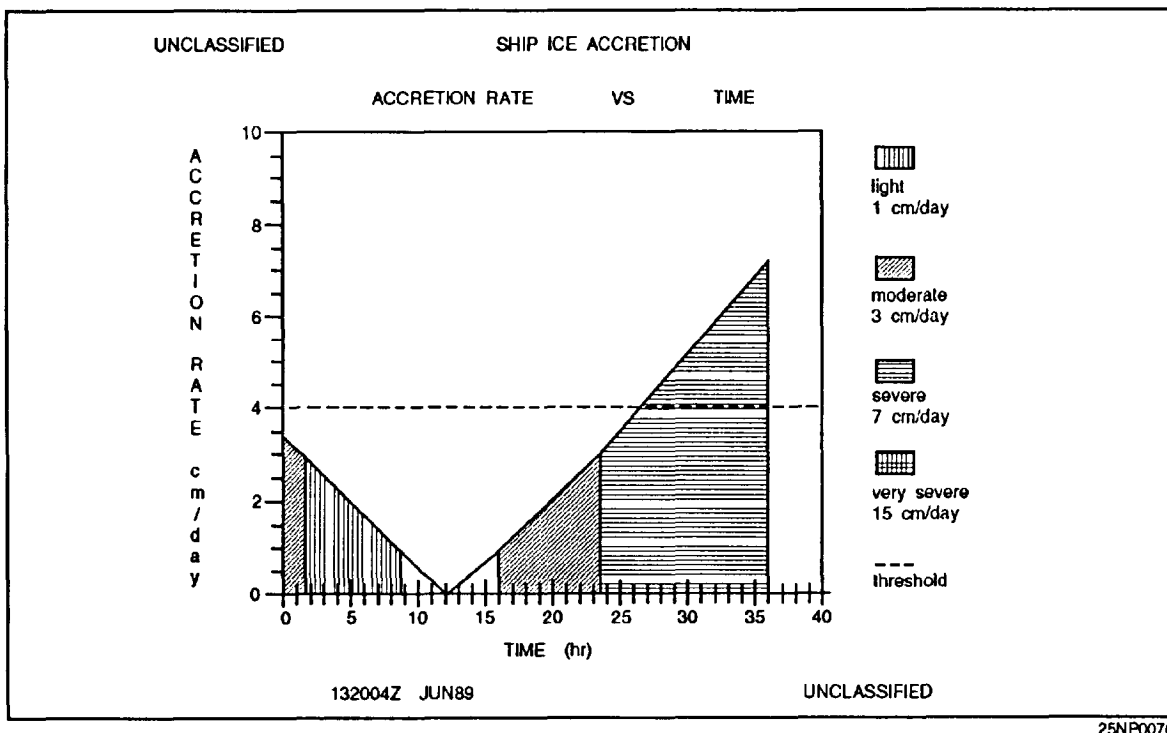

Figure 7-5.-Example output of the SHIP ICE program.

SOUND FOCUS (SOCUS)

LEARNING OBJECTIVES Interpret SOCUS noise prediction graphs. Identify limitations and assumptions. Explain an example output of the explosive noise prediction plot.

In the atmosphere, sound waves propagating from an explosive blast are frequently refracted toward the surface. Under certain atmospheric conditions this energy may be focused, resulting in minor property damage, such as cracked plaster and broken windows at these points of focus (caustics). Large-scale refraction of blast waves toward the surface, even without the presence of caustics, can contribute to increased overpressure levels at distances greater than 50 km from the blast, resulting in numerous complaints from area residents. These large-scale refractive and focusing conditions are caused by temperature inversions or strong vertical wind shears.

The SOCUS program provides the following forecast products:

- A sound speed profile with respect to height
- A profile of maximum explosive noise (peak overpressure) with respect to range from the explosive source
- The range from the explosive source of caustics
- The minimum and maximum aircraft ground speed versus height

These products are provided for an operator-specified bearing of interest. Program input includes profiles of temperature, wind speed, and wind direction (for the time and location of interest from the EDFs), the explosive weight of the charge, and the bearing of the explosive source.

APPLICATION

The SOCUS program allows METOC personnel to determine whether atmospheric conditions favor the formation of caustics (sound focus points) or the large-scale refraction of sound toward populated areas during explosive exercises. The appropriate action can then be taken to minimize the number of complaints or claims for minor property damage.

LIMITATIONS AND ASSUMPTIONS

The restrictions as well as the principles taken for granted in using the SOCUS program areas follows:

- Sound focusing is quite sensitive to small temperature, wind direction, and wind speed variations with respect to height and time. Therefore, a valid sound focus forecast can be obtained only when accurate data from a sounding taken near the time and location of the explosive exercise are used.

- This SOCUS/Prediction model was developed using measurements of surface explosions where the airblast propagated several kilometers over water and then over flat land. The effects of barriers such as mountains or forests are not known when focusing is caused by low-altitude weather conditions. Channeling effects through mountains are also unknown.

- Maximum explosive noise levels in the vicinity of caustics are normally between 2 and 8 dB higher than the explosive noise levels plotted on the graphic output. (The locations of caustics are denoted by X's on the plot.)

- To compute maximum explosive noise levels for muzzle blasts from 5-inch naval gunfire, an equivalent explosive weight of 66 pounds is used.

- To compute explosive noise levels for muzzle blasts from 16-inch naval gunfire, an equivalent explosive weight of 330 pounds is used for a reduced charge.

- To compute noise levels for muzzle blast from 16-inch naval gunfire, an equivalent explosive weight of 660 pounds is used for a full charge.

- Noise levels resulting from impact explosions of the HE-ET/PD, Mk 19 Mod O, HC, and AP projectiles may be computed using the respective equivalent explosive weights: 155, 27, 155, and 41 pounds.

- Maximum noise levels are to be found in the direction of fire from 5-inch and 16-inch naval guns.

- Maximum subsonic ground speeds are only computed using a headwind/tailwind. Operators must make an interpolation for headings that differ from these.

FUNCTIONAL DESCRIPTION

There are two outputs from this product, figure 7-6 and figure 7-7. Figure 7-6 shows an example output of

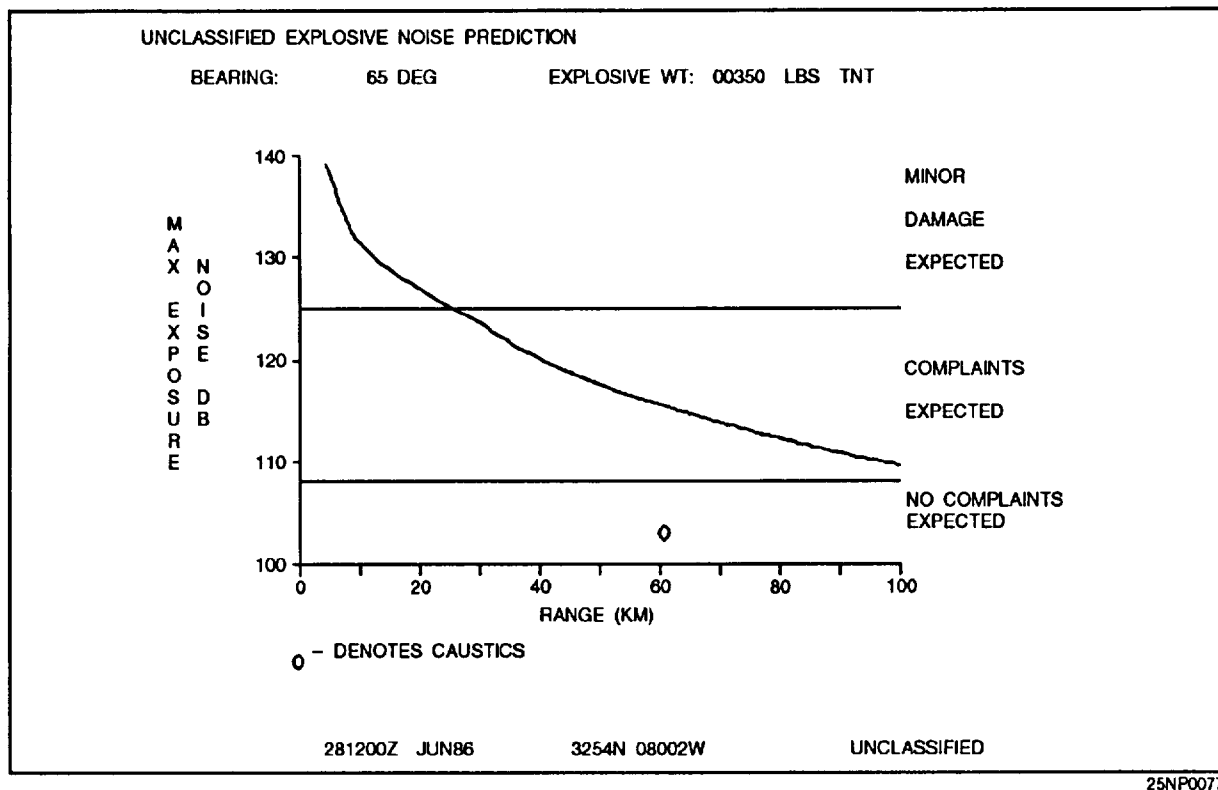

Figure 7-6.-Example output of the explosive noise prediction plot.

UNCLASSIFIED				
MAXIMUM SUBSONIC AIRCRAFT GROUND SPEEDS				
HEADWIND			TAILWIND	
Flt Level (feet)	Speed (knots)	Bearing (deg)	Speed (knots)	Bearing (deg)
5000	646	157	681	337
10000	637	165	678	345
15000	623	174	668	354
20000	607	183	659	3
25000	591	194	649	14
30000	573	204	638	24
35000	554	213	627	33
40000	533	219	615	39
45000	516	225	607	45
50000	515	231	619	51
101800 UTC MAY89 2800N 09300W			UNCLASSIFIED	

Figure 7-7.-Sample output of maximum subsonic aircraft ground speeds.

the explosive noise prediction plot. Output from this program consists of an explosive noise prediction plot that shows expected noise (dB) against range, sound speed profiles (total sound speed and speed due to wind) in the direction of interest with respect to height. Figure 7-7 shows an example of a tabular output of maximum subsonic aircraft ground speeds with respect to height. For instance, an aircraft flying at 681 knots at 5,000 feet with a tailwind, the explosive noise source would be 337° (relative) from the aircraft.

LASER RANGE PREDICTION (LRP)

LEARNING OBJECTIVES: Interpret LRP displays for low-level laser radiation. Identify limitations and assumptions.

The LRP displays range information for exposures to low-level laser radiation, both height vs. range and by differences between day and night conditions. The program also displays range vs. time of exposure for different levels of exposure to laser radiation.

APPLICATION

LRP produces ranges for exposures to laser radiation that could be hazardous to aircraft pilots or crewmembers in the line of sight of this radiation.

LIMITATIONS AND ASSUMPTIONS

The restrictions as well as the principles taken for granted in using the LRP program are as follows:

- This program operates on a wavelength-specified basis. If the operator selects a wavelength that is available to the program, then the closest wavelength will be run for calculations.
- The power is the averaged power for a pulsed laser that pulses over a 1-second period. Data-base computations select the pulse repetition frequency for maximum power of a particular radar.
- No power increase is taken into account in the calculations for the displays due to magnification effects (for example, binoculars).
- The vertical extent of the transmission models is 7 km in height for gaseous components and 2 km for aerosol components in the selected environment. This

limits surface-to-surface results and possible outputs to other displays.

- The Night/Day display assumes one set of eye apertures for the night/twilight/day exposures.
- This program is not to be applied to air-to-air cases since the variation of the atmosphere with height will effectively change the resultant ranges.

FUNCTIONAL DESCRIPTION

The operator specifies a set of laser parameters or selects a laser from the laser database. The atmosphere and environment are then specified by the operator. Output from this program is classified and should be labeled as required.

BALLISTICS WINDS AND DENSITIES CORRECTIONS (BALWND)

LEARNING OBJECTIVES Interpret BALWND correction factors for U.S. and NATO gunfire support. Identify limitations and assumptions. List the types of forecast messages produced by the BALWND program.

The BALWND program computes ballistic wind and density correction factors for U.S. Navy and North Atlantic Treaty Organization (NATO) gunfire support. Correction factors are produced for the following types of gunfire: surface-to-surface <16-inch, surface-to-air >16-inch, surface-to-surface 16-inch full charge, and surface-to-surface 16-inch reduced full charge. Ballistic wind and density correction factors are output in standard U.S. Navy and NATO ballistic message format. User-specified input includes the duration of the ballistic forecast and a specification of the radiosonde data set to be used. The user-specified radiosonde data set is retrieved from the EDFs and contains the upper air and upper wind profiles necessary to produce a ballistic wind and density forecast.

APPLICATION

Ballistic correction factors are used by gunfire support personnel to correct for current or forecast atmospheric conditions. These correction factors are required to obtain close hits with initial firings of naval guns.

LIMITATIONS AND ASSUMPTIONS

The restrictions as well as the principles taken for granted in using the BALWND program areas follows:

- This program requires that the user-selected radiosonde data set contain an upper wind profile.
- Care must be taken that a radiosonde data set representative of the area where naval gunfire is to take place is selected
- Ballistic wind and density correction factors are output only to the ballistic zone through which a complete set of environmental data is available.

FUNCTIONAL DESCRIPTION

All output from the BALWND program is classified and should be labeled as required, The program consists of the following messages:

- NATO surface-to-air ballistic forecast message.
- NATO surface-to-surface ballistic forecast message.
- U.S. Navy ballistic forecast message for surface-to-surface <16-inch gunfire.
- U.S. Navy ballistic forecast message for surface-to-air <16-inch gunfire.
- U.S. Navy ballistic forecast message for surface-to-surface 16-inch full-charge gunfire.
- U.S. Navy ballistic forecast message for surface-to-surface 16-inch reduced-charge gunfire.

RADIOLOGICAL FALLOUT (RADFO)

LEARNING OBJECTIVES Interpret RADFO forecasts for radiation doses produced by a nuclear detonation. Identify limitations and assumptions. Interpret an example output of the RADFO model, and an example of ATP-45 outputs.

The RADFO model generates forecasts of the accumulated radiation dose from fallout produced by the detonation of a nuclear device. This program replaces the radiological fallout templates in order to better assess early fallout from a radioactive cloud.

Output consists of an analysis of accumulated dose of radioactive energy in roentgens for a user-defined location, time, and forecast duration. Appropriate ATP-45 data, such as the radius of the nuclear cloud and the deposition boundary, are also output.

User-supplied input includes either the yield of the weapon or the height of the top of the nuclear cloud, the type of burst (land, sea, or air), the location (latitude and longitude) of surface zero, a specification of the prediction period with respect to time zero, and a specification of the contours to be plotted. The user also specifies a radiosonde data set, which contains an upper wind profile that is to be retrieved from the EDFs. If an applicable upper wind profile is not available, the user may enter one based on either height or pressure levels.

APPLICATION

The RADFO model forecasts a pattern of accumulated dose of radioactive energy caused by a specified type of nuclear detonation and dispersed by upper level winds. The forecast is produced in a timely manner for the ship's captain or staff, and it is used to determine ship and unit maneuvering to avoid potential nuclear radiation hazards.

LIMITATIONS AND ASSUMPTIONS

RADFO is used to forecast the pattern of accumulated dose of radiation caused by nuclear fallout after the detonation of a nuclear weapon. Care must be taken to select a radiosonde data set that contains an upper wind profile representative of the upper winds at surface zero. Care must also be taken to accurately estimate either the yield of the nuclear weapon or the height of the top of the nuclear cloud.

- Meteorological conditions are considered to be constant for the entire fallout period; no spatial or temporal variations of the upper wind are taken into account.

- This model does not assess radiation from other nuclear phenomena such as the thermal radiation, electromagnetic effects, or initial nuclear radiation emitted in the actual fission or fusion process. This model should only be used as a resource tool to better assess early fallout from the radioactive cloud. Early fallout from a radioactive cloud is normally defined as the fallout that is down within the first 48 hours.

- The RADFO model is meant to be used only for nuclear detonations that occur near the surface (those

that throw a significant amount of radiological fallout into the atmosphere). This model should not be used for high-altitude bursts or deep-water bursts.

- This model assumes a 100 percent fission yield through the complete spectrum of nuclear weapons, including thermonuclear weapons; this is a worst case estimate.

FUNCTIONAL DESCRIPTION

Output consists of an analysis of dosage of radioactive energy plotted on an appropriate geographic background. The speed and direction of the effective fallout wind are included on the display. ATP-45 output, such as the cloud radius and deposition boundary, is provided on a second screen. Figure 7-8 shows an example output of the RADFO model, and figure 7-9 shows an example of ATP-45 outputs.

FORWARD-LOOKING INFRARED (FLIR)

LEARNING OBJECTIVES: Identify applications, limitations, and assumptions of the FLIR program. Interpret FLIR tables for detection ranges for predefined altitudes and target types.

The FLIR System Prediction program determines the detection, categorization, and identification ranges of airborne FLIR sensors against surface targets. Ranges are given as a function of aircraft altitude and are for a 50 percent probability of detection, categorization, and identification of the target. The atmospheric data consisting of height, atmospheric pressure, air temperature, and dewpoint temperature come from the atmospheric environmental file (AEF). Surface wind speed and visibility are input from the keyboard when the program is run.

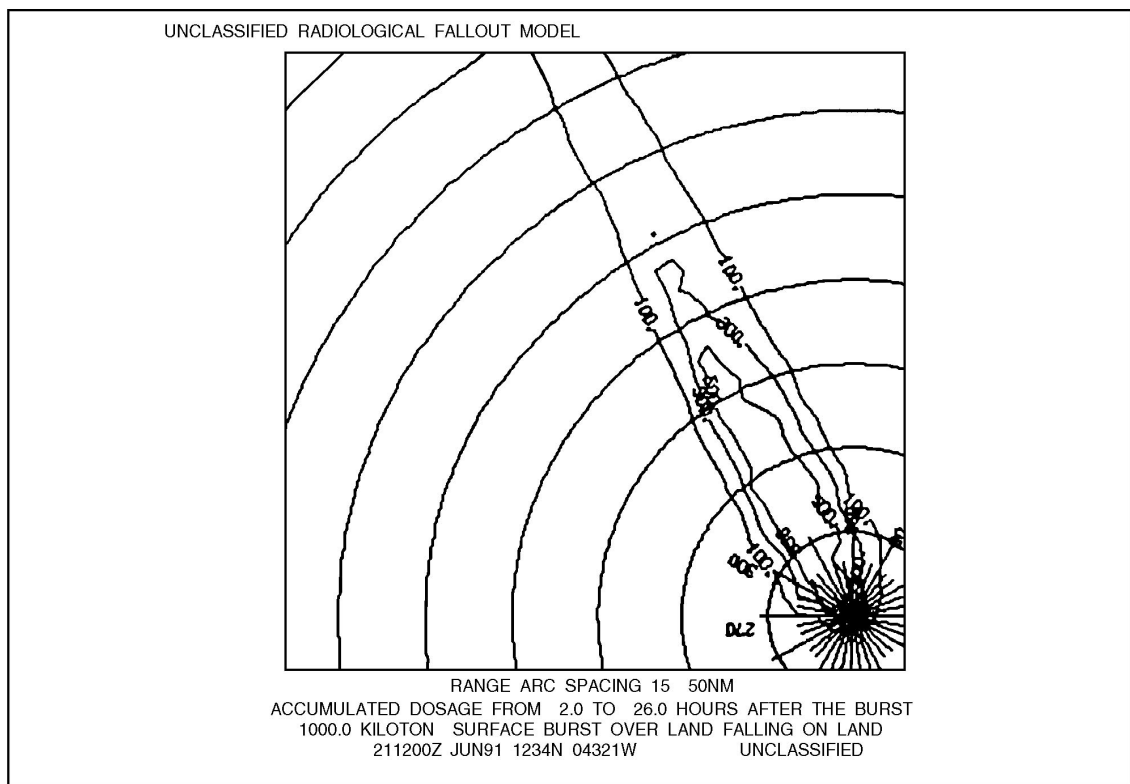

Figure 7-8.-Example output of the RADFO model.

UNCLASSIFIED	RADFO ATP-45 OUTPUT	
	ENGLISH	
CLOUD RADIUS	9.6	NM
EFFECTIVE DOWNWIND DIRECTION	332.	DEG
EFFECTIVE FALLOUT WIND SPEED	45	KNOTS
SECTOR ANGLE	40.	DEG
DISTANCE TO ZONE 1	154.6	NM
DEPOSITION BOUNDARY	1156.5 TO 1183.0	NM
	METRIC	
CLOUD RADIUS	17.7	KM
EFFECTIVE DOWNWIND DIRECTION	332.	DEG
EFFECTIVE FALLOUT WIND SPEED	83	M/S
SECTOR ANGLE	40.	DEG
DISTANCE TO ZONE 1	286.3	KM
DEPOSITION BOUNDARY	2141.6 TO 2190.7	KM
211200 UTC JUN91 1234N 04321W	UNCLASSIFIED	

Figure 7-9.-Example ATP-45 output.

Ranges may be predicted for several FLIR devices against surface or ASW targets.

APPLICATION

Users of the FLIR output include mission planners, pilots in the air wing, and the carrier group staff. The FLIR output can assist them in placing aircraft at altitudes to maximize FLIR detection of surface or ASW targets.

LIMITATIONS AND ASSUMPTIONS

The restrictions as well as the principles taken for granted in using the FLIR program areas follows:

- The input environmental data are representative of the entire area of interest. Therefore, changes in the environment over time and over space are not accounted for.
- Radiation is absorbed by molecules and both absorbed and scattered by aerosols. Other effects such as attenuation by rain, fog, and haze are neglected.
- Targets are limited to rectangular bodies of fixed dimension with fixed target-to-background temperature differences, T_{eff} . The target dimensions and temperatures correspond to "effective" target parameters. For example, a "periscope detection" attempts to emulate detection of a target area larger than a periscope, corresponding more to detection of a

Table 7-4. Effective Target Values

Target Type	Length (m)	Height (m)	T _{eff} (°C)
Large	170	18	5
Medium	136	14	5
Small	100	10	5
Submarine	50	5	5
Snorkel	5	0.5	20
Periscope	5	0.5	5

submarine-generated wake. Table 7-4 lists effective target values used by the FLIR program.

The effective dimensions produce more realistic ranges than use of actual target dimensions.

- An airborne FLIR sensor is viewing targets well inside the horizon against an essentially blackbody sea. That is, the FLIR program does not account for changes in viewing angle resulting in a new target background and thus a new T_{eff}.

- If the relative humidity calculated from the input dewpoint depression is <35 percent, then a minimum value of 35 percent relative humidity is used only to calculate the aerosol extinction. Design of the model prevents accurate aerosol extinction calculations below 35 percent relative humidity.

- All environmental data from the AEF must be quality controlled. Bad atmospheric data will produce unreliable results.

If -1 is entered for an unknown surface visibility, the aerosol extinction coefficient is calculated with a visibility computed from the atmospheric sounding. The calculated visibility is displayed on output; however, it may or may not be similar to visibility conditions observed. The computed visibility is a limited approximation of the true visibility.

If -1 is entered for unknown surface wind speed, the global average wind speed of 6.9 meters per second (about 14 knots) is used for calculations. Actual wind speeds lower than the global average generally yield longer ranges. Actual wind speeds higher than the global average will generally yield shorter ranges.

The FLIR program does not calculate ranges at altitudes greater than the maximum height of the

sounding. This limits the height of the FLIR sensor to the top of the meteorological data.

FUNCTIONAL DESCRIPTION

Fifty percent FLIR detection ranges are output for predefine altitudes and target types in tabular form based on the FLIR device selected. The 50 percent detection range curve is also depicted graphically for each of the target types. Output from this program is classified and should be labeled as required

AIRCRAFT ICING (AIRICE)

LEARNING OBJECTIVES: Interpret AIRICE displays for potential aircraft icing vs. pressure levels. Identify limitations and assumptions.

The AIRICE program analyzes radiosonde data from the AEF for potential ice accumulation on aircraft. AIRICE checks each radiosonde level for potential icing starting from the lifting condensation level (LCL). If ice accumulation is possible, then the icing type and intensity are determined. The icing analysis (icing probability, type, and intensity) is displayed in tabular form along with radiosonde analysis data.

APPLICATION

The accumulation of ice on the exterior surfaces of aircraft has the potential of causing serious handling problems and can lead to a crash. Ice accretion also increases the weight of the aircraft and reduces its payload capacity and fuel efficiency. The main cause of aircraft ice accretion is freezing cloud droplets. The purpose of this function is to provide an aircraft icing assessment from which a naval forecaster can predict flight levels where hazardous icing conditions may occur.

LIMITATIONS AND ASSUMPTIONS

The restrictions as well as the principles taken for granted in using the AIRICE program areas follows:

- Icing conditions are indicated at actual radiosonde levels. The possibility of icing may exist between the level indicated and the next higher and next lower levels. The icing type and intensity apply to the layer indicated, but may be valid up to the next higher level.

- AIRICE begins the icing analysis at the LCL. In the case where surface conditions are unstable (LCL is undefined), the analysis begins at the surface. This latter condition can yield greater severity in the icing intensity.

- The possible icing types displayed are clear, mixed, rime, or engine induction.

- The possible icing intensities are trace, light, moderate, or severe.

- The possible icing probabilities displayed are 10, 20, 50, and 100 percent.

- The operator has the capability to change the cloud base height of the level that is displayed. The only effect that changing the cloud base height has on the output is to change the icing intensity value. The

radiosonde profile information, icing type, and probability are not changed.

FUNCTIONAL DESCRIPTION

Table 7-5 shows an example of the AIRICE product. The analysis may be in either English or metric units. The display may be shown on two screens if the sounding has many levels.

SUMMARY

In this chapter we have discussed a few of the many computer and climatological products available to aid the Aerographer's Mate in the analysis and forecasting of meteorological conditions, thus ensuring optimum support of surface and airborne operations.

Table 7-5.-Example Output of the AIRICE Product

UNCLASSIFIED			AIRCRAFT ICING ANALYSIS/TABULAR RESULTS-ENGLISH					
PRESS (hPa)	TEMP (F)	RH (%)	HEIGHT (F)	LAPSE RATE (F/KFT)	STAB	ICING PROB (%)	ICE TYPE	ICING INTENSITY
1013.0	43.0	94	32.8	.56	S			
1000.0	43.2	92	387.3	-1.39	S			
900.0	39.2	84	3258.0	-2.21	CU			
850.0	35.8	89	4793.8	-1.79	CU	50.0	IND	UNK
788.0	32.2	99	6802.6	-2.72	CU	50.0	IND	UNK
746.0	28.3	91	8234.8	-.85	S	100.0	RIME	SEV
700.0	26.9	59	9881.5	-2.13	CU			
564.0	15.3	69	15331.6	-1.77	CU	10.0	RIME	TRACE
524.0	12.1	95	17134.7	-2.29	CU	10.0	RIME	SEV
500.0	9.5	94	18270.7	-2.52	CU	10.0	RIME	SEV
400.0	-3.7	71	23506.6	-3.02	CU			
384.0	-6.5	67	24432.8	.00				
070900 UTC MAY87 0345N 06000W						UNCLASSIFIED		

CHAPTER 8

OCEANOGRAPHIC PRODUCTS AND TACTICAL DECISION AIDS

In the past 10 to 15 years an ever-increasing emphasis has been applied to the study of the oceans (both surface and subsurface). This increased emphasis on oceanography has provided on-scene commanders with tailored oceanographic computer products that help ensure successful evolutions at sea.

In this chapter, we will discuss various computer-generated oceanographic products that benefit the planning and execution of successful underway operations. Although this chapter only deals with TESS 3 products, benefit may also be realized with the products found in the *Navy Oceanographic Data Distribution System (NODDS) Products Manual*, the *Naval Integrated Tactical Environmental Sub-System (NITES)*, the *National Oceanography Data Distribution exchange System (NODDES)*, and the *Joint Maritime Combat Information System (JMCIS)*. The applications, limitations, assumptions, and functional descriptions of various aids to the forecaster will be covered. For more detailed information, refer to the respective *Tactical Environmental Support System (TESS (3))* and *Shipboard Meteorological and Oceanographic Observing System (SMOOS) Operator's Manuals*, NAVMETOCCOM instructions, and special publications. Now let's begin our discussion of the computer-generated aids.

TIDAL PREDICTION (TIDE)

LEARNING OBJECTIVES Identify applications, limitations, and assumptions of the tidal prediction product. Interpret the 24-hour tide station prediction and the tides geographic display.

The TIDE module uses location-specific tide data in combination with astronomical and bathymetric effects to yield quick reliable predictions. The tidal height may be forecast at any location for which observed tide data are available. These locations are provided in the tide data base. The tabular and graphic output of the module depict tidal height versus time at

individual locations, as well as tidal heights at a given time for several locations.

APPLICATION

A knowledge of tides is important to safe navigation and naval warfare applications. The tides interact with surf conditions and storm surge. These near-shore phenomena in turn may heavily impact coastal and amphibious operations. Because the TIDE module provides a versatile method of rapidly forecasting tides, commensurate with the computer technology used for on-scene environmental prediction, it is a useful means of assessing tidal effects on pertinent operations.

LIMITATIONS AND ASSUMPTIONS

The restrictions as well as the principles taken for granted in using the TIDE program areas follows:

- Spatial variations in tidal heights may be depicted for 4°, 2°, 1°, 0.5°, and 0.2° squares only.
- Tidal heights may only be forecast at locations for which observed tide data are available (that is, tide stations provided by the data base).
- Tidal currents are not predicted by this model.
- The impact of storm surge and surf conditions is not addressed by this model.
- The times of tidal extremes (high/low) are predicted to the nearest 6 minutes (min).
- Tidal stations previously saved to the "TIDAL STATION SELECTION" input screen will be erased when new tidal stations are saved at a later time.
- Only 15 tidal stations can be retrieved at one time in the area size selected. If more than 15 are retrieved, the user must choose a different area size or move the location slightly.

FUNCTIONAL DESCRIPTION

The TIDE module can generate tidal height forecasts at numerous locations on a worldwide basis.

Table 8-1 shows an example output of a 24-hour time/height graph. It is displayed if the prediction length is 1 day and a tabular output is selected. Figure 8-1 shows an example output of a geographic display. An X placed in the column labeled "GEOGRAPHIC" on the "TIDAL STATION SELECTION" input screen sends the user directly to the Tides Geographic Display.

**NAVAL SEARCH AND RESCUE
(NAVSAR)**

LEARNING OBJECTIVES Identify applications, limitations, and assumptions of the NAVSAR product. Interpret the three NAVSAR outputs.

The NAVSAR program provides search assistance with two main functions:

1. Search Object Probability of Location Map
2. Recommended Search Plan

Both functions use environmental data to compute the search object's drift from distress time to determine the area of the search where the object maybe found. Function (1) divides the area into several cell areas of equal size, and ranks them according to probability of search object containment. The second function provides a search plan by determining either the search asset on-station durations or the probability of search success or search effort for cell areas.

NAVSAR auxiliary functions include organizing and storing environmental and search object scenario data on a status board, and computing immersion survival time.

APPLICATION

NAVSAR provides information and planning assistance to the search mission coordinator (SMC) during search and rescue incidents at sea. NAVSAR is designed to assist the SMC in deciding where to search for a target, how many assets to commit to a search, and how to assign those assets to maximize their effectiveness.

Table 8-1.-Example Output of a 24-hour Tide Time/Height Graph

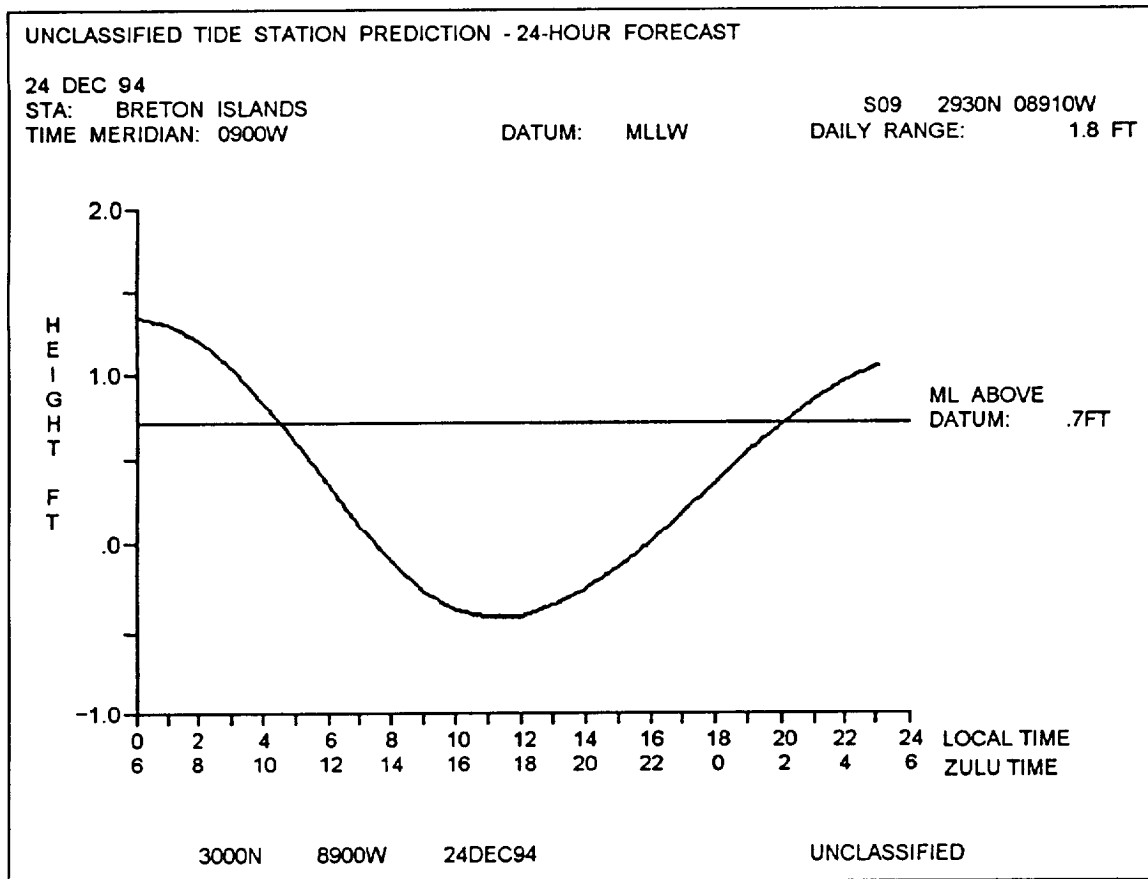

25NP0079

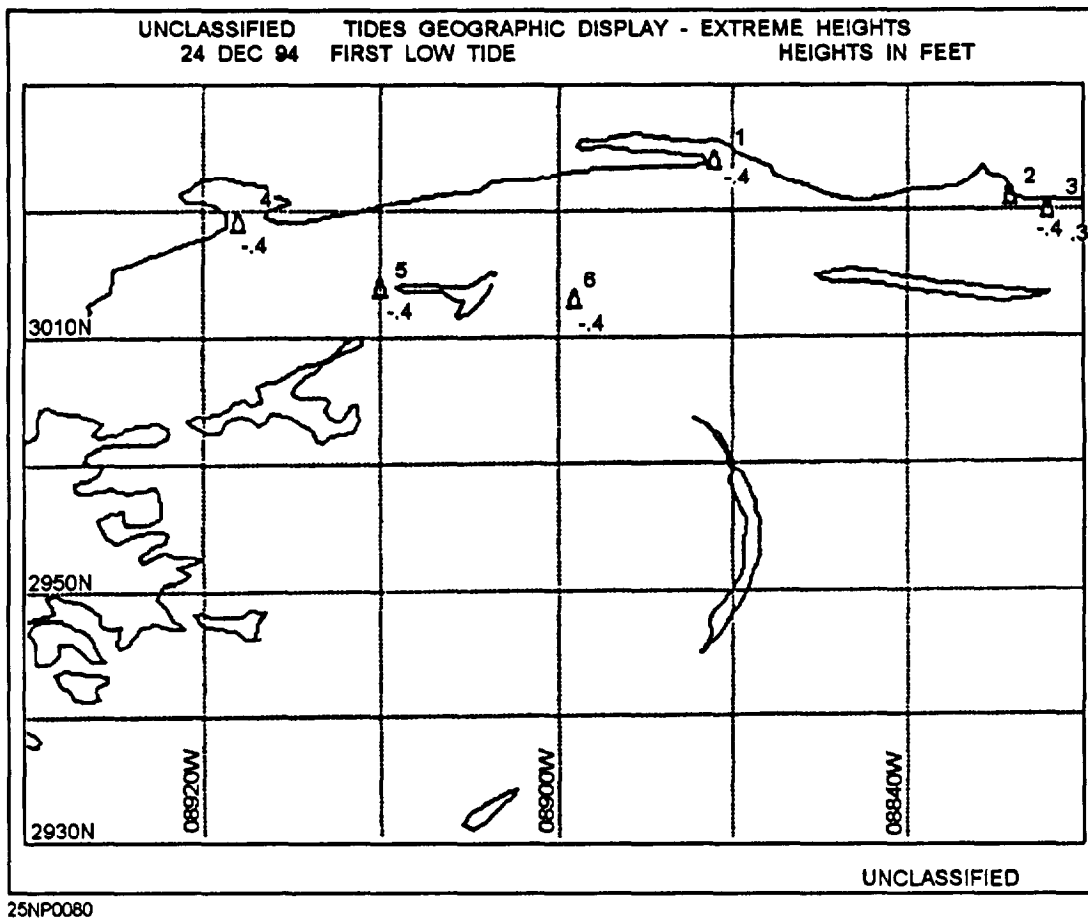

Figure 8-1.-Example output of the Tides Geographic Display.

NAVSAR uses the search object's description its last known location, and environmental data to estimate the search object location at the time of the search. Using search asset information provided by the SMC, the program will provide search recommendations in terms of rectangular areas in which to search.

LIMITATIONS AND ASSUMPTIONS

The restrictions as well as the principles taken for granted in using the NAVSAR program areas follows:

- There are three search object location scenarios to define the search object's location prior to distress time. These are Last Known Position, Trackline, and Area of Uncertainty. The operator can select up to five plans of action to enter on the status board, but only one can be a Trackline scenario.

- There are two processing modes used by NAVSAR that result in different output formats for the recommended search plan. The first processing mode is referred to as level I. The level I mode occurs when the only object location scenario is the Last Known Position scenario. The recommended search is evenly

distributed over the entire area, All other location scenarios and combinations of scenarios invoke the level II mode. The recommended search plan will contain a search effort density map. Search effort concentration is given as swept areas.

- A level I recommended search plan can be added to the status board. A level II recommended search plan cannot be added to the status board, but can be entered manually as a search plan via the search plan data.

- The operator selects the type of object to be searched from a predefine list.

- A search object trackline is described by up to four leg segments defined as either all great-circle or rhumb lines.

- Each search object location scenario must have a confidence value entered by the user. The total confidence values for all scenarios must add up to 100 percent. When revising the status board, the operator enters anew search object location scenario, and at least one of the previous location scenario confidence entries must be changed so that the total confidence for all scenarios is once again 100 percent.

- Up to eight weather and sea-current observations can be entered into NAVSAR. Sea-current observations that do not include the wind current need wind-speed and -direction observations prior to the time of the sea-current observation. Ideally, wind-speed and -direction observations representing conditions 48 hours before the sea-current observation should be entered. If there are no sea- or wind-current observations, sources of sea-current data consists of Fleet Numerical Meteorological and Oceanographic Center (FNMO) monthly current charts and the Naval Oceanographic Office (NAVOCEANO) surface-current atlases.

- A maximum of five search assets can be entered on the status board for a particular search.

- Up to five search object probability maps can be requested for display in sequence.

- A maximum of five search plans can be added to the status board.

- NAVSAR computes the sweep widths for both visual and electronic search sensor types. For any other sensor types, the user must provide the sweep width.

- The searching altitude to enter for aircraft is the flight altitude; for ships, it is the bridge height or the height of the sensor.

- Search object location maps can only be produced after the earliest distress scenario date-time group (DTG).

FUNCTIONAL DESCRIPTION

NAVSAR can be subdivided into three main functions:

1. The status board maintenance function performs the data base management.

2. The map generation function purpose is to produce probability maps for the search object at user-entered times based on the data available in the current status board.

3. The search planning function is to provide search plan recommendations that allow the most effective use of the available search assets.

Table 8-2 shows an example output of the View Status Board. This is an organized table of the search object description, location scenario's ejection

Table 8-2.-Example Output of the NAVSAR View Status Board

UNCLASSIFIED NAVSAR STATUS BOARD						
SEARCH OBJECT TYPE IS:						
BOAT 30-60 FT						
SEARCH OBJECT LOCATION DESCRIPTION:						
# 1 LAST KNOWN POSITION		NAV AID:	NAVSAT			
DTG	CONF	CEN LAT	CEN LNG			
1807940800	90.%	6700N	0500W			
SEA CURRENT INFORMATION						
DTG	CURRENT TO	CURRENT SPEED	INCLUDES WIND CURRENT			
1707940800	70. DEG	3.0 KT	Y			
1907940800	70. DEG	3.0 KT	Y			
WEATHER INFORMATION						
DTG	WIND FROM	WIND SPEED	VIS	CLOUD	MIXED LAYER	
1707940800	90. DEG	10 KT	7 NMI	50%	100 FT	
1907940800	90. DEG	10 KT	7 NMI	50%	100 FT	
SEARCH ASSET INFORMATION						
NAME	SPEED	SENSOR	V =VISUALE	=FF	BEACON	0#### =SWEEP WIDTH
IN NMI						
SAR EFFORT 0800Z 19 JUL 94				UNCLASSIFIED		

information, sea-current data, weather observations, search asset data, and search plan information.

Figure 8-2 shows an example output of the search location density map. The output shows numbered cells that represent relative probabilities of the search object being located within the cell.

Table 8-3 shows an example output of a search recommendation, level I. This is a tabular display describing a recommended rectangular search area. The available assets are listed with their on-station duration and area of coverage. Also shown is the position of the search and the cumulative detection probability of previous searches.

RAYTRACE (RAY)

LEARNING OBJECTIVES Identify applications, limitations, and assumptions of the RAY program, Interpret the RAY program output.

The RAY program may be used to understand how sound propagates through a specific environment by tracing and displaying the paths of individual sound

rays. The rays to be traced maybe specified by the user or selected by the module.

APPLICATION

The RAY program graphically displays the interaction between the environment and the sound energy propagating through it. Its function is to display regions of a water column for a given set of environmental parameters (that is, sound speed profile and bottom topography [insonify regions]). Likewise, it can be used to easily display those regions of the water column that are not insonified due to shadow zones and bathymetric blockage. The RAY program serves as a modifier of flat bottom omnidirectional propagation-loss output by depicting the ranges/bearings from the source location where bottom effects may impact the propagation-loss curve. For a skilled interpreter, a finely detailed ray diagram can also point out possible locations for convergence zones (CZs) and shadow zones.

LIMITATIONS AND ASSUMPTIONS

The restrictions as well as the principles taken for granted in using the RAY program areas follows:

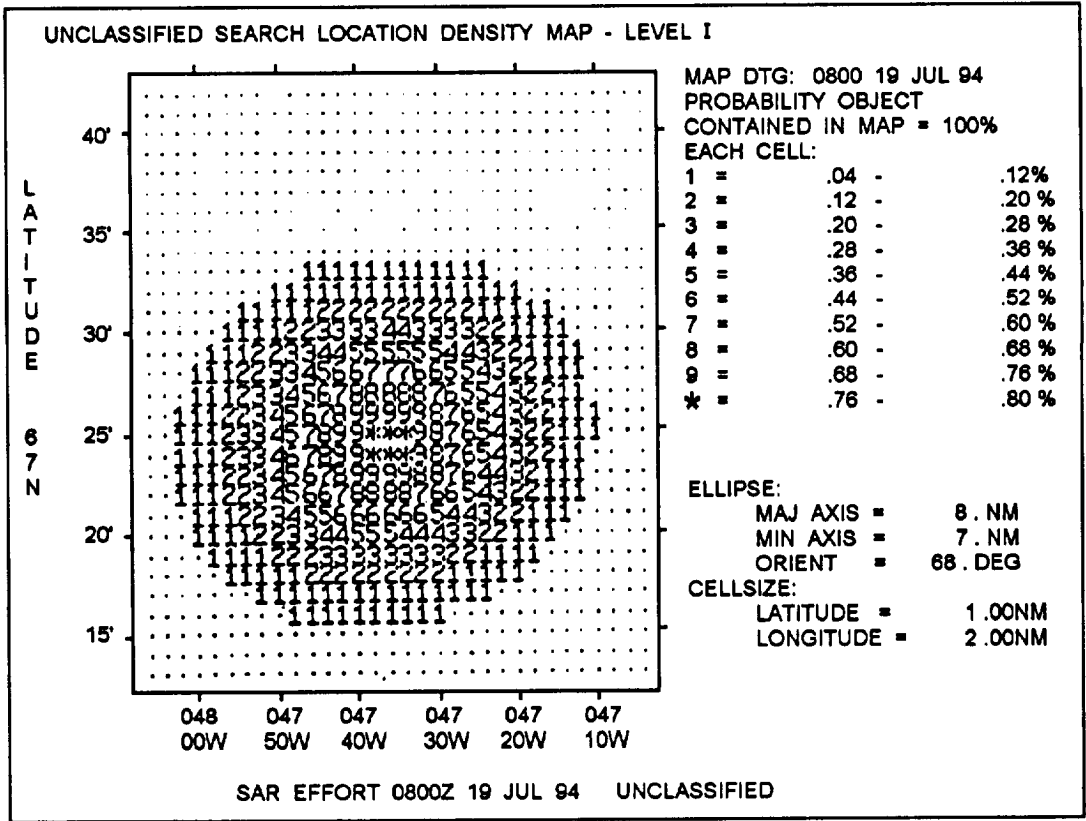

25NP0081

Figure 8-2.-Example output of a search location density map.

Table 8-3.-Example Output of a Search Recommendation - Level I

UNCLASSIFIED						
SEARCH RECOMMENDATION - LEVEL I						
SEARCH TIME: 1907940800						
PROB OF SUCCESS: 100.0%						
CUM DETECTION PROB: 100.0%						
SEARCH AREA RECTANGLE:						
CENTER LATITUDE:	6725N	CENTER LONGITUDE:	04736W			
LENGTH:	42.NMI	WIDTH:	37.NMI			
ORIENTATION:	68.DEG	TOTAL AREA:	1563.SQ-NMI			
SEARCH ASSET INFORMATION AND RECOMMENDATION						
ASSET NAME	SPEED	ALTITUDE	SENSOR	ON STA	AREA	COVERED
	(KT)	(FEET)		(HHMM)	(%)	(SQ-NMI)
P3	200.	1000.	v	0500	100.	1563.
SAR EFFORT 0800Z 19 JUL 94 UNCLASSIFIED						

- The RAY program uses a single sound speed profile, generated by the Sound Speed Profile (SSP) program. Thus, sound speeds used-in this program are a function of depth, but not range.

- In output displays, horizontal and vertical plotting scales are often different, resulting in an apparent difference between the angle of incidence and the angle of reflection with respect to a locally sloping bottom.

- A positive ray is downgoing; a negative ray is upgoing.

- If the source is located at the surface (that is, source depth of zero), the operator should not select any negative (upgoing) rays.

- The module traces only outgoing rays. If the angle of reflection from a sloping bottom is $\leq -89.9^\circ$, then the ray is terminated.

- Computed ray diagrams are very sensitive to the user's selection of launch angles and source depth, as well as bathymetry and sound speed,

- The RAY program uses the sound speed profile to calculate ray paths. If variable bottom depths, either automatically retrieved or manually supplied, exceed

the deepest depth of that sound speed profile, the Raytrace module extrapolates the sound speed profile to the deepest variable bottom depth provided

- Because of computational limitations a 0° ray cannot be traced Whenever a 0° ray is requested or expected on the output diagram, a $+0.01^\circ$ ray and a -0.01° ray will be traced.

- Because temperature and salinity are relatively stable below 2500 m, sound speed profiles reaching 2500 m are accurately extrapolated. Extrapolations of sound speed profiles that do not extend to 2500 m, however, are suspect. Computed ray paths that descend to depths where extrapolated sound speeds are suspect should be used with caution.

FUNCTIONAL DESCRIPTION

The principle means of detection used in antisubmarine warfare (ASW) employs acoustic energy, Water, a poor medium for the transmission of electromagnetic (EM) energy, is an excellent conductor of acoustic energy or sound. Sound is a wave phenomenon, consisting of alternate compression and refraction of the medium. The speed of sound, or speed at which the acoustic waves advance through the medium, depend on certain characteristics of the

medium. Properties of seawater that affect sound speed are salinity, temperature, and pressure. Output from this program is classified and should be labeled as required.

PASSIVE ACOUSTIC PROPAGATION LOSS (PPL)

LEARNING OBJECTIVES Identify applications, limitations, and assumptions of the PPL program. Interpret PPL outputs.

The PPL program calculates transmission loss as a function of range, frequency, source depth, and receiver depth. The calculations from this program will be used in the prediction of ASW sensor systems performance. The purpose of this program is to define the acoustic propagation conditions within the ocean area of interest. It is intended as an interface between environmental data read from the ocean environmental file (OEF) and operational data. The program will translate information about existing oceanographic conditions into an assessment of PPL versus range that is necessary for sensor system performance predictions.

APPLICATION

The PPL program computes the loss of sound intensity in traveling from the selected source (for example, submarine) to the receiver (for example, passive sonobuoy) for ranges (kyd) out to the maximum range specified. The operator-selectable input is the desired frequencies, source and receiver depths, and maximum range. The propagation-loss curve aids the operator in computing detection ranges and possible detection paths.

The range should be chosen to include the first CZ. A typical maximum range value varies from 60 to 100 kyd.

When the propagation-loss curve is displayed on the monitor, the operator can see the transmission loss associated with each range. In general, the propagation loss increases with range but may decrease rapidly (spike) when environmental conditions allow formation of CZs. If the operator knows the figure of merit (FOM), in decibels (dB), detection ranges can be determined instantly by looking at the display. At any range point where the FOM is greater than the propagation loss, the probability of detection (POD) is at least 50 percent.

LIMITATIONS AND ASSUMPTIONS

The restrictions as well as the principles taken for granted in using the PPL program are as follows:

- The PPL program incorporates low-frequency bottom-loss (LFBL) data base processes, assumptions, and correction factors. Viability of output depends upon the degree of difference between the model and actual seabed conditions.
- System correction factors are preset to define an omnidirectional/vertical-line array DIFAR (VLAD) sonobuoy.
- Maximum range should include the first CZ.
- Horizontal homogeneity is assumed. Therefore, the output should be used with caution in areas of high variability (for example, fronts and eddies).
- The SSP program must be used to create the environmental data set used by RAYMODE. The SSP program stores a sound speed profile, bottom depth, high- and low-frequency bottom-type information, wind speed, and so on, in the OEF.
- Propagation-loss curves may be generated for target frequencies in the range of 1 to 35,000 Hz. Due to the limitations of the LFBL data base, reliable output is constrained to frequencies >30 Hz.

FUNCTIONAL DESCRIPTION

The RAYMODE propagation-loss model was developed at the Naval Underwater Systems Center, New London, Conn. The original version of this model has been updated to incorporate factors for determining bottom-loss and system correction factors. This model considers the ocean bottom as a varying sound receptor and not simply a reflector. Computation of losses in the bottom sediment are a feature of PPL that treats the bottom of the ocean as a continuation of the water column, and computes the contribution of the bottom sediment to propagation loss, considering refracted paths through the sediment and reflections at the basement.

Locations beyond the coverage of the LFBL data base use the COLOSSUS data base model to estimate propagation loss. Output from this program is classified and should be labeled as required.

NEAR-SURFACE OCEAN THERMAL STRUCTURE (NOTS)

LEARNING OBJECTIVES Identify applications, limitations, and assumptions of the NOTS program. Interpret NOTS program outputs.

The NOTS program is used to forecast changes in the upper ocean thermal structure due to mixing by surface winds, heating and cooling by surface heat, precipitation, and evaporation. Program output consists of profiles of temperature with respect to depth at operator-specified forecast intervals; forecast profiles may be run through the SSP program and then routed to the OEF for use in various oceanographic and acoustic programs.

APPLICATION

The NOTS program uses initial temperature profiles and observed or forecasted surface meteorological data to predict changes in the upper ocean thermal structure with respect to time. The forecast NOTS temperature profiles can be input to SSP and then used by the RAY, PPL, and Sensor Performance Prediction (SPP) programs to predict acoustic propagation conditions and to predict environmental effects on fleet ASW sensors and operations.

LIMITATIONS AND ASSUMPTIONS

The restrictions as well as the principles taken for granted in using the NOTS program areas follows:

- This program operates under the assumption that oceanic conditions are horizontally homogeneous. (Horizontal changes in the ocean thermal structure are not considered.) This program should not be used in the vicinity of strong currents, ocean fronts, or eddies.

- Since the quality of meteorological forecasts can degrade significantly with respect to time, NOTS forecasts more than 24 hours long should be used with caution.

- The operator should use caution when specifying cloud cover and precipitation rate information for a given forecast time. The program linearly interpolates these values for model forecast times between the meteorological forecast times.

- This program should not be used for locations over the continental shelf; neither should it be used near regions of significant river runoff.

FUNCTIONAL DESCRIPTION

The NOTS model is used to forecast changes in the upper ocean density structure due to mixing by surface winds, heating and cooling by surface heat fluxes, and evaporation and precipitation. Input to the model consists of date, time, and position information; initial temperature and salinity profiles; turbidity information; and forecasts (or observations) of surface meteorological conditions such as wind speed, wind direction, air temperature, humidity, atmospheric pressure, cloud cover, and precipitation rate. The date, time, and position information, as well as the initial temperature salinity profiles, are retrieved for the operator-selected data set in the OEF. The surface meteorological data are entered by the operator by way of the keyboard. Optical water-type (turbidity) information for location of interest is retrieved from the permanent data base (PDB) file.

Performing an upper ocean thermal structure forecast involves three processing steps:

1. Initializing the model
2. Calculating surface fluxes
3. Using the model to calculate the effects

Output from the NOTS program consists of forecast profiles of temperature with respect to depth for operator-selected forecast times. These profiles are routed to the NOTS forecast file. Operator-selected forecast profiles are displayed, both in tabular and graphical formats. Output from this program is classified and should be labeled as required.

SOUND SPEED PROFILE (SSP) GENERATOR MODULE

LEARNING OBJECTIVES: Identify applications, limitations, and assumptions of the SSP program. Interpret SSP module outputs.

The SSP generator module computes a sound speed profile by applying Wilson's equation for ocean sound speed to a merged depth/temperature/salinity profile. This creates a sound speed profile that represents local

oceanic conditions. The output generated by the SSP generator module is a sound speed vs. depth profile from the sea surface to the ocean bottom, which is essential in making accurate sensor range predictions.

APPLICATION

The SSP module yields tactically useful information when a basic knowledge of underwater acoustics is applied to the products. This information can be used to make decisions regarding sensor depth settings, optimum frequency bands for search, and buoy pattern. By examining the sound speed profile and other module output, the experienced ASW technician can learn a great deal about available acoustic transmission paths and sensor performance.

The optimum frequency for detection in the sonic layer may be determined from the sonic layer cutoff frequency calculated by SSP. The presence, quality, and accessibility of a sound channel to available sensors can be identified from the generated sound speed profile.

CZs may exist where the sound speed at the bottom exceeds the sound speed at the source depth, providing there is an experienced analyst with a means to estimate CZ range and width from the shape of the sound speed profile.

LIMITATIONS AND ASSUMPTIONS

The restrictions as well as the principles taken for granted in using the SSP product areas follows:

- SSP allows the operator to review and correct manual input. This prevents aborting runs due to operator-input errors.
- In deep-water areas, on-scene bathythermograph (BT) data that do not extend below 200 m should be used with caution.
- Where no historical profile data are available, operator entry of surface-to-bottom depth/temperature/salinity sound speed values is required.

FUNCTIONAL DESCRIPTION

The SSP module provides the operator with a sound speed profile that is representative of local oceanic conditions. This module also provides a link between environmental variability and sonar performance. An on-scene BT and a historical depth/temperature/salinity profile are used to compute the sound speed profile and related data.

The SSP merging routine combines BT data with a historical profile to form a surface-to-bottom temperature/salinity profile. The resulting merged profile consists of the BT data in the upper portion and the historical profile, modified by the merge, in the lower portion. The lower portion extends from the first depth value below the available BT data to the bottom depth. Output from this program is classified and should be labeled as required.

The first portion of this chapter was devoted to computer aids generated by the TESS 3 configuration. Now let's look at the BT collective product.

BATHYTHERMOGRAPH COLLECTIVE PRODUCT

LEARNING OBJECTIVES Identify applications, limitations, and assumptions of the bathythermograph collective product.

FLENUMMETOCEN is capable of providing synoptic (real-time) and historical bathythermograph (BATHY) observation collectives for a specified area and timeframe. Pre-1985 BATHYs are stored in the Master Oceanographic Observation Data Set (MOODS) with over 4.6 million observations. More recent BATHYs, which have not yet been added to the MOODS data base are stored in a separate archive in a format called 4D. The last 12 hours of BATHYs are stored on the operational computers. Output from this program is classified and should be labeled as required.

APPLICATION

The BATHY collective product provides a convenient means for an activity or unit to retrieve historical data and/or receive synoptic data for a specific area/time period. The product can be used for onboard prediction systems or for exercise planning/reconstruction.

LIMITATIONS AND ASSUMPTIONS

The synoptic BATHY collective is a simple and easily transmittable product that provides detailed temperature/depth data.

The synoptic or real-time BATHY collectives are transmitted in the raw JJXX format, not passing through quality control procedures as do those that are extracted from the historical data base.

Now let's look at the Mad Operational Effectiveness (MOE) charts, which are discussed in more detail in *Environmental Effects on Weapons Systems and Naval Warfare (U)*, (S)RP1.

MAD OPERATIONAL EFFECTIVENESS (MOE) CHARTS

LEARNING OBJECTIVES: Explain the purpose of MOE charts. Describe the method used to obtain MOE charts.

MOE charts are prepared for selected areas throughout the world, and they display predicted environmental magnetic noise levels.

MOE charts are available through the *DMA Catalog of Maps, Charts, and Related Products, Part 2 - Hydrographic Products*. NAVOCEANO RP 28, *MAD Tactical Use of MOE Charts*, is also available from Defense Mapping Agency (DMA) distribution centers.

SUMMARY

In this chapter, we have discussed applications, limitations, assumptions, and functional descriptions of just a few of many computer and climatological products available to aid the Aerographer's Mate in the analysis and forecasting of oceanographic conditions, thus ensuring optimum support of operations at sea.

CHAPTER 9

OPERATIONAL OCEANOGRAPHY

In this chapter we will be discussing information on a number of oceanography products and environmental factors of utmost importance to the Aerographer's Mate.

By being familiar with these products, parameters, limitations, and request procedures the Aerographer can provide the on-scene commander with a detailed accounting of environmental conditions above, as well as below, the ocean's surface.

We will first discuss the products available from the Navy Oceanographic Data Distribution System (NODDS). NODDS was developed in 1982 as a means to make FLENUMETOCEN (FNMOC) environmental products available to METOCFACS and METOCDETS who had no direct access to this data. Through the years, the system has grown in use as product support has expanded. NODDS 3.0 was distributed in December 1991, and it was unique in its approach to environmental data communications. Once a user has defined the products desired for a specific area, an automatic process of acquiring data is initiated. Using a commercial "off the shelf" licensed communications software package, the system dials FLENUMMETOCEN and requests the data fields from a security shell in a host mainframe computer. The required data is extracted from one of the global data bases as a compacted ASCII transmission which is generated for each field/product. By transmitting field data and limiting the area of extraction, the transmissions are small and communications are efficient. Once the raw data is received by the user's NODDS, the required contouring, streamlining, shading, and so forth, is performed automatically until all products are in a ready-to-display format.

The NODDS User's Manual contains explanations of system functions and step-by-step procedures for using the NODDS terminal. By selecting the "Convert Data" option of the "Data Manager" file from the main menu the user can convert the NODDS geographic displays to alphanumeric displays. Underway units may also access NODDS data using a VHF Stel Modem along with a STU-III Secure phone. There are limitations associated with all of the NODDS acoustic products listed in this section, such as low grid resolutions and graphic depiction errors. A general

description of each product will be covered along with example outputs. Further discussion on parameter derivation and user provided inputs may be found in the NODDS Products Manual, FLENUMMETOCENINST 3147.1. Now let's look at some of the products available from NODDS.

CONVERGENCE ZONE RANGE (CZR)

LEARNING OBJECTIVES Recognize characteristics of a convergence zone. Evaluate CZR products. Identify the two graphic outputs of the product.

The CZR product predicts the expected ranges to the first convergence zone for a sonar. Convergence zones are regions in the deep ocean where sound rays, refracted from the depths, are focused at or near the surface. Convergence zones are repeated at regular range intervals and have been observed out to 500 nmi or more. Convergence zone ranges are those ranges capable of being achieved when operating sonar in the path of a convergence zone.

SOUND DISTRIBUTION

The distribution of sound throughout the deep ocean is characterized by a complex series of shadow zones and convergence zones. The presence and extent of these zones are determined by the sound speed profile, the location of the surface, bottom, and source relative to the profile, and the existence of caustics.

CAUSTICS

A caustic is the envelope formed by the intersection of adjacent rays. When a caustic intersects the sea surface or a region at or near the surface, a convergence zone is created. Convergence zones are regions of high sound intensity. Thus, a receiver may be expected to pick up high sound intensity gain within a convergence zone versus outside of it, where only a single strong propagation path occurs.

CONVERGENCE ZONE REQUIREMENTS

The existence of a convergence zone requires a negative sound-speed gradient at or near the surface and a positive gradient below. In addition, there must be sufficient depth for usable convergence zone to occur, that is, the water column must be deeper than the limiting depth by at least 200 fathoms.

SOUND SPEED PROFILE

The sound speed profile of the deep ocean varies with latitude. In cold surface waters the depth of the deep sound channel axis is shallow, the range to the convergence zone is small, and the range interval between zones is small. In the Mediterranean Sea, the bottom water is much warmer than in the open ocean and, consequently, the sound speed near the bottom is higher. Since the limiting depth is much shallower and the acoustic energy is refracted upward at a much shallower depth, ranges are much shorter than those generally found in the open ocean.

Although the acoustic characteristics and sufficient depth excess for convergence zone propagation may exist, bathymetry does play a role as the presence of a seamount or ridge may block the convergence zone path.

EXAMPLE OUTPUT

There are two graphic outputs available with the CZR product.

1. A shaded convergence zone range display, which depicts areas of predicted range in nautical miles (nmi). See figure 9-1. The amount of the shading indicates the range as follows:

Clear	No CZs
Light	Short range CZs
Medium	Medium range CZs
Heavy	Long range CZs

2. The shaded convergence zone usage product displays the areas of CZ probability based on an analysis of depth and/or sound speed excess. See figure 9-2. The amount of shading indicates the probability as follows:

Clear	No CZs
Medium	Possible CZs
Heavy	Reliable CZs

BOTTOM BOUNCE RANGE (BBR)

LEARNING OBJECTIVES: Explain the theory associated with the BBR. Evaluate BBR products. Identify the two graphic outputs of the product.

The BBR product provides an estimate of the horizontal ranges expected for active sonars operating in the bottom bounce mode.

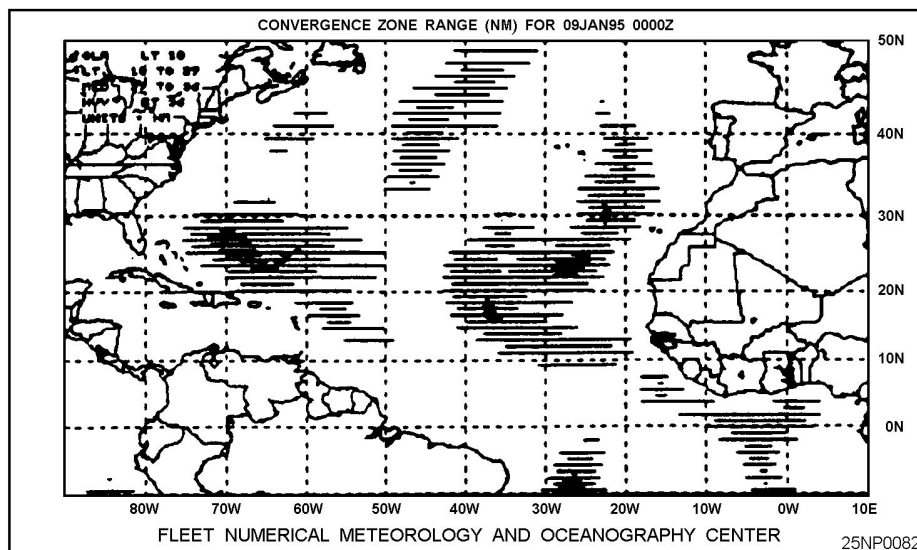

Figure 9-1.-A shaded convergence zone range display.

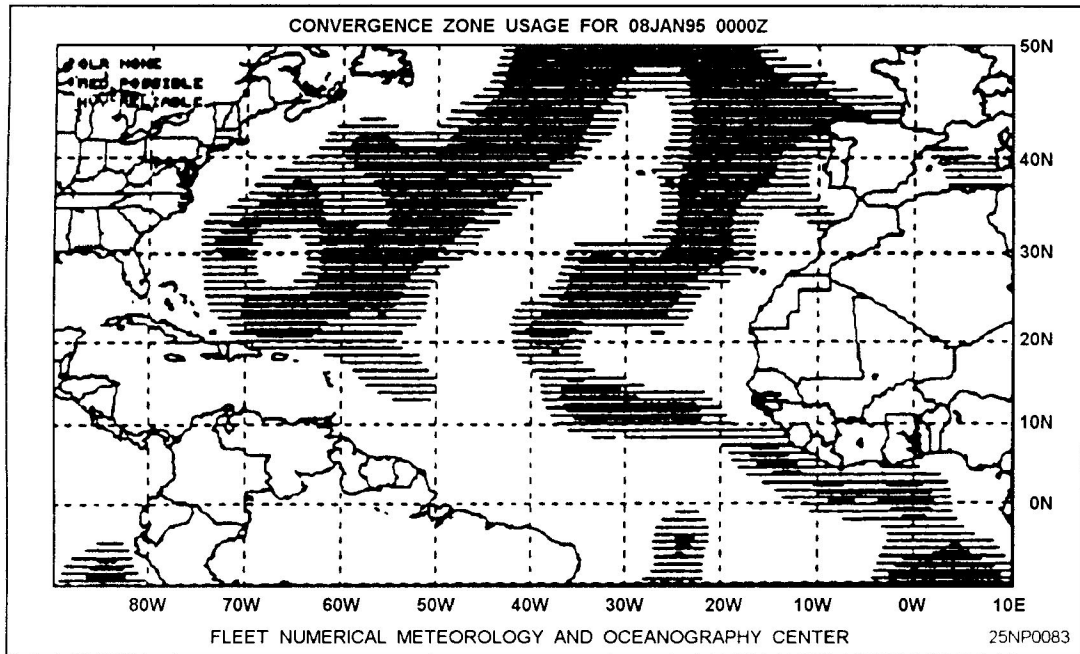

Figure 9-2.-A shaded contoured convergence zone probability display.

In the bottom bounce mode, sound energy is directed towards the bottom. This path is successful because the angle of the sound ray path is such that the sound energy is affected to a lesser degree by sound speed changes than the more nearly horizontal ray paths of other transmission modes (that is, surface duct, deep sound channel, convergence zone).

RANGE VERSUS DEPTH

Long-range paths can occur with water depths greater than 1,000 fathoms, depending on bottom slope. At shallower depths high intensity loss is produced from multiple-reflected bottom bounce paths that develop between the source and receiver. Since 85 percent of the ocean is deeper than 1,000 fathoms and bottom slopes are generally less than or equal to 1°, relatively steep angles can be used for single bottom reflection. With steeply inclined rays, transmission is relatively free from thermal effects at the surface, and the major part of the sound path is in nearly stable water.

ACTIVE DETECTION

Inactive detection, bottom bounce transmission can produce extended ranges with fewer shadow zones because more than one single-reflected bottom path exists between the sonar and the target. These paths combine to produce an increase in the received

signal and reduce the extent of the shadow zone. The major factors affecting bottom bounce transmission include the angle at which the sound ray strikes the bottom (grazing angle), the sound frequency, the bottom composition, and the bottom roughness.

EXAMPLE OUTPUT

There are two graphic outputs available with the BBR product.

1. A shaded bottom bounce range display. The amount of shading indicates the range in nmi. See figure 9-3.

Light	1-5 nmi range
Medium	5-10 nmi range
Heavy	>10 nmi range

2. A shaded bottom bounce probability display. This product provides estimates of the existence of low-loss bottom bounce paths between a sonar (source) and the target (receiver) based on the environmental and geoacoustic parameters. See figure 9-4. The amount of shading indicates the probability conditions as follows:

Clear	No
Medium	Fair
Heavy	Good

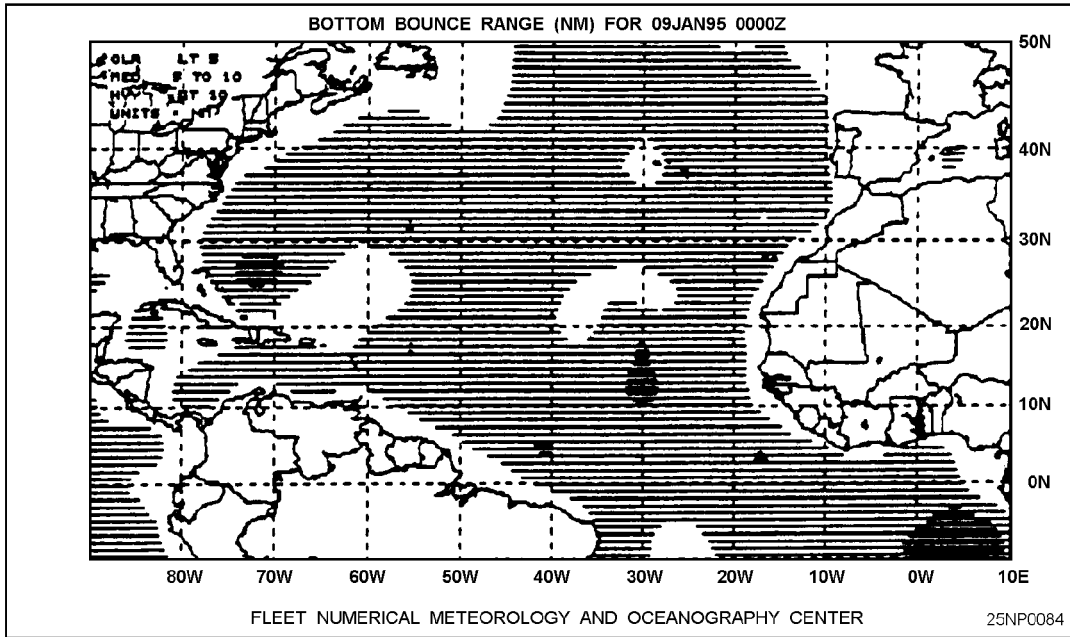

Figure 9-3.-A shaded bottom bounce range display.

SONIC LAYER DEPTH (SLD)

LEARNING OBJECTIVES Recognize characteristics of the SLD. Evaluate SLD product. Identify the graphic output products.

The SLD product displays the layer depth that can be used to locate areas of strong sound propagation in the near-surface layer. The sound field in a layer depends greatly upon the layer depth. The deeper the layer, the farther the sound can travel without having to reflect off the surface and the greater is the amount of energy initially trapped.

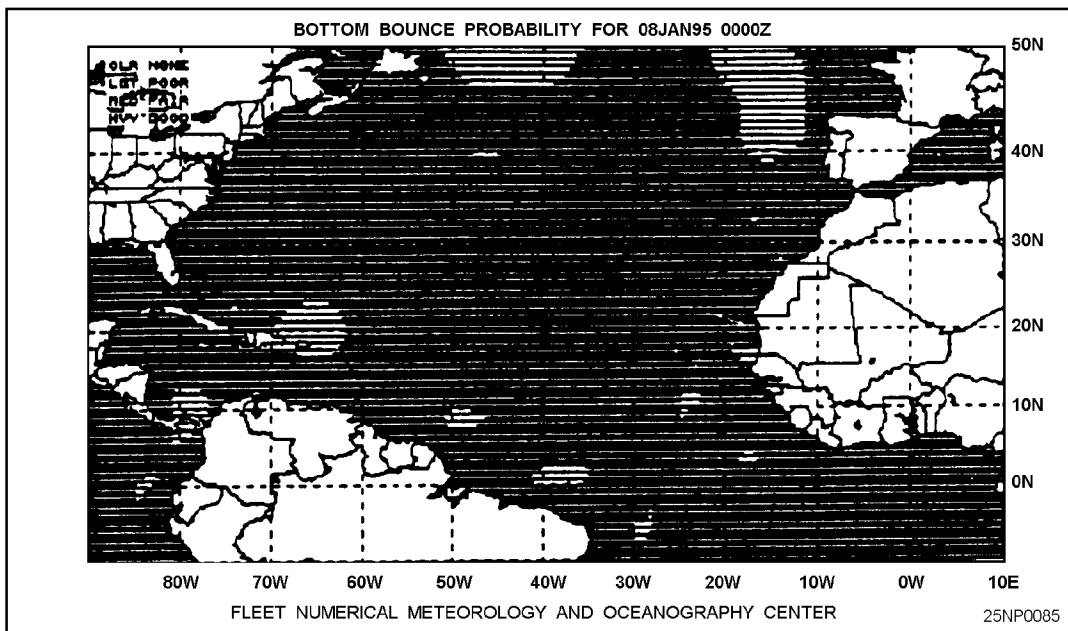

Figure 9-4.-A shaded bottom bounce probability display.

EXAMPLE OUTPUT

There is only one graphic output available with the SLD product. It is a shaded sonic layer depth display. The amount of shading indicates the range of depth in feet. See figure 9-5.

Clear	<50 ft
Light	50-100 ft
Medium	100- 350 ft
Heavy	>350 ft

SURFACE DUCT CUTOFF FREQUENCY (SFD)

LEARNING OBJECTIVES: Describe the two conditions under which a surface duct may occur. Evaluate the SFD product. Identify the graphic output of the product.

The SFD product displays the cutoff frequency values where a surface duct may occur in the mixed layer of the ocean if one of two conditions exist: (1) the temperature in the layer increases with depth or (2) an isothermal layer is near the surface. In condition 1, sound speed increases as the temperature increases. In condition 2, there is no temperature or salinity gradient and pressure causes sound speed to increase with depth.

In the mixed (or surface) layer the velocity of sound is susceptible to the daily and local changes of heating, cooling, and wind action. Under prolonged calm and sunny conditions the mixed layer disappears and is replaced by water where the temperature decreases with depth.

ADVANTAGES OF THE SURFACE DUCT

The potential for using these ducts in long-range detection was not fully realized in early sonar operation since the equipment was generally in the supersonic frequency range (24 kHz and above) and attenuation due to leakage and absorption was great. As a result of the continuous trend in sonar toward lower frequencies, the use of this duct is an aid for both active and passive detection.

FREQUENCY

At low frequencies, sound will not be trapped in the surface duct. This occurs when the frequency approaches the cutoff frequency; that is, the wavelength has become too large to "fit" in the duct. This does not represent a sharp cutoff. However, at frequencies much lower than the cutoff frequency, sound energy is strongly attenuated by scattering and leakage out of the duct.

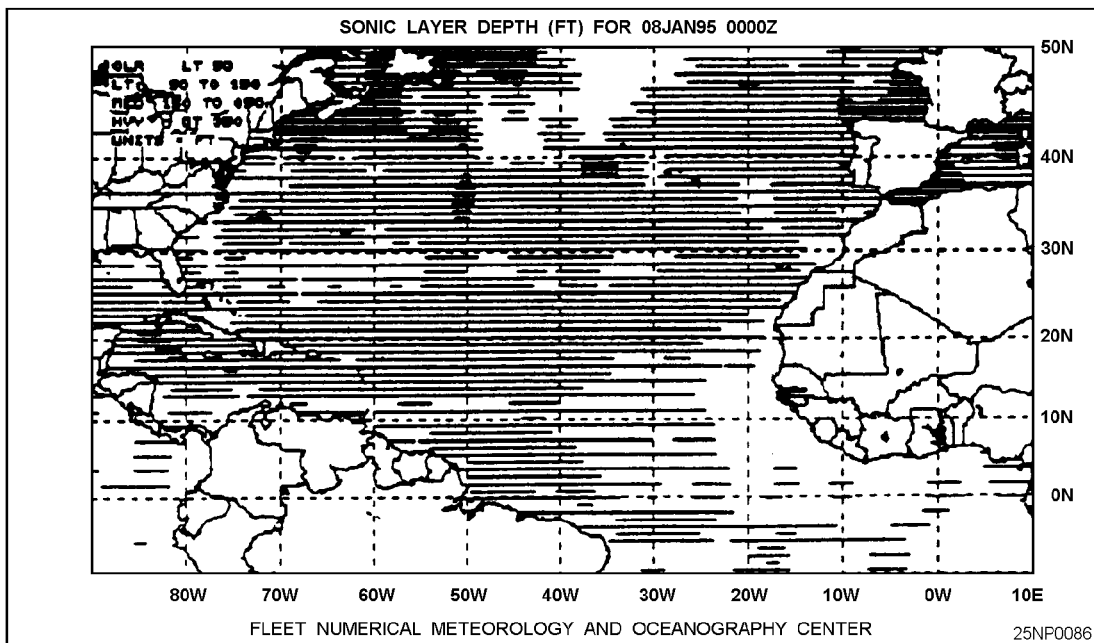

Figure 9-5.-A shaded sonic layer depth display.

DUCT QUALITY

The quality of transmission in the surface duct varies greatly with the thickness of the duct, surface roughness, gradient below the layer, and frequency.

EXAMPLE OUTPUT

There is one graphic output available with the SFD product. It is a shaded surface duct cutoff frequency display. The amount of shading indicates the range of frequencies. See figure 9-6.

Clear	No duct or >300 Hz
Light	150-300 Hz
Medium	50-150 Hz
Heavy	1 - 50 Hz

DIRECT PATH RANGE (DPR)

LEARNING OBJECTIVES: Understand the conditions under which DPRs are most likely to occur. Evaluate the DPR product. Identify the graphic output of the program.

The DPR displays the most probable ranges that can be expected for acoustic surveillance system modes that use direct path propagation. The direct path is the simplest propagation path. It occurs

where there is approximately a straight-line path between sonar (source) and target (receiver), with no reflection and only one change of direction due to refraction. The maximum range obtained in the direct path propagation mode occurs out to the point at which the surface duct limiting ray comes back up and is reflected from the surface.

EXAMPLE OUTPUT

There is one graphic output available with the DPR product, a shaded direct path range display. The amount of shading indicates the range in nmi. See figure 9-7.

Light	0-2 nmi
Medium	2-4 nmi
Heavy	>4 nmi

HALF-CHANNEL CONDITIONS (HAF)

LEARNING OBJECTIVES: Understand the situations that are most favorable for HAF. Evaluate the HAF product. Identify the graphic output of the program.

The HAF product displays areas where positive sound speed profile gradient (half-channel) conditions

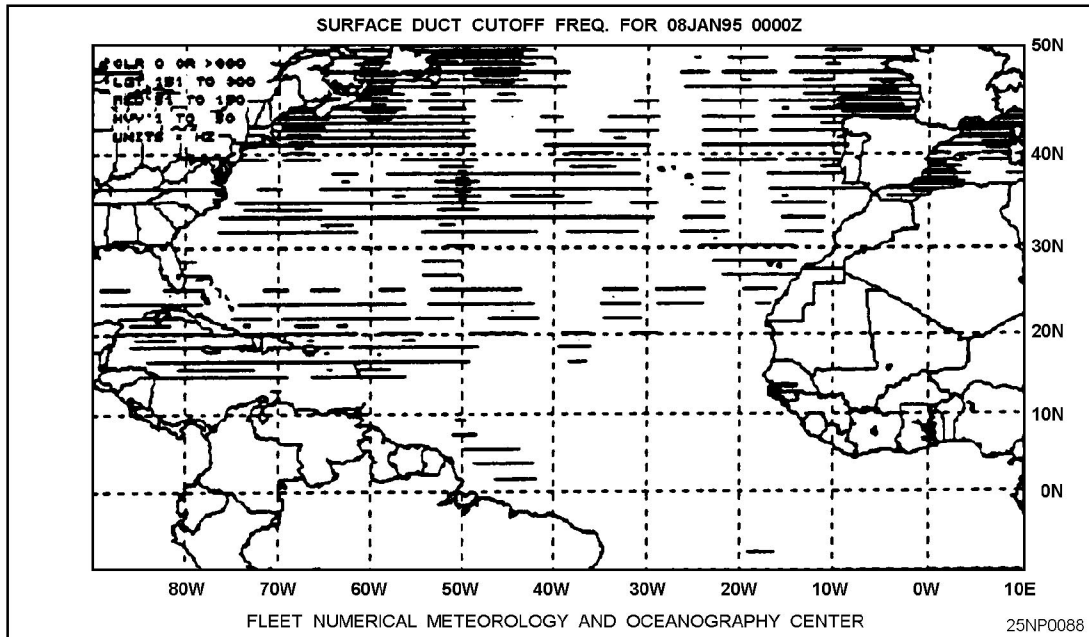

Figure 9-6.-A shaded surface duct cutoff frequency display.

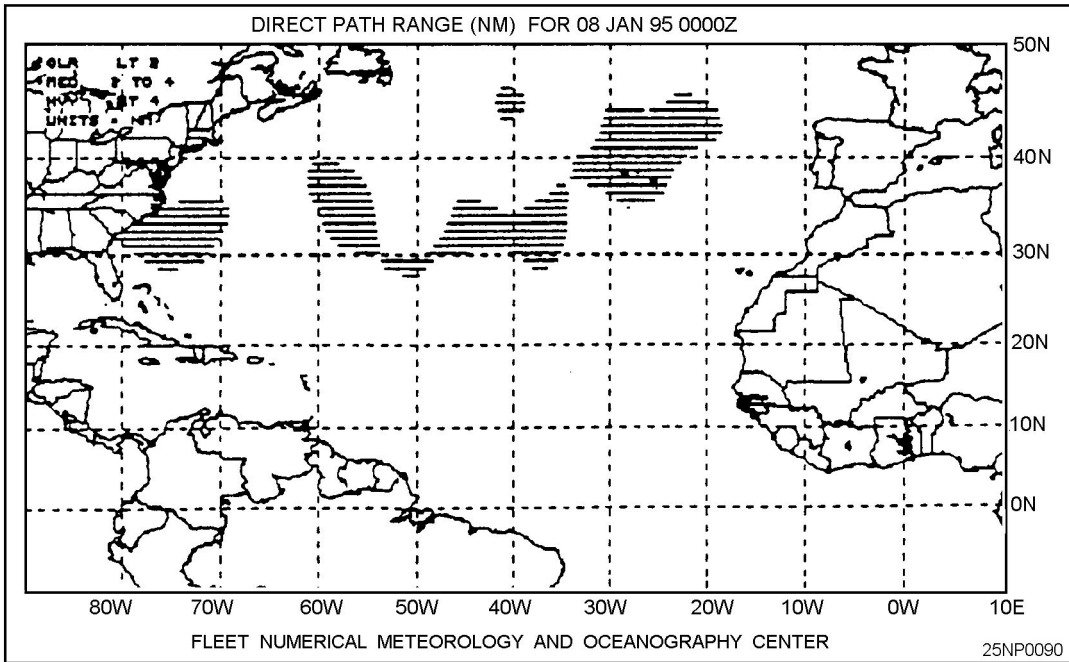

Figure 9-7.-A shaded direct path range display.

exist. Half-channel conditions exist where the water is essentially isothermal from the sea surface to the bottom, so that sound speed increases continuously with increasing depth. Under these conditions, the greatest sound speed is at the bottom of the ocean, and sound energy will be refracted upward, then reflected downward at the surface, and refracted upward again. The effect is similar to a strong surface duct, so long ranges are possible. Half-

channel propagation is common during winter in the Mediterranean Sea and polar regions.

EXAMPLE OUTPUT

There is one graphic output available with the HAF product. It is a shaded half-channel conditions display. The half-channel conditions are indicated by the vertical shading: clear no; heavy yes. See figure 9-8.

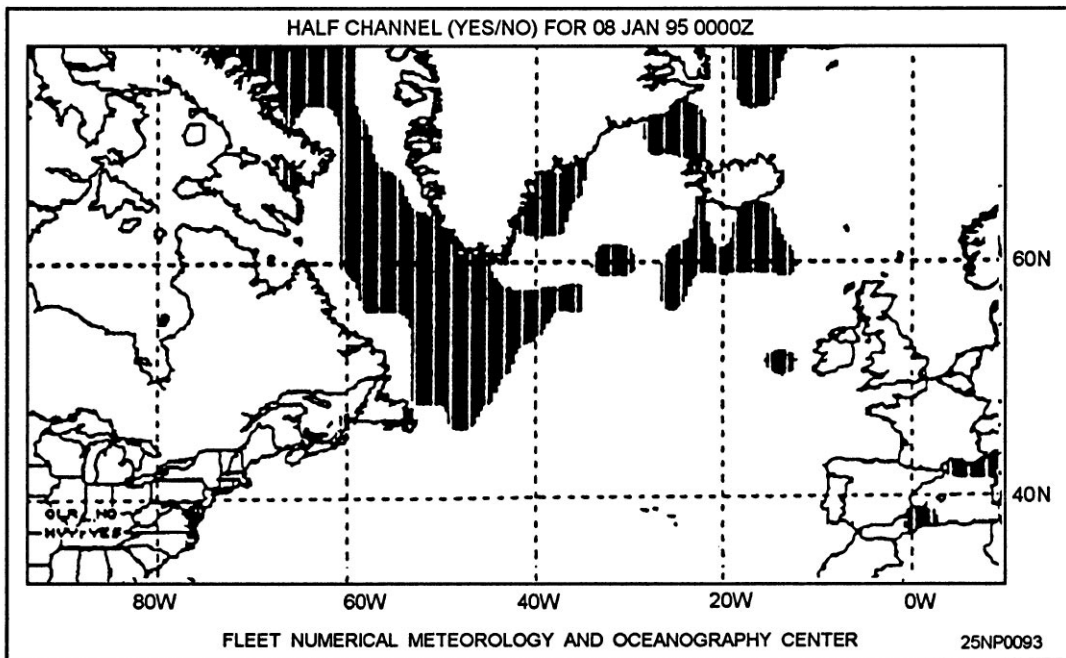

Figure 9-8.-A shaded half-channel conditions display.

SOUND CHANNEL AXIS DEPTH

LEARNING OBJECTIVES: Recognize subsurface oceanographic features conducive to deep and shallow channel conditions. Evaluate deep sound channel axis (DSC) and shallow sound channel axis (SSX) depth products. Identify the graphic and tabular outputs of each.

In this section we will discuss both the deep and shallow channel axis products. First, let's look at the deep sound channel axis.

DEEP SOUND CHANNEL AXIS DEPTH (DSC)

A deep sound channel occurs when the deep sea is warm on top and cold below. The surface-warming effect is not sufficient to extend all the way to the bottom and is limited to the upper part of the water column, below which it forms the main thermocline. The main thermocline exhibits a decrease in temperature at a moderately rapid rate with depth. Below the main thermocline, the sea is nearly isothermal about 38°F) and therefore has a positive sound speed gradient due to the effects of pressure.

Sound Ray Refraction

The DSC axis is located at the depth of minimum sound speed in the deep sound channel. This sound speed minimum causes the sea to act like a kind of lens, as expressed by Snell's law, where sound rays above and below the minimum are continuously bent by refraction toward the DSC axis. That is, as the ray enters the deep sound channel from above, the sound speed follows a negative gradient and the ray bends downward toward the depth of the minimum sound speed, the axis. Conversely, after the ray reaches the axis, the sound speed gradient is positive and the ray bends upward toward the axis.

This refraction pattern forms the low-loss deep sound channel, as a portion of the power radiated by a source in the deep sound channel remains within the channel and encounters no acoustic losses by reflection from the sea surface and bottom. Because of the low transmission loss, very long ranges can be obtained from a source of moderate acoustic power output, especially when it is located near the depth of minimum velocity, the axis of the sound channel. Note that not all propagation paths in the DSC are entirely refracted

paths. When the source or receiver or both lie beyond the limits of the channel, only reflected paths that encounter either the surface or bottom or both are possible.

Ocean Variations

The ocean by no means is laterally uniform. Because the temperature structure of the ocean varies with location, the axis depth ranges from 4,000 feet (1,225 meters) in mid-latitudes to near-surface in polar regions. As the channel axis becomes shallower, low values of attenuation can be reported. For example, the channel axis becomes shallower with increasing latitude northward from Hawaii, so a shallow source finds itself closer to the DSC axis as it moves northward. As a result, the transmission becomes better than it would be if the DSC axis were at a constant depth. Also, signals in the DSC can be found to reach a maximum and then begin to decrease with increasing range instead of the normal linear decrease. This effect is attributed to poor sound channel conditions along part of the path. The horizontal variations of the DSC axis can be readily observed on the DSC product.

Sound Fixing and Ranging (SOFAR) Channel

The deep sound channel is sometimes referred to as the SOFAR (sound fixing and ranging) channel. Its remarkable transmission characteristics were used in the SOFAR system for rescue of aviators downed at sea. In SOFAR a small explosive charge is dropped at sea by a downed aviator and is received at shore stations thousands of miles away. The time of arrival at two or more stations gives a "fix," locating the point at which the detonation of the charge took place. More recently, the ability to measure accurately the arrival time of explosive signals traveling along the axis of the deep sound channel has been used for geodetic distance determinations and missile-impact locations as a part of the Missile Impact Location System (MILS) network.

EXAMPLE OUTPUT

There is one graphic output available with the DSC product. It is a shaded deep sound channel axis depth display. The amount of shading indicates the range of depth in feet. See figure 9-9.

Clear	< 1,500 feet
Light	1,500 – 3,000 feet
Medium	3,000-4,500 feet
Heavy	>4,500 feet

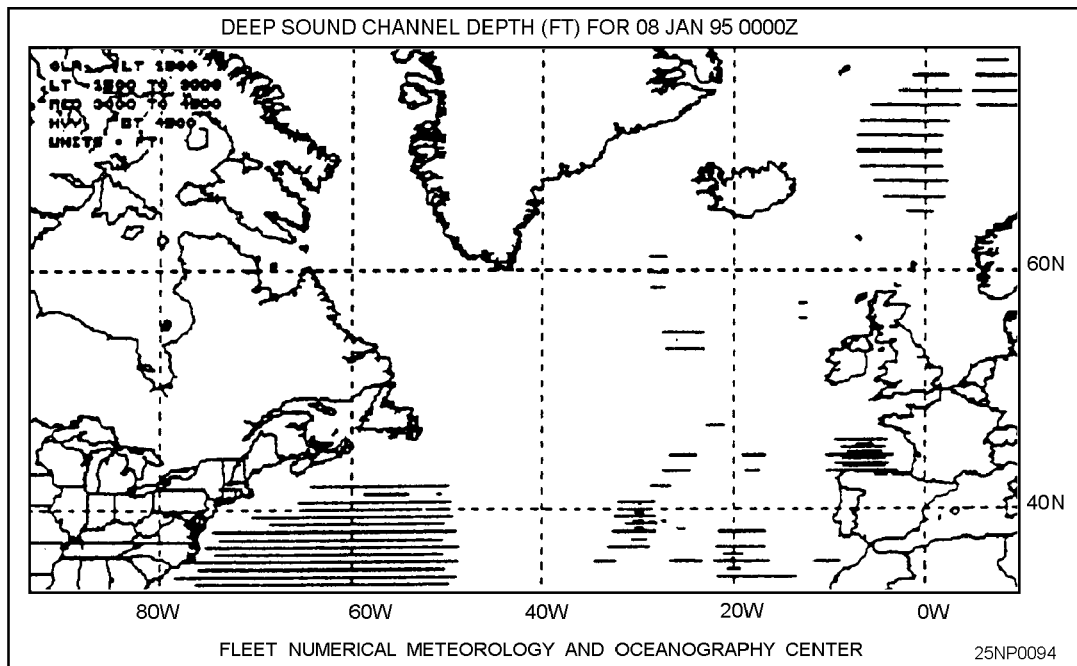

Figure 9-9.-A shaded deep sound channel axis depth display.

SHALLOW SOUND CHANNEL AXIS DEPTH (SSX)

The SSX product displays the axis depth values used in determining whether useful shallow sound channels (or ducts) exist within the area specified.

Thermocline and Mixed Layer Relationships

Shallow subsurface sound channels occur in the upper levels of the water column in the thermocline. The thermocline is the layer of sea water where the temperature decreases continuously with depth between the isothermal mixed layer and the deep sound channel axis. The relative strength of a sound channel depends upon the thickness of the channel and the maximum angle of the trapped rays.

Geographic Locations

Studies indicate that shallow sound channels beneath the mixed layer depth occur most often north of 40°N in the area between Hawaii and the continental United States. They are also frequently observed in the vicinity of the Gulf Stream. The prevalent depth of these shallow channels ranges from 90 to 150 meters.

During the summer a shallow channel exists in the Mediterranean Sea. In this region, the heating by the sun of the upper layers of the water, together with an absence of mixing by the wind, causes a strong near-surface negative gradient to develop during the spring and summer months. This thermocline overlies isothermal water at greater depths. The result is a strong sound channel with its axial depth near 100 meters. Although shallow sound channels are more local and transitory in nature, they often have a strong effect on sonar operations.

EXAMPLE OUTPUT

There are three graphic outputs available with the SSX product:

1. A shaded shallow sound channel axis depth display. The amount of shading indicates the range of depth in feet. See figure 9-10.

Clear	None (or depth <150 ft or >1000 ft)
Light	axis depth 150-300 feet
Medium	axis depth 300-600 feet
Heavy	axis depth 600 – 1,000 feet

2. A shaded shallow sound channel magnitude (strength) display. The amount of shading indicates the

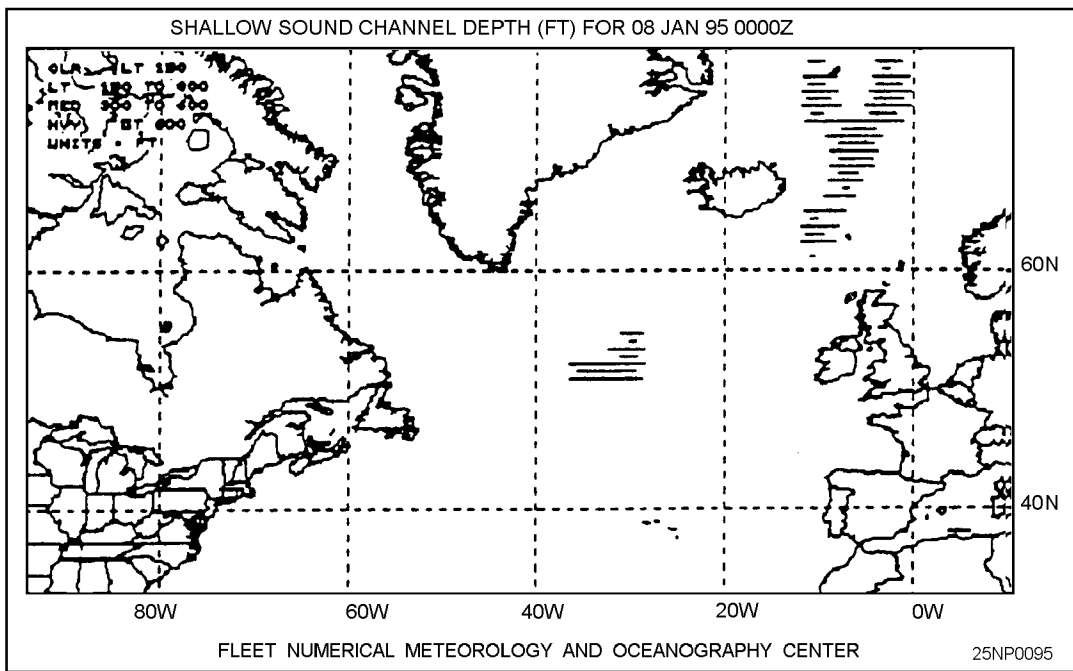

Figure 9-10.-A shaded shallow sound channel axis depth display.

strength of the shallow sound channel (SSC) at those grid points where these channels exist and meet minimal descriptive criteria. See figure 9-11.

frequency of the shallow sound channel. See figure 9-12.

- Clear No shallow sound channels or strength <3 ft/sec
- Light Strength 3 – 5 ft/sec
- Heavy Strength >5 ft/sec

- Clear No shallow channels or frequency > 300 Hertz
- Light Frequency 151 – 300 Hertz
- Medium Frequency 51-150 Hertz
- Heavy Frequency 1- 50 Hertz

3. A shaded shallow sound channel cutoff frequency display. The amount of shading indicates the limiting

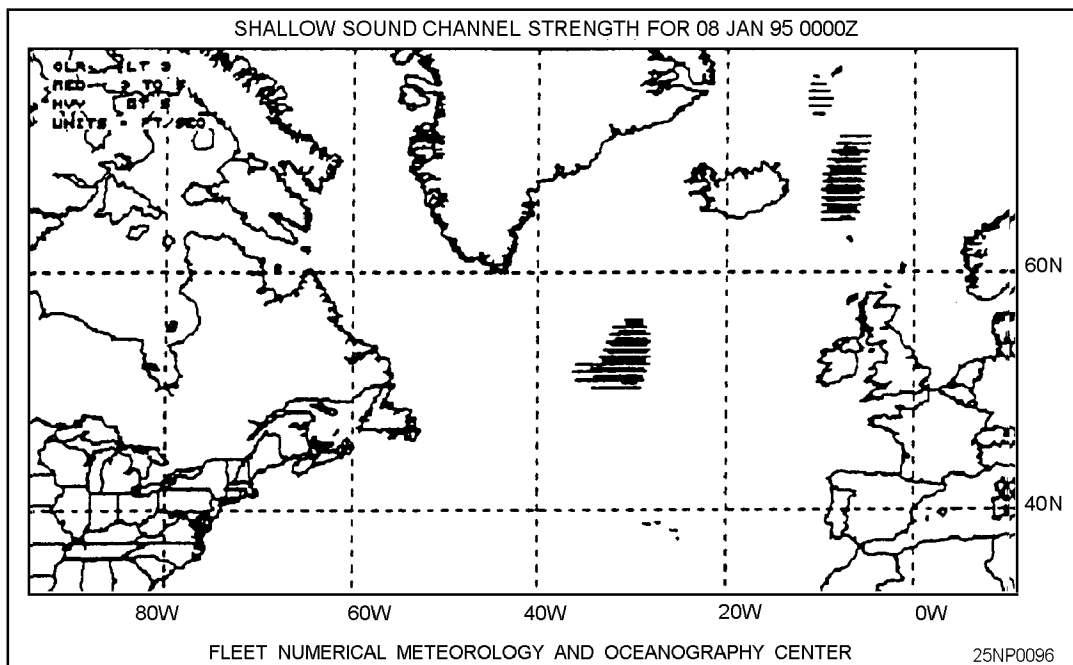

Figure 9-11.-A shaded shallow sound channel strength display.

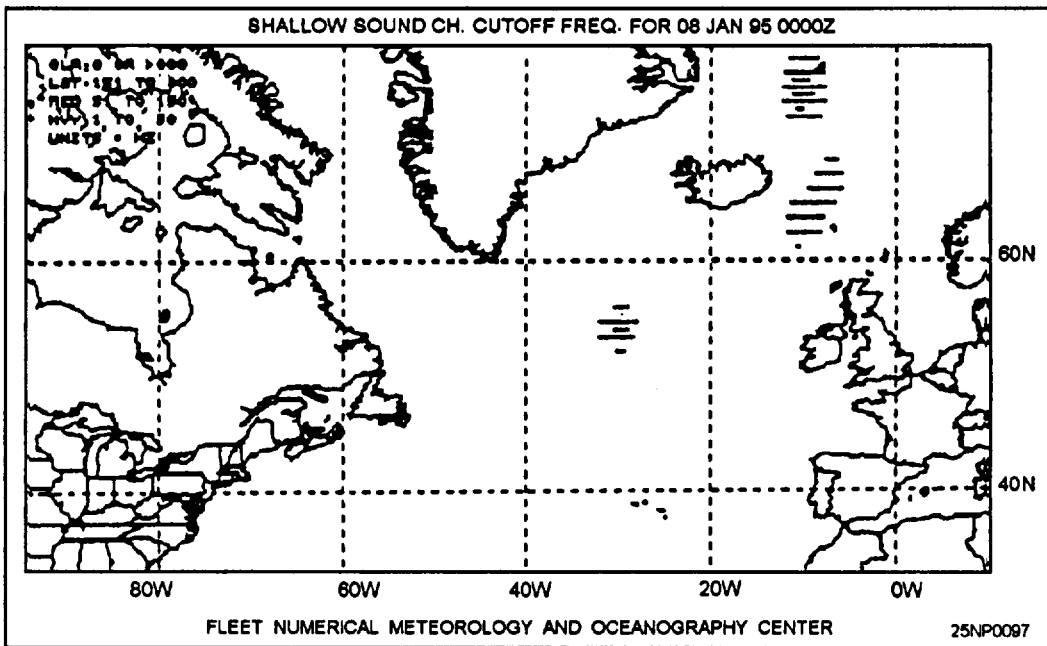

Figure 9-12.-A shaded shallow sound channel cutoff frequency display.

The first portion of this chapter was devoted to those oceanographic products that were accessed using the NODDS.

We will now discuss phenomena and principles covered in the *Fleet Oceanographic and Acoustic Reference Manual*, RP33. A brief overview will be presented for each area discussed. For more information, see RP33.

FORECASTING EFFECTS OF AMBIENT NOISE

LEARNING OBJECTIVES Distinguish ambient noise from self-noise. Identify characteristics of surface ship traffic and sea-state noises.

The problem of listening for recognizable sounds in the ocean is to distinguish them from the total noise background. Ambient noise is that part of the total noise background not due to some identifiable localized source. It exists in the medium independent of the observer's activity. Interfering noise sources that are located on, or are a part of, the platform on which a sensor is installed are sources of self-noise.

AMBIENT NOISE

Deep-sea ambient noise measurements have been made over a frequency range from 1 Hz to 100 kHz. Over this range the noise is due to a variety of sources, each of which may be dominant in one region of the spectrum. Principal sources of ambient noise in the frequency range of about 30 Hz to 10 kHz are distant shipping and wind-generated surface agitation. Other important contributors are rain, ice, and biological activity. Under certain conditions, these latter sources of background noise can seriously interfere with detection systems; however, not enough is known about their occurrence to permit meaningful predictions. Figure 9-13 indicates ambient levels of shipping and sea noise.

Figure 9-13 may be analyzed as follows:

- Along the Gulf Stream and major trans-Atlantic shipping lanes, the heavy traffic predictor (curve F) forecasts average noise within ± 2 dB at 100 and 200 Hz. Maximum values usually occur with ships closer than 10 nmi and the values follow the individual ship's curve (curve G), Minimum values vary radically but appear to group around the average traffic curve (curves D and E).
- For 440 Hz, the predictor curves appear to be 2 or 3 dB too low.

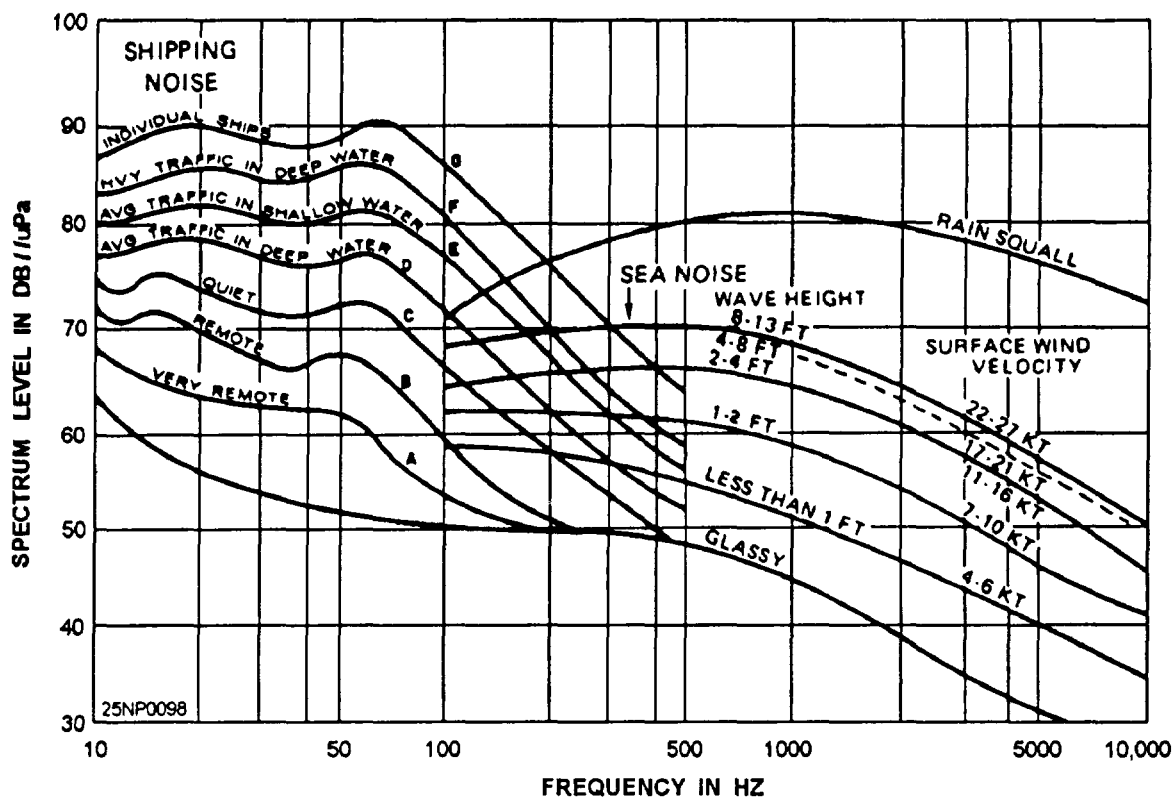

Figure 9-13.-Ambient noise levels.

- Four or more ships closer than 30 nmi constitute heavy noise, with ships closer than 10 nmi driving the noise level up to the individual ship's target curve (curve G). Where the bulk of the traffic is farther than 40 nmi, the average traffic curves (curves D and E) apply. This does not apply to a carrier task group.
- Correlations of noise intensity with distance to nearest ship, with all ships present in the shipping lanes, were negative. For areas not immediately in a heavy traffic area, ship concentration and distance became critical.

SURFACE-SHIP TRAFFIC NOISE

At the lower frequencies the dominant source of ambient noise is the cumulative effect of ships that are too far away to be heard individually. The spectrum of the noise radiated from ships as observed at great distances differs from the spectrum at close range due to the effect of frequency-dependent attenuation.

Sea-state noise

Sea state is a critical factor in both active and passive detection. Inactive sonobuoy detection, waves 6 feet or

greater will start to produce a sea-state-limited situation. For shipboard sonar systems, location of the sonar dome, ship's speed, course, and relation to the sea all have an effect. The limiting situation is generally sea state 4 or 5. For passive detection, the noise level created by wind waves of 10 feet or greater will result in a minimum of antisubmarine warfare (ASW) operational effectiveness, depending on the type of sensor.

WIND-GENERATED NOISE.— Sea-state noise generated by surface wave activity is usually the primary component over a range of frequencies from 300 Hz to 5 kHz. It maybe considered to be one of the most critical variables in active and passive detection.

SEA-STATE NOISE LEVELS.— The wind-generated noise level decreases with increasing acoustic frequency and increases with increasing sea state (approximately 6 dB for each increase in sea state). It is very important to understand that all sound-sensor ranges are reduced by additional noise, and that there can be a 20-dB spread in background noise between various sea states.

Other Ambient-noise Sources

Ambient noise is also produced by intermittent and local effects such as earthquakes, biologics, precipitation, ice, and breakage of waves.

PRECIPITATION.– Rain and hail will increase ambient-noise levels at some frequencies (usually between 500 Hz and 15 kHz). Large storms can generate noise at frequencies as low as 100 Hz and can substantially affect sonar conditions at a considerable distance from the storm center.

ICE.– Sea ice affects ambient-noise levels in polar regions. Provided that no mechanical or thermal pressure is being exerted upon the ice, the noise level generally is relatively low during the growth of ice. According to investigations carried out in the Bering Sea, the noise level should not exceed that for a sea state 2, even for winds over 35 knots. The exception to this rule is extremely noisy conditions due to entrapped air.

BIOLOGICS.– Biological noise may contribute significantly to ambient noise in many areas of the ocean. The effect of biological activity on overall noise levels is more pronounced in shallow coastal waters than in the open sea. It is more pronounced in the tropics and temperate zones than in colder waters. By far the most intense and widespread noises from animal sources in shallow water observed to this time are those produced by croakers and snapping shrimp. Fish, more than crustaceans (crabs, lobsters, shrimp), are the source of biological noise in most of the open ocean.

Marine Mammals

Mammal sounds include a much greater range of frequencies than do the sounds of either crustaceans or fish. They have been recorded as low as 19 Hz (whale sounds) and as high as 196 kHz (porpoise sounds).

EVALUATING THE IMPACT OF BIOLUMINESCENCE

LEARNING OBJECTIVES: Identify the primary sources of bioluminescence in the oceans. Recognize distinguishing features of sheet, spark-type, glowing ball, and exotic light display luminescence.

Plankton organisms are chiefly responsible for bioluminescence in the sea. The smallest forms are luminescent bacteria that usually feed on decaying

matter or live in various marine animals. However, with a supply of the proper nutrients, luminescent bacteria can develop in great masses in the sea, causing a general bluish-green glow in the water. The glow is usually diffused and barely detectable, although exceptionally bright displays caused by luminous bacteria occasionally are observed in coastal regions near the outflow of large rivers. The light given off frequently outlines the current front where the river and ocean meet.

TYPES OF BIOLUMINESCENT DISPLAYS

Bioluminescent displays may be classified according to their appearance. They are sheet, spark-type, glowing ball, and exotic light.

Sheet Bioluminescence

Most bioluminescence in the oceans is of a sheet-type display and is produced by one-celled organisms. This type is most commonly observed in coastal waters. The color is usually green or blue and many displays appear white when the organisms are present in great numbers.

Spark-type Bioluminescence

Spark-type displays are created by a large number of crustaceans. Most of these displays occur in colder, disturbed waters and only rarely in tropical waters. The light emitted gives the ocean surface a “twinkling” appearance.

Glowing-ball-type Bioluminescence

Glowing ball or globe-type displays are seen most frequently in the warmer waters of the world. The ocean may seem to be full of balls or discs of light, some flashing brightly as they are disturbed, and others dimming after the initial disruption has ceased. The light given off is usually blue or green; displays of white, yellow, orange, or red have occasionally been reported.

Luminescent jellyfish also cause many glowing-ball displays. Large shining round or oval spots of light may appear in the water.

Exotic Light Displays

Exotic light formations like wheels, undulating waves of light, and bubbles of light appear to be separate and distinct from the displays previously discussed. The cause of such phenomena are still unknown.

ARABIAN SEA BIOLUMINESCENCE

The Arabian Sea is one of the richest areas in the world for marine bioluminescence. It is known to appear with the onset of the southwest and northeast monsoons.

Reports indicate that there is no correlation between this phenomena and meteorological conditions.

UNDERWATER VISIBILITY

LEARNING OBJECTIVES: Recognize the six factors affecting underwater visibility. Compare water transparency in various parts of the North Atlantic ocean.

Visibility in seawater is restricted in a manner somewhat similar to the restriction of visibility in the atmosphere. The restriction in seawater differs from that in the atmosphere primarily because of scattering (predominant in coastal waters) and absorption (predominant in deep, clear ocean waters).

FACTORS AFFECTING UNDERWATER VISIBILITY

Underwater visibility depends primarily upon the transparency of the water, reflectance and contrast, water color, sea state, incident illumination, and optical image.

Transparency

The term *transparency* is often thought of as that property of water that permits light of different wavelengths to be transmitted; transparency is sometimes measured as the percent of radiation penetrating a path length of 1 meter. However, the most commonly used definition and measurement of transparency, as applied to underwater visibility, is the average depth below sea surface at which a Secchi disc (white disc) first disappears and then reappears at the surface to an observer who successively lowers and raises the disc.

The degree to which seawater becomes transparent is a function of the combined effects of scattering and absorption of light by the water surface, suspended, organic and inorganic particulate matter, dissolved substances, plankton, and the water's molecular structure.

Reflectance and Contrast

For a target to be visible, it must contrast with its background.

Water Color

Deep (clear) water is very transparent to the blue portion of the light spectrum and less transparent to the green, yellow, red, and violet portions. In the more turbid coastal waters, green and yellow light penetrates to greater depths than does blue.

Sea State

Irregular sea surfaces affect visibility in several ways. Variable refraction results in a reduction of the contrast of a target. Winds that barely ruffle the surface reduce contrast of a target by as much as 40 percent.

Incident Illumination

The amount of incident illumination, as determined by cloud coverage and the sun above the horizon, is a definite consideration in underwater visibility.

Optical Image

The optical image of a target can be due to its own light, to reflected light, or to its being silhouetted against an illuminated background.

GEOGRAPHIC VARIATION OF TRANSPARENCY

Figure 9-14 depicts the Seawater transparency of the North Atlantic. Figure 9-14 also shows that deep North Atlantic waters range in transparency from approximately 50 feet off the continental slope to over 115 feet in the Sargasso Sea.

EFFECTS OF OCEAN FRONTS, EDDIES, AND UPWELLING

LEARNING OBJECTIVES Define oceanic fronts, eddies, and upwelling. Recognize typical locations of oceanic fronts, eddies, and upwelling in the Pacific and Atlantic oceans. Be familiar with the effects of oceanic fronts, eddies, and upwelling on acoustics. Recognize oceanic front, eddy, and upwelling locations using satellite data.

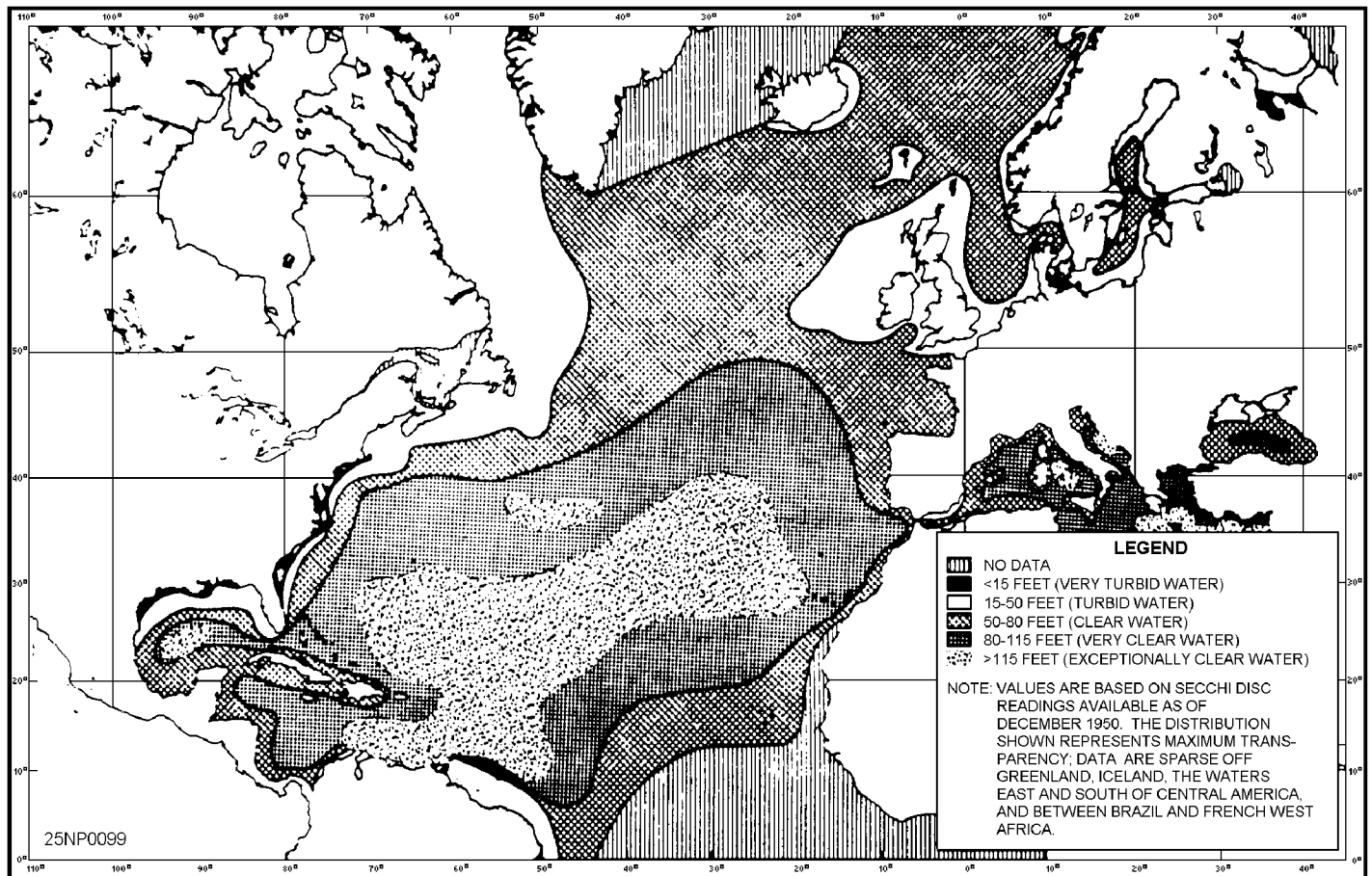

Figure 9-14.-Seawater transparency of the North Atlantic.

First of all, let's consider the definitions of fronts, eddies, and upwelling.

OCEAN FRONTS

An ocean front is the interface between two water masses of different physical characteristics. Usually, fronts show strong horizontal gradients of temperature and salinity, with resulting density variation and current shear. Some fronts which have weak horizontal gradients at the surface have strong gradients below the surface. In some cases, gradients are weak at all levels, but variability across the front, as reflected by the shape of the thermal profile, is sufficient to complicate sound transmission.

A useful definition for the purpose of naval operations can be stated as: A tactically significant front is any discontinuity in the ocean which significantly alters the pattern of sound transmission and propagation loss. Thus, a rapid change in the depth of the sound channel, a difference in the sonic-layer depth, or a temperature inversion would denote the presence of a front.

OCEAN EDDIES

An eddy is a rotating parcel of fluid. As such, the eddy concept can be applied to phenomena ranging from momentary vortices in the sea-surface flow to the steady circulation of a basin-wide gyre. For ASW application, however, mesoscale features of 100 to 400 km (55 -215 nmi) are most important. These eddies are rotating masses of water that have broken off from a strong front such as the Gulf Stream. They can be considered circular fronts with water trapped inside having different physical properties from the surrounding water.

UPWELLING

Surface winds cause vertical water movements. Upwelling can be caused by winds blowing across the ocean surface. Coastal upwelling occurs where prevailing winds blow parallel to the coast. Winds cause surface water to move, but the presence of land or a shallow bottom restricts water movements. When the wind-induced water movement is off-shore, subsurface water flows to the surface near the coast. This slow,

upward flow, from 100 to 200 meters (300 to 600 feet) deep, replaces surface waters blown seaward. Coastal upwelling is common along the west coast of continents.

Upwelling also occurs in the equatorial open oceans. This wind-induced upwelling is caused by the change in direction of the Coriolis effect at the equator. Westward flowing, wind-driven surface currents near the equator flow northward on the north side and southward on the south side of the equator.

TYPICAL LOCATIONS OF PACIFIC AND ATLANTIC OCEAN FRONTS

Figures 9-15 and 9-16 show approximate locations of Pacific and Atlantic Ocean fronts. The dashed lines

are *weak* fronts, which may not be significant to ASW operations. The *solid* lines represent the moderate fronts which, under certain conditions, may be important operationally. The *heavy* lines are the strong fronts, which usually have a significant effect on ASW tactics.

Although it is not possible to show typical locations of large ocean eddies due to their constant motion, they are generally found on either side of strong fronts such as the Gulf Stream or the Kuroshio. Smaller eddies, such as those formed by upwelling can be found in any part of the ocean.

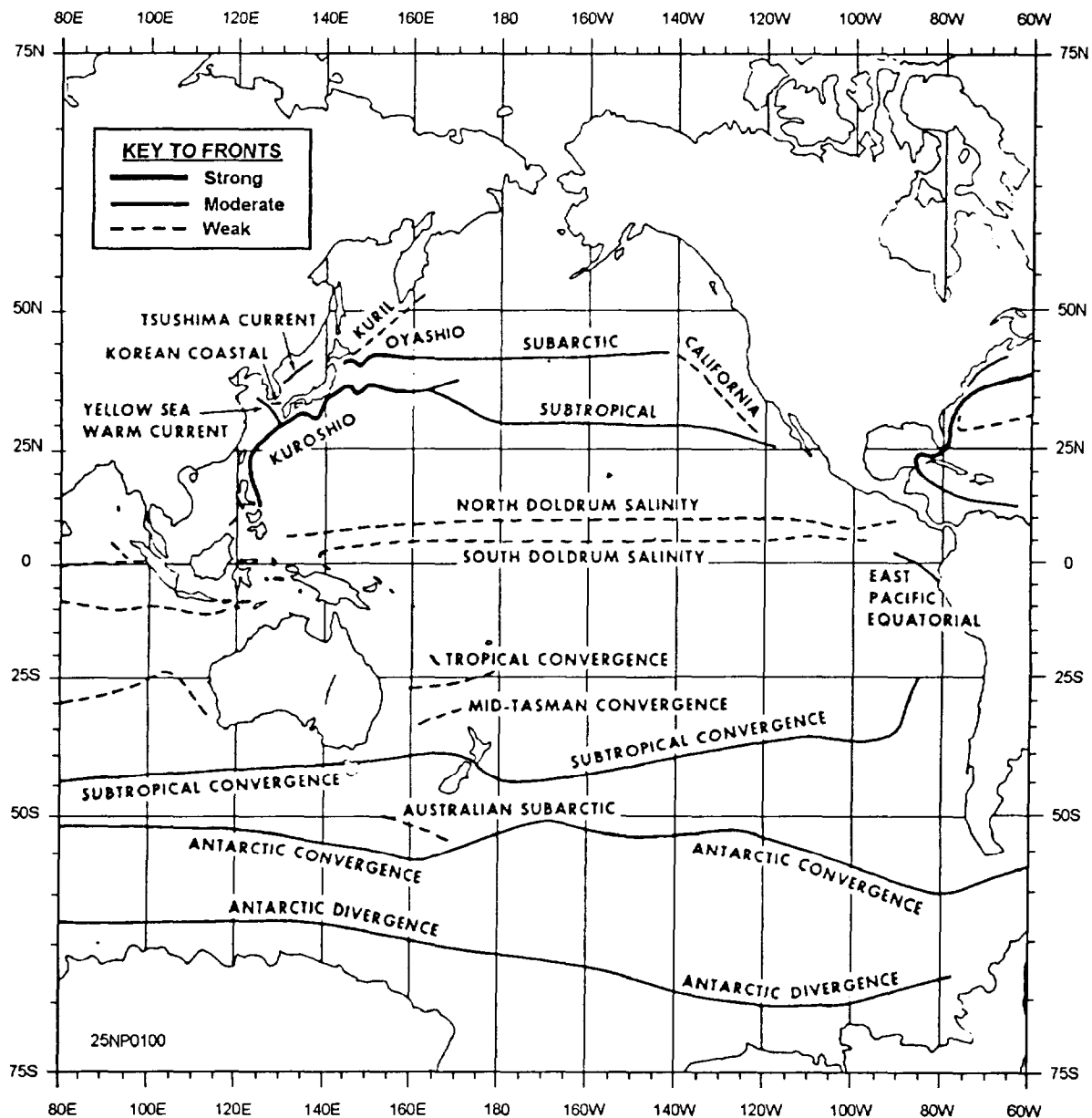

Figure 9-15.-Mean position of Pacific fronts.

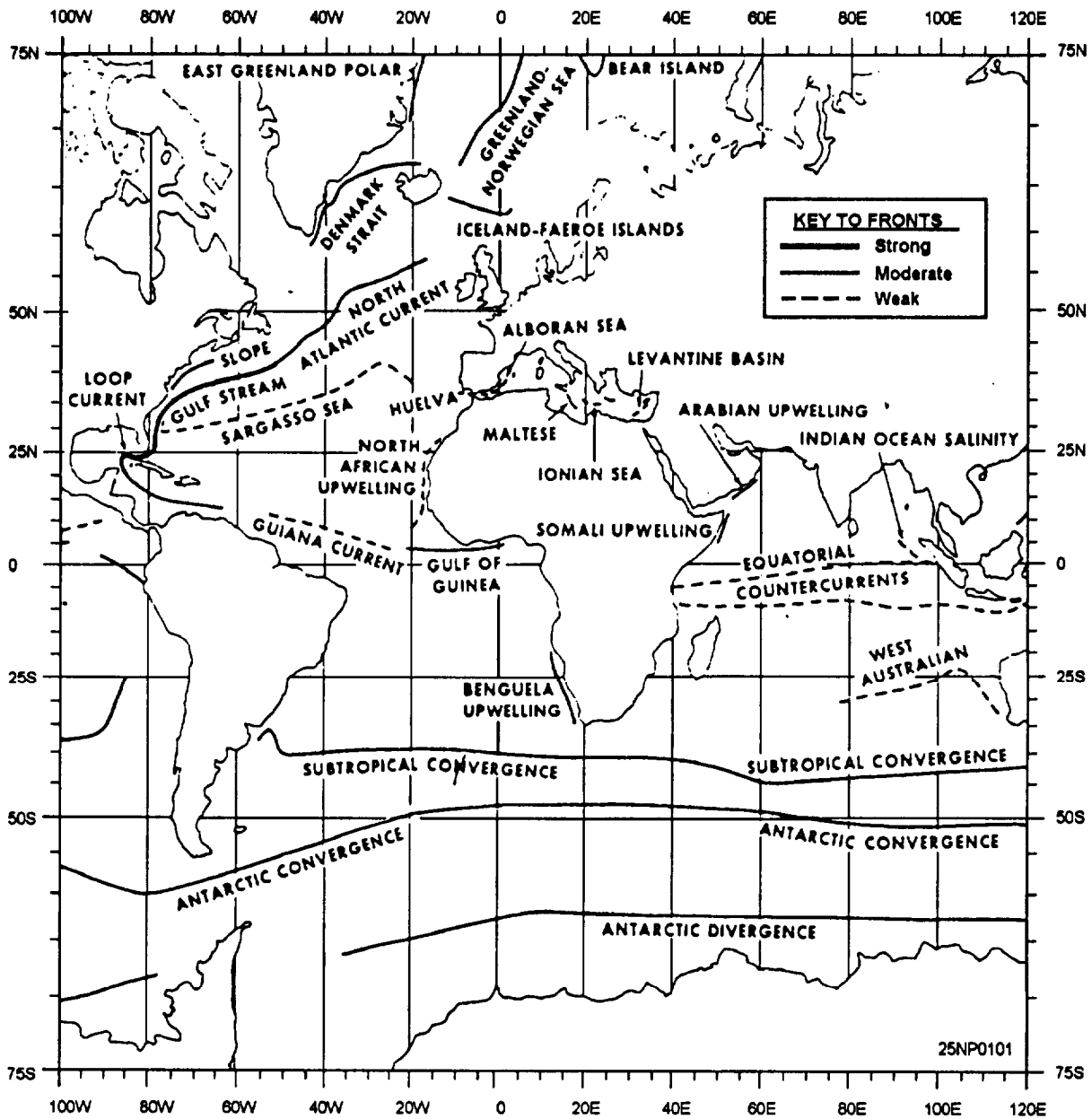

Figure 9-16.-Mean position of Atlantic fronts.

ACOUSTIC EFFECTS OF FRONTS

The following changes can be of significant importance to acoustics as a front is crossed:

- Near-surface sound speed can change by as much as 100 ft/sec. Although this is due to the combined effect of changing temperature and salinity, temperature is usually the dominant factor.
- Sonic-layer depth (SLD) can change by as much as 1,000 feet from one side of a front to the other during certain seasons.
- A change of in-layer and below-layer gradient usually accompanies a change in surface sound speed and SLD.
- Depth of the deep sound-channel (DSC) axis can change by as much as 2,500 feet when crossing from one water mass to the other.
- Increased biological activity generally found along a front will increase reverberation and ambient noise.
- Sea-air interaction along a frontal zone can cause a dramatic change in sea state and thus increase ambient levels.

- Changes in the vertical arrival angle of sound rays as they pass through a front can cause towed array bearing errors.

It is clear that any one of these effects can have a significant impact on ASW operations. Together they determine the mode and range of sound propagation and thus control the effectiveness of both short- and long-range acoustic systems. The combined effect of these characteristics is so complex that it is not always possible to develop simple rules for using ocean fronts for ASW tactics. For example, the warm core of the Gulf Stream south of Newfoundland will bend sound rays downward into the deep sound channel, thereby enhancing the receiving capability of a deep receiver. The same situation with a slightly shallower bottom south of Maine may create a bottom-limited situation, and the receiving capability at the same hydrophore will be impeded. In view of this, the acoustic effects of a front must be determined for each particular situation by using multiprofile (range-dependent environment) acoustic models. The input for these models can come from detailed oceanographic measurements, or from historical data in combination with surface frontal positions obtained from satellites.

DETERMINING FRONTAL POSITION USING SATELLITE DATA

Most fronts exhibit surface-temperature signatures that can be detected by satellite infrared (IR) sensors and are used in determining frontal positions. Figure 9-17 is an example of a satellite IR image obtained by the TIROS-N showing the location of the Gulf Stream and formation of a warm ring. Because surface-temperature gradients are not always reliable indicators of the subsurface front, satellite images must be interpreted by a skilled analyst, preferably in combination with data from other sources such as BTs. Automatic interpretation of satellite data is also being developed using techniques generally known as automatic imagery-pattern recognition or artificial intelligence.

Now let's discuss oceanographic effects on mine warfare (MIW). *Environmental Effects on Weapons Systems and Naval Warfare (U)*, (S)RP1, provides further detail on this subject.

MINE WARFARE (MIW)

LEARNING OBJECTIVES Recognize the parameters affecting MIW operations. Identify the various mine hunting sonars. Be familiar with the procedures for obtaining MIW support products.

MIW is the strategic and tactical use of sea mines and their countermeasures. MIW may be offensive (mining to interfere with enemy ship movement) or defensive (mining to defend friendly waters [mine-countermeasures]) in nature. Mine warfare is almost always conducted in nearshore areas that present special environmental conditions not usually encountered in open ocean areas, including:

- Sound speed that is highly dependent upon salinity. Although salinity may be treated as constant for open ocean areas, fresh water runoff creates strong salinity gradients in nearshore areas.
- Ambient noise that is higher than normal.
- Biologic activity levels and diversity that are higher.
- Nearshore areas that typically have a high level of nonmilitary activity.
- Land runoff that generates much more turbidity than for open ocean areas.

MINE WARFARE ENVIRONMENTAL SUPPORT

MIW planning (mining and mine countermeasures) requires a considerable environmental input. The following parameters should be considered for discussion in any MIW environmental support package:

- Water depth
- Physical properties of water column
- Tides
- Currents
- Sea ice
- Bottom characteristics



Figure 9-17.-An example of a satellite IR image obtained by the TIROS-N.

- Biologic activity
- Wave activity

PRINCIPAL MINE HUNTING SONAR SYSTEMS

All mine hunting sonars operate at very high frequencies to achieve high resolution

- AN/SQQ-14: ACME and AGGRESSIVE class MSOs

- AN/SQQ-32: Newest mine hunting sonar; installed on AVENGER class MCMs and planned for LERICI class MHCs

- AN/ALQ-14: RH-53-53D/E MCM helicopters

ENVIRONMENTAL SUPPORT SYSTEMS AND PRODUCTS FOR MINE WARFARE

The following support systems and products are available in TESS 3/MOSS:

SUMMARY

- Oceanography and acoustic support modules
- Solar and lunar data (rise and set times, percent illumination)
- Tidal data

Other useful publications/products include:

- MIW pilots
- NAVOCEANO Environmental Guides
- NAVOCEANO drift trajectory support product
- Mk 60 CAPTOR Mine Environmental Guides
- Sailing Directions and Planning Guides

In this chapter we first discussed oceanographic products available using the Navy Oceanographic Data Distribution System (NODDS). General descriptions and example outputs were covered for each. Effects of ambient noise, bioluminescence, underwater visibility, ocean fronts, eddies, and upwelling were then presented along with definitions and general descriptions of each. Lastly, MIW issues of interest to the Aerographer were discussed along with an overview of environmental support. Also presented was a listing of mine hunting sonars and available support products.

SPECIAL OBSERVATIONS AND FORECASTS

In this chapter we will discuss a few special observations and forecasts generated to ensure the safety of U.S. Navy ships, aircraft, shore-based commands, and personnel.

The first topic to be discussed will be those products disseminated by theater METOCCENS and METOCFACS. The warnings and advisories presented are further described in the *U.S. Navy Oceanographic and Meteorological Support System Manual*, NAVMETOCCOMINST 3140.1, as well as local command standard operating procedures.

SIGNIFICANT WEATHER, SEA ADVISORIES, AND WARNINGS

LEARNING OBJECTIVES: Describe the content of various warnings, advisories, and forecasts issued by NAVMETOCCOM and USMC units.

Advisories and warnings of potentially destructive weather are routinely issued by NAVMETOCCOM and USMC weather activities. These services are provided in direct support of Navy requirements outlined in OPNAVINST 3140.24, *Warnings and Conditions of Readiness Concerning Hazardous or Destructive Weather Phenomena*. Conditions of readiness are set by the local area commander or designated representative. NAVMETOCCOM does not set these conditions.

These advisories and warnings are based on forecast wind velocities and significant wave heights.

- *Wind velocity.* Because of its variability, wind velocity is usually expressed in a 10-knot range in speed and 45-degree range indirection. Wind speed forecasts are not averages over the forecast period, but are rather the sustained wind speeds (2-minute average) expected over the period and area of the forecast. Amplifying remarks, such as backing, veering, shifting, and so forth, are added to wind advisories and warnings, as appropriate.

- *Significant wave height.* Significant wave height is defined as the average of the highest one-third of all waves observed in the sea, which includes both short-period and long-period waves. Short-period waves (seas) are normally generated by local winds, while long-period waves (swells) are generated by winds at a distance.

WIND WARNINGS

Wind warnings are characterized by the origin of the disturbance and the wind speed.

Extra-tropical Systems

The following warnings pertain to extra-tropical systems, or tropical systems other than closed cyclonic circulations.

- *Small Craft Warnings.* Small craft warnings are issued in harbors, inland waters, and coastal OPAREAS, as well as other coastal inshore regions prescribed by the local area commander. The lower limit of the sustained wind speed used to set this warning varies by region and is defined by the local area commander. The local NAVMETOCCOM or USMC aviation weather activity can provide further information.

- *Gale Warnings.* Area(s) experiencing sustained wind speeds of 35 knots or higher will be bounded and a gale warning issued.

- *Storm Warnings.* Area(s) experiencing sustained wind speeds of 50 knots or higher will be bounded and a storm warning issued.

- *Wind Warnings.* Wind warnings for the Northern Hemisphere are automatically disseminated via the Fleet Multichannel Broadcast or Automatic Digital Network (AUTODIN). Automatic dissemination of warnings in the Southern Hemisphere are limited to specifically defined areas designated by fleet commanders due to limited naval operations and sparsity of observations. Wind warnings are normally issued every 12 hours.

Cyclonic Circulations of Tropical Origin

Table 10-1 lists tropical warnings and associated wind speeds where applicable:

Issuance of Advisories and Warnings

Tropical Cyclone Formation Alert (TCFA) advisories are issued whenever conditions are right for the development of a tropical cyclone.

Tropical depression/storm and hurricane/typhoon warnings are issued via AUTODIN and the Fleet Multichannel Broadcast every 6 hours for storms in the Northern Hemisphere. They originate from three places:

1. NAVLANTMETOCEN Norfolk issues warnings for storms in the North Atlantic, Caribbean Sea, and Gulf of Mexico.
2. NAVPACMETOCEN Pearl Harbor issues warnings for storms in the eastern and mid-Pacific.
3. NAVPACMETOCEN WEST Guam issues warnings for storms in the western Pacific and the Indian Ocean.

HIGH SEAS WARNINGS

These warnings are issued every 12 hours whenever actual or forecast significant wave heights in an ocean area of the Northern Hemisphere equal or exceed 12 feet.

THUNDERSTORM WARNINGS

These warnings are issued as warranted. If there is information received from the National Severe Storms Center with regard to threat of tornadic activity, the information is reviewed, and if warranted, disseminated as a Severe Thunderstorm Watch/Warning.

ADDITIONAL WARNINGS/ADVISORIES

We will now briefly discuss two additional warnings/advisories that, if conditions warrant, would be included in forecasts/travel advisories.

Freezing Rain

If the synoptic situation is conducive to freezing rain, the information would be reflected in all forecasts/travel advisories until the likelihood ceases.

Table 10-1.-Tropical Warning and Associated Wind Speeds

TYPE OF WARNING	WIND SPEED
Tropical Cyclone Formation Alert (TCFA)	N/A
Tropical Depression	Up to 33 knots
Tropical Storm	34 to 63 knots
Hurricane/Typhoon/ Tropical Cyclones	64 knots or more

Extreme Temperatures

When conditions warrant, Heat Index and Wind-Chill are reflected in all forecasts/travel advisories until the likelihood ceases.

VERIFICATION OF WARNINGS, ADVISORIES, AND FORECASTS

LEARNING OBJECTIVES: Verify all warnings, advisories, and forecasts for accuracy to determine whether or not conditions occurred as forecasted.

To provide the optimum product it is very important that all forecasts and warnings be verified after the fact. All NAVMETOC and USMC commands have procedures in place to verify the accuracy of all products, whether they be Small Craft, Gale/Storm, or High Seas Warnings.

By monitoring observations from underway units and closely monitoring weather features, enroute weather forecasts can be fine tuned.

The following are products that are routinely verified for accuracy:

- High Seas Warnings
- Gale/Storm Warnings
- Small Craft Warnings
- Optimum Track Ship Routing (OTSR) Requests
- Enroute weather forecasts

In the next section we will discuss evaporative ducts and their importance to weather analysis and forecasting; specifically, the Atmospheric Refractivity Profile Generator.

REFRACTIVITY FORECASTS USING ATMOSPHERIC REFRACTIVITY PROFILE GENERATOR (ARPGEN)

LEARNING OBJECTIVES: Identify applications, limitations, assumptions, and functional description of the ARPGEN product.

The ARPGEN is used for two purposes:

1. To create a refractivity data set (RDS)
2. To place it into the RDS for use by the various electromagnetic propagation programs

The RDS displays a profile of modified refractive index (M) with respect to height, the height of the evaporation duct, and the surface wind speed.

The operator directly enters the necessary surface observation data for all except the historical option of the program; the historical option is retrieved from the permanent data base (PDB) files.

APPLICATION

ARPGEN is used to create RDS. These data sets describe the effects of the environment on the propagation of electromagnetic (EM) energy in the microwave portion of the spectrum.

LIMITATIONS AND ASSUMPTIONS

The restrictions as well as principles taken for granted in using the ARPGEN product are as follows:

- ARPGEN allows a maximum entry of 30 M-unit versus height pairs. Levels with heights >10,000 m are discarded due to insignificant refractive effects at higher altitudes.
- The standard atmospheric lapse rate is used to extrapolate for a sea-surface M-unit value.
- The evaporation duct-height algorithm assumes that entered surface weather observations are at a height of 6 m above the sea surface.
- The RDS menu selection can accommodate up to 10 refractivity data sets. As these sets are created,

they are placed into higher numbered positions in the RDS. When 10 data sets are present, a newly created data set takes the place of the data set not accessed for the longest period of time.

- M-unit profiles must be entered in ascending order.
- For historical data sets, the M-unit profile is retrieved for the closest radiosonde station to the operator-selected location; the surface data are retrieved for the closest Marsden square containing data in the PDB. In many instances, these locations for data may be several hundred miles apart. Data base coverage maps are provided in the TESS (3) Operators Manual.
- Four types of historical profiles can be created by this function; standard, surface-based duct, elevated duct, and combined surface-based and elevated duct.
- The position of the RDS (for nonhistorical profiles) is specified when the operator selects to compute rather than enter an evaporation duct height. This location will be associated with the operator-selected refractivity profile.
- The RDS (with the airborne microwave refractometer [AMR]) option accommodates five flights containing refractivity information. Different portions of a particular flight can be accessed to generate different refractivity profiles. This function will not appear in the menu if an AMR tape-reading device is not connected.

FUNCTIONAL DESCRIPTION

ARPGEN provides four methods in which refractivity data sets can be created:

1. M-Unit Profile Entry - This option allows the operator to create refractivity data sets by entering M-unit profiles directly. After the M-unit profile and the appropriate surface observation and location information are entered, the profile is checked to determine if an M-unit value at the sea-surface level is present. If one is not present, a surface value is determined by extrapolation, assuming a standard atmosphere gradient.

The evaporation duct height is calculated using the operator-entered air temperature, relative humidity, wind speed, and sea-surface temperature. These parameters are used to determine the bulk-Richardson number, the vapor pressure at the sea surface and at the observation altitude, and the near-surface N-unit gradient. If the N-unit gradient is positive, the

evaporation duct is zero. When the N-unit gradient is zero or negative and the atmosphere is stable (positive bulk-Richardson number), the evaporation duct height is a linear function of the N-unit gradient and the atmospheric stability; when the atmosphere is unstable, the evaporation duct height is a power function of the N-unit gradient and the atmospheric stability. When the computed value of the evaporation duct height is >40 m, it is set to 40 m.

2. Radiosonde Data Set Selection - Using this option, an M-unit profile is entered by operator selection of a radiosonde data set from the atmosphere environmental file (AEF). M-unit versus height pairs are extracted for the first 30 levels of the sounding or for levels between 0 and 10,000 m heights. When the lowest sounding level is not at the 0 m height, a sea-surface M-unit value is extrapolated using the lowest M-unit value/height pair in the profile, assuming a standard atmospheric gradient.

The surface wind speed and evaporation height complete the information required to generate an RDS. The evaporation duct height is computed in the same manner as when an M-unit profile is entered. The location and the date and time of the RDS are specified by the operator on the Evaporation Duct-Height Parameters Input form.

3. Historical Refractivity Data Set - Using this option, a historical RDS is generated for an operator-specified location, month, and profile type (standard atmosphere, surface-hosed duct, elevated duct, or combined surface-based and elevated duct). The upper air data used to specify the M-unit profile with respect to height are retrieved from the Radiosonde Data file. The mean surface wind speed and evaporation duct height are retrieved from the Surface Observation Data tile. Note that the closest long-term mean radiosonde observation location and Marsden square containing the information desired are retrieved from the PDB. In some data-void regions, this may result in an inappropriate RDS being created. Use the climatological electromagnetic propagation conditions summary function to evaluate the general climatologic electromagnetic propagation conditions before using this option. The use of climatological refractivity data sets should be limited to planning functions.

4. Analysis of an AMR tape - This option allows the operator to create an RDS by analyzing a tape generated by the AN/AMH-3 electronic refractometer set. These devices are routinely flown on E-2C aircraft. Refer to the functional description for additional information.

FORECASTING ALTIMETER SETTINGS

LEARNING OBJECTIVES: Discuss the basic considerations in forecasting altimeter settings. Determine altimeter setting errors due to surface pressure variation and nonstandard temperatures. Describe the forecasting of altimeter settings.

Under certain conditions it may be necessary to forecast or develop an altimeter setting for a station or a location for which an altimeter setting is not received. There is also a possibility that an altimeter setting may be required for an area not having a weather station. A forecast of the lowest altimeter setting (QNH) for the forecast period is required. For these reasons it is important that forecasters have a basic understanding as to the importance of correct altimeter settings and a knowledge of procedures for forecasting altimeter settings.

The altimeter is generally corrected to read zero at sea level. A procedure used in aircraft on the ground is to set the altimeter setting to the elevation of the airfield.

BASIC CONSIDERATIONS

An altimeter is primarily an aneroid barometer calibrated to indicate altitude in feet instead of units of pressure. An altimeter reads accurately only in a standard atmosphere and when the correct altimeter setting is used. Since standard atmospheric conditions seldom exist, the altimeter reading usually requires corrections. It will indicate 10,000 feet when the atmospheric pressure is 697 hectopascals, whether or not the altitude is actually 10,000 feet.

Altimeter Errors (Pressure)

The atmospheric pressure frequently differs at the point of landing from that of takeoff; therefore, an altimeter correctly set at takeoff may be considerably in error at the time of landing. Altimeter settings are obtained in flight by radio from navigational aids with voice facilities. Otherwise, the expected altimeter setting for landing should be obtained by the pilot before takeoff.

To illustrate this point, figure 10-1 shows an example of altimeter errors due to change in surface pressure. The figure shows the pattern of isobars in a cross section of the atmosphere from New Orleans to Miami. The atmospheric pressure at Miami is 1019

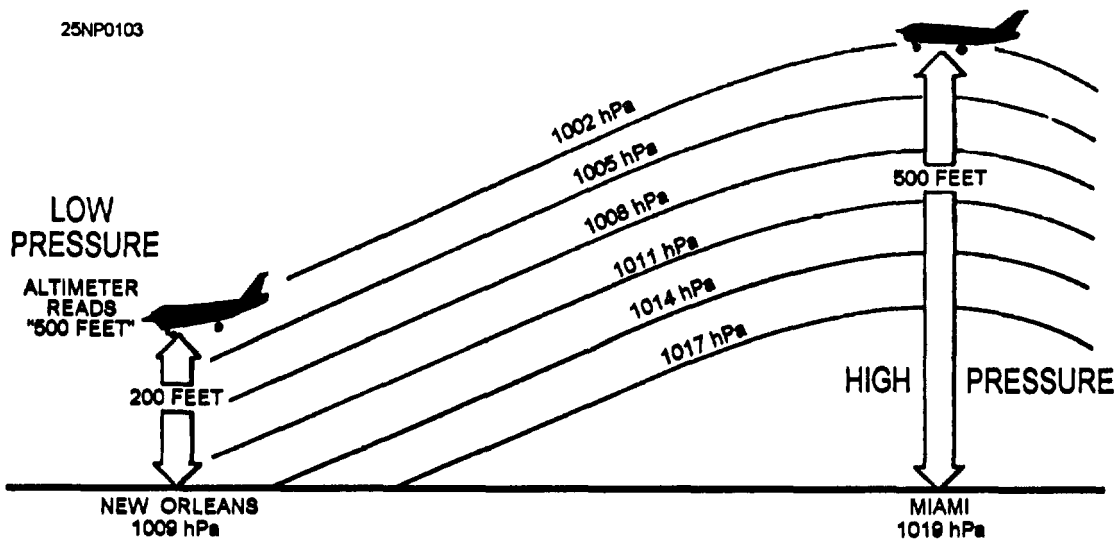

Figure 10-1.-Altimeter errors due to change in surface pressure.

hectopascals and the atmospheric pressure at New Orleans is 1009 hectopascals, a difference of 10 hectopascals. Assume that an aircraft takes off from Miami on a flight to New Orleans at an altitude of 500 feet. A decrease in the mean sea level pressure of 10 hectopascals from Miami to New Orleans would cause the aircraft to gradually lose altitude, and although the altimeter indicates 500 feet, the aircraft would be actually flying at approximately 200 feet over New Orleans. The correct altitude can be determined by obtaining the correct altimeter from New Orleans and resetting the altimeter to agree with the destination adjustment.

NOTE: The following relationships generally hold true up to approximately 15,000 feet:

34 hectopascals = 1 in. (Hg) = 1,000 feet of elevation, Since 1 hectopascal is equal to about 30 feet (below 10,000 feet altitude), a change of 10 hectopascals would result in an approximate error of 300 feet.

Altimeter Errors (Temperature)

Another type of altimeter error is due to nonstandard temperatures. Even though the altimeter is properly set for surface conditions, it will often be incorrect at higher levels. If the air is warmer than the standard for the flight altitude, the aircraft will be higher than the altimeter indicates; if the air is colder than standard for flight altitude, the aircraft will be lower than the altimeter indicates. Figure 10-2 shows an example of altimeter errors due to nonstandard air temperatures.

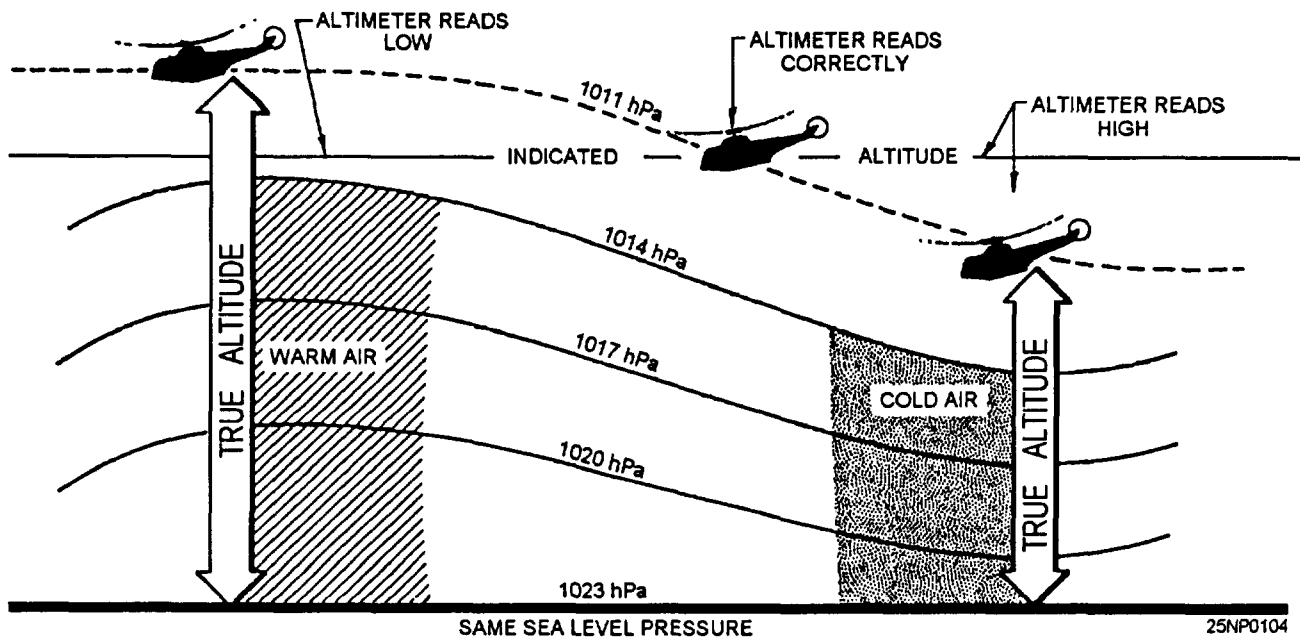

Figure 10-2.-Altimeter errors due to nonstandard air temperatures.

For more information, refer to *The Airman's Information Manual*, which is the official guide to flight information and air traffic control (ATC) procedures, and is used primarily by pilots, naval flight officers, and air traffic controllers. This publication is promulgated quarterly by the Federal Aviation Administration and contains useful information from a pilot's perspective. All forecasters should be familiar with this publication.

FORECASTING PROCEDURES

The first step in the forecasting of altimeter settings is to forecast the sea level pressure for the valid time of the desired altimeter reading. This may be done by using the recommended procedures of prognosis presented in earlier chapters of this training manual.

The next step is modification of the sea level pressure. After the value for the expected sea level pressure has been obtained, it is modified to reflect the diurnal pressure change at the location in question. Pressure tendency charts, locally prepared diurnal curves, and other available information may be used to obtain representative diurnal changes.

The final result of the first two steps will normally be expressed in hectopascals since it is conventional to work in these units on related charts. If this is the case, then the resultant pressure in hectopascals must be converted into inches of mercury before it can be used for an altimeter setting.

In the next section, we will consider the use of electro-optical (EO) systems by the Department of Defense. Because EO systems are being used more and more, it becomes important that Aerographers know about the problems associated with these systems.

FORECASTING ENVIRONMENTAL EFFECTS ON ELECTRO-OPTICAL (EO) SYSTEMS

LEARNING OBJECTIVES: Identify how the environment affects EO systems, and state the problems associated with these systems, Explain the lessons learned with EO systems.

EO systems are concerned with millimeter-wave, IR optical, and UV wavelengths. As these wavelengths decrease, resolution increases, but at the same time there is a decrease in penetration and range. Typically, these systems are line of sight.

BASIC EO PROBLEMS

The following problems should be considered when dealing with EO systems:

- You must assess the environment's effect on the ability of a line of sight instrument to detect or track a target. The view of the instrument might be obscured by material in the atmosphere or may be distorted by refraction.

- There may be some limited range over which the EO sensor will work.

- Cloud layers affect some sensors.

- Battle-induced smoke or dust restrict ranges.

- Time-of-day will be a limiting factor, if the sensor relies on reflected sunlight or distinct contrasts (visual or thermal).

- Radiative transfer - as electromagnetic energy travels through the air.

- Some of the energy may go unimpeded, directly from the source to the detector,

- Some energy may be scattered away (loss); energy not associated with the source may be scattered toward the sensor (noise).

- Some energy may be absorbed before it ever gets to the sensor (loss).

- Some energy may even be emitted from particles within the path (more noise).

- These effects, along with signal loss due to spherical spreading, all contribute to attenuation of the desired signal.

- Spreading - The energy going from the target back to the sensor undergoes further loss due to spreading. This is true even for the return trip (reflection) for an active sensor, although the spreading of the transmitted energy is focused or beamed.

- Contrast - For adequate detection on tracking, sufficient contrast must exist between the intended target and its background. Background might be the sea surface, sky, or terrain. The EO sensor may use thermal, textural, color, light intensity, or pattern contrasts as the method for detection. Insufficient contrast between the intended target and the background causes no acquisition or tracking. Radiative crossover is a key example. The temperature between a metallic object and the ground has different rates of heating and cooling.

Twice a day both will be at about the same temperature and will provide no contrast to IR sensors.

- Wavelength dependence - Each of these loss phenomena is dependent upon wavelength. Sensors operating in certain bands have markedly different characteristics. Remember, the compromise is usually between better resolution and less susceptibility to atmospheric phenomena. While resolution increases with decreasing wavelength, so does weather sensitivity. Table 10-2 shows how environmental elements affect wavelengths.

- Lessons learned from the field
 - Battle experience in desert areas has shown that the operation of optical instruments suffers greatly in these environments. Rapid changes in the index of refraction can result in the shimmering of images, causing optical instruments to lose lock-on tracked targets.
 - Mirages and other refractive phenomena also add to the confusion.
 - Frequent airborne haze, dust, sand, and smoke from both naturally occurring winds and storms, and horn the battle, can hamper guidance or surveillance systems operating in, at, or near optical wavelengths. The effects are more severe at these wavelengths than at microwave, UHF, or VHF.

WEAX AND AVWX

LEARNING OBJECTIVES: Familiarize yourself with the procedures for obtaining route weather forecast (WEAX) or aviation route weather forecast (AVWX) support. Recognize the standard format of the two products.

Consider the obstacles a ship underway in the Pacific in July may have to overcome. The CO feels uneasy; it is tropical storm season and there isn't a weather division on board. Knowledge of this subject area may help the CO accomplish a successful mission.

WEAX or AVWX information is useful to ships receiving OTSR support as well as for independent steaming units, since the OTSR service does not include specifically tailored weather forecasts. WEAX forecasts are designed for ships without embarked aviation units, while AVWX is tailored for ships with an embarked aviation unit.

PROCEDURES

WEAX/AVWX support services are requested in the movement report (MOVREP) in accordance with NWP 10-1-10. Once WEAX/AVWX has been requested on the initial MOVREP, units should continue entering the WEAX/AVWX notation to any subsequent MOVREP to ensure support is continued.

Table 10-2.-How Environmental Elements Affect Wavelengths

WEATHER PARAMETERS					
	Visible and Near IR	Shortwave IR	Midwave IR	Longwave IR	Millimeterwave
Low Visibility	severe	moderate	low	low	none
Rain/Snow	moderate	moderate	moderate	moderate	moderate/low
High Humidity	low	low	moderate	moderate	low/none
Fog/Clouds	severe	severe	moderate/severe	moderate/severe	moderate/low
Phosphorous/Dust	severe	severe/moderate	moderate	moderate/low	low/none
Fog Oil/Smoke	severe	moderate	low	low	none

Frequency of Issuance

WEAX/AVWX service is available for both in port and underway periods. In port WEAX/AVWX will only be issued if requested and if the unit is not in a port supported by one of the NAVMETOCCOM activities listed in NAVMETOCCOMINST 3140.1. In port WEAX/AVWX are issued once daily.

As a ship passes from one NAVMETOCCOM center's area of responsibility to another, the forecast responsibility is automatically passed between the centers. Ships will be advised when this occurs in the Remarks section of the WEAX/AVWX message.

When WEAX/AVWX service is requested, forecasts will be provided at least once per 24-hour period and updated whenever a significant change in the forecast occurs, whether caused by atmospheric changes or changes in the ship's operating area or route.

WEAX/AVWX will be issued to a unit twice daily when located within areas bounded by wind and high sea warnings, and when conditions exceed those specified by a unit involved in towing, salvage, or other unique operations that require tailored support.

During *minimize*, only units experiencing conditions listed in the previous paragraph will receive routine WEAX/AVWX. All other units will receive an initial WEAX/AVWX when *minimize* is imposed. Updates will be provided only when conditions are forecast to exceed those listed in the previous paragraph during the 48-hour outlook period.

Product Consideration

Wind, sea, and tropical cyclone warnings, and so forth will be referenced in the WEAX/AVWX message when applicable. For more information in this area, see NAVMETOCCOMINST 3140.1.

WEAX/AVWX STANDARD FORMAT

Table 10-3 shows the standard format used by NAVMETOCCOM activities responsible for providing WEAX/AVWX services.

The WEAX/AVWX meteorological situation will include the locations of pertinent high-and low-pressure centers. The bearing and range from a geographical reference point or from the unit receiving the forecast will be specified.

Appropriate items in subparagraph 2G of table 10-3 will be included when the MOVREP indicates an aviation unit is embarked, or if otherwise requested. Significant convective activity within 100 nmi of the ship will be included. AVWX forecasts will be issued twice daily when visibility and/or ceiling is at, or decreases below 3 nmi or 1,000 ft. If the difference between sea and swell direction and/or height is significant, it will be indicated.

An Alfa index forecast will be included in subparagraph 2H of table 10-3 for light airborne multipurpose system (LAMPS) capable ships. When refractivity data based on upper air soundings are available, information regarding radar/radio performance predictions and/or refractive index structure data tailored to the ship's radar configuration may be included in this paragraph. Requests for refractivity data should, when possible, include a current upper air sounding. For more information on WEAX and AVWX support, see the *U.S. Navy Oceanographic and Meteorological Support System Manual*, NAVMETOCCOMINST 3140.1. Refer to NWP's 65-0-1 and 65-0-2, *Characteristics and Capabilities of U.S. Navy Combatant Ships*, which list the types and characteristics of radar on USN ships.

AIRCRAFT DITCH HEADING FORECASTS

LEARNING OBJECTIVES: Be familiar with the procedures for obtaining the ditch heading product. Recognize the characteristics of the product. Identify its uses.

Navy aircraft are routinely involved in oceanic flights. In the event of an in-flight emergency, a pilot must make a decision on which direction to ditch the aircraft.

PRODUCT DESCRIPTION

The NODDS ditch headings product provides a graphic depiction, using arrows, to show the recommended direction *into* which an aircraft should land on a water surface. Directions are calculated from 0 to 359 degrees relative to magnetic north.

Table 10-3.-Enroute Weather Forecast (WEAX/AVWX) Standard Format

ENROUTE WEATHER FORECAST (WEAX/AVWX) STANDARD FORMAT

P/O (Precedence)
FM: NAVMETOCCEN
TO: _____
INFO: (Include appropriate NAVMETOCCOM activities)
BT
(Classification)//N03145//
SUBJ: WEAX or AVWX (U)
MSGID/GENADMIN/NAVMETOCCEN//
REF/A/(MOVREP reference)//
REF/B/(OTSR Divert MSG reference)//
REF/C/(Wind/Tropical Warning reference)//
REF/D/(High Seas Warning reference)//
REF/E/(Passing MSG reference)//
AMPN/NARR/As Required//
RMKS/1. () Meteorological situation at: _____. See ref(s)
_____ for warnings affecting your track.
2. () 24 hour forecast commencing _____UTC along track from
_____N(S) to_____ E(W) _____ N(S) _____E(W) as indicated
ref(s)
A and _____.
A. Sky, weather: _____
B. VSBY (NM): _____
C. Surface Winds (KTS): _____
D. Max/Min Temps (°F): _____
E. SST (°F): _____
F. Combined Sea (FT): _____
G. Aviation Parameters:
(1) Cloud Tops/Ceilings: _____
(2) Winds Aloft: 1000 FT _____
3000 FT _____
5000 FT _____
(3) Turbulence: _____
(4) Freezing LVL (FT): _____
(5) Icing: _____
(6) Lowest Expected Altimeter Setting: _____
(7) (Additional information, e.g., PA/Da forecasts): _____
(8) Divert Fields: _____
H. Remarks: (e.g., radar refraction) _____
3. () Outlook to 48 hours: _____
4. () OTSR Update as required
5. () (Select as appropriate)
(NAVY) REQ 6 HRLY WX REPORTS IAW NAVMETOCCOMINST 3140.1J
(USCG) REQ 6 HRLY WX OBSERVATION REPORTS IAW INTERNATIONAL
SHIP WEATHER CODE
(MSC) REQ 6 HRLY WX OBSERVATION REPORTS IAW COMSCINST 3141.1
THIS IS MY FINAL FORECAST UNOREQ
TIMELY OBS RECEIVED FROM YOUR COMMAND GREATLY APPRECIATED
NEXT FORECAST WILL BE ISSUED BY (Appropriate Center).
REQ (Appropriate Center) ACK.
OUTLOOK FOR ARRIVAL AT YOUR DESTINATION: _____
DECL: (If appropriate) _____//

PRODUCT AVAILABILITY

The ditch headings product is available as an analysis and as a forecast at 12-hour increments to 72 hours. See figure 10-3.

PRODUCT EXPLANATION

The Global Spectral Ocean Wave Model (GSOWM) primary swell direction and primary wave height fields and Navy Operational Global Analysis and Prediction System (NOGAPS) marine wind direction and velocity fields are used to calculate the optimal direction to land an aircraft. The earth's magnetic variations are used in the final calculation of the heading.

PRODUCT USE

The ditch headings product is generally used in preparation of a transoceanic flight weather packet. In case of distress, the pilot must make a decision on which direction to land an aircraft to minimize impact damage to the aircraft and loss of life. Except in calm seas, ditching an aircraft is more complicated than landing into the wind. Large waves can severely damage aircraft upon impact. Ditch headings are used primarily in instrument flight rule (IFR) conditions when a pilot cannot observe the sea conditions. The general

considerations when ditching becomes necessary are as follows:

- If only one swell is present, landing should take place parallel to the swell, preferably on the top or backside of the swell.

- If two or more swell systems are present, and the primary system is significantly higher, landing should take place parallel to the primary swell. If the swell systems are comparable in height, landing should take place at a 45-degree angle to both swell systems on the downside of the swell.

- If the secondary swell system is in the same direction as the wind, landing should take place parallel to the primary swell with the wind and secondary-system at an angle. The choice of whether to land with the angle of the wind upwind or downwind to the plane depends on the wind speed and height of the secondary swell system.

- In all cases, if the swell system is huge, it is advisable to accept more cross wind than to land into the swell.

PRODUCT LIMITATION

The ditch headings product does not take into account secondary swell conditions. For further information, refer to the *NODDS Products Manual*, FLENUMMETOCCENINST 3147.1.

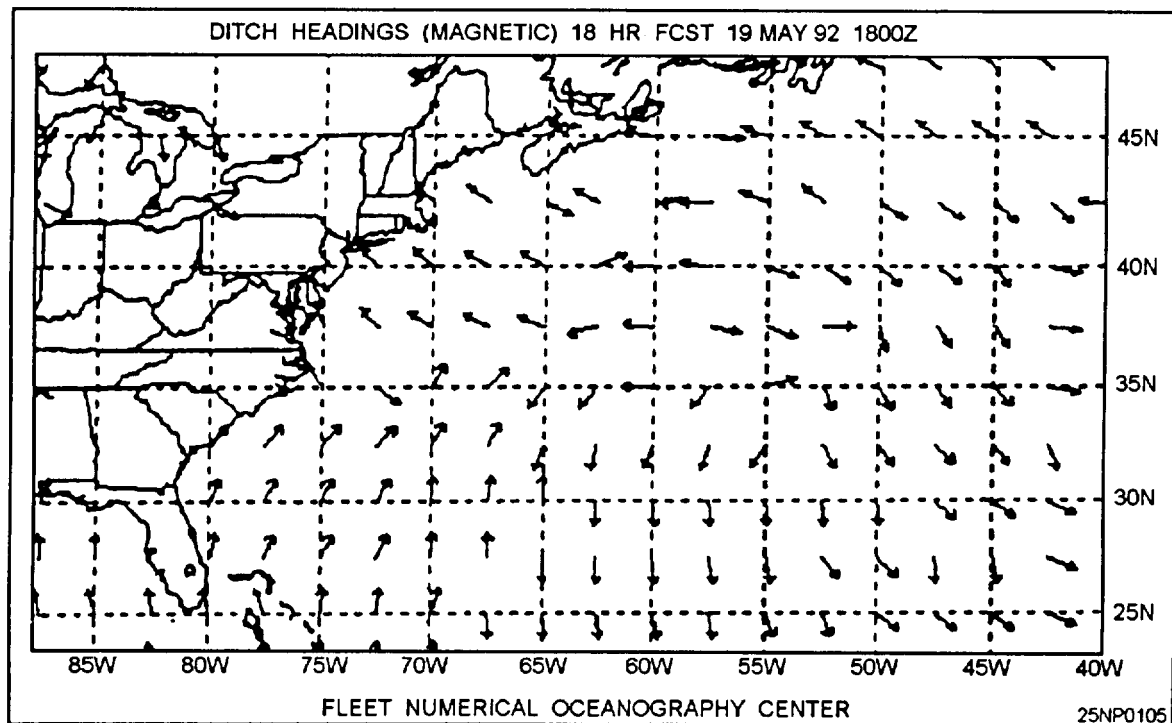

Figure 10-3.-Example of the ditch headings product.

AVIATION FORECAST PRODUCT VERIFICATION

LEARNING OBJECTIVES: Verify Optimum Path Aircraft Routing System (OPARS) requests, Horizontal Weather Depictions (HWDs), Airmen's Meteorological Information (AIRMETs)/Significant Meteorological Information (SIGMETs), and Terminal Aerodrome Forecasts (TAFs) for accuracy.

VERIFICATION OF OPARS

The *OPARS User's Manual*, FLENUMMETOCCENINST 3710.1, and the *AG2 TRAMAN*, volume 2, list procedures and the format for OPARS requests.

VERIFICATION OF HWDs

Procedures governing flight weather briefings and preparing DD Form 175-1 and *U.S. Navy Flight Forecast Folders* are outlined in NAVMETOCCOMINST 3140.14. Both the *AG2 TRAMAN*, volume 2, and NAVMETOCCOMINST 3140.14 list procedures and formats for the preparation and dissemination of flight weather packets.

VERIFICATION OF AIRMETS AND SIGMETS

The *Airman's Information Manual*, Official Guide to Basic Flight Information, and ATC Procedures briefly discuss in-flight weather advisories disseminated by the National Weather Service (NWS) as well as foreign nations.

VERIFICATION OF TAFs

Commands throughout the claimancy having aircraft on station prepare and update TAFs. Information on the TAF code is presented in the *AG2 TRAMAN*, volume 2. NAVMETOCCOMINST 3143.1 promulgates instructions for using the code.

As discussed earlier in this chapter, Aerographers should be familiar with the format and encoding of OPARS, HWDs, AIRMETs/SIGMETs, and TAFs. But these products serve little value unless there is a procedure in place to verify them for accuracy. By

verifying these products we take into consideration lessons learned when preparing them in the future.

The last area discussed in this chapter covers sources of climatic information.

CLIMATOLOGY

LEARNING OBJECTIVES: Recognize available sources of climatic information for the planning of exercises.

In preparing for operations or exercises, the officer-in-tactical command (OTC) and commanding officers must be briefed regarding the climatic conditions expected to occur during the operation or exercise. Climatology is normally used for long range planning only and should not be used when reliable, real-time data becomes available. However, in certain situations, it maybe *the only* forecast data available. For more information on this subject refer to NAVMETOCCOMINST 3140.1.

Climatology generally refers to summarizations and/or studies of historical data. Climatology data can be presented in a variety of forms (tabular, graphical, narrative, or analytical charts). When summaries and studies are used for planning, it should be kept in mind that statistical averaging causes smoothing of the observed data. Additionally, the mean or average of a given parameter may be a value that is seldom actually observed.

Units should review their climatology publications on a routine basis to ensure they have the necessary publications for their area of responsibility (AOR) plus any other areas as may be required during contingency operations.

Reference material, which may be used in the preparation of forecaster's handbooks and independent studies in the fields of oceanography and meteorology, is available through the Naval Research Laboratory (NRL Monterey).

PUBLICATIONS AND SUMMARIES

Existing climatological publications and summaries can satisfy many requirements. They should be consulted as a primary source in order to avoid unnecessary or duplicative data processing efforts. Included among these are the following:

- Navy publications of the NAVAIR 50-1C-series (listed in *SPAWM* [Space Warfare Systems Command] *Meteorological Allowance Lists*, EEOOO-AA-MAL-101/W141-QL22 and EEOOO-AB-MAL-101/W141-QL23.)

- Defense Mapping Agency (DMA) publications, including *Sailing Directions and Planning Guides* (listed in Catalog P2V10). For ordering instructions refer to NAVMETOCCOMINST 3140.1.

- Special studies and summaries for marine and land stations and areas (listed in FLENUMMETOCDET Asheville Notice 3140 - Atmospheric Climatic Publications). For ordering instructions refer to NAVMETOCCOMINST 3140.1.

- Various Navy and Air Force station and area climatological summaries, which are periodically updated and provide world coverage - (listed in NAVAIR 50-1C-534, *Guide to Standard Weather Summaries*).

- Various National Oceanographic and Atmospheric Administration (NOAA) summaries for stations and areas in the United States (listed in NOAA Pub. No. 4.11)

- Monthly local area climatological summaries that are routinely prepared and distributed to local commands and activities by NAVMETOCCOM.

- Special atlas-type publications entitled *Environmental Guides* that provide oceanographic information for various regions of the world's oceans. For ordering instructions, refer to NAVMETOCCOMINST 3140.1.

- Routine climatological products available from FLENUMMETOCCEN include:

- Monthly wind and direction frequency tables
- Monthly means of Northern Hemispheric polar stereographic fields for atmospheric and oceanographic parameters

SPECIAL CLIMATOLOGICAL STUDIES

Special studies or summaries are sometimes necessary to meet specific support. FLENUMMETOCDET Asheville can provide assistance in planning specific climatology requirements. *Atmospheric Climatic Publication*, FLENUMMETOCDET ASHEVILLENOTE 3146 outlines procedures for obtaining climatic publications and also has a concise list of available climatic publications.

REQUESTS FOR SPECIAL CLIMATOLOGICAL STUDIES

NAVMETOCCOMINST 3140.1 lists procedures for obtaining special climatological studies.

HISTORICAL DATA REQUESTS

All requests for meteorological and oceanographic historical (climatological) data should be forwarded by letter as listed in NAVMETOCCOMINST 3140.1.

SUMMARY

In this chapter, we have discussed selected significant weather warnings and sea advisories. The importance of verifying these warnings and advisories was also presented. Means for forecasting evaporative ducts and altimeter settings was then presented. We also discussed how aerosols in the atmosphere affect EO sensors, weapons, and communications. We discussed WEAX and AVWX formats as well as procedures for obtaining them. We listed publications used in identifying ship-class radars, and then discussed a means for obtaining aircraft ditch heading products. Next, we discussed the importance of verifying TAFs, OPARs, HWDs, and AIRMETS and SIGMETs. Finally, we outlined the various climatological publications, their content, and a means for obtaining them.

TROPICAL FORECASTING

Forecasting in the Tropics is a difficult problem. It necessitates a good meteorological and physics background, vast amounts of climatological knowledge, a keen mind's eye that can observe the most minute deviation in a mass of nearly homogeneous data, and last, but not least, diligence and dedication in the approach to the forecast.

The types of forecasts in the Tropics are the same as anywhere, in that you encounter flight, route, terminal, operational, general, fleet, local area, and destructive weather forecasts, as well as pertinent warnings and advisories.

Your concern in this chapter is with preparing local area forecasts, including destructive weather warnings and forecasts, and forecasting the movement of the Inter Tropical Convergence Zone (ITCZ) and tropical waves. The treatment of destructive weather warnings and forecasts is limited to tropical storms and cyclones since tornadoes are largely non-existent in the Tropics. Note also, that thunderstorms are covered in chapter 5 of this manual.

The Composite Warfare Oceanographic Support Modules (CWOSM), Part 1, TM 0492, contains further reading on severe weather features. Information may also be found in the *AG2 TRAMAN*, volume 1, NAVEDTRA 10370.

LOCAL AREA FORECASTS

LEARNING OBJECTIVES: Analyze upper air features and refer to local area climatology for preparation of surface analyses and forecasts.

The importance of local and general area climatology can have a profound impact on operations in the tropics. It is in the preparation of the local area forecast that this knowledge will be most beneficial.

During the analysis of the various charts, most forecasters form a mental image of the forecast charts and develop certain fundamental ideas as to the weather in the area of responsibility (AOR) for the next 24 or 48 hours. Climatology serves as a guide for analysis and

forecasting within the AOR. The next step in the procedure is to expand and refine these ideas.

The ideal approach to a local area forecast is to prog the upper air features first as it is from the upper air charts that the surface chart is eventually prepared. The prognostic surface chart is then used as a basis for the local area forecast. Of course other data must also be considered in preparing the forecast, such as streamline analysis, weather distribution charts, time sections, and climatology.

TROPICAL CYCLONE FORECASTING

LEARNING OBJECTIVES: Recognize synoptic features conducive to tropical cyclone development. Identify situations affecting movement and intensification of tropical cyclones. Interpret tropical cyclone warnings.

There is at present no one formal procedure for forecasting the development and movement of tropical *cyclones*. This can be understood when one considers the enormous complexity of the problem, the sparsity of data in the oceanic tropical regions compared to that available in the highly populated continents, and the lack of ship reports from areas of tropical cyclone activity. There are also regional influences to consider. A very obvious consequence of regional influences can be demonstrated when you compare the North Atlantic area with the North Pacific area. The North Pacific has almost twice the tropical water area and also better than double the average number of tropical cyclones per year.

THE PROBLEM

Forecasting tropical cyclones evolves into the following problems: formation, detection, location, intensification, movement, recurvature, and decay.

The factors that enter into forecast preparation are mainly dynamic (relating to the energy or physical forces in motion), but there are also important thermodynamic influences. For instance, tropical storms will not develop in air that is drier and slightly

cooler in the surface layers than the air normally present over the tropical oceans in summer. This also holds true in air with a trade inversion and upper dry layer present. Surface ship temperature and dew point reports, along with upper air data, are extremely valuable in determining whether the surface layers are truly tropical or whether they contain old polar air not yet completely transformed.

THE DYNAMICS OF TROPICAL CYCLONES

Dynamically, storms (existing and potential) are subject to influences from the surrounding areas. In the Tropics, we usually encounter two layers in the troposphere, and these levels have very different characteristics. Most of the time, a steady trade wind blows in the lower levels (surface to 500 hPa), while a succession of large cyclonic and anticyclonic vortices are present in the upper troposphere in the 400- to 150-hPa strata. In some regions, such as the area between the Mariana Islands and the South China Sea during midsummer, intense eddy activity also takes place near the surface. It is not possible to deduce from charts drawn in the lower layers what is taking place above 500 hPa. Therefore, it is necessary to keep track of events in both layers.

Aside from the surface chart, the 700-hPa level chart is very helpful in determining low-level flow patterns. The 200-hPa level is representative of the upper layer, whereas the 500-hPa level, often located in the transition zone, is of much less use in tropical than in extratropical forecasting.

However, forecast considerations should not be limited to the two layers in the Tropics. Middle latitude weather also influences and shares in the control of weather changes in low latitudes. The position and movement of troughs and ridges in the westerlies affect both the formation and motion of tropical storms. Therefore, middle latitude analysis is important. Since forecasts generally run from 1 to 3 days, there should also be a hemispheric analysis.

The climatological approach to the forecast problem should also be taken into consideration. It is obvious that a forecaster must be familiar with regional and seasonal changes; for instance, areas of frequent tropical cyclone formation, mean storm tracks, the scattering of individual tracks about the mean, and the month to month variations of all of the above. Mean tracks and other data on Pacific storms are available in several publications. These maps and charts reveal that

the "climatological" approach gives some useful information, but it cannot be relied on in anyone specific area, or in the case of any particular storm to the exclusion of synoptic indications for the forecast. These probability considerations are used mainly for long-range planning and when data are unavailable. Therefore, we reach the conclusion that climatological information should be treated as a weighing factor to be included after evaluating synoptic data.

FORMATION

A full-blown typhoon/hurricane cannot be forecast as such when there are no indications of any type of irregularity on the charts or aids used in the tropical analysis. Only when the incipient stage first appears among the data can we begin to think in terms of an actual typhoon/hurricane, and often not even then. For the most part, the forecast evolution from "area of disturbed weather" to typhoon/hurricane is a matter of step-by-step progression. Assume the term *formation* means formation of a "potential" typhoon/hurricane.

Empirical rules or checks have evolved through the years that enjoy a measure of reliability to warrant their use, and of course, the more signs that point to formation, the more likely formation will occur.

Synoptic Conditions Favorable for Development

The following list contains conditions favorable for development of tropical cyclones. In this list, no attempt is made to separate the surface from the upper air indications, as the two are most often occurring simultaneously and are interrelated.

- Marked cyclonic turning in the wind field.
- A shift in the low-level wind direction when easterlies are normally present. Wind-speeds generally 10 knots or more.
- Greater than normal cloudiness, rainfall, and pressure falls. Cloudiness that increases in vertical as well as horizontal extent.
- Moderate to strong outflow aloft.
- Sea level pressures lower than normal. The value is dependent upon the region analyzed; however, a deviation of greater than 3 hPa is the normal criterion.
- Easterly wind speeds 25 percent or more above normal in a limited area, especially when the flow is Cyclonic.

- Temperatures above normal at sea level, generally 26°C (79°F) or more in the lower layers.
- Moisture above normal at all levels.
- Westerlies greater than average, north of the latitude of the seasonal maximum.
- Easterlies weaker than average in a wide zone.
- Easterlies decreasing with height.
- The latitude of the subtropical ridge is higher than normal above the 500-hPa level.
- Evidence of a fracture in a trough aloft (at 200 hPa).
- Long waves that are slowly progressive.
- A zone of heavy convection is present, indicating the absence of the trade inversion.
- An increasing surface pressure gradient north and west of the suspect area.
- The disturbance has relative motion toward the upper ridge at or above 400 hPa.

Other Indications of Development

Other indications of development are sea swell and tide observations. Swells associated with a tropical storm will have a frequency less than average and an amplitude greater than average. The normal swell frequency is 8 per minute in the Atlantic and 14 per minute in the Gulf of Mexico. Hurricane winds set up swells with a frequency that can decrease to four per minute. The period of the swell will also be much longer than usual. Swells will approach the observer approximately from the direction in which the storm is located. The swell height is an indication of the storm's intensity, especially when the swells have not encountered shallow water before reaching shore.

Abnormally high tides along broad coastlines and along shores of partially enclosed water bodies are also a good indication of storm development. The highest tides will normally be found to the right of the storm path, looking downstream.

DETECTION

Meteorological satellites have greatly aided in the detection of tropical disturbances, especially during the early life cycle. It is important for meteorologists, analysts, and forecasters to be able to effectively

interpret these pictures to extract their maximum benefit. Through proper interpretation of satellite data, determination of size, movement, extent of coverage, and an approximation of surface wind speed and direction can be made. Satellites have become the most important method of detection of disturbances.

Aircraft reconnaissance also plays an important role in tropical cyclone detection throughout the North Atlantic, Caribbean Sea, and the Gulf of Mexico. This has become even more important when used in conjunction with the data from satellites. Areas of suspicious cloud structure can be investigated by aircraft whose crews include trained meteorologists. These reconnaissance flights can provide on-station data, either high- or low-level, that would not be available otherwise.

Another method of detecting tropical disturbances is through the use of radar. Present radar ranges extend about 300 miles and can scan an area approximately 300,000 square miles.

The Navy and NOAA also maintain several different types of moored METOC buoys that report various meteorological and oceanographic elements. These stations send out measured data automatically or upon query.

LOCATION

The problems of formation, detection, and location are in reality a single three-in-one problem. One is dependent on the other.

In the case of satellite pictures, reconnaissance, and radar detection, the location is fairly certain, barring navigational errors. If detection is made through the analysis, the exact location is more difficult to ascertain in the incipient stage of the storm, especially when the analysis is diffuse. The exact location should be decided upon only after the most intensive study of the data. The analyst should be prepared to revise his or her decision in the face of developments which are more conclusive.

INTENSIFICATION

Only when easterlies extend vertically to 25,000 feet or more at the latitude of the vortex is intensification possible. This most frequently occurs when the subtropical ridge lies poleward of its normal position for the season. The following characteristics are indications of intensification:

- Movement is less than 13 knots.

- The disturbance is decelerating or moving at a constant speed.
- The system has a northward component of motion.
- A migratory anticyclone passes to the north of the storm center.
- A strong net outflow (divergence) is manifested by anticyclonic flow in the upper levels (200 hPa).
- Long waves are slowly progressive. (Applicable to genesis also.)
- The trade inversion is absent; convection deep.

Other considerations to bear in mind:

- Intensification occurs when the cyclone passes under an upper-level trough or cyclone, provided there is relative motion between the two. There is some indication that intensification does not take place when the two remain superimposed.
- Poleward movement of the cyclone is favorable for intensification; equatorward motion is not favorable.
- Intensification occurs only in areas where the sea surface temperature is 79°F or greater, with a high moisture content at all levels.
- Other factors being equal, deepening will occur more rapidly in higher than in lower latitudes. (Coriolis force is stronger.)
- When a storm moves overland, the intensity will immediately diminish. The expected amount of decrease in wind speeds can be 30 to 50 percent for storms with winds of 65 knots or more; and 15 to 30 percent for storms with less than 65 knots. If the terrain is rough, there is more decrease in each case than if the terrain is flat.

Once an intense tropical cyclone has formed, there will be further changes in its intensity and in the course of its motion within the Tropics and during recurvature. The forecaster should consider these changes in connection with the predicted path of movement.

MOVEMENT

Tropical cyclones usually move with a direction and speed that closely approximates the tropospheric current that surrounds them. Logically, therefore, charts of the mean flow of the troposphere should be used as a basis for predicting the movement of tropical cyclones, but lack of observations generally precludes this approach.

Generally there is a tendency for tropical cyclones to follow a curved path away from the Equator; however, departures from this type of track are frequent and of great variety,

Tropical cyclones move toward the greatest surface pressure falls and toward the area where the surface pressure falls increase fastest with time. Calculation is necessary for this rule to be used.

Numerous theories have been advanced to explain the cyclone tracks of the past and to predict those of the future. Observational data have never been sufficient to prove or disprove most of them.

Tropical storms move under the influence of both external and internal forces. The external forces are a result of air currents that surround a storm and carry it along. The internal forces appear to produce a tendency for a northward displacement of the storm (which probably is proportional to the intensity of the storm), a westward displacement that decreases as latitude increases, and aperiodic oscillation about a mean track.

Initial Movement of Intense Cyclones

The movement of cyclones that are undergoing or have just completed initial intensification (about 24 hours) will be as follows:

- Storms developing in westward moving wave troughs in the easterlies move toward the west and also with a pole ward component given by an angle of approximately 20° to the right of the axis of the trough looking downstream. (See fig. 11-1.)
- The motion of storms developing from preexisting vortices can be extrapolated from the track of these vortices.

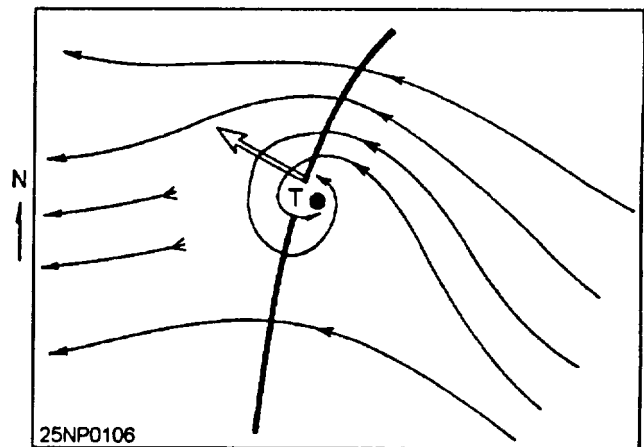

Figure 11-1.-Illustration of initial movement of tropical cyclones forming in a wave trough in the easterlies.

- Storms developing on the eastern edge of polar troughs initially move up the trough.

- Pacific storms forming on equatorial shearlines usually are most active in the southern and southwestern portions at the start and they move slowly northeast. After 1 to 2 days, the influence of the trades becomes dominant and the storms turn back toward a direction ranging from west to north. (This appears to be true mainly for cyclones deepening near or west of 130°E.)

- If a storm is discovered without information as to its past movement and the upper air current, it is best to start it along the climatological mean track and then secure the data necessary to determine the steering current.

Extrapolation

At present, the most practical prognostic technique used by the tropical meteorologist consists of extrapolating the past movement of the synoptic features on his or her chart into the future. The past track of a cyclone represents the integrated effects of the steering forces acting upon it. Accelerations and changes in course are the results of the changes in these steering forces. The effect of these forces can be examined and extrapolated directly from the past position of the cyclone.

Before applying the extrapolation technique, the forecaster must attempt to smooth out the minor irregularities in the past track. The first step in the use of extrapolation is to determine the mean direction and speed of the cyclonic center between each two known positions. The next step is to determine the rate of change in direction and speed between successive pairs of fixes. The forecast position thus determined from extrapolation of movement should be smoothed out for minor irregularities and compared to the applicable climatological tracks of cyclones in the area. If large differences exist, the forecast should be completely reexamined. The climatological tracks should receive less weight for short-term forecasts of 6 to 12 hours and more weight for forecasts in excess of 24 hours.

For short-term forecasts (6 to 12 hours), extrapolation is as reliable as any known method for movement.

Steering

The movement of a tropical cyclone is determined to a large extent by the direction and speed of the basic current in which it is embedded. This concept appears

to work well as long as the cyclone remains small and remains in a deep broad current. By the time a tropical cyclone has reached hurricane intensity, these conditions seldom exist. It then becomes necessary to integrate the winds at all levels through which the cyclone extends and in all quadrants of the storm to determine the effective steering current. Although the principle is not fully understood and has not yet received universal acceptance as a valid rule, it does have practical applications. For example, changes in winds at one or more levels in the area surrounding the cyclone can sometimes be anticipated, and in such cases, a qualitative estimate of the resulting change in the movement of the cyclone can be made. Conversely, when it appears likely that none of the winds in the vicinity of the cyclone will change appreciably during the forecast period, no change in the direction and speed of movement should be anticipated.

Further, this rule applies to situations of nonrecurvature and only some cases of recurvature. It is difficult to determine the steering current, since the observed winds represent the combined effects of the basic current and disturbances. As most storms extend into the high troposphere, it is better to calculate a "steering layer" than a steering level, since presumably the wind throughout most of the troposphere influences the storm movement. One writer recommends an integration of the mean flow between the surface and 300 hPa, over a band 8° in latitude centered over the storm. Another writer indicates that for moderate and intense storms the best hurricane steering winds would be found in the layer between 500 and 200 hPa and averaged over a ring extending from 2° to 6° latitude from the storm center.

STREAMLINE ANALYSIS AND VECTOR AVERAGES.— Other practical applications of the steering concept to short-range tropical cyclone motion use differing approaches in attempting to measure the basic current. One is by streamline analysis of successive levels to find a height at which the vertical circulation diminishes to a point such that the winds are supposedly representative of the undisturbed flow. Another method is to take vector averages of reconnaissance winds near the zone of strongest winds in the storm.

USE OF OBSERVED WINDS ALOFT.— When sufficient data are available, it has been found that the use of streamline analysis of successive levels usually gives valuable indications of tropical storm movement for as much as 24 hours in advance. However, since wind observations are usually scarce in the vicinity of a

hurricane, their analysis is necessarily rather subjective. Some forecasters claim dependable results in using this concept when data were available to high levels near the storm. The technique is not based on the assumption that wind at any single level is responsible for steering the storm, since the forces controlling movement are active through a deep layer of the atmosphere. However, as successive levels are analyzed, a level is found at which the closed cyclonic circulation of the storm virtually disappears. This *steering* level coincides with the top of the warm vortex and varies in height with different stages and intensities of the storm. It may be located as low as 20,000 feet or, in the case of a large mature storm, as high as 50,000 feet. It has been found in analysis that most weight should be given to the winds in advance of the storm within a radius of 200 to 300 miles in preference to those in the rear quadrants. The hurricane generally moves with a speed of 60 to 80 percent of the current at the steering level.

THE DIRECTION OF MOVEMENT.— The direction of movement is not always exactly parallel to the steering current, but has a component toward high pressure that varies inversely with the speed of the current, ranging from almost 0° with rapid movement to as much as 20° with speeds under 20 knots. In westward moving storms, a component of motion toward high pressure could result from the poleward acceleration arising from the variation of the Coriolis parameter across the width of the storm. This would indicate that, to the extent that this effect accounts for the component of motion toward high pressure, northward moving storms would fit the direction of the steering current more closely than westward moving ones. The tendency for poleward drift would be added to the speed of forward motion in the case of a northward moving storm so that it would approach more closely the speed of the steering current. Empirical evidence supports this hypothesis.

Corrections for both direction and rate of movement should be made when this is indicated by the windflow downstream in the region into which the storm will be moving. For prediction beyond several hours, changes in the flow pattern for a considerable distance from the storm must be anticipated. It should also be remembered that intensification or decay of a storm may call for use of a higher or lower level, respectively, to estimate the future steering current.

THERMAL STEERING.— A number of efforts have been made to correlate hurricane movement with thermal patterns. For example, one writer suggests that

a storm will move along tongues of warm air in the layer from 700 to 500 hPa that often extends out to 1,000 miles ahead of the storm. The orientation of the axis of the tongue then may be regarded as a reliable indicator of storm movement for the next 24 hours. A considerable difficulty in applying this technique is created by the fact that the warm tongue sometimes has more than one branch and it is questionable as to which is the major axis.

RECURVATURE

One of the fundamental problems of forecasting the movement of tropical cyclones is that of recurvature. Will the cyclone move along a relatively straight line until it dissipates, or will it follow a track that curves poleward and eastward? When recurvature is expected, the forecaster must next decide where and when it will take place. Then, he or she is faced with the problem of forecasting the radius of the curved track. Even after the cyclone has begun to recurve, there are a great variety of paths that it may take. At any point, it may change course sharply.

The most common recurvature situation arises when an extratropical trough approaches a storm from the west or when the storm moves west to northwest toward a stationary or slowly moving trough.

Indicators of Possible Recurvature

Some of the indicators of possible recurvature are as follows:

- If the base of the polar westerlies lowers to 15,000 to 20,000 feet west of the storm's latitude, and remains in this position, recurvature may then be expected to occur.

- However, if there is the building of a dynamic high or an eastward movement of this high to the rear of the advancing trough, and the westerlies dissipate in the low latitudes, the storm will move past the trough to its south and continue its westward path.

- The above rule also holds true in cases where the polar trough moves from the west against a blocking high. The higher latitude portion of the trough continues to move eastward while the southern segment of the trough is retarded and is no longer connected with the upper portion of the trough.

- Recurvature may be expected when an anchor trough is about 500 miles west of the storm and when the forward edge of the westerlies is from 500 to 700

miles to the west. Correlated with this parameter, R. J. Shafer found that a spot value of the thickness between 850 to 500 hPa 7.5 degrees of latitude to the northwest of the storm was one of the most valuable of all parameters on recurvature or as an indication of future movement of Atlantic hurricanes. This thickness reflects the relative strength of cold troughs to the west essential for recurvature. Low values of thickness, 14,000 feet (approximately 4,270 meters) or less, almost always indicate recurvature; and high values, 14,200 feet (4,330 meters) or more, generally indicate continued westward motion.

- The major trough west of the storm (in the westerlies) is slowly progressive.
- Long waves are stationary or slowly progressive.
- There is a rapid succession of minor troughs aloft.
- The climatological mean track indicates recurvature (use with caution).
- When the neutral point at the southern extremity of the trough in the westerlies at the 500-hPa level lies at or equatorward of the latitude of the cyclone, recurvature into the trough will usually occur. In this situation, the cyclone would normally be under the influence of southerly winds from the upper limits to a level well below the 500-hPa level while approaching the trough.
- When the subtropical ridge at the 500-hPa level is broad and consists of large anticyclones, recurvature usually occurs. This case represents a low index situation in which the cyclone remains under the influence of a single, large, slow-moving anticyclone for a relatively long time.

- Weak troughs exist between two separate subtropical high cells. Sometimes tropical storms move northward through these very weak breaks in subtropical highs.

Nonrecurvature

The following flow patterns are associated with nonrecurvature:

- Strong subtropical anticyclone or ridge to the north of the storm with the mean trough in the westerlies located far to the west of the longitude of the storm. If this pattern develops strongly over the western oceans or continents, a storm will generally be driven inland

and dissipate before it recurves into the western end of the ridge.

- Flat (small-amplitude waves) in the westerlies at latitudes near or north of the normal position. A narrow subtropical ridge separates the westerlies from the tropical trough. In many cases the mean trough in the westerlies may be located at the same longitude of the storm.

Motion During Recurvature

The following rules apply during recurvature only:

- When the radius of recurvature of a storm is greater than 300 miles, it will not decelerate and may even accelerate. The storm will slowdown if the radius of recurvature is less than 300 miles. In general, when the radius of recurvature is large, it is usually very uniform. A small radius will occur along a brief portion of the track. (See fig. 11-2.)
- A large radius of recurvature is to be expected if the high northeast of the tropical cyclone has a vertical axis (fig. 11-3 (A)). This will occur when long waves are stationary.
- When the high slopes south to southeast with height (fig. 11-3 (B)), the cyclone is transferred rapidly from the influence of upper easterlies to that of the upper westerlies and the track has a short bend. This occurs when long waves are progressive.

The following rules refer to short-term (24 hours or less) forecasting:

- Tropical cyclones move toward the area of greatest surface pressure falls (12- to 24-hour pressure change).

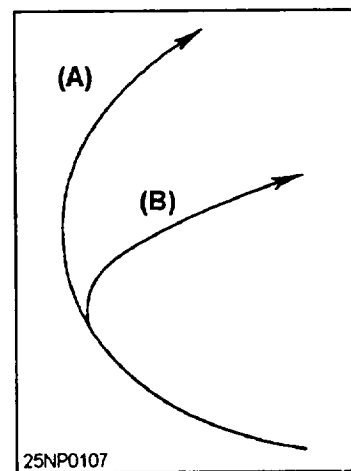

Figure 11-2.- (A) Recurvature at a constant speed; (B) First decelerating and then accelerating.

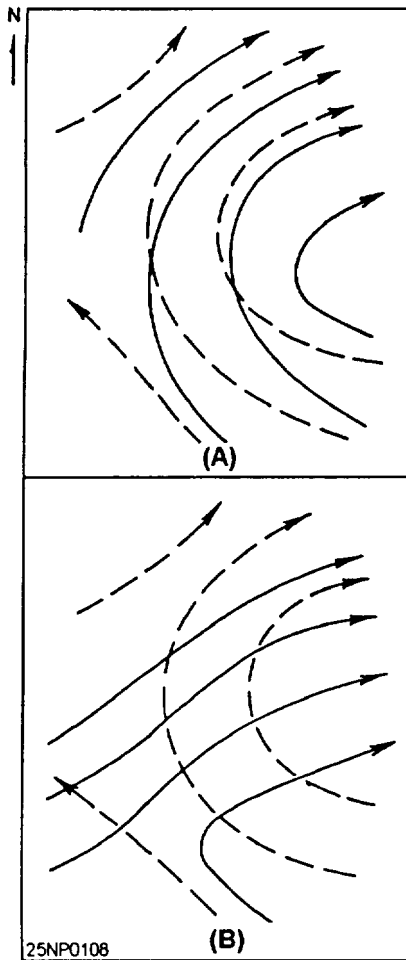

Figure 11-3.-Surface flow pattern (dashed line) and 300- to 200-hPa flow pattern (solid lines). (A) Corresponds to track (A) in figure 11-2; (B) Corresponds to track (B) in figure 11-2.

- Tropical cyclones move toward the area where the surface pressure falls increase most rapidly with time. For calculation, 3-hourly reports are necessary. Take, for example, the 24-hour pressure change at 1800 and subtract it from the 24-hour pressure change at 1500. This gives the acceleration of the pressure fall. If this quantity is computed for a network of stations and isolines are drawn for a suitable interval, the negative center helps to pinpoint the expected cyclone position. This rule is used at intervals of 12 hours or less, and is especially helpful in determining the precise place of landfall for a storm that is just offshore.

CHANGES IN INTENSITY DURING MOVEMENT OUT OF THE TROPICS

During movement out of the Tropics the storm comes under influences different from those in its origin and tropical path. The following rules and observations

can be helpful in forecasting the storm's changes in intensity:

- A storm drifting slowly northward with a slight east or west component will preserve its tropical characteristics.
- Storms moving northward into a frontal area or area of strong temperature gradients usually become extratropical storms. In this case the concentrated center dies out rapidly while the area of gale winds and precipitation expands. The closed circulation aloft gives way to a wave pattern and the storm accelerates to the northeast.
- If the tropical cyclone recurves into a trough containing a deep, slowly moving surface low, it normally will overtake this low and combine with it. Temporary intensification may result.
- If the tropical cyclone recurves into a trough containing an upper cold core low, it appears to move into the upper low in most cases.

SHORT-RANGE PREDICTION BY OBJECTIVE TECHNIQUES

As in all so-called objective techniques, no one method will serve to produce an accurate forecast for all tropical storms or extratropical systems. In the following section several techniques that have been developed in recent years are discussed. It should be mentioned that objective techniques should not be considered as the ultimate forecast tool and that all other rules, empirical relationships, and synoptic indications should be integrated into the final forecast. Wholly inaccurate forecasts may result if objective methods are the only ones considered in preparing a forecast.

Statistical Methods

One of the most prominent and widely used of these methods was devised by Veigas-Miller to predict the 24-hour displacement of hurricanes based primarily on the latest sea-level pressure distribution. Sea-level pressures were used rather than upper air data due primarily to the longer available record of sea-level data, and also because of the advantage of denser areas and time coverage, and the more rapid availability of the data after observation time. In addition to the sea-level pressure field, this method also incorporates the past 24-hour motion and climatological aspects of the storm.

Pressure values are read from predetermined points located at intersections of latitude and longitude lines

with values divisible by 5. Two different sets of equations are used: one set for a northerly zone, between latitudes 27.6° and 40.0°N, and the other set from longitudes from 65.0° to 100.0°W. The southerly zone encompasses the same longitudes as the northerly zone, but the latitudes are for 17.5° and 27.5°N.

The method described in the preceding two paragraphs was tested by Veigas and Miller on 125 independent cases, about equally distributed between the two zones, during the years 1924-27 and 1954-56. The average vector errors in 24-hour forecast position were about 150 nautical miles for the northerly zone and 95 nautical miles for the southerly zone.

30-Hour Movement of Certain Atlantic Hurricanes

R. J. Shafer has developed an objective method for determining the 30-hour movement of hurricanes by use of sea-level data over the ocean areas and upper air data over the land areas. Motion is described in two components: zonal and meridional. Westerly motion is determined by consideration of the component of the sea-level pressure gradient surrounding the hurricane and is opposed graphically by the mean temperature field between 850 and 500 hPa. The correlation of these parameters is modified by extrapolation and the geographic locations. Meridional motion is similarly predicted by sea-level and thickness parameters modified by extrapolation. The meridional and zonal computations are then combined into the final 30-hour forecast.

In a test of dependent and independent data it was found that some 85 percent of the storms predicted in the 31 sample cases fell within 2° of the predicted position.

MOVEMENT OF TROPICAL CYCLONES

Griffith Wang of the Civil Air Transport Service, Taiwan, developed a method for objectively predicting the movement of typhoons in the western Pacific. The method is titled *A Method in Regression Equations for Forecasting the Movement of Typhoons*. The equation utilizes 700-hPa data and is based on the following criteria:

- The 700-hPa contour height and its tendency 10° latitude north of the typhoon center.
- The 700-hPa contour height and tendency 10° latitude from the typhoon center and 90° to the right of its path of motion.

- The 700-hPa contour height and its tendency 10° latitude from the typhoon center and 90° to the left of its path of motion.

- The intensity and the orientation of the major axis of the subtropical anticyclone which steers the movement of the typhoon.

Percentage of frequency of direction of movement and speed tables are provided for a rough first approximation of the movement of the typhoon.

This method, as well as all other methods based on a single chart, is dependent upon a good network of reports and a good analysis. A full test of the value of this method has not been made, but in limited dependent and independent data cases tested it appears to have a good verification and provides another useful tool in the integrated forecast.

Full details on the procedure and application of this method can be found in the *Bulletin of the American Meteorological Society*, Vol. 41, No. 3, March 1960.

Use of the Geostrophic Wind for Steering

The expansion of aircraft reconnaissance reports have made it practical to carry out more detailed analyses of constant pressure surface over the tropical storm belt and to make use of a forecast based on geostrophic components at that level. This technique, developed by Riehl, Haggard, and Sanborn, and issued as an NA publication *Objective Prediction of 24-Hour Tropical Cyclone Movement* uses this steering concept. The technique makes use of 500-hPa height averages alongside of a rectangular grid approximately centered on the storm. The grid is 15° longitude, centered at the initial longitude of the storm and between 10° and 15° latitude with the southern end fixed at a distance of 5° latitude south of the latitude of the storm center. A more northward extension of the grid is used for storms found to be moving more rapidly northward. The relatively small size of the grid indicates that tropical cyclone motion for 24 hours is determined to a great extent by circulation features closely bordering the storm, and that the average features outside this area will not greatly affect its movement within the time interval. The 500-mb chart is the basic chart for computations.

Comparison of Steering Levels

Another method that uses the steering concept is *A Comparison of Hurricane Steering Levels* by B. I. Miller and P. L. Moore of the National Hurricane

Center. In their study it was found that the standard rule for steering tropical cyclones (the movement of the storm from about 10° to 20° to the right of the current flowing over the top of the core) was only reliable prior to recurvature and that storms after recurvature frequently move to the left of the steering current. Operating on the premise that the motion of the tropical storm is not governed by forces acting at any one level, their study encompasses three levels, the 700-, 500-, and 300- hPa levels. They found that the 700- and 500-mb charts were about equal in forecasting hurricane motion. In the final analysis, the 700-hPa level was selected and combined with the previous 12-hour motion of the storm. From their study, a slightly better verification of predicted tracks of hurricanes resulted rather than from use of sea level data (statistical method) or the 500-mb chart alone.

The Basic Grid in Steering Tropical Systems

The basic grid is essentially the same as that used in the 500-hPa method except that gradients were computed at intervals of 2.5° latitude instead of 5°. The previous 12-hour motion was also incorporated into the forecast. This method was tested on 23 forecasts during the 1958 hurricane season. The average error was 95 nautical miles for the 24-hour forecast and ranged from 15 nautical miles to 170 nautical miles.

A further explanation of this method and its procedure for application may be found in the *Bulletin of the American Meteorological Society*, Vol. 41, No. 2, February 1960.

TROPICAL CYCLONE WARNINGS

Tropical cyclone warnings are issued to protect not only Department of Defense assets but also those of allied nations.

Tropical Cyclone Warnings of the Atlantic

Tropical cyclone warnings are issued to operating forces of the Atlantic Ocean, the Gulf of Mexico, and the Caribbean region by NAVLANTMETOCCEN Norfolk, Va. Warnings for the southern hemisphere are provided as required. NAVLANTMETOCCEN primarily uses the National Hurricane Center's interagency and public advisories as guidance.

Hurricane, tropical storm, and tropical depression warnings are issued four times daily at 0300 UTC, 0900 UTC, 1500 UTC, and 2100 UTC. They are listed under

the MAANOP heading *WHNT_ KNGU*. The blank space is for the numerical sequence of the warning.

Special advisories and warnings are issued in the event of significant changes in intensity or movement.

Daily tropical weather summaries are issued at 1800 UTC from 01 June through 30 November for the subtropical Atlantic (south of 30°N), the Caribbean, and the Gulf of Mexico. Daily tropical weather summaries are listed under the MANOP heading *ABCA KNGU*.

Tropical cyclone warning messages are transmitted via AUTODIN and the Fleet Multichannel Broadcast every 6 hours for storms in the Northern Hemisphere.

Tropical Cyclone Warnings of the Pacific

Tropical cyclone warnings are issued to operating forces of the Pacific Ocean (west of 180° longitude), Philippine Sea, South China Sea, Bay of Bengal, and Indian Ocean in both the Northern and Southern Hemispheres by the Joint Typhoon Warning Center (JTWC), Guam.

Tropical cyclone warnings are issued to operating forces of the Pacific Ocean east of 180° longitude by NAVPACMETOCCEN Pearl Harbor, Hawaii. Warnings for the Southern Hemisphere are provided as required. NAVPACMETOCCEN primarily uses the National Hurricane Center's interagency and public advisories as guidance.

Typhoon, tropical storm, tropical depression, and tropical cyclone warnings are issued four times daily at 0300 UTC, 0900 UTC, 1500 UTC, and 2100 UTC. The warnings from the JTWC are listed under the MANOP heading *WTPN PGTW* and the warnings from NAVPACMETOCCEN Pearl Harbor are listed under the MANOP heading *WTPZ PHNL*. The blank space is for the numerical sequence of the warning.

Special advisories and warnings are issued in the event of significant changes in intensity or movement.

Tropical cyclone warning messages are transmitted via AUTODIN and the Fleet Multichannel Broadcast every 6 hours for storms in the Northern Hemisphere.

NAVMETOCCOM centers monitor Southern Hemisphere tropical cyclones in their individual AORs. Because of the limited data and weather satellite coverage of the Southern Hemisphere, warnings are issued by AUTODIN and Fleet Multichannel Broadcast only at 12- and 24-hour intervals and may contain less specific information than Northern Hemisphere warnings.

SUMMARY

In this chapter we have discussed various topics related to tropical forecasting. Our discussion first dealt with local area forecasts in general. Following local area forecasting we then discussed tropical cyclone forecasting. First discussed was the problem involved with forecasting tropical cyclones, followed by the dynamics associated with these systems. Tropical

cyclone formation and detection was then presented. In addition, tropical cyclone movement and factors affecting movement were then discussed. Next, we covered intensity changes and factors affecting those changes, along with a discussion of various objective forecasting techniques for tropical cyclones. Finally, we looked at tropical cyclone warnings, forecast issuing authorities, and forecast issue times.

WEATHER RADAR

This chapter will be devoted to the discussion of various types of radar, their characteristics, principles, and elements.

The first portion of our discussion will deal with characteristics and principles of nondoppler radar, followed by a discussion of principles, characteristics, and phenomena associated with doppler radar. Finally, we will look at the Next Generation Weather Radar (NEXRAD) system, principally the WSR-88D.

NONDOPPLER RADAR

LEARNING OBJECTIVES: Interpret the effects of wavelength on nondoppler radar. Recognize principles of wavelength on nondoppler weather radars. Evaluate nondoppler radar beam characteristics.

Now let's begin our discussion of nondoppler radar. For additional information, refer to the Federal Meteorological Handbook No. 7, *Weather Radar Observations*, Part B, NAVAIR 50-1D-7.

EFFECTS OF WAVELENGTH AND FREQUENCY ON RADAR PERFORMANCE

The concept of energy moving as waves through a medium such as water is easily understood because we can observe the oscillation of the material. Both

electrical and magnetic energy are transmitted by these waves. Viewed along the direction of transmission, the envelope containing vectors representing an electromagnetic field appears in wave form. Figure 12-1 shows the common method for representing radio energy waves. The radio energy waves have some semblance to water waves in that they retain their size while all traveling at the same speed. Therefore, they could also be represented as concentric circles about the generating device, as seen in figure 12-2. In this case, we could say that the circles represent wave fronts that move away from the source. In the case of focused waves, such as we have with weather radars, we could show the wave fronts moving along the beam path, as in figure 12-3. In all three illustrations, the distance from wave front to wave front, and from any part of a wave to the corresponding part of the next wave, remains constant. This distance is determined by two factors, the speed with which the waves move and the rapidity with which the generating device operates. The generating device is said to oscillate, and could be thought of as moving up and down, or back and forth. Each complete oscillation produces one complete wave. The waves move away from the oscillator as they are being generated so that the wave front will be 1 wavelength away from the oscillator when the next wave front is just being formed. Because the speed of wave travel remains constant, there is a constant, inverse relationship between the frequency of the oscillation and the length of the wave; the faster the oscillation (higher frequency), the shorter the wavelength.

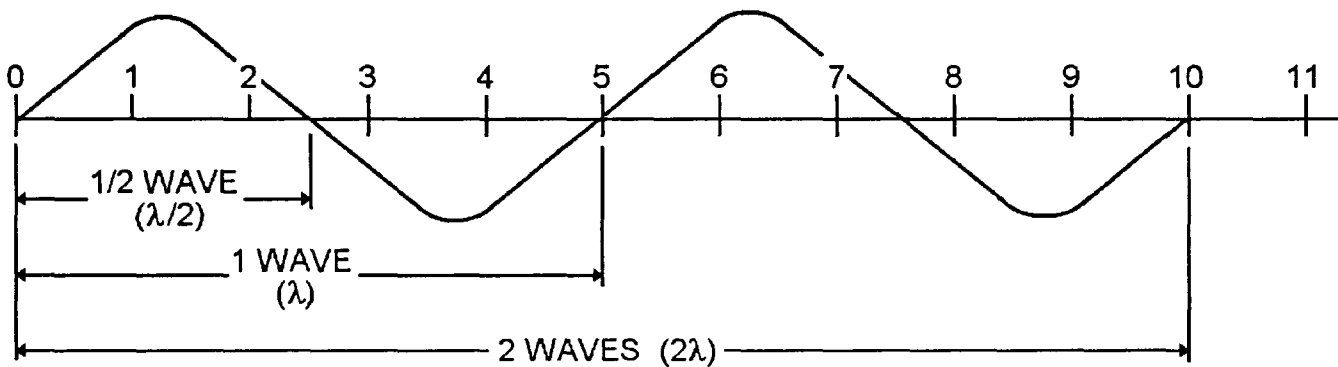

25NP0109

Figure 12-1.-Energy wave represented as oscillations. These are 5 cm long.

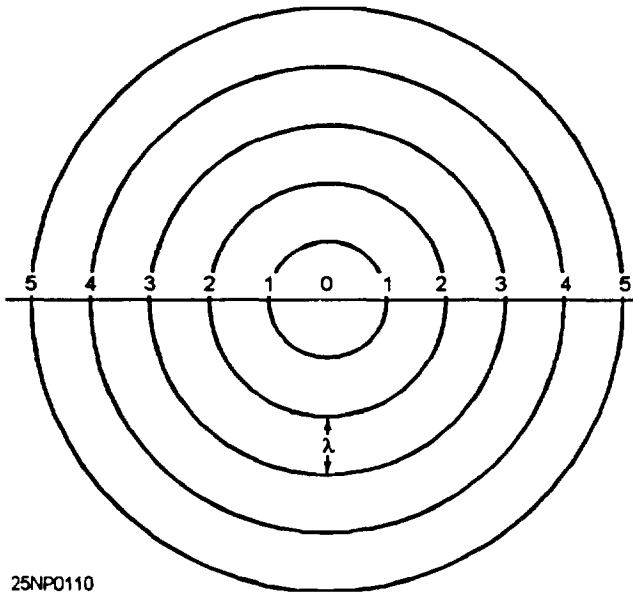

25NPO110

Figure 12-2.-Flve 1-cm energy waves represented as concentric circles around the wave emittcr.

Thus, radar waves can be described either in terms of frequency or wavelength. The two are related by the following equation:

$$\text{FREQUENCY} = \frac{c}{\lambda}$$

where λ is the wavelength and c is the speed of light (300,000,000 meters per second or 3×10^8).

Wavelengths for Weather Radars

All the wavelengths commonly used for radars will be reflected by large objects such as buildings and airplanes, but some waves are so large they are not affected significantly by small objects such as raindrops, and, therefore, do not effectively detect their presence. Other waves are so small that they are completely scattered and absorbed by raindrops and, therefore, cannot penetrate beyond the first drops to detect others

far away. Any object that is easily detected by a particular wave is one that reflects, absorbs, or scatters that wave, decreasing its potential to detect more distant objects. The target for weather surveillance radars is the raindrop, with a diameter usually less than 5 mm. We must select a wavelength small enough to detect the raindrop, but large enough not to be completely reflected and absorbed by a large number of drops. The choice usually comes to either 5- or 10-cm waves.

Wavelength for Cloud Detection Radars

Wavelengths shorter than 3 cm will detect most cloud particles. The optimum wavelength for cloud detection is about 1 cm (anything shorter is too greatly attenuated).

RADAR BEAM CHARACTERISTICS

In the following section we will deal with some of the characteristics of the radar beam.

Beam Height and Width

Although we must always keep in mind that the radar energy discussed here is emitted in short pulses rather than in a steady stream, it is useful to think of the path of the pulses as a beam much like a flashlight beam. Each pulse has three dimensions within the beam-height, width, and length-and each pulse is composed of a number of waves of energy. The beam is created when the energy waves are directed onto the reflector, which focuses them in a desired direction and a predetermined shape. The height and width of each radar pulse is determined by the radar beam shape and size, and the beam, in turn, is determined by the shape and size of the antenna reflector. For weather radars, we almost always use a narrow cone, or "pencil beam," so that we can concentrate the energy in a small spot and make both vertical and horizontal measurements of the

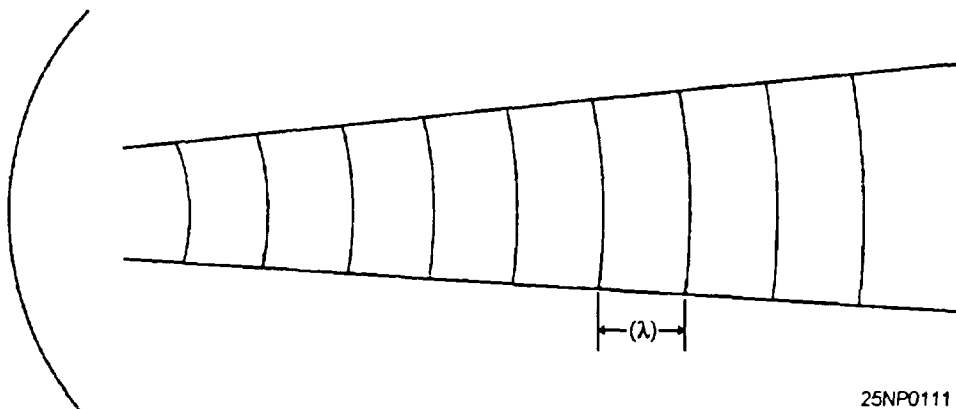

25NPO111

Figure 12-3.-Energy waves represented as concentric arcs inn a radar beam.

location of the targets. This kind of beam is created with a parabolic reflector, the end of the waveguide being at the focal point of the parabola.

Radars display targets on the scope as if the targets are at the center of the beam, even though the target may have been illuminated by energy that has been scattered outside the beam. This means that any object illuminated sufficiently by the radar energy to return to the antenna some of that energy will be shown on the indicators as being directly in front of the antenna, while it actually maybe several degrees to the side. Although this sometimes leads to inaccurate interpretation of the radar-scope information, the problem usually concerns strong targets fairly close to the radar that are masked in the ground clutter.

Pulse Length and Pulse Repetition Frequency

The length (h) of a radar pulse in space is determined by the product of the pulse duration (τ) and the speed of light (c):

$$h = \tau c = \tau(3 \times 10^8 \text{ m sec}^{-1})$$

For instance, a pulse of 1-second duration would have a length of

$$\begin{aligned} h &= (1 \text{ sec})(3 \times 10^8 \text{ m sec}^{-1}) \\ &= 3 \times 10^8 \text{ m} \\ &= 300,000 \text{ km.} \end{aligned}$$

Beam Resolution and Target Distortion

Resolution describes the ability of the radar to show objects separately. There are two distinct resolution problems:

1. Range resolution—The ability to distinguish between two targets in the same direction from the radar, but at different ranges.
2. Beam-width resolution—The ability to distinguish between two targets at the same range, but in different directions.

Both resolution problems arise from the fact that the radar pulse occupies considerable space, and any part of the pulse may illuminate a target sufficiently for detection. If two targets are detected at the same time, the radar will present only one echo on the scope.

Range Effect on Signal Strength and Echo Definition

The cross-sectional area of the radar beam is proportional to the range from the radar, becoming larger as the range increases. Accordingly, the energy incident on a unit area of the beam cross section decreases with range, being inversely proportional to the square of the range. This is often called range attenuation, although the term *attenuation* is more properly applied to the dissipation of energy by the medium through which it passes.

Now let's look at the history of doppler weather radar, as well as a discussion of principles, characteristics, and phenomena associated with doppler radar. Information on doppler radar maybe found in the Federal Meteorological Handbook No. 11 (FMH-11), *Doppler Radar Meteorological Observations*, parts B, C, and D. Additional information maybe found in *The Doppler Radar Glossary, Thunderstorm Morphology and Dynamics*, and *Doppler Radar Principles*, KWXN-5002, KWXN-1005, and KWXN-1002, which are practical training publications produced by the United States Air Force Training School at Keesler Air Force Base, Mississippi.

DOPPLER RADAR

LEARNING OBJECTIVES: Discuss the history of doppler radar. Recognize velocity-aliased data, range-folded data, and ground clutter and assess their impact on radar interpretation. Evaluate doppler velocity and wind shear patterns. Interpret radar presentations of cloud layers and the bright band.

In the following we will be discussing a brief history of Doppler Radar from the first real-time Doppler display in 1967, to the present day Weather Surveillance Radar 1988 – Doppler (WSR-88D).

HISTORY

In 1967, the first simultaneous observations of atmospheric flow patterns by two doppler radars were made. This was performed in central Oklahoma by the National Severe Storms Laboratory (NSSL) and Cornell Aeronautical Laboratory and concurrently in England by the Royal Radar Establishment. Data in these studies was stored in real time and analyzed later. At about the

same time, the first real-time doppler radar display, The Plan Shear Indicator, was developed by the Air Force Cambridge Research Laboratories.

In the early 1970s, a unique new class of high-powered, sophisticated S-band doppler weather radar appeared, incorporating integrated circuitry and advanced computer processing. Two were built by the NSSL. Others were built by the National Center for Atmospheric Research and by the University of Chicago in cooperation with the Illinois State Water Survey in Champaign, Illinois. By the mid 1970s, technological advances allowed real-time processors to be linked to color displays.

Joint Doppler Operations Project (JDOP)

Studies conducted by NOAA Environmental Research Laboratories for the National Weather Service (NWS) during 1975 and 1976 showed that it was not feasible to convert existing network radars to suitable doppler systems. As a result, the historic Joint Doppler Operations Project (JDOP) was conducted from 1977 to 1979 at the NSSL by the Air Force, the Federal Aviation Administration (FAA), and the NWS. This was the true birthplace of the WSR-88D.

JDOP demonstrated the meteorological utility of operational doppler radars and also benchmarked the engineering requirements for the NEXRAD. The NEXRAD program formally began with the establishment of the Joint System Program Office (JSPO) at NWS headquarters in 1979. Since this time, NEXRAD has been officially renamed the (WSR-88D).

A detailed discussion of the WSR-88D PUP and its capabilities is beyond the scope of this text. For a detailed discussion of capabilities and procedures refer to the technical manual, *Operation Instructions Principal User Processor (PUP) Group/Doppler Meteorological Radar WSR-88D*, NAV EM400-AF-OPI-010/WSR-88D.

We will now discuss velocity-aliased data, followed by a discussion on it's recognition.

VELOCITY ALIASED DATA

Doppler radar uses the change in frequency between the outgoing signal and the returning signal (*doppler shift*) to determine radar velocities. However, limitations in velocity measurements do exist. We now will take a look at an example to see what can go wrong.

Trains are designed to go as fast forward as in reverse. The speedometer shows both forward and reverse speed. Refer to figure 12-4 throughout this discussion. Direct reading of speeds between 0-49 mph, whether forward or reverse is quite easy. As with a train's speedometer, radar has limits to speeds that it can measure without error. These speeds that can be measured without error are known as *Unambiguous Velocities*.

In part (a), the train is traveling at 40 mph in a forward direction. The speedometer indicates the correct speed. In part (b), the speed of the train has increased by 20 mph, so that the train is now traveling at 60 mph, but, the speedometer indicates 40 mph in reverse. The maximum forward speed was exceeded on

25NP0112

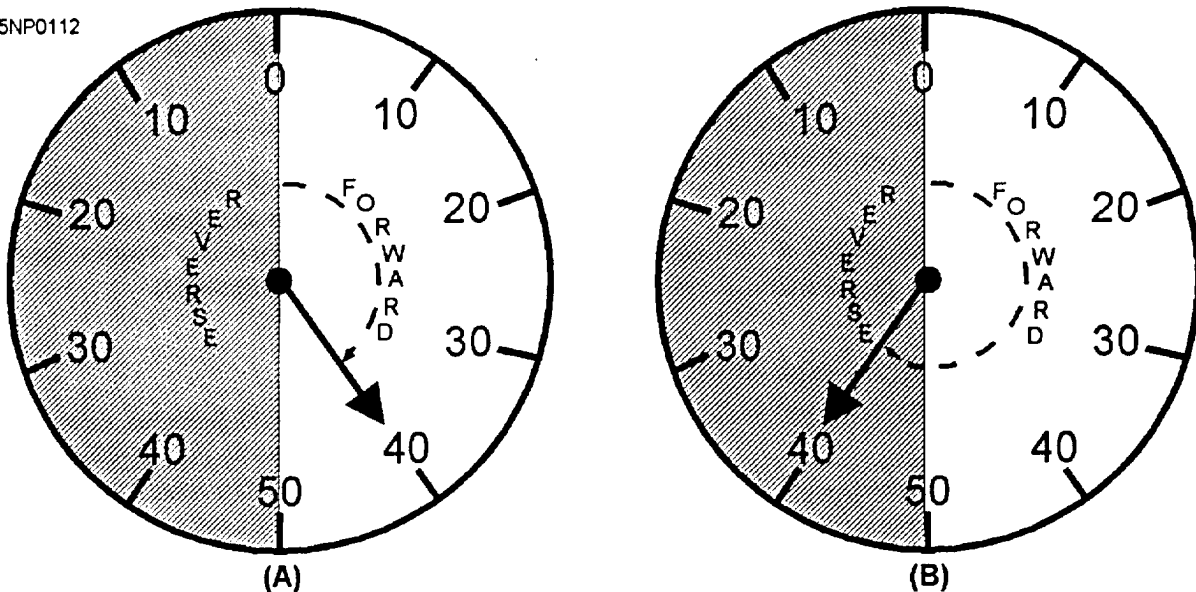

Figure 12-4. Speedometer.

the speedometer, therefore, speeds of 0-49 mph are unambiguous. Radar speeds that exceed the maximum unambiguous velocity are said to be *aliased*, and referred to as *aliased velocities*.

Velocity aliasing occurs when frequencies too high to be analyzed with the given sampling interval appear as a frequency less than the Nyquist frequency (the highest frequency that can be determined in data that has been sampled). In other words, wind speed greater than the unambiguous velocity (Nyquist co-interval [the entire range of detectable velocities]) for the current pulse repetition frequency (PRF) are wrapped around into the incorrect Nyquist co-interval. A sophisticated velocity-dealiasing technique is implemented in the WSR-88D (referenced in part D of the FMH-11). However, it is expected that improperly dealiased data will occasionally occur.

Recognition of Velocity-Aliased Data

Data that are incorrectly dealiased can be difficult to ascertain. However, understanding the limitations of the algorithm should help to recognize improperly dealiased data.

If the suspected data is in an area isolated from other data and there is a large variation in the subsynoptic or mesoscale wind field, the algorithm may not be able to initially assign the correct velocity. Other instances of incorrect dealiasing may occur when there are shifts in the inward- and outward-bound velocities along the radials of data that do not fit those allowed by the algorithm. In these cases, the actual values maybe off by a factor of twice the unambiguous velocity of the PRF in use at the time. Typical unambiguous velocities for the WSR-88D, in the Precipitation mode, range from 40 to 60 kts. Occasionally, groupings of data appear along a small set of ranges that could not be successfully dealiased. These should be obvious.

Assessing Impacts of Velocity Aliasing

Incorrectly dealiased velocity data can seriously impact certain WSR-88D algorithms and products. Mean Radial Velocity products will be difficult to analyze when contaminated with incorrectly dealiased data. To determine the extent of the dealiasing problem, it is recommended that earlier displays of these products be examined to determine if there is time or space continuity. In addition, other elevation angles of the Mean Radial Velocity products may be used to determine if there is vertical continuity.

Algorithms and products that ingest mean radial velocity data can output incorrect results when such data are used. In the case of the mesocyclone detection algorithm, there will likely be a lack of vertical continuity of incorrectly dealiased data. Consequently, only uncorrelated shears should result from using aliased data. In the rare event of a tornadic vortex signature being output in the vicinity of an identified mesocyclone because of vertical continuity of incorrectly dealiased data, other products should be examined to verify the existence of a severe thunderstorm.

It is expected that incorrectly dealiased data will not have a large impact on Combined Shear products because of the amount of averaging of data done by the algorithm.

RANGE-FOLDED DATA

Second trip echoes (*range folding*) occurs when the radar hears a previous pulse, while listening for the most recent pulse.

Due to the sensitivity and narrow beam width of the WSR-88D, precipitation echoes beyond 250 nmi will occasionally appear in closer range due to range folding. However, far more significant are the range ambiguities in the doppler velocity and width fields caused by the WSR-88D'S pulsed doppler sampling interval (referenced in part B of the FMH-11). For any pulsed doppler system, the product of the unambiguous range and the doppler Nyquist interval is a constant function of the wavelength of the radar and the speed of light. Decreasing the PRF allows for a longer listening time, thus increasing the unambiguous range, but, this lower PRF creates a problem in determining radial velocities.

THE DOPPLER DILEMMA

High PRFs are required for high velocity measurements and low PRFs are required for long ranges. The solution to this dilemma lies in finding a balance between the effects of velocity aliasing and range folding. This dilemma is caused by physical restrictions based on the laws of nature. To solve this dilemma, the WSR-88D will use several methods to work around these restrictions. One method is to operate at variable PRFs; the second is to collect refractivity information at low PRFs and velocity information at high PRFs. The two sets of information collected are compared, then processed to estimate true radial velocities and ranges.

The radar interprets velocity and spectrum width returns from beyond the ambiguous range as occurring within the range. Range dealiasing software has been implemented in the Radar Data Acquisition (RDA) component preprocessor. The purpose is to attempt to replace range-folded doppler data to its proper range. This software compares radar power returns from the possible ranges of doppler velocity and spectrum width data. If the power at one possible range is more than the power at the other ranges, the data are assigned to that range and the doppler data from the other ranges are considered ambiguous. If the power from the different cringes is within 10 dB, the doppler data at all those ranges are considered unambiguous. Ambiguous doppler data are flagged as range folded, treated as missing by all algorithms, and are displayed as purple (adaptable) at the principal user processor (PUP).

Recognition of Range-Folded Data

Range-folded data should be easily recognized in a Reflectivity product. Range-folded data have a “spiky” appearance in the radials where they appear. In addition, the reflectivity values where the data are folded will not be similar to those surrounding them.

Range-folded data are detectable by comparing Reflectivity and Mean Radial Velocity products, as well as comparing current displays with previous products for time and space continuity.

Range folding may occur under conditions of anomalous propagation where the radar beam is constrained to follow a path close to the Earth’s surface, or when strong convection occurs beyond the first trip (250 nmi).

When possible, the range dealiasing software will place the doppler velocity and spectrum width data at the proper range. When this software cannot determine the proper range, the data will be flagged and displayed as range folded.

Assessing the Impact of Range-Folded Data

Range-folded data can impact products and algorithms that use reflectivity data. When range-folded data are present, corrupted data are displayed with valid data. Products using multiple reflectivity scans may be affected as well.

The impact of doppler velocity and spectrum width range folding is significant, both in the radar’s unambiguous range limits and in areas of significant velocity data lost due to ambiguous returns. In addition,

range ambiguous values are treated as missing by the velocity-based algorithms and can, therefore, seriously impact those algorithms.

Assessing Impacts of Range-Folded Data on Velocity Products

The presence of range-folded (overlaid) data on Mean Radial Velocity products is inevitable. The inability to determine velocity estimates for the sample volumes results from the inability of the range unfolding algorithm to distinguish between power returns from two or more sample volumes at the same relative location within different trips. Therefore, valid velocity estimates can be derived for only one corresponding sample volume along each radial. The ring of range-folded (overlaid) data at the beginning of the second and subsequent trips is caused by the first trip ground clutter and is a common result of this range unfolding limitation.

NON-METEOROLOGICAL RADAR ECHOES

This section will briefly describe methods of identifying and assessing the impacts of ground clutter, anomalous propagation, sidelobes, and solar effects.

Ground Clutter

Prior to calculation of reflectivity, velocity, or spectrum width, return signals from ranges within the radar’s normal ground clutter pattern are processed to remove most of the signal returned from targets that are stationary (part B of the FMH-11). The portion of signal not removed, called residual clutter, will remain as part of many of the products.

RECOGNITION OF RESIDUAL GROUND CLUTTER.— A low-elevation Reflectivity product will show ground clutter close to the radar or distant mountainous terrain. It will normally appear as a cluster of points (having a speckled nature) or as a large area of contiguous returns. Errors are recognizable as wedges having sharp radial discontinuities from adjacent regions and whose predominant colors differ markedly. Errors may also appear as radial spikes several volume samples in length, whose velocities are shifted toward high positive or negative values. A time lapse of Reflectivity products will show no movement of these returns. With increasing antenna elevations, ground clutter returns will disappear. Generally, mean velocities will be near zero and spectrum widths will be very narrow.

ASSESSING IMPACTS OF RESIDUAL GROUND CLUTTER.— Residual ground clutter near the radar may be recognized by its speckled appearance. When it is imbedded in a meteorological signal over the radar, the velocity dealiasing algorithm may introduce errors in the velocity field due to radial and azimuthal gate-to-gate shears greater than the Nyquist velocity. This problem is most likely to occur in the Clear Air mode using VCP (volume coverage pattern) 31, where the Nyquist velocity is about 21 kts. If this problem occurs in the Precipitation mode, the induced shears may be picked up by the mesocyclone algorithm and carried as a feature.

Ground Clutter Returns from Anomalous Propagation

Anomalous propagation of the radar beam is caused by nonstandard atmospheric temperature or moisture gradients (part B of the FMH-11). Super refraction, which is frequently caused by temperature inversions, bends the beam toward the earth and can cause the radar to detect ground returns from distances far exceeding the normal ground clutter area.

RECOGNITION OF GROUND CLUTTER RETURNS FROM ANOMALOUS PROPAGATION.— With increasing antenna elevation, these returns will usually disappear. A time lapse of Reflectivity products may show apparent motion or changing patterns. There can be a 20 dBZ_e (a decibel of the equivalent radar reflectivity factor) or more difference between adjacent returns in the absence of precipitation, mean velocities maybe near zero, and spectrum widths may be narrow. Ground returns from anomalous propagation mixed with precipitation may result in large spectrum width values and low velocities. Erratic movement of ground returns from anomalous propagation, in comparison with the motion of precipitation echoes, may also be seen.

ASSESSING IMPACTS OF GROUND CLUTTER RETURNS FROM ANOMALOUS PROPAGATION.— Ground return from anomalous propagation mainly affects interpretation of reflectivity echoes in the affected areas. It can cause erroneous output and increase edit time of the radar coded message in these areas. It may also affect algorithmic output; for example, if reflectivity is greater than 30 dBZ_e, erroneous identification of a storm may occur and precipitation accumulation values may be degraded. Super refraction of the radar beam frequently occurs behind the cold air outflow regions of thunderstorms. In these instances, the precipitation processing algorithms may

erroneously interpret the ground returns as precipitation echoes and significantly overestimate the precipitation.

REMOVAL OF GROUND CLUTTER RETURNS FROM ANOMALOUS PROPAGATION.— Anomalous propagation can be removed, to a large extent, by application of the clutter filter to the elevation angles affected. This is accomplished by overriding the clutter map resident in the RDA through editing of the Clutter Suppression Regions menu at the Unit Control Position. Up to 15 clutter suppression regions can be edited in which three levels of suppression can be defined for the reflectivity and doppler channels. Unit Radar Committee guidance on the use of the clutter map editor must be obtained.

If weather is not a factor, that is, when operating in the Clear Air mode or when ground clutter or anomalous propagation is in a precipitation-free sector in the Precipitation mode, it is reasonable to apply the clutter filter. If anomalous propagation is mixed with precipitation, the filter should not be applied.

Sidelobes

An occasional source of data contamination is simultaneous reception of signals at comparable power levels through both the main antenna pattern and its sidelobes (part B of the FMH-11).

RECOGNITION OF SIDELOBES.— Sidelobes are found to the right, left, above, and below high reflectivity areas. Potential interference from sidelobes can be diagnosed by knowing how much difference in power there is between the main beam and the sidelobe. The location of potential sidelobe interference will be specified by a particular number of degrees between the axis of the main beam and the sidelobe. The velocity field of sidelobes will display noisy or erratic values. Spectrum widths will achieve extreme values and are the best indicator of sidelobe interference.

ASSESSING IMPACTS OF SIDELOBES.— The presence of sidelobes may indicate erroneously high storm tops or new storm growth where there is none. Sidelobes can also impact velocities in a weak echo region, where mesocyclones occur, by providing noisy or erroneous values that mask true velocity patterns. Algorithmic output may be affected.

Solar Effects

Due to the sensitivity of the WSR-88D, anomalous returns near sunrise or sunset usually appear for several radials. These returns are generated because the sun

radiates energy in the same microwave region of the electromagnetic spectrum that is used by the WSR-88D.

RECOGNITION OF SOLAR EFFECTS.— These echoes may be expected to appear as continuous returns, in a narrow “baseball bat” shape, out one or two radials at the solar attitude. Reflectivity values generally range between 10 and 20 dBZe. See figure 12-5. Solar effects will appear for one or two volume scans at a single elevation of the Reflectivity, Mean Radial Velocity, or Spectrum Width product and up to 30 min on a Composite Reflectivity product.

ASSESSING IMPACTS OF SOLAR EFFECTS.— In the absence of other echoes, typical reflectivity values from solar effects are from near zero dBZe in close to the radar, to 20 dBZe or higher at 250 nmi. The apparent reduction in the sun’s signal nearer the radar is due to the range normalization correction applied to reflectivity. The velocity and spectrum width fields indicate range-aliased data out to the maximum range of these products, that is, 124 nmi. Other Reflectivity-derived products that will show this

contamination are the Echo Tops, Composite Reflectivity, and Layer Composite Reflectivity. The Storm Series algorithms will generally not be affected since the reflectivity values are below the thresholds used to detect storms.

Velocity-derived products that will be contaminated are the Storm Relative Mean Radial Velocity Map, and Region. At longer ranges, the contaminated radial may disrupt pattern vectors used to identify circulations in the mesocyclone algorithm, where the sun’s signal is stronger than the corresponding storm echo. At close-in ranges, the sun’s signal is too weak to impact the Tornado Vortex Signature algorithm.

The solar effects can also cause erroneous output and increase edit time of the radar-coded message in these areas.

INTERPRETATION OF DOPPLER VELOCITY PATTERNS

Although a single doppler radar observes only the component of the wind in a radial direction from the

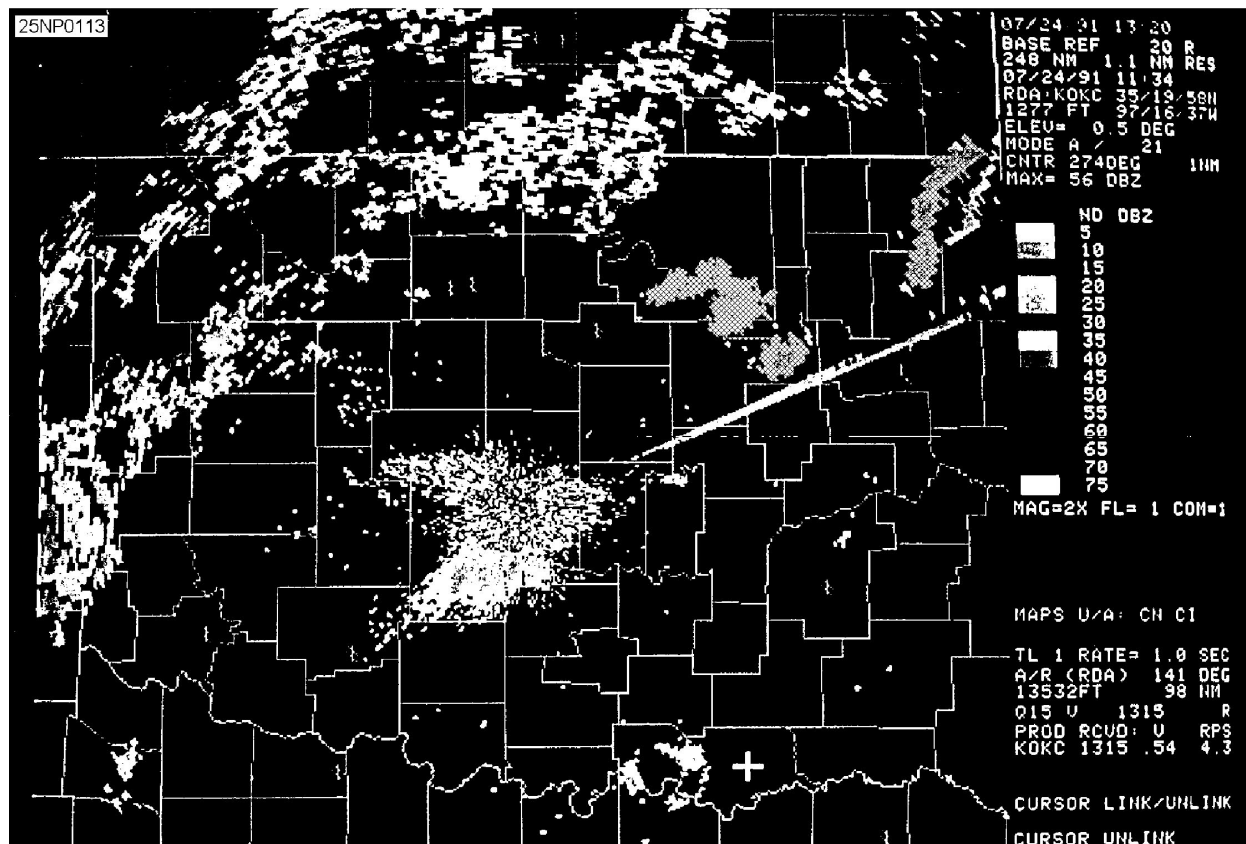

Figure 12-5.-Streaks of low reflectivity extending outward for two radials to the northeast of the radar caused by solar effects.

radar, a wide variety of weather features of great importance can be identified. It is beyond the scope of this manual to describe the interpretation of doppler velocity patterns. For a detailed explanation of the interpretation of doppler velocity patterns refer to the FMH-11 (part B).

MESOCYCLONE SIGNATURE DETECTION

Mesocyclones have been found to be precursors to many tornadoes. They generally have a core diameter of 1.5 to 5 nmi, maximum tangential velocities of 40 kts or greater, and time and height continuity. Previous doppler experiments have found that weak mesocyclone signatures generally result in severe thunderstorms. Stronger signatures generally produce tornadoes, especially if a tornadic vortex signature is present.

If an alert is received that a mesocyclone exists, or if there is no alert, but a mesocyclone is suspected, there are several products that can be used to confirm its presence. These products and how they might be used are discussed in the following paragraphs.

Recognition of a Mesocyclone Signature

A mesocyclone typically will develop at the midlevels of a tomadic storm and build down to lower levels as the storm matures. It may be possible to monitor development of storm rotation or a mesocyclone in the velocity field. The time lapse capability with continuous update may be useful in monitoring this development. In the velocity field, the feature will appear as two velocity peaks of opposite signs, separated azimuthally.

Interrogation of different elevation scans of the Mean Radial Velocity product (at 2000 ft intervals between 15,000 and 19,000 ft) can aid in determining the height continuity of a mesocyclone. The Quarter Screen mode can be useful for this purpose.

If correctly oriented through the storm, storm rotation (cyclonic or anticyclonic) or a well-developed mesocyclone may be evident in the Mean Radial Velocity Cross Section product. The cross section should be generated perpendicular to the mean flow. If a mesocyclone is not evident in the Mean Radial Velocity product or the Severe Weather Analysis Mean Radial Velocity product, the Storm Relative Mean Radial Velocity Map or Region products may display this feature (part C of the FMH-11).

Removing the storm motion may aid in the detection of a mesocyclone, but the mesocyclone circulation

pattern will exist in the velocity field even if the storm motion is not removed.

In the presence of a strong rotational signature, the Combined Moment product can be very useful in determining the existence of a mesocyclone. In such a case, rotational phenomena should be clearly evident due to the relative position of the arrows in a given area. In addition, high reflectivity core and high spectrum width values may be evident in the area.

In a tornadic supercell, doppler data have indicated that a separation of the mesocyclone core from the bounded weak echo region occurs prior to or during the collapse of the bounded weak echo region. With the development of severe weather possible at this stage, the separation of the mesocyclone core from the bounded weak echo region may be monitored by displaying an appropriate Reflectivity product on one graphic screen and a Storm Relative Mean Radial Velocity Map product on the other. A time lapse of the Mean Radial Velocity or Storm Relative Mean Radial Velocity Map product, magnified on the storm under investigation, may prove very useful in determining the separation of the mesocyclone core from the bounded weak echo region. If a mesocyclone is evident in the Mean Radial Velocity product, this separation may be monitored using the time lapse capability with continuous update for the Mean Radial Velocity and Reflectivity products.

Considerations

The mesocyclone algorithm provides the position of the feature reflected onto the lowest elevation angle in which the feature was detected. This is due to the fact that mesocyclones are often tilted and are, therefore, displaced at higher elevations. Mesocyclones may not always be identified by the algorithm for high reflectivity core storms, for storms that produce downbursts, or for weak tornadoes produced as a result of convergence boundaries. Since there is no tracking algorithm for mesocyclone features, time continuity must be established. In addition, the Storm Relative Mean Radial Velocity Map and Region products display the maximum velocity sampled over four 0.13 nmi range bins. The peak velocity values, and thus the peak shear associated with a mesocyclone feature, are more likely to be displayed on these products than on the Mean Radial Velocity product, which simply displays every fourth 0.13 nmi range bin at the same resolution.

Depending upon selection of storm motion removal, the existence of a mesocyclone may be more evident in the Storm Relative Mean Radial Velocity Map and

Region products than in the Mean Radial Velocity product.

Due to beam broadening and an average mesocyclone size of 2.7 nmi, the range of detection is generally limited to about 124 nmi. Mesocyclones formed in vertical wind shear may not be detected beyond 38 nmi due to the small size vorticity maximum found at low levels, and initial formation in a precipitation-free environment.

Multiple mesocyclone cores can form within a storm complex, but not in the same cell.

WIND SHEAR

A major hazard to aviation is the presence of low-level wind shear. Wind shear may result from a variety of phenomena such as synoptic fronts, boundaries associated with thunderstorms, terrain, and nocturnal inversions.

Recognition of Wind Shear

Wind shear will appear as a discontinuity in the doppler velocity field and is frequently associated with wide spectrum widths. Monitoring changes in the velocity field over time is likely the best approach to recognition of wind shear phenomena. Low-level wind shear can be detected close to the radar in the Mean Radial Velocity product. An indication of extreme shear will show up in a narrow band in the velocity field. This narrow band will likely not be identified in the Velocity Azimuth Display Wind Profile product. However, this product can be useful in keeping track of significant wind speed and direction changes within about 16 nmi of the radar and provide an indication of shear in the vertical.

Variations in the spectrum width field are related to the mean wind shear across the radar beam; therefore, a shear layer(s) will usually show up as an enhanced area in the Spectrum Width product. Values of 14 kts, or higher, are usually associated with significant wind shear or turbulence, or both.

Considerations

The Combined Shear product could be useful for the detection of areas affected by strong wind shear. The product, however, tends to be “noisy” and, in the absence of strong signatures, may be of little use. The product does not take vertical shear into account. For indications of shear in the vertical, the Mean Radial

Velocity or Spectrum Width Cross Section products may be useful.

CLOUD LAYERS

The sensitivity of the WSR-88D provides the user the capability of detecting cloud layers. This information has application to such things as aviation forecasting and forecasting the evolution of precipitation.

The WSR-88D can detect large ice crystals that are present in middle and high-level clouds. These reflectivities may range as high as plus 20 dBZ_e. The Velocity Azimuth Display algorithm will use doppler velocity measurements from middle and high level clouds to generate profiles into the middle atmosphere. These wind profiles allow the operator to monitor the movement of synoptic and smaller scale waves and troughs.

Recognition of Cloud Layers

With the high sensitivity of the WSR-88D, it is possible to obtain reflectivity estimates of elevated clouds, which generally reflect at levels between minus 12 to plus 5 dBZ_e.

The depth of cloud layers maybe inferred from two processes. A four-panel display of the Reflectivity product for successively higher elevation scans can provide information on the depth as well as the structure of a layer. The top of a cloud layer and its depth can also be inferred from a Reflectivity Cross Section product, depending on the distance from the radar and the viewing angle. However, resolution is better with the Reflectivity product than the Cross Section product since the cross section integrates returns from the surface to 70,000 ft.

The following is a technique that will allow the determination of the top, base, and depth of a cloud layer. Using the Reflectivity product for the elevation that intersects the cloud layer, place the cursor at the point where the base appears to be and get a readout on the screen of azimuth, range, elevation, and height. Then, place the cursor at the apparent top of the cloud layer and get the same information. The depth can be computed from the difference in heights. If the cloud base or top is not uniform, this technique will have to be repeated several times to get average heights and thicknesses. This will also help ensure that the true radar cloud top and base are being observed.

An increasing moisture source and gravity waves in the velocity field can also be detected. Gravity waves should coincide with the alternating increases and decreases in reflectivity. This may also be apparent in the Echo Tops product if the minimum reflectivity threshold of 18 dBZ_e is met.

Considerations

In the Clear Air mode, cloud detection maybe best using VCP-31 due to a better signal-to-noise ratio. If the minimum reflectivity threshold of 18 dBZ_e is met, the Echo Tops product can provide an indication of the top of a cloud layer. Layer Composite Reflectivity products may show returns at given layers, indicative of clouds. These products should be supported with the use of the Reflectivity product to determine the existence and extent of the cloud layers. Stratus clouds and fog will usually not be detected by the radar due to small cloud particle size.

The Velocity Azimuth Display Wind Profile product may be useful in determining moisture advection for development of cloud layers, depending on distance from the radar.

For further discussion of preconvective, convective, multicell and supercell development as well as severe storm identification, refer to part D of the FMH-11.

THE STRUCTURE OF LARGE-SCALE PRECIPITATING WEATHER SYSTEMS

The character of precipitation is largely controlled by vertical air motions. Radar observations of the aerial extent, and lifetime of precipitation systems are evidence of the physical processes at work in the atmosphere. Depending on the dominant mechanism responsible for the vertical air motion, precipitation is usually classified into one of these two types:

1. Stratiform – Widespread, continuous precipitation produced by large-scale ascent due to frontal or topographical lifting or large-scale horizontal air convergence caused by other means.

2. Convective – Localized, rapidly changing, showery precipitation produced by cumulus-scale convection in unstable air.

The distinction between stratiform and convective precipitation is not always clear in practice. Widespread precipitation, for example, is often accompanied by fine-scale structures, or embedded convective elements. In fact, precipitation systems generally are composed of a wide spectrum of scales and intensities. Nevertheless,

it is usually possible to classify precipitation patterns by their dominant scale.

Stratiform Rain or Snow

Stratiform precipitation is most often produced in nimbostratus clouds or dissipating cumulus clouds. Upward air motions are weak and the vertical structure of the reflectivity pattern is closely related to the precipitation patterns by their dominant scale.

The presence of stratiform precipitation facilitates wind measurements with the velocity azimuth display (VAD) to much higher altitudes than possible in clear air (part B of the FMH-11). The wind profiles observed during precipitation may be useful in determining the nature of fronts. A layer of warm air advection (veering of wind with height) is evident from the “S” pattern near the surface (at close slant ranges). Cold air advection (backing with height) is present at greater altitudes (far slant ranges). Generally, the reflectivity pattern depicts stratiform precipitation without prominent small-scale features.

On some occasions, mesoscale precipitation bands form within the stratiform precipitation area. The band is just ahead of and parallel to the wind shift line marking the location of the cold front. Other bands have different orientations with respect to cold fronts. Bands also occur in the vicinity of warm fronts and in precipitation areas away from frontal locations, particularly in the warm sector of a large-scale system.

Mesoscale Convective Systems

Some large-scale precipitating systems begin as combinations of a number of convective elements. The resulting system, although still feeding on unstable air, takes on a character much different from typical cumulus-scale convection. Regions of strong convection and heavy showers can become randomly distributed within a larger area of developing stratiform precipitation, or the strong convection can be limited to the large system's leading edge with the rest of the system primarily composed of stratiform rain. When organized in a linear fashion, the convective cells are typically distributed along a band about 20 km (11 nmi) wide and hundreds of kilometers long. The bands are usually related to low-level convergence and wind shear, but the Earth's topography also affects the structure of the rain areas. The characteristics of precipitation bands have been categorized, but it is not completely understood why precipitation has the strong

tendency to become organized into the characteristic scales and patterns that are observed.

Precipitation areas can be grouped into categories of size and lifetime. Observations show that synoptic areas that are larger than 29,000 nmi² have lifetimes of one day or longer; large mesoscale areas that range from 2,900 to 29,000 nmi² last several hours; small mesoscale areas that cover 54 to 216 nmi² last about an hour; and elements that are about 5.4 nmi² in size usually last no longer than half an hour. Although the smallest elements have the highest rain rates, the major contribution to the total rainfall over large areas comes from the small and large mesoscale features.

The Mesoscale Convective System (MCS) includes all precipitation systems 11 to 270 nmi wide that contain deep convection. Examples in middle-latitudes are large isolated thunderstorms, squall lines, Mesoscale Convective Complexes (MCCs), and rainbands. The aerial extent of these systems is generally too large to be covered by a single radar. Examinations of composite maps from a network of radars is required to capture the full extent of most MCSs.

Refer to part B of the FMH-11 for further discussion of mesoscale convective systems.

THE BRIGHT BAND

In stratiform precipitation where lower portions of the echo are at above freezing temperatures, a thin layer of relatively high reflectivity (bright band) is often observed just below the level of 0°C. As snowflakes descend into this layer, they begin to melt and stick together. The radar reflectivity of the large wet snowflakes is higher, principally because of their large size and because the dielectric constant of water exceeds that of ice by a factor of five. Descending further below the bright band, the snowflakes become more compact, break up, and become raindrops. The raindrops fall faster than snowflakes so their concentration in space is diminished. This decrease in size and number density of hydrometers accounts for the lower reflectivity just below the bright band.

The last section of this chapter will deal with the Next Generation Weather Radar (NEXRAD) program.

WEATHER SURVEILLANCE RADAR 1988-DOPPLER (WSR-88D)

LEARNING OBJECTIVES: Recognize criteria for the three groups of alert thresholds. Understand data access procedures for the WSR-88D. Be familiar with the various user functions, as well as archiving procedures.

The following discussion will deal with weather radar alert areas and thresholds, the editing and sending of data, and the various user functions of the WSR-88D.

ALERT AREAS AND THRESHOLDS

Radar product generators (RPGs) can automatically issue alerts upon detection of user-specified meteorological phenomena. Automated alerts relieve the operator from constantly monitoring the Principle User Processor (PUP) for significant meteorological phenomena and allow automatic generation of paired products when a particular phenomena occurs. The forecaster determines various thresholds for meteorological phenomena. The PUP operator then selects which phenomena and associated threshold values to use, based upon local watch/warning criteria.

Alert Thresholds

Alert thresholds allow several individual PUPs to select agency unique alert threshold criteria. Alert threshold criteria are broken down into three groups preset at the Unit Control Positions (UCPs):

1. Grid Group- Alert areas based on geographical points or grid boxes that occur within a user-defined alert area. The first grid box within a defined alert area that meets or exceeds a phenomena threshold triggers the alert.

2. Volume Group – These are alerts occurring within a user-defined area requiring completion of a volume scan. Detection is based on meteorological phenomena meeting or exceeding an assigned threshold or algorithm output. If there is more than one storm exceeding a category threshold in the same alert area, the alert triggers on the stronger storm.

3. Forecast Group – Alert categories with this group are storm based only and are triggered when phenomena is located in or forecast to enter an active alert area. This group is storm oriented (based on the

movement of a storm associated with the phenomena) and requires a complete volume scan..

To enter the alert you first determine which of the three alert thresholds groups correspond to the geographically based alert area(s) you are considering.

DATA ACCESS

The following section will deal with the editing of products, annotations, maps, and alert areas.

Edit/Send Radar Coded Messages (RCM)

In general, there are two types of RCM products sent out by the RPG. One type is the operational RCM, which is called the post-edit alphanumeric RCM. This RCM is available to all PUPS and is displayed only on the alphanumeric terminal via the Display menu. It is requested from the RPG either via the Display menu or the RPS list. This is an alphanumeric-only product that may have already undergone editing at the PUP and been returned to the RPG for distribution.

The other type of RCM is the pre-edit version to be edited by one designated PUP per NEXRAD unit. There is adaption data at the PUP which specifies whether the PUP is designated for editing of the pre-edit version of the RCM. This is called the Edit RCM flag. It is located on the RCM Parameter edit screen which is accessible from the Extended Adaption Data menu, which, itself, is accessible via password from the Adaption Data menu. The RPG also has adaption data which specifies which PUP in the NEXRAD unit is designated to receive, edit, and return the pre-edit version of RCM. This adaption data must match the PUP adaption data as to who is to do the RCM editing.

Generation/Distribution of Free Text Messages

Any PUP can generate free text messages (FTM) and distribute them to other users. Only RPG OP can distribute messages to the RPG. While the message is being generated, it is called a PUP text message (PTM). This generated PTM is known as a FTM by the RPG after it is distributed. When messages are received from any RPG, they are considered FTMs.

Edit/Send Product Annotations (Graphic)

Product annotations for graphic products are overlays. These annotations can be selected for display by default whenever the annotated product is displayed using the Overlay Associations edit screen. A PUP or

RPG OP can annotate any graphic product Only an RPG OP can send a product's annotation to the RPG. When an annotation is generated for a particular product, the annotations are associated with only that one specific version of the product. After generation via the graphic screen, a graphic product's annotation can be distributed to the RPG by using an alphanumeric terminal command listed on the Gen and Distribute Products menu. Once the annotations are sent to the RPG, the RPG may distribute the annotated product to the PUPS, and the "Other Users" on its distribution list.

Edit Background Maps

To enable the editing of background maps, the System Option Command (P)ASSWORD, (E)DIT MAPS, (E)NABLE must have been selected previously (since the last PUP restart).

There are two versions of both the low- and high-detail maps; the original (which cannot be altered) and the modified (the latest edited version).

Edit Alert Areas and Alert Categories

There are two separate alert areas that are definable by each PUP for the NEXRAD unit coverage area via the graphic tablet and on one of the graphic screens. The other graphic screen will operate normally during this procedure.

Alert areas 1 and 2 are separate overlays displayable with products. When a product is displayed with an alert area overlay, only the included alert boxes are displayed.

Each alert area has its own set of up to 10 alert categories associated with it. These categories describe the types of alerts and the threshold level numbers that trigger alerts.

Section 12 of the technical manual, *Operation Instructions Principal User Processor (PUP) Group/Doppler Meteorological Radar* contains detailed guidance on editing/sending of RCMs, generation/distribution of FTMs, editing/sending product annotations (graphic), editing background maps, and editing of alert areas and alert categories.

USER FUNCTION OPERATIONS

User function operations provides a way for the operator to predefine up to 31 normal PUP operator selections into a single user function. Upon subsequent selection of a user function for execution, each of its predefine selections is performed in sequence, as

though they had been individually selected by the operator. This feature is particularly useful for function sequences that are time consuming and frequently performed.

User functions may be linked to other user functions at any sequence, or into a loop, so that they may run continuously until canceled. Time delays may be built into user functions to allow time for correct execution, operator observations, or prescheduled sequences.

Discussion of all PUP user functions are beyond the scope of this text. For a detailed discussion of user functions, time delays within user functions, end user function definitions, examining/editing user functions, executing user functions, and the canceling of user functions, refer to section 11 of the technical manual, *Operation Instructions Principal User Processor (PUP) Group/Doppler Meteorological Radar*.

STATUS AND ALERTS

There are two types of status and alerts: those that are selected and those that are automatically displayed.

The 11 operator selected status options are as follows:

1. NEXRAD Unit Status (operator selected and automatic display)
2. Types of Products Available in PUP Data Base
3. Products in PUP Data Base (by ID number)
4. Earliest time in PUP Data Base
5. RPG Products Available
6. Monitor Performance Display
7. System Status
8. Status of Archive
9. Communications Line Status
10. Status of Background Maps
11. Alert Status Display

All of these may be selected via the alphanumeric (S)TATUS or (M)ONITOR PERFORMANCE commands. The NEXRAD unit status is also available as a graphic display, selected from the graphic tablet.

Discussion of PUP status and alert functions are beyond the scope of this text. For a detailed discussion of status and alert functions, refer to section 8 of the technical manual, *Operation Instructions Principal*

User Processor (PUP) Group/Doppler Meteorological Radar.

ARCHIVING DATA

All archive functions may be selected via the alphanumeric (A)RCHIVE menu. The archive functions are used to record to optical disk and recall from optical disk: products, received background maps, and status message data. Only one non-auto archive function may be performed at a time per archive device. Monitor performance data is recorded onto a streamer tape rather than an optical disk.

PUP archived optical disks or RPG archived optical disks may be used at any PUP location. However, at a PUP or RPG, created optical disks can only be read, not written to. If archived products are to be read in by another PUP associated with a different RPG, it is possible to archive background maps with them. The background maps must be requested from the RPG over the dial-up communications line or read in from an optical disk in order to be able to archive them. Optionally, the other PUP may have the necessary set of maps prestored on optical disk. When reading an archive optical disk with products from another RPG, you must read the correct set of background maps off this or another optical disk before the products can be displayed with maps. Maps for the associated RPG can be read from optical disk into the associated background map file. Additionally, maps from up to three non-associated RPGs can be read from optical disk and be stored in auxiliary map files where they remain until they are replaced by retrieval of a selected map set from optical disk to a specified auxiliary map file.

Optical disks used in the Training mode are created using the write archive functions. If an optical disk is to be used for training, and the training is to be performed at a different PUP site than where the optical disk was made, follow the instructions in the previous paragraph on using optical disks at other locations.

There are two types of archive devices associated with a PUP system, optical disk and streamer tape. The optical disk is the main archive device and is used for writing to and retrieval from optical disk, background maps (received from an RPG over a dial-up line), status messages, and associated/auxiliary map sets. The streamer tape device is used only for the archive of monitor performance file data.

Discussion of archiving optical disk and tape usage is beyond the scope of this text. For a detailed discussion of archiving optical disk and tape usage, refer

to section 10 of the technical manual, *Operation Instructions Principal User Processor (PUP) Group/Doppler Meteorological Radar*.

SUMMARY

In this chapter, we first discussed nondoppler radar and the effects of wavelength and frequency on radar performance. Next we looked at wavelengths for weather and cloud detection radars followed by an examination of radar beam characteristics. A discussion of the development of Doppler radar was then presented, followed by an overview of the system's characteristics and many benefits. Some problems associated with

Doppler radar were also discussed. The last section of this chapter dealt with principles of the Weather Surveillance Radar (WSR-88D), including alert areas and thresholds, data access, user functions, status and alerts, and the archiving of data.

The practical training publications, *The WSR-88D System Concepts*, KWXN-1003, and *WSR-88D Products*, KWXN-1004, produced by the United States Air Force Training School, Keesler Air Force Base, Mississippi, offer additional guidance and technical reference for the WSR-88D system, concepts, and products.

CHAPTER 13

METEOROLOGICAL AND OCEANOGRAPHIC BRIEFS

In previous chapters of this manual you were given information on various aids available to help you provide the best products to on-scene commanders. This chapter will deal with the briefing of just a few of these aids. In addition, we will highlight specific environmental factors that must be considered when mine warfare and amphibious warfare briefings are being prepared.

Now that you have been given all this information, your biggest challenge may be to sell it to the on-scene commander.

The success of any operation or exercise depends, to a large extent, on the various “players” being prepared for any eventualities. It is of utmost importance that the Aerographer become aware of these “what ifs” and brief the players accordingly.

Unit 5 of *AG2 TRAMAN*, Volume 2, NAVEDTRA 10371, covers briefing techniques. It would be to your advantage to review this material prior to conducting any METOC briefings.

TROPICAL CYCLONE DISASTER PLANNING

LEARNING OBJECTIVES: Evaluate unit/activity preparedness for tropical cyclones. Familiarize yourself with sources of information used in the preparation of tropical cyclone briefs.

In order to brief tropical cyclone advisories/warnings effectively, a thorough understanding of tropical cyclone principles, characteristics, and climatology must first be understood. These topics were discussed in detail in chapter 11.

PREPAREDNESS

When dealing with tropical cyclone preparedness you should be aware of the following important items:

- The affects that a tropical cyclone may have on units or activities
 - What activities are prone to wind, sea, and/or surge damage
 - The significance of wind direction and time of onset of severe weather
 - The potential for evacuation or sortie
- That effective lines of communication must exist throughout the threat period

SEVERE WEATHER CONDITIONS OF READINESS

OPNAVINST 3140.24 provides specific guidance and criteria for issuing conditions of readiness (COR). Destructive weather poses a significant threat to personnel, ships, aircraft, installations, and other resources. Adequate and timely weather warnings, coupled with prompt and effective action by commanders concerned, will minimize loss and damage from destructive weather. Table 13-1 lists the conditions of readiness for tropical cyclones, subtropical, or extratropical wind storms. The lower portion of table 13-1 list the conditions of readiness for small area storms, that is, thunderstorms and tornadoes.

Local area forecaster handbooks and climatological data are very valuable as planning tools in preparing and presenting tropical cyclone disaster briefs.

For further information on tropical cyclone disaster planning and associated phenomena, see module 12 of the *Composite Warfare Oceanographic Support Modules (CWOSM)*.

Table 13-1.-Conditions of Readiness

CONDITIONS OF READINESS	
TROPICAL CYCLONE, SUBTROPICAL, OR EXTRATROPICAL WIND STORMS (Issue using gale, storm, tropical storm or hurricane/typhoon to indicate force of destructive winds.)	
CONDITION IV	Trend indicates a possible threat of destructive winds of the force indicated within 72 hours . Review hazardous and destructive weather implementation plans, as established by local regulations.
CONDITION III	Destructive winds of the force indicated are possible within 48 hours . Take preliminary precautions.
CONDITION II	Destructive winds of the force indicated are anticipated within 24 hours . Take precautions that will permit establishment of an appropriate state of readiness on short notice.
CONDITION I	Destructive winds of the force indicated are occurring or anticipated within 12 hours . Take final precautions as prescribed.

SMALL AREA STORMS	THUNDERSTORM OR TORNADO CONDITIONS
CONDITION II	Destructive winds accompanying the phenomena indicated are expected in the general area within 6 hours . Associated lightning/thunder, torrential rain, hail, severe downbursts, and sudden wind shifts are possible. Take precautions that will permit establishment of an appropriate state of readiness on short notice.
CONDITION I	Destructive winds accompanying the phenomena indicated are imminent or are occurring . Associated lightning/thunder, torrential rain, hail, severe downbursts, and sudden wind shifts are possible. Take immediate safety precautions and shelter.

**BRIEFING CLIMATOLOGICAL
SUMMARIES OF TROPICAL
CYCLONE STORM
TRACKS**

LEARNING OBJECTIVES: List the sources for obtaining climatological tropical cyclone storm track information.

There may be occasions when climatological data is required for an area for which your activity does not hold the necessary climatology publications. FNMOC Asheville prepares the publication, *Atmospheric Climatic Publication*, FLENUMMETOCDET ASHEVILLENOTE 3146, which contains a concise list

of climatological publications, and the procedures for obtaining them.

Among those available to assist the Aerographer are:

- *Marine Climatic Atlases of the World*
- *Global Tropical/Extrotropical Cyclone Climatic Atlases*

Since 1990 FNMOC Asheville has been shifting away from climatic atlases in hard copy to compact disc-read only memory (CD-ROM).

We will now discuss a few Geophysics Fleet Mission Program Library (GFMLP) products used as aids in the event of evasive and/or sortie measures due to tropical cyclones.

**BRIEFING OF TROPICAL CYCLONE
EVASIVE/SORTIE
RECOMMENDATIONS**

LEARNING OBJECTIVES: Identify GF MPL products used as aids in assessing tropical cyclone evasive/sortie recommendations.

Aerographers can't have too many METOC products at their disposal to assist them in their day-to-day duties. They must put all their experiences and learning to use, particularly when a tropical system is bearing down on an activity or unit. The *Geophysics Fleet Mission Program Library (GF MPL) Summary*, GF MPL-SUM-91-01, provides meteorological, oceanographic, electromagnetic, and acoustic software for use as aids in planning various operations.

WARNINGS PLOT

The Warnings Plot program is composed of three primary functions: Tropical Cyclone Plot, High Winds Plot, and High Seas Plot. The Warnings Plot program provides the capability to enter Tropical Cyclone, High Winds, and High Seas warning messages and their subsequent forecasts or both. This product is available on GF MPL HP-9020.

ADDITIONAL GF MPL AIDS

Two additional programs available in GF MPL to assist the Aerographer with tropical cyclone preparation are Tropical Cyclone and Tropical Cyclone Applications Software System (TCASS).

Tropical Cyclone

GF MPL offers the program, TROPICAL CYCLONE, which plots tropical cyclone track and forecast information on a map background.

Tropical Cyclone Applications Software System (TCASS)

Tropical cyclones can pose a serious threat to the safety of ship and battle group operations. TCASS is designed to be used by Aerographer personnel to evaluate the probability that dangerous tropical cyclone winds will threaten the ship or battle group. These tropical cyclone applications programs can also be used to evaluate the threat of tropical cyclone winds at ports

and other locations. In the event that the probability of encountering dangerous winds exceeds the critical probability specified by the operator, these tropical cyclone applications programs may also be used to reroute the ship around hazardous areas.

SURGE BRIEFING AIDS

LEARNING OBJECTIVES: Identify Geophysics Fleet Mission Program Library (GF MPL) products used as aids in assessing surge threats.

The greatest danger to coastal areas being threatened by a tropical cyclone is not necessarily the extreme winds, but the wall of water being pushed ahead of the storm by those winds. Tropical storm surges have caused much devastation over the last 50 years to structures along the coastline. Forecasting of maximum surge heights will allow preparations to be made accordingly.

The *GF MPL Summary*, GF MPL-SUM-91-01, contains a program called SURGE that serves as an aid in the planning of the surge threat.

The SURGE program provides an approximation of peak storm surge for tropical cyclones moving onshore or alongshore on the Atlantic or Gulf coasts of the United States (a similar program for the Pacific region is not yet available). This estimate provides a "worst case" storm surge for any given storm and location. This information can be used in choosing precautionary actions for coastal activities. The estimated peak storm surge is a function of storm and coastline characteristics. Radius of maximum winds, central pressure drop, and storm speed and direction are inferred from the tropical cyclone warning. The user may specify a coastal station of interest from the list provided by SURGE, in which case the shoaling factor (the effect of the surge approaching shallower water) and coastline orientation are retrieved from the SURGE data base, or the user may also enter these values directly. Now let's look at METOC effects on various warfare operations.

METOC EFFECTS ON VARIOUS WARFARE OPERATIONS

LEARNING OBJECTIVES: Identify the publication that outlines the contents of antisubmarine (ASW), space and electronic warfare (SEW), strike warfare (STW), antisurface warfare (ASUW), and antiair warfare (AAW) briefs.

It is beyond the scope of this text to discuss all the information considered important for the various METOC briefs listed below. Significant information regarding these briefs, for the most part, is confidential. Refer to the text *Environmental Effects on Weapon Systems and Naval Warfare*, (S)RP1, for a discussion of these topics:

- Environmental factors affecting ASW operations
- Environmental effects on special warfare
- Environmental effects on SEW
- Environmental effects on chemical, biological, and radiological (CBR) operations
- Environmental considerations for STW operations
- Environmental considerations for ASUW operations
- Environmental considerations for AAW operations
- Target environmental conditions

Now let's discuss those elements of importance during the planning and execution of minewarfare (MIW) operations.

BRIEFING OF METOC EFFECTS ON MIW OPERATIONS

LEARNING OBJECTIVES: Brief the effects that water depth, currents, tides, and bottom characteristics have on MIW operations. Understand the impact of the magnetic, acoustic, pressure, and biological environments on MIW operations.

There are environmental considerations unique to the planning of MIW operations and this section will be

devoted to this topic. For further discussion of MIW operations, refer to the technical manual, *Composite Warfare Oceanographic Support Modules (CWOSM), Part 1*, TM 04-92.

WATER DEPTH

Water depth is a factor to be considered in the spacing of mines, sensitivity setting, mine type, and mine impact velocity (air-laid mines).

- **Bottom mines** — In deep water (180 ft or greater), detonation will not cause much of a disturbance in the upper layers of the ocean.
- **Moored mines** — Depth may exceed the mooring range required for the mine to be effective.
- **Sensitivity and actuation width** — Important for bottom mines since an increase in depth will result in a decrease of the sensitivity and actuation width of a bottom mine.
- **Damage width** — Water depth affects the damage width in the same way as in actuation width. Increasing water depth causes a reduction in the damage width of a mine.
- **Mine burial upon impact** — The depth at which terminal velocity is reached depends on the initial velocity when launched and the depth of the water.

CURRENTS

Subsurface currents may *set* in different direction as mines descend, and current velocity may also vary during descent. These factors must be considered during planning of MIW operations.

- **Burial** — Burial on the sea floor can result from *scour* (water velocity increases around the mine, setting sand and sediments in motion, burying the mine). Once the mine is completely buried, scouring stops.
- **Sand ridge migration** — Currents may cause large sand dunes to migrate along the bottom in the direction of the current. The dunes can be as high as 12 to 20 ft.
- **Mine dip** (vertical movement of mines) — An increase in mine depth from the normal vertical position above the mooring point. Current action creates forces against the mine, increasing the depth. Dip is directly proportional to current speed; therefore, dip will increase with faster currents. During *flood* and *ebb*

tides, mine dip is at a maximum, which is the best time to penetrate a minefield.

- *Mine walking* (horizontal movement of a mine) — Movement of the mine anchor caused by currents. In regions where the bottom slope is greater than 5° and a strong current exists, moored mines can walk downslope into deeper water. Walking is also dependent on bottom sediment, bottom topography, and wave action.

- *Mine rolling* — Rolling or tilting of a mine on the bottom may result in magnetic or acoustic pressure causing the mine to detonate. A delay-arming device is used to eliminate this possibility.

- *Acoustic mines* — Strong currents can produce enough turbulence to increase ambient noise at the acoustic sensor to partially mask a ship's acoustic signature.

- *Pressure mines*— A ship drifting with the current will have a reduced pressure signature as if the ship's speed was reduced.

- *Explosive ordnance demolition (EOD) operations* — Current velocity for surface water may not be the same as that below the surface. The layers of water above and below the thermocline can move independent of one another, so divers may drift in several directions while descending.

- *Mine neutralization vehicle (MNV) operations* — Using an unmanned, tethered, remote-controlled submersible known as an MNV, it provides mine countermeasure (MCM) ships with mine neutralization capabilities. MNV maneuverability can be drastically reduced by currents because of the drag on the cable.

- *Navigation errors* — Currents can cause the ship's track to vary significantly from the intended trackline. Mine laying (spacing) and mine countermeasures (sweep coverage) depend on an accurate track

- *Mine drift* — By utilizing prevailing currents, drift mines may be launched at safe distances to occupy a minefield that would otherwise be inaccessible. A change in current direction could present an inherent danger to the mining forces or to other friendly forces in the later stages of the campaign.

TIDES

Local topographic features, meteorological conditions, currents, and the influences of the sun and

moon must be considered to establish the tidal characteristics for a given area.

- *Selection of mooring depth* —Tides may cause depth variations of a moored mine and can cause the mine to surface during low tide and be too deep during high tide.

- *Mine sensitivity and damage width* — In areas where the tidal range is great, the position of a moored mine relative to the sea surface may vary significantly. As with the impact of water depth, increasing the depth of a mine will cause a reduction in its sensitivity, actuation width, and damage width.

- *Submergence of reference buoys* — Reference buoys are used to mark the position of mines and as aids to navigation. If these buoys are deployed at low tide, they may become submerged during high tide.

BOTTOM CHARACTERISTICS

Bottom sediments vary in porosity, water content, compactibility, and plasticity.

- *Reverberation* — Bottom reverberation depends on frequency and grazing angle. Bottom scattering depends on sediment type and bottom roughness.

- *Acoustic contrast* — Detecting and classifying mines with high-frequency mine hunting sonars creates a problem in acoustically distinguishing mines from the background.

- *Bottom sediments (hardness)* — Initial penetration in silt or clay will be greater than rock, gravel, or a sandy bottom.

- *Impact velocity* — Softer bottom types affect initial penetration more so than hard bottoms.

- *Weight of the mine* — This causes subsequent penetration. This results from *plastic flow* (sediment flow out from under the mine upon impact), and/or scour and deposition.

- *Angle of impact* — The more perpendicular the angle of impact, the greater the expected initial penetration.

- *Mine movement* — A mine will not roll on a bottom composed of various mixtures of fine-grained sand, silt, and clay. Initial penetration into the bottom will prevent subsequent rolling.

- *Mine burial* — Burial of a mine will have little influence upon a magnetic-actuated mechanism, but an

acoustic signal may be attenuated by overlying sediment.

- *Bottom clutter* — This phenomena results in non-mine targets being detected by a minehunting sonar system. This makes it difficult for the operator to identify targets from the ambient noise.

- *Sediment resistivity* — This is the ability of sediment to conduct electrical current. Resistivity depends upon salinity, electrical conductivity of the sediment, and the thickness of the sediment.

MAGNETIC ENVIRONMENT

The factors that affect the sensitivity of magnetic sweep equipment are as follows:

- The effectiveness of magnetic sweep equipment is influenced by the water depth and the conductivity of the water (salinity and temperature).

- Magnetic storms cause momentary fluctuations in the earth's magnetic field. These storms sometimes closely resemble the magnetic signature of a ship and may result in magnetic influences firing mines prematurely.

ACOUSTIC ENVIRONMENT

Ambient noise can create problems for mines and MCMs in shallow water.

- High ambient noise levels present a problem for the performance of acoustic influence mines, since the target must be discriminated from ambient noise over relatively long ranges.

- High-frequency components of ambient noise tend to have little effect on minehunting operations because of the high receiver directivity characteristics of minehunting sonar systems.

PRESSURE ENVIRONMENT

Water pressure can play a significant role in MIW operations.

- The effective pressure change caused by wave heights at the surface diminishes with increasing depth.

- Generally, pressure mines require other influences, such as acoustic or magnetic influences to be present simultaneously in order for the mine to explode.

BIOLOGICAL ENVIRONMENT

Biologics may influence sonar detection, the neutralization of mines by EOD divers, and the performance of acoustic influence mines.

- *Marine biofouling* — Both plant and animal forms constitute major fouling agents in shallow waters, animal forms being dominant in deeper waters.

- *Marine life* — Divers can be exposed to dangerous marine life in open waters.

- *Bioluminescence* — Bioluminescent displays may reveal minedrops or outline moored mines and cables.

- *Biological ambient noise* — Minehunting sonars and most acoustic mines are not seriously affected by this type of ambient noise.

PHYSICAL CHARACTERISTICS

Water temperature, and temperature profile versus depth can play a significant role in MIW operations.

Temperature

Strong negative temperature gradients found in shallow water will result in strong bottom reverberation. Detection ranges may be sharply reduced.

Variable Depth Sonar (VDS) Transducers

Depth and tilt angles can be adjusted to be optimally tuned to existing environmental conditions.

Diving Operations

Diver performance is affected by water temperature as well as water clarity.

- In cold water, a diver's ability to concentrate and work efficiently will be greatly reduced.

- The possibility of exhaustion exists when diving operations are conducted in the vicinity of industrial outflow due to higher temperature waste water.

Salinity

There are salinity considerations that must be addressed in the planning and conducting of MIW operations.

- Areas of lower salinity (river runoff, ice edge) will reduce the conductivity of the water and overall effectiveness of MIW operations. Conductivity is directly proportional to salinity and temperature.

- In coastal environments with a large input of fresh water from river runoff, a strong positive sound velocity gradient can form causing upward refraction of the sonar beam.

Meteorology

There are several METOC considerations that must be addressed in the planning and conducting of MIW operations.

- *Surface winds* — If they are too strong, can we have an effective operation?

- *Wave action* — Affects underwater visibility, burial and movement of mines, accuracy of navigation, sound velocity profiles, deployment of MNVs, sweep gear, and divers.

- *Prevailing visibility* — If obstructions to visibility are present, navigation, minehunting and sweep effectiveness is decreased.

- *Hours of daylight* — Airborne minehunting, minesweeping, and EOD diver operations are primarily conducted during daylight hours.

Now let's discuss the environmental support for amphibious warfare (AMW) operations.

BRIEFING OF METOC SUPPORT FOR AMW OPERATIONS

LEARNING OBJECTIVES: Brief the Commander, Amphibious Task Force (CATF), and all interested personnel on expected METOC conditions during the planning, embarkation, rehearsal, movement, and assault phases of AMW operations.

In this discussion of AMW operations we will be discussing environmental support during the Planning phase, followed by the Embarkation phase, Rehearsal phase, Movement phase, and lastly the Assault phase (PERMA).

THE PLANNING PHASE

The Aerographer must first become familiar with the initial operation plans (OPPLANS) and operation orders (OPORDs), and must attend pre-mission briefings and conferences so that environmental factors affecting the various aspects of the mission can be addressed. In addition, the Aerographer must be prepared to provide the following:

- Long-range climatological and historical data. During the planning phase this can prove critical to mission success. Determine conditions that will most likely influence the location and time of landing including:

- Weather. Emphasis should be given to cloud ceiling height, visibility, and winds. This also includes local effects.
- Sea, swell, and surf conditions.
- Sea surface temperatures.

- Astronomical data (sunrise/sunset, moonrise/moonset, and percent of illumination), tidal data that affects local anchorages, as well as surf conditions to include:

- Character of surf zone.
- Degree of exposure of potential obstacles in the surf zone.
- Beach slope/s.
- Wave oscillation in harbor/s.

- Hydrographic data for inshore navigation of landing craft.

- Treacherous regions of bays, harbors, etc.
- Sandbars.
- Reefs.

THE EMBARKATION PHASE

During this phase, equipment and troops are embarked in assigned ships. Load out is accomplished.

- Amphibious operations are keyed to sequential events.

- Environmental support may include both mid-range and short-range forecasts.

- The OA division aboard the LHA/LHD/LPH becomes the focal point of the operation.

- OA division personnel must make environmental recommendations to the CATF and Commander, Landing Force (CLF).

- Factors in the environment that can be exploited to enhance safety, covertness, or defense readiness must be made known to the appropriate parties.

- METOC conditions play an enormous role in the successful outcome of AMW operations.

THE REHEARSAL PHASE

This phase is the “dry run” and is used to test the adequacy of plans and to evaluate the readiness of forces. It also is used to check the timing sequence of each event and also as an opportunity to test communications. This phase may or may not take place, depending on the situation.

- OA division personnel should take this opportunity to test the adequacy of support and support timing for the actual assault and make changes as necessary.

- Weaknesses uncovered in the development of support products, the Amphibious Warfare Environmental Summary, and in the timeliness of delivery during this phase will prove to be a valuable “lessons learned”.

- OA division personnel should also check familiarity with OPPLANS/OPTASK METOC.

THE MOVEMENT PHASE

During this phase, the Amphibious Task Force (ATF) is vulnerable to enemy interception so the full spectrum of defensive/offensive support products should be disseminated and updated twice daily.

- OA division personnel should provide necessary environmental support according to the OPOD.

- It is important to avoid heavy weather to minimize effects to deckloaded cargo and embarked troops.

- Intelligence may have aerial photographs of the assault site, which can be useful in locating and determining such features as surf zone, rip currents, bottom obstacles, and floating debris.

ASSAULT PHASE

This phase starts with the arrival of the ATF in the Amphibious Objective Area (AOA) and terminates with the accomplishment of the ATF mission.

Operations conducted during this phase are critically dependent upon environmental factors.

Significant Weather

Significant weather includes the following factors:

- *Precipitation* — Heavy precipitation interferes with the movement ashore and the push inland. Strike capability is greatly diminished.

- *Lightning* — Poses a grave danger during boat operations.

- *Low visibility* — Hampers small boat operation.

- *Wind direction/speed* — Can modify breaker type in the surf zone and affect flight operations. May also reduce visibility in the surf zone.

- *Modified surf index (MSI)* — Most critical parameter in a waterborne assault.

Aviation Weather

Aviation weather is dependent on the following factors:

- Cloud cover (bases and tops).

- Prevailing and sector visibilities,

- Surface and upper level winds.

- Density altitude (DA) and pressure altitude (PA).

- Air/sea temperature, icing, freezing level.

- Contrail formation.

- Bingo fields.

- EO weapon/sensor performance.

- Any other significant weather.

Currents

In the discussion of currents we will first discuss, offshore currents, followed by rip currents, and shore currents.

OFFSHORE CURRENTS.— These currents are found outside the surf zone (both tidal and nontidal).

- Tidal currents are predominant near entrances to bays and sounds, channels, between islands, or between islands and the mainland.

- Tidal currents usually reverse direction on a periodic basis (every 6 to 12 hours) and can reach speeds up to several knots.

RIP CURRENTS.— These currents result from waves piling water up against the coast. They flow along the coast until they are deflected seaward by bottom irregularities or until they meet another current.

- Flow can reach speeds as high as 12 kts, but usually attain speeds of 2 to 4 kts. Prevents most landing craft from making any headway ashore.

- The *head* (leading edge) of the current is often discolored by silt in suspension.

- If the beach is irregular, they will flow along the beach for a short distance and then flow out to sea.

- They are easily identified by aircraft, as they create a turbid flume offshore.

SHORE CURRENTS.— The following discussion deals with the formation and characteristics of shore currents.

- Generated by waves breaking at an angle to the beach.

- Littoral or longshore currents flow parallel to the beach inside the breakers.

- Speeds increase with increasing breaker height, with increasing angle of the breaker with the beach, and with steeper slopes.

- Speeds decrease with increasing wave period.

- In areas where longshore/littoral currents are common, sandbars are usually present.

- Longshore/littoral currents must be considered in selecting a beach or landing site. A littoral current can cause a landing craft to broach.

Further discussion of beach topography, beach composition, beach surveys, breakers, and offshore sealswells may be found in the technical manual, *CWOSM, Part 1*, TM 04-92.

For further discussion of AMW operations refer to the technical manual, *CWOSM, Part 1*, TM 04-92 and *Joint Surf Manual*, COMNAVSURFPAC/COMNAVSURFLANT Instruction 3840.1. The last topic of discussion in this chapter will be the briefing of METOC services available from OA divisions.

BRIEFING OF AVAILABLE METOC SERVICES

LEARNING OBJECTIVES: Brief OTCs and interested personnel on METOC conditions, as well as communications.

Previous discussions in this chapter have dealt with various briefs that OA division personnel are required to present on a routine basis. METOC support was standardized recently to better support afloat units Navywide. This plan includes Meteorology/Oceanography (OPTASK METOC) and several tactical support summaries. This standardized format will now be contained in ANNEX H to numbered fleet basic OPORDs.

The standardization to ANNEX H to the numbered fleet OPORDs and information previously presented in this chapter and technical manual, *CWOSM, Part 1*, should ensure all METOC briefs, regardless of respective fleets, will outline all necessary elements of benefit to OTCs.

SUMMARY

In this chapter we discussed various METOC briefs conducted by Aerographer personnel. Among those presented were tropical cyclone disaster planning, tropical cyclone evasion/sortie, storm surge, MIW, AMW, and those used in fleet coordinated exercises/operations. It should be understood that these are just a few of the many METOC briefs that Aerographers may present.

CHAPTER 14

ADMINISTRATION AND TRAINING

Command effectiveness is directly related to the efficiency of command administrative functions and command training programs; the command that handles their day-to-day administrative duties and training evolutions efficiently will excel.

This chapter will deal with just a few of the many administrative details and training initiatives that the senior petty officer and chief petty officer should be familiar with.

We will first discuss command administrative functions, followed by command training functions.

ADMINISTRATIVE FUNCTIONS

LEARNING OBJECTIVES: Prepare monthly records transmittal forms, monthly bathythermograph observations records (when required), annual meteorological station and description reports, and, as required, special incident reports.

This section will introduce three administrative functions, the first being a monthly requirement, the second an annual requirement, and the third, as the situation warrants. The first two topics are covered in the *U.S. Navy Oceanographic and Meteorological Support System Manual*, NAVMETOCCOMINST 3140.1, and the third in the instruction, *Special Incident Reporting (OPREP-3 and UNIT SITREP) Procedures*, NAVMETOCCOMINST 3100.2.

METEOROLOGICAL RECORDS TRANSMITTAL

The monthly meteorological records transmittal should include meteorological information and, if required, bathythermographic information.

Meteorological Information

Only the original copy of observation records will be forwarded. Ensure the records are neat, legible, and in chronological order. Geographical positions *will not* be deleted in order to make the records unclassified.

Classified observations will be forwarded in accordance with OPNAVINST 5510.1.

Use CNMOC Form 3140/6, Meteorological Records Transmittal Form (Report Symbol 3140-6), in preparing your package. See figure 14-1. Instructions for completing the form and for packaging are found on the back of the form. The form further specifies all enclosures. Mail the package between the first and fifth of the following month to:

Officer-in-Charge
FLENUMMETOCDET
Federal Building
Asheville, NC 28801-2696

NOTE: A new digital transmittal form will go into effect during 1995. This form, CNMOC Form 3140/2DF, will replace the current CNMOC Form 3140/6.

Copies of all weather records are to be retained for a minimum of 6 months.

Bathythermograph Observation Records

Forward the original copy of the Bathythermograph Log (Report Symbol 3140-1), CNMOC Form 3167/2 (see fig. 14-2), between the first and fifth of the following month as follows:

Classified log sheets are to be forwarded in accordance with OPNAVINST 5510.1 to:

Commanding Officer
Naval Oceanographic Office
ATTN: Code N3412
Stennis Space Center, MS 39522-5001

Unclassified log sheets are to be forwarded to:

National Oceanographic Data Center
1825 Connecticut Ave., N.W.
Washington, DC 20235

Ensure all entries of date/time, position, and declassification instructions are included, as appropriate.

NAVAL OCEANOGRAPHY COMMAND

METEOROLOGICAL RECORDS

TRANSMITTAL FORM



FROM: ACTIVITY & ADDRESS	TO: OFFICER IN CHARGE NAVAL OCEANOGRAPHY COMMAND DETACHMENT FEDERAL BUILDING ASHEVILLE, NC 28801	DATE: DAILY HOURS OF SURFACE OBSERVATIONS:
--------------------------	--	---

METEOROLOGICAL RECORDS SUBMITTED

SURFACE OBSERVATIONS		(X)	AUTOGRAPHS		(X)
NOC Form 3141/1 (Airways)			GMC - 29 (Wind Speed/Direction Chart)		
NOC Form 3141/2 (Ship)			Barograph		
NOC Form 3140.11 (METAR)			Other:		
TOTAL # OF UPPER AIR OBSERVATIONS			RADIOSONDE ELEMENTS & COMPUTERS		
WINDS ALOFT	(#)	RADIOSONDE	(#)	Thermistor:	
0000 UTC		0000 UTC		Temperature Computer:	
0600 UTC		0600 UTC		Hygriator:	
1200 UTC		1200 UTC		Radiosonde Tape:	
1800 UTC		1800 UTC		Balloon Size	
Other:		Other:		Other:	
TYPE OF GROUND EQUIPMENT			(X)	OBSERVATIONS PROCESSING	
GMD - 1				Manual Computation	
OL - 192				Computer Derived:	
TMQ - 5				ZAPS	
SMQ - 1/3MQ -3				Z - 120	
Buckers				Z - 248	
UMQ -12 (MRS)				RIA (Radiosonde Initial Analysis)	
Other:				Other:	

UPPER AIR OBSERVATIONS

MANUAL OBSERVATIONS		(X)	COMPUTER ASSISTED OBSERVATIONS		(X)
Recorder Records			Recorder Records		
Recorder Calibration			Radiosonde Calibration Charts		
Radiosonde Calibration Charts			Computer Paper Printouts		
Angular Tapes (RAWIN)			Computer Tapes		
Manual Computations			Computer Worksheets		
DOD WPC 9-31 (Adiabatic Charts)			ZAPS Diskettes		
OPNAV Form 3140-14 (Wind Loft)			RIA Diskettes		
RAOB Computation Sheets					
Wind Aloft Computation Sheets					
Other:					
UMQ - 12 (MRS) OBSERVATIONS		(X)	REMARKS:		
Computer Printout					
Diskettes					
Other:					

The environmental records forwarded herewith have been checked for accuracy, completeness, and legibility; they are forwarded IAW NAVOCEANCOMINST 3140.1

SUBMITTED:	DATE:	APPROVED:
------------	-------	-----------

Note: This form supersedes all previous meteorological records transmittal forms.

NOC 3140/6 (11/88) 0108-LF-006

Figure 14-1.-CNMOC Form 3140/6, Meteorological Records Transmittal Form.

BATHYTHERMOGRAPH LOG

Prepared by the COMMANDER, NAVAL OCEANOGRAPHY COMMAND
 and the NATIONAL OCEANIC AND ATMOSPHERIC ADMINISTRATION
 in accordance with specifications established by the
 INTERGOVERNMENTAL OCEANOGRAPHIC COMMISSION (IOC)
 and WORLD METEOROLOGICAL ORGANIZATION (WMO)

FOR NAVY AIRCRAFT USE

FOR NAVY SHIP USE

SHIP TYPE		HULL NUMBER		YR	MON	Z	T
B	A						
1	2	3	4	5	6	7	12
							13-14
							15
							22

SODN TYPE		SODN NMBR		SORTIE NUMBER		YR	MON	Z	T
B	A								
1	2	3	4	5	6	7	8	11	12
									13-14
									15
									22

1. REFERENCE INFORMATION

PLATFORM		
TYPE	NAME	DESIGNATOR
COUNTRY		INSTITUTION
CRUISE NUMBER	PROJECT	
STATION NUMBER	OBSERVATION NUMBER	INSTRUMENT

II. OPTIONAL ENVIRONMENTAL INFORMATION

DEPTH 1 TO BOTTOM (METERS)	WIND DIR		SPEED		SEA LEVEL PRESSURE		AIR TEMP ± DRY BULB		AIR TEMP ± WET BULB							
	u	d	d	f	f	P	P	P	S _n	T	T	T	S _n	T	T	T
SEA TEMP °C		WAVE PER HT		SWELL DIR PER HT		SOLAR RADIATION		PRECIP		TRANS						
T _w	T _w	T _w	INSTR	P _w	P _w	H _w	H _w	d _w	d _w	P _w	H _w	H _w	LANGMIN	R	R	METERS

I. REFERENCE INFORMATION

STATION NUMBER	OBSERVATION NUMBER	INSTRUMENT
----------------	--------------------	------------

II. OPTIONAL ENVIRONMENTAL INFORMATION

DEPTH 1 TO BOTTOM (METERS)	WIND DIR		SPEED		SEA LEVEL PRESSURE		AIR TEMP ± DRY BULB		AIR TEMP ± WET BULB							
	u	d	d	f	f	P	P	P	S _n	T	T	T	S _n	T	T	T
SEA TEMP °C		WAVE PER HT		SWELL DIR PER HT		SOLAR RADIATION		PRECIP		TRANS						
T _w	T _w	T _w	INSTR	P _w	P _w	H _w	H _w	d _w	d _w	P _w	H _w	H _w	LANGMIN	R	R	METERS

I. REFERENCE INFORMATION

STATION NUMBER	OBSERVATION NUMBER	INSTRUMENT
----------------	--------------------	------------

II. OPTIONAL ENVIRONMENTAL INFORMATION

DEPTH 1 TO BOTTOM (METERS)	WIND DIR		SPEED		SEA LEVEL PRESSURE		AIR TEMP ± DRY BULB		AIR TEMP ± WET BULB							
	u	d	d	f	f	P	P	P	S _n	T	T	T	S _n	T	T	T
SEA TEMP °C		WAVE PER HT		SWELL DIR PER HT		SOLAR RADIATION		PRECIP		TRANS						
T _w	T _w	T _w	INSTR	P _w	P _w	H _w	H _w	d _w	d _w	P _w	H _w	H _w	LANGMIN	R	R	METERS

REMARKS:

III. RADIO MESSAGE INFORMATION
 a. METRIC Coding Example

1	2	3	4	5	6
M ₁ M ₁ M ₁ M ₁	DATE (GMT) DAY MONTH YR	TIME (GMT) HOUR MIN	QUAD LATITUDE DEG MIN	LONGITUDE DEG MIN	INDICATOR GROUP
J J X X	Y Y M M J	G G g g /	G _c L _a L _a L _a L _a	L _o L _o L _o L _o L _o	8 8 8 8 8
16 17	18 - 21	22 - 27	28 - 32	25NP0115	
BATHYTHERMOGRAPH TRACE READINGS					
DEPTH TEMP Z ₀ Z ₀ T ₀ T ₀	DEPTH TEMP Z Z T _z T _z	DEPTH TEMP Z Z T _z T _z	DEPTH TEMP Z Z T _z T _z	DEPTH TEMP Z Z T _z T _z	DEPTH TEMP Z Z T _z T _z
0 0	Z Z T _z T _z	Z Z T _z T _z	Z Z T _z T _z	Z Z T _z T _z	Z Z T _z T _z
Z Z T _z T _z	Z Z T _z T _z	Z Z T _z T _z	Z Z T _z T _z	Z Z T _z T _z	Z Z T _z T _z
Z Z T _z T _z	Z Z T _z T _z	Z Z T _z T _z	Z Z T _z T _z	Z Z T _z T _z	Z Z T _z T _z
38 - 42	43 - 47	48 - 52	53 - 57	58 - 62	63 - 67
RADIO CALL					

b. ENGLISH Coding Example

1	2	3	4	5	6
M ₁ M ₁ M ₁ M ₁	DATE (GMT) DAY MONTH YR	TIME (GMT) HOUR MIN	QUAD LATITUDE DEG MIN	LONGITUDE DEG MIN	INDICATOR GROUP
J J X X	Y Y M M J	G G g g /	*C L _a L _a L _a L _a	L _o L _o L _o L _o L _o	8 8 8 8 8
16 17	18 - 21	22 - 27	28 - 32	25NP0115	
BATHYTHERMOGRAPH TRACE READINGS					
DEPTH TEMP Z ₀ Z ₀ T ₀ T ₀	DEPTH TEMP Z Z T _z T _z	DEPTH TEMP Z Z T _z T _z	DEPTH TEMP Z Z T _z T _z	DEPTH TEMP Z Z T _z T _z	DEPTH TEMP Z Z T _z T _z
0 0	Z Z T _z T _z	Z Z T _z T _z	Z Z T _z T _z	Z Z T _z T _z	Z Z T _z T _z
Z Z T _z T _z	Z Z T _z T _z	Z Z T _z T _z	Z Z T _z T _z	Z Z T _z T _z	Z Z T _z T _z
Z Z T _z T _z	Z Z T _z T _z	Z Z T _z T _z	Z Z T _z T _z	Z Z T _z T _z	Z Z T _z T _z
38 - 42	43 - 47	48 - 52	53 - 57	58 - 62	63 - 67
RADIO CALL					

Figure 14-2.—CNMOC Form 3167/2, Bathythermograph Log.

25NP0116

NAVAL OCEANOGRAPHY COMMAND METEOROLOGICAL STATION REPORT DESCRIPTION AND INSTRUMENTATION

FROM: (ACTIVITY AND MAILING ADDRESS)

TO:
OFFICER IN CHARGE
NAVAL OCEANOGRAPHY COMMAND DETACHMENT
FEDERAL BUILDING
ASHEVILLE, NC 28801-2690

REASON FOR SUBMISSION

- Annual
- New Location
- Station Release
- Instruments Relocated
- Correction of Datum

LATITUDE ____° ____' LONGITUDE ____° ____' WMO# _____

LST ____th MERIDIAN CALL LETTERS _____

HOURS TO CONVERT TO GMT: ADD ____ SUBTRACT ____

ELEVATIONS AND
DATES ESTABLISHED
(DEF. ON REVERSE)

GROUND
FIELD
BAROMETER

FEET (MSL)
H _____
H_a _____
H_z _____

DATE

X - IN USE S - STANDBY 0 - NONE	TYPE	HT. ABV GRND (FT) (SHIPS ABV SEA)	LOCATION	NEAREST OBSTRUCTION	DIST & DIR TO OBSTN	HT. OF OBSTN ABV INSTR	DATE COMM. PRESENT EX- POSURE
	SATELLITE RECEIVER						
	BAROMETER (Aneroid)						
	BAROGRAPH						
	THERMOSCREEN						
	STANDARD AIR THERM.						
	MAX & MIN AIR THERM						
	PSYCHROMETER						
	WIND MEASURING EQUIP.						
	WIND RECORDER						
	SEMI-AUTO. MET. STATION						
	CEILING LIGHT						
	CLOUD HEIGHT SET						
	THEODOLITE						
	TRANSMISSOMETER						
	RADAR						
	RADIOSONDE/Rawinsonde Set						

RELEASE POINT HT MSL INSTRUMENT SHELTER FLOOR HT MSL WHERE PEN SET HT MSL

DESCRIPTION OF STATION EXPOSURE AND GENERAL EMARKS INCLUDING ADDITIONAL EQUIPMENT (Continue on Reverse)

DESCRIPTION OF STATION EXPOSURE AND GENERAL EMARKS INCLUDING ADDITIONAL EQUIPMENT (Continue on Reverse)

SUBMITTED (Signature and Title)

DATE OF TRANSMITTAL

APPROVED (Signature and Title)

CNOC FORM 3140/5 (REV 07-84)

SN 01088-LF-000-5001

Figure 14-3.-CNMOC Form 3140/5, Meteorological Station and Description Report.

METEOROLOGICAL STATION AND DESCRIPTION REPORT

All METOC units will prepare the Meteorological Station and Description Report, CNMOC Form 3140/5 (Report Symbol 3140-7). See figure 14-3. Instructions are found on the back of the form. The report is to be mailed annually by the 25th of January, or anytime unit instrumentation, or its location, is changed. The report reflects current station instrumentation as of 1 January of the year submitted.

NOTE: CNMOC Form 3140/5 will be replaced by a new digital form CNMOC Form 3140/1 DF, Station Information File, during 1995.

A new form, CNMOC Form 3140/3DF, Upper Air Termination Log, will also go into effect during 1995 (figure 14-4). This form will be used to track termination heights that are used in compilation of monthly and semiannual station quality control reports.

The accuracy of studies derived from environmental observations are, to a large extent,

dependent on correct documentation describing instruments and sensors, exposures, location, height above the ground, orographic features surrounding the station, and other pertinent remarks regarding sensor performance. Instructions for completing the form and for mailing are found on the form.

Along with paper copies of upper air soundings, digital sounding data on floppy diskettes are to be submitted to FLENUMMETOC DET Asheville as well. The entire sounding is needed during downloading to floppy diskette, including the "load sonde" program (the header page), the environmental data, and the TEMP, and LIST outputs. *Be sure to write perfect the disk.*

SPECIAL INCIDENT REPORTING (OPREP-3 AND UNIT SITREP) PROCEDURES

The instruction, *Special Incident Reporting (OPREP-3 and UNIT SITREP) Procedures*, COMNAVMETOCCOMINST 3100.2, requires that all METOC units file an OPREP-3 or UNIT SITREP as

25NP0117									
UPPER AIR TERMINATION LOG									
STATION NAME:					MONTH/YR				
DAY	TIME	H(PA)	HT(FT)		DAY	TIME	H(PA)	HT(FT)	

Figure 14-4.-CNMOC Form 3140/3DF, Upper Air Termination Log.

appropriate in the event of special incidents that may attract national and/or high-level U.S. Navy interest, and in addition, other incidents that are of interest to the Commander, Naval Meteorology and Oceanography Command (CNMOC).

Mission Impairment

Incidents impairing mission performance are reported as a Unit Situation Report (UNIT SITEEP) in the format of CNMOC 3100.2, while certain weather-related incidents are reported in accordance with enclosure (1) of the instruction (UNIT SITREP Weather-Related Accidents/Incidents). COMNAVMETOCCOM interest is in incidents causing significant and extended mission impairment that is not adequately covered by the CASREP System.

Weather-Related Accidents/Incidents

We will now briefly discuss required actions in the event of weather-related accidents/incidents.

PURPOSE.— To notify the chain of command of weather-related/high seas accidents/incidents involving ships, aircraft, personnel, facilities, or other resources that may generate press interest, or become the subject of formal inquiries.

REPORTING CRITERIA.— A UNIT SITREP is required when accidents/incidents are weather-related or potentially so. Reports are *not desired* when accident/incidents are *clearly not weather-related*.

For amplifying instructions for the proper procedures for submitting accurate and timely OPREP-3'S and UNITS SITREPs, refer to CNMOC 3100.2, as well as the instruction, *Special Incident Reporting*, OPNAVINST 3100.6.

The remaining portions of this chapter will deal with training functions associated with all METOC activities.

TRAINING FUNCTIONS

LEARNING OBJECTIVES: Describe instrument ground school training for naval aviators and naval flight officers. Explain the requirement to update command local area forecaster handbooks. Review the *U.S. Navy Oceanographic and Meteorological Support System Manual*, METOC technical bulletins, METOC OPORDs, and climatology publications for possible data inclusion in pre-deployment briefings.

In the following sections we will discuss the training functions for which the METOCs are responsible.

INSTRUMENT GROUND SCHOOL

All METOCCENs, METOCFACs, and METOCDETs with aviation units are required to annually conduct Instrument Ground School for all naval aviators and naval flight officers.

Instruction, at a minimum, should include meteorological parameters, pilot reporting procedures, code formats, briefing forms, OPARS forms and procedures, NATOPS requirements, and severe weather warnings.

For further discussion of minimum content of Instrument Ground School, refer to the instruction, *NATOPS General Flight and Operating Instructions*, OPNAVINST 3710.7, chapter 13.

LOCAL AREA FORECASTER HANDBOOKS

One of the first publications that all newly reporting forecasters should review upon reporting to a new command is the Local Area Forecaster's Handbook. These handbooks are an invaluable source in anticipating local meteorological and oceanographic phenomena.

The instruction, *Local Area and Area of Responsibility (AOR) Forecaster's Handbooks*, NAVMETOCCOMINST 3140.2, states the requirements for maintenance of Forecaster's Handbooks and basic guidance on their form and content.

There is a continuing need to update Forecaster's Handbooks. Each command should have a program in place that continually verifies local thumb rules, as well as a program to develop new forecasting techniques. For this reason, all Forecaster's Handbooks are to be reviewed and updated at least annually.

The Naval Oceanographic Office is now in the process of assembling and publishing a compendium of all Forecaster's Handbooks developed by NAVMETOCCOM and USMC activities in compact disc-read only memory (CD-ROM).

For further discussion of the need and content of the Forecaster's Handbooks, refer to NAVMETOCCOMINST 3140.2.

The forecaster will find there are a multitude of details involved in the planning and execution of underway evolutions, as well as in the everyday operation of METGCCOM activities. In the following

section we will discuss various sources of information, and factors to be considered and acted upon.

PUBLICATION REVIEW

When preparing for operations or exercises the forecaster should review all available METOC publications to assess the environmental impact on the area of interest.

Review of the U.S. Navy Oceanographic and Meteorological Support System Manual, NAVMETOCCOMINST 3140.1

It is a good practice to review the *U.S. Navy Oceanographic and Meteorological Support System Manual* at the earliest time prior to any operation or exercise, if for no other reason, to jog your memory for potential sources of support.

Review of METOC Technical Bulletins

COMNAVMETOCCOM, NAVOCEANO, and the National Weather Service to name just a few commands and organizations, promulgate on a nonroutine basis bulletins that may be of benefit in the planning and execution of operations. It is incumbent on the forecaster to review these bulletins and publications for possible application in upcoming operations.

Review of METOC OPORDs

It is critical that the OA division be involved at the earliest in the drafting, planning, and execution of exercise OPORDs. Weather guard assignments, planned intended movements (PIMs), and required METOC services are just a few of many considerations that will be covered in the OPTASK METOC section of an OPORD.

Review of Climatology

As discussed earlier in this manual, climatology plays a critical role in operational planning. The various players will want to know at the earliest opportunity what type of weather conditions can be expected. Chapters 10 and 13 of this text deal with climatology and its various sources. The *U.S. Navy Oceanographic and Meteorological Support System Manual*, NAVMETOCCOMINST 3140.1, contains a chapter on climatology support services for planning and research.

In planning for a future exercise, it helps to glean information from previous deployments. The next section will deal with this subject.

METEOROLOGICAL AND OCEANOGRAPHIC (METOC) POST-DEPLOYMENT REPORTS

The instruction, *Oceanographic Post Deployment Reports*, NAVMETOCCOMINST 3140.23, requires a post-deployment report be prepared to describe meteorological and oceanographic conditions encountered (and quality of support received) after a major deployment by ships with permanently assigned METOC personnel.

Content

At a minimum, METOC post-deployment reports should contain an overview of the following:

- Environmental support received
- Unique METOC conditions experienced
- Services provided to other units
- Problems encountered
- Any new procedures attempted

Enclosure (1) to NAVMETOCCOMINST 3140.23 provides an outline to be followed in preparing the report. A daily log will ease preparation of the report.

Discussion

The instruction, *Meteorological and Oceanographic Post-Deployment Reports*, NAVMETOCCOMINST 3140.23, has been coordinated with Commander-in-Chief, Pacific Fleet (CINCPACFLT), Commander-in-Chief, Atlantic Fleet (CINCLANTFLT), and Commander-in-Chief, U.S. Navy, Europe (CINCUSNAVEUR).

CLASSIFICATION.— Normally, METOC post-deployment reports are unclassified. However, if necessary, a confidential enclosure may be included. Secret enclosures are discouraged, but may be included if deemed germane.

TIMELINESS.— Post-deployment reports should be submitted via the ship's commanding officer *within 6 weeks* of the end of the deployment.

In this day of regular introduction of new and more sophisticated METOC equipment, platform sensors, and

weapon's systems, it becomes more and more crucial that our personnel receive top-notch training. In the following section we will discuss the Naval Meteorology and Oceanography Command Training Program.

THE COMMAND TRAINING AND CERTIFICATION PROGRAM

LEARNING OBJECTIVES: Be familiar with the Naval Meteorology and Oceanography Command Training and Certification Program, as well as the instructions guiding the technical inspections of afloat units.

The instruction, *Naval Meteorology and Oceanography Command Training and Certification Program*, NAVMETOCCOMINST 1500.2, sets forth policy, assigns responsibility, and establishes procedures for the training and certification of Naval Meteorology and Oceanography command personnel.

APPLICABILITY

NAVMETOCCOMINST 1500.2 is applicable to all officer and enlisted personnel assigned to NAVMETOCCOM activities, Marine Corps weather service activities, the Naval Meteorology and Oceanography Reserve Program, and civilian personnel assigned to NAVMETOCCOM activities providing meteorological and oceanographic services to the fleet. This instruction has the concurrence of the Commandant of the Marine Corps and the Commander, Naval Reserve Force.

RESPONSIBILITIES

Commanding officers, officers-in-charge, and chief petty officer/petty officer/staff noncommissioned officers-in-charge of all NAVMETOCCOM and Marine Corps weather service activities are responsible to perform the following:

- Increase the military and professional knowledge of their personnel by developing and implementing local training programs, obtain training media, and use the available pipeline and service schools.
- Designate a training officer/petty officer to assist the executive officer or officer-in-charge in the administration of a training program.

- Establish a Planning Board for Training (PBFT).
- Establish and maintain both short- and long-range training programs.
- Maintain current training folders for each enlisted member, and ensure prompt entries are made.
- *Conspicuously* post and update Personnel Qualification Standards (PQS) and training progress charts.
- Ensure that general military training (GMT) is implemented.
- Establish and maintain a PQS program in accordance with current instructions and directives.
- Prepare job qualification requirements (JQRs) to augment PQS as necessary for site unique watchstation requirements.
- Ensure and document certification for personnel who have completed JQRs and specified PQS requirements.
- Provide leadership training incorporating NAVLEAD principles.
- Budget for, and send personnel to pertinent training on a temporary assigned duty (TAD) basis.

Refer to NAVMETOCCOMINST 1500.2 for a detailed discussion of the requirements and command responsibilities of local training programs.

TECHNICAL INSPECTIONS OF AFLOAT UNITS

The last topic to be discussed in this manual will be that of technical inspections of afloat units.

We all cringe when the division officer passes the word that the weather office will be inspected. But if you consider the inspection as a learning and sharing experience, it won't be quite so painful. The intent of these inspections is not to put your office on report, but to assist the office in identifying any shortcomings, if any, as well as to identify and acknowledge those areas in which the office excels.

The responsibility for technical inspections of afloat units lies with the respective fleet commanders in chief in your AOR.

Applicability

The respective fleet commanders in chief instructions regarding inspection of afloat units contain recommended inspection guide lists. These guide lists should be used by the inspecting officer to ensure standardization. Advance preparation of these guide lists by those units being inspected is not required, but an advance review of the areas will be of benefit to facilitate inspection of the units' operation and administration.

Action

When requested by inspection authorities, COMNAVMETOCOM will direct regional activities to provide METOC officers to serve as inspecting officers.

SUMMARY

In this chapter, we first discussed command administrative functions. Those administrative

functions addressed were the monthly Meteorological Records Transmittal Form, including Bathythermograph Observation Records, when required. Facets of the annual Meteorological Station and Description Report were then discussed. The last topic discussed under administrative functions was that of Special Incident (OPREP-3 and UNIT SITREP) Procedures, with background information, purpose, and reporting criteria addressed. The remaining portion of this chapter dealt with command training functions. We discussed the intent and the requirement for Instrument Ground School. Next, was a discussion on the requirement for the preparation of local area forecaster's handbooks and their value. We then presented various publications and documents that should be reviewed by METOC personnel prior to operations/exercises, including, the *U.S. Navy Oceanographic and Meteorological Support System Manual*, various METOC bulletins, OPORDs, and climatology publications. Finally, we discussed the Naval Meteorology and Oceanography Command training and certification program, and the technical inspections of afloat units.

APPENDIX I

REFERENCES USED TO DEVELOP THE TRAMAN

Chapter 1

Meteorology Today, 4th ed., C. Donald Ahrens, West Publishing, St. Paul, MN, 1991.

Chapter 2

Naval Oceanographic Data Distribution System (NODDS), Products Manual, FLENUMOCEAN INSTRUCTION 3147.1, Commanding Officer, Fleet Numerical Oceanography Center, Monterey, CA, 1983.

Meteorology Today, 4th ed., C. Donald Ahrens, West Publishing, St. Paul, MN, 1991.

The Use of the Skew T, Log P Diagram in Analysis and Forecasting, Naval Air Instruction 50-1P-5, Naval Oceanography Command, Stennis Space Center, MS, 1990.

Chapter 3

Meteorology Today, 4th ed., C. Donald Ahrens, West Publishing, St. Paul, MN, 1991.

Centrally Produced Guidance and Analysis Products, Vol. 1, AFOS, National Weather Service Forecasting Handbook No. 1, U.S. Department of Commerce, Washington, D.C., 1993.

The Prediction of Maritime Cyclones, Naval Air Instruction 50-1P-545, Naval Oceanography Command, Stennis Space Center, MS, 1968.

Chapter 4

The Prediction of Snow Vs. Rain, Forecasting Guide No. 2, U.S. Department of Commerce, Washington, D.C., 1957.

The Use of the Skew T, Log P Diagram in Analysis and Forecasting, Naval Air Instruction 50-1P-5, Naval Oceanography Command, Stennis Space Center, MS, 1990.

A Workbook on Tropical Cloud Systems Observed in Satellite Imagery, Vol. 1, NAVEDTRA 40970, Naval Oceanography Command, Stennis Space Center, MS, 1993.

Satellite Imagery Interpretation in Synoptic and Mesoscale Meteorology, NAVEDTRA 40950, Naval Oceanography Command, Stennis Space Center, MS, 1993.

Chapter 5

Meteorology Today, 4th ed., C. Donald Ahrens, West Publishing, St. Paul MN, 1991.

Airman's Information Manual, Department of Transportation/Federal Aviation Administration, Washington D.C., 1994.

Doppler Radar Meteorological Observations, (Part D), Federal Meteorological Handbook No. 11, Washington D.C., 1992.

Terminal Aerodrome Forecast (TAF) Code, NAVOCEANCOM Instruction 3143.1E, Naval Oceanography Command, Stennis Space Center, MS, 1993.

Chapter 6

Joint Surf Manual, COMNAVSURFPAC/COMNAVSURFLANT Instruction 3840.1B, with change 1, 1987.

Sea and Swell Forecasting, NAVEDTRA 40560, Naval Oceanography Command, Stennis Space Center, MS, 1984.

Surf Forecasting, NAVEDTRA 40570, Naval Oceanography Command, Bay St. Louis, MS, 1987.

Chapter 7

Operator's Manual, Tactical Environmental Support System (TESS (3)) and Shipboard Meteorological and Oceanography Observing System (SMOOS), Vols. I, II, IIA, IIB, III, and IV, NAVEXCEN VJO 14203-0302428A, Vallejo, CA, 1993.

Tactical Environmental Support System, TESS 2.1, User's Guide, Naval Oceanographic Office, Stennis Space Center, MS, 1989.

Chapter 8

Environmental Effects on Weapon Systems and Naval Warfare (U), RP-1, Commander, Naval Oceanography Command, Stennis Space Center, MS, 1993.

Operator's Manual, Tactical Environmental Support system (TESS (3)) and Shipboard Meteorological and Oceanographic Observing System (SMOOS), Vols. I, II, IIA, IIB, III, and IV, NAVEXCEN VJO 14203-0302428A, Vallejo, CA, 1993.

Tactical Environmental Support System, TESS 2.1, User's Guide, Naval Oceanographic Office, Stennis Space Center, MS, 1989.

Chapter 9

Fleet Oceanographic and Acoustic Reference Manual, RP 33, Naval Oceanographic Office, Stennis Space Center, MS, 1989.

Navy Oceanographic Data Distribution System Products Manual, FLENUMOCEANCEN Instruction 3147.1, Fleet Numerical Oceanography Center, Monterey, CA, 1993.

Navy Oceanographic Data Distribution System Users Manual, Fleet Numerical Oceanography Center, Monterey, CA, 1993.

Chapter 10

Composite Warfare Oceanographic Support Modules (CWOSM) (Part 1), Training Manual TM 04-92, Naval Oceanographic Office, Stennis Space Center, MS, 1992.

Fleet Oceanographic and Acoustic Reference Manual, RP 33, Stennis Space Center, MS, 1989.

Meteorology Today, 4th ed., C. Donald Ahrens, West Publishing, St. Paul MN, 1991.

Navy Oceanographic Data Distribution System (NODDS), Version 3.1, User's Manual, Commanding Officer, Fleet Numerical Oceanography Center, Monterey, CA, 1993.

Optimum Path Aircraft Routing System, User's Manual, FLENUMOCEANCENINST 3710.1B, Fleet Numerical Oceanography Center, Monterey, CA, 1990.

Procedures Governing Flight Weather Briefings and Preparing DD Form 175-1 and U.S. Navy Flight Forecast Folder, NAVOCEANCOM Instruction 3140.14C, Stennis Space Center, MS, 1993.

Operator's Manual, Tactical Environmental Support System (TESS (3)) and Shipboard Meteorological and Oceanographic Observing System (SMOOS), NAVEXCEN VJO 14203-0302428A, Vallejo, CA, 1993.

Terminal Aerodrome Forecast (TAF) Code, NAVOCEANCOM Instruction 3143.1E, Commander, Naval Oceanography Command, Stennis Space Center, MS, 1993.

U.S. Navy Oceanographic & Meteorological Support System Manual, NAVOCEANCOMINST 3140.1J, Commander, Naval Oceanography Command, Stennis Space Center, MS, 1991.

Chapter 11

Composite Warfare Oceanographic Support Modules (CWOSM) (PART 1)
Training Manual, TM 04-92, Stennis Space Center, MS, 1992.

Chapter 12

Doppler Meteorological Radar, WSR-88D, Technical Manual, NAV-EM400-
AF-OPI-010/WSR88D, 1992.

Doppler Radar Meteorological Observations (Part B), Federal Meteorological
Handbook No. 11, Washington, D.C., 1990.

Doppler Radar Meteorological Observations (Part D), Federal Meteorological
Handbook No. 11, Washington, D.C., 1992.

Weather Radar Observations (Part B), Federal Meteorological Handbook No.
7, Washington, D.C., 1981.

Chapter 13

Atmospheric Climatic Publications, Officer in Charge, Naval Oceanographic
Command Detachment, Asheville, NC, 1993.

Composite Warfare Oceanographic Support Modules (CWOSM) (PART 1),
Naval Oceanographic Office, Stennis Space Center, MS, 1992.

Environmental Effects on Weapon Systems and Naval Warfare (U), RP-1,
Commander, Naval Oceanography Command, Stennis Space Center, MS,
1993.

Geophysics Fleet Mission Program Library (GFMPPL) Summary, Naval
Oceanographic Office, Stennis Space Center, MS, 1992.

Guide to Standard Weather Summaries and Climatic Services, Naval
Oceanography Command Detachment, Asheville, NC, 1986.

Joint Surf Manual, COMNAVSURFPAC/COMNAVSURFLANT Instruction
3840.1B, with change 1, 1987.

*Warnings and Conditions of Readiness Concerning Hazardous or Destructive
Weather Phenomena*, OPNAV Instruction 3140.24E, Department of the
Navy, Chief of Naval Operations, Washington, D.C., 1993,

Chapter 14

Special Incident Reporting (OPREP-3 and UNIT SITREP) Procedures,
NAVOCEANCOM Instruction 3100.2D, Naval Oceanography Command,
Stennis Space Center, MS, 1989.

Local Area and Area of Responsibility (AOR) Forecaster's Handbooks,
NAVOCEANCOM Instruction 3140.2D, Naval Oceanography Command,
Stennis Space Center, MS, 1992.

NATOPS General Flight and Operating Instructions, OPNAV Instruction 3710.7P, Washington D.C., 1992.

Naval Meteorology and Oceanography Command Training and Certification Program, NAVMETOCCOM Instruction 1500.2H, Naval Meteorology and Oceanography Command, Stennis Space Center, MS, 1994.

Oceanographic Post-Deployment Reports, NAVOCEANCOM Instruction 3140.23A, Naval Oceanography Command, Stennis Space Center, MS, 1990.

INDEX

A

- Administration, *see* Command administrative functions
- Advection stratum, 1-2
- Aircraft icing, 5-28 to 5-34
 - forecasting, 5-30 to 5-34
 - intensities, 5-29
 - operational aspects, 5-29 to 5-30
 - process of formation, 5-28 to 5-29
 - tactical decisions aids, 7-20 to 7-21
 - thunderstorm hazard, 5-2
 - use of Skew T Log P Diagram, 5-31 to 5-34
- Airmass cloudiness and weather, 4-6 to 4-8
- Airmass thunderstorms, 5-8
- Altimeter setting, 10-4 to 10-6. *See also*
 - Thunderstorm altimetry
 - errors, 10-4 to 10-6
 - forecasting, 10-6
- Ambient noise, 9-11 to 9-13
 - effects on mine warfare, 13-6
- Amphibious warfare, 13-7 to 13-9. *See also* Surf forecasting
- Angular spreading, 6-4, 6-10 to 6-11
- ARPGEN program, 10-3 to 10-4

B

- Bathythermograph collective product, 8-9 to 8-10
- Bathythermograph observation records, 14-1
- Bioluminescence, 9-13 to 9-14
 - effects on mine warfare, 13-6
- Blocking highs, 2-5 to 2-6
 - formation, 2-9
 - intensity, 2-8
- Bottom bounce, 9-2 to 9-3
- Briefing, METOC, 9-18 to 9-20, 10-11 to 10-12, 13-1 to 13-9. *See also* Tactical decision aids
 - amphibious warfare, 13-7 to 13-9
 - climatology, 10-11 to 10-12, 13-2
 - conditions of readiness, 13-1 to 13-2

- Briefing, METOC—Continued
 - evasion/sortie 13-3
 - mine warfare, 9-18 to 9-20, 13-4 to 13-7
 - storm surge 13-3
 - tropical cyclone disaster planning, 13-1 to 13-2

C

- Cirrus clouds, 4-19 to 4-21
 - forecasting, 4-20 to 4-21
 - indications from RAOB data, 4-19
 - observation and formation, 4-19 to 4-20
 - relation to jet stream, 4-21
 - relation to tropopause, 4-20
- Climatology, 10-11 to 10-12. *See also* Tropical cyclones
 - climatological studies, 10-12
 - publications and summaries, 10-11 to 10-12
- Cloud analysis and forecasting, 4-3 to 4-21
 - airmass cloudiness, 4-6 to 4-8
 - ceiling height, 4-10 to 4-12
 - cirrus clouds, 4-19 to 4-21
 - dewpoint, 4-14
 - frontal and orographic, 4-4 to 4-6
 - frost point, 4-14
 - icing, 5-31
 - nephanalysis, 4-9
 - precipitation, 4-19
 - stratus clouds, 5-23 to 5-24, 5-27 to 5-28
 - turbulence, 5-38
 - use of RAOB data, 4-13 to 4-19, 5-27 to 5-28
- Command administrative functions, 14-1 to 14-8
 - bathythermograph observation records transmittal, 14-1
 - local area forecaster handbooks, 14-6
 - meteorological records transmittal, 14-1
 - meteorological station and description reports, 14-5
 - post-deployment reports, 14-7 to 14-8
 - publication review, 14-7

Command administrative functions—Continued
 special incident reports, 14-5 to 14-6
Command training functions, 14-6 to 14-9
 inspection of afloat units, 14-8 to 14-9
 instrument ground school, 14-6
 training and certification program, 14-8
Condensation processes, 4-1
 dissipation processes, 4-3
Conditions of readiness (COR), 13-1 to 13-2
Convergence, 1-1 to 1-7, 1-10 to 1-11, 4-2 to 4-3
 effects on weather, 1-7
 features aloft, 1-3 to 1-6
 mass convergence, 1-2
 surface pressure systems, 1-3
 vorticity, 1-10 to 1-11
 wind shear, 1-1 to 1-2
Convergence zone, 9-1 to 9-2
Critical eccentricity, 2-7
Currents, 6-15, 6-17 to 6-18
 coastal and tidal, 6-17 to 6-18
 eddies, 6-17
 effects on amphibious warfare, 13-8 to 13-9
 effects on mine warfare, 13-4 to 13-5
 Ekman spiral 6-18
 wind-driven, 6-17 to 6-18
Cutoff low, 2-8 to 2-9
 formation, 2-9
 intensity, 2-8

D

Direct path, 9-6
Ditch headings, 10-8, 10-10
Divergence, 1-1 to 1-7, 1-10 to 1-11, 4-2 to 4-3
 effects on weather, 1-7
 features aloft, 1-3 to 1-6
 mass divergence, 1-2
 surface pressure systems, 1-3
 vorticity, 1-10 to 1-11
 wind shear, 1-1 to 1-2
Doppler radar, 12-3 to 12-15
 alert areas and thresholds, 12-12 to 12-13
 anomalous propagation, 12-7

Doppler radar—Continued
 archiving data, 12-14 to 12-15
 bright band, 12-12
 cloud layer detection, 12-10 to 12-11
 data access, 12-13
 doppler shift, 12-4
 ground clutter, 12-6 to 12-7
 history, 12-3 to 12-4
 interpretation of velocity patterns, 12-8 to 12-12
 large scale weather systems, 12-11 to 12-12
 mesocyclone signature detection, 12-9 to 12-10
 Principle User Processor, 12-4, 12-12 to 12-15
 range-folded data, 12-5 to 12-6
 side lobes, 12-7
 solar effects, 12-7 to 12-8
 user function operations, 12-13 to 12-14
 velocity aliased data, 12-4 to 12-5
 wind shear detection, 12-10

E

Eddies, 6-17
 acoustic effects, 9-15
Ekman spiral, 6-18
Electromagnetic coverage display, 7-10 to 7-12
Electromagnetic path loss, 7-4 to 7-6
Electronic countermeasures, 7-1 to 7-2
Electronic support measures, 7-6 to 7-8
Electro-optical systems, 10-6 to 10-7
 environmental effects, 10-6 to 10-7
 FLIR program, 7-18 to 7-20
 LRP program, 7-16

F

Fetch limited sea, 6-6
Fog and stratus, 5-18 to 5-28
 dissipation, 5-26 to 5-28
 effect of air mass stability, 5-18 to 5-19
 forecasting, 5-19 to 5-28
 formation, 5-19 to 5-25
 types, 5-19, 5-21 to 5-25
 use of Skew T Log P Diagram, 5-25 to 5-28

Frontogenesis, 3-20

Frontolysis, 3-20

Fronts, 3-17 to 3-20, 4-2 to 4-5, 4-9 to 4-12

forecasting clouds and weather, 4-9 to 4-12

forecasting intensity, 3-20

forecasting movement, 3-17 to 3-20

frontal lifting, 4-2

frontogenesis, 3-20

frontolysis, 3-20

G

Geophysics Fleet Mission Program Library (GFMPPL), 7-1 to 7-21, 8-1 to 8-9, 9-20, 10-3 to 10-4, 13-3. *See also* Tactical decision aids

ARPGEN program, 10-3 to 10-4

meteorological products, 7-1 to 7-21

mine warfare products, 9-20

oceanographic products, 8-1 to 8-9

surge program, 13-3

tropical cyclone applications, 13-3

Geostrophic wind, 3-17 to 3-20, 11-9

H

Hail, *see* Thunderstorms

Half-channel, 9-6 to 9-7

High seas warnings, 10-2

I

Isopycnic level, 1-2 to 1-3

J

Jet stream, 2-3, 2-7, 3-7, 4-9, 4-21, 5-34, 5-36, 5-38

clear air turbulence, 5-34, 5-38

effect on movement of surface lows, 3-7

effect on upper air systems, 2-3, 2-7

relation to cirrus clouds, 4-21

turbulence, 5-36

L

Lightning, *see* Thunderstorms

Local area forecaster handbooks, 13-1, 14-6

Long waves, 2-3, 4-32

relative to tropical cyclones, 11-3 to 11-4, 11-7

M

MAD operational effectiveness (MOE) charts, 8-10

Maritime cyclones, 3-7

Mine warfare, 9-18 to 9-20, 13-4 to 13-7

briefing of environmental effects, 9-18 to 9-19, 13-4 to 13-7

mine hunting sonar systems, 9-19

support systems and products, 9-19 to 9-20

Modified surf index, 6-15, 13-8

N

NAVSAR program, 8-2 to 8-5

NODDS products, 2-10, 3-12, 7-1, 8-1. *See also*

Operational oceanography

oceanographic products, 9-1 to 9-10

ditch headings product, 10-8, 10-10

Nephanalysis, 4-9

O

Ocean fronts, 9-15 to 9-18

acoustic effects, 9-17 to 9-18

determining position, 9-16, 9-18

eddies, 9-15

Ocean waves, *See* Sea surface forecasting

Operational oceanography, 9-1 to 9-20. *See also*

Tactical decision aids, *and* Sea surface forecasting

ambient noise, 9-11 to 9-13

bioluminescence, 9-13 to 9-14

bottom bounce, 9-2 to 9-3

bottom bounce products, 9-3

convergence zone, 9-1 to 9-2

Operational oceanography-Continued

- convergence zone products, 9-2
- direct path, 9-6
- direct path product, 9-6
- half-channel, 9-6 to 9-7
- half-channel conditions product, 9-7
- ocean fronts and eddies, 9-15 to 9-18
- shallow sound channel axis, 9-9
- shallow sound channel axis products, 9-9 to 9-10
- sonic layer depth, 9-4
- sonic layer depth product, 9-5
- sound channel axis, 9-8
- sound channel axis depth product, 9-8
- sound fixing and ranging channel, 9-8
- surface duct, 9-5 to 9-6
- surface duct cutoff frequency product, 9-6
- underwater visibility, 9-14
- upwelling, 9-15 to 9-16

OPTASK METOC, 13-9, 14-7

P

Precipitation processes, 4-1 to 4-12, 4-19, 4-21 to 4-30

- airmass precipitation, 4-6 to 4-8
- dissipation processes, 4-3
- frontal and orographic, 4-1 to 4-2, 4-4 to 4-6, 4-9 to 4-12
- snow versus rain, 4-21 to 4-30
- vertical motion, 4-8
- vertical stretching, 4-2 to 4-3
- vorticity, 4-8

R

Radar, weather, 5-2, 5-10, 11-3, 12-1 to 12-15. *See also* Doppler radar

- anomalous propagation, 12-7
- attenuation, 12-3
- doppler radar, 12-3 to 12-15
- effects of wavelength and frequency, 12-1 to 12-2
- ground clutter, 12-6 to 12-7

Radar, weather-Continued

- nondoppler radar, 12-1 to 12-3
- pulse length and pulse repetition frequency, 12-3
- radar beam characteristics, 12-2 to 12-3
- sidelobes, 12-7
- signal strength and echo definition, 12-3
- solar effects, 12-7 to 12-8
- thunderstorm detection, 5-2, 5-10
- tropical cyclone detection, 11-3

RAOB, 4-13 to 4-20, 5-5 to 5-15, 5-25 to 5-28, 5-30 to 5-34, 5-38

- cirrus cloud forecasting, 4-19 to 4-20
- cloud analysis, 4-13 to 4-19
- fog and stratus forecasting, 5-25 to 5-28
- hail forecasting, 5-10 to 5-15
- icing, 5-30 to 5-34
- precipitation forecasting, 4-19
- thunderstorm forecasting, 5-5 to 5-10
- turbulence 5-38

Ridges, 1-5 to 1-6, 1-9 to 1-10, 2-2 to 2-5

- divergence and convergence 1-5 to 1-6
- effects of super gradient winds, 2-4 to 2-5
- forecasting intensity, 2-4 to 2-5
- forecasting movement, 2-2 to 2-3
- vorticity, 1-9 to 1-10

S

Satellite imagery, 2-2, 2-10, 3-1 to 3-2, 3-15 to 3-17, 4-6 to 4-8, 9-18, 11-3

- airmass cloud patterns, 4-6 to 4-8
- constructing upper level prognostic charts, 2-10
- determining ocean frontal position, 9-18
- formation of new pressure systems, 3-1 to 3-2
- tropical cyclone detection, 11-3

Sea surface currents, *see* currents

Sea surface forecasting, 6-1 to 6-19

- sea waves, 6-1
- sea wave forecasting, 6-5 to 6-9
- sine waves, 6-1
- surf forecasting, 6-11 to 6-17
- surface currents, 6-15, 6-17 to 6-18
- swell waves, 6-1

Sea surface forecasting-Continued

swell wave forecasting, 6-9 to 6-11

wave properties, 6-2 to 6-4

wave spectrum, 6-4 to 6-5

Severe weather, 5-1 to 5-39, 10-1 to 10-2, 13-1 to

13-2. *See also* Thunderstorms

conditions of readiness (COR), 13-1 to 13-2

fog and stratus, 5-18 to 5-28

icing, 5-28 to 5-33

tornadoes, 5-15, 5-17 to 5-18

turbulence, 5-34 to 5-39

warnings, 10-1 to 10-2

waterspouts, 5-18

Ship ice accretion, 7-12 to 7-13

Shoaling, 6-13

Significant wave height, 10-1

Snow, 4-21 to 4-30

area of maximum snowfall, 4-27 to 4-30

forecasting techniques and aids, 4-23 to 4-27

snow versus rain forecast, 4-21 to 4-30

Sound speed profile, 8-5 to 8-9, 9-2 to 9-9, 9-17 to

9-18, 13-6

bottom bounce, 9-3

convergence zones, 9-2

direct path, 9-6

effects of ocean fronts, 9-17 to 9-18

effects on mine warfare, 9-18, 13-6

half-channel, 9-6 to 9-7

NOTS program, 8-8

PPL program, 8-7

RAY program, 8-5 to 8-6

sonic layer depth, 9-4

sound channels, 9-8 to 9-9

SSP program, 8-8 to 8-9

surface ducts, 9-5 to 9-6

Special observations and forecasts, 10-1 to 10-12

altimeter settings, 5-4 to 5-5, 10-4 to 10-6

atmospheric refractivity, 10-3 to 10-4

climatology, 10-11 to 10-12

ditch headings, 10-8, 10-10

electro-optics, 10-6 to 10-7

extreme temperatures, 10-2

freezing rain, 10-2

Special observations and forecasts-Continued

gale warnings, 10-1

high seas warnings, 10-2

significant weather, 10-1

small craft warnings, 10-1

storm warnings, 10-1

thunderstorm warnings, 10-2

tropical cyclone warnings, 10-2, 11-10 to 11-11

verification of forecasts, 10-11

verification of warnings, 10-2

WEAX/AVWX issuance, 10-7 to 10-9

wind warnings, 10-1 to 10-2

Stability indexes, 5-8 to 5-10

Subgradient winds, 1-6

Super gradient winds, 1-5 to 1-6, 2-4 to 2-5

Surf forecasting, 6-11 to 6-17, 13-7 to 13-9

modified surf index, 6-15, 13-8

objective techniques, 6-15 to 6-17

Surface systems, 1-3, 2-8 to 2-9, 3-1 to 3-21, 4-3 to

4-5

application of satellite imagery, 3-1 to 3-2, 13-5 to 13-17

divergence and convergence, 1-3

forecasting formation, 2-8 to 2-9, 3-1 to 3-3

forecasting intensity, 2-8, 3-8 to 3-15, 3-20 to 3-21

forecasting movement, 3-3 to 3-8, 3-17 to 3-20

forecasting principles, 3-6 to 3-8

frontal clouds and weather, 4-3 to 4-5

prognostic charts, 3-1 to 3-3, 3-12, 3-17 to 3-21

T

Tactical decision aids, meteorological, 7-1 to 7-21, 10-3 to 10-4

aircraft icing (AIRICE), 7-20 to 7-21

ARPGEN program, 10-3 to 10-4

ballistic wind and densities corrections (BALWND), 7-16 to 7-17

battle group vulnerability (BGV), 7-4

D-values (DVAL), 7-2 to 7-3

electromagnetic coverage diagram (COVER), 7-10 to 7-12

- Tactical decision aids, meteorological-Continued
 electromagnetic path loss versus range (LOSS),
 7-4 to 7-6
 electronic countermeasures effectiveness (ECM),
 7-1 to 7-2
 electronic support measures (ESM), 7-6 to 7-8
 forward-looking infrared (FLIR), 7-18 to 7-20
 laser range prediction (LRP), 7-16
 platform vulnerability (PV), 7-8 to 7-10
 radiological fallout (RADFO), 7-17 to 7-18
 ship ice accretion (SHIP ICE), 7-12 to 7-13
 sound focus (SOCUS), 7-14 to 7-16
 surface search radar range (SSR), 7-10
 tropical cyclone applications, 13-3
 tropical storm surge (SURGE), 13-3
- Tactical decision aids, oceanographic 8-1 to 8-10.
See also Operational oceanography
 naval search and rescue (NAVSAR), 8-2 to 8-5
 near-surface ocean thermal structure (NOTS),
 8-8
 passive acoustic propagation loss (PPL), 8-7
 raytrace (RAY), 8-5 to 8-7
 sound speed profile generator module (SSP), 8-8
 to 8-9
 tidal prediction (TIDE), 8-1 to 8-2
- Tactical Environmental Support System (TESS), 7-1
 to 7-21, 8-1 to 8-9, 9-20, 10-3 to 10-4, 13-3.
See also Tactical decision aids
 ARPGEN program, 10-3 to 10-4
 meteorological products, 7-1 to 7-21
 mine warfare products, 9-20
 oceanographic products, 8-1 to 8-9
 surge program, 13-3
 tropical cyclone applications, 13-3
- Temperature, air, 4-21 to 4-32, 10-2
 advection, 4-31
 advisories, 10-2
 cold wave, 4-32
 evaporation and condensation, 4-31
 heat wave, 4-32
 insolation and radiation, 4-30 to 4-31
 snow versus rain, 4-21 to 4-30
 vertical heat transport, 4-31
- Thunderstorms, 5-1 to 5-15, 10-2, 12-9 to 12-12,
 13-1 to 13-2
 airmass, 5-8
 conditions of readiness (COR), 13-1 to 13-2
 entrainment, 5-2
 flight hazards, 5-2 to 5-3
 forecasting, 5-5 to 5-15
 hail, 5-1 to 5-2, 5-11 to 5-15
 icing, 5-2
 lightning, 5-2
 maximum gusts, 5-11
 movement, 5-10
 radar detection, 5-2, 5-10, 12-9 to 12-12
 rain, 5-2
 surface phenomena, 5-3 to 5-4
 turbulence, 5-1
 use of RAOB data, 5-5 to 5-15
 warnings, 10-2
- Thunderstorm altimetry, 5-4 to 5-5
- Tides, 6-17 to 6-18
 effects on amphibious warfare, 13-9
 effects on mine warfare, 13-5
- Tide prediction, 8-1 to 8-2
- Tornadoes, 5-15, 5-17 to 5-18
 conditions of readiness (COR), 13-1 to 13-2
 forecasting, 5-17 to 5-18
 radar detection, 12-9
 types, 5-18
- Training, *see* Command training functions
- Tropical cyclone, 10-2, 11-1 to 11-11, 13-1 to 13-3
 climatological summaries, 13-2
 conditions of readiness, 13-1 to 13-2
 detection, 11-3
 disaster planning, 13-1 to 13-2
 dynamics, 11-2
 evasion/sortie briefings, 13-3
 formation, 11-2 to 11-3
 intensification, 11-3 to 11-4, 11-8
 movement, 11-4 to 11-10
 prediction by objective techniques, 11-8 to 11-10
 recurvature, 11-6 to 11-8
 software applications, 13-3
 warnings, 10-2, 11-10

Tropical forecasting, 11-1 to 11-11

local area forecasts, 11-1

Troughs, 1-5 to 1-6, 1-9 to 1-10, 2-2 to 2-5

effects of super gradient winds, 2-4 to 2-5

divergence and convergence, 1-5 to 1-6

forecasting intensity, 2-4 to 2-5

forecasting movement, 2-2 to 2-3

vorticity, 1-9 to 1-10

Turbulence, 5-1,5-34 to 5-39

characteristics, 5-34

classification and intensity, 5-36 to 5-37

clear air turbulence (CAT), 5-34 to 5-35, 5-38

convective cloud turbulence, 5-38

mountain waves, 5-35 to 5-36

surface turbulence, 5-38

thunderstorm turbulence, 5-1

U

Upper level systems, 1-3 to 1-6, 2-1 to 2-10, 3-2 to 3-3, 3-5 to 3-8, 3-10 to 3-15, 3-20, 4-4 to 4-5

analysis, 2-1

application of satellite imagery, 2-2, 2-10

critical eccentricity, 2-7

divergence and convergence, 1-3 to 1-6, 3-11 to 3-14

forecasting, 2-1 to 2-10

forecasting intensity, 2-4 to 2-5, 2-8

forecasting movement, 2-2 to 2-3, 2-5 to 2-8

formation, 2-8 to 2-9

influence on surface features, 3-5 to 3-8, 3-10 to 3-15,3-20

prognostic charts, 2-1 to 2-2, 2-9 to 2-10, 3-2 to 3-3

Upwelling, 9-15 to 9-16

V

Vertical motion, 1-3 to 1-4, 1-7,4-8

vertical velocity charts, 1-7

Vertical stretching, 4-2 to 4-3

Vorticity, 1-8 to 1-11, 3-10,4-8

absolute, 1-8 to 1-9

evaluation of, 1-9 to 1-10

effects on cyclogenesis, 3-10

precipitation, 4-8

relation to weather processes, 1-10 to 1-11

relative, 1-8 to 1-9

W

Waterspouts, 5-18

Warnings, *see* Special observations and forecasts

Weather elements, forecasting of, 4-1 to 4-32

WEAX/AVWX, 10-2, 10-7 to 10-9

frequency of issuance, 10-8

standard format, 10-8 to 10-9

verification, 10-2

Wind shear, 1-1 to 1-2, 12-10, 5-34 to 5-39. *See also*

Vorticity

directional, 1-1 to 1-2

radar detection, 12-10

turbulence, 5-34 to 5-39

velocity, 1-2

WSR-88D radar, *see* Doppler radar

Assignment Questions

Information: The text pages that you are to study are provided at the beginning of the assignment questions.

ASSIGNMENT 1

Textbook Assignment: "Convergence, Divergence, and Vorticity," "Forecasting Upper Air Systems," and "Forecasting Surface Systems." Pages 1-1 through 3-10.

- 1-1. Maximum convergence and divergence occurs between what levels aloft?
1. 850- to 700-hPa levels
 2. 700- to 500-hPa levels
 3. 500- to 300-hPa levels
 4. 300- to 200-hPa levels

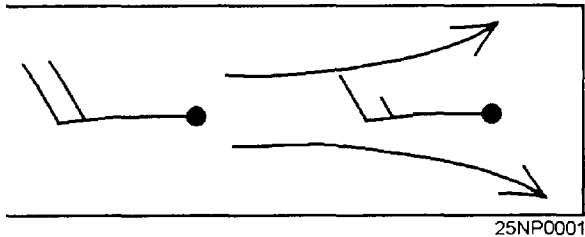

Figure 1-A

IN ANSWERING QUESTION 1-2, REFER TO FIGURE 1-A.

- 1-2. The wind symbols and streamlines in Figure 1-A depict what information?
1. Speed divergence and directional divergence
 2. Speed convergence and directional divergence
 3. Speed divergence and directional convergence
 4. Speed convergence and directional convergence
- 1-3. The "advection" stratum may be regarded as the stratum below what specific level?
1. The 200-hPa level
 2. The 300-hPa level
 3. The 400-hPa level
 4. The 500-hPa level

- 1-4. If all other motions of convergence and divergence are neglected, rising and falling heights at the isopycnic level are the result of what actions?

1. Rising heights are due to subsidence, and falling heights are due to convection
2. Rising heights are due to convection, and falling heights are due to subsidence
3. Rising heights are due to divergence above the isopycnic level, and falling heights are due to convergence above the isopycnic level
4. Rising heights are due to convergence above the isopycnic level, and falling heights are due to divergence above the isopycnic level

- 1-5. The level of maximum velocity convergence, located between the 300- and 200-hPa levels, is the primary cause of which of the following conditions?

1. Pressure rises at the surface
2. pressure falls at the surface
3. Height rises in the upper troposphere and lower stratosphere
4. Height falls in the upper troposphere and lower stratosphere

- 1-6. Assume that the vertical motion is upward and is a result of low-level convergence. This is indicative of what type of circulation?

1. Lower vertical circulation in an anticyclone
2. Upper vertical circulation in an anticyclone
3. Lower vertical circulation in advance of a low
4. Upper vertical circulation in advance of a low

- 1-7. Maximum horizontal divergence occurs at approximately what pressure level?

1. The 500-hPa level
2. The 400-hPa level
3. The 300-hPa level
4. The 150-hPa level

- 1-8. What is the result of stratospheric flow over a developing cyclone?
1. Downward vertical motion, and convergence at the level of maximum horizontal divergence
 2. Upward vertical motion, and divergence at the level of maximum horizontal divergence
 3. Upward vertical motion, and convergence at the level of maximum horizontal divergence
 4. Downward vertical motion, and divergence at the level of maximum horizontal divergence
- 1-9. You are looking downstream and find that high-speed winds are moving towards weak, cyclonically curved contours. What effect should this have on upper-level heights?
1. Heights should decrease downstream to the left
 2. Heights should decrease downstream to the right
 3. Heights should increase downstream to the left
 4. Heights should increase downstream to the right
- 1-10. When an anticyclonic circulation center is out of phase with its pressure center, what movement(s) bring(s) about a readjustment?
1. The movement of the circulation and pressure centers toward each other
 2. The movement of the circulation center toward the pressure center
 3. Both 1 and 2 above
 4. The movement of the pressure center toward the circulation center
- 1-11. You encounter a well-developed ridge that has sharply curved anticyclonic contours with a deep trough a short distance downstream. What action should you expect to take place?
1. Deepening and reorientation of a portion of the trough
 2. The cutoff low to retrograde from its position and the trough to reorient
 3. Dissipation of the low at the lower end of the trough, depending on the initial winds in the ridge to the west
 4. Filling and reorientation of the trough
- 1-12. Under what condition does the greatest overshooting of high-speed winds occur?
1. When high-speed winds in the ridge are more than twice the measured geostrophic winds
 2. When measured geostrophic winds in the ridge are more than twice the high-speed winds in the ridge
 3. When low-speed winds approach the west side of the anticyclonic ridge
 4. When low-speed winds are located in the southwesterly flow of the downstream ridge
- 1-13. Convergence on the western side of a downstream trough has what results?
1. Dynamic heating
 2. A decrease in upper-level heights
 3. An increase in upper-level heights
 4. A decrease in moisture
- 1-14. Which of the following statements concerning the convection process is valid?
1. Air-mass stability is increased by the process
 2. Air-mass stability is decreased by the process
 3. The air mass is compressed
 4. Stratiform type clouds predominate in areas of convection
- 1-15. Upward motion will always result in cloudiness.
1. True
 2. False
- 1-16. When relative vorticity is evaluated, which of the following components of rotational motion should be considered?
1. Wind shear and streamline curvature
 2. Wind shear and atmospheric rotation
 3. Streamline curvature and atmospheric rotation
 4. Atmospheric rotation and cyclostrophic motion

IN ANSWERING QUESTION 1-17, REFER TO FIGURE 1-4 IN YOUR TRAMAN.

1-17. In evaluating relative vorticity from the shear effect alone on straight contours in the northern hemisphere, which evaluations of relative vorticity should you make?

1. Parcel No. 1 has anticyclonic or negative vorticity; Parcel No. 2 has cyclonic or positive vorticity; Parcel No. 3 has zero vorticity
2. Parcel No. 1 has zero vorticity; Parcel No. 2 has anticyclonic or negative vorticity; Parcel No. 3 has cyclonic or positive vorticity
3. Parcel No. 1 has cyclonic or positive vorticity; Parcel No. 2 has anticyclonic or negative vorticity; Parcel No. 3 has zero vorticity
4. Parcel No. 1 has zero vorticity; Parcel No. 2 has cyclonic or positive vorticity; Parcel No. 3 has anticyclonic or negative vorticity

IN ANSWERING QUESTION 1-18, REFER TO FIGURE 1-5 IN YOUR TRAMAN.

1-18. When you are considering the curvature effect alone for an evaluation of relative vorticity, point P is considered to be a point of NO curvature and, therefore, zero vorticity. What is another name for this point of NO curvature?

1. Mid-point of vorticity
2. Point of negative vorticity
3. Point of positive vorticity
4. Inflection point

IN ANSWERING QUESTION 1-19, REFER TO FIGURE 1-9 IN YOUR TRAMAN.

1-19. If only the curvature effect were considered, the relative vorticity would increase in which of the following regions?

1. Regions I and II
2. Regions I and IV
3. Regions II and III
4. Regions III and IV

1-20. When relative vorticity is decreasing downstream in the upper troposphere, what should you expect to occur?

1. Convergence aloft and surface pressure falls
2. Decreased precipitation if sufficient moisture was initially present
3. Decreased thicknesses between standard isobaric surfaces in the region of decreasing relative vorticity
4. Divergence aloft and surface pressure falls

1-21. Long waves of relatively short wavelength, well-defined major troughs and ridges, and well-developed surface cyclones and anticyclones are associated with which of the following wave patterns?

1. Changing long-wave patterns
2. Retrogression of long waves
3. Progressive long waves
4. Stationary long waves

1-22. Which of the following conditions would NOT be an indication of the retrogression of a long wave?

1. Increased cold air advection in the upstream ridge
2. 24-hr height change trajectories do not correspond to the band of maximum winds
3. New height centers appear
4. Surface lows to the west of the major trough position deepen

1-23. Which of the following statements is generally valid when poleward moving jet streams move into the upper midlatitudes?

1. The amplitudes of the long waves decrease
2. Low zonal indexes are reversed
3. The number of long waves increases
4. Associated long waves speed up

- 1-24. When changes in intensity of troughs and ridges aloft are forecast, the time differential chart is most valuable in forecasting which of the following features?
1. Surface pressure centers
 2. Single height change centers with no apparent history
 3. Height change centers due to convergence or divergence not associated with a short wave trough or ridge
 4. Height change centers with a well-defined history that are associated with short wave troughs and ridges
- 1-25. You are trying to determine the change in intensity of a long wave trough and you notice that the warm air advection on the east side of the trough is less than the cold air advection on the west side. What intensity change, if any, should you forecast for this trough?
1. It will fill slowly
 2. It will deepen
 3. It will fill rapidly
 4. None
- 1-26. Which of the following conditions is favorable for the filling of a trough?
1. The strongest winds are on the west side of the trough
 2. The strongest winds are on the east side of the trough
 3. The strongest winds are at the crest of the associated ridge
 4. The strongest winds are in the southern quadrant of the trough
- 1-27. Upper height falls are associated with low-speed winds approaching straight or cyclonically curved contours.
1. True
 2. False
- 1-28. What seasonal movement and intensity changes occur with the semipermanent high-pressure centers?
1. A poleward movement and decrease in intensity in the summer
 2. An equatorward movement and decrease in intensity in the summer
 3. A poleward movement and increase in intensity in the summer
 4. An equatorward movement and increase in intensity in the summer
- 1-29. A blocking high at 500-hPa has several closed contours, and the strongest winds in these contours are to the south in the easterlies. What forecast should you make for this high?
1. It will move slowly eastward
 2. It will move slowly westward
 3. It will move rapidly eastward
 4. It will remain stationary
- 1-30. Intensification of a blocking high will occur under which of the following conditions?
1. During high zonal index conditions
 2. When cold air advection and mass convergence occur in the lower troposphere
 3. When warm air advection and mass divergence occur in the upper troposphere
 4. When cold air advection and mass convergence occur in the upper troposphere
- 1-31. Concerning the extrapolation of closed lows, which of the following statements is NOT accurate?
1. Extrapolation should only be used for their movement
 2. A central height trend over time should be established
 3. Changes in intensity may be determined
 4. Extrapolation should be used in conjunction with other methods

- 1-32. A deep low is situated at 50°N, and the closed contours are nearly circular around the center. The strongest winds south of the low have a speed of 50 knots, and from these winds to the center of the low is 5° of latitude. The wind speed to the north of the low is 30 knots. According to the Eccentricity Formula, this low should move in what manner?
1. Eastward at 5.5 knots
 2. Westward at 5.5 knots
 3. Westward at 1.8 knots
 4. Eastward at 1.8 knots
- 1-33. Which of the following statements is valid concerning the isotherm-contour relationship of lows aloft?
1. If isotherms and contours are out of phase, lows will remain stationary
 2. Cold air advection to the west indicates weakening
 3. Warm air advection to the east indicates filling
 4. Cold air advection to the west indicates retrogression
- 1-34. The Time-Differential chart shows no height rises for a particular ridge you are forecasting at the 500-hPa level. The 300-hPa chart indicates high-speed winds in the northwestern portion of the ridge approaching anticyclonically curved, weak contours. The advection between the 1000- and 500-hPa levels in that portion of the ridge is warm. What should you forecast for this ridge?
1. The ridge should weaken slowly
 2. The ridge should intensify
 3. The ridge should weaken rapidly
 4. The ridge should remain at its present intensity
- 1-35. In forecasting the intensity of a particular low, you discover that a jet maximum is located to the west of the low, and it is preceded by another jet maximum downstream beyond the southern periphery of the low. What should you forecast for this low?
1. The low should fill
 2. The low should intensify rapidly
 3. The low should intensify slowly
 4. The low should remain at its present intensity
- 1-36. Which of the following conditions is NOT an indication that a cutoff low is forming aloft?
1. Height falls are moving south or southeastward
 2. Strong cold air advection is on the west side of the trough
 3. Strong southwesterlies are situated on the eastern side of the trough
 4. Strong northerlies are situated on the western side of the trough
- 1-37. In the construction of forecasted 500-hPa contours, the change in intensity of a particular system is correlated with all EXCEPT which of the following factors to arrive at specific values for these contours?
1. The sign and the amount of rise and fall in the centers
 2. Convergence and divergence at 500-hPa
 3. Advection of 50% of the thickness gradient
 4. Convergence and divergence in the 850- to 700-hPa stratum
- 1-38. The comma-shaped cloud formation found on satellite imagery is normally the result of upward motion produced by positive vorticity advection.
1. True
 2. False
- 1-39. The 700-hPa chart is used in the construction of an advection chart for which of the following reasons?
1. It is the most readily available
 2. It contains data considered to be the most accurate of any upper-level chart
 3. It approximates the contours of the mean wind vector between the 1000- and 500-hPa levels
 4. It is considered to be the steering level for cold core highs
- 1-40. What is the first step you should take when forecasting the movement of pressure systems?
1. Consult your station's Forecaster's Handbook
 2. Refer to your constructed 1000-500-hPa thickness chart
 3. Note the past history of the pressure system
 4. Note the thermal characteristics of the pressure system

- 1-41. If the path of a cyclone indicates its future movement will run into a stationary anticyclone over the eastern Pacific Ocean, which of the following conditions may occur?
1. Its speed will increase, and its path will curve northward paralleling the isobars of the high
 2. Its speed will decrease, and it will become quasi-stationary and probably dissipate
 3. Its speed will decrease, and its path will curve northward, paralleling the isobars of the high
 4. Its speed will decrease, and its path will be perpendicular to the isobars of the high
- 1-42. Anticyclone centers tend to move toward which of the following areas?
1. Toward the area of greatest pressure rises
 2. Toward the area of greatest pressure falls
 3. Toward the area of maximum low-level convergence
 4. Toward the warm sector isobars
- 1-43. Warm unoccluded lows move in the general direction of the current in the warm air. What general statement is valid regarding their paths and speed?
1. They usually have straight paths, and their speed is approximately the same as that of the cold front
 2. They usually have straight paths, and their speed is somewhat faster than that of the warm air
 3. They usually have straight paths, and their speed is about the same as that of the warm air
 4. They usually have straight paths, and their speed is somewhat slower than that of the warm air
- 1-44. Which pressure systems should be considered first when the steering method is used?
1. Warm highs and cold lows
 2. Warm highs and warm lows
 3. Cold highs and warm lows
 4. Cold highs and cold lows
- 1-45. Assume you are using the steering method to forecast the movement of surface systems in relation to the upper level flow. Where possible, what upper level(s) should you use?
1. Use the 700-hPa level only
 2. Use the 500-hPa level only
 3. Integrate the results of the 500- and 300-hPa levels
 4. Integrate the results of the movement and speed from the 700- and 500-hPa levels
- 1-46. Assume you are forecasting the movement and speed of a surface low. The upper level winds for the 700-hPa stratum are northwesterly at 20 knots. you should forecast this low to move in what manner?
1. In an unknown direction, at a speed of 14 knots
 2. In an unknown direction, at a speed of 20 knots
 3. Southeastward at 20 knots
 4. Southeastward at 14 knots
- 1-47. When the 500-hPa chart is used for steering a surface system, the orientation of the contours determines the direction of motion. What factor should be used to compute the speed?
1. 50% of the forecast upstream winds for the 24-hr period
 2. 50% of the forecast downstream winds for the 24-hr speed
 3. 70% of the forecast downstream winds for the 24-hr speed
 4. 70% of the forecast upstream winds for the 24-hr speed
- 1-48. Warm, unoccluded lows tend to move in what direction in relation to the steering current aloft?
1. Slightly to the left of it
 2. Slightly to the right of it
 3. At right angles to it
 4. Parallel to it
- 1-49. Assume that in an unoccluded low the thickness gradient and the mean wind flow are both strong. In what direction should you expect the low to move?
1. Closer to the direction of the mean wind flow than the thermal wind
 2. Closer to the direction of the thermal wind than the mean flow
 3. Midway between the direction of the mean flow and the direction of the thickness contours

- 1-50. Surface lows move with approximately what percent of the thermal wind in the 1000- to 700-hPa stratum?
1. 50%
 2. 75%
 3. 80%
 4. 100%
- 1-51. Relative to the use of statistical studies in forecasting, which of the following statements is accurate?
1. Valid statistical studies provide the forecaster with virtually infallible rules in making long range forecasts
 2. Statistical studies are of little value to the forecaster in predicting the future behavior of storms, as they are mainly for climatological purposes
 3. Valid statistical studies should be scrutinized and weighed in light of other factors in the integrated forecast
 4. Once a weather situation has been identified, the forecaster can assume the feature will behave in an identical manner
- 1-52. The objective technique for the prediction of maritime cyclones may be employed for which of the following periods?
1. All maritime cyclones in all seasons of the year
 2. All maritime cyclones during the winter months only
 3. All maritime cyclones during the summer months only
 4. Maritime cyclones whose initial positions are north of 30° latitude during the winter months
- 1-53. During periods of westerly flow aloft, surface highs tend to migrate in what general manner?
1. Toward the east
 2. Poleward
 3. Toward areas of decreasing isallobaric gradient
 4. Equatorward
- 1-54. When the direction of movement of a surface low is parallel to the warm sector isobars, it can be expected to deepen with a rate equal to which of the following location pressure tendencies?
1. The warm sector tendency
 2. The tendency in advance of the warm front
 3. The tendency at the trough line
 4. The tendency north of the center of the low
- 1-55. Wave cyclones are most likely to develop along a front in what location?
1. Along the accelerating portion of a cold front where the 700-hPa winds are parallel to the front
 2. Along the decelerating portion of a cold front where the 700-hPa winds are parallel to the front
 3. Along the decelerating portion of a cold front where the 700-hPa winds are perpendicular to the front
 4. Along the accelerating portion of a cold front where the 700-hPa winds are perpendicular to the front
- 1-56. A change in pressure at the surface can be estimated to be equal to which of the following conditions?
1. A change in pressure at some level aloft
 2. A change in mass between the surface and some upper level
 3. A change in pressure at some upper level plus the change in mass between the surface and that upper level
 4. A change in pressure at some upper level minus the change in mass between the surface and that upper level

1-57. Concerning the relationship between vorticity aloft and the deepening/filling of surface lows, all EXCEPT which of the following statements is correct?

1. Increasing cyclonic (positive) relative vorticity induces downstream surface pressure falls
2. Increasing anticyclonic (negative) relative vorticity induces downstream surface pressure rises
3. A wave will be stable if the 700-hPa wind over it possesses anticyclonic relative vorticity
4. A wave will be stable if the 700-hPa wind field over it possesses cyclonic relative vorticity

ASSIGNMENT 2

Textbook Assignment: "Forecasting Surface Systems (continued)," and "Forecasting Weather Elements." Pages 3-10 through 4-32.

2-1. When there are several waves along a front, the wave nearest the axis of the trough will normally develop at the expense of the others.

1. True
2. False

2-2. Assume you have a northwestward moving surface low situated over the eastern United States. The low is beneath the 10,700-m contour at the 200-hPa level. It is expected to move northeastward and be located beneath the 10,520-m contour at the 200-hPa level in 24 hr. If you use the approximation method, what would be the expected deepening of the low in 24 hr?

1. 7.2 hPa
2. 10.8 hPa
3. 13.5 hPa
4. 21.0 hPa

2-3. When a surface low moves beneath or ahead of the major ridge position at the 500-hPa level, what changes can be anticipated of the surface low?

1. The surface low will deepen
2. The surface low will fill
3. The associated weather will become more widespread
4. The surface low will move rapidly eastward

2-4. With a southerly flow at the 700-hPa level along the east coast of the United States, where can you anticipate development of a secondary low?

1. The northern Gulf of Mexico
2. Over the gulf states
3. Offshore, New England
4. The vicinity of Cape Hatteras

2-5. What would most likely occur in the lower stratosphere above the 300-hPa level if the column of air in a deepening low below the 300-hPa level were to become colder?

1. Subsidence in the lower stratosphere, resulting in warming and lowering of the constant pressure surfaces
2. Convergence in the lower stratosphere, resulting in cooling and lowering of the constant pressure surfaces
3. Subsidence in the lower stratosphere, resulting in cooling and lowering of the constant pressure surfaces
4. Convergence in the lower stratosphere, resulting in warming and lowering of the constant pressure surfaces

IN ANSWERING QUESTION 2-6, REFER TO FIGURE 3-8 IN YOUR TRAMAN.

2-6. Which of the following assumptions can be made from figure 3-8?

1. A surface high would exist to the left
2. The level of equal density is above the 200-hPa level
3. The tropopause layer is not significantly altered by the upper high
4. All of the above assumptions can be made

2-7. Assume that the upper current over a surface low is undisturbed and the low is deviating to the left of the upper contours (looking downstream). What should you forecast for this low?

1. The low should fill
2. The low should deepen
3. The low should split
4. The low should remain unchanged

2-8. Deepening lows always move more slowly than filling lows.

1. True
2. False

- 2-9. In the development of an anticyclone, what changes occur in the troposphere and lower stratosphere?
1. Warming occurs both in the 400- to 200-hPa stratum, and in the lower troposphere due to subsidence
 2. Cooling occurs above the 400- to 200-hPa stratum, and warming occurs in the lower troposphere due to convergence
 3. Warming occurs in the 400- to 200-hPa stratum due to subsidence, and cooling occurs in the lower troposphere due to convergence
 4. Cooling occurs above the 200-hPa level due to convergence in the 400- to 200-hPa stratum, and warming occurs in the lower troposphere
- 2-10. Assume you are forecasting a surface high. you find that the 500-hPa height is NOT forecasted to increase, although convergence is occurring above 500 hPa. What should you forecast for this high?
1. It will split
 2. It will weaken
 3. It will intensify
 4. It will remain unchanged in intensity
- 2-11. In regard to satellite imagery interpretation of intensity changes of surface cyclones, which of the following statements is valid?
1. Filling is indicated when Positive Vorticity Advection (PVA) becomes broader
 2. High clouds surrounding a vortex indicate cold air advection
 3. High and/or middle clouds surrounding a vortex indicate the cyclone has reached maturity
 4. Deepening is indicated when PVA becomes narrower
- 2-12. The forecasting of frontal displacement by the geostrophic wind method should be based on which of the following components?
1. The geostrophic wind component parallel to the front obtained at the time of the forecast
 2. The geostrophic wind component normal to the front obtained at the time of the forecast
 3. A forecast of the mean component of the geostrophic wind, parallel to the front, which is expected to prevail during the forecast period
 4. A forecast of the mean component of the geostrophic wind, normal to the front, which is expected to prevail during the forecast period
- 2-13. You should expect a front to have a rapid west-east movement with little southward penetration during what index cycle?
1. A low zonal index
 2. A high zonal index
 3. A changing zonal index
 4. A decreasing zonal index
- 2-14. Which of the following movements would NOT indicate intensification of a surface front?
1. The surface front approaches a deep upper level trough
 2. The mean isotherms become more normal to the surface front
 3. The mean isotherms become more parallel to the surface, and tend to pack
 4. Both air masses have strengthened due to the underlying surface
- 2-15. When the mean isotherms associated with a frontal system become more perpendicular to the surface front, what process should be anticipated?
1. Frontogenesis
 2. Frontolysis
 3. Cyclogenesis
 4. Cyclolysis

- 2-16. Assume you are forecasting an isobar over your station. You find that the current 500-hPa height over your station is 5580-m and the forecasted value is 5640-m. The current 1000- to 500-hPa thickness is 5640-m, and the forecasted value is 5520-m. The current sea level pressure is 1029.0 hPa. What value should you forecast for the sea level pressure?
1. 1014.0 hPa
 2. 1021.5 hPa
 3. 1036.5 hPa
 4. 1044.0 hPa
- 2-17. Which of the following processes is capable of producing precipitation in appreciable amounts.
1. Nonadiabatic cooling
 2. Adiabatic lifting of air
 3. Evaporation of additional moisture into the air
 4. Radiation and conduction associated with advection
- 2-18. Adiabatic lifting of air can be caused by all EXCEPT which of the following cooling processes?
1. Frontal lifting
 2. Orographic lifting
 3. Vertical stretching
 4. Horizontal divergence
- 2-19. Which of the following cooling processes is the most-effective and intensive?
1. Frontal lifting
 2. Orographic lifting
 3. Vertical stretching
 4. Horizontal divergence
- 2-20. The most marked convergence occurs at what position?
1. 1
 2. 2
 3. 7
 4. 4
- 2-21. Horizontal convergence, orographic lifting, or frontal lifting acting alone or in combination with one another can occur in any particular weather situation.
1. True
 2. False
- 2-22. Which of the following processes will NOT prevent precipitation by increasing the temperature of the air?
1. Air descending the lee side of a mountain
 2. Air descending from aloft to compensate for divergence of air from another region
 3. Air descending because the mass ahead of a front is moving with a relative component away from the front
 4. Air ascending the lee side of a mountain
- 2-23. When frontal weather extends far behind a surface cold front, the 700-hPa level isoheights will be at what relative position?
1. Perpendicular to the surface front
 2. Parallel to the upper front
 3. Parallel to the surface front
 4. Perpendicular to the isotherms
- 2-24. Well-developed cloud bands noted on satellite imagery are associated with active cold fronts at the surface, and are the result of which of the following processes?
1. The veering of the winds aloft associated with the surface front
 2. The backing of the winds aloft associated with the surface front
 3. An upper wind flow that is nearly perpendicular to the frontal zone
 4. An upper wind flow that is parallel, or nearly parallel, to the frontal zone

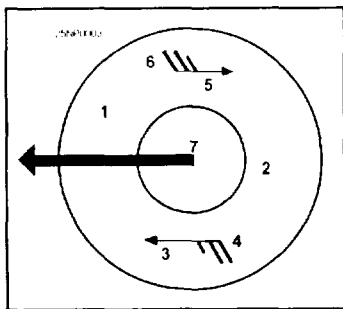

Figure 2-A

IN ANSWERING QUESTION 2-20, REFER TO FIGURE 2-A.

- 2-25. Excluding the cirrus cloud shield, what is considered to be the forward limit of warm frontal cloudiness?
1. The 500-hPa ridge ahead of the front
 2. The 700-hPa ridge ahead of the front
 3. The 850-hPa ridge ahead of the front
 4. The 925-hPa ridge ahead of the front
- 2-26. The slope of a warm front is nearly horizontal near the surface, but is steep several hundred miles to the north. Where should the heaviest precipitation occur?
1. At the surface front
 2. Immediately behind the surface front
 3. South of the surface front
 4. Where the slope of the surface front is greatest
- 2-27. What type of flow aloft tends to diminish cloudiness and precipitation?
1. Convergent flow
 2. Cyclonic flow
 3. Straight flow
 4. Anticyclonic flow
- 2-28. Open cellular clouds are typically found in which of the following locations?
1. Stable air masses
 2. The area immediately ahead of cold fronts
 3. The cold air side of a cold front
 4. The warm air side of a warm front
- 2-29. Closed cellular clouds are predominately composed of which of the following elements?
1. Cumuliform elements
 2. Stratocumulus elements
 3. Stratiform elements
 4. Cirriform elements
- 2-30. Which of the following conditions is indicative of "fair weather"?
1. The relative vorticity increases downstream along the streamlines
 2. The relative vorticity decreases downstream along the streamlines
 3. The relative vorticity increases upstream along the streamlines
 4. The relative vorticity remains constant along the streamlines
- 2-31. Satisfactory forecasting of the movement of precipitation areas by using isochrones may be obtained if the isochrones indicate areas that have what type of precipitation?
1. Continuous precipitation
 2. Showery precipitation only
 3. Intermittent precipitation only
 4. Either showery or intermittent precipitation
- 2-32. Relative to the behavior of the cloud base and ceiling in an area of continuous precipitation, which of the following statements is accurate?
1. Both the ceiling and the cloud base will drop rapidly
 2. Both the ceiling and the cloud base will drop gradually
 3. The ceiling will drop gradually, and the cloud base will drop rapidly
 4. The ceiling will drop rapidly, and the cloud base will drop gradually
- 2-33. Before an extrapolation of ceiling trends can be made by using the x-t diagram, which of the following conditions may necessitate the smoothing of the "curves"?
1. Diurnal ceiling fluctuations
 2. Ceiling irregularities caused by topographic influences
 3. Rapid and erratic up-and-down fluctuations of the ceiling
 4. All of the above
- 2-34. What should be the first step in the construction of a "trend chart"?
1. Determine the source direction of the weather
 2. Identify predictor station(s)
 3. Determine the "critical factor"
 4. Analyze the mesoscale situation

2-35. "Time-liners" are particularly useful for making the analysis and extrapolation of which of the following aids?

1. Trend charts only
2. Time-distance charts only
3. Isochrone analyses
4. Trend and time-distance charts

2-36. The temperature and dewpoint curves constructed on a RAOB may be used to determine the presence and thickness of cloud layers, as well as potential areas of cloud formation.

1. True
2. False

2-37. The temperature to which air must be cooled or heated adiabatically to reach saturation with respect to ice is the definition of what meteorological term?

1. Dewpoint
2. Potential temperature
3. Frost point
4. Relative humidity

2-38. Under what condition will the true temperature lie between the true dewpoint and the true frost point in a cloud?

1. When the cloud consists entirely of super-cooled water droplets
2. When the cloud temperature is above freezing
3. When the cloud consists entirely of ice crystals
4. When the temperature is representative of the sub-freezing portion of a cloud

2-39. A cirrus cloud is saturated with respect to water with a dewpoint of -31°C . What is the correct frost point to the nearest whole degree?

1. -22°C
2. -28°C
3. -34°C
4. -40°C

2-40. Assume that a sounding indicates a layer of moderate decrease in dewpoint depression, followed by another layer of stronger decrease in dewpoint depression. What assumption can be made relative to the cloud layer associated with the depression?

1. The top of the cloud layer should be identified with the base of the stronger decrease
2. The top of the cloud layer should be identified with the weaker decrease
3. The base of the cloud layer should be identified with the base of the stronger decrease
4. The base of the cloud layer should be identified with the base of the weaker decrease

IN ANSWERING QUESTION 2-41, REFER TO FIGURE 4-19 IN YOUR TRAMAN.

2-41. What is the probability of clear or scattered conditions when a sounding that terminated at the 850-hPa level indicates a dewpoint depression of 6°C ?

1. 20%
2. 35%
3. 60%
4. 70%

2-42. Assume a 500-hPa level dewpoint depression analysis is constructed to determine the probable cloud areas. Where would cloud layers be indicated?

1. At the 500-hPa level only
2. At and below the 500-hPa level only
3. At and above the 500-hPa level only
4. At, above, and below the 500-hPa level

2-43. What is the greatest factor in determining the type and intensity of precipitation observed at the surface?

1. Cloud types
2. Thickness of the cloud types
3. Height of the base of the clouds
4. Temperature in the upper portion of the clouds

- 2-44. Most high-level jet operational problems are created by what type of cirriform clouds?
1. Cirruncinus
 2. Cirrocumulus
 3. Cirrostratus
 4. Cirrus (proper)
- 2-45. In the upper troposphere, what is the result of the slow ascent of air that has insufficient freezing nuclei in the higher levels?
1. The formation of cirrus haze
 2. The formation of cirrocumulus clouds
 3. The formation of cirrostratus clouds
 4. The formation of "anvil" cirrus clouds
- 2-46. Assume that an aircraft is to fly through thin cirrus clouds in which the temperature is -35°C and the dewpoint is -37°C . What aircraft visibility should be forecasted?
1. 1 mile
 2. 2 miles
 3. 3 miles
 4. 7 miles
- 2-47. A ridge line is approaching your station. You should forecast extensive cirrostratus clouds to occur at what period?
1. Before arrival of the 500-hPa ridge line
 2. After passage of the 500-hPa ridge line
 3. Before arrival of the surface ridge line
 4. After passage of the surface ridge line
- 2-48. The mean height of the bases of cirriform clouds are greater at the equator than in the mid-latitudes.
1. True
 2. False
- 2-49. Where are the densest and most extensive cirrus clouds found relative to the jet stream?
1. Below the jet stream axis
 2. Above the jet stream axis
 3. Poleward of the jet stream axis
 4. Equatorward of the jet stream axis
- 2-50. The correct prediction of rain versus snow at a location depends mostly upon which of the following factors?
1. The height of the cloud bases
 2. The temperature at the surface
 3. The height of the freezing level
 4. The temperature at the base of the cloud
- 2-51. In most precipitation situations, warming in the lower troposphere is generally expected to accompany the precipitation due to which of the following movements?
1. Strong warm air advection and upward vertical motion
 2. Strong warm air advection and downward vertical motion
 3. Cold air advection and strong upward vertical motion
 4. Cold air advection and strong downward vertical motion
- 2-52. What is the primary cause of the lowering of the "bright band" within the first 1 1/2 hours after the onset of precipitation?
1. Vertical motion
 2. Horizontal advection
 3. Evaporational cooling
 4. Combined effects of all of the above
- 2-53. A rain-snow zone is most closely tied to which of the following factors?
1. The position of the warm front
 2. The position of the polar front
 3. The direction of the surface winds
 4. The track of the surface disturbance
- 2-54. Which of the following local thermal parameters used in a snow versus rain forecast is the LEAST reliable when considered by itself?
1. Stratum thickness
 2. Surface temperature
 3. Upper level temperature
 4. Freezing level height

- 2-55. Wagner's study of the 1000- to 500-hPa thickness as a predictor of precipitation type in the United States verified which of the following statements?
1. Critical thickness values increase with increasing altitude
 2. Critical thickness values increase with decreasing altitude
 3. Critical thickness values decrease with increasing altitude
 4. Critical thickness is unaffected by increasing or decreasing altitude
- 2-56. During periods of normal winter conditions, how far upstream should you look in forecasting a 24-hour temperature?
1. 200 nm
 2. 300 nm
 3. 400 nm
 4. 500 nm
- 2-57. In what area of a blizzard should you expect maximum snowfall?
1. To the left of the storm's track
 2. To the right of the storm's track
 3. Along the storm's track
 4. 100 to 300 nm equatorward of the storm's track
- 2-58. Which of the following is a characteristic of a warm advection type snowstorm?
1. An occluded low-pressure center to the east
 2. A strong, active low-pressure center in the vicinity of the maximum snowfall area
 3. The absence of a low-pressure center in the vicinity of the maximum snowfall area
 4. An unoccluded low-pressure center to the east
- 2-59. What type of snowstorm may occur when a sharp, north-south oriented cold front lies in a deep trough?
1. Post-cold frontal
 2. Warm advection
 3. Major snowstorm
 4. Blizzard
- 2-60. Maximum snowfall at any one station is of shortest duration if the snowstorm is of what type?
1. Blizzard
 2. Warm advection
 3. Post-cold frontal
 4. Major storm
- 2-61. What 850-hPa level moisture isopleth and isotherm are used as the defining line for locating areas of maximum snowfall in the Great Lakes region of the United States?
1. The -10°C dewpoint isopleth and the -3°C isotherm
 2. The -10°C dewpoint isopleth and the 0°C isotherm
 3. The -5°C dewpoint isopleth and the -3°C isotherm
 4. The -5°C dewpoint isopleth and the 0°C isotherm
- 2-62. Assume that yesterday the maximum temperature was 15°F and the lapse rate was stable; today, the lapse rate has become unstable while sky conditions have remained the same. How will today's temperature compare with yesterday's?
1. It will be greater
 2. It will be the same
 3. It will be less
- 2-63. all EXCEPT which of the following characteristics are prerequisites for a cold wave over the United States?
1. Strong northerly or northwesterly flow develops aloft over west central Canada
 2. A strong ridge exists over the eastern portion of the United States
 3. Intense southwesterly flow develops over the eastern Pacific ocean
 4. An extremely cold Arctic air mass exists over west central Canada
- 2-64. A stationary long wave trough over the Rocky mountains in the summer always warns of a "heat wave" for the eastern United states.
1. True
 2. False

ASSIGNMENT 3

Textbook Assignment: "Forecasting Severe Weather Features," and "Sea Surface Forecasting."
Pages 5-1 through 6-18.

- 3-1. At what stage(s) in the life cycle of a thunderstorm should you expect updrafts to occur from below the base to the top of the cloud?
1. The cumulus stage
 2. The mature stage
 3. The dissipating stage
 4. Throughout all stages
- 3-2. The least severe turbulence associated with thunderstorms is generally found at what location?
1. Near the top of the cloud
 2. Near the base of the cloud
 3. Near the freezing level
 4. 1500 ft above the freezing level
- 3-3. Hail is associated with the mature stage of a thunderstorm and is found with the greatest frequency between which levels?
1. The surface and 5,000-ft level
 2. The 5,000- and 10,000-ft level
 3. The 10,000- and 15,000-ft level
 4. The 15,000- and 20,000-ft level
- 3-4. When the intensities of turbulence and precipitation are compared, what relationship should be assumed?
1. Turbulence intensity varies inversely with precipitation intensity
 2. Turbulence intensity varies directly with precipitation intensity
 3. The relationship between turbulence and precipitation intensities is dependent on the size of the thunderstorm
 4. Turbulence intensity is not related to precipitation
- 3-5. Which of the following activities produces electrical charges in cumulonimbus clouds?
1. Raindrops falling through the cloud produce static charges
 2. The passage of another cloud with opposite polarity
 3. A cloud passing in the vicinity of a high electrical field of opposite polarity
 4. Opposite polarity within the cloud relative to the earth's surface
- 3-6. In what area of a thunderstorm does lightning most frequently occur?
1. Immediately beneath the storm
 2. In areas with temperatures in the range of 0°C to -9°C
 3. Within the "anvil" atop the cumulonimbus cloud
 4. At the trailing edge of the thunderstorm
- 3-7. What is the primary in-flight hazard associated with lightning?
1. Injury to personnel
 2. Discomfort for personnel
 3. Damage to radio equipment
 4. Damage to aircraft structural components
- 3-8. Severe turbulence in thunderstorms is most frequently encountered within what stratum?
1. The 5,000- and 10,000-ft level
 2. The 7,500- and 12,000-ft level
 3. The 8,000- and 15,000-ft level
 4. The 10,000- and 20,000-ft level
- 3-9. Lightning strikes are most likely to occur within which of the following thermal stratums?
1. Near or slightly above the 0°C isotherm level
 2. Near or slightly above the -5°C isotherm level
 3. Near or slightly below the -10°C isotherm level
 4. Near or slightly above the -15°C isotherm level
- 3-10. The mass of cool air that spreads out at the base of a thunderstorm as a result of downdrafts may develop into which of the following features?
1. A small low-pressure area
 2. A small high-pressure area
 3. A squall line
 4. A microscale thunderstorm

- 3-11. How do pressure changes associated with a thunderstorm influence aircraft altimeter readings?
1. The altimeter reading decreases as the storm approaches and remains low until the storm moves away
 2. The altimeter reading increases as the storm approaches, decreases while in the rain showers, and returns to normal as the storm moves away
 3. The altimeter reading decreases in the cumulus stage of the thunderstorm, increases in the mature stage of the thunderstorm, and returns to normal in the dissipation stage
 4. The altimeter reflects decreasing altitudes as the aircraft approaches the thunderstorm, increased altitude as the aircraft flies through the rain, and returns to normal as the aircraft flies away from the storm
- 3-12. A pilot sets the altimeter immediately before the passage of a thunderstorm. Following the passage of the thunderstorm, what should the altimeter read?
1. High
 2. Low
 3. Accurate
- 3-13. When the parcel method is analyzed on a Skew T log P diagram and used to forecast thunderstorms, which of the following statements is valid?
1. With a large positive area, thunderstorms may be forecast with a high degree of confidence
 2. When thunderstorms are not indicated, you may safely assume that no thunderstorms will occur
 3. The parcel method gives little indication of stability or instability when used alone as a forecasting aid
 4. The size of the positive area is a good indication of instability, but other factors, such as the distribution of low tropospheric moisture, should be considered
- 3-14. Which parcel method condition, when considered alone, would NOT be favorable for thunderstorm development?
1. The negative energy area exceeds the positive energy area
 2. The positive energy area exceeds the negative energy area
 3. An ample supply of moisture is uniformly distributed throughout the lower troposphere
 4. The parcel will rise to a temperature level of -10°C
- IN ANSWERING QUESTION 3-15, REFER TO FIGURE 5-3 IN YOUR TRAMAN.
- 3-15. From an analysis of figure 5-3, you should draw which of the following conclusions?
1. The base of the inversion can be safely assumed to be the top of cumulus activity
 2. Sufficient heating during the day will dissipate the low-level inversion; therefore, a forecast of thunderstorm activity may be made
 3. In spite of favorable lapse rate conditions, there is insufficient moisture for thunderstorm development
 4. Although the positive energy areas exceed the negative energy areas, due to the intensity of the low-level inversion, thunderstorms would probably not form
- 3-16. When the parcel method for mechanical lifting is used, what level(s) is/are determined on the Skew T log P diagram?
1. LCL
 2. LFC
 3. Both 1 and 2 above
 4. LND

- 3-17. Which of the following procedures is NOT used in discounting regional forecasting of air-mass thunderstorms?
1. Dewpoint depressions of 13°C or more at any level within the 850- to 700-hPa stratum
 2. Dry air advection in the lower levels
 3. Freezing levels below 12,000 ft in an unstable cyclonic flow producing only light showers
 4. Dewpoint depressions of 15°C or greater at the 700- to 600-hPa levels
- 3-18. Stability indexes are most valuable in forecasting thunderstorms or showers in which of the following situations?
1. When used to forecast thunderstorm or shower activity for individual locations
 2. When plotted and analyzed on stability index charts for large areas, and evaluated in light of other synoptic considerations
 3. When plotted and analyzed on stability index charts and when used alone as indicators of probable thunderstorm activity
 4. When plotted for several locations, and conclusions of possible thunderstorm or shower activity are arrived at for each location in light of surrounding locations
- 3-19. When Showalter Index computations reveal an index of -4°C, what should be indicated for thunderstorm activity?
1. Light thunderstorms
 2. Moderate thunderstorms
 3. Severe thunderstorms
 4. No thunderstorm activity
- 3-20. The occurrence of a tornado is possible if a Showalter Index of
1. greater than 3°C is computed
 2. less than -2°C is computed
 3. greater than 6°C is computed
 4. less than -6°C is computed
- 3-21. Which of the following statements regarding the movement of thunderstorms relative to upper-level wind direction and speed is valid?
1. Upper-level wind direction and speed can be used as a guide in forecasting thunderstorm movement, but without a great deal of confidence
 2. Upper-level wind direction and speed can be used with considerable confidence in forecasting the direction of, but not the speed of movement of thunderstorms
 3. Upper-level wind direction and speed can be used with confidence in forecasting the speed of movement, but not the direction of thunderstorms
 4. The 700-hPa level winds can be used with a considerable degree of accuracy in forecasting both the speed and direction of movement of thunderstorms
- 3-22. Within the 10,000- to 20,000-ft stratum, most hail is encountered outside the thunderstorm.
1. True
 2. False
- 3-23. Which of the following phrases defines the Equilibrium level (EL) as used in the Yes-No hail forecasting technique?
1. The top of a negative area in a sounding where the saturation adiabat traced from the CCL intersects the temperature curve
 2. The top of the lowest positive area at the intersection of the dry adiabat
 3. The top of a positive area in a sounding where the saturation adiabat traced from the CCL intersects the temperature curve
 4. The area between the first positive and negative energy areas
- 3-24. When preparing hail size forecasts by using the Skew T log P diagram, you should trace the moist adiabat upward from the CCL to what dry-bulb temperature level?
1. 0°F
 2. 0°C
 3. -5°F
 4. -5°C

3-25. Most tornadoes in the United States occur during what season(s) of the year?

1. Fall
2. Midwinter
3. Summer and early fall
4. Spring and early summer

3-26. Which type of tornado is normally associated with squall lines?

1. Great Plains
2. Gulf Coast
3. West Coast
4. Eastern

3-27. Although the phenomena are not similar, the formation of both thunderstorms and fog originates in a moist, unstable air mass.

1. True
2. False

3-28. Frontal fog would be LEAST likely to form in which of the following areas?

1. In advance of a warm front
2. To the rear of a slow-moving cold front
3. To the rear of a fast-moving cold front
4. In the warm sector of a low-pressure area

IN ANSWERING QUESTION 3-29, REFER TO FIGURE 5-17 IN YOUR TRAMAN.

3-29. Assume that smoke was present during the day and night preceding the fog formation indicated in figure 5-17. What should be your forecast time of fog formation?

1. 0230 local standard time
2. 0330 local standard time
3. 0430 local standard time
4. 0530 local standard time

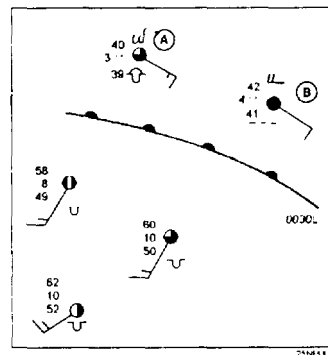

Figure 3-A

IN ANSWERING QUESTION 3-30, REFER TO FIGURE 3-A.

3-30. The warm front depicted in figure 3-A is located 40 miles southwest of stations A and B. It is forecast to move northeastward at 20 knots, and is expected to pass stations A and B at approximately 0230 local standard time. The wind will shift to the southwest at 16 knots. What should be your forecast for stations A and B at 0430 local standard time?

1. Heavy fog with possible drizzle
2. Moderate fog with possible drizzle
3. Low stratus clouds and possible drizzle
4. Stratocumulus clouds with unrestricted visibility

3-31. Which of the following meteorological situations is most favorable for the formation of radiation fog?

1. A clear, cool night with strong winds in a fast-moving, high-pressure area
2. A cloudy, warm night with light breezes in the warm sector of a low-pressure area
3. A clear, cool night with light breezes in a stationary high-pressure area
4. A sultry, humid evening with calm winds in the warm sector of a low-pressure area

3-32. What type of fog is formed when a warm, rainy air mass overrides a stable, continental polar (cP) air mass?

1. Frontal passage fog
2. Postfrontal fog
3. Radiational fog
4. Prefrontal fog

- 3-33. Postfrontal fog may be formed under which of the following conditions?
1. Two air masses are near saturation and accompanied by light winds
 2. The postfrontal air mass is temporarily heated from below
 3. Hydrocarbon fuels are present with a quasi-stationary frontal system
 4. A quasi-stationary east-west oriented cold front is present and the continental polar air behind the front is stable
- 3-34. Frontal passage fog may form where associated air masses are near saturation, with light frontal winds.
1. True
 2. False
- 3-35. Sea fogs tend to dissipate under which of the following conditions?
1. When the winds are greater than 6 knots
 2. When the underlying water continually becomes colder
 3. When there is radiational cooling from the warm water
 4. When the sea fog flows over warm land
- 3-36. Assume that a sounding is taken at a time when stratus clouds are observed over your location. Which of the following conditions will usually exist near the surface?
1. A moist adiabatic lapse rate
 2. A dry adiabatic lapse rate
 3. A shallow convective cloud deck
 4. A temperature inversion
- 3-37. You are using the dry adiabatic method to predict the height of the top of a layer of fog. The average mixing ratio line intersects the temperature curve at 20°C, and the dry adiabat of this intersection reaches the surface level at a temperature of 30°C. The top of this layer of fog will be at what height?
1. 1,000 ft
 2. 1,640 ft
 3. 3,280 ft
 4. 5,280 ft
- 3-38. The "critical temperature" is the surface temperature at which fog will
1. form, provided no changes have taken place in the sounding
 2. dissipate, regardless of changes in the sounding
 3. dissipate, provided no changes have taken place in the sounding
 4. form, regardless of changes in the sounding
- 3-39. A stratus layer is over your station when you take a morning sounding at 0600 local standard time, with a surface temperature of 8.5°C. The surface temperature at which dissipation will begin is computed to be 16°C, with dissipation to be complete when the temperature reaches 24°C. If heating is forecast to increase at the rate of 4°C per hour for the first 2 hours, and 6°C per hour for the next 3 hours, at what time should you forecast the stratus layer to dissipate?
1. 0915 local standard time
 2. 0945 local standard time
 3. 1015 local standard time
 4. 1045 local standard time
- 3-40. What causes a supercooled water droplet to freeze on contact with an aircraft at -3°C when it will not normally freeze until the temperature is between -10°C and -40°C?
1. The internal stability of the droplet is destroyed when it strikes the aircraft, and its freezing point is raised
 2. The surrounding air temperature is below 0°C, causing the water droplets to freeze immediately
 3. The airflow created by the engine creates sufficient disturbance to destroy the stability of the water droplets
 4. Supercooled water droplets normally freeze at -3°C
- 3-41. In the course of a flight from takeoff to landing, at what stage is a turbojet aircraft LEAST susceptible to icing?
1. When in the landing pattern
 2. When taking off
 3. When in final approach
 4. At cruising altitude and speed

- 3-42. In which of the following meteorological situations should you forecast the greatest probability of aircraft icing?
1. Cold air advection, temperature of -5°C, and dewpoint depression of 2°C
 2. Cold air advection, temperature of -7°C, and dewpoint depression of 3°C
 3. Warm air advection, temperature of -15°C, and dewpoint depression of 4°C
 4. Warm air advection, temperature of -10°C, and dewpoint depression of 3°C

IN ANSWERING QUESTION 3-43, REFER TO FIGURE 5-20 IN YOUR TRAMAN.

- 3-43. Assume that you have weak cold air advection between approximately 9,000 and 12,000 ft. On the basis of the temperatures and the dewpoint depressions, what should your icing intensity forecast be for this area?
1. Light
 2. Moderate
 3. Severe
 4. Extreme

IN ANSWERING QUESTION 3-44, REFER TO FIGURE 5-21 IN YOUR TRAMAN.

- 3-44. What determines the intensity of expected icing?
1. The size of the hatched area
 2. The value of the combined dewpoints
 3. The size of the area between the temperatures and the dewpoints
 4. The stability of the air mass
- 3-45. Which of the following icing conditions should be expected if the -8D curve is to the left of the temperature curve in an area with temperatures ranging from -10 to -18°C?
1. Light glaze icing
 2. Light rime icing
 3. Light hoarfrost
 4. No icing

- 3-46. Wind shear produces turbulence because of eddies created due to tight vertical or horizontal gradients in wind velocity in a specific direction along the same line.

1. True
2. False

- 3-47. A pilot files a DD Form 175-1 for an IFR flight in a P-3 aircraft along a route that will cross over a mountainous area where mountain waves exist. If the height of the tallest en route peak is 5,280 ft, and the pilot can NOT avoid the area, what is the minimum altitude the pilot must maintain in flying over the area?

1. 3,440 ft
2. 7,920 ft
3. 11,160 ft
4. 11,280 ft

- 3-48. Turbulent eddies on mountain ridges usually exist in much deeper layers on what part of the slope?

1. At the highest peak
2. At the lowest base
3. On the windward side
4. On the leeward side

- 3-49. Clear air turbulence (CAT) is most frequently encountered in the winter months.

1. True
2. False

- 3-50. CAT occurs primarily at which of the following locations?

1. Poleward of the jet stream core
2. Equatorward of the jet stream core
3. Within the jet stream core
4. At the 40,000-ft level in warm troughs

- 3-51. Which of the following statements is NOT a valid characteristic of sea waves?

1. Sea waves are created by local winds
2. Sea waves are composed of a small spectrum of sine waves
3. Sea waves remain in their generating area
4. Sea waves are very irregular in appearance

- 3-52. What is the relationship, if any, between wave amplitude and wave height?
1. Wave amplitude equals one-half the wave height
 2. Wave amplitude equals the wave height
 3. Wave amplitude is twice the wave height
 4. None
- 3-53. State the relationship between wave frequency and wave period?
1. Wave frequency is twice the wave period
 2. The lower the wave frequency, the longer the wave period
 3. Wave frequency equals one-half the wave period
 4. The greater the wave frequency, the longer the wave period
- 3-54. If the mean period of a group of waves is 1.5 sec, what would be the group wave speed?
1. 6 knots
 2. 2 knots
 3. 8 knots
 4. 4 knots
- 3-55. What is the significance of the filter area in swell wave forecasting?
1. The filter area allows only certain frequencies of swell waves to arrive at the forecast point
 2. The filter area has little significance in swell wave forecasting
 3. The filter area allows all frequencies of swell waves to arrive at the forecast point
 4. The filter area allows only high frequency swell waves to arrive at the forecast point
- 3-56. What is the importance, if any, of the significant frequency range?
1. Low value frequencies with E-values greater than 5% are eliminated
 2. It determines the range of periods at the forecast point
 3. High value frequencies with E-values greater than 3% are eliminated
 4. None
- 3-57. When, if ever, does the energy transfer from the wind to the sea wave cease?
1. When the speed of the sea wave equals the speed of the wind
 2. When the speed of the sea wave exceeds the speed of the wind
 3. When the speed of the sea wave first exceeds one-half the wind speed
 4. Never
- 3-58. Which of the following statements is NOT accurate regarding fully developed seas?
1. Generated wave frequencies equal to or greater than the minimum frequency for the wind speed may be propagated
 2. The leeward portion of the fetch area is in a steady state
 3. Sea waves can not be generated at higher heights than the maximum value for the wind speed
 4. The windward portion of the fetch is in a steady state
- 3-59. What is the first step in preparing a wave forecast?
1. Determine the duration of the winds
 2. Determine a representative wind speed
 3. Determine a representative wind direction
 4. Locate the fetch area
- 3-60. Which of the following is the LEAST accurate measure of wind speed over a fetch area?
1. Ship observations
 2. Reports from ships traveling in opposing directions
 3. Uncorrected geostrophic winds
 4. Corrected geostrophic winds
- 3-61. Which of the following statements regarding curvature corrections is accurate?
1. Add a 10% correction to the geostrophic wind for moderately curved cyclonic curvature
 2. Straight isobars over shallow basins require a 10% correction
 3. For isobars with sharp cyclonic curvature, decrease the geostrophic wind by 10%
 4. For isobars with sharply curved anticyclonic curvature, decrease the geostrophic wind by 10%

- 3-62. The fact that longer period waves move faster than shorter period waves is best described by what term?
1. Dispersion
 2. Angular spreading
 3. Ekman spiral
 4. Spatial spreading
- 3-63. Which of the following characteristics is NOT affected when a wave "feels" bottom?
1. Wave length
 2. Wave period
 3. Wave speed
 4. Wave direction
- 3-64. The bending of a wave to conform to bottom contours is a definition of what term?
1. Shoaling
 2. Diffraction
 3. Angular spreading
 4. Refraction
- 3-65. Which type of breaker is characterized by a loud, explosive sound?
1. A spilling breaker
 2. A surging breaker
 3. A plunging breaker
 4. A cresting breaker
- 3-66. Surf zone width is normally measured in what increments?
1. Feet
 2. Meters
 3. Yards
 4. Fathoms
- 3-67. The Modified Surf Index is NOT applicable to which of the following landing craft?
1. LARC
 2. LCM-8
 3. LCAC
 4. LVTP-5
- 3-68. What type of currents are most pronounced in the entrances to large tidal basins?
1. Coastal currents
 2. wind-driven currents
 3. Eddy currents
 4. Tidal currents

ASSIGNMENT 4

Textbook Assignment: "Meteorological Products and Tactical Decision Aids," "Oceanographic Products and Tactical Decision Aids," "Operational Oceanography" and "Special Observations and Forecasts." Pages 7-1 through 10-12.

-
- 4-1. The Electronic Countermeasures (ECM) effectiveness display provides airborne jammer effectiveness for a maximum of how many ranges?
1. 10
 2. 7
 3. 5
 4. 4
- 4-2. Which of the following parameters is NOT an input to the D-Value (DVAL) program?
1. Temperature
 2. Pressure level in feet
 3. Specification of output units
 4. Specification of output altitude increments
- 4-3. Which of the following factors is considered the primary cause of EM propagation loss with regard to the Battle Group Vulnerability (BGV) product?
1. Water vapor
 2. Refraction
 3. Haze
 4. Obstructions to vision
- 4-4. The Electromagnetic Path Loss (LOSS) program is valid only for EM systems with frequencies between what range?
1. 10 Hz and 100 Hz
 2. 100 Hz and 1 MHz
 3. 1 MHz and 1 GHz
 4. 100 MHz and 20 GHz
- 4-5. What is the maximum intercept range available when you use the Electronic Support Measure (ESM) program?
1. 100 km
 2. 500 km
 3. 1,000 km
 4. 10,000 km
- 4-6. The Platform Vulnerability (PV) program assumes emitters are radiating at what power level?
1. Average power level
 2. Minimum power level
 3. Maximum power level
 4. Multiple power level
- 4-7. Which of the following statements is accurate concerning detection ranges in the Surface-Search Radar Range (SSR) tables?
1. There are three screen outputs
 2. Ranges are expressed in metric units only
 3. Detection ranges represent average distances to the objects only
 4. Detection ranges represent minimum, average, and maximum ranges to the objects
- 4-8. The coverage display model can be used for all EXCEPT which of the following applications?
1. Airborne or surface-based surface-search radars employed against surface targets
 2. Long-range air-search radars, surface-based or airborne
 3. Surface-search radars when employed against low-flying targets
 4. Sonobuoys (with proper antenna height and frequency)
- 4-9. The function of the coverage display model is to calculate the maximum radar range for a given radar and target.
1. True
 2. False
- 4-10. The Ship Ice Accretion (SHIP ICE) program algorithm considers air temperatures in what range?
1. 35°F to -10°F
 2. 33°F to -5°F
 3. 0°C to -21°C
 4. -2°C to -21°C
- 4-11. What equivalent explosive weight is used with the Sound Focus (SOCUS) program in a reduced charge muzzle blast from a 16-inch naval gun?
1. 66 lb
 2. 198 lb
 3. 330 lb
 4. 400 lb

- 4-12. Which of the following statements is valid concerning the Laser Range Prediction (LRP) program?
1. The program's Night/Day display incorporates several sets of eye apertures for various exposures
 2. The program operates on a frequency specified basis
 3. The program is not to be used for air-to-air scenarios
 4. Data-base computations select the pulse repetition frequency for the minimum power of a particular radar
- 4-13. What is the minimum requirement, if any, for the upper air-sounding used with the Ballistic Wind and Densities Corrections (BALWND) program?
1. The sounding must contain at least five significant levels between the surface and the 700-hPa level
 2. The sounding must contain upper wind data
 3. The sounding must be within 100 nm of the forecast point
 4. None
- 4-14. All EXCEPT which of the following parameters are user inputs to the Radiological Fallout (RADFO) model?
1. Weapon yield
 2. Type of burst
 3. Location
 4. M-unit profile
- 4-15. The RADFO model is meant to be used only for which type of nuclear bursts?
1. High-altitude bursts
 2. Deep-water bursts
 3. Deep-underground bursts
 4. surface or near-surface bursts
- 4-16. Which of the following statements is accurate with regard to the Forward-Looking Infrared (FLIR) program?
1. Weather changes throughout the forecast period are inputs to the program
 2. Attenuation due to rain, fog, and haze are considered in the program
 3. FLIR data may be interpolated for a layer above the maximum height of the sounding
 4. Generally, the higher the wind speed, the shorter the ranges
- 4-17. At which of the following levels does the Aircraft Icing (AIRICE) program start its analysis?
1. The LFC
 2. The LCL, or the surface if no LCL exists
 3. The 1,000-hPa level
 4. The CCL
- 4-18. Which of the following percentages are icing probability outputs from the AIRICE program?
1. 10, 20, 50, and 100% probabilities
 2. 50 and 100% probabilities
 3. 25, 50, 75, and 100% probabilities
 4. Trace, 50, and 100% probabilities
- 4-19. Which of the following statements concerning the Tidal Prediction (TIDE) module is valid?
1. The TIDE module can be used for any coastal location
 2. By inputting the current surface observation, surf conditions may also be calculated
 3. A maximum of five stations may be retrieved at any one time
 4. Tidal currents can not be predicted by using the TIDE module
- 4-20. What is the maximum number of leg segments that may be used with the trackline scenario of the Naval Search and Rescue (NAVSAR) program?
1. One
 2. Five
 3. Three
 4. Four
- 4-21. Which of the following statements is NOT valid regarding the NAVSAR program?
1. The user can request up to five search object probability maps
 2. The search altitude entry for a ship is the ship's bridge height or the height of the sensor
 3. The user inputs all sweep widths
 4. A maximum of eight weather observations may be entered

- 4-22. Which of the following statements is valid regarding the Raytrace (RAY) program?
1. The program uses several sound speed profiles simultaneously to generate a RAY diagram
 2. The program traces only outgoing rays
 3. The program calculates RAY diagrams for flat ocean bottoms only
 4. Extrapolated data from sound speed profiles that do not extend to 2500 m is very accurate
- 4-23. Which of the following inputs is/are selectable for the Passive Acoustic Propagation Loss (PPL) program?
1. Mean water salinity
 2. Mean water density
 3. Target trackline data
 4. Source and receiver depths
- 4-24. Which of the following statements is accurate regarding the Passive Acoustic Propagation Loss (PPL) program?
1. Convergence zone path cannot be inferred from the PPL output
 2. The homogeneity of the watermass is not considered when using the program
 3. Reliable output is constrained
 4. PPL is a range dependent acoustic model
- 4-25. The QPL program uses both the LFBL data base and the COLOSSUS data base to estimate propagation loss.
1. True
 2. False
- 4-26. Which of the following statements is accurate regarding the Near-Surface Ocean Thermal Structural (NOTS) program?
1. The program may be used in all oceanic areas
 2. The program is used to forecast changes in the upper ocean temperatures
 3. Output is available in a tabular output only
 4. Output from the program is always unclassified
- 4-27. Which of the following information may NOT be inferred from a Sound Speed Profile (SSP) module output?
1. The existence of sound channels
 2. The existence of convergence zones
 3. The sonic layer depth
 4. The presence of bottom bounce
- 4-28. Fleet Numerical Meteorology and Oceanography Center (FNMOC), Monterey, California, reviews all Bathy data prior to retransmission in a Bathy collective.
1. True
 2. False
- 4-29. RP33 offers assistance in the ordering of MOE charts.
1. True
 2. False
- 4-30. In order for a usable convergence zone path to exist, the water column must be deeper than the limiting depth by at least how many fathoms?
1. 50
 2. 200
 3. 300
 4. 500
- 4-31. Which of the following factors has a major impact on bottom bounce transmission?
1. Composition of the bottom
 2. Depth of the sound channel axis
 3. Depth of the mixed layer
 4. Strength of the thermocline gradient
- 4-32. Which of the following displays is an output from the Sonic Layer Depth (SLD) product?
1. A shaded SLD display expressed in meters
 2. A shaded SLD display expressed in feet
 3. A shaded SLD display expressed in kiloyards
 4. A Regional Grid SLD display expressed in kiloyards

- 4-33. Which of the following statements regarding surface ducts is NOT valid?
1. Surface ducts may occur if the temperature within the mixed layer increases with depth
 2. Surface ducts may occur if the temperature within the mixed layer decreases with depth
 3. Surface ducts may occur if the temperature within the mixed layer remains isothermal
 4. Generally, the deeper the mixed layer the more useful the surface duct
- 4-34. Which, if any, of the following statements pertaining to direct path propagation is valid?
1. Direct path is the simplest propagation path
 2. Direct path ranges occur where there is slight to moderate reflection in the layer
 3. The source and receiver must be within 90° of one another in order for direct path to be useful
 4. None of the above
- 4-35. What influence does half-channel conditions have on the speed of sound in water?
1. Sound speeds increase to the top of the main thermocline, then decrease
 2. Sound speeds decrease to the top of the main thermocline, then increase
 3. Sound speed decreases with increasing depth
 4. Sound speed increases with increasing depth
- 4-36. Where is the deep sound channel axis depth located?
1. At the depth of maximum sound speed in the deep sound channel
 2. Always above the mixed layer depth
 3. At the depth of minimum sound speed in the deep sound channel
 4. Always within the main thermocline
- 4-37. What is another name for the deep sound channel?
1. The Optimum (OP) channel
 2. The Sound Fixing and Ranging (SOFAR) channel
 3. The Range/Bearing (RAB) channel
 4. The Search and Rescue (SAR) channel
- 4-38. The relative strength of a shallow sound channel depends upon which of the following characteristics?
1. Surface turbidity
 2. Surface turbidity and temperature
 3. Stratum thickness
 4. Density
- 4-39. Heavy shading on the Shallow Sound Channel Cutoff Frequency display indicates what limiting frequency range?
1. 1 to 50 Hz
 2. 51 to 150 Hz
 3. 151 to 300 Hz
 4. 300 to 500 Hz
- 4-40. Which of the following noise sources is NOT referred to as ambient noise?
1. Noise due to earthquake activity
 2. Noise due to precipitation
 3. Self-noise
 4. Fish/crustacean noise
- 4-41. What is the primary source of low frequency ambient noise?
1. Distant shipping traffic
 2. Fish
 3. Ocean fronts
 4. Turbidity currents
- 4-42. At what sea height would waves first begin to affect active sonobuoy detection?
1. 12 ft
 2. 9 ft
 3. 6 ft
 4. 3 ft
- 4-43. What is a good rule of thumb for sea state noises?
1. Sea state noise increases approximately 2 dB for each increase in sea state
 2. Sea state noise increases approximately 3 dB for each increase in sea state
 3. Sea state noise increases approximately 5 dB for each increase in sea state
 4. Sea state noise increases approximately 6 dB for each increase in sea state

- 4-44. Which of the following statements pertaining to bioluminescent displays is accurate?
1. Most sheet-type bioluminescent displays are found in deep basins
 2. Jellyfish may cause glowing-ball displays
 3. Undulating waves of light are categorized as sheet bioluminescence
 4. Spark-type bioluminescence primarily occurs in warmer waters
- 4-45. The Secchi Disc is used to obtain which of the following information?
1. A common measurement of water transparency
 2. A common measurement of water color
 3. A common measurement of incident illumination
 4. A common measurement of reflectivity
- 4-46. Upwelling is normally found in the western portions of major oceans.
1. True
 2. False
- 4-47. Which of the following statements is NOT characteristic of acoustic effects of fronts?
1. The sonic layer depth (SLD) can change by as much as 1,000 ft in crossing a front
 2. Increased biological activity generally found along a front will increase ambient noise
 3. Towed array accuracies will increase through the front
 4. The depth of the deep sound channel may change by as much as 2,500 ft in crossing a front
- 4-48. Of the following systems, which is a principal mine hunting sonar system?
1. AN/SQQ-32
 2. AN/SQQ-47
 3. AN/SQR-19
 4. AN/SQS-53
- 4-49. Sustained winds of 35 knots or greater define the minimum criteria for which of the following warnings?
1. Wind warnings
 2. Storm warnings
 3. Gale warnings
 4. Small craft warnings
- 4-50. Of the following commands, which would issue tropical warnings for the western Pacific Ocean?
1. NAVPACMETOCEN WEST GUAM
 2. NAVPACMETOCEN PEARL HARBOR
 3. NAVPACMETOCFAC YOKOSUKA
 4. NAVLANTMETOCEN NORFOLK
- 4-51. Which of the following statements regarding the Atmospheric Refractivity Profile Generator (ARPGEN) product is NOT valid?
1. The refractivity data set can accommodate a maximum of five data sets
 2. Levels above 10,000 m are discarded
 3. Four types of historical profiles may be created
 4. M-unit profiles are entered in ascending order
- 4-52. When using the M-unit profile entry of the ARPGEN program, the evaporative duct height is determined by using which of the following parameters?
1. Air temperature, sea level pressure, relative humidity, and wind speed only
 2. Sea surface temperature, dewpoint, relative humidity, and air temperature only
 3. Air temperature, relative humidity, wind speed, and sea surface temperature only
 4. Air temperature and relative humidity only
- 4-53. Which of the following is an accurate statement with regard to altimeter settings?
1. The altimeter is set to the height of the cockpit
 2. The altimeter is set to the station elevation
 3. The altimeter is set to 10 ft above the deck
 4. Naval aircraft have self-adjusting altimeters that do not need manual adjustment
- 4-54. Assume that an aircraft is flying at 9,000 ft. There is a 20-hPa pressure differential between the departure and arrival fields. Approximately how many feet of elevation change would this be?
1. 100 ft
 2. 300 ft
 3. 600 ft
 4. 900 ft

- 4-55. Which of the following statements is generally valid of aircraft during flight?
1. In warmer ambient air, the altitude would be less than indicated
 2. In warmer ambient air, the altitude would be greater than indicated
 3. In colder ambient air, the altitude would be greater than indicated
 4. Aircraft altimeters should never be adjusted while in flight
- 4-56. Which of the following statements is/are valid regarding environmental effects on electro-optical (EO) systems?
1. As wavelength decreases, resolution increases
 2. As wavelength decreases, range decreases
 3. Both 1 and 2
 4. As wavelength decreases, range increases
- 4-57. Of the following statements, which one is accurate concerning "radiative crossover" and electro-optic contrast?
1. Unlike substances always have differing temperatures, enhancing contrast
 2. Like substances heat and cool at different rates, enhancing contrast
 3. All objects heat and cool at the same rate, inhibiting contrast
 4. Different objects may have the same temperature at least twice daily, inhibiting contrast
- 4-58. En route weather (WEAX) and Aviation weather (AVWX) support are requested in movement reports (MOVREPS) in accordance with which of the following publications?
1. NWP-10-1-10
 2. ATP-45
 3. NTP-3
 4. NWP-11
- 4-59. WEAX/AVWX support will be issued twice per day under which of the following weather conditions?
1. Wind speeds equal or exceed 25 knots, or are expected to equal or exceed 25 knots
 2. Seas are 9 ft or greater, or expected to be 9 ft or greater
 3. MINIMIZE is in effect
 4. Seas equal or exceed 12 ft, or are expected to equal or exceed 12 ft
- 4-60. When aircraft are embarked, AVWX will increase to twice per day when which of the following situations occur?
1. Prevailing visibility is at or decreases to less than 6 nm
 2. Prevailing visibility is at or decreases to less than 5 nm
 3. The ceiling is at or decreases to less than 1,500 ft
 4. The ceiling is at or decreases to less than 1,000 ft
- 4-61. Which of the following publications lists characteristics and capabilities of U. S. Navy ships?
1. NWP 65-0-1
 2. NTP-3 SUPP 1
 3. NTP-4
 4. ATP-45
- 4-62. When ditching an aircraft becomes necessary, how should the landing take place when only one swell is present?
1. Landing should take place perpendicular to the swell, preferably on the top or backside of the swell
 2. Landing should take place at a 45-degree angle to the swell, facing into the swell
 3. Landing should take place parallel to the swell, preferably on the top or backside of the swell
 4. No landing should be attempted when swell is present
- 4-63. Which of the following commands can provide assistance in planning specific climatology requirements?
1. NETPMSA, Pensacola
 2. FLENUMMETOCDET, Asheville
 3. NAVEURMETOCEN, Rota
 4. NAVICECEN, Suitland

ASSIGNMENT 5

Textbook Assignment: "Tropical Forecasting," "Weather Radar," "Meteorological and Oceanographic Briefs," and "Administration and Training." Pages 11-1 through 14-8.

- 5-1. Of the following statements, which one is valid regarding the development of tropical systems?
1. Trade inversions may accelerate development
 2. Warmer, drier air may accelerate development
 3. Twice as many tropical systems develop over the Atlantic Ocean as the Pacific Ocean
 4. Cooler, drier air tends to hamper development
- 5-2. Which of the following weather patterns would be indicative of tropical cyclone development?
1. Easterlies increasing with height
 2. Cyclonic turning in the wind field
 3. Outflow at the lower levels
 4. Decreasing surface pressure gradient to the north of the suspect area
- 5-3. Long period swell waves may be an indication of the development of a tropical system.
1. True
 2. False
- 5-4. All EXCEPT which of the following weather patterns would be an indication of the deepening of a tropical system?
1. Movement over warmer water
 2. The presence of a trade inversion
 3. Poleward migration of the system
 4. Deceleration of the system
- 5-5. Tropical cyclones that form along the eastern periphery of a polar trough tend to move in what direction?.
1. Toward the southeast
 2. Toward the west
 3. 90° to the left of the orientation of the trough line
 4. Along the trough
- 5-6. Upper-level winds may be used for the steering of tropical systems. Which of the following wind patterns should be given the most consideration?
1. Those to the rear of the system
 2. Those in advance of the system
 3. Those in the left semicircle of the system
 4. Those in the right semicircle of the system
- 5-7. Which of the following synoptic features would be an indicator of tropical cyclone recurvature?
1. The base of the polar westerlies lowers to 15,000 to 20,000 feet east of the storm's latitude
 2. There are no breaks in the subtropical high
 3. Long waves are stationary or slowly progressive
 4. The neutral point in the southern extremity of the trough in the westerlies at the 500-hPa level lies poleward of the storm's latitude
- 5-8. Assume that the associated long wave is progressive, and the surface high slopes to the southeast with height. Which of the following weather patterns would be indicated relative to a tropical cyclone?
1. The tropical cyclone comes under the influence of the upper westerlies, and its track would reverse itself
 2. The tropical cyclone comes under the influence of the upper easterlies, and its track would reverse itself
 3. The tropical cyclone comes under the influence of the upper easterlies, and a large degree of recurvature would take place
 4. The tropical cyclone comes under the influence of the upper westerlies, and a small degree of recurvature would take place

- 5-9. What weather pattern may develop when a tropical cyclone moves northward into an area with a strong temperature gradient?
1. The tropical cyclone center will maintain its circulation, and the area of gale force winds will decrease
 2. The tropical cyclone center will lose its circulation, and the area of gale force winds will increase
 3. The tropical cyclone center will lose its circulation, and the area of gale force winds will decrease
 4. The tropical cyclone center will maintain its circulation, and the area of gale force winds will increase
- 5-10. If you use the regression equation method for forecasting the movement of typhoons, all EXCEPT which of the following criteria should be considered?
1. The 700-hPa heights and tendency 10° latitude from the typhoon's center, and 90° to the right of its path of motion
 2. The 700-hPa level moisture
 3. The 700-hPa heights and tendency 10° latitude north of the typhoon's center
 4. The intensity and orientation of the axis of the subtropical anticyclone that is steering the system
- 5-11. Which of the following is the correct MANOP heading for tropical cyclone warnings in the Atlantic Ocean?
1. WHNT _____ KNCA
 2. WHPN _____ KNGA
 3. WHPN _____ KNGU
 4. WHNT _____ KNGU
- 5-12. Which of the following is the correct WOP heading for tropical cyclone warnings in the western Pacific Ocean?
1. WTPN _____ PGTW
 2. WTPN _____ PGUA
 3. WTPN _____ PGUM
 4. WTPA _____ PGTW
- 5-13. Which of the following wavelengths is considered optimum for use by weather radar in the detection of precipitation?
1. 1 to 5 cm
 2. 5 to 10 cm
 3. 15 to 20 cm
 4. 20 to 25 cm
- 5-14. The ability to distinguish between two targets in the same direction from the radar, but at different ranges, is a definition of what term?
1. Range finding
 2. Range differentiation
 3. Range resolution
 4. Range attenuation
- 5-15. The advent of the WSR-88D occurred during the period 1977 through 1979 in the United States at what location?
1. The National oceanographic and Atmospheric Administration (NOAA) Environmental Research Laboratories, Washington D.C.
 2. The University of Colorado at Boulder
 3. The Naval Research Laboratory (NRL) San Diego
 4. The National Severe Storms Laboratory in Oklahoma
- 5-16. Which of the following would be an example of velocity aliased data?
1. Velocities that can be measured without error
 2. Velocities that exceed the maximum unambiguous velocity
 3. Velocities equal to the Nyquist frequency
 4. Wind speeds equal to the Nyquist frequency
- 5-17. A radar set hearing a previous pulse, while listening for the most recent pulse, would be a definition of what term?
1. Attenuation
 2. Range-folding
 3. Aliased data
 4. Pulse repetition frequency (PRF) reversal
- 5-18. In the radials where it appears, range-folded data has what type appearance?
1. Baseball bat
 2. Globular
 3. Elliptical
 4. Spiked

- 5-19. Which of the following statements is NOT accurate pertaining to ground clutter?
1. Ground clutter normally appears as a cluster of points that have a speckled nature
 2. Ground clutter may be identifiable as wedges of different colors
 3. Decreasing the antenna elevation will decrease ground clutter
 4. A time-lapse of the Reflectivity products will show no movement of ground clutter returns
- 5-20. What is the maximum number of clutter suppression regions that may be edited at the Unit Control Position (UCP)?
1. 15
 2. 12
 3. 10
 4. 5
- 5-21. The presence of sidelobes may have an impact on which of the following parameters?
1. The pulse repetition frequency (PRF)
 2. The reflectivity of ground clutter
 3. The velocity pattern in strong echo regions
 4. The accurate assessment of storm cloud tops
- 5-22. Anomalous returns may occur near sunrise and sunset for several radials due to solar effects. What appearance may these solar effects take?
1. Numerous "speckled" areas
 2. A narrow "baseball bat" shape
 3. Numerous "spiked" areas
 4. "Elliptically" shaped returns
- 5-23. The Mean Radial Velocity Cross-Section product may be used as an aid in identifying mesocyclone signatures.
1. True
 2. False
- 5-24. The mesocyclone algorithm provides the position of the mesocyclone reflected onto the lowest elevation angle in which the mesocyclone was detected. What fact makes this possible?
1. Mesocyclones cannot be detected by doppler radar at mid and high levels of the atmosphere
 2. The higher the elevation angle, the less accurate the tracking information
 3. Mesocyclones can only be identified at low elevation angles
 4. Mesocyclones normally "tilt" with increasing height
- 5-25. Which of the following procedures is best for identifying wind shear in the doppler velocity field?
1. Note changes in the velocity field over time
 2. Increase the unit gain
 3. Note wider bands in the velocity field
 4. Note any elliptical shaped returns
- 5-26. The Cross-section product can integrate returns from cloud layers from the surface to what maximum height?
1. 30,000 ft
 2. 50,000 ft
 3. 70,000 ft
 4. 90,000 ft
- 5-27. Stratus-type clouds may NOT be detected by the WSR-88D for which of the following reasons?
1. Transparency of the layer
 2. Vertical extent of the layer
 3. The size of the cloud particles
 4. Stratus-type clouds generally form at levels below the lowest antenna angle
- 5-28. Frontal precipitation from stratiform clouds is occurring at your station. Which of the following statements would be valid when you observe the wind profile on the WSR-88D?
1. The wind profile may be useful in determining the nature of the front
 2. Backing of the wind profile with height would indicate warm air advection
 3. Veering of the wind profile with height would indicate cold air advection

- 5-29. The Mesoscale Convective System (MCS) includes all precipitation systems 11 to 270 nm wide that contain which of the following features?
1. Weak convection
 2. Deep convection
 3. Heavy fog
 4. A center of action
- 5-30. The reflectivity of hydrometers is lower immediately below the bright band for which of the following reasons?
1. The decreased downward velocity of the hydrometers
 2. The increased size of the hydrometers
 3. The decreased concentration of the hydrometers
 4. The increased concentration of the hydrometers
- 5-31. Which of the following Alert Thresholds is storm based only?
1. Grid
 2. Volume
 3. Area
 4. Forecast
- 5-32. All EXCEPT which of the following statements regarding an operational radar coded message (RCM) is accurate?
1. It can only be requested from the display menu
 2. It is an alphanumeric only product
 3. It is also known as a "post-edit alphanumeric RCM"
 4. It is available to all units
- 5-33. Graphics products may be annotated at all Principal User Processors (PUPS).
1. True
 2. False
- 5-34. What is the maximum number of alert categories available to each alert area?
1. 10
 2. 8
 3. 6
 4. 4
- 5-35. All EXCEPT which of the following status options is operator selected?
1. Monitor Performance Display
 2. System Status
 3. Status of Background Maps
 4. Wavelength and Frequency Status
- 5-36. What are the two types of archive devices associated with a PUP?
1. Optical disk and CD-ROM
 2. CD-ROM and streamer tape
 3. Optical disk and streamer tape
 4. Optical disk and 3.5 HD disk
- 5-37. OPNAVINST 3140.24 provides specific guidance and criteria applicable to which of the following subjects?
1. WEAX/AVWX forecasts
 2. Climatology
 3. Post-deployment reports
 4. Destructive weather warnings
- IN ANSWERING QUESTION 5-38, REFER TO TABLE 13-1 IN YOUR TRAMAN.
- 5-38. Assume that destructive winds are forecast to be at your station within 48 hours. What condition of readiness (COR) would be applicable?
1. Condition I
 2. Condition II
 3. Condition III
 4. Condition IV
- 5-39. Which of the following publications outlines procedures for obtaining climatic information?
1. Atmospheric Climatic Publications; FLENUMMETOCDET ASHEVILLENOTE 3146
 2. Atmospheric Climatic Publications; NAVEDTRA 43431
 3. Atmospheric Climatic Publications; NAVMETOCCOMNOTE 3140
 4. Atmospheric Climatic Publications; FLENUMMETOCCENNOTE 3143
- 5-40. The "Warnings Plot" program of GFMP is capable of plotting which of the following messages?
1. High wind and seas warnings
 2. Tropical cyclone warnings
 3. Both 1 and 2 above
 4. Ice edge positions

- 5-41. Which of the following statements is valid regarding the GFMP "Surge" program?
1. It provides a "worst case" forecast
 2. The program is available for the Pacific Ocean basin only
 3. If a coastal station of interest is not one of the menu options, you may not input characteristics manually
 4. The estimated peak storm surge output is a function of coastline characteristics only
- 5-42. The publication *Environmental Effects on Weapon's Systems and Naval Warfare*, (S), RPl, contains information on ASW, SEW, ASUW, AAW, and STW warfare.
1. True
 2. False
- 5-43. In what manner may an increase in water depth degrade bottom mine effectiveness?
1. By decreasing the actuation width of the mine
 2. By increasing the actuation width of the mine
 3. By increasing the damage width of the mine
 4. By increasing mine burial upon impact
- 5-44. Subsurface current speed is important in MIW operations for which of the following reasons?
1. Decreased subsurface current speeds may result in scouring of mines
 2. Decreased subsurface current speeds may result in mine dip
 3. Decreased subsurface current speeds may increase ambient noise
 4. "Mine walking" may occur
- 5-45. Which of the following statements regarding MIW is accurate?
1. Bottom scattering is dependent on grazing angle
 2. Bottom sediment has no effect on MIW operations
 3. The weight of a mine affects the "plastic flow"
 4. Burial has significant impact on magnetic moored mines
- 5-46. Which of the following parameters is NOT a significant factor in MIW operations?
1. The clarity of the water
 2. The salinity of the water
 3. The depth of the water
 4. Bioluminescence
- 5-47. The acronym "CATF" stands for what officer?
1. Commander, Allied Task Force
 2. Commander, Amphibious Troop Force
 3. Commander, Amphibious Task Force
 4. Commander, Amphibious Flotilla
- 5-48. OA division personnel should test the adequacy of support and support timing during what phase of an amphibious operation?
1. The Planning phase
 2. The Rehearsal phase
 3. The Movement phase
 4. The Assault phase
- 5-49. When does the assault phase of an AMW operation begin?
1. When troops first reach the beach
 2. When amphibious vehicles debark the ships for the beach
 3. When troops man amphibious vehicles
 4. When the task force first reaches the amphibious objective area (AOA)
- 5-50. What is the single most important environmental parameter in amphibious assaults?
1. The deep water wave height
 2. The swell wave period
 3. The modified surf index
 4. The littoral current
- 5-51. Which of the following statements is valid regarding offshore currents?
1. Tidal currents are not categorized as offshore currents
 2. Offshore currents are found outside the surf zone
 3. Offshore currents are generated by waves breaking over sandbars
 4. Offshore currents include littoral currents

- 5-52. What annex standardizes meteorological and oceanographic information for the planning and execution of naval exercises?
1. ANNEX W to the numbered Fleet Basic OPORD
 2. ANNEX H to the numbered Fleet Basic OPORD
 3. The ANNEX identifier will vary, but the required information will always be found in the numbered Fleet Basic OPORD
 4. ANNEX B to the numbered Fleet Basic OPORD
- 5-53. Guidance for the preparation and mailing of classified Meteorological and oceanographic (METOC) data is contained in what instruction?
1. NAVMETOCCOMINST 3100.2
 2. OPNAVINST 1510.1
 3. NAVMETOCCOMINST 5520.1
 4. OPNAVINST 5510.1
- 5-54. Copies of all weather records are to be retained for a minimum of how many months?
1. 12
 2. 24
 3. 3
 4. 6
- 5-55. A Unit Situation Report (SITREP) would be required in which of the following circumstances?
1. All accident/incident occurs within the vicinity of a METOC unit
 2. A CASREP is sent from a shore-based METOC unit
 3. An accident/incident occurs at a METOC unit, and is weather related
 4. TMI accident/incident occurs aboard an underway unit and is not weather related
- 5-56. METOC commands with aviation units are required to annually conduct instrument ground school.
1. True
 2. False
- 5-57. Commands should review and update forecaster handbooks at what interval?
1. Quarterly
 2. Semiannually
 3. Annually
 4. Every 2 years
- 5-58. All EXCEPT which of the following statements is accurate regarding METOC post-deployment reports?
1. METOC post-deployment reports are always unclassified
 2. NAVMETOCCOMINST 3140.23 outlines content and format of METOC post-deployment reports
 3. METOC post-deployment reports should contain a section on any unique weather conditions experienced
 4. METOC post-deployment reports should contain a section on services provided to other units
- 5-59. What directive outlines the responsibilities for the training of NAVMETOCCOM personnel?
1. NAVMETOCCOMINST 1515.1
 2. NAVMETOCCOMINST 1500.2
 3. NAVMETOCCOMINST 1510.4
 4. NAVMETOCCOMINST 3100.4
- 5-60. The responsibility for technical inspection of afloat units lies with what authority?
1. COMNAVMETOCCOM
 2. NAVOCEANO
 3. The respective Fleet Commanders
 4. The theater METOCEN

