

Rosemount™ 3107 Level and 3108 Flow Transmitters

Ultrasonic



Rosemount Ultrasonic 3107 and 3108 Transmitters

⚠ WARNING

Read this manual before working with the product. For personal and system safety, and for optimum product performance, make sure you thoroughly understand the contents before installing, using, or maintaining this product.

Within the United States, Rosemount Inc. has two toll-free assistance numbers.

Customer Central: 1-800-999-9307 (7:00 a.m. to 7:00 p.m. CST)

Technical support, quoting, and order-related questions.

North American Response Center:

Equipment service needs.

1-800-654-7768 (24 hours a day – Includes Canada)

For equipment service or support needs outside the United States, contact your local Rosemount representative.

⚠ CAUTION

The products described in this document are NOT designed for nuclear-qualified applications.

Using non-nuclear qualified products in applications that require nuclear-qualified hardware or products may cause inaccurate readings.

For information on Rosemount nuclear-qualified products, contact your local Rosemount Sales Representative.

This device complies with part 15 of the FCC rules. Operation is subject to the following two conditions: (1) This device may not cause harmful interference, and (2) this device must accept any interference received, including interference that may cause undesired operation.

Table of Contents

Section 1: Introduction

1.1 Safety messages.....	1
1.2 Manual overview	2
1.3 Service support.....	2
1.4 Product recycling/disposal.....	2

Section 2: Transmitter Overview

2.1 Introduction to the transmitters.....	3
2.2 Theory of operation.....	4
2.3 Components of the transmitter	4
2.4 System architecture.....	5

Section 3: Installation

3.1 Safety messages.....	7
3.2 Considerations before installation	8
3.2.1 Safety considerations	8
3.2.2 Environmental considerations.....	9
3.3 Mechanical installation	9
3.3.1 Consider liquid surface conditions	11
3.3.2 Consider in-tank effects	11
3.3.3 Mounting the transmitter above the liquid surface.....	11
3.3.4 Open channel flow installations	12
3.4 Electrical installation	16
3.4.1 Connecting the transmitter.....	16
3.4.2 Remote temperature sensor (on 3108 only)	17
3.4.3 Wiring to allow HART communication.....	18
3.4.4 Lightning / surge protection and other loop devices	18

Section 4: Configuration

4.1 Overview	19
4.2 Command parameters	20
4.2.1 Base units	20
4.2.2 Set as empty.....	21
4.2.3 Present depth.....	22

4.2.4	Learn false echo	23
4.2.5	Auto tank map	24
4.2.6	Simulation of PV.....	25
4.2.7	Restart device.....	27
4.2.8	Load defaults	28
4.2.9	Simulate current output.....	29
4.2.10	Trim 4mA / Trim 20mA.....	30
4.3	Configuration parameters	31
4.3.1	Message (P000)	31
4.3.2	Tag (P001).....	32
4.3.3	Descriptor (P002).....	33
4.3.4	Final assembly number (P004)	34
4.3.5	Serial number (P005)	35
4.3.6	Bottom reference (P010)	35
4.3.7	Upper blanking (P023)	38
4.3.8	Lower blanking (P063)	39
4.3.9	Distance offset (P060).....	40
4.3.10	Level offset (P069).....	41
4.3.11	Tank shape / non-linear profile (P011).....	42
4.3.12	Contents (volume) measurement	43
4.3.13	Flow measurement	48
4.3.14	Primary variable units (P012).....	51
4.3.15	Scale factor / K-factor (P013).....	52
4.3.16	Profile height / Power factor (P014).....	53
4.3.17	Profile points 1 to 10 (P030 to P039)	55
4.3.18	Upper range value (P015).....	56
4.3.19	Lower Range Value (P016)	57
4.3.20	Damping (P020).....	58
4.3.21	Lost echo delay (P021)	59
4.3.22	Lost echo action (P022)	60
4.3.23	Speed of sound (P024)	62
4.3.24	Temperature (P025)	63
4.3.25	Set threshold (P026)	64
4.3.26	Transmit power control (P040)	66
4.3.27	Pulse repeat (P041)	67
4.3.28	Echoes needed (P042)	67
4.3.29	Threshold 1 time (P043).....	68

4.3.30	Threshold 1 size (P048)	69
4.3.31	Target pulses (P044)	71
4.3.32	Target frequency (P045)	72
4.3.33	Spike rejection (P049)	73
4.3.34	False echo data (P081 to P088)	74
4.3.35	Clear false echoes (P089)	75
4.3.36	Transducer material (P970)	76
4.3.37	Poll address (D951)	77
4.3.38	Maximum temperature (P046)	78
4.3.39	Minimum temperature (P047)	78
4.3.40	Date (P003)	79

Section 5: Service and Troubleshooting

5.1	Safety messages	81
5.2	Servicing	82
5.3	Power failure	82
5.4	False echoes under certain ambient operating conditions	82
5.5	Monitoring and diagnostic parameters	83
5.5.1	Process Value / Primary Variable (PV) (D900)	84
5.5.2	Level / Secondary Variable (SV) (D901)	85
5.5.3	Distance / Tertiary Variable (TV) (D902)	86
5.5.4	Temperature / Fourth Variable (FV) (D903)	87
5.5.5	% of current output (D905)	88
5.5.6	Current output (D906)	89
5.5.7	Distance (D910)	90
5.5.8	Echo size (D911)	91
5.5.9	Echo success (D912)	92
5.5.10	Target echoes (D913)	93
5.5.11	Speed of sound (D914)	94
5.5.12	Temperature for SoS calculation (D915)	94
5.5.13	Frequency (D916)	96
5.5.14	Threshold in use (D917)	97
5.5.15	Pulses in use (D918)	98
5.5.16	Transmit power (D919)	99
5.5.17	Model code (D949)	100
5.5.18	Hardware rev. (D952)	101
5.5.19	Software revision (D953)	102

5.5.20	Manufacturer (D960)	103
5.5.21	Unique Device ID (D961)	104
5.5.22	HART revision (D962)	105
5.5.23	Transmitter specific command rev. (D963)	106
5.5.24	Preambles (D964)	107
5.5.25	Transmitter flags (D965)	108
5.5.26	Primary variable trend	108
5.5.27	Temperature trend	109
5.5.28	Distance and echo size trend	109

Appendix A: Reference Data

A.1	Specifications	111
A.1.1	General	111
A.1.2	Measuring performance	111
A.1.3	Configuration	112
A.1.4	Electrical	112
A.1.5	Materials of construction	113
A.1.6	Mechanical	113
A.1.7	Measuring	113
A.1.8	Environment	113
A.1.9	Temperature and pressure ratings	114
A.1.10	Load limitations	114
A.2	Dimensional drawings	115
A.3	Ordering information	118
A.3.1	Spare parts and accessories	120

Appendix B: Product Certifications

B.1	Safety messages	121
B.2	Approved manufacturing locations	122
B.3	European Union directive information	122
B.4	MCERTS certification	122
B.5	Hazardous locations certifications	122
B.5.1	American and canadian approvals	122
B.5.2	European certifications	123
B.5.3	Rest of the world certifications	123
B.6	Approval drawings	125

Appendix C: Rosemount 3490 Series Universal Control Unit

C.1 Menus and parameters	127
--------------------------------	-----

Appendix D: Field Communicator

D.1 Menus and parameters	131
--------------------------------	-----

Section 1 Introduction

Safety messages	page 1
Manual overview	page 2
Service support	page 2
Product recycling/disposal	page 2

1.1 Safety messages

Procedures and instructions in this manual may require special precautions to ensure the safety of the personnel performing the operations. Information that raises potential safety issues is indicated by a caution symbol (⚠). The external hot surface symbol (🔥) is used when a surface is hot and care must be taken to avoid possible burns. If there is a risk of an electrical shock the (⚡) symbol is used. Refer to the safety messages listed at the beginning of each section before performing an operation preceded by this symbol.

⚠ WARNING

Failure to follow these installation guidelines could result in death or serious injury.

- Make sure only qualified personnel perform the installation.
- Use the equipment only as specified in this manual. Failure to do so may impair the protection provided by the equipment.

Explosions could result in death or serious injury.

- Verify that the operating environment of the transmitter is consistent with the appropriate hazardous locations certifications.
- Before connecting a HART®-based communicator in an explosive atmosphere, make sure the instruments in the loop are installed in accordance with intrinsically safe or non-incendive field wiring practices.

Electrical shock could cause death or serious injury.

- Use extreme caution when making contact with the leads and terminals.
-

⚠ WARNING

Any substitution of non-recognized parts may jeopardize safety. Repair, e.g. substitution of components etc., may also jeopardize safety and is under no circumstances allowed.

1.2 Manual overview

This manual provides installation, configuration, and maintenance information for the Rosemount 3107 Level and 3108 Flow Transmitter.

- Section 2: Transmitter Overview
- Section 3: Installation
- Section 4: Configuration
- Section 5: Service and Troubleshooting
- Section A: Reference Data
- Section B: Product Certifications
- Section C: Rosemount 3490 Series Universal Control Unit
- Section D: Field Communicator

1.3 Service support

To expedite the return process outside of the United States, contact the nearest Emerson representative.

Within the United States, call the Emerson Instrument and Valves Response Center using the 1 800 654 7768 toll-free number. This center, available 24 hours a day, will assist you with any needed information or materials.

The center will ask for product model and serial numbers, and will provide a Return Material Authorization (RMA) number. The center will also ask for the process material to which the product was last exposed.

⚠ CAUTION

Individuals who handle products exposed to a hazardous substance can avoid injury if they are informed of, and understand, the hazard. If the product being returned was exposed to a hazardous substance as defined by OSHA, a copy of the required Material Safety Data Sheet (MSDS) for each hazardous substance identified must be included with the returned goods.

1.4 Product recycling/disposal

Recycling of equipment and packaging should be taken into consideration. The product and packaging should be disposed of in accordance with local and national legislation.

Section 2 Transmitter Overview

Introduction to the transmitters	page 3
Theory of operation	page 4
Components of the transmitter	page 4
System architecture	page 5

2.1 Introduction to the transmitters

The Rosemount 3107 and Rosemount 3108 are sealed 4–20 mA loop-powered liquid level transmitters, and are designed for use in waste water and effluent treatment plant applications. The 3108 is MCERTS certified for open flow channel applications.

These rugged UPVC transmitters are certified Intrinsically Safe for use in Zone 0 areas, and factory fitted with up to 164 ft. (50 m) of two-core cable for simple low cost installation in sumps, wet-wells and over open channel flow structures.

The transmitters can be connected directly to a plant control system, or used with a Rosemount 3490 Series Control Unit for programmable control functionality.

Note

- The Rosemount 3490 Series Control Unit software must be version 3.40 or later.

Figure 2-1. Typical application using a Rosemount 3108 flow transmitter

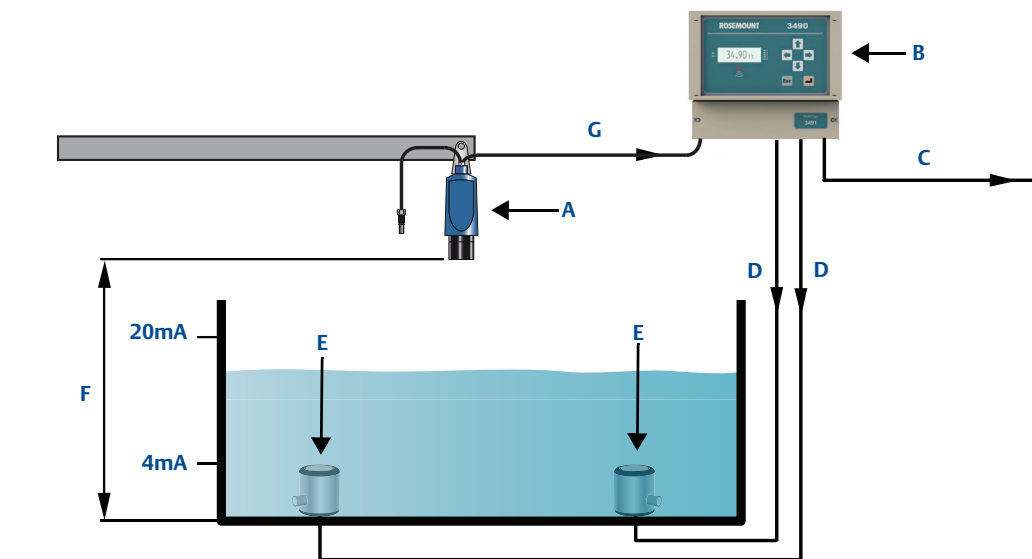

- | | |
|---------------------------------------|----------------------------------|
| A. Rosemount 3108 Flow Transmitter | E. Pump |
| B. Rosemount 3490 Series Control Unit | F. Transmitter Bottom Reference |
| C. 4–20 mA signal output | G. 4–20 mA and HART signal input |
| D. Relay | |

2.2 Theory of operation

The level transmitter is designed to be mounted above a liquid (Figure 2-1 on page 3), and uses ultrasonic pulses to continuously measure the distance to the liquid surface. The electronics calculate distance to the liquid level using the time delay between transmitting and receiving signals.

When programmed with the bottom reference of the application – usually the bottom of a tank – the transmitter calculates the liquid depth (level), and outputs the result as a 4–20 mA and HART signal.

The 3108 and the 3107 can calculate contents (volume) or open channel flow when programmed with further application information, and outputs the result as a 4–20 mA and HART signal.

2.3 Components of the transmitter

The transmitter has a housing containing advanced electronics to generate ultrasonic pulses, process the resultant signals, and provide a 4–20mA and HART® output.

There is a factory-fitted cable for the signal output and connecting an external power supply. The 3108 has a factory-fitted Remote Temperature Sensor.

Figure 2-2. Transmitter components

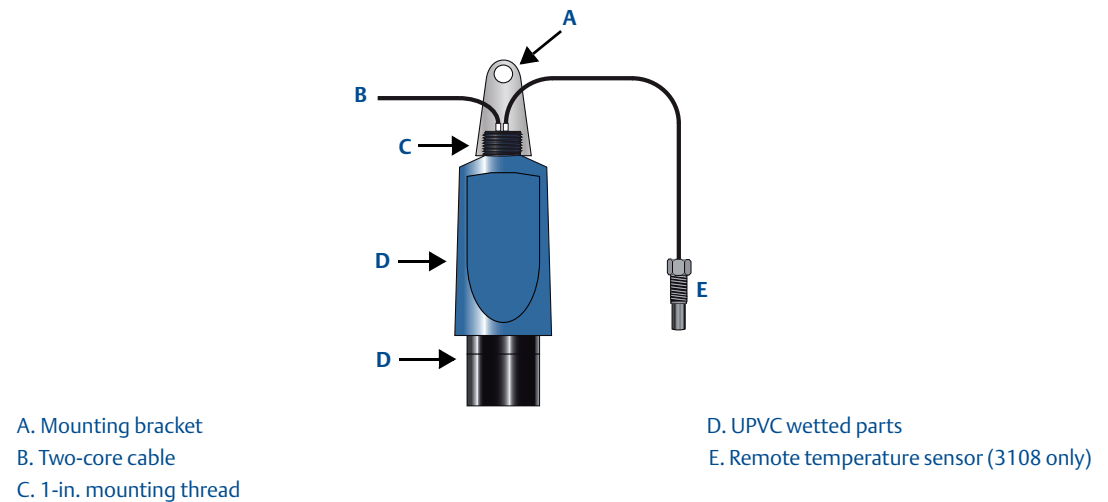

2.4 System architecture

The Rosemount 3107 and 3108 are loop-powered which means they use the same two wires for both power supply and output signal.

The transmitter can be connected to any suitable direct current (dc) power source using the factory-fitted two-core, shielded cable.

The output is a 4–20mA analog signal and a digital HART signal.

Note

- It is possible to use the multidrop function with the HART protocol (see [Figure 2-3](#)). In this case, communication is restricted to digital since the current is fixed to 4 mA.

The transmitters can easily be configured by using a Rosemount 3490 Series Control Unit. Alternatively, a Field Communicator, or a PC with AMS™ Suite: Intelligence Device Manager software, can be used to configure the transmitter.

Note

- The Rosemount 3490 Control Unit software must be version 3.40 or later.

A comprehensive specification for the Rosemount 3107 and 3108 is in the section “Specifications” on page 111.

Figure 2-3. System architecture

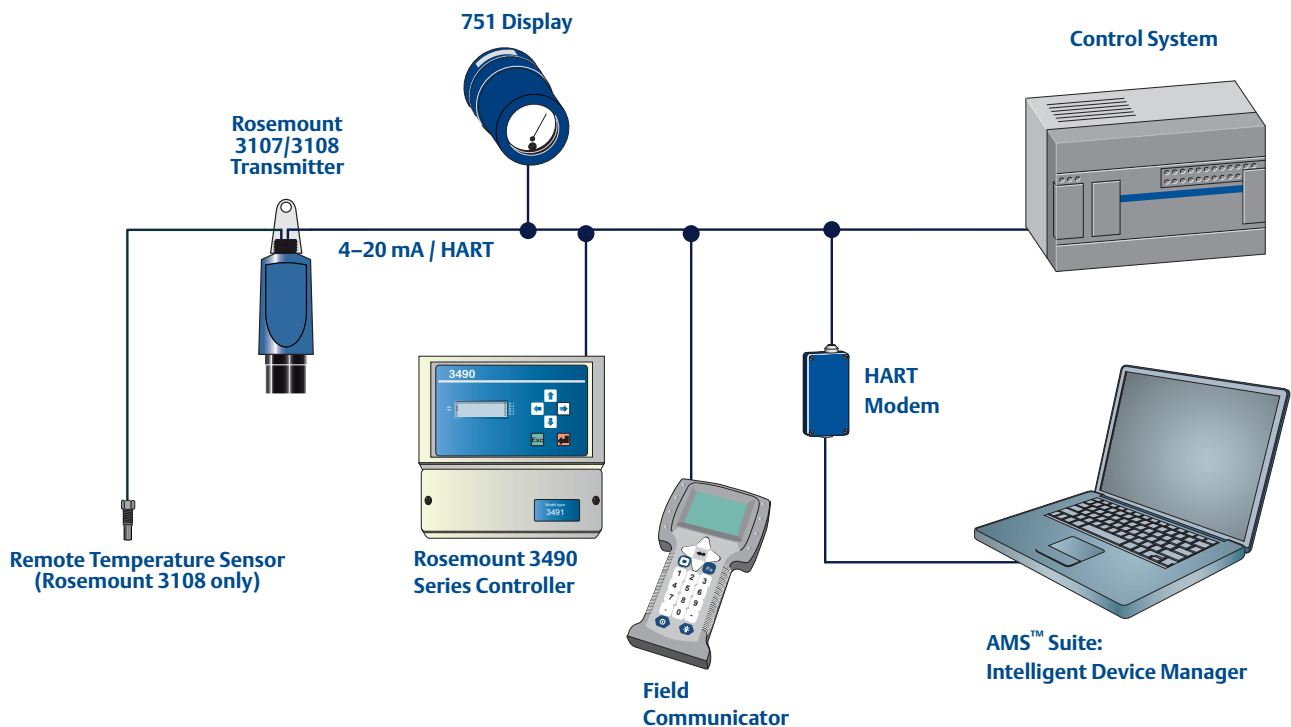

Section 3 Installation

Safety messages	page 7
Considerations before installation	page 8
Mechanical installation	page 9
Electrical installation	page 16

3.1 Safety messages

Procedures and instructions in this manual may require special precautions to ensure the safety of the personnel performing the operations. Information that raises potential safety issues is indicated by a caution symbol (⚠). The external hot surface symbol (🔥) is used when a surface is hot and care must be taken to avoid possible burns. If there is a risk of an electrical shock the (⚡) symbol is used. Refer to the safety messages listed at the beginning of each section before performing an operation preceded by this symbol.

⚠ WARNING

Failure to follow these installation guidelines could result in death or serious injury

- Make sure only qualified personnel perform the installation.
- Use the equipment only as specified in this manual. Failure to do so may impair the protection provided by the equipment.

Explosions could result in death or serious injury

- Verify that the operating environment of the transmitter is consistent with the appropriate hazardous locations certifications.
- Before connecting a HART[®]-based communicator in an explosive atmosphere, make sure the instruments in the loop are installed in accordance with intrinsically safe or non-incendive field wiring practices.

Electrical shock could cause death or serious injury

- Use extreme caution when making contact with the leads and terminals.

⚠ WARNING

Any substitution of non-recognized parts may jeopardize safety. Repair, e.g. substitution of components etc., may also jeopardize safety and is under no circumstances allowed.

3.2 Considerations before installation

The Rosemount 3107 and 3108 may be used for level and volume measurement in open or closed tanks, or open channel flow measurement.

The transmitter must be installed in a location where it is protected from ultraviolet radiation to prevent long term degradation of the plastics used in its construction e.g. shrouded from direct sunlight.

It is important to correctly position the transmitter for reliable ultrasonic level measurement. For maximum accuracy and stability of the level measurement reading, the transmitter should always be shrouded from direct sunlight and radiated heat.

The transmitter may be site-tuned to deal with most application conditions, but it is recommended that the following guidelines be adopted wherever relevant.

3.2.1 Safety considerations

Guidelines

1. Installation must be carried out by suitably trained personnel in accordance with the applicable code of practice.
2. If the equipment is likely to come into contact with *aggressive substances*, it is the responsibility of the user to take *suitable precautions* that prevent it from being adversely affected, thus ensuring that the type of protection is not compromised.

Aggressive substances are acidic liquids or gases that may attack metals or solvents that may affect polymeric materials.

Suitable precautions are regular checks as part of routine inspections, or establishing, from the material's datasheet, that it is resistant to specific chemicals.
3. The equipment should only be cleaned with a damp cloth. Do not use solvents.
4. The equipment is not intended to be repaired by the user and is to be replaced by an equivalent certified unit. Repairs should only be carried out by the manufacturer or approved repairer.
5. The transmitter is *Double Insulated*, and therefore Protective Earthing is not required.
6. Note that if the equipment is used in a manner not specified by the manufacturer, the protection afforded by the equipment may be impaired.
7. To ensure electro-magnetic compatibility in any European member state, it should not be installed in a residential area.

Note

- It is not advisable to mount the transmitter in close proximity to a source of electrical noise such as a variable-speed drive, or other high-powered electrical device.
-

3.2.2 Environmental considerations

The Rosemount 3107 and 3108 ultrasonic transmitters are Intrinsically Safe (IS) approved for hazardous area installations.

1. The 3107 is designed for open or closed tank installation. It is weatherproof and protected against the ingress of dust
2. The 3108 is designed for open channel flow measurement. It is weatherproof and protected against the ingress of dust
3. Avoid installing the 3107 and 3108 near heat sources

Figure 3-1. Environmental considerations

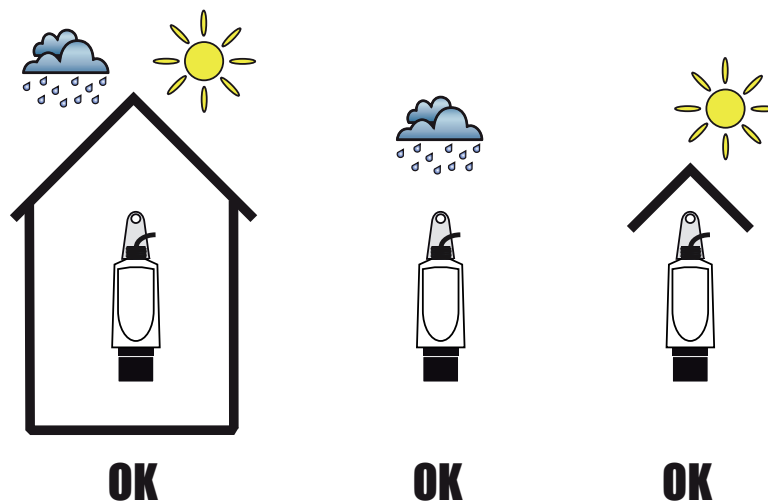

3.3 Mechanical installation

Guidelines

1. Mount the transmitter above the liquid using the 1-in. thread provided, but not closer than 12 in. (0,3 m) to the surface. The transmitter does not detect any liquid surface closer than 12 in. (0,3 m) to the transmitter face. (See “Mounting the transmitter above the liquid surface” on page 11).
Optional flanges and bracket kits are available to help mounting. (See “Spare parts and accessories” on page 120.)
2. The transmitter should be mounted vertically to ensure a *good echo* from the liquid surface. The transmitter beam half angle is 6 degrees (See Figure 3-2 on page 10).
3. Obstructions in the tank, or well, may generate echoes which can be confused with the real liquid surface echo. Obstructions within the beam angle generate strong false echoes. Wherever possible, the transmitter should be positioned to avoid false echoes.

4. To avoid detecting unwanted objects in the tank or well, it is advisable to maintain a distance of at least 1.3 in. from the center line of the transmitter for every foot (11 cm per meter) range to the obstruction.
5. No false echoes are generated if the transmitter is located near the side of the tank or well, and the wall is smooth and free of protrusions. However, there will still be a reduction in the echo size. It is recommended that the transmitter be mounted no closer than 12 in. (0,3 m) to the wall to avoid a large reduction in the echo size.
6. If the transmitter is mounted in an enclosed tank with a domed top, avoid mounting the transmitter in the center of the tank roof because this could act as a parabolic reflector and create unwanted echoes.
7. Avoid applications where heavy condensation could form on the transmitter face.
8. If the transmitter is mounted in a stand-off or nozzle, the transmitter face should protrude at least 0.2 in. (5 mm) into the tank.
9. If the transmitter is used in environments where direct sunlight can cause high surface temperatures on exposed instruments, a sun-shade is recommended.

Figure 3-2. Considerations when installing in a tank

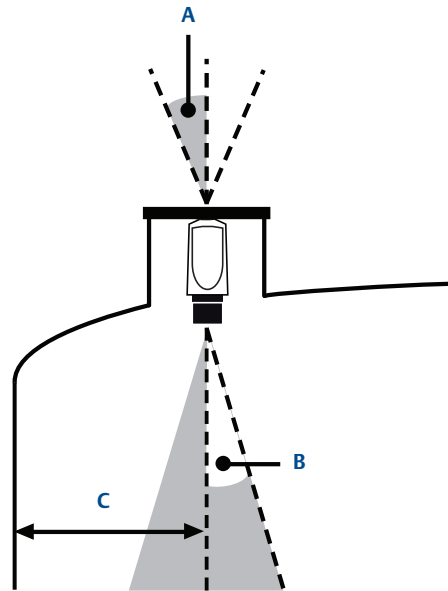

- A. Transmitter is mounted vertically (maximum deviation of 3°).
- B. 6° beam half angle.
- C. 1.3 in./ft. (11 cm/m). Minimum of 12 in. (0.3 m).

3.3.1 Consider liquid surface conditions

Guidelines

1. Foaming liquids can reduce the size of the returned echo because foam is a poor ultrasonic reflector.

Mount an ultrasonic transmitter over an area of clear liquid, such as near the inlet to a tank or well. In extreme conditions, or where this is not possible, the transmitter may be mounted in a vented stilling tube provided that the inside measurement of the stilling tube is at least 4 in. (100 mm) and is smooth and free from joints or protrusions. It is important that the bottom of the stilling tube stays covered to prevent the ingress of foams.
2. Avoid mounting the transmitter directly over any inlet stream.
3. Liquid surface turbulence is not normally a problem unless it is excessive. The effects of turbulence are minor, but excessive turbulence can be dealt with by fine-tuning the transmitter on site, if necessary.

3.3.2 Consider in-tank effects

Guidelines

1. Stirrers or agitators can cause a vortex. Mount the transmitter off-center of any vortex to maximize the return echo.
2. If stirrer blades become uncovered, they create echoes as they pass through the ultrasonic beam. The transmitter can learn to ignore false echoes (see [“Learn false echo” on page 23](#)).
3. In tanks with rounded or conical bottoms, mount the transmitter off-center. If needed, a perforated reflector plate can be installed on the tank bottom directly under the transmitter center line to ensure a satisfactory return echo.
4. Avoid detecting pump casings, as the liquid falls away, by not mounting the transmitter directly above pumps. If this is not possible, fine-tuning of the transmitter on-site may be required.

3.3.3 Mounting the transmitter above the liquid surface

A 1-in. thread is provided to mount the transmitter. The thread form is either **BSPP (G1)** or **NPT**, and is *marked* below the mounting thread.

To help installation, flange accessories and bracket kits are available from Emerson. The accessory flanges supplied are manufactured from PVC and are a full face design. Care must be taken when installing to raised face mating flanges on the tank or vessel to prevent distortion of the PVC flange by over-tightening the bolts. See [“Spare parts and accessories” on page 120](#) for ordering information.

Note

- Never suspend the transmitter by the cable.
-

Bracket mounting

The transmitter is supplied with a purpose made 316 Stainless Steel mounting bracket which should be used to mount the transmitter over the liquid surface. The bracket is designed to fit over the threaded neck of the transmitter and is retained by a locknut (see “[1-in. NPT/BSPP bracket kits](#)” on page 117 for dimensions).

Use a chain or wire through the hole provided in the bracket, which is shaped to ensure that the transmitter will hang perpendicular to the liquid surface. Check that the material of the chain or wire is corrosion resistant to the liquids and any vapors present.

The bracket may be bolted to a suitable cross member above the liquid surface. Ensure that the transmitter is *perpendicular* to the liquid surface to maximise the return echo size.

Note

- Check that the maximum liquid level will not enter the 12 in. (0.3 m) blanking zone of the transmitter.
 - To help with alignment, the echo size (signal strength) can be indicated on the Rosemount 3490 Series Control Unit or a Field Communicator.
-

Flange mounting

The instrument (accessory) flanges supplied by Emerson are manufactured from PVC and are a full face design. Care must be taken when installing to a raised face mating flange on the tank or vessel to prevent distortion of the PVC flange by over-tightening the bolts. See “[Spare parts and accessories](#)” on page 120 for part numbers.

Mounting from a conduit

The 3107 and the 3108 can be mounted from a conduit using the optional adaptor (03107-7003-0003 and 03107-7003-1004). See “[Spare parts and accessories](#)” on page 120.

3.3.4 Open channel flow installations

There are normally two distinct parts to an open channel flow measurement system; the primary element (flow structure) and the secondary element (Head measurement instrumentation). For accurate open channel flow measurement, both parts of the system must be correctly installed. This section explains the important parts of installing the transmitter (secondary element). The flow structure (primary element) installation can be referenced in the British (BS3680) or ISO International standards.

Note

- The transmitter should be free from a situation where it is likely to 'drown' (refer to the relevant standard for further information)
 - The Rosemount 3108 has a factory-fitted Remote Temperature Sensor. See “[Positioning of the remote temperature sensor \(3108 only\)](#)” on page 14.
 - For some installations, the use of a calibration device is mandatory. Emerson offers the Rosemount Head Verification Device (HVD) for this purpose. See “[Spare parts and accessories](#)” on page 120 for further information.
-

Positioning of the transmitter

The positioning is critical, and should be the correct distance upstream from the flow structure as stated in the relevant standard for your country. For example, in the ISO standards, the distance should be four to five times the maximum height of the water (H_{max}) for a thin plate weir, or three to four times H_{max} for a flume. For optimum accuracy, position the transmitter's front face at a height equal to the sum of the maximum flow depth plus the transmitter deadband of 12.2 in. (300 mm) plus an extra 2 in. (50 mm).

Figure 3-3. Choosing the height position above a flow

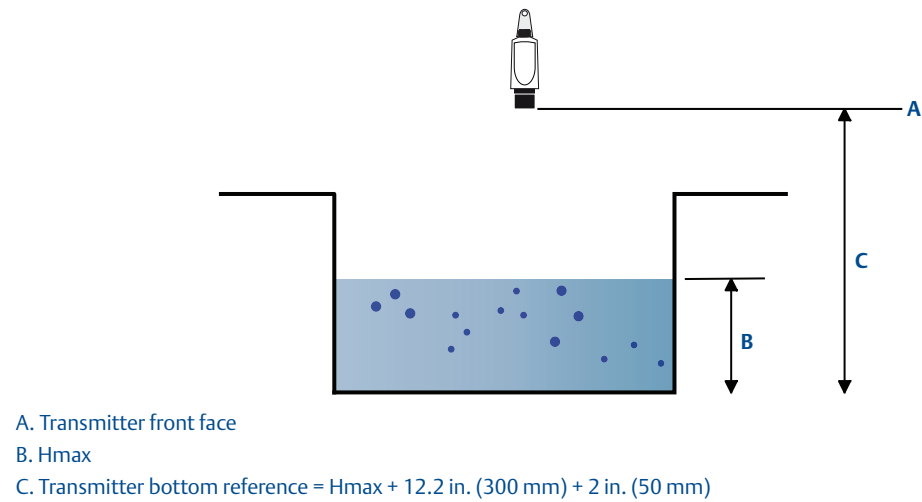

It is important that the **bottom reference** of the transmitter should be related to the datum of the primary measuring device (Figure 3-4).

Figure 3-4. Bottom Reference of a flume or weir

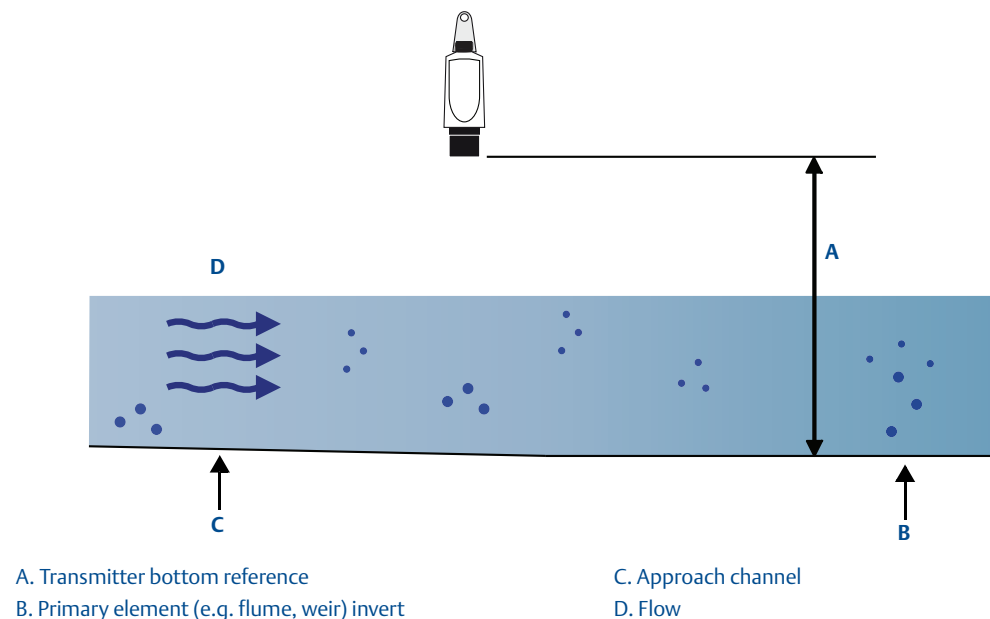

When setting the bottom reference on a 'V' notch weir, it is important the true invert is used and not the meniscus level (Figure 3-5).

Figure 3-5. Bottom reference of a 'V' notch weir

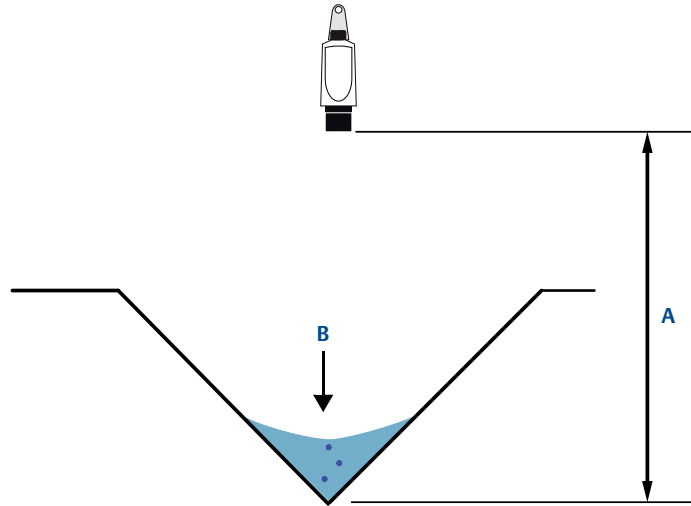

- A. Transmitter bottom reference (i.e. true invert)
- B. Meniscus level

Positioning of the remote temperature sensor (3108 only)

The Rosemount 3108 transmitter has a factory fitted remote temperature sensor. The temperature sensor is enclosed in a M8 x 1.5 threaded stainless steel body.

Figure 3-6 and Figure 3-7 on page 15 show two typical arrangements for installing the temperature sensor in an open or enclosed chamber. The sensor may be installed in a suitable plastic conduit box and clamped in place using a suitable compression type cable gland.

1. Open weir chamber (Figure 3-6 on page 15)
Mount the remote temperature sensor so that it is representative of the mean air temperature in the chamber and is in a shaded area away from direct sunlight and solar radiation.
2. Enclosed or partially covered flume chamber (Figure 3-7 on page 15)
Mount the remote temperature sensor in the approach channel, in a shaded area away from direct sunlight and solar radiation. In Figure 3-7 on page 15, the sensor is partially covered by grating which helps prevent solar gain. (Full grating is removed for clarity.)

The temperature sensor should be positioned in the weir chamber or flume approach channel so the average air temperature can be accurately measured. The temperature sensor **must** be protected at all times from direct sunlight and any radiated heat.

In extreme high temperatures, for the best accuracy and stability of level measurement reading, the transmitter should be shrouded to prevent the incidence of direct sunlight and solar radiation. If the flow structure permits, mount the transmitter within the flow channel or chamber.

Figure 3-6. Open weir chamber arrangement with Rosemount Head Verification Device



Figure 3-7. Enclosed or partially covered flume chamber arrangement



3.4 Electrical installation

3.4.1 Connecting the transmitter

The Rosemount 3490 Series is a two-wire loop-powered transmitter accepting power supplies as follows:

- 12 to 40 Vdc in a non-hazardous area (ordinary location)
- 12 to 30 Vdc in a hazardous area (classified location)

Note

- To comply with the CSA requirements, the transmitters must be powered from a Rosemount 3490 Series Control Unit or class 2 or separate extra-low voltage (SELV) source.
 - Other devices may reset if connecting the transmitter to a multi-drop system while the loop is powered. De-energize the loop to avoid devices being reset.
-

Each transmitter is supplied with a factory-fitted PVC sheathed, two-core, shielded cable for communications and external power supply connections. There are no cable conduit entries and no covers to remove. The cable may be cut to length on site or may be extended using a junction box and suitable extension cable.

See “[Wiring to allow HART communication](#)” on page 18 if HART digital communication is required.

Installation in a non-hazardous area (ordinary location)

The 3107 and the 3108 are suitable for non-hazardous (ordinary location) applications.

To connect the transmitter:

1. Make sure that the power supply is disconnected.
2. Connect the cable wires as shown in [Figure 3-8 on page 17](#), taking note of the required voltage of **12 to 40 Vdc for non-hazardous (ordinary location) applications**.

Installation in a hazardous area (classified location)

The 3107 and the 3108 are suitable for Intrinsically Safe (IS) applications. [Appendix B: Product Certifications](#) has the safety approval information and control drawings.

When the transmitters are used with a Rosemount 3490 Series Control Unit, no additional safety barriers are required as the control unit output is Intrinsically Safe.

If powering the transmitter from any other source, ensure a suitable Intrinsically Safe (IS) barrier is fitted in the non-hazardous area. The barrier must be chosen such that its output parameters U_o , I_o and P_o are less than U_i , I_i and P_i of the transmitter (see [Appendix B: Product Certifications](#) for the parameter values). In addition, the sum of the capacitance and the inductance of the transmitter and any extra cable fitted must not exceed the maximum specified for the barrier. Suitable barriers include the MTL products 706, 706S, 787, and 787S.

To connect the transmitter:

1. Make sure that the power supply is disconnected.
2. Connect the cable wires (see [Figure 3-8 on page 17](#)), **taking note of the restricted voltage of 12 to 30 Vdc for hazardous area (classified location) applications.**

Note

- Other devices may reset if connecting the transmitter to a multi-drop system while the loop is powered. De-energize loop to avoid devices being reset.
 - Make sure that the instruments in the loop are installed according to intrinsically-safe field wiring practices and control drawings, when applicable.
-

Figure 3-8. Wiring diagram

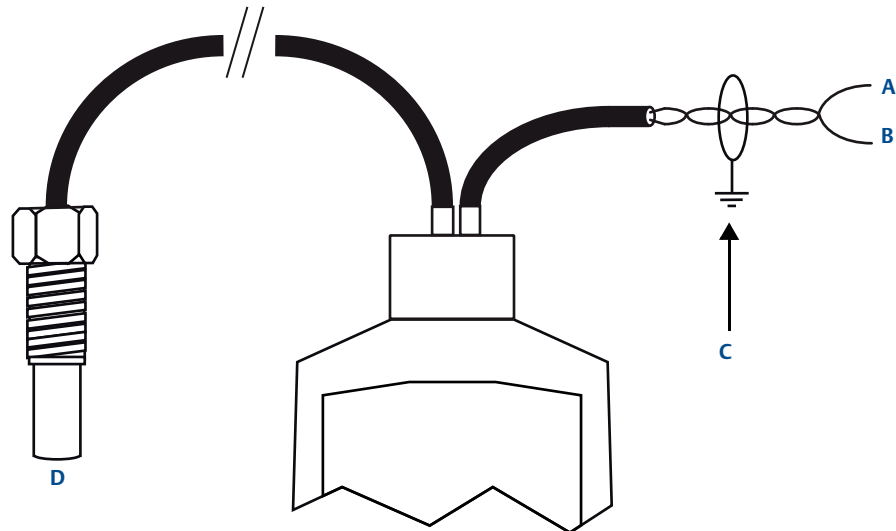

- A. Black: 0 Vdc
 - B. Red: 12 to 40 Vdc (for non-hazardous area) or 12 to 30 Vdc from protective barrier (for hazardous area)
 - C. Non-hazardous area: connect cable screen to standard ground (earth) or hazardous area: connect cable screen to intrinsically safe ground (earth)
 - D. Remote temperature sensor (3108 only)
-

3.4.2 Remote temperature sensor (on 3108 only)

The factory-fitted remote temperature sensor on the 3108 may be installed in a hazardous area without the need for any additional protection or barriers.

Note

- See also “Positioning of the remote temperature sensor (3108 only)” on page 14.
-

3.4.3 Wiring to allow HART communication

If HART communications is required, a 250 Ohm (minimum), 0.25 W load resistor must be installed in the loop. (See “Load limitations” on page 114).

Note

- When the transmitter is used with a Rosemount 3490 Series Control Unit, there is no need to install an external load resistor in the loop because a suitable resistor is built in to the control unit.
-

If the transmitter is being supplied through a safety barrier, ensure the type chosen will pass HART information.

After the load resistor is installed, a Field Communicator can be connected across the load resistor, or across the loop at any point downstream of the load resistor. **It is the responsibility of the installer to ensure that any Field Communicator used in the hazardous area is suitably certified.**

Note

- Make sure that the instruments in the loop are installed according to intrinsically-safe field wiring practices and control drawings, when applicable.
-

3.4.4 Lightning / surge protection and other loop devices

If the area is prone to lightning strikes or voltage surges, a suppressor device may be installed between the transmitter and the control unit.

If an additional loop-powered device or separately powered device is included in the two-wire loop, ensure the transmitter receives a minimum voltage of 12 Vdc (see “Load limitations” on page 114).

Section 4 Configuration

Overview	page 19
Command parameters	page 20
Configuration parameters	page 31

4.1 Overview

The Rosemount 3107 and Rosemount 3108 support HART communications, which may be used to program or interrogate the transmitters from any point on the two-wire loop.

This section contains information on configuring the transmitters using a Field Communicator, PC with AMS, or Rosemount 3490 Series Control Unit.

Rosemount 3490 Series control unit

The product manual 00809-0100-4841 provides detailed instructions on installation and operation of the control unit.

A full menu map showing how to access transmitter parameters using the control unit's menu system is in Appendix [Appendix C: Rosemount 3490 Series Universal Control Unit](#). For convenience, the parameter identification numbers (P*** and D***) are used in parameter headings and descriptions in this configuration section.

When using the control unit, use the **Enter** (↵) key to start editing a configuration parameter and then use the arrow keys to change the setting. Changes are confirmed by pressing the **Enter** key, or abandoned by pressing the **Esc** key. Commands e.g. **Set As Empty** are run using the **Enter** (↵) key.

Note

- The Rosemount 3490 Control Unit software must be version 3.40 or later.
-

Field Communicator and AMS

For convenience, Field Communicator fast key sequences are labeled “Fast Keys” for each software function below the appropriate headings.

Example software function

Fast Keys	1, 2, 3, etc.
-----------	---------------

When using a Field Communicator, some configuration changes are sent to the transmitter by pressing “SEND”. AMS configuration changes are implemented when the “Apply” button is clicked.

Connect the Field Communicator leads to the transmitter, and turn on the Field Communicator by pressing the ON/OFF key. The Field Communicator will search for a HART-compatible device

and indicate when the connection is made. If the Field Communicator fails to connect, it indicates that no device was found. If this occurs, check the lead connections and re-try.

A full menu map showing how to access transmitter parameters using the Field Communicator is in Appendix [Appendix D: Field Communicator](#).

4.2 Command parameters

4.2.1 Base units

Fast Keys	3, 4, 3, 3
-----------	------------

When the transmitter is shipped from the factory, the default factory setting for **Base Units** is “**metric**” or “**imperial ft**” depending on the model order code (see “[Ordering information](#)” on page 118).

Note

- Keep a record of your programmed settings. Changing base units resets parameters to their default factory settings in the appropriate units.

Field Communicator

To view or change the transmitter base units:

1. From the *Home* screen, select **3: Service Tools**.
2. Select **4: Maintenance**.
3. Select **3: Utilities**.
4. Select **3: Set Base Units**.
5. Use the up and down navigation keys to select new base units, and then save the selection by pressing “**ENTER**”.
6. Press “**ENTER**” to select **1: Yes** (in response to “Are you sure?”).
7. Use the left navigation key to return to the previous menu.

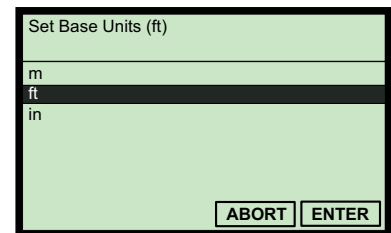

(Field Communicator Screen)

Note

- When messages appear, take appropriate action if needed and press “**OK**”.

Rosemount 3490 Series Control Unit

To view or change the transmitter base units:

1. From the *Main Menu* screen, select **SETUP**.
2. Select the transmitter (e.g. “**Tx1: 3107**”).
3. Select **SYSTEM**.

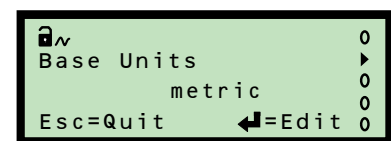

(Rosemount 3491 Screen)

4. Select **Base Units**.
5. Follow on-screen instructions to select and confirm the new base units.
6. Select “**Quit**” to exit to the previous menu.
7. To get the same base units on the control unit, switch the power off and then on again. The control unit prompts for the transmitter’s **Bottom Reference** value (page 35) in the new base units.

Note

- The display units (reported units) of the transmitter’s PV (Process Value) can be changed to *metric* or *imperial* measurement units using the parameter **Primary Variable Units** (page 51), but this does not automatically re-scale the PV.

4.2.2 Set as empty

Fast Keys	2, 2, 2, 3, 2
-----------	---------------

If the bottom reference is unknown and the tank is empty, the transmitter can change the **Bottom Reference** value (page 35) to the **Distance** measurement with the tank empty.

$$P010 = (D910 - P060)$$

Where:

- P010 = Bottom Reference setting.
- D910 = Distance measurement (see page 90).
- P060 = Distance Offset setting (see page 40).

Field Communicator

To select the Set As Empty command:

1. From the *Home* screen, select **2: Configure**.
2. Select **2: Manual Setup**.
3. Select **2: Level**.
4. Select **3: Present Depth**.
5. Select **2: Set as Empty**, and then press “**ENTER**”.

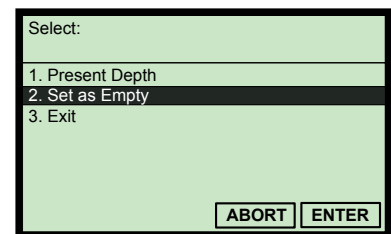

(Field Communicator Screen)

Note

- When messages appear, take appropriate action if needed and press “**OK**”.
- Set As Empty is also available at Fast Key sequence 2, 1, 2.

Rosemount 3490 Series Control Unit

To select the Set As Empty command:

1. From the *Main Menu* screen, select **SETUP**.
2. Select the transmitter (e.g. “Tx1: 3107”).
3. Select **DUTY**.
4. Select **SET AS EMPTY**.
5. Follow on-screen instructions to perform the Set As Empty action. (If prompted to change the mode to off-line, press the **Enter** key).
6. Select “**Quit**” to exit to the previous menu.

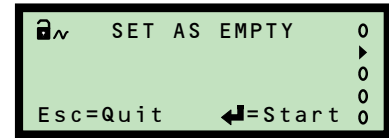

(Rosemount 3491 Screen)

4.2.3 Present depth

Fast Keys	2, 2, 2, 3, 1
-----------	---------------

If the Bottom Reference is unknown but the present liquid depth is known, the transmitter can set the **Bottom Reference** value using the Present Depth value, the live distance measurement, and optional offsets:

$$P010 = (\text{Depth} + D910) - (P060 + P069)$$

Where:

- P010 = Bottom Reference (see [page 35](#)).
- Depth = Present Depth setting (live level value snapshot but can be edited).
- D910 = Distance measurement (see [page 90](#)).
- P060 = Distance Offset (see [page 40](#)).
- P069 = Level Offset (see [page 41](#)).

Field Communicator or AMS

To use the Present Depth action:

1. From the *Home* screen, select **2: Configure**.
2. Select **2: Manual Setup**.
3. Select **2: Level**.
4. Select **3: Present Depth**.
5. Select **1: Present Depth**, and then press “**ENTER**”.
6. Follow the on-screen instructions to input the present depth, which will then change the transmitter’s bottom reference using the calculation.
7. Press “**ENTER**” to confirm the input present depth.

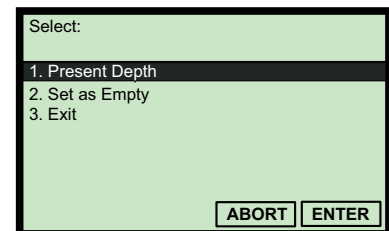

(Field Communicator Screen)

Note

- When messages appear, take appropriate action if needed and press “OK”.
- Present Depth is also available at Fast Key sequence 2, 1, 2.

Rosemount 3490 Series Control Unit

To select the Set As Empty command:

1. From the *Main Menu* screen, select **SETUP**
2. Select the transmitter (e.g. “Tx1: 3107”).
3. Select **DUTY**.
4. Select **Present Depth**.
5. Follow the on-screen instructions to input the present depth, which will then change the transmitter’s bottom reference using the calculation.
(If prompted to change the mode to “off-line”, press the **Enter** key).
6. Select “**Quit**” to exit to the previous menu.

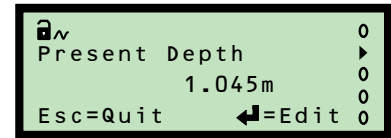

(Rosemount 3491 Screen)

4.2.4

Learn false echo

Fast Keys	2, 2, 6, 6
-----------	------------

The transmitter can be manually told the live **Distance** (on [page 90](#)) is being calculated from a *false target echo* and that echo can therefore be ignored.

If there is another false target echo, repeat the learning process again. A maximum of **four** false echoes can be learnt.

Field Communicator or AMS

To ignore a false target echo:

1. From the *Home* screen, select **2: Configure**.
2. Select **2: Manual Setup**.
3. Select **6: False Echoes**.
4. Select **6: Learn False Echo**.
5. Wait three seconds while the transmitter learns to ignore the false echo.

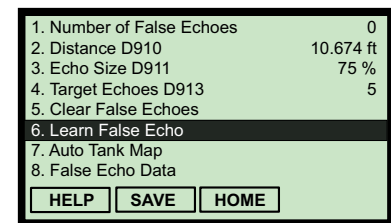

(Field Communicator Screen)

Note

- When messages appear, take appropriate action if needed and press “OK”.

Rosemount 3490 Series Control Unit

To ignore a false target echo:

1. From the *Main Menu* screen, select **SETUP**.
2. Select the transmitter (e.g. “Tx1: 3107”).
3. Select **ENGINEERING**.
4. Select **FALSE ECHO ACTION**.
5. Select **Learn False Echo**.
6. Follow the on-screen instruction (“**Start**”) to ignore a false echo.
(Press the **Enter** (↵) key if prompted to change the mode to “off-line”).
7. Select “**Quit**” to exit to the previous menu.

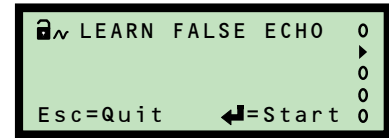

(Rosemount 3491 Screen)

Note

- To clear all learned false echoes, see **Clear False Echoes** on page 75.
- To edit existing false echo data, see **False Echo Data** on page 74.
- Use the “**Auto Tank Map**” feature for automatic learning (page 24).

4.2.5 Auto tank map

Fast Keys	2, 2, 6, 7
-----------	------------

The transmitter can automatically map up to **four** echoes from false targets within an empty tank. The tank needs to be empty so that echoes from all false targets are exposed.

Note

- Set the **Bottom Reference** (page 35) before using Auto Tank Map.

Field Communicator or AMS

To automatically map up to **four** echoes from false targets:

1. From the *Home* screen, select **2: Configure**.
2. Select **2: Manual Setup**.
3. Select **6: False Echoes**.
4. Select **7: Auto Tank Map**.
5. Wait while the transmitter learns about the empty tank to ignore the false echoes. This process takes less than one minute.

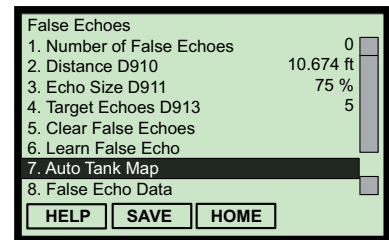

(Field Communicator Screen)

Note

- When messages appear, take appropriate action if needed and press “**OK**”.

Rosemount 3490 Series Control Unit

To automatically map up to **four** echoes from false targets:

1. From the *Main Menu* screen, select **SETUP**.
2. Select the transmitter (e.g. “Tx1: 3107”).
3. Select **ENGINEERING**.
4. Select **FALSE ECHO ACTION**.
5. Select **Auto Tank Map**.
6. Follow the on-screen instruction (“**start**”) to ignore a false echo. (Press the **Enter** key if prompted to change the mode to “off-line”).
7. Wait while the transmitter learns about the empty tank to ignore the false echoes. The process takes less than one minute.
8. Select “**Quit**” to exit to the previous menu.

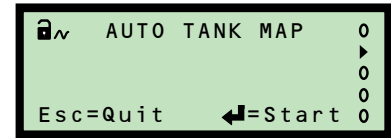

(Rosemount 3491 Screen)

Note

- To clear all learned false echoes, see **Clear False Echoes** on page 75.
- To edit existing false echo data, see **False Echo Data** on page 74.
- Use the “**Learn False Echo**” feature manual learning (page 23).

4.2.6 Simulation of PV

Fast Keys	3, 5, 1
-----------	---------

The transmitter simulations automatically cycle the PV between the bottom of the tank and the nearest measurable distance. The cycle direction is given by the name of the simulation mode selected.

Simulation modes are:

- “Run up” – cycles up, and then down, repeatedly until stopped.
- “Run down” – cycles down, and then up, repeatedly until stopped.
- “Run from Zero” – as “Run up” except the PV initially starts from 0.

A single cycle takes 100 seconds to complete. The Current Output responds according to the PV.

The cycling may be paused with the “pause” mode, and then re-started by selecting another simulation mode.

To stop the cycling, select the “normal” mode.

Field Communicator or AMS

To use the simulation tool:

1. From the *Home* screen, select **3: Service Tools**.
2. Select **5: Simulate**.
3. Select **1: Primary Variable**.
4. Select **2: Change Mode**.
5. Select a simulation mode e.g. **2: Run Up**.
6. The simulation is now running, and Simulation Enabled is **“ON”**.
7. Monitor the parameters **Primary Variable (PV)**, **Current Output**, and **Percentage of Current Output** on the LCD screen.
8. When finished, change the mode to **“Normal”**.

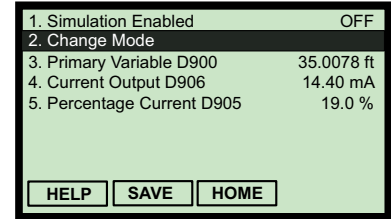

(Field Communicator Screen Shown)

Note

- When messages appear, take appropriate action if needed and press **“OK”**.

Rosemount 3490 Series Control Unit

To use the simulation tool:

1. From the *Main Menu* screen, select **SETUP**.
2. Select the transmitter (e.g. **“Tx1: 3107”**).
3. Select **SYSTEM**.
4. Select **Simulation**.
5. Select a simulation mode.
6. When finished, select **“Quit”** to exit to the previous menu.

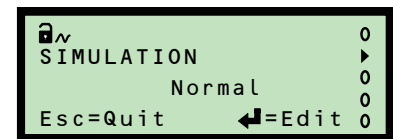

(Rosemount 3491 Screen)

4.2.7 Restart device

Fast Keys	3, 4, 3, 1
-----------	------------

This re-starts the transmitter as if the power has been interrupted.

Field Communicator or AMS

To restore the original factory configuration:

1. From the *Home* screen, select **3: Service Tools**.
2. Select **4: Maintenance**.
3. Select **3: Utilities**.
4. Select **1: Restart Device**.
5. When the message “About to restart the transmitter” appears, press “**OK**” to continue (or “**ABORT**” to not continue).
6. Select **1: Yes** to restart the transmitter.

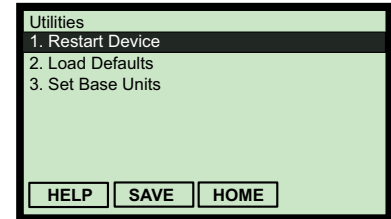

(Field Communicator Screen)

Note

- When messages appear, take appropriate action if needed and press “**OK**”.

Rosemount 3490 Series Control Unit

To restore the original factory configuration:

1. From the *Main Menu* screen, select **SETUP**.
2. Select the transmitter (e.g. “**Tx1: 3107**”).
3. Select **SYSTEM**, and then select **RESTART DEVICE**.
4. Follow the on-screen instruction (“**Start**”) to restart the transmitter. (Press the **Enter** (↵) key if prompted to change the mode to “off-line”).
5. Select “**Quit**” to exit to the previous menu.

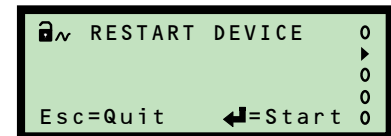

(Rosemount 3491 Screen)

4.2.8 Load defaults

Fast Keys	3, 4, 3, 2
-----------	------------

This restores the transmitter parameters to the factory default values for the selected base units. This is sometimes necessary, particularly if the data held in the transmitter is in doubt.

Note

- Restoring the factory defaults values overwrites all site entered data. After loading the factory defaults, the transmitter automatically re-starts and communication is interrupted until the re-start is complete.

Field Communicator or AMS

To restore the factory default settings of the transmitter:

- From the *Home* screen, select **3: Service Tools**.
- Select **4: Maintenance**.
- Select **3: Utilities**.
- Select **2: Load Defaults**.
- When the message “About to restore factory defaults” appears, press “**OK**” to continue (or “**ABORT**” to not continue).
- Select **1: Yes** to restore the factory defaults.

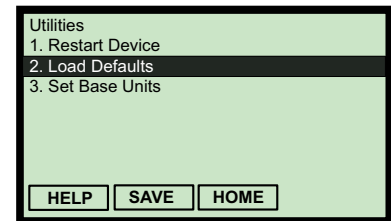

(Field Communicator Screen)

Note

- When messages appear, take appropriate action if needed and press “**OK**”.

Rosemount 3490 Series Control Unit

To restore the factory default settings of the transmitter:

- From the *Main Menu* screen, select **SETUP**.
- Select the transmitter (e.g. “**Tx1: 3107**”).
- Select **SYSTEM**, and then select **DEFAULTS**.
- Follow the on-screen instructions (select “**Start**” and answer “**Yes**”) to restore the factory defaults.
(Press the **Enter** (↵) key if prompted to change the mode to “off-line”).
- Select “**Quit**” to exit to the previous menu.

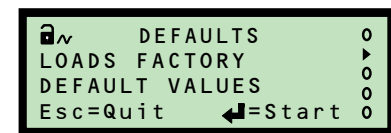

(Rosemount 3491 Screen)

4.2.9 Simulate current output

Fast Keys	3, 5, 2, 1
-----------	------------

This forces a fixed output current in the range 4 to 20 mA. This feature *temporarily* overrides the normal function of the transmitter’s PV driving the 4–20mA Current Output until exiting to the previous menu.

Note

- The simulation is automatically cancelled after 20 minutes, and the output current returns to representing the transmitter’s PV.

Field Communicator or AMS

To fix the output current:

1. From the *Home* screen, select **3: Service Tools**.
2. Select **5: Simulate**.
3. Select **2: Loop Current**.
4. Select **1: Loop Test**.
5. Select the required output current e.g. **1: 4mA**.
6. When a message appears saying the output current is fixed, press **“OK”**.
7. Select **4: End** to exit and restore the output current to normal.

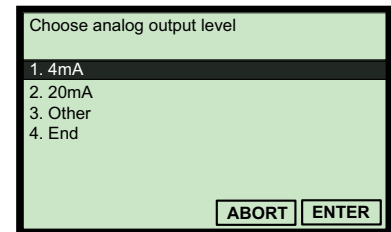

(Field Communicator Screen)

Note

- When messages appear, take appropriate action if needed and press **“OK”**.

Rosemount 3490 Series Control Unit

To fix the output current:

1. From the *Main Menu* screen, select **SETUP**.
2. Select the transmitter (e.g. **“Tx1: 3107”**).
3. Select **SYSTEM**, and then select **TRIM**.
4. Select **Fix Current**.
5. Follow on-screen instructions to input the required output current.
(Press the **Enter (↵)** key if prompted to change the mode to “off-line”).
6. When finished, select **“Quit”** to exit to the previous menu.

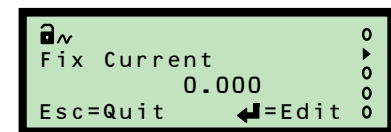

(Rosemount 3491 Screen)

4.2.10 Trim 4mA / Trim 20mA

Fast Keys	3, 4, 1, 1
-----------	------------

This is for calibrating the 4mA and 20mA output current from the transmitter. The output current is temporarily set to 4mA and 20mA. Measure the *actual output current* and then input that mA value to re-calibrate. The output current resumes normal operation after exiting.

Note

- The re-calibration procedure is automatically cancelled after 20 minutes of inactivity, and the previous calibration is restored.

Field Communicator or AMS

To re-calibrate the 4mA and 20mA output current:

1. From the *Home* screen, select **3: Service Tools**.
2. Select **4: Maintenance**,
3. Select **1: Analog Calibration**.
4. Select **1: D/A Trim**.
5. Follow the instruction “**Connect reference meter**”, and then press “**OK**”.
6. Input the measured mA from the reference meter, and press “**ENTER**”.
7. Select **1: Yes**.
8. Select “**OK**” to continue to calibrate the 20mA output current.
9. Input the measured mA from the reference meter, and press “**ENTER**”.
10. Select **1: Yes**. (The output current now returns to normal operation).

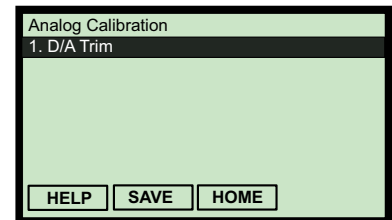

(Field Communicator Screen)

Note

- When messages appear, take appropriate action if needed and press “**OK**”.

Rosemount 3490 Series Control Unit

To re-calibrate the 4mA output current:

1. From the *Main Menu* screen, select **SETUP**.
2. Select the transmitter (e.g. “**Tx1: 3107**”).
3. Select **SYSTEM**, select **TRIM**, and then select **Trim 4mA**.
4. Connect a reference meter.

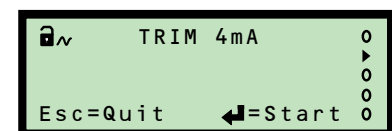

(Rosemount 3491 Screen)

5. Follow the on-screen instructions to start the re-calibration feature.
(Press the **Enter** (↵) key if prompted to change the mode to “off-line”).
6. Input the measured mA from the reference meter, and select “**Save**”.
7. Select the “**Quit**” instruction to exit.

To re-calibrate the 20mA output current:

1. From the *Main Menu* screen, select **SETUP**.
2. Select the transmitter (e.g. “**Tx1: 3107**”).
3. Select **SYSTEM**, select **TRIM**, and then select **Trim 20mA**.
4. Follow the on-screen instructions to start the re-calibration feature.
(Press the **Enter** (↵) key if prompted to change the mode to “off-line”).
5. Measure the *actual output current*, and input that new value.
6. Select “**Quit**” to exit to the previous menu.

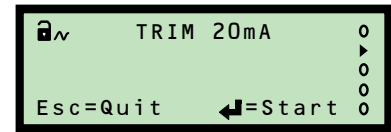

(Rosemount 3491 Screen)

4.3 Configuration parameters

4.3.1 Message (P000)

Fast Keys	2, 2, 4, 1, 3
-----------	---------------

This allows a general 32-character message to be edited (12 characters if using a Rosemount 3490 Series Control Unit). It can be used for any purpose, such as recording the initials of the person who programmed it, a support contact number, details of last programming change, etc.

Field Communicator or AMS

To view or change the message:

1. From the *Home* screen, select **2: Configure**.
2. Select **2: Manual Setup**.
3. Select **4: HART / Identity**.
4. Select **1: Identity**.
5. Select **3: Message P000**.
6. Input the new message, and then press “**ENTER**” to save it.
7. Press “**SEND**” to update the transmitter.

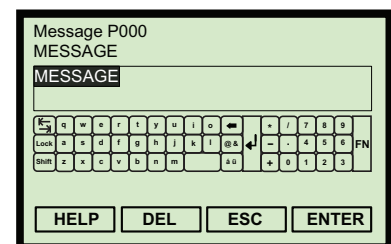

(Field Communicator Screen)

Rosemount 3490 Series Control Unit

To view or change the message:

1. From the *Main Menu* screen, select **SETUP**.
2. Select the transmitter (e.g. “Tx1: 3107”).
3. Select **DUTY**, and then select **IDENTITY**.
4. Select **Message**.
5. Follow on-screen instructions to input and save the message.
6. Select “**Quit**” to exit to the previous menu.



(Rosemount 3491 Screen)

4.3.2 Tag (P001)

Fast Keys	2, 2, 4, 1, 1
-----------	---------------

This is for editing an electronic ‘label’ of up to 8 characters for the transmitter. The tag is typically a reference number, but it can also be used to identify the location or duty of the transmitter in plant item terms.

Note

- This tag helps identify the transmitter being interrogated when using a HART Master Device such as the Rosemount 3490 Series Control Unit.

Field Communicator or AMS

To view or change the tag:

1. From the *Home* screen, select **2: Configure**.
2. Select **2: Manual Setup**.
3. Select **4: HART / Identity**.
4. Select **1: Identity**.
5. Select **1: Tag P001**.
6. Input the new tag, and then press “**ENTER**” to save it.
7. Press “**SEND**” to update the transmitter.

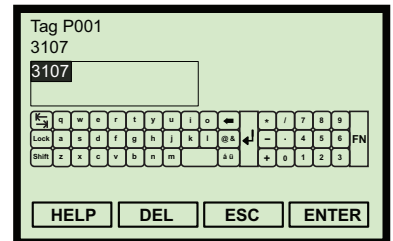

(Field Communicator Screen)

Rosemount 3490 Series Control Unit

To view or change the tag:

1. From the *Main Menu* screen, select **SETUP**.
2. Select the transmitter (e.g. “Tx1: 3107”).
3. Select **DUTY**, and then select **IDENTITY**.

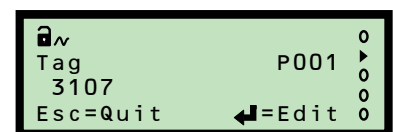

(Rosemount 3491 Screen)

4. Select **Tag**.
5. Follow on-screen instructions to input and save the tag.
6. Select “**Quit**” to exit to the previous menu.

4.3.3 Descriptor (P002)

Fast Keys	2, 2, 4, 1, 2
-----------	---------------

This is for editing up to 16 characters, and can be used for any purpose e.g. to expand on **Tag** (page 32) if needed.

Field Communicator or AMS

To view or change the descriptor:

1. From the *Home* screen, select **2: Configure**.
2. Select **2: Manual Setup**.
3. Select **4: HART / Identity**.
4. Select **1: Identity**.
5. Select **2: Descriptor P002**.
6. Input the descriptor, and then press “**ENTER**” to save it.
7. Press “**SEND**” to update the transmitter.

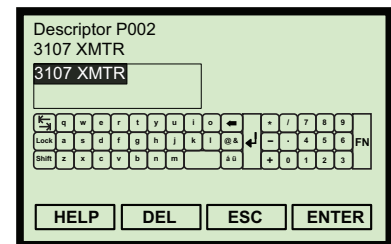

(Field Communicator Screen)

Rosemount 3490 Series Control Unit

To view or change the descriptor:

1. From the *Main Menu* screen, select **SETUP**.
2. Select the transmitter (e.g. “**Tx1: 3107**”).
3. Select **DUTY**, and then select **IDENTITY**.
4. Select **Descriptor**.
5. Follow on-screen instructions to input and save the descriptor.
6. Select “**Quit**” to exit to the previous menu.



(Rosemount 3491 Screen)

4.3.4 Final assembly number (P004)

Fast Keys	2, 2, 4, 1, 8
------------------	---------------

This is a read-only, factory set parameter showing a multiple-digit number. It is used by the factory to track the manufacturing history of an individual transmitter.

Field Communicator or AMS

To view the final assembly number:

1. From the *Home* screen, select **2: Configure**.
2. Select **2: Manual Setup**.
3. Select **4: HART / Identity**.
4. Select **1: Identity**.
5. Select **8: Final Assembly Number P004**.
6. Press “**EXIT**” to exit to the previous menu.

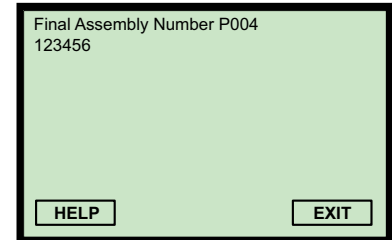

(Field Communicator Screen)

Rosemount 3490 Series Control Unit

To view the final assembly number:

1. From the *Main Menu* screen, select **SETUP**.
2. Select the transmitter (e.g. “**Tx1: 3107**”).
3. Select **SYSTEM**.
4. Select **FIXED**.
5. Select **Final Assy No.**
6. Use the **ENTER** (↵) key to exit to the previous menu.

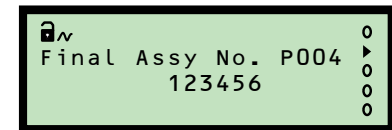

(Rosemount 3491 Screen)

4.3.5 Serial number (P005)

Fast Keys	2, 2, 4, 1, 9
-----------	---------------

This is a read-only, factory set parameter showing a multiple-digit number. It is used by the factory to identify an individual transmitter.

Field Communicator or AMS

To view the serial number:

1. From the *Home* screen, select **2: Configure**.
2. Select **2: Manual Setup**.
3. Select **4: HART / Identity**.
4. Select **1: Identity**.
5. Select **9: Serial Number P005**.
6. Press “**EXIT**” to exit to the previous menu.

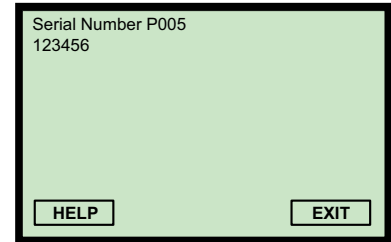

(Field Communicator Screen)

Rosemount 3490 Series Control Unit

To view the serial number:

1. From the *Main Menu* screen, select **SETUP**.
2. Select the transmitter (e.g. “**Tx1: 3107**”).
3. Select **SYSTEM**.
4. Select **FIXED**.
5. Select **Serial Number**.
6. Use the **ENTER** (↵) key to exit to the previous menu.

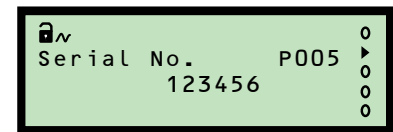

(Rosemount 3491 Screen)

4.3.6 Bottom reference (P010)

Fast Keys	2, 2, 1, 2
-----------	------------

This is the transmitter’s **Bottom Reference** setting. It is the distance measured vertically along the ultrasonic beam path from the *user preferred sensor reference point* to the *zero level* of a tank or an open channel (see [Figure 4-1 on page 37](#)).

The zero level establishes where the transmitter starts to measure the process value. It is not necessary to have the 4 mA output start at the zero level, and the 4 mA starting pointing can be any liquid height above or below this zero level.

Note

- This parameter is important for calibrating and configuring the transmitter.

Field Communicator or AMS

To view or change the bottom reference:

1. From the *Home* screen, select **2: Configure**.
2. Select **2: Manual Setup**.
3. Select **1: Basic Setup**.
4. Select **2: Bottom Reference P010**.
5. Input the new bottom reference, and then press “**ENTER**” to save it.
6. Press “**SEND**” to update the transmitter.

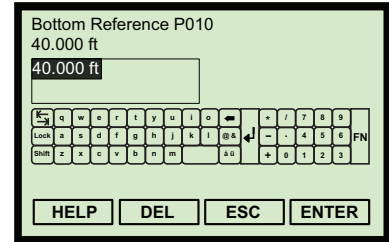

(Field Communicator Screen)

Rosemount 3490 Series Control Unit

To view or change the bottom reference:

1. From the *Main Menu* screen, select **SETUP**.
2. Select the transmitter (e.g. “**Tx1: 3107**”).
3. Select **DUTY**.
4. Select **Bottom Ref.**
5. Follow the on-screen instructions to input and save the new setting. (Press the **Enter** (↵) key if prompted to change the mode to “off-line”).
6. Select “**Quit**” to exit to the previous menu.

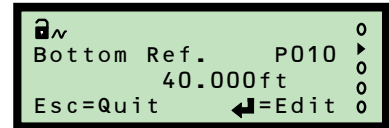

(Rosemount 3491 Screen)

Figure 4-1. Tank geometry

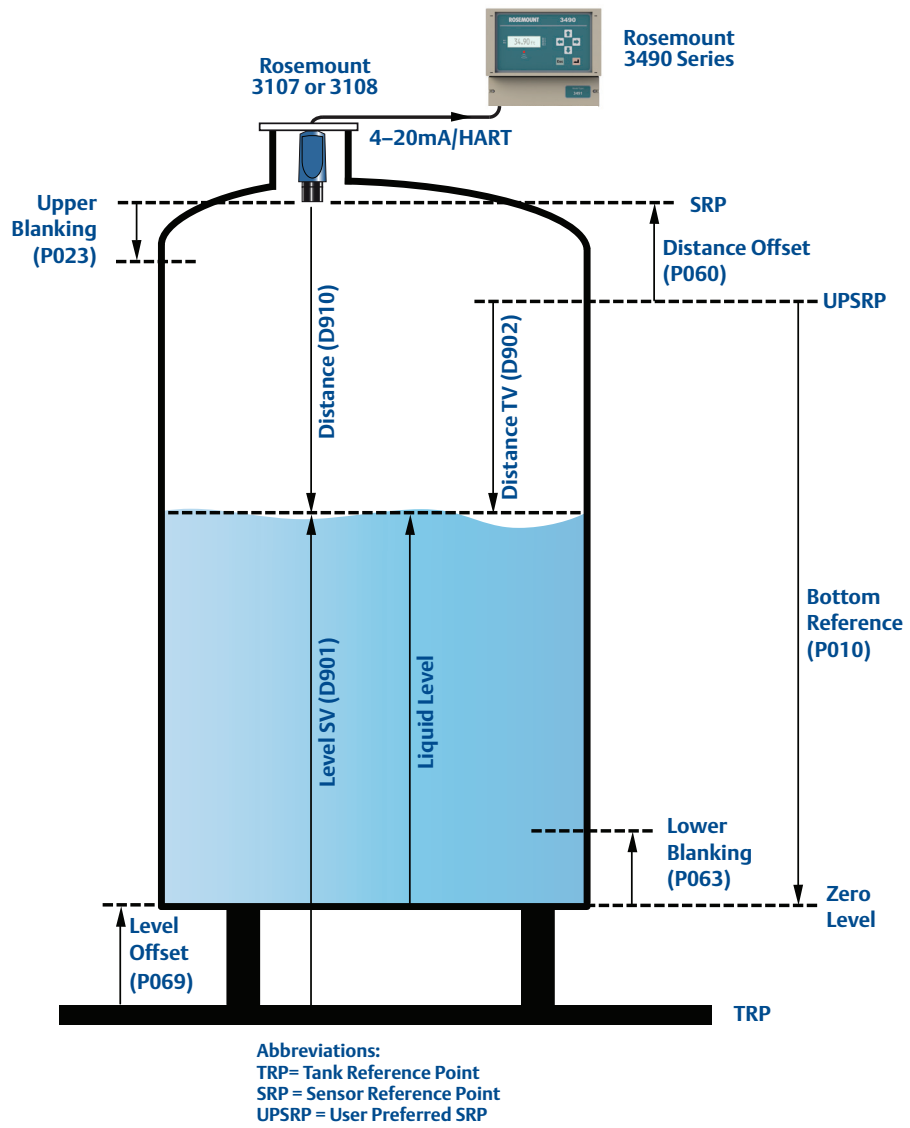

Data processing sequence:

1. Echoes are processed that occur between **Upper Blanking (P023)** and **Lower Blanking (P063)**.
2. D910 is derived from the Target Echo's Time of Flight and the calculated Speed of Sound: $D910 = (\text{Time of Flight} \times \text{Speed of Sound}) / 2$
3. $D902 = (D910 - P060)$
4. $\text{Liquid Level} = (P010 - D902)$
5. $D901 = (\text{Liquid Level} + P069)$

4.3.7 Upper blanking (P023)

Fast Keys	2, 2, 5, 5
-----------	------------

This defines a zone close to the transmitter where echoes are to be ignored. Establishing this zone eliminates echoes from false targets such as mounting fittings or the end of stub pipes.

Enter the vertical distance from the transmitter face to where a valid surface echo can be detected. See [Figure 4-1 on page 37](#) for this zone in a tank geometry illustration.

Note

- In applications where elevated ambient temperatures of around 50 to 60 °C are experienced, together with poor liquid surface conditions (excessive surface agitation, foam, etc.) at a high level and within 0.5 m of the transducer face, the transmitter may see a false echo and report a false high level measurement.

The factory default value of this parameter is 0.3 m, measured down from the transducer face. If it is possible to operate with an increased value between 0.3 and 0.5 m, then setting P023 to a value of 0.5 m eliminates the false echo. Trying several different values is recommended as a smaller value of **P023**, if the application requires, may be possible. See also **Threshold 1 Size** ([page 69](#)) for related information.
- The upper blanking distance should not be set to less than the factory default setting.
- The pulse transmission stops if the sum of the **Lower Blanking** ([page 41](#)) and **Upper Blanking** and is greater than the **Bottom Reference** ([page 35](#)).

Field Communicator or AMS

To view or change the upper blanking distance:

1. From the *Home* screen, select **2: Configure**.
2. Select **2: Manual Setup**.
3. Select **5: Engineering**.
4. Select **5: Upper Blanking P023**.
5. Input the new upper blanking distance, and press “**ENTER**” to save it.
6. Press “**SEND**” to update the transmitter.

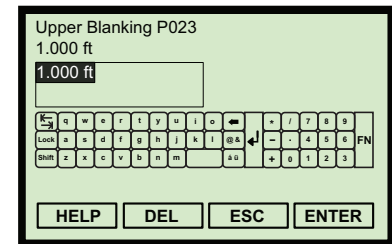

(Field Communicator Screen)

Note

- When messages appear, take appropriate action if needed and press “**OK**”.

Rosemount 3490 Series Control Unit

To view or change the upper blanking distance:

1. From the *Main Menu* screen, select **SETUP**.
2. Select the transmitter (e.g. “**Tx1: 3107**”).
3. Select **ENGINEERING**.

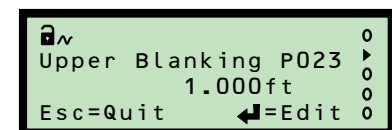

(Rosemount 3491 Screen)

4. Select **Upper Blanking**.
5. Follow the on-screen instructions to edit and save the new setting.
(Press the **Enter** (↵) key if prompted to change the mode to “off-line”).
6. Select **“Quit”** to exit to the previous menu.

4.3.8 Lower blanking (P063)

Fast Keys	2, 2, 5, 6
-----------	------------

This defines the zone above the **Bottom Reference** (page 35) where echoes are ignored. The zone eliminates echoes from false targets at the bottom of the tank e.g. pumps uncovered as the liquid level decreases.

Note

- See [Figure 4-1 on page 37](#) for this zone in a tank geometry illustration.
- The pulses transmission stops if the sum of the **Upper Blanking** (page 62) and **Lower Blanking** is greater than the **Bottom Reference** (page 35).

Field Communicator or AMS

To view or change the lower blanking distance:

1. From the *Home* screen, select **2: Configure**.
2. Select **2: Manual Setup**.
3. Select **5: Engineering**.
4. Select **6: Lower Blanking**.
5. Input the new lower blanking distance, and press **“ENTER”** to save it.
6. Press **“SEND”** to update the transmitter.

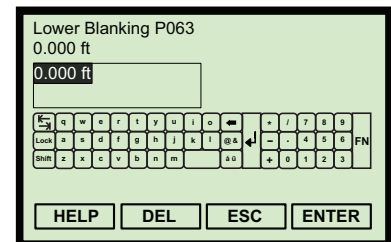

(Field Communicator Screen)

Note

- When messages appear, take appropriate action if needed and press **“OK”**.

Rosemount 3490 Series Control Unit

To view or change the lower blanking distance:

1. From the *Main Menu* screen, select **SETUP**.
2. Select the transmitter (e.g. **“Tx1: 3107”**).
3. Select **ENGINEERING**.
4. Select **Lower Blanking**.

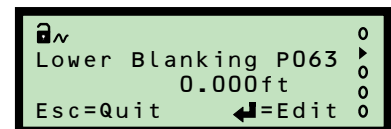

(Rosemount 3491 Screen)

5. Follow the on-screen instructions to edit and save the new setting. (Press the **Enter** (↵) key if prompted to change the mode to “off-line”).
6. Select “**Quit**” to exit to the previous menu.

4.3.9 Distance offset (P060)

Fast Keys	2, 2, 2, 2
-----------	------------

This defines the distance from the Sensor Reference Point (SRP) to the User Preferred Sensor Reference Point (UPSRP).

Note

- See [Figure 4-1 on page 37](#) for these points in a tank geometry illustration.

The distance offset is subtracted from the live **Distance** value ([page 90](#)) to produce the read-only **Distance / Tertiary Variable** value (see [page 86](#)).

Note

- The live **Distance** value is not affected by changes to the distance offset.

Field Communicator or AMS

To view or change the distance offset:

1. From the *Home* screen, select **2: Configure**.
2. Select **2: Manual Setup**.
3. Select **2: Level**.
4. Select **2: Distance Offset P060**.
5. Input the new distance offset, and press “**ENTER**” to save it.
6. Press “**SEND**” to update the transmitter.

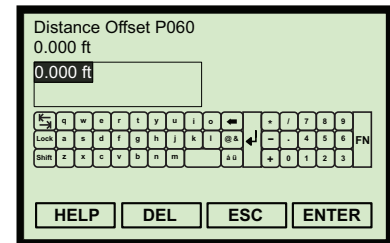

(Field Communicator Screen)

Note

- When messages appear, take appropriate action if needed and press “**OK**”.

Rosemount 3490 Series Control Unit

To view or change the distance offset:

1. From the *Main Menu* screen, select **SETUP**.
2. Select the transmitter (e.g. “**Tx1: 3107**”).
3. Select **DUTY**.
4. Select **Distance Offset**.

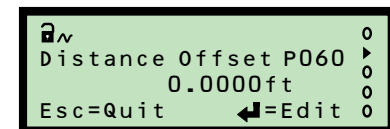

(Rosemount 3491 Screen)

5. Follow the on-screen instructions to edit and save the new setting. (Press the **Enter** (↵) key if prompted to change the mode to “off-line”).
6. Select “**Quit**” to exit to the previous menu.

4.3.10 Level offset (P069)

Fast Keys	2, 2, 2, 4
-----------	------------

This defines the distance from the Tank Reference Point (TRP) to the transmitter’s Bottom Reference. The level offset is added to the measured level to produce the read-only **Level / Secondary Variable value** (page 85).

Note

- See Figure 4-1 on page 37 for these points in a tank geometry illustration.

Field Communicator or AMS

To view or change the level offset:

1. From the *Home* screen, select **2: Configure**.
2. Select **2: Manual Setup**.
3. Select **2: Level**.
4. Select **4: Level Offset P069**.
5. Input the new level offset, and press “**ENTER**” to save it.
6. Press “**SEND**” to update the transmitter.

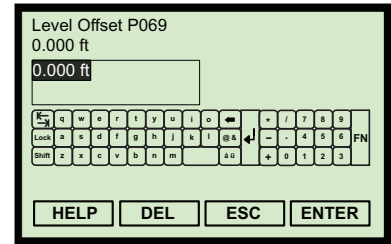

(Field Communicator Screen)

Note

- When messages appear, take appropriate action if needed and press “**OK**”.

Rosemount 3490 Series Control Unit

To view or change the level offset:

1. From the *Main Menu* screen, select **SETUP**.
2. Select the transmitter (e.g. “**Tx1: 3107**”).
3. Select **DUTY**.
4. Select **Level Offset**.
5. Follow the on-screen instructions to edit and save the new setting. (Press the **Enter** (↵) key if prompted to change the mode to “off-line”).
6. Select “**Quit**” to exit to the previous menu.

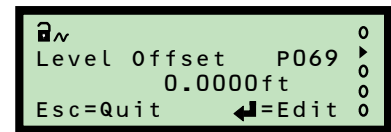

(Rosemount 3491 Screen)

4.3.11 Tank shape / non-linear profile (P011)

Fast Keys	2, 2, 3, 2
------------------	------------

This selects the shape of a tank or an open channel, and establishes the linear or non-linear relationship between the live liquid level (height) and the process value (PV) derived from that level.

Note

- The displayed (reported) measurement units for the output PV are set using the **Primary Variable Units** parameter (page 51). Changing these units does not automatically re-scale the output PV value.

The transmitter is pre-programmed with popular profiles that are mathematical formulas to convert a linear level reading to a flow or volumetric process value (PV). The Current Output is then driven by the flow or volumetric PV.

The profile options are described in the following sections:

- “Contents (volume) measurement” on page 43
- “Flow measurement” on page 48

Field Communicator or AMS

To change the tank shape / non linear profile:

1. From the *Home* screen, select **2: Configure**.
2. Select **2: Manual Setup**.
3. Select **3: Profiling**.
4. Select **2: Set Non-Linear Profile**.
5. Select a new profile, and then press “**Enter**” to save the selection.
6. Press “**SEND**” to update the transmitter.

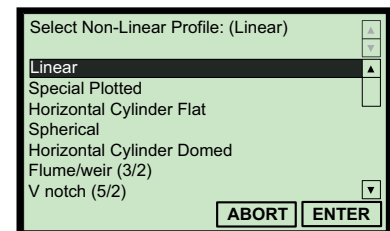

(Field Communicator Screen)

Note

- When messages appear, take appropriate action if needed and press “**OK**”.
- The selected profile can be viewed at Fast Key sequence 2, 2, 3, 3.

Rosemount 3490 Series Control Unit

To view or change the tank shape:

1. From the *Main Menu* screen, select **SETUP**.
2. Select the transmitter (e.g. “**Tx1: 3107**”).
3. Select **DUTY**.
4. Select **Tank Shape**.

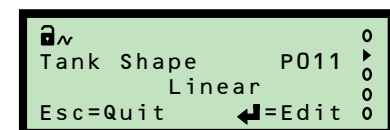

(Rosemount 3491 Screen)

5. Follow the on-screen instructions to select and save the new setting. (Press the **Enter** (↵) key if prompted to change the mode to “off-line”).
6. Select “**Quit**” to exit to the previous menu.

4.3.12 Contents (volume) measurement

There are 5 shape options available to select, including:

- Tank shape/NLP (P011) = “Linear” (see [page 43](#))
- Tank shape/NLP (P011) = “Special Plot” (see [page 43](#))
- Tank Shape/NLP (P011) = “Horizontal Cyl Flat” (see [page 46](#))
- Tank Shape/NLP (P011) = “Spherical” (see [page 46](#))
- Tank Shape/NLP (P011) = “Horizontal Cyl Dome” (see [page 47](#))

Tank shape/NLP (P011) = “Linear”

This default setting is for level or volume (content) measurements involving a tank with a constant cross-section. When “**Linear**” is selected, the level or volume is the liquid height above the *zero level* multiplied by a scaling factor. If volume is not required, the **Scale Factor** parameter ([page 52](#)) is set to 1.0 unless other measurement units for the output PV are required.

The volume of the contents is calculated by entering the volume-per-meter of height into the **Scale Factor** parameter ([page 52](#)). If the liquid level is being measured in feet or inches, enter the volume-per-foot or volume-per-inch respectively.

Tank shape/NLP (P011) = “Special Plot”

When selecting “**Special Plot**”, parameters **Profile Point 1 to 10** ([page 55](#)) can be edited to plot the unique profile of an irregular shaped tank or open channel (see [Figure 4-2 on page 44](#)).

To derive the 10 profile points, it is necessary to have tabulated or graphical data to relate the process value (PV) to the live liquid height. [Figure 4-3 on page 45](#) shows an example graph of PV versus Liquid Height. In the example, 60% of the maximum height on the X-axis relates to a percentage of the maximum PV on the Y-axis. The related percentage, say 55%, is entered into parameter **Profile Point 6**.

The transmitter will interpolate linearly between the plotted points to give an accurate curve fit, which will determine the output PV from the live level (height) measurement.

Each live level measurement is converted into a percentage (0 to 100%), which is proportional to the maximum height. In graph terms, the converted percentage corresponds to an X ordinate on the X-axis. Using this X ordinate, the Y ordinate is then calculated to get a percentage proportional to the maximum PV. This percentage is multiplied by the maximum height to get the output process value (PV).

Setting-up Procedure for “**Special Plot**” Option:

1. Select the displayed (reported) units for the output PV (see [page 51](#)).
2. Draw the graph of PV versus Liquid Height, and note the maximum points.
3. Enter the *maximum* liquid height into **Profile Height** ([page 53](#)).
4. Enter the *maximum* volume or flow into **PV Scale Factor** ([page 52](#)).
5. Enter the distance from the transmitter face to the zero point (Y=0) into the **Bottom Reference** parameter ([page 35](#)).
6. Use parameters **Profile Point 1 (P030)** to **Profile Point 10 (P039)** to enter the percentage values that relate to the X-axis fixed percentages.

Figure 4-2. Two-stage weir cross-section

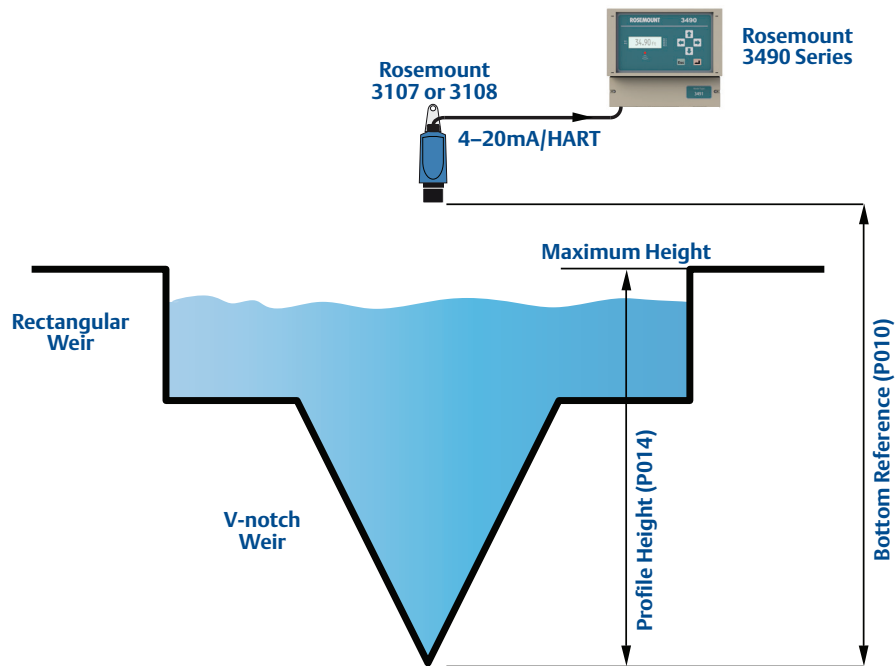

Note

- The origin (0,0) is always used as the start point. It is not a parameter.
- It is possible the process value (PV) at the maximum height is less than 100% of the maximum volume or flow. (See [Figure 4-4 on page 45](#)).

Figure 4-3. Graph 1 of PV versus Height

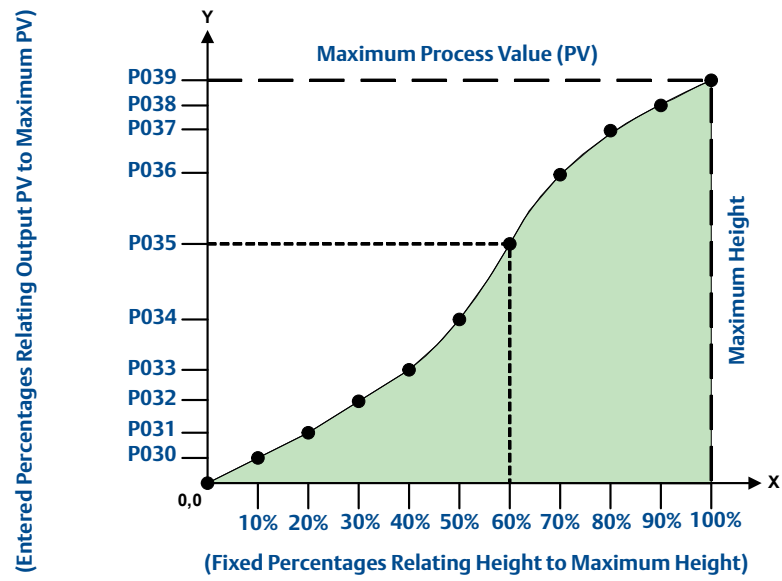
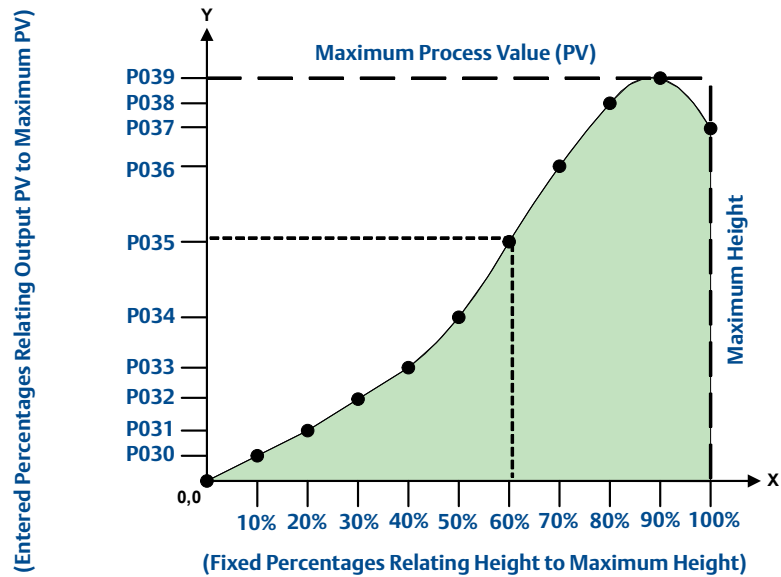

Figure 4-4. Graph 2 of PV versus Height



Tank Shape/NLP (P011) = “Horizontal Cyl Flat”

This Horizontal Cylinder With Flat Ends setting is applicable when volume measurements are needed from a horizontally-oriented cylindrical tank with a constant diameter (see [Figure 4-5 on page 47](#) for a cross-sectional view).

The volume is calculated from the live level measurement, the full volume of an ideal cylindrical tank, and the diameter of that tank.

Setting-up Procedure for “**Horizontal Cyl Flat**”:

1. Use the **Tank Shape/NLP (P011)** parameter to select the option “**Horizontal Cyl Flat**”.
2. Enter the full volume into the **PV Scale Factor** parameter ([page 52](#)).
3. Enter the tank diameter into the **Profile Height / Power Factor** parameter ([page 53](#)).

Tank Shape/NLP (P011) = “Spherical”

This setting is applicable when volume measurements are needed from a spherical tank with a constant diameter (see [Figure 4-5 on page 47](#) for a cross-sectional view).

The volume is calculated from the liquid level measurement and the full volume of the ideal spherical tank.

Setting-up Procedure for “**Spherical**”:

1. Use the **Tank Shape/NLP (P011)** parameter to select “**Spherical**”.
2. Enter the full volume into the **PV Scale Factor** parameter ([page 52](#)).
3. Enter the tank diameter into the **Profile Height / Power Factor** parameter ([page 53](#)).

Figure 4-5. Cylindrical or spherical tank cross-section

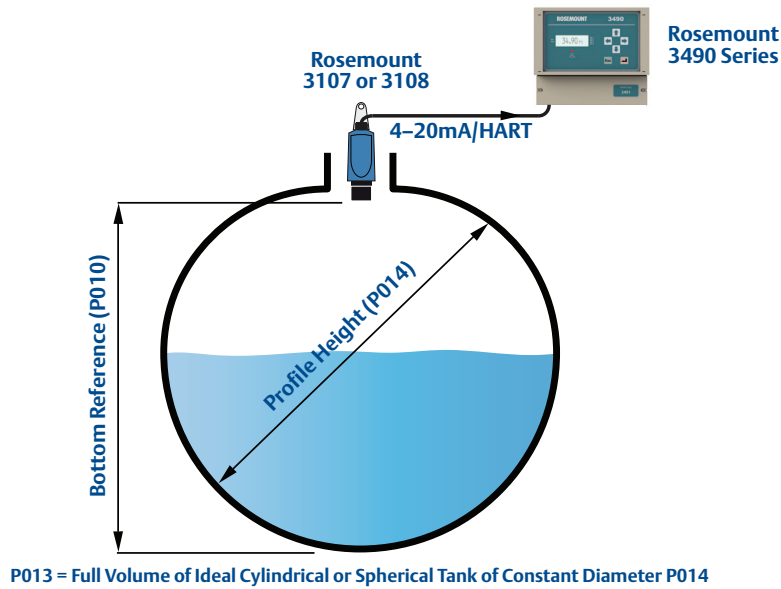

Tank Shape/NLP (P011) = “Horizontal Cyl Dome”

This Horizontal Cylinder With Domed Ends setting is applicable when volume measurements are needed from a horizontally-oriented cylindrical tank with a constant diameter (see [Figure 4-5](#) for a cross-sectional view).

The volume is calculated from the live level measurement, the full volume of an ideal cylindrical tank, and the diameter of that tank.

Setting-up Procedure for “Horizontal Cyl Dome”:

1. Use the **Tank Shape/NLP (P011)** parameter to select the option “**Horizontal Cyl Dome**”.
2. Enter the full volume into the **PV Scale Factor** parameter ([page 52](#)).
3. Enter the tank diameter into the **Profile Height / Power Factor** parameter ([page 53](#)).

4.3.13 Flow measurement

Table 4-1 on page 50 lists the **Tank Shape/Non-Linear Profile (P011)** options that select a standard flow structure profile and the conversion (scale) factors used to calculate a flow process value (PV).

Tank Shape/NLP (P011) = “Special Plot”

The “**Special Plot**” option is used for *irregular-shaped* flow profiles. See page 43 for a full description.

Tank Shape/NLP (P011) = “Flume/Weir-3/2”

This setting is applicable when flow rate measurements are needed from an open channel with a flume or weir profile (see Figure 4-6 on page 49).

The rate of flow per second is calculated by:

$$Q = k \times h^{Pwr}$$

Where ‘h’ is the live liquid level, ‘Q’ is flow rate per second, ‘Pwr’ is the power factor and ‘k’ is a user-entered scale factor.

The transmitter automatically populates parameter **Power Factor / Profile Height** (page 53) with a power factor from Table 4-1.

Flumes that deviate from the standard “3/2 power law”, e.g. round-bottomed flumes, must use the “**Special Plot**” profile option that is based on flow versus height tabulations (see page 43).

Setting-up Procedure for “**Flume/Weir-3/2**”:

1. Use parameter **Tank Shape/NLP (P011)** to select “**Flume/Weir-3/2**”.
2. Enter the scale factor into the **PV Scale Factor** parameter (page 52).

Tank Shape/NLP (P011) = “V-Notch-5/2”

This setting is applicable when flow measurements are needed from an open channel with a V-notch profile.

The rate of flow through a V-notch is calculated using:

$$Q = k \times h^{Pwr}$$

Where ‘h’ is the live liquid level, ‘Q’ is flow rate per second, ‘Pwr’ is the power factor, and ‘k’ is a user-entered scale factor.

The transmitter automatically populates parameter **Power Factor / Profile Height** (page 53) with a power factor from Table 4-1.

Setting-up Procedure for “**V-Notch-5/2**”:

1. Edit parameter **Tank Shape/NLP (P011)** to select “**V-Notch-5/2**”.
2. Enter the scale factor into the **PV Scale Factor** parameter (page 52).

Figure 4-6. Rectangular weir cross-section

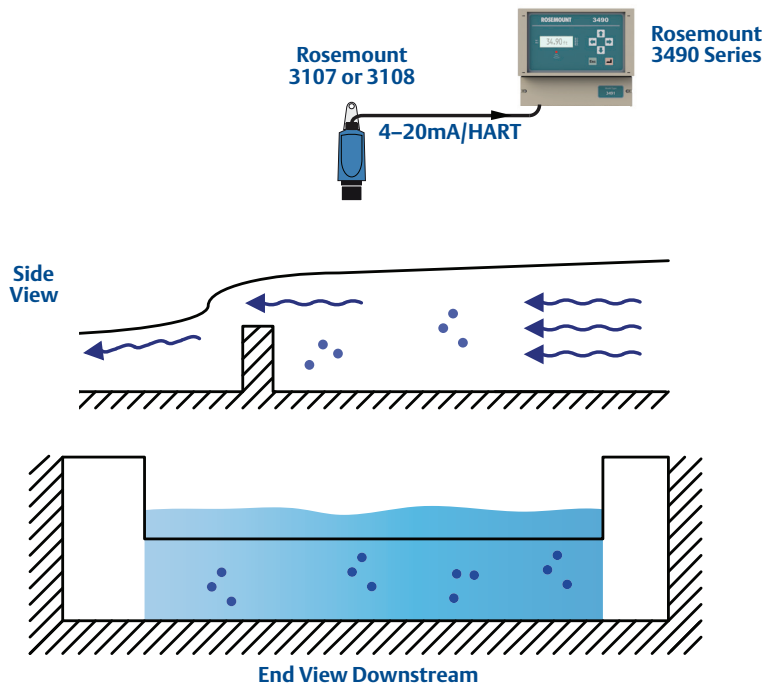

Figure 4-7. V-notch cross-section

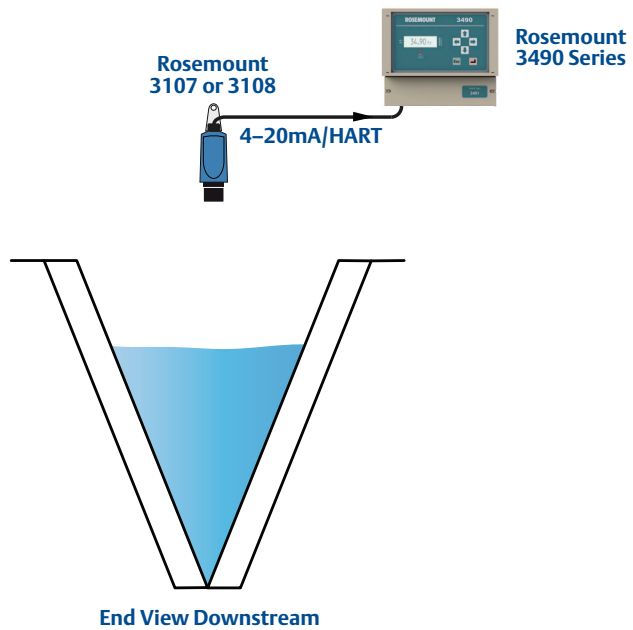

Table 4-1. Standard Flow Profile Options

TankShape/NLP (P011) Options	Flow Structures	Hmax		Scale Factor		Power Factor	20 mA Point ⁽¹⁾	
		Metric (m)	Imperial (ft/in.)	Metric (m ³ /hour)	Imperial (GPM ⁽²⁾)		Metric (m)	Imperial (ft/in.)
Flume/Weir-3/2	Flume 3/2 flow law	-	-	(User)	(User)	1.5	(User)	(User)
V-Notch-5/2	V-Notch 5/2 flow law	-	-	(User)	(User)	2.5	(User)	(User)
mann	Manning formula	-	-	(User)	(User)	(User)	(User)	(User)
PAr01	1 in. Parshall flume	0.75	2.5	217.3	151.7	1.55	17.9	87.3
PAr02	2 in. Parshall flume	0.75	2.5	434.6	303.4	1.55	50.7	215
PAr03	3 in. Parshall flume	0.75	2.5	635.5	445.2	1.547	125	516
PAr06	6 in. Parshall flume	0.75	2.5	1372	924.5	1.58	389	1750
PAr09	9 in. Parshall flume	0.75	2.5	1927	1378	1.53	882	3980
PAr1	1 ft Parshall flume	0.75	2.5	2487	1795	1.522	1610	7240
PAr1.5	1 1/2 ft Parshall flume	0.75	2.5	3803	2693	1.538	2440	11000
PAr2	2 ft Parshall flume	0.75	2.5	5143	3590	1.550	3290	14900
PAr3	3 ft Parshall flume	0.75	2.5	7863	5386	1.566	5010	22600
PAr4	4 ft Parshall flume	0.75	2.5	10630	7181	1.578	6750	30500
PAr5	5 ft Parshall flume	0.75	2.5	13440	8976	1.587	8510	38400
PAr6	6 ft Parshall flume	0.75	2.5	16280	10770	1.595	10300	46400
PAr8	8 ft Parshall flume	0.75	2.5	22010	14360	1.607	13900	62600
PAr10	10 ft Parshall flume	0.75	2.5	26862	17672	1.6	20700	89200
FF01 ⁽³⁾	Flume Flat 1 (m)	0.102	-	134.7877	-	1.5	9	-
FF02 ⁽³⁾	Flume Flat 2 (m)	0.191	-	178.2664	-	1.5	36	-
FF03 ⁽³⁾	Flume Flat 3 (m)	0.267	-	313.4177	-	1.5	90	-
FF04 ⁽³⁾	Flume Flat 4 (m)	0.406	-	541.7157	-	1.5	360	-
FF05 ⁽³⁾	Flume Flat 5 (m)	0.635	-	811.1058	-	1.5	900	-
FF06 ⁽³⁾	Flume Flat I	0.200	-	132.2	-	1.5	30	-
FF07 ⁽³⁾	Flume Flat II	0.250	-	177.7	-	1.5	60	-
FF08 ⁽³⁾	Flume Flat III	0.300	-	217.58	-	1.5	90	-
FF09 ⁽³⁾	Flume Flat III bis	0.3333	-	328.35	-	1.5	200	-
FF10 ⁽³⁾	Flume Flat III ter	0.400	-	272.0	-	1.5	200	-
FF11 ⁽³⁾	Flume Flat IV	0.400	-	352.1726	-	1.5	180	-
FF12 ⁽³⁾	Flume Flat V	0.500	-	442.932	-	1.5	360	-
FF13 ⁽³⁾	Flume Flat V bis	0.400	-	400.5	-	1.5	320	-
FF14 ⁽³⁾	Flume Flat VI	0.540	-	499.0569	-	1.5	720	-
FF15 ⁽³⁾	Flume Flat VII	0.700	-	623.7	-	1.5	1080	-
FF16 ⁽³⁾	Flume Flat VIII	0.600	-	881.16	-	1.5	1440	-
FF17 ⁽³⁾	Flume Flat VIII bis	0.666	-	798.0	-	1.5	1500	-
FF18 ⁽³⁾	Flume Flat IX	0.800	-	1065.186	-	1.5	1800	-
FF19 ⁽³⁾	Flume Flat IX bis	0.733	-	814.8	-	1.5	1700	-
FF20 ⁽³⁾	Flume Flat X	0.867	-	1322.2761	-	1.5	3600	-
FF21 ⁽³⁾	Flume Flat X bis	1.200	-	1609.0	-	1.5	7500	-
FF22 ⁽³⁾	Flume Flat X ter	0.959	-	1064.884	-	1.5	3500	-
FF2 3 ⁽³⁾	Flume Flat XI	1.200	-	1650.99	-	1.5	7200	-
FP01 ⁽³⁾	Flume Parabolic 1	0.200	-	15878.5	-	2.3	20	-
FP02 ⁽³⁾	Flume Parabolic 2	0.250	-	17591.1	-	2.3	40	-
FP03 ⁽³⁾	Flume Parabolic 3	0.310	-	11645.6	-	2.2	90	-
FP04 ⁽³⁾	Flume Parabolic 4	0.380	-	13669.5	-	2.2	180	-
FP05 ⁽³⁾	Flume Parabolic 5	0.460	-	9802.7	-	2.1	360	-
FP06 ⁽³⁾	Flume Parabolic 6	0.600	-	11367.8	-	2.1	720	-
FP07 ⁽³⁾	Flume Parabolic 7	0.800	-	12227.7	-	2.1	1400	-

(1) Upper range value if set to AUTO. Lower range value (4 mA) is set to 0.

(2) The gallons are US gallons.

(3) Flume option not available if base units are imperial.

4.3.14 Primary variable units (P012)

Fast Keys	2, 2, 3, 1
-----------	------------

This selects alternative display units for the HART Primary Variable (PV), which are then reported to a HART Master Device such as a Rosemount 3490 Series Control Unit.

Note

- Selecting alternative display units does not automatically re-scale the PV value. Use the parameter **PV Scale Factor** to manually re-scale the value.

Field Communicator or AMS

To view or change the displayed units for the PV:

1. From the *Home* screen, select **2: Configure**.
2. Select **2: Manual Setup**.
3. Select **3: Profiling**.
4. Select **1: Primary Variable Units P012**.
5. Select new units, and then press “**ENTER**” to save the selection.
6. Press “**SEND**” to update the transmitter.

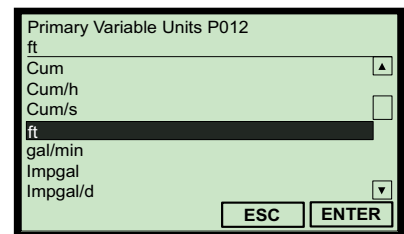

(Field Communicator Screen)

Note

- If the HART PV has no units, select and confirm the “**None**”, “**Unknown**”, or “**Not Used**” option as appropriate for the HART Master Device (host).

Rosemount 3490 Series Control Unit

To view or change the displayed units for the PV:

1. From the *Main Menu* screen, select **SETUP**.
2. Select the transmitter (e.g. “**Tx1: 3107**”).
3. Select **UNITS**.
4. Select **PV Units**.
5. Follow the on-screen instructions to select and confirm the new setting. If the HART PV has no units, select and confirm the “**None**” option. (Press the **Enter** (↵) key if prompted to change the mode to “off-line”).
6. Select “**Quit**” to exit to the previous menu.

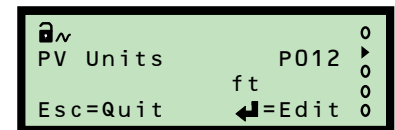

(Rosemount 3491 Screen)

4.3.15 Scale factor / K-factor (P013)

Fast Keys	2, 2, 3, 4
-----------	------------

Level measurement

When the process value (PV) is a level measurement in meters, feet, or inches, this parameter converts (scales) the level measurement into alternative units before being output. Enter a value of 1.0 if alternative units are not required.

Volume measurement

When the PV is a volume measurement from a *standard non-linear-shaped* tank e.g. cylinder or sphere, use this parameter to enter the volume of the ideal shaped tank (Figure 4-5 on page 47).

When the PV is a volume measurement from a *regular-shaped* tank e.g. square or rectangular, use this parameter to enter the volume change per unit of the base unit.

When the PV is a volume measurement from an *irregular-shaped* tank, use this parameter to enter the maximum volume. See also the Special Plot section on page 43 for defining the *irregular-shaped* tank.

Open channel measurement

When the PV is the flow rate in a *standard* open channel, use this parameter to enter the scale factor ('k' term) in a flow rate calculation. See "Flow measurement" on page 48 for selecting a standard flow profile.

When the PV is the flow rate in an *irregular-shaped* open channel, use this parameter to enter the maximum flow rate. See also the Special Plot section on page 48 for defining the *irregular-shaped* channel.

Field Communicator or AMS

To view or change the scale factor / k-factor:

1. From the *Home* screen, select **2: Configure**.
2. Select **2: Manual Setup**.
3. Select **3: Profiling**.
4. Select **4: Scale Factor P013** or **4: k-factor P013**, depending on the Non-Linear Profile selected (see page 38).
5. Input the new factor, and press "ENTER" to save it.
6. Press "SEND" to update the transmitter.

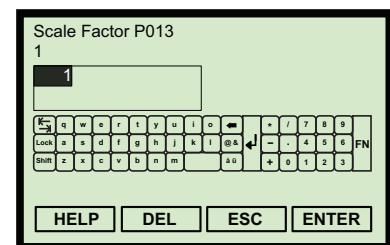

(Field Communicator Screen)

Rosemount 3490 Series Control Unit

To view or change the scale factor / k-factor:

1. From the *Main Menu* screen, select **SETUP**.
2. Select the transmitter (e.g. “Tx1: 3107”).
3. Select **DUTY**.
4. Select **PV Scale Factor**.
5. Follow the on-screen instructions to edit and save the new setting.
(Press the **Enter** (↵) key if prompted to change the mode to “off-line”).
6. Select “**Quit**” to exit to the previous menu.

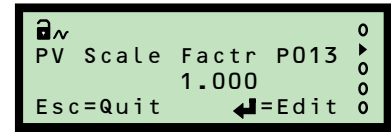

(Rosemount 3491 Screen Shown)

4.3.16 Profile height / Power factor (P014)

Fast Keys	2, 2, 3, 5
-----------	------------

Level measurement

This is not used for level measurements. It does not appear on the Field Communicator unless required for volume or flow measurements.

Volume measurement

When the process value (PV) is a volume measurement from a *standard non-linear-shaped* tank e.g. an ideal horizontal cylinder or a sphere, use this parameter to enter the diameter (see [Figure 4-5 on page 47](#)).

When the PV is a volume measurement from a *regular-shaped* tank e.g. square or rectangular, this parameter is not used.

When the PV is a volume measurement from an *irregular-shaped* tank, use this parameter to enter the maximum height (see [page 43](#)). See also the Special Plot section on [page 43](#) for defining the *irregular-shaped* tank.

Open channel measurement

When the process value (PV) is a flow rate in a *standard* open channel, this parameter is used as the power factor (‘pwr’ term) in a flow rate calculation (see “[Flow measurement](#)” on [page 48](#)).

When the PV is the flow rate in an *irregular-shaped* open channel, use this parameter to enter the maximum height (see [page 43](#)). See also the Special Plot section on [page 48](#) for defining the *irregular-shaped* channel.

Field Communicator or AMS

To view or change the diameter, maximum height, or power factor:

1. From the *Home* screen, select **2: Configure**.
2. Select **2: Manual Setup**.
3. Select **3: Profiling**.
4. Select **5: Non-Linear Profile Height P014** or **5:Power Factor P014**, depending on the Non-Linear Profile selected (see [page 38](#)).
5. Input a new value, and press “**ENTER**” to save it.
6. Press “**SEND**” to update the transmitter.

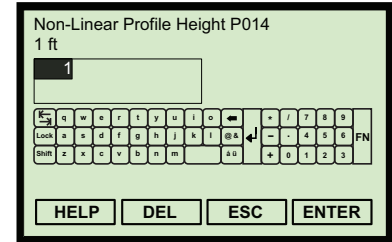

(Field Communicator Screen Shown)

Rosemount 3490 Series Control Unit

To view or change the diameter, maximum height, or power factor:

1. From the *Main Menu* screen, select **SETUP**.
2. Select the transmitter (e.g. “**Tx1: 3107**”).
3. Select **DUTY**.
4. Select **Profile Height**.
5. Follow the on-screen instructions to edit and save the new setting. (Press the **Enter** (↵) key if prompted to change the mode to “off-line”).
6. Select “**Quit**” to exit to the previous menu.

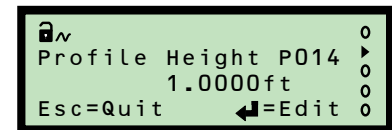

(Rosemount 3491 Screen)

4.3.17 Profile points 1 to 10 (P030 to P039)

Fast Keys	2, 2, 3, 6
-----------	------------

These parameters are used to define an irregular-shaped profile for calculating the process value (PV) from a live level reading.

Note

- See page 43 for examples of how these parameters are used.

Field Communicator or AMS

To view or change the profile point:

- From the *Home* screen, select **2: Configure**.
- Select **2: Manual Setup**.
- Select **3: Profiling**.
- Select **6: Plot Non-Linear Profile Points**.
- Select a profile point e.g. **1: Profile Point1 P030**.
- Input a new value, and then select “**ENTER**” to save it.
- Press “**SEND**” to update the transmitter.

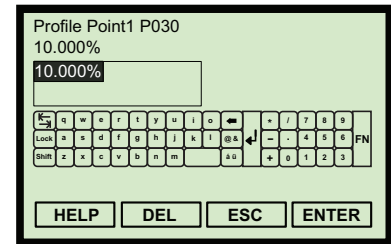

(Field Communicator Screen)

Note

- The profile point parameters are only accessible on a Field Communicator if they are required for a selected Non-linear Profile (see page 38). The points can be changed only if the “Special Plotted” profile has been selected.

Rosemount 3490 Series Control Unit

To view or change the profile point:

- From the *Main Menu* screen, select **SETUP**.
- Select the transmitter (e.g. “**Tx1: 3107**”).
- Select **DUTY**.
- Select **NLP CURVE**.
- Select a profile point e.g. “**Profile Pt. 1**”.
- Follow the on-screen instructions to edit and save the new setting. (Press the **Enter** (↵) key if prompted to change the mode to “off-line”).
- Select “**Quit**” to exit to the previous menu.

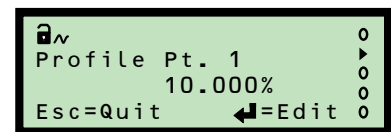

(Rosemount 3491 Screen)

4.3.18 Upper range value (P015)

Fast Keys	2, 2, 1, 3
-----------	------------

This defines the process value (PV) represented by a 20 mA output from the transmitter.

The span of the 4–20 mA current output is defined by the **Upper Range Value** parameter and the **Lower Range Value** parameter (page 57).

As an example, consider a tank with a 120 gallons capacity. When full, a 20 mA output current is required from the transmitter. Therefore, the upper range value is set to 120 if the PV is in gallon units. The lower range value is typically set to 0 (gallons) for the 4 mA output to indicate an empty tank.

The upper range value can be less than the lower range value, in which case the current output will decrease for an increasing process value (PV).

Note

- The upper range value is *automatically overwritten* when the **Tank Shape/NLP** parameter is used to select a flume flow profile, but the populated value can still be edited if required. See Table 4-1 on page 50 for the 20 mA point values.
- The displayed units are selected using the parameter **Primary Variable Units** (see page 51). Changing units does not re-scale the upper range value.

Field Communicator or AMS

To view or change the upper range value:

1. From the *Home* screen, select **2: Configure**.
2. Select **2: Manual Setup**.
3. Select **1: Basic Setup**.
4. Select **3: Upper Range Value P015**.
5. Input a new value, and then select “**ENTER**” to save it.
6. Press “**SEND**” to update the transmitter.

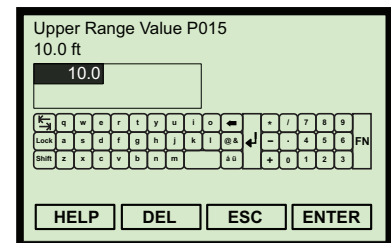

(Field Communicator Screen)

Note

- When messages appear, take appropriate action if needed and press “**OK**”.

Rosemount 3490 Series Control Unit

To view or change the upper range value:

1. From the *Main Menu* screen, select **SETUP**.
2. Select the transmitter (e.g. “**Tx1: 3107**”).
3. Select **OUTPUT**.

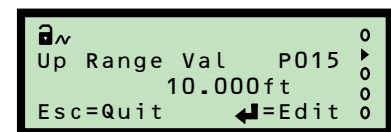

(Rosemount 3491 Screen)

4. Select **CURRENT**.
5. Select **Up Range Val**.
6. Follow the on-screen instructions to edit and save the new setting.
(Press the **Enter** (↵) key if prompted to change the mode to “off-line”).
7. Select **Quit** to exit to the previous menu.

4.3.19 Lower Range Value (P016)

Fast Keys	2, 2, 1, 4
-----------	------------

This defines the process value (PV) represented by a 4 mA output from the transmitter.

The span of the 4–20 mA current output is defined by the **Upper Range Value** parameter (page 56) and the **Lower Range Value** parameter.

As an example, consider a tank with a 120 gallons capacity. When empty, a 4 mA output current is required from the transmitter. Therefore, the lower range value is set to 0. The upper range value is typically set to 120 (gallons) for the 20 mA output current to indicate an full tank.

The lower range value can be greater than the upper range value, in which case the current output will decrease for an increasing process value (PV).

Note

- The displayed units are selected using the parameter **Primary Variable Units** (see page 51). Changing units does not re-scale the lower range value.

Field Communicator or AMS

To view or change the lower range value:

1. From the *Home* screen, select **2: Configure**.
2. Select **2: Manual Setup**.
3. Select **1: Basic Setup**.
4. Select **4: Lower Range Value P016**.
5. Input a new value, and then select **ENTER** to save it.
6. Press **SEND** to update the transmitter.

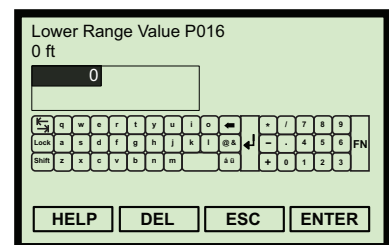

(Field Communicator Screen)

Note

- When messages appear, take appropriate action if needed and press **OK**.

Rosemount 3490 Series Control Unit

To view or change the lower range value:

1. From the *Main Menu* screen, select **SETUP**.
2. Select the transmitter (e.g. “Tx1: 3107”).
3. Select **OUTPUT**.
4. Select **CURRENT**.
5. Select **Low Range Val**.
6. Follow the on-screen instructions to input and save the new setting. (Press the **Enter** (↵) key if prompted to change the mode to “off-line”).
7. Select “**Quit**” to exit to the previous menu.

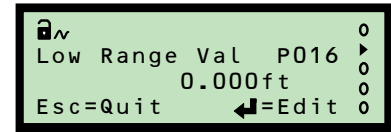

(Rosemount 3491 Screen)

4.3.20 Damping (P020)

Fast Keys	2, 2, 1, 5
-----------	------------

The damping value is a time constant in seconds, and is applied as smoothing to the level reading and the output current.

A larger value will have the effect of smoothing out rapid changes of level, and smooth out the effects of turbulence and ripples on the liquid surface.

A value of zero can be edited, in which case no smoothing is applied and transmitter readings immediately change the output.

Note

- The pulse repetition frequency of the transmitter is one pulse per second, which means that the system response time cannot be faster than this.

Field Communicator or AMS

To view or change the damping:

1. From the *Home* screen, select **2: Configure**.
2. Select **2: Manual Setup**.
3. Select **1: Basic Setup**.
4. Select **5: Damping P020**.
5. Input a new value, and then select “**ENTER**” to save it.
6. Press “**SEND**” to update the transmitter.

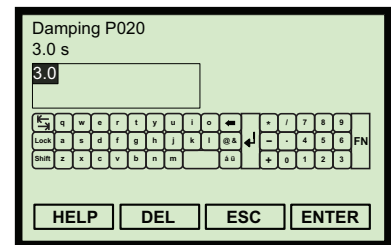

(Field Communicator Screen)

Note

- When messages appear, take appropriate action if needed and press “**OK**”.

Rosemount 3490 Series Control Unit

To view or change the damping:

1. From the *Main Menu* screen, select **SETUP**.
2. Select the transmitter (e.g. “Tx1: 3107”).
3. Select **OUTPUT**.
4. Select **CURRENT**.
5. Select **Damping**.
6. Follow the on-screen instructions to edit and save the new setting. (Press the **Enter** (↵) key if prompted to change the mode to “off-line”).
7. Select “**Quit**” to exit to the previous menu.

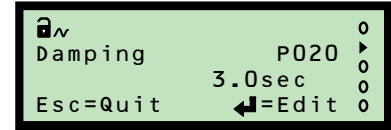

(Rosemount 3491 Screen)

4.3.21 Lost echo delay (P021)

Fast Keys	2, 2, 5, 1
-----------	------------

In pulse echo level measurement systems, ultrasonic pulse echoes are sometimes lost due to adverse liquid surface conditions such as turbulence or foam. The ultrasonic pulse transmitted towards the surface is sometimes not returned, deflected away from the transmitter, or attenuated significantly. In these conditions, the transmitter holds the last valid data and transmits another pulse to see if the echo is returned.

Lost Echo Delay (P021) defines the period that the transmitter will hold and display the present valid surface measurement, waiting to update the measurement when the echo is recovered.

A “lost echo” fault condition is signalled if the Lost Echo Delay period ends with no valid echoes returned.

A valid returned echo occurs inside a 'window' on either side of the liquid level. The 'window' increases as the range to the target increases. All echoes within the 'window' are monitored and averaged to smooth of the liquid level output under turbulent conditions.

Any returned echo from closer than the liquid surface is considered valid if a minimum required number of echoes (page 67) have been received. The output will then change to this new value.

Any echo returned further than the liquid surface and outside the 'window' is ignored. However, if a lost echo condition is developing and a period

(Lost Echo Delay divided by two⁽¹⁾) has elapsed, any echoes received from further away targets are treated as valid. The liquid level measured changes to the new value after receiving four such echoes.

(1) Maximum of 20 seconds.

Field Communicator or AMS

To view or change the lost echo delay:

1. From the *Home* screen, select **2: Configure**.
2. Select **2: Manual Setup**, and then select **5: Engineering**.
3. Select **1: Lost Echo Delay P021**.
4. Input a new value, and then select “**ENTER**” to save it.
5. Press “**SEND**” to update the transmitter.

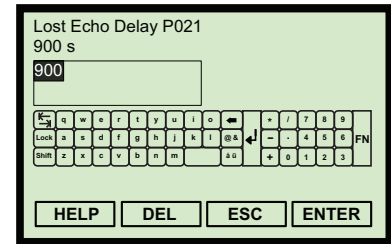

(Field Communicator Screen)

Note

- When messages appear, take appropriate action if needed and press “**OK**”.

Rosemount 3490 Series Control Unit

To view or change the lost echo delay:

1. From the *Main Menu* screen, select **SETUP**.
2. Select the transmitter (e.g. “**Tx1: 3107**”).
3. Select **ENGINEERING.**, and then select **LE Delay**.
4. Follow the on-screen instructions to edit and save the new setting. (Press the **Enter** (↵) key if prompted to change the mode to “off-line”).
5. Select “**Quit**” to exit to the previous menu.

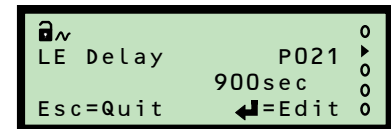

(Rosemount 3491 Screen)

4.3.22 Lost echo action (P022)

Fast Keys	2, 2, 5, 2
-----------	------------

This defines what happens to the process value (PV) and output current when a “lost echo” condition exists (see [page 59](#)).

“MINIMUM” action

The PV is forced to zero while a “lost echo” condition exists.

In addition, the two-wire loop current changes to indicate a *low* or *high* alarm as specified by the model code (see “[Special Alarm Options](#)” on [page 118](#)). The current remains at that level until the correct target echo is recovered.

“MAXIMUM” action

The PV is forced to the maximum while a “lost echo” condition exists. The maximum PV is the value that occurs when an echo is received from the transmitter face.

In addition, the two-wire loop current changes to indicate a *low* or *high* alarm as specified by the model code (see “Special Alarm Options” on page 118). The current remains at that level until the correct target echo is recovered.

“HOLD” action

The current output is held at the last good PV value.

Field Communicator or AMS

To view or change the lost echo action:

1. From the *Home* screen, select **2: Configure**.
2. Select **2: Manual Setup**.
3. Select **5: Engineering**.
4. Select **2: Lost Echo Action P022**.
5. Select a new action, and then press “**ENTER**” to save it.
6. Press “**SEND**” to update the transmitter.

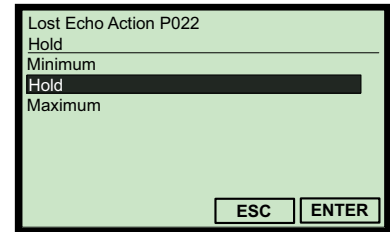

(Field Communicator Screen)

Note

- When messages appear, take appropriate action if needed and press “**OK**”.

Rosemount 3490 Series Control Unit

To view or change the lost echo action:

1. From the *Main Menu* screen, select **SETUP**.
2. Select the transmitter (e.g. “**Tx1: 3107**”).
3. Select **ENGINEERING**.
4. Select **LE Action**.
5. Follow the on-screen instructions to edit and save the new setting. (Press the **Enter** (↵) key if prompted to change the mode to “off-line”).
6. Select “**Quit**” to exit to the previous menu.

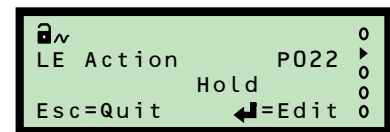

(Rosemount 3491 Screen)

4.3.23 Speed of sound (P024)

Fast Keys	2, 2, 5, 4
-----------	------------

This is for entering the speed of sound of the gas above the liquid surface (ullage gas) in a closed tank at 32 °F (0 °C). Table 4-2 shows Speed of Sound values for ullage gases at 32 °F (0 °C).

A new speed of sound is then calculated for the ullage gas at the temperature and humidity level in the tank (see calculated **Speed of Sound** on page 94). The correction for temperature effects is made using the parameter **Temperature** (page 63) and assumes the entered Speed of Sound (P024) value is valid at 32 °F (0 °C).

For systems monitoring aqueous liquids with air (or nitrogen) as the primary gas in the ullage space, the entered Speed of Sound (P024) value should be 1088.6 ft/s (331.80 m/s). This is the most accurate setting for temperatures in the range of 32 to 104 °F (0 to 40 °C). It takes into account the typical variations in humidity and assumes the temperature compensation is based on the temperature sensor measurement.

If the tank vapor space is filled with a different gas, a revised Speed of Sound (P024) value should be entered. Gas mixtures have speed of sound values calculated as an average according to the proportion of the gases present.

Note

- The speed of sound is inversely proportional to the molecular weight of the gas molecules. Certain triatomic gases attenuate ultrasound significantly, because of molecular resonance. Examples are carbon dioxide, oxides of nitrogen and sulphur and chlorine. Ultrasonics should not be used where carbon dioxide or chlorine is present in the ullage space and only after careful consideration in the case of oxides of nitrogen and sulphur. Operational performance of ultrasonic pulse echo systems is significantly reduced when such gases exceed small percentages in the Ullage space (e.g. 5%).

Table 4-2. Speed of sound of ullage gases

Ullage Gas	Speed of Sound ft/s (m/s)	Ullage Gas	Speed of Sound ft/s (m/s)
Acetaldehyde	800.53 (244)	Ethylether	675.85 (206)
Ammonia	1361.55 (415)	Methane	1410.76 (430)
Argon	1010.50 (308)	Methanol	1099.08 (335)
Benzene	580.71 (177)	Nitrogen	1105.64 (337)
Carbon Dioxide	849.74 (259)	Nitric oxide	1095.80 (334)
Carbon Tetrachloride	475.72 (145)	Oxygen	1089.24 (332)
Cyclohexane	593.83 (181)	Propane	780.84 (238)
Ethane	1036.35 (316)	Sulphur hexafluoride	436.35 (133)
Ethylalcohol	846.46 (258)		

Field Communicator or AMS

To view or change the speed of sound setting:

1. From the *Home* screen, select **2: Configure**.
2. Select **2: Manual Setup**.
3. Select **5: Engineering**.
4. Select **4: Speed of Sound P024**.
5. Input a new value, and then select “**ENTER**” to save it.
6. Press “**SEND**” to update the transmitter.

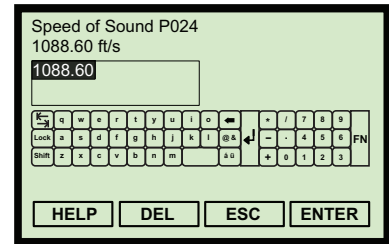

(Field Communicator Screen)

Note

- When messages appear, take appropriate action if needed and press “**OK**”.

Rosemount 3490 Series Control Unit

To view or change the speed of sound setting:

1. From the *Main Menu* screen, select **SETUP**.
2. Select the transmitter (e.g. “**Tx1: 3107**”).
3. Select **ENGINEERING**, and then select **Speed of Sound**.
4. Follow the on-screen instructions to edit and save the new setting.
(Press the **Enter** (↵) key if prompted to change the mode to “off-line”).
5. Select “**Quit**” to exit to the previous menu.

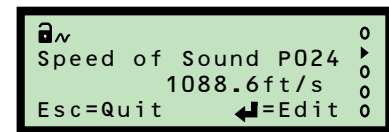

(Rosemount 3491 Screen)

4.3.24 Temperature (P025)

Fast Keys	2, 2, 9, 1, 5
-----------	---------------

This is for temperature-correcting the speed of sound base value in parameter **Speed of Sound** (page 62).

For automatic (dynamic) corrections using the temperature sensor, select the “**Auto**” option. The live temperature measurement is indicated in the read-only parameter **Temperature SoS Calculation** (page 94). If the sensor fails and “**Auto**” is selected, the setting reverts to 68 °F (20 °C).

Note

- The integral temperature sensor on the 3107 measures the air temperature at the transmitter, and not the average temperature across the ullage space. If the average temperature is known, enter this into Temperature (P025). The same value is then indicated by the read-only parameter **Temperature For SoS Calculation** (page 94) and is used to correct the speed of sound.

Field Communicator or AMS

To view or change the temperature setting:

1. From the *Home* screen, select **2: Configure**.
2. Select **2: Manual Setup**.
3. Select **8: Set Temperature**.
4. Select **1: Temperature**.
5. Select **4: Set Temperature**.
6. Select **1: Set to Automatic (NaN)** for automatic (dynamic) corrections.
7. Alternatively, select **2: Edit to fix temperature**, input a temperature, and then save it by pressing “**ENTER**”.

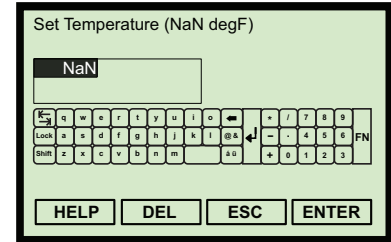

(Field Communicator Screen)

Note

- When messages appear, take appropriate action if needed and press “**OK**”.
- The Fast Key sequence 2, 2, 8, 1 indicates if the *internal temperature sensor* or the *remote temperature sensor* is in use (**OFF/ON**), and if the temperature is fixed (**OFF/ON**).

Rosemount 3490 Series Control Unit

To view or change the temperature setting:

1. From the *Main Menu* screen, select **SETUP**.
2. Select the transmitter (e.g. “**Tx1: 3107**”).
3. Select **ENGINEERING.**, and then select **Temperature**.
4. Follow the on-screen instructions to edit and save the new setting. (Press the **Enter** (↵) key if prompted to change the mode to “off-line”).
5. Select “**Quit**” to exit to the previous menu.

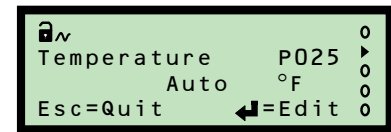

(Rosemount 3491 Screen)

4.3.25 Set threshold (P026)

Fast Keys	2, 2, 8, 2, 2
-----------	---------------

This sets the sensitivity of the echo detection circuits in the transmitter. The threshold is a percentage defining the minimum signal level, above which an echo is detected and treated as a potentially valid surface or target.

When the threshold is set to “**Auto**”, the sensitivity is automatically adjusted over a range of values, depending on the echo strengths being received. The threshold is adjusted to one quarter of the peak value of the largest signal detected to give best overall performance. The live value is indicated in the read-only **Threshold In Use** parameter (page 97).

The threshold can be a constant value, which may be needed to overcome on-site difficulties or special conditions.

Note

- The threshold value can be adjusted in conjunction with parameters **Upper Blanking** (page 38), **Lower Blanking** (page 39), **Threshold 1 Time** (page 68), and **Threshold 1 Size** (page 69)

Field Communicator or AMS

To view or change the threshold setting:

1. From the *Home* screen, select **2: Configure**.
2. Select **2: Manual Setup**.
3. Select **7: Advanced Processing**.
4. Select **2: Threshold**.
5. Select **2: Set Threshold**.
6. Select **1: Set to Automatic (NaN)** for automatic (dynamic) adjustments.
7. Alternatively, select **2: Edit to fix threshold**, input a threshold percentage, and then save it by pressing “**ENTER**”.

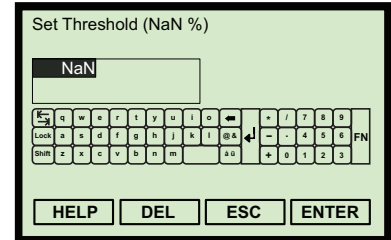

(Field Communicator Screen)

Note

- When messages appear, take appropriate action if needed and press “**OK**”.
- Fast Key sequence 2, 2, 8 indicates the status *Threshold Is Fixed (OFF/ON)* and the status *Threshold Is Not Optimum (OFF/ON)*.

Rosemount 3490 Series Control Unit

To view or change the threshold setting:

1. From the *Main Menu* screen, select **SETUP**.
2. Select the transmitter (e.g. “**Tx1: 3107**”).
3. Select **ENGINEERING**, and then select **Set Threshold**.
4. Follow the on-screen instructions to edit and save the new setting. (Press the **Enter** (↵) key if prompted to change the mode to “off-line”).
5. Select “**Quit**” to exit to the previous menu.

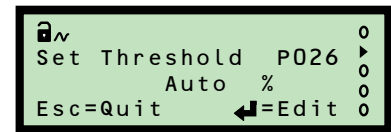

(Rosemount 3491 Screen)

4.3.26 Transmit power control (P040)

Fast Keys	2, 2, 7, 4, 1
-----------	---------------

The transmitted ultrasonic energy can be controlled automatically to avoid strong close echoes saturating the electronics of the transmitter. The live level is indicated in the read-only **Transmit Power** parameter (page 99).

Field Communicator or AMS

To enable or disable Transmit Power Control:

1. From the *Home* screen, select **2: Configure**.
2. Select **2: Manual Setup**.
3. Select **7: Advanced Processing**.
4. Select **4: Set Power Control**.
5. Select **1: Power Control P040**.
6. Select “**Disable**” or “**Enable**”, and then press “**ENTER**” to confirm it.
7. Press “**SEND**” to update the transmitter.

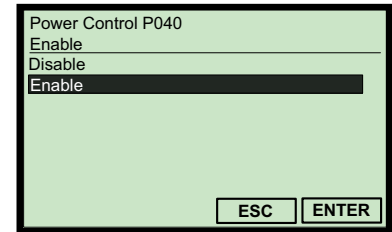

(Field Communicator Screen)

Note

- Fast Key sequence 2, 2, 7, 4 indicates the status *Power Control Is Active (OFF/ON)* and the live **Transmit Power** level.

Rosemount 3490 Series Control Unit

To enable or disable Transmit Power Control:

1. From the *Main Menu* screen, select **SETUP**.
2. Select the transmitter (e.g. “**Tx1: 3107**”).
3. Select **ENGINEERING**.
4. Select **ADVANCED**.
5. Select **Tx Pwr Control**.
6. Follow the on-screen instructions to edit and save the new setting. (Press the **Enter** (↵) key if prompted to change the mode to “off-line”).
7. Select “**Quit**” to exit to the previous menu.

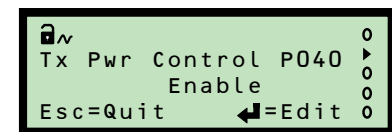

(Rosemount 3491 Screen)

4.3.27 Pulse repeat (P041)

Fast Keys	-
-----------	---

The nominal rate of repetition for ultrasonic pulses from the transmitter is one pulse per second. If two transmitters were located within the same tank, it is possible this would allow ultrasonic pulses from one unit to be received by the other. If pulses were consistently occurring at the same time, the receiving transmitter could mistakenly identify this crosstalk as a valid surface echo. This can be prevented by having both transmitters operate with different rates of pulse repetition, which means this interference is rejected as not consistent (pulse-to-pulse).

Pulse Repeat (P041) allows the pulse repetition interval to be adjusted by increments of 0.1 seconds in the range 0.5 to 2.0 seconds, allowing sufficient separation to avoid crosstalk problems.

Field Communicator or AMS

This parameter is not available in the 3100 Series DD (Device Descriptor) file.

Rosemount 3490 Series Control Unit

To view or change the pulse rate:

1. From the *Main Menu* screen, select **SETUP**.
2. Select the transmitter (e.g. "Tx1: 3107").
3. Select **ENGINEERING**.
4. Select **ADVANCED**.
5. Select **Pulse Repeat**.
6. Follow the on-screen instructions to edit and save the new setting. (Press the **Enter** (↵) key if prompted to change the mode to "off-line").
7. Select **Quit** to exit to the previous menu.

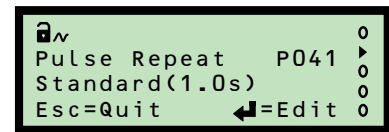

(Rosemount 3491 Screen)

4.3.28 Echoes needed (P042)

Fast Keys	-
-----------	---

Echoes Needed is used to avoid stirrers that give occasional high level signals when they protrude from the liquid surface.

The transmitter monitors the echoes returned from the liquid surface or any other target within range. A valid surface echo is one that exceeds the signal strength threshold consistently for more ultrasonic pulse cycles than set by Echoes Needed (P042).

The default value for Echoes Needed is four, meaning four echoes must be received consecutively from a new surface echo before this is taken as the actual liquid level.

Field Communicator or AMS

This parameter is not available in the 3100 Series DD (Device Descriptor) file.

Rosemount 3490 Series Control Unit

To view or change the number of echoes needed:

1. From the *Main Menu* screen, select **SETUP**.
2. Select the transmitter (e.g. “Tx1: 3107”).
3. Select **ENGINEERING**.
4. Select **ADVANCED**.
5. Select **Echoes Needed**.
6. Follow the on-screen instructions to edit and save the new setting.
(Press the **Enter** (↵) key if prompted to change the mode to “off-line”).
7. Select “**Quit**” to exit to the previous menu.

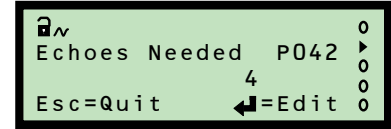

(Rosemount 3491 Screen)

4.3.29 Threshold 1 time (P043)

Fast Keys	2, 2, 7, 2, 6
-----------	---------------

False echoes may occur close to the transmitter face. If they occur outside the **Upper Blanking** distance (page 62), the false echo can be ignored by entering the *echo size* as a percentage and a *duration* (representing distance) for how long this *echo size* should be ignored.

Enter the *duration* (representing distance) into the parameter **Threshold 1 Time (P043)**. For example, 6 ms represents an approximate distance of 1 m, and 2 ms represents a distance of approximately 1 ft.

See “**Threshold 1 size (P048)**” on page 69 for entering the *echo size*.

Field Communicator or AMS

To view or change the threshold time:

1. From the *Home* screen, select **2: Configure**.
2. Select **2: Manual Setup**.
3. Select **7: Advanced Processing**.
4. Select **2: Threshold**.
5. Select **6: Threshold 1 Time P043**.
6. Input a new value, and then select “**ENTER**” to save it.
7. Press “**SEND**” to update the transmitter.

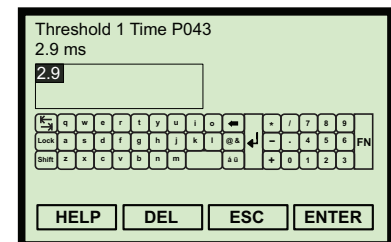

(Field Communicator Screen)

Rosemount 3490 Series Control Unit

To view or change the threshold time:

1. From the *Main Menu* screen, select **SETUP**.
2. Select the transmitter (e.g. “Tx1: 3107”).
3. Select **ENGINEERING**.
4. Select **ADVANCED**.
5. Select **Thresh 1 Time**.
6. Follow the on-screen instructions to edit and save a new setting.
7. Select “**Quit**” to exit to the previous menu.

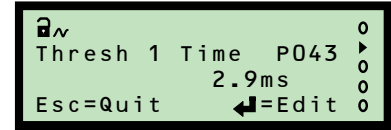

(Rosemount 3491 Screen)

4.3.30 Threshold 1 size (P048)

Fast Keys	2, 2, 7, 2, 7
-----------	---------------

False echoes may occur close to the transmitter face. If they occur outside the **Upper Blanking** distance (page 62), the false echo can be ignored by entering the *echo size* as a percentage and a *duration* (representing distance) for how long this echo size should be ignored. The *echo size* is set by the parameter **Threshold 1 Size (P048)**.

See “**Threshold 1 time (P043)**” on page 68 for entering the *duration* (representing distance).

Note

- In applications where elevated ambient temperatures of around 50 to 60 °C are experienced, together with poor liquid surface conditions (excessive surface agitation, foam, etc.) at a high level and within 0.5 m of the transducer face, the transmitter may see a false echo and report a false high level measurement.

The factory default value of parameter **P048** is 4%.

If the false echo is reported at the end of the **Upper Blanking Distance** (0.3 m or as adjusted in **P023** (page 38)), then it is recommended to set the value of **Threshold 1 Size** parameter **P048** to a value sufficient to ignore this false echo.

This should be implemented by reading the size of the false echo (using parameter **Echo Size**, page 91), and setting the **P048** to a value 4% greater than the reported value in the parameter **Echo Size** (page 91).

Note that this particular approach has an impact on the liquid level reading accuracy when the liquid level is within approximately 0.5 m of the transducer face. The accuracy may be reduced from ± 2.5 to $+2.5/-5.5$ mm or, in extreme conditions, $+2.5/-8.5$ mm.

- Use the read-only parameter **Echo Size** (page 91) as a reference for the false echo size.

Field Communicator or AMS

To view or change the threshold size:

1. From the *Home* screen, select **2: Configure**.
2. Select **2: Manual Setup**.
3. Select **7: Advanced Processing**.
4. Select **2: Threshold**.
5. Select **7: Threshold 1 Size P048**.
6. Input a new value, and then select “**ENTER**” to save it.
7. Press “**SEND**” to update the transmitter.

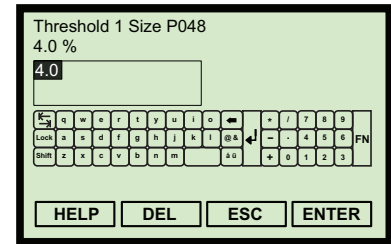

(Field Communicator Screen)

Rosemount 3490 Series Control Unit

To view or change the threshold size:

1. From the *Main Menu* screen, select **SETUP**.
2. Select the transmitter (e.g. “**Tx1: 3107**”).
3. Select **ENGINEERING**.
4. Select **ADVANCED**.
5. Select **Thresh 1 Size**.
6. Follow the on-screen instructions to edit and save the new setting.
(Press the **Enter** (↵) key if prompted to change the mode to “off-line”).
7. Select “**Quit**” to exit to the previous menu.

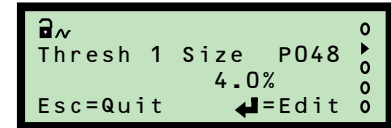

(Rosemount 3491 Screen)

4.3.31 Target pulses (P044)

Fast Keys	2, 2, 7, 5, 1
-----------	---------------

Target Pulses (P044) is the number of ultrasonic pulses in each burst sent from the transmitter every second.

The factory default “**Automatic**” setting allows the transmitter to decide the number of pulses. Alternatively, select a number in the range 4 to 32.

Note

- See **Pulses in Use** (page 98) for the actual number of pulses used.

Field Communicator or AMS

To view or change the number of pulses in a burst:

- From the *Home* screen, select **2: Configure**.
- Select **2: Manual Setup**.
- Select **7: Advanced Processing**.
- Select **5: Set Target Pulses**.
- Select **1: Target Pulses P044**.
- Select a new setting, and then select “**ENTER**” to save it.
- Press “**SEND**” to update the transmitter.

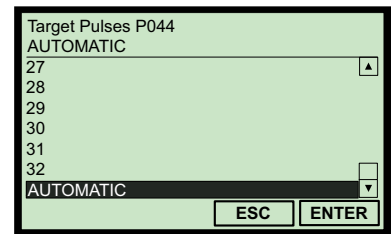

(Field Communicator Screen)

Rosemount 3490 Series Control Unit

To view or change the number of pulses in a burst:

- From the *Main Menu* screen, select **SETUP**.
- Select the transmitter (e.g. “**Tx1: 3107**”).
- Select **ENGINEERING**.
- Select **ADVANCED**.
- Select **Target Pulses**.
- Follow the on-screen instructions to edit and save the new setting. (Press the **Enter** (↵) key if prompted to change the mode to “off-line”).
- Select “**Quit**” to exit to the previous menu.

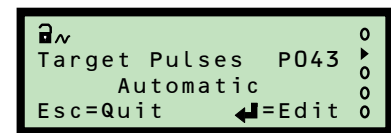

(Rosemount 3491 Screen)

4.3.32 Target frequency (P045)

Fast Keys	2, 2, 7, 6, 1
-----------	---------------

This sets the frequency used for transmitting an ultrasonic pulse. The optimum frequency depends on the characteristics of the transmitter’s piezoelectric crystals, which are affected by temperature.

The transmitter has a look-up table to select a frequency value to give the highest echo strength from the prevailing conditions at the site. This look-up function operates when Target Frequency (P045) is set to “Auto”.

Site conditions sometimes require a fixed frequency. Target Frequency (P045) is used to set a fixed frequency, but the actual frequency value used is selected from the look-up table and the nearest to that entered value is selected automatically.

Note

- See also **Frequency** (page 96) for the actual frequency used.

Field Communicator or AMS

To view or change the target frequency:

- From the *Home* screen, select **2: Configure**.
- Select **2: Manual Setup**.
- Select **7: Advanced Processing**.
- Select **6: Set Frequency**.
- Select **1: Target Frequency P045**.
- Select a new setting, and then select “**ENTER**” to save it.
- Press “**SEND**” to update the transmitter.

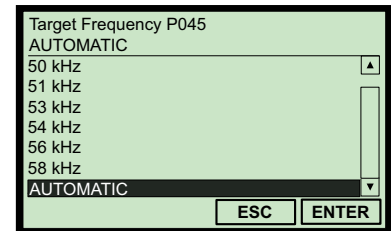

(Field Communicator Screen)

Rosemount 3490 Series Control Unit

To view or change the target frequency:

- From the *Main Menu* screen, select **SETUP**.
- Select the transmitter (e.g. “**Tx1: 3107**”).
- Select **ENGINEERING**.
- Select **ADVANCED**.
- Select **Target Freq.**
- Follow the on-screen instructions to edit and save the new setting. (Press the **Enter** (↵) key if prompted to change the mode to “off-line”).
- Select “**Quit**” to exit to the previous menu.

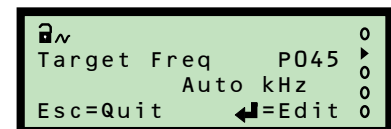

(Rosemount 3491 Screen)

4.3.33 Spike rejection (P049)

Fast Keys	2, 2, 7, 3, 1
-----------	---------------

This sets the minimum duration of a valid echo signal, and is used to reject transient electrical interference (spike) signals.

Note

- Spike rejection is switched-off when it is set to 0.

Field Communicator or AMS

To view or change the spike rejection:

1. From the *Home* screen, select **2: Configure**.
2. Select **2: Manual Setup**.
3. Select **7: Advanced Processing**.
4. Select **3: Set Spike Reject**.
5. Select **1: Spike Reject P049**.
6. Input a new setting, and then select “**ENTER**” to save it.
7. Press “**SEND**” to update the transmitter.

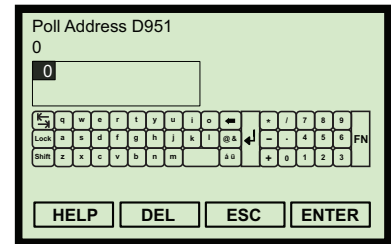

(Field Communicator Screen)

Rosemount 3490 Series Control Unit

To view or change the spike rejection:

1. From the *Main Menu* screen, select **SETUP**.
2. Select the transmitter (e.g. “**Tx1: 3107**”).
3. Select **ENGINEERING**.
4. Select **ADVANCED**.
5. Select **Spike Reject**.
6. Follow the on-screen instructions to edit and save the new setting. (Press the **Enter** (↵) key if prompted to change the mode to “off-line”).
7. Select “**Quit**” to exit to the previous menu.

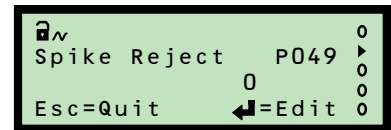

(Rosemount 3491 Screen)

4.3.34 False echo data (P081 to P088)

Fast Keys	2, 2, 6, 8
------------------	------------

These parameters are the four false echo data records, each storing a false echo as distance-to-surface (e.g. 1.7 m) and echo size (e.g. 44%). The transmitter ignores these false target echoes.

See also:

- Section “Learn false echo” on page 23.
- Section “Auto tank map” on page 24.

Field Communicator or AMS

To view or change the false echo data:

1. From the *Home* screen, select **2: Configure**.
2. Select **2: Manual Setup**.
3. Select **6: False Echoes**.
4. Select **8: False Echo Data**.
5. Select **1 to 8** for the distance-to-surface or echo size data of a false echo record, as appropriate.
6. Input a new setting, and then select “**ENTER**” to save it.
7. Press “**SEND**” to update the transmitter.

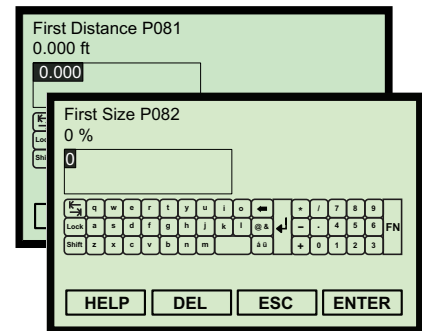

(Field Communicator Screens)

Rosemount 3490 Series Control Unit

To view or change the false echo data:

1. From the *Main Menu* screen, select **SETUP**.
2. Select the transmitter (e.g. “**Tx1: 3107**”).
3. Select **ENGINEERING**.
4. Select **FALSE ECHO DATA**.
5. Select a menu option for the distance-to-surface or echo size data of a false echo record, as appropriate.
6. Follow the on-screen instructions to edit and save the new setting. (Press the **Enter** (↵) key if prompted to change the mode to “off-line”).
7. Select “**Quit**” to exit to the previous menu.

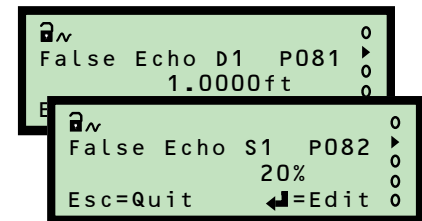

(Rosemount 3491 Screens)

4.3.35 Clear false echoes (P089)

Fast Keys	2, 2, 6, 5
-----------	------------

This is used to clear a specified False Echo Data record, or clear all of the False Echo Data records. Options are:

- “False Echo 1”
- “False Echo 2”
- “False Echo 3”
- “False Echo 4”
- “All”

Field Communicator or AMS

To clear false echo data:

1. From the *Home* screen, select **2: Configure**.
2. Select **2: Manual Setup**.
3. Select **6: False Echoes**.
4. Select **5: Clear False Echoes**.
5. Select “**All**” or a numbered false echo record, and then press “**ENTER**” to confirm the selection.
6. Press “**SEND**” to update the transmitter.

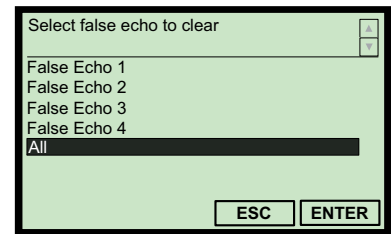

(Field Communicator Screen)

Note

- When messages appear, take appropriate action if needed and press “**OK**”.

Rosemount 3490 Series Control Unit

To clear false echo data:

1. From the *Main Menu* screen, select **SETUP**.
2. Select the transmitter (e.g. “**Tx1: 3107**”).
3. Select **ENGINEERING**, and then select **FALSE ECHO ACTION**.
4. Select **Clear False Echoes**.
5. Select “**Edit**” (↵), then select an option using the up-arrow or down-arrow keys, and finally select “**Save**” (↵) to confirm the selection.
(Press the **Enter** (↵) key if prompted to change the mode to “off-line”).
6. When finished, select “**Quit**” to exit to the previous menu.

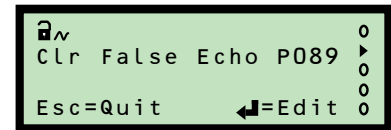

(Rosemount 3491 Screen)

4.3.36 Transducer material (P970)

Fast Keys	1, 3, 1, 2, 1
-----------	---------------

This read-only parameter indicates the transmitter's construction material.

Field Communicator or AMS

To view the transmitter material description:

1. From the *Home* screen, select **1: Overview**.
2. Select **3: Shortcuts**.
3. Select **1: Device Information**.
4. Select **2: Materials of Construction**.
5. Select **1: Transducer Material P970**.
6. When finished, press **EXIT** to exit to the previous menu.

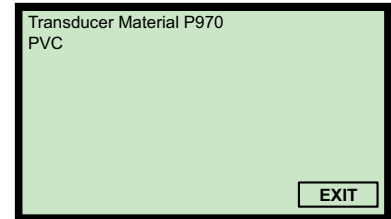

(Field Communicator Screen)

Rosemount 3490 Series Control Unit

To clear false echo data:

1. From the *Main Menu* screen, select **SETUP**.
2. Select the transmitter (e.g. "Tx1: 3107").
3. Select **SYSTEM**, and then select **FIXED**.
4. Select **Tx Material**.
5. When finished, select **Quit** to exit to the previous menu.

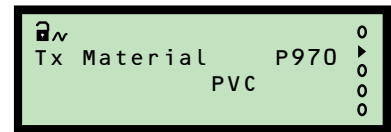

(Rosemount 3491 Screen)

4.3.37 Poll address (D951)

Fast Keys	2, 2, 4, 2, 1
-----------	---------------

This indicates the transmitter polling address for the HART protocol.

The poll address range is 0 to 15. When it is 0, the transmitter is in 4–20 mA mode. For all other addresses, the transmitter is in multi-drop mode and the current output is fixed to 4 mA.

Field Communicator or AMS

To view or change the poll address:

1. From the *Home* screen, select **2: Configure**.
2. Select **2: Manual Setup**.
3. Select **4: HART/Identity**.
4. Select **2: Communication**.
5. Select **1: Poll Address D951**.
6. Input a new setting, and then select “**ENTER**” to save it.
7. Press “**SEND**” to update the transmitter.

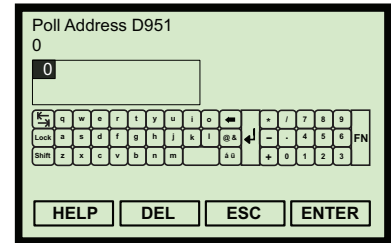

(Field Communicator Screen)

Rosemount 3490 Series Control Unit

To view or change the poll address:

1. From the *Main Menu* screen, select **SETUP**.
2. Select the transmitter (e.g. “**Tx1: 3107**”).
3. Select **SYSTEM**.
4. Select **FIXED**.
5. Select **HART**.
6. Select **Poll Address**.
7. Follow the on-screen instructions to edit and save the new setting.
(Press the **Enter** (↵) key if prompted to change the mode to “off-line”).
8. When finished, select “**Quit**” to exit to the previous menu.

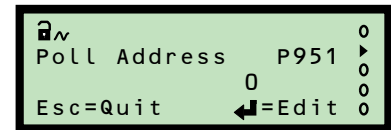

(Rosemount 3491 Screen)

4.3.38 Maximum temperature (P046)

Fast Keys	2, 2, 8, 3. 2
-----------	---------------

This is a record of the maximum measured temperature.

Field Communicator or AMS

To view the maximum temperature:

1. From the *Home* screen, select **2: Configure**.
2. Select **2: Manual Setup**.
3. Select **8: Set Temperature**.
4. Select **3: Internal Extremes**.
5. Select **2: Maximum Temperature P046**.

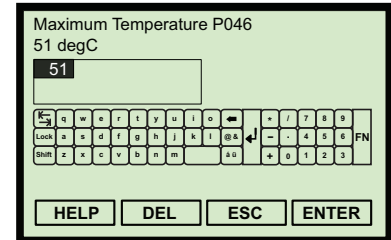

(Field Communicator Screen)

Rosemount 3490 Series Control Unit

To view the maximum temperature:

1. From the *Main Menu* screen, select **MONITOR**.
2. Select the transmitter (e.g. "Tx1: 3107").
3. Select **DIAGNOSTICS**.
4. Select **HISTORY**.
5. Select **Max Temp**.
6. When finished, select "Quit" to exit to the previous menu.

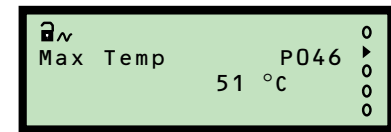

(Rosemount 3491 Screen)

4.3.39 Minimum temperature (P047)

Fast Keys	2, 2, 8, 3. 4
-----------	---------------

This is a record of the lowest measured temperature.

Field Communicator or AMS

To view the minimum temperature:

1. From the *Home* screen, select **2: Configure**.
2. Select **2: Manual Setup**.
3. Select **8: Set Temperature**.
4. Select **3: Internal Extremes**.
5. Select **4: Minimum Temperature P047**.

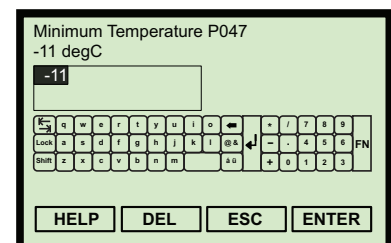

(Field Communicator Screen)

Rosemount 3490 Series Control Unit

To view the minimum temperature:

1. From the *Main Menu* screen, select **MONITOR**.
2. Select the transmitter (e.g. “Tx1: 3107”).
3. Select **DIAGNOSTICS**.
4. Select **HISTORY**.
5. Select **Min Temp**.
6. When finished, select “**Quit**” to exit to the previous menu.

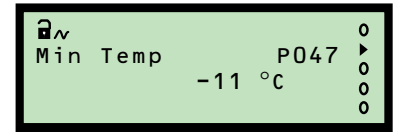

(Rosemount 3491 Screen)

4.3.40 Date (P003)

Fast Keys	2, 2, 4, 1, 6
-----------	---------------

This is a record of the last date there was a change.

Field Communicator or AMS

To view the date:

1. From the *Home* screen, select **2: Configure**.
2. Select **2: Manual Setup**.
3. Select **4: HART/Identity**.
4. Select **1: Identity**.
5. Select **6: Date P003**.

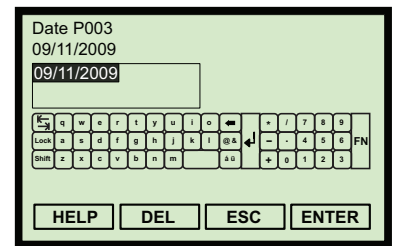

(Field Communicator Screen)

Rosemount 3490 Series Control Unit

To view the date:

1. From the *Main Menu* screen, select **MONITOR**.
2. Select the transmitter (e.g. “Tx1: 3107”).
3. Select **DIAGNOSTICS**.
4. Select **HISTORY**.
5. Select **Date**.
6. When finished, select “**Quit**” to exit to the previous menu.

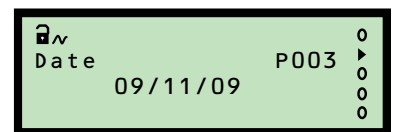

(Rosemount 3491 Screen)

Section 5 Service and Troubleshooting

Safety messages	page 81
Servicing	page 82
Power failure	page 82
False echoes under certain ambient operating conditions	page 82
Monitoring and diagnostic parameters	page 83

5.1 Safety messages

Procedures and instructions in this manual may require special precautions to ensure the safety of the personnel performing the operations. Information that raises potential safety issues is indicated by a caution symbol (⚠). The external hot surface symbol (🔥) is used when a surface is hot and care must be taken to avoid possible burns. If there is a risk of an electrical shock the (⚡) symbol is used. Refer to the safety messages listed at the beginning of each section before performing an operation preceded by this symbol.

⚠ WARNING

Failure to follow these installation guidelines could result in death or serious injury.

- Make sure only qualified personnel perform the installation.
- Use the equipment only as specified in this manual. Failure to do so may impair the protection provided by the equipment.

Explosions could result in death or serious injury.

- Verify that the operating environment of the transmitter is consistent with the appropriate hazardous locations certifications.
- Before connecting a HART[®]-based communicator in an explosive atmosphere, make sure the instruments in the loop are installed in accordance with intrinsically safe or non-incendive field wiring practices.

Electrical shock could cause death or serious injury.

- Use extreme caution when making contact with the leads and terminals.

⚠ WARNING

Any substitution of non-recognized parts may jeopardize safety. Repair, e.g. substitution of components etc., may also jeopardize safety and is under no circumstances allowed.

5.2 Servicing

The only maintenance required is to occasionally check the transmitter face to ensure it remains clean and check that the wiring is in good condition. There are no spare parts for the transmitter. If a problem persists, contact Rosemount Inc. for advice.

5.3 Power failure

All parameters are held in EPROM memory. In the event of a power failure, or disconnection from the power supply, the transmitter will remember all of its last parameter values and will resume correct operation once power is restored.

5.4 False echoes under certain ambient operating conditions

In applications where elevated ambient temperatures of around 50 to 60 °C are experienced, together with poor liquid surface conditions (excessive surface agitation, foam, etc.) at a high level and within 0.5 m of the transducer face, the transmitter may see a false echo and report a false high level measurement.

If this situation happens, with reference to [Section 4](#) and this section, there are two field-configurable resolutions:

- Upper Blanking Distance (P023)
The factory default value of this parameter is 0.3 m, measured down from the transducer face.
If it is possible to operate with an increased value between 0.3 and 0.5 m, then setting P023 to a value of 0.5 m eliminates the false echo. Trying several different values is recommended as a smaller value of P023, if the application requires, may be possible.
- Threshold 1 Size (P048)
The factory default value of this parameter is 4%.
If the false echo is reported at the end of the Upper Blanking Distance (0.3 m or as adjusted in P023 above), then it is recommended to set the value of parameter Threshold 1 Size (P048) to a value sufficient to ignore this false echo. This should be implemented by reading the size of the false echo (see D911 on [page 91](#)), and setting the P048 to a value 4% greater than the reported value in D911.

Note that this particular approach has an impact on the liquid level reading accuracy when the liquid level is within approximately 0.5 m of the transducer face. The accuracy may be reduced from ± 2.5 to $+2.5/-5.5$ mm or, in extreme conditions, $+2.5/-8.5$ mm.

5.5 Monitoring and diagnostic parameters

Note

- For menu structures, see [Appendix C: Rosemount 3490 Series Universal Control Unit](#) or [Appendix D: Field Communicator](#) as appropriate for your HART Master Device.
-

Rosemount 3490 Series Control Unit

The 'D' prefixed parameters (e.g. D900) monitor the transmitter operation. For convenience, the parameter identification numbers (D***) are used in parameter headings and descriptions in this section.

A full menu map showing how to access transmitter parameters using the control unit's menu system is in [Appendix C: Rosemount 3490 Series Universal Control Unit](#).

Note

- The Rosemount 3490 Control Unit software must be version 3.40 or later.
-

Field Communicator and AMS

For convenience, Field Communicator fast key sequences are labeled "Fast Keys" for each software function below the appropriate headings.

Example software function

Fast Keys	1, 2, 3, etc.
-----------	---------------

Connect the Field Communicator leads to the transmitter, and turn on the Field Communicator by pressing the ON/OFF key. The Field Communicator will search for a HART-compatible device and indicate when the connection is made. If the Field Communicator fails to connect, it indicates that no device was found. If this occurs, check the lead connections and re-try.

A full menu map showing how to access transmitter parameters using the Field Communicator is in [Appendix D: Field Communicator](#).

5.5.1 Process Value / Primary Variable (PV) (D900)

Fast Keys	1, 2, 1
-----------	---------

This indicates the live process value that drives the 4–20 mA Current Output. In HART terminology, this parameter is the Primary Variable (PV).

The factory default is for the process value to be a level measurement in meters, feet, or inches. It can be a volume or flow measurement if the transmitter has been configured to do those calculations.

Note

- Reported units for the HART Primary Variable is selectable (see [page 51](#)).

Field Communicator or AMS

To view the live PV:

- From the *Home* screen, select 1: Overview.
- Select 2: Primary Purpose Variables.
- Select 1: Primary Variable D900.
- When finished, press EXIT to exit to the previous menu.

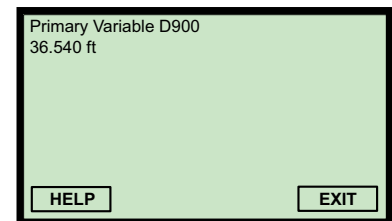

(Field Communicator Screen)

Note

- PV is available at other Fast Key sequences e.g. 3, 2, 1, 1 (see [Appendix D: Field Communicator](#) for a full menu map).

Rosemount 3490 Series Control Unit

To view the live PV:

- From the *Main Menu* screen, select MONITOR.
- Select the transmitter (e.g. “Tx1: 3107”).
- Select READINGS.
- Select VARIABLES.
- Select Xmtr PV.
- When finished, select “Quit” to exit to the previous menu.

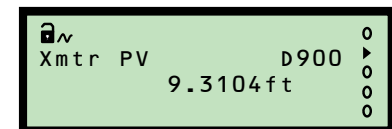

(Rosemount 3491 Screen)

5.5.2 Level / Secondary Variable (SV) (D901)

Fast Keys	1, 2, 2
-----------	---------

This indicates the live level measured by the transmitter. In HART terminology, SV is the Secondary Variable.

Note

- Figure 4-1 on page 37 shows this parameter in a tank geometry illustration.
- Units are in meters, feet, or inches depending on base units (see page 20).

Field Communicator or AMS

To view the live level measurement:

1. From the *Home* screen, select 1: Overview.
2. Select 2: Primary Purpose Variables.
3. Select 2: Level (SV) D901.
4. When finished, press EXIT to exit to the previous menu.

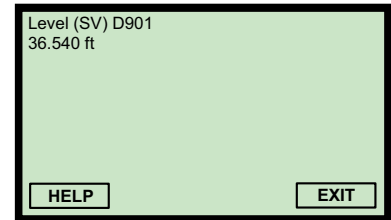

(Field Communicator Screen)

Note

- SV is also available at the Fast Key sequence 3, 2, 1, 2 (see Appendix D: Field Communicator for a full menu map).

Rosemount 3490 Series Control Unit

To view the live level measurement:

1. From the *Main Menu* screen, select MONITOR.
2. Select the transmitter (e.g. "Tx1: 3107").
3. Select READINGS.
4. Select VARIABLES.
5. Select Level (SV).
6. When finished, press the ESC key to exit to the previous menu.

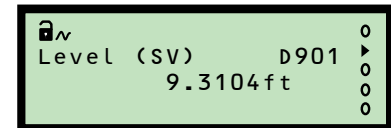

(Rosemount 3491 Screen)

5.5.3 Distance / Tertiary Variable (TV) (D902)

Fast Keys	3, 2, 1, 3
------------------	------------

This indicates the live distance-to-surface measured by the transmitter. In HART terminology, this parameter is the Tertiary Variable (TV).

Note

- Figure 4-1 on page 37 shows this parameter in a tank geometry illustration, and how Distance Offset (page 40) affects this value.
- Units are in meters, feet, or inches depending on base units (see page 20).

Field Communicator or AMS

To view the live distance-to-surface measurement:

1. From the *Home* screen, select 3: Service Tools.
2. Select 2: Variables.
3. Select 1: Variables.
4. Select 3: Distance (TV) D902.
5. When finished, press EXIT to exit to the previous menu.

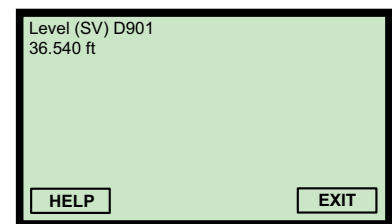

(Field Communicator Screen)

Rosemount 3490 Series Control Unit

To view the live distance-to-surface measurement:

1. From the *Main Menu* screen, select MONITOR.
2. Select the transmitter (e.g. "Tx1: 3107").
3. Select READINGS, and then select VARIABLES.
4. Select Distance (TV).
5. When finished, press the ESC key to exit to the previous menu.

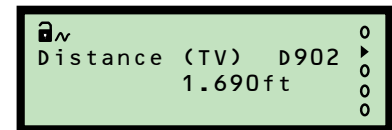

(Rosemount 3491 Screen)

Note

- Units are in meters, feet, or inches depending on base units (see page 20).

5.5.4 Temperature / Fourth Variable (FV) (D903)

Fast Keys	3, 2, 1, 4
-----------	------------

This indicates the live transmitter temperature on the Rosemount 3107, and the ambient temperature on the Rosemount 3108.

In HART terminology, this parameter is the Fourth Variable (FV).

Note

- Units are in °C or °F depending on the base units selected (see [page 20](#)).

Field Communicator or AMS

To view the live temperature measurement:

- From the *Home* screen, select 3: Service Tools.
- Select 2: Variables.
- Select 1: Variables.
- Select 4: Transducer Temperature D903.
- When finished, press EXIT to exit to the previous menu.

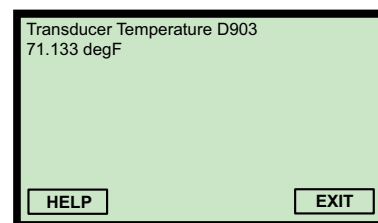

(Field Communicator Screen)

Rosemount 3490 Series Control Unit

To view the live temperature measurement:

- From the *Main Menu* screen, select MONITOR.
- Select the transmitter (e.g. “Tx1: 3107”).
- Select READINGS.
- Select VARIABLES.
- Select Xducer temp.
- When finished, press the ESC key to exit to the previous menu.

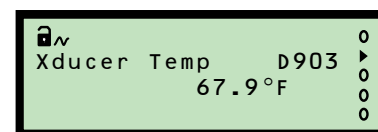

(Rosemount 3491 Screen)

5.5.5 % of current output (D905)

Fast Keys	3, 2, 2, 3
------------------	------------

This indicates the percentage of the 4–20 mA output current in use.

- 0% represents 4 mA
- 100% represents 20 mA

Note

- When the Poll Address (page 101) is a non-zero number, the transmitter is in *multi-drop mode* and the current output is fixed at 4 mA.

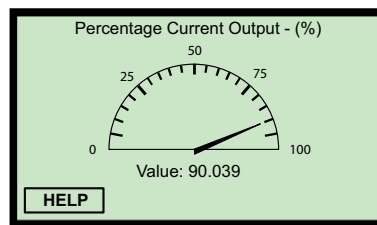

(Field Communicator Screen)

Field Communicator or AMS

To view the percentage of current output in use:

1. From the *Home* screen, select 3: Service Tools.
2. Select 2: Variables, and then 2: Analog Output.
3. Select 3: Percentage of Current Output.
4. When finished, press the Bksp key to exit to the previous menu.

Rosemount 3490 Series Control Unit

To view the percentage of current output in use:

1. From the *Main Menu* screen, select MONITOR.
2. Select the transmitter (e.g. “Tx1: 3107”).
3. Select READINGS, and then select CURRENT.
4. Select % of Current Output.
5. When finished, press the ESC key to exit to the previous menu.

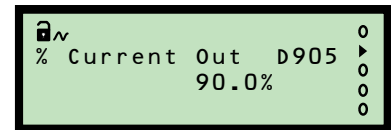

(Rosemount 3491 Screen)

5.5.6 Current output (D906)

Fast Keys	3, 2, 2, 1
-----------	------------

This indicates the actual output current in mA.

Note

- When the Poll Address (page 101) is a non-zero number, the transmitter is in *multi-drop mode* and the current output is fixed at 4 mA.

Field Communicator or AMS

To view the actual output current:

- From the *Home* screen, select 3: Service Tools.
- Select 2: Variables.
- Select 2: Analog Output.
- Select 1: Current Output.
- When finished, press the Bksp key to exit to the previous menu.

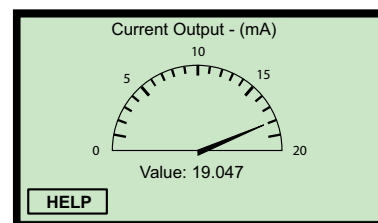

(Field Communicator Screen)

Rosemount 3490 Series Control Unit

To view the actual output current:

- From the *Main Menu* screen, select MONITOR.
- Select the transmitter (e.g. "Tx1: 3107").
- Select READINGS, and then select CURRENT.
- Select Current Output.
- When finished, press the ESC key to exit to the previous menu.

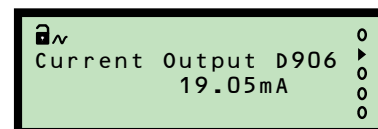

(Rosemount 3491 Screen)

5.5.7 Distance (D910)

Fast Keys	3, 1, 2, 1, 1
-----------	---------------

This indicates the distance from the transmitter face to a detected surface.

It is a useful diagnostic because a false surface signal can be identified and related to the physical nature of the installation.

Note

- Figure 4-1 on page 37 shows this parameter in a tank geometry illustration, and how Distance Offset (page 40) does not affect this value.

Field Communicator or AMS

To view the distance to a detected surface:

1. From the *Home* screen, select 3: Service Tools.
2. Select 1: Alerts.
3. Select 2: Diagnostic Data.
4. Select 1: Target Data.
5. Select 1: Distance D910.
6. When finished, press EXIT to exit to the previous menu.

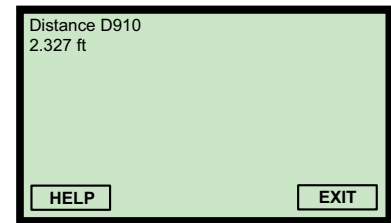

(Field Communicator Screen)

Rosemount 3490 Series Control Unit

To view the distance to a detected surface:

1. From the *Main Menu* screen, select MONITOR.
2. Select the transmitter (e.g. "Tx1: 3107").
3. Select DIAGNOSTICS.
4. Select Distance.
5. When finished, press the ESC key to exit to the previous menu.

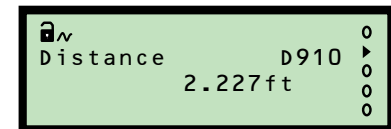

(Rosemount 3491 Screen)

5.5.8 Echo size (D911)

Fast Keys	3, 1, 2, 1, 2
------------------	---------------

The size of the echo returned from a surface depends on the surface range, gas composition and temperature, transmitter performance, in-tank conditions (turbulence, presence of surface foam, and draughts), and other factors.

The received echo strength may vary from pulse-to-pulse but monitoring the read-only parameter Echo Size (D911) indicates the latest echo strengths.

The indicated value is an averaged percentage of the last five echoes, with 100% representing a saturated returned signal.

Field Communicator or AMS

To view the echo strength:

1. From the *Home* screen, select 3: Service Tools.
2. Select 1: Alerts.
3. Select 2: Diagnostic Data.
4. Select 1: Target Data.
5. Select 2: Echo Size D911.
6. When finished, press EXIT to exit to the previous menu.

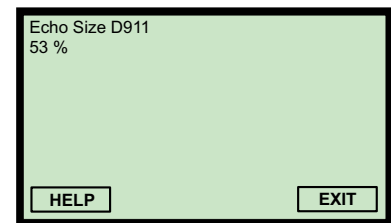

(Field Communicator Screen)

Rosemount 3490 Series Control Unit

To view the echo strength:

1. From the *Main Menu* screen, select MONITOR.
2. Select the transmitter (e.g. "Tx1: 3107").
3. Select DIAGNOSTICS
4. Select Echo Size.
5. When finished, press the ESC key to exit to the previous menu.

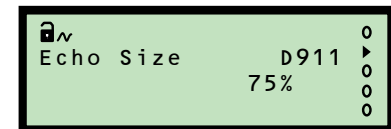

(Rosemount 3491 Screen)

5.5.9 Echo success (D912)

Fast Keys	3, 1, 2, 1, 3
-----------	---------------

This is a measure of the quality of the echo returned. It is a percentage indicating the success rate achieved from the last ten pulse transmissions.

The success rate may fall below 100% due to the effect of extreme surface turbulence or stirrers, which might return a surface echo that is then rejected by the transmitter.

A surface echo might be rejected because it is outside the allowed 'window', set-up to establish the true liquid level. This rejects invalid readings on the principle that liquid levels do not change very quickly (see “Lost echo delay (P021)” on page 59).

One rejected surface echo causes Echo Success to decrease by 10%, but a subsequent valid surface echo increases the percentage by 10%. The transmitter is biased to ignore sudden liquid level changes.

Field Communicator or AMS

To view the echo success:

1. From the *Home* screen, select 3: Service Tools.
2. Select 1: Alerts.
3. Select 2: Diagnostic Data.
4. Select 1: Target Data.
5. Select 3: Success Rate D912.
6. When finished, press EXIT to exit to the previous menu.

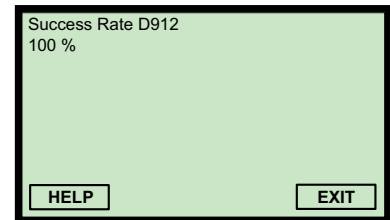

(Field Communicator Screen)

Rosemount 3490 Series Control Unit

To view the echo success:

1. From the *Main Menu* screen, select MONITOR.
2. Select the transmitter (e.g. “Tx1: 3107”).
3. Select DIAGNOSTICS
4. Select Echo Success.
5. When finished, press the ESC key to exit to the previous menu.



(Rosemount 3491 Screen)

5.5.10 Target echoes (D913)

Fast Keys	3, 1, 2, 1, 4
-----------	---------------

This indicates the number of echoes detected by the transmitter. The maximum number displayed is seven.

The echo closest to the transmitter face, i.e. the highest liquid level, is used to calculate the PV (page 84). This is because the other echoes may be caused by multiple path surface reflections from the tank roof or wall.

Field Communicator or AMS

To view the number of echoes received:

1. From the *Home* screen, select 3: Service Tools.
2. Select 1: Alerts.
3. Select 2: Diagnostic Data.
4. Select 1: Target Data.
5. Select 4: Target Echoes D913.
6. When finished, press EXIT to exit to the previous menu.

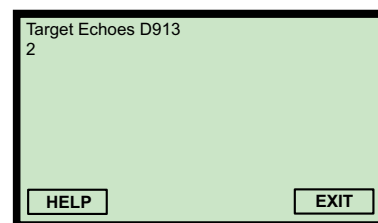

(Field Communicator Screen)

Rosemount 3490 Series Control Unit

To view the number of echoes received:

1. From the *Main Menu* screen, select MONITOR.
2. Select the transmitter (e.g. "Tx1: 3107").
3. Select DIAGNOSTICS.
4. Select Target Echoes.
5. When finished, press the ESC key to exit to the previous menu.

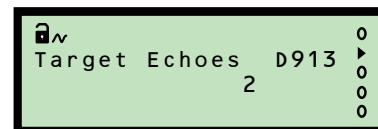

(Rosemount 3491 Screen)

5.5.11 Speed of sound (D914)

Fast Keys	3, 1, 2, 2, 1
-----------	---------------

This indicates the temperature-corrected speed of sound calculated by the transmitter. It relates the returned echo time delay to a distance. The value is calculated using the Temperature SoS Calc value (page 94) and the base value entered into configuration parameter Speed of Sound (page 62).

Field Communicator or AMS

To view the calculated speed of sound:

1. From the *Home* screen, select 3: Service Tools.
2. Select 1: Alerts.
3. Select 2: Diagnostic Data.
4. Select 2: Speed of Sound Data.
5. Select 1: Speed of Sound D914.
6. When finished, press “EXIT” to return to the previous menu.

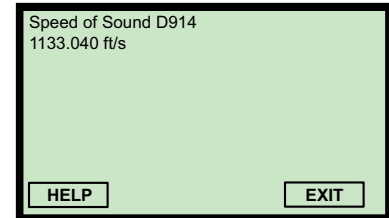

(Field Communicator Screen)

Rosemount 3490 Series Control Unit

To view the calculated speed of sound:

1. From the *Main Menu* screen, select MONITOR.
2. Select the transmitter (e.g. “Tx1: 3107”).
3. Select DIAGNOSTICS.
4. Select Speed of Sound.
5. When finished, press the ESC key to exit to the previous menu.

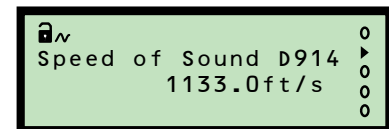

(Rosemount 3491 Screen)

5.5.12 Temperature for SoS calculation (D915)

Fast Keys	3, 1, 2, 2, 2
-----------	---------------

This indicates the temperature used in calculating the temperature-corrected speed of sound (see above). The temperature may be a live or fixed value depending on the configuration of the parameter Temperature (page 63).

Note

- The live temperature is always indicated in the read-only parameter Temperature / Fourth Variable (FV) (page 87).

Field Communicator or AMS

To view the temperature used for calculating the speed of sound:

1. From the *Home* screen, select 3: Service Tools.
2. Select 1: Alerts.
3. Select 2: Diagnostic Data.
4. Select 2: Speed of Sound Data.
5. Select 2: Temperature for Calculation D915.
6. When finished, press EXIT to exit to the previous menu.

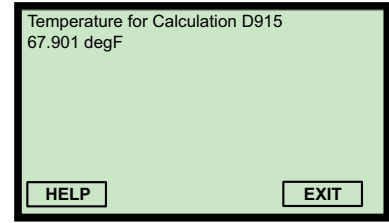

(Field Communicator Screen)

Note

- This is also available at the Fast Key sequence 2, 2, 8, 1, 6 (see [Appendix D: Field Communicator](#) for a full menu map).

Rosemount 3490 Series Control Unit

To view the temperature used for calculating the speed of sound:

1. From the *Main Menu* screen, select MONITOR.
2. Select the transmitter (e.g. "Tx1: 3107").
3. Select DIAGNOSTICS.
4. Select Temp SoS Calc.
5. When finished, press the ESC key to exit to the previous menu.

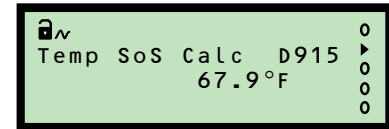

(Rosemount 3491 Screen)

Note

- Units are in °C or °F depending on the base units selected (see [page 20](#)).

5.5.13 Frequency (D916)

Fast Keys	3, 1, 2, 3, 1
-----------	---------------

This indicates the transmitter's actual operating frequency.

Note

- The factory default setting is to automatically set the operating frequency for optimum performance (see Target Frequency on [page 72](#)).

Field Communicator or AMS

To view the actual operating frequency:

1. From the *Home* screen, select 3: Service Tools.
2. Select 1: Alerts.
3. Select 2: Diagnostic Data.
4. Select 3: Operation.
5. Select 1: Transducer Frequency D916.
6. When finished, press EXIT to exit to the previous menu.

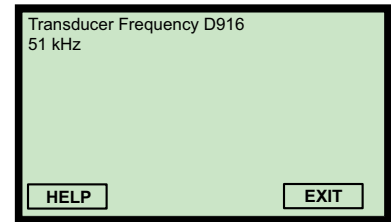

(Field Communicator Screen)

Note

- This is also available at the Fast Key sequence 2, 2, 7, 6, 2 (see [Appendix D: Field Communicator](#) for a full menu map).

Rosemount 3490 Series Control Unit

To view the actual operating frequency:

1. From the *Main Menu* screen, select MONITOR.
2. Select the transmitter (e.g. "Tx1: 3107").
3. Select DIAGNOSTICS.
4. Select OPERATION.
5. Select Xducer Freq.
6. When finished, press the ESC key to exit to the previous menu.

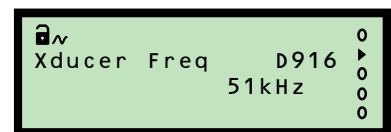

(Rosemount 3491 Screen)

5.5.14 Threshold in use (D917)

Fast Keys	3, 1, 2, 3, 2
-----------	---------------

This indicates the echo strength threshold limit, below which echoes are rejected.

Note

- The factory default setting is to automatically set the threshold level for optimum performance (see Set Threshold on [page 64](#)).

Field Communicator or AMS

To view the threshold limit:

1. From the *Home* screen, select 3: Service Tools.
2. Select 1: Alerts.
3. Select 2: Diagnostic Data.
4. Select 3: Operation.
5. Select 2: Threshold In Use D917.
6. When finished, press EXIT to exit to the previous menu.

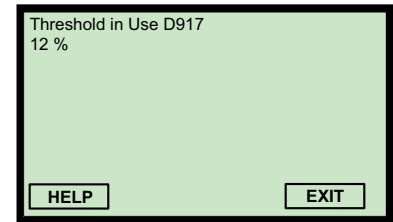

(Field Communicator Screen)

Note

- This is also available at the Fast Key sequence 2, 2, 7, 2, 4 (see [Appendix D: Field Communicator](#) for a full menu map).

Rosemount 3490 Series Control Unit

To view the threshold limit:

1. From the *Main Menu* screen, select MONITOR.
2. Select the transmitter (e.g. "Tx1: 3107").
3. Select DIAGNOSTICS.
4. Select OPERATION.
5. Select Thresh In Use.
6. When finished, press the ESC key to exit to the previous menu.

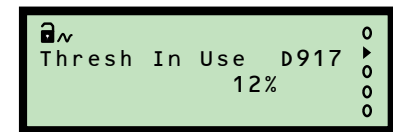

(Rosemount 3491 Screen)

5.5.15 Pulses in use (D918)

Fast Keys	3, 1, 2, 3, 3
-----------	---------------

This is the actual number of pulses transmitted in the previous burst of pulses.

Note

- The factory default setting is to automatically decide the number of pulses in a burst for optimum performance (see Target Pulses on [page 71](#))

Field Communicator or AMS

To view the number of pulses being used in a burst:

1. From the *Home* screen, select 3: Service Tools.
2. Select 1: Alerts.
3. Select 2: Diagnostic Data.
4. Select 3: Operation.
5. Select 3: Pulses In Use D918.
6. When finished, press EXIT to exit to the previous menu.

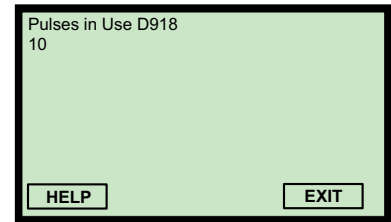

(Field Communicator Screen)

Note

- This is also available at the Fast Key sequence 2, 2, 7, 5, 2 (see [Appendix D: Field Communicator](#) for a full menu map).

Rosemount 3490 Series Control Unit

To view the number of pulses being used in a burst:

1. From the *Main Menu* screen, select MONITOR.
2. Select the transmitter (e.g. "Tx1: 3107").
3. Select DIAGNOSTICS.
4. Select OPERATION.
5. Select Pulses In Use.
6. When finished, select "Quit" to exit to the previous menu.

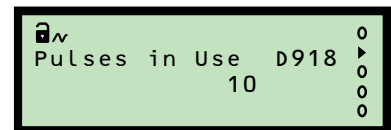

(Rosemount 3491 Screen Shown)

5.5.16 Transmit power (D919)

Fast Keys	3, 1, 2, 3, 4
------------------	---------------

This indicates the level of power in use for ultrasonic pulse transmission.

- The lower the level number, the less power is being used
- The higher the level number, the more power being used

Note

- The factory default setting is to optimize the power needed for ultrasonic pulse transmission (see Transmit Power Control on [page 66](#))

Field Communicator or AMS

To view the pulse transmission power in use:

1. From the *Home* screen, select 3: Service Tools.
2. Select 1: Alerts.
3. Select 2: Diagnostic Data.
4. Select 3: Operation.
5. Select 4: Transmit Power D919.
6. When finished, press EXIT to exit to the previous menu.

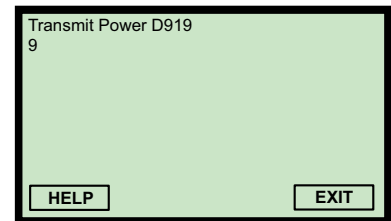

(Field Communicator Screen)

Note

- This is also available at the Fast Key sequence 2, 2, 7, 4, 3 (see [Appendix D: Field Communicator](#) for a full menu map).

Rosemount 3490 Series Control Unit

To view the pulse transmission power in use:

1. From the *Main Menu* screen, select MONITOR.
2. Select the transmitter (e.g. "Tx1: 3107").
3. Select DIAGNOSTICS.
4. Select OPERATION.
5. Select Transmit Power.
6. When finished, select "Quit" to exit to the previous menu.

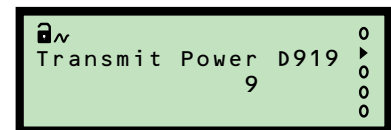

(Rosemount 3491 Screen Shown)

5.5.17 Model code (D949)

Fast Keys	1, 3, 1, 1, 1, 2
-----------	------------------

This indicates the transmitter model code.

Field Communicator or AMS

To view the transmitter model code:

1. From the *Home* screen, select 1: Overview.
2. Select 3: Shortcuts.
3. Select 1: Device Information *twice*.
4. Select 1: Identification.
5. Select 2: Model Code D949.
6. When finished, press EXIT to exit to the previous menu.

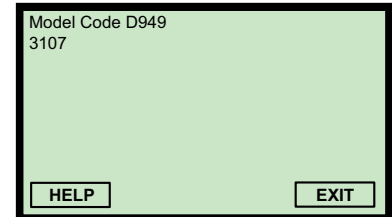

(Field Communicator Screen)

Note

- This is also available at the Fast Key sequence 2, 2, 4, 1, 5 (see [Appendix D: Field Communicator](#) for a full menu map).

Rosemount 3490 Series Control Unit

To view the transmitter model code:

1. From the *Main Menu* screen, select SETUP.
2. Select the transmitter (e.g. "Tx1: 3107").
3. Select SYSTEM.
4. Select FIXED.
5. Select HART.
6. Select Model Code.
7. When finished, select "Quit" to exit to the previous menu.

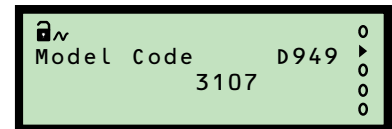

(Rosemount 3491 Screen)

5.5.18 Hardware rev. (D952)

Fast Keys	1, 3, 1, 1, 1, 7
-----------	------------------

This is the overall hardware revision number of at time of manufacture.

Field Communicator or AMS

To view the hardware revision number:

1. From the *Home* screen, select 1: Overview.
2. Select 3: Shortcuts.
3. Select 1: Device Information *twice*.
4. Select 1: Identification.
5. Select 7: Hardware Revision D952.
6. When finished, press EXIT to exit to the previous menu.

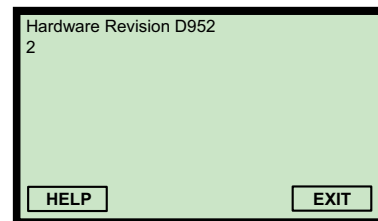

(Field Communicator Screen)

Rosemount 3490 Series Control Unit

To view the hardware revision number:

1. From the *Main Menu* screen, select SETUP.
2. Select the transmitter (e.g. "Tx1: 3107").
3. Select SYSTEM.
4. Select FIXED.
5. Select HART.
6. Select Hardware Rev.
7. When finished, select "Quit" to exit to the previous menu.

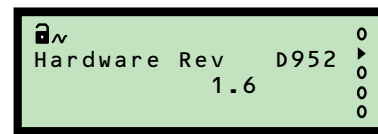

(Rosemount 3491 Screen)

5.5.19 Software revision (D953)

Fast Keys	1, 3, 1, 1, 1, 6
-----------	------------------

This is the embedded software revision number at time of manufacture.

Field Communicator or AMS

To view the software revision number:

1. From the *Home* screen, select 1: Overview.
2. Select 3: Shortcuts.
3. Select 1: Device Information *twice*.
4. Select 1: Identification.
5. Select 6: Software Revision D953.
6. When finished, press EXIT to exit to the previous menu.

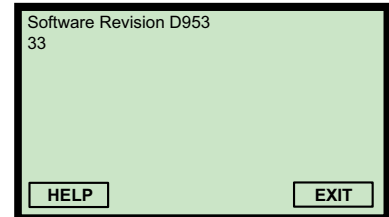

(Field Communicator Screen)

Rosemount 3490 Series Control Unit

To view the software revision number:

1. From the *Main Menu* screen, select SETUP.
2. Select the transmitter (e.g. "Tx1: 3107").
3. Select SYSTEM.
4. Select FIXED.
5. Select HART.
6. Select Software Rev.
7. When finished, select "Quit" to exit to the previous menu.

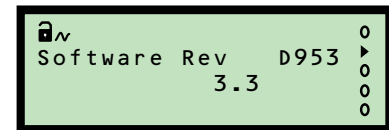

(Rosemount 3491 Screen)

5.5.20 Manufacturer (D960)

Fast Keys	2, 2, 4, 1, 4
-----------	---------------

This is the manufacturer name.

Field Communicator or AMS

To view the manufacturer name:

1. From the *Home* screen, select 2: Configure.
2. Select 2: Manual Setup.
3. Select 4: HART/Identity.
4. Select 1: Identity.
5. Select 4: Manufacturer D960.
6. When finished, press EXIT to exit to the previous menu.

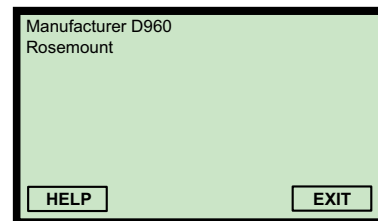

(Field Communicator Screen)

Rosemount 3490 Series Control Unit

To view the manufacturer name:

1. From the *Main Menu* screen, select SETUP.
2. Select the transmitter (e.g. "Tx1: 3107").
3. Select SYSTEM.
4. Select FIXED.
5. Select HART.
6. Select Manufacturer.
7. When finished, select "Quit" to exit to the previous menu.

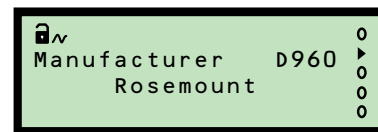

(Rosemount 3491 Screen)

5.5.21 Unique Device ID (D961)

Fast Keys	2, 2, 4, 1, 7
------------------	---------------

This is a factory set unique device identification number and is used by the HART protocol. It is typically the same as the Serial Number (page 35).

Field Communicator or AMS

To view the factory set unique device identification number:

1. From the *Home* screen, select 2: Configure.
2. Select 2: Manual Setup.
3. Select 4: HART/Identity.
4. Select 1: Identity.
5. Select 7: Device ID D961.
6. When finished, press EXIT to exit to the previous menu.

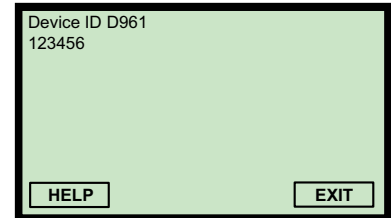

(Field Communicator Screen)

Rosemount 3490 Series Control Unit

To view the factory set unique device identification number:

1. From the *Main Menu* screen, select SETUP.
2. Select the transmitter (e.g. "Tx1: 3107").
3. Select SYSTEM.
4. Select FIXED.
5. Select HART.
6. Select Unique ID.
7. When finished, select "Quit" to exit to the previous menu.

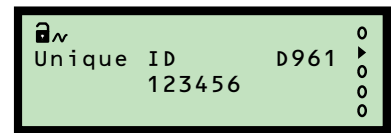

(Rosemount 3491 Screen)

5.5.22 HART revision (D962)

Fast Keys	1, 3, 1, 1, 1, 4
-----------	------------------

This is the major revision number of the standard used for the HART communications protocol.

Field Communicator or AMS

To view the HART revision number:

1. From the *Home* screen, select 1: Overview.
2. Select 3: Shortcuts.
3. Select 1: Device Information *twice*.
4. Select 1: Identification.
5. Select 4: HART Revision D962.
6. When finished, press EXIT to exit to the previous menu.

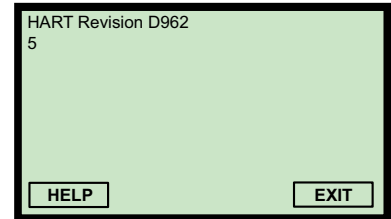

(Field Communicator Screen)

Rosemount 3490 Series Control Unit

To view the HART revision number:

1. From the *Main Menu* screen, select SETUP.
2. Select the transmitter (e.g. "Tx1: 3107").
3. Select SYSTEM.
4. Select FIXED.
5. Select HART.
6. Select HART Rev.
7. When finished, select "Quit" to exit to the previous menu.

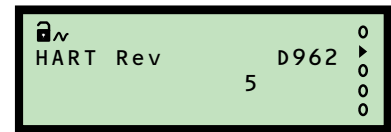

(Rosemount 3491 Screen)

5.5.23 Transmitter specific command rev. (D963)

Fast Keys	1, 3, 1, 1, 1, 5
------------------	------------------

This is the minor revision number of specific (non-standard) HART commands supported by the transmitter.

Field Communicator or AMS

To view the revision number:

1. From the *Home* screen, select 1: Overview.
2. Select 3: Shortcuts.
3. Select 1: Device Information *twice*.
4. Select 1: Identification.
5. Select 5: Device Revision D963.
6. When finished, press EXIT to exit to the previous menu.

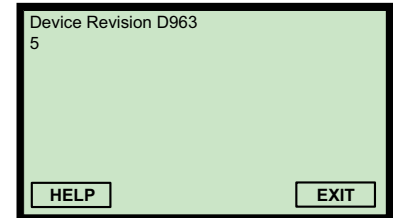

(Field Communicator Screen)

Rosemount 3490 Series Control Unit

To view the revision number:

1. From the *Main Menu* screen, select SETUP.
2. Select the transmitter (e.g. "Tx1: 3107").
3. Select SYSTEM.
4. Select FIXED.
5. Select HART.
6. Select Field Dev Rev.
7. When finished, select "Quit" to exit to the previous menu.



(Rosemount 3491 Screen)

5.5.24 Preambles (D964)

Fast Keys	2, 2, 4, 2, 2
------------------	---------------

This is read by a HART Master Device e.g. a Rosemount 3490 Series Control Unit to determine how many preamble bytes are to be sent with each HART protocol message.

Field Communicator or AMS

To view the number of preamble bytes:

1. From the *Home* screen, select 2: Configure.
2. Select 2: Manual Setup.
3. Select 4: HART/Identity.
4. Select 2: Communication.
5. Select 2: Preambles D964.
6. When finished, press EXIT to exit to the previous menu.

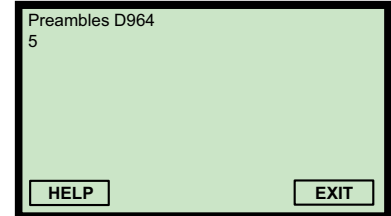

(Field Communicator Screen)

Rosemount 3490 Series Control Unit

To view the number of preamble bytes:

1. From the *Main Menu* screen, select SETUP.
2. Select the transmitter (e.g. "Tx1: 3107").
3. Select SYSTEM.
4. Select FIXED.
5. Select HART.
6. Select Num Req Preams.
7. When finished, select "Quit" to exit to the previous menu.

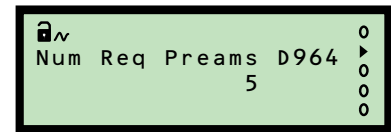

(Rosemount 3491 Screen)

5.5.25 Transmitter flags (D965)

Fast Keys	-
-----------	---

These flags (8 digits) are used by the HART protocol.

Field Communicator or AMS

This parameter is not available in the 3100 Series DD (Device Descriptor) file.

Rosemount 3490 Series Control Unit

To view the flags:

1. From the *Main Menu* screen, select SETUP.
2. Select the transmitter (e.g. "Tx1: 3107").
3. Select SYSTEM.
4. Select FIXED.
5. Select HART.
6. Select Flags.
7. When finished, select "Quit" to exit to the previous menu.

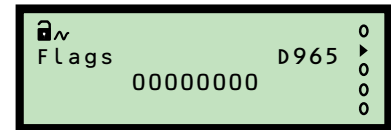

(Rosemount 3491 Screen)

5.5.26 Primary variable trend

Fast Keys	3, 3, 1, 1
-----------	------------

This indicates the history of PV changes.

Note

- The live PV is always indicated in the read-only parameter Process Value / Primary Variable (PV) (page 84).

Field Communicator or AMS

To view the trend:

1. From the *Home* screen, select 3: Service Tools.
2. Select 3: Trends.
3. Select 1: Primary Variable *twice*.
4. When finished, press EXIT to exit to the previous menu.

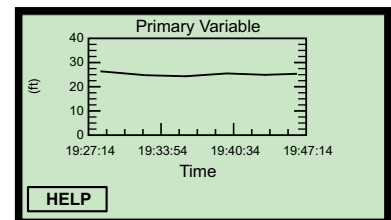

(Field Communicator Screen Shown)

Note

- Units are the selected PV Units (see page 51).

Rosemount 3490 Series Control Unit

This feature is only available on the Field Communicator and AMS.

5.5.27 Temperature trend

Fast Keys	3, 3, 2, 1
-----------	------------

This indicates the history of temperature changes.

Note

- The live temperature is always indicated in the read-only parameter Temperature / Fourth Variable (FV) (page 87).

Field Communicator or AMS

To view the trend:

1. From the *Home* screen, select 3: Service Tools.
2. Select 3: Trends.
3. Select 2: Temperature.
4. Select 1: Temperature.
5. When finished, press EXIT to exit to the previous menu.

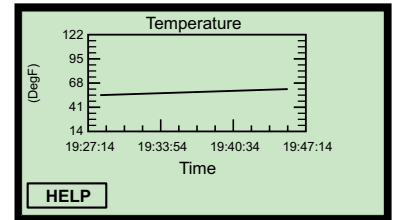

(Field Communicator Screen)

Note

- Units are in °C or °F depending on the base units selected (see page 20).

Rosemount 3490 Series Control Unit

This feature is only available on the Field Communicator and AMS.

5.5.28 Distance and echo size trend

Fast Keys	3, 3, 3, 1
-----------	------------

This indicates the history of distance and echo size changes.

Field Communicator or AMS

To view the trend:

1. From the *Home* screen, select 3: Service Tools.
2. Select 3: Trends.
3. Select 3: Distance / Echo Size *twice*.
4. Select Distance (default) or Echo Size from the pull-down menu.

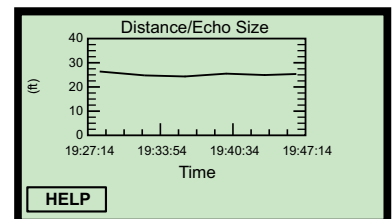

(Field Communicator Screen)

5. When finished, press EXIT to exit to the previous menu.

Note

- Distance units are in meters, feet, or inches depending on base units (see [page 20](#)).
-

Rosemount 3490 Series Control Unit

This feature is only available on the Field Communicator and AMS.

Appendix A Reference Data

Specifications	page 111
Dimensional drawings	page 115
Ordering information	page 118

A.1 Specifications

A.1.1 General

Product

- Rosemount 3107 and 3108 Ultrasonic Transmitters:
Level, Content (Volume), and Open channel flow measurement

Measurement principle

- Ultrasonic, time-of-flight

A.1.2 Measuring performance

Measurement range

- 3107: 1 to 39 ft (0,3 to 12 m)
- 3108: 1 to 11 ft (0,3 to 3,3 m)

Blanking distance (dead zone)

- 12 in. (0,3 m)

Level resolution

- Better than 0.06 in. (1 mm)

Level accuracy under reference conditions⁽¹⁾

- ± 0.1 in. (2,5 mm) for measured distance < 3.3 ft. (1 m)
- $\pm 0.25\%$ of distance for measured distance > 3.3 ft. (1 m)

Ultrasonic pulse rate

- 1 per second (user configurable 0.5 to 2.0 seconds)

(1) Temperature: 68 °F (20 °C), Pressure: 1013 mbar (atmospheric pressure), Relative Humidity: 50%, calm and stable water surface.

A.1.3 Configuration

Output process variable (PV)

- Level (Linear or Scaled), Content (Volume), or Open Channel Flow

Configuration tools⁽¹⁾

- Field Communicator
- Rosemount 3490 Series Universal Control Unit
- Rosemount AMS™ Suite

A.1.4 Electrical

Cable

- Factory fitted 2-core shielded cable for external power supply and communication

Cable sheath

- PVC

Cable length

- 10, 65, or 164 ft. (3, 20, or 50 m)
- All cables may be shortened or extended on site

External power supply

- 12 to 40 Vdc (non-hazardous area)
- 12 to 30 Vdc (hazardous area)

Earthing

- Connect the cable screen to earth

Communication (signal output)

- Analog 4–20 mA, HART

Signal on alarm

- Standard: Low = 3.75 mA. High = 21.75 mA
- Namur NE43: Low = 3.6 mA. High = 22.5 mA

Saturation levels

- Standard: Low = 3.9 mA. High = 20.8 mA
- Namur NE43: Low = 3.8 mA. High = 20.5 mA

Electrical parameters

- $U_i = 30\text{ V}$, $I_i = 120\text{ mA}$, $P_i = 0,82\text{ W}$, $C_i = 5\text{ nF}$, $L_i = 27\text{ mH}$

(1) The Rosemount 3490 Series Control Unit software must be version 3.40 (or later).

A.1.5 Materials of construction

Body

- UPVC (stabilized)

Lock nut

- Glass-filled nylon

A.1.6 Mechanical

Mounting thread size

- 1-in. NPT or 1-in. BSPP
- See Table A-3 on page 120 for optional mounting accessories

Weight of transmitter

- 3.1 lb with 10 ft. cable, 4.1 lb with 65 ft. cable, and 5.8 lb with 164 ft. cable
- (1,4 kg with 3 m cable, 1,9 kg with 20 m cable, and 2,6 kg with 50 m cable)

A.1.7 Measuring

Temperature compensation

- 3107: Automatic with integral temperature compensation
- 3108: Automatic with factory fitted remote temperature sensor for dynamic temperature compensation

A.1.8 Environment

Ambient temperature

- -40 to 140 °F (-40 to 60 °C)

Process temperature

- -40 to 140 °F (-40 to 60 °C)

Process pressure

- -4 to 44 psi (-0,25 to 3,0 bar)

Ingress protection

- IP68 to 33 ft. (10 m)

Electromagnetic compatibility

- EN 61326-1:2006

Certifications

- CE-mark, FM, CSA, ATEX, or IECEx, dependent on order code.
- The 3108 is MCERTS⁽¹⁾ certified.

A.1.9 Temperature and pressure ratings

The process temperature and process pressure rating depends on the design of the transmitter in combination with the flange materials.

Figure A-1. Graph of process temperature versus process pressure ratings

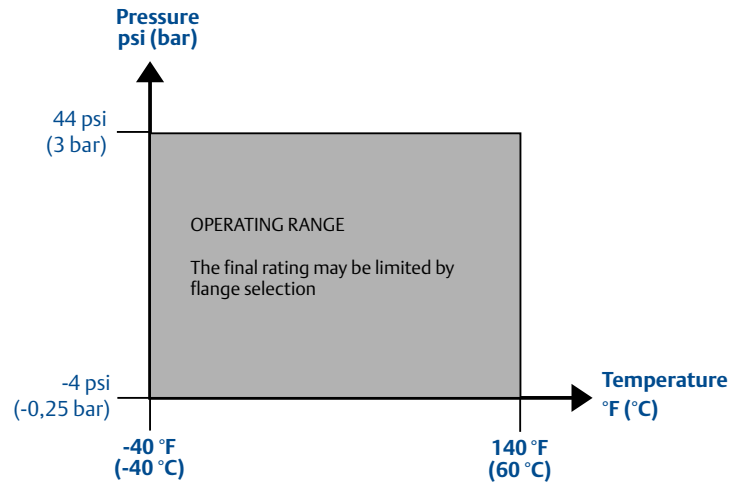

Process Temperature and Pressure Chart for the Rosemount 3107 and 3108

A.1.10 Load limitations

A Field Communicator requires a minimum load resistance of 250 Ohm within the loop in order to function properly. Communication with a Rosemount 3490 Series Control Unit does not require additional resistance. The load resistance can be determined from these diagrams:

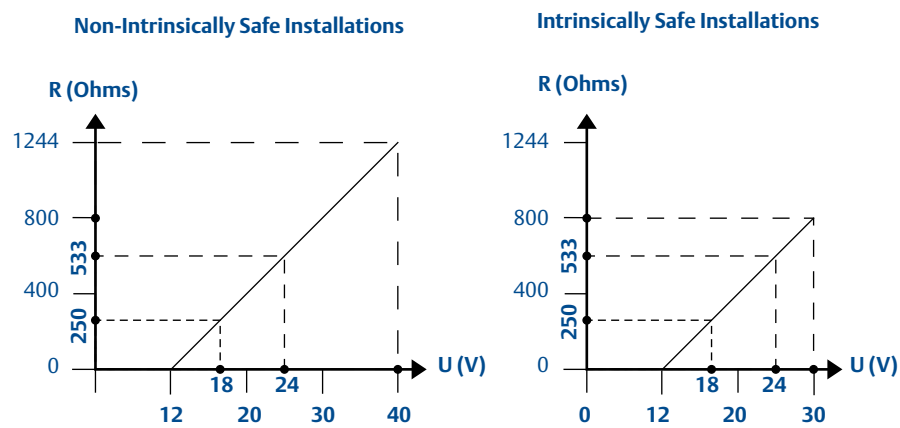

Rosemount 3107 and Rosemount 3108

Note

- R = Maximum Load Resistance
- U = External Power Supply Voltage

(1) The Rosemount 3108 forms part of an MCERTS certified system when used with a Rosemount 3490 Series Control Unit.

A.2 Dimensional drawings

Figure A-2. Rosemount 3107 threaded Mounting

Note: Dimensions are in inches (mm).

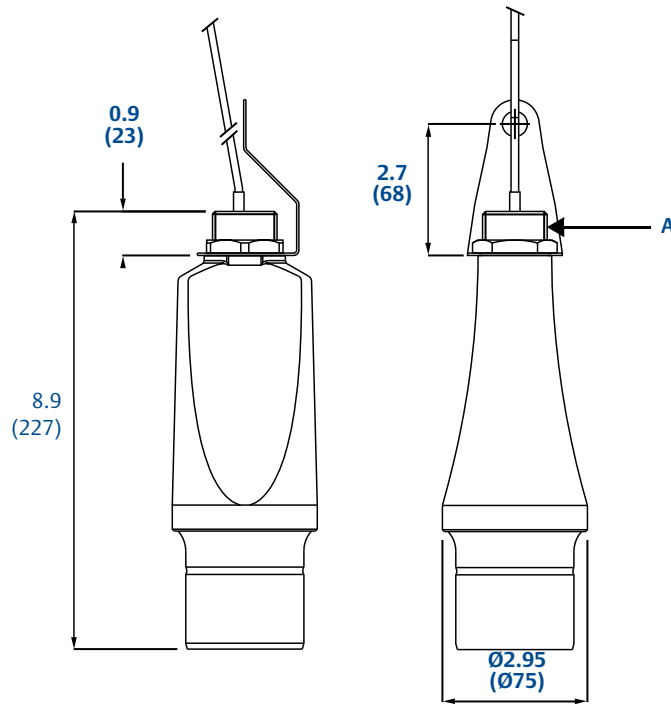

A. 1 in. thread

Figure A-3. Rosemount 3108 threaded mounting

Note: Dimensions are in inches (mm).

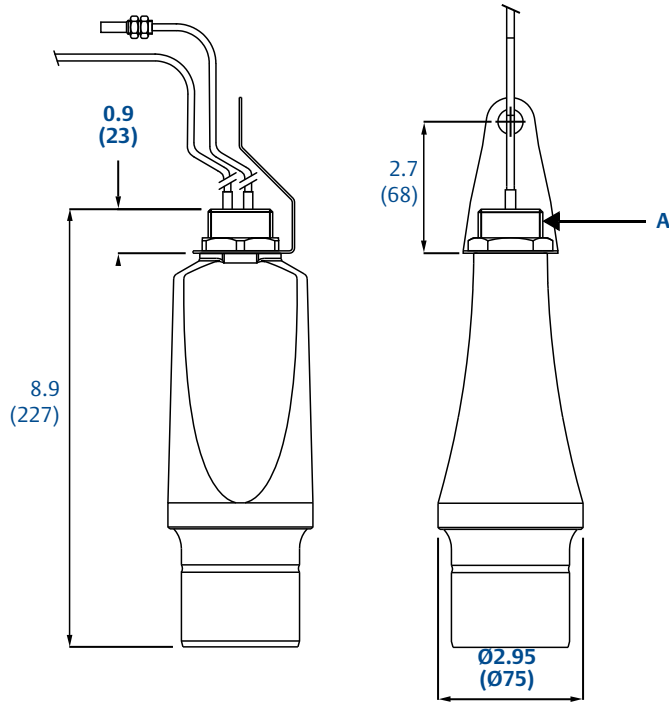

A. 1 in. thread

Figure A-4. 1-in. NPT/BSPP bracket kits

Note: Dimensions are in inches (mm).

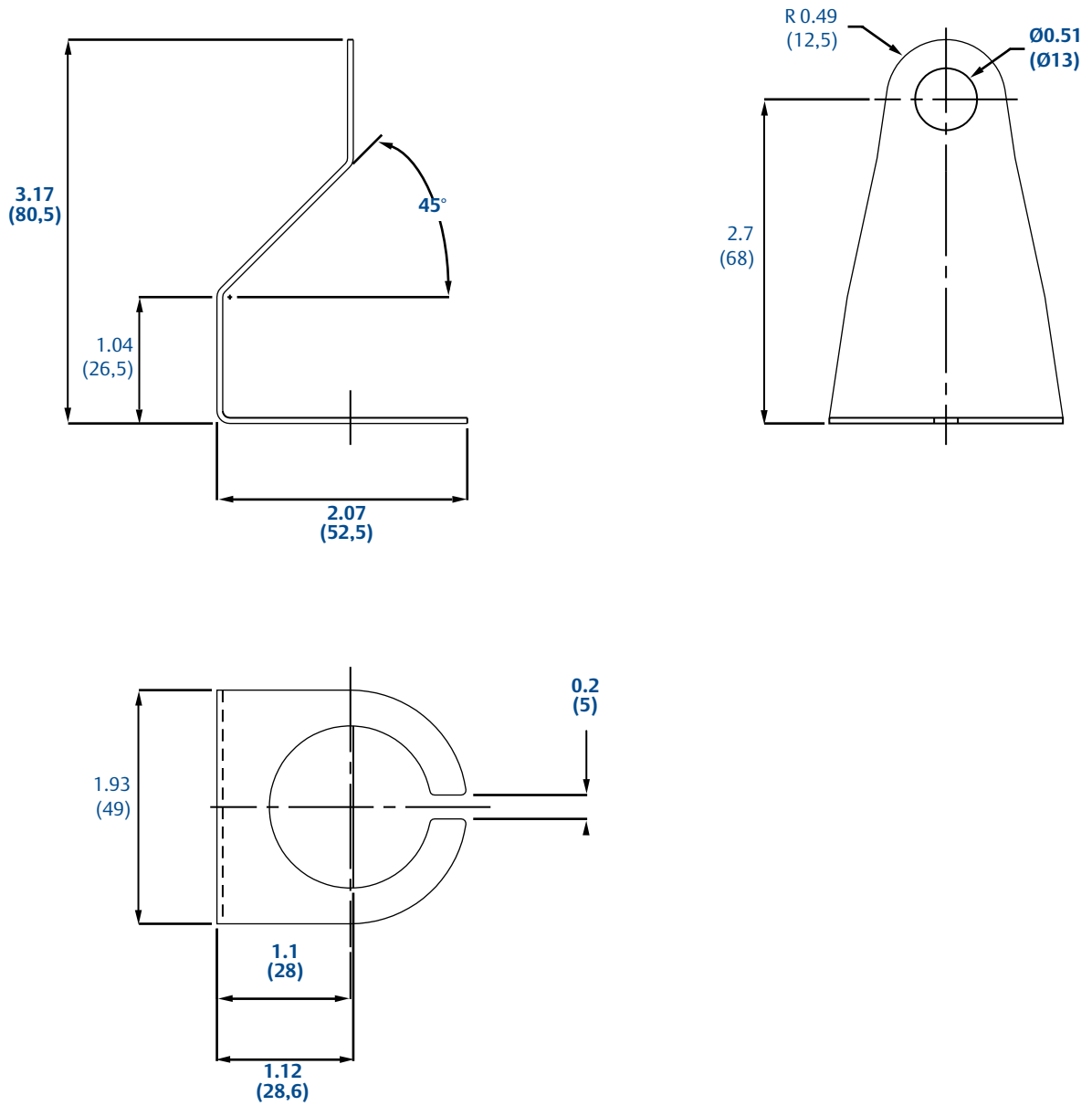

A.3 Ordering information

Table A-1. Rosemount 3107 ordering information

★The Standard offering represents the most common models and options. These options should be selected for best delivery. The Expanded offering is subject to additional delivery lead time.

Model	Product Description	
3107	Ultrasonic level transmitter, 39 ft. (12 m) range	
Signal Output		
Standard		Standard
H	4–20 mA with HART communication	★
Housing Material		
Standard		Standard
P	UVPC	★
Cable Lengths		
Standard		Standard
1	10 ft. (3 m)	★
2	65 ft. (20 m)	★
3	164 ft. (50 m)	★
Wet-side Material		
Standard		Standard
P	UVPC	★
Process Connection		
Standard		Standard
N1 ⁽¹⁾	1-in. NPT thread	★
G1 ⁽²⁾	1-in. BSPP thread	★
Certificates		
Standard		Standard
I1	ATEX Intrinsically Safe	★
I5	FM Intrinsically Safe	★
I6	CSA Intrinsically Safe	★
I7	IECEx Intrinsically Safe	★
Special Alarm Options⁽³⁾⁽⁴⁾		
Standard		Standard
C4	Namur NE43 alarm and saturation levels, high alarm	★
C5	Namur NE43 alarm and saturation levels, low alarm	★
C8	Low alarm (Standard Rosemount alarm and saturation levels)	★
Special Certification Option		
Standard		Standard
Q4	Certificate of functional test	★
Typical Model Number: 3107 HP 1 PG1 I5		

(1) Choosing this option implies US (Imperial) units of measurement are required for the default configuration. Configuration can be changed on-site.

(2) Choosing this option implies Metric units of measurement are required for the default configuration. Configuration can be changed on-site.

(3) When no Special Alarm option code is selected, the configuration is a high alarm (standard Rosemount alarm and saturation levels).

(4) See “Electrical” on page 112 for more information about the saturation levels and alarm signal indication.

Table A-2. Rosemount 3108 ordering information

★The Standard offering represents the most common models and options. These options should be selected for best delivery. The Expanded offering is subject to additional delivery lead time.

Model	Product Description	
3108	Ultrasonic Open Channel Flow Transmitter with remote temperature sensor, 11 ft. (3,3 m) range	
Signal Output		
Standard		Standard
H	4–20 mA with HART communication	★
Housing Material		
Standard		Standard
P	UVPC	★
Cable Lengths		
Standard		Standard
2	65 ft. (20 m)	★
Wet-side Material		
Standard		Standard
P	UVPC	★
Process Connection		
Standard		Standard
N1 ⁽¹⁾	1-in. NPT thread	★
N2 ⁽¹⁾	1-in. NPT thread with 1-in. NPT to 3/4-in. NPT female conduit adaptor	★
G1 ⁽²⁾	1-in. BSPP thread	★
G2 ⁽²⁾	1-in. BSPP thread with 1-in. BSPP to M20 female conduit adaptor	★
Certificates		
Standard		Standard
I1	ATEX Intrinsically Safe	★
I5	FM Intrinsically Safe	★
I6	CSA Intrinsically Safe	★
I7	IECEX Intrinsically Safe	★
Special Alarm Options⁽³⁾⁽⁴⁾		
Standard		Standard
C4	Namur NE43 alarm and saturation levels, high alarm	★
C5	Namur NE43 alarm and saturation levels, low alarm	★
C8	Low alarm (Standard Rosemount alarm and saturation levels)	★
Special Certification Option		
Standard		Standard
Q4	Certificate of functional test	★
Typical Model Number: 3108 H P 2 P N1 I5		

(1) Choosing this option implies US (Imperial) units of measurement are required for the default configuration. Configuration can be changed on-site.

(2) Choosing this option implies Metric units of measurement are required for the default configuration. Configuration can be changed on-site.

(3) When no Special Alarm option code is selected, the configuration is a high alarm, and standard Rosemount alarm and saturation levels.

(4) See “Electrical” on page 112 for more information about the saturation levels and alarm signal indication.

A.3.1 Spare parts and accessories

Table A-3. Spare parts and accessories

★The Standard offering represents the most common models and options. These options should be selected for best delivery. The Expanded offering is subject to additional delivery lead time.

Spares and accessories		
Standard		Standard
03107-7001-0001	Flange Mounting, 1-in. NPT to 3-in. ASME B16.5 Class 150, PVC	★
03107-7001-0002	Flange Mounting, 1-in. NPT to 4-in. ASME B16.5 Class 150, PVC	★
03107-7002-0001	Flange Mounting, 1-in. BSPP to PN10 DN80, PVC	★
03100-7002-0002	Flange Mounting, 1-in. BSPP to PN10 DN100, PVC	★
03107-7003-0001	Submersion shield for the 3107/3108	★
03107-7003-0002	316 Stainless Steel Suspension Bracket and 1-in. locknut (supplied with the 3107 and the 3108)	★
03107-7003-0003	Conduit adaptor boss, 1-in. BSPP female to M20 x 1.5 female	★
03107-7003-0004	Conduit adaptor boss, 1-in. NPT female to 3/4-in. NPT female	★
03107-7003-0005 ⁽¹⁾	Head Verification Device (HVD), 304 stainless steel for use with 3107 or 3108 transmitters	★

(1) The HVD is recommended for open channel flow applications to allow checking and certification of the transmitter. It features a target plate at a fixed distance from the transmitter face. The target plate is moved under the transmitter to verify the transmitter accuracy.

Appendix B Product Certifications

Safety messages	page 121
Approved manufacturing locations	page 122
European Union directive information	page 122
MCERTS certification	page 122
Hazardous locations certifications	page 122
Approval drawings	page 125

B.1 Safety messages

Procedures and instructions in this manual may require special precautions to ensure the safety of the personnel performing the operations. Information that raises potential safety issues is indicated by a caution symbol (⚠). The external hot surface symbol (🔥) is used when a surface is hot and care must be taken to avoid possible burns. If there is a risk of an electrical shock the (⚡) symbol is used. Refer to the safety messages listed at the beginning of each section before performing an operation preceded by this symbol.

⚠ WARNING

Failure to follow these installation guidelines could result in death or serious injury.

- Make sure only qualified personnel perform the installation.
- Use the equipment only as specified in this manual. Failure to do so may impair the protection provided by the equipment.

Explosions could result in death or serious injury.

- Verify that the operating environment of the transmitter is consistent with the appropriate hazardous locations certifications.
- Before connecting a HART[®]-based communicator in an explosive atmosphere, make sure the instruments in the loop are installed in accordance with intrinsically safe or non-incendive field wiring practices.

Electrical shock could cause death or serious injury.

- Use extreme caution when making contact with the leads and terminals.

⚠ WARNING

Any substitution of non-recognized parts may jeopardize safety. Repair, e.g. substitution of components etc., may also jeopardize safety and is under no circumstances allowed.

B.2 Approved manufacturing locations

- Rosemount Inc.
 - Chanhassen, Minnesota, USA
- Rosemount Measurement Limited
 - Slough, Berkshire, United Kingdom
- Emerson Asia Pacific Private Limited
 - Singapore

B.3 European Union directive information

Note

- Refer to the housing label to identify the approvals for your transmitter.
-

The EC declaration of conformity for all applicable European directives for this product can be found on the Rosemount web site at www.rosemount.com.
A hard copy may be obtained by contacting our local sales representative.

ATEX directive (94/9/EC)

- Emerson complies with the ATEX Directive

Pressure equipment directive (PED) (97/23/EC)

- The 3107 and 3108 are outside the scope of PED Directive

Electro magnetic compatibility (EMC) (2004/108/EC)

- EN 61326-1:2006

B.4 MCERTS certification

MCERTS certificate number (3108 only)

- Sira Certificate No. MC080131

B.5 Hazardous locations certifications

Note

- Refer to the housing label to identify the approvals for your transmitter.
-

B.5.1 American and canadian approvals

Factory Mutual (FM) approval

- I5** FM Intrinsic Safety
 - Intrinsically Safe for Class I, Division 1, Groups A, B, C, and D
 - Zone Marking: Class I, Zone 0, AEx ia IIC
 - Temperature Code T6 ($T_a = 55\text{ }^\circ\text{C}$)
 - Temperature Code T4 ($T_a = 60\text{ }^\circ\text{C}$)

Entity Parameters:

$V_{Max} = 30\text{ V}$, $I_{Max} = 120\text{ mA}$, $P_i = 0.82\text{ W}$, $C_i = 5\text{ nF}$, $L_i = 27\text{ }\mu\text{H}$.

Intrinsically Safe when installed in accordance with Rosemount drawing 71097/1300
IP66, IP68

Special condition of use:

1. To protect against UV exposure when installed outdoors, the transmitter shall be installed in accordance with the section “[Environmental considerations](#)” on page 9.

Canadian Standards Association (CSA) approval

16 Certificate Number: 02 CSA 1352094 X

CSA Intrinsic Safety

Ex ia IIC

Intrinsically Safe when installed with certified barrier meeting transmitter entity parameters:

$U_i = 30\text{ V}$, $I_i = 120\text{ mA}$, $P_i = 0.82\text{ W}$, $C_i = 5\text{ nF}$, $L_i = 27\text{ }\mu\text{H}$

Temperature Code T4 at $T_a = -40\text{ to }60\text{ }^\circ\text{C}$ or T6 at $T_a = -40\text{ to }55\text{ }^\circ\text{C}$

Special condition of use:

1. Risk of electrostatic charge build up on plastic surfaces. Clean only with a damp cloth.

B.5.2 European certifications

ATEX approval

11 ATEX Intrinsic Safety

Certificate No.: Sira 09ATEX2299X

II 1G, Ex ia IIC Ga

T6 ($T_a = -40\text{ to }55\text{ }^\circ\text{C}$), T4 ($T_a = -40\text{ to }60\text{ }^\circ\text{C}$)

$U_i = 30\text{ V}$, $I_i = 120\text{ mA}$, $P_i = 0,82\text{ W}$, $C_i = 5\text{ nF}$, $L_i = 27\text{ }\mu\text{H}$

IP66, IP68

See also “[ATEX and IECEx conditions for safe use \(X\)](#)” on page 124

B.5.3 Rest of the world certifications

IECEx approval

17 IECEx Intrinsic Safety

Certificate No.: IECEx SIR 09.0124X

IECEx Intrinsic Safety

Ex ia IIC Ga

T6 ($T_a = -40\text{ to }55\text{ }^\circ\text{C}$), T4 ($T_a = -40\text{ to }60\text{ }^\circ\text{C}$)

$U_i = 30\text{ V}$, $I_i = 120\text{ mA}$, $P_i = 0,82\text{ W}$, $C_i = 5\text{ nF}$, $L_i = 27\text{ }\mu\text{H}$

IP66, IP68

See also “[ATEX and IECEx conditions for safe use \(X\)](#)” on page 124

ATEX and IECEx conditions for safe use (X)

Model numbers covered:

3107****I1****, 3108****I1****, 3107****I7****, 3108****I7****
(* indicates options in construction, function and materials).

1. The equipment may be used with flammable gases and vapors with apparatus groups IIA, IIB, and IIC, and with temperature classes T1, T2, T3, T4, T5, and T6.
2. Installation of this equipment shall be carried out by suitably trained personnel, in accordance with the applicable code of practice.
3. The equipment is not intended to be repaired by the user and is to be replaced by an equivalent certified unit. Repairs should only be carried out by the manufacturer or approved repairer.
4. If the equipment is likely to come into contact with aggressive substances, it is the responsibility of the user to take suitable precautions that prevent it from being adversely affected, thus ensuring that the type of protection is not compromised.

Aggressive Substances e.g. acidic liquids or gases that may attack metals or solvents that may affect polymeric materials.

Suitable Precautions e.g. regular checks as part of routine inspections or establishing from the material's data sheet that it is resistant to specific chemicals.
5. The apparatus electronics is only certified for use in ambient temperatures in the range of -40 to 60 °C for T4 or -40 to 55 °C for T6. It should not be used outside this range.
6. It is the responsibility of the user to ensure the voltage and current limits for this equipment are not exceeded.
7. Technical Data:
 - a. Materials of construction:
UPVC moulded body and front face.
PVC sheathed 2 core shielded cable.
Glass filled nylon lock nut.
316SS hanging bracket.
Epoxy adhesive sealant.
 - b. Coding:
ATEX: II 1 G, Ex ia IIC Ga, T6 ($T_a = -40$ to 55 °C), T4 ($T_a = -40$ to 60 °C)
IECEx: Ex ia IIC Ga, T6 ($T_a = -40$ to 55 °C), T4 ($T_a = -40$ to 60 °C)
 $U_i = 30$ V, $I_i = 120$ mA, $P_i = 0,82$ W, $C_i = 5$ nF, $L_i = 27$ μ H
8. Special conditions for safe use:
 - a. The equipment must not be installed directly in any process where the enclosure might be charged by the rapid flow of non-conductive media.
 - b. The equipment must only be cleaned with a damp cloth.
 - c. Do not mount the 3107/3108 on a structure that is subject to vibration, or in a position where damage may be caused by impact or thermal stress.
 - d. The equipment is not intended to be used in areas exposed to dust.
9. Manufacturer:
Rosemount Measurement Ltd., 158 Edinburgh Avenue, Slough, Berkshire, SL1 4UE, UK

B.6 Approval drawings

This section contains the FM installation drawing. You must follow the installation guidelines presented in order to maintain certified ratings for installed transmitters.

- Rosemount Drawing 71097/1300, Issue 2
System Control Drawing for hazardous location installation of intrinsically safe FM approved apparatus.

Figure B-1.
System control drawing for hazardous location installation of intrinsically safe FM-approved apparatus

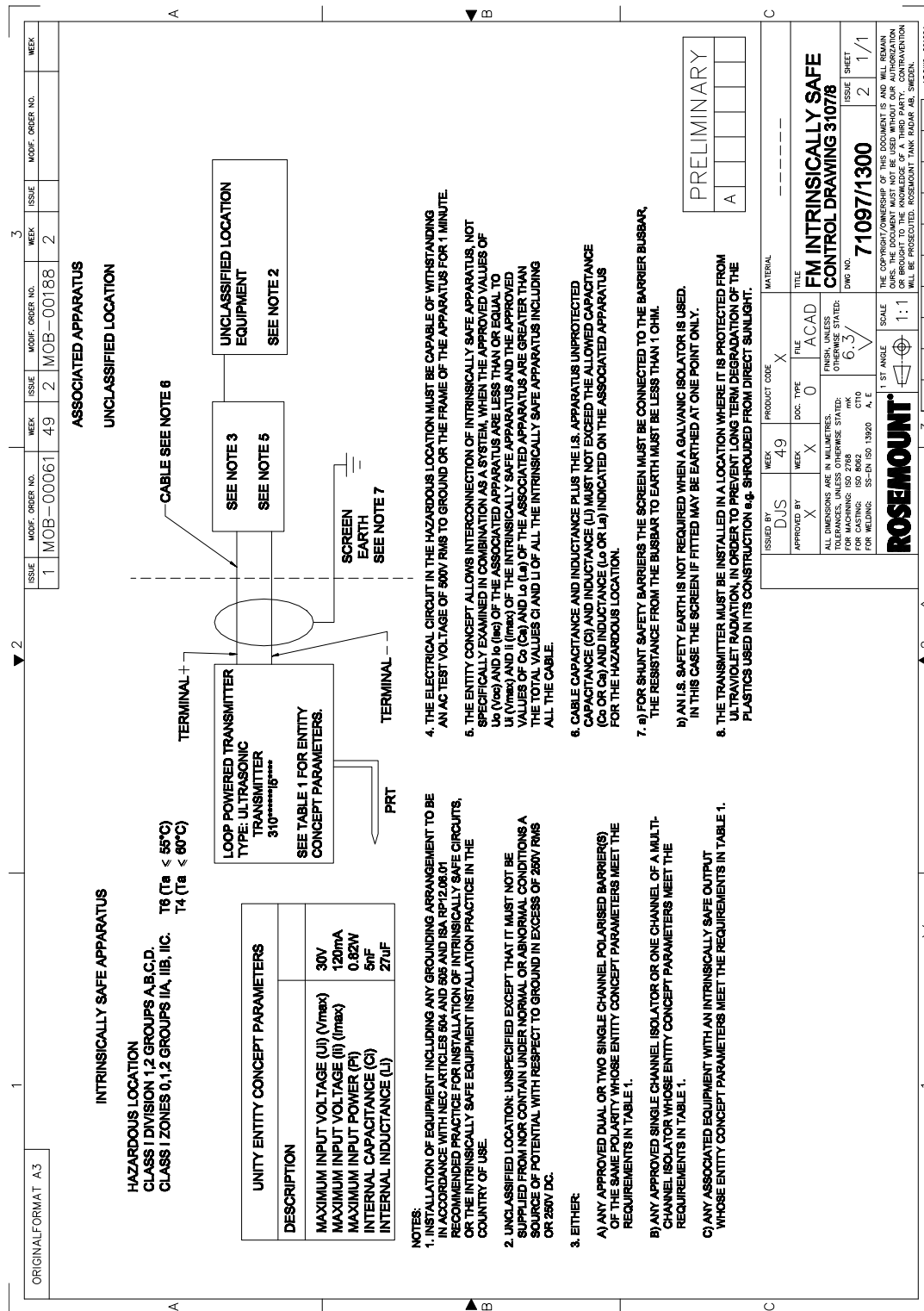

Appendix C Rosemount 3490 Series Universal Control Unit

C.1 Menus and parameters

The Rosemount 3107 and Rosemount 3108 can be used with the Rosemount 3490 Series Control Unit ([Table C-1 on page C-128](#)). This control unit supplies the 24 Vdc loop-power to the transmitter, and provides control functionality using the 4–20 mA and HART signals from the transmitter.

The control unit has HART communications capability, and access to all of the parameters of the transmitter as shown in the following pages.

Note

- The Rosemount 3490 Series manual (Document No. 00809-0100-4841) provides detailed instructions on the use and features of the control unit.
-

Menu Level 1 (Setup)	Menu Level 2 (Engineering)	Menu Level 3 (Advanced)	Menu Level 4	Parameter ID and Descriptor	3107 Default Settings				3108 Default Settings				
					Units	m	ft	In	m	ft	In	in	
				P048	Threshold 1 Size (page 69)	%	4.0	4.0	4.0	4.0	4.0	4.0	4.0
				P049	Spike Rejection (page 73)	-	0	0	0	0	0	0	0
			FALSE ECHO DATA	P081	False Echo D 1 (page 74)	(2)	0.0	0.0	0.0	0.0	0.0	0.0	0.0
				P082	False Echo S 1 (page 74)	%	0.0	0.0	0.0	0.0	0.0	0.0	0.0
				P083	False Echo D 2 (page 74)	(2)	0.0	0.0	0.0	0.0	0.0	0.0	0.0
				P084	False Echo S 2 (page 74)	%	0.0	0.0	0.0	0.0	0.0	0.0	0.0
				P085	False Echo D 3 (page 74)	(2)	0.0	0.0	0.0	0.0	0.0	0.0	0.0
				P086	False Echo S 3 (page 74)	%	0.0	0.0	0.0	0.0	0.0	0.0	0.0
				P087	False Echo D 4 (page 74)	(2)	0.0	0.0	0.0	0.0	0.0	0.0	0.0
				P088	False Echo S 4 (page 74)	%	0.0	0.0	0.0	0.0	0.0	0.0	0.0
				D980	No. of False Echoes Stored	-	-	-	-	-	-	-	-
				P089	Clear False Echoes (page 75)	-	-	-	-	-	-	-	-
					LEARN FALSE ECHO (page 23)	-	-	-	-	-	-	-	-
					AUTO TANK MAP (page 24)	-	-	-	-	-	-	-	-
					SIMULATION (page 25)	-	-	-	-	-	-	-	-
					FIX CURRENT (page 29)	-	-	-	-	-	-	-	-
			TRIM		TRIM 4mA (page 30)	-	-	-	-	-	-	-	-
						TRIM 20mA (page 31)	-	-	-	-	-	-	-
					RESTART DEVICE (page 27)	-	-	-	-	-	-	-	-
					LOAD DEFAULTS (page 28)	-	-	-	-	-	-	-	-
					FACTORY USE	-	-	-	-	-	-	-	-
					Base Units (page 20)	-	-	-	-	-	-	-	-
			FIXED	P004	Final Assembly Num. (page 34)	-	-	(Factory Set)	-	(Factory Set)	-	(Factory Set)	-
				P005	Serial Number (page 35)	-	-	(Factory Set)	-	(Factory Set)	-	(Factory Set)	-
				P970	Transducer Material (page 76)	-	-	PVC	-	PVC	-	PVC	-
				D949	Model Code (page 100)	-	-	51 (=3107)	-	50 (=3108)	-	50 (=3108)	-
				D951	Poll Address (page 77)	-	-	0	-	0	-	0	-
				D952	Hardware Revision (page 101)	-	-	(Factory Set)	-	(Factory Set)	-	(Factory Set)	-
				D953	Software Revision (page 102)	-	-	(Factory Set)	-	(Factory Set)	-	(Factory Set)	-
				D960	Manufacturer (page 103)	-	-	Rosemount	-	Rosemount	-	Rosemount	-
				D961	Unique ID (page 104)	-	-	(Factory Set)	-	(Factory Set)	-	(Factory Set)	-
				D962	HART Revision (page 105)	-	5	5	5	5	5	5	5
				D963	Field Device Rev. (page 106)	-	-	(Factory Set)	-	(Factory Set)	-	(Factory Set)	-
				D964	Preambles (page 107)	-	5	5	5	5	5	5	5
				D965	Flags (page 108)	-	-	-	-	-	-	-	-
				D900	Primary Variable (page 84)	As P012	-	-	-	-	-	-	-
				D901	Level (SV) (page 85)	(2)	-	-	-	-	-	-	-
				D902	Distance (TV) (page 86)	(2)	-	-	-	-	-	-	-
				D903	Temperature (FV) (page 87)	°C or °F	-	-	-	-	-	-	-
MONITOR (1)	READINGS	VARIABLES											

Menu Level 1 (Monitor)	Menu Level 2 (Readings) DIAGNOSTICS	Menu Level 3 CURRENT	Menu Level 4	Parameter ID and Descriptor	Units	3107 Default Settings			3108 Default Settings							
						m	ft	In	m	ft	in					
				D906	Current Output (page 89)	-	-	-	-	-	-	-	-	-	-	-
				D905	% Current Output (page 88)	%	-	-	-	-	-	-	-	-	-	-
				D910	Distance (page 90)	(2)	-	-	-	-	-	-	-	-	-	-
				D911	Echo Size (page 91)	%	-	-	-	-	-	-	-	-	-	-
				D912	Echo Success (page 92)	%	-	-	-	-	-	-	-	-	-	-
				D913	Target Echoes (page 93)	-	-	-	-	-	-	-	-	-	-	-
				D914	Speed Of Sound (page 94)	m ft in/s	-	-	-	-	-	-	-	-	-	-
				D915	Temperature SoS calc(page 94)	°C or °F	-	-	-	-	-	-	-	-	-	-
				D916	Frequency (page 96)	kHz	-	-	-	-	-	-	-	-	-	-
				D917	Threshold in Use (page 97)	%	-	-	-	-	-	-	-	-	-	-
				D918	Pulses In Use (page 98)	-	-	-	-	-	-	-	-	-	-	-
				D919	Transmit Power (page 99)	-	-	-	-	-	-	-	-	-	-	-
				P003	Date (page 78)	ddmmyy	-	-	-	-	-	-	-	-	-	-
				P046	Max. Temperature (page 78)	°C	-	-	-	-	-	-	-	-	-	-
				P047	Min. Temperature (page 78)	°C	-	-	-	-	-	-	-	-	-	-
				D991	Device Status Group 1	-	-	-	-	-	-	-	-	-	-	-
				D992	Device Status Group 2	-	-	-	-	-	-	-	-	-	-	-
				D993	Device Status Group 3	-	-	-	-	-	-	-	-	-	-	-
				D994	Device Status Group 4	-	-	-	-	-	-	-	-	-	-	-
				D995	Device Status Group 5	-	-	-	-	-	-	-	-	-	-	-
				D996	Device Status Group 6	-	-	-	-	-	-	-	-	-	-	-

(1) Selecting this menu presents a SELECT INSTRUMENT screen if a HART transmitter is assigned to a Current Input channel. Select TRANSMITTER tag to see Menu Level 1 options.

(2) Units are the same as PV Units selection.

(3) These parameters are used by the AMS Device Suite.

Appendix D Field Communicator

D.1 **Menus and parameters**

The Rosemount 3107 and Rosemount 3108 support HART communications, which may be used to program or interrogate the transmitter from any point on the two-wire loop. This appendix contains the full menu structure.

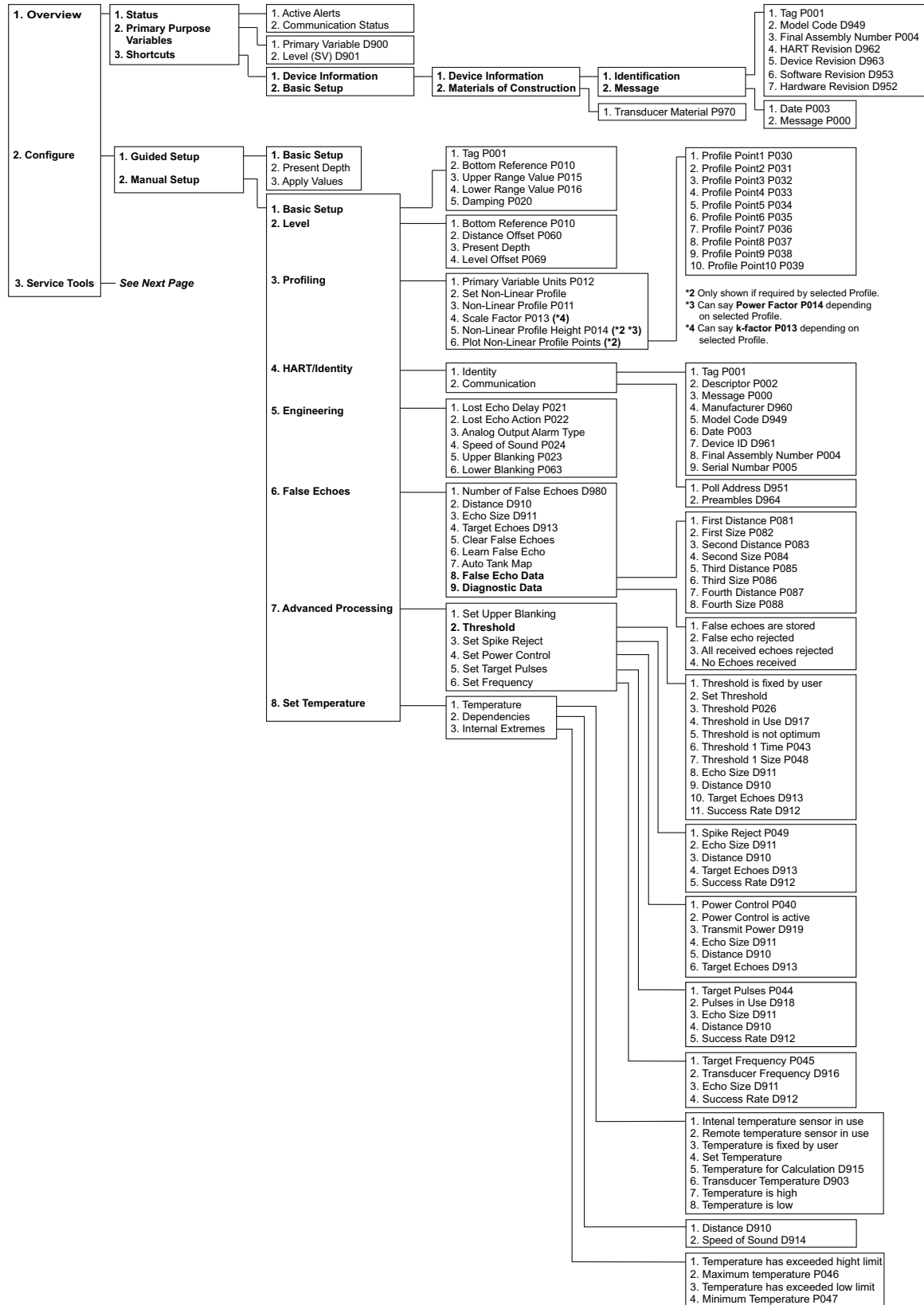

Figure D-1. Rosemount 3107 and 3108 transmitter menus and parameters on a Field Communicator

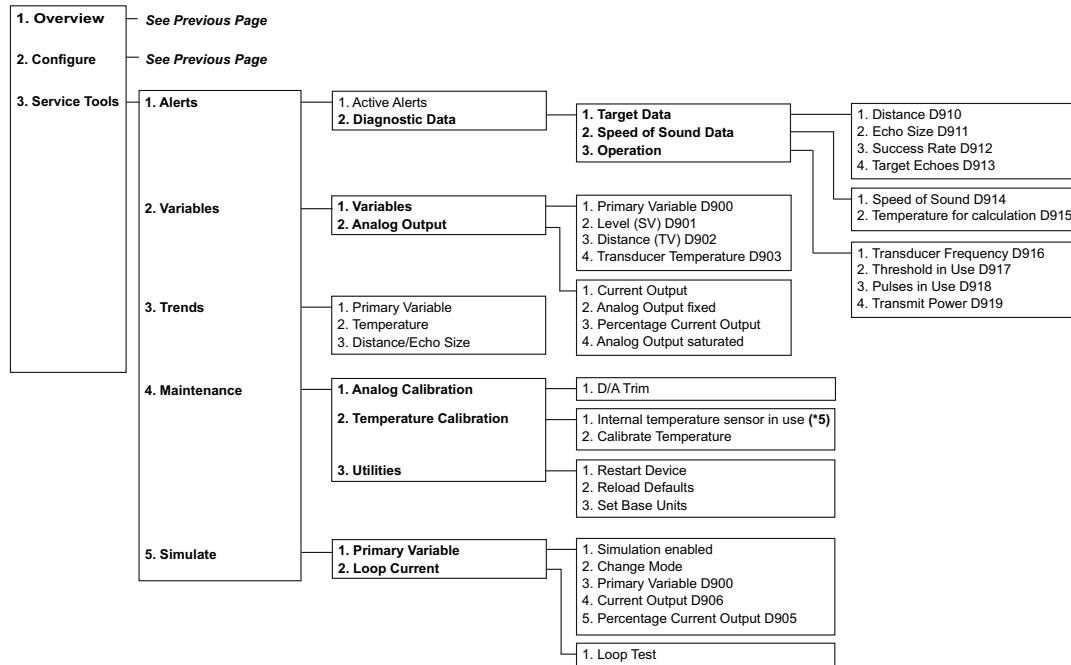





Global Headquarters

Emerson Automation Solutions
6021 Innovation Blvd
Shakopee, MN 55379 USA

 +1 800 999 9307 or +1 952 906 8888
 +1 952 949 7001
 RFQ.RMD-RCC@Emerson.com



North America Regional Office

Emerson Automation Solutions
8200 Market Blvd.
Chanhassen, MN 55317, USA

 +1 800 999 9307 or +1 952 906 8888
 +1 952 949 7001
 RFQ.RMD-RCC@Emerson.com



Latin America Regional Office

Emerson Automation Solutions
Sunrise, FL 33323, USA

 T +1 954 846 5030
 +1 954 846 5121
 RFQ.RMD-RCC@Emerson.com



EUROPE

Emerson Automation Solutions
Neuhofstrasse 19a PO Box 1046
CH-6340 Baar
Switzerland

 T +41 (0) 41 768 6111
 +41 (0) 41 768 6300
 RFQ.RMD-RCC@Emerson.com



ASIA-PACIFIC

Emerson Automation Solutions
1 Pandan Crescent
Singapore 128461
Republic of Singapore

 +65 6 777 8211
 +65 6 777 0947
 Enquiries@AP.Emerson.com

MIDDLE EAST AND AFRICA

Emerson Automation Solutions
Emerson FZE
Jebel Ali Free Zone
Dubai, United Arab Emirates, P.O. Box 17033

 +971 4 811 8100
 +971 4 886 5465
 RFQ.RMTMEA@Emerson.com

 [Linkedin.com/company/Emerson-Automation-Solutions](https://www.linkedin.com/company/Emerson-Automation-Solutions)

 twitter.com/rosemount_news

 [Facebook.com/Rosemount](https://www.facebook.com/Rosemount)

 [youtube.com/RosemountMeasurement](https://www.youtube.com/RosemountMeasurement)

 [google.com/+RosemountMeasurement](https://plus.google.com/+RosemountMeasurement)

 [AnalyticExpert.com](https://www.analyticexpert.com)

©2019 Emerson. All rights reserved.

The Emerson logo is a trademark and service mark of Emerson Electric Co. Rosemount is mark of one of the Emerson family of companies. All other marks are the property of their respective owners.