

# MOTOR-LESS SINGLE AXIS ACTUATOR

LBAS

LGXS

Familiar motors or drivers can be installed.

There are abundant lead variations and specifications suitable for the customer's needs can be selected.



## ■ Easy selection

The tact time and service life can be calculated easily at [YAMAHA's website](#).

# For a wide range of usage from positioning to conveyance.

## Basic model LBAS

P.204



- High Rigidity
- Compact
- Low Cost

- Maximum payload 2 kg to 100 kg
- Maximum speed 300 to 1,333 mm/sec
- Stroke 50 to 1,100 mm

## Advanced model LGXS

P.210



- High Precision Accuracy Class C5
- High Durability
- Clean specification as a standard feature

- Maximum payload 2 kg to 160 kg
- Maximum speed 300 to 2,400 mm/sec
- Stroke 50 to 1,450 mm

Model	Adaptable motor (W)	Stroke (mm)	Maximum speed (mm/sec.) <sup>Note 1</sup> (or equivalent)	Ball screw lead (mm)	Maximum payload <sup>Note 2</sup> (or equivalent)		Page	
					Horizontal	Vertical		
Basic model	LBAS04	50	50 to 800 (50 pitch)	800	12	12	2	P.204
				400	6	20	5	
	LBAS05	100	50 to 800 (50 pitch)	1333	20	12	3	P.206
				666	10	24	6	
	LBAS08	200	50 to 1100 (50 pitch)	333	5	40	12	P.208
				1200	20	40	8	
Advanced model	LGXS05	50	50 to 800 (50 pitch)	600	10	80	20	P.210
				1333	20	40	8	
				333	5	100	30	
	LGXS05L	100	50 to 800 (50 pitch)	1333	20	12	3	P.212
				666	10	24	6	
				333	5	32	12	
	LGXS07	100	50 to 1100 (50 pitch)	1800	30	10	2	P.214
				1200	20	25	4	
				600	10	45	8	
				300	5	85	16	
	LGXS10	200	100 to 1250 (50 pitch)	1800	30	25	4	P.216
				1200	20	40	8	
				600	10	80	20	
				300	5	100	30	
	LGXS12	400	100 to 1250 (50 pitch)	1800	30	35	8	P.218
				1200	20	50	15	
				600	10	95	25	
				300	5	115	45	
	LGXS16	750	100 to 1450 (50 pitch)	2400	40	45	12	P.220
				1200	20	95	28	
				600	10	130	55	
	LGXS20	750	100 to 1450 (50 pitch)	2400	40	65	15	P.222
				1200	20	130	35	
				600	10	160	65	

Note 1. When a moving distance is short and depending on an operation condition, it may not reach the maximum speed.  
 Note 2. The rated thrust and maximum transferable weight are values assuming the attached motor outputs the rated torque.

# Common features of Robonity Series

Wide range of selection for transfer and positioning application  
 Wide variety of ball screw lead and stroke length to choose from

## POINT 1

### Supports major brands and standards ▶ Build a system with motor/driver of your choice

In addition to the conventional servomotors, stepping motors are also newly supported and actuators can be used in accordance with customers' needs.

\* For the supported models and capacities, refer to the specification page P.201.

#### LBAS Supported motor manufacturers

##### [Servo motor]

Yasukawa Electric	Mitsubishi Electric	KEYENCE
OMRON	SANYO DENKI	TAMAGAWA SEIKI
DELTA ELECTRONICS	Panasonic	FANUC
Siemens AG	Rockwell Automation, Inc.	
Schneider Electric SA	KINGSERVO Hoof automation CO., LTD.	
Beckhoff Automation GmbH & Co. KG		

##### [Stepping motor]

Oriental Motor

##### [NEMA standards]

NEMA17 NEMA23

#### LGXS Supported motor manufacturers

##### [Servo motor]

- Yasukawa Electric
- Mitsubishi Electric
- KEYENCE
- OMRON
- Panasonic

## POINT 2

### Easy selection ▶ Easy simulation of cycle time and service life of motorless single axis actuator.

Simulator on web site will provide cycle time and service life of ball screw or guide.  
 Selection of most suitable model with confidence.

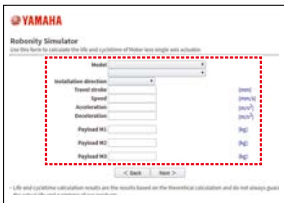

Just enter simple parameters ...

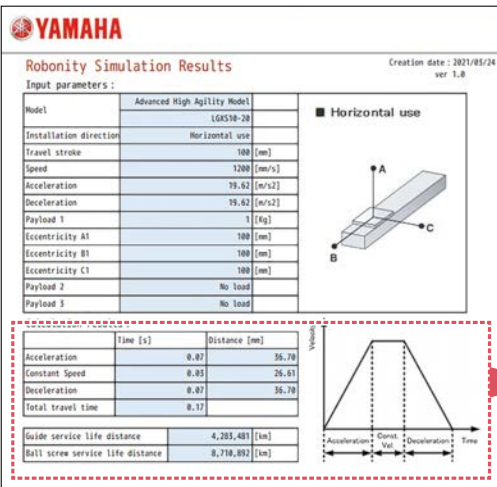

Easy Automatic calculation

- Acceleration/deceleration time
- Uniform velocity time
- Total movement time
- Uniform velocity distance
- Life distance of guide
- Life distance of ball screw

Access the website below.



[https://robot.yamaha-motor.co.jp/robot/member/motorless\\_eng/motorless.php](https://robot.yamaha-motor.co.jp/robot/member/motorless_eng/motorless.php)

\* These contents are not available on smartphones.

### POINT 3

#### Most suitable specification from wide range of selection.

Many selection of leads, stroke length, and size to choose from.

### POINT 4

#### Long stroke

Strong length from 50 mm to 1450 mm to choose from.

### POINT 5

#### Compact

Space efficient compact design (20% less than current model).

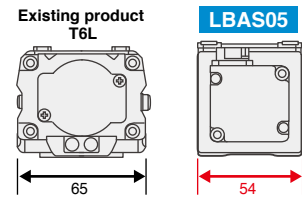

## Basic model LBAS

Newly designed integrated guide rail/frame structure.  
 Improved moment load capacity in compact frame size.  
 Designed to accommodate motors from most leading manufacturers.



### POINT 1

#### High Rigidity

Moment rigidity is increased approximately three times from current models.

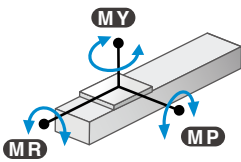

	Existing product T6L	LBAS05		Existing product T9H	LBAS08
MY	35	59	MY	86	221
MP	40	63	MP	133	309
MR	50	103	MR	117	343
		(N · m)			(N · m)

### POINT 2

#### High Precision

Straightness (running parallelism):  
 +/-0.02/800 mm

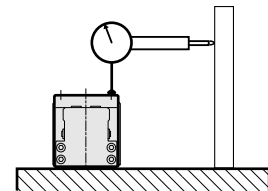

### POINT 3

#### Motor mounting orientation – Easily adjustable with Adapter Kit.

##### Straight type



Standard

##### Bending type



Left



Right



Bottom



### POINT 4

#### Installation process is simple and easy

1. Mounting holes are accessible from top or bottom without disassembling actuator unit.
2. Standard surface on the side and dowel pin holes on the bottom.

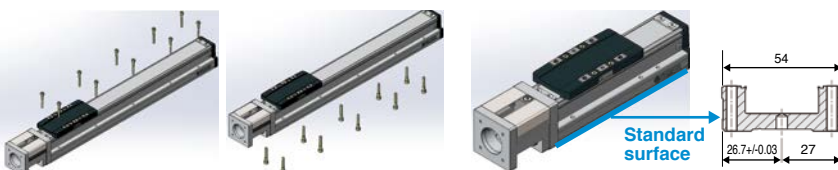

### POINT 5

#### Easy Maintenance

Moving parts can be lubricated from outside without opening actuator

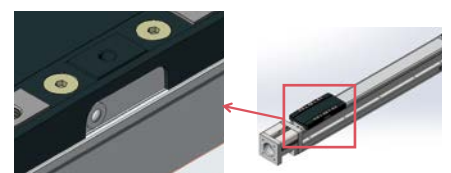

Grease nipple on the slider side surface

## Advanced model LGXS

Higher efficiency, accuracy, and reliability from ground ball screw.  
Ideal for base axis of multi-axis configuration.



### POINT 1

#### Shortest Overall Length

Shortest overall length per effective stroke in industry.

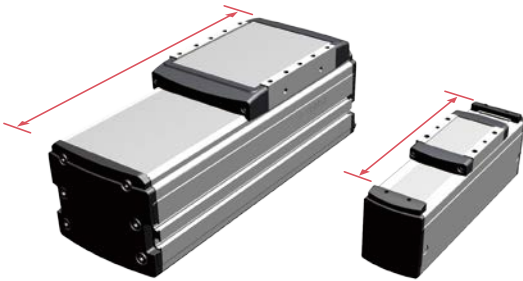

### POINT 2

#### High Precision

- Adopted ground ball screws  
Ball screw Remove Accuracy: Accuracy class C5
- Positioning Remove Accuracy repeatability:  $\pm 5 \mu\text{m}$

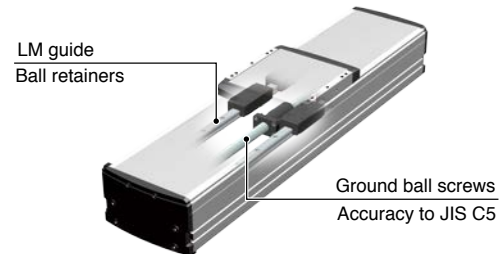

### POINT 3

#### Cleanroom Ready Design

- Protective stainless dust shield
- Ports are ready for vacuum fittings

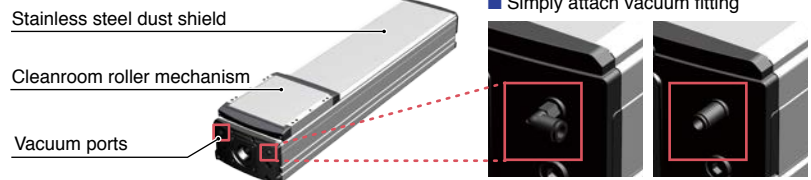

### POINT 4

#### Motor orientation is changeable with optional conversion unit

Choice of motor orientation (standard, right, or left).

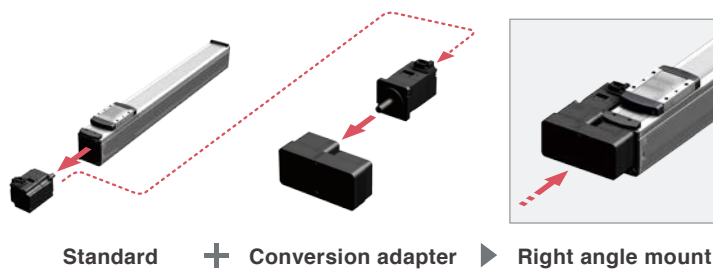



# Maximum acceleration 2G! KAIZEN process of productivity starts from single axis robots.

LGXS series were added to Robonity line to meet the increasing demand of productivity improvement.



## Benefit of higher acceleration/deceleration:

Reduction of operation time in the same lot = increased production volume in the same time



## »» Impact of higher G acceleration/deceleration

### Comparison of tact time with the payload of 1 kg.

For LGXS10-20-100 Comparison of 2G and 0.5G acceleration/deceleration

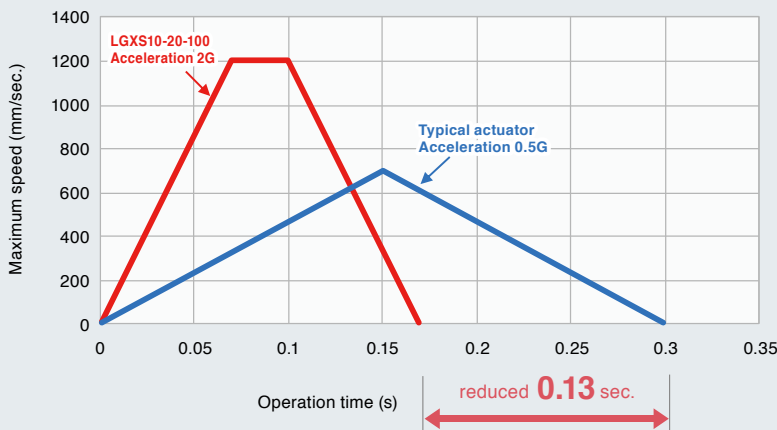

Production volume is increased only by increasing the acceleration/deceleration of the single-axis robot!



### Improvement effect

<Example> Movement stroke is 100 mm. Payload is 1 kg. Robot operates 8 times per cycle.  
Daily operation hours are 8 hours. Robot operates for 20 days every month. Operating ratio is 100%.  
The estimation is made under the above conditions.

	Work time	Robot operation time	Total time	Production volume per hour	Production volume per day	Production volume per month
<b>0.5G</b>	8 sec.	0.3 sec.	10.4 sec.	346 pcs.	2,768 pcs.	55,360 pcs.
<b>2.0G</b>	8 sec.	0.17 sec.	9.36 sec.	384 pcs.	3,072 pcs.	61,440 pcs.

As a result, there is a difference of about 6,000 pcs. (about 10%) in one month under exactly the same operating conditions.





## What's new with advanced LGXS series?

It is a ground ball screw for higher precision, longer life, and better dynamic characteristics.



### Service life when the payload is 1 kg.

For LGXS10-20-100

<Example> Overhang amount  
A: 100mm B: 100mm C: 100mm



**YAMAHA**

### Robonity Simulation Results

Creation date: 2021/05/24  
ver 1.0

Input parameters:

Model	Advanced High Agility Model
Installation direction	Horizontal use
Travel stroke	100 [mm]
Speed	1200 [mm/s]
Acceleration	19.62 [m/s <sup>2</sup> ]
Deceleration	19.62 [m/s <sup>2</sup> ]
Payload 1	1 [kg]
Eccentricity A1	100 [mm]
Eccentricity B1	100 [mm]
Eccentricity C1	100 [mm]
Payload 2	No load
Payload 3	No load

■ Horizontal use

Time [s]	Distance [mm]
Acceleration	0.07 36.70
Constant Speed	0.05 26.61
Deceleration	0.07 36.70
Total travel time	0.17

Guide service life distance	4,283,401 [km]
Ball screw service life distance	8,710,892 [km]



A robot is a robot...  
regardless of brand...isn't it?

No, Not all linear actuators are created equal.



### From Yamaha R&D

Yamaha's single-axis robots have excellent durability and long product service life. The "Robonity" series has been evolved further. By utilizing our accumulated know-how and the features of each component to the maximum extent, the products confidently meet various needs of our customers, such as low cost, productivity, space saving, and quality improvement.

Please contact Yamaha representative for all features Robonity series provide.



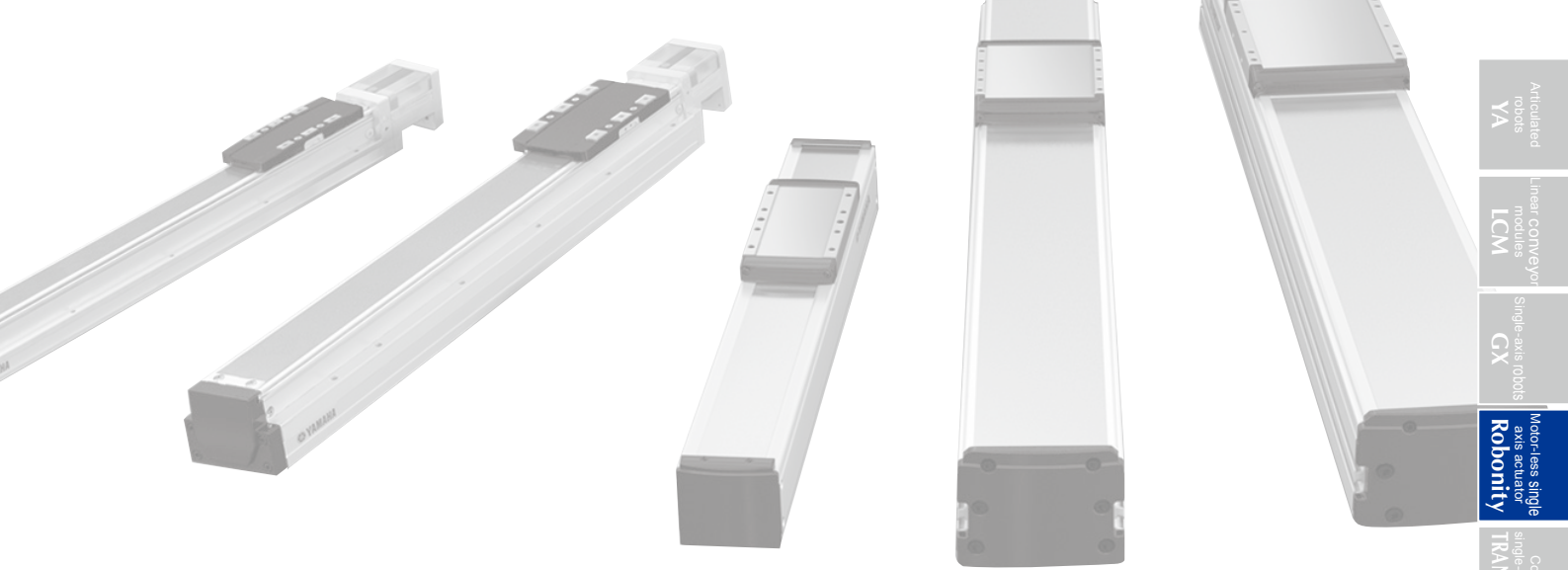

Articulated robots YA	Linear conveyor modules LCM	Single-axis robots CX	Motor-less single axis actuator <b>Robonity</b>	Compact single-axis robots TRANSEVO	Single-axis robots FLIP-X	Linear motor single-axis robots PHASER	Cartesian robots XY-X	SCARA robots YK-X	Pick & Place robots YP-X	CLEAN	CONTROLLER	INFORMATION	LBAS	LGXS	Option
--------------------------	--------------------------------	--------------------------	--	--	------------------------------	---	--------------------------	----------------------	-----------------------------	-------	------------	-------------	------	------	--------

## MOTOR-LESS SINGLE AXIS ACTUATOR

# Robonity

## SERIES

### CONTENTS

■ Basic Specifications List ...202

■ Robot ordering method terminology ..203

#### Basic model

LBAS04.....204

LBAS05.....206

LBAS08.....208

#### Advanced model

LGXS05.....210

LGXS05L.....212

LGXS07.....214

LGXS10.....216

LGXS12.....218

LGXS16.....220

LGXS20.....222

● External Sensor Installation Guide  
(Left side shown) ..... 224

● Reference guide for right angle motor mount  
(Right side shown) ..... 227

● Acceleration/Deceleration and Inertia Moment... 228

# Robonity Specifications List

A motor is not attached to this product.  
For a motor and driver, prepare, attach, and adjust by the customer.

## Basic model LBAS

Model	LBAS04				LBAS05				LBAS08		
Adaptable motor	50 W				100 W				200 W		
Repeatability <sup>Note 1</sup>	±0.01 mm				±0.01 mm				±0.01 mm		
Deceleration mechanism	Shifting position ball screw φ 10 (C7 class)				Shifting position ball screw φ 12 (C7 class)				Shifting position ball screw φ 16 (C7 class)		
Stroke	50 mm to 800 mm (50 mm pitch)				50 mm to 800 mm (50 mm pitch)				50 mm to 1100 mm (50 mm pitch)		
Maximum speed <sup>Note 2</sup> (or equivalent)	800 mm/sec		400 mm/sec		1333 mm/sec	666 mm/sec	333 mm/sec	133 mm/sec	1200 mm/sec	600 mm/sec	300 mm/sec
Ball screw lead	12 mm		6 mm		20 mm	10 mm	5 mm	2 mm	20 mm	10 mm	5 mm
Maximum payload <sup>Note 3</sup> (or equivalent)	12 kg		20 kg		12 kg	24 kg	40 kg	45 kg	40 kg	80 kg	100 kg
	2 kg		5 kg		3 kg	6 kg	12 kg	15 kg	8 kg	20 kg	30 kg
Rated thrust <sup>Note 3</sup> (or equivalent)	71 N		141 N		84 N	169 N	339 N	854 N	174 N	341 N	683 N
Maximum dimensions of cross section of main unit	W 44 mm × H 52 mm				W 54 mm × H 60 mm				W 82 mm × H 78 mm		
Overall length	ST + 214 mm				ST + 220.5 mm				ST + 278 mm		
Using ambient temperature and humidity	0 to 40 °C, 35 to 80 %RH (non-condensing)										
Detailed info page	<a href="#">P204</a>				<a href="#">P206</a>				<a href="#">P208</a>		

Note 1. Positioning repeatability in one direction.  
Note 2. When a moving distance is short and depending on an operation condition, it may not reach the maximum speed.  
Note 3. The rated thrust and maximum transferable weight are values assuming the attached motor outputs the rated torque.

## Advanced model LGXS

Model	LGXS05				LGXS05L				LGXS07			
Adaptable motor	50 W				100 W				100 W			
Repeatability <sup>Note 1</sup>	±0.005 mm				±0.005 mm				±0.005 mm			
Deceleration mechanism	Ground ball screw φ 12 (C5 class)				Ground ball screw φ 12 (C5 class)				Ground ball screw φ 15 (C5 class)			
Stroke	50 mm to 800 mm (50 mm pitch)				50 mm to 800 mm (50 mm pitch)				50 mm to 1100 mm (50 mm pitch)			
Maximum speed <sup>Note 2</sup> (or equivalent)	1333 mm/sec	666 mm/sec	333 mm/sec	1333 mm/sec	666 mm/sec	333 mm/sec	1800 mm/sec	1200 mm/sec	600 mm/sec	300 mm/sec		
Ball screw lead	20 mm	10 mm	5 mm	20 mm	10 mm	5 mm	30 mm	20 mm	10 mm	5 mm		
Maximum payload <sup>Note 3</sup> (or equivalent)	5 kg		8 kg		13 kg		12 kg		24 kg		32 kg	
	2 kg		4 kg		8 kg		3 kg		6 kg		12 kg	
Rated thrust <sup>Note 3</sup> (or equivalent)	41 N		69 N		138 N		84 N		169 N		339 N	
Maximum dimensions of cross section of main unit	W 48 mm × H 65 mm				W 48 mm × H 65 mm				W 70 mm × H 76.5 mm			
Overall length	ST + 131.5 mm				ST + 161.5 mm				ST + 202 mm			
Degree of cleanliness <sup>Note 4</sup>	ISO CLASS 3 (ISO14644-1) or equivalent											
Intake air <sup>Note 5</sup>	30 Nℓ/min to 100 Nℓ/min				30 Nℓ/min to 100 Nℓ/min				30 Nℓ/min to 115 Nℓ/min			
Using ambient temperature and humidity	0 to 40 °C, 35 to 80 %RH (non-condensing)											
Detailed info page	<a href="#">P210</a>				<a href="#">P212</a>				<a href="#">P214</a>			

Model	LGXS10				LGXS12				LGXS16				LGXS20			
Adaptable motor	200 W				400 W				750 W				750 W			
Repeatability <sup>Note 1</sup>	±0.005 mm				±0.005 mm				±0.005 mm				±0.005 mm			
Deceleration mechanism	Ground ball screw φ 15 (C5 class)				Ground ball screw φ 15 (C5 class)				Ground ball screw φ 20 (C5 class)				Ground ball screw φ 20 (C5 class)			
Stroke	100 mm to 1250 mm (50 mm pitch)				100 mm to 1250 mm (50 mm pitch)				100 mm to 1450 mm (50 mm pitch)				100 mm to 1450 mm (50 mm pitch)			
Maximum speed <sup>Note 2</sup> (or equivalent)	1800 mm/sec	1200 mm/sec	600 mm/sec	300 mm/sec	1800 mm/sec	1200 mm/sec	600 mm/sec	300 mm/sec	2400 mm/sec	1200 mm/sec	600 mm/sec	2400 mm/sec	1200 mm/sec	600 mm/sec		
Ball screw lead	30 mm	20 mm	10 mm	5 mm	30 mm	20 mm	10 mm	5 mm	40 mm	20 mm	10 mm	40 mm	20 mm	10 mm		
Maximum payload <sup>Note 3</sup> (or equivalent)	25 kg		40 kg		80 kg		100 kg		35 kg		50 kg		95 kg		115 kg	
	4 kg		8 kg		20 kg		30 kg		8 kg		15 kg		25 kg		45 kg	
Rated thrust <sup>Note 3</sup> (or equivalent)	113 N		170 N		341 N		683 N		225 N		339 N		678 N		1360 N	
Maximum dimensions of cross section of main unit	W 100 mm × H 99.5 mm				W 125 mm × H 101 mm				W 160 mm × H 130 mm				W 200 mm × H 140 mm			
Overall length	ST + 175.5 mm				ST + 211.5 mm				ST + 242.5 mm				ST + 288.5 mm			
Degree of cleanliness <sup>Note 4</sup>	ISO CLASS 3 (ISO14644-1) or equivalent															
Intake air <sup>Note 5</sup>	30 Nℓ/min to 90 Nℓ/min															
Using ambient temperature and humidity	0 to 40 °C, 35 to 80 %RH (non-condensing)															
Detailed info page	<a href="#">P216</a>				<a href="#">P218</a>				<a href="#">P220</a>				<a href="#">P222</a>			

Note 1. Positioning repeatability in one direction.  
Note 2. When a moving distance is short and depending on an operation condition, it may not reach the maximum speed.  
Note 3. The rated thrust and maximum transferable weight are values assuming the attached motor outputs the rated torque.  
Note 4. When using in a clean environment, attach a suction air joint. The degree of cleanliness is the cleanliness level achieved when using at 1000 mm/sec or less.  
Note 5. The required suction amount will vary according to the operating conditions and operating environment.

# Robot ordering method terminology

Articulated  
robots  
YA

Linear conveyor  
modules  
LCM

Single-axis robots  
CX

Motorless single  
axis actuator  
Robotivity

Compact  
single-axis robots  
TRANSERVO

Single-axis robots  
FLIP-X

Linear motor  
single-axis robots  
PHASER

Cartesian  
robots  
XY-X

SCARA  
robots  
YK-X

Pick & Place  
robots  
YP-X

CLEAN

CONTROLLER

INFORMATION

LBAS

LGXS

Option

## [Basic model LBAS]

① Model	Fill in the model of the motorless actuator main body.
② Lead designation	Select the ball screw lead.
③ Shape	Select the actuator shape. <b>S</b> : Straight <b>A</b> : Bending
④ Motor specification	<p><b>[Adaptable Servo Motor]</b>  <b>Y</b> : Yaskawa Electric Corp.                  Keyence Corp.                  Mitsubishi Electric Corp.                  Omron Electronics                  Panasonic Corp. (MHMF5A / MHMF01)                  Sanyo Denki                  Tamagawa Seiki                  Delta Electronics                  Fanuc Corp.                  Siemens AG                  Rockwell Automation, Inc.                  Schneider Electric SA                  KINGSERVO Hoof automation CO., LTD.                  Beckhoff Automation GmbH &amp; Co. KG</p> <p><b>P</b> : Panasonic Corp. (MSMD / MSMF / MHMF02)  <b>K</b> : KINGSERVO Hoof automation CO., LTD.</p> <p><b>[Applicable stepping motor]</b>  <b>A</b> : Oriental Motor                  (AZM46 / ARM46 / RKS54)  <b>S</b> : Oriental Motor                  (AZM48)  <b>N</b> : NEMA standard                  (NEMA17 / NEMA23)</p>
⑤ Stroke	Select the stroke of the actuator working envelope.

## [Advanced model LGXS]

① Model	Fill in the model of the motorless actuator main body.
② Lead designation	Select the ball screw lead.
③ Side cover (LGXS05/LGXS05L/ LGXS07 only)	Select the side cover when installing any external sensor. <b>No entry</b> : Standard <b>W</b> : With T-groove (both sides) <b>R</b> : With T-groove (right side) <b>L</b> : With T-groove (left side)
④ Motor specification (LGXS10/LGXS12/ LGXS16 / LGXS20 only)	<p><b>[Adaptable Servo Motor]</b>  <b>No entry</b> : Yaskawa Electric Corp.                  Keyence Corp.                  Mitsubishi Electric Corp.</p> <p><b>P</b> : Omron Electronics                  Panasonic Corp.</p>
⑤ Stroke	Select the stroke of the actuator working envelope.

# LBAS04

Basic model

Motor-less Single Axis Actuator



## Ordering method

### LBAS04

Model	Lead	Shape	Motor specification	Stroke
	12: 12 mm 6: 6 mm	S: Straight A: Bending	Y: Y specification (see below) P: P specification (see below) A: A specification (see below) S: S specification (see below) N: N specification (see below)	50 to 800 (50 mm pitch)

### Caution

This system is provided as mechanical actuator unit and not including any adaptors or electric components. Motor, driver and other components required for installation are user's responsibility. Refer to user's manual for installation details. Refer to your motor manual for tuning or adjustment. Vibration or resonance from actuator will affect service life of actuator. The product performance may not be satisfied depending on the compatible motor. For special parts for motor installation, install and adjust on your side.

## Specifications

Adaptable motor	50 W	
Repeatability <sup>Note 1</sup>	+/-0.01 mm	
Deceleration mechanism	Shifting position ball screw $\phi$ 10 (C7 class)	
Stroke	50 mm to 800 mm (50 mm pitch)	
Maximum speed <sup>Note 2</sup> (or equivalent)	800 mm/sec    400 mm/sec	
Ball screw lead	12 mm    6 mm	
Maximum payload <sup>Note 3</sup> (or equivalent)	Horizontal	12 kg    20 kg
	Vertical	2 kg    5 kg
Rated thrust <sup>Note 3</sup> (or equivalent)	Horizontal	71 N    141 N
	Vertical	71 N    141 N
Maximum dimensions of cross section of main unit	W 44 mm x H 52 mm	
Overall length	ST + 214 mm	
Using ambient temperature and humidity	0 to 40 °C, 35 to 80 %RH (non-condensing)	

Note 1. Positioning repeatability in one direction.  
 Note 2. When a moving distance is short and depending on an operation condition, it may not reach the maximum speed.  
 If the effective stroke exceeds 500 mm, the ball screw may resonate. (Critical speed)  
 At this time, make the adjustment to decrease the speed while referring to the maximum speed shown in the table.  
 Note 3. The rated thrust and maximum transferable weight are values assuming the attached motor outputs the rated torque.  
 Note. See P.228 for acceleration/deceleration and inertia moment.

## Allowable overhang <sup>Note</sup>

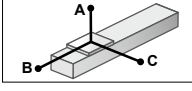
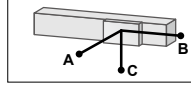
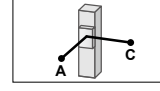
LBAS04-12			
Horizontal installation (Unit: mm)	Wall installation (Unit: mm)	Vertical installation (Unit: mm)	
A	B	C	
2kg: 1187	271	325	
8kg: 473	62	77	
12kg: 431	41	53	

LBAS04-6			
Horizontal installation (Unit: mm)	Wall installation (Unit: mm)	Vertical installation (Unit: mm)	
A	B	C	
4kg: 1808	155	217	
12kg: 801	47	65	
20kg: 546	25	35	

Note. Distance from center of slider top to center of gravity of object being carried at a guide service life of 10,000 km.  
 Note. Service life is calculated for 500 mm stroke models.

## Applicable motor

Adaptable Servo Motor		
Specification	Flange size	<input type="checkbox"/> 40
	Wattage	50 W

Note. Motor models marked with \* may not be 50W, but can be installed.

Motor specification	Manufacturer	Model
Y	Yaskawa Electric Corp.	SGMJV-A5 SGMJJ-A5
	Keyence Corp.	SV-□005 SV2-□005
		HF-KP053 HG-KR053 HK-KT053
	Mitsubishi Electric Corp.	R88M-K05030 R88M-1M05030
	Omron Electronics	MHMF5A R2□A04005
	Parasonic Corp.	TSM3102
	Sanyo Denki	ECMA-C1040F
	Tamagawa Seiki	$\beta$ IS0.2/5000
	Delta Electronics	1FK2102-0AG 1FL6022-2AF
	Fanuc Corp.	BCH2MBA53
	Siemens	AM3011B * TLY-A120 *
	Schneider	MSMD5A
	Beckhoff	MSMF5A
	Allen-Bradley	
	P	Parasonic Corp.

## Applicable stepping motor

Specification	Flange size	<input type="checkbox"/> 42	
A	Oriental Motor	AZM46 ARM46 RKS54	
	S	Oriental Motor	AZM48
		NEMA standard	NEMA17

Note. For the NEMA standard motor, check the shaft diameter and shaft length.  
 Note. For the motor specifications A, S, and N, the parts dedicated for bending cannot be used.

## Static loading moment

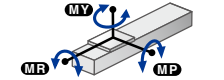

	MY	MP	MR
(Unit: N·m)	54	54	75

## LBAS04 Straight type (S)

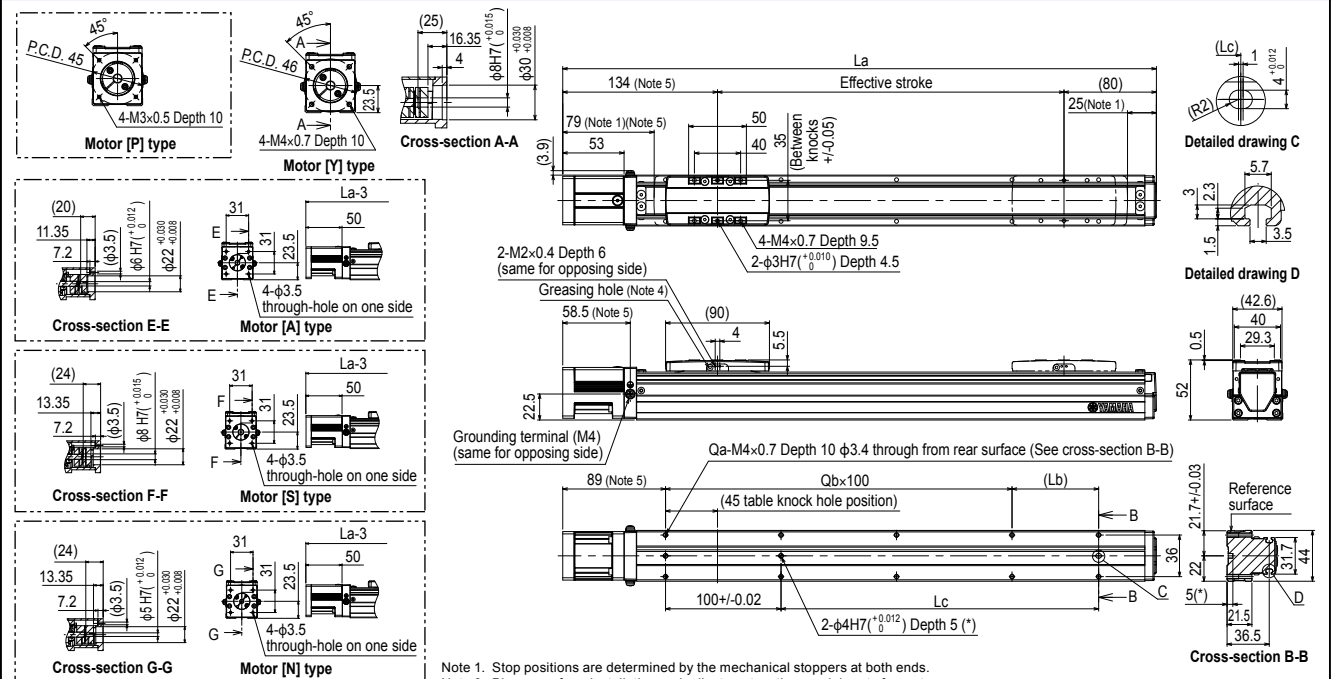

Note 1. Stop positions are determined by the mechanical stoppers at both ends.  
 Note 2. Please perform installation and adjustment on the special parts for motor installation by the customer. For detail, refer to the manual.

Effective stroke	50	100	150	200	250	300	350	400	450	500	550	600	650	700	750	800	
La	264	314	364	414	464	514	564	614	664	714	764	814	864	914	964	1014	
Lb	25	75	25	75	25	75	25	75	25	75	25	75	25	75	25	75	
Lc	25	75	125	175	225	275	325	375	425	475	525	575	625	675	725	775	
Qa	6	6	8	8	10	10	12	12	14	14	16	16	18	18	20	20	
Qb	1	1	2	2	3	3	4	4	5	5	6	6	7	7	8	8	
Weight (kg)	0.9	1.1	1.3	1.5	1.6	1.8	2	2.2	2.4	2.5	2.7	2.9	3.1	3.3	3.4	3.6	
Maximum speed (mm/sec)	Lead 12	800										720	600	480	400	360	320
	Lead 6	400										360	300	240	200	180	160
Speed setting	-										90%	75%	60%	50%	45%	40%	

Note 3. For the installation through hole, the length under head << 30 mm or more >> is recommended for the hex socket head bolts <M3 x 0.5>. In the installation tap hole, the length under head << thickness of stand + 10 mm or less >> is recommended for the hex socket head bolts <M4 x 0.7> used to install the main unit.  
 Note 4. Nozzle set for greasing (recommended) (see P.224 for detail)  
 Part number: KFJ-M3861-00  
 Note 5. For the motor specifications A, S, and N, the dimensions are that those stated in the table << 3 mm >>.

LBAS04 Bending type (A)

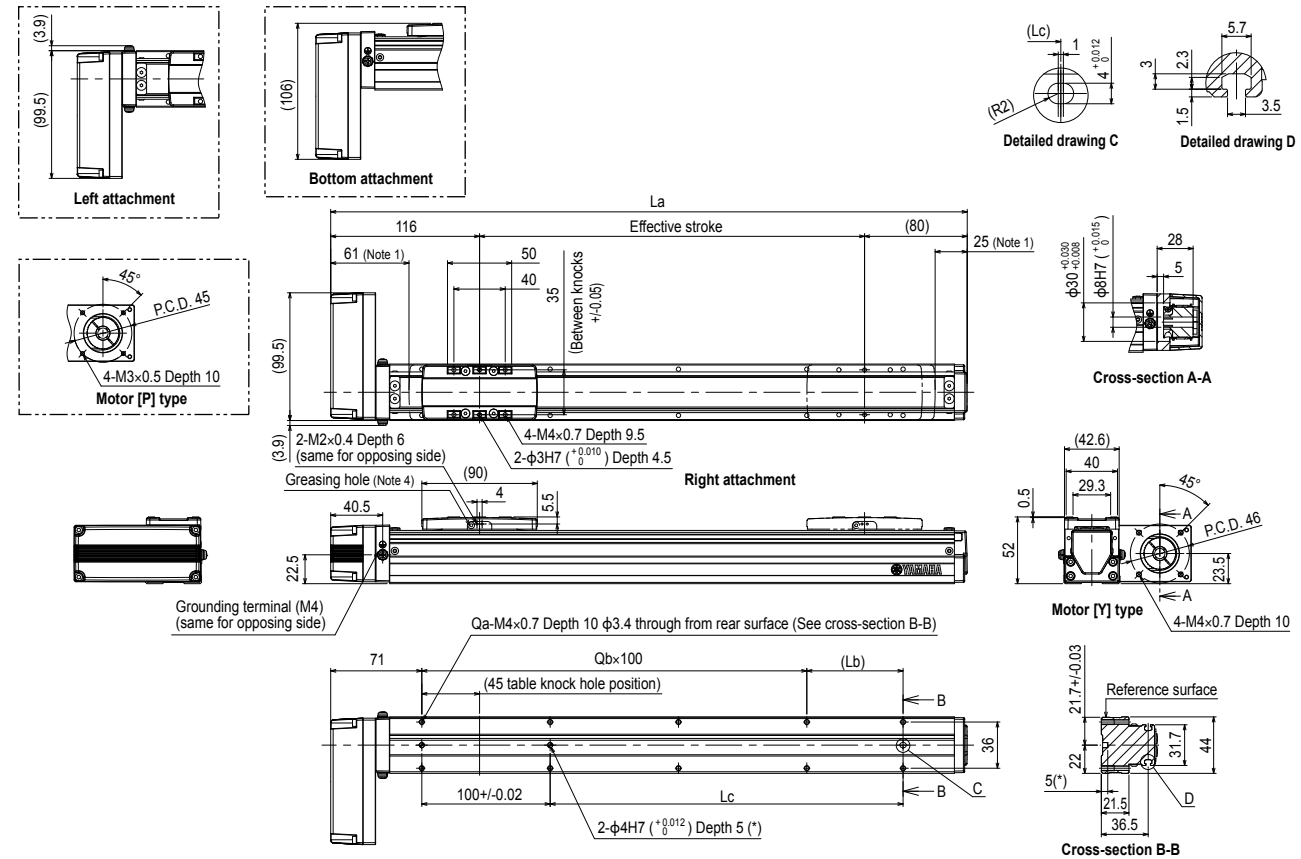

Effective stroke	50	100	150	200	250	300	350	400	450	500	550	600	650	700	750	800	
La	246	296	346	396	446	496	546	596	646	696	746	796	846	896	946	996	
Lb	25	75	25	75	25	75	25	75	25	75	25	75	25	75	25	75	
Lc	25	75	125	175	225	275	325	375	425	475	525	575	625	675	725	775	
Qa	6	6	8	8	10	10	12	12	14	14	16	16	18	18	20	20	
Qb	1	1	2	2	3	3	4	4	5	5	6	6	7	7	8	8	
Weight (kg)	1.1	1.2	1.4	1.6	1.8	1.9	2.1	2.3	2.5	2.7	2.8	3	3.2	3.4	3.6	3.7	
Maximum speed (mm/sec)	Lead 12										800	720	600	480	400	360	320
	Lead 6										400	360	300	240	200	180	160
Speed setting										-	90%	75%	60%	50%	45%	40%	

- Note 1. Stop positions are determined by the mechanical stoppers at both ends.
- Note 2. Please perform installation and adjustment on the special parts for motor installation by the customer. For detail, refer to the manual.
- Note 3. For the installation through hole, the length under head << 30 mm or more >> is recommended for the hex socket head bolts <M3 x 0.5>. In the installation tap hole, the length under head << thickness of stand +10 mm or less >> is recommended for the hex socket head bolts <M4 x 0.7> used to install the main unit.
- Note 4. Nozzle set for greasing (recommended) (see P.224 for detail)  
Part number: KFU-M3861-00



# LBAS05

Basic model

Motor-less Single Axis Actuator

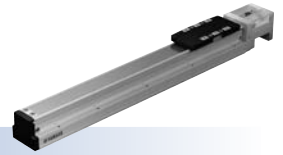

## Ordering method

### LBAS05

Model	Lead	Shape	Motor specification	Stroke
	20: 20 mm 10: 10 mm 5: 5 mm	S: Straight A: Bending	Y: Y specification (see below) P: P specification (see below) A: A specification (see below) S: S specification (see below) N: N specification (see below)	50 to 800 (50 mm pitch)

### [Caution]

This system is provided as mechanical actuator unit and not including any adapters or electric components. Motor, driver and other components required for installation are user's responsibility. Refer to user's manual for installation details. Refer to your motor manual for tuning or adjustment. Vibration or resonance from actuator will affect service life of actuator. The product performance may not be satisfied depending on the compatible motor. For special parts for motor installation, install and adjust on your side.

## Specifications

Adaptable motor	100 W
Repeatability <sup>Note 1</sup>	+/-0.01 mm
Deceleration mechanism	Shifting position ball screw $\phi$ 12 (C7 class)
Stroke	50 mm to 800 mm (50 mm pitch)
Maximum speed <sup>Note 2</sup> (or equivalent)	1333 mm/sec    666 mm/sec    333 mm/sec
Ball screw lead	20 mm    10 mm    5 mm
Maximum payload <sup>Note 3</sup> (or equivalent)	Horizontal: 12 kg    24 kg    40 kg Vertical: 3 kg    6 kg    12 kg
Rated thrust <sup>Note 3</sup> (or equivalent)	84 N    169 N    339 N
Maximum dimensions of cross section of main unit	W 54 mm x H 60 mm
Overall length	ST + 220.5 mm
Using ambient temperature and humidity	0 to 40 °C, 35 to 80 %RH (non-condensing)

Note 1. Positioning repeatability in one direction.  
 Note 2. When a moving distance is short and depending on an operation condition, it may not reach the maximum speed. If the effective stroke exceeds 550 mm, the ball screw may resonate. (Critical speed)  
 At this time, make the adjustment to decrease the speed while referring to the maximum speed shown in the table.  
 Note 3. The rated thrust and maximum transferable weight are values assuming the attached motor outputs the rated torque.  
 Note. See P.229 for acceleration/deceleration and inertia moment.

## Allowable overhang <sup>Note</sup>

LBAS05-20	Horizontal installation (Unit: mm)			Wall installation (Unit: mm)			Vertical installation (Unit: mm)		
	A	B	C	A	B	C	A	B	C
2kg	549	324	272	272	324	549	1kg	544	544
8kg	155	73	65	65	73	155	2kg	276	276
12kg	117	46	42	42	46	117	3kg	195	195

LBAS05-10	Horizontal installation (Unit: mm)			Wall installation (Unit: mm)			Vertical installation (Unit: mm)		
	A	B	C	A	B	C	A	B	C
5kg	769	178	213	213	178	769	2kg	443	443
15kg	314	53	64	64	53	314	4kg	218	218
24kg	216	29	36	36	29	216	6kg	142	142

LBAS05-5	Horizontal installation (Unit: mm)			Wall installation (Unit: mm)			Vertical installation (Unit: mm)		
	A	B	C	A	B	C	A	B	C
10kg	921	97	131	131	97	921	3kg	345	345
25kg	459	33	45	45	33	459	8kg	124	124
40kg	436	17	23	23	17	436	12kg	79	79

Note. Distance from center of slider top to center of gravity of object being carried at a guide service life of 10,000 km.  
 Note. Service life is calculated for 500 mm stroke models.

## Static loading moment

	MY	MP	MR
(Unit: N·m)	59	63	103

## LBAS05 Straight type (S)

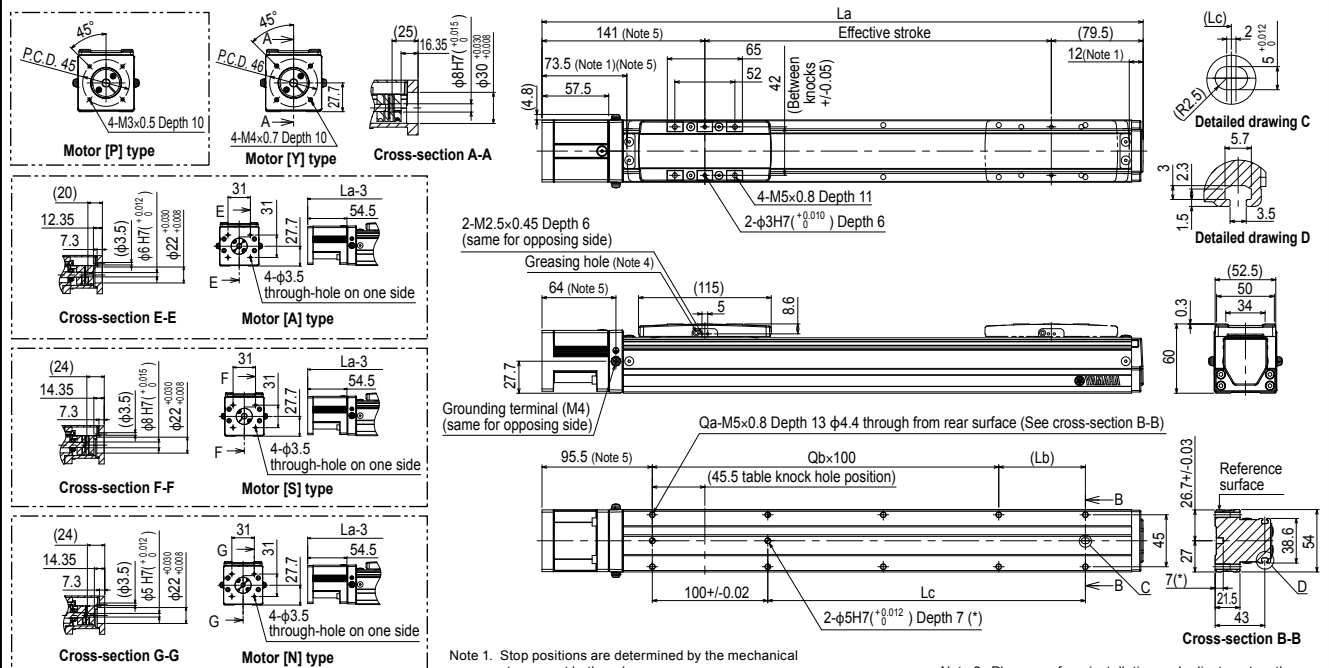

Note 1. Stop positions are determined by the mechanical stoppers at both ends.

Note 2. Please perform installation and adjustment on the special parts for motor installation by the customer. For detail, refer to the manual.

Note 3. For the installation through hole, the length under head << 30 mm or more >> is recommended for the hex socket head bolts <M4 x 0.7>. In the installation tap hole, the length under head << thickness of stand +10 mm or less >> is recommended for the hex socket head bolts <M5 x 0.8> used to install the main unit.

Note 4. Nozzle set for greasing (recommended) (see P.224 for detail)

Note 5. For the motor specifications A, S, and N, the dimensions are that those stated in the table << 3 mm >>.

Effective stroke	50	100	150	200	250	300	350	400	450	500	550	600	650	700	750	800
La	270.5	320.5	370.5	420.5	470.5	520.5	570.5	620.5	670.5	720.5	770.5	820.5	870.5	920.5	970.5	1020.5
Lb	25	75	25	75	25	75	25	75	25	75	25	75	25	75	25	75
Lc	25	75	125	175	225	275	325	375	425	475	525	575	625	675	725	775
Qa	6	6	8	8	10	10	12	12	14	14	16	16	18	18	20	20
Qb	1	1	2	2	3	3	4	4	5	5	6	6	7	7	8	8
Weight (kg)	1.6	1.8	1.9	2.1	2.4	2.5	2.5	2.7	2.8	2.9	3.1	3.3	3.4	3.6	3.7	4.1
Maximum speed (mm/sec)	Lead 20	1333										1133	933	799	666	599
	Lead 10	666										566	466	399	333	299
	Lead 5	333										283	233	199	166	149
Speed setting	-										85%	70%	60%	50%	45%	

LBAS05 Bending type (A)

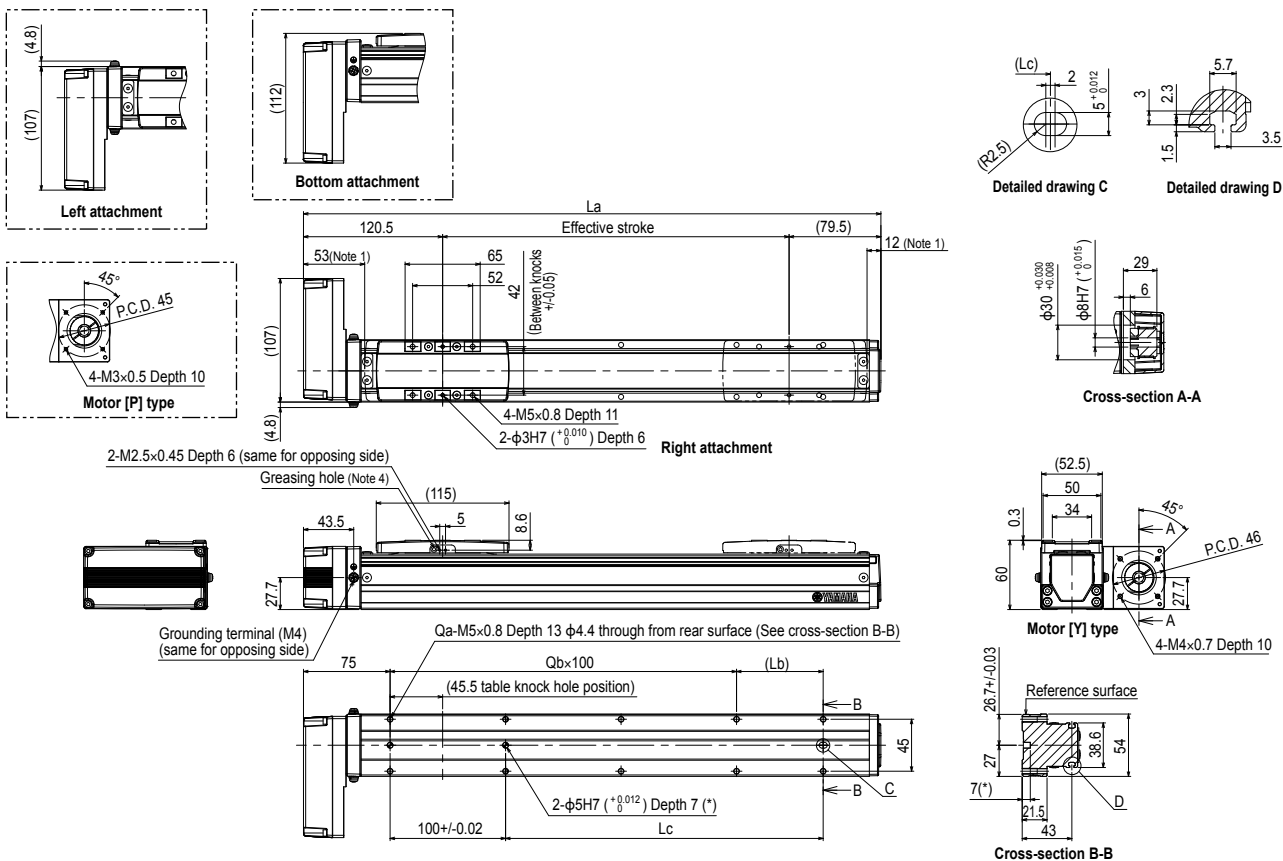

Effective stroke	50	100	150	200	250	300	350	400	450	500	550	600	650	700	750	800
La	250	300	350	400	450	500	550	600	650	700	750	800	850	900	950	1000
Lb	25	75	25	75	25	75	25	75	25	75	25	75	25	75	25	75
Lc	25	75	125	175	225	275	325	375	425	475	525	575	625	675	725	775
Qa	6	6	8	8	10	10	12	12	14	14	16	16	18	18	20	20
Qb	1	1	2	2	3	3	4	4	5	5	6	6	7	7	8	8
Weight (kg)	1.7	1.8	2	2.2	2.4	2.6	2.6	2.8	2.9	3	3.2	3.3	3.5	3.6	3.8	4.1
Maximum speed (mm/sec)	Lead 20	1333														
	Lead 10	666														
	Lead 5	333														
	Speed setting	-														
												85%	70%	60%	50%	45%

- Note 1. Stop positions are determined by the mechanical stoppers at both ends.
- Note 2. Please perform installation and adjustment on the special parts for motor installation by the customer. For detail, refer to the manual.
- Note 3. For the installation through hole, the length under head << 30 mm or more >> is recommended for the hex socket head bolts <M4 x 0.7>. In the installation tap hole, the length under head << thickness of stand + 10 mm or less >> is recommended for the hex socket head bolts <M5 x 0.8> used to install the main unit.
- Note 4. Nozzle set for greasing (recommended) (see P.224 for detail)  
Part number: KFU-M3861-00



# LBAS08

Basic model

Motor-less Single Axis Actuator

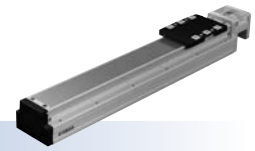

## Ordering method

### LBAS08

Model	Lead	Shape	Motor specification	Stroke
	20: 20 mm 10: 10 mm 5: 5 mm	S: Straight A: Bending	Y: Y specification (see below) P: P specification (see below) K: K specification (see below) A: A specification (see below) N: N specification (see below)	50 to 1100 (50 mm pitch)

### Caution

This system is provided as mechanical actuator unit and not including any adapters or electric components. Motor, driver and other components required for installation are user's responsibility. Refer to user's manual for installation details. Refer to your motor manual for tuning or adjustment. Vibration or resonance from actuator will affect service life of actuator. The product performance may not be satisfied depending on the compatible motor. For special parts for motor installation, install and adjust on your side.

## Specifications

Adaptable motor	200 W
Repeatability <sup>Note 1</sup>	+/-0.01 mm
Deceleration mechanism	Shifting position ball screw $\phi$ 16 (C7 class)
Stroke	50 mm to 1100 mm (50 mm pitch)
Maximum speed (or equivalent)	1200 mm/sec 600 mm/sec 300 mm/sec
Ball screw lead	20 mm 10 mm 5 mm
Maximum payload (or equivalent)	Horizontal 40 kg 80 kg 100 kg Vertical 8 kg 20 kg 30 kg
Rated thrust (or equivalent)	174 N 341 N 683 N
Maximum dimensions of cross section of main unit	W 82 mm x H 78 mm
Overall length	ST + 278 mm
Using ambient temperature and humidity	0 to 40 °C, 35 to 80 %RH (non-condensing)

Note 1. Positioning repeatability in one direction.  
 Note 2. When a moving distance is short and depending on an operation condition, it may not reach the maximum speed. If the effective stroke exceeds 650 mm, the ball screw may resonate. (Critical speed)  
 At this time, make the adjustment to decrease the speed while referring to the maximum speed shown in the table.  
 Note 3. The rated thrust and maximum transferable weight are values assuming the attached motor outputs the rated torque.  
 Note. See P.231 for acceleration/deceleration and inertia moment.

## Allowable overhang <sup>Note</sup>

LBAS08-20		LBAS08-10		LBAS08-5	
Horizontal installation (Unit: mm)		Horizontal installation (Unit: mm)		Horizontal installation (Unit: mm)	
	A B C		A B C		A B C
15kg	356 131 146	30kg	465 83 120	30kg	1604 95 153
25kg	278 73 86	50kg	341 44 65	50kg	1035 52 83
40kg	517 54 76	80kg	228 22 34	80kg	719 27 44
Wall installation (Unit: mm)		Wall installation (Unit: mm)		Wall installation (Unit: mm)	
	A B C		A B C		A B C
15kg	146 131 356	30kg	120 83 465	30kg	153 95 1604
25kg	86 73 278	50kg	65 44 341	50kg	83 52 1035
40kg	76 54 517	80kg	34 22 228	80kg	44 27 719
Vertical installation (Unit: mm)		Vertical installation (Unit: mm)		Vertical installation (Unit: mm)	
	A C		A C		A C
3kg	634 634	5kg	551 551	10kg	312 312
6kg	321 321	10kg	270 270	20kg	149 149
8kg	240 240	20kg	129 129	30kg	95 95

Note. Distance from center of slider top to center of gravity of object being carried at a guide service life of 10,000 km.  
 Note. Service life is calculated for 600 mm stroke models.

## Static loading moment

	MY	MP	MR
(Unit: N·m)	221	309	343

## LBAS08 Straight type (S)

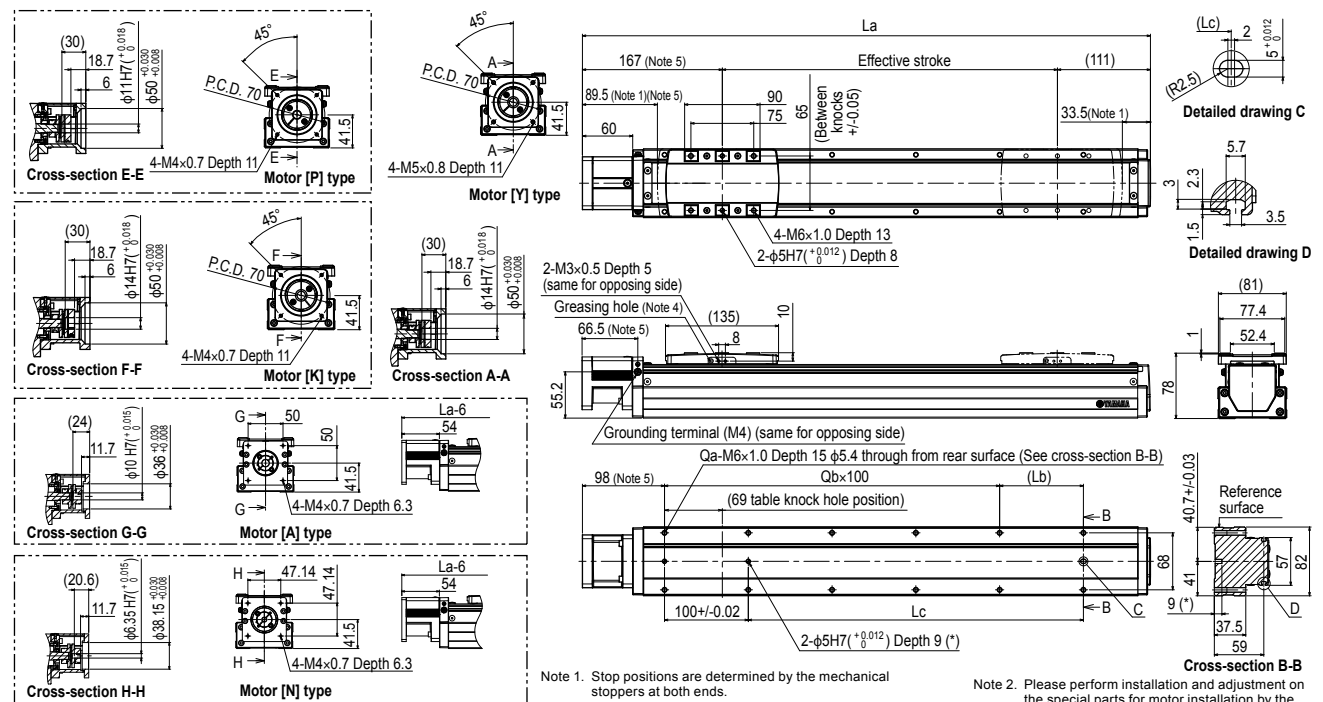

Effective stroke	50	100	150	200	250	300	350	400	450	500	550	600	650	700	750	800	850	900	950	1000	1050	1100						
La	328	378	428	478	528	578	628	678	728	778	828	878	928	978	1028	1078	1128	1178	1228	1278	1328	1378						
Lb	50	100	50	100	50	100	50	100	50	100	50	100	50	100	50	100	50	100	50	100	50	100						
Lc	50	100	150	200	250	300	350	400	450	500	550	600	650	700	750	800	850	900	950	1000	1050	1100						
Qa	6	6	8	8	10	10	12	12	14	14	16	16	18	18	20	20	22	22	24	24	26	26						
Qb	1	1	2	2	3	3	4	4	5	5	6	6	7	7	8	8	9	9	10	10	11	11						
Weight (kg)	3.7	4.1	4.5	4.8	5.2	5.5	5.8	6.2	6.5	6.8	7.2	7.5	7.9	8.2	8.5	8.8	9.2	9.4	9.8	10.1	10.5	10.9						
Maximum speed (mm/sec)	Lead 20	1200																										
	Lead 10	600																										
	Lead 5	300																										
Speed setting		-																										
		1020	900	780	660	600	540	480	420	360	510	450	390	330	300	270	240	210	180	255	225	195	165	150	135	120	105	90
		85%	75%	65%	55%	50%	45%	40%	35%	30%																		

Note 1. Stop positions are determined by the mechanical stoppers at both ends.  
 Note 2. Please perform installation and adjustment on the special parts for motor installation by the customer. For detail, refer to the manual.  
 Note 3. For the installation through hole, the length under head << 45 mm or more >> is recommended for the hex socket head bolts <M5 x 0.8>. In the installation tap hole, the length under head << thickness of stand +15 mm or less >> is recommended for the hex socket head bolts <M6 x 1.0> used to install the main unit.  
 Note 4. Nozzle set for greasing (recommended) (see P.224 for detail)  
 Part number: KFJ-M3861-00  
 Note 5. For the motor specifications A and N the dimensions are that those stated in the table << 3 mm >>.

### LBAS08 Bending type (A)

**Left attachment** (156)

**Bottom attachment** (151.5)

**Motor [K] type**  
 45°  
 P.C.D. 70  
 4-M4×0.7 Depth 12  
 φ50<sup>+0.030</sup>/<sub>-0.008</sub>  
 φ14H7 ( <sup>+0.016</sup>/<sub>0</sub> )  
 34  
 5

**Cross-section F-F**

**Detailed drawing C**  
 (Lc)  
 2  
 15  
 5.7

**Detailed drawing D**  
 3  
 2.3  
 1.5  
 3.5

**Motor [P] type**  
 45°  
 P.C.D. 70  
 φ11H7 ( <sup>+0.018</sup>/<sub>0</sub> )  
 φ50<sup>+0.030</sup>/<sub>-0.008</sub>  
 4-M4×0.7 Depth 12  
 34  
 5

**Cross-section E-E**

**Right attachment**  
 153.5  
 Effective stroke (111)  
 33.5 (Note 1)  
 76 (Note 1)  
 90  
 75  
 65  
 (Between knock holes +0.05)  
 4-M6×1.0 Depth 13  
 2-φ5H7 ( <sup>+0.012</sup>/<sub>0</sub> ) Depth 8

**Cross-section A-A**  
 φ50<sup>+0.030</sup>/<sub>-0.008</sub>  
 φ14H7 ( <sup>+0.016</sup>/<sub>0</sub> )  
 34  
 5

**Motor [Y] type**  
 45°  
 P.C.D. 70  
 4-M5×0.8 Depth 12  
 81  
 77.4  
 52.4  
 78  
 1  
 41.5  
 41  
 40.7±0.03  
 9 (\*)  
 37.5  
 59

**Cross-section B-B**  
 Reference surface  
 57  
 82  
 41  
 37.5  
 59

**Main Assembly Drawing**  
 2-M3×0.5 Depth 5 (same for opposing side)  
 Greasing hole (Note 4)  
 53  
 135  
 8  
 10  
 55.2  
 Grounding terminal (M4) (same for opposing side)  
 Qa-M6×1.0 Depth 15 φ5.4 through from rear surface (See cross-section B-B)  
 Qb×100  
 (69 table knock hole position)  
 (Lb)  
 84.5  
 2-φ5H7 ( <sup>+0.012</sup>/<sub>0</sub> ) Depth 9 (\*)  
 100±0.02  
 Lc  
 68

Effective stroke	50	100	150	200	250	300	350	400	450	500	550	600	650	700	750	800	850	900	950	1000	1050	1100	
La	314.5	364.5	414.5	464.5	514.5	564.5	614.5	664.5	714.5	764.5	814.5	864.5	914.5	964.5	1014.5	1064.5	1114.5	1164.5	1214.5	1264.5	1314.5	1364.5	
Lb	50	100	50	100	50	100	50	100	50	100	50	100	50	100	50	100	50	100	50	100	50	100	
Lc	50	100	150	200	250	300	350	400	450	500	550	600	650	700	750	800	850	900	950	1000	1050	1100	
Qa	6	6	8	8	10	10	12	12	14	14	16	16	18	18	20	20	22	22	24	24	26	26	
Qb	1	1	2	2	3	3	4	4	5	5	6	6	7	7	8	8	9	9	10	10	11	11	
Weight (kg)	4.1	4.5	4.9	5.2	5.6	5.9	6.2	6.6	6.9	7.2	7.6	7.9	8.3	8.6	8.9	9.2	9.6	9.8	10.2	10.5	10.9	11.3	
Maximum speed (mm/sec)	Lead 20	1200																					
	Lead 10	600																					
	Lead 5	300																					
Speed setting	-														85%	75%	65%	55%	50%	45%	40%	35%	30%

**Note 1.** Stop positions are determined by the mechanical stoppers at both ends.

**Note 2.** Please perform installation and adjustment on the special parts for motor installation by the customer. For detail, refer to the manual.

**Note 3.** For the installation through hole, the length under head << 45 mm or more >> is recommended for the hex socket head bolts <M5 × 0.8>. In the installation tap hole, the length under head << thickness of stand +15 mm or less >> is recommended for the hex socket head bolts <M6 × 1.0> used to install the main unit.

**Note 4.** Nozzle set for greasing (recommended) (see P.224 for detail)  
 Part number: KFU-M3861-00

# LGXS05

Advanced model

Motor-less Single Axis Actuator



## Ordering method

### LGXS05

Model	Lead	Side cover	Stroke
	20: 20 mm 10: 10 mm 5: 5 mm	No entry: Standard W: With T-groove (both sides) R: With T-groove (right side) L: With T-groove (left side)	50 to 800 (50 mm pitch)

### [Caution]

This system is provided as mechanical actuator unit and not including any adopters or electric components. Motor, driver and other components required for installation are user's responsibility. Refer to user's manual for installation details. Refer to your motor manual for tuning or adjustment. Vibration or resonance from actuator will affect service life of actuator. The product performance may not be satisfied depending on the compatible motor. The bending unit cannot be used for the high agility model.

## Specifications

Adaptable motor	50 W		
Repeatability <sup>Note 1</sup>	+/-0.005 mm		
Deceleration mechanism	Ground ball screw $\phi$ 12 (C5 class)		
Stroke	50 mm to 800 mm (50 mm pitch)		
Maximum speed (or equivalent)	1333 mm/sec	666 mm/sec	333 mm/sec
	20 mm	10 mm	5 mm
	Ball screw lead		
Maximum payload (or equivalent)	Horizontal	5 kg	8 kg
	Vertical	2 kg	4 kg
Rated thrust (or equivalent)	41 N	69 N	138 N
	Maximum dimensions of cross section of main unit	W 48 mm x H 65 mm	
	Overall length	ST + 131.5 mm	
Degree of cleanliness <sup>Note 4</sup>	ISO CLASS 3 (ISO14644-1) or equivalent		
Intake air <sup>Note 5</sup>	30 N $\ell$ /min to 100 N $\ell$ /min		
Using ambient temperature and humidity	0 to 40 °C, 35 to 80 %RH (non-condensing)		

- Note 1. Positioning repeatability in one direction.  
 Note 2. When a moving distance is short and depending on an operation condition, it may not reach the maximum speed. If the effective stroke exceeds 600 mm, the ball screw may resonate. (Critical speed)  
 At this time, make the adjustment to decrease the speed while referring to the maximum speed shown in the table.  
 Note 3. The rated thrust and maximum transferable weight are values assuming the attached motor outputs the rated torque.  
 Note 4. When using in a clean environment, attach a suction air joint. The degree of cleanliness is the cleanliness level achieved when using at 1000 mm/sec or less.  
 Note 5. The required suction amount will vary according to the operating conditions and operating environment.  
 Note. See P.233 for acceleration/deceleration and inertia moment.

## Allowable overhang <sup>Note</sup>

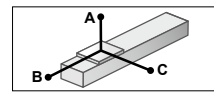

### LGXS05-20

Horizontal installation (Unit: mm)			
	A	B	C
2kg	898	269	350
5kg	583	112	159

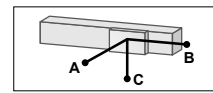

Wall installation (Unit: mm)			
	A	B	C
2kg	323	234	809
5kg	119	76	427

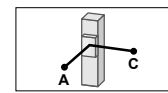

Vertical installation (Unit: mm)		
	A	C
1kg	452	452
2kg	217	217

### LGXS05-10

Horizontal installation (Unit: mm)			
	A	B	C
2kg	2505	382	625
5kg	1366	149	246
8kg	1036	90	150

Wall installation (Unit: mm)			
	A	B	C
2kg	585	346	2386
5kg	195	113	1164
8kg	95	54	745

Vertical installation (Unit: mm)		
	A	C
1kg	732	732
2kg	351	351
4kg	160	160

### LGXS05-5

Horizontal installation (Unit: mm)			
	A	B	C
3kg	4604	281	497
8kg	2197	101	179
13kg	1593	59	105

Wall installation (Unit: mm)			
	A	B	C
3kg	439	245	4371
8kg	117	65	1812
13kg	42	24	1000

Vertical installation (Unit: mm)		
	A	C
4kg	183	183
6kg	111	111
8kg	75	75

Note. Distance from center of slider top to center of gravity of object being carried at a guide service life of 10,000 km.  
 Note. Service life is calculated for 600 mm stroke models.

## Static loading moment

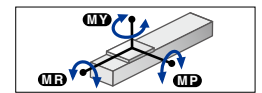

(Unit: N·m)		
MY	MP	MR
24	27	23

## Adaptable Servo Motor

Specification	Flange size <input type="checkbox"/> 40
	Wattage 50 W

Manufacturer	Model
Yaskawa Electric Corp.	SGMJV-A5 SGM7J-A5
Keyence Corp.	SV- <input type="checkbox"/> 005 SV2- <input type="checkbox"/> 005
Mitsubishi Electric Corp.	HF-KP053 <sup>Note</sup> HG-KR053 <sup>Note</sup> HK-KT053 <sup>Note</sup>
Omron Electronics	R88M-K05030 R88M-1M05030 <sup>Note</sup>
Panasonic Corp.	MHMF5A

Note. To combine with the conversion adapter <GX-BEND-40>, the shim plate (t1) is necessary.

Conversion adapter product model	Shim plate part number
GX-BEND-40	KES-M2295-00

## When used with high acceleration or deceleration (High agility model)

## Specifications

Stroke	50 mm to 550 mm (50 mm pitch)		
Ball screw lead	20 mm	10 mm	5 mm
Maximum payload	Horizontal	2 kg	3 kg
	Vertical	1 kg	2 kg
Maximum acceleration	Horizontal	11.77 m/s <sup>2</sup> (1.2 G)	11.77 m/s <sup>2</sup> (1.2 G)
	Vertical	11.77 m/s <sup>2</sup> (1.2 G)	7.17 m/s <sup>2</sup> (0.7 G)

## Allowable overhang <sup>Note</sup>

### LGXS05-20

Horizontal installation (Unit: mm)			
	A	B	C
1kg	498	324	323
2kg	230	157	150

Wall installation (Unit: mm)			
	A	B	C
1kg	297	288	468
2kg	123	120	199

Vertical installation (Unit: mm)		
	A	C
1kg	223	223

### LGXS05-10

Horizontal installation (Unit: mm)			
	A	B	C
1kg	1159	460	645
3kg	381	148	206

Wall installation (Unit: mm)			
	A	B	C
1kg	606	424	1129
3kg	163	112	346

Vertical installation (Unit: mm)		
	A	C
1kg	396	396
2kg	182	182

### LGXS05-5

Vertical installation (Unit: mm)		
	A	C
1kg	478	478
3kg	138	138

Note. Distance from center of slider top to center of gravity of object being carried at a guide service life of 10,000 km.  
 Note. Service life is calculated for 550 mm stroke models.

## Payload - Acceleration / Deceleration Graph (Estimate)

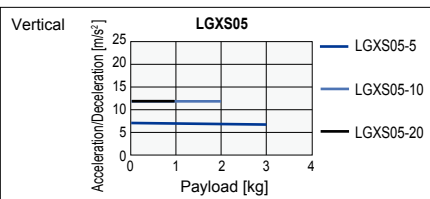
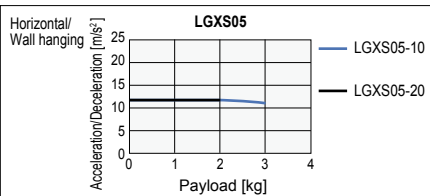

## Effective stroke and maximum speed during high acceleration or deceleration

Maximum speed (mm/sec)	Effective stroke										
	50	100	150	200	250	300	350	400	450	500	550
	Lead 20	1333									
Lead 10	666										
Lead 5	333										

Note. The bending unit cannot be used for the high agility model.  
 Note. The high agility model is used in an effective stroke range of 50 to 550 (50 mm pitch).  
 Note. There is no critical speed setting. The maximum speed can be set for a selectable stroke.  
 The speed may not reach the maximum speed if the movement distance is short or depending on the operating conditions.  
 Note. See P.234 for acceleration/deceleration and inertia moment.

Access the website below.



▶ The tact simulation and service life calculation can be performed easily from our member site. For details, see P.42.

Articulated robots  
YA

Linear conveyer modules  
LCM

Single-axis robots  
CX

Motor-less single axis actuator  
Robonity

Compact single-axis robots  
TRANSEVO

Single-axis robots  
FLIP-X

Linear motor single-axis robots  
PHASER

Cartesian robots  
XY-X

SCARA robots  
YK-X

Pick & place robots  
YP-X

CLEAN

CONTROLLER

INFORMATION

LBAS

LGXS

Option

LGXS05

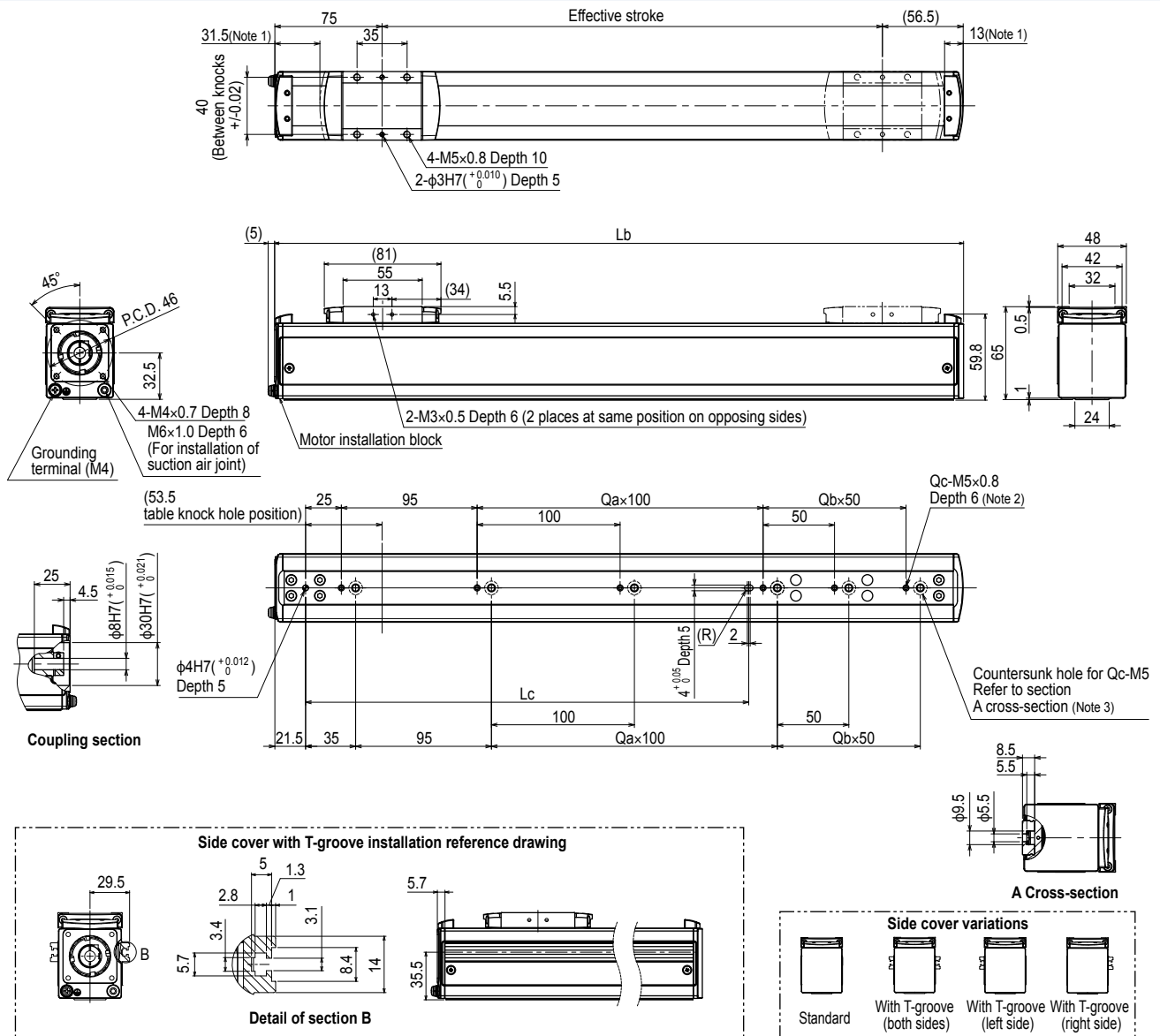

- Note 1. Stop positions are determined by the mechanical stoppers at both ends.
- Note 2. When using the tap holes to mount the body, remove the set screws first.
- Note 3. When using the countersunk holes (section A cross section) to mount the body, remove the cap from the inner side and then fix. The length under head of the hex socket head bolts (M5 × 0.8) used must be 15 mm or less.
- Note 4. Side cover with T-groove is used to install the sensor.

Effective stroke	50	100	150	200	250	300	350	400	450	500	550	600	650	700	750	800	
Lb	181.5	231.5	281.5	331.5	381.5	431.5	481.5	531.5	581.5	631.5	681.5	731.5	781.5	831.5	881.5	931.5	
Lc	110	110	110	110	310	310	310	310	310	310	610	610	610	610	610	610	
Qa	0	0	0	0	2	2	2	2	2	2	5	5	5	5	5	5	
Qb	0	1	2	3	0	1	2	3	4	5	0	1	2	3	4	5	
Qc	2	3	4	5	4	5	6	7	8	9	7	8	9	10	11	12	
Weight (kg)	1.2	1.4	1.5	1.7	1.9	2.0	2.2	2.3	2.5	2.6	2.8	2.9	3.1	3.2	3.4	3.5	
Maximum speed (mm/sec)	Lead 20												1333	1066	933	800	666
	Lead 10												666	532	466	400	333
	Lead 5												333	266	233	200	166
	Speed setting												-	80%	70%	60%	50%

# LGXS05L

Advanced model

Motor-less Single Axis Actuator



## Ordering method

### LGXS05L

Model	Lead	Side cover	Stroke
	20: 20 mm 10: 10 mm 5: 5 mm	No entry: Standard W: With T-groove (both sides) R: With T-groove (right side) L: With T-groove (left side)	50 to 800 (50 mm pitch)

### [Caution]

This system is provided as mechanical actuator unit and not including any adopters or electric components. Motor, driver and other components required for installation are user's responsibility. Refer to user's manual for installation details. Refer to your motor manual for tuning or adjustment. Vibration or resonance from actuator will affect service life of actuator. The product performance may not be satisfied depending on the compatible motor. The bending unit cannot be used for the high agility model.

## Specifications

Adaptable motor	100 W		
Repeatability <sup>Note 1</sup>	±0.005 mm		
Deceleration mechanism	Ground ball screw φ 12 (C5 class)		
Stroke	50 mm to 800 mm (50 mm pitch)		
Maximum speed <sup>Note 2</sup> (or equivalent)	1333 mm/sec	666 mm/sec	333 mm/sec
Ball screw lead	20 mm	10 mm	5 mm
Maximum payload <sup>Note 3</sup> (or equivalent)	Horizontal	12 kg	24 kg
	Vertical	3 kg	6 kg
Rated thrust <sup>Note 3</sup> (or equivalent)	Horizontal	84 N	169 N
	Vertical	339 N	
Maximum dimensions of cross section of main unit	W 48 mm × H 65 mm		
Overall length	ST + 161.5 mm		
Degree of cleanliness <sup>Note 4</sup>	ISO CLASS 3 (ISO14644-1) or equivalent		
Intake air <sup>Note 5</sup>	30 Nℓ/min to 100 Nℓ/min		
Using ambient temperature and humidity	0 to 40 °C, 35 to 80 %RH (non-condensing)		

- Note 1. Positioning repeatability in one direction.  
 Note 2. When a moving distance is short and depending on an operation condition, it may not reach the maximum speed. If the effective stroke exceeds 600 mm, the ball screw may resonate. (Critical speed) At this time, make the adjustment to decrease the speed while referring to the maximum speed shown in the table.  
 Note 3. The rated thrust and maximum transferable weight are values assuming the attached motor outputs the rated torque.  
 Note 4. When using in a clean environment, attach a suction air joint. The degree of cleanliness is the cleanliness level achieved when using at 1000 mm/sec or less.  
 Note 5. The required suction amount will vary according to the operating conditions and operating environment.  
 Note. See P.235 for acceleration/deceleration and inertia moment.

## Allowable overhang <sup>Note</sup>

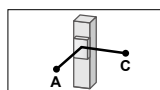
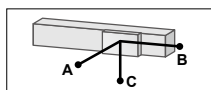
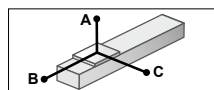

### LGXS05L-20

Horizontal installation (Unit: mm)	A	B	C
3kg	1755	559	426
8kg	737	200	153
12kg	608	133	104

Wall installation (Unit: mm)	A	B	C
3kg	396	486	1594
8kg	106	128	525
12kg	52	61	329

Vertical installation (Unit: mm)	A	C
1kg	1486	1486
2kg	730	730
3kg	478	478

### LGXS05L-10

Horizontal installation (Unit: mm)	A	B	C
6kg	2416	389	333
12kg	1397	187	161
24kg	875	87	74

Wall installation (Unit: mm)	A	B	C
6kg	277	316	2192
12kg	101	115	1084
24kg	12	14	276

Vertical installation (Unit: mm)	A	C
4kg	555	555
6kg	360	360

### LGXS05L-5

Horizontal installation (Unit: mm)	A	B	C
10kg	3127	254	225
20kg	1841	120	106
32kg	1554	70	62

Wall installation (Unit: mm)	A	B	C
10kg	162	181	2800
20kg	42	47	1273
32kg	0	0	0

Vertical installation (Unit: mm)	A	C
5kg	501	501
10kg	235	235
12kg	190	190

Note. Distance from center of slider top to center of gravity of object being carried at a guide service life of 10,000 km.  
 Note. Service life is calculated for 600 mm stroke models.

## Static loading moment

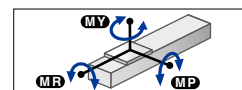

(Unit: N·m)		
MY	MP	MR
72	72	64

## Adaptable Servo Motor

Specification	Flange size □ 40
	Wattage 100 W

Manufacturer	Model
Yaskawa Electric Corp.	SGMJV-01 SGM7J-01
Keyence Corp.	SV-□010 SV2-□010
Mitsubishi Electric Corp.	HF-KP13 <sup>Note</sup> HG-KR13 <sup>Note</sup> HK-KT13 <sup>Note</sup>
Omron Electronics	R88M-K10030 R88M-1M10030 <sup>Note</sup>
Panasonic Corp.	MHMF01

Note. To combine with the conversion adapter <GX-BEND-40>, the shim plate (t1) is necessary.

Conversion adapter product model	Shim plate part number
GX-BEND-40	KES-M2295-00

## When used with high acceleration or deceleration (High agility model)

## Specifications

Stroke	50 mm to 550 mm (50 mm pitch)		
Ball screw lead	20 mm	10 mm	5 mm
Maximum payload	Horizontal	5 kg	10 kg
	Vertical	1 kg	2 kg
Maximum acceleration	Horizontal	14.72 m/s <sup>2</sup> (1.5 G)	14.72 m/s <sup>2</sup> (1.5 G)
	Vertical	14.72 m/s <sup>2</sup> (1.5 G)	12.68 m/s <sup>2</sup> (1.3 G)

## Allowable overhang <sup>Note</sup>

### LGXS05L-20

Horizontal installation (Unit: mm)	A	B	C
2kg	675	501	332
5kg	330	191	131

Wall installation (Unit: mm)	A	B	C
2kg	294	428	626
5kg	87	118	251

Vertical installation (Unit: mm)	A	C
1kg	728	728

### LGXS05L-10

Horizontal installation (Unit: mm)	A	B	C
3kg	1208	469	385
6kg	665	227	188
10kg	441	130	108

Wall installation (Unit: mm)	A	B	C
3kg	331	396	1144
6kg	131	155	580
10kg	49	58	315

Vertical installation (Unit: mm)	A	C
1kg	1298	1298
2kg	636	636

### LGXS05L-5

Vertical installation (Unit: mm)	A	C
1kg	1555	1555
2kg	762	762
4kg	365	365

Note. Distance from center of slider top to center of gravity of object being carried at a guide service life of 10,000 km.  
 Note. Service life is calculated for 550 mm stroke models.

## Payload - Acceleration / Deceleration Graph (Estimate)

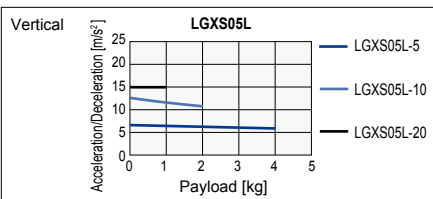
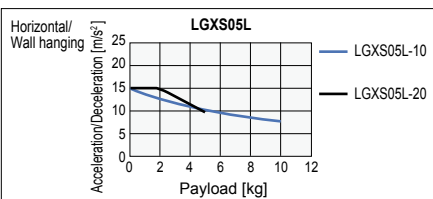

## Effective stroke and maximum speed during high acceleration or deceleration

Effective stroke	50	100	150	200	250	300	350	400	450	500	550
Maximum speed (mm/sec)	Lead 20	1333									
	Lead 10	666									
	Lead 5	333									

Note. The bending unit cannot be used for the high agility model.  
 Note. The high agility model is used in an effective stroke range of 50 to 550 (50 mm pitch).  
 Note. There is no critical speed setting. The maximum speed can be set for a selectable stroke.  
 The speed may not reach the maximum speed if the movement distance is short or depending on the operating conditions.  
 Note. See P.236 for acceleration/deceleration and inertia moment.

Access the website below.



▶ The tact simulation and service life calculation can be performed easily from our member site. For details, see P.42.





# LGXS07

Advanced model

Motor-less Single Axis Actuator

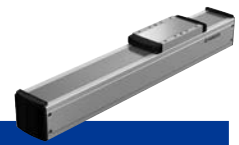

## Ordering method

### LGXS07

Model	Lead	Side cover	Stroke
	30: 30 mm 20: 20 mm 10: 10 mm 5: 5 mm	No entry: Standard W: With T-groove (both sides) R: With T-groove (right side) L: With T-groove (left side)	50 to 1100 (50 mm pitch)

### [Caution]

This system is provided as mechanical actuator unit and not including any adapters or electric components. Motor, driver and other components required for installation are user's responsibility. Refer to user's manual for installation details. Refer to your motor manual for tuning or adjustment. Vibration or resonance from actuator will affect service life of actuator. The product performance may not be satisfied depending on the compatible motor. The bending unit cannot be used for the high agility model.

## Specifications

Adaptable motor	100 W
Repeatability <sup>Note 1</sup>	+/-0.005 mm
Deceleration mechanism	Ground ball screw $\phi$ 15 (C5 class)
Stroke	50 mm to 1100 mm (50 mm pitch)
Maximum speed <sup>Note 2</sup> (or equivalent)	1800 mm/sec 1200 mm/sec 600 mm/sec 300 mm/sec
Ball screw lead	30 mm 20 mm 10 mm 5 mm
Maximum payload <sup>Note 3</sup> (or equivalent)	Horizontal
	Vertical
Rated thrust <sup>Note 3</sup> (or equivalent)	Horizontal
	Vertical
Maximum dimensions of cross section of main unit	W 70 mm x H 76.5 mm
Overall length	ST + 202 mm
Degree of cleanliness <sup>Note 4</sup>	ISO CLASS 3 (ISO14644-1) or equivalent
Intake air <sup>Note 5</sup>	30 N $\ell$ /min to 115 N $\ell$ /min
Using ambient temperature and humidity	0 to 40 °C, 35 to 80 %RH (non-condensing)

- Note 1. Positioning repeatability in one direction.  
 Note 2. When a moving distance is short and depending on an operation condition, it may not reach the maximum speed.  
 If the effective stroke exceeds 700 mm, the ball screw may resonate. (Critical speed)  
 At this time, make the adjustment to decrease the speed while referring to the maximum speed shown in the table.  
 Note 3. The rated thrust and maximum transferable weight are values assuming the attached motor outputs the rated torque.  
 Note 4. When using in a clean environment, attach a suction air joint. The degree of cleanliness is the cleanliness level achieved when using at 1000 mm/sec or less.  
 Note 5. The required suction amount will vary according to the operating conditions and operating environment.  
 Note. See P.237 for acceleration/deceleration and inertia moment.

## Allowable overhang <sup>Note</sup>

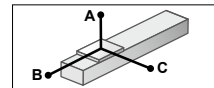

LGXS07-30	Horizontal installation (Unit: mm)		
	A	B	C
2kg	3078	1509	1221
6kg	1191	501	418
10kg	957	317	282

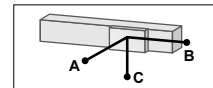

LGXS07-30	Wall installation (Unit: mm)		
	A	B	C
2kg	1237	1442	2975
6kg	393	435	1062
10kg	244	251	793

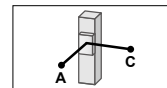

LGXS07-30	Vertical installation (Unit: mm)	
	A	C
1kg	2335	2335
2kg	1158	1158

## Static loading moment

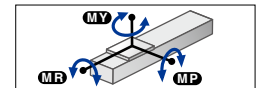

(Unit: N·m)		
MY	MP	MR
138	121	121

## Adaptable Servo Motor

Specification	Flange size	□ 40
	Wattage	100 W

Manufacturer	Model
Yaskawa Electric Corp.	SGMJV-01 SGM7J-01
Keyence Corp.	SV-□010 SV2-□010
Mitsubishi Electric Corp.	HF-KP13 <sup>Note</sup> HG-KR13 <sup>Note</sup> HK-KT13 <sup>Note</sup>
Omron Electronics	R88M-K10030 R88M-1M10030 <sup>Note</sup>
Panasonic Corp.	MHMF01

Note. To combine with the conversion adapter <GX-BEND-40>, the shim plate (t1) is necessary.

Conversion adapter product model	Shim plate part number
GX-BEND-40	KES-M2295-00

## When used with high acceleration or deceleration (High agility model)

## Specifications

Stroke	50 mm to 650 mm (50 mm pitch)			
Ball screw lead	30 mm	20 mm	10 mm	5 mm
Maximum payload	Horizontal	5 kg	10 kg	20 kg
	Vertical	1 kg	2 kg	4 kg
Maximum acceleration	Horizontal	14.72 m/s <sup>2</sup> (1.5 G)	14.72 m/s <sup>2</sup> (1.5 G)	9.64 m/s <sup>2</sup> (1 G)
	Vertical	14.72 m/s <sup>2</sup> (1.5 G)	14.72 m/s <sup>2</sup> (1.5 G)	8.44 m/s <sup>2</sup> (0.9 G)

## Allowable overhang <sup>Note</sup>

LGXS07-30	Horizontal installation (Unit: mm)		
	A	B	C
2kg	1020	897	608
5kg	461	346	245

LGXS07-30	Wall installation (Unit: mm)		
	A	B	C
2kg	579	830	976
5kg	208	279	401

LGXS07-30	Vertical installation (Unit: mm)	
	A	C
1kg	1165	1165

LGXS07-5	Vertical installation (Unit: mm)	
	A	C
3kg	1093	1093
5kg	639	639
8kg	384	384

LGXS07-20	Horizontal installation (Unit: mm)		
	A	B	C
3kg	1224	758	640
6kg	684	369	321
10kg	459	214	190

LGXS07-20	Wall installation (Unit: mm)		
	A	B	C
3kg	600	692	1175
6kg	274	303	621
10kg	138	147	376

LGXS07-20	Vertical installation (Unit: mm)	
	A	C
1kg	1793	1793
2kg	891	891

LGXS07-10	Horizontal installation (Unit: mm)		
	A	B	C
5kg	2208	622	665
12kg	991	249	266
20kg	637	142	152

LGXS07-10	Wall installation (Unit: mm)		
	A	B	C
5kg	603	556	2129
12kg	200	182	890
20kg	83	75	497

LGXS07-10	Vertical installation (Unit: mm)	
	A	C
1kg	3012	3012
2kg	1487	1487
4kg	725	725

- Note. Distance from center of slider top to center of gravity of object being carried at a guide service life of 10,000 km.  
 Note. Service life is calculated for 600 mm stroke models.

## Payload - Acceleration / Deceleration Graph (Estimate)

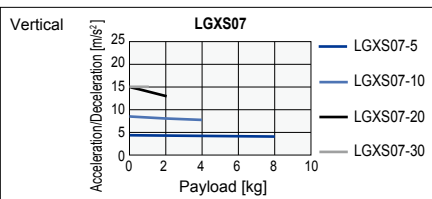
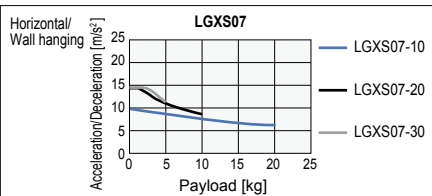

## Effective stroke and maximum speed during high acceleration or deceleration

Effective stroke	50 100 150 200 250 300 350 400 450 500 550 600 650											
	Lead 30											1800
Maximum speed (mm/sec)	Lead 20											1200
	Lead 10											600
	Lead 5											300

- Note. The bending unit cannot be used for the high agility model.  
 Note. The high agility model is used in an effective stroke range of 50 to 650 (50 mm pitch).  
 Note. There is no critical speed setting. The maximum speed can be set for a selectable stroke.  
 The speed may not reach the maximum speed if the movement distance is short or depending on the operating conditions.  
 Note. See P.239 for acceleration/deceleration and inertia moment.

Access the website below.



► The tact simulation and service life calculation can be performed easily from our member site. For details, see P.42.



Articulated robots  
YA

Linear conveyor modules  
LCM

Single-axis robots  
CX

Motor-less single axis actuator  
Robonity

Compact single-axis robots  
TRANSEVO

Single-axis robots  
FLIP-X

Linear motor single-axis robots  
PHASER

Cartesian robots  
XY-X

SCARA robots  
YK-X

Pick & place robots  
YP-X

CLEAN

CONTROLLER

INFORMATION

LBAS

LGXS

Option

LGXS07

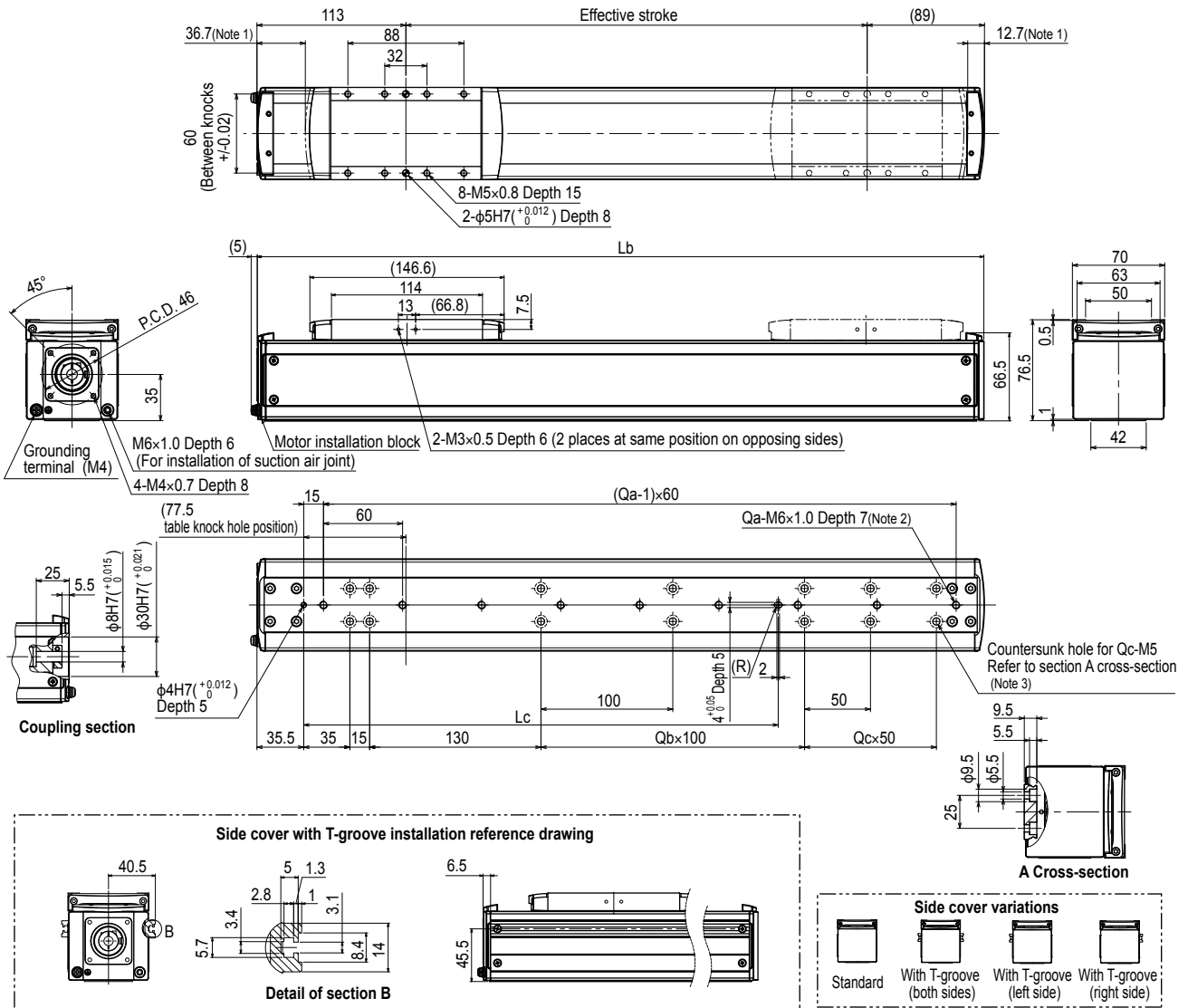

- Note 1. Stop positions are determined by the mechanical stoppers at both ends.
- Note 2. When using the tap holes to mount the body, remove the set screws first.
- Note 3. When using the countersunk holes (section A cross section) to mount the body, remove the cap from the inner side and then fix.
- Note 4. Side cover with T-groove is used to install the sensor.

Effective stroke	50	100	150	200	250	300	350	400	450	500	550	600	650	700	750	800	850	900	950	1000	1050	1100					
Lb	252	302	352	402	452	502	552	602	652	702	752	802	852	902	952	1002	1052	1102	1152	1202	1252	1302					
Lc	160	160	160	160	360	360	360	360	360	360	360	360	360	760	760	760	760	760	760	760	760	760	760				
Qa	4	5	5	6	7	8	9	10	10	11	12	13	14	15	15	16	17	18	19	20	20	21	21				
Qb	0	0	0	0	2	2	2	2	2	2	2	2	6	6	6	6	6	6	6	6	6	6	6				
Qc	0	1	2	3	0	1	2	3	4	5	6	7	0	1	2	3	4	5	6	7	8	9	9				
Qd	6	8	10	12	10	12	14	16	18	20	22	24	18	20	22	24	26	28	30	32	34	36	36				
Weight (kg)	3.2	3.4	3.7	4.0	4.3	4.5	4.8	5.1	5.3	5.6	5.9	6.2	6.4	6.7	7.0	7.2	7.5	7.8	8.1	8.3	8.6	8.9	8.9				
Maximum speed (mm/sec)	Lead 30														1800												
	Lead 20														1200												
	Lead 10														600												
	Lead 5														300												
Speed setting														-													
														1530	1350	1170	990	900	810	720	630						
														1020	900	780	660	600	540	480	420						
														510	450	390	330	300	270	240	210						
														255	225	195	165	150	135	120	105						
														85%	75%	65%	55%	50%	45%	40%	35%						

# LGXS10

Advanced model

Motor-less Single Axis Actuator

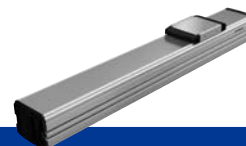

## Ordering method

### LGXS10

Model	Lead	Motor specification	Stroke
	30: 30 mm 20: 20 mm 10: 10 mm 5: 5 mm	No entry: Standard P: P specification (see below)	100 to 1250 (50 mm pitch)

### [Caution]

This system is provided as mechanical actuator unit and not including any adopters or electric components. Motor, driver and other components required for installation are user's responsibility. Refer to user's manual for installation details. Refer to your motor manual for tuning or adjustment. Vibration or resonance from actuator will affect service life of actuator. The product performance may not be satisfied depending on the compatible motor. The bending unit cannot be used for the high agility model.

## Specifications

Adaptable motor	200 W			
Repeatability <sup>Note 1</sup>	±0.005 mm			
Deceleration mechanism	Ground ball screw $\phi$ 15 (C5 class)			
Stroke	100 mm to 1250 mm (50 mm pitch)			
Maximum speed <sup>Note 2</sup> (or equivalent)	1800 mm/sec	1200 mm/sec	600 mm/sec	300 mm/sec
Ball screw lead	30 mm	20 mm	10 mm	5 mm
Maximum payload <sup>Note 3</sup> (or equivalent)	Horizontal	25 kg	40 kg	80 kg
	Vertical	4 kg	8 kg	20 kg
Rated thrust <sup>Note 3</sup> (or equivalent)	113 N	170 N	341 N	683 N
Maximum dimensions of cross section of main unit	W 100 mm × H 99.5 mm			
Overall length	ST + 175.5 mm			
Degree of cleanliness <sup>Note 4</sup>	ISO CLASS 3 (ISO14644-1) or equivalent			
Intake air <sup>Note 5</sup>	30 N $\ell$ /min to 90 N $\ell$ /min			
Using ambient temperature and humidity	0 to 40 °C, 35 to 80 %RH (non-condensing)			

- Note 1. Positioning repeatability in one direction.  
 Note 2. When a moving distance is short and depending on an operation condition, it may not reach the maximum speed.  
 If the effective stroke exceeds 700 mm, the ball screw may resonate. (Critical speed)  
 At this time, make the adjustment to decrease the speed while referring to the maximum speed shown in the table.  
 Note 3. The rated thrust and maximum transferable weight are values assuming the attached motor outputs the rated torque.  
 Note 4. When using in a clean environment, attach a suction air joint. The degree of cleanliness is the cleanliness level achieved when using at 1000 mm/sec or less.  
 Note 5. The required suction amount will vary according to the operating conditions and operating environment.  
 Note. See P.240 for acceleration/deceleration and inertia moment.

## Allowable overhang <sup>Note</sup>

	LGXS10-30			Wall installation (Unit: mm)			Vertical installation (Unit: mm)				
	A	B	C	A	B	C	A	B	C		
	10kg	878	537	292	10kg	271	473	803	1kg	4135	4135
	20kg	609	256	146	20kg	118	192	481	4kg	985	985
	25kg	608	211	124	25kg	93	147	454			
	LGXS10-20			Wall installation (Unit: mm)			Vertical installation (Unit: mm)				
	A	B	C	A	B	C	A	B	C		
	15kg	1269	451	282	15kg	252	387	1159	3kg	2062	2062
	25kg	754	253	158	25kg	123	189	629	6kg	1012	1012
	40kg	466	142	88	40kg	51	78	311	8kg	750	750
	LGXS10-10			Wall installation (Unit: mm)			Vertical installation (Unit: mm)				
A	B	C	A	B	C	A	B	C			
30kg	1794	298	203	30kg	162	234	1623	5kg	1926	1926	
50kg	1358	162	111	50kg	68	98	1060	10kg	931	931	
80kg	1266	86	59	80kg	16	22	552	20kg	434	434	
	LGXS10-5			Wall installation (Unit: mm)			Vertical installation (Unit: mm)				
	A	B	C	A	B	C	A	B	C		
	30kg	5605	321	225	30kg	181	258	5195	10kg	1018	1018
50kg	3694	177	124	50kg	79	113	3111	20kg	477	477	
80kg	2619	95	67	80kg	22	31	1557	30kg	296	296	
100kg	2224	68	48	100kg	0	0	0				

Note. Distance from center of slider top to center of gravity of object being carried at a guide service life of 10,000 km.  
 Note. Service life is calculated for 600 mm stroke models.

## Static loading moment

(Unit: N·m)		
MY	MP	MR
274	274	241

## Adaptable Servo Motor

Specification	Flange size	60
	Wattage	200 W
Motor specification	Manufacturer	Model
No entry	Yaskawa Electric Corp.	SGMJV-02 SGMJ-02
	Keyence Corp.	SV-□020 SV2-□020
	Mitsubishi Electric Corp.	HF-KP23 HG-KR23 <sup>Note 1</sup> HK-KT23 <sup>Note 1</sup>
	Omron Electronics	R88M-K20030 R88M-1M20030
P <sup>Note 2</sup>	Panasonic Corp.	MSMD02 MSMF02 MHMF02
Conversion adapter product model		Shim plate part number
GX-BEND-60		KEV-M2295-00

Note 1. To combine with the conversion adapter <GX-BEND-60>, the shim plate (t1) is necessary.  
 Note 2. For the specifications P, the bending unit cannot be used.

## When used with high acceleration or deceleration (High agility model)

### Specifications

Stroke	100 mm to 650 mm (50 mm pitch)			
Ball screw lead	30 mm	20 mm	10 mm	5 mm
Maximum payload	Horizontal	10 kg	20 kg	30 kg
	Vertical	2 kg	4 kg	8 kg
Maximum acceleration	Horizontal	19.62 m/s <sup>2</sup> (2 G)	19.62 m/s <sup>2</sup> (2 G)	11.71 m/s <sup>2</sup> (1.2 G)
	Vertical	19.62 m/s <sup>2</sup> (2 G)	19.62 m/s <sup>2</sup> (2 G)	10.84 m/s <sup>2</sup> (1.1 G)
Maximum acceleration	Horizontal	19.62 m/s <sup>2</sup> (2 G)	19.62 m/s <sup>2</sup> (2 G)	5.53 m/s <sup>2</sup> (0.6 G)
	Vertical	19.62 m/s <sup>2</sup> (2 G)	19.62 m/s <sup>2</sup> (2 G)	5.53 m/s <sup>2</sup> (0.6 G)

### Payload - Acceleration / Deceleration Graph (Estimate)

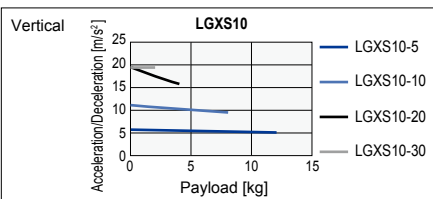
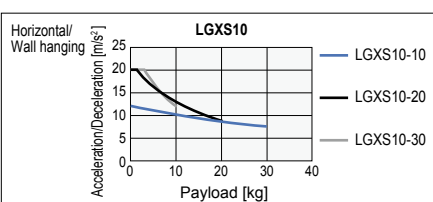

### Allowable overhang <sup>Note</sup>

	LGXS10-30			Wall installation (Unit: mm)			Vertical installation (Unit: mm)				
	A	B	C	A	B	C	A	B	C		
	3kg	1041	1117	541	3kg	521	1046	1009	1kg	2054	2054
	6kg	581	534	266	6kg	241	466	539	2kg	994	994
	10kg	384	300	153	10kg	125	235	327			
	LGXS10-20			Wall installation (Unit: mm)			Vertical installation (Unit: mm)				
	A	B	C	A	B	C	A	B	C		
	5kg	1218	844	493	5kg	464	778	1177	2kg	1602	1602
	12kg	575	326	193	12kg	159	261	516	4kg	788	788
	20kg	375	177	106	20kg	70	113	290			
	LGXS10-10			Wall installation (Unit: mm)			Vertical installation (Unit: mm)				
A	B	C	A	B	C	A	B	C			
10kg	1851	568	383	10kg	343	504	1784	3kg	1849	1849	
20kg	973	263	177	20kg	136	199	885	5kg	1086	1086	
30kg	671	162	109	30kg	67	98	552	8kg	656	656	

Note. Distance from center of slider top to center of gravity of object being carried at a guide service life of 10,000 km.  
 Note. Service life is calculated for 600 mm stroke models.

## Effective stroke and maximum speed during high acceleration or deceleration

Maximum speed (mm/sec)	Effective stroke	100	150	200	250	300	350	400	450	500	550	600	650	
	Lead 30	1800												
Maximum speed (mm/sec)	Lead 20	1200												
	Lead 10	600												
	Lead 5	300												

Note. The bending unit cannot be used for the high agility model.  
 Note. The high agility model is used in an effective stroke range of 100 to 650 (50 mm pitch).  
 Note. There is no critical speed setting. The maximum speed can be set for a selectable stroke.  
 The speed may not reach the maximum speed if the movement distance is short or depending on the operating conditions.  
 Note. See P.242 for acceleration/deceleration and inertia moment.

Access the website below.



► The tact simulation and service life calculation can be performed easily from our member site. For details, see P.42.



# LGXS12

Advanced model

Motor-less Single Axis Actuator



## Ordering method

### LGXS12

<b>Model</b>	<b>Lead</b>	<b>Motor specification</b>	<b>Stroke</b>
	30: 30 mm 20: 20 mm 10: 10 mm 5: 5 mm	No entry: Standard P: P specification (see below)	100 to 1250 (50 mm pitch)

### [Caution]

This system is provided as mechanical actuator unit and not including any adopters or electric components. Motor, driver and other components required for installation are user's responsibility. Refer to user's manual for installation details. Refer to your motor manual for tuning or adjustment. Vibration or resonance from actuator will affect service life of actuator. The product performance may not be satisfied depending on the compatible motor. The bending unit cannot be used for the high agility model.

## Specifications

<b>Adaptable motor</b>	400 W
<b>Repeatability</b> <sup>Note 1</sup>	+/-0.005 mm
<b>Deceleration mechanism</b>	Ground ball screw φ 15 (C5 class)
<b>Stroke</b>	100 mm to 1250 mm (50 mm pitch)
<b>Maximum speed</b> <sup>Note 2</sup> (or equivalent)	1800 mm/sec 1200 mm/sec 600 mm/sec 300 mm/sec
<b>Ball screw lead</b>	30 mm 20 mm 10 mm 5 mm
<b>Maximum payload</b> <sup>Note 3</sup> (or equivalent)	Horizontal 35 kg 50 kg 95 kg 115 kg Vertical 8 kg 15 kg 25 kg 45 kg
<b>Rated thrust</b> <sup>Note 3</sup> (or equivalent)	225 N 339 N 678 N 1360 N
<b>Maximum dimensions of cross section of main unit</b>	W 125 mm × H 101 mm
<b>Overall length</b>	ST + 211.5 mm
<b>Degree of cleanliness</b> <sup>Note 4</sup>	ISO CLASS 3 (ISO14644-1) or equivalent
<b>Intake air</b> <sup>Note 5</sup>	30 Nℓ/min to 90 Nℓ/min
<b>Using ambient temperature and humidity</b>	0 to 40 °C, 35 to 80 %RH (non-condensing)

- Note 1. Positioning repeatability in one direction.  
 Note 2. When a moving distance is short and depending on an operation condition, it may not reach the maximum speed.  
 If the effective stroke exceeds 700 mm, the ball screw may resonate. (Critical speed)  
 At this time, make the adjustment to decrease the speed while referring to the maximum speed shown in the table.  
 Note 3. The rated thrust and maximum transferable weight are values assuming the attached motor outputs the rated torque.  
 Note 4. When using in a clean environment, attach a suction air joint. The degree of cleanliness is the cleanliness level achieved when using at 1000 mm/sec or less.  
 Note 5. The required suction amount will vary according to the operating conditions and operating environment.  
 Note. See P.244 for acceleration/deceleration and inertia moment.

## Allowable overhang <sup>Note</sup>

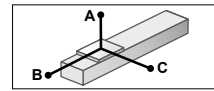

**LGXS12-30**

Horizontal installation (Unit: mm)			
	A	B	C
10kg	1796	1074	637
20kg	1300	531	332
35kg	1341	334	227

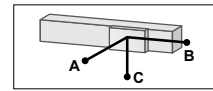

Wall installation (Unit: mm)			
	A	B	C
10kg	631	1009	1720
20kg	316	466	1171
35kg	197	269	1130

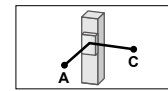

Vertical installation (Unit: mm)		
	A	C
3kg	2642	2642
6kg	1289	1289
8kg	951	951

## Static loading moment

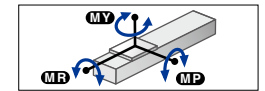

(Unit: N·m)		
MY	MP	MR
334	334	294

## Adaptable Servo Motor

Specification	Flange size	<input type="checkbox"/> 60	
	Wattage	400 W	
Motor specification	Manufacturer	Model	
	Yaskawa Electric Corp.	SGMJV-04 SGMJJ-04	
	Keyence Corp.	SV-□040 SV2-□040	
	Mitsubishi Electric Corp.	HF-KP43 HG-KR43 <sup>Note 1</sup> HK-KT43 <sup>Note 1</sup>	
No entry	Omron Electronics	R88M-K40030 R88M-1M40030	
	Panasonic Corp.	MSMD04 MSMF04 MHMF04	
	P <sup>Note 2</sup>	Conversion adapter product model	Shim plate part number
		GX-BEND-60	KEV-M2295-00

Note 1. To combine with the conversion adapter <GX-BEND-60>, the shim plate (1) is necessary.  
 Note 2. For the specifications P, the bending unit cannot be used.

## When used with high acceleration or deceleration (High agility model)

### Specifications

<b>Stroke</b>	100 mm to 650 mm (50 mm pitch)			
<b>Ball screw lead</b>	30 mm	20 mm	10 mm	5 mm
<b>Maximum payload</b>	20 kg	30 kg	40 kg	-
<b>Maximum acceleration</b>	Horizontal 19.62 m/s <sup>2</sup> (2 G)	19.62 m/s <sup>2</sup> (2 G)	19.62 m/s <sup>2</sup> (2 G)	-
<b>Maximum payload</b>	4 kg	8 kg	16 kg	24 kg
<b>Maximum acceleration</b>	Vertical 19.62 m/s <sup>2</sup> (2 G)	19.62 m/s <sup>2</sup> (2 G)	19.62 m/s <sup>2</sup> (2 G)	9.85 m/s <sup>2</sup> (1 G)

### Payload - Acceleration / Deceleration Graph (Estimate)

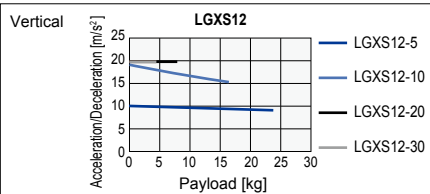
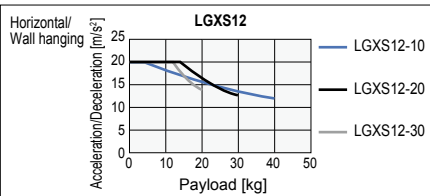

### Allowable overhang <sup>Note</sup>

**LGXS12-30**

Horizontal installation (Unit: mm)			
	A	B	C
5kg	1216	1297	669
12kg	461	506	252
20kg	316	280	147

Wall installation (Unit: mm)			
	A	B	C
5kg	648	1224	1183
12kg	226	436	427
20kg	117	213	266

Vertical installation (Unit: mm)		
	A	C
2kg	1984	1984
4kg	960	960

**LGXS12-5**

Vertical installation (Unit: mm)		
	A	C
8kg	1487	1487
16kg	712	712
24kg	454	454

**LGXS12-20**

Horizontal installation (Unit: mm)			
	A	B	C
10kg	999	807	489
20kg	521	378	231
30kg	382	234	146

Wall installation (Unit: mm)			
	A	B	C
10kg	458	740	966
20kg	196	311	479
30kg	109	168	325

Vertical installation (Unit: mm)		
	A	C
3kg	2031	2031
5kg	1193	1193
8kg	722	722

**LGXS12-10**

Horizontal installation (Unit: mm)			
	A	B	C
15kg	1668	737	535
25kg	1060	423	308
40kg	709	246	180

Wall installation (Unit: mm)			
	A	B	C
15kg	491	672	1628
25kg	263	358	1012
40kg	134	181	644

Vertical installation (Unit: mm)		
	A	C
5kg	2071	2071
10kg	1011	1011
16kg	612	612

Note. Distance from center of slider top to center of gravity of object being carried at a guide service life of 10,000 km.  
 Note. Service life is calculated for 600 mm stroke models.

## Effective stroke and maximum speed during high acceleration or deceleration

Maximum speed (mm/sec)	Effective stroke										
	100	150	200	250	300	350	400	450	500	550	600
Lead 30	1800										
	1200										
	600										
	300										

Note. The bending unit cannot be used for the high agility model.  
 Note. The high agility model is used in an effective stroke range of 100 to 650 (50 mm pitch).  
 Note. There is no critical speed setting. The maximum speed can be set for a selectable stroke.  
 The speed may not reach the maximum speed if the movement distance is short or depending on the operating conditions.  
 Note. See P.246 for acceleration/deceleration and inertia moment.

Access the website below.



▶ The tact simulation and service life calculation can be performed easily from our member site. For details, see P.42.





# LGXS16

Advanced model

Motor-less Single Axis Actuator



## Ordering method

<b>LGXS16</b>			
<b>Model</b>	<b>Lead</b>	<b>Motor specification</b>	<b>Stroke</b>
	40: 40 mm 20: 20 mm 10: 10 mm	No entry: Standard P: P specification (see below)	100 to 1450 (50 mm pitch)

### [Caution]

This system is provided as mechanical actuator unit and not including any adapters or electric components. Motor, driver and other components required for installation are user's responsibility. Refer to user's manual for installation details. Refer to your motor manual for tuning or adjustment. Vibration or resonance from actuator will affect service life of actuator. The product performance may not be satisfied depending on the compatible motor. The bending unit cannot be used for the high agility model.

## Specifications

<b>Adaptable motor</b>	750 W		
<b>Repeatability</b> <sup>Note 1</sup>	±0.005 mm		
<b>Deceleration mechanism</b>	Ground ball screw $\phi$ 20 (C5 class)		
<b>Stroke</b>	100 mm to 1450 mm (50 mm pitch)		
<b>Maximum speed (or equivalent)</b>	2400 mm/sec	1200 mm/sec	600 mm/sec
<b>Ball screw lead</b>	40 mm	20 mm	10 mm
<b>Maximum payload (or equivalent)</b>	Horizontal	45 kg	95 kg
	Vertical	12 kg	28 kg
<b>Rated thrust (or equivalent)</b>	320 N	640 N	1280 N
<b>Maximum dimensions of cross section of main unit</b>	W 160 mm × H 130 mm		
<b>Overall length</b>	ST + 242.5 mm		
<b>Degree of cleanliness</b> <sup>Note 4</sup>	ISO CLASS 3 (ISO14644-1) or equivalent		
<b>Intake air</b> <sup>Note 5</sup>	30 Nℓ/min to 90 Nℓ/min		
<b>Using ambient temperature and humidity</b>	0 to 40 °C, 35 to 80 %RH (non-condensing)		

- Note 1. Positioning repeatability in one direction.  
 Note 2. When a moving distance is short and depending on an operation condition, it may not reach the maximum speed.  
 If the effective stroke exceeds 800 mm, the ball screw may resonate. (Critical speed)  
 At this time, make the adjustment to decrease the speed while referring to the maximum speed shown in the table.  
 Note 3. The rated thrust and maximum transferable weight are values assuming the attached motor outputs the rated torque.  
 Note 4. When using in a clean environment, attach a suction air joint. The degree of cleanliness is the cleanliness level achieved when using at 1000 mm/sec or less.  
 Note 5. The required suction amount will vary according to the operating conditions and operating environment.  
 Note. See P.248 for acceleration/deceleration and inertia moment.

## Allowable overhang <sup>Note</sup>

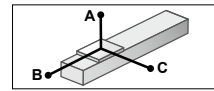

**LGXS16-40**

Horizontal installation (Unit: mm)	A	B	C
15kg	2876	1866	1253
30kg	2385	997	776
45kg	2339	720	604

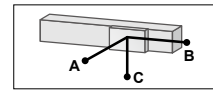

**Wall installation (Unit: mm)**

A	B	C
15kg	1273	1802
30kg	782	935
45kg	598	658

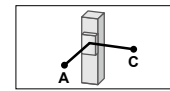

**Vertical installation (Unit: mm)**

A	C
3kg	6605
6kg	3699
12kg	2827

**LGXS16-20**

Horizontal installation (Unit: mm)	A	B	C
30kg	3862	1255	1106
50kg	2568	733	652
80kg	1798	440	394
95kg	1579	362	325

**Wall installation (Unit: mm)**

A	B	C
30kg	1102	1192
50kg	630	671
80kg	360	377
95kg	288	300

**Vertical installation (Unit: mm)**

A	C
10kg	3404
20kg	1740
28kg	1504

**LGXS16-10**

Horizontal installation (Unit: mm)	A	B	C
50kg	6253	1026	1024
80kg	4447	623	624
100kg	3957	489	490
130kg	3786	365	367

**Wall installation (Unit: mm)**

A	B	C
50kg	980	964
80kg	573	561
100kg	437	426
130kg	312	302

**Vertical installation (Unit: mm)**

A	C
15kg	3434
30kg	1684
55kg	889

Note. Distance from center of slider top to center of gravity of object being carried at a guide service life of 10,000 km.  
 Note. Service life is calculated for 600 mm stroke models.

## Static loading moment

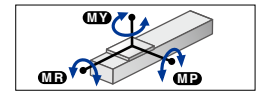

(Unit: N·m)

MY	MP	MR
706	706	620

## Adaptable Servo Motor

Specification	Flange size	<input type="checkbox"/> 80
	Wattage	750 W

Motor specification	Manufacturer	Model
No entry	Yaskawa Electric Corp.	SGMJV-08 SGMJJ-08
	Keyence Corp.	SV-□075 SV2-□075
	Mitsubishi Electric Corp.	HF-KP73 HG-KR73 <sup>Note 1</sup> HK-KT7M3 <sup>Note 1</sup>
	Omron Electronics	R88M-K75030 R88M-1M75030
P <sup>Note 2</sup>		M5MD08 M5MF08 M5HM08

Note 1. To combine with the conversion adapter <GX-BEND-80>, the shim plate (1) is necessary.  
 Note 2. For the specifications P, the bending unit cannot be used.

Conversion adapter product model	Shim plate part number
GX-BEND-80	KEX-M2295-00

## When used with high acceleration or deceleration (High agility model)

### Specifications

<b>Stroke</b>	100 mm to 800 mm (50 mm pitch)		
<b>Ball screw lead</b>	40 mm	20 mm	10 mm
<b>Maximum payload</b>	30 kg	60 kg	-
<b>Maximum acceleration</b>	Horizontal	19.62 m/s <sup>2</sup> (2 G)	19.84 m/s <sup>2</sup> (2 G)
	Vertical	8 kg	16 kg
<b>Maximum acceleration</b>	Horizontal	19.62 m/s <sup>2</sup> (2 G)	11.17 m/s <sup>2</sup> (1.1 G)
	Vertical	18.43 m/s <sup>2</sup> (1.9 G)	11.17 m/s <sup>2</sup> (1.1 G)

### Payload - Acceleration / Deceleration Graph (Estimate)

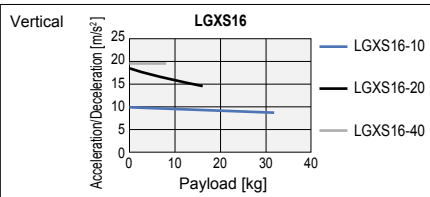
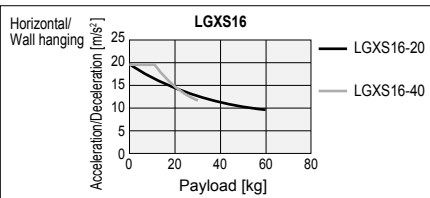

### Allowable overhang <sup>Note</sup>

**LGXS16-40**

Horizontal installation (Unit: mm)	A	B	C
10kg	1271	1669	836
20kg	725	803	429
30kg	534	514	287

**Wall installation (Unit: mm)**

A	B	C
10kg	816	1585
20kg	404	725
30kg	259	441

**Vertical installation (Unit: mm)**

A	C
3kg	2904
5kg	1710
8kg	1038

**LGXS16-20**

Horizontal installation (Unit: mm)	A	B	C
20kg	1722	1123	875
40kg	952	535	428
60kg	682	339	276

**Wall installation (Unit: mm)**

A	B	C
20kg	842	1056
40kg	388	470
60kg	232	275

**Vertical installation (Unit: mm)**

A	C
5kg	3473
10kg	1723
16kg	1064

Note. Distance from center of slider top to center of gravity of object being carried at a guide service life of 10,000 km.  
 Note. Service life is calculated for 600 mm stroke models.

**LGXS16-10**

Vertical installation (Unit: mm)	A	C
10kg	2951	2951
20kg	1438	1438
32kg	870	870

### Effective stroke and maximum speed during high acceleration or deceleration

Effective stroke	100	150	200	250	300	350	400	450	500	550	600	650	700	750	800
<b>Maximum speed (mm/sec)</b>	Lead 40														
	Lead 20														
	Lead 10														

Note. The bending unit cannot be used for the high agility model.  
 Note. The high agility model is used in an effective stroke range of 100 to 800 (50 mm pitch).  
 Note. There is no critical speed setting. The maximum speed can be set for a selectable stroke.  
 The speed may not reach the maximum speed if the movement distance is short or depending on the operating conditions.  
 Note. See P.250 for acceleration/deceleration and inertia moment.

Access the website below.



▶ The tact simulation and service life calculation can be performed easily from our member site. For details, see P.42.

LGXS16

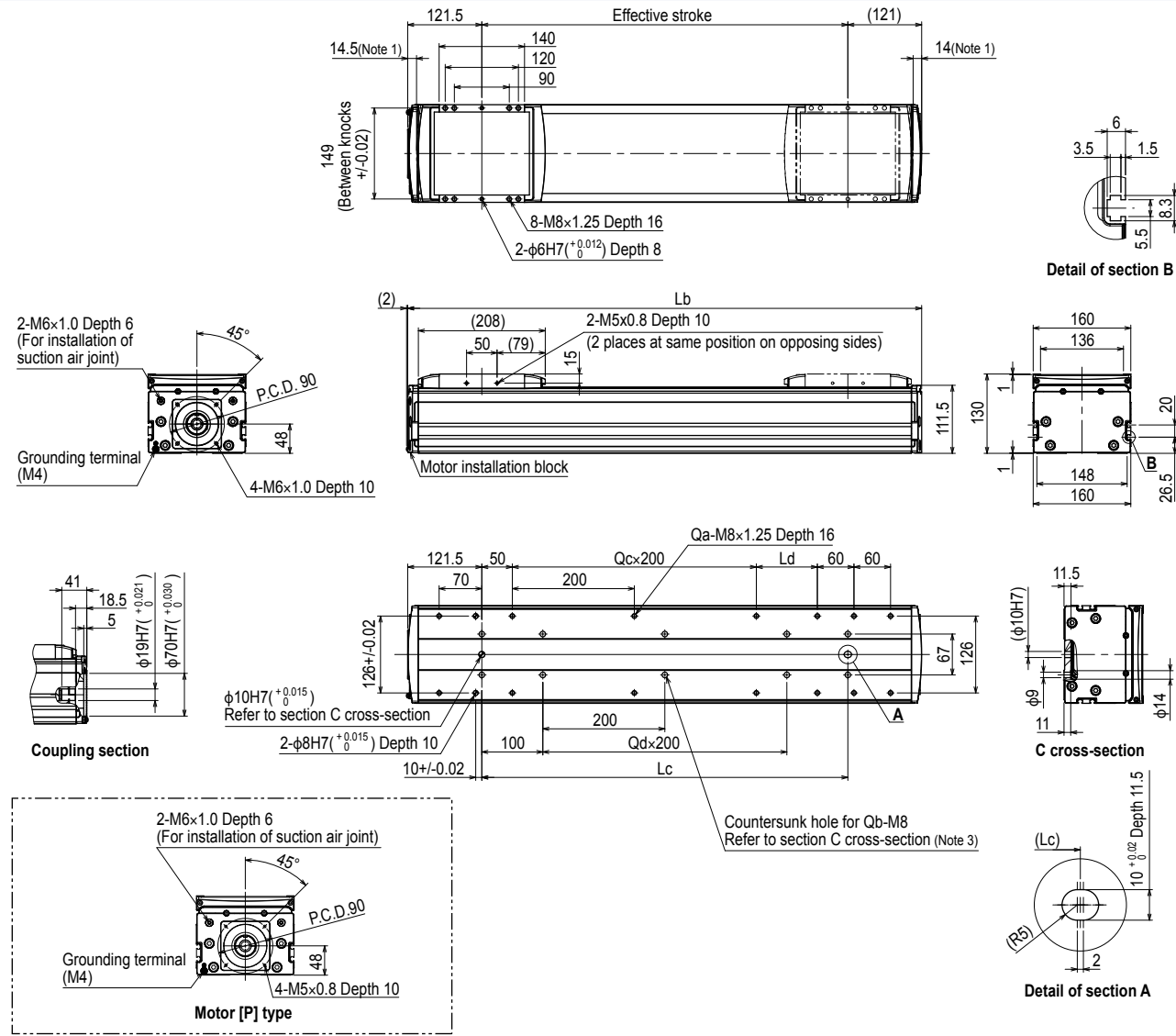

Note 1. Stop positions are determined by the mechanical stoppers at both ends.

Note 2. The length under head of the hex socket head bolts <M8 × 1.25> used to mount the body with the mounting countersunk holes (section C cross-section) must be <<25 mm or more>>. The recommended length under head of the hex socket head bolts <M8 × 1.25> used to mount the body with the mounting tap hole specifications is <<frame thickness + 15 mm or less>>.

Note 3. When using the mounting countersunk holes (section C cross-section) to mount the body, remove the seal, and then fix.

Effective stroke	100	150	200	250	300	350	400	450	500	550	600	650	700	750	800	850	900	950	1000	1050	1100	1150	1200	1250	1300	1350	1400	1450			
<b>Lb</b>	342.5	392.5	442.5	492.5	542.5	592.5	642.5	692.5	742.5	792.5	842.5	892.5	942.5	992.5	1042.5	1092.5	1142.5	1192.5	1242.5	1292.5	1342.5	1392.5	1442.5	1492.5	1542.5	1592.5	1642.5	1692.5			
<b>Lc</b>	100	150	200	250	300	350	400	450	500	550	600	650	700	750	800	850	900	950	1000	1050	1100	1150	1200	1250	1300	1350	1400	1450			
<b>Ld</b>	0	50	100	150	200	50	100	150	200	50	100	150	200	50	100	150	200	50	100	150	200	50	100	150	200	50	100	150			
<b>Qa</b>	8	10	10	10	10	12	12	12	12	14	14	14	14	16	16	16	16	18	18	18	18	20	20	20	20	22	22	22			
<b>Qb</b>	4	6	6	6	6	8	8	8	8	10	10	10	10	12	12	12	12	14	14	14	14	16	16	16	16	18	18	18			
<b>Qc</b>	0	0	0	0	0	1	1	1	1	2	2	2	2	3	3	3	3	4	4	4	4	5	5	5	5	6	6	6			
<b>Qd</b>	0	0	0	0	0	1	1	1	1	2	2	2	2	3	3	3	3	4	4	4	4	5	5	5	5	6	6	6			
<b>Weight (kg)</b>	11.7	12.7	13.7	14.7	15.7	16.6	17.6	18.6	19.6	20.6	21.5	22.5	23.5	24.5	25.5	26.5	27.4	28.4	29.4	30.4	31.4	32.4	33.3	34.3	35.3	36.3	37.3	38.2			
<b>Maximum speed (mm/sec)</b>	<b>Lead 40</b>															2160	1920	1680	1440	1320	1200	1080	960	840	720	600					
	<b>Lead 20</b>															1080	960	840	720	660	600	540	480	420	360	300					
	<b>Lead 10</b>															540	480	420	360	330	300	270	240	210	180	150					
	<b>Speed setting</b>															90%	80%	70%	60%	55%	50%	45%	40%	35%	30%	25%					

Articulated robots  
YA

Linear conveyors  
LCM

Single-axis robots  
CX

Motor-less single axis actuator  
Robonity

Compact single-axis robots  
TRANSERO

Single-axis robots  
FLIP-X

Linear motor single-axis robots  
PHASER

Cartesian robots  
XY-X

SCARA robots  
YK-X

Pick & place robots  
YP-X

CLEAN

CONTROLLER INFORMATION

LBAS

LGXS

Option



# LGXS20

Advanced model

Motor-less Single Axis Actuator



## Ordering method

### LGXS20

Model	Lead	Motor specification	Stroke
	40: 40 mm 20: 20 mm 10: 10 mm	No entry: Standard P: P specification (see below)	100 to 1450 (50 mm pitch)

### [Caution]

This system is provided as mechanical actuator unit and not including any adopters or electric components. Motor, driver and other components required for installation are user's responsibility. Refer to user's manual for installation details. Refer to your motor manual for tuning or adjustment. Vibration or resonance from actuator will affect service life of actuator. The product performance may not be satisfied depending on the compatible motor.

## Specifications

Adaptable motor	750 W		
Repeatability <sup>Note 1</sup>	±0.005 mm		
Deceleration mechanism	Ground ball screw φ20 (C5 class)		
Stroke	100 mm to 1450 mm (50 mm pitch)		
Maximum speed <sup>Note 2</sup> (or equivalent)	2400 mm/sec	1200 mm/sec	600 mm/sec
Ball screw lead	40 mm	20 mm	10 mm
Maximum payload (or equivalent) <sup>Note 3</sup>	Horizontal	65 kg	130 kg
	Vertical	15 kg	35 kg
Rated thrust (or equivalent) <sup>Note 3</sup>		320 N	640 N
			1280 N
Maximum dimensions of cross section of main unit	W 200 mm × H 140 mm		
Overall length	ST + 288.5 mm		
Degree of cleanliness <sup>Note 4</sup>	ISO CLASS 3 (ISO14644-1) or equivalent		
Intake air <sup>Note 5</sup>	30 Nℓ/min to 90 Nℓ/min		
Using ambient temperature and humidity	0 to 40 °C, 35 to 80 %RH (non-condensing)		

- Note 1. Positioning repeatability in one direction.  
 Note 2. When a moving distance is short and depending on an operation condition, it may not reach the maximum speed. If the effective stroke exceeds 800 mm, the ball screw may resonate. (Critical speed) At this time, make the adjustment to decrease the speed while referring to the maximum speed shown in the table. The rated thrust and maximum transferable weight are values assuming the attached motor outputs the rated torque.  
 Note 3. The required suction amount will vary according to the operating conditions and operating environment.  
 Note 4. When using in a clean environment, attach a suction air joint. The degree of cleanliness is the cleanliness level achieved when using at 1000 mm/sec or less.  
 Note 5. The required suction amount will vary according to the operating conditions and operating environment.  
 Note. See P.251 for acceleration/deceleration and inertia moment.

## Allowable overhang <sup>Note</sup>

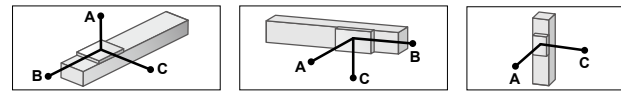

### LGXS20-40

Horizontal installation (Unit: mm)	A	B	C	Wall installation (Unit: mm)	A	B	C	Vertical installation (Unit: mm)	A	C			
	20kg	5318	2821		2096	20kg	2171		2751	5211	5kg	8187	8187
	40kg	4836	1609		1369	40kg	1417		1539	4667	10kg	5203	5203
	65kg	4824	1088	1001	65kg	1013	1018	4575	15kg	4810	4810		

### LGXS20-20

Horizontal installation (Unit: mm)	A	B	C	Wall installation (Unit: mm)	A	B	C	Vertical installation (Unit: mm)	A	C			
	50kg	5436	1493		1377	50kg	1390		1423	5265	20kg	3436	3436
	80kg	4417	911		854	80kg	849		841	4153	30kg	2600	2600
	100kg	4592	756	727	100kg	708	686	4253	35kg	3073	3073		
	130kg	4338	596	584	130kg	550	526	3933					

### LGXS20-10

Horizontal installation (Unit: mm)	A	B	C	Wall installation (Unit: mm)	A	B	C	Vertical installation (Unit: mm)	A	C			
	40kg	22519	2607		2713	40kg	2704		2537	22210	20kg	5157	5157
	80kg	16716	1274		1331	80kg	1293		1204	16141	40kg	2553	2553
	120kg	14066	830	868	120kg	818	760	13223	65kg	1600	1600		
	160kg	12284	608	637	160kg	580	538	11190					

- Note. Distance from center of slider top to center of gravity of object being carried at a guide service life of 10,000 km.  
 Note. Service life is calculated for 600 mm stroke models.

## Static loading moment

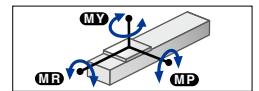

MY	MP	MR
1423	1423	1251

## Adaptable Servo Motor

Specification	Flange size	φ80
	Wattage	750 W
Motor specification	Manufacturer	Model
No entry	Yaskawa Electric Corp.	SGMJV-08
		SGMJJ-08
	Keyence Corp.	SV-□075
		SV2-□075
	Mitsubishi Electric Corp.	HF-KP73
P <sup>Note 2</sup>		HG-KR73
		HK-KT7M3 <sup>Note 1</sup>
	Omron Electronics	R88M-K75030
		R88M-1M75030
	Panasonic Corp.	MSMD08
	MSMF08	
	MHMF08	

- Note 1. To combine with the conversion adapter <GX-BEND-80>, the shim plate (t1) is necessary.  
 Note 2. For the specifications P, the bending unit cannot be used.

Conversion adapter product model	Shim plate part number
GX-BEND-80	KEX-M2295-00

## LGXS20

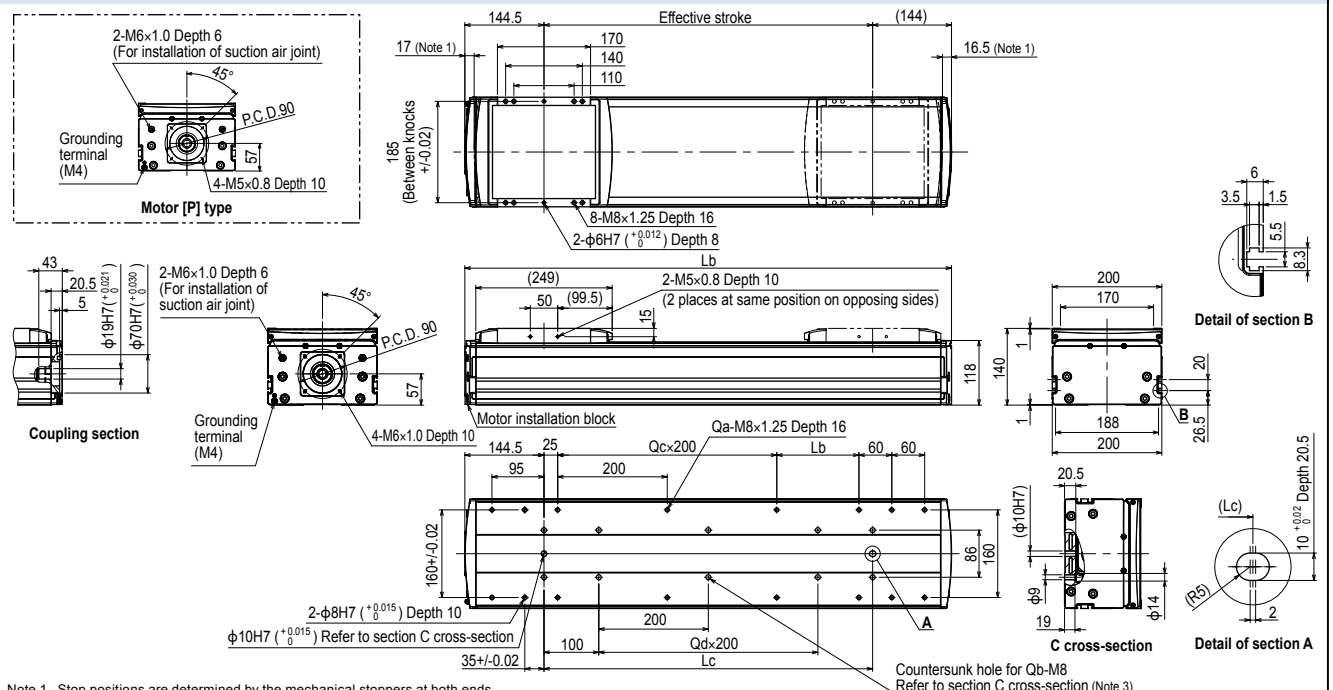

- Note 1. Stop positions are determined by the mechanical stoppers at both ends.  
 Note 2. The length under head of the hex socket head bolts <M8 × 1.25> used to mount the body with the mounting countersunk holes (section C cross-section) must be <<25 mm or more>>. The recommended length under head of the hex socket head bolts <M8 × 1.25> used to mount the body with the mounting tap hole specifications is <<frame thickness + 15 mm or less>>.  
 Note 3. When using the mounting countersunk holes (section C cross-section) to mount the body, remove the seal, and then fix.

Effective stroke	100	150	200	250	300	350	400	450	500	550	600	650	700	750	800	850	900	950	1000	1050	1100	1150	1200	1250	1300	1350	1400	1450
Lb	388.5	438.5	488.5	538.5	588.5	638.5	688.5	738.5	788.5	838.5	888.5	938.5	988.5	1038.5	1088.5	1138.5	1188.5	1238.5	1288.5	1338.5	1388.5	1438.5	1488.5	1538.5	1588.5	1638.5	1688.5	1738.5
Lc	100	150	200	250	300	350	400	450	500	550	600	650	700	750	800	850	900	950	1000	1050	1100	1150	1200	1250	1300	1350	1400	1450
Ld	50	100	150	200	50	100	150	200	50	100	150	200	50	100	150	200	50	100	150	200	50	100	150	200	50	100	150	200
Qa	10	10	10	10	12	12	12	12	14	14	14	14	16	16	16	18	18	18	18	18	20	20	20	20	22	22	22	22
Qb	4	6	6	6	6	8	8	8	10	10	10	10	12	12	12	12	14	14	14	14	16	16	16	16	16	18	18	18
Qc	0	0	0	0	1	1	1	1	2	2	2	2	3	3	3	3	4	4	4	4	5	5	5	5	6	6	6	6
Qd	0	0	0	0	0	1	1	1	2	2	2	2	3	3	3	3	4	4	4	4	5	5	5	5	6	6	6	6
Weight (kg)	17.2	18.5	19.8	21.1	22.4	23.7	25.0	26.3	27.6	28.8	30.1	31.4	32.7	34.0	35.3	36.6	37.9	39.2	40.4	41.7	44.3	45.6	46.9	48.2	49.5	50.8	52.0	52.0
Maximum speed (mm/sec)	Lead 40	2400															2160	1920	1680	1440	1320	1200	1080	960	840	720	600	
	Lead 10	1200															1080	960	840	720	660	600	540	480	420	360	300	
Speed setting	Lead 10	600															540	480	420	360	330	300	270	240	210	180	150	120
	Speed setting	-															90%	80%	70%	60%	55%	50%	45%	40%	35%	30%	25%	

Articulated robots  
YA

Linear conveyor modules  
LCM

Single-axis robots  
CX

Motorless single axis actuator  
**Robomity**

Compact single-axis robots  
TRANSEVO

Single-axis robots  
FLIP-X

Linear motor single-axis robots  
PHASER

Cartesian robots  
XY-X

SCARA robots  
YK-X

Pick & Place robots  
YP-X

CLEAN

CONTROLLER

INFORMATION

LBAS

LGXS

Option

Robonity series

External Sensor Installation Guide (Left side shown)

■ Sensor Spec

Item	Specification	
Manufacturer	Panasonic Industrial Device SUNX, Co., Ltd.	
Model	GX-F8A	GX-F8B
Output method	NPN type	
Output action	ON when approaching	ON when leaving
Power voltage	DC12 to 24V	
Load current	100 mA or less	
Consumption current	15 mA or less	

Item	Specification
Display lamp	Orange LED (ON when output ON)
Ambient environment and humidity	-25 to +75 °C, 35 to 85 %RH
Protection structure	IP68
Cable length	5 m

[Caution]

- Bracket screw tightening torque: 0.5 N-m
- The detection surface of the sensor and sensor plate clearance is approx. 1 mm.

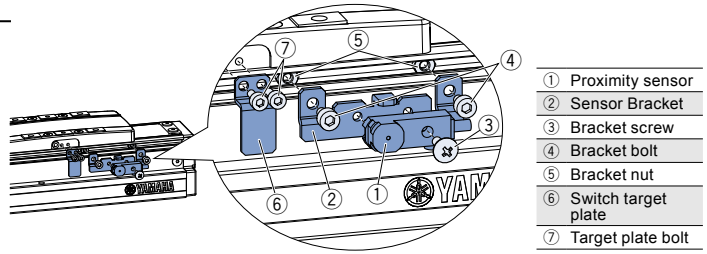

Note 1. Installation is users' responsibility  
 Note 2. Mounting hardware included  
 Note 3. Sensor cable is 5 m. Adjust as needed.  
 Note 4. Sensor cable outlet can be either motor end or no motor end of actuator

LBAS04

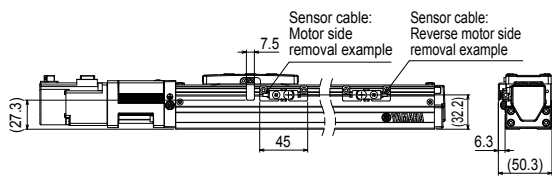

Proximity sensor option

Class	Name	Number		Qty	Remarks
		ON when approaching (NO, Normally Open)	ON when leaving (NC, Normally Closed)		
Assy	Proximity sensor option	KFU-M2205-10	KFU-M2205-00		
Component	① Proximity sensor	KES-M4855-00	KP6-M4855-01	1	
	② Sensor Bracket	KFU-M22FF-00		1	
	③ Bracket screw	90990-66J004		1	M3 × 0.5 Length 8
	④ Bracket bolt	91312-03005		2	M3 × 0.5 Length 5
	⑤ Bracket nut	95302-03700		2	M3

Target plate option

Class	Name	Number	Qty	Remarks
Assy	Target plate option	KFT-M2206-00		
Component	⑥ Switch target plate	KFT-M22G5-00	1	
	⑦ Target plate bolt	90112-02J005	2	M2 × 0.4 Length 5

LBAS05

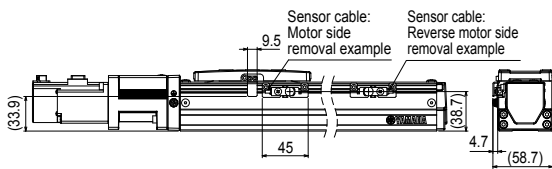

Proximity sensor option

Class	Name	Number		Qty	Remarks
		ON when approaching (NO, Normally Open)	ON when leaving (NC, Normally Closed)		
Assy	Proximity sensor option	KFU-M2205-10	KFU-M2205-00		
Component	① Proximity sensor	KES-M4855-00	KP6-M4855-01	1	
	② Sensor Bracket	KFU-M22FF-00		1	
	③ Bracket screw	90990-66J004		1	M3 × 0.5 Length 8
	④ Bracket bolt	91312-03005		2	M3 × 0.5 Length 5
	⑤ Bracket nut	95302-03700		2	M3

Target plate option

Class	Name	Number	Qty	Remarks
Assy	Target plate option	KFU-M2206-00		
Component	⑥ Switch target plate	KFU-M22G5-00	1	
	⑦ Target plate bolt	90112-2AJ005	2	M2.5 × 0.4 Length 5

LBAS08

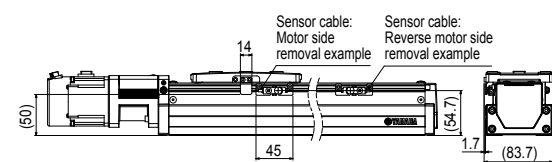

Proximity sensor option

Class	Name	Number		Qty	Remarks
		ON when approaching (NO, Normally Open)	ON when leaving (NC, Normally Closed)		
Assy	Proximity sensor option	KFU-M2205-10	KFU-M2205-00		
Component	① Proximity sensor	KES-M4855-00	KP6-M4855-01	1	
	② Sensor Bracket	KFU-M22FF-00		1	
	③ Bracket screw	90990-66J004		1	M3 × 0.5 Length 8
	④ Bracket bolt	91312-03005		2	M3 × 0.5 Length 5
	⑤ Bracket nut	95302-03700		2	M3

Target plate option

Class	Name	Number	Qty	Remarks
Assy	Target plate option	KFU-M2206-00		
Component	⑥ Switch target plate	KFU-M22G5-00	1	
	⑦ Target plate bolt	91312-03005	2	M3 × 0.5 Length 5

■ Grease Gun Nozzle (LBAS Model)

Specially designed for LBAS model for lubrication on ball screw and linear guide.

\* It can be used by attaching to a commercially available general grease gun.

● Lubrication Kit

Grease nozzle and nozzle tip

Part number	KFU-M3861-00
-------------	--------------

● Nozzle tip

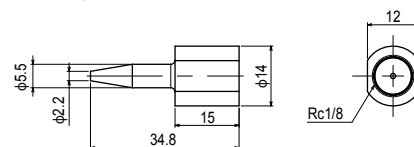

Part number	KFU-M2941-00
-------------	--------------

● Grease nozzle

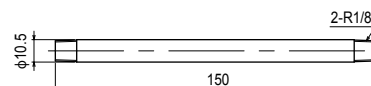

Part number	KFU-M2942-00
-------------	--------------

Robonity series

External Sensor Installation Guide (Left side shown)

■ Sensor Spec

Item	Specification
Manufacturer	Panasonic Industrial Device SUNX, Co., Ltd.
Model	GX-F8A GX-F8B
Output method	NPN type
Output action	ON when approaching ON when leaving
Power voltage	DC12 to 24V
Load current	100 mA or less
Consumption current	15 mA or less

Item	Specification
Display lamp	Orange LED (ON when output ON)
Ambient environment and humidity	-25 to +75 °C, 35 to 85 %RH
Protection structure	IP68
Cable length	5 m

[Caution]

- Bracket screw tightening torque: 0.5 N-m
- The detection surface of the sensor and sensor plate clearance is approx. 1 mm.

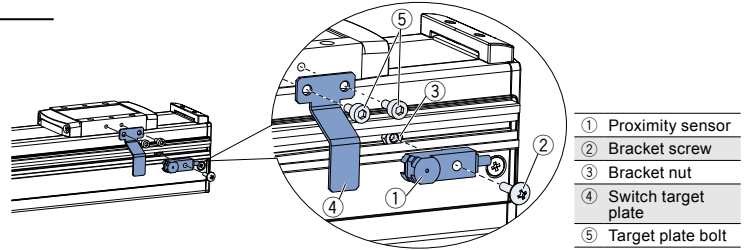

- Note 1. Installation is users' responsibility  
 Note 2. Mounting hardware included  
 Note 3. Sensor cable is 5 m. Adjust as needed.  
 Note 4. To install the sensor option, side cover with T groove is needed.

LGXS05

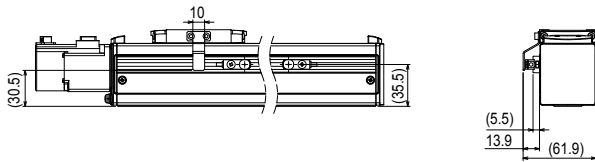

Proximity sensor option

Class	Name	Number		Qty	Remarks
		ON when approaching (NO, Normally Open)	ON when leaving (NC, Normally Closed)		
Assy	Proximity sensor option	KES-M2205-10	KES-M2205-00		
Component	① Proximity sensor	KES-M4855-00	KP6-M4855-01	1	
	② Bracket screw	90990-66J025		1	M3 × 0.5 Length 10
	③ Bracket nut	95302-03600		2	M3

Target plate option

Class	Name	Number	Qty	Remarks
Assy	Target plate option	KES-M2206-00		
Component	④ Switch target plate	KES-M22G5-00	1	
	⑤ Target plate bolt	91312-03006	2	M3 × 0.5 Length 6

LGXS05L

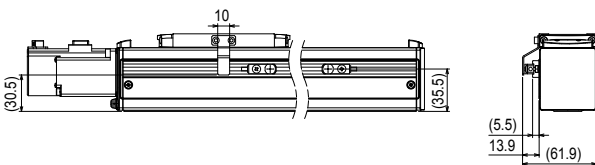

Proximity sensor option

Class	Name	Number		Qty	Remarks
		ON when approaching (NO, Normally Open)	ON when leaving (NC, Normally Closed)		
Assy	Proximity sensor option	KES-M2205-10	KES-M2205-00		
Component	① Proximity sensor	KES-M4855-00	KP6-M4855-01	1	
	② Bracket screw	90990-66J025		1	M3 × 0.5 Length 10
	③ Bracket nut	95302-03600		2	M3

Target plate option

Class	Name	Number	Qty	Remarks
Assy	Target plate option	KES-M2206-00		
Component	④ Switch target plate	KES-M22G5-00	1	
	⑤ Target plate bolt	91312-03006	2	M3 × 0.5 Length 6

LGXS07

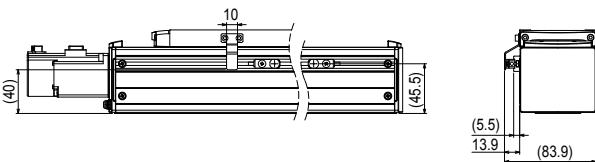

Proximity sensor option

Class	Name	Number		Qty	Remarks
		ON when approaching (NO, Normally Open)	ON when leaving (NC, Normally Closed)		
Assy	Proximity sensor option	KES-M2205-10	KES-M2205-00		
Component	① Proximity sensor	KES-M4855-00	KP6-M4855-01	1	
	② Bracket screw	90990-66J025		1	M3 × 0.5 Length 10
	③ Bracket nut	95302-03600		2	M3

Target plate option

Class	Name	Number	Qty	Remarks
Assy	Target plate option	KES-M2206-00		
Component	④ Switch target plate	KES-M22G5-00	1	
	⑤ Target plate bolt	91312-03006	2	M3 × 0.5 Length 6

Articulated robots YA  
 Linear conveyor modules LCM  
 Single-axis robots CX  
 Motor-less single-axis robots Robonity  
 Compact single-axis robots TRANSERO  
 Single-axis robots FLIP-X  
 Linear motor single-axis robots PHASER  
 Cartesian robots XY-X  
 SCARA robots YK-X  
 Pick & place robots YP-X  
 CLEAN  
 CONTROLLER  
 INFORMATION  
 LBAS  
 LGXS  
 Option

Robonity series

External Sensor Installation Guide (Left side shown)

■ Sensor Spec

Item	Specification	
Manufacturer	Panasonic Industrial Device SUNX, Co., Ltd.	
Model	GX-F8A	GX-F8B
Output method	NPN type	
Output action	ON when approaching	ON when leaving
Power voltage	DC12 to 24V	
Load current	100 mA or less	
Consumption current	15 mA or less	

Item	Specification
Display lamp	Orange LED (ON when output ON)
Ambient environment and humidity	-25 to +75 °C, 35 to 85 %RH
Protection structure	IP68
Cable length	5 m

**[Caution]**

- Bracket screw tightening torque: 0.5 N·m
- The detection surface of the sensor and sensor plate clearance is approx. 1 mm.

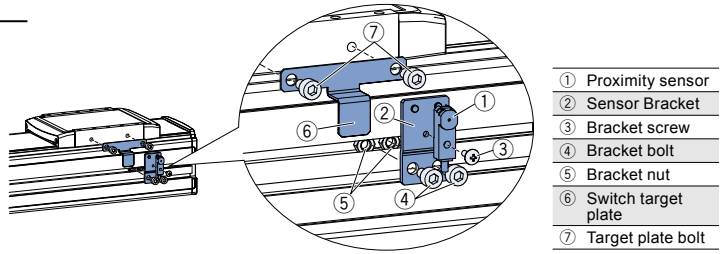

Note 1. Installation is users' responsibility  
 Note 2. Mounting hardware included  
 Note 3. Sensor cable is 5 m. Adjust as needed.

**LGXS10**

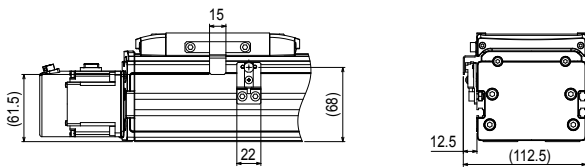

Proximity sensor option

Class	Name	Number		Qty	Remarks
		ON when approaching (NO, Normally Open)	ON when leaving (NC, Normally Closed)		
Assy	Proximity sensor option	KEV-M2205-10	KEV-M2205-00		
Component	① Proximity sensor	KES-M4855-00	KP6-M4855-01	1	
	② Sensor Bracket	KEV-M22FF-00		1	
	③ Bracket screw	90990-66J004		1	M3 × 0.5 Length 8
	④ Bracket bolt	91312-05008		2	M5 × 0.8 Length 8
	⑤ Bracket nut	95302-05700		2	M5

Target plate option

Class	Name	Number	Qty	Remarks
Assy	Target plate option	KEV-M2206-00		
Component	⑥ Switch target plate	KEV-M22G5-00	1	
	⑦ Target plate bolt	91312-05008	2	M5 × 0.8 Length 8

**LGXS12**

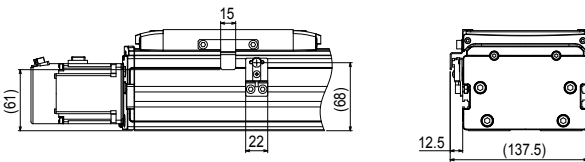

Proximity sensor option

Class	Name	Number		Qty	Remarks
		ON when approaching (NO, Normally Open)	ON when leaving (NC, Normally Closed)		
Assy	Proximity sensor option	KEV-M2205-10	KEV-M2205-00		
Component	① Proximity sensor	KES-M4855-00	KP6-M4855-01	1	
	② Sensor Bracket	KEV-M22FF-00		1	
	③ Bracket screw	90990-66J004		1	M3 × 0.5 Length 8
	④ Bracket bolt	91312-05008		2	M5 × 0.8 Length 8
	⑤ Bracket nut	95302-05700		2	M5

Target plate option

Class	Name	Number	Qty	Remarks
Assy	Target plate option	KEV-M2206-00		
Component	⑥ Switch target plate	KEV-M22G5-00	1	
	⑦ Target plate bolt	91312-05008	2	M5 × 0.8 Length 8

**LGXS16**

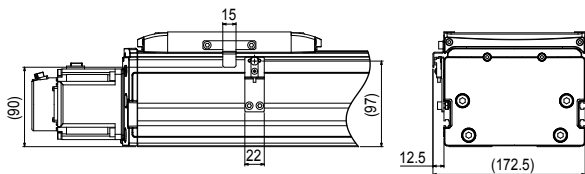

Proximity sensor option

Class	Name	Number		Qty	Remarks
		ON when approaching (NO, Normally Open)	ON when leaving (NC, Normally Closed)		
Assy	Proximity sensor option	KEX-M2205-10	KEX-M2205-00		
Component	① Proximity sensor	KES-M4855-00	KP6-M4855-01	1	
	② Sensor Bracket	KEY-M22FF-00		1	
	③ Bracket screw	90990-66J004		1	M3 × 0.5 Length 8
	④ Bracket bolt	91312-05008		2	M5 × 0.8 Length 8
	⑤ Bracket nut	95302-05700		2	M5

Target plate option

Class	Name	Number	Qty	Remarks
Assy	Target plate option	KEV-M2206-00		
Component	⑥ Switch target plate	KEV-M22G5-00	1	
	⑦ Target plate bolt	91312-05008	2	M5 × 0.8 Length 8

**LGXS20**

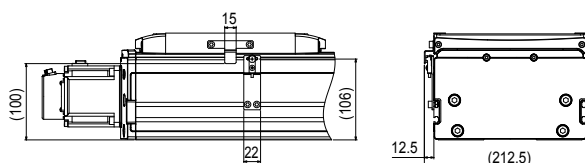

Proximity sensor option

Class	Name	Number		Qty	Remarks
		ON when approaching (NO, Normally Open)	ON when leaving (NC, Normally Closed)		
Assy	Proximity sensor option	KEY-M2205-10	KEY-M2205-00		
Component	① Proximity sensor	KES-M4855-00	KP6-M4855-01	1	
	② Sensor Bracket	KEY-M22FF-00		1	
	③ Bracket screw	90990-66J004		1	M3 × 0.5 Length 8
	④ Bracket bolt	91312-05008		2	M5 × 0.8 Length 8
	⑤ Bracket nut	95302-05700		2	M5

Target plate option

Class	Name	Number	Qty	Remarks
Assy	Target plate option	KEV-M2206-00		
Component	⑥ Switch target plate	KEV-M22G5-00	1	
	⑦ Target plate bolt	91312-05008	2	M5 × 0.8 Length 8

Robonity series

Reference guide for right angle motor mount (right side shown)

LGXS05

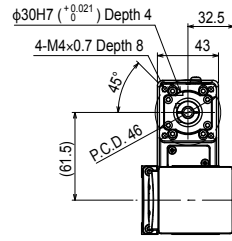
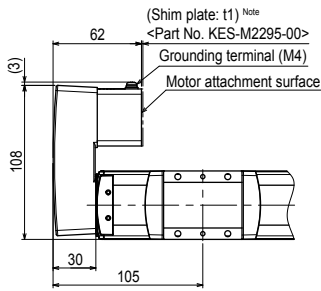

Note. For the availability of shim plate, see the adaptable servo motor table (P.210).

LGXS05L

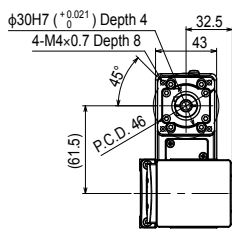
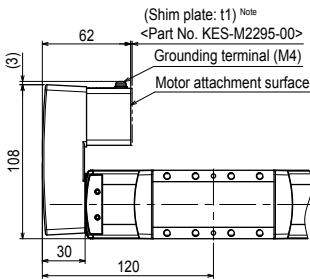

Note. For the availability of shim plate, see the adaptable servo motor table (P.212).

LGXS07

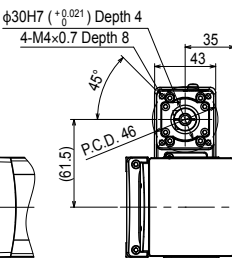
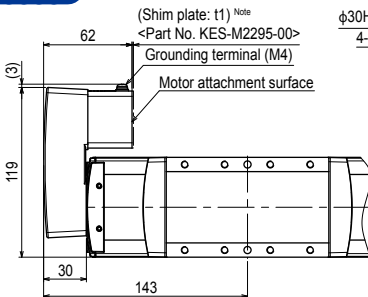

Note. For the availability of shim plate, see the adaptable servo motor table (P.214).

LGXS10

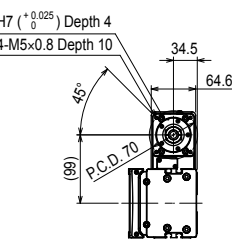
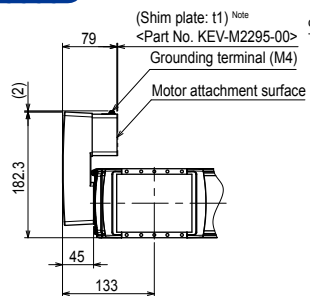

Note. For the availability of shim plate, see the adaptable servo motor table (P.216).

LGXS12

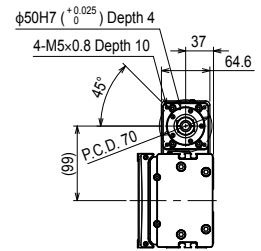
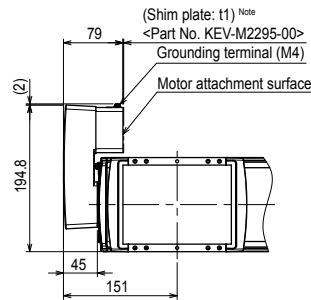

Note. For the availability of shim plate, see the adaptable servo motor table (P.218).

LGXS16

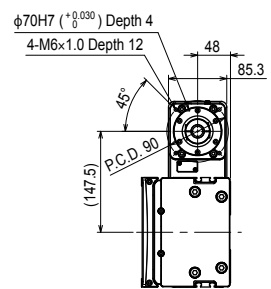
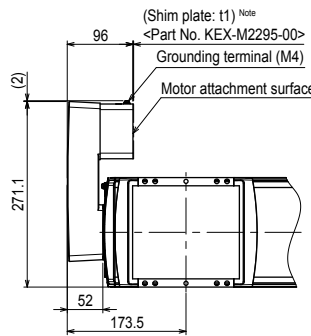

Note. For the availability of shim plate, see the adaptable servo motor table (P.220).

LGXS20

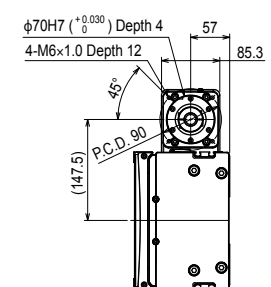
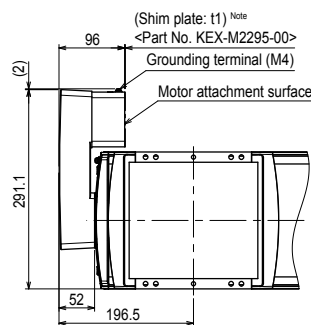

Note. For the availability of shim plate, see the adaptable servo motor table (P.222).

Note 1. Use by attaching the conversion adapter to the main unit. Refer to the manual for the attachment method.

Note 2. A motor is not included in the conversion adapter. Remove a motor from the main unit, and install the conversion adapter.

Note 3. Right installation and left installation are possible.

Model	Product model	Part No.	Weight
LGXS05, LGXS05L, LGXS07	GX-BEND-40	KES-M221M-00	0.4 kg
LGXS10, LGXS12	GX-BEND-60	KEV-M221M-00	1.2 kg
LGXS16, LGXS20	GX-BEND-80	KEX-M221M-00	2.7 kg

- Articulated robots YA
- Linear conveyor modules LCM
- Single-axis robots CX
- Motor-less single axis actuator Robonity
- Compact single-axis robots TRANSERO
- Single-axis robots FLIP-X
- Linear motor single-axis robots PHASER
- Cartesian robots XY-X
- SCARA robots YK-X
- Pick & Place robots YP-X
- CLEAN
- CONTROLLER
- INFORMATION
- LBAS
- LGXS
- Option