

A WORD TO ROADSTER OWNERS

Thank you for choosing a Tesla Roadster. Not only have you chosen one of the finest sports cars on the road, you have also chosen the most energy efficient sports car ever sold. You are participating in a revolution, demonstrating that kicking the oil habit does not mean you have to give up performance and driving pleasure.

Take the time to get well acquainted with your Tesla Roadster by reading this manual. The more you know and understand your vehicle, the more safety and pleasure you'll experience driving it.

Tesla Motors knows your Roadster best. So when service or maintenance is required, Tesla Motors is the place to go. Visit us regularly at www.teslamotors.com for more information about your Tesla Roadster. By signing into the owners area of this web site, you can access all the information you need about your specific vehicle, including service information.

Enjoy your Tesla Roadster!

Tesla Motors
Palo Alto, California, USA

Table of Contents

Introduction		Maintenance and care	
Important notes about your vehicle	1-2	Maintenance	8-2
Your vehicle at a glance		Fluid reservoirs	8-4
Exterior	2-2	Windshield wiper and washer	8-6
Interior	2-4	Cleaning and vehicle care	8-7
Seating and safety restraints		Wheels and tyres	8-10
Seats	3-2	Vehicle diagnostic information	8-18
Seat belts	3-3	Roadside emergencies	
Airbag system	3-6	Tool kit	9-2
Doors, locks, and security		Energy depletion	9-3
Keys and handsets	4-2	Tyre repair	9-4
Doors and glove box	4-4	Wheels	9-6
Trunk	4-6	Fuse replacement	9-7
Vehicle security	4-7	Bulb replacement	9-10
Charging your vehicle		Raising the vehicle	9-12
Charging components	5-2	Vehicle recovery	9-14
Information about charging	5-4	Technical specifications	
Charge settings	5-7	Vehicle identification	10-2
Charging instructions	5-9	Approved fluids and capacities	10-3
Driving your vehicle		Vehicle dimensions and weights	10-4
Driving basics	6-2	Wheels and tyres	10-6
Switches and controls	6-8	Subsystem specifications	10-7
Instruments	6-12		
Comfort and convenience			
Power windows	7-2		
Rear view mirrors	7-3		
Interior temperature control	7-4		
Interior accessories	7-7		
Removable roof	7-9		
HomeLink®	7-15		

For information on how to use the touch screen and how to charge your vehicle, refer to the separate manuals provided in your owner's package. For information on how to use the audio and navigation system, refer to the Original Equipment Manufacturer (OEM) documentation provided by Tesla Motors.

Important notes about your vehicle

Electric vehicle precautions	1-2
Vehicle modifications	1-2
Service data recording	1-2
Change of address or ownership	1-2
Copyright and trademarks	1-2
About this manual	1-3
Symbols glossary	1-3

Important notes about your vehicle

Electric vehicle precautions

 **WARNING: HIGH VOLTAGE.** The Tesla Roadster™ has both AC and DC high voltage systems in addition to a normal 12V DC system. High voltage is very dangerous and can cause personal injury including electric shock, severe burns and even fatal injury. ▲

The Tesla Roadster has been designed and built with user safety as a priority but please be aware of the following precautions:

- Always observe and obey the instructions on all labels attached to components on your vehicle.
- Do not touch, remove or replace any high voltage parts.
- If your vehicle is involved in an accident, do not touch any high voltage wiring (identified by the orange outer sleeving), the connectors or the components connected to the wiring.

Vehicle modifications

 **WARNING:** The fitting of non approved parts and accessories, or the implementation of non approved modifications to any vehicle components, including any “hacking” of the vehicle’s software, may be dangerous and could affect the safety of your vehicle and its occupants and also invalidate the terms and conditions of the Vehicle Warranty. ▲

 **WARNING:** Tesla Motors™ will not accept any liability for death, personal injury or damage to property which may occur as a direct or indirect result of non approved modifications or the fitment of non approved accessories. ▲

If you have a disability which requires modification to your vehicle, consult Tesla Motors before making these modifications.

Service data recording

Service data recorders in your vehicle are capable of collecting and storing diagnostic information about your vehicle. This potentially includes information about the performance or status of various systems and control modules in your vehicle such as motor, accelerator, or brakes. To properly diagnose and service your vehicle, Tesla Motors and service facilities may access vehicle diagnostic information through a direct connection to your vehicle.

Change of address or ownership

If you change your address, it is in your best interest to notify Tesla Motors so we can contact you should the need arise. Send in the ‘Change of Address Notice’ found in the ‘Vehicle Warranty’ booklet, or simply call Tesla Motors.

If you sell your vehicle, please pass on the owner’s package documents to the next owner.

If you bought this vehicle used, either fill in the ‘Change of Address Notice’, or simply call Tesla Motors.

Copyright and trademarks

©2010 TESLA MOTORS INC. All rights reserved. This material may not be reproduced or copied, in whole or in part, without the written permission of Tesla Motors, Inc.

Tesla Motors™ and Tesla Roadster™ are trademarks of Tesla Motors, Inc.

iPod® is a registered trademark of Apple Computer, Inc.

Havoline® is a registered trademark of Chevron or its affiliates.

All other trademarks are the property of their respective owners.

About this manual

This owner's manual contains a great deal of information you need to know about a Tesla Roadster. We urge you to read it carefully and familiarize yourself with the vehicle before driving.

For your own safety, follow the instructions and warnings contained in this manual. Ignoring them could result in damage to the vehicle or personal injury to you or others. Vehicle damage caused by failure to follow instructions is not covered by the Vehicle Warranty.

Keep this manual in your Roadster as a reference for the safe and enjoyable use of your Tesla Roadster. Should you sell your vehicle, be sure to provide this manual to the new owner.

All specifications and descriptions are accurate at the time of printing. Because improvement is a constant goal at Tesla Motors, we reserve the right to make changes at any time, without notice and without obligation.

This manual applies to all Roadster 2 and Roadster Sport vehicles. As a result, you may find some explanations for equipment or options not installed on your vehicle. When required, Tesla Motors distributes an addendum to provide updated information.

An effective way to find the information you need is to use the index at the back of this manual.

If you are unable to find the information you need, the following additional documents are included in your owner's package:

- Quick Reference - a summarized version of this document allowing you to quickly familiarise yourself with the vehicle and its features.
- Touch Screen Users Manual - describes how to use the screens to display important information while parking, driving, and charging the vehicle
- Roadside Assistance Guide - describes the Tesla Motors Roadside Assistance program and provides instructions on how to transport the vehicle
- Warranty Guide - details the Vehicle Warranty

In addition to the documents in your owner's package, Tesla provides the following documents:

- Mobile Connector Users Manual - describes how to use a Tesla Motors mobile connector.
- OEM Audio & Navigation System manual - describes how to use the vehicle's audio and navigation system. This manual is provided in your vehicle's trunk.
- High Power Wall Connector Manual - provides step-by-step instructions on the installation and use of the Tesla Motors High Power Wall Connector.

When required, Tesla Motors may also include an addendum in the owner's package if your vehicle differs from what is in the manuals. If you are missing a document, please contact Tesla Motors.

Symbols glossary

The following symbols used within this manual call your attention to specific types of information:

 **WARNING:** Indicates a situation in which serious bodily injury or death could result if the warning is ignored. ▲

 **Caution:** Indicates a situation in which bodily injury or damage to your vehicle, or both, could result if the caution is ignored.

 Identifies items that must be disposed of safely to prevent unnecessary damage to the environment.

Note: A note provides useful supporting information and sometimes suggests how to make better use of your vehicle.

Your vehicle at a glance

Exterior

Exterior overview 2-3

Interior

Dashboard overview 2-5

Exterior

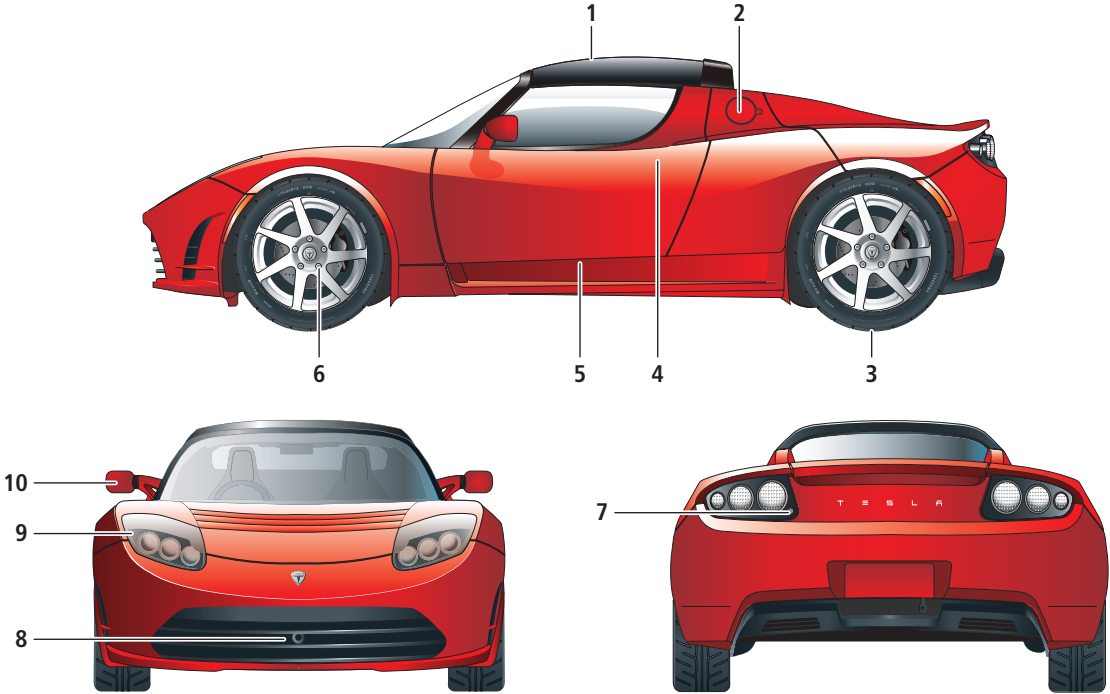

TR1487

Exterior overview

1. Roof. See Removable roof, page 7-9.
2. Charging port door. See Charging instructions, page 5-9.
3. Wheels and tires. See Wheels and tyres, page 10-6.
4. Exterior door release. See Exterior door release, page 4-4.
5. Emergency door unlock. See Emergency unlocking, page 4-5.
6. Wheel bolts. See Removing the wheel, page 9-6.
7. Trunk lock. See Opening the trunk, page 4-6.
8. Vehicle recovery eye. See Attaching the recovery eye, page 9-14.
9. Headlights. See Exterior lights, page 6-8.
10. Exterior mirrors. See Exterior rear view mirrors, page 7-3.

Interior

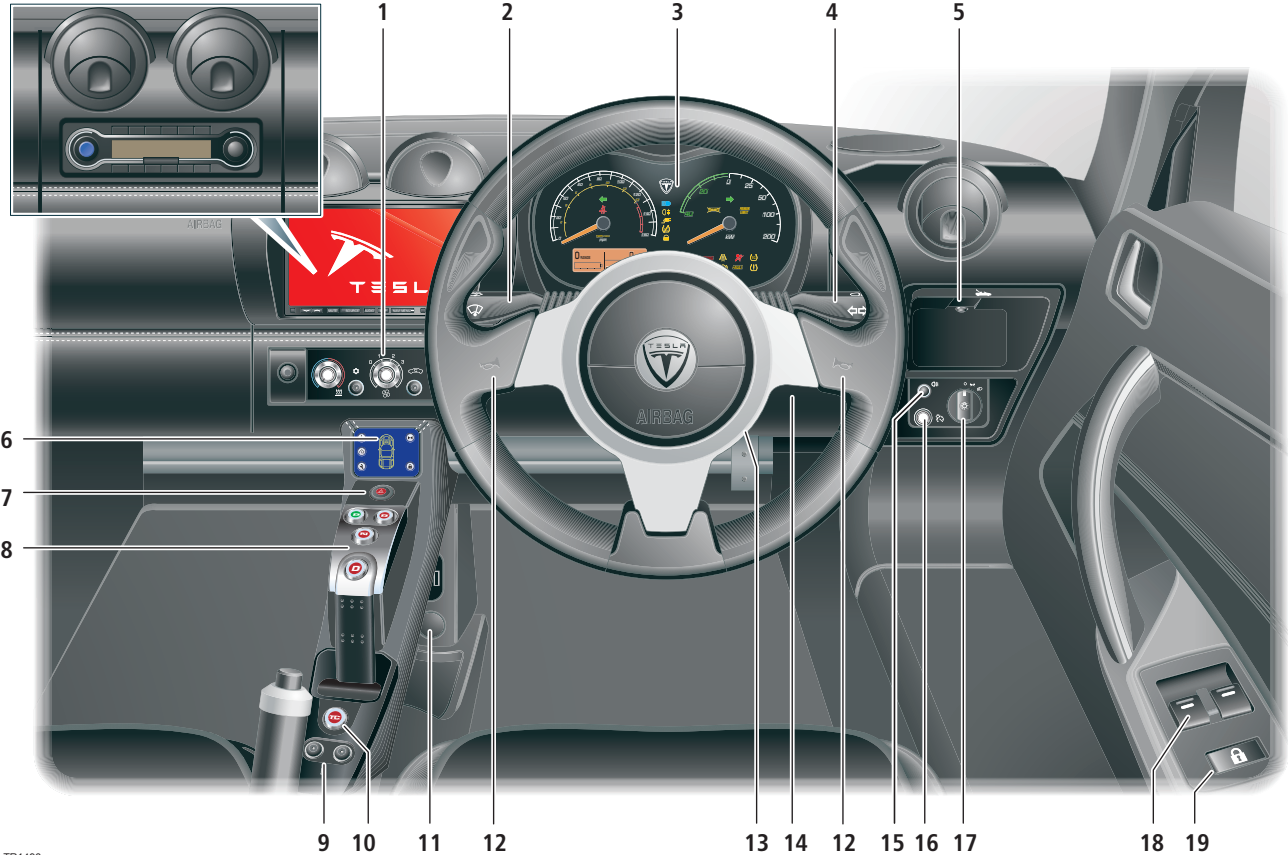

TR1493

Dashboard overview

1. Heating and air conditioning. See Interior temperature control, page 7-4.
2. Turn signals, headlight high beam and cruise control. See Exterior lights, page 6-8 and Cruise control, page 6-11.
3. Instruments. See Instruments, page 6-12.
4. Windshield wiper and washer. See Windshield wiper and washer, page 6-10.
5. Trunk release. See Opening the trunk, page 4-6.
6. Touch Screen. See 'Touch Screen User's Manual'.
7. Hazard warning light switch. See Hazard warning, page 6-9.
8. Gear selector. See Selecting gears, page 6-5.
9. Seat heaters. See Seat heaters, page 7-6.
10. Traction control switch. See Traction control, page 6-7.
11. Accessory power socket. See Accessory power socket, page 7-7.
12. Horn. See Horn, page 6-9.
13. Starter switch. See Starting the vehicle, page 6-2.
14. Bonnet release. See Opening and closing the bonnet, page 8-3.
15. Rear fog lamp. See Rear fog light, page 6-9.
16. Instrument panel illumination control. See Instrument panel lighting, page 6-15.
17. Exterior lights master switch. See Exterior lights, page 6-8.
18. Power windows. See Operating the windows, page 7-2.
19. Central door locking. See Central door locking, page 4-4.

Seating and safety restraints

Seats

Seat adjustment 3-2

Seat belts

General information 3-3

Seat belt safety instructions 3-3

Seat belt reminder 3-3

Using the seat belts 3-4

Wearing seat belts during pregnancy 3-4

Seat belt tensioners 3-4

Caring for seat belts 3-5

Child seats and restraints 3-5

Airbag system

General information 3-6

How the system works 3-6

Obstruction of airbags 3-6

Deployment effects 3-7

Airbag warning indicator 3-7

Passenger airbag deactivation 3-7

Airbag warning labels 3-7

Using child seats 3-7

Airbag service information 3-8

Vehicle modifications 3-8

Seats

Seat adjustment

⚠ WARNING: Never adjust the driver's seat while your vehicle is moving. Unexpected or sudden seat movement could result in an accident. ▲

Driver's seat position

To adjust the forward/rearward position of the driver's seat, raise the bar beneath the front of the seat and slide the seat to the required position. Release the bar to lock the seat into position. Ensure that the seat is locked in position before driving, by trying to slide the seat forward.

To reduce the risk of injury in the event of an accident, Tesla recommends the following when adjusting seat position:

- Adjust the seat so that you can press the foot pedals fully to the floor with your knees slightly bent.
- Make sure that you can comfortably reach the top of the steering wheel.
- Ideally a minimum distance of 254 mm (10 inches) is recommended between the steering wheel cover and your breastbone.
- Fasten your seat belt correctly.

Head restraints

Each seat is provided with a head restraint. The head restraints are integral with the seats and therefore can not be adjusted or removed.

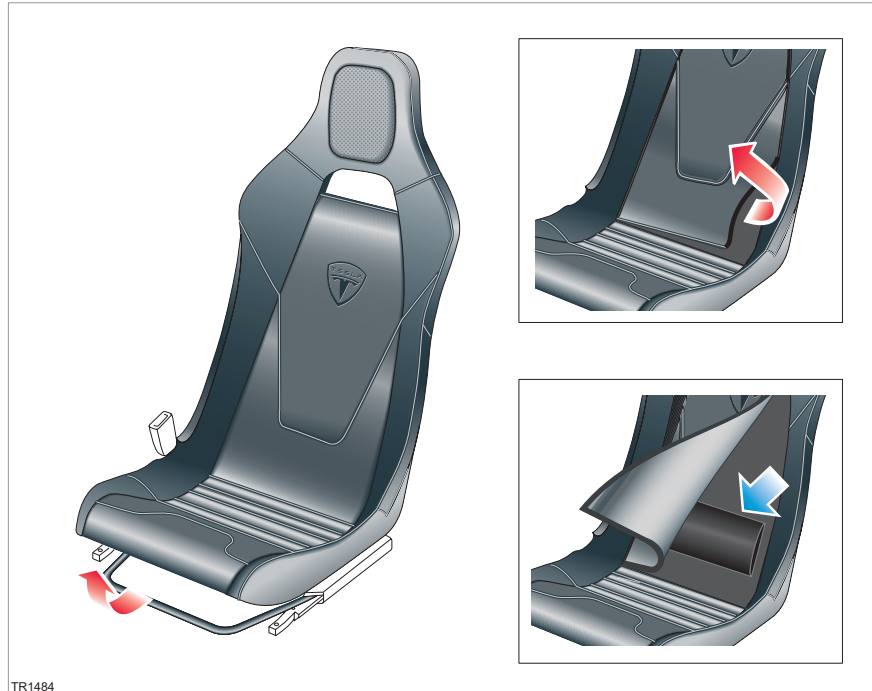

Lumbar support

Lumbar support is provided using a pad inserted under the seat cushion.

To adjust lumbar support, the position of the pad can be moved or additional lumbar support pads can be added. Lumbar support pads are available from Tesla Motors.

To access the lumbar support pad, carefully pull the lower edge of the seat covering towards you. Move the existing pad as required or install an additional one.

Once complete, push the seat cover back into place.

General information

 **WARNING:** Seat belts should be worn by all occupants, for every journey no matter how short. Failure to do so greatly increases the risk of death or serious injury in the event of an accident. ▲

Both the driver and passenger seating positions are equipped with three-point inertia reel seat belts. Inertia reel belts are tensioned automatically and allow freedom of movement during normal driving conditions.

The belt reel automatically locks, preventing movement of occupant, whenever your vehicle experiences the force associated with hard acceleration, braking, cornering or on impact in a collision. The reel may also lock when driving on steep hills or slopes.

The driver's seat belt includes a buckle sensor to detect when the buckle is latched.

Seat belt safety instructions

 **WARNING:** The airbag SRS is designed to add to the overall effectiveness of the seat belts. It does not replace them. Seat belts must always be worn. ▲

 **WARNING:** Ensure that all seat belts are worn correctly. An improperly worn seat belt increases the risk of death or serious injury in the event of a collision. ▲

 **WARNING:** Seat belts are designed to bear upon the bony structure of the body, and should be worn low across the front of the pelvis or the pelvis, chest and shoulders, as applicable; wearing the lap section of the belt across the abdominal area must be avoided. ▲

 **WARNING:** Seat belts should be adjusted as firmly as possible, consistent with comfort, to provide the protection for which they have been designed. A slack belt will greatly reduce the protection afforded to the wearer. ▲

 **WARNING:** Do not wear seat belts over hard, fragile or sharp items in clothing, such as pens, keys, eyeglasses, etc. In an impact, the pressure from the seat belt on such items can cause them to break, which in turn may cause serious injury. ▲

 **WARNING:** Each belt assembly must only be used by one occupant; it is dangerous to put a belt around a child being carried on the occupant's lap. ▲

 **WARNING:** Belts should not be worn with straps twisted. ▲

 **WARNING:** It is essential to replace the entire assembly after it has been worn in a severe impact even if damage to the assembly is not obvious. ▲

 **WARNING:** If a seat belt fails to retract or latch into the buckle, it must be replaced immediately. ▲

 **WARNING:** Care should be taken to avoid contamination of the webbing with polishes, oils and chemicals and particularly battery acid. Cleaning may be safely carried out using mild soap and water. The belt should be replaced if webbing becomes frayed, contaminated or damaged. ▲

 **WARNING:** No modifications or additions should be made that prevent the seat belt mechanism from taking up slack, or that prevent the seat belt being adjusted to remove slack. A slack belt greatly reduces the level of occupant protection. ▲

Seat belt reminder

 The seat belt warning indicator in the instrument panel illuminates whenever the driver's seat belt is unbuckled. Also, an audible sound will be heard for six seconds if the key is turned to the ON position and the driver's seat belt is unbuckled.

Note: If the car is driven more than 160 m (1/10 mile) with the driver's seat belt unbuckled, a warning tone will sound.

Seat belts



Using the seat belts

1. Ensure the seat is correctly positioned.
2. Draw the belt out smoothly, ensuring the belt lays flat across the pelvis, chest and mid-point of the collar bone between the neck and shoulder.
3. Insert the latch plate into the buckle and press down until you hear a “click” indicating it is securely locked in place.
4. Pull the belt to check it is securely fastened.
5. Pull the diagonal part of the belt towards the reel to remove any excess slack.

Releasing the belt

Release the seat belts by pressing the red button on the buckle. The belt retracts automatically.

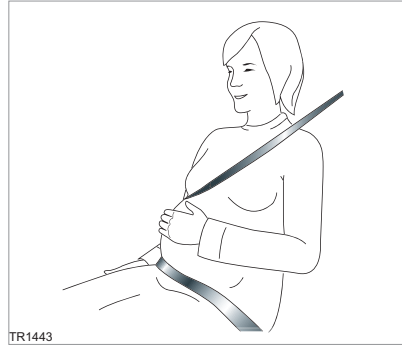

Wearing seat belts during pregnancy

! WARNING: Pregnant woman should always wear seat belts to protect themselves and their unborn child. ▲

! WARNING: Never place anything between you and the seat belt to cushion the impact in the event of an accident. ▲

The lap portion of the belt should be worn as low as possible across the hips, not the waist. Position the diagonal part of the belt between the breasts and to the side of the abdomen. Ensure that the seat belt is not slack or twisted.

If you have any concerns about wearing seat belts, contact your doctor.

Seat belt tensioners

! WARNING: The seat belt tensioners will only activate once, and then must be replaced by Tesla Motors or an authorised repairer. After any accident, always have the airbags, seat belt pre-tensioners and any associated components checked and, if necessary, replaced. ▲

The seat belts are equipped with pre-tensioners that activate in conjunction with the airbags and provide additional protection in the event of a severe frontal impact on your vehicle.

The pre-tensioners automatically retract the seat belt buckle, reducing any slack in both the lap and diagonal portions of the belts, resulting in reduced forward movement of the occupant.

Following an accident in which the pre-tensioners have been activated, the seat belts continue to function as restraints and must be worn if you drive your vehicle.

Caring for seat belts

! WARNING: Regularly check the condition of both belts. Replace seat belts if you notice any damage to the belt webbing, fittings, retractor mechanisms or buckles. ▲

Three tests for checking seat belts:

1. With the seat belt fastened, give the webbing nearest the buckle a quick upward pull. The buckle should remain securely locked.
2. With the belt unfastened, unreel the belt to its limit. Check that it unreels smoothly with snatches or snags. Visually check the webbing for wear. Allow the belt to retract, checking that retraction is smooth and complete.
3. With the webbing half unreeled, hold the tongue plate and pull forward quickly. The mechanism must lock automatically and prevent further unreeling.

If a seat belt fails any of these tests, contact Tesla Motors or an authorised repairer immediately.

For seat belt cleaning information, see Seat belts, page 8-9.

Child seats and restraints

! WARNING: The seat belts fitted to your vehicle are designed to secure adult sized passengers only. ▲

! WARNING: Children under age 12 and those weighing less than 36 kg (80 lb) are not of sufficient size to be carried safely wearing a standard seat belt of the type fitted to your vehicle. ▲

! WARNING: It is dangerous for children to travel in any type of vehicle without being restrained by a harness, child seat, or restraint system suitable for both their age and size. ▲

! WARNING: Never let a passenger hold a child on his or her lap while your vehicle is moving. The passenger cannot protect the child from injury in a collision. ▲

Currently, child seats and restraints are not approved for use in your vehicle. Until these are available, Tesla Motors strongly recommends that children are not carried as passengers in your vehicle.

Note: In some countries legislation prohibits children travelling in the front of a vehicle. Ensure that you are familiar with the legislation in force where the vehicle is being used and are in full compliance.

! WARNING: Original text according to EEC R94.01. Extreme Hazard! Do not use a rearward facing child restraint on a seat protected by an airbag in front of it ▲



This label warns against the use of a rearward facing child seat in vehicles fitted with a front passenger air bag.

Airbag system



TR1444

General information

The airbag for the driver (1) is located in the padded hub of the steering wheel. The airbag for the passenger (2) is located on the dashboard. These are indicated by the word **AIRBAG** on the trim.

Provided the occupants are correctly seated and the seat belts are properly worn, the airbags provide additional protection to the chest and face of the occupants in the event of a severe frontal impact.

Note: Airbags inflate and deflate very quickly and will not protect occupants against the effects of secondary impacts that may occur.

How the system works

! **WARNING:** The airbags are a supplemental restraint system providing additional protection in certain types of collisions only - they do not replace the need to wear a seat belt. ▲

Operation of the airbag system depends on the rate at which your vehicle's passenger compartment changes speed as a result of a collision.

In the event of a collision, the airbag control unit monitors the rate of deceleration induced by the collision to determine whether the airbags should be deployed.

When deployed, airbags inflate instantly, with considerable force accompanied by a loud noise. The inflated airbag, together with the seat belt, limit the movement of the occupants, thereby reducing the risk of injury to the head and upper torso.

The airbag system is not designed to operate as a result of:

- Rear collisions
- Minor front impacts
- Minor side impacts
- Heavy braking
- Driving over bumps or potholes

It follows, therefore, that significant superficial damage can occur without the air bags deploying or, conversely, that a relatively small amount of structural damage can cause the airbags to be deployed.

Obstruction of airbags

! **WARNING:** Do not allow passengers to obstruct the operation of the airbags by placing feet, knees or any other part of the body, or any other objects in contact with, or in close proximity to, an airbag module. ▲

! **WARNING:** Do not attach or position items on an airbag cover which could interfere with the inflation of the airbag or be propelled inside your vehicle and injure occupants. ▲

Deployment effects

! **WARNING:** The airbag module inflates with considerable speed and force. An inflating airbag can cause facial abrasions and other injuries. To limit these injuries, ensure that occupants are correctly seated, with the seat as far back as is practical, and are wearing seat belts. ▲

! **WARNING:** Following inflation, some airbag system components are hot. Do not touch until they have cooled. ▲

! **WARNING:** The powder released when an airbag inflates may cause breathing difficulties for asthma sufferers or people with other respiratory problems. ▲

When the airbags are deployed, a fine powder is released. This is not a malfunction. However, the powder may irritate the skin and should be thoroughly flushed from the eyes and from any cuts or abrasions on the skin.

After inflation, the airbags will deflate to provide a gradual cushioning effect for the occupants and to ensure the driver's forward vision is not obscured.

If the airbags have been deployed or if your vehicle has been in an accident, always have the airbags, seat belt pre-tensioners and any associated components checked and, if necessary, replaced by Tesla Motors or an authorised repairer.

Airbag warning indicator

! A warning indicator in the instrument panel alerts you of any malfunction of the airbag system.

The components of the system being monitored include: the airbag modules, the seat belt pre-tensioners, the airbag control unit and the airbag wiring harness.

When the key is turned to the ON position, the airbag control unit monitors the readiness of the system's electrical circuits.

Seek qualified assistance urgently if:

- The warning indicator fails to illuminate when the key is turned to the ON position.
- The warning indicator fails to extinguish within approximately six seconds after the key is turned to the ON position.
- The warning indicator illuminates while the vehicle is being driven.

Passenger airbag deactivation

! **WARNING:** Your vehicle is fitted with an airbag system that has no provision for switching off or deactivating the front passenger airbag. ▲



TR1393

Airbag warning labels

! **WARNING:** Extreme hazard! Do not use a rearward facing child restraint on a seat protected by an airbag in front of it. Doing so increases the risk of death or serious injury when the airbag deploys. ▲

Airbag warning information is printed on the driver's and passenger's sun visor.

Using child seats

! **WARNING:** Currently, child seats and restraints are not approved for use in your vehicle. Until these are available, Tesla Motors strongly recommends that children are not carried as passengers in your vehicle, and that you do not fit any type of child seat into your vehicle. Death or serious injury may occur if the child is too close to the dashboard when the airbag inflates. ▲

Airbag system

Airbag service information

 **WARNING:** The disposal of used airbag units is subject to stringent regulations, and should only be handled by Tesla Motors. ▲

For your safety, a Tesla Motors technician, or an authorised repairer who is familiar with your vehicle, must perform the following tasks:

- Removal, replacement, repair, or modification, of any wiring or component in the vicinity of airbag system components, including the steering wheel, steering column, dashboard and instrument panel.
- Modification to the front or side of your vehicle, including the bumper and chassis.

In addition, always contact Tesla Motors or an authorised repairer if:

- An airbag inflates
- A pre-tensioner activates
- The front or side of your vehicle is damaged, even if the airbag has not inflated
- Any part of an airbag module cover shows signs of cracking or damage

Vehicle modifications

 **WARNING:** The airbag system components are sensitive to both electrical and physical interference, either of which could cause the inadvertent operation or a malfunction of the airbag modules. ▲

Owner's with disabilities that may require the vehicle to be modified must contact Tesla Motors or an authorised repairer before any modifications are made.

Doors, locks, and security

Keys and handsets

About your keys and handsets	4-2
Using the handset	4-2
Vehicle immobiliser	4-3

Doors and glove box

Exterior door release	4-4
Interior door release	4-4
Central door locking	4-4
Emergency unlocking	4-5
Glove box	4-5

Trunk

Opening the trunk	4-6
Closing the trunk	4-6

Vehicle security

Alarm system	4-7
Security PIN	4-7
Valet mode	4-9

Keys and handsets

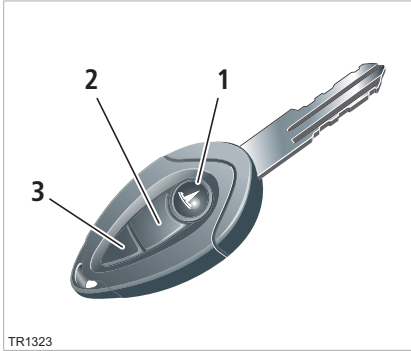

About your keys and handsets

! Caution: The handset (key fob) contains delicate electronic circuits and must be protected from impact, water damage and high temperatures. Avoid contact with solvents, waxes and abrasive cleaners.

You have been supplied with three keys. Two of the keys have integral remote handsets.

The handset buttons operate as follows:

1. Lock button.
2. Unlock button.
3. Trunk release/panic alarm button.

Keep the third key in a secure place for use in emergencies. If you lose a key, contact Tesla Motors to obtain a replacement.

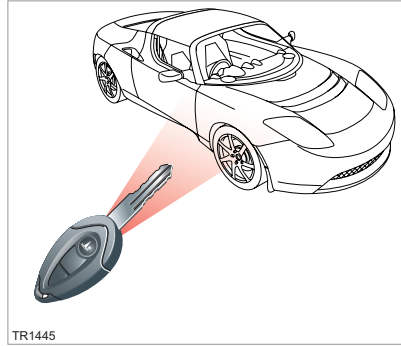

Using the handset

The buttons on the handset transmit a coded radio signal to a receiver in your vehicle. It is not necessary to point the handset at your vehicle, but you must be within operating range and you must hold the button down for two seconds. The operating range will vary according to the condition of the handset battery and other physical factors.

If the vehicle can not be locked or unlocked using the associated button on the handset, you may need to change the battery in the handset. See Replacing the handset battery, page 4-3.

Note: Interference from other radio equipment operating on a similar frequency may affect the operation of the handset. If this happens, operate the handset as close to your vehicle as

possible. If you are still unable to unlock your vehicle with the handset, use the emergency key lock. See Emergency unlocking, page 4-5.

Locking

! **WARNING:** Never leave anyone in your vehicle when it is locked using the handset. Operation of the exterior door release handles is inhibited, which will delay access in an emergency. **▲**

Press the Lock button on the handset to lock the doors and arm the alarm.

Note: The glove box will also be locked.

The turn signals will flash once and the security indicator in the instrument panel will illuminate and then continue to flash while the vehicle is locked.

If a door, the bonnet or the trunk are not fully closed when the Lock button is pressed, the turn signals will not flash and your vehicle is not armed. Check that the doors, bonnet and trunk are fully closed, then try again.

If the doors, bonnet or trunk are opened after the alarm has been set, the horn will sound and the turn signals will flash for 30 seconds. See Alarm system, page 4-7.

Unlocking

Press the Unlock button on the handset to unlock the doors, disarm the alarm and switch off the vehicle immobiliser. See Vehicle immobiliser, page 4-3.

The turn signals will flash twice and the alarm indicator in the instrument panel will extinguish.

Note: If a door or the trunk is not opened within two minutes, the doors will re-lock and the alarm will arm.

Trunk release

To open the trunk, press the trunk release button twice within 1.5 seconds. See Opening the trunk, page 4-6.

Panic alarm

Press and hold the trunk release button for two seconds to activate the alarm. The alarm will sound and the exterior lights will flash. To cancel the alarm, press any button on the handset.

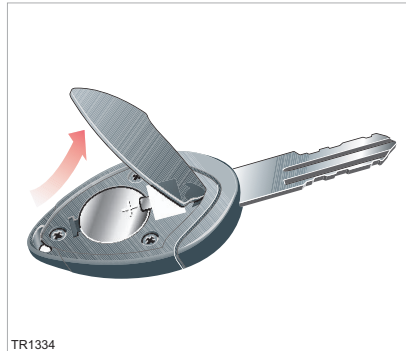

TR1334

Replacing the handset battery

The handset battery should last for approximately one year depending on use. When the battery needs replacing, you'll notice a deterioration in performance. For example, you'll gradually need to be closer to the vehicle to operate the handset.

To replace the battery:

1. Insert a screwdriver into the top of the handset and carefully separate the two halves. Avoid damaging the seal between the two halves.
2. Remove the battery, taking care to avoid touching the circuit board or the contact surfaces of the battery holder.
3. Fit the new battery (type CR2032) with the '+' sides facing upwards.

If possible, avoid touching the flat surfaces of the battery because finger marks will reduce battery life. Wipe the battery clean before fitting.

4. Re-assemble the two halves of the handset by aligning them and pressing them together until they snap into place.

Vehicle immobiliser

Your vehicle is equipped with a vehicle immobiliser that, when active, prevents the vehicle from being started.

To switch off the immobiliser press the Unlock button on the handset.

Note: Unless the starter switch is turned to the ON position within 45 seconds of the handset Unlock button being pressed, the immobiliser will be reactivated. Press the Unlock button on the handset again to start the vehicle.

If the immobiliser is active when the starter switch is turned to the ON position a message will be displayed on the touch screen advising you to switch off the immobiliser. Press the unlock button on the handset.

The immobiliser is automatically activated when the vehicle is locked using the handset or 45 seconds after the starter switch is turned from the ON position to the ACC or OFF position.

Note: If for any reason you cannot unlock the vehicle using the handset, you will not be able to switch off the immobiliser. Call Roadside Assistance for help.

Doors and glove box

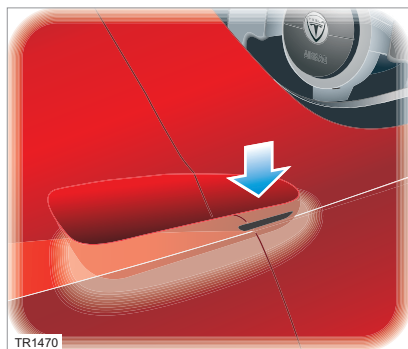

Exterior door release

With the doors unlocked, *lightly* press the touch pad (located in the air inlet on the door) to release the door. There is no need to press hard. Pull the door to open.

Note: The door release touch pads operate only if the doors have been unlocked using the handset.

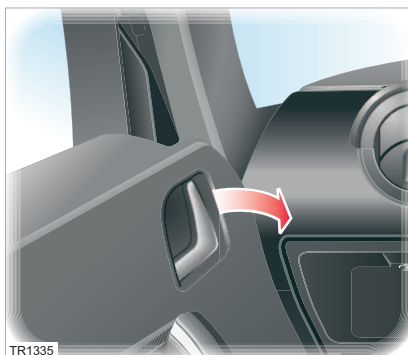

Interior door release

From inside your vehicle, pull the interior door release handle to unlock and open the door.

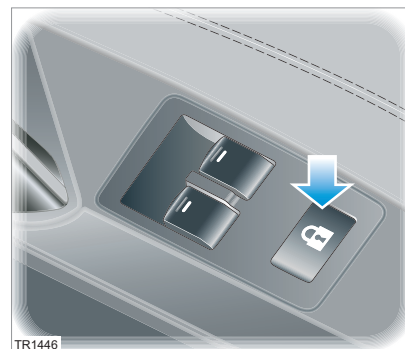

Central door locking

For your security, you can lock both doors from inside your vehicle by pressing the central locking switch on the driver's door panel.

Press the switch once to lock the doors and inhibit the use of the exterior door release touch pads. The alarm indicator on the instrument panel will illuminate when the doors are locked.

Press the switch to unlock the doors and enable operation of the exterior door release touch pads. You can also unlock the doors using the handset.

Note: The central door locking switch does not operate if the doors have been locked using the handset. Additionally, the switch will not operate if a door, the trunk, or the bonnet is not completely closed.

Drive away locking

For your security, the doors lock and the trunk release switch is inhibited whenever your vehicle's speed exceeds 8 km/h (5 mph).

The trunk release button is reactivated when your vehicle's speed is less than 8 km/h (5 mph).

Note: The exterior door release touch pads will not operate until the doors have been unlocked with the central door locking switch.

Emergency unlocking

If the handset fails to unlock the doors (for instance if there is an electrical failure), you can unlock the left-hand door using the key blade.

A mechanical lock is located on the underside of the left-hand door. Turn the key clockwise to unlock the door.

Note: If active, the alarm will sound when the door is opened. To cancel the alarm, press the Unlock button on the handset.

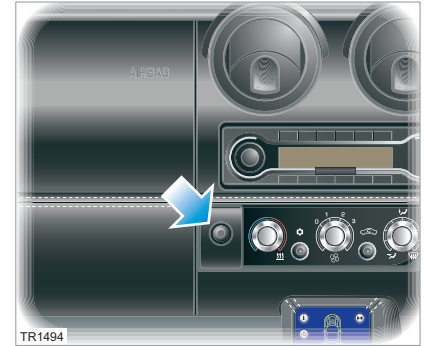

Glove box

To open the glove box, press the button located on the dashboard immediately to the right of the glove box.

To close the glove box, simply push it closed.

Note: The glove box can not be opened if the vehicle has been locked with the handset.

Trunk

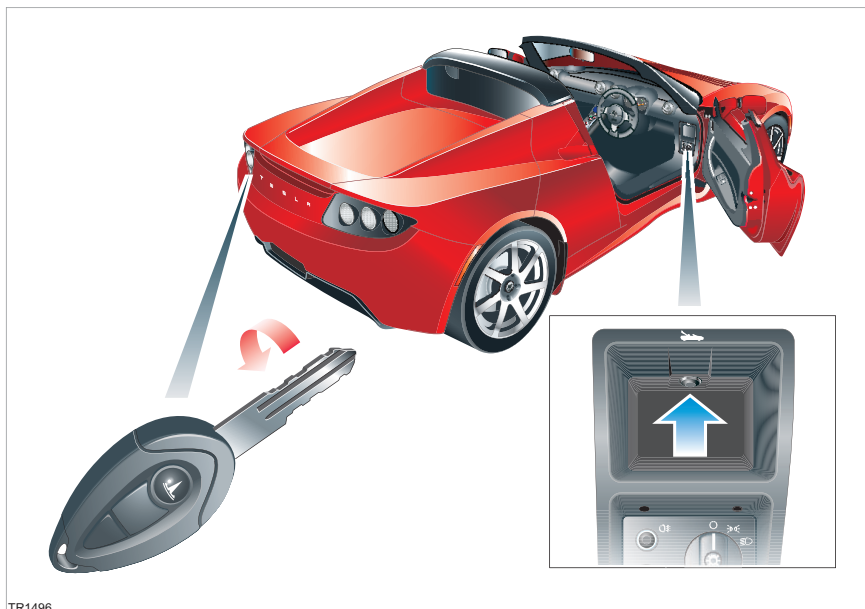

TR1496

Opening the trunk

To open the trunk, press the trunk release button on the handset twice within 1.5 seconds or, if the vehicle is unlocked, press the button on the dashboard.

The trunk can also be opened by inserting the key in the external lock and turning it counter-clockwise.

Note: If the alarm is active, the horn will sound if the trunk is opened using the key.

The trunk release button is disabled when the doors are locked with the handset, or when the vehicle's speed exceeds 8 km/h (5 mph).

Closing the trunk

Close the trunk one side at a time. Use both hands to firmly but gently apply downward pressure on one side of the rear spoiler until you hear it "click" into place. Repeat for the other side.

Alarm system

Your vehicle is equipped with an anti-theft alarm system. The alarm is switched on automatically when you lock the doors with the handset. The turn signals flash once to confirm that your vehicle is locked and an audible tone will also be heard from inside the vehicle.

The alarm indicator in the instrument panel flashes red whenever the alarm is active.

Once activated, the alarm monitors the opening of the following areas:

- Bonnet
- Doors
- Trunk

Whenever the alarm is active, the horn will sound if a protected area is opened or the starter switch is turned to the ON position.

To switch off the alarm, press the Unlock button on the handset.

Note: If the doors are unlocked with the handset, they will automatically re-lock if neither the trunk or a door is opened within two minutes of the Unlock button being pressed.

Alarm indicator

An indicator on the instrument panel shows the current status of the alarm.



Flashing red - doors are locked and the alarm system is active.



Green - doors are locked but the alarm system is not active.

If the vehicle didn't lock



Caution: Always check that the doors are locked before leaving the vehicle.

If the vehicle doesn't lock when you press the Lock button on the handset, the turn signals will not flash. Check that both doors, the bonnet and the trunk are fully closed before pressing the Lock button again. If the problem persists, contact Tesla Motors or an authorised repairer.

Switching off the alarm

If the alarm is triggered, the horn will sound for 30 seconds and the turn signals will flash to attract attention. To silence the alarm, press the Unlock button on the handset.

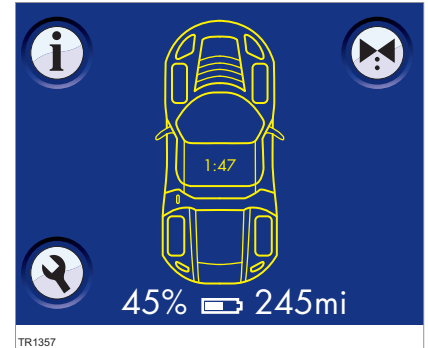

TR1357

Security PIN

The security PIN (Personal Identification Number) is used to activate or deactivate the valet mode feature. Valet mode can be selected from the touch screen's parked screen. See Valet mode, page 4-9.

Note: The parked screen is active whenever the hand brake is engaged.

The default PIN code is 1234. Tesla Motors strongly recommends that you change this to a unique PIN code.

Note: If you sell your vehicle, please inform the new owner of the PIN code as this will be required to allow them to change the PIN code.

Vehicle security



Setting the security PIN

 With the hand brake engaged, touch the **SETTINGS** icon on the main parked screen (or any of the drive screens) to display the settings screens.

Press the right arrow icon to navigate to the second settings screen.

Touch **Security PIN**.

You will be asked to **Enter old PIN code**. Enter the old PIN code (if you haven't previously set a PIN code, the default code is 1234) by touching the numbers on the screen and then touch **OK**.

If you enter an incorrect PIN code, an invalid entry message will be displayed. Either enter the correct PIN code or touch the **EXIT** icon to return to the previous screen.

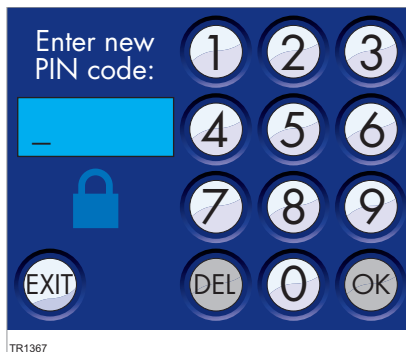

You will then be asked to **Enter the new PIN code**. Enter a new PIN code and then touch **OK**.

Note: The PIN code must be between four and eight digits in length.

You will then be asked to **Confirm the new PIN code**. Enter the new PIN code again and then touch **OK**.

If the PIN code does not match the previously entered code a message will be displayed telling you that the PINs differ and you will need to enter the PIN code again.

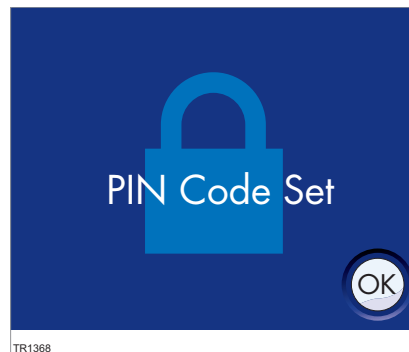

If the PIN codes match, then the PIN Code Set screen will be displayed.

Touch **OK** to return to the Settings screen.

Note: Always keep a record of your PIN code and store it in a safe place. Do not store your PIN code in your vehicle.

Valet mode

For your peace of mind, your vehicle has a unique valet mode for those times that your vehicle is parked by another person.

When valet mode is active, your vehicle's power is limited and the touch screen displays activity information about the vehicle. The maximum speed the vehicle can travel in valet mode is 80 km/h (50 mph). Operation of the touch screen is restricted to the valet mode screen which displays information on how your vehicle was used while in valet mode.

Note: The glove box is automatically locked whenever valet mode is active, providing a secure location for storing personal items.

Valet mode can only be deactivated by entering the vehicle's PIN code.

Activating Valet mode



To activate valet mode, touch the bow tie icon on the touch screen's main parked screen.

Provided a vehicle PIN code has been set, you'll be prompted to enter your PIN code. Enter your PIN code and touch **OK**. The touch screen displays the Valet Mode Activated screen.

If a PIN code has not been set, the Touch Screen displays a message telling you to enter a new PIN code. Touch **OK** to enter a new PIN code. See Security PIN, page 4-7.

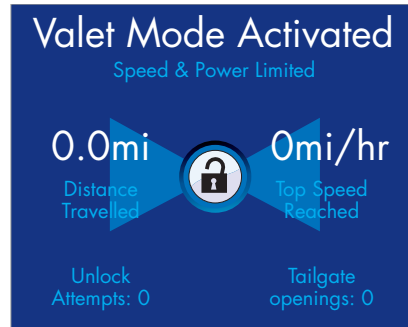

TR1372

The touch screen displays the following information for the current period that valet mode has been active:

- Distance travelled
- Top speed reached
- Unlock attempts (the number of unsuccessful attempts at entering a PIN code)
- Tailgate openings (the number of times the trunk has been opened)

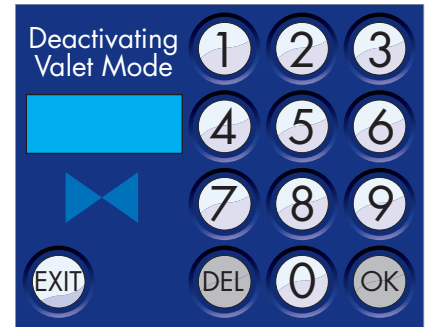

TR1373

Deactivating Valet mode



To deactivate valet mode, touch the unlock icon to display the PIN code entry screen.

Enter your PIN code and then touch **OK**. If the correct PIN code was entered, the touch screen displays the main parked screen.

If you enter an incorrect PIN code, a message is displayed telling you that you've made an invalid entry. Either enter the correct PIN code or touch the **EXIT** icon to return to the previous screen.

Charging your vehicle

Charging components

Mobile Connector	5-2
High Power Wall Connector	5-3

Information about charging

Important!	5-4
The Battery	5-4
Designed to be plugged in	5-4
Leaving the vehicle unplugged	5-4
Storing your vehicle	5-5
Battery charge level	5-5
Vehicle range and remaining charge level	5-5
How long does it take to charge?	5-6

Charge settings

About charge settings	5-7
Other charging modes	5-7
Schedule the charge time	5-8
Setting the current limit	5-8
Cost	5-8

Charging instructions

Connecting the charge cable	5-9
Stopping the charge process	5-10
Charging port light	5-10
Disconnecting the charge cable	5-10

Charging components

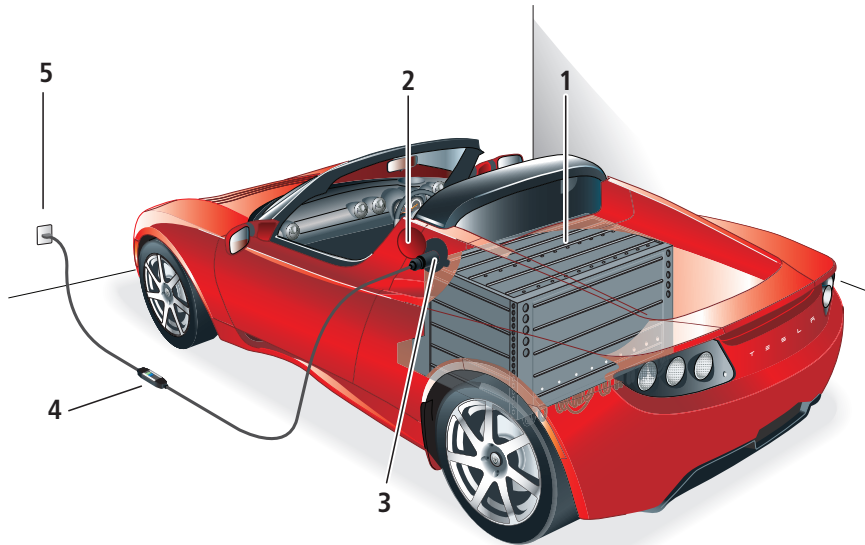

TR1497

1. Battery
2. Charging port door
3. Charging cable connector
4. Mobile connector
5. Electrical outlet

Mobile Connector

The Mobile Connector supplied with your vehicle will connect to most power outlets, allowing you to charge your vehicle either at home or when away. Its small size allows it to be carried in the vehicle's trunk.

Before driving, always check the vehicle's charge level and plan your route and charging requirements accordingly.

Always keep in mind the amount of time it will take to charge the vehicle using the Mobile Connector.

For further details on how to use the Mobile Connector to charge your vehicle, refer to the 'Mobile Connector Users Manual'.

Charging components

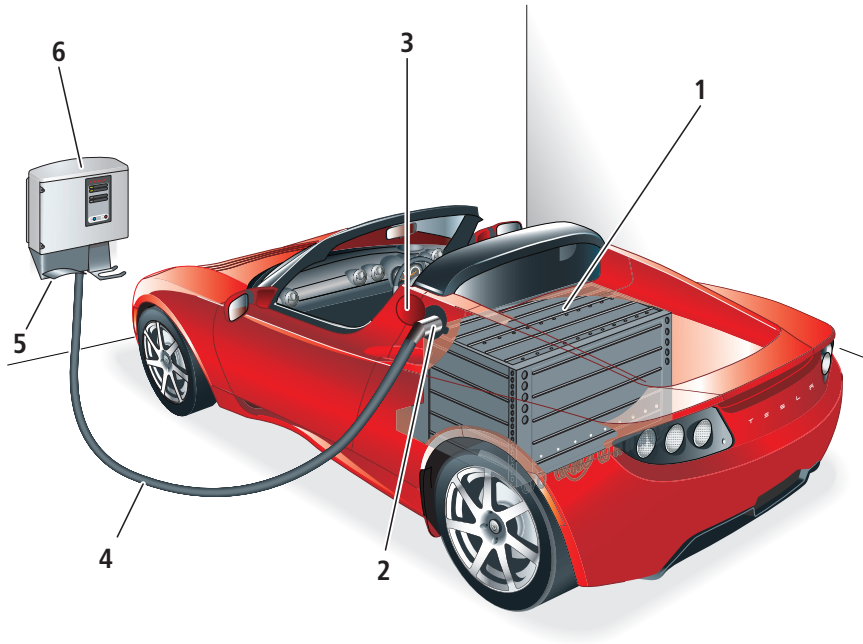

High Power Wall Connector

The optional High Power Wall Connector is the fastest way to recharge your vehicle when at home. Connected to a high voltage/high amperage electricity supply, the High Power Wall Connector will significantly reduce the time for charging your vehicle.

Usually installed at the location you store your vehicle overnight, the High Power Wall Connector provides you with an easily accessible connection for charging your vehicle when not in use.

Refer to the user manual supplied with the High Power Wall Connector for details on how to safely charge your vehicle.

Note: For further details on the High Power Wall Connector, please contact Tesla Motors.

TR1498

1. Battery
2. Charging cable connector
3. Charging port door
4. Charging cable
5. Cable hanger
6. High Power Wall Connector

Information about charging

Important!

 **WARNING:** The Battery has no parts that an owner, or a non-Tesla authorized technician can service. Under no circumstances should you open or tamper with the Battery. Always contact Tesla Motors to arrange for Battery servicing. ▲

 **Caution:** If the Battery's charge level falls to 0%, it must be plugged in immediately. Failure to do so can permanently damage the Battery and this damage is not covered by the Vehicle Warranty. Also, if you allow the Battery to fall to a critically low level it may not be possible to charge the vehicle. If you are unable to charge the vehicle, contact Tesla Motors.

 At the end of its service life, the Battery will be recycled. Contact Tesla Motors for recycling arrangements.

Note: During charging or in high ambient temperatures, the cooling fan and coolant pump may automatically switch on for a period of time to cool the cells in the battery. Some noise may be heard from the vehicle. This is normal and not a cause for concern.

The Battery

The Tesla Roadster's Battery provides power to the motor as well as all the other electrical systems on the vehicle, such as lights, instruments, audio system, etc.

The Battery is one of the largest and most advanced battery packs in the world, consisting of several thousand lithium-ion battery cells that store enough energy for the vehicle to travel over 320 km (200 miles) without recharging.

Note: Actual range will vary based on driving style. The vehicle consumes more energy if you are driving aggressively, driving up hills, or are using more resources such as air conditioning. Also, over time, the Battery experiences a gradual loss of capacity, inherent in all lithium-ion batteries. So, as your vehicle ages, the capacity of the Battery declines.

As you drive your vehicle, the level of charge in the Battery is depleted and you will need to recharge it. The Roadster's built-in charging system allows you to easily recharge it by connecting an electrical power supply to the vehicle's charging port.

Designed to be plugged in

The Tesla Roadster is designed to be plugged in when not in use. This ensures that the next time you use the vehicle, it is fully charged and ready to go. There is no advantage in waiting until the battery level

is low before charging. Plugging in every night eliminates the risk of damage that could be caused by fully depleting the battery.

When plugged in, the vehicle optimises the lifetime of the Battery by managing its charge level and temperature. The vehicle wakes up every 24 hours and, if needed, automatically initiates the charging process to keep the Battery at an optimum charge level.

Note: If you are not driving your vehicle every day, see Storing your vehicle, page 5-5.

Leaving the vehicle unplugged

 **Caution:** Permanent damage to the Battery can occur if it is left discharged for extended periods of time.

Even when you are not driving the vehicle, the Battery will slowly lose its charge. Therefore, when you're not using the vehicle, you should leave it plugged in.

However, situations may arise in which you must leave the vehicle unplugged for an extended time (for example, at an airport when travelling). If this is the case, always fully charge the battery before leaving the vehicle.

Keep in mind that when the vehicle is left unplugged with a fully charged Battery, the initial rate of decline can be significant. When fully charged, the Battery's charge level can drop as much as 7% a day and

50% within the first week. When the Battery's charge level falls below 50%, the rate of decline slows to approximately 5% per week.

If for some reason, you are unable to leave the vehicle plugged in when it is not being used, it is your responsibility to preserve battery life. Regularly check the Battery charge level and the ambient temperature the vehicle is being stored at.

If leaving your vehicle unplugged for more than 24 hours, follow these do's and don'ts to avoid prematurely decreasing the life of your vehicle's Battery:

- DO leave the vehicle plugged in whenever possible.
- DO maintain at least a 15% charge level in the Battery if leaving it unplugged for more than 48 hours.
- DO fully charge the Battery before leaving it unplugged. This maintains the charge level needed to keep the Battery's electronics operational.
- DO NOT expose an unplugged vehicle to ambient temperatures below -29°C (-20°F) or above 49°C (120°F).

Use the vehicle's touch screen to check the charge level and temperature of the Battery. For details, refer to the 'Touch Screen Users Manual'.

Storing your vehicle

If you plan to leave the vehicle unused for longer than 15 days, it is strongly recommended that you leave the vehicle plugged in and select the Storage charge setting using the touch screen.

Charging the vehicle using the Storage setting maintains a lower level of charge within the Battery, this in turn helps to optimise the life of the individual cells within the Battery.

Note: The reduced charge level also reduces the vehicle's available driving range. So remember to change the setting back to 'Standard' before taking the vehicle on an extended drive.

For details on how to select the Storage charge setting, refer to the 'Touch Screen Users Manual'.

Battery charge level

The level the Battery will be charged to depends on the charge setting you select (see About charge settings, page 5-7).

The Standard charge setting is the preferred setting for normal use. Selecting the Range or Performance charge settings will charge the Battery to its maximum allowable charge level, whereas selecting the Storage charge setting will charge the Battery to a relatively low level.

Vehicle range and remaining charge level

The touch screen displays values for Battery charge level and estimated vehicle range.

Note: This information is also displayed on the LCD panel (see LCD panel, page 6-12).

The estimated vehicle range displayed on the touch screen can be calculated in two different ways:

- EST RANGE - calculates the distance based on how the vehicle has been driven for the last 64 km (40 miles).
- IDEAL RANGE - calculates the distance you could achieve in ideal driving situations.

The charge level and estimated distance you can drive are continuously updated.

Therefore, if you have been driving on hills for the past 64 km (40 miles), and you are now driving on a flat highway, the distance you can drive on the remaining charge will actually be more than the estimate that is displayed when EST RANGE is selected. Likewise, if you are displaying vehicle range based on IDEAL RANGE, but are using the vehicle's air conditioning system and driving aggressively, the distance you can drive on the remaining charge will be less than the estimate that is displayed.

The estimated distance you can drive may be lower or higher after a period of rest. For example, when parking your vehicle

Information about charging

you notice that the estimated remaining distance is 85. When returning to your vehicle a few hours later, you notice that the estimated distance is now 91. This is normal behaviour and is not a cause for concern. The distance that is displayed when the vehicle has been at rest is more accurate.

How long does it take to charge?

The amount of time it takes to fully charge the vehicle is dependant upon the remaining Battery charge level, the available electricity supply (amperage and voltage) and the charge setting you are using. For example, a full charge on the Range or Performance charge setting will take approximately 15% longer than on Standard.

Note: Charge time is also impacted by both the ambient air temperature and the temperature of the vehicle's Battery. If the temperature is outside the optimal range, the vehicle's heating and cooling system will operate to warm or cool the Battery accordingly. This will consume some of the energy used for charging.

Use the following table as a guideline when estimating how long it will take to charge your vehicle. This table assumes you are charging a fully depleted Battery to a full charge using the Standard or Range charge setting.

Estimated charging times

Electricity supply (amps/voltage)	Charge Time (hours)	
	Standard mode	Range mode
10A/240V	23.5	26.5
13A/240V	18	20
16A/240V	14.5	16
24A/240V	10	11
30A/240V	8	9
32A/240V	7.5	8
40A/240V	6.2	7
48A/240V	5.3	6
56A/240V	4.7	5
64A/240V	4.2	4.7
70A/240V	4	4.5

Note: The charge process slows down as the Battery approaches a full charge. Therefore, reaching a high level of charge is much quicker than reaching a full charge.

About charge settings

Your vehicle has been configured with default charging settings. However, you can override these default settings. You may want to optimise the charging environment when storing your vehicle, or you may want to extend the vehicle's driving range. You can also reduce the default charge current, set a time that you want charging to begin, and display your electrical cost per charge.

Other charging modes

There are four available charging modes that can be selected using the touch screen when the charging port door is open. For details on how to use the touch screen to adjust settings, refer to the 'Touch Screen Users Manual'.

The default vehicle charge mode is Standard charge. If you select a different charge mode when charging the vehicle, the charge setting will change back to Standard the next time the charging port door is opened.

Note: The charging mode will only revert back to Standard if the vehicle has been driven more than 160 m (1/10 mile) between charges.

Standard

By default, the vehicle will charge using the Standard charge setting. This setting provides the best combination of vehicle performance and maximum life of the Battery.

Storage

If you are not using the vehicle for an extended period of time, Tesla Motors recommends you leave the vehicle plugged in and change the charge setting to Storage.

This setting maintains a lower level of charge within the Battery to optimise the life of the individual cells, while also maintaining the integrity of the vehicle's electronic systems, such as the security system.

If the vehicle is driven after being charged using the Storage setting, the range of the vehicle will be reduced because the charge level is lower than the other charge settings. This is temporary and will return to normal after charging the vehicle using the Standard setting.

This charge setting is automatically cancelled (reverting back to Standard) if the vehicle has been driven more than 160 m (1/10 mile) between charges.

Range

 Caution: Repeated use of the Range setting will reduce the lifetime of the cells within the Battery.

This setting charges the Battery to the maximum available level. It also limits the vehicle's power by 50%. The result is that the vehicle can achieve the maximum number of miles possible on a single charge.

To preserve the life of the Battery, this charge setting is automatically cancelled (reverting back to Standard) after 72 hours or if the vehicle has been driven more than 160 m (1/10 mile) between charges.

Performance

 Caution: Repeated use of the Performance setting will reduce the lifetime of the cells within the Battery.

This setting is available for those rare times you want to achieve maximum power and hence, minimize the time it takes to accelerate from 0-100 km/h (0-60 mph). Use this setting with caution because it charges the cells within the Battery to the maximum available level and allows the Battery to run at a higher operating temperature.

Note: Frequent use of this setting is strongly discouraged as it will reduce the life of the cells within the Battery.

Charge settings

To preserve the life of the Battery, this charge setting is automatically cancelled (reverting back to Standard) after 72 hours or if the vehicle has been driven more than 160 m (1/10 mile) between charges.

Schedule the charge time

If you don't want the vehicle to begin charging immediately after you plug it in, you can set a time for charging to start. This is a useful way to charge the vehicle during non-peak hours when there is less demand on your electrical system and when your electricity may cost less.

Setting the current limit

The charging current is automatically set to the maximum available from the connected electricity supply. If required, you can use the touch screen's Charge settings screen to manually change the current limit.

Once changed, the value remains in effect for the current location until you manually change it. This allows you to set a different current limit for each charging location.

Note: The vehicle location is determined by the internal global positioning system (GPS).

Cost

After charging the vehicle, you can display the cost of the charge on the touch screen.

To obtain an accurate reading of your power cost for each charge cycle you can enter your cost of power (in kWh) on the Cost Settings screen.

Note: In most areas, you can obtain your power costs from your utility bill.

For details on setting charge costs, refer to the 'Touch Screen Users Manual'.

Charging instructions

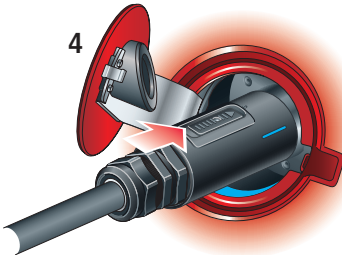
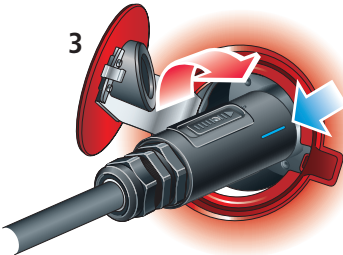
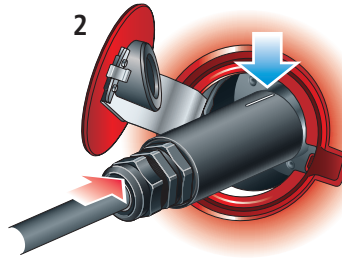
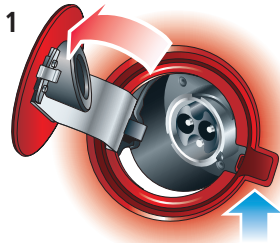

TR0083

Connecting the charge cable

⚠ Caution: The connector end of the charge cable is heavy and can damage the vehicle's paint if dropped when connecting or disconnecting.

Note: You cannot charge the vehicle if Tow Mode is active.

Position the vehicle so that the charge cable easily reaches the charging port on the vehicle.

Remove the key from the starter switch.

Note: If the key is in the starter switch, the vehicle will not charge.

If you do not want to use the Standard charge setting, use the touch screen to select the required setting. See Other charging modes, page 5-7.

1. Open the charging port door on the left-hand side of the vehicle. This instructs the vehicle to enter charging mode and engages **P** (Park) on the transmission. Within a few seconds, the ring around the charging port illuminates white.

 The charge indicator on the instrument panel will illuminate red.

Note: If the charging port door is open but the charge cable is not connected, the charging port light will eventually extinguish. The door will need to be closed and opened again to restart the charge process.

2. Align the charge cable connector to the charging port and insert fully.
3. Push the collar on the connector forward while rotating it clockwise to secure the connector to the charging port.
4. Push the tab on the connector forward to lock it into place.

The ring around the charging port flashes blue for approximately 15 seconds to indicate that the vehicle is communicating with the charging equipment. You may hear “clunking” sounds as the contacts close. The ring around the charging port will then begin to pulse amber, which

Charging instructions

indicates that charging has started successfully. The frequency at which this ring pulses will slow down as the charge level approaches full.

Note: If the vehicle's doors are locked during charging, the light around the charging port will not illuminate during the charging process.

Depending on the temperature of the Battery, heating or cooling may be required before it can be charged. This is activated automatically but may result in a significant delay before charging begins.



While the vehicle is charging, the charge indicator on the instrument panel will flash.

When charging is complete, the ring around the charging port stops pulsing and illuminates green.

If the ring around the charging port illuminates red while charging, a fault has been detected. Check the touch screen for an error message that describes the fault.

Note: A fault condition can occur due to something as common as a power outage.

Stopping the charge process

The charging process can be stopped at any time using the touch screen. For details, refer to the 'Touch Screen User Manual' provided in your owner's package.

Charging port light

Colour	Charging state
White	Charging port door is open and charge mode is initiated.
Blue	The vehicle is successfully connected to the charging system.
Blue (pulsing)	The vehicle is preparing to charge.
Amber (pulsing)	Charging is in progress. The rate of pulsing decreases as charging progresses.
Green	Charging is complete.
Red (flashing)	A fault is detected and charging has stopped.

Note: If you are charging a locked vehicle, the charging port light will not illuminate.

Disconnecting the charge cable

Note: Tesla Motors strongly recommends leaving the charge cable connected whenever the vehicle is not in use. This will maintain the vehicle at the selected level of charge.

To disconnect the charge cable from the vehicle:

1. Pull the locking tab on the connector towards you.
2. Rotate the locking ring on the connector counterclockwise.
3. Pull the charge cable connector to release from the charging port.
4. Close the charging port door.

Driving your vehicle

Driving basics

Starting the vehicle	6-2
Key positions	6-2
Steering column lock	6-3
Driving tips and information	6-3
Selecting gears	6-5
Hand brake	6-5
Braking	6-6
Anti-lock Braking System (ABS)	6-6
Traction control	6-7

Switches and controls

Exterior lights	6-8
Turn signals	6-8
Rear fog light	6-9
Hazard warning	6-9
Horn	6-9
Windshield wiper and washer	6-10
Cruise control	6-11

Instruments

Instrument panel components	6-12
Power meter	6-12
LCD panel	6-12
Warning indicators	6-13
Instrument panel lighting	6-15

Driving basics

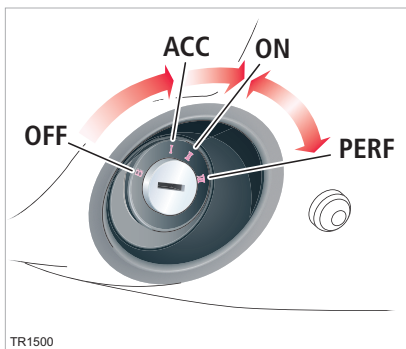

Starting the vehicle

To start the vehicle, turn the starter switch to the ON position.

All warning indicators on the instrument panel will illuminate briefly. When these indicators extinguish and the gear selector buttons illuminate, the vehicle is ready to be driven.

To drive the vehicle, press the brake pedal and then select **D** (Drive) or **R** (Reverse).

Note: If more than 45 seconds elapse between unlocking the vehicle with the handset and the starter switch being turned the vehicle immobiliser will be activated. To switch off the immobiliser, press the handset Unlock button.

Key positions

The starter switch has the following key positions to control the electrical circuits and steering column lock.

OFF

When the starter switch is OFF, the P (Park) gear is automatically selected and the following features are operational:

- Touch screen
- All interior and exterior lights (including trunk light and hazard warning lights)
- Central door locking switch
- Trunk release switch

Note: When turning the key to the OFF position, the circuits that operate in ACC will continue to operate until the key is removed.

ACC

In addition to the features that operate when the starter switch is OFF, the following features operate when the switch is in the ACC position:

- Audio and navigation systems
- Heating and air conditioning systems
- Seat heaters
- Brake lights
- Windshield wiper and washer
- Windows
- LCD panel

ON

When the key is in the ON position, all controls, switches, lights, instruments, warning indicators and electrical circuits are operational.

PERF - Performance

Turn the key all the way forward to engage 'Performance' mode. When active, the word **Performance** will be displayed in the centre of the battery image on the touch screen's 'Standard' screen.

Note: You cannot select 'Performance' mode using the key within the first 10 seconds of starting the vehicle, or if you are driving in Range mode with the Battery almost fully depleted.

'Performance' mode should be selected for those times you want to achieve maximum power and hence, minimize the time it takes to accelerate from 0-100 km/h (0-60 mph). Use this setting with caution because it allows the Battery to run at a higher operating temperature.

Note: Frequent use of this setting is strongly discouraged as it will reduce the life of the cells within the Battery.

To cancel Performance mode, turn the key all the way forward again.

Performance mode can also be selected or cancelled using the touch screen. For more information, see Performance, page 5-7 or refer to the 'Touch Screen Users Manual'.

Removing the key

 **WARNING:** Never remove the key when the vehicle is moving. The steering column will lock and you will not be able to steer the vehicle. ▲

To remove the key, turn the starter switch to the OFF position.

Exterior lights (except hazard warning lights) will automatically turn off when you remove the key.

Note: If you open the driver's door when the key is in the starter switch, you will hear an audible alert reminding you to remove the key.

Steering column lock

The steering column locks whenever you remove the key. You may need to turn the steering wheel slightly to align the mechanism that engages the lock.

To release the steering column lock, turn the starter switch to the ACC position. If it is difficult to turn the key, turn the steering wheel slightly.

Driving tips and information

Driving an electric vehicle is similar to driving a petroleum fuelled vehicle. To maximise driving range use the same driving habits you would use when maximising fuel economy. However, here are a few guidelines:

Drive sensibly to maximise range

Energy consumption depends on driving style and the current operating conditions. Your vehicle is designed to travel over 320 km (200 miles) on a charge.

To get the maximum distance from a charge, you should:

- Avoid frequent acceleration and deceleration.
- Anticipate stops and instead of using the brake pedal to slow down, lift your foot off the accelerator. Whenever the vehicle is moving and the accelerator is not applied, regenerative braking will slow the vehicle and feed energy back to the battery.
- Drive with the windows up and the roof on to minimise aerodynamic drag.
- Ensure tyres are inflated to the recommended pressures.
- Remove unnecessary items from the trunk.
- Minimise the use of resources like the heating and air conditioning. Using the seat heaters to keep warm is more efficient than heating the cabin.

In addition to driving style, energy consumption is affected by environmental conditions, such as cold weather and hilly roads.

The power meter on the instrument panel and the touch screen's 'Energy' screen displays precise real-time feedback on the amount of energy you're using.

Warm weather driving

When driving in warm weather, keep in mind that the vehicle's air conditioning system is unique in that the same system is used to cool both the Battery and the passenger cabin.

Use these tips to stay cool:

- When first getting into a warm vehicle, roll down your windows to move warm air out of the cabin. Then, when driving, roll up the windows and turn on the air conditioning system.
- To cool the air inside the vehicle, turn the blower fan on and then press the air conditioning button. Rotate the temperature control to achieve the desired temperature. To turn off, press the air conditioning button again.
- When running the air conditioning, press the Air Recirculation button (see page 5) to recirculate the air inside the vehicle. This prevents warm air from outside the vehicle entering the cabin.
- Charge the vehicle using the Range setting (see Range, page 5-7) to pre-cool the Battery. By having the

Driving basics

Battery pre-cooled, the air conditioning system will be focused on cooling just the cabin.

Keep in mind that frequent use of the Range setting will decrease the lifetime of the Battery when you allow the vehicle to charge to 100% using this setting. Therefore, charge the vehicle in Standard mode, and then switch to Range mode approximately twenty minutes before driving - just enough to cool the Battery without reaching 100% charge level.

- Drive in Performance mode (see page 2). Driving in Performance Mode allows the Battery to operate at a higher temperature. If you're driving and notice reduced performance of the air conditioning system, switching to Performance mode will redirect the air conditioning back to the cabin.
- Adjust your driving style. Aggressive driving heats up the Battery, which in turn demands more cooling. By driving more conservatively, the air conditioning system can focus on the cabin.

Note: Some of the vehicle's sensors and diagnostics are sensitive to hot temperatures and the Touch Screen may display messages such as **Motor Over Temp - Power Reduced** or **PEM Over Temp - Power Reduced**. This is no cause for alarm, the Roadster will take care of itself. However, if you see these messages,

remember that driving more conservatively will help the vehicle cool down quicker.

Deep water



Driving the vehicle through deep water may cause serious damage to the vehicle and will not be covered by the vehicle warranty.

Do not drive through flooded areas, water of unknown depth, or deep puddles. When driving through even a relatively shallow puddle, drive slowly to prevent water from entering the vehicle.

Carrying items in cabin area

The trunk is the preferred place to carry objects. In an accident, during hard braking, or sudden manoeuvres, loose items carried in the vehicle's cabin area can be thrown around, and cause injury to occupants unless securely fastened.

Battery cooling

Note: Even with the starter key removed, the cooling fan and coolant pump may continue to operate for a period of time to cool the cells in the battery. Some noise may be heard from the vehicle. This is normal and not a cause for concern.



Selecting gears

The vehicle has four selectable gears.

- **P** (Park). Selectable whenever the vehicle's forward speed is less than 1.6 km/h (1 mph). With Park engaged the transmission is locked and the rear wheels cannot turn.

To select another gear when the vehicle is in Park, you must press the brake pedal.

Whenever the starter switch is in the OFF position, Park is automatically engaged, regardless of which gear was previously selected.

Note: If for any reason the vehicle needs to be moved on a flatbed truck, Park must be deactivated before pulling the vehicle onto the truck. Select Neutral or activate Tow Mode using the touch screen. See Vehicle recovery, page 9-14.

- **N** (Neutral). Allows the vehicle to be stationary without the transmission being locked. If the hand brake is not applied, the vehicle will roll freely if pushed, or if located on a slope.

To select another gear when the vehicle is in Neutral and moving at a speed less than 5 km/h (3 mph), you must press the brake pedal.

- **R** (Reverse). Selectable whenever the vehicle's forward speed is less than 5 km/h (3 mph).

The maximum speed in reverse is limited to 24 km/h (15 mph). An audible tone will be heard when you select Reverse.

- **D** (Drive). Can be selected at any time except when the vehicle is moving over 5 km/h (3 mph) in reverse.

When a gear is engaged, its associated button will illuminate green. If you select a gear that is not allowed by the current situation (i.e. if you select Reverse and the forward speed is more than 5 km/h (3 mph)), the button will illuminate red to indicate that the gear change is denied.

Note: Similar to a conventional automatic transmission, when you select Drive or Reverse, the vehicle will move, even if you have not pressed the accelerator pedal.

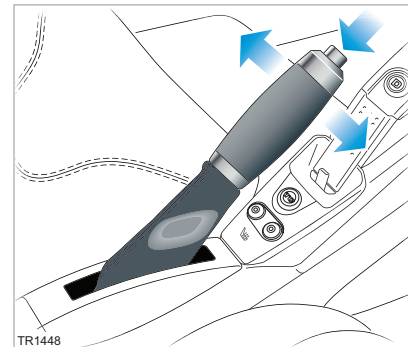

Hand brake

WARNING: Do not apply the hand brake when the vehicle is moving. This could result in a loss of control and may damage the rear brakes. ▲

To apply the parking brake, pull the lever fully upwards.

! If the starter switch is in the ON position the warning indicators in the instrument panel will illuminate when the hand brake is applied.

The touch screen will display the main 'Parked' screen whenever the hand brake is applied.

! Caution: If you apply the hand brake when the brakes are hot (i.e. after prolonged or frequent hard use), ensure the lever is fully engaged. As the brakes cool, the amount of braking applied by the lever decreases.

Driving basics

To release the hand brake, pull the lever up slightly, depress the button and fully lower the lever. The warning indicator will extinguish and the touch screen will display the 'Drive' screen.

Note: The hand brake operates on the rear wheels only, and is totally independent of the foot-operated hydraulic brake system.

Braking

 **WARNING:** After driving through heavy rain, you may experience a loss of response from the brakes. As soon as safety permits, apply the brakes to generate heat and dry the brake components. ▲

The brakes operate through dual circuits. If one circuit fails, the other continues to function, but braking performance is reduced. If you experience longer stopping distances, or if you find that you need to increase pressure on the brake pedal, you should not drive the car. Contact Tesla Motors or an authorised repairer as soon as possible.

The brakes are servo-assisted, but only when the starter switch is in the ON position and the electrical systems are operating. Without servo assistance, you will need to apply more pressure on the brake pedal and you will experience longer stopping distances.

Regenerative braking

Whenever the vehicle is moving and your foot is off the accelerator, regenerative braking slows the vehicle and feeds energy back to the battery.

By anticipating your stops and simply lifting your foot from the accelerator to slow down, you can take advantage of the energy gained from regenerative braking. A visual display on the instrument panel provides real-time feedback of the vehicle's regenerative braking. See Instruments, page 6-12.

The amount of regenerative braking will vary depending on the current state of the Battery. For example, you'll experience a loss of regenerative braking if the Battery is extremely hot or cold or if the Battery has already been charged to its maximum allowable level using the Range or Performance charge setting.

The amount of regenerative braking will also vary on roads with low traction levels (i.e. wet or gravel surfaces). The traction control indicator on the instrument panel may flash and you may experience that the brakes feel slightly different. This is not a cause for concern.

 When regenerative braking is not available or has been significantly reduced, a warning indicator illuminates on the instrument panel.

Anti-lock Braking System (ABS)

 **WARNING:** ABS cannot overcome physical limitations such as stopping the vehicle in too short a distance, turning the vehicle at high speeds, or the lack of grip on the road's surface. ▲

 **WARNING:** Do not take driving risks and hope that ABS will correct judgement errors. It is always your responsibility to drive with due care and attention. ▲

Your vehicle is equipped with an anti-lock braking system (ABS) that prevents the wheels from locking when you apply maximum brake pressure. This allows you to maintain steering control during heavy braking on most road conditions.

During emergency braking conditions, the ABS constantly monitors the speed of each wheel and varies the brake pressure according to the grip available.

The alteration of brake pressure can be felt as a pulsing sensation through the brake pedal. This demonstrates that ABS is operating and is not a cause for concern. Keep a firm and steady pressure on the brake pedal while experiencing the pulsation.

Emergency braking

! WARNING: DO NOT pump the foot brake. ABS does this for you and by pumping the foot brake yourself, you are interfering with ABS operation, which may increase braking distance. ▲

In an emergency, fully press the brake pedal even when the road surface is slippery. ABS will vary the braking pressure to each wheel according to the amount of traction available. This prevents the wheels from locking and ensures that the vehicle stops as safely as possible.

Note: ABS operates only when control of the vehicle is jeopardized. It can not compensate for driver error.

ABS warning indicator

When the starter switch is turned to the ON position, and also at frequent intervals while driving, the ABS checks that all its components are operating correctly.

(ABS) If a fault is detected, the warning indicator in the instrument panel illuminates and the ABS shuts down. Contact Tesla Motors or an authorised repairer as soon as possible.

Note: The vehicle's brakes remain fully operational and are not affected by an ABS failure. However, braking distances may increase and wheels may lock under heavy braking.

Traction control

! WARNING: Traction control cannot overcome the physical limitations of the vehicle turning at too high a speed and cannot prevent any accident which may result. ▲

(TC) The traction control system constantly monitors the difference in speed between the front and rear wheels. If a loss of traction is detected, it reduces torque to the rear wheels to minimize wheel spin. When this happens, you may notice the traction control warning indicator on the instrument panel illuminate briefly.

Traction control is automatically switched on each time the starter switch is turned to the ON position. The traction control button on the centre console illuminates amber to indicate the vehicle's traction control system is operating.

Note: For safety reasons, traction control must be active when using cruise control. If you disable traction control, cruise control will also be disabled. Or, if you are driving without traction control and then enable cruise control, traction control will be automatically switched on.

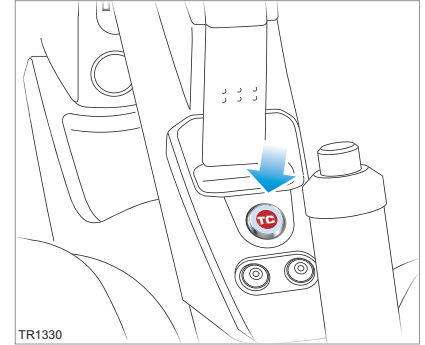

Switching off traction control

If required, traction control can be manually switched off by pressing the switch on the centre console. When the button is released, traction control will be disabled, the traction control button will be illuminated red.

(TC) The warning indicator in the instrument panel illuminates whenever the vehicle is operating without the advantages of traction control.

Under normal conditions, traction control should be left on. The system should only be switched off in circumstances where you deliberately want the wheels to slip. As soon as the circumstances requiring you to switch traction control off have passed, press the switch to turn traction control back on.

Switches and controls

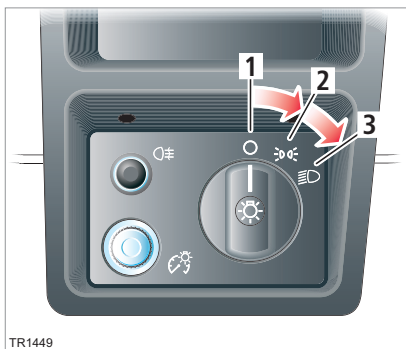

Exterior lights

The exterior lights are controlled using a rotary switch mounted on the dashboard.

The switch has three positions:

1. All exterior lighting and backlighting for instruments and switches is switched off.
2. Side lights, tail lights and license plate light are switched on.

If the starter switch is in the ACC or ON position, backlighting for instruments and switches is also switched on.

3. Headlights on.

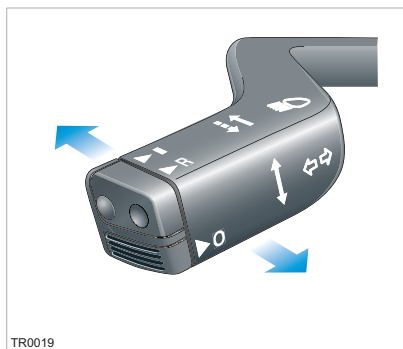

Headlight high beam

Push the left-hand steering column lever away from you to select high beam. To cancel high beam, pull the lever towards you.

 An indicator in the instrument panel illuminates when high beam is active.

Headlight high beam flash

High beams can be flashed by briefly pulling the steering column lever towards you and releasing.

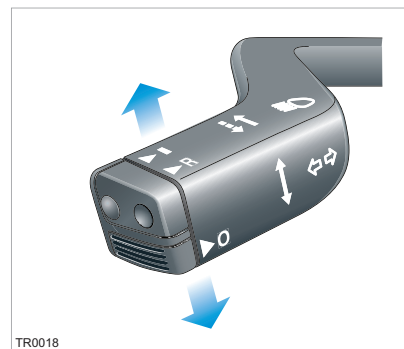

Turn signals

Move the left-hand steering column lever down to operate the left turn signals or up to operate the right turn signals. The turn signals continue to operate until cancelled by the steering wheel or by returning the lever to its central position.

 Indicators in the instrument panel illuminate green and flash to show which turn signals are operating. An audible ticking is also heard.

Note: The turn signals operate only when the starter switch is in the ON position.

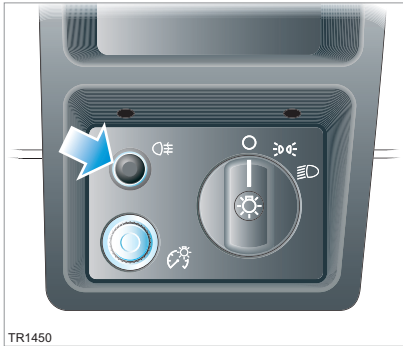

Rear fog light

With the headlights switched on, press the button to switch on the rear fog light.

 An indicator in the instrument panel will illuminate whenever the rear fog light is operating.

Press the button again to switch off the fog light.

Note: The fog light will be automatically switched off if the starter switch or the exterior lighting switch is turned to the OFF position.

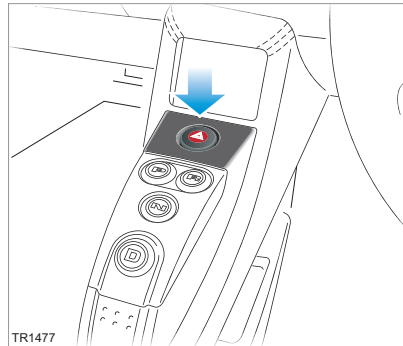

Hazard warning

The hazard warning switch is located in the centre console and operates even when the key is not in the starter switch.

Press to operate. All turn signals will flash and the turn signal indicators on the instrument panel will also flash.

Note: Only use hazard warning lights in an emergency to warn other road users of a breakdown or other potential danger. Remember to switch off when the hazardous situation has been resolved.



Horn

Press either of the two horn symbols embossed on the steering wheel to sound the horn.

Switches and controls

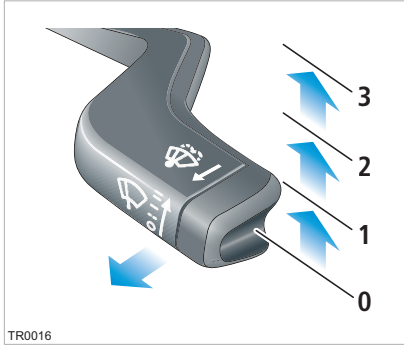

Windshield wiper and washer



Operation of the windshield wiper and washer is controlled by the right-hand steering column lever. Move the lever to the following positions to operate:

- 0. OFF
- 1. Intermittent operation of wiper
- 2. Wiper operates at normal speed
- 3. Wiper operates at fast speed

Note: The windshield wiper and washer operate only if the starter switch is in the ON position.

Windshield washer

Pull the lever towards you to operate the windshield washer and wiper. The washer and wiper continue to operate as long as the lever is held in this position. When you release the lever, the wiper blade operates for six sweeps of the blade.

-  Caution: Do not operate the wiper on a dry windshield.
-  Caution: In freezing or very hot temperatures, ensure that the wiper blade is not frozen or adhered to the windshield before operating.
-  Caution: In winter, remove any snow or ice from the windshield, wiper arm and blade before operating.

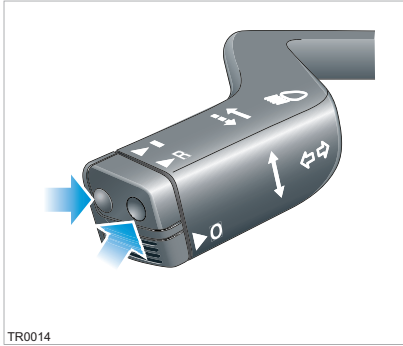

Cruise control

⚠ WARNING: Do not use cruise control in traffic conditions where a constant speed cannot be maintained or on winding or slippery road surfaces. ▲

The cruise control system allows you to maintain a selected vehicle speed above 48 km/h (30 mph) without having to use the accelerator pedal.

CRUISE When cruise control is active, the warning indicator in the instrument panel illuminates.

Operating cruise control

Operate cruise control using the controls on the left-hand steering column lever:

▶○ - OFF

▶I - initially sets the current speed. Subsequent presses increase the speed.

▶R - initially resumes a previously set speed. Subsequent presses reduce the speed.

Setting the vehicle speed

To engage cruise control, the vehicle speed must be more than 48 km/h (30 mph). Once you have accelerated to your desired speed, press and release ▶I to set the speed at which the vehicle is currently travelling. Cruise control is engaged and the set speed will be maintained when you release your foot from the accelerator pedal. To actively disengage cruise control, press the ▶○ button on the end of the control lever.

Note: Cruise control automatically disengages when you press the brake pedal, apply the hand brake, or when the vehicle's speed falls below 48 km/h (30 mph).

⚠ Caution: When you disengage cruise control, the vehicle decelerates rapidly.

Changing the set speed

Accelerate or decelerate to the desired speed and then press and release ▶I to change the set speed.

- Press and release ▶I to increase the speed in 1.6 km/h (1 mph) increments or press and hold until the desired speed is reached.

- Press and release ▶R to reduce the speed in 1.6 km/h (1 mph) increments or press and hold until the desired speed is reached. Pressing ▶R when the vehicle is at, or below, 50 km/h (31 mph) cancels cruise control.

Alternatively, use the rocker switch to increase (▶I) or reduce (▶R) speed when cruise control is active.

You can press the accelerator pedal to exceed the set speed. Then, on releasing the pedal, the vehicle will decelerate until the set speed is reached.

Resuming a set speed

⚠ Caution: The resume function should only be used if you are aware of the set speed and want to return to it.

Press ▶R to accelerate to the previously set speed. This function will not operate if the previously set speed is zero or if cruise control is already operating.

The set speed is reset to zero when:

1. The starter switch is turned to the OFF position.
2. Reverse gear is selected.
3. The hand brake is applied.
4. The vehicle speed is below 1.6 km/h (1 mph).

Instruments



TR1316

Instrument panel components

1. Speedometer
2. Power meter
3. LCD panel
4. Warning indicators

Power meter

The power meter **2** displays the amount of power currently leaving or entering (regenerative braking) the Battery.

LCD panel

The Liquid Crystal Display (LCD) panel in the instrument panel operates whenever the key is in the ON position. The LCD displays three types of information.

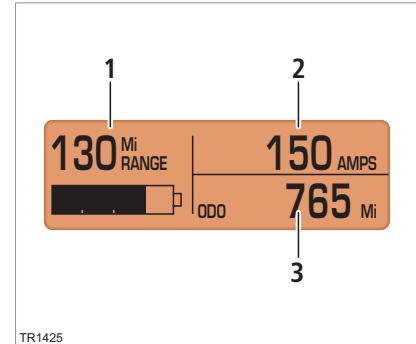

TR1425

1. Range and charge level
2. Current
3. Odometer/trip display

Using the touch screen, you can set this panel to display either miles or kilometers. For details, refer to the 'Touch Screen Uses Manual'.

Range and Charge level

The left side of the LCD panel **1** displays the remaining range and charge level.

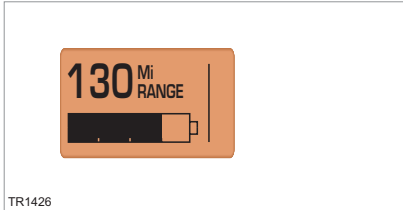

The size of the filled region within the battery icon provides a visual indicator of the amount of charge remaining in the Battery.

Current

The number at the top right of the LCD **2** indicates the amount of current (in amps) entering or leaving the Battery.

Odometer and trip display

This portion of the LCD display **3** can display either odometer or trip display information. To toggle back and forth between these two types of information, press the button located on the right-hand side of the steering column:

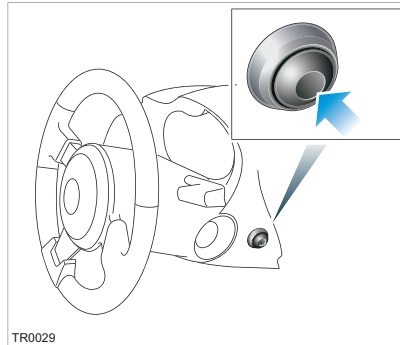

- The TRIP display shows the miles travelled since the trip display was last reset. To reset the trip display to zero, press and hold the button on the side of the steering column for about one second.

Note: The TRIP display can also be viewed and reset using the touch screen's Drive screen called "Trip". Resetting the TRIP display using the button on the steering column resets the trip display on the Touch Screen, and vice versa.

- The ODO display shows the total distance travelled by the vehicle in its lifetime.

If the starter switch is in the OFF position, pressing the TRIP button temporarily illuminates the instrument panel to show the ODO display.

Warning indicators

The following warning indicators light up for approximately four seconds when you turn the starter switch to the ON position. They will then extinguish (unless the indicator is applicable to the current situation) and the gear buttons on the centre console will light up, indicating the vehicle is ready to be driven.



Turn signals. Flashes green to indicate which turn signal is operating. Both indicators will flash when the hazard warning lights are operating. If an indicator flashes quickly or irregularly, you may need to replace the associated turn signal bulb.





Seat belt warning. Illuminates red whenever the driver's seat belt is unbuckled and the starter switch is in the ON position. An audible sound will also be heard for six seconds when the starter switch is turned to the ON position and the driver's seat belt is unbuckled.





Regenerative braking off. Regenerative braking has been temporarily disabled. This occurs when the battery has reached its maximum charge level and can not accept additional charging. For example, the Battery is full after being charged using the Range setting. It can also occur if the Battery has reached extremely high temperature or if a fault has occurred.

Instruments

 **Power Limit.** Illuminates amber when the vehicle's power is being limited. This could possibly be caused by overheating of a component, or if the remaining charge level of the Battery is less than 20%. Power will be restored automatically when conditions are appropriate.

 **Rear fog lamp.** Illuminates amber when the rear fog lamp is turned on.

 **High beam.** Illuminates blue when the headlight high beams are selected.

 **Charge indicator.** Flashes amber when the vehicle is charging.

 **Charge indicator.** Illuminates red when the charging port door is open and the vehicle is not charging.

 **Traction control disabled.** Illuminates when the traction control has been manually disabled.

 **Traction control active.** Briefly illuminates in situations where traction control is in use.

 **Alarm system active.** Flashes red when the vehicle is locked and the alarm system is active.

 **Doors locked.** Illuminates green when the vehicle is locked but the alarm system is not active. Occurs when the doors are locked and you are driving, or if the doors have been locked from inside the vehicle.

 **Cruise control.** Illuminates green when the cruise control system is operating.

 **ABS indicator.** Illuminates when an ABS fault is detected. Contact Tesla Motors or an authorised repairer as soon as possible.

 **Hand brake.** Illuminates red when the hand brake is applied.

 **Brake indicator.** Illuminates red when the hand brake is applied. If the indicator illuminates at any other time, a fault with the brake system has been detected.

- Indicator permanently illuminated - brake fluid level is low.
- Indicator flashing - fault with the brake system is detected.

 **WARNING:** Driving the vehicle with the brake indicator illuminated could result in fatal or serious injury. Stop the vehicle as soon as safety permits and seek qualified assistance. ▲

 **Frost warning.** Illuminates amber when the temperature outside the vehicle falls below 3° C (37° F). Extinguishes when the temperature rises above 5° C (41° F).

 **Airbag warning.** Illuminates red during the system check that occurs when the key is turned to the ON position. This indicator should extinguish within approximately six seconds.

If the light fails to illuminate, or fails to extinguish after six seconds, a fault has occurred. Contact Tesla Motors or an authorised repairer urgently to have the fault remedied.

 **WARNING:** If the airbag indicator is illuminated, the airbag system will be deactivated and in the event of an accident the airbags may not inflate. ▲

 **FAULT** Non-critical fault. Illuminates amber when a non-critical fault is detected. The touch screen will display a message describing the fault. Contact Tesla Motors or an authorised repairer as soon as possible.

 **FAULT** Critical fault. Illuminates red when a critical fault is detected. This is usually accompanied by the inability to drive the vehicle and a shutdown of all electrical systems. The touch screen will display a message describing the fault. Stop the vehicle as soon as it is safe to do so, and seek qualified assistance immediately.

 **Tyre pressure indicator.** Illuminates amber when the pressure of a tyre is out of range. If a fault with the Tyre Pressure Monitoring (TPM) system is detected, the warning indicator flashes. Check the touch screen for more information.



Instrument panel lighting

The control for the instrument panel lighting is located on the right-hand side of the dashboard.

When instrument panel lighting is turned on, you can reduce or increase the amount of backlighting for the instrument panel, touch screen and the centre console by turning this knob counter-clockwise or clockwise respectively.

Comfort and convenience

Power windows	
Driver's door window controls	7-2
Operating the windows	7-2
Rear view mirrors	
Exterior rear view mirrors	7-3
Interior rear view mirror	7-3
Interior temperature control	
Control panel	7-4
General information	7-4
Operating the system	7-4
Ventilation	7-5
Windshield defrosting	7-5
Seat heaters	7-6
Interior accessories	
Interior light	7-7
Sun visors	7-7
Accessory power socket	7-7
USB Port	7-7
iPod® connector	7-8
Cup holder	7-8
Removable roof	
Hard-top and soft-top roofs	7-9
Installing the soft-top roof	7-10
Removing the soft-top roof	7-11
Installing the hard-top roof	7-13
Removing the hard-top	7-14
HomeLink®	
HomeLink® Universal Transmitter	7-15

Power windows

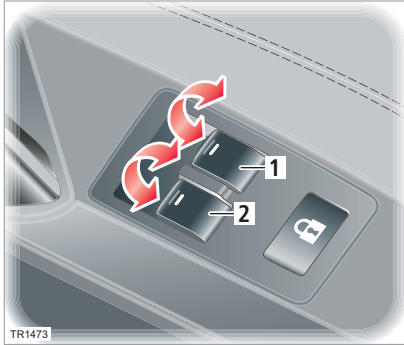

Driver's door window controls

The windows can be operated whenever the starter switch is in the ACC or ON positions.

1. Driver's window
2. Passenger window

Note: The passenger window can also be operated using the switch on the passenger door.

Operating the windows

! WARNING: Closing power windows on fingers, hands or other vulnerable parts of the body may result in serious injury. Ensure that your passenger is familiar with the window controls and aware of the potential dangers. ▲

! WARNING: To prevent the risk of injury, always remove the key if a child is to be left unattended in the vehicle. ▲

! WARNING: Never leave a child or an animal unattended in the vehicle with the windows closed and the roof fitted. In hot weather conditions they could succumb to heat exhaustion. ▲

Press and hold the respective switch to lower the driver's or passenger's window. Window movement stops when the switch is released.

To raise a window, pull the switch and hold until the window is fully raised.

One-touch opening

Both windows are equipped with a one-touch opening feature.

Briefly press the switch down and release, the window will continue to lower until fully open. Pressing or pulling the switch again will stop the window.

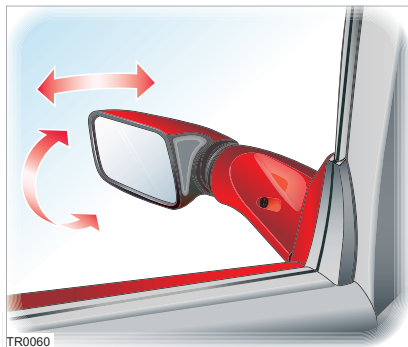

Exterior rear view mirrors

! **WARNING:** Convex mirrors can make objects appear smaller and further away than a regular flat mirror. Always double-check the speed and position of vehicles around you, by looking in the interior mirror and over your shoulder, before changing lanes. ▲

Note: The passenger side exterior mirror is fitted with a convex lens to improve the field of vision and reduce possible blind spots.

Seated in a correctly adjusted driver's seat, adjust the position of the exterior mirrors by manually moving them to the desired position.

Note: To adjust the mirror on the passenger side of the vehicle, it is helpful to get assistance from another person.

Mirrors should be adjusted to give the best view of the road behind and to each side of the vehicle, while maintaining a view of part of the vehicle for reference.

Mirror folding

The exterior mirrors are spring-loaded to reduce any possible damage in the event of accidental contact.

! **Caution:** The mirrors are not designed to be folded flat against the vehicle.

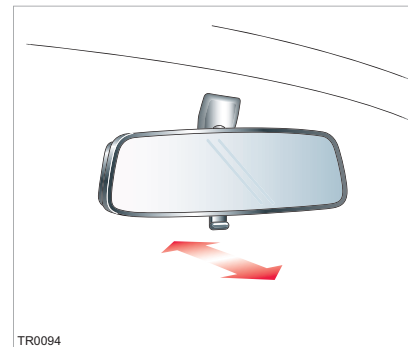

Interior rear view mirror

The interior mirror can be manually dipped to reduce glare from a following vehicle's headlights.

Push the lever on the underside of the mirror to dip the mirror. Pull the lever to restore normal visibility.

! **Caution:** Take care when using the mirror in the dipped position, the reflected view may distort the true position of a following vehicle.

Interior temperature control

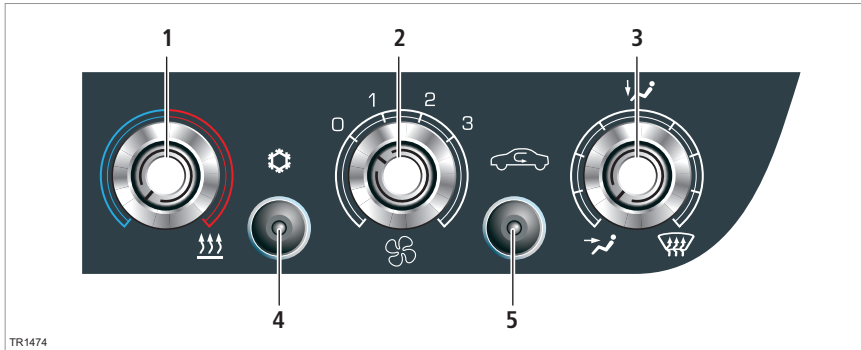

TR1474

Control panel

1. Temperature
2. Fan
3. Air distribution
4. Air conditioning
5. Air recirculation

General information

The temperature of the air inside the vehicle is controlled using the controls on the dashboard.

Heating is provided by a high voltage electric heater and cooling is provided by an all-electric air conditioning system. Both of these systems are located under the bonnet.

In addition to cooling the passenger compartment, the air conditioning system also cools the Battery coolant.

Note: In high ambient temperatures, the system may not be able to achieve the desired passenger compartment temperature. This is normal, with priority being given to cooling the Battery to ensure that cell temperatures stay within a range that supports long life and efficient performance.

Operating the system

Note: The fan, heating system and air conditioning system are all powered by the Battery. Prolonged use will decrease the range of the vehicle.

Temperature

Rotate the control **1** clockwise (warmer) or counterclockwise (cooler) to adjust the air temperature.



- To heat the vehicle, the fan must be on.
- To cool the vehicle, the fan must be on and then press the air conditioning button.

Fan

Rotate the control **2** clockwise to increase fan speed. With the fan switched off, the amount of air entering the vehicle depends on your driving speed.

Air distribution

Rotate the control **3** to change the locations at which air enters the passenger compartment.

-  Windshield vents
-  Footwell vents
-  Face vents

To allow air to flow from more than one vent location, position the control between distribution settings.

Air conditioning

To cool the air inside the vehicle, turn the fan on, then press the air conditioning button **4**. The button illuminates to indicate the system is operating.

Rotate the temperature control to achieve the desired air temperature. To turn off, press the air conditioning button again.

Air recirculation

Press the air recirculation button **5** to recirculate the air inside the vehicle. The button will illuminate to indicate that air is being recirculated. Press again to switch off.

When air recirculation is operating, and the roof is installed, 90% of the air inside the vehicle is recirculated, instead of being drawn from outside the vehicle. You can use this to prevent fumes from entering the vehicle or to more effectively maintain a constant temperature inside the vehicle.

Note: It is recommended that you switch off air recirculation for a short period each hour to refresh the air inside the vehicle, and to help prevent window misting.

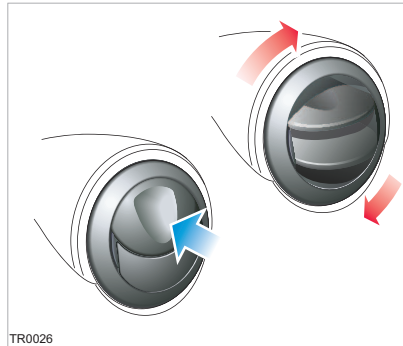

Ventilation

Air is drawn into the ventilation system through the grill at the front of the vehicle. Keep the grill clear of obstructions (leaves, snow, etc.).

Press the thumb depression to open the vents. Rotate to direct air as required. The vents on each side of the dashboard can be adjusted to direct air onto the side windows.

Note: When you open the face level vents, airflow to the foot and windshield vents is reduced.

Windshield defrosting

For maximum efficiency when removing frost or mist from your windshield, set the controls as follows:

- Rotate the air distribution control to windshield.
- Rotate the fan control fully clockwise.
- Switch on the air conditioning.
- Rotate the heating control for maximum heat.

When the windshield has fully cleared, adjust the controls as required.

Interior temperature control



The seat heaters are thermostatically controlled to maintain a constant temperature. The indicator in the switch remains illuminated until either the seat heater is manually turned off or the starter switch is turned to the OFF position.

Note: Although the seat heaters consume energy from the Battery, they are a more efficient way of keeping warm than using the interior heating system.

Seat heaters

The seat heaters operate only when the starter switch is in the ACC or ON position.

Note: The seat heaters have to be selected each time the starter switch is turned to the ON position.

Press the respective button to operate the required seat heater. The seat heaters can be operated at two different levels:

- Press once to operate at a high level. The switch indicator will illuminate amber.
- Press again to operate at low level. The switch indicator will illuminate green.
- Press again to switch off.

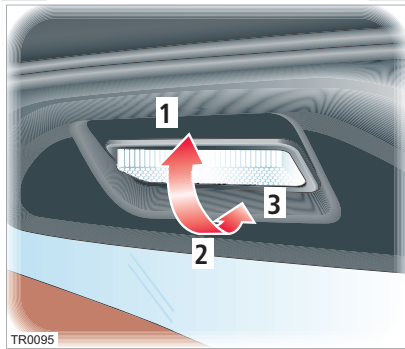

Interior light

The interior light is located on the rear header rail. The light has three positions:

1. Light on.

2. Automatic operation.

The light illuminates whenever the vehicle is unlocked or if a door is opened. The light turns off 30 seconds after the door is closed or when the starter switch is turned to the ON position.

3. Light off.

The light does not illuminate when a door is opened.

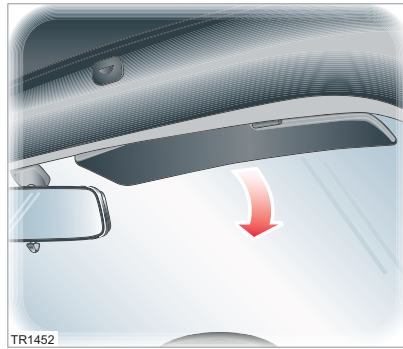

Sun visors

To help reduce the glare from the sun, visors are provided for both the driver and passenger. Pull the visor down from its stowed position when required.

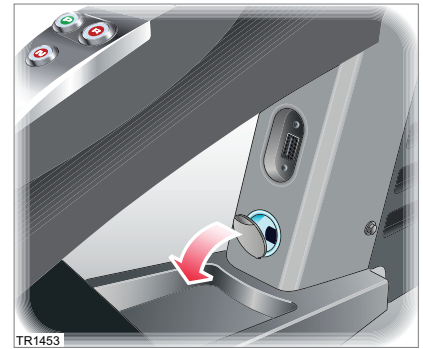

Accessory power socket

The accessory socket has a hinged cover to prevent dirt from getting into the socket when not in use.

Power from the socket is available whenever the starter switch is in the ACC or ON position.

Note: The power socket is suitable for accessories requiring up to 10A or a maximum of 125 watts.

USB Port

The USB port, located directly above the power socket, is for service use only. If requested, it can be used to download your vehicle log file so you can send it to Tesla Motors. See Providing information to Tesla Motors, page 8-18.

Note: This port is not for the connection of portable media devices (i.e. an iPod®).

Interior accessories



iPod® connector

An iPod® connector is provided for both connecting your iPod to the audio unit and recharging while in use.

The connector is located on the centre console.

Connect your iPod® and select **Aux** on the audio system. For details of using your iPod® with the audio system, please refer to the supplied audio system operating instructions.

 **Caution:** To prevent the connector from being damaged when not in use, fit the protective cap.



Cup holder

 **WARNING:** Do not carry open drink containers. A spilled hot drink could cause personal injury as well as damage to upholstery, carpeting and electrical systems. ▲

Pull the cup holder from the side of the centre console to use. The fingers of the cup holder are spring-loaded to hold the cup securely. Open the fingers and insert the cup. The base of the cup should rest on the floor.

 **Caution:** After use, return the cup holder to the centre console to prevent it being broken when occupants are entering or leaving the passenger side of the vehicle.

Hard-top and soft-top roofs

In the Tesla Roadster, you can enjoy exposure to the natural environment and drive without the confinement of a cockpit roof. To provide weather protection in unfavourable conditions, you have the choice of installing either the soft-top or hard-top roof.

The Tesla Roadster is designed to accommodate changing loads and strains that constantly occur while driving. It also accommodates the tolerances needed to allow repeated removal and installation of the roof. As a result, wind noise and minor water leaks can occur and are considered normal.

 **WARNING:** Never attempt to install or remove the roof while the vehicle is moving. ▲

Instructions for installing and removing the soft-top and hard-top roofs are provided on the following pages.

Removable roof

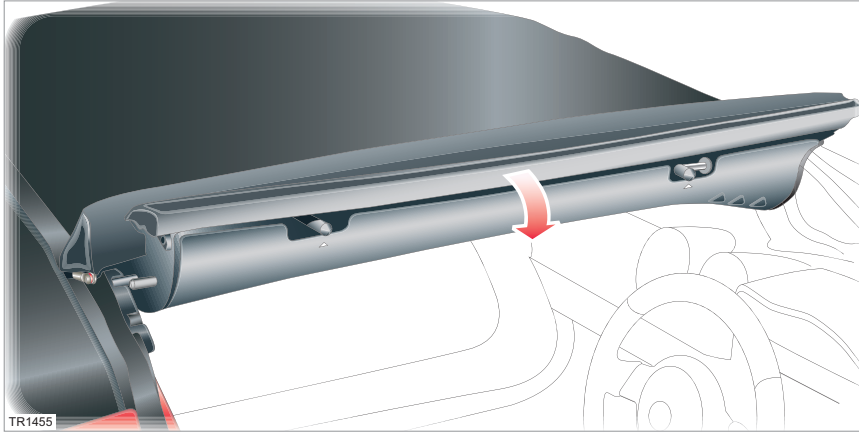

Installing the soft-top roof

⚠ WARNING: Never attempt to install the roof while the vehicle is moving. This could cause an accident in which you or others may be seriously injured or killed. ▲

Open both doors. Remove the roof assembly and support stays from the bag.

Note: The support stays and the side rails on the roof assembly have arrows on them which should point to the front of the vehicle when installing.

1. Fit the two support stays between the header rails. The support stays will need to be flexed to enable them to fit into the slots in the header rails.

2. Inspect the channels in the header rails and remove any debris (such as leaves) that may have accumulated.
3. Position the roof assembly across the space between the two support stays. Ensure that the arrows moulded on the side rails are pointing to the front of the vehicle.
4. Standing at the left-hand side, unroll the roof. Starting at the left-hand side minimizes potential damage to the roof seals.
5. Position the side rail so that the black locating pins are located in the uppermost slots on the front and rear header rails.

6. Ensure that the front and rear edges of the roof are correctly located in the channels on the header rails.
7. Rotate the side rail downwards until the side rail locking pins are correctly located in the lower slots and you hear them 'click' into place.
8. Check that both locking pins are correctly engaged by attempting to rotate the side rail upwards.
9. Repeat steps 5 through 8 for the passenger side of the roof. You may need to pull on the side rail to engage the locating pins on the header rails.
10. Inspect the fitted roof to ensure that the front and rear edges are correctly located in the channels on the header rails. Incorrect fitment can result in damaged seals and water leakage.

⚠ WARNING: Before driving, check that both side rails are securely fitted. An incorrectly fitted or unsecured roof could lead to serious injury or even death. ▲

Note: The window position has been adjusted to accommodate the roof supplied with your vehicle. To prevent water from entering the passenger compartment when using the alternate type of roof, you should have Tesla Motors or an authorised repairer adjust your windows.

Removing the soft-top roof

! **WARNING:** Never attempt to remove the roof while the vehicle is moving. This could cause an accident in which you or others may be seriously injured or killed. **▲**

! **Caution:** It is recommended that you release the side towards the front of the vehicle first to prevent the adjusters for the tensioning cables from damaging the roof seals.

1. With the vehicle stationary, open both doors.
2. Locate the two release levers on the inside face of the side rail.
3. Press both levers inwards to release the side rail locking pins and rotate the rail upwards. You may need to push down on the side rail while pressing the levers.
4. Lift the side rail to disengage the two locating pins from the front and rear header rails.
5. Release the front and rear edges of the roof from the channels in the header rails and then roll the roof towards the centre of the vehicle.
6. Repeat the above steps for the other side.

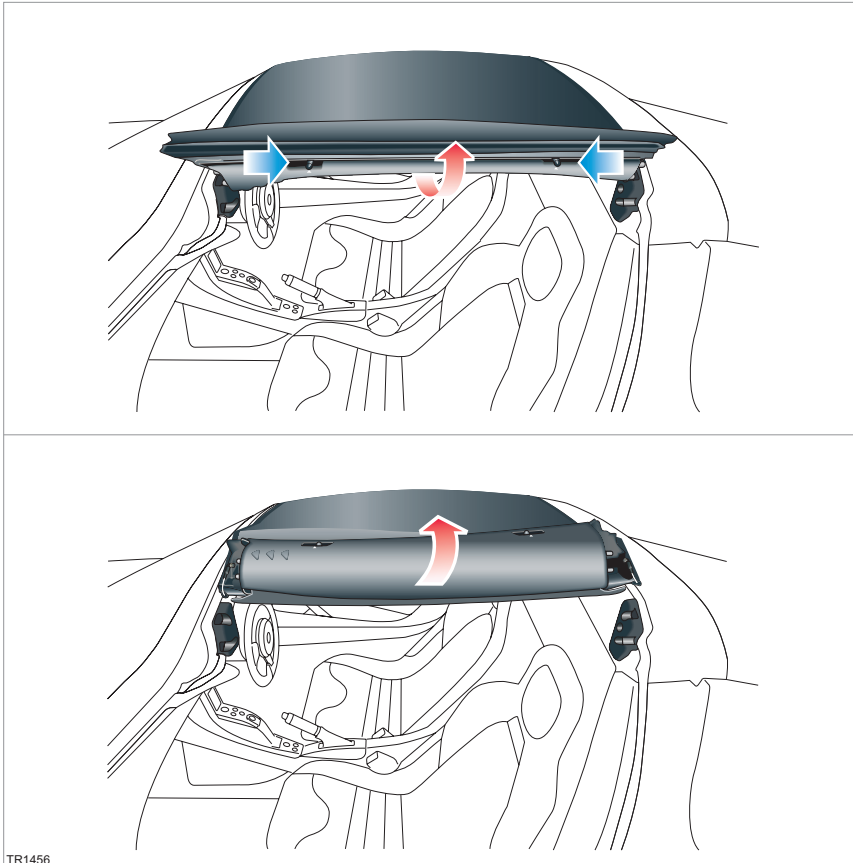

Removable roof

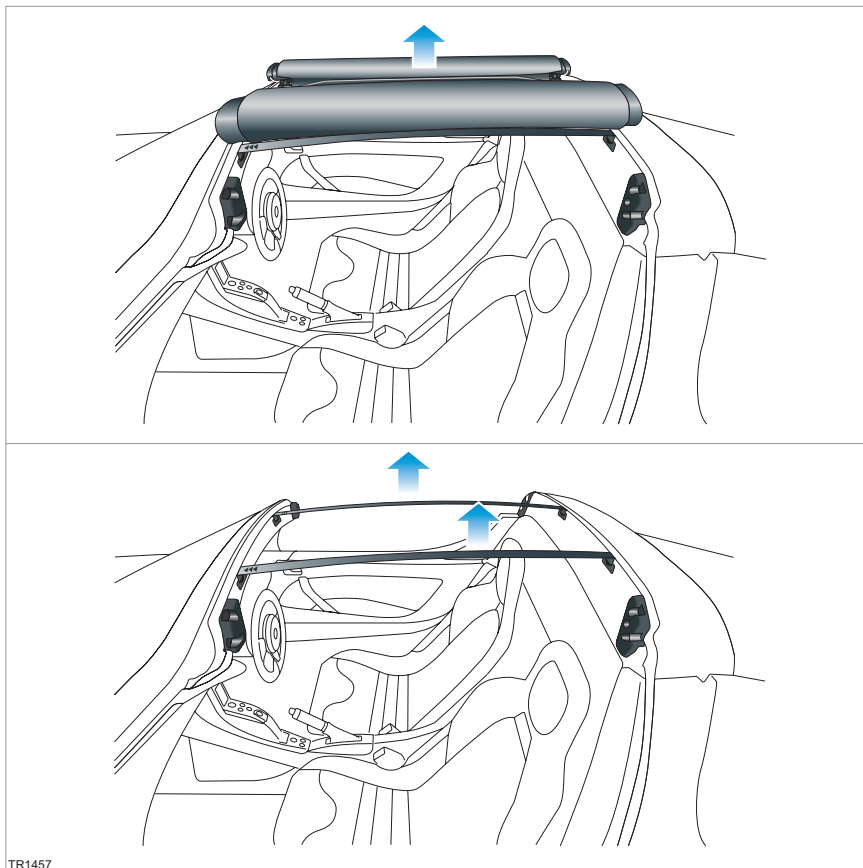

TR1457

7. Remove the roof assembly from the vehicle and store in the storage bag.
8. Remove the two roof support stays from the vehicle. Flex the ends of the stays inwards to release them
9. Store the roof support stays in the bag with the roof.

Note: If the roof is damp when removed, it is recommended that it is unrolled or refitted at the soonest opportunity to allow it to dry completely. Prolonged storage of a damp roof may damage the appearance or the fabric of the roof.

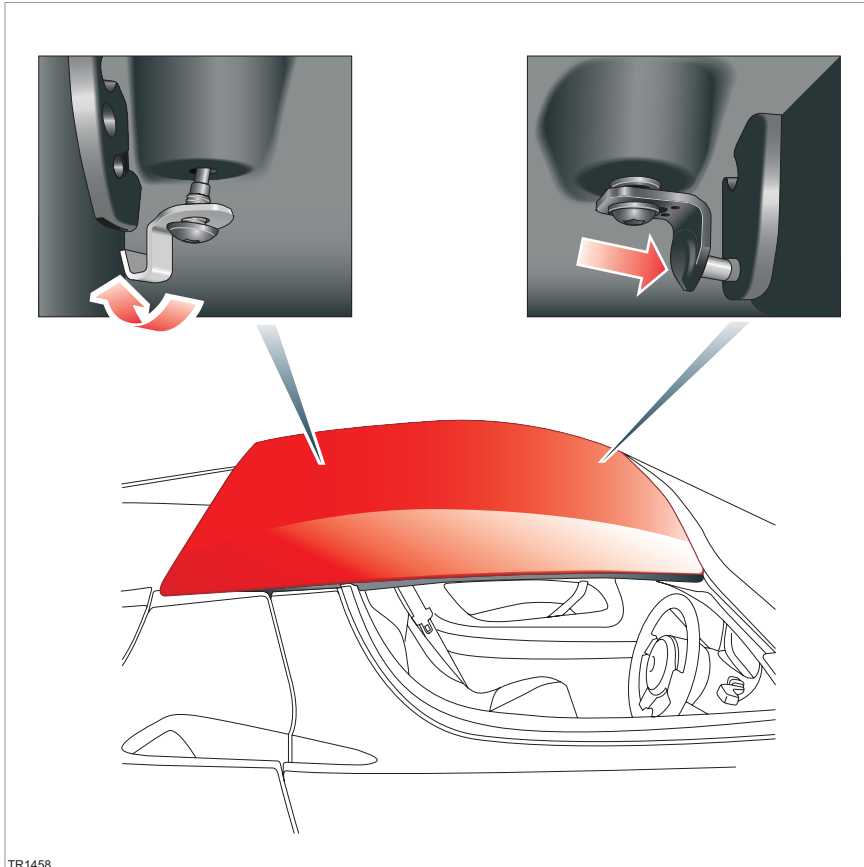

Installing the hard-top roof

The hard-top roof has been designed to provide a seasonal alternative to the standard soft-top roof. To ensure correct installation, Tesla recommends that the is installed by a Tesla service technician.

⚠ WARNING: The mounting bracket bolts securing the hard-top to the vehicle should be routinely checked and tightened. An incorrectly fitted or unsecured hard-top could result in an accident. **▲**

When storing the roof of the vehicle, care should be taken to avoid damaging the corners. If the roof must be stood on its end, use a suitable soft floor covering.

Note: Because of its size, the hard-top should only be removed or installed when a second person is available to assist.

1. If necessary, remove the soft-top. For instructions, see Removing the soft-top roof, page 7-11.
2. Open both doors.
3. With the aid of an assistant, lift the roof into position on the vehicle. Take care to avoid getting hands or fingers trapped.
4. Tilt the front of the roof to engage the locating pins into the lower most slots on the header rail. If necessary, loosen the locating pin bolts to ensure that the pins engage correctly on the header rail.

Removable roof

5. Push the roof into position on the front header rail and then lower the rear edge of the roof.
6. Engage the hook on the rear mounting brackets with the fixings on the rear header rail.
7. Use the hex key supplied in the toolkit to tighten the bolts just enough to keep the rear brackets engaged. Do not fully tighten.

 **Caution:** To prevent damage to the roof, only use only the hex key supplied in the toolkit to tighten the bolts.

8. Ensure the roof is correctly aligned on the vehicle.
9. Holding the rear mounting brackets to prevent them from twisting, tighten the bolts to secure the roof in place. Do not overtighten.
10. Check and tighten the bolts securing the front locating pins to the hard-top.

 **WARNING:** Make sure that the roof is securely fitted by trying to lift each corner in turn. If any movement is evident, check and tighten the roof fixings. Driving with a loose or incorrectly secured roof could result in an accident which could lead to serious injury and even death. ▲

11. Check that both doors shut correctly with the windows in the fully raised position.
12. Position the front header rail trim panel and align the bolts to the holes in the roof.

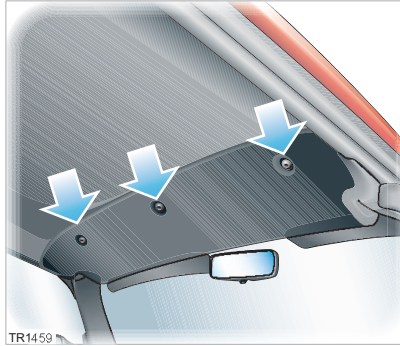

13. Starting with the bolt in the center, tighten the three bolts to secure the trim panel. Do not overtighten.

 **WARNING:** Do not drive the vehicle with the trim panel removed. In a collision, injury could result from contact with the brackets. ▲

14. Return the hex key to the tool kit.

Note: The window position has been adjusted to accommodate the roof supplied with your vehicle. To prevent water from entering the passenger compartment when using the alternate type of roof, you should have Tesla Motors or an authorised repairer adjust your windows.

Removing the hard-top

1. Open both doors.
2. Using the hex key supplied in the toolkit, loosen the three bolts securing the header rail trim panel to the roof.
3. Remove the trim panel.
4. Loosen the two bolts securing the rear of the roof to the vehicle.
5. Disengage the brackets from the rear header rail.
6. With the aid of an assistant, lift the rear edge of the roof and slide it towards the rear of the vehicle to disengage the front locating pins.
7. Store the roof in a safe place where it will not get damaged. If the roof must be stood vertically, use a suitable soft floor covering to protect the corners.
8. Return the hex key to the tool kit.

HomeLink® Universal Transmitter

Your vehicle is equipped with a HomeLink® Universal Transmitter that you can use to operate most Radio Frequency (RF) devices such as garage doors, gates, lights and security systems. Your transmitter can be programmed using the Touch Screen to operate up to three individual devices.



Devices can be operated by touching a button on the Touch Screen. You can also program the third button on the handset to operate a device. For details on how to program HomeLink®, refer to the Touch Screen Users Manual, provided in your owner's package.

! WARNING: Do not use the HomeLink® Universal Transmitter with any garage door opener that lacks safety stop and reverse features. A garage door opener which cannot detect an object in the path of a closing door and then automatically stop and reverse the door, does not meet current safety standards. Using a garage door opener without these features increases the risk of serious injury or death. ▲

HomeLink® is a registered trademark owned by Johnson Controls, Inc. Milwaukee, Wisconsin.

Precautions



WARNING: During programming, the garage door or gate may open or close. Make sure that people and objects are clear of the garage door or gate that you are programming. ▲

For safety reasons, it is recommended that the vehicle is Parked with the starter key in the ACC position when programming the HomeLink® Universal Transmitter

Once programmed, the vehicle's HomeLink® transmitter replaces the need to use the transmitter supplied with the equipment. Be sure to retain your original transmitter for future programming procedures (i.e. a new vehicle purchase).

Prior to selling your vehicle, you should erase all your personal HomeLink® settings.

Maintenance and care

Maintenance

General information	8-2
Routine maintenance	8-2
Owner maintenance	8-2
Opening and closing the bonnet	8-3
Closing the bonnet	8-3

Fluid reservoirs

Fluid reservoir locations	8-4
Brake fluid	8-4
Windshield washer fluid	8-5
Battery coolant	8-5

Windshield wiper and washer

Checking the wiper blade	8-6
Replacing the wiper blade	8-6
Windshield washer jets	8-6

Cleaning and vehicle care

Environmental precautions	8-7
Cleaning the vehicle exterior	8-7
Polishing the body	8-8
Using a car cover	8-8
Paint damage and rectification	8-9
Cleaning the vehicle interior	8-9

Wheels and tyres

Tyre care	8-10
Winter tyres and chains	8-12
Tyre Pressure Monitoring (TPM) System	8-13
Tyre markings	8-15
Wheels and tyres glossary	8-17

Vehicle diagnostic information

Providing information to Tesla Motors	8-18
---------------------------------------	------

Maintenance

General information

Regular maintenance is the key to ensuring the continued reliability and efficiency of your vehicle.

Maintenance is the owner's responsibility and you must ensure that the appropriate maintenance is carried out when required and according to the recommendations specified by Tesla Motors.

Routine maintenance

Take your vehicle to Tesla Motors or an authorised repairer at the scheduled maintenance intervals of every 12 months, or every 20,000 km (12,000 miles), whichever comes first.

Most of the necessary maintenance and servicing of your vehicle will require specialist knowledge or equipment, and should be entrusted to Tesla Motors or an authorised repairer.

Fluid replacement

Brake fluid requires changing every two years, irrespective of the distance the vehicle has travelled.

Battery coolant must be changed every four years, irrespective of the distance the vehicle has travelled.

Note: Both of these fluids will be changed by Tesla Motors or an authorised repairer at the service nearest the conclusion of each period of time.

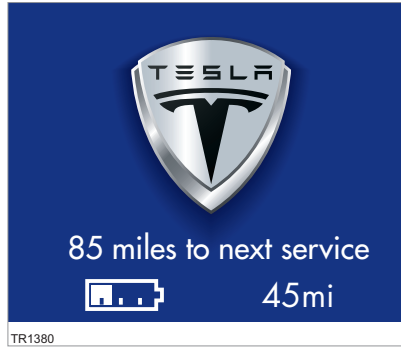

Service interval indicator

When the key is inserted and turned to the ACC position, the touch screen momentarily displays how many miles you can drive before the vehicle is due for servicing.

This information can also be displayed by Touching the **Info** button on the touch screen's main 'Parked' screen (which is displayed whenever the hand brake is engaged). For details, refer to the 'Touch Screen Users Manual'.

Owner maintenance

WARNING: Any significant or sudden drop in fluid levels, or uneven tyre wear should be rectified immediately. ▲

In addition to the routine maintenance, a few simple checks must be carried out more frequently. Details are provided in the pages that follow.

Daily checks

- Check that all lights, horn, turn indicators, wipers, washers and warning indicators operate
- Check that seat belts and brakes operate
- Check for fluid deposits underneath the vehicle that might indicate a leak

Weekly checks

- Check brake fluid level. Refer to Brake fluid, page 8-4.
- Check windshield washer fluid level. Refer to Windshield washer fluid, page 8-5.
- Check battery coolant. Refer to Battery coolant, page 8-5.
- Check condition and pressure of each tyre. Refer to Wheels and tyres, page 8-10.
- Check operation of the air conditioning system. Refer to Interior temperature control, page 7-4.

Opening and closing the bonnet

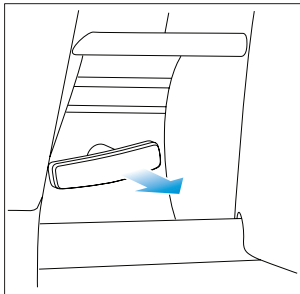

TR1460

! **WARNING:** Never work on a vehicle that is plugged in. Always remember to unplug the vehicle before working under the bonnet or the underside of the vehicle. ▲

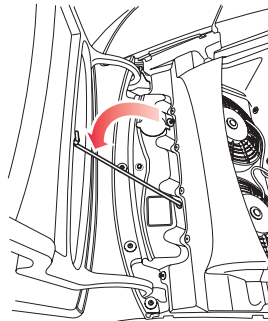
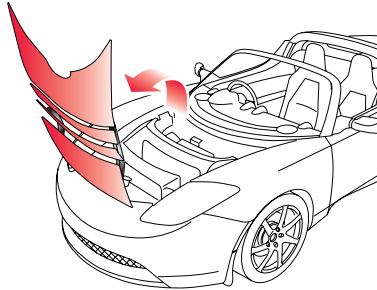

! **WARNING:** Make sure that the bonnet is in the fully open position before working in the area under the bonnet. In windy conditions, you may need to secure the bonnet stay to prevent the bonnet from being closed by the wind. ▲

Opening the bonnet

To open the bonnet:

1. Pull the bonnet release handle located to the right of the steering column.
2. Raise the bonnet.
3. Insert the bonnet stay into the slot.

Closing the bonnet

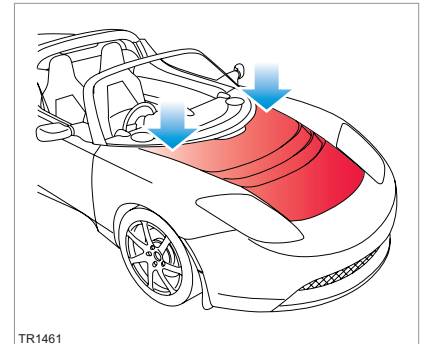

TR1461

Return the bonnet stay to its original position and lower the bonnet to the closed position. Press down firmly on each side of the bonnet to engage the locks. You can hear the locks 'click' into place.

! **Caution:** Before driving, check that the locks on both sides of the bonnet are fully engaged by attempting to lift the bonnet. There should be no movement.

Fluid reservoirs

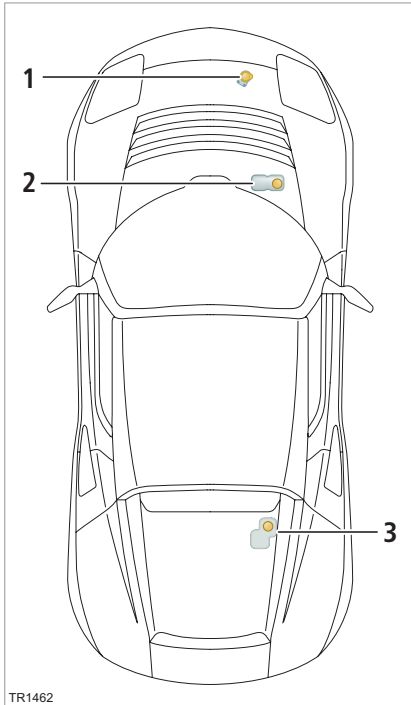

Fluid reservoir locations

1. Windshield washer fluid
2. Brake fluid
3. Battery coolant

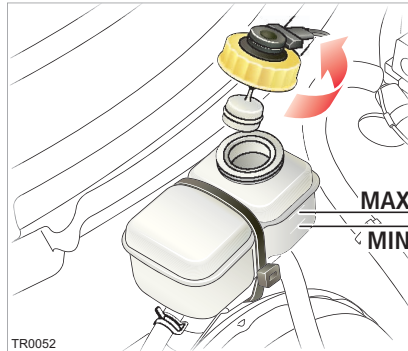

Brake fluid

! **WARNING:** Seek qualified assistance immediately if the movement of the brake pedal has increased, or if there is a significant loss of brake fluid. Driving under such conditions could result in extended stopping distances or complete brake failure. ▲

Fluid level check

Check the brake fluid level weekly with the vehicle on level ground. The fluid level can be checked visually through the side of the reservoir without removing the filler cap.

The brake fluid level should be between the **MIN** and the **MAX** marks.

Topping up the fluid

! **WARNING:** Brake fluid is highly toxic. Keep containers sealed and out of the reach of children. In the event of accidental consumption, seek medical attention immediately. ▲

1. Clean the filler cap before removing to prevent dirt from entering the reservoir.
2. Unscrew the cap and remove.
3. Top-up the reservoir to the **MAX** mark using brake fluid meeting DOT4 specification.
4. Replace the reservoir cap.

! **Caution:** Brake fluid will damage painted surfaces. Immediately soak up any spills with an absorbent cloth and wash the area with a mixture of vehicle shampoo and water.

! **Caution:** Only use new fluid from an airtight container. Fluid from opened containers or fluid that has been previously bled from the system will have absorbed moisture which will decrease braking performance, and must not be used.

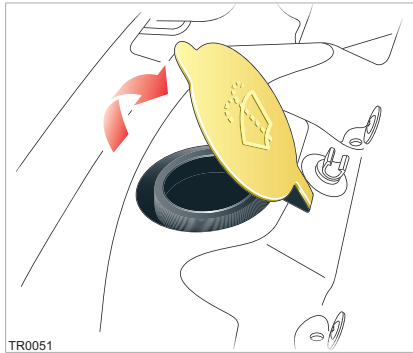

Windshield washer fluid

To ensure proper cleaning of the windshield and to prevent freezing in cold weather, check the reservoir level weekly. If needed, top up with windshield washer fluid.

⚠ Caution: Always follow the directions provided by the windshield washer fluid manufacturer. If the windshield washer fluid requires dilution, carefully follow the manufacturer's directions and mix the recommended quantities of water and windshield washer fluid in a separate container before topping up the reservoir. Undiluted windshield washer fluid can cause the vehicle's paint to discolour.

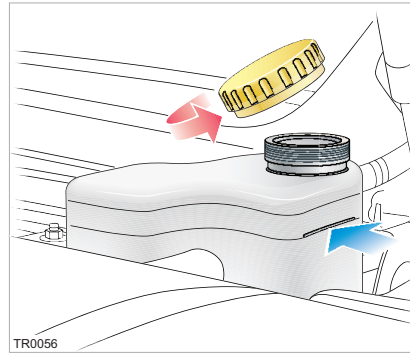

Battery coolant

⚠ WARNING: The cooling system is under pressure when the system is warm. Always allow the system to cool before removing the reservoir cap. ▲

Fluid level check

Check the fluid level weekly with the vehicle on level ground and when the vehicle is cool. The fluid level can be checked visually through the side of the reservoir without removing the filler cap. The fluid level should be between the **MIN** and the **MAX** marks.

If the level drops significantly, a leak may exist. Contact Tesla Motors before using the vehicle.

Topping up the coolant

♻ The cooling system for your vehicle contains a propylene glycol (PG) based antifreeze. Compared to conventional ethylene glycol based antifreezes, propylene glycol is less toxic, safer for children, pets and wildlife, and safer for the environment.

Top-up to the **MAX** mark with a 50% mix of water and one of the following:

- Havoline® Extended Life Antifreeze Coolant-PG (Havoline XLC-PG).
- Glacelf MPG SUPRA.

⚠ Caution: Do not mix with any other type of antifreeze! In an emergency, top up with distilled water only and be aware of the reduced frost and corrosion protection.

Antifreeze contains important corrosion inhibitors. Maintain the antifreeze content of the coolant between 50% and 60% year round. Do not exceed 60% or cooling efficiency will be impaired.

Ensure cap is replaced and fully tightened after topping up.

Note: The coolant must be changed every four years, regardless of the distance the vehicle has travelled.

Windshield wiper and washer

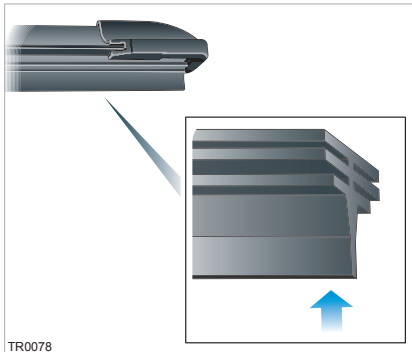

Checking the wiper blade

Periodically check and clean the wiping edge of the wiper blade.

Check the blade rubber for cracks, splits and roughness. If any damage, wear or roughness is detected, replace immediately to prevent damage to the glass.

Clean the blade edge by wiping with a soft cloth or sponge, using warm soapy water.

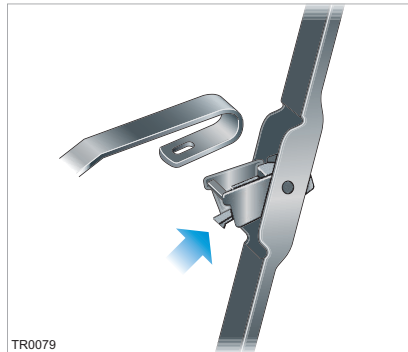

Replacing the wiper blade

Install only a replacement wiper blade that is identical to the original specification.

1. Lift the wiper arm away from the windshield.
2. Turn the blade at right angles to the arm.
3. Depress the locking tab while sliding the blade down the arm.

To install the new blade, position the new assembly on the wiper arm and slide the blade towards the hooked end of the arm until it locks into place.

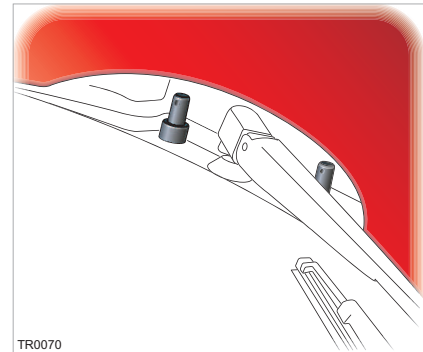

Windshield washer jets

The position of the washer jets are set during vehicle manufacture and should not need adjusting.

If necessary, use a needle to clear any blockages from the nozzles, or to redirect the spray towards the centre of the windshield.

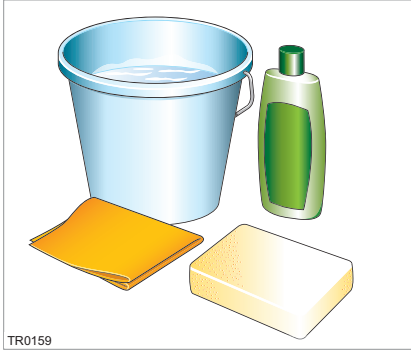

Environmental precautions



Some cleaning products contain chemicals that are hazardous to the environment. Always take precautions to prevent fluids from spilling.

It is illegal to pollute drains, rivers and waterways. Used toxic chemicals must be disposed of at authorized waste disposal sites only.

Cleaning the vehicle exterior

Hand washing

! Caution: Substances that are corrosive, such as bird droppings, tree resin, dead insects, tar spots, road salt and industrial fall-out can damage the vehicle's paint. Remove such deposits as soon as possible to prevent damage.

To preserve the paint finish, observe the following:

- Before washing, use a hose to remove heavy deposits of mud and dirt from the body.
- Never wash a vehicle that is "hot to the touch" or during exposure to strong, direct sunlight.
- Wash the body using cold or lukewarm water containing a good quality wash and wax shampoo.
- Never use strong household detergents or soap. These products can discolour and spot painted surfaces.
- For best results, always use a clean sponge or car wash mitt with plenty of water.
- After washing, rinse with clean water and thoroughly wipe dry with a chamois. Do not allow cleaning agents to dry on the finish.

Automatic car washers and pressure washers

! Caution: Tesla Motors recommends that you hand wash your vehicle. Do not use an automatic car washer or pressure washer as these may damage your vehicle's paint finish, soft top, or other components.

! Caution: Never use a pressure washer to clean components in the Battery compartment as it may damage critical seals on the Battery and other electrical components.

Note: Vehicle or paint damage caused by using an automatic car washer or pressure washer will not be covered under the vehicle warranty.

Underbody maintenance

From time to time, but particularly during winter months if salt has been used on the highways, use a hose to wash the underside of the vehicle.

Flush away accumulations of mud in areas where debris easily collects (for example, wheel arches and panel seams).

Removing tar spots

Use denatured alcohol to remove tar spots and stubborn grease stains from paint. After cleaning, immediately wash the area with soapy water to remove all traces of alcohol.

Cleaning and vehicle care

Washing the soft-top



Caution: Scrubbing or brushing with a hard bristle brush will damage the fibres of the fabric, causing fabric deterioration and impairing its cosmetic appearance.

When washing the soft-top, follow these guidelines:

1. Before washing, vacuum the soft-top using a soft brush attachment to remove dust and dirt.
2. Soften encrusted dirt using soap and water, then rinse with clean water.
3. Wash using mild soap and water. Never use solvent, petroleum or chemical-based cleaners, detergents, or wash/wax compounds.

Wheels



Caution: Do not use chemical based wheel cleaners as these can damage the finish of the wheel.

Clean with warm, fresh water containing a good quality wash and wax shampoo. Thoroughly rinse the wheels to remove any residue.

It is recommended that the wheels are regularly treated with car polish to assist in keeping the wheels clean.

Windshield, windows and mirrors

Regularly clean all windows inside and out using a window cleaning solution. An automotive glass cleaner is recommended.

After washing the vehicle with wash/wax products, clean the outside of the windshield with glass cleaner.

Mirror glass is particularly susceptible to damage. Do not use abrasive cleaning compounds.

Wiper blades

Clean wiper blades using mild soap and warm water only. Do not use petroleum or alcohol-based cleaners.

Polishing the body

To preserve the cosmetic appearance of the body, occasionally apply a good quality polish. A good polish should contain a very mild abrasive that removes surface contamination without damaging the surface, a mild filling compound to reduce the appearance of scratches, and wax to provide a barrier between the cleaned body surface and airborne contaminants.

Do not use cutting paste, colour restoration compounds, or polishes containing a harsh abrasive. These can scour the surface and permanently degrade the body.

Using a car cover



Caution: Never use a car cover when the vehicle is plugged in, doing so can prevent the battery from being adequately cooled during charging.

To preserve the cosmetic appearance of the body, you may want to use a car cover. Only an approved Tesla Motors car cover should be used.

Paint damage and rectification

Treat chips and scratches to the paint using a paint touch-up pen. Use the touch-up pen after washing but before polishing or waxing.

More extensive repairs to the body should only be carried out by a facility approved by Tesla Motors. Contact Tesla Motors for a list of approved body repair facilities.

Cleaning the vehicle interior

Plastic materials



Caution: Do not polish the upper surfaces of the dashboard. Polished surfaces are reflective and may interfere with the driver's view.

Clean with diluted upholstery cleaner, then wipe with a damp cloth.

Carpet and fabrics

Clean with diluted upholstery cleaner. Test a concealed area first.

Leather

Clean with warm water and a non-detergent soap. Dry and polish with a dry, clean, lint-free cloth.

Seat belts

Extend the belts and clean with warm, soapy, fresh water only. Do not use any type of detergent or chemical cleaning agent. Allow the belts to dry naturally while extended, preferably away from direct sunlight.

Instruments and display screens

Clean the instrument panel, touch screen, and audio system screen using a damp cloth. Do not use cleaning compounds or solutions.

Wheels and tyres

Tyre care

 **WARNING:** Defective tyres are dangerous. Do not drive if any tyre is damaged, is excessively worn, or is inflated to an incorrect pressure. ▲

Always consider tyre conditions when driving, and regularly inspect the tread and side walls for any sign of distortion (bulges), cuts or wear.

The way you drive has a significant influence on your safety and on the life of your tyres. Cultivate good habits for your own benefit:

- Make sure tyres are inflated to the correct pressures.
- Observe posted speed limits.
- Avoid fast starts, stops and turns.
- Avoid potholes and objects in the road.
- Do not drive up kerbs or rub the tyre against them when parking.

 **Caution:** Avoid contaminating the tyres with vehicle fluids as they may cause damage to the tyre compound.

Driving in low ambient temperatures

Tyre performance reduces in low ambient temperatures, resulting in less grip and an increased susceptibility to damage from impacts. When driving in sustained temperatures below -10°C (15°F), it is recommended that winter tyres are fitted.

Tyre pressure information

 **WARNING:** If the vehicle has been parked in strong sunlight or used in high ambient temperatures, do not reduce the tyre pressures. Move the vehicle into the shade and allow the tyres to cool before checking. ▲

Correctly inflated tyres will ensure that you enjoy the best combination of vehicle range, tyre life, ride comfort and road handling.

Each tyre should be checked monthly when cold and inflated to the inflation pressure recommended on the tyre information label.

Note: If your vehicle has tyres of a different size than the size indicated on the tyre information label, you should determine the proper inflation pressure for those tyres.

 As an added safety feature, your vehicle has been equipped with a Tyre Pressure Monitoring (TPM) system that illuminates a tyre pressure telltale when one or more of your tyres is significantly under-inflated. Accordingly, when the low tyre pressure telltale illuminates, you should stop and check your tyres as soon as possible, and inflate them to the proper pressure.

Driving on a significantly under-inflated tyre causes the tyre to overheat and can lead to tyre failure. Under-inflation also reduces vehicle range and tyre tread life,

and may affect the vehicle's handling and stopping ability.

The TPM system is not a substitute for proper tyre maintenance, and it is the driver's responsibility to maintain correct tyre pressure, even if under-inflation has not reached a level to trigger illumination of the TPM system tyre pressure telltale.

Checking tyre pressures

 **WARNING:** Tyre pressures should be checked regularly using an accurate pressure gauge when cold. Under-inflation is the most common cause of tyre failures and may result in severe tyre cracking, tread separation or "blowout", with unexpected loss of vehicle control and increased risk of injury. ▲

Check the pressures when the tyres are cold. Be aware that it only takes 1.5 km (1 mile) of driving to warm up the tyres sufficiently to affect the tyre pressures. If it is necessary to check the tyres when they are warm, you should expect the pressures to have increased. Do not let air out of warm tyres in an attempt to match the recommended cold tyre pressures.

Note: You can check the pressures for each tyre by displaying the values on the touch screen's 'Tire Pressure' screen. However, the values displayed on the touch screen will not be updated until the car has been driven long enough for the TPM system to take new readings.

Always inflate your tyres to inflation pressure recommended by Tesla Motors even if it is different from the maximum inflation pressure information found on the tyre itself. See Tyre pressures, page 10-6.

The following procedure should be used to check and adjust tyre pressures:

1. Remove the cap from the valve.
2. Firmly attach a tyre pressure gauge/inflator onto the valve and measure the pressure.
3. If required add air to reach the required pressure.
4. Check the pressure by removing the gauge and then re-attaching it.
Note: Failure to remove and re-attach the gauge to the valve could cause the gauge to show an incorrect reading.
5. If too much air is added, air can be released by pushing on the metal stem in the center of the valve.
6. Recheck the pressure with the gauge and adjust if necessary.
7. Refit the valve cap.

Valves

Fit the valve caps securely to prevent dirt from entering the valve. Periodically check the valve for damage and leaks.

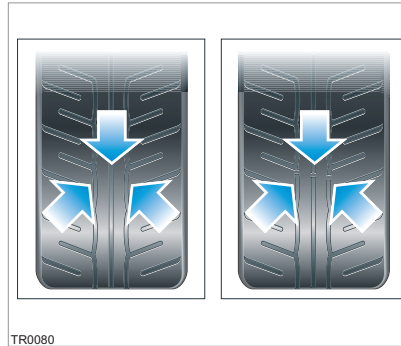

Tyre wear

WARNING: The tyres should be checked regularly for wear and to make sure that there are no cuts, bulges or exposure of the ply/cord structure. Do not drive with tyres which are worn or damaged. The safety of the vehicle and occupants will be adversely affected. ▲

Tyres fitted as original equipment have wear indicators moulded into the tread pattern.

When the tread has been worn down to 1.6 mm (1/16 inch), the indicators start appearing at the surface of the tread pattern, producing the effect of a continuous band of rubber across the width of the tyre.

To maintain grip and performance, a tyre must be replaced as soon as an indicator band becomes visible or sooner if the tread depth reaches the minimum permitted by legislation.

Note: If tread wear is uneven across the tyre, or becomes abnormally excessive, the wheel alignment should be checked.

Age degradation

Tyres degrade over time due to the effects of ultraviolet light, extreme temperatures, high loads, and environmental conditions. It is recommended that tyres are replaced every six years, or sooner if required.

Punctured tyres

Your vehicle is fitted with tubeless tyres, which may not leak when penetrated, provided the object remains in the tyre.

If, however, you feel a sudden vibration or ride disturbance while driving, reduce your speed and when safe to do so, stop and check for the cause of the vibration.

A puncture will eventually cause the tyre to lose pressure, which is why frequent checking of tyre pressures is important. Punctured or damaged tyres must be permanently repaired or replaced as soon as possible.

Wheels and tyres

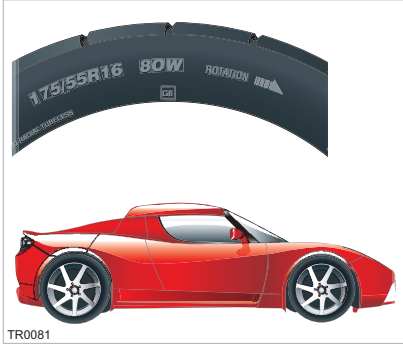

Directional tyres

WARNING: Road holding will be seriously impaired if directional tyres are incorrectly installed. ▲

Your vehicle is fitted with directional tyres. An arrow on the tyre wall shows the direction of rotation. These tyres must be fitted to rotate in the direction of the arrow when the vehicle is moving forward.

For this reason, tyres must not be swapped from one side of the vehicle to the other, and replacements must be fitted with regard for axle/wheel rotation.

Replacement wheels and tyres

WARNING: For your safety, it is recommended that only wheels and tyres that match the original specification are fitted to the vehicle. ▲

Wheel rims and tyres are matched to suit handling characteristics of the vehicle. Always check that replacement tyres comply with the original specification. If tyres other than those specified are used, ensure that the load and speed ratings (shown on the tyre side wall) equal or exceed those of the original specification.

For the specification of the original wheels and tyres fitted to the vehicle, refer to Wheel specifications, page 10-6.

Note: Different sizes are specified for front and rear tyres. Therefore, wheels must not be swapped from front to rear or vice versa.

Winter tyres and chains

For recommendations on winter tyres, contact Tesla Motors.

Tyre chains are not recommended for use on the Tesla Roadster unless they are required by regulation. In regions where chains are required by regulation, you must contact Tesla Motors for specific chain recommendations.

WARNING: If tyre chains are required, use only those that are recommended by Tesla Motors. Tyre chains can damage the vehicle. As described in the New Vehicle Limited Warranty, Tesla Motors is not responsible for any consequential damage caused by the use of tyre chains.

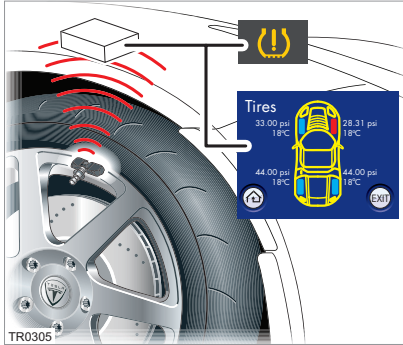

Tyre Pressure Monitoring (TPM) System

⚠ WARNING: The TPM system is not a substitute for manually checking tyre pressures. The system only provides a tyre pressure warning and does not re-inflate the tyres. ▲

⚠ WARNING: The TPM system cannot register damage to a tyre. Regularly check the condition of your tyres. ▲

The Tyre Pressure Monitoring (TPM) system monitors the pressure of the tyres using sensors located in each wheel and receivers located within the vehicle. The sensors communicate with the receiver using Radio Frequency (RF) signals.

Note: The Installation of accessories that have not been approved by Tesla Motors may interfere with the TPM system.

⚠ An amber tyre pressure warning indicator in the instrument panel will illuminate when one or more of your tyres is significantly under inflated. The touch screen will also display a warning message.

If the warning light illuminates, stop and check your tyres as soon as possible and inflate them to the correct pressure.

If low pressure warning occurs frequently, the cause must be found and rectified. Driving on an under-inflated tyre can cause the tyre to overheat and lead to tyre failure.

The tyre pressure warning indicator will extinguish when all tyres are inflated to the correct pressure.

TPMS malfunction

Your vehicle has been equipped with a TPM system malfunction indicator to indicate when the system is not operating properly.

The malfunction indicator is combined with the tyre pressure indicator. When the system detects a malfunction, the indicator will flash. This sequence will continue upon subsequent vehicle start-ups as long as the malfunction exists.

When a malfunction occurs, the system may not be able to detect or signal low tyre pressure as intended.

Malfunctions can occur for a variety of reasons, including the installation of replacement or alternate tyres or wheels. Always check the TPM system malfunction indicator after replacing a tyre or a wheel to ensure the system is functioning properly.

Note: If a tyre has been replaced or repaired after using the tyre sealant, and a low tyre pressure is detected, it is possible that the tyre sensor has been damaged. The aerosol sealant can damage the sensor. Therefore, whenever tyre sealant has been used, the tyre sensor must be replaced.

Setting the tyre pressures

Your vehicle allows you to use two sets of tyre pressures, refer to Tyre pressures, page 10-6.

When inflating your tyres to the other recommended pressures, you will need to select the correct pressure settings using the touch screen.

Replacing a tyre sensor

If you are experiencing frequent low tyre pressure warnings or the touch screen reports a "Tire Pressure Hardware Fault", the system should be checked by Tesla Motors or an authorised repairer. They will be able to determine if a tyre sensor requires replacement.

Wheels and tyres



Dynamic tyre pressure monitoring

The touch screen can display the pressure and temperature for each tyre.

 Touch the information icon on the main parked screen to display the 'Info' screen.

Touch the **Tires** option to display the data being received by the sensors adjacent to the respective wheel.

Note: When you turn on the vehicle, you may experience a delay of up to 8 minutes before tyre pressures are displayed. To reduce the length of this delay, drive the vehicle for a short distance.

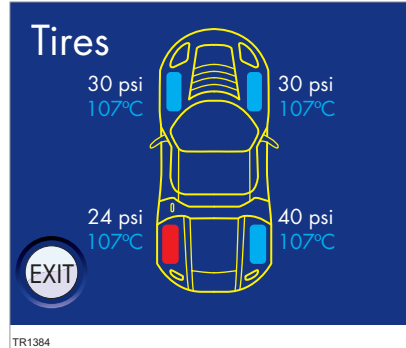

A blue wheel indicates an acceptable operating pressure for the tyre.

A red wheel indicates that the pressure is below the recommended operating pressure, and that immediate action must be taken to rectify the issue.

Note: If the vehicle has been driven, the temperature of the tyres will have increased and hence the pressure of the air in the tyre will also have increased. Tyre pressures should only be checked when the tyres are cold. See Checking tyre pressures, page 8-10.

Touch the **EXIT** icon to return to the previous screen.

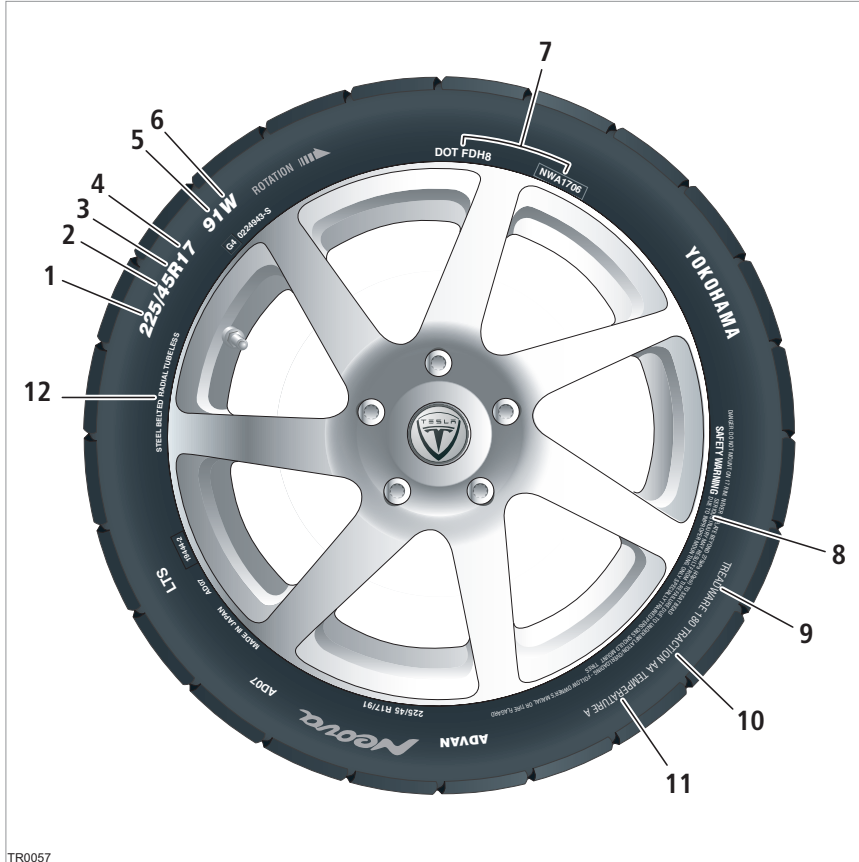

TR0057

Tyre markings

1, Tyre width

This three digit number gives the width in millimetres of the tyre from sidewall edge to sidewall edge.

2, Aspect ratio

This two digit number, known as the aspect ratio or profile, gives the sidewall height as a percentage of the tread width. So, if the tread width is 205 mm, and the aspect ratio is 50, the sidewall height will be 102 mm.

3, Tyre construction

R indicates that the tyre is of Radial ply construction.

4, Wheel diameter

This two digit number is the diameter of the wheel rim in inches.

5, Load index

This two or three digit number is the tyre's load index. It is a measurement of how much weight each tyre can support. This number is not always shown.

6, Speed rating

The speed rating, when stated, denotes the maximum speed at which the tyre should be used for extended periods. The ratings range from 99 mph to 186 mph. These ratings are listed in the following table.

Wheels and tyres

Rating	Speed (mph)
Q	99
R	106
S	112
T	118
U	124
H	130
V	149
W	168
Y	186

7, Tyre manufacturing standard information

Most of this information relates to the tyre manufacturer and the place of manufacture. The last four numbers represent the week and year the tyre was built. For example, the numbers **1706** means the 17th week of 2006. The other numbers are marketing codes used at the manufacturer's discretion. This information can be used to contact consumers if a tyre defect requires a recall.

8, Maximum permissible inflation pressure

The maximum inflation pressure for the tyre. This pressure should not be used for normal driving.

9, Treadwear grade

This number indicates the tyre's wear rate. The higher the treadwear number is, the longer it should take for the tread to wear down. A tyre rated at 400 for example, will last twice as long as a tyre rated at 200.

10, Traction grade

This letter indicates a tyre's ability to stop on wet pavement. A higher graded tyre should allow you to stop your vehicle on wet roads in a shorter distance than a tyre with a lower grade.

Traction is graded from highest to lowest as **AA, A, B, and C**.

11, Temperature grade

Heat resistance grading. The tyre's resistance to heat is grade **A, B, or C**, with A indicating the greatest resistance to heat. This grading is provided for a correctly inflated tyre, which is being used within its speed and loading limits.

12, Tire composition and materials

The number of plies in both the tread area, and the sidewall area, indicates how many layers of rubber coated material make up the structure of the tyre. Information is also provided on the type of materials used.

Wheels and tyres glossary

Accessory weight

The combined weight (in excess of those items replaced) of items available as factory installed equipment.

Bead

The inner edge of a tyre that is shaped to fit to the rim and form an air tight seal. The bead is constructed of steel wires which are wrapped, or reinforced, by the ply cords.

Cold tyre pressure

The air pressure in a tyre which has been standing in excess of three hours, or driven for less than one mile.

Gross vehicle weight

The maximum permissible weight of a vehicle with driver, passengers, load, luggage, and equipment.

Kerb weight

The weight of a standard vehicle, including any optional equipment fitted, and with the correct fluid levels.

kPa (kilo pascal)

Metric unit of measure for pressure. One kilo Pascal equals approximately .145 PSI.

Maximum inflation pressure

The maximum pressure to which the tyre should be inflated. This pressure is given on the tyre side wall in lbf/in² and kPa.

Note: This pressure is the maximum allowed by the tyre manufacturer. It is not the pressure recommended for use. See Tyre pressures, page 10-6.

Maximum loaded vehicle weight

The sum of curb weight, accessory weight, vehicle capacity weight, and production options weight.

Production options weight

The combined weight of options installed which weigh in excess of 1.4 kg (3 lb) more than the standard items that they replaced, and are not already considered in kerb or accessory weights.

PSI (lbf/in²)

Pounds per square inch. Imperial unit of measure for pressure.

Rim

The metal support for a tyre, or tyre and tube, upon which the tyre beads are seated.

Vehicle diagnostic information

Providing information to Tesla Motors

Tesla Motors is committed to providing quality customer service and can often diagnose and potentially resolve issues remotely by reviewing your vehicle's log file.

To send the vehicle log file, you will need a USB flash drive (smaller than 4GB) and a computer with an internet connection.

Note: The use of larger flash drives have been known to cause the download to fail.

1. Contact your Tesla service representative to inform Tesla that you are sending your vehicle's log file.
2. Using a computer, create a top-level folder on the memory stick called "VehicleLogs" (case-sensitive). This naming convention is very important.
3. Download the log file to the USB flash drive:

- Ensure the starter switch is turned to OFF and the vehicle is not charging.
- Insert the memory stick into the vehicle's USB port. See USB Port, page 7-7.

The touch screen will display an alert asking you not to remove the flash drive and provides a status of the file transfer.

If the touch screen goes to "sleep," touch the screen to "wake it up". The process will take about 15 minutes.

- When the alert is no longer shown, remove the flash drive.

Note: The log file is stored on the flash drive in VehicleLogs/VIN/YYYYMMDDHHMMSS.tar (where VIN is your Vehicle Identification Number).

4. Send the log file to Tesla:

- Go to the following web address: <http://upload.teslamotors.com/>
- Click Browse, select the log file (.tar) from your flash drive.
- Select your country from the drop down list.
- Enter a comment (optional, but recommended).
- Click **SEND**.

Note: A Tesla service representative is automatically notified when a log file is received. They will contact you once the file has been reviewed.

Roadside emergencies

Tool kit	
Tool kit location	9-2
Tool kit components	9-2
Energy depletion	
Dealing with a low Battery	9-3
Going that little bit further	9-3
Tyre repair	
Tyre sealant	9-4
Safety precautions	9-4
Repairing a tyre	9-5
Replacing the tyre sealant	9-5
Wheels	
Removing the wheel	9-6
Replacing the wheel	9-6
Fuse replacement	
Replacing a fuse	9-7
Fuse specification chart	9-8
Bulb replacement	
Bulb specifications	9-10
Replacing a bulb	9-10
Interior light	9-10
Trunk light	9-11
License plate light	9-11
Headlight low beam	9-11
Raising the vehicle	
Vehicle jacking points	9-12
Vehicle lifting points	9-13
Vehicle recovery	
Transporting the vehicle	9-14
Tow mode	9-15
Securing the wheels	9-16

Tool kit

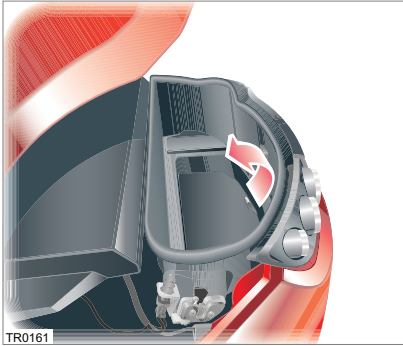

Tool kit location

The tool kit is located in the storage space beneath the trunk floor. To access the storage space, pull the tab located at the rear edge of the floor covering.

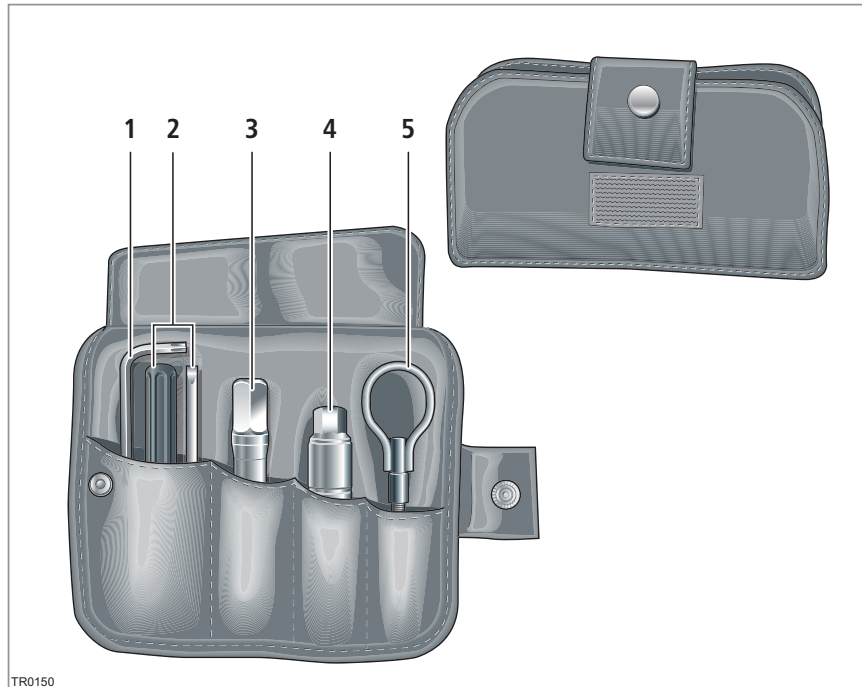

Tool kit components

1. Hard-top hex key
2. Screwdriver
3. Wheel bolt extension tool
4. Locking wheel nut adapter
5. Vehicle recovery eye

Note: A label with the number for the locking wheel nut adaptor is included in the tool kit. In the event that you lose the locking wheel nut adapter, you will need this number to reorder the correct adapter from Tesla Motors.

Dealing with a low Battery

IMPORTANT! Do not ignore charge level warnings. If you continue to drive the vehicle, the charge level will eventually reach 0% and the vehicle will shut down.

When driving the vehicle, the touch screen displays warning messages as the level of charge approaches a low level.

If you see the warnings and are unlikely to be able to complete your journey on the remaining charge, pull over to a safe location and call Roadside Assistance

As the charge level approaches a low level, you will also notice the colour of the charge level graph turn yellow and then red, to alert you that you need to charge the vehicle.

Going that little bit further

If you are driving in Standard or Performance mode and your Battery is approaching a low level, you can extend the driving range by putting the vehicle into Range mode using the touch screen's 'Charge Settings' screen. For details on using the touch screen, refer to the 'Touch Screen Users Manual'.

If the vehicle is not in Range mode and it shuts down because the Battery's charge level has reached 0%, you'll see the following message on the touch screen:



To access final reserve, turn the starter switch to the ACC position then back to the ON position. When you use this feature, the touch screen will no longer display warning messages or provide an estimate for vehicle range.

Switching the vehicle to Range mode, or accessing final reserve, allows you to extend the vehicle range but should be used with caution. Failure to immediately charge the Battery after use could result in the battery level falling to a critically low level and it may not be possible to recharge it. These options are intended ONLY to allow you to travel just far enough to park the vehicle in a safe location.

Note: The distance you can travel depends on the age of the Battery and the amount of energy the vehicle requires to operate.

In the best case scenario, it could allow you to travel up to 32 km (20 miles) but it could also be as little as 1.5 km (1 mile).

If the Battery reaches 0% when driving in Range mode or after you have cycled the starter switch to access final reserve, the vehicle will shut down. There is no other reserve and you must charge the Battery immediately.

FULLY DEPLETING THE BATTERY WHILE IN RANGE MODE OR IN RESERVE, AND THEN NOT CHARGING IT IMMEDIATELY, CAN DAMAGE THE BATTERY.

Note: Damage caused to the Battery by failing to charge it immediately when its charge level falls to 0% is not covered by the vehicle warranty. If you are unable to charge the vehicle, contact Tesla Motors immediately.

Tyre repair



TR0168

Tyre sealant

Your vehicle has no spare tyre. Instead, you have been provided with a tyre sealant aerosol located in the storage space beneath the trunk floor.

The tyre sealant contains liquid latex and a propellant. When injected into the tyre through the valve, the liquid latex penetrates the puncture site and cures to form a temporary repair. At the same time the propellant inflates the tyre, allowing you to drive the vehicle at low speed to reach a tyre repair facility.

Note: The kit can only be used to repair small punctures in the tread. In the event of side wall or severe tread damage (punctures larger than 5 mm), ripped tyres or tyres that have come off the rim, seek assistance from a breakdown service.

You are advised to have the tyre repaired or replaced as soon as possible.

! Caution: Do not drive on a deflated tyre as this can cause serious damage to the wheel and the vehicle. If the tyre is too badly damaged, call Roadside Assistance to have the vehicle transported to a repair facility.

Safety precautions

! WARNING: Under no circumstances should speeds of 48 km/h (30 mph) be exceeded while driving with a repaired tyre. ▲

! WARNING: Never drive with a deflated tyre, vehicle handling and braking will be compromised. ▲

! WARNING: Always read the directions and warnings on the tyre sealant before starting a repair. Follow the directions on the aerosol exactly and pay attention to the following precautions. ▲

! WARNING: Always keep the tyre sealant out of the reach of children. ▲

! WARNING: The tyre sealant contains components which are harmful if consumed or inhaled: ▲

- If swallowed, do not induce vomiting. Seek medical assistance immediately.
- If inhaled, breathe fresh air. If breathing is affected, seek medical assistance immediately.

- If the sealant comes into contact with the eyes, immediately flush the eyes with water. If irritation persists, seek medical assistance.
- Do not breathe gas, fumes, vapour or spray that may be emitted from the tyre sealant. Inhalation can cause drowsiness and dizziness.

! WARNING: Store the tyre sealant in its correct location in the trunk. Temperatures in other locations may exceed safe storage conditions. Never carry the tyre aerosol in the vehicle's cabin area. ▲

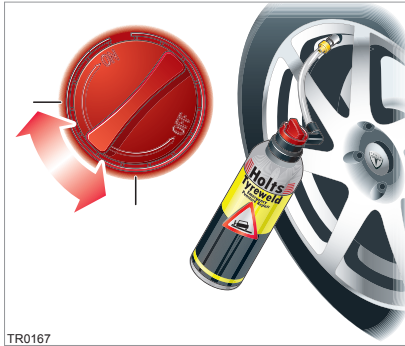

Repairing a tyre

If possible, stop in a safe place away from traffic. Always ask a passenger to wait in a safe area away from traffic. Switch on the hazard warning lights to alert other road users, then follow these steps:

1. Inspect the deflated tyre for cause of puncture. If possible, remove foreign material (such as screws or nails) from the tread.
2. Remove the tyre sealant from the trunk.
Note: In cold conditions, use the vehicle's heater to warm the aerosol.
3. Position the wheel (if possible) so that the puncture is at the bottom.
4. Remove the valve cap and clean the valve thread.
5. Vigorously shake the tyre sealant for approximately 30 seconds.

6. Screw the filler tube onto the tyre valve and break the safety seal.
7. Hold the aerosol upright and turn the knob 1/4 turn clockwise. If you need to stop the process, simply turn the knob back to the 'OFF' position.
8. Empty the entire contents of the aerosol into the tyre. When the sealant stops flowing through the filler tube, turn the knob to the 'OFF' position and unscrew the filler tube from the tyre valve.

Note: If tyre sealant comes into contact with the vehicle's paint, immediately wash the area with water to avoid permanent damage.

9. If the wheel rim has lifted from the ground, drive immediately for 10 to 20 km (6 to 12 miles) to distribute the sealant evenly inside the tyre. Drive gently and do not exceed 48 km/h (30 mph).

! WARNING: If the wheel rim has not lifted from the ground, call Roadside Assistance to have the vehicle transported to a repair facility. ▲

10. Drive to the nearest service station and inflate the tyre to the correct pressure (see Tyre pressures, page 10-6.)
If the required pressure cannot be reached, then the tyre is too severely damaged and you should have the vehicle transported to a tyre repair facility. **Do not drive!**

Note: The pressure of the repaired tyre can be monitored using the touch screen while driving. If you notice any drop in pressure while driving, stop the vehicle in a safe location and call Roadside assistance.

11. If the correct tyre pressure was achieved, continue driving. Drive carefully and do not exceed 48 km/h (30 mph).

At the earliest opportunity, have the tyre repaired or replaced and replace the used tyre sealant.

! WARNING: Always inform the tyre repairer that tyre sealant has been used. If the tyre is to be subsequently deflated, only do so in a well ventilated area. ▲

Note: Tyre sealant can damage the tyre pressure sensors installed in the wheels. It is therefore recommended that the sensor is always replaced when tyre sealant has been used. If the tyre is not repaired or replaced by Tesla Motors or an authorised repairer, the TPM system will not provide tyre pressure information until a Tesla service technician has performed a brief set-up procedure.

Replacing the tyre sealant

Always replace the used tyre sealant with one of the same type and capacity, 400 ml (13.5 ounces). Tyre sealants are available through most reputable automotive retailers.

Wheels

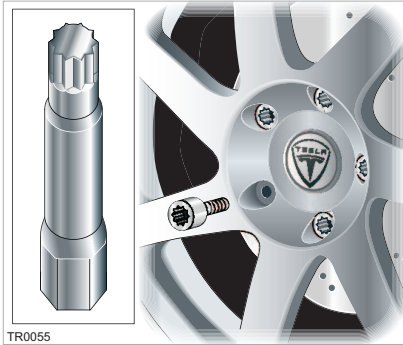

Removing the wheel

WARNING: Never work under the vehicle with a jack as the only means of support. If the vehicle slips off the jack, you or someone else could be seriously injured. ▲

1. Apply the hand brake and remove the key.
2. Loosen each wheel bolt one turn using the wheel bolt extension tool, the locking wheel bolt adapter (located in the tool kit), a 17 mm socket and a wrench.
3. Position a jack at the jacking points identified on the vehicle (see Vehicle jacking points, page 9-12), and raise the vehicle.

Caution: Jacking the vehicle at any point other than those specified can damage the vehicle.

4. Remove the wheel bolts and store in a safe place.
5. Remove the wheel.

Caution: Place the wheel face up to avoid scratching the surface.

Replacing the wheel

WARNING: Before replacing the wheel, inspect the mating faces of the wheel and hub. Remove any corrosion, dirt or foreign material. Fitting the wheels without correct surface-to-surface contact can cause the wheel bolts to loosen, resulting in a loss of vehicle control. ▲

1. Position the wheel on the hub.
2. Fit the wheel bolts and tighten until the wheel is firmly seated against the hub.
3. Lower the vehicle and remove the jack.

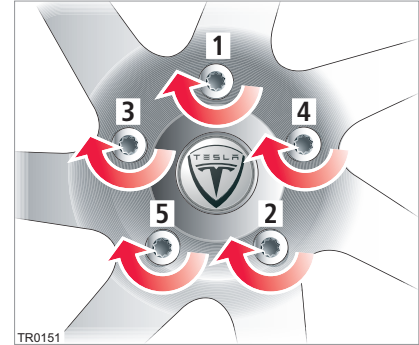

4. Using a torque wrench, fully tighten the bolts in the sequence shown to 105 Nm (77 lbf.ft).
5. Return the wheel bolt extension tool and the locking wheel bolt adapter to the tool kit.

Note: It is recommended that the wheel bolts are checked and retightened after 1600 km (1000 miles).

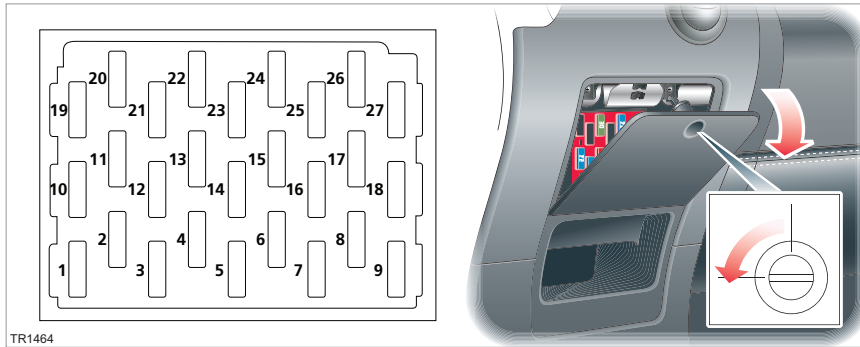

TR1464

Fuse colours

Fuse Colour	Rating (amps)
Orange	5
Brown	7.5
Red	10
Blue	15
Yellow	20
Clear	25
Green	30

Replacing a fuse

! WARNING: Use replacement fuses of the same rating and type or fuses of matching specification. Incorrect fuse ratings can overload a system and cause a fire or malfunction. Blown fuses should be replaced and no attempt should be made to repair a blown fuse. ▲

Fuses protect the vehicle's electrical systems from damage. The failure of any fuse will render the equipment it protects inoperative.

1. Before removing a fuse, turn off all electrical equipment and remove the key.
2. Remove the fuse box access panel on the passenger side of the dashboard. Using a screwdriver (supplied in the toolkit) rotate the fastener 90° counterclockwise and then release the panel from the dashboard.

3. Consult the fuse specification chart to determine which fuse is protecting the non-functioning electrical system.

Note: A label is also affixed to the inside of the access panel.

4. Remove the appropriate fuse and replace with a fuse of the same amperage as the original. If in doubt, check the fuse specification chart on the following pages.
5. Re-install the access panel by aligning the hinges at the bottom of the panel with the slots on the surrounding dashboard area. Secure the panel by rotating the fastener 90° clockwise.

If a replacement fuse fails to solve an electrical failure, or the replacement fuse fails prematurely, the problem should be referred to a qualified technician.

Fuse replacement

Fuse specification chart

Fuse number	Rating (amps)	Circuit protected
1	10	Anti-lock Braking System (ABS)
2	15	Auxiliary power socket
3	20	Heating and ventilation fan
4	15	Windshield wiper motor and washer
5	7.5	Electrical accessories, audio and navigation systems
6	10	Turn signals and side lights
7	10	Starter switch in 'ON' position
8	5	Instruments
9	15	Horn
10	7.5	Interior and trunk lights
11	20	Interior lighting and seat heaters
12	30	Radiator cooling fans
13	7.5	Alarm
14	7.5	Starter switch in 'ACC' position (Electrical accessories, alarm, audio and navigation systems)
15	10	Left-hand headlight - low beam
16	10	Right-hand headlight - low beam
17	7.5	Left-hand headlight - high beam
18	7.5	Right-hand headlight - high beam
19	20	Right-hand power window
20	20	Left-hand power window
21	10	Central door locking
22	7.5	Brake pump
23	15	Heating, ventilation, and accessory power socket

Fuse replacement

Fuse number	Rating (amps)	Circuit protected
24	15	Audio system amplifier
25	30	Starter switch in 'ON' position
26	5	Brake lights
27	7.5	Heating and ventilation

Bulb replacement

Bulb specifications

! Caution: Only replace a bulb with one of identical specification.

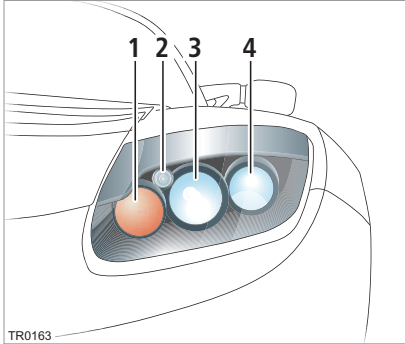

Location	Watts	Type
1 Front turn signal	21	PY21W
2 Front side light	5	W5W
3 Headlight high beam	65	H9B
4 Headlight low beam	60	HB3A
Interior	5	W5W
Trunk	5	C5W
License plate	5	C5W

Replacing a bulb

Always check the operation of all exterior lights before driving the vehicle.

Headlights

The lights within the headlight unit do have replaceable bulbs but due to the lack of access it is recommended that these bulbs are only replaced by Tesla Motors or an authorised repairer.

Note: If you are familiar with working on vehicles it is possible to replace the headlamp low beam bulb, but additional tools will be required. The replacement procedure has been included for your reference.

Light Emitting Diode (LED) lights

The following lights on your vehicle use the latest LED technology:

- Side repeater light
- Reverse light
- Rear fog light
- Tail/brake lights
- Rear turn signals

Unlike traditional filament bulbs, these lights have a long life and low power consumption while providing the same amount of illumination.

Note: If any of these lights stop working, it will need to be replaced by Tesla Motors or an authorised repairer.

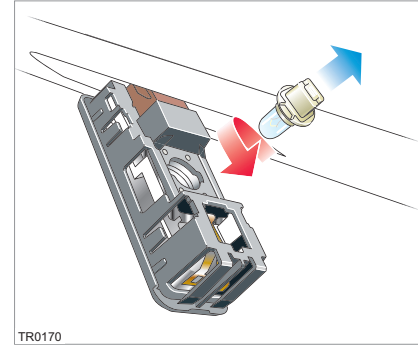

Interior light

To remove the bulb:

1. Using the screwdriver supplied in the toolkit, depress the retaining clips and carefully pry the light unit from the rear header rail.
2. Rotate the bulb holder 90° counterclockwise and remove.
3. Pull the bulb from the holder.

To install the new bulb, reverse the above procedure.

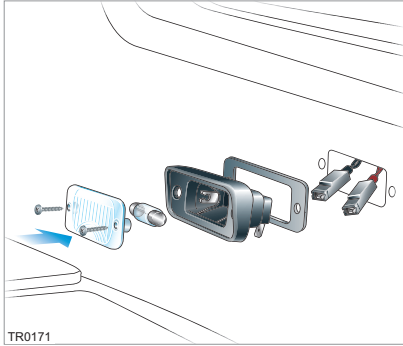

Trunk light

To remove the bulb:

1. Using the screwdriver supplied in the toolkit, remove the two screws securing the light unit to the inside of the trunk.
2. Withdraw the light unit from the trunk and disconnect the two connectors.
3. Remove the lens from the light.
4. Spring the bulb holder clips apart to release the bulb.

To install the new bulb, reverse the above procedure.

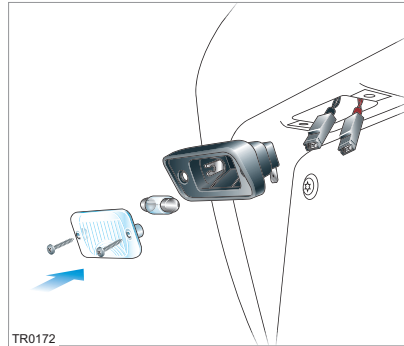

License plate light

To remove the bulb:

1. Using the screwdriver supplied in the toolkit, remove the two screws securing the light unit to the rear bumper.
2. Withdraw the light unit from the bumper and disconnect the two connectors.
3. Remove the lens from the light.
4. Spring the bulb holder clips apart to release the bulb.

To install the new bulb, reverse the above steps.

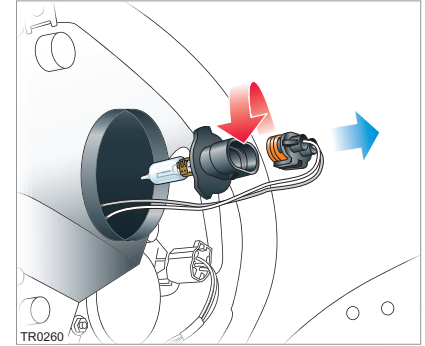

Headlight low beam

To remove the bulb:

1. Remove the two bolts securing the headlight access panel to the wheel arch liner.
2. Release and remove the access panel.
3. Remove the cover from the rear of the headlight.
4. Rotate the bulb holder 60° counterclockwise and withdraw the bulb from the headlight.
5. Disconnect the connector from the bulb holder.

To install the new bulb, reverse the above procedure. Ensure that the bulb holder is correctly located and locked into the rear of the headlight.

Raising the vehicle

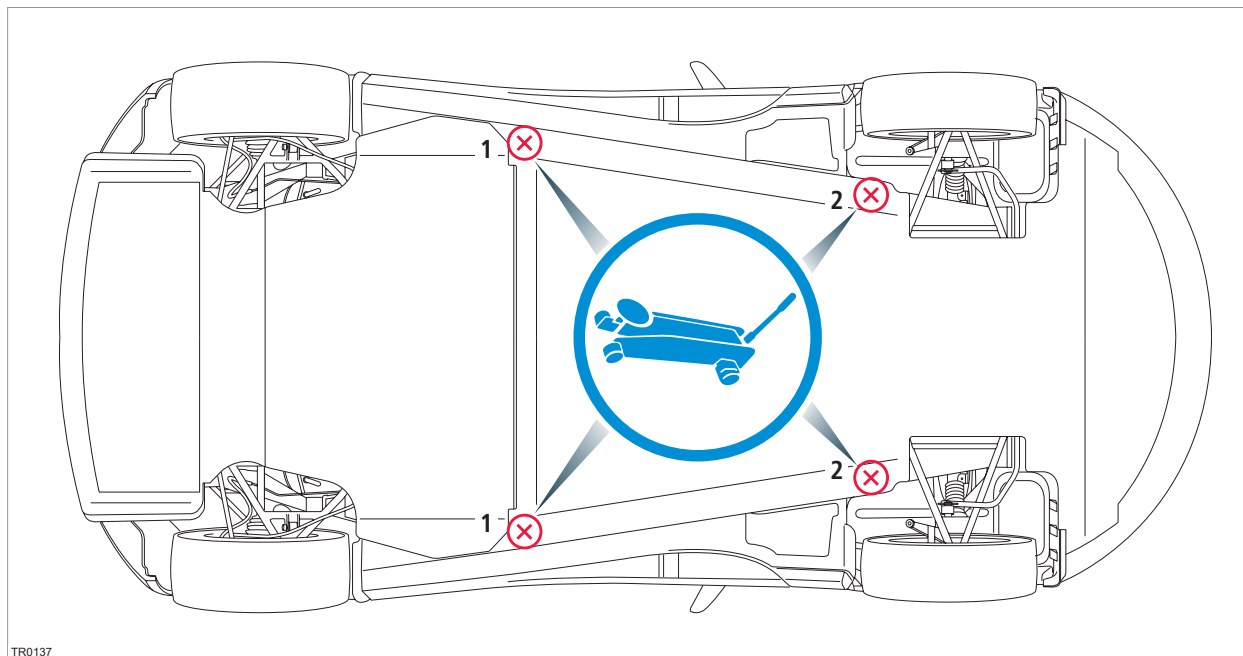

Vehicle jacking points

! **WARNING:** Never raise a vehicle when the charge cable is connected, even if charging is not in progress. Always disconnect the charge cable before raising the vehicle. ▲

Refer to the illustration, and the labels on the vehicle, for correct jacking locations. If lifting the vehicle on a two-post lift, refer to the next page.

- 1. Side jacking point**
This point will raise both the front and rear wheels.
- 2. Front jacking point**

! **Caution:** Jacking the vehicle at any other point will damage the vehicle.

! **Caution:** Use a suitable rubber or wood pad to protect the chassis from surface damage. Do not lift from a body panel.

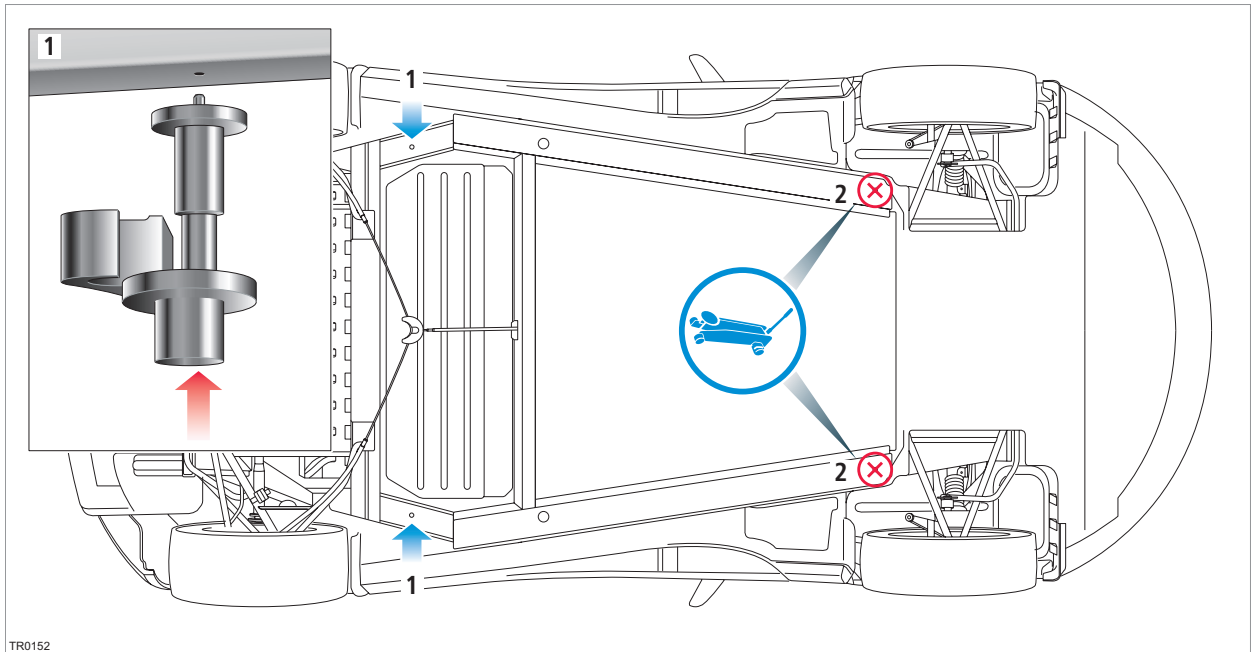

Vehicle lifting points

! **WARNING:** Death, serious injury or vehicle damage can occur if the vehicle is lifted on a two-post lift with the rear undershield still in place. ▲

! **WARNING:** Never raise a vehicle that is plugged in. Always unplug the vehicle before raising it. ▲

Refer to the illustration, and the labels on the vehicle, for the correct support locations for lifting the vehicle. If jacking the vehicle, refer to the previous page.

Before lifting on a two-post lift, you must remove the rear undershield and fit rear lift point adaptors **1** to the chassis. Rear lift point adaptors can be purchased from Tesla Motors.

! **Caution:** Rear lift point adaptors must be used when lifting the vehicle on a two-post lift.

Position the arms of the two-post lift under the rear lift point adaptors and the front jacking points **2**.

Vehicle recovery

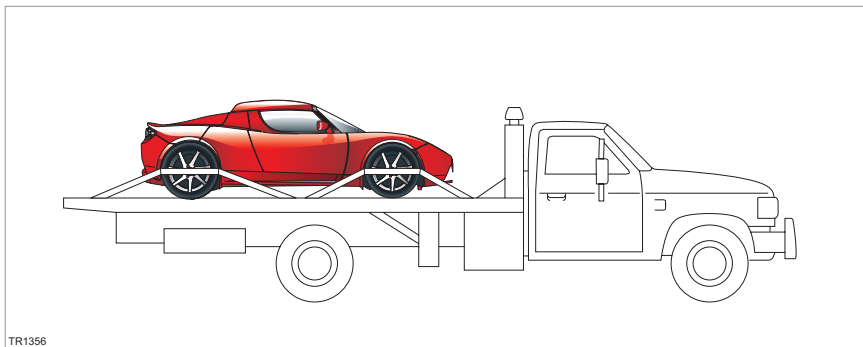

Transporting the vehicle

! Caution: Serious damage to the vehicle and transmission will occur if the vehicle is towed with the wheels on the ground or on a suspended lift.

The only approved method of recovering or transporting your vehicle is using a flatbed trailer or transporter.

Note: Damage caused by any other recovery method will not be covered by the vehicle warranty.

Before pulling the vehicle onto a flatbed trailer or transporter, follow these steps:

- attach the vehicle recovery eye
- activate **Tow Mode** to disengage the transmission lock, or turn the starter switch to the ON position and select the Neutral gear position

! Caution: The transmission lock will only be disengaged if the vehicle's electrical systems are operational.

Attaching the recovery eye

A vehicle recovery eye can be attached to the front of the vehicle to allow the vehicle to be pulled onto a transporter in situations when the vehicle can roll freely.

! Caution: Under no circumstances should the vehicle be towed using the vehicle recovery eye. Doing so can cause significant damage to your vehicle.

1. Retrieve the recovery eye from the tool kit located in the trunk.

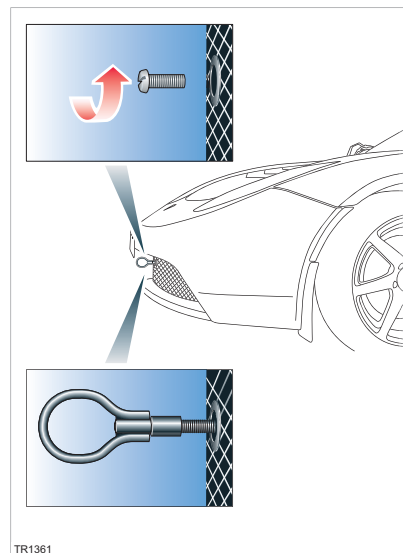

2. Using a screwdriver, remove the blanking plug from the recovery eye mounting point behind the front grille.

Note: The license plate may need to be removed to access the recovery eye.

3. Insert the recovery eye through the hole in the front grille and screw into the mounting point. Ensure the recovery eye is fully tightened.

After use, remove the recovery eye and return it to the tool kit. Install the blanking plug back into the mounting point to prevent dirt from entering.

Tow mode

Tow Mode disengages the transmission lock so the vehicle can roll freely.

Note: You can not start or charge the vehicle when Tow Mode is active.

Activating Tow Mode

 Caution: In the unlikely situation in which electrical systems are not functioning and Tow Mode can not be activated, wheeled dollies or skid pads must be used to prevent damage to the vehicle.

Turn the starter switch to the **OFF** position and apply the hand brake. The touch screen will display the main 'Parked' screen.

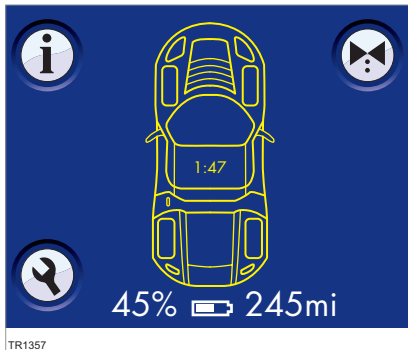

 Touch the settings icon to display the 'Settings' screen.

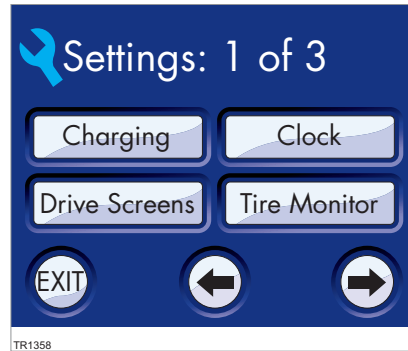

 Touch the back icon to display the third settings screen.

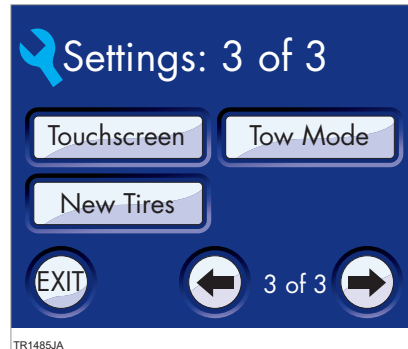

Touch **Tow Mode**, then touch **OK** to confirm.

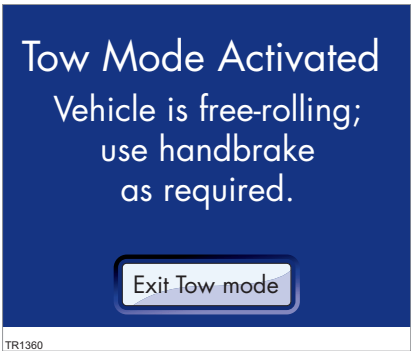

Release the hand brake when appropriate.

 Caution: Once Tow Mode has been activated the car can roll freely. If the vehicle is not on a level surface, do not release the hand brake until the vehicle is ready to be towed.

Note: Activating Tow Mode will not release the steering column lock. To release the steering column lock, turn the starter switch to the **ACC** position. If it is difficult to turn the key, move the steering wheel slightly.

Vehicle recovery

Securing the wheels

When the vehicle is in position on the transporter or trailer, use chocks and tie down straps to secure the wheels.

To avoid damage:

- Ensure that metal parts on tie down straps do not contact the vehicle's painted surfaces or the face of any wheels.
- Do not place straps over or through the vehicle's body panels.



Caution: Attaching straps to the chassis, suspension or other parts of the body can damage the vehicle.

Technical specifications

Vehicle identification

Vehicle Identification Number	10-2
Manufacturers label	10-2

Approved fluids and capacities

Fluid specifications	10-3
----------------------	------

Vehicle dimensions and weights

Exterior dimensions	10-4
Vehicle weights	10-5

Wheels and tyres

Wheel specifications	10-6
Tyre pressures	10-6

Subsystem specifications

Motor	10-7
Transmission	10-7
Steering	10-7
Front suspension	10-8
Rear suspension	10-8
Brakes	10-9
Electrical	10-9
Battery	10-9
Type approvals	10-10

Vehicle identification

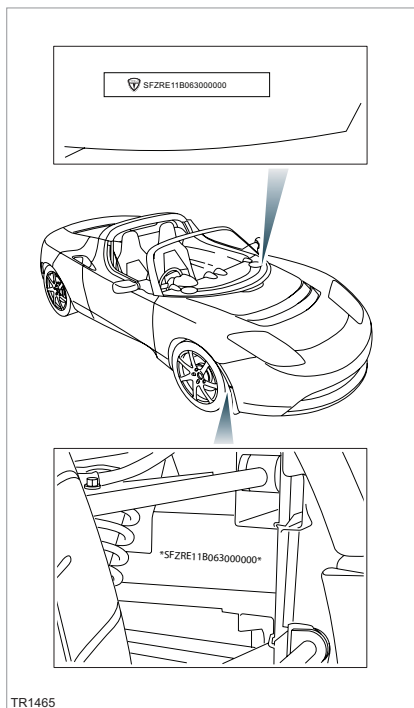

Vehicle Identification Number

If you need to communicate with Tesla Motors, you may be asked to quote the Vehicle Identification Number (VIN).

You can find the Vehicle Identification Number (VIN) in the following locations:

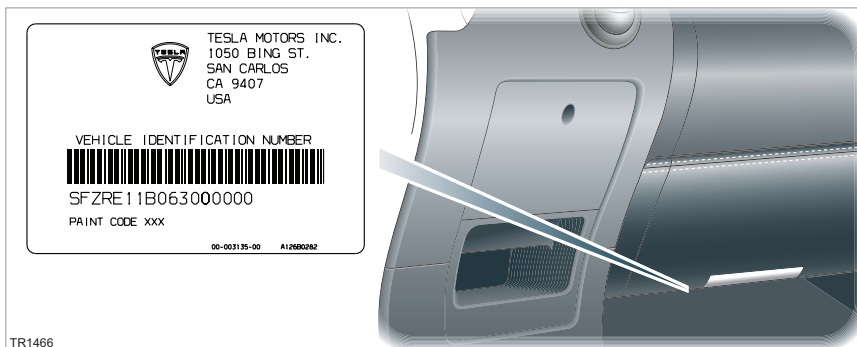

- Top of Dashboard - the VIN is stamped on a plate which is visible through the lowest part of the left-hand side of the windshield.
- Chassis - the VIN is stamped on the vehicle chassis, and is visible behind the right-hand front wheel.
- Underside of Dashboard - a VIN label is attached to the underside of the dashboard. This label also displays the vehicle paint code should repairs to the vehicle's painted surfaces be required.
- Touch screen - the VIN can also be displayed on the touch screen when your vehicle is parked. For details, refer to the 'Touch Screen Users Manual'.

Manufacturers label

This label is located on the opening face of the driver's door. In addition to the Vehicle Identification Number (VIN), this label also has vehicle certification and vehicle weight information printed on it.

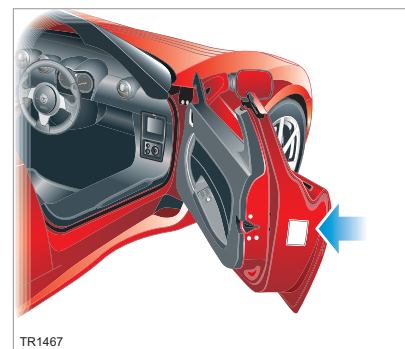

Fluid specifications



Caution: Only use new fluid from sealed containers.

Capacities

Battery cooling system*	7.0 litres	12.3 pints
Brake fluid*	1.5 litres	2.6 pints
Transmission fluid	1.325 litres	2.3 pints
Washer reservoir *	2.2 litres	3.9 pints
Air conditioning refrigerant	800 g	1.76 lb
*For instructions on topping up battery coolant and brake fluid, refer to Fluid reservoirs, page 8-4.		

Battery Coolant

One of the following recommended solutions:

- Havoline® Extended Life Antifreeze Coolant-PG (Havoline XLC-PG).
- Glacelf MPG SUPRA.

Brake fluid

Any proprietary brand of brake fluid (or brake and clutch fluid) meeting DOT 4 specification.

Transmission fluid

Dexron VI ATF

Air conditioning

The air conditioning system is filled with R134a refrigerant. If oil needs to be added to the system, only use Daphne Hermetic Oil FV Series.

Vehicle dimensions and weights

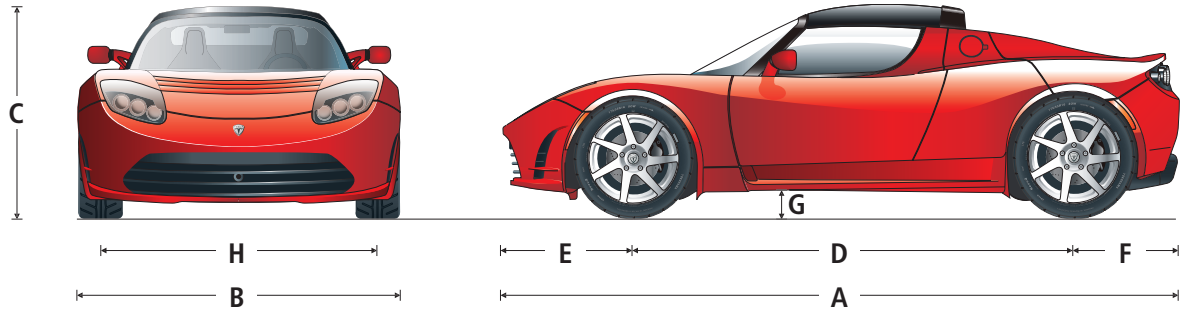

TR1482

Exterior dimensions

A	Overall length	3,946 mm	155.4 in
B	Overall width (including mirrors)	1,851 mm	72.9 in
C	Overall height (mid laden weight)	1,127 mm	44.4 in
D	Wheel base	2,351 mm	92.6 in
E	Front overhang	871 mm	34.3 in
F	Rear overhang	723 mm	28.5 in
G	Ground clearance (mid laden weight)	130 mm	5.12 in
H	Track - Front	1,455.6 mm	57.7 in
	Track - Rear	1,484.5 mm	59.0 in
	Approach angle (at kerb weight)		11°
	Departure angle (at kerb weight)		18°
	Ramp breakover angle		12.7°

Vehicle dimensions and weights

Vehicle weights

Kerb weight (no occupants or cargo)	1,235 kg	2,723 lb
Mid laden weight *	1,385 kg	3,053 lb
Gross vehicle weight †	1,485 kg	3,273 lb
Maximum front axle load	519 kg	1,144 lb
Maximum rear axle load	974 kg	2,147 lb
Trailer towing	Not permissible	
* Mid laden weight is calculated with two 75 kg (165 lb) occupants and no cargo.		
† Gross vehicle weight is calculated with two 100 kg (220 lb) occupants and 50 kg (110 lb) of cargo.		

Wheels and tyres

Wheel specifications

Wheel type	Location	Size
Roadster - cast alloy, Roadster Sport - forged light alloy	Front	6J x 16
	Rear	7.5J x 17

Tyre type	Location	Size
Roadster - Yokohama Neova AD07 LTS - Directional	Front	175/55 R16
	Rear	225/45 R17
Roadster Sport - Yokohama AD048 Performance - Directional	Front	195/50 R16
	Rear	225/45 R17

Road wheel bolt torque	105 Nm	77 lbf.ft
------------------------	--------	-----------

Note: For details on where to position a jack to lift the vehicle, see Vehicle jacking points, page 9-12.

Tyre pressures

Tyre	Tyre Pressure	
	Recommended	Comfort setting
Front	207 kPa, 2.1 bar (30 lb/in ²)	172 kPa, 1.7 bar (25 lb/in ²)
Rear	276 kPa, 2.8 bar (40 lb/in ²)	248 kPa, 2.5 bar (36 lb/in ²)

Note: The recommended tyre pressures have been calculated to provide the best combination of vehicle range, tyre life, ride comfort and road handling.

Driving the vehicle with the tyres inflated to the comfort setting will improve ride comfort and road handling, but will decrease vehicle range (the number of miles you can travel on a charge) and Battery life (see the 'Warranty Guide', provided in your owner's package, for details on expected range of the Battery).

Motor

Type	AC induction motor, air-cooled, with variable frequency drive.
Rating	375 Volts
Maximum speed	14,000 rpm
Maximum net power: Roadster Roadster Sport	215 kW (288 HP) @ 5,000-6,000 rpm 215 kW (288 HP) @ 4,400-6,000 rpm
Maximum torque: Roadster Roadster Sport	370 Nm (273 lbf.ft) @ 0-5,400 rpm 400 Nm (295 lbf.ft) @ 0-5,100 rpm
Efficiency	92% peak, 85% at max power.

Transmission

Type	Single speed fixed gear with electrically-actuated parking lock mechanism and mechanical lubrication pump.
Overall final drive ratio	8.28:1
Reverse gear	Reverse direction of motor, limited to 24 km/h (15 mph).
Final drive ratio	3.12:1

Steering

Type	Rack and pinion.
Number of turns lock to lock	2.8
Turning circle (curb to curb)	11.05 m (36.25 ft)

Subsystem specifications

Front suspension

Type	Roadster	Independent. Upper and lower unequal length wishbones. Co-axial coil spring/telescopic damper. Sway bar.
	Roadster Sport	Adjustable damping. Adjustable anti-roll bar.
Alignment	optimum	0.1 mm toe-in
	tolerance	0.5 mm toe-out to 0.7 mm toe-in overall. Maximum side to side 0.3 mm.
Camber	optimum	- 0.1°
	tolerance	+ 0.1° to - 0.3°. Maximum side to side 0.2°.
Castor	optimum	+ 3.8°
	tolerance	+ 3.5° to 4.1°. Maximum cross castor 0.35°.

Rear suspension

Type	Roadster	Independent. Upper and lower unequal length wishbones. Co-axial coil spring/telescopic damper. Sway bar.
	Roadster Sport	Adjustable damping. Adjustable anti-roll bar.
Alignment	optimum	3.0 mm toe-in
	tolerance	2.4 mm toe-in, to 3.6 mm toe-in. Maximum side to side 0.3 mm.
Camber	optimum	- 1.8°
	tolerance	- 1.6° to - 2.0°. Maximum side to side 0.2°.

Brakes

Type	Hydraulically operated. Tandem master cylinder with vacuum servo and Anti-lock Braking System.
Discs	Ventilated front and rear discs.
Hand brake	Cable operation of rear calipers. Self-adjusting for pad wear.
Brake pedal free travel	Not adjustable

Electrical

Type	Rechargeable Battery.
Rating	13 V to 400 V DC, and up to 400 V AC.
Polarity	Negative (-) ground.

Battery

Type	Lithium ion (Li-ion).
Number of cells	6,831
Weight	992 lb (450 kg)
Output	High voltage: 366V DC. Low voltage: 13 V DC.
Operating temperature	Driving: -17°C to 50°C (-1°F to 122°F). Charging: 0°C to 45°C (32°F to 113°F).

Subsystem specifications

Type approvals

The following table lists those devices fitted to your vehicle that may require type approval as a radio device.

System	Type approval number	Type approval mark
Alarm and immobiliser	E11*72/245*2006/28*4225*00	E11 034225
Tyre Pressure Monitoring	E13*10R00*10R02*9986*00	E13 10R-02 9986

Note: The type approval information for any audio, navigation or telephone equipment fitted to your vehicle can be found in the supplied manufacturer's operating instructions.

A			
Accessing your vehicle.....	4-2		
Accessory power socket.....	7-7		
Air conditioning.....	7-5		
Air distribution.....	7-4		
Air recirculation.....	7-4		
Air vents.....	7-5		
Airbags			
Deactivation.....	3-7		
Deployment effects.....	3-7		
Disposal information.....	3-8		
General information.....	3-6		
Obstruction of air bags.....	3-6		
Safety information.....	3-6		
Service information.....	3-8		
Warning indicator.....	3-7		
Warning labels.....	3-7		
Warnings.....	3-7		
Alarm system			
Indicator light.....	4-7		
Operation.....	4-7		
Switching off.....	4-7		
Ammeter display.....	6-12, 6-13		
Antifreeze.....	8-5, 10-3		
Anti-lock Braking System (ABS).....	6-6		
Anti-theft alarm.....	4-7		
B			
Battery.....	5-4		
Charging.....	5-2		
Coolant.....	8-5		
Cooling fan operation.....	5-4, 6-4		
Depletion.....	9-3		
Environmental note.....	5-4		
Fluid check and top-up.....	8-5		
Low Battery condition.....	9-3		
Preserving.....	5-5		
Range.....	6-3		
Specifications.....	10-9		
Battery life			
Overview.....	5-4		
Body			
Cleaning.....	8-7		
Covering.....	8-8		
Polishing.....	8-8		
Removing tar spots.....	8-7		
Repairs.....	8-9		
Bonnet closing.....	8-3		
Bonnet opening.....	8-3		
Brake warning indicator.....	6-5		
Brake warning indicator light.....	6-13		
Brakes			
Anti-Lock Braking System (ABS).....	6-6		
Emergency braking.....	6-7		
Fluid specification.....	10-3		
Fluid top-up.....	8-4		
Foot brake.....	6-6		
Parking brake.....	6-5		
Regenerative braking.....	6-6		
Specifications.....	10-9		
Bulb replacement.....	9-10		
Bulb specifications.....	9-10		
C			
Car covers.....	8-8		
Car washes.....	8-7		
Central door locking.....	4-4		
Chains.....	8-12		
Change of ownership.....	1-2		
Charge cable			
Connecting.....	5-9		
Disconnecting.....	5-10		
Charge level			
Low.....	9-3		
Charge level display.....	6-13		
Charging			
Charge level.....	5-4		
Charge settings.....	5-7		
Charge types.....	5-7		
Charging port colors.....	5-10		
Connecting the charge cable.....	5-9		
Cost.....	5-8		
Current limit.....	5-8		
High Power Wall Connector.....	5-3		
Performance setting.....	5-7		
Range setting.....	5-7		
Standard setting.....	5-7		
Stopping the charge process.....	5-10		
Storage setting.....	5-7		
Storing your vehicle.....	5-5		
Charging indicator light.....	6-13		
Charging port.....	5-2		
Charging port colors.....	5-10		
Child passengers.....	3-5		
Child restraints.....	3-5		
Child seat air bag hazard.....	3-7		
Child seats.....	3-5		
Cleaning			
Exterior.....	8-7		
Interior.....	8-9		
Removing tar.....	8-7		
Roof.....	8-8		
Underbody.....	8-7		
Wheels.....	8-8		
Windshield, windows and mirrors.....	8-8		
Wiper blades.....	8-8		
Climate control.....	7-4		
Coolant			
Battery.....	8-5		
Specification.....	10-3		
Cost of charging.....	5-8		
Covering the vehicle.....	8-8		
Cruise control.....	6-11		
Cruise control indicator light.....	6-13		
Cup holder.....	7-8		
Current limit.....	5-8		

Index

D

Dashboard overview.....	2-5
Data recording.....	1-2
Defrosting.....	7-5
Diagnostic information.....	8-18
Dimensions.....	10-4
Doors	
Automatic locking when driving.....	4-5
Exterior door release.....	4-4
Interior door release.....	4-4
Locking.....	4-4
Mislocking.....	4-7
Unlocking with key.....	4-5
Driving.....	6-2

E

Economical driving.....	6-3
Electrical current display.....	6-12, 6-13
Electrical specifications.....	10-9
Emergency braking.....	6-7
Emergency flashers.....	6-9
Emergency unlocking.....	4-5
Energy depletion.....	9-3
Exterior	
Dimensions.....	10-4
Overview.....	2-3
Exterior lights.....	6-8
Exterior mirrors.....	7-3

F

Fan speed control.....	7-4
Fault indicator.....	6-13
Flat tyre repair.....	9-4
Flatbed transporting.....	9-16
Fluid reservoirs.....	8-4
Fluid specifications.....	10-3
Front suspension specifications.....	10-8
Frost warning indicator light.....	6-13

Fuse

Colours.....	9-7
Location.....	9-7
Specifications.....	9-8

G

Garage door opener.....	7-15
Gear selector.....	6-5
Glove box.....	4-5
Ground clearance.....	10-4

H

Hand brake.....	6-5
Handset	
Battery replacement.....	4-3
Panic alarm.....	4-3
Trunk release.....	4-3
Using.....	4-2
Handset battery.....	4-3
Hard-top	
Installing.....	7-13
Removing.....	7-14
Hauling your vehicle.....	9-16
Hazard warning.....	6-9
Hazard warning lights.....	6-9
Headlight high beam.....	6-8
Heated seats.....	7-6
Heater controls.....	7-4
Heating and ventilation.....	7-4
High beam headlights.....	6-8
High beam indicator light.....	6-13
High voltage.....	1-2
HomeLink®.....	7-15
Horn.....	6-9

I

Identification numbers.....	10-2
Instrument panel.....	6-12

Instrument panel lighting.....	6-15
Interior	
Door release handle.....	4-4
Light.....	7-7
Overview.....	2-5
Temperature.....	7-4
iPod connector.....	7-8

J

Jacking the vehicle.....	9-12
--------------------------	------

K

Key fob. See handset.	
Key positions.....	6-2
Keys.....	4-2
Unlocking driver's door.....	4-5

L

Label	
Airbags.....	3-7
LCD panel.....	6-12
License plate light bulb.....	9-11
Lifting the vehicle.....	9-13
Lights	
Bulb replacement.....	9-10
Bulb specification.....	9-10
Exterior.....	6-8
Hazard warning.....	6-9
Headlight high beam.....	6-8
Instrument panel.....	6-15
Interior.....	7-7
Replacing interior light bulb.....	9-10
Replacing license plate bulb.....	9-11
Replacing trunk light bulb.....	9-11
Warning indicators.....	6-13
Locking your vehicle.....	4-2
Low tyre pressure indicator light.....	6-13
Lumbar support.....	3-2

M

Maintenance	
Brake fluid	8-4
Cleaning the exterior	8-7
Cleaning the interior.....	8-9
Daily checks.....	8-2
Fluids.....	8-4
Owner maintenance.....	8-2
Paint repair	8-9
Removing tar	8-7
Routine maintenance.....	8-2
Service internal indicator	8-2
Underbody	8-7
Washer fluid	8-5
Washer jets	8-6
Weekly checks.....	8-2
Windshield wiper.....	8-6
Master door locking switch.....	4-4
Mileage.....	6-3
Mirrors	7-3
Mobile Connector	
Overview.....	5-2
Modifying your vehicle	1-2
Motor specifications	10-7

O

Odometer display	6-13
Opening the doors	
Inside the vehicle.....	4-4
Outside the vehicle	4-4
Ownership change	1-2

P

Paint code.....	10-2
Paint damage	8-9
Panic alarm.....	4-3
Parking brake	6-5
Passenger airbag deactivation	3-7
Performance charge setting.....	5-7

PIN code	4-7
Polishing the bodywork.....	8-8
Power meter display.....	6-12, 6-13
Power socket	7-7
Power windows	7-2
Pressure washers	8-7

R

Raising the vehicle.....	9-12
Range charge setting	5-7
Rear fog guard lights.....	6-9
Rear suspension specifications.....	10-8
Rear view mirrors.....	7-3
Regenerative braking	6-6
Regenerative braking display	6-12
Regenerative braking visual display.....	6-13
Removing the hard-top	7-14
Replacement bulbs.....	9-10
Roof	
Hard-top.....	7-13
Soft-top	7-11

S

Safety instructions	
Child seats	3-5, 3-7
Jacking the vehicle	9-12
Lifting the vehicle.....	9-13
Obstruction of airbags	3-6
Seat belts.....	3-3
Tyre repair	9-4
Wearing seat belts when pregnant	3-4
Windows	7-2
Seat belts	
Care.....	3-5
Cleaning	8-9
General information.....	3-3
Pre-tensioners.....	3-4
Reminder.....	3-3, 6-13
Safety instructions	3-3

Testing	3-5
Wearing	3-4
Wearing when pregnant	3-4
Seat heater controls.....	7-4
Seat heaters.....	7-6
Seats	
Adjustment.....	3-2
Child seats and restraints	3-5
Lumbar support.....	3-2
Security	4-7
Security code.....	4-7
Service data recording.....	1-2
Soft top	
Installing	7-10
Removing	7-11
Specifications	
Antifreeze	10-3
Battery	10-9
Brake fluid.....	10-3
Brakes.....	10-9
Coolant	10-3
Electrical.....	10-9
Fluids	10-3
Front suspension.....	10-8
Motor	10-7
Rear suspension	10-8
Steering	10-7
Transmission.....	10-7
Tyres	10-6
Wheels	10-6
Standard charge setting.....	5-7
Starter switch	6-2
Starting the vehicle	6-2
Steering column lock	6-3
Steering specifications.....	10-7
Storage charge setting	5-7
Storing your vehicle	5-5
Sun visors	7-7
Supplementary Restraint System (SRS) ...	3-6

Index

T	
Temperature control.....	7-4
Theft prevention.....	4-7
Tool kit	
Components.....	9-2
Location.....	9-2
TPM system.....	8-13
Traction control.....	6-7
Traction control indicator light.....	6-13
Transmission.....	6-5
Transmission specifications.....	10-7
Trip display.....	6-13
Trunk	
Interior release handle.....	4-6
Light replacement.....	9-11
Opening and closing.....	4-6
Turn signal indicator light.....	6-13
Turn signals.....	6-8
Type approvals.....	10-10
Tyre pressure checking.....	8-10
Tyre Pressure Monitoring (TPM) system	
Malfunction.....	8-13
Operation.....	8-13
Tyre repair.....	9-4, 9-5
Tyre sealant replacement.....	9-5
Tyres	
Care.....	8-10
Chains.....	8-12
Changing pressure settings.....	8-13
Degradation.....	8-11
Glossary of terms.....	8-17
Markings.....	8-15
Pressure monitoring.....	8-13
Pressures.....	8-10, 10-6
Replacement of.....	8-12
Replacing a tyre sensor.....	8-13
Specification.....	10-6
Tyre sealant.....	9-4
Wear.....	8-11
Winter.....	8-12

U	
Unlocking your vehicle.....	4-3
USB port.....	7-7
V	
Valet mode.....	4-9
Vehicle Identification Number (VIN).....	10-2
Vehicle immobiliser.....	4-3
Vehicle lashing.....	9-16
Vehicle log file.....	8-18
Ventilation.....	7-5
VIN (Vehicle Identification Number).....	10-2
Voltage warning.....	1-2

W	
Warm weather driving.....	6-3
Warning indicator	
ABS.....	6-7
Airbags.....	3-7
Anti-theft alarm.....	4-7
Brake.....	6-5
Charging.....	5-9
Cruise control.....	6-11
Fault.....	6-13
Frost.....	6-13
Headlights.....	6-8
Seat belt.....	3-3
Traction control.....	6-7
Turn signals.....	6-8
Warning light summary.....	6-13
Washer fluid.....	8-5
Washing the soft-top.....	8-8
Washing the vehicle.....	8-7
Weekly checks.....	8-2
Weights.....	10-5
Wheel nut tightening.....	9-6
Wheel removal.....	9-6
Wheel replacement.....	8-12
Wheel specifications.....	10-6

Wheelbase.....	10-4
Windows.....	7-2
Windshield defrosting.....	7-5
Windshield washer	
Fluid top-up.....	8-5
Jets.....	8-6
Operation.....	6-10
Windshield wiper	
Checking blade.....	8-6
Operation.....	6-10
Wiper.....	6-10
Wiper blade inspection.....	8-6