

# Modicon X80

## BMXEHC0200 Counting Module

### User Manual

Original instructions

10/2019

---

The information provided in this documentation contains general descriptions and/or technical characteristics of the performance of the products contained herein. This documentation is not intended as a substitute for and is not to be used for determining suitability or reliability of these products for specific user applications. It is the duty of any such user or integrator to perform the appropriate and complete risk analysis, evaluation and testing of the products with respect to the relevant specific application or use thereof. Neither Schneider Electric nor any of its affiliates or subsidiaries shall be responsible or liable for misuse of the information contained herein. If you have any suggestions for improvements or amendments or have found errors in this publication, please notify us.

You agree not to reproduce, other than for your own personal, noncommercial use, all or part of this document on any medium whatsoever without permission of Schneider Electric, given in writing. You also agree not to establish any hypertext links to this document or its content. Schneider Electric does not grant any right or license for the personal and noncommercial use of the document or its content, except for a non-exclusive license to consult it on an "as is" basis, at your own risk. All other rights are reserved.

All pertinent state, regional, and local safety regulations must be observed when installing and using this product. For reasons of safety and to help ensure compliance with documented system data, only the manufacturer should perform repairs to components.

When devices are used for applications with technical safety requirements, the relevant instructions must be followed.

Failure to use Schneider Electric software or approved software with our hardware products may result in injury, harm, or improper operating results.

Failure to observe this information can result in injury or equipment damage.

© 2019 Schneider Electric. All rights reserved.

---

# Table of Contents

---



	<b>Safety Information</b> . . . . .	<b>7</b>
	<b>About the Book</b> . . . . .	<b>11</b>
<b>Part I</b>	<b>Introduction to the Counting Function</b> . . . . .	<b>15</b>
<b>Chapter 1</b>	<b>General Information on the Counting Function</b> . . . . .	<b>17</b>
	General Information on Counting Functions . . . . .	<b>17</b>
<b>Chapter 2</b>	<b>Presentation of Counting Module</b> . . . . .	<b>19</b>
	General Information about Counting Module . . . . .	<b>20</b>
	General Information about the Counting Module Operation . . . . .	<b>21</b>
	Presentation of the BMX EHC 0200 Counting Module . . . . .	<b>22</b>
<b>Chapter 3</b>	<b>Presentation of the Counting Module Operation</b> . . . . .	<b>23</b>
	Overview of BMX EHC 0200 Module Functionalities . . . . .	<b>23</b>
<b>Part II</b>	<b>Counting Module BMX EHC 0200 Hardware Implementation</b> . . . . .	<b>25</b>
<b>Chapter 4</b>	<b>General Rules for Installing Counting Module BMX EHC 0200</b> . . . . .	<b>27</b>
	Physical Description of the Counting Module . . . . .	<b>28</b>
	Fitting of Counting Modules . . . . .	<b>30</b>
	Fitting 10-Pin and 16-Pin Terminal Blocks to a BMX EHC 0200 Counting Module . . . . .	<b>32</b>
	How to Connect BMX EHC 0200 Module: Connecting 16-Pin and 10-Pin Terminal Blocks . . . . .	<b>33</b>
<b>Chapter 5</b>	<b>BMX EHC 0200 Counting Module Hardware Implementation</b> . . . . .	<b>35</b>
	Standards and Certifications . . . . .	<b>36</b>
	Characteristics for the BMX EHC 0200 Module and its Inputs and Outputs . . . . .	<b>37</b>
	Display and Diagnostics of the BMX EHC 0200 Counting Module . . . . .	<b>40</b>
	BMX EHC 0200 Module Wiring . . . . .	<b>42</b>
	Shielding Connection Kit . . . . .	<b>50</b>
<b>Part III</b>	<b>Counting Module BMX EHC 0200 Functionalities</b> . . . . .	<b>53</b>
<b>Chapter 6</b>	<b>BMX EHC 0200 Counting Module Functionalities</b> . . . . .	<b>55</b>
6.1	BMX EHC 0200 Module Configuration . . . . .	<b>56</b>
	Input Interface Blocks . . . . .	<b>57</b>
	Programmable Filtering . . . . .	<b>58</b>
	Comparison . . . . .	<b>59</b>

	Output Block Functions .....	62
	Diagnostics .....	67
	Synchronization, Homing, Enable, Reset to 0 and Capture Functions	69
	Modulo Flag and Synchronization Flag .....	77
	Sending Counting Events to the Application .....	79
6.2	BMX EHC 0200 Module Operation Modes .....	82
	BMX EHC 0200 Module Operation in Frequency Mode .....	83
	BMX EHC 0200 Module Operation in Event Counting Mode .....	84
	BMX EHC 0200 Module Operation in Period Measuring Mode .....	86
	BMX EHC 0200 Module Operation in Ratio Mode .....	89
	BMX EHC 0200 Module Operation in One Shot Counter Mode .....	92
	BMX EHC 0200 Module Operation in Modulo Loop Counter Mode .....	95
	BMX EHC 0200 Module Operation in Free Large Counter Mode .....	99
	BMX EHC 0200 Module Operation in Pulse Width Modulation Mode .....	107
<b>Part IV</b>	<b>Counting Module BMX EHC 0200 Software Implementation .....</b>	<b>109</b>
<b>Chapter 7</b>	<b>Software Implementation Methodology for BMX EHC xxxx Counting Modules .....</b>	<b>111</b>
	Installation Methodology .....	111
<b>Chapter 8</b>	<b>Accessing the Functional Screens of the BMX EHC xxxx Counting Modules .....</b>	<b>113</b>
	Accessing the Functional Screens of the BMX EHC 0200 Counting Modules .....	114
	Description of the Counting Module Screens .....	116
<b>Chapter 9</b>	<b>Configuration of the BMX EHC 0200 Counting Modules .....</b>	<b>119</b>
9.1	Configuration Screen for BMX EHC xxxx Counting Modules .....	120
	Configuration Screen for BMX EHC 0200 Counting Modules in a Modicon M340 Local Rack .....	120
9.2	Configuration of Modes for the BMX EHC 0200 Module .....	123
	Frequency Mode Configuration .....	124
	Event Counting Mode Configuration .....	126
	Period Measuring Mode Configuration .....	128
	Ratio Mode Configuration .....	130
	One Shot Counter Mode Configuration .....	132
	Modulo Loop Counter Mode Configuration .....	134
	Free Large Counter Mode Configuration .....	137
	Pulse Width Modulation Mode Configuration .....	140

<b>Chapter 10</b>	<b>BMX EHC xxxx Counting Module Settings . . . . .</b>	<b>143</b>
	Adjust Screen for BMX EHC 0200 Counting Modules . . . . .	144
	Setting the Preset Value . . . . .	146
	Setting the Calibration Factor . . . . .	147
	Modulo Adjust . . . . .	148
	Setting the Hysteresis Value . . . . .	149
<b>Chapter 11</b>	<b>Debugging the BMX EHC 0200 Counting Modules . . . .</b>	<b>151</b>
11.1	Debug Screen for BMX EHC xxxx Counting Modules . . . . .	152
	Debug Screen for BMX EHC xxxx Counting Modules . . . . .	152
11.2	BMX EHC 0200 Module Debugging . . . . .	155
	Frequency Mode Debugging . . . . .	156
	Event Counting Mode Debugging . . . . .	157
	Period Measuring Mode Debugging . . . . .	158
	Ratio Mode Debugging . . . . .	159
	One Shot Counter Mode Debugging . . . . .	160
	Modulo Loop Counter Mode Debugging . . . . .	161
	Free Large Counter Mode Debugging . . . . .	163
	Pulse Width Modulation Mode Debugging . . . . .	165
<b>Chapter 12</b>	<b>Display of BMX EHC xxxx Counting Module Error . . . . .</b>	<b>167</b>
	Fault Display Screen for BMX EHC 0200 Counting Modules . . . . .	168
	Faults Diagnostics Display . . . . .	170
	List of Error . . . . .	171
<b>Chapter 13</b>	<b>The Language Objects of the Counting Function . . . . .</b>	<b>173</b>
13.1	The Language Objects and IODDT of the Counting Function . . . . .	174
	Introducing Language Objects for Application-Specific Counting . . . .	175
	Implicit Exchange Language Objects Associated with the Application-Specific Function . . . . .	176
	Explicit Exchange Language Objects Associated with the Application-Specific Function . . . . .	177
	Management of Exchanges and Reports with Explicit Objects . . . . .	179
13.2	Language Objects and IODDT Associated with the Counting Function of the BMX EHC xxxx Modules. . . . .	184
	Details of Implicit Exchange Objects for the T_Unsigned_CPT_BMX and T_Signed_CPT_BMX-types IODDTs . . . . .	185
	Details of the Explicit Exchange Objects for the T_CPT_BMX-type IODDT . . . . .	190
13.3	The IODDT Type T_GEN_MOD Applicable to All Modules . . . . .	192
	Details of the Language Objects of the IODDT of Type T_GEN_MOD . . . . .	192

---

13.4	Device DDTs Associated with the Counting Function of the BMX EHC xxxx Modules.....	194
	Counter Device DDT .....	195
	MOD_FLT Byte Description .....	203
<b>Part V</b>	<b>Quick Start: Example of Counting Module Implementation.....</b>	<b>205</b>
<b>Chapter 14</b>	<b>Description of the Application.....</b>	<b>207</b>
	Overview of the Application .....	207
<b>Chapter 15</b>	<b>Installing the Application Using Control Expert.....</b>	<b>209</b>
15.1	Presentation of the Solution Used .....	210
	Technological Choices Used .....	211
	Process Using Control Expert .....	212
15.2	Developing the Application.....	213
	Creating the Project .....	214
	Configuration of the Counting Module .....	215
	Declaration of Variables.....	218
	Creating the Program for Managing the Counter Module .....	220
	Creating the Labelling Program in ST .....	222
	Creating the I/O Event Section in ST .....	224
	Creating a Program in LD for Application Execution .....	225
	Creating an Animation Table .....	228
	Creating the Operator Screen .....	229
<b>Chapter 16</b>	<b>Starting the Application .....</b>	<b>231</b>
	Execution of Application in Standard Mode .....	231
<b>Index</b>	.....	<b>235</b>

---

# Safety Information

---



## Important Information

### NOTICE

Read these instructions carefully, and look at the equipment to become familiar with the device before trying to install, operate, service, or maintain it. The following special messages may appear throughout this documentation or on the equipment to warn of potential hazards or to call attention to information that clarifies or simplifies a procedure.



The addition of this symbol to a “Danger” or “Warning” safety label indicates that an electrical hazard exists which will result in personal injury if the instructions are not followed.



This is the safety alert symbol. It is used to alert you to potential personal injury hazards. Obey all safety messages that follow this symbol to avoid possible injury or death.

## **DANGER**

**DANGER** indicates a hazardous situation which, if not avoided, **will result in** death or serious injury.

## **WARNING**

**WARNING** indicates a hazardous situation which, if not avoided, **could result in** death or serious injury.

## **CAUTION**

**CAUTION** indicates a hazardous situation which, if not avoided, **could result in** minor or moderate injury.

## **NOTICE**

**NOTICE** is used to address practices not related to physical injury.

---

## PLEASE NOTE

Electrical equipment should be installed, operated, serviced, and maintained only by qualified personnel. No responsibility is assumed by Schneider Electric for any consequences arising out of the use of this material.

A qualified person is one who has skills and knowledge related to the construction and operation of electrical equipment and its installation, and has received safety training to recognize and avoid the hazards involved.

## BEFORE YOU BEGIN

Do not use this product on machinery lacking effective point-of-operation guarding. Lack of effective point-of-operation guarding on a machine can result in serious injury to the operator of that machine.

 <b>WARNING</b>
<b>UNGUARDED EQUIPMENT</b>
<ul style="list-style-type: none"><li>• Do not use this software and related automation equipment on equipment which does not have point-of-operation protection.</li><li>• Do not reach into machinery during operation.</li></ul>
<b>Failure to follow these instructions can result in death, serious injury, or equipment damage.</b>



This automation equipment and related software is used to control a variety of industrial processes. The type or model of automation equipment suitable for each application will vary depending on factors such as the control function required, degree of protection required, production methods, unusual conditions, government regulations, etc. In some applications, more than one processor may be required, as when backup redundancy is needed.

Only you, the user, machine builder or system integrator can be aware of all the conditions and factors present during setup, operation, and maintenance of the machine and, therefore, can determine the automation equipment and the related safeties and interlocks which can be properly used. When selecting automation and control equipment and related software for a particular application, you should refer to the applicable local and national standards and regulations. The National Safety Council's Accident Prevention Manual (nationally recognized in the United States of America) also provides much useful information.

In some applications, such as packaging machinery, additional operator protection such as point-of-operation guarding must be provided. This is necessary if the operator's hands and other parts of the body are free to enter the pinch points or other hazardous areas and serious injury can occur. Software products alone cannot protect an operator from injury. For this reason the software cannot be substituted for or take the place of point-of-operation protection.



---

Ensure that appropriate safeties and mechanical/electrical interlocks related to point-of-operation protection have been installed and are operational before placing the equipment into service. All interlocks and safeties related to point-of-operation protection must be coordinated with the related automation equipment and software programming.

**NOTE:** Coordination of safeties and mechanical/electrical interlocks for point-of-operation protection is outside the scope of the Function Block Library, System User Guide, or other implementation referenced in this documentation.

## START-UP AND TEST

Before using electrical control and automation equipment for regular operation after installation, the system should be given a start-up test by qualified personnel to verify correct operation of the equipment. It is important that arrangements for such a check be made and that enough time is allowed to perform complete and satisfactory testing.

### WARNING

#### EQUIPMENT OPERATION HAZARD

- Verify that all installation and set up procedures have been completed.
- Before operational tests are performed, remove all blocks or other temporary holding means used for shipment from all component devices.
- Remove tools, meters, and debris from equipment.

**Failure to follow these instructions can result in death, serious injury, or equipment damage.**

Follow all start-up tests recommended in the equipment documentation. Store all equipment documentation for future references.

#### **Software testing must be done in both simulated and real environments.**

Verify that the completed system is free from all short circuits and temporary grounds that are not installed according to local regulations (according to the National Electrical Code in the U.S.A, for instance). If high-potential voltage testing is necessary, follow recommendations in equipment documentation to prevent accidental equipment damage.

Before energizing equipment:

- Remove tools, meters, and debris from equipment.
- Close the equipment enclosure door.
- Remove all temporary grounds from incoming power lines.
- Perform all start-up tests recommended by the manufacturer.

---

## OPERATION AND ADJUSTMENTS

The following precautions are from the NEMA Standards Publication ICS 7.1-1995 (English version prevails):

- Regardless of the care exercised in the design and manufacture of equipment or in the selection and ratings of components, there are hazards that can be encountered if such equipment is improperly operated.
- It is sometimes possible to misadjust the equipment and thus produce unsatisfactory or unsafe operation. Always use the manufacturer's instructions as a guide for functional adjustments. Personnel who have access to these adjustments should be familiar with the equipment manufacturer's instructions and the machinery used with the electrical equipment.
- Only those operational adjustments actually required by the operator should be accessible to the operator. Access to other controls should be restricted to prevent unauthorized changes in operating characteristics.

---

# About the Book

---



## At a Glance

### Document Scope

This manual describes the hardware and software implementation of the Modicon X80 counting module BMXEHC0200.

### Validity Note

This documentation is valid for EcoStruxure™ Control Expert 14.1 or later.

The technical characteristics of the devices described in the present document also appear online. To access the information online:

Step	Action
1	Go to the Schneider Electric home page <a href="http://www.schneider-electric.com">www.schneider-electric.com</a> .
2	In the <b>Search</b> box type the reference of a product or the name of a product range. <ul style="list-style-type: none"><li>• Do not include blank spaces in the reference or product range.</li><li>• To get information on grouping similar modules, use asterisks (*).</li></ul>
3	If you entered a reference, go to the <b>Product Datasheets</b> search results and click on the reference that interests you. If you entered the name of a product range, go to the <b>Product Ranges</b> search results and click on the product range that interests you.
4	If more than one reference appears in the <b>Products</b> search results, click on the reference that interests you.
5	Depending on the size of your screen, you may need to scroll down to see the datasheet.
6	To save or print a datasheet as a .pdf file, click <b>Download XXX product datasheet</b> .

The characteristics that are presented in the present document should be the same as those characteristics that appear online. In line with our policy of constant improvement, we may revise content over time to improve clarity and accuracy. If you see a difference between the document and online information, use the online information as your reference.

## Related Documents

Title of documentation	Reference number
Electrical installation guide	EIGED306001EN (English)
Modicon M580, M340, and X80 I/O Platforms, Standards and Certifications	EIO0000002726 (English), EIO0000002727 (French), EIO0000002728 (German), EIO0000002730 (Italian), EIO0000002729 (Spanish), EIO0000002731 (Chinese)
EcoStruxure™ Control Expert, Program Languages and Structure, Reference Manual	35006144 (English), 35006145 (French), 35006146 (German), 35013361 (Italian), 35006147 (Spanish), 35013362 (Chinese)
EcoStruxure™ Control Expert, Operating Modes	33003101 (English), 33003102 (French), 33003103 (German), 33003104 (Spanish), 33003696 (Italian), 33003697 (Chinese)
EcoStruxure™ Control Expert, I/O Management, Block Library	33002531 (English), 33002532 (French), 33002533 (German), 33003684 (Italian), 33002534 (Spanish), 33003685 (Chinese)
EcoStruxure™ Control Expert, Communication, Block Library	33002527 (English), 33002528 (French), 33002529 (German), 33003682 (Italian), 33002530 (Spanish), 33003683 (Chinese)

You can download these technical publications and other technical information from our website at [www.schneider-electric.com/en/download](http://www.schneider-electric.com/en/download).

---

**Product Related Information**

 **WARNING**

**UNINTENDED EQUIPMENT OPERATION**

The application of this product requires expertise in the design and programming of control systems. Only persons with such expertise should be allowed to program, install, alter, and apply this product.

Follow all local and national safety codes and standards.

**Failure to follow these instructions can result in death, serious injury, or equipment damage.**



---

# Part I

## Introduction to the Counting Function

---

### Subject of this Part

This part provides a general introduction to the counting function and the operating principles of the BMX EHC 0200.

### What Is in This Part?

This part contains the following chapters:

Chapter	Chapter Name	Page
1	General Information on the Counting Function	17
2	Presentation of Counting Module	19
3	Presentation of the Counting Module Operation	23





---

# Chapter 1

## General Information on the Counting Function

---

### General Information on Counting Functions

#### At a Glance

The counting function enables fast counting using couplers, Control Expert screens and specialized language objects. The general operation of expert modules also known as couplers is described in the section Presentation of the Counting Module Operation BMX EHC 0200.

In order to implement the counting, it is necessary to define the physical context in which it is to be executed (rack, supply, processor, modules etc.) and to ensure the software implementation (*see page 109*).

This second aspect is performed from the different Control Expert editors:

- in offline mode
- in online mode



---

# Chapter 2

## Presentation of Counting Module

---

### Subject of this Chapter

This chapter deals with the Modicon X80 counting module BMX EHC 0200.

### What Is in This Chapter?

This chapter contains the following topics:

Topic	Page
General Information about Counting Module	20
General Information about the Counting Module Operation	21
Presentation of the BMX EHC 0200 Counting Module	22

## General Information about Counting Module

### Introduction

Counting module is standard format module that enable pulses from a sensor to be counted at a maximum frequency of 60 KHz (BMX EHC 0200).

The BMX EHC 0200 module has 2 channels.

### Sensors Used

The sensors used on each channel may be:

- 24 VDC two-wire proximity sensors
- Incremental signal encoders with 10/30 VDC output and push-pull outputs.

### Illustration

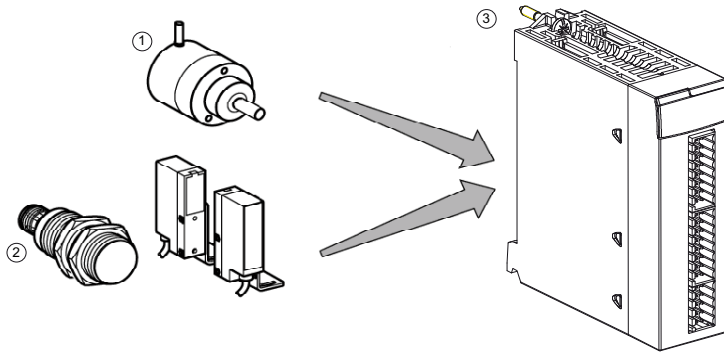

- 1 Incremental encoder
- 2 Proximity sensors
- 3 Counting module BMX EHC 0200

## General Information about the Counting Module Operation

### Introduction

The BMX EHC 0200 module have:

- Counting-related functions (comparison, capture, homing, reset to 0)
- Event generation functions designed for the application program
- Outputs for actuator use (contacts, alarms, relays)

### Characteristics

The main characteristics of BMX EHC 0200 module are as follows.

Application	Number of channels per module	Number of physical inputs per channel	Number of physical outputs per channel	Maximum frequency
<ul style="list-style-type: none"> <li>● Counting</li> <li>● Downcounting</li> <li>● Up/Down counting</li> <li>● Measurement</li> <li>● Frequency meter</li> <li>● Frequency generator</li> <li>● Axis monitoring</li> </ul>	2	6	2	60 KHz

## Presentation of the BMX EHC 0200 Counting Module

### At a Glance

The BMX EHC 0200 counting module enables the counting or downcounting of pulses to be performed. It has the following functions:

- Enable
- Capture
- Comparison
- Homing or reset to 0
- 2 physical outputs

### Structure of a counter channel

The following illustration shows the overall structure of a counter channel:

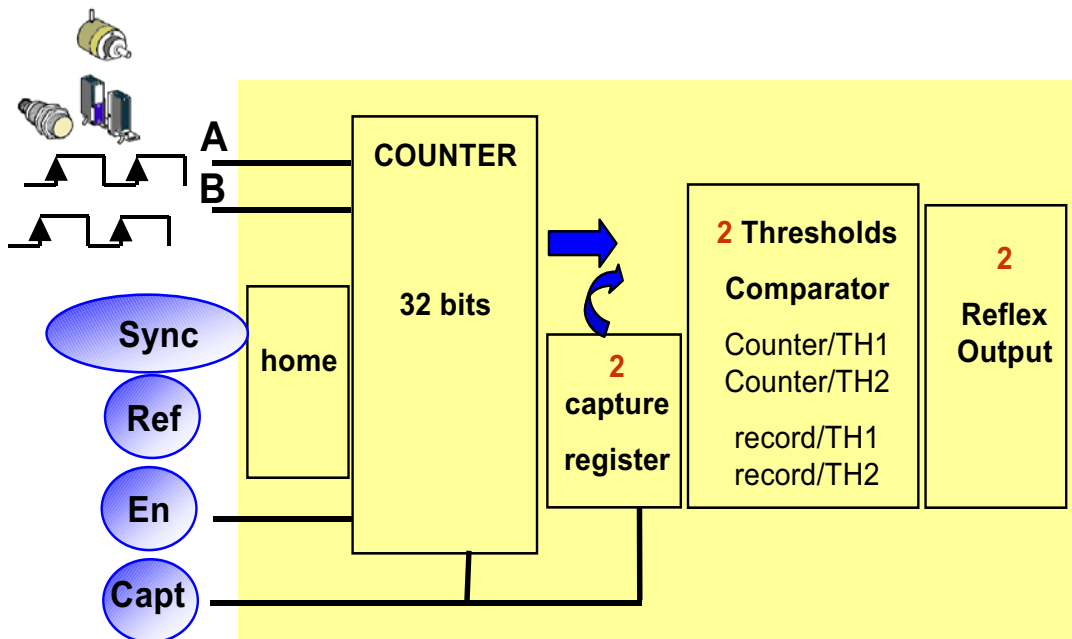

---

# Chapter 3

## Presentation of the Counting Module Operation

---

### Overview of BMX EHC 0200 Module Functionalities

#### At a Glance

This part presents the different types of user applications for the BMX EHC 0200 module.

#### Measurement

The following table presents the measurement functionality for the BMX EHC 0200 module:

User application type	Mode
Speed measurement/stream measurement	Frequency
Random events monitoring	Event counting
Pulse evaluation/Speed control	Period measuring
Flow control	Ratio

#### Counting

The following table presents the counting functionality for the BMX EHC 0200 module:

User application type	Mode
Grouping	One shot counter
Level 1 packaging/labeling	Modulo loop counter
Level 2 packaging/labeling	Free large counter
Accumulator	Free large counter
Axis control	Free large counter

**NOTE:** In case of a user application such as level 1 packaging/labeling, the machine makes constant spacing between parts. In case of a user application such as level 2 packaging/labeling, the counting module learns the incoming edge of each part.

#### Frequency Generator

The following table presents the frequency generator functionality for the BMX EHC 0200 module:

User application type	Mode
Input frequency device	Pulse width modulation

## Interface

The BMX EHC 0200 module may be interfaced with the following components:

- mechanical switch
- 24 VDC two-wire proximity sensor
- 24 VDC three-wire proximity sensor
- 10/30 VDC encoder with push-pull outputs



---

# Part II

## Counting Module BMX EHC 0200 Hardware Implementation

---

### Subject of this Part

This part presents the hardware implementation of the BMX EHC 0200 counting module.

### What Is in This Part?

This part contains the following chapters:

Chapter	Chapter Name	Page
4	General Rules for Installing Counting Module BMX EHC 0200	27
5	BMX EHC 0200 Counting Module Hardware Implementation	35



---

# Chapter 4

## General Rules for Installing Counting Module BMX EHC 0200

---

### Subject of this Chapter

This chapter presents the general rules for installing counting module BMX EHC 0200.

### What Is in This Chapter?

This chapter contains the following topics:

Topic	Page
Physical Description of the Counting Module	28
Fitting of Counting Modules	30
Fitting 10-Pin and 16-Pin Terminal Blocks to a BMX EHC 0200 Counting Module	32
How to Connect BMX EHC 0200 Module: Connecting 16-Pin and 10-Pin Terminal Blocks	33

## Physical Description of the Counting Module

### Illustration

The figure below present the counting module BMX EHC 0200 :

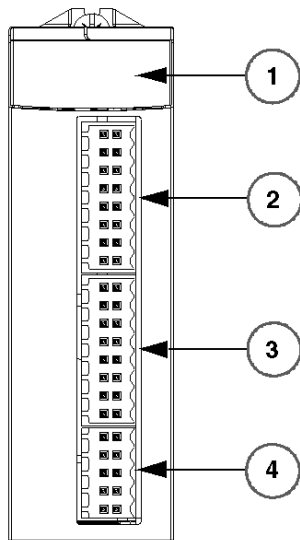

BMX EHC 0200

### Physical Elements of the Modules

The table below presents the elements of the counting module BMX EHC 0200:

Number	Description
1	Module state LEDs: <ul style="list-style-type: none"> <li>● State LEDs at module level</li> <li>● State LEDs at channel level</li> </ul>
2	16-pin connector to connect the counter 0 sensors
3	16-pin connector to connect the counter 1 sensors
4	10-pin connector to connect: <ul style="list-style-type: none"> <li>● Auxiliary outputs</li> <li>● Sensor power supplies</li> </ul>

## Accessories

The BMX EHC 0200 module requires the use of the following accessories:

- Two 16-pin terminal blocks
- One 10-pin terminal block
- One BMXXSP•••• shielding connection kit (*see page 50*)

**NOTE:** The two 16-pin connectors and the 10-pin connector are available under the reference BMX XTS HSC 20.

## Fitting of Counting Modules

### At a Glance

The counting modules are powered by the rack bus. The modules may be handled without turning off power supply to the rack, without damage or disturbance to the PLC.

Fitting operations (installation, assembly, and disassembly) are described below.

### Installation Precautions

The counting modules may be installed in any of the positions in the rack except for the first two (marked PS and 00) which are reserved for the rack power supply module (BMX CPS ••••) and the processor (BMX P34 ••••) respectively. Power is supplied by the bus at the bottom of the rack (3.3 V and 24 V).

Before installing a module, you must take off the protective cap from the module connector located on the rack.

**⚡ ⚠ DANGER**

**HAZARD OF ELECTRIC SHOCK**

- Turn off all power to sensor and pre-actuator devices before connection or disconnection of the terminal block.
- Remove the terminal block before plugging / unplugging the module on the rack.

**Failure to follow these instructions will result in death or serious injury.**

### Installation

The diagram below shows counting module BMX EHC 0200 mounted on the rack:

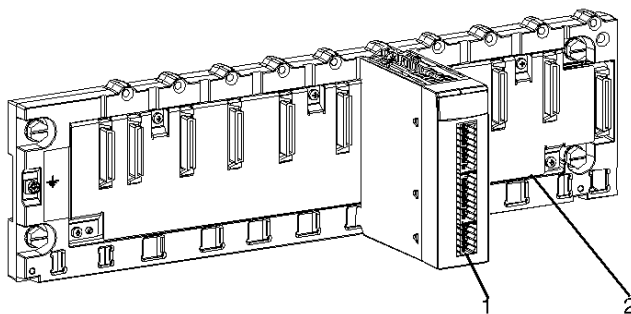

The following table describes the different elements which make up the assembly below:

Number	Description
1	BMX EHC 0200 counting module
2	Standard rack

### Installing the Module on the Rack

The following table shows the procedure for mounting the counting module in the rack:

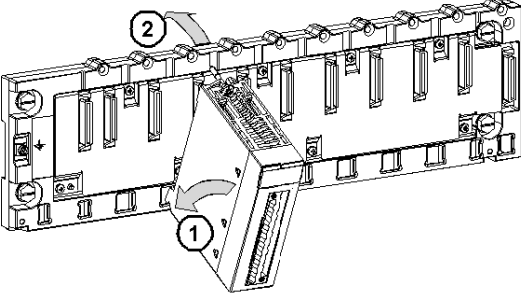
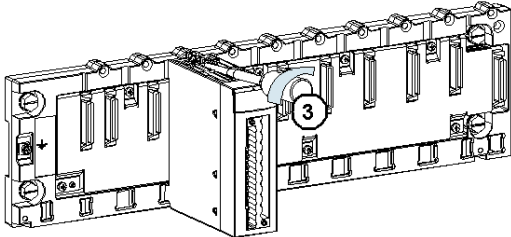
Step	Action	Illustration
1	Position the locating pins situated at the rear of the module (on the bottom part) in the corresponding slots in the rack.  <b>NOTE:</b> Before positioning the pins, make sure you have removed the protective cover.	Steps 1 and 2
2	Swivel the module towards the top of the rack so that the module sits flush with the back of the rack. It is now set in position.	
3	Tighten the mounting screw to ensure that the module is held in place on the rack. Tightening torque: 0.4...1.5 N•m (0.30...1.10 lbf-ft)	Step 3
		

## Fitting 10-Pin and 16-Pin Terminal Blocks to a BMX EHC 0200 Counting Module

### At a Glance

BMX EHC 0200 counting modules with 10-pin and 16-pin terminal block connections require terminal blocks to be connected to the module. The fitting operations (assembly and disassembly) are described below.

### Installing the 10-Pin and 16-Pin Terminal Blocks



**DANGER**

**HAZARD OF ELECTRIC SHOCK**

Turn off all power to sensor and pre-actuator devices before connection or disconnection of the terminal block.

**Failure to follow these instructions will result in death or serious injury.**

If two 16-pin terminal blocks are used, each can be plugged into the middle or the top connector of the module. Therefore, despite the indicators on the terminal blocks and module, it is possible to invert the two terminal blocks and thus create incorrect wiring.

**CAUTION**

**UNEXPECTED BEHAVIOR OF APPLICATION**

Do careful tests on the wiring before any connection of material (sensors, actuators) and before any application tests.

**Failure to follow these instructions can result in injury or equipment damage.**

The following table shows the procedure for assembling the 10-pin and 16-pin terminal blocks onto a BMX EHC 0200 counting module:

Step	Action
1	Plug the 10-pin terminal block into the bottom connector of the module.
2	Plug the 16-pin terminal block into the middle connector of the module if it is used.
3	Plug the 16-pin terminal block into the top connector of the module if it is used.

**NOTE:** The three module connectors have indicators which show the proper direction to use for terminal block installation.



## How to Connect BMX EHC 0200 Module: Connecting 16-Pin and 10-Pin Terminal Blocks

### At a Glance

The BMX EHC 0200 counting module uses the following terminal blocks:

- Two 16-pin terminal blocks for the inputs
- One 10-pin terminal block for supplies outputs

### Description of the 10 and 16 Pin Terminal Blocks

The following table shows the characteristics of the BMX EHC 0200 terminal blocks:

Characteristic		Available
Type of terminal block		Spring terminal blocks
Number of wires accommodated		1
Wire gauge accommodated	Minimum	AWG 20 (0.5 mm <sup>2</sup> )
	Maximum	AWG 18 (1 mm <sup>2</sup> )
Wiring constraints		To insert and remove wires from the connectors, use a flat-tipped screwdriver with a 2.5 mm wide and 0.4 mm thick blade. With the screwdriver, push the flexible plate down on the outside (the side closest to the corresponding receptacle) to open the round receptacle. A screwing (rotating) or bending motion is not required.



#### HAZARD OF ELECTRIC SHOCK

Turn off all power to sensor and pre-actuator devices before connection or disconnection of the terminal block.

**Failure to follow these instructions will result in death or serious injury.**



---

# Chapter 5

## BMX EHC 0200 Counting Module Hardware Implementation

---

### Subject of this Chapter

This chapter deals with the hardware characteristics of the BMX EHC 0200 module.

### What Is in This Chapter?

This chapter contains the following topics:

Topic	Page
Standards and Certifications	36
Characteristics for the BMX EHC 0200 Module and its Inputs and Outputs	37
Display and Diagnostics of the BMX EHC 0200 Counting Module	40
BMX EHC 0200 Module Wiring	42
Shielding Connection Kit	50

## Standards and Certifications

### Download

Click the link that corresponds to your preferred language to download standards and certifications (PDF format) that apply to the modules in this product line:

Title	Languages
Modicon M580, M340, and X80 I/O Platforms, Standards and Certifications	<ul style="list-style-type: none"> <li>● English: <a href="#">EIO0000002726</a></li> <li>● French: <a href="#">EIO0000002727</a></li> <li>● German: <a href="#">EIO0000002728</a></li> <li>● Italian: <a href="#">EIO0000002730</a></li> <li>● Spanish: <a href="#">EIO0000002729</a></li> <li>● Chinese: <a href="#">EIO0000002731</a></li> </ul>

## Characteristics for the BMX EHC 0200 Module and its Inputs and Outputs

### Ruggedized Version

The BMX EHC 0200H (hardened) equipment is the ruggedized version of the BMX EHC 0200 (standard) equipment. It can be used at extended temperatures and in harsh chemical environments.

For more information, refer to chapter *Installation in More Severe Environments* (see *Modicon M580, M340, and X80 I/O Platforms, Standards and Certifications*).

### Altitude Operating Conditions

The characteristics in the table below apply to the modules BMX EHC 0200 and BMX EHC 0200H for use at altitude up to 2000 m (6560 ft). When the modules operate above 2000 m (6560 ft), apply additional derating.

For detailed information, refer to chapter *Operating and Storage Conditions* (see *Modicon M580, M340, and X80 I/O Platforms, Standards and Certifications*).

### General Characteristics

This table presents the general characteristics for the BMX EHC 0200 and BMX EHC 0200H modules:

Module type		2 counting channels
Operating temperature	BMX EHC 0200	0...60 °C (32...140 °F)
	BMX EHC 0200H	-25...70 °C (-13...158 °F)
Maximum frequency at counting inputs		60 kHz
Number of inputs/outputs per counting channel	Inputs	6 Type three 24 VDC inputs
	Outputs	Two 24 VDC outputs
Power Supply	Sensor supply voltage	19.2...30 VDC
	Module consumption	Does not take into account sensors or encoder consumption <ul style="list-style-type: none"> <li>● All inputs OFF: Typical: 15 mA</li> <li>● All inputs ON: Typical: 75 mA</li> </ul>
	Actuator supply current	500 mA maximum per output 2 A per module
Power distribution to sensors		Yes with short-circuit and overload protection - typical 300 mA (short-circuit limited to 2.5 A)
Hot replacement		Yes, under the following conditions: The module may be removed and reinserted into its location while the rack is switched on, but the counter may have to be revalidated when it is reinserted into its base.

Dimensions	Width	Module only	32 mm
		On the rack	32 mm
	Height	Module only	103.76 mm
		On the rack	103.76 mm
	Depth	Module only	92 mm
		On the rack	104.5 mm
Encoder compliance		10...30 VDC incremental encoder model with push-pull at outputs	
Insulation voltage of the ground to the bus		1500 V RMS for 1 min	
Rack 24 V supply bus	Current for the 24 V bus	Typical: 40 mA	
Rack 3 V supply bus	Current for the 3 V bus	Typical: 200 mA	
Module Cycle Time		1 ms	

** WARNING**

**OVERHEATING MODULE**

Do not operate the **BMX EHC 0200H** at 70°C (158°F) if the sensor power supply is greater than 26.4 V or less than 21.1 V.

**Failure to follow these instructions can result in death, serious injury, or equipment damage.**

**Input Characteristics**

This table presents the general characteristics of the input channels for the module:

Number of inputs per channel		Six 24 VDC inputs	
Inputs: IN A, IN B, IN SYNC, IN EN, IN REF, IN CAP	Voltage		30 VDC maximum
	At state 1	Voltage	11 VDC... 30 VDC
		Current	5 mA (up to 30 VDC)
	At state 0	Voltage	< 5 VDC
		Current	< 1.5 mA
	Current at 11 VDC		> 2 mA

## Characteristics of Outputs

This table presents the general characteristics of the output channels for the module:

Number of outputs per channel		2
Type		source 24 VDC 0.5 A
Voltage		19.2...30 VCC
Minimum load current		None
Maximum load current	Each point	0.5 A
	Per module	2 A
Leakage current at state 0		0.1 mA maximum
Voltage drop at state 1		3 VDC maximum
Output current short-circuit	Each point	1.5 A maximum
Maximum load capacity		50 $\mu$ F
Short-circuit and overload		Channel protection
Polarity for each output channel	By default	Normal logic on both channels
	User configuration	Reverse logic for one or several channels
Maximum inductive load		<p>The inductive load is calculated using the following formula:</p> $L = 0,5 / I^2 \times F$ <p>The formula above uses the following parameters:</p> <ul style="list-style-type: none"> <li>● <b>L</b>: load inductance in Henry</li> <li>● <b>I</b>: load current in Amperes</li> <li>● <b>F</b>: switching frequency in Hertz</li> </ul>

## Display and Diagnostics of the BMX EHC 0200 Counting Module

### At a Glance

The BMX EHC 0200 counting module has LEDs that enable the status of the module to be viewed:

- Module state LEDs: RUN, ERR, I/O
- State LEDs for inputs/outputs of each channel: IA, IB, IS, IE, IP, IC, Q0 and Q1.

### Illustration

The following drawing shows the display screen of the BMX EHC 0200 module:

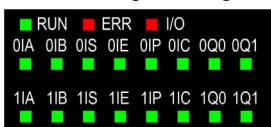

### Fault Diagnostics

The following table presents the various module states according to the LED states:

Module status	LED indicators										
	ERR	RUN	IO	IA	IB	IS	IE	IP	IC	Q0	Q1
The module is faulty or switched off	○										
The module has a fault	●	○									
The module is not configured	⊗	○	○								
The module has lost communication	⊗	●									
The sensors have a supply fault	○	●	●	⊗							
The actuators have a supply fault	○	●	●							⊗	
Short circuit on output Q0	○	●	●							⊗	
Short circuit on output Q1	○	●	●								⊗
The channels are operational	○	●	○								
The voltage is present at output Q0	○	●	○							●	
The voltage is present at output Q1	○	●	○								●
The voltage is present at input IN_A	○	●	○	●							
The voltage is present at input IN_B	○	●	○		●						



The voltage is present at input IN_SYNC	○	●	○		●	
The voltage is present at input IN_EN	○	●	○		●	
The voltage is present at input IN_REF	○	●	○		●	
The voltage is present at input IN_CAP	○	●	○		●	
<b>Legend</b>						
● LED on						
○ LED off						
⊗ LED flashing slowly						
⊙ LED flashing fast						
An empty cell indicates that the state of the LED(s) is not taken into account						

## BMX EHC 0200 Module Wiring

### At a Glance

The BMX EHC 0200 counting module uses the following:

- Two 16-pin connectors for the inputs
- One 10-pin connector for the outputs

DANGER

**HAZARD OF ELECTRIC SHOCK**

- Turn off all power to sensor and pre-actuator devices before connection or disconnection of the terminal block.
- Remove the terminal block before plugging / unplugging the module on the rack.

**Failure to follow these instructions will result in death or serious injury.**

**NOTE:** The two 16-pin connectors and the 10-pin connector are sold separately and are available in the BMX XTS HSC 20 connection kit.

### Field Sensors

The module has type 3 of IEC 61131 inputs that support signals from mechanical switching equipment such as:

- Contact relays
- Push-buttons
- Limit switch sensors
- Switches with 2 or 3 wires

The equipment must have the following characteristics:

- Voltage drop less than 8 V
- Minimum operating current less than or equal to 2 mA
- Maximum current in blocked state less than or equal to 1.5 mA

The module complies with most encoders that have a supply of 10...30 V and push-pull outputs.

**NOTE:** The module 24 V supply for sensors has thermal and short-circuit protection.

### Assignment of the 16-Pin Connector

The figure below shows the physical location of the pin numbers for the 16-pin connector:

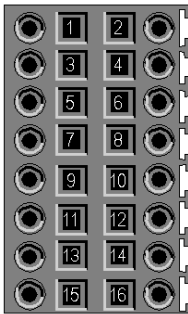

The symbol and description of each pin are described in the following table:

Pin number	Symbol	Description
1, 2, 7, 8	24V_SEN	24 VDC output for sensors supply
5, 6, 13, 14	GND_SEN	24 VDC output for sensors supply
15, 16	FE	Functional earth
3	IN_A	Input A
4	IN_SYNC	Synchronization input
9	IN_B	Input B
10	IN_EN	Enable input selected
11	IN_REF	Homing input
12	IN_CAP	Capture input

### Sensor Connections

The example below shows sensors with applied to inputs IN\_A and IN\_B and equipment with applied to inputs IN\_EN and IN\_SYNC:

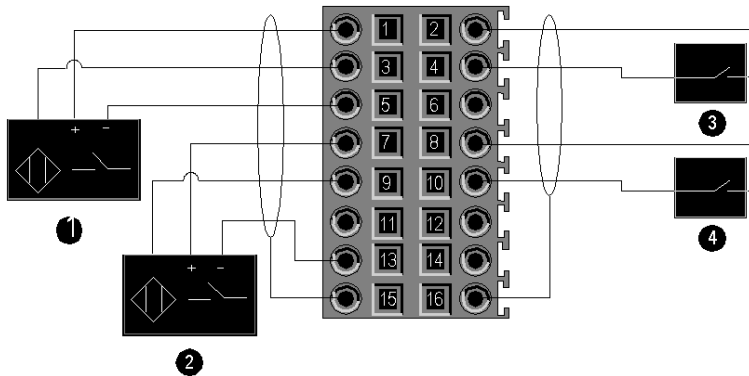

- 1 IN\_A input
- 2 IN\_B input
- 3 IN\_SYNC input (synchronization input)
- 4 IN\_EN input (enable input)

## Encoder Connection

The example below shows an incremental encoder used for axis control and the three auxiliary inputs used especially for the 32-bit counter mode:

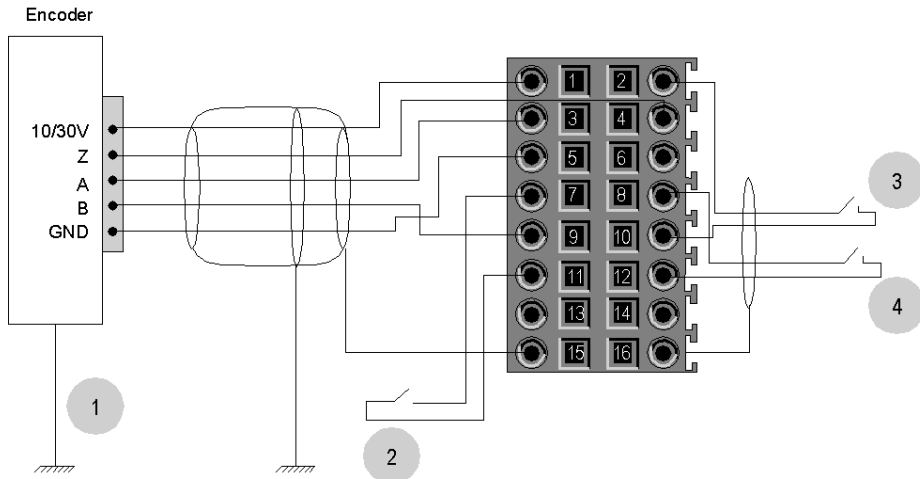

- 1 Encoder (inputs A, B and Z)
- 2 IN\_REF input (homing input)
- 3 IN\_EN input (enable input)
- 4 IN\_CAP input (capture input)

### Connecting Outputs and Output Supplies

The figure below shows the connection of supplies and actuators to the 10-pin connector:

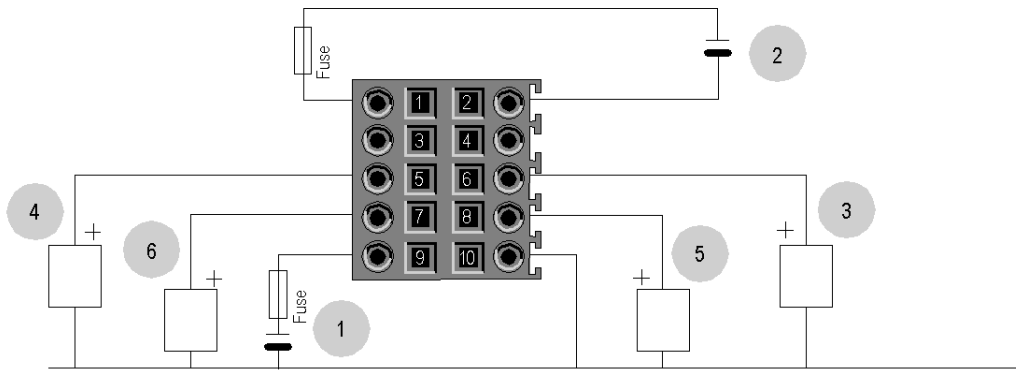

- 1 24 V supply for actuators
- 2 24 V supply for sensors
- 3 Actuator for the Q0 output of counting channel 0
- 4 Actuator for the Q1 output of counting channel 0
- 5 Actuator for the Q0 output of counting channel 1
- 6 Actuator for the Q1 output of counting channel 1

### Field Actuators

The Q0 and Q1 outputs are limited by a maximum current of 0.5 A.

**NOTE:** The Q0 and Q1 outputs have a thermal protection as well as short-circuit protection.

### Assignment of the 10-Pin Connector

The figure below shows the physical location of the pin numbers for the 10-pin connector:

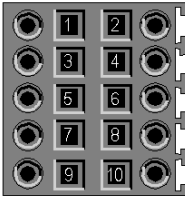

The symbol and description of each pin are described in the table below:

Pin number	Symbol	Description
1	24V_IN	24 VDC input for sensors supply
2	GND_IN	0 VDC input for sensors supply
5	Q0-1	Q1 output for counting channel 0
6	Q0-0	Q0 output for counting channel 0
7	Q1-1	Q1 output for counting channel 1
8	Q1-0	Q0 output for counting channel 1
9	24V_OUT	24 VDC input for actuators supply
10	GND_OUT	0 VDC input for actuators supply

## Safety Instructions

Electromagnetic perturbations may cause the application to operate in an unexpected manner. Follow all local and national safety codes and standards.

### DANGER

#### HAZARD OF ELECTRIC SHOCK

If you cannot prove that the end of a shielded cable is connected to the local ground, the cable must be considered as dangerous and personal protective equipment (PPE) must be worn.

**Failure to follow these instructions will result in death or serious injury.**

### WARNING

#### UNEXPECTED EQUIPMENT OPERATION

Follow these instructions to reduce electromagnetic perturbations:

- Adapt the programmable filtering to the frequency applied at the inputs.
- Use a shielded cable (connected to the functional ground) connected to pins 15 and 16 of the connector when using an encoder or a fast detector.

In a highly disturbed environment:

- Use the BMXXSP•••• shielding connection kit (*see page 50*) to connect the shielding without programmable filtering and
- Use a specific 24 VDC supply for inputs and a shielded cable for connecting the supply to the module.

**Failure to follow these instructions can result in death, serious injury, or equipment damage.**



The figure below shows the recommended circuit for high-noise environment using the shielding connection kit:

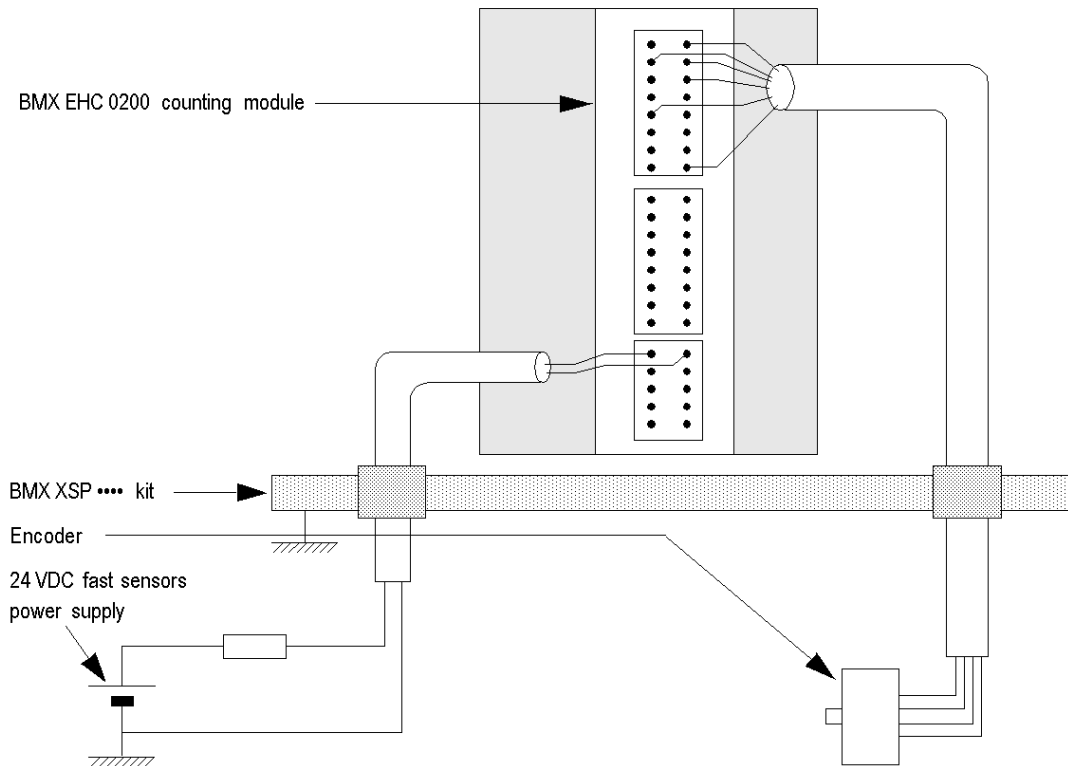

Improper fuse selection could result in damage to the module.

## ***NOTICE***

### **MODULE DAMAGE**

Use fast acting fuses to protect the electronic components of the module from overcurrent and reverse polarity of the input/output supplies.

**Failure to follow these instructions can result in equipment damage.**

## Shielding Connection Kit

### Introduction

The BMXXSP.... shielding connection kit allows to connect the cable shielding directly to the ground and not to the module shielding to help protect the system from electromagnetic perturbations.

Connect the shielding on the cordsets for connecting:

- Analog module,
- Counter module,
- Encoder interface module,
- Motion control module,
- An XBT console to the processor (via shielded USB cable).

### Kit References

Each shielding connection kit includes the following components:

- A metal bar
- Two sub-bases

The reference is dependent on the number of slots on the Modicon X80 rack:

Modicon X80 rack	Number of slots	Shielding Connection Kit
BMXXBP0400(H) BMEXBP0400(H)	4	BMXXSP0400
BMXXBP0600(H) BMEXBP0600(H)	6	BMXXSP0600
BMXXBP0800(H) BMEXBP0800(H) BMEXBP0602(H)	8	BMXXSP0800
BMXXBP1200(H) BMEXBP1200(H) BMEXBP1002(H)	12	BMXXSP1200

### Clamping Rings

Use clamping rings to connect the shielding on cordsets to the metal bar of the kit.

**NOTE:** The clamping rings are not included in the shielding connection kit.

Depending on the cable diameter, the clamping rings are available under the following references:

- STBXSP3010: small rings for cables with cross-section 1.5...6 mm<sup>2</sup> (AWG16...10).
- STBXSP3020: large rings for cables with cross-section 5...11 mm<sup>2</sup> (AWG10...7).

## Kit Installation

Installation of the shielding connection kit to the rack can be done with module already installed on the rack except for the BMXXBE0100 rack extender module.

Fasten the sub-bases of the kit at each end of the rack to provide a connection between the cable and the ground screw of the rack:

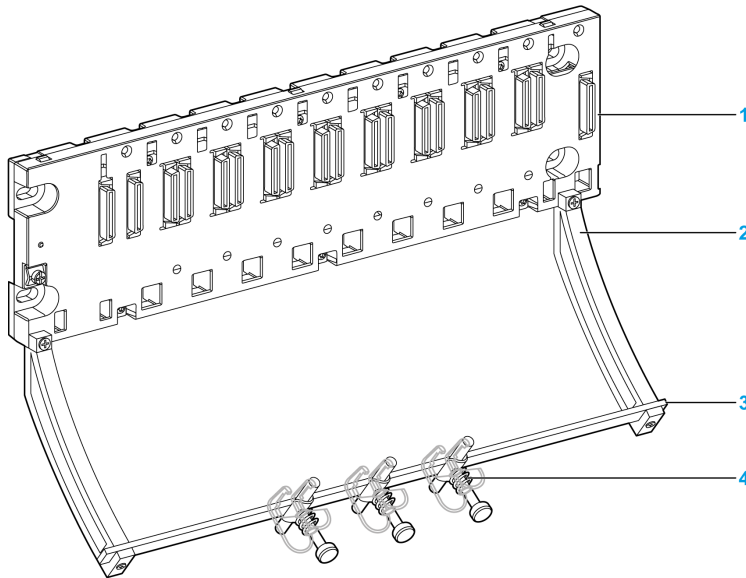

- 1 rack
- 2 sub-base
- 3 metallic bar
- 4 clamping ring

Tightening torques to install the shielding connection kit:

- For the screws fixing the sub-base to the Modicon X80 rack: Max. 0.5 N•m (0.37 lbf-ft)
- For the screws fixing the metallic bar to the sub-bases: Max. 0.75 N•m (0.55 lbf-ft)

**NOTE:** A shielding connection kit does not modify the volume required when installing and uninstalling modules.

**Kit Dimensions**

The following figure gives the dimensions (height and depth) of a Modicon X80 rack with its shielding connection kit:

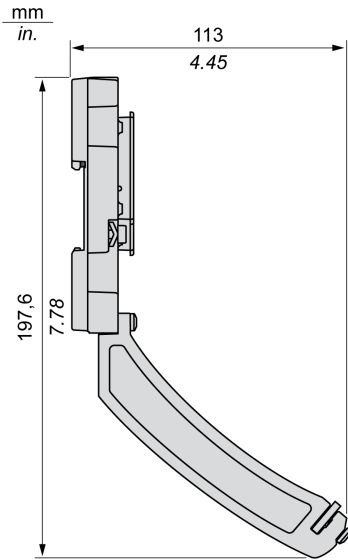

**NOTE:** The overall width equals to the width of the Modicon X80 rack.

---

# Part III

## Counting Module BMX EHC 0200 Functionalities

---



---

# Chapter 6

## BMX EHC 0200 Counting Module Functionalities

---

### Subject of this Chapter

This chapter deals with functionalities and counting modes of the BMX EHC 0200 module.

### What Is in This Chapter?

This chapter contains the following sections:

Section	Topic	Page
6.1	BMX EHC 0200 Module Configuration	56
6.2	BMX EHC 0200 Module Operation Modes	82

# Section 6.1

## BMX EHC 0200 Module Configuration

---

### Subject of this Section

This section deals with the configuration of the BMX EHC 0200 module.

### What Is in This Section?

This section contains the following topics:

Topic	Page
Input Interface Blocks	57
Programmable Filtering	58
Comparison	59
Output Block Functions	62
Diagnostics	67
Synchronization, Homing, Enable, Reset to 0 and Capture Functions	69
Modulo Flag and Synchronization Flag	77
Sending Counting Events to the Application	79



## Input Interface Blocks

### Description

The BMX EHC 0200 counting module has six inputs:

- 3 fast inputs
- 3 classic inputs

### Fast Inputs

The table below presents the module's fast inputs.

Input	Use with sensors	Use with an encoder
IN_A input	Clock input for measurement or single upcounting	For signal A
IN_B input	Second clock input for differential counting or measurement	For signal B
IN_SYNC input	Main synchronization input used for starting and homing	For signal Z Used for homing

### Classic Inputs

The table below presents the module's classic inputs:

Input	Use
IN_EN input	Used to authorize counter operation
IN_REF input	Used for homing in advanced mode
IN_CAP input	Used for register capture

## Programmable Filtering

### At a Glance

The BMX EHC 0200 counting module's six inputs are compatible with the use of mechanical switches.

A programmable debounce filter with 3 levels (low, medium and high) is available at every input.

### Debounce Filter Diagram

The figure below shows the debounce filter with a low filtering level:

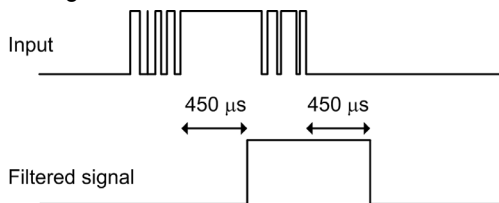

In this mode, the system delays all transitions until the signal is stable for 450 μs.

### Selecting the Filtering Level

The table below specifies the characteristics of each input for the selected level of filtering:

Filtering level	Input	Maximum delay	Minimum pulse	Maximum frequency
None	IN_A, IN_B	-	5 μs	60 KHz
	IN_SYNC	-	5 μs	200 Hz
	IN_EN	50 μs	-	-
	IN_CAP, IN_REF	-	50 μs	200 Hz
Low for bounces > 2 KHz	IN_A, IN_B	-	450 μs	1 KHz
	IN_EN	450 μs	-	-
	IN_SYNC, IN_CAP, IN_REF	-	500 μs	200 Hz
Resource for bounces > 1 KHz	IN_A, IN_B	-	1.25 ms	350 Hz
	IN_EN	1.25 ms	-	-
	IN_SYNC, IN_CAP, IN_REF	-	1.25 ms	200 Hz
High for bounces > 250 Hz	IN_A, IN_B	-	4.2 ms	100 Hz
	IN_EN	4.2 ms	-	-
	IN_SYNC, IN_CAP, IN_REF	-	4.2 ms	100 Hz

## Comparison

### At a Glance

The comparison block operates automatically. This block is available in certain counting modes:

- Frequency
- Period measuring
- Ratio
- One shot counter
- Modulo loop counter
- Free large counter

### Comparison Thresholds

The comparison block has two thresholds:

- The upper threshold: `upper_th_value` double word (%QDr.m.c.4)
- The lower threshold: `lower_th_value` double word (%QDr.m.c.2)

The upper threshold value must be greater than the lower threshold value.

If the upper threshold is less than or equal to the lower threshold, the lower threshold does not change but it is ignored.

This rule takes into account the format of the counter value.

### Comparison Status Register

The result of the comparison is stored in the `compare_status` register (%IWr.m.c.1).

The values of the two capture registers and the current value of the counter are compared with the thresholds.

The possible results are:

- Low: The value is less than the lower threshold value.
- Window: The value is between the upper and lower thresholds or equal to one of the two thresholds.
- High: The value is greater than the upper threshold.

The `compare_enabler` register (%IWr.m.c.1) consists of:

<b>Status register bit</b>	15	14	13	12	11	10	9	8	7	6	5	4	3	2	1	0
<b>Compared element</b>								Capture 1			Capture 0			Counter		
<b>Comparison result</b>								High	Window	Low	High	Window	Low	High	Window	Low

**Update**

When the `compare_enable` bit (`%QWr.m.c.0.5`) is set to 0, the comparison status register is deleted.

The comparison with capture 0 and capture 1 registers values is performed every time the registers are loaded.

The comparison with the counter current value is performed as follows:

Counting mode	Registers updating
Frequency	Intervals of 10 ms
Period measuring	At the end of the period
Ratio	Intervals of 10 ms
Event counting	Period intervals defined by the user
One shot counter	Intervals of 1 ms Counter reloading Counter stops Threshold crossing
Modulo loop	Intervals of 1 ms Counter reloading or resetting to 0 Counter stops Threshold crossing
Free large counter	Intervals of 1 ms Counter reloading Threshold crossing
Pulse width modulation	Function not available in this mode

### Modification of the Thresholds during the Operational Phase

When the `compare_enable` bit (`%QWr.m.c.0.5`) is set to 0, the comparison status register is deleted.

When the `compare_suspend` bit (`%QWr.m.c.0.6`) is set to 1, the value of the comparison status register is frozen until the bit switches back to 0.

The application may change threshold values without causing any disturbance when the `compare_suspend` bit (`%QWr.m.c.0.6`) is set to 1.

This functionality allows modifying the application thresholds without modifying the status register behaviour.

When this bit switches back to 0, the comparisons restart with new threshold values.

The following figure illustrates the actions of the `compare_enable` bit (`%QWr.m.c.0.5`) and the `compare_suspend` bit (`%QWr.m.c.0.6`):

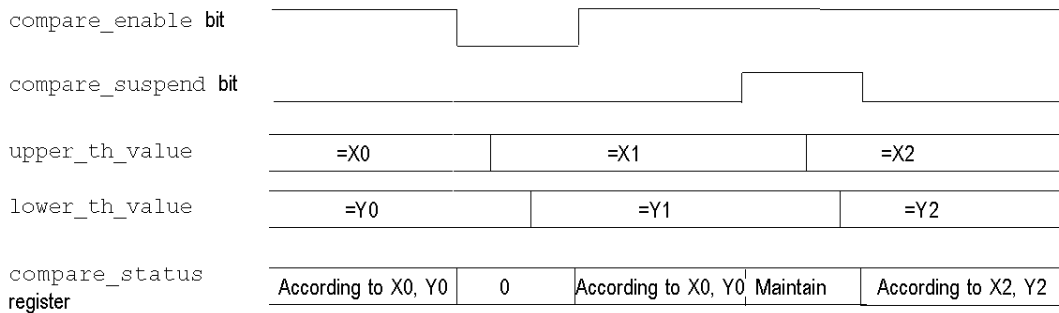

## Output Block Functions

### Output Function Blocks

Every channel in the counting module has two programmable output blocks that operate with the comparison status register and affect the behavior of physical outputs Q0 and Q1.

There are two ways to control the output:

- From the application: in this case, the output corresponds to the status of the output bit from the output command bit.
- From the output function block: in this case, the user must enable the output block function. Then, the output corresponds to the status of the output bit from the function block.

The following figure shows the output function block Q0:

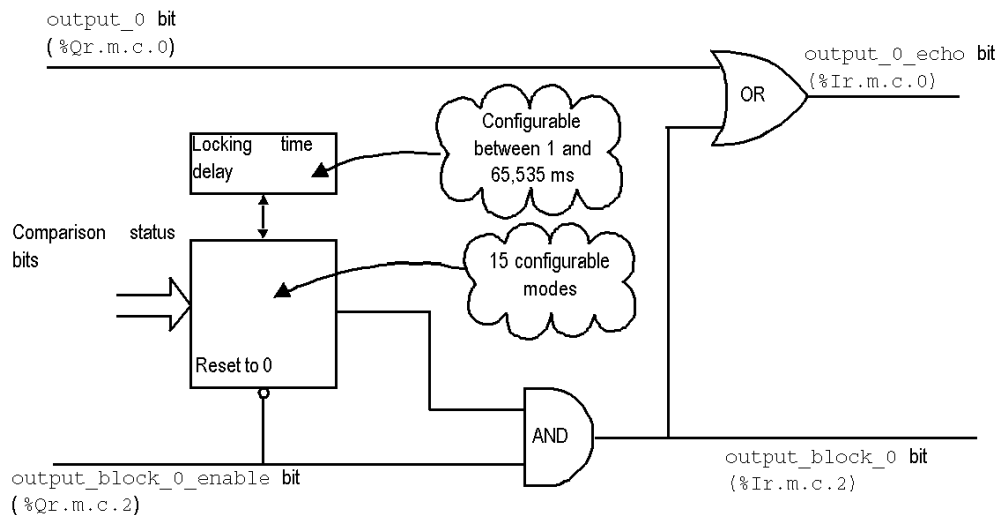

### Use of the Function Block

Every physical output is controlled by two bits:

- `output_block_0_enable (%Qr.m.c.2)` and `output_0 (%Qr.m.c.0)` for block 0
- `output_block_1_enable (%Qr.m.c.3)` and `output_1 (%Qr.m.c.1)` for block 1

The `output_block_0(1)_enable` bit enables the operation of the function block 0(1) to be authorized when it is set to 1. When the bit is set to 0, Bit `output_block_0(1)` is maintained at 0.

The `output_0(1)` bit is applied at the logic output Q0(1) and must be set to 0 when the function block is used. When the bit is set to 1, the output is forced to 1.

In the operational modes where the block generates a pulse, the pulse width can be configured thanks to the configuration screen.

## Output Programming

The table below shows the configurable functions:

Function code	Programming
0	Disabled = no direct action (Default value)
1	Low counter. The output is high if the counter value is less than the low threshold.
2	Counter in a window The output is high if the counter value is between the upper and lower thresholds or equal to one of the two thresholds.
3	High counter. The output is high if the counter value is greater than the upper threshold.
4	Pulse less than the lower threshold. The output pulse starts when the counter value decreases and crosses the lower threshold value -1.
5	Pulse greater than the lower threshold. The output pulse starts when the counter value increases and crosses the lower threshold value +1.
6	Pulse less than the upper threshold. The output pulse starts when the counter value decreases and crosses the upper threshold value -1.
7	Pulse greater than the upper threshold. The output pulse starts when the counter value increases and crosses the upper threshold value +1.
8	Counter stopped (only in one shot counter mode). The output changes to high if the counter is stopped.
9	Counter running (only in one shot counter mode). The output changes to high if the counter is running.
10	Capture 0 low value. The output is high if the capture 0 value is less than the lower threshold.
11	Capture 0 value in a window. The output is high if the capture 0 value is between the upper and lower thresholds or equal to one of the two thresholds.
12	Capture 0 high value. The output is high if the capture 0 value is greater than the upper threshold.
13	Capture1 low value. The output is high if the capture1 value is less than the lower threshold.

Function code	Programming
14	Capture1 value in a window. The output is high if the capture1 value is between the upper and lower thresholds or equal to one of the two thresholds.
15	Capture1 high value. The output is high if the capture1 value is greater than the upper threshold.

**NOTE:** The output 0 function block is inactive when using the counter in pulse width modulation mode.

### Output Performances

In general, these reflex actions act with a delay less than 0.6 ms. The repeatability is about +/- 0.3 ms.

Special boost functions:

- "Counter Low" (function code 1) applied to Output Block 0
- "Counter High" (function code 3) applied to Output Block 1 speed up timing.

Delay is less than 0.2 ms. The repeatability is about +/- 1 s.

### Output Properties

The counting module BMX EHC 0200 enables output signals to be exchanged with two 24VCC field actuators.

It is possible to configure the following parameters for each output:

- The module response for fault recovery
- The output polarity for each counting channel (positive or negative polarity)
- The fallback mode and state for every module channel

These three parameters are described in the following pages.



## Fault Recovery response

Outputs Q0 and Q1 are current limited (0.5 A maximum).

A thermal shutdown protects each output.

When a short-circuit is detected on one of the output channels, the counting module enables one of the two following actions according to the configuration:

- `fault_recovery` parameter configured as `latched off`: The counting module latches off the output channel
- `fault_recovery` parameter configured as `autorecovery`: The counting module latches off the output channel and automatically attempts to recover the error and to resume operation on the channel when the error is corrected.

In case of the `fault_recovery` parameter is configured to `latched off`, if an output channel has been latched off because of short-circuit detection, the counting module recovers the fault upon the following sequence is processed:

- The error has been corrected
- You explicitly reset the fault: To reset the error, the application software must:
  - Reset the `output_block_enable` bit if it is active
  - Command the output to 0 V ( depends on the polarity).

In case of the `fault_recovery` parameter is configured to `auto recovery`, an output channel that has been turned off because of error detection starts operating again as soon as the error is corrected. No user intervention is required to reset the channels.

**NOTE:** A minimum delay of 10 s occurs before the error is cleared in both latched off and auto recovery modes.

## Output Polarity Programming

It is possible to configure the `polarity` parameter for each output during the channel configuration:

- `polarity` parameter configured as `polarity +`: The physical output is 24 VDC when the output is at the high level (`output_0_echo = 1`)
- `polarity` parameter configured as `polarity -`: The physical output is 24 VDC when the output is at the low level (`output_0_echo = 0`)

By default, the two output channels are in positive polarity.

## Output Fallback Modes

The fallback modes are the predefined states to which the output channels revert when the channel is not controlled by the processor (when communications are lost or when the processor is stopped for example).

The fallback mode of each output channel can be configured as one of the following modes:

- Fallback value: With. You may configure the fallback value to apply as 0 or 1
- Fallback value: Without. The output block function continues to operate according to the last received commands.

**NOTE:** By default, the fallback mode of the 2 output channels is `with` and the `fallback value` parameter is 0.

## Diagnostics

### Consistency Rules for Inputs Interface

The input interface requires that the sensor power supply remains active for counting operations. When the sensor power supply interrupts lasts 1 ms or less, the counter remains stable.

In case of power interrupt is greater than 1 ms, all counter values are disabled.

By default, the sensor supply fault makes the CH\_ERROR (%Ir.m.c.ERR) global status bit at the high level and the red led IO lighted.

The configuration screen allows to unlink the sensor supply fault to the CH\_ERROR bit by configuring the parameter Input Supply Fault as local instead of General IO Fault.

IODDT\_VAR1 is of the type T\_Unsigned\_CPT\_BMX or T\_Signed\_CPT\_BMX

### Consistency Rules for Outputs Interface

The output interface requires that the actuator power supply remains active for output blocks functions operations.

When the actuator supply voltage is insufficient the outputs are held to 0 V.

By default, the actuator supply fault makes the CH\_ERROR (%Ir.m.c.ERR) global status bit at the high level and the red led IO lighted.

The configuration screen allows to unlink the actuator supply fault to the CH\_ERROR bit by configuring the parameter Output Supply Fault as local instead of General IO Fault.

IODDT\_VAR1 is of the type T\_Unsigned\_CPT\_BMX or T\_Signed\_CPT\_BMX

### Explicit channel status words

The table below presents the composition of the %MWr.m.c.2 and %MWr.m.c.3 status words:

Status Word	Bit position	Designation
%MWr.m.c.2	0	External fault at inputs
	1	External fault at outputs
	4	Internal error or self-testing.
	5	Configuration Fault
	6	Communication Error
	7	Application fault
%MWr.m.c.3	2	Sensor supply fault
	3	Actuator supply fault
	4	Short circuit on output Q0
	5	Short circuit on output Q1

## IO Data

All input/output statuses are provided in the channel data bits.

The table below shows the channel data bits:

Input/Output data field	Designation
%Ir.m.c.0	Logical state of output Q0
%Ir.m.c.1	Logical state of output Q1
%Ir.m.c.2	State of the output block function 0
%Ir.m.c.3	State of the output block function 1
%Ir.m.c.4	Electrical state of IN_A input
%Ir.m.c.5	Electrical state of IN_B input
%Ir.m.c.6	Electrical state of IN_SYNC input
%Ir.m.c.7	Electrical state of IN_EN input
%Ir.m.c.8	Electrical state of IN_REF input
%Ir.m.c.9	Electrical state of IN_CAP input

## Synchronization, Homing, Enable, Reset to 0 and Capture Functions

### Introduction

This section presents the functions used by the various counting modes of the BMX EHC 0200 module:

- Synchronization function
- Homing function
- Enable function
- Reset to 0 function
- Capture functions

Each function uses at least one of the following two bits:

- `valid_(function)` bit: Setting this bit to 1 allows you to take into account the occurrence of an external event which activates the function. If this bit is set to 0, the event is not taken into account and does not activate the function. The `functions_enabling` word (`%QWr.m.c.0`) contains all the `valid_(function)` bits.
- `force_(function)` bit: Setting this bit to 1 allows you to activate the function irrespective of the status of the external event. All the `force_(function)` bits are `%Qr.m.c.4...%Qr.m.c.8` language objects.

### Synchronization Function

The synchronization function is used to synchronize the counter operation upon a transition applied to the `IN_SYNC` (`%I r.m.c.6`) physical input or the `force_sync` bit set to 1.

This function is usable in the following counting modes:

- Pulse width modulation: to restart the output signal at the beginning (phase at 1)
- Modulo loop counter: to reset and start the counter
- One shot counter: to preset and start the counter
- Event counting: to restart the internal time base at the beginning

The user may configure the `synchro` `edge` parameter in the configuration screen by choosing from the following two possibilities to configure the sensitive edge that carries out the synchronization:

- Rising edge of the `IN_SYNC` input
- Falling edge of the `IN_SYNC` input

The following table presents the *force\_sync* bit in bold which is an element of the %Qr.m.c.d output command word:

Language object	Standard symbol	Meaning
%Qr.m.c.0	OUTPUT_0	Forces OUTPUT_0 to level 1
%Qr.m.c.1	OUTPUT_1	Forces OUTPUT_1 to level 1
%Qr.m.c.2	OUTPUT_BLOCK_0_ENABLE	Implementation of output 0 function block
%Qr.m.c.3	OUTPUT_BLOCK_1_ENABLE	Implementation of output 1 function block
<b>%Qr.m.c.4</b>	<b>FORCE_SYNC</b>	<b>Counting function synchronization and start</b>
%Qr.m.c.5	FORCE_REF	Set to preset counter value
%Qr.m.c.6	FORCE_ENABLE	Implementation of counter
%Qr.m.c.7	FORCE_RESET	Reset counter
%Qr.m.c.8	SYNC_RESET	Reset SYNC_REF_FLAG
%Qr.m.c.9	MODULO_RESET	Reset MODULO_FLAG

The following table presents the *valid\_sync* bit in bold which is an element of the %QWr.m.c.0 function enabling word:

Language object	Standard symbol	Meaning
<b>%QWr.m.c.0.0</b>	<b>VALID_SYNC</b>	<b>Synchronization and start authorization for the counting function via the IN_SYNC input</b>
%QWr.m.c.0.1	VALID_REF	Operation authorization for the internal preset function
%QWr.m.c.0.2	VALID_ENABLE	Authorization of the counter enable via the IN_EN input
%QWr.m.c.0.3	VALID_CAPT_0	Capture authorization in the capture0 register
%QWr.m.c.0.4	VALID_CAPT_1	Capture authorization in the capture1 register
%QWr.m.c.0.5	COMPARE_ENABLE	Comparators operation authorization
%QWr.m.c.0.6	COMPARE_SUSPEND	Comparator frozen at its last value

The following table presents the synchronization principle:

Edge	Status of the <code>valid_sync</code> ( <code>%QWr.m.c.0.0</code> ) bit	Status of the counter
Rising or falling edge on <code>IN_SYNC</code> (depending on the configuration)	Set to 0	Not synchronized
Rising or falling edge on <code>IN_SYNC</code> (depending on the configuration)	Set to 1	Synchronized
Rising edge on <code>force_sync</code> ( <code>%Qr.m.c.4</code> ) bit	Set to 0 or 1	Synchronized

When the synchronization occurs, the application can react using :

- either the `SYNC_REF_FLAG` input (`%IWr.m.c.0.2`) (*see page 77*)
- or the `EVT_SYNC_PRESET` input (`%IWr.m.c.10.2`) (*see page 79*).

### Homing Function

This homing function loads the value predefined in the adjust screen `preset value` (`%MDr.m.c.6`) into the counter when the preset condition (defined by the `preset mode` parameter) occurs. This preset condition takes into account the `IN_SYNC` and `IN_REF` physical inputs to define the reference point of the process.

This function is only used in the free large counter mode.

The user may change the `Preset Mode` parameter in the configuration screen by choosing from the following five possibilities to configure the preset condition:

- Rising edge of the `IN_SYNC` input
- Rising edge of the `IN_REF` input
- Rising edge of the `IN_SYNC` input and high level of the `IN_REF` input
- First rising edge of the `IN_SYNC` input and high level of the `IN_REF` input
- First rising edge of the `IN_SYNC` input and low level of the `IN_REF` input

The following table presents the *force\_ref* bit in bold which is an element of the %Qr.m.c.d output command word:

Language object	Standard symbol	Meaning
%Qr.m.c.0	OUTPUT_0	Forces OUTPUT_0 to level 1
%Qr.m.c.1	OUTPUT_1	Forces OUTPUT_1 to level 1
%Qr.m.c.2	OUTPUT_BLOCK_0_ENABLE	Implementation of output 0 function block
%Qr.m.c.3	OUTPUT_BLOCK_1_ENABLE	Implementation of output 1 function block
%Qr.m.c.4	FORCE_SYNC	Counting function synchronization and start
<b>%Qr.m.c.5</b>	<b>FORCE_REF</b>	<b>Set to preset counter value</b>
%Qr.m.c.6	FORCE_ENABLE	Implementation of counter
%Qr.m.c.7	FORCE_RESET	Reset counter
%Qr.m.c.8	SYNC_RESET	Reset SYNC_REF_FLAG
%Qr.m.c.9	MODULO_RESET	Reset MODULO_FLAG

The following table presents the *valid\_ref* bit in bold which is an element of the %QWr.m.c.0 function enabling word:

Language object	Standard symbol	Meaning
%QWr.m.c.0.0	VALID_SYNC	Synchronization and start authorization for the counting function via the IN_SYNC input
<b>%QWr.m.c.0.1</b>	<b>VALID_REF</b>	<b>Operation authorization for the internal preset function</b>
%QWr.m.c.0.2	VALID_ENABLE	Authorization of the counter enable via the IN_EN input
%QWr.m.c.0.3	VALID_CAPT_0	Capture authorization in the capture0 register
%QWr.m.c.0.4	VALID_CAPT_1	Capture authorization in the capture1 register
%QWr.m.c.0.5	COMPARE_ENABLE	Comparators operation authorization
%QWr.m.c.0.6	COMPARE_SUSPEND	Comparator frozen at its last value



The following table presents the homing principle:

Edge	Status of the <b>valid_ref</b> bit (%QWr.m.c.0.1)	Status of the counter
Homing condition edge (depending on the configuration)	Set to 0	Not preset
Homing condition edge (depending on the configuration)	Set to 1	Preset
Rising edge on <b>force_ref</b> bit (%Qr.m.c.5)	Set to 0 or 1	Preset

When the preset occurs consequently to the preset condition, the application can react using:

- either the SYNC\_REF\_FLAG input (%IW.r.m.c.0.2) (*see page 77*)
- or the EVT\_SYNC\_PRESET input (%IW.r.m.c.10.2) (*see page 79*).

### Enable Function

This function is used to authorize changes to the current counter value depending on the status of the IN\_EN physical input.

This function is used in the following counting modes:

- Pulse width modulation
- Modulo loop counter
- One shot counter
- Free large counter

The following table presents the **force\_enable** bit in bold which is an element of the %Qr.m.c.d output command word:

Language object	Standard symbol	Meaning
%Qr.m.c.0	OUTPUT_0	Forces OUTPUT_0 to level 1
%Qr.m.c.1	OUTPUT_1	Forces OUTPUT_1 to level 1
%Qr.m.c.2	OUTPUT_BLOCK_0_ENABLE	Implementation of output 0 function block
%Qr.m.c.3	OUTPUT_BLOCK_1_ENABLE	Implementation of output 1 function block
%Qr.m.c.4	FORCE_SYNC	Counting function synchronization and start
%Qr.m.c.5	FORCE_REF	Set to preset counter value
<b>%Qr.m.c.6</b>	<b>FORCE_ENABLE</b>	<b>Implementation of counter</b>
%Qr.m.c.7	FORCE_RESET	Reset counter
%Qr.m.c.8	SYNC_RESET	Reset SYNC_REF_FLAG
%Qr.m.c.9	MODULO_RESET	Reset MODULO_FLAG

The following table presents the `valid_enable` bit in bold which is an element of the `%QWr.m.c.0` function enabling word:

Language object	Standard symbol	Meaning
<code>%QWr.m.c.0.0</code>	VALID_SYNC	Synchronization and start authorization for the counting function via the IN_SYNC input
<code>%QWr.m.c.0.1</code>	VALID_REF	Operation authorization for the internal preset function
<code>%QWr.m.c.0.2</code>	<b>VALID_ENABLE</b>	<b>Authorization of the counter enable via the IN_EN input</b>
<code>%QWr.m.c.0.3</code>	VALID_CAPT_0	Capture authorization in the capture0 register
<code>%QWr.m.c.0.4</code>	VALID_CAPT_1	Capture authorization in the capture1 register
<code>%QWr.m.c.0.5</code>	COMPARE_ENABLE	Comparators operation authorization
<code>%QWr.m.c.0.6</code>	COMPARE_SUSPEND	Comparator frozen at its last value

The following table presents the validation principle:

Condition	Status of the <code>valid_enable</code> bit ( <code>%QWr.m.c.0.2</code> ) and <code>force_enable</code> bit ( <code>%Qr.m.c.6</code> )	Status of the counter
IN_EN set to 1	The 2 bits are set to 0	Not counting (frozen)
IN_EN set to 1	At least one of the two bits is set to 1	Counting (free)

## Reset to 0 Function

This function is used to load the value 0 into the counter via software command.

This function is used in the following counting modes:

- Free large counter
- Modulo loop counter
- One shot counter

The following table presents the `force_reset` bit in bold which is an element of the `%Qr.m.c.d` output command word:

Language object	Standard symbol	Meaning
<code>%Qr.m.c.0</code>	OUTPUT_0	Forces OUTPUT_0 to level 1
<code>%Qr.m.c.1</code>	OUTPUT_1	Forces OUTPUT_1 to level 1
<code>%Qr.m.c.2</code>	OUTPUT_BLOCK_0_ENABLE	Implementation of output 0 function block
<code>%Qr.m.c.3</code>	OUTPUT_BLOCK_1_ENABLE	Implementation of output 1 function block
<code>%Qr.m.c.4</code>	FORCE_SYNC	Counting function synchronization and start
<code>%Qr.m.c.5</code>	FORCE_REF	Set to preset counter value
<code>%Qr.m.c.6</code>	FORCE_ENABLE	Implementation of counter
<b><code>%Qr.m.c.7</code></b>	<b>FORCE_RESET</b>	<b>Reset counter</b>
<code>%Qr.m.c.8</code>	SYNC_RESET	Reset SYNC_REF_FLAG
<code>%Qr.m.c.9</code>	MODULO_RESET	Reset MODULO_FLAG

The function is only activated by the rising edge of the `force_reset` bit (`%Qr.m.c.7`). There is no `valid_reset` bit because the function is not activated by any physical input.

## Capture Function

This function allows to store the current counter value into a capture register upon an external condition.

Each BMX EHC 0200 module channel has 2 capture registers:

- `capture0`
- `capture1`.

The capture function is used in the following counting modes:

- Modulo loop counter
- Free large counter.

In the modulo loop counter mode, only the `capture0` function is available.

The function enables to record the current counter value according to the synchronisation condition.

If the `IN_SYNC` input receives the sensitive edge of synchronization (*see page 69*), the current counter value is stored into the `capt_0_val` register (`%IDr.m.c.14`). The `valid_capt_0` bit (`%QWr.m.c.0.3`) must be set to 1 to operate.

When the synchronization is required at the same time (with the `valid_sync` bit set to 1) the storage into the `capt_0_val` register occurs just before resetting the current counter value.

In the free large counter mode, both `capture0` and `capture1` registers are available.

The `capture1` function always stores the current counter value into the `capt_1_val` register (`%IDr.m.c.16`) as soon as the `IN_CAP` input receives a rising edge. The `valid_capt_1` bit (`%QWr.m.c.0.4`) must be set to 1 to operate.

The `capture0` function can be configured as one of the following 2 conditions:

- Preset condition
- Falling edge of the `IN_CAP` input.

The `valid_capt_0` bit (`%QWr.m.c.0.3`) must be set to 1 to operate.

If the `capture0` function is configured as the preset condition, the function stores the current counter value into the `capt_0_val` register (`%IDr.m.c.4`) when the defined preset condition (*see page 71*) occurs.

When the preset is required at the same time (with the `valid_ref` bit set to 1) the storage into the `capt_0_val` register occurs just before loading the current counter value at the preset value.

In all cases, the current counter value must be valid before the capture event (the `validity` bit (`%IWwr.m.c.0.3`) set to 1)

## Modulo Flag and Synchronization Flag

### At a Glance

This section presents the operation of the bits relating to the following events:

- Synchronization or counter homing event, depending on the counting mode.
- Counter rollovers the modulo or its limits in forward or reverse.

The table below presents the counting modes that may activate synchronization, homing and modulo events:

Flag	Counting mode concerned
sync_ref_flag bit (%IW <sub>r</sub> .m.c.0.2)	<ul style="list-style-type: none"> <li>• Free Large counter: When the counter presets</li> <li>• Modulo loop counter: When the counter resets</li> <li>• One shot counting: When the counter presets and starts</li> </ul>
modulo_flag bit (%IW <sub>r</sub> .m.c.0.1)	<ul style="list-style-type: none"> <li>• Modulo loop counter: When the counter rollovers the modulo or 0</li> <li>• Free large counter: When the counter rollovers its limits.</li> </ul>

### Operation of the Flag Bits

The synchronization or homing event's flag bit is set to 1 when a counter synchronization or homing occurs.

The modulo event's flag bit is set to 1 in the following counting modes:

- Modulo loop counter mode: the flag bit is set to 1 when the counter rollovers the modulo
- Free large counter mode: the flag bit is set to 1 when the counter rollovers its limits in forward or reverse

### Location of the Flag Bits

The following table presents the modulo\_flag and sync\_ref\_flag bits which are elements of the %IW<sub>r</sub>.m.c.d status word:

Language object	Standard symbol	Meaning
%IW <sub>r</sub> .m.c.0.0	RUN	The counter operates in one shot mode only
%IW <sub>r</sub> .m.c.0.1	MODULO_FLAG	<b>Flag set to 1 by a modulo switch event</b>
%IW <sub>r</sub> .m.c.0.2	SYNC_REF_FLAG	<b>Flag set to 1 by a preset or synchronization event</b>
%IW <sub>r</sub> .m.c.0.3	VALIDITY	The current numerical value is valid
%IW <sub>r</sub> .m.c.0.4	HIGH_LIMIT	The current numerical value is locked at the upper threshold value
%IW <sub>r</sub> .m.c.0.5	LOW_LIMIT	The current numerical value is locked at the lower threshold value

### Resetting the Flag Bits to 0

The user application must reset the flag bit to 0 (if it is active) by using the appropriate command bit from the following two bits:

- `sync_reset (%IWr.m.c.8)` bit to reset the synchronization or homing event's flag bit to 0
- `modulo_reset (%IWr.m.c.9)` bit to reset the modulo reached event's flag bit to 0

### Location of Reset to 0 Commands

The following table presents the `sync_reset` and `modulo_reset` bits which are elements of the `%Qr.m.c.d` output command word:

Language object	Standard symbol	Meaning
<code>%Qr.m.c.0</code>	<code>OUTPUT_0</code>	Forces <code>OUTPUT_0</code> to level 1
<code>%Qr.m.c.1</code>	<code>OUTPUT_1</code>	Forces <code>OUTPUT_1</code> to level 1
<code>%Qr.m.c.2</code>	<code>OUTPUT_BLOCK_0_ENABLE</code>	Implementation of output 0 function block
<code>%Qr.m.c.3</code>	<code>OUTPUT_BLOCK_1_ENABLE</code>	Implementation of output 1 function block
<code>%Qr.m.c.4</code>	<code>FORCE_SYNC</code>	Counting function synchronization and start
<code>%Qr.m.c.5</code>	<code>FORCE_REF</code>	Set to preset counter value
<code>%Qr.m.c.6</code>	<code>FORCE_ENABLE</code>	Implementation of counter
<code>%Qr.m.c.7</code>	<code>FORCE_RESET</code>	Reset counter
<b><code>%Qr.m.c.8</code></b>	<b><code>SYNC_RESET</code></b>	<b>Reset <code>SYNC_REF_FLAG</code></b>
<b><code>%Qr.m.c.9</code></b>	<b><code>MODULO_RESET</code></b>	<b>Reset <code>MODULO_FLAG</code></b>

## Sending Counting Events to the Application

### At a Glance

The event task number must be declared in the module's configuration screen to enable the events sending.

The BMX EHC 0200 module has eight event sources contained in the `events_source` word at the address `%IWr.m.c.10`:

Address	Standard Symbol	Description	Counting mode concerned
<code>%IW<sub>r</sub>.m.c.10.0</code>	<code>EVT_RUN</code>	Event due to start of counting.	One Shot Counter mode
<code>%IW<sub>r</sub>.m.c.10.1</code>	<code>EVT_MODULO</code>	Event due to counter being equal to modulo value - 1 or equal to value 0.	<ul style="list-style-type: none"> <li>● Modulo Loop Counter Mode</li> <li>● Free Large Counter mode</li> </ul>
<code>%IW<sub>r</sub>.m.c.10.2</code>	<code>EVT_SYNC_PRESET</code>	Event due to a synchronization or counter homing.	<ul style="list-style-type: none"> <li>● Event Counting mode</li> <li>● One Shot Counter mode</li> <li>● Modulo Loop Counter mode</li> <li>● Free Large Counter mode</li> </ul>
<code>%IW<sub>r</sub>.m.c.10.3</code>	<code>EVT_COUNTER_LOW</code>	Event due to counter being less than the lower threshold.	<ul style="list-style-type: none"> <li>● Frequency mode</li> <li>● Event Counting mode</li> <li>● Period Measuring mode</li> <li>● Ratio mode</li> <li>● One Shot Counter mode</li> <li>● Modulo Loop Counter mode</li> <li>● Free Large Counter mode</li> </ul>
<code>%IW<sub>r</sub>.m.c.10.4</code>	<code>EVT_COUNTER_WINDOW</code>	Event due to counter being between the upper and lower thresholds.	<ul style="list-style-type: none"> <li>● Frequency mode</li> <li>● Event Counting mode</li> <li>● Period Measuring mode</li> <li>● Ratio mode</li> <li>● One Shot Counter mode</li> <li>● Modulo Loop Counter mode</li> <li>● Free Large Counter mode</li> </ul>
<code>%IW<sub>r</sub>.m.c.10.5</code>	<code>EVT_COUNTER_HIGH</code>	Event due to counter being greater than the upper threshold.	<ul style="list-style-type: none"> <li>● Frequency mode</li> <li>● Event Counting mode</li> <li>● Period Measuring mode</li> <li>● Ratio mode</li> <li>● One Shot Counter mode</li> <li>● Modulo Loop Counter mode</li> <li>● Free Large Counter mode</li> </ul>
<code>%IW<sub>r</sub>.m.c.10.6</code>	<code>EVT_CAPT_0</code>	Event due to capture 0.	<ul style="list-style-type: none"> <li>● Modulo Loop Counter Mode</li> <li>● Free Large Counter mode</li> </ul>
<code>%IW<sub>r</sub>.m.c.10.7</code>	<code>EVT_CAPT_1</code>	Event due to capture 1.	Free Large Counter mode

Address	Standard Symbol	Description	Counting mode concerned
%IW <sub>r</sub> .m.c.10.8	EVT_OVERRUN	Event due to overrun	<ul style="list-style-type: none"> <li>● Frequency mode</li> <li>● Event Counting mode</li> <li>● Period Measuring mode</li> <li>● Ratio mode</li> <li>● One Shot Counter mode</li> <li>● Modulo Loop Counter mode</li> <li>● Free Large Counter mode</li> </ul>

All the events sent by the module, whatever their source, call the same single event task in the PLC.

There is normally only one type of event indicated per call.

The `evt_sources` word (%IW<sub>r</sub>.m.c.10) is updated at the start of the event task processing.

### Enabling Events

In order for a source to produce an event, the validation bit corresponding to the event must be set to 1:

Address	Description
%QW <sub>r</sub> .m.c.1.0	Start of counting event validation bit.
%QW <sub>r</sub> .m.c.1.1	Counter rollovering modulo, 0 or its limits event validation bit.
%QW <sub>r</sub> .m.c.1.2	Synchronization or counter homing event validation bit.
%QW <sub>r</sub> .m.c.1.3	Counter less than lower threshold event validation bit.
%QW <sub>r</sub> .m.c.1.4	Counter between the upper and lower thresholds event validation bit.
%QW <sub>r</sub> .m.c.1.5	Counter greater than upper threshold event validation bit.
%QW <sub>r</sub> .m.c.1.6	Capture 0 event validation bit.
%QW <sub>r</sub> .m.c.1.7	Capture 1 event validation bit.

### Input Interface

The event only has one input interface. This interface is only updated at the start of the event task processing. The interface consists of:

- The `evt_sources` word (%IW<sub>r</sub>.m.c.10)
- The current value of the counter during the event (or an approximate value) contained in the `counter_value` word (%ID<sub>r</sub>.m.c.12)
- The `capt_0_val` register (%ID<sub>r</sub>.m.c.14) updated if the event is the capture 0
- The `capt_1_val` register (%ID<sub>r</sub>.m.c.16) updated if the event is the capture 1



### Operating Limits

Each counter channel can produce a maximum of one event per millisecond, but this flow may be slowed down by simultaneously sending events to several modules on the PLC bus.

Each counter channel has a four slot transmission buffer which can be used to store several events while waiting to be sent.

If the channel is unable to send all of the internally produced events, the `overrun_evt` bit (`%IWr.m.c.10.8`) of the `evt_sources` word is set to 1.

## Section 6.2

### BMX EHC 0200 Module Operation Modes

---

#### Subject of this Section

This section deals with the different counting modes of the BMX EHC 0200 module.

#### What Is in This Section?

This section contains the following topics:

Topic	Page
BMX EHC 0200 Module Operation in Frequency Mode	83
BMX EHC 0200 Module Operation in Event Counting Mode	84
BMX EHC 0200 Module Operation in Period Measuring Mode	86
BMX EHC 0200 Module Operation in Ratio Mode	89
BMX EHC 0200 Module Operation in One Shot Counter Mode	92
BMX EHC 0200 Module Operation in Modulo Loop Counter Mode	95
BMX EHC 0200 Module Operation in Free Large Counter Mode	99
BMX EHC 0200 Module Operation in Pulse Width Modulation Mode	107

## BMX EHC 0200 Module Operation in Frequency Mode

### At a Glance

Using the frequency mode allows you to measure an event frequency, speed, rate and flow.

### Basic Principle

In this mode, the module monitors the pulses applied only to the IN\_A input and calculates the number of pulses in time intervals of 1 s. The current frequency is then shown in number of events per second (hertz). The counting register is updated at the end of each 10 ms interval.

### Counter Status Bits in Frequency Mode

The table below shows the composition of the counter's `%IWr.m.c.0` status word in frequency mode.

Bit	Label	Description
<code>%IWr.m.c.0.3</code>	VALIDITY	Validity bit is used to indicate that the counter current value (frequency) and compare status registers contain valid data. If the bit is set to 1, the data is valid. If the bit is set to 0, the data is not valid.
<code>%IWr.m.c.0.4</code>	HIGH_LIMIT	The bit is set to 1 when the input frequency signal is out of range.

### Type of the IODDT

In this mode, the type of the IODDT must be `T_UNSIGNED_CPT_BMX`.

### Operating Limits

The maximum frequency that the module can measure on the IN\_A input is 60 kHz. Beyond 60 kHz, the counting register value may decrease until it reaches 0. Beyond 60 kHz and up to the real cut-off frequency of 100 kHz, the module may indicate that it has exceeded the frequency limit.

When there is a variation in frequency, the value restoration time is 1 s with a value precision of 1 Hz. When there is a very significant variation in frequency, an accelerator enables you to restore the frequency value with a precision of 10 Hz in 0.1 s.

The maximum duty cycle at 60 KHz is 60%.

**NOTE:** You have to check the `validity` bit (`%IWr.m.c.0.3`) before taking into account the numerical values such as the counter and the capture registers. Only the `validity` bit at the high level (set to 1) guarantees that the mode will operate correctly within the limits.

## BMX EHC 0200 Module Operation in Event Counting Mode

### At a Glance

Using the event counting mode allows you to determine the number of events received in a scattered manner.

### Basic Principle

In this mode, the counter assesses the number of pulses applied at the IN\_A input, at time intervals defined by the user. The counting register is updated at the end of each interval with the number of events received.

It is possible to use the IN\_SYNC input over a time interval, provided that the validation bit is set to 1. This restarts the event counting for a new predefined time interval. Depending on the selection made by the user, the time interval starts at the rising edge or at the falling edge on the IN\_SYNC input.

### Operation

The trend diagram below illustrates the counting process in event counting mode:

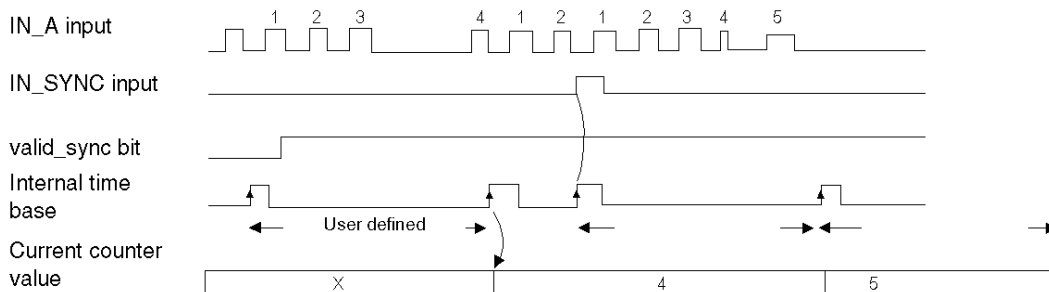

### Counter Status Bits in Event Counting Mode

The table below shows the composition of the counter's `%IWr.m.c.0` status word in event counting mode:

Bit	Label	Description
<code>%IWr.m.c.0.2</code>	SYNC_REF_FLAG	The bit is set to 1 when the internal time base has been synchronized. The bit is set to 0 when the <code>sync_reset</code> command is received (rising edge of the <code>%Qr.m.c.8</code> bit).
<code>%IWr.m.c.0.3</code>	VALIDITY	Validity bit is used to indicate that the counter current value (events number) and compare status registers contain valid data. If the bit is set to 1, the data is valid. If the bit is set to 0, the data is not valid.
<code>%IWr.m.c.0.4</code>	HIGH_LIMIT	The bit is set to 1 when the number of received events exceeds the counter size. The bit is reset to 0 at the next period if the limit is not reached.
<code>%IWr.m.c.0.5</code>	LOW_LIMIT	The bit is set to 1 when more than one synchronization is received within 5 ms period. The bit is reset to 0 at the next period if the limit is not reached.

### Type of the IODDT

In this mode, the type of the IODDT must be `T_UNSIGNED_CPT_BMX`.

### Operating Limits

The module counts the pulses applied at the `IN_A` input every time the pulse duration is greater than 5  $\mu$ s (without debounce filter).

The synchronization of the counter must not be done more than one time per 5 ms.

**NOTE:** You have to check the `validity` bit (`%IWr.m.c.0.3`) before taking into account the numerical values such as the counter and the capture registers. Only the `validity` bit at the high level (set to 1) guarantees that the mode will operate correctly within the limits.

## BMX EHC 0200 Module Operation in Period Measuring Mode

### At a Glance

Using the period measuring mode allows to:

- determine the duration of an event.
- determine the time between two events.
- set and measure the execution time for a process.

### Basic Principle

This counting mode consists of two sub-modes:

- Rising edge to falling edge mode (edge to opposite): allows you to measure the duration of an event.
- Rising edge to rising edge mode (edge to edge): allows you to measure the length of time between two events.

The user may also use the IN\_SYNC input to enable or stop a measurement. It is also possible to specify a time out value in the configuration screen. This function allows to stop a measurement that exceeds this time out. In this case, the counting register is not valid until the next complete measurement.

The units used to measure the length of time of an event or between two events are defined by the user (1  $\mu$ s, 100  $\mu$ s or 1 ms).

### Edge to Opposite Mode

In this sub-mode, the measurement is taken between the rising edge and the falling edge of the IN\_A input. The counting register is updated as soon as the falling edge is detected.

The trend diagram below shows the operating mode of the edge to opposite sub-mode:

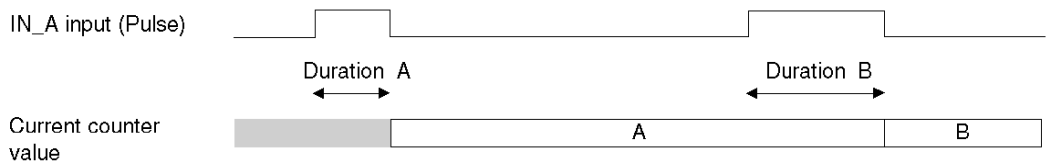

### Edge to Edge Mode

In this sub-mode, the measurement is taken between two rising edges of the IN\_A input. The counting register is updated as soon as the second rising edge is detected.

The trend diagram below shows the operating mode of the edge to edge sub-mode:

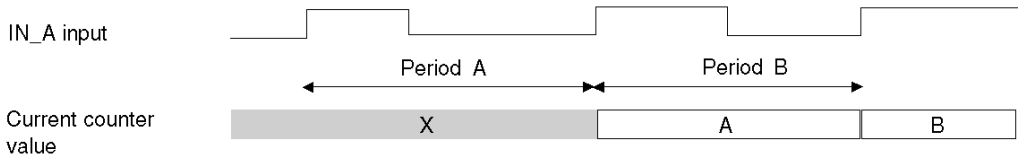

### Using the Synchronization Function

The trend diagram below illustrates the period measurement counting process in edge to opposite mode when using the synchronization function:

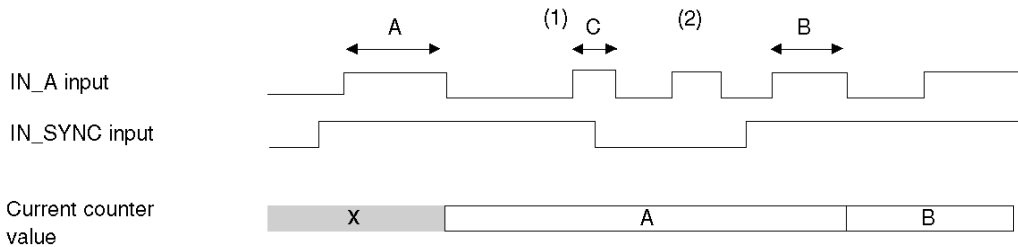

- (1) The falling edge of the IN\_SYNC input stops measurement C.
- (2) This pulse is not measured because the IN\_SYNC input is not at the high level.

**NOTE:** The `valid_sync` bit (`%QWr.m.c.0.0`) must be set to 1 to enable the IN\_SYNC input. If the IN\_SYNC input is not wired, the application must force the setting of the `force_sync` bit (`%Qr.m.c.4`) to 1 to authorize the measurements.

### Counter Status Bits in Period Measuring Mode

The table below shows the composition of the counter's `%IWr.m.c.0` status word in period measuring mode:

Bit	Label	Description
<code>%IW<sub>r</sub>.m.c.0.3</code>	VALIDITY	Validity bit is used to indicate that the counter current value (period value) and compare status registers contain valid data. If the bit is set to 1, the data is valid. If the bit is set to 0, the data is not valid.
<code>%IW<sub>r</sub>.m.c.0.4</code>	HIGH_LIMIT	The bit is set to 1 when the measured period exceeds the user-defined timeout. The bit is reset to 0 at the next period if the timeout is not reached.
<code>%IW<sub>r</sub>.m.c.0.5</code>	LOW_LIMIT	The bit is set to 1 when more than one measure occurs within 5 ms period. The bit is reset to 0 at the next period if the limit is not reached.

### Type of the IODDT

In this mode, the type of the IODDT must be `T_UNSIGNED_CPT_BMX`.

### Operating Limits

The module can perform a maximum of 1 measurement every 5 ms.

The shortest pulse that can be measured is 100  $\mu$ s, even if the unit defined by the user is 1  $\mu$ s.

The maximum duration that can be measured is 1,073,741,823 units of time (unit defined by the user).

**NOTE:** You have to check the `validity` bit (`%IWr.m.c.0.3`) before taking into account the numerical values such as the counter and the capture registers. Only the `validity` bit at the high level (set to 1) guarantees that the mode will operate correctly within the limits.



## BMX EHC 0200 Module Operation in Ratio Mode

### At a Glance

The ratio mode only uses the IN\_A and IN\_B inputs. This counting mode consists of two sub-modes:

- Ratio 1: is used to divide two frequencies (Frequency IN\_A / Frequency IN\_B) and is useful, for example, in applications such as flowmeters and mixers.
- Ratio 2: is used to subtract two frequencies (Frequency IN\_A - Frequency IN\_B) and is used in the same applications but which require more precise adjustment (closer frequencies).

**NOTE:** A positive value indicates that the frequency measured on the IN\_A input is greater than the frequency measured on the IN\_B input.

A negative value indicates that the frequency measured on the IN\_A input is less than the frequency measured on the IN\_B input.

### Ratio 1 Mode

The figure below shows BMX EHC 0200 module operation in Ratio 1 mode.

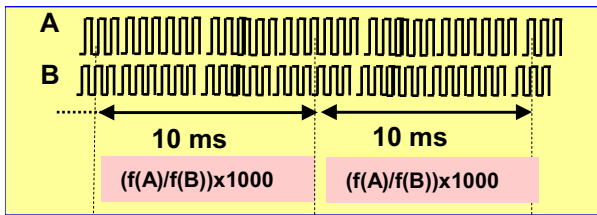

In this mode, the counter evaluates the ratio between the number of rising edges of the IN\_A input and the number of rising edges of the IN\_B input over a period of 1 s. The register value is updated every 10 ms.

An absolute limit value is declared on the configuration screen. If this limit value is exceeded, the counter\_value register (%IDr.m.c.12) is disabled by setting the validity bit (%IW.r.m.c.0.3) to 0.

If no frequency is applied to the IN\_A or IN\_B inputs, the counter\_value register (%IDr.m.c.12) is disabled by setting the validity bit (%IW.r.m.c.0.3) to 0.

**NOTE:** The ratio 1 mode presents the results in thousandths in order to have greater level of precision (where 2,000 is displayed, this corresponds to a value of 2).

### Ratio 2 Mode

The figure below shows BMX EHC 0200 module operation in Ratio 2 mode.

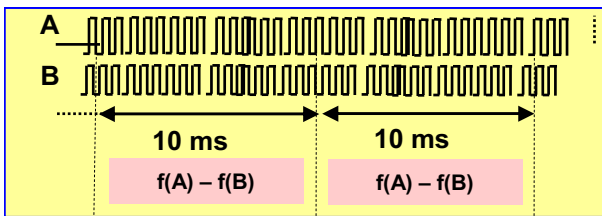

In this mode, the counter evaluates the difference between the number of rising edges of the IN\_A input and the number of rising edges of the IN\_B input over a period of 1 s. The `counter_value` register (`%IDr.m.c.12`) is updated at the end of each 10 ms interval.

An absolute limit value is declared on the configuration screen. If this limit value is exceeded, the `counter_value` register (`%IDr.m.c.12`) is disabled and the `validity bit` (`%IWrr.m.c.0.3`) to 0.

### Counter Status Bits in Ratio Mode

The table below shows bits that are used by the status word `%IWrr.m.c.0` when the counter is configured in ratio mode:

Bit	Label	Description
<code>%IWrr.m.c.0.3</code>	VALIDITY	Validity bit is used to indicate that the counter current value (ratio value) and compare status registers contain valid data. If the bit is set to 1, the data is valid. If the bit is set to 0, the data is not valid.
<code>%IWrr.m.c.0.4</code>	HIGH_LIMIT	The bit signals a error when the ratio exceeds the absolute limit. The bit is set to 1 when frequency to IN_A becomes too fast. The bit is reset to 0 when the frequency to IN_A remains correct.
<code>%IWrr.m.c.0.5</code>	LOW_LIMIT	The bit signals a error when the ratio exceeds the absolute limit. The bit is set to 1 when frequency to IN_B becomes too fast. The bit is reset to 0 when the frequency to IN_B remains correct.

### Type of the IODDT

In this mode, the type of the IODDT must be `T_SIGNED_CPT_BMX`.

### Operating Limits

The maximum frequency that the module can measure on the IN\_A and IN\_B inputs is 60 kHz.

The measured values are between -60,000,000,000 and +60,000,000,000.

**NOTE:** You have to check the `validity` bit (`%IWr.m.c.0.3`) before taking into account the numerical values such as the counter and the capture registers. Only the `validity` bit at the high level (set to 1) guarantees that the mode will operate correctly within the limits.

## BMX EHC 0200 Module Operation in One Shot Counter Mode

### At a Glance

Using the one shot counter mode allows you to quantify a group of parts.

### Basic Principle

In this mode, activating the synchronization function starts the counter which, starting from a value defined by the user in the adjust screen (`preset value`), decreases with every pulse applied to the IN\_A input until it reaches the value 0. Downcounting is made possible when the enable function is activated. The counting register is thus updated every 1 ms.

One basic use of this mode is, using an output, to indicate the end of a group of operations (when the counter reaches 0).

### Operation

The trend diagram below illustrates the counting process in one shot counter mode:

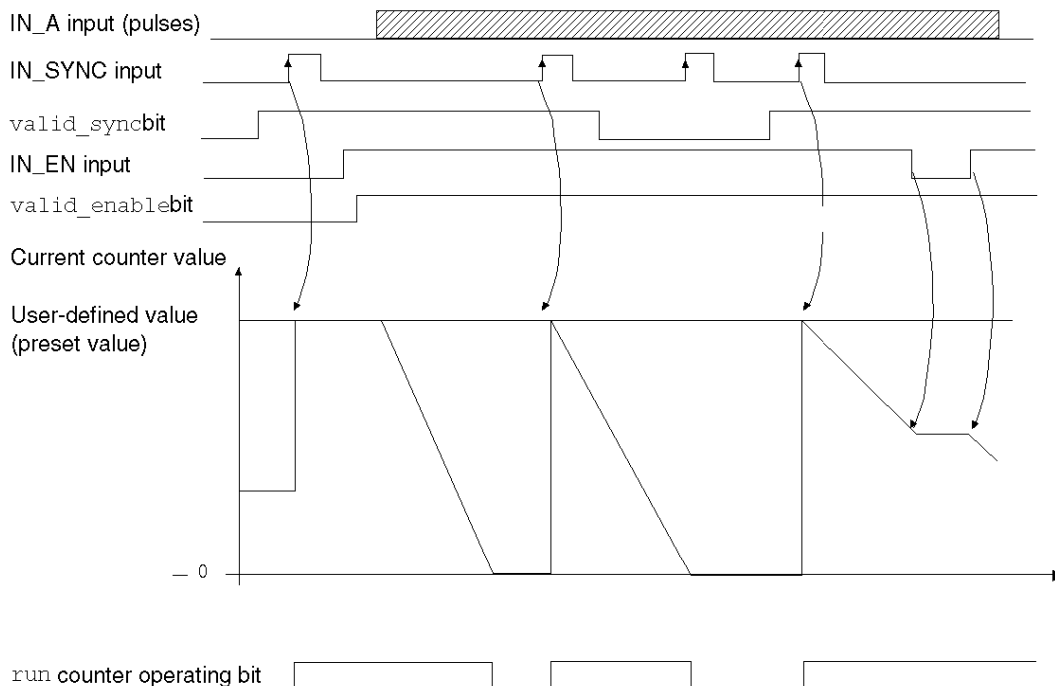

In the trend diagram above, we can see that the counter is set to the preset value at the IN\_SYNC input's rising edge. Then, the counter decrements the counting register with every pulse applied to the IN\_A input. When the register is set to 0, the counter awaits a new signal from the IN\_SYNC input. The IN\_A input pulses have no effect on the register value as long as the counter is set to 0.

The enable function must be activated during the counting by:

- setting to 1 the `force_enable` bit
- setting to 1 the `valid_enable` bit and when the IN\_EN input is at the high level

When the enable function is deactivated, the last value reported in the counting register is maintained and the counter ignores the pulses applied to the IN\_A input. However, it does not ignore the IN\_SYNC input status.

Each time the counter starts a downcounting operation, the `run` bit switches to the high level. It switches to the low level when the register value reaches 0.

**NOTE:** The pulses applied to IN\_SYNC and IN\_EN inputs are only taken into account when the inputs are enabled (*see page 73*).

The value defined by the user (preset value) is contained in the word `%MDr.m.c.6`. The user may change this value by specifying the value of this word by configuring the parameter in the adjust screen or by using the `WRITE_PARAM(IODDT_VAR1)` Function. `IODDT_VAR1` is of the type `T_UNSIGNED_CPT_BMX`. This value change is only taken into account by the module after one of the following conditions has been established:

- At the next synchronization if the counter is stopped (`run` bit set to 0)
- At the second synchronization if the counter is activated (`run` bit set to 1).

### Counter Status Bits in One shot Counter Mode

The table below shows bits that are used by the status word `%IW_r.m.c.0` when the counter is configured in one shot counter mode:

Bit	Label	Description
<code>%IW_r.m.c.0.0</code>	RUN	The bit is set to 1 when the counter is running. The bit is set to 0 when the counter is stopped.
<code>%IW_r.m.c.0.2</code>	SYNC_REF_FLAG	The bit is set to 1 when the counter has been set to the preset value and (re)started. The bit is reset to 0 when the <code>sync_reset</code> command is received (rising edge of the <code>%Qr.m.c.8</code> bit).
<code>%IW_r.m.c.0.3</code>	VALIDITY	Validity bit is used to indicate that the counter current value and compare status registers contain valid data. If the bit is set to 1, the data is valid. If the bit is set to 0, the data is not valid.

### Type of the IODDT

In this mode, the type of the IODDT must be `T_UNSIGNED_CPT_BMX`.

### Operating Limits

The maximum frequency that can be applied to the IN\_SYNC input is 1 pulse every 5 ms.

The maximum value defined by the user (preset value) is 4,294,967,295.

**NOTE:** You have to check the `validity` bit (`%IWr.m.c.0.3`) before taking into account the numerical values such as the counter and the capture registers. Only the `validity` bit at the high level (set to 1) guarantees that the mode will operate correctly within the limits.

## BMX EHC 0200 Module Operation in Modulo Loop Counter Mode

### At a Glance

The use of the modulo loop counter mode is recommended for packaging and labeling applications for which actions are repeated for series of moving objects.

### Basic Principle

In the upcounting direction, the counter increases until it reaches the modulo value -1, the modulo value being defined by the user. At the following pulse in the counting direction, the counter is reset to 0 and the counting resumes.

In the downcounting direction, the counter decreases until it reaches 0. At the next pulse in the counting direction, the counter is reset to the modulo value -1, the modulo value being defined by the user. The downcounting may then be resumed.

The enable function must be activated during the counting by:

- Setting to 1 the `force_enable` bit (`%Qr.m.c.6`)
- Setting to 1 the `valid_enable` bit (`%QWr.m.c.0.2`) when the `IN_EN` input is at the high level

When the enable function is deactivated, the last value reported in the counting register is maintained and the counter ignores the pulses applied to the `IN_A` input. However, it does not ignore the preset condition.

In the modulo loop counter mode, the counter must be synchronized at least one time to operate. The current counter value is cleared each time the synchronization occurs.

The current counter value can be recorded into the `capture0` register (*see page 76*) when the condition of synchronization occurs (*see page 69*).

The modulo value defined by the user is contained in the `modulo_value` word `%MDr.m.c.4`. The user may change this value by specifying the value of this word:

- In the `ajust` screen
- In the application, using the `WRITE_PARAM(IODDT_VAR1)` Function. `IODDT_VAR1` is of the type `T_UNSIGNED_CPT_BMX`.

The new modulo value is acknowledged if one of the two following conditions is met:

- The synchronization is activated
- The counter rollovers the value 0 in the downcounting direction or the modulo value -1 (this value is the modulo value recorded before editing the new modulo value) in the upcounting direction.

### Counting Interface

In this mode, the user may select one of the following counting configurations:

- A = Up, B = Down (default configuration)
- A = Impulse, B = Direction
- Normal Quadrature X1
- Normal Quadrature X2
- Normal Quadrature X4
- Reverse Quadrature X1
- Reverse Quadrature X2
- Reverse Quadrature X4.

The following table shows the upcounting and downcounting principle according to the selected configuration:

Selected configuration	Upcounting condition	Downcounting condition
A = Up, B = Down	Rising edge at the IN_A input.	Rising edge at the IN_B input.
A = Impulse, B = Direction	Rising edge at the IN_A input and low state at the IN_B input.	Rising edge at the IN_A input and high state at the IN_B input.
Normal Quadrature X1	Rising edge at the IN_A input and low state at the IN_B input.	Falling edge at the IN_A input and low state at the IN_B input
Normal Quadrature X2	Rising edge at the IN_A input and low state at the IN_B input. Falling edge at the IN_A input and high state at the IN_B input.	Falling edge at the IN_A input and low state at the IN_B input. Rising edge at the IN_A input and high level at the IN_B input.
Normal Quadrature X4	Rising edge at the IN_A input and low state at the IN_B input. High state at the IN_A input and rising edge at the IN_B input. Falling edge at the IN_A input and high state at the IN_B input. Low state at the IN_A input and falling edge at the IN_B input.	Falling edge at the IN_A input and low state at the IN_B input. Low state at the IN_A input and rising edge at the IN_B input. Rising edge at the IN_A input and high level at the IN_B input. High state at the IN_A input and falling edge at the IN_B input.
Reverse Quadrature X1	Falling edge at the IN_A input and low state at the IN_B input.	Rising edge at the IN_A input and low state at the IN_B input.
Reverse Quadrature X2	Falling edge at the IN_A input and low state at the IN_B input. Rising edge at the IN_A input and high level at the IN_B input.	Rising edge at the IN_A input and low state at the IN_B input. Falling edge at the IN_A input and high state at the IN_B input.



Selected configuration	Upcounting condition	Downcounting condition
Reserve Quadrature X4	Falling edge at the IN_A input and low state at the IN_B input. Low state at the IN_A input and rising edge at the IN_B input. Rising edge at the IN_A input and high level at the IN_B input. High state at the IN_A input and falling edge at the IN_B input.	Rising edge at the IN_A input and low state at the IN_B input. High state at the IN_A input and rising edge at the IN_B input. Falling edge at the IN_A input and high state at the IN_B input. Low state at the IN_A input and falling edge at the IN_B input.

**Operation**

The trend dithe modulo counting process in the configuration by default (IN\_A = counting, In\_B = downcounting):

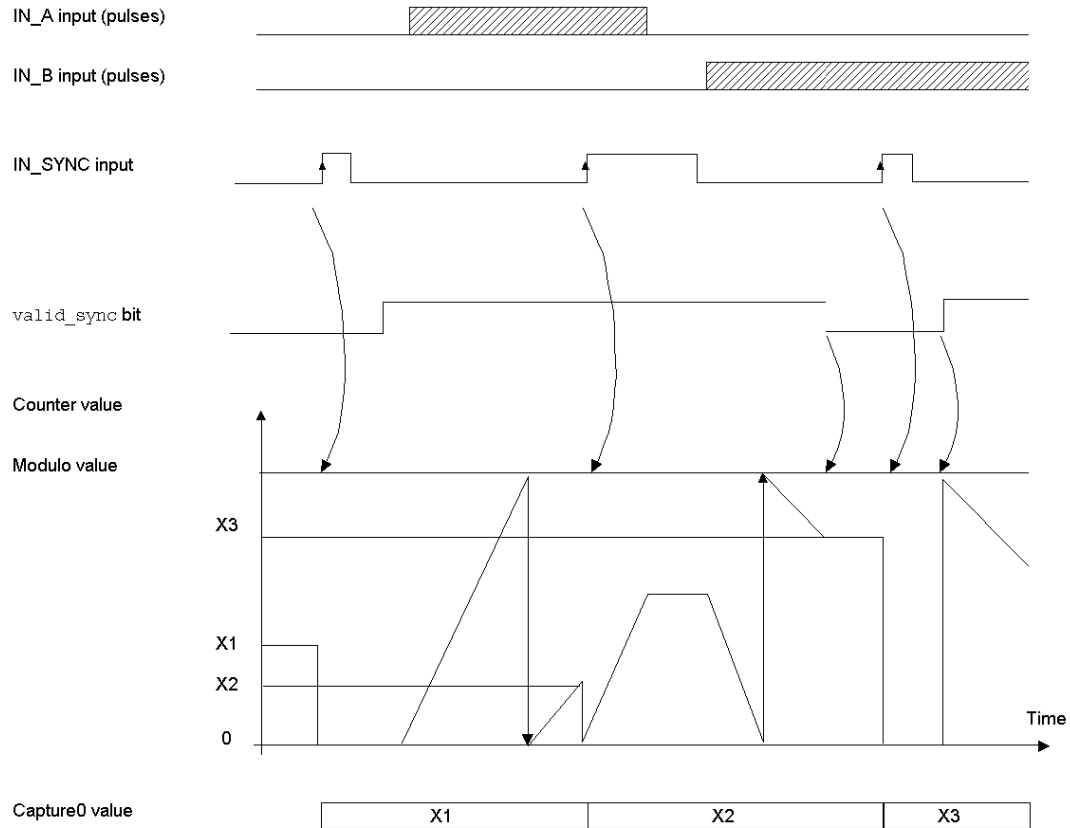

### Counter Status Bits in Modulo Loop Counter Mode

The table below shows the composition of the counter's `%IWr.m.c.0` status word in modulo loop counter mode:

Bit	Label	Description
<code>%IW<sub>r</sub>.m.c.0.1</code>	MODULO_FLAG	The bit is set to 1 when the counter rollovers the modulo and is . The bit is reset to 0 when the command <code>MODULO_RESET (%Q<sub>r</sub>.m.c.9)</code> is received (rising edge of the <code>MODULO_RESET</code> bit).
<code>%IW<sub>r</sub>.m.c.0.2</code>	SYNC_REF_FLAG	The bit is set to 1 when the counter have been set to 0 and (re)started. The bit is reset to 0 when the command <code>SYNC_RESET (%Q<sub>r</sub>.m.c.8)</code> is received (rising edge of the <code>SYNC_RESET</code> bit).
<code>%IW<sub>r</sub>.m.c.0.3</code>	VALIDITY	Validity bit is used to indicate that the counter current value and compare status registers contain valid data. If the bit is set to 1, the data is valid. If the bit is set to 0, the data is not valid.

### Type of the IODDT

In this mode, the type of the IODDT must be `T_UNSIGNED_CPT_BMX`.

### Operating Limits

The maximum frequency that can be applied to the `IN_SYNC` input is 1 pulse every 5 ms.

The maximum frequency for the modulo event is once every 5 ms.

The maximum value for the defined modulo value and the counter is 4,294,967,295.

**NOTE:** You have to check the `validity` bit (`%IWr.m.c.0.3`) before taking into account the numerical values such as the counter and the capture registers. Only the `validity` bit at the high level (set to 1) guarantees that the mode will operate correctly within the limits.

## BMX EHC 0200 Module Operation in Free Large Counter Mode

### At a Glance

The use of the free large counter mode is especially recommended for axis monitoring or labeling where the incoming position of each part has to be learned.

### Basic Principle

The upcounting (or downcounting) starts as soon as the homing function is completed.

The enable function must be activated during the counting by:

- Setting to 1 the `force_enable` bit (`%Qr.m.c.6`)
- Setting to 1 the `valid_enable` bit (`%QWr.m.c.0.2`) when the `IN_EN` input is at the high level.

When the enable function is deactivated, the last value reported in the counting register is maintained and the counter ignores the pulses applied to the `IN_A` input. However, it does not ignore the preset condition.

In the free large counter mode, the counter must be preset at least one time to operate. The current counter value is load with the `preset_value` each time the preset condition occurs.

The current counter can be recorded into the `capture0` register when the preset condition occurs or using the `IN_CAP` input.

The current counter value can be stored into the `capture1` register using the `IN_CAP` input.

For further information, you may see the synchronization function (*see page 69*) and the capture function (*see page 76*).

In the free large counter mode, the counting register is updated at 1 ms intervals.

### Counting Configurations

In this mode, the user may select one of the following counting configurations:

- A = Up, B = Down (default configuration)
- A = Impulse, B = Direction
- Normal Quadrature X1
- Normal Quadrature X2
- Normal Quadrature X4
- Reverse Quadrature X1
- Reverse Quadrature X2
- Reverse Quadrature X4

The following table shows the upcounting and downcounting principle according to the selected configuration:

Selected configuration	Upcounting condition	Downcounting condition
A = Up, B = Down	Rising edge at the IN_A input.	Rising edge at the IN_B input.
A = Impulse, B = Direction	Rising edge at the IN_A input and low state at the IN_B input.	Rising edge at the IN_A input and high state at the IN_B input.
Normal Quadrature X1	Rising edge at the IN_A input and low state at the IN_B input.	Falling edge at the IN_A input and low state at the IN_B input
Normal Quadrature X2	Rising edge at the IN_A input and low state at the IN_B input. Falling edge at the IN_A input and high state at the IN_B input.	Falling edge at the IN_A input and low state at the IN_B input. Rising edge at the IN_A input and high level at the IN_B input.
Normal Quadrature X4	Rising edge at the IN_A input and low state at the IN_B input. High state at the IN_A input and rising edge at the IN_B input. Falling edge at the IN_A input and high state at the IN_B input. Low state at the IN_A input and falling edge at the IN_B input.	Falling edge at the IN_A input and low state at the IN_B input. Low state at the IN_A input and rising edge at the IN_B input. Rising edge at the IN_A input and high level at the IN_B input. High state at the IN_A input and falling edge at the IN_B input.
Reverse Quadrature X1	Falling edge at the IN_A input and low state at the IN_B input.	Rising edge at the IN_A input and low state at the IN_B input.
Reverse Quadrature X2	Falling edge at the IN_A input and low state at the IN_B input. Rising edge at the IN_A input and high level at the IN_B input.	Rising edge at the IN_A input and low state at the IN_B input. Falling edge at the IN_A input and high state at the IN_B input.

Selected configuration	Upcounting condition	Downcounting condition
Reserve Quadrature X4	Falling edge at the IN_A input and low state at the IN_B input. Low state at the IN_A input and rising edge at the IN_B input. Rising edge at the IN_A input and high level at the IN_B input. High state at the IN_A input and falling edge at the IN_B input.	Rising edge at the IN_A input and low state at the IN_B input. High state at the IN_A input and rising edge at the IN_B input. Falling edge at the IN_A input and high state at the IN_B input. Low state at the IN_A input and falling edge at the IN_B input.

### Homing Function

This function allows to record the `current_counter_value` register in the `capt_0_val` register and/or to set the `current_counter_value` register to the user-predefined parameter `preset_value`.

The value defined by the user as `preset_value` is contained in the `%MDr.m.c.4` word.

The user may change this value by specifying the value of this word:

- In the `ajust` screen
- In the application, by using the `WRITE_PARAM( IODDT_VAR1 )` Function. `IODDT_VAR1` is of the type `T_SIGNED_CPT_BMX`.

For further information, you may see the homing function (*see page 71*) and the capture function (*see page 76*).

The module configuration enables you to select the following homing conditions:

- Rising edge of the IN\_SYNC input (default)
- Rising edge of the IN\_REF input
- Rising edge of the IN\_SYNC input at the IN\_REF input's high level:

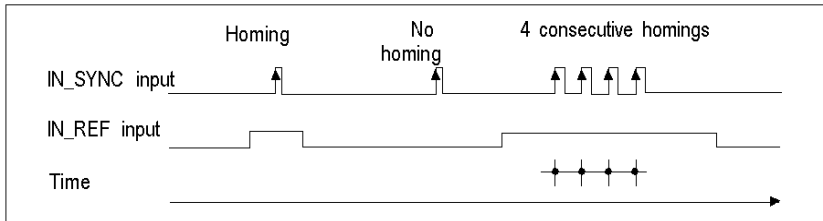

⬆ moment when the homing is carried out

- First rising edge of the IN\_SYNC input and high level at the IN\_REF input

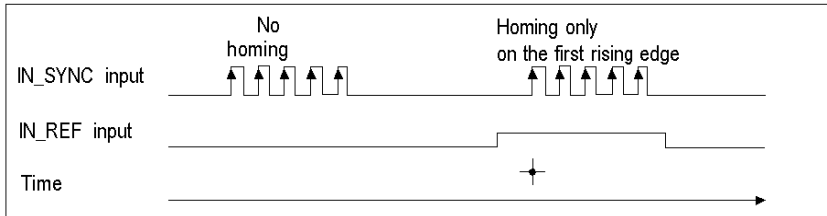

✦ moment when the homing is carried out

- First rising edge of the IN\_SYNC input and low level at the IN\_REF input

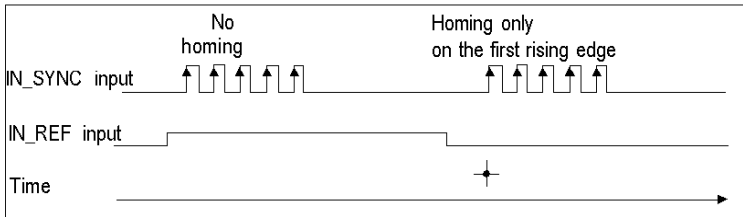

✦ moment when the homing is carried out

**Operation**

The trend diagram below illustrates the counting process for a free large counter in the configuration by default:

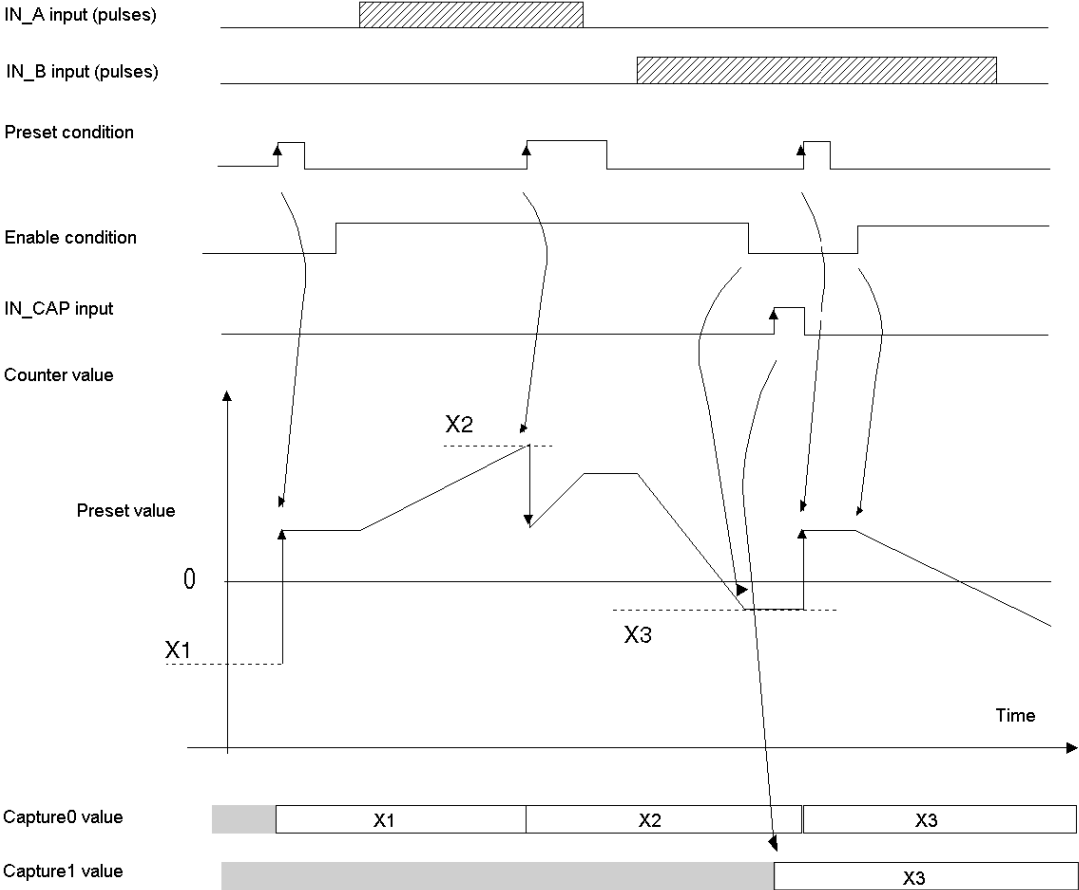

### Behavior at the Counting Limits

When the upper or lower limit is exceeded, the counter behaves differently according to its configuration.

In the lock on limits default configuration, the counting register maintains the limit value once it has been reached and the counting validity bit changes to 0 until the next preset condition occurs:

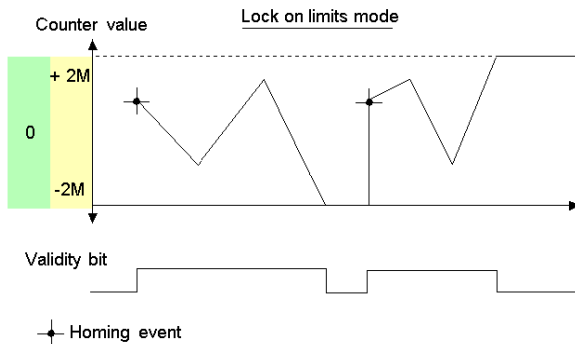

**NOTE:** Overflow or underflow is indicated by two bits `LOW_LIMIT` and `HIGH_LIMIT` until the application reloads the counting value predefined by the user (`force_ref` bit set to 1 or preset condition true). The upcounting or downcounting may therefore resume.

In the rollover configuration, the counting register switches to the opposite limit value when one of the two limits is exceeded:

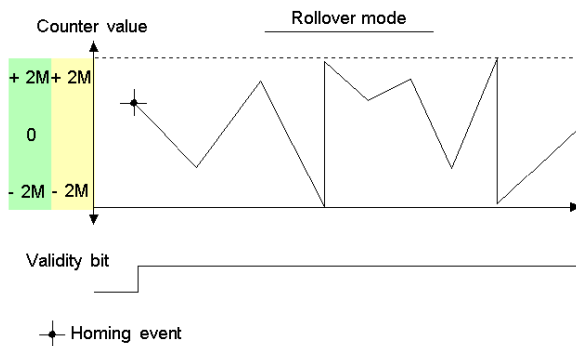



## Slack Delete

In the free large counter mode, the counter may apply a hysteresis if the rotation is inverted. The `hysteresis` parameter configured with the adjust screen defines the number of points that are not acknowledged by the counter during the rotation inversion. This aims to take into account the slack between the encoder/motor axis and the mechanical axis (e.g. an encoder measuring the position of a mat).

This behavior is described in the following figure:

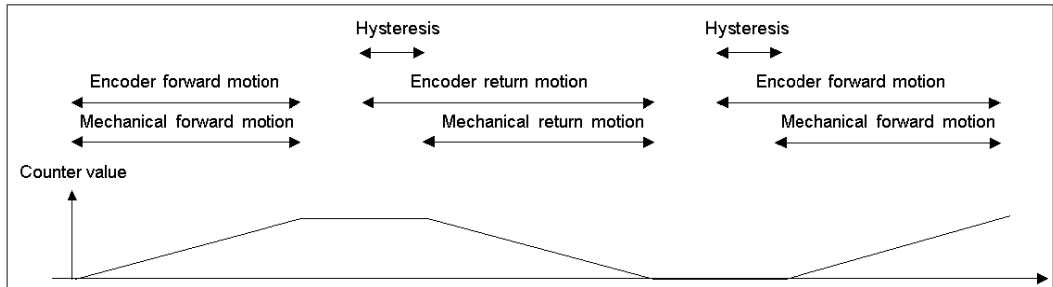

The value defined by the user as the `Hysteresis (slack)` value is contained in the `%MWr.m.c.9` word. The user may change this value by specifying the value of this word (this value is from 0 to 255):

- In the adjust screen
- In the application by using the `WRITE_PARAM(IODDT_VAR1)` Function. `IODDT_VAR1` is of the type `T_SIGNED_CPT_BMX`.

## Counter Status Bits in Free Large Counter Mode

The table below shows the composition of the counter's `%IWr.m.c.0` status word in free large counter mode:

Bit	Label	Description
<code>%IWr.m.c.0.1</code>	MODULO_FLAG	The bit status changes in the rollover mode. The bit is set to 1 when the counter rollovers its limits (-2,147,483,648 or +2,147,483,647). The bit is reset to 0 when the command <code>MODULO_RESET</code> ( <code>%Qr.m.c.9</code> ) is received (rising edge of the <code>MODULO_RESET</code> bit).
<code>%IWr.m.c.0.2</code>	SYNC_REF_FLAG	The bit is set to 1 when the counter have been set to the preset value and (re)started. The bit is reset to 0 when the command <code>SYNC_RESET</code> ( <code>%Qr.m.c.8</code> ) is received (rising edge of the <code>SYNC_RESET</code> bit).
<code>%IWr.m.c.0.3</code>	VALIDITY	Validity bit is used to indicate that the counter current value and compare status registers contain valid data. If the bit is set to 1, the data is valid. If the bit is set to 0, the data is not valid.
<code>%IWr.m.c.0.4</code>	HIGH_LIMIT	The bit status changes in the lock on limits mode. The bit is set to 1 when the counter reaches +2,147,483,647. The bit is reset to 0 when the counter presets or resets.
<code>%IWr.m.c.0.5</code>	LOW_LIMIT	The bit status changes in the lock on limits mode. The bit is set to 1 when the counter reaches -2,147,483,648. The bit is reset to 0 when the counter presets or resets.

## Type of the IODDT

In this mode, the type of the IODDT must be `T_SIGNED_CPT_BMX`.

## Operating Limits

The shortest pulse applied to the `IN_SYNC` input is 100  $\mu$ s.

The maximum homing event frequency is once every 5 ms.

The counter value is between -2,147,483,648 and +2,147,483,647.

**NOTE:** You have to check the `validity` bit (`%IWr.m.c.0.3`) before taking into account the numerical values such as the counter and the capture registers. Only the `validity` bit at the high level (set to 1) guarantees that the mode will operate correctly within the limits.

## BMX EHC 0200 Module Operation in Pulse Width Modulation Mode

### At a Glance

In this operating mode, the module uses an internal clock generator to supply a periodic signal at the module's Q0 output. Only the Q0 output is concerned by this mode as the Q1 output is independent of this mode.

### Basic Principle

The `output_block_0_enable` command bit (`%Qr.m.c.2`) must be set to 1 in order to enable a modulation at the Q0 output.

The active validation function enables the operation of the internal clock generator that produces the output signal to be validated.

The active synchronization function enables the output signal to be synchronized by resetting to 0 the internal clock generator.

The wave form of the output signal depends on:

- The `pwm_frequency` value (`%QDr.m.c.6`): it defines the frequency from 0.1 Hz (value is equal to 1) to 4 KHz (value is equal to 40,000), in increments of 0.1 Hz
- The `pwm_duty` value (`%QWr.m.c.8`): it defines the duty cycle from 5 % (value is equal to 1) to 95 % (value is equal to 19) in increments of 5 %.

The following figure shows the operation of the module in the pulse width modulation mode:

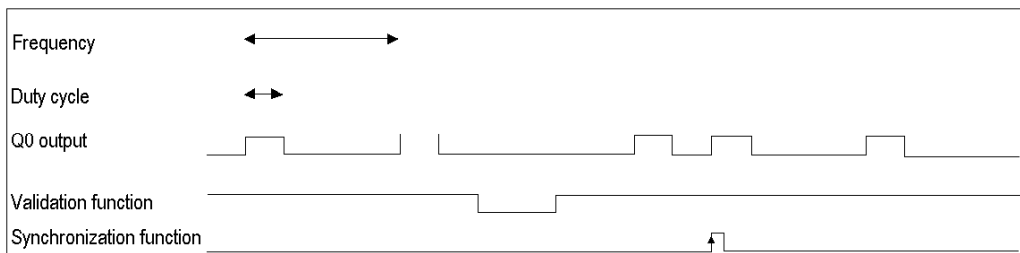

### Counter Status Bits in Pulse Width Modulation Mode

The table below shows the composition of the counter's %IW<sub>r.m.c.0</sub> status word in pulse width modulation mode:

Bit	Label	Description
%IW <sub>r.m.c.0.3</sub>	VALIDITY	Validity bit is used to indicate that the output data (frequency and duty cycle) under current value and compare status registers contain valid data. If the bit is set to 1, the data is valid. If the bit is set to 0, the data is not valid.
%IW <sub>r.m.c.0.4</sub>	HIGH_LIMIT	The output frequency or the duty cycle is out of range (high limit).
%IW <sub>r.m.c.0.5</sub>	LOW_LIMIT	The output frequency or the duty cycle is out of range (low limit).

### Type of the IODDT

In this mode, the type of the IODDT must be T\_UNSIGNED\_CPT\_BMX.

### Operating Limits

The maximum output frequency is 4 kHz.

The maximum frequency that can be applied to the IN\_SYNC input is 1 pulse every 5 ms.

The Q0 driver is "source type", therefore a load resistance is required to switch the output signal Q0 to 0 V using the correct frequency. We recommend a load resistance of 250 Ω.

The allowed duty cycle varies according to the frequency of the Q0 output.

The table below shows duty cycle values according to the selected frequency. These values must be observed for normal operation:

Frequency	Duty cycle
0.1... 250 Hz	95% - 5%
251... 500 Hz	90% - 10%
501... 1 000 Hz	80% - 20%
1001... 1 500 Hz	70% - 30%
1501... 2 000 Hz	60% - 40%
2 001... 2 500 Hz	50%
2 5001... 4 000 Hz	50% (See following note )

**NOTE:** If the frequency and the duty cycle do not respect this table, the output and the validity bit (%IW<sub>r.m.c.0.3</sub>) remains in the low state.

**NOTE:** You have to check the validity bit (%IW<sub>r.m.c.0.3</sub>) before taking into account the numerical values such as the counter and the capture registers. Only the validity bit at the high level (set to 1) guarantees that the mode will operate correctly within the limits.

**NOTE:** From 2501 Hz to 4000 Hz, the 50% ratio is not guaranteed on output.

---

# Part IV

## Counting Module BMX EHC 0200 Software Implementation

---

### Subject of this Part

This part describes the software implementation and functions of the BMX EHC 0200 counting module.

**NOTE:** This part concerns also the hardened module BMX EHC 0200H.

### What Is in This Part?

This part contains the following chapters:

Chapter	Chapter Name	Page
7	Software Implementation Methodology for BMX EHC xxxx Counting Modules	111
8	Accessing the Functional Screens of the BMX EHC xxxx Counting Modules	113
9	Configuration of the BMX EHC 0200 Counting Modules	119
10	BMX EHC xxxx Counting Module Settings	143
11	Debugging the BMX EHC 0200 Counting Modules	151
12	Display of BMX EHC xxxx Counting Module Error	167
13	The Language Objects of the Counting Function	173



---

# Chapter 7

## Software Implementation Methodology for BMX EHC xxxx Counting Modules

---

### Installation Methodology

#### At a Glance

The software installation of the BMX EHC \*\*\*\* counting modules is carried out from the various Control Expert editors:

- in offline mode,
- in online mode.

The following order of installation phases is recommended but it is possible to change the order of certain phases (for example, starting with the configuration phase).

#### Installation Phases

The following table shows the different installation phases:

Phase	Description	Mode
Declaration of variables	Declaration of IODDT-type variables for the application-specific modules and variables of the project.	Offline <sup>(1)</sup>
Programming	Project programming.	Offline <sup>(1)</sup>
Configuration	Declaration of modules.	Offline
	Module channel configuration	
	Entering the configuration parameters <b>Note:</b> All the parameters are configurable online except the <code>event</code> parameter.	Offline <sup>(1)</sup>
Association	Association of IODDTs with the channels configured (variable editor)	Offline <sup>(1)</sup>
Build	Project generation (analysis and editing of links)	Offline
Transfer	Transfer project to PLC	Online
Adjustment/ Debugging	Debug project from debug screens, animation tables	Online
	Debugging the program and adjustment parameters	
Documentation	Building documentation file and printing miscellaneous information relating to the project	Online <sup>(1)</sup>

Phase	Description	Mode
Operation/ Diagnostic	Displaying miscellaneous information necessary for supervisory control of the project	Online
	Diagnostics of project and modules	
Key:		
(1)	These various phases can also be performed in online mode	



---

# Chapter 8

## Accessing the Functional Screens of the BMX EHC xxxx Counting Modules

---

### Subject of this Chapter

This chapter describes the various functional screens of the BMX EHC •••• counting modules to which the user has access.

### What Is in This Chapter?

This chapter contains the following topics:

Topic	Page
Accessing the Functional Screens of the BMX EHC 0200 Counting Modules	114
Description of the Counting Module Screens	116

## Accessing the Functional Screens of the BMX EHC 0200 Counting Modules

### At a Glance

This section describes how to access the functional screens of the BMX EHC 0200 counting modules.

### Procedure

To access the screens, execute the following actions:

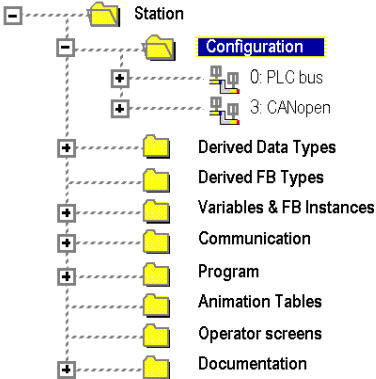
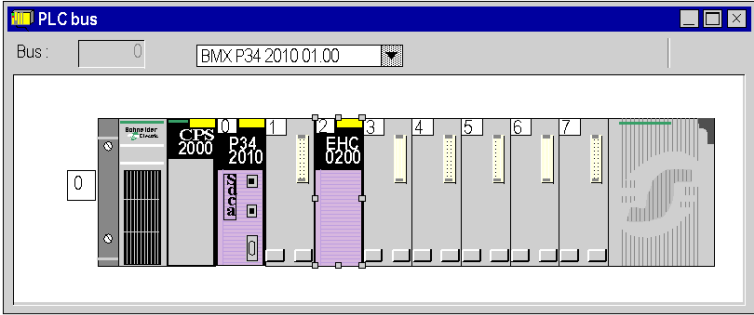
Step	Action
1	<p>Expand the Configuration directory in the project browser.  <b>Result:</b> the following screen appears:</p> 
2	<p>Double-click on the PLC Bus directory.  <b>Result:</b> the following screen appears:</p> 

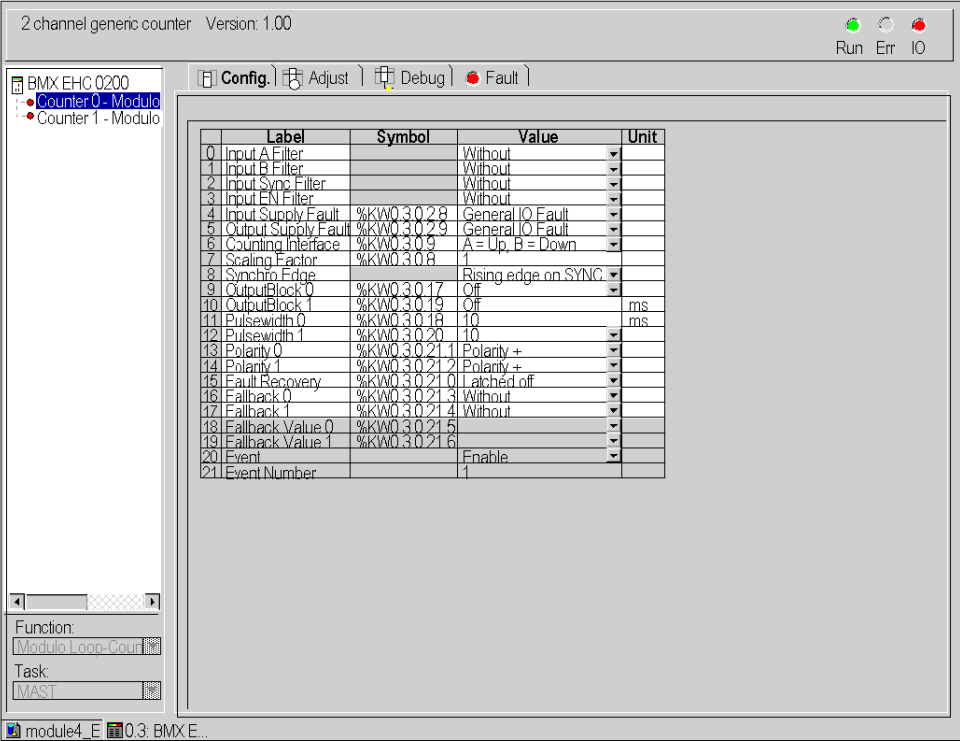
Step	Action																																																																																																																			
3	<p>Double-click on the counting module.  <b>Result:</b> the module screen appears:</p>  <p>The screenshot shows the configuration interface for a '2 channel generic counter' (Version: 1.00). The main area contains a table with the following data:</p> <table border="1"> <thead> <tr> <th></th> <th>Label</th> <th>Symbol</th> <th>Value</th> <th>Unit</th> </tr> </thead> <tbody> <tr><td>0</td><td>Input A Filter</td><td></td><td>Without</td><td></td></tr> <tr><td>1</td><td>Input B Filter</td><td></td><td>Without</td><td></td></tr> <tr><td>2</td><td>Input Sync Filter</td><td></td><td>Without</td><td></td></tr> <tr><td>3</td><td>Input EN Filter</td><td></td><td>Without</td><td></td></tr> <tr><td>4</td><td>Input Supply Fault</td><td>%KWO.3.0.2.8</td><td>General I/O Fault</td><td></td></tr> <tr><td>5</td><td>Output Supply Fault</td><td>%KWO.3.0.2.9</td><td>General I/O Fault</td><td></td></tr> <tr><td>6</td><td>Counting Interface</td><td>%KWO.3.0.9</td><td>A = Up, B = Down</td><td></td></tr> <tr><td>7</td><td>Scaling Factor</td><td>%KWO.3.0.8</td><td>1</td><td></td></tr> <tr><td>8</td><td>SyncIn Edge</td><td></td><td>Rising edge on SYNC</td><td></td></tr> <tr><td>9</td><td>OutputBlock 0</td><td>%KWO.3.0.17</td><td>Off</td><td></td></tr> <tr><td>10</td><td>OutputBlock 1</td><td>%KWO.3.0.19</td><td>Off</td><td>ms</td></tr> <tr><td>11</td><td>Pulsewidth 0</td><td>%KWO.3.0.18</td><td>10</td><td>ms</td></tr> <tr><td>12</td><td>Pulsewidth 1</td><td>%KWO.3.0.20</td><td>10</td><td></td></tr> <tr><td>13</td><td>Polarity 0</td><td>%KWO.3.0.21.1</td><td>Polarity +</td><td></td></tr> <tr><td>14</td><td>Polarity 1</td><td>%KWO.3.0.21.2</td><td>Polarity +</td><td></td></tr> <tr><td>15</td><td>Fault Recovery</td><td>%KWO.3.0.21.0</td><td>Latched off</td><td></td></tr> <tr><td>16</td><td>Fallback 0</td><td>%KWO.3.0.21.3</td><td>Without</td><td></td></tr> <tr><td>17</td><td>Fallback 1</td><td>%KWO.3.0.21.4</td><td>Without</td><td></td></tr> <tr><td>18</td><td>Fallback Value 0</td><td>%KWO.3.0.21.5</td><td></td><td></td></tr> <tr><td>19</td><td>Fallback Value 1</td><td>%KWO.3.0.21.6</td><td></td><td></td></tr> <tr><td>20</td><td>Event</td><td></td><td>Enable</td><td></td></tr> <tr><td>21</td><td>Event Number</td><td></td><td>1</td><td></td></tr> </tbody> </table> <p>Additional interface elements include a left sidebar with a tree view showing 'Counter 0 - Module' and 'Counter 1 - Module', a top toolbar with 'Config.', 'Adjust', 'Debug', and 'Fault' buttons, and a bottom status bar showing 'module4_E 0.3: BMX E...'.</p>		Label	Symbol	Value	Unit	0	Input A Filter		Without		1	Input B Filter		Without		2	Input Sync Filter		Without		3	Input EN Filter		Without		4	Input Supply Fault	%KWO.3.0.2.8	General I/O Fault		5	Output Supply Fault	%KWO.3.0.2.9	General I/O Fault		6	Counting Interface	%KWO.3.0.9	A = Up, B = Down		7	Scaling Factor	%KWO.3.0.8	1		8	SyncIn Edge		Rising edge on SYNC		9	OutputBlock 0	%KWO.3.0.17	Off		10	OutputBlock 1	%KWO.3.0.19	Off	ms	11	Pulsewidth 0	%KWO.3.0.18	10	ms	12	Pulsewidth 1	%KWO.3.0.20	10		13	Polarity 0	%KWO.3.0.21.1	Polarity +		14	Polarity 1	%KWO.3.0.21.2	Polarity +		15	Fault Recovery	%KWO.3.0.21.0	Latched off		16	Fallback 0	%KWO.3.0.21.3	Without		17	Fallback 1	%KWO.3.0.21.4	Without		18	Fallback Value 0	%KWO.3.0.21.5			19	Fallback Value 1	%KWO.3.0.21.6			20	Event		Enable		21	Event Number		1	
	Label	Symbol	Value	Unit																																																																																																																
0	Input A Filter		Without																																																																																																																	
1	Input B Filter		Without																																																																																																																	
2	Input Sync Filter		Without																																																																																																																	
3	Input EN Filter		Without																																																																																																																	
4	Input Supply Fault	%KWO.3.0.2.8	General I/O Fault																																																																																																																	
5	Output Supply Fault	%KWO.3.0.2.9	General I/O Fault																																																																																																																	
6	Counting Interface	%KWO.3.0.9	A = Up, B = Down																																																																																																																	
7	Scaling Factor	%KWO.3.0.8	1																																																																																																																	
8	SyncIn Edge		Rising edge on SYNC																																																																																																																	
9	OutputBlock 0	%KWO.3.0.17	Off																																																																																																																	
10	OutputBlock 1	%KWO.3.0.19	Off	ms																																																																																																																
11	Pulsewidth 0	%KWO.3.0.18	10	ms																																																																																																																
12	Pulsewidth 1	%KWO.3.0.20	10																																																																																																																	
13	Polarity 0	%KWO.3.0.21.1	Polarity +																																																																																																																	
14	Polarity 1	%KWO.3.0.21.2	Polarity +																																																																																																																	
15	Fault Recovery	%KWO.3.0.21.0	Latched off																																																																																																																	
16	Fallback 0	%KWO.3.0.21.3	Without																																																																																																																	
17	Fallback 1	%KWO.3.0.21.4	Without																																																																																																																	
18	Fallback Value 0	%KWO.3.0.21.5																																																																																																																		
19	Fallback Value 1	%KWO.3.0.21.6																																																																																																																		
20	Event		Enable																																																																																																																	
21	Event Number		1																																																																																																																	

## Description of the Counting Module Screens

### Introduction

The various available screens for the BMX EHC 0200 counting modules are:

- Configuration screen
- Adjust screen
- Debug screen (can only be accessed in online mode)
- Faults screen (can only be accessed in online mode)

### Description of the Screens

The following diagram presents the counting modules configuration screen.

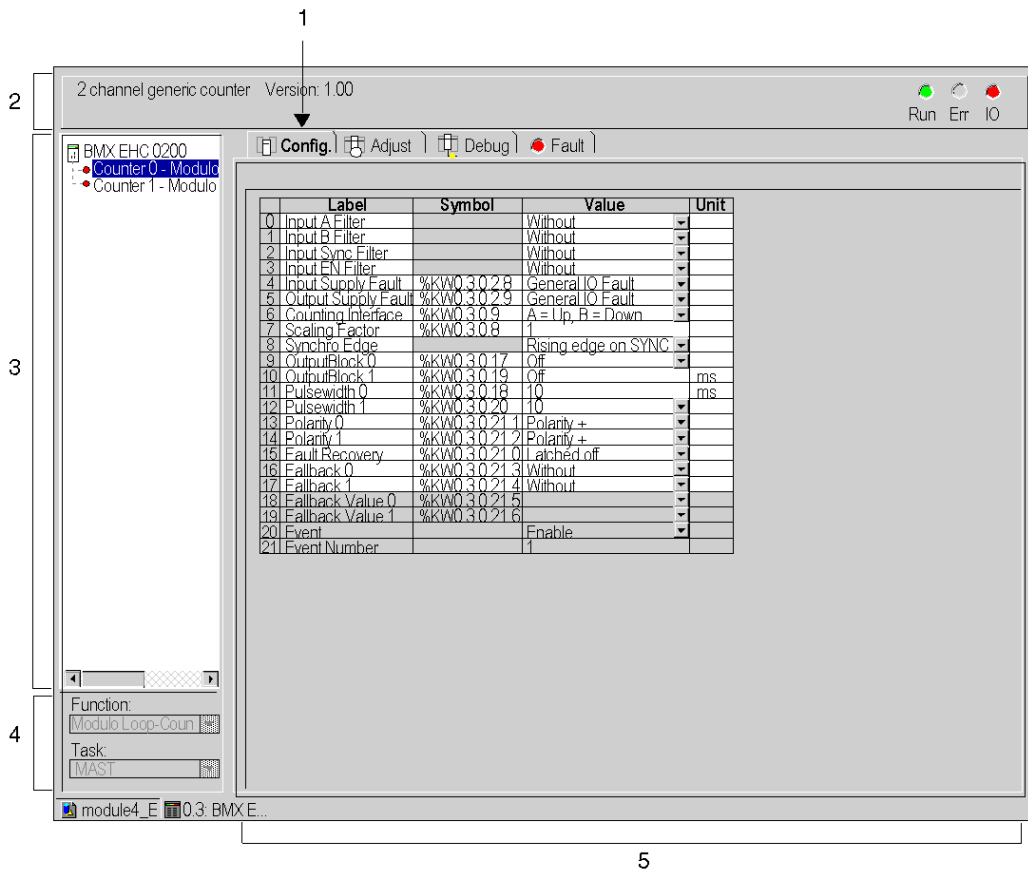

The following table presents the parts of the various screens.

Number	Element	Function
1	Tabs	The tab in the foreground indicates the mode in progress ( <b>Configuration</b> in this example). Every mode can be selected using the respective tab. The available modes are: <ul style="list-style-type: none"> <li>● <b>Configuration</b></li> <li>● <b>Adjust</b></li> <li>● <b>Debug</b> (which can only be accessed in online mode)</li> <li>● <b>Faults</b> (which can only be accessed in online mode)</li> </ul>
2	Heading area	Provides an abbreviation as a reminder of the module and module status in online mode (LEDs).
3	<b>Module area</b>	Is used: <ul style="list-style-type: none"> <li>● By clicking on the reference number, to display the tabs: <ul style="list-style-type: none"> <li>○ <b>Description</b> which gives the characteristics of the device.</li> <li>○ <b>I/O Objects</b> or <b>Device DDT</b> depending on the I/O data type selected at module insertion in the Control Expert project.</li> </ul> </li> </ul>
	<b>Channel area</b>	Is used: <ul style="list-style-type: none"> <li>● By clicking on the channel (Counter) number, to display the tabs: <ul style="list-style-type: none"> <li>○ <b>Configuration</b> which gives the characteristics of the channel. By default in topological I/O data model, no function is configured. By default in device DDT data model, all channels are <b>Frequency Mode</b> configured and a channel can not be set to <b>None</b>.</li> <li>○ <b>Adjust</b>: consists of various sections to be completed (parameter values), displayed according to the choice of counting function.</li> <li>○ <b>Debug</b>: displays the status of the inputs and outputs, as well as the various parameters of the current counting function (in online mode).</li> <li>○ <b>Fault</b> which shows the device errors (in online mode).</li> </ul> </li> </ul>
4	<b>General parameters area</b>	Allows you to select the counting function and the task associated with the channel: <ul style="list-style-type: none"> <li>● <b>Function</b>: counting function among those available for the modules involved. Depending on this choice, the headings of the configuration area may differ.</li> <li>● <b>Task</b>: defines the task through which the channel's implicit exchange objects will be exchanged.</li> </ul> <p>These choices are only possible in offline mode.</p>
5	<b>Parameters in progress area</b>	This area has various functionalities which depend upon the current mode: <ul style="list-style-type: none"> <li>● <b>Configuration</b>: is used to configure the channel parameters.</li> <li>● <b>Adjust</b>: consists of various sections to be completed (parameter values), displayed according to the choice of counting function.</li> <li>● <b>Debug</b>: displays the status of the inputs and outputs, as well as the various parameters of the current counting function.</li> <li>● <b>Fault</b>: displays the errors that have occurred on the counting channels.</li> </ul>



---

# Chapter 9

## Configuration of the BMX EHC 0200 Counting Modules

---

### Subject of this Chapter

This chapter deals with the configuration of the BMX EHC 0200 counting modules. This configuration can be accessed from the Configuration tab on the functional screens of BMX EHC 0200 (*see page 116*) modules.

### What Is in This Chapter?

This chapter contains the following sections:

Section	Topic	Page
9.1	Configuration Screen for BMX EHC xxxx Counting Modules	120
9.2	Configuration of Modes for the BMX EHC 0200 Module	123

## Section 9.1

### Configuration Screen for BMX EHC xxxx Counting Modules

---

#### Configuration Screen for BMX EHC 0200 Counting Modules in a Modicon M340 Local Rack

##### At a Glance

This section presents the configuration screen for BMX EHC 0200 counting modules.



**Illustration**

The figure below presents the configuration screen for the BMX EHC 0200 module in modulo loop counter mode:

The screenshot shows the configuration interface for a BMX EHC 0200 module. At the top, it displays '2 channel generic counter' and 'Version : 1.00'. On the right, there are status indicators for Run (green), Err (grey), and IO (red). Below this is a toolbar with buttons for Config, Adjust, Debug, and Fault. A left sidebar shows the module tree with 'Counter 0 - Modulo L' selected. The main area contains a table of parameters:

Label	Symbol	Value	Unit
0	Input A Filter	Without	
1	Input B Filter	Without	
2	Input Sync Filter	Without	
3	Input EN Filter	Without	
4	Input Supply Fault	%KW0.3.0.2.8	General IO Fault
5	Output Supply Fault	%KW0.3.0.2.9	General IO Fault
6	Counting Interface	%KW0.3.0.9	A = Up, B = Down
7	Scaling Factor	%KW0.3.0.8	1
8	Synchro Edge	Rising edge on SYNC	
9	OutputBlock 0	%KW0.3.0.17	Off
10	OutputBlock 1	%KW0.3.0.19	Off
11	Pulsewidth 0	%KW0.3.0.18	10
12	Pulsewidth 1	%KW0.3.0.20	10
13	Polarity 0	%KW0.3.0.21.1	Polarity +
14	Polarity 1	%KW0.3.0.21.2	Polarity +
15	Fault Recovery	%KW0.3.0.21.0	Latched off
16	Fallback 0	%KW0.3.0.21.3	Without
17	Fallback 1	%KW0.3.0.21.4	Without
18	Fallback Value 0	%KW0.3.0.21.5	
19	Fallback Value 1	%KW0.3.0.21.6	
20	Event	Enable	
21	Event Number	1	

At the bottom left, there are dropdown menus for 'Function' (set to 'Modulo Loop-') and 'Task' (set to 'MAST'). The window title is 'module4\_E 0.3: BMX E...'.

**NOTE:** When adding a BMX EHC 0200 in a local rack the default function is **Frequency mode**

### Description of the Screen

The following table presents the various parts of the above screen:

Number	Element	Function
1	Tab	The tab in the foreground indicates the current mode. The current mode is therefore the configuration mode in this example.
2	<b>Label</b> field	This field contains the name of each variable that may be configured. This field may not be modified.
3	<b>Symbol</b> field	This field contains the address of the variable in the application. This field may not be modified.
4	<b>Value</b> field	If this field has a downward pointing arrow, you can select the value of each variable from various possible values in this field. The various values can be accessed by clicking on the arrow. A drop-down menu containing all the possible values is displayed and the user may then select the required value of the variable.
5	<b>Unit</b> field	This field contains the unit of each variable that may be configured. This field may not be modified.

---

# Section 9.2

## Configuration of Modes for the BMX EHC 0200 Module

---

**Subject of this Section**

This section deals with the configuration of the modes of the BMX EHC 0200 counting modules.

**What Is in This Section?**

This section contains the following topics:

Topic	Page
Frequency Mode Configuration	124
Event Counting Mode Configuration	126
Period Measuring Mode Configuration	128
Ratio Mode Configuration	130
One Shot Counter Mode Configuration	132
Modulo Loop Counter Mode Configuration	134
Free Large Counter Mode Configuration	137
Pulse Width Modulation Mode Configuration	140

## Frequency Mode Configuration

### At a Glance

The configuration of a counting module is stored in the configuration constants (%KW).

The parameters r,m and c shown in the following tables represent the topologic addressing of the module. Each parameter had the following signification:

- r: represents the rack number,
- m: represents the position of the module on the rack,
- c: represents the channel number.

### Configuration Objects

The table below presents the frequency mode configurable elements.

Label	Address in the configuration	Configurable values
Counting mode	%KW <sub>r.m.c</sub> .2 (least significant byte)	Frequency mode. The value of the least significant byte of this word is 1.
IN_A input filter	%KW <sub>r.m.c</sub> .3 (least significant byte)	The least significant byte can take the following values: <ul style="list-style-type: none"> <li>● 0: none,</li> <li>● 1: low,</li> <li>● 2: medium,</li> <li>● 3: high.</li> </ul>
Input power supply fault	%KW <sub>r.m.c</sub> .2.8	General input/output fault (bit set to 0) Local (bit set to 1)
Scale factor	%KW <sub>r.m.c</sub> .6 (least significant byte)	Edit (value in the range 1...255)
Output block 0	%KW <sub>r.m.c</sub> .17	This word can take the following values: <ul style="list-style-type: none"> <li>● 0: off,</li> <li>● 1: low counter,</li> <li>● 2: counter in a window,</li> <li>● 3: High counter,</li> <li>● 4: pulse = less than the lower threshold (LT),</li> <li>● 5: pulse = greater than the lower threshold (LT),</li> <li>● 6: pulse = less than the upper threshold (UT),</li> <li>● 7: pulse = greater than the upper threshold (UT).</li> </ul>

Label	Address in the configuration	Configurable values
Output block 1	%KW $\Gamma$ .m.c.19	This word can take the following values: <ul style="list-style-type: none"> <li>● 0: off,</li> <li>● 1: low counter,</li> <li>● 2: counter in a window,</li> <li>● 3: High counter,</li> <li>● 4: pulse = less than the lower threshold (LT),</li> <li>● 5: pulse = greater than the lower threshold (LT),</li> <li>● 6: pulse = less than the upper threshold (UT),</li> <li>● 7: pulse = greater than the upper threshold (UT).</li> </ul>
Polarity 0	%KW $\Gamma$ .m.c.21.1	Polarity + (bit set to 0) Polarity - (bit set to 1)
Polarity 1	%KW $\Gamma$ .m.c.21.2	Polarity + (bit set to 0) Polarity - (bit set to 1)
Fault recovery	%KW $\Gamma$ .m.c.21.0	Automatic reaction (bit set to 1) Activated (bit set to 0)
Fallback 0	%KW $\Gamma$ .m.c.21.3	None (bit set to 0) With (bit set to 1)
Fallback 1	%KW $\Gamma$ .m.c.21.4	None (bit set to 0) With (bit set to 1)
Fallback value 0	%KW $\Gamma$ .m.c.21.5	0 (bit set to 0) 1 (bit set to 1)
Fallback value 1	%KW $\Gamma$ .m.c.21.6	0 (bit set to 0) 1 (bit set to 1)
Output power supply fault	%KW $\Gamma$ .m.c.2.9	General input/output fault (bit set to 0) Offline (bit set to 1)
Pulse width 0	%KW $\Gamma$ .m.c.18	Edit (value in the range 1..65535)
Pulse width 1	%KW $\Gamma$ .m.c.20	Edit (value in the range 1..65535)
Event Event number	%KW $\Gamma$ .m.c.0	Activated (if activated is selected, the entered event number is coded on the most significant byte of this word) Deactivated (all bits of the most significant byte of this word are set to 1)

## Event Counting Mode Configuration

### At a Glance

The configuration of a counting module is stored in the configuration constants (%KW).

The parameters r,m and c shown in the following tables represent the topologic addressing of the module. Each parameter had the following signification:

- r: represents the rack number,
- m:represents the position of the module on the rack,
- c: represents the channel number.

### Configuration Objects

The table below presents the event counting mode configurable elements

Label	Address in the configuration	Configurable values
Counting mode	%KW <sub>r.m.c</sub> .2 (least significant byte)	Event counting mode. The value of the least significant byte of this word is 2.
IN_A input filter	%KW <sub>r.m.c</sub> .3 (least significant byte)	The least significant byte can take the following values: <ul style="list-style-type: none"> <li>● 0: none,</li> <li>● 1: low,</li> <li>● 2: medium,</li> <li>● 3: high.</li> </ul>
IN_SYNC input filter	%KW <sub>r.m.c</sub> .4 (least significant byte)	The least significant byte can take the following values: <ul style="list-style-type: none"> <li>● 0: none,</li> <li>● 1: low,</li> <li>● 2: medium,</li> <li>● 3: high.</li> </ul>
Input power supply fault	%KW <sub>r.m.c</sub> .2.8	General input/output fault (bit set to 0) Local (bit set to 1)
Synchronization edge	%KW <sub>r.m.c</sub> .10.8	Rising edge at IN_SYNC (bit set to 0) Falling edge at IN_SYNC (bit set to 1)
Time base	%KW <sub>r.m.c</sub> .7	This word can take the following values: <ul style="list-style-type: none"> <li>● 0: 0.1 s,</li> <li>● 1: 1 s,</li> <li>● 2: 10 s,</li> <li>● 3: 1 min</li> </ul>

Label	Address in the configuration	Configurable values
Output block 0	%KW $\tau$ .m.c.17	This word can take the following values: <ul style="list-style-type: none"> <li>● 0: off,</li> <li>● 1: low counter,</li> <li>● 2: counter in a window,</li> <li>● 3: High counter,</li> <li>● 4: pulse = less than the lower threshold (LT),</li> <li>● 5: pulse = greater than the lower threshold (LT),</li> <li>● 6: pulse = less than the upper threshold (UT),</li> <li>● 7: pulse = greater than the upper threshold (UT).</li> </ul>
Output block 1	%KW $\tau$ .m.c.19	This word can take the following values: <ul style="list-style-type: none"> <li>● 0: off,</li> <li>● 1: low counter,</li> <li>● 2: counter in a window,</li> <li>● 3: High counter,</li> <li>● 4: pulse = less than the lower threshold (LT),</li> <li>● 5: pulse = greater than the lower threshold (LT),</li> <li>● 6: pulse = less than the upper threshold (UT),</li> <li>● 7: pulse = greater than the upper threshold (UT).</li> </ul>
Polarity 0	%KW $\tau$ .m.c.21.1	Polarity + (bit set to 0) Polarity - (bit set to 1)
Polarity 1	%KW $\tau$ .m.c.21.2	Polarity + (bit set to 0) Polarity - (bit set to 1)
Fault recovery	%KW $\tau$ .m.c.21.0	Automatic reaction (bit set to 1) Activated (bit set to 0)
Fallback 0	%KW $\tau$ .m.c.21.3	None (bit set to 0) With (bit set to 1)
Fallback 1	%KW $\tau$ .m.c.21.4	None (bit set to 0) With (bit set to 1)
Fallback value 0	%KW $\tau$ .m.c.21.5	0 (bit set to 0) 1 (bit set to 1)
Fallback value 1	%KW $\tau$ .m.c.21.6	0 (bit set to 0) 1 (bit set to 1)
Output power supply fault	%KW $\tau$ .m.c.2.9	General input/output fault (bit set to 0) Offline (bit set to 1)
Pulse width 0	%KW $\tau$ .m.c.18	Edit (value in the range 1...65535)
Pulse width 1	%KW $\tau$ .m.c.20	Edit (value in the range 1...65535)
Event Event number	%KW $\tau$ .m.c.0	Activated (if activated is selected, the entered event number is coded on the most significant byte of this word) Deactivated (all bits of the most significant byte of this word are set to 1)

## Period Measuring Mode Configuration

### At a Glance

The configuration of a counting module is stored in the configuration constants (%KW).

The parameters r,m and c shown in the following tables represent the topologic addressing of the module. Each parameter had the following signification:

- r: represents the rack number,
- m:represents the position of the module on the rack,
- c: represents the channel number.

### Configuration Objects

The table below presents the period measuring mode configurable elements.

Label	Address in the configuration	Configurable values
Counting mode	%KW <sub>r.m.c</sub> .2 (least significant byte)	Period measuring mode. The value of the least significant byte of this word is 3.
IN_A input filter	%KW <sub>r.m.c</sub> .3 (least significant byte)	The least significant byte can take the following values: <ul style="list-style-type: none"> <li>• 0: none,</li> <li>• 1: low,</li> <li>• 2: medium,</li> <li>• 3: high.</li> </ul>
IN_SYNC input filter	%KW <sub>r.m.c</sub> .4 (least significant byte)	The least significant byte can take the following values: <ul style="list-style-type: none"> <li>• 0: none,</li> <li>• 1: low,</li> <li>• 2: medium,</li> <li>• 3: high.</li> </ul>
Input power supply fault	%KW <sub>r.m.c</sub> .2.8	General input/output fault (bit set to 0) Local (bit set to 1)
Resolution	%KW <sub>r.m.c</sub> .8 (most significant byte)	The most significant byte can take the following values: <ul style="list-style-type: none"> <li>• 0: 1 μs,</li> <li>• 1: 100 μs,</li> <li>• 2: 1 ms.</li> </ul>
Mode	%KW <sub>r.m.c</sub> .8 (least significant byte)	The least significant byte can take the following values: <ul style="list-style-type: none"> <li>• 0: From one edge to the same edge at input IN_A,</li> <li>• 1: From one edge to the opposite edge at input IN_A.</li> </ul>
Time out	%KDr.m.c.14	0... 1 073 741 823



Label	Address in the configuration	Configurable values
Output block 0	%KW $\Gamma$ .m.c.17	This word can take the following values: <ul style="list-style-type: none"> <li>● 0: off,</li> <li>● 1: low counter,</li> <li>● 2: counter in a window,</li> <li>● 3: High counter,</li> <li>● 4: pulse = less than the lower threshold (LT),</li> <li>● 5: pulse = greater than the lower threshold (LT),</li> <li>● 6: pulse = less than the upper threshold (UT),</li> <li>● 7: pulse = greater than the upper threshold (UT).</li> </ul>
Output block 1	%KW $\Gamma$ .m.c.19	This word can take the following values: <ul style="list-style-type: none"> <li>● 0: off,</li> <li>● 1: low counter,</li> <li>● 2: counter in a window,</li> <li>● 3: High counter,</li> <li>● 4: pulse = less than the lower threshold (LT),</li> <li>● 5: pulse = greater than the lower threshold (LT),</li> <li>● 6: pulse = less than the upper threshold (UT),</li> <li>● 7: pulse = greater than the upper threshold (UT).</li> </ul>
Polarity 0	%KW $\Gamma$ .m.c.21.1	Polarity + (bit set to 0) Polarity - (bit set to 1)
Polarity 1	%KW $\Gamma$ .m.c.21.2	Polarity + (bit set to 0) Polarity - (bit set to 1)
Fault recovery	%KW $\Gamma$ .m.c.21.0	Automatic reaction (bit set to 1) Activated (bit set to 0)
Fallback 0	%KW $\Gamma$ .m.c.21.3	None (bit set to 0) With (bit set to 1)
Fallback 1	%KW $\Gamma$ .m.c.21.4	None (bit set to 0) With (bit set to 1)
Fallback value 0	%KW $\Gamma$ .m.c.21.5	0 (bit set to 0) 1 (bit set to 1)
Fallback value 1	%KW $\Gamma$ .m.c.21.6	0 (bit set to 0) 1 (bit set to 1)
Output power supply fault	%KW $\Gamma$ .m.c.2.9	General input/output fault (bit set to 0) Offline (bit set to 1)
Pulse width 0	%KW $\Gamma$ .m.c.18	Edit (value in the range 1...65535)
Pulse width 1	%KW $\Gamma$ .m.c.20	Edit (value in the range 1...65535)
Event Event number	%KW $\Gamma$ .m.c.0	Activated (if activated is selected, the entered event number is coded on the most significant byte of this word) Deactivated (all bits of the most significant byte of this word are set to 1)

## Ratio Mode Configuration

### At a Glance

The configuration of a counting module is stored in the configuration constants (%KW).

The parameters r,m and c shown in the following tables represent the topologic addressing of the module. Each parameter had the following signification:

- r: represents the rack number,
- m:represents the position of the module on the rack,
- c: represents the channel number.

### Configuration Objects

The table below presents ratio mode configurable elements.

Label	Address in the configuration	Configurable values
Counting mode	%KW $r.m.c.2$ (least significant byte)	The least significant byte of this word can take the following values in this mode: <ul style="list-style-type: none"> <li>● 4: ratio 1 mode,</li> <li>● 5: ratio 2 mode.</li> </ul>
IN_A input filter	%KW $r.m.c.3$ (least significant byte)	The least significant byte can take the following values: <ul style="list-style-type: none"> <li>● 0: none,</li> <li>● 1: low,</li> <li>● 2: medium,</li> <li>● 3: high.</li> </ul>
IN_B input filter	%KW $r.m.c.3$ (most significant byte)	The most significant byte can take the following values: <ul style="list-style-type: none"> <li>● 0: none,</li> <li>● 1: low,</li> <li>● 2: medium,</li> <li>● 3: high.</li> </ul>
Input power supply fault	%KW $r.m.c.2.8$	General input/output fault (bit set to 0) Local (bit set to 1)
Scale factor	%KW $r.m.c.6$ (least significant byte)	Edit (value in the range 1...255)
Absolute limit	%KD $r.m.c.12$	Edit

Label	Address in the configuration	Configurable values
Output block 0	%KW $\tau$ .m.c.17	This word can take the following values: <ul style="list-style-type: none"> <li>● 0: off,</li> <li>● 1: low counter,</li> <li>● 2: counter in a window,</li> <li>● 3: High counter,</li> <li>● 4: pulse = less than the lower threshold (LT),</li> <li>● 5: pulse = greater than the lower threshold (LT),</li> <li>● 6: pulse = less than the upper threshold (UT),</li> <li>● 7: pulse = greater than the upper threshold (UT).</li> </ul>
Output block 1	%KW $\tau$ .m.c.19	This word can take the following values: <ul style="list-style-type: none"> <li>● 0: off,</li> <li>● 1: low counter,</li> <li>● 2: counter in a window,</li> <li>● 3: High counter,</li> <li>● 4: pulse = less than the lower threshold (LT),</li> <li>● 5: pulse = greater than the lower threshold (LT),</li> <li>● 6: pulse = less than the upper threshold (UT),</li> <li>● 7: pulse = greater than the upper threshold (UT).</li> </ul>
Polarity 0	%KW $\tau$ .m.c.21.1	Polarity + (bit set to 0) Polarity - (bit set to 1)
Polarity 1	%KW $\tau$ .m.c.21.2	Polarity + (bit set to 0) Polarity - (bit set to 1)
Fault recovery	%KW $\tau$ .m.c.21.0	Automatic reaction (bit set to 1) Activated (bit set to 0)
Fallback 0	%KW $\tau$ .m.c.21.3	None (bit set to 0) With (bit set to 1)
Fallback 1	%KW $\tau$ .m.c.21.4	None (bit set to 0) With (bit set to 1)
Fallback value 0	%KW $\tau$ .m.c.21.5	0 (bit set to 0) 1 (bit set to 1)
Fallback value 1	%KW $\tau$ .m.c.21.6	0 (bit set to 0) 1 (bit set to 1)
Output power supply fault	%KW $\tau$ .m.c.2.9	General input/output fault (bit set to 0) Offline (bit set to 1)
Pulse width 0	%KW $\tau$ .m.c.18	Edit (value in the range 1..65535)
Pulse width 1	%KW $\tau$ .m.c.20	Edit (value in the range 1..65535)
Event Event number	%KW $\tau$ .m.c.0	Activated (if activated is selected, the entered event number is coded on the most significant byte of this word) Deactivated (all bits of the most significant byte of this word are set to 1)

## One Shot Counter Mode Configuration

### At a Glance

The configuration of a counting module is stored in the configuration constants (%KW).

The parameters r,m and c shown in the following tables represent the topologic addressing of the module. Each parameter had the following signification:

- r: represents the rack number,
- m: represents the position of the module on the rack,
- c: represents the channel number.

### Configuration Objects

The table below presents the one shot counter mode configurable elements

Label	Address in the configuration	Configurable values
Counting mode	%KW <sub>r.m.c</sub> .2 (least significant byte)	One shot counter mode. The value of the least significant byte of this word is 6.
IN_A input filter	%KW <sub>r.m.c</sub> .3 (least significant byte)	The least significant byte can take the following values: <ul style="list-style-type: none"> <li>● 0: none,</li> <li>● 1: low,</li> <li>● 2: medium,</li> <li>● 3: high.</li> </ul>
IN_SYNC input filter	%KW <sub>r.m.c</sub> .4 (least significant byte)	The least significant byte can take the following values: <ul style="list-style-type: none"> <li>● 0: none,</li> <li>● 1: low,</li> <li>● 2: medium,</li> <li>● 3: high.</li> </ul>
IN_EN input filter	%KW <sub>r.m.c</sub> .4 (most significant byte)	The most significant byte can take the following values: <ul style="list-style-type: none"> <li>● 0: none,</li> <li>● 1: low,</li> <li>● 2: medium,</li> <li>● 3: high.</li> </ul>
Input power supply fault	%KW <sub>r.m.c</sub> .2.8	General input/output fault (bit set to 0) Local (bit set to 1)
Scale factor	%KW <sub>r.m.c</sub> .6 (least significant byte)	Edit (value in the range 1...255)
Synchronization edge	%KW <sub>r.m.c</sub> .10.8	Rising edge (bit set to 0) Falling edge (bit set to 1)

Label	Address in the configuration	Configurable values
Output block 0	%KW <sub>r</sub> .m.c.17	This word can take the following values: <ul style="list-style-type: none"> <li>● 0: off,</li> <li>● 1: low counter,</li> <li>● 2: counter in a window,</li> <li>● 3: High counter,</li> <li>● 4: pulse = less than the lower threshold (LT),</li> <li>● 5: pulse = greater than the lower threshold (LT),</li> <li>● 6: pulse = less than the upper threshold (UT),</li> <li>● 7: pulse = greater than the upper threshold (UT).</li> </ul>
Output block 1	%KW <sub>r</sub> .m.c.19	This word can take the following values: <ul style="list-style-type: none"> <li>● 0: off,</li> <li>● 1: low counter,</li> <li>● 2: counter in a window,</li> <li>● 3: High counter,</li> <li>● 4: pulse = less than the lower threshold (LT),</li> <li>● 5: pulse = greater than the lower threshold (LT),</li> <li>● 6: pulse = less than the upper threshold (UT),</li> <li>● 7: pulse = greater than the upper threshold (UT).</li> </ul>
Polarity 0	%KW <sub>r</sub> .m.c.21.1	Polarity + (bit set to 0) Polarity - (bit set to 1)
Polarity 1	%KW <sub>r</sub> .m.c.21.2	Polarity + (bit set to 0) Polarity - (bit set to 1)
Fault recovery	%KW <sub>r</sub> .m.c.21.0	Automatic reaction (bit set to 1) Activated (bit set to 0)
Fallback 0	%KW <sub>r</sub> .m.c.21.3	None (bit set to 0) With (bit set to 1)
Fallback 1	%KW <sub>r</sub> .m.c.21.4	None (bit set to 0) With (bit set to 1)
Fallback value 0	%KW <sub>r</sub> .m.c.21.5	0 (bit set to 0) 1 (bit set to 1)
Fallback value 1	%KW <sub>r</sub> .m.c.21.6	0 (bit set to 0) 1 (bit set to 1)
Output power supply fault	%KW <sub>r</sub> .m.c.2.9	General input/output fault (bit set to 0) Offline (bit set to 1)
Pulse width 0	%KW <sub>r</sub> .m.c.18	Edit (value in the range 1...65535)
Pulse width 1	%KW <sub>r</sub> .m.c.20	Edit (value in the range 1...65535)
Event Event number	%KW <sub>r</sub> .m.c.0	Activated (if activated is selected, the entered event number is coded on the most significant byte of this word) Deactivated (all bits of the most significant byte of this word are set to 1)

## Modulo Loop Counter Mode Configuration

### At a Glance

The configuration of a counting module is stored in the configuration constants (%KW).

The parameters r,m and c shown in the following tables represent the topologic addressing of the module. Each parameter had the following signification:

- r: represents the rack number,
- m:represents the position of the module on the rack,
- c: represents the channel number.

### Configuration Objects

The table below presents modulo loop counter mode configurable elements.

Label	Address in the configuration	Configurable values
Counting mode	%KW <sub>r.m.c.2</sub> (least significant byte)	Modulo loop counter mode. The value of the least significant byte of this word is 7.
IN_A input filter	%KW <sub>r.m.c.3</sub> (least significant byte)	The least significant byte can take the following values: <ul style="list-style-type: none"> <li>● 0: none,</li> <li>● 1: low,</li> <li>● 2: medium,</li> <li>● 3: high.</li> </ul>
IN_A input filter	%KW <sub>r.m.c.3</sub> (most significant byte)	The most significant byte can take the following values: <ul style="list-style-type: none"> <li>● 0: none,</li> <li>● 1: low,</li> <li>● 2: medium,</li> <li>● 3: high.</li> </ul>
IN_SYNC input filter	%KW <sub>r.m.c.4</sub> (least significant byte)	The least significant byte can take the following values: <ul style="list-style-type: none"> <li>● 0: none,</li> <li>● 1: low,</li> <li>● 2: medium,</li> <li>● 3: high.</li> </ul>
IN_EN input filter	%KW <sub>r.m.c.4</sub> (most significant byte)	The most significant byte can take the following values: <ul style="list-style-type: none"> <li>● 0: none,</li> <li>● 1: low,</li> <li>● 2: medium,</li> <li>● 3: high.</li> </ul>
Input power supply fault	%KW <sub>r.m.c.2.8</sub>	General input/output fault (bit set to 0) Local (bit set to 1)

Label	Address in the configuration	Configurable values
Input mode	%KWr.m.c.9	This word can take the following values: <ul style="list-style-type: none"> <li>● 0: A = High, B = Low,</li> <li>● 1: A = Pulse, B = Direction,</li> <li>● 2: normal quadrature 1,</li> <li>● 3: normal quadrature 2,</li> <li>● 4: normal quadrature 4,</li> <li>● 5: inverse quadrature 1,</li> <li>● 6: inverse quadrature 2,</li> <li>● 7: inverse quadrature 4.</li> </ul>
Scale factor	%KWr.m.c.6 (least significant byte)	Edit (value in the range 1...255)
Synchronization edge	%KWr.m.c.10 (most significant byte)	Rising edge (bit set to 0) Falling edge (bit set to 1)
Output block 0	%KWr.m.c.17	This word can take the following values: <ul style="list-style-type: none"> <li>● 0: off,</li> <li>● 1: low counter,</li> <li>● 2: counter in a window,</li> <li>● 3: High counter,</li> <li>● 4: pulse = less than the lower threshold (LT),</li> <li>● 5: pulse = greater than the lower threshold (LT),</li> <li>● 6: pulse = less than the upper threshold (UT),</li> <li>● 7: pulse = greater than the upper threshold (UT).</li> </ul>
Output block 1	%KWr.m.c.19	This word can take the following values: <ul style="list-style-type: none"> <li>● 0: off,</li> <li>● 1: low counter,</li> <li>● 2: counter in a window,</li> <li>● 3: High counter,</li> <li>● 4: pulse = less than the lower threshold (LT),</li> <li>● 5: pulse = greater than the lower threshold (LT),</li> <li>● 6: pulse = less than the upper threshold (UT),</li> <li>● 7: pulse = greater than the upper threshold (UT).</li> </ul>
Polarity 0	%KWr.m.c.21.1	Polarity + (bit set to 0) Polarity - (bit set to 1)
Polarity 1	%KWr.m.c.21.2	Polarity + (bit set to 0) Polarity - (bit set to 1)
Fault recovery	%KWr.m.c.21.0	Automatic reaction (bit set to 1) Activated (bit set to 0)
Fallback 0	%KWr.m.c.21.3	None (bit set to 0) With (bit set to 1)
Fallback 1	%KWr.m.c.21.4	None (bit set to 0) With (bit set to 1)

Label	Address in the configuration	Configurable values
Fallback value 0	%KW <sub>r</sub> .m.c.21.5	0 (bit set to 0) 1 (bit set to 1)
Fallback value 1	%KW <sub>r</sub> .m.c.21.6	0 (bit set to 0) 1 (bit set to 1)
Output power supply fault	%KW <sub>r</sub> .m.c.2.9	General input/output fault (bit set to 0) Offline (bit set to 1)
Pulse width 0	%KW <sub>r</sub> .m.c.18	Edit (value in the range 1...65535)
Pulse width 1	%KW <sub>r</sub> .m.c.20	Edit (value in the range 1...65535)
Event Event number	%KW <sub>r</sub> .m.c.0	Activated (if activated is selected, the entered event number is coded on the most significant byte of this word) Deactivated (all bits of the most significant byte of this word are set to 1)



## Free Large Counter Mode Configuration

### At a Glance

The configuration of a counting module is stored in the configuration constants (%KW).

The parameters r,m and c shown in the following tables represent the topologic addressing of the module. Each parameter had the following signification:

- r: represents the rack number,
- m: represents the position of the module on the rack,
- c: represents the channel number.

### Configuration Objects

The table below presents the free large counter mode configurable elements.

Label	Address in the configuration	Configurable values
Counting mode	%KW <sub>r.m.c</sub> .2 (least significant byte)	Free large counter mode. The value of the least significant byte of this word is 8.
IN_A input filter	%KW <sub>r.m.c</sub> .3 (least significant byte)	The least significant byte can take the following values: <ul style="list-style-type: none"> <li>• 0: none,</li> <li>• 1: low,</li> <li>• 2: medium,</li> <li>• 3: high.</li> </ul>
IN_B input filter	%KW <sub>r.m.c</sub> .3 (most significant byte)	The most significant byte can take the following values: <ul style="list-style-type: none"> <li>• 0: none,</li> <li>• 1: low,</li> <li>• 2: medium,</li> <li>• 3: high.</li> </ul>
IN_SYNC input filter	%KW <sub>r.m.c</sub> .4 (least significant byte)	The least significant byte can take the following values: <ul style="list-style-type: none"> <li>• 0: none,</li> <li>• 1: low,</li> <li>• 2: medium,</li> <li>• 3: high.</li> </ul>
IN_EN input filter	%KW <sub>r.m.c</sub> .4 (most significant byte)	The most significant byte can take the following values: <ul style="list-style-type: none"> <li>• 0: none,</li> <li>• 1: low,</li> <li>• 2: medium,</li> <li>• 3: high.</li> </ul>
IN_REF input filter	%KW <sub>r.m.c</sub> .5 (least significant byte)	The least significant byte can take the following values: <ul style="list-style-type: none"> <li>• 0: none,</li> <li>• 1: low,</li> <li>• 2: medium,</li> <li>• 3: high.</li> </ul>

Label	Address in the configuration	Configurable values
IN_CAP input filter	%KW <sub>r</sub> .m.c.5 (most significant byte)	The most significant byte can take the following values: <ul style="list-style-type: none"> <li>● 0: none,</li> <li>● 1: low,</li> <li>● 2: medium,</li> <li>● 3: high.</li> </ul>
Input power supply fault	%KW <sub>r</sub> .m.c.2.8	General input/output fault (bit set to 0) Local (bit set to 1)
Input mode	%KW <sub>r</sub> .m.c.9	This word can take the following values: <ul style="list-style-type: none"> <li>● 0: A = High, B = Low</li> <li>● 1: A = Pulse, B = Direction</li> <li>● 2: normal quadrature 1</li> <li>● 3: normal quadrature 2</li> <li>● 4: normal quadrature 4</li> <li>● 5: inverse quadrature 1</li> <li>● 6: inverse quadrature 2</li> <li>● 7: inverse quadrature 4</li> </ul>
Scale factor	%KW <sub>r</sub> .m.c.6 (least significant byte)	Edit (value in the range 1..255)
Preset mode	%KW <sub>r</sub> .m.c.10 (least significant byte)	The least significant byte can take the following values: <ul style="list-style-type: none"> <li>● 0: rising edge at IN_SYNC</li> <li>● 1: rising edge at IN_REF</li> <li>● 2: rising edge at IN_SYNC and IN_REF</li> <li>● 3: first rising edge at IN_SYNC and IN_REF at 1</li> <li>● 4: first rising edge at IN_SYNC and IN_REF at 0</li> </ul>
Capture 0 settings	%KW <sub>r</sub> .m.c.16.1	Preset condition (bit set to 0) Falling edge at the IN_CAP input (bit set to 1)
Output block 0	%KW <sub>r</sub> .m.c.17	This word can take the following values: <ul style="list-style-type: none"> <li>● 0: off,</li> <li>● 1: low counter,</li> <li>● 2: counter in a window,</li> <li>● 3: High counter,</li> <li>● 4: pulse = less than the lower threshold (LT),</li> <li>● 5: pulse = greater than the lower threshold (LT),</li> <li>● 6: pulse = less than the upper threshold (UT),</li> <li>● 7: pulse = greater than the upper threshold (UT).</li> </ul>

Label	Address in the configuration	Configurable values
Output block 1	%KWr.m.c.19	This word can take the following values: <ul style="list-style-type: none"> <li>● 0: off,</li> <li>● 1: low counter,</li> <li>● 2: counter in a window,</li> <li>● 3: High counter,</li> <li>● 4: pulse = less than the lower threshold (LT),</li> <li>● 5: pulse = greater than the lower threshold (LT),</li> <li>● 6: pulse = less than the upper threshold (UT),</li> <li>● 7: pulse = greater than the upper threshold (UT).</li> </ul>
Polarity 0	%KWr.m.c.21.1	Polarity + (bit set to 0) Polarity - (bit set to 1)
Polarity 1	%KWr.m.c.21.2	Polarity + (bit set to 0) Polarity - (bit set to 1)
Fault recovery	%KWr.m.c.21.0	Automatic reaction (bit set to 1) Activated (bit set to 0)
Fallback 0	%KWr.m.c.21.3	None (bit set to 0) With (bit set to 1)
Fallback 1	%KWr.m.c.21.4	None (bit set to 0) With (bit set to 1)
Fallback value 0	%KWr.m.c.21.5	0 (bit set to 0) 1 (bit set to 1)
Fallback value 1	%KWr.m.c.21.6	0 (bit set to 0) 1 (bit set to 1)
Output power supply fault	%KWr.m.c.2.9	General input/output fault (bit set to 0) Offline (bit set to 1)
Pulse width 0	%KWr.m.c.18	Edit (value in the range 1...65535)
Pulse width 1	%KWr.m.c.20	Edit (value in the range 1...65535)
Event Event number	%KWr.m.c.0	Activated (if activated is selected, the entered event number is coded on the most significant byte of this word) Deactivated (all bits of the most significant byte of this word are set to 1)

## Pulse Width Modulation Mode Configuration

### At a Glance

The configuration of a counting module is stored in the configuration constants (%KW).

The parameters r,m and c shown in the following tables represent the topologic addressing of the module. Each parameter had the following signification:

- r: represents the rack number,
- m: represents the position of the module on the rack,
- c: represents the channel number.

### Configuration Objects

The table below presents the pulse width modulation mode configurable elements.

Label	Address in the configuration	Configurable values
Counting mode	%KW <sub>r.m.c.2</sub> (least significant byte)	Pulse width modulation mode. The value of the least significant byte of this word is 9.
IN_SYNC input filter	%KW <sub>r.m.c.4</sub> (least significant byte)	The least significant byte can take the following values: <ul style="list-style-type: none"> <li>• 0: none,</li> <li>• 1: low,</li> <li>• 2: medium,</li> <li>• 3: high.</li> </ul>
Synchronization edge	%KW <sub>r.m.c.10.8</sub>	Rising edge at IN_SYNC (bit set to 0) Falling edge at IN_SYNC (bit set to 1)
IN_EN input filter	%KW <sub>r.m.c.4</sub> (most significant byte)	The most significant byte can take the following values: <ul style="list-style-type: none"> <li>• 0: none,</li> <li>• 1: low,</li> <li>• 2: medium,</li> <li>• 3: high.</li> </ul>
Input power supply fault	%KW <sub>r.m.c.2.8</sub>	General input/output fault (bit set to 0) Local (bit set to 1)
Polarity 0	%KW <sub>r.m.c.21.1</sub>	Polarity + (bit set to 0) Polarity - (bit set to 1)
Polarity 1	%KW <sub>r.m.c.21.2</sub>	Polarity + (bit set to 0) Polarity - (bit set to 1)
Fault recovery	%KW <sub>r.m.c.21.0</sub>	Automatic reaction (bit set to 1) Activated (bit set to 0)
Fallback 0	%KW <sub>r.m.c.21.3</sub>	None (bit set to 0) With (bit set to 1)

Label	Address in the configuration	Configurable values
Fallback 1	%KW <sub>r</sub> .m.c.21.4	None (bit set to 0) With (bit set to 1)
Fallback value 0	%KW <sub>r</sub> .m.c.21.5	0 (bit set to 0) 1 (bit set to 1)
Fallback value 1	%KW <sub>r</sub> .m.c.21.6	0 (bit set to 0) 1 (bit set to 1)
Output power supply fault	%KW <sub>r</sub> .m.c.2.9	General input/output fault (bit set to 0) Offline (bit set to 1)
Event Event number	%KW <sub>r</sub> .m.c.0	Activated (if activated is selected, the entered event number is coded on the most significant byte of this word) Deactivated (all bits of the most significant byte of this word are set to 1)



---

# Chapter 10

## BMX EHC xxxx Counting Module Settings

---

### Subject of this Chapter

This chapter deals with the possible settings for the counting modes of the BMX EHC •••• modules. These settings can be accessed from the Configuration tab on the functional screens of BMX EHC •••• modules (*see page 116*).

### What Is in This Chapter?

This chapter contains the following topics:

Topic	Page
Adjust Screen for BMX EHC 0200 Counting Modules	144
Setting the Preset Value	146
Setting the Calibration Factor	147
Modulo Adjust	148
Setting the Hysteresis Value	149

## Adjust Screen for BMX EHC 0200 Counting Modules

### At a Glance

This section presents the adjust screen for BMX EHC 0200 counting modules.

### Illustration

The figure below presents the adjust screen for the BMX EHC 0200 module in modulo loop counter mode:

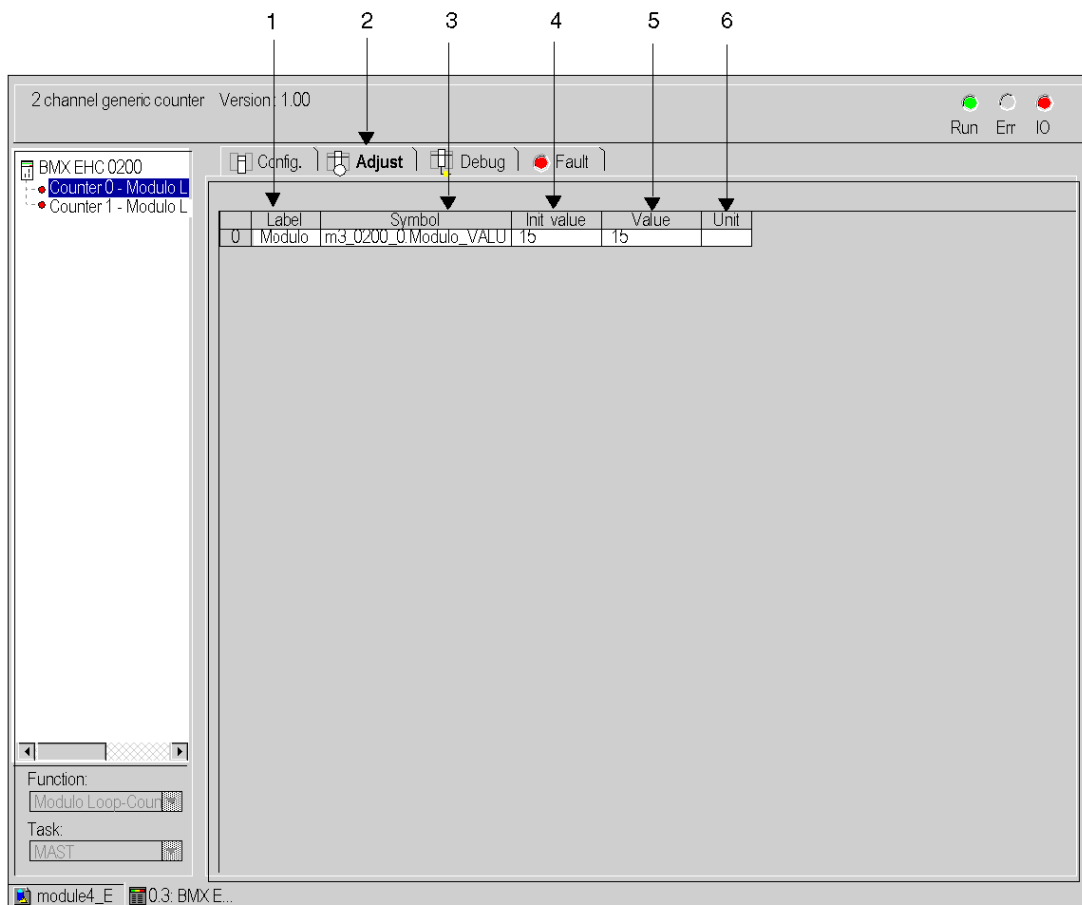



## Description of the Screen

The following table presents the various parts of the above screen:

Number	Element	Function
1	<b>Label</b> field	This field contains the name of each variable that may be adjusted. This field may not be modified and can be accessed in both local and online modes.
2	Tab	The tab in the foreground indicates the current mode. The current mode is therefore the adjust mode in this example.
3	<b>Symbol</b> field	This field contains the mnemonics of the variable. This field may not be modified and can be accessed in both offline and online modes.
4	<b>Initial value</b> field	This field displays the value of the variable that the user has adjusted in offline mode. This field is only accessible in online mode.
5	<b>Value</b> field	The function of this field depends on the mode in which the user is working: <ul style="list-style-type: none"> <li>● <b>In offline mode:</b> this field is used to adjust the variable.</li> <li>● <b>In online mode:</b> this field is used to display the current value of the variable.</li> </ul>
6	<b>Unit</b> field	This field contains the unit of each variable that may be configured. This field may not be modified and can be accessed in both offline and online modes.

## Setting the Preset Value

### Introduction

The preset value concerns the following counting modes:

- for the BMX EHC 0200 module:
  - one shot counter mode
  - free large counter mode

### Description

The following table shows the preset value setting:

Number	Address in the configuration	Value	Default value
Preset value	%MDr.m.c.12 (Low)	Edit	0

## Setting the Calibration Factor

### Introduction

The calibration factor concerns the frequency and ratio modes for the BMX EHC 0200 .

### Description

The following table shows the calibration factor setting:

Number	Address in the configuration	Value	Default value
Calibration factor	%MWz .m .c . 14	Edit	0

## Modulo Adjust

### Introduction

The modulo concerns the modulo loop counter modes for the counting modules BMX EHC \*\*\*\*.

### Description

The following table shows the modulo adjust:

Number	Address in the configuration	Value	Default value
Modulo	%MDx.y.v.10 (Low)	Edit	0xFFFF

## Setting the Hysteresis Value

### Introduction

The hysteresis value concerns free large counter mode for module BMX EHC 0200.

### Description

The following table shows the setting for the hysteresis value:

Number	Address in the configuration	Value	Default value
Hysteresis (release value)	%MWr.m.c.9	Edit	0



---

# Chapter 11

## Debugging the BMX EHC 0200 Counting Modules

---

### Subject of this Chapter

This chapter deals with the debugging settings applicable to BMX EHC 0200 modules. These settings can be accessed from the Debug tab on the functional screens of the BMX EHC 0200 (*see page 114*) modules.

### What Is in This Chapter?

This chapter contains the following sections:

Section	Topic	Page
11.1	Debug Screen for BMX EHC xxxx Counting Modules	152
11.2	BMX EHC 0200 Module Debugging	155

# Section 11.1

## Debug Screen for BMX EHC xxxx Counting Modules

---

### Debug Screen for BMX EHC xxxx Counting Modules

#### At a Glance

This section presents the debug screen for BMX EHC •••• counting modules. A module's debug screen can only be accessed in online mode.



**Illustration**

The figure below presents the debug screen for the BMX EHC 0200 module in modulo loop counter mode:

2 channel generic counter Version : 1.00

Run Err IO

BMX EHC 0200

- Counter 0 - Modulo L
- Counter 1 - Modulo L

Config Adjust Debug Fault

Reference	Label	Symbol	Value
0	%ID0.3.0.2 Counter value	m3_0200_0.COUNTER_CURRENT_VALUE	0
1	%IW0.3.0.0.3 Counter Valid	m3_0200_0.COUNTER_STATUS	No
2	%IW0.3.0.1.0 Counter low	m3_0200_0.COOMPARE_STATUS	No
3	%IW0.3.0.1.1 Counter in window	m3_0200_0.COOMPARE_STATUS	No
4	%IW0.3.0.1.2 Counter high	m3_0200_0.COOMPARE_STATUS	No
5	%IW0.3.0.0.5 Counter in low limit	m3_0200_0.COUNTER_STATUS	No
6	%IW0.3.0.0.4 Counter in high limit	m3_0200_0.COUNTER_STATUS	No
7	%ID0.3.0.4 Capture 0 value	m3_0200_0.CAPT_0_VALUE	0
8	%IW0.3.0.1.3 Capture 0 low	m3_0200_0.COOMPARE_STATUS	No
9	%IW0.3.0.1.4 Capture 0 in window	m3_0200_0.COOMPARE_STATUS	No
10	%IW0.3.0.1.5 Capture 0 high	m3_0200_0.COOMPARE_STATUS	No
11	%QW0.3.0.0.3 Capture 0 enable	m3_0200_0.FUNCTIONS_ENABLING	0
12	%Q0.3.0.4 Input A	m3_0200_0.INPUT_A	0
13	%Q0.3.0.5 Input B	m3_0200_0.INPUT_B	0
14	%Q0.3.0.6 Input SYNC	m3_0200_0.INPUT_SYNC	0
15	%QW0.3.0.0.0 SYNC enable	m3_0200_0.FUNCTIONS_ENABLING	0
16	%Q0.3.0.4 SYNC force	m3_0200_0.FORCE_SYNC	0
17	%IW0.3.0.0.2 SYNC state	m3_0200_0.COUNTER_STATUS	Yes
18	%Q0.3.0.8 SYNC reset	m3_0200_0.SYNC_RESET	0
19	%Q0.3.0.7 Input EN	m3_0200_0.INPUT_EN	0
20	%QW0.3.0.0.2 EN enable	m3_0200_0.FUNCTIONS_ENABLING	0
21	%Q0.3.0.6 Counter enable	m3_0200_0.FORCE_ENABLE	1
22	%Q0.0.0.0 Output 0 state	m3_0200_0.OUTPUT_0_Echo	0
23	%Q0.3.0.0 Output 0 cmd	m3_0200_0.OUTPUT_0	0
24	%Q0.3.0.1 Output 1 state	m3_0200_0.OUTPUT_1_Echo	0
25	%Q0.3.0.1 Output 1 cmd	m3_0200_0.OUTPUT_1	0
26	%Q0.3.0.7 Counter reset	m3_0200_0.FORCE_RESET	0
27	%Q0.3.0.2 Output latch 0 state	m3_0200_0.OUTPUT_BLOCK_0	0
28	%Q0.3.0.2 Output latch 0 enable	m3_0200_0.OUTPUT_BLOCK_0_ENABLE	0
29	%Q0.3.0.3 Output latch 1 state	m3_0200_0.OUTPUT_BLOCK_1	0
30	%Q0.3.0.3 Output latch 1 enable	m3_0200_0.OUTPUT_BLOCK_1_ENABLE	0
31	%QD0.3.0.2 Low threshold value	m3_0200_0.LOWER_TH_VALUE	0
32	%QD0.3.0.4 High threshold value	m3_0200_0.UPPER_TH_VALUE	12
33	%QW0.3.0.0.5 Compare enable	m3_0200_0.FUNCTIONS_ENABLING	1
34	%QW0.3.0.0.6 Compare suspend	m3_0200_0.FUNCTIONS_ENABLING	0
35	%IW0.3.0.0.1 Modulo flag	m3_0200_0.COUNTER_STATUS	Yes
36	%Q0.3.0.9 Modulo reset	m3_0200_0.MODULO_RESET	0

Function: Modulo Loop-Count

Task: MAST

module4\_E 0.3: BMX E...

### Description of the Screen

The following table presents the various parts of the above screen:

Number	Element	Function
1	<b>Reference</b> field	This field contains the address of the variable in the application. This field may not be modified.
2	<b>Label</b> field	This field contains the name of each variable that may be configured. This field may not be modified.
3	Tab	The tab in the foreground indicates the current mode. The current mode is therefore the debug mode in this example.
4	<b>Symbol</b> field	This field contains the mnemonics of the variable. This field may not be modified.
5	<b>Value</b> field	If the field has a downward pointing arrow, you can select the value of each variable from various possible values in this field. The various values can be accessed by clicking on the arrow. A drop-down menu containing all the possible values is displayed and the user may then select the required value of the variable. If there is no downward pointing arrow, this field simply displays the current value of the variable.

---

## Section 11.2

### BMX EHC 0200 Module Debugging

---

#### Subject of this Section

This section deals with the debugging of the BMX EHC 0200 counting module modes.

#### What Is in This Section?

This section contains the following topics:

Topic	Page
Frequency Mode Debugging	156
Event Counting Mode Debugging	157
Period Measuring Mode Debugging	158
Ratio Mode Debugging	159
One Shot Counter Mode Debugging	160
Modulo Loop Counter Mode Debugging	161
Free Large Counter Mode Debugging	163
Pulse Width Modulation Mode Debugging	165

## Frequency Mode Debugging

### At a Glance

The table below presents the frequency mode debugging elements:

Label	Language object	Type
Frequency value	%IDr.m.c.2	Digital
Frequency valid	%IWr.m.c.0.3	Binary
Frequency low	%IWr.m.c.1.0	Binary
Frequency in window	%IWr.m.c.1.1	Binary
Frequency high	%IWr.m.c.1.2	Binary
Frequency in high limit	%IWr.m.c.0.4	Binary
Input A state	%Ir.m.c.4	Binary
Output 0 state	%Ir.m.c.0	Binary
Output 0 cmd	%Qr.m.c.0	Binary
Output 1 state	%Ir.m.c.1	Binary
Output 1 cmd	%Qr.m.c.1	Binary
Output latch 0 state	%Ir.m.c.2	Binary
Output latch 0 enable	%Qr.m.c.2	Binary
Output latch 1 state	%Ir.m.c.3	Binary
Output latch 1 enable	%Qr.m.c.3	Binary
Low threshold value	%QDr.m.c.2	Digital
High threshold value	%QDr.m.c.4	Digital
Compare enable	%QWr.m.c.0.5	Binary
Compare suspend	%QWr.m.c.0.6	Binary

For a description of each language object refer to T\_UNSIGNED\_CPT\_BMX IODDT (*see page 185*).

## Event Counting Mode Debugging

### At a Glance

The table below presents the event counting mode debugging elements:

Label	Language object	Type
Counter value	%IDr.m.c.2	Digital
Counter valid	%IWr.m.c.0.3	Binary
Counter low	%IWr.m.c.1.0	Binary
Counter in window	%IWr.m.c.1.1	Binary
Counter high	%IWr.m.c.1.2	Binary
Counter in low limit	%IWr.m.c.0.5	Binary
Counter in high limit	%IWr.m.c.0.4	Binary
Input A state	%Ir.m.c.4	Binary
Input SYNC state	%Ir.m.c.6	Binary
SYNC enable	%QWr.m.c.0.0	Binary
SYNC force	%Qr.m.c.4	Binary
SYNC state	%IWr.m.c.0.2	Binary
SYNC reset	%Qr.m.c.8	Binary
Output 0 state	%Ir.m.c.0	Binary
Output 0 cmd	%Qr.m.c.0	Binary
Output 1 state	%Ir.m.c.1	Binary
Output 1 cmd	%Qr.m.c.1	Binary
Output latch 0 state	%Ir.m.c.2	Binary
Output latch 0 enable	%Qr.m.c.2	Binary
Output latch 1 state	%Ir.m.c.3	Binary
Output latch 1 enable	%Qr.m.c.3	Binary
Low threshold value	%QDr.m.c.2	Digital
High threshold value	%QDr.m.c.4	Digital
Compare enable	%QWr.m.c.0.5	Binary
Compare suspend	%QWr.m.c.0.6	Binary

For a description of each language object refer to T\_UNSIGNED\_CPT\_BMX IODDT (*see page 185*).

## Period Measuring Mode Debugging

### At a Glance

The table below presents the period measuring mode debugging elements:

Label	Language object	Type
Period value	%IDr.m.c.2	Digital
Period valid	%IWr.m.c.0.3	Binary
Period low	%IWr.m.c.1.0	Binary
Period in window	%IWr.m.c.1.1	Binary
Period high	%IWr.m.c.1.2	Binary
Period in low limit	%IWr.m.c.0.5	Binary
Period in high limit	%IWr.m.c.0.4	Binary
Input A state	%Ir.m.c.4	Binary
Input SYNC state	%Ir.m.c.6	Binary
SYNC enable	%QWr.m.c.0.0	Binary
SYNC force	%Qr.m.c.4	Binary
SYNC state	%IWr.m.c.0.2	Binary
SYNC reset	%Qr.m.c.8	Binary
Output 0 state	%Ir.m.c.0	Binary
Output 0 cmd	%Qr.m.c.0	Binary
Output 1 state	%Ir.m.c.1	Binary
Output 1 cmd	%Qr.m.c.1	Binary
Output latch 0 state	%Ir.m.c.2	Binary
Output latch 0 enable	%Qr.m.c.2	Binary
Output latch 1 state	%Ir.m.c.3	Binary
Output latch 1 enable	%Qr.m.c.3	Binary
Low threshold value	%QDr.m.c.2	Digital
High threshold value	%QDr.m.c.4	Digital
Compare enable	%QWr.m.c.0.5	Binary
Compare suspend	%QWr.m.c.0.6	Binary

For a description of each language object refer to T\_UNSIGNED\_CPT\_BMX IODDT (*see page 185*).

## Ratio Mode Debugging

### At a Glance

The table below presents the ratio mode debugging elements:

Label	Language object	Type
Ratio value	%IDr.m.c.2	Digital
Ratio valid	%IWr.m.c.0.3	Binary
Ratio low	%IWr.m.c.1.0	Binary
Ratio in window	%IWr.m.c.1.1	Binary
Ratio high	%IWr.m.c.1.2	Binary
Ratio in low limit	%IWr.m.c.0.5	Binary
Ratio in high limit	%IWr.m.c.0.4	Binary
Input A state	%Ir.m.c.4	Binary
Input B state	%Ir.m.c.5	Binary
Output 0 state	%Ir.m.c.0	Binary
Output 0 cmd	%Qr.m.c.0	Binary
Output 1 state	%Ir.m.c.1	Binary
Output 1 cmd	%Qr.m.c.1	Binary
Output latch 0 state	%Ir.m.c.2	Binary
Output latch 0 enable	%Qr.m.c.2	Binary
Output latch 1 state	%Ir.m.c.3	Binary
Output latch 1 enable	%Qr.m.c.3	Binary
Low threshold value	%QDr.m.c.2	Digital
High threshold value	%QDr.m.c.4	Digital
Compare enable	%QWr.m.c.0.5	Binary
Compare suspend	%QWr.m.c.0.6	Binary

For a description of each language object refer to T\_SIGNED\_CPT\_BMX IODDT (*see page 185*).

## One Shot Counter Mode Debugging

### At a Glance

The table below presents the one shot counter mode debugging elements:

Label	Language object	Type
Counter value	%IDr.m.c.2	Digital
Counter valid	%IWrr.m.c.0.3	Binary
Counter low	%IWrr.m.c.1.0	Binary
Counter in window	%IWrr.m.c.1.1	Binary
Counter high	%IWrr.m.c.1.2	Binary
RUN	%IWrr.m.c.0.0	Binary
Input A state	%Irr.m.c.4	Binary
Input SYNC state	%Irr.m.c.6	Binary
SYNC enable	%QWrr.m.c.0.0	Binary
SYNC force	%Qrr.m.c.4	Binary
SYNC state	%IWrr.m.c.0.2	Binary
SYNC reset	%Qrr.m.c.8	Binary
Input EN	%Irr.m.c.7	Binary
EN enable	%QWrr.m.c.0.2	Binary
Counter enable	%Qrr.m.c.6	Binary
Output 0 state	%Irr.m.c.0	Binary
Output 0 cmd	%Qrr.m.c.0	Binary
Output 1 state	%Irr.m.c.1	Binary
Output 1 cmd	%Qrr.m.c.1	Binary
Output latch 0 state	%Irr.m.c.2	Binary
Output latch 0 enable	%Qrr.m.c.2	Binary
Output latch 1 state	%Irr.m.c.3	Binary
Output latch 1 enable	%Qrr.m.c.3	Binary
Low threshold value	%QDr.m.c.2	Digital
High threshold value	%QDr.m.c.4	Digital
Compare enable	%QWrr.m.c.0.5	Binary
Compare suspend	%QWrr.m.c.0.6	Binary

For a description of each language object refer to T\_UNSIGNED\_CPT\_BMX IODDT ([see page 185](#)).



## Modulo Loop Counter Mode Debugging

### At a Glance

The table below presents the modulo loop counter mode debugging elements:

Label	Language object	Type
Counter value	%IDr.m.c.2	Digital
Counter valid	%IWr.m.c.0.3	Binary
Counter low	%IWr.m.c.1.0	Binary
Counter in window	%IWr.m.c.1.1	Binary
Counter high	%IWr.m.c.1.2	Binary
Counter in low limit	%IWr.m.c.0.5	Binary
Counter in high limit	%IWr.m.c.0.4	Binary
Capture value	%IDr.m.c.4	Digital
Capture low	%IWr.m.c.1.3	Binary
Capture in window	%IWr.m.c.1.4	Binary
Capture high	%IWr.m.c.1.5	Binary
Capture enable	%QWr.m.c.0.3	Binary
Input A state	%Ir.m.c.4	Binary
Input B state	%Ir.m.c.5	Binary
Input SYNC state	%Ir.m.c.6	Binary
SYNC enable	%QWr.m.c.0.0	Binary
SYNC force	%Qr.m.c.4	Binary
SYNC state	%IWr.m.c.0.2	Binary
SYNC reset	%QWr.m.c.8	Binary
Input EN	%Ir.m.c.7	Binary
EN enable	%QWr.m.c.0.2	Binary
Counter enable	%Qr.m.c.6	Binary
Output 0 state	%Ir.m.c.0	Binary
Output 0 cmd	%Qr.m.c.0	Binary
Output 1 state	%Ir.m.c.1	Binary
Output 1 cmd	%Qr.m.c.1	Binary
Counter reset	%Qr.m.c.7	Binary
Output latch 0 state	%Ir.m.c.2	Binary
Output latch 0 enable	%Qr.m.c.2	Binary
Output latch 1 state	%Ir.m.c.3	Binary

Label	Language object	Type
Output latch 01enable	%Qr.m.c.3	Binary
Low threshold value	%QDr.m.c.2	Digital
High threshold value	%QDr.m.c.4	Digital
Compare enable	%QWr.m.c.0.5	Binary
Compare suspend	%QWr.m.c.0.6	Binary
Modulo state	%IWr.m.c.0.1	Binary
Modulo reset	%Qr.m.c.9	Binary

For a description of each language object refer to T\_UNSIGNED\_CPT\_BMX IODDT (*see page 185*).

## Free Large Counter Mode Debugging

### At a Glance

The table below presents the free large counter mode debugging elements:

Label	Language object	Type
Counter value	%IDr.m.c.2	Digital
Counter valid	%IWr.m.c.0.3	Binary
Counter low	%IWr.m.c.1.0	Binary
Counter in window	%IWr.m.c.1.1	Binary
Counter high	%IWr.m.c.1.2	Binary
Counter in low limit	%IWr.m.c.0.5	Binary
Counter in high limit	%IWr.m.c.0.4	Binary
Capture 0 value	%IDr.m.c.4	Digital
Capture 0 low	%IWr.m.c.1.3	Binary
Capture 0 in window	%IWr.m.c.1.4	Binary
Capture 0 high	%IWr.m.c.1.5	Binary
Capture 0 enable	%QWr.m.c.0.3	Binary
Capture 1 value	%IDr.m.c.16	Digital
Capture 1 low	%IWr.m.c.1.6	Binary
Capture 1 in window	%IWr.m.c.1.7	Binary
Capture 1 high	%IWr.m.c.1.8	Binary
Capture 1 enable	%QWr.m.c.0.4	Binary
Input A state	%Ir.m.c.4	Binary
Input B state	%Ir.m.c.5	Binary
IN_SYNC input	%Ir.m.c.6	Binary
Modulo state	%IWr.m.c.0.1	Binary
Modulo reset	%Qr.m.c.9	Binary
SYNC state	%IWr.m.c.0.2	Binary
SYNC reset	%Qr.m.c.8	Binary
Input EN	%Ir.m.c.7	Binary
EN enable	%QWr.m.c.0.2	Binary
Counter enable	%Qr.m.c.6	Binary
Input REF	%Ir.m.c.8	Binary
REF enable	%QWr.m.c.0.1	Binary
REF force	%QWr.m.c.5	Binary

Label	Language object	Type
Input CAP	%Ir.m.c.9	Binary
Output 0 state	%Ir.m.c.0	Binary
Output 0 cmd	%Qr.m.c.0	Binary
Output 1 state	%Ir.m.c.1	Binary
Output 1 cmd	%Qr.m.c.1	Binary
Counter reset	%Qr.m.c.7	Binary
Output latch 0 state	%Ir.m.c.2	Binary
Output latch 0 enable	%Qr.m.c.2	Binary
Output latch 1 state	%Ir.m.c.3	Binary
Output latch 1 enable	%Qr.m.c.3	Binary
Low threshold value	%QDr.m.c.2	Digital
High threshold value	%QDr.m.c.4	Digital
Compare enable	%QWr.m.c.0.5	Binary
Compare suspend	%QWr.m.c.0.6	Binary

For a description of each language object refer to T\_SIGNED\_CPT\_BMX IODDT (*see page 185*).

## Pulse Width Modulation Mode Debugging

### At a Glance

The table below presents the pulse width modulation mode debugging elements:

Label	Language object	Type
Frequency valid	%IW <sub>r.m.c.</sub> 0.3	Binary
Frequency in low limit	%IW <sub>r.m.c.</sub> 0.5	Binary
Frequency in high limit	%IW <sub>r.m.c.</sub> 0.4	Binary
PWM frequency	%QD <sub>r.m.c.</sub> 6	Digital
PWM duty	%QW <sub>r.m.c.</sub> 8	Digital
Input SYNC state	%Ir <sub>m.c.</sub> 6	Binary
SYNC enable	%QW <sub>r.m.c.</sub> 0.0	Binary
SYNC force	%Qr <sub>m.c.</sub> 4	Binary
Input EN	%Ir <sub>m.c.</sub> 7	Binary
EN enable	%QW <sub>r.m.c.</sub> 0.2	Binary
Counter enable	%Qr <sub>m.c.</sub> 6	Binary
Output latch 0 enable	%Qr <sub>m.c.</sub> 2	Binary
Output 0 state	%Ir <sub>m.c.</sub> 0	Binary
Output 0 cmd	%Qr <sub>m.c.</sub> 0	Binary
Output 1 state	%Ir <sub>m.c.</sub> 1	Binary
Output 1 cmd	%Qr <sub>m.c.</sub> 1	Binary

For a description of each language object refer to T\_UNSIGNED\_CPT\_BMX IODDT (*see page 185*).



---

# Chapter 12

## Display of BMX EHC xxxx Counting Module Error

---

### Subject of this Chapter

This chapter deals with the display of possible errors for the BMX EHC•••• modules.

### What Is in This Chapter?

This chapter contains the following topics:

Topic	Page
Fault Display Screen for BMX EHC 0200 Counting Modules	168
Faults Diagnostics Display	170
List of Error	171

## Fault Display Screen for BMX EHC 0200 Counting Modules

### At a Glance

This section presents the fault display screen for BMX EHC 0200 counting modules. A module's fault display screen may only be accessed in online mode.

### Illustration

The figure below presents the fault display screen for the BMX EHC 0200 module in modulo loop counter mode.

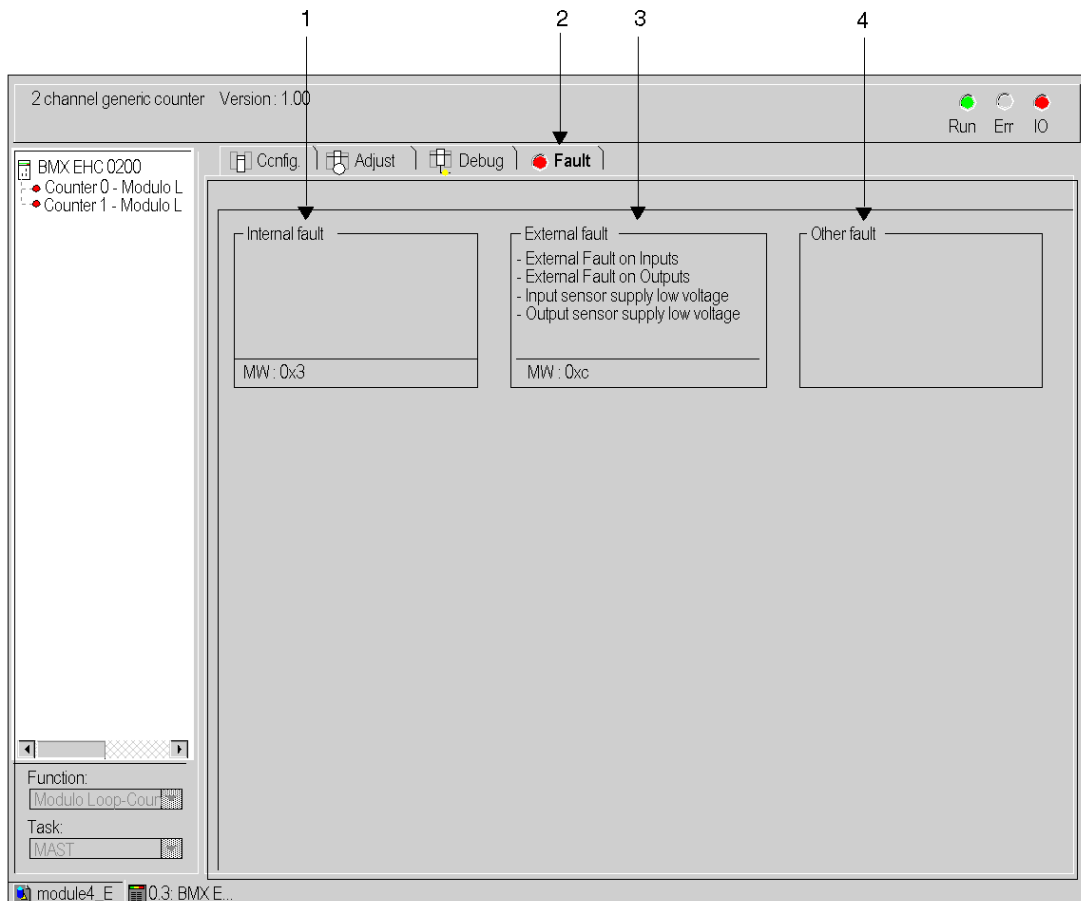



### Description of the Screen

The following table presents the various parts of the above screen.

Number	Element	Function
1	Internal faults field	This field displays the module's active internal faults.
2	Tab	The tab in the foreground indicates the current mode. The current mode is therefore the fault display mode in this example.
3	External faults field	This field displays the module's active external faults.
4	Other faults field	This field displays the module's active faults, other than internal and external faults.

## Faults Diagnostics Display

### At a Glance

The diagnostic screens (*see page 113*) on the module or channel are only accessible in connected mode. When an un-masked fault appears, it is reported:

- in the configuration screen of the rack, with the presence of a red square in the position of the faulty counting module,
- in all screens at module level (**Description** and **Fault** tabs),
  - in the module field with the LED
- in all channel level screens (**Configuration**, **Adjustment**, **Debug** and **Fault** tabs),
  - in the module zone with the LED
  - in the channel zone with the fault LED
- in the fault screen that is accessed by the **Fault** where the fault diagnostics are described.

The fault is also signaled:

- On the module, on the central display,
- by dedicated language objects: CH\_ERROR (%Ir.m.c.ERR) and MOD\_ERROR (%Ir.m.MOD.ERR), %MWr.m.MOD.2, etc. and status words.

**NOTE:** Even if the fault is masked, it is reported by the flashing of the **I/O** LED and in the fault screen.

## List of Error

### At a Glance

The messages displayed on the diagnostics screens are used to assist with debugging. These messages must be concise and are sometimes ambiguous (as different faults may have the same consequences).

These diagnostics are on two levels: module and channel, the latter being the most explicit.

The lists below show the message headings with suggestions for identifying issues.

### List of the Module Error Messages

The table below provides a list of the module error messages.

Fault indicated	Possible interpretation and/or action.
Module failure	The module has a error. Check the module mounting. Change the module.
Faulty channel(s)	One or more channels have a fault. Refer to channel diagnostics.
Self-test	The module is running a self-test. Wait until the self-test is complete.
Different hardware and software configurations	There is a lack of compatibility between the module configured and the module in the rack. Make the hardware configuration and the software configuration compatible.
Module is missing or off	Install the module. Fasten the mounting screws.

### BMX EHC 0200 Module Error

The table below provides a list of error that may appear on the BMX EHC 0200 module.

Language object	Description
%MWr.m.c.2.0	External fault at inputs
%MWr.m.c.2.1	External fault at outputs
%MWr.m.c.2.4	Internal error or self-testing.
%MWr.m.c.2.5	Configuration Fault
%MWr.m.c.2.6	Communication Error
%MWr.m.c.2.7	Application fault
%MWr.m.c.3.2	Sensor power supply fault
%MWr.m.c.3.3	Actuator supply fault
%MWr.m.c.3.4	Short circuit on output 0
%MWr.m.c.3.5	Short circuit on output 1

### List of Channel Error Messages

The table below gives the list of error messages at channel level.

Fault indicated. Other consequences.	Possible interpretation and/or action.
External fault or counting input fault: <ul style="list-style-type: none"> <li>● encoder or proximity sensor supply fault</li> <li>● line break or short circuit of at least one encoder differential signal (1A, 1B, 1Z)</li> <li>● specific fault on absolute encoder</li> </ul> Outputs are set to 0 in automatic mode. <b>Invalid measurement</b> message.	Check the sensor connections. Check the sensor power supply. Check the sensor operation. Delete the fault and acknowledge if the fault storing is configured. Counting pulses or incremental encoder: preset or reset to acknowledge the <b>Invalid measurement</b> message.
Counting application fault: <ul style="list-style-type: none"> <li>● measurement overrun</li> <li>● overspeed</li> </ul> Outputs are set to 0 in automatic mode. <b>Invalid measurement</b> message.	Diagnose the fault more precisely (external causes). Check the application again, if necessary. Delete the fault and acknowledge if the fault storing is configured. Counting pulses or incremental encoder: preset or reset to 0 to acknowledge the <b>Invalid measurement</b> message.
Auxiliary input/output fault: <ul style="list-style-type: none"> <li>● power supply</li> <li>● short circuit of at least one output</li> </ul> Outputs are set to 0 in automatic mode	Check the output connections Check the input/output power supply (24V) Diagnose the fault more precisely (external causes) Delete the fault and acknowledge if the fault storing is configured
Internal error or channel self-testing: <ul style="list-style-type: none"> <li>● module faulty</li> <li>● module missing or off</li> <li>● module running self-test</li> </ul>	Module fault has gone down to channel level. Refer to module level diagnostics.
Different hardware and software configurations	Module fault has gone down to channel level. Refer to module level diagnostics.
Invalid software configuration: <ul style="list-style-type: none"> <li>● incorrect constant</li> <li>● bit combination not associated with any configuration</li> </ul>	Check and modify the configuration constants.
Communication error	Check the connections between the racks.
Application fault: refusal to configure or adjust	Diagnose the fault more precisely.

---

# Chapter 13

## The Language Objects of the Counting Function

---

### Subject of this Chapter

This chapter describes the language objects associated to the counting tasks as well as the different ways of using them.

### What Is in This Chapter?

This chapter contains the following sections:

Section	Topic	Page
13.1	The Language Objects and IODDT of the Counting Function	174
13.2	Language Objects and IODDT Associated with the Counting Function of the BMX EHC xxxx Modules.	184
13.3	The IODDT Type T_GEN_MOD Applicable to All Modules	192
13.4	Device DDTs Associated with the Counting Function of the BMX EHC xxxx Modules.	194

---

# Section 13.1

## The Language Objects and IODDT of the Counting Function

---

### Subject of this Section

This section describes the general features of the language objects and IODDT of the counting function.

### What Is in This Section?

This section contains the following topics:

Topic	Page
Introducing Language Objects for Application-Specific Counting	175
Implicit Exchange Language Objects Associated with the Application-Specific Function	176
Explicit Exchange Language Objects Associated with the Application-Specific Function	177
Management of Exchanges and Reports with Explicit Objects	179

---

## Introducing Language Objects for Application-Specific Counting

### General

The counting modules have only two associated IODDTs. These IODDTs are predefined by the manufacturer and contains language objects for inputs/outputs belonging to the channel of an application-specific module.

The IODDT associated with the counting modules are of T\_ Unsigned\_CPT\_BMX and T\_Signed\_CPT\_BMX types.

**NOTE:** IODDT variables can be created in two different ways:

- Using the **I/O objects** (see *EcoStruxure™ Control Expert, Operating Modes*) tab.
- Using the Data Editor (see *EcoStruxure™ Control Expert, Operating Modes*).

### Language Object Types

Each IODDT contains a set of language objects allowing its operation to be controlled and checked.

There are two types of language objects:

- **Implicit Exchange Objects:** these objects are automatically exchanged on each cycle revolution of the task associated with the module.
- **Explicit Exchange Objects:** these objects are exchanged on the application's request, using explicit exchange instructions.

Implicit exchanges concern the inputs/outputs of the module (measurement results, information and commands). These exchanges enable the debugging of the counting modules.

Explicit exchanges enable the module to be set and diagnosed.

---

## Implicit Exchange Language Objects Associated with the Application-Specific Function

### At a Glance

An integrated application-specific interface or the addition of a module automatically enhances the language objects application used to program this interface or module.

These objects correspond to the input/output images and software data of the module or integrated application-specific interface.

### Reminders

The module inputs (%I and %IW) are updated in the PLC memory at the start of the task, the PLC being in RUN or STOP mode.

The outputs (%Q and %QW) are updated at the end of the task, only when the PLC is in RUN mode.

**NOTE:** When the task occurs in STOP mode, either of the following are possible, depending on the configuration selected:

- outputs are set to fallback position (fallback mode)
- outputs are maintained at their last value (maintain mode)

### Figure

The following diagram shows the operating cycle of a PLC task (cyclical execution).

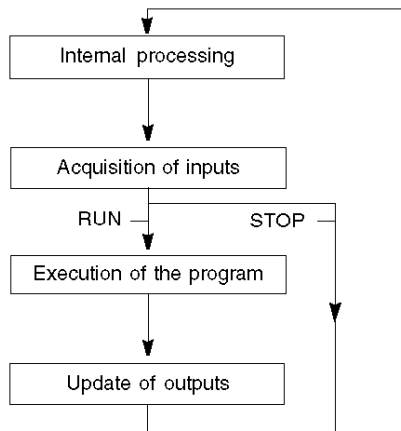



---

## Explicit Exchange Language Objects Associated with the Application-Specific Function

### Introduction

Explicit exchanges are performed at the user program's request using these instructions:

- READ\_STS (read status words)
- WRITE\_CMD (write command words)
- WRITE\_PARAM (write adjustment parameters)
- READ\_PARAM (read adjustment parameters)
- SAVE\_PARAM (save adjustment parameters)
- RESTORE\_PARAM (restore adjustment parameters)

For more details about instructions, refer to *EcoStruxure™ Control Expert, I/O Management, Block Library*.

These exchanges apply to a set of %MW objects of the same type (status, commands or parameters) that belong to a channel.

These objects can:

- provide information about the module (for example, type of error detected in a channel)
- have command control of the module (for example, switch command)
- define the module's operating modes (save and restore adjustment parameters in the process of application)

**NOTE:** To avoid several simultaneous explicit exchanges for the same channel, it is necessary to test the value of the word EXCH\_STS (%MW<sub>r.m.c.0</sub>) of the IODDT associated to the channel before calling any EF addressing this channel.

**NOTE:** Explicit exchanges are not supported when X80 analog and digital I/O modules are configured through an eX80 adapter module (BMECRA31210) in a Quantum EIO configuration. You cannot set up a module's parameters from the PLC application during operation.

## General Principle for Using Explicit Instructions

The diagram below shows the different types of explicit exchanges that can be made between the application and module.

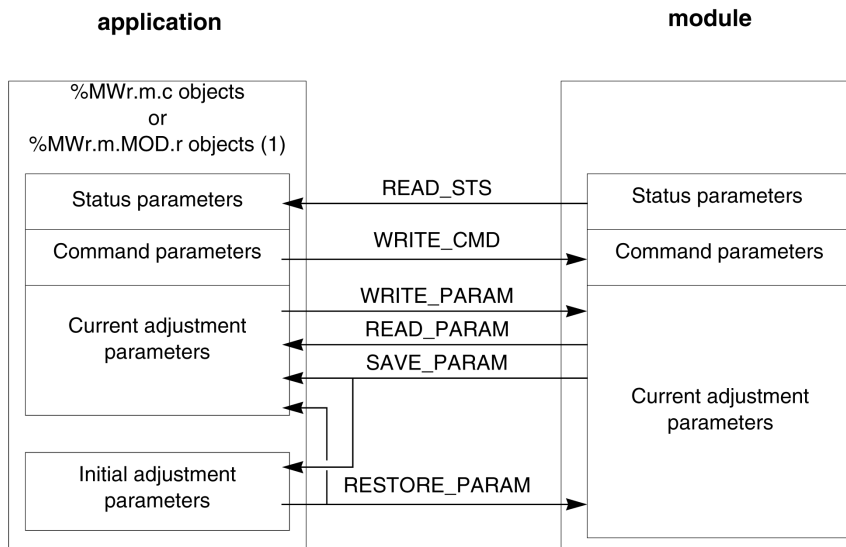

(1) Only with READ\_STS and WRITE\_CMD instructions.

## Managing Exchanges

During an explicit exchange, check performance to see that the data is only taken into account when the exchange has been correctly executed.

To do this, two types of information is available:

- information concerning the exchange in progress (*see page 182*)
- the exchange report (*see page 182*)

The following diagram describes the management principle for an exchange.

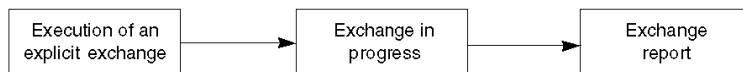

**NOTE:** In order to avoid several simultaneous explicit exchanges for the same channel, it is necessary to test the value of the word EXCH\_STS (%MWr.m.c.0) of the IODDT associated to the channel before calling any EF addressing this channel.

---

## Management of Exchanges and Reports with Explicit Objects

### At a Glance

When data is exchanged between the PLC memory and the module, the module may require several task cycles to acknowledge this information. IODDTs use two words to manage exchanges:

- EXCH\_STS (%MW<sub>r.m.c.0</sub>): exchange in progress
- EXCH\_RPT (%MW<sub>r.m.c.1</sub>): report

#### NOTE:

Depending on the localization of the module, the management of the explicit exchanges (%MW0.0.MOD.0.0 for example) will not be detected by the application:

- For in-rack modules, explicit exchanges are done immediately on the local PLC Bus and are finished before the end of the execution task. So, the READ\_STS, for example, is finished when the %MW0.0.mod.0.0 bit is checked by the application.
- For remote bus (Fipio for example), explicit exchanges are not synchronous with the execution task, so the detection is possible by the application.

### Illustration

The illustration below shows the different significant bits for managing exchanges:

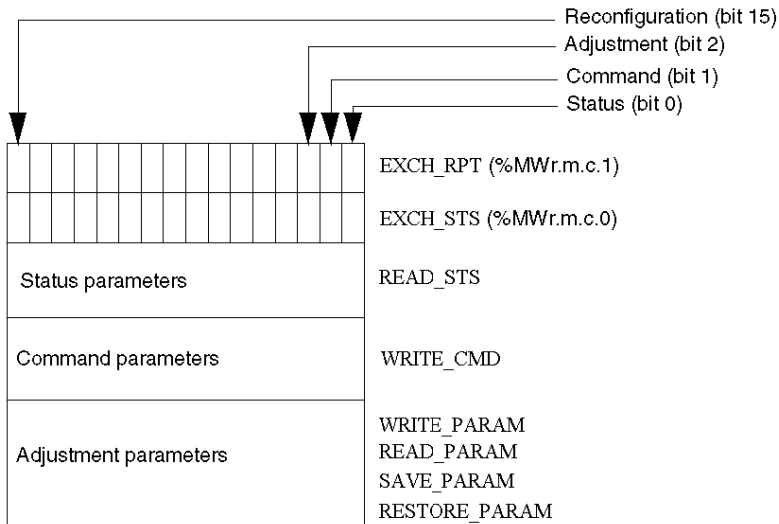

---

## Description of Significant Bits

Each bit of the words `EXCH_STS` (`%MWr.m.c.0`) and `EXCH_RPT` (`%MWr.m.c.1`) is associated with a type of parameter:

- Rank 0 bits are associated with the status parameters:
  - The `STS_IN_PROGR` bit (`%MWr.m.c.0.0`) indicates whether a read request for the status words is in progress.
  - The `STS_ERR` bit (`%MWr.m.c.1.0`) specifies whether a read request for the status words is accepted by the module channel.
- Rank 1 bits are associated with the command parameters:
  - The `CMD_IN_PROGR` bit (`%MWr.m.c.0.1`) indicates whether command parameters are being sent to the module channel.
  - The `CMD_ERR` bit (`%MWr.m.c.1.1`) specifies whether the command parameters are accepted by the module channel.
- Rank 2 bits are associated with the adjustment parameters:
  - The `ADJ_IN_PROGR` bit (`%MWr.m.c.0.2`) indicates whether the adjustment parameters are being exchanged with the module channel (via `WRITE_PARAM`, `READ_PARAM`, `SAVE_PARAM`, `RESTORE_PARAM`).
  - The `ADJ_ERR` bit (`%MWr.m.c.1.2`) specifies whether the adjustment parameters are accepted by the module. If the exchange is correctly executed, the bit is set to 0.
- Rank 15 bits indicate a reconfiguration on channel **c** of the module from the console (modification of the configuration parameters + cold start-up of the channel).
- The *r*, *m* and *c* bits indicates the following elements:
  - the **r** bit represents the rack number.
  - The **m** bit represents the position of the module in the rack.
  - The **c** bit represents the channel number in the module.

**NOTE:** **r** represents the rack number, **m** the position of the module in the rack, while **c** represents the channel number in the module.

**NOTE:** Exchange and report words also exist at module level `EXCH_STS` (`%MWr.m.MOD`) and `EXCH_RPT` (`%MWr.m.MOD.1`) as per IODDT type `T_GEN_MOD`.

## Example

Phase 1: Sending data by using the `WRITE_PARAM` instruction

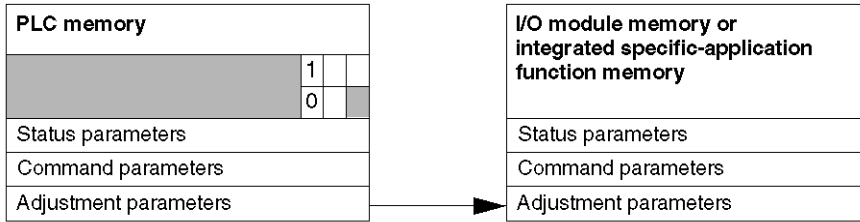

When the instruction is scanned by the PLC, the **Exchange in progress** bit is set to 1 in `%MWr.m.c`.

Phase 2: Analysis of the data by the I/O module and report.

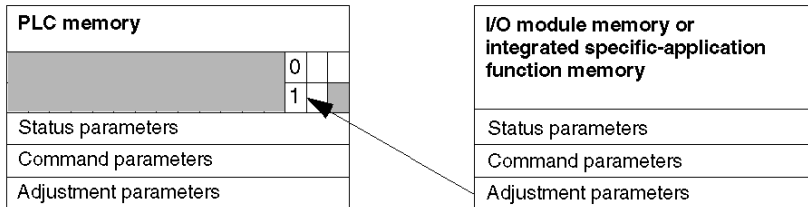

When the data is exchanged between the PLC memory and the module, acknowledgement by the module is managed by the `ADJ_ERR` bit (`%MWr.m.c.1.2`).

This bit makes the following reports:

- 0: correct exchange
- 1: incorrect exchange)

**NOTE:** There is no adjustment parameter at module level.

---

### Execution Indicators for an Explicit Exchange: EXCH\_STS

The table below shows the control bits of the explicit exchanges: EXCH\_STS (%MWr.m.c.0)

Standard Symbol	Type	Access	Meaning	Address
STS_IN_PROGR	BOOL	R	Reading of channel status words in progress	%MWr.m.c.0.0
CMD_IN_PROGR	BOOL	R	Command parameters exchange in progress	%MWr.m.c.0.1
ADJ_IN_PROGR	BOOL	R	Adjust parameters exchange in progress	%MWr.m.c.0.2
RECONF_IN_PROGR	BOOL	R	Reconfiguration of the module in progress	%MWr.m.c.0.15

**NOTE:** If the module is not present or is disconnected, explicit exchange objects (READ\_STS for example) are not sent to the module (STS\_IN\_PROG (%MWr.m.c.0.0) = 0), but the words are refreshed.

### Explicit Exchange Report: EXCH\_RPT

The table below shows the report bits: EXCH\_RPT (%MWr.m.c.1)

Standard Symbol	Type	Access	Meaning	Address
STS_ERR	BOOL	R	Error detected while reading channel status words (1 = detected error)	%MWr.m.c.1.0
CMD_ERR	BOOL	R	Error detected during a command parameter exchange (1 = detected error)	%MWr.m.c.1.1
ADJ_ERR	BOOL	R	Error detected during an adjust parameter exchange (1 = detected error)	%MWr.m.c.1.2
RECONF_ERR	BOOL	R	Error detected during reconfiguration of the channel (1 = detected error)	%MWr.m.c.1.15

---

## Counting Module Use

The following table describes the steps realized between a counting module and the system after a power-on.

Step	Action
1	Power on.
2	The system sends the configuration parameters.
3	The system sends the adjust parameters by WRITE_PARAM method. <b>Note:</b> When the operation is finished, the bit %MWr.m.c.0.2 switches to 0.

If, in the beginning of your application, you use a WRITE\_PARAM command, wait until the bit %MWr.m.c.0.2 switches to 0.

---

## Section 13.2

### Language Objects and IODDT Associated with the Counting Function of the BMX EHC xxxx Modules.

---

#### Subject of this Section

This section presents the language objects and IODDTs associated with the counting function of BMX EHC xxxx modules.

#### What Is in This Section?

This section contains the following topics:

Topic	Page
Details of Implicit Exchange Objects for the T_Unsigned_CPT_BMX and T_Signed_CPT_BMX-types IODDTs	185
Details of the Explicit Exchange Objects for the T_CPT_BMX-type IODDT	190



## Details of Implicit Exchange Objects for the T\_Unsigned\_CPT\_BMX and T\_Signed\_CPT\_BMX-types IODDTs

### At a Glance

The tables below present the T\_Unsigned\_CPT\_BMX and T\_Signed\_CPT\_BMX-types IODDTs implicit exchange objects which are applicable to all **BMX EHC** counting modules.

### Counter Value and Sensor Values

The table below presents the various IODDT implicit exchange objects:

Standard symbol	Type	Access	Meaning	Language object
COUNTER_CURRENT_VALUE	DINT	R	Current counter value	%IDr.m.c.2
CAPT_0_VALUE	DINT	R	Counter value when captured in register 0	%IDr.m.c.4
CAPT_1_VALUE	DINT	R	Counter value when captured in register 1	%IDr.m.c.6
COUNTER_VALUE	DINT	R	Current counter value during event	%IDr.m.c.12
CAPT_0_VAL	DINT	R	Capture value 0	%IDr.m.c.14
CAPT_1_VAL	DINT	R	Capture value 1	%IDr.m.c.16

### %Ir.m.c.d Word

The table below presents the meanings of the %Ir.m.c.d words:

Standard symbol	Type	Access	Meaning	Language object
CH_ERROR	BOOL	R	Channel error	%Ir.m.c.ERR
OUTPUT_0_Echo	BOOL	R	Logical state of output 0	%Ir.m.c.0
OUTPUT_1_Echo	BOOL	R	Logical state of output 1	%Ir.m.c.1
OUTPUT_BLOCK_0	BOOL	R	State of output block 0	%Ir.m.c.2
OUTPUT_BLOCK_1	BOOL	R	State of output block 1	%Ir.m.c.3
INPUT_A	BOOL	R	Physical state of IN_A input	%Ir.m.c.4
INPUT_B	BOOL	R	Physical state of IN_B input	%Ir.m.c.5
INPUT_SYNC	BOOL	R	Physical state of the IN_SYNC input (or IN_AUX)	%Ir.m.c.6
INPUT_EN	BOOL	R	Physical state of IN_EN input (enable)	%Ir.m.c.7
INPUT_REF	BOOL	R	Physical state of the IN_REF input (preset)	%Ir.m.c.8
INPUT_CAPT	BOOL	R	Physical state of IN_CAP input (capture)	%Ir.m.c.9

### Counter Status, %IW<sub>r</sub>.m.c.0 Word

The following table presents the meanings of the bits of the %IW<sub>r</sub>.m.c.0 status word:

Standard symbol	Type	Access	Meaning	Language object
RUN	BOOL	R	The counter operates in counting mode only	%IW <sub>r</sub> .m.c.0.0
MODULO_FLAG	BOOL	R	Flag set to 1 by a modulo switch event	%IW <sub>r</sub> .m.c.0.1
SYNC_REF_FLAG	BOOL	R	Flag set to 1 by a preset or synchronization event	%IW <sub>r</sub> .m.c.0.2
VALIDITY	BOOL	R	The current numerical value is valid	%IW <sub>r</sub> .m.c.0.3
HIGH_LIMIT	BOOL	R	The current numerical value is locked at the upper threshold value	%IW <sub>r</sub> .m.c.0.4
LOW_LIMIT	BOOL	R	The current numerical value is locked at the lower threshold value	%IW <sub>r</sub> .m.c.0.5

### Comparison Status, %IW<sub>r</sub>.m.c.1 Word

The following table presents the meanings of the bits of the %IW<sub>r</sub>.m.c.1 status word:

Standard symbol	Type	Access	Meaning	Language object
COUNTER_LOW	BOOL	R	Current counter value less than lower threshold (%QD <sub>r</sub> .m.c.2)	%IW <sub>r</sub> .m.c.1.0
COUNTER_WIN	BOOL	R	Current counter value is between lower threshold (%QD <sub>r</sub> .m.c.2) and upper threshold (%QD <sub>r</sub> .m.c.4)	%IW <sub>r</sub> .m.c.1.1
COUNTER_HIGH	BOOL	R	Current counter value greater than upper threshold (%QD <sub>r</sub> .m.c.4)	%IW <sub>r</sub> .m.c.1.2
CAPT_0_LOW	BOOL	R	Value captured in register 0 is less than lower threshold (%QD <sub>r</sub> .m.c.2)	%IW <sub>r</sub> .m.c.1.3
CAPT_0_WIN	BOOL	R	Value captured in register 0 is between lower threshold (%QD <sub>r</sub> .m.c.2) and upper threshold (%QD <sub>r</sub> .m.c.4)	%IW <sub>r</sub> .m.c.1.4
CAPT_0_HIGH	BOOL	R	Value captured in register 0 is greater than upper threshold (%QD <sub>r</sub> .m.c.4)	%IW <sub>r</sub> .m.c.1.5
CAPT_1_LOW	BOOL	R	Value captured in register 1 is less than lower threshold (%QD <sub>r</sub> .m.c.2)	%IW <sub>r</sub> .m.c.1.6
CAPT_1_WIN	BOOL	R	Value captured in register 1 is between lower threshold (%QD <sub>r</sub> .m.c.2) and upper threshold (%QD <sub>r</sub> .m.c.4)	%IW <sub>r</sub> .m.c.1.7
CAPT_1_HIGH	BOOL	R	Value captured in register 1 is greater than upper threshold (%QD <sub>r</sub> .m.c.4)	%IW <sub>r</sub> .m.c.1.8

## Event Sources, %IWr.m.c.10 Word

The following table presents the meanings of the bits of the %IWr.m.c.10 word:

Standard symbol	Type	Access	Meaning	Language object
EVT_SOURCES	INT	R	Event sources field	%IWr.m.c.10
EVT_RUN	BOOL	R	Event due to start of counter.	%IWr.m.c.10.0
EVT_MODULO	BOOL	R	Event due to modulo switch	%IWr.m.c.10.1
EVT_SYNC_PRESET	BOOL	R	Event due to synchronization or preset	%IWr.m.c.10.2
EVT_COUNTER_LOW	BOOL	R	Event due to counter value being less than lower threshold	%IWr.m.c.10.3
EVT_COUNTER_WINDOW	BOOL	R	Event due to counter value being between the two thresholds	%IWr.m.c.10.4
EVT_COUNTER_HIGH	BOOL	R	Event due to counter value being greater than upper threshold	%IWr.m.c.10.5
EVT_CAPT_0	BOOL	R	Event due to capture function 0	%IWr.m.c.10.6
EVT_CAPT_1	BOOL	R	Event due to capture function 1	%IWr.m.c.10.7
EVT_OVERRUN	BOOL	R	Warning: lost event(s)	%IWr.m.c.10.8

## Output Thresholds and Frequency

The table below presents the various IODDT implicit exchange objects:

Standard symbol	Type	Access	Meaning	Language object
LOWER_TH_VALUE	DINT	R/W	Lower threshold value	%QDr.m.c.2
UPPER_TH_VALUE	DINT	R/W	Upper threshold value	%QDr.m.c.4
PWM_FREQUENCY	DINT	R/W	Output frequency value (unit = 0.1 Hz)	%QDr.m.c.6
PWM_DUTY	INT	R/W	Duty cycle value of the output frequency (unit = 5%)	%QDr.m.c.8

## %Qr.m.c.d Words

The following table presents the meanings of the bits of the %Qr.m.c.d words:

Standard symbol	Type	Access	Meaning	Language object
OUTPUT_0	BOOL	R/W	Forces OUTPUT_0 to level 1	%Qr.m.c.0
OUTPUT_1	BOOL	R/W	Forces OUTPUT_1 to level 1	%Qr.m.c.1
OUTPUT_BLOCK_0_ENABLE	BOOL	R/W	Implementation of output 0 function block	%Qr.m.c.2
OUTPUT_BLOCK_1_ENABLE	BOOL	R/W	Implementation of output 1 function block	%Qr.m.c.3
FORCE_SYNC	BOOL	R/W	Counting function synchronization and start	%Qr.m.c.4
FORCE_REF	BOOL	R/W	Set to preset counter value	%Qr.m.c.5
FORCE_ENABLE	BOOL	R/W	Implementation of counter	%Qr.m.c.6
FORCE_RESET	BOOL	R/W	Reset counter	%Qr.m.c.7
SYNC_RESET	BOOL	R/W	Reset SYNC_REF_FLAG	%Qr.m.c.8
MODULO_RESET	BOOL	R/W	Reset MODULO_FLAG	%Qr.m.c.9

## FUNCTIONS\_ENABLING, %QWr.m.c.0 Word

The following table presents the meanings of the bits of the %QWr.m.c.0 words:

Standard symbol	Type	Access	Meaning	Language object
VALID_SYNC	BOOL	R/W	Synchronization and start authorization for the counting function via the IN_SYNC input	%QWr.m.c.0.0
VALID_REF	BOOL	R/W	Operation authorization for the internal preset function	%QWr.m.c.0.1
VALID_ENABLE	BOOL	R/W	Authorization of the counter enable via the IN_EN input	%QWr.m.c.0.2
VALID_CAPT_0	BOOL	R/W	Capture authorization in the capture0 register	%QWr.m.c.0.3
VALID_CAPT_1	BOOL	R/W	Capture authorization in the capture1 register	%QWr.m.c.0.4
COMPARE_ENABLE	BOOL	R/W	Comparators operation authorization	%QWr.m.c.0.5
COMPARE_SUSPEND	BOOL	R/W	Comparator frozen at its last value	%QWr.m.c.0.6

---

## EVENT\_SOURCES\_ENABLING, %QWr.m.c.1 Word

The following table presents the meanings of the bits of the %QWr.m.c.1 words:

Standard symbol	Type	Access	Meaning	Language object
EVT_RUN_ENABLE	BOOL	R/W	EVENT task call at start of the counting function	%QWr.m.c.1.0
EVT_MODULO_ENABLE	BOOL	R/W	EVENT task call when there is a counter reversal	%QWr.m.c.1.1
EVT_REF_ENABLE	BOOL	R/W	EVENT task call during counter synchronization or preset	%QWr.m.c.1.2
EVT_COUNTER_LOW_	BOOL	R/W	EVENT task call when the counter value is less than lower threshold	%QWr.m.c.1.3
EVT_COUNTER_WINDOW_ENABLE	BOOL	R/W	EVENT task call when the counter is between the lower and upper threshold	%QWr.m.c.1.4
EVT_COUNTER_HIGH_ENABLE	BOOL	R/W	EVENT task call when the counter value is greater than the upper threshold	%QWr.m.c.1.5
EVT_CAPT_0_ENABLE	BOOL	R/W	EVENT task call during capture in register 0	%QWr.m.c.1.6
EVT_CAPT_1_ENABLE	BOOL	R/W	EVENT task call during capture in register 1	%QWr.m.c.1.7

---

## Details of the Explicit Exchange Objects for the T\_CPT\_BMX-type IODDT

### At a Glance

This section presents the explicit exchange objects for the T\_Unsigned\_CPT\_BMX and T\_Signed\_CPT\_BMX- types IODDTs which are applicable to all BMX EHC •••• counting modules. They includes word type objects whose bits have a specific meaning. These objects are described in detail below.

Sample variable declaration: T\_Unsigned\_CPT\_BMX and T\_Signed\_CPT\_BMX-types  
IODDT\_VAR1.

#### NOTE:

- in general, the meaning of the bits is given for bit status 1.
- not all bits are used.

### Exchange Status: EXCH\_STS

The table below shows the meaning of channel exchange status bits from the EXCH\_STS channel (%MWr.m.c.0).

Standard symbol	Type	Access	Meaning	Language object
STS_IN_PROG	BOOL	R	Status parameter read in progress	%MWr.m.c.0.0
ADJ_IN_PROG	BOOL	R	Adjust parameter exchange in progress	%Mwr.m.c.0.2
RECONF_IN_PROG	BOOL	R	Reconfiguration in progress	%MWr.m.c.0.15

### Channel Report: EXCH\_RPT

The following table presents the meanings of the report bits of the EXCH\_RPT channel (%MWr.m.c.1).

Standard symbol	Type	Access	Meaning	Language object
STS_ERR	BOOL	R	Error while reading channel status	%MWr.m.c.1.0
ADJ_ERR	BOOL	R	Error while adjusting the channel	%Mwr.m.c.1.2
RECONF_ERR	BOOL	R	Error while reconfiguring the channel	%MWr.m.c.1.15

---

### Channel Error: CH\_FLT

The table below presents the meaning of the error bits on the CH\_FLT channel (%MWr.m.c.2).

Standard symbol	Type	Access	Meaning	Language object
EXTERNAL_FLT_INPUTS	BOOL	R	External error at inputs	%MWr.m.c.2.0
EXTERNAL_FLT_OUTPUTS	BOOL	R	External error at outputs	%MWr.m.c.2.1
INTERNAL_FLT	BOOL	R	Internal error: channel inoperative	%MWr.m.c.2.4
CONF_FLT	BOOL	R	Hardware or software configuration error	%MWr.m.c.2.5
COM_FLT	BOOL	R	Bus Communication error	%MWr.m.c.2.6
APPLI_FLT	BOOL	R	Application error	%MWr.m.c.2.7

### Channel Error: %MWr.m.c.3

The table below presents the meaning of the error bits on the %MWr.m.c.3 word.

Standard symbol	Type	Access	Meaning	Language object
SENSOR_SUPPLY	BOOL	R	Low input power supply for the sensors	%MWr.m.c.3.2
ACTUATOR_SUPPLY_FLT	BOOL	R	Output power supply failure	%MWr.m.c.3.3
SHORT_CIRCUIT_OUT_0	BOOL	R	Short circuit on output 0	%MWr.m.c.3.4
SHORT_CIRCUIT_OUT_1	BOOL	R	Short circuit on output 1	%MWr.m.c.3.5

# Section 13.3

## The IODDT Type T\_GEN\_MOD Applicable to All Modules

### Details of the Language Objects of the IODDT of Type T\_GEN\_MOD

#### Introduction

The Modicon X80 modules have an associated IODDT of type T\_GEN\_MOD.

#### Observations

In general, the meaning of the bits is given for bit status 1. In specific cases an explanation is given for each status of the bit.

Some bits are not used.

#### List of Objects

The table below presents the objects of the IODDT.

Standard Symbol	Type	Access	Meaning	Address
MOD_ERROR	BOOL	R	Module detected error bit	%I.r.m.MOD.ERR
EXCH_STS	INT	R	Module exchange control word	%MWr.m.MOD.0
STS_IN_PROGR	BOOL	R	Reading of status words of the module in progress	%MWr.m.MOD.0.0
EXCH_RPT	INT	R	Exchange report word	%MWr.m.MOD.1
STS_ERR	BOOL	R	Event when reading module status words	%MWr.m.MOD.1.0
MOD_FLT	INT	R	Internal detected errors word of the module	%MWr.m.MOD.2
MOD_FAIL	BOOL	R	module inoperable	%MWr.m.MOD.2.0
CH_FLT	BOOL	R	Inoperative channel(s)	%MWr.m.MOD.2.1
BLK	BOOL	R	Terminal block incorrectly wired	%MWr.m.MOD.2.2
CONF_FLT	BOOL	R	Hardware or software configuration anomaly	%MWr.m.MOD.2.5
NO_MOD	BOOL	R	Module missing or inoperative	%MWr.m.MOD.2.6
EXT_MOD_FLT	BOOL	R	Internal detected errors word of the module (Fipio extension only)	%MWr.m.MOD.2.7
MOD_FAIL_EXT	BOOL	R	Internal detected error, module unserviceable (Fipio extension only)	%MWr.m.MOD.2.8
CH_FLT_EXT	BOOL	R	Inoperative channel(s) (Fipio extension only)	%MWr.m.MOD.2.9
BLK_EXT	BOOL	R	Terminal block incorrectly wired (Fipio extension only)	%MWr.m.MOD.2.10



---

<b>Standard Symbol</b>	<b>Type</b>	<b>Access</b>	<b>Meaning</b>	<b>Address</b>
CONF_FLT_EXT	BOOL	R	Hardware or software configuration anomaly (Fipio extension only)	%MWr.m.MOD.2.13
NO_MOD_EXT	BOOL	R	Module missing or inoperative (Fipio extension only)	%MWr.m.MOD.2.14

---

## Section 13.4

### Device DDTs Associated with the Counting Function of the BMX EHC xxxx Modules.

---

#### Subject of this Section

This section presents the Device DDTs associated with the counting function of BMX EHC .... modules.

#### What Is in This Section?

This section contains the following topics:

Topic	Page
Counter Device DDT	195
MOD_FLT Byte Description	203

---

## Counter Device DDT

### Introduction

This topic describes the device DDT for the Modicon X80 counter module, the instance default naming is described in Device DDT Instance Naming Rule (*see EcoStruxure™ Control Expert, Program Languages and Structure, Reference Manual*).

Regarding the device DDT, its name contains the following information:

- platform with:
  - M for Modicon X80 module
- device type (CPT for counter)
- function (STD for standard)
- direction:
  - IN
  - OUT
- max channel (2 or 8)

Example: For a Modicon X80 counter module with 2 standard inputs: T\_M\_CPT\_STD\_IN\_2

### Adjustment Parameter limitation

Adjustment parameters cannot be changed from the PLC application during operation (no support of READ\_PARAM, WRITE\_PARAM, SAVE\_PARAM, RESTORE\_PARAM) for:

- counter modules in a Quantum EIO
- counter modules in a M580 RIO

Modifying the adjustment parameters of a channel from Control Expert during a CCOTF operation causes the channel to be re-initialized.

The concerned parameters are:

- PRESET\_VALUE  
Preset value
- CALIBRATION\_FACTOR  
Calibration Factor
- MODULO\_VALUE  
Modulo value
- SLACK\_VAL (Hysteresis)  
Offset value

### List of Implicit Device DDT

The following table shows the list of device DDT and their X80 modules:

Device DDT	Modicon X80 modules
T_M_CPT_STD_IN_2	BMX EHC 0200
T_M_CPT_STD_IN_8	BMX EHC 0800

## Implicit Device DDT Description

The following table shows the T\_M\_CPT\_STD\_IN\_x status word bits:

Standard Symbol	Type	Meaning	Access
MOD_HEALTH	BOOL	0 = the module has a detected error 1 = the module is operating correctly	read
MOD_FLT	BYTE	internal detected errors byte ( <i>see page 203</i> ) of the module	read
CPT_CH_IN	ARRAY [0..x-1] of T_M_CPT_STD_CH_IN	Array of structure	

The following table shows the T\_M\_CPT\_STD\_CH\_IN\_x[0..x-1] status word bits:

Standard Symbol	Type	Bit	Meaning	Access
FCT_TYPE	WORD	-	1 = Frequency	read
			2 = EvtCounting	
			3 = PeriodMeasuring	
			4 = Ratio1	
			5 = Ratio2	
			6 = OneShotCounter	
			7 = ModuleLoopCounter	
			8 = FreeLargeCounter	
			9 = PulseWidthModulation	
			10 = UpDownCounting	
			11 = DualPhaseCounting	
CH_HEALTH	BOOL	-	0 = the channel has a detected error	read
			1 = the channel is operating correctly	
ST_OUTPUT_0_ECHO	EBOOL	-	logical state of output 0	read
ST_OUTPUT_1_ECHO	EBOOL	-	logical state of output 1	read
ST_OUTPUT_BLOCK_0	EBOOL	-	status of physical counting output block 0	read
ST_OUTPUT_BLOCK_1	EBOOL	-	status of physical counting output block 1	read
<b>(1)</b> Signed application specific function (ASF) must be used				
<b>(2)</b> Unsigned application specific function (ASF) must be used				

Standard Symbol		Type	Bit	Meaning	Access
ST_INPUT_A		EBOOL	–	status of physical counting input A	read
ST_INPUT_B		EBOOL	–	status of physical counting input B	read
ST_INPUT_SYNC		EBOOL	–	physical state of the IN_SYNC input (or IN_AUX)	read
ST_INPUT_EN		EBOOL	–	physical state of IN_EN input (enable)	read
ST_INPUT_REF		EBOOL	–	physical state of the IN_REF input (preset)	read
ST_INPUT_CAPT		EBOOL	–	physical state of IN_CAP input (capture)	read
COUNTER_STATUS [INT]	RUN	BOOL	0	the counter operates in counting mode only	read
	MODULO_FLAG	BOOL	1	flag set to 1 by a modulo switch event	read
	SYNC_REF_FLAG	BOOL	2	flag set to 1 by a preset or synchronization event	read
	VALIDITY	BOOL	3	the current numerical value is valid	read
	HIGH_LIMIT	BOOL	4	the current numerical value is locked at the upper threshold value	read
	LOW_LIMIT	BOOL	5	the current numerical value is locked at the lower threshold value	read
<b>(1)</b> Signed application specific function (ASF) must be used <b>(2)</b> Unsigned application specific function (ASF) must be used					

Standard Symbol		Type	Bit	Meaning	Access
COMPARE_STATUS [INT]	COUNTER_LOW	BOOL	0	current counter value less than lower threshold (LOWER_TH_VALUE)	read
	COUNTER_WIN	BOOL	1	current counter value is between lower threshold (LOWER_TH_VALUE) and upper threshold (UPPER_TH_VALUE)	read
	COUNTER_HIGH	BOOL	2	current counter value greater than upper threshold (UPPER_TH_VALUE)	read
	CAPT_0_LOW	BOOL	3	Value captured in register 0 is less than lower threshold (LOWER_TH_VALUE)	read
	CAPT_0_WIN	BOOL	4	Value captured in register 0 is between lower threshold (LOWER_TH_VALUE) and upper threshold (UPPER_TH_VALUE)	read
	CAPT_0_HIGH	BOOL	5	Value captured in register 0 is greater than upper threshold (UPPER_TH_VALUE)	read
	CAPT_1_LOW	BOOL	6	Value captured in register 1 is less than lower threshold (LOWER_TH_VALUE)	read
	CAPT_1_WIN	BOOL	7	Value captured in register 1 is between lower threshold (LOWER_TH_VALUE) and upper threshold (UPPER_TH_VALUE)	read
	CAPT_1_HIGH	BOOL	8	Value captured in register 1 is greater than upper threshold (UPPER_TH_VALUE)	read
COUNTER_CURRENT_VALUE_S <sup>(1)</sup>		DINT	–	Current counter value during event	read
CAPT_0_VALUE_S <sup>(1)</sup>		DINT	–	Value captured in register 0	read
CAPT_1_VALUE_S <sup>(1)</sup>		DINT	–	Value captured in register 1	read
COUNTER_CURRENT_VALUE_US <sup>(2)</sup>		UDINT	–	Current counter value during event	read
CAPT_0_VALUE_US <sup>(2)</sup>		UDINT	–	Value captured in register 0	read
<b>(1)</b> Signed application specific function (ASF) must be used					
<b>(2)</b> Unsigned application specific function (ASF) must be used					

Standard Symbol		Type	Bit	Meaning	Access
CAPT_1_VALUE_US <sup>(2)</sup>		UDINT	–	Value captured in register 1	read
OUTPUT_0		EBOOL	–	forces OUTPUT_0 to level 1	read / write
OUTPUT_1		EBOOL	–	forces OUTPUT_1 to level 1	read / write
OUTPUT_BLOCK_0_ENABLE		EBOOL	–	implementation of output 0 function block	read / write
OUTPUT_BLOCK_1_ENABLE		EBOOL	–	implementation of output 1 function block	read / write
FORCE_SYNC		EBOOL	–	counting function synchronization and start	read / write
FORCE_REF		EBOOL	–	set to preset counter value	read / write
FORCE_ENABLE		EBOOL	–	implementation of counter	read / write
FORCE_RESET		EBOOL	–	reset counter	read / write
SYNC_RESET		EBOOL	–	reset SYNC_REF_FLAG	read / write
MODULO_RESET		EBOOL	–	reset MODULO_FLAG	read / write
FUNCTIONS_ENABLING [INT]	VALID_SYNC	BOOL	0	synchronization and start authorization for the counting function via the IN_SYNC input	read / write
	VALID_REF	BOOL	1	operation authorization for the internal preset function	read / write
	VALID_ENABLE	BOOL	2	authorization of the counter enable via the IN_EN input	read / write
	VALID_CAPT_0	BOOL	3	capture authorization in the capture 0 register	read / write
	VALID_CAPT_1	BOOL	4	capture authorization in the capture 1 register	read / write
	COMPARE_ENABLE	BOOL	5	comparators operation authorization	read / write
	COMPARE_SUSPEND	BOOL	6	comparator frozen at its last value	read / write
LOWER_TH_VALUE_S <sup>(1)</sup>		DINT	–	lower threshold value	read / write
<b>(1) Signed application specific function (ASF) must be used</b>					
<b>(2) Unsigned application specific function (ASF) must be used</b>					

Standard Symbol	Type	Bit	Meaning	Access
UPPER_TH_VALUE_S <sup>(1)</sup>	DINT	–	upper threshold value	read / write
PWM_FREQUENCY_S <sup>(1)</sup>	DINT	–	output frequency value (unit = 0.1 Hz)	read / write
LOWER_TH_VALUE_US <sup>(2)</sup>	UDINT	–	lower threshold value	read / write
UPPER_TH_VALUE_US <sup>(2)</sup>	UDINT	–	upper threshold value	read / write
PWM_FREQUENCY_US <sup>(2)</sup>	UDINT	–	output frequency value (unit = 0.1 Hz)	read / write
PWM_DUTY	INT	–	duty cycle value of the output frequency (unit = 5%)	read / write
<b>(1)</b> Signed application specific function (ASF) must be used				
<b>(2)</b> Unsigned application specific function (ASF) must be used				

Here below is all the signed ASF that must be used with a counter BMX EHC 0200:

- Free Large counter Mode
- Ratio 1
- Ratio 2

Here below is all the unsigned ASF that must be used with a counter BMX EHC 0200:

- Event Counting Mode
- Frequency Mode
- Modulo Loop Counter Mode
- One Shot Counter Mode
- Period Measuring Mode
- Pulse Width Modulation Mode

Here below is all the signed ASF that must be used with a counter BMX EHC 0800:

- Up Down Counting Mode

Here below is all the unsigned ASF that must be used with a counter BMX EHC 0800:

- Event Counting Mode
- Frequency Mode
- Modulo Loop Counter Mode
- One Shot Counter Mode



## Use and Description of DDT for Explicit Exchange

The following table shows the Derived Data Type (DDT) used for the variables connected to dedicated EFB parameter to perform an explicit exchange:

DDT	Description	
T_M_CPT_STD_CH_STS	Structure to read the channel status of a counting module.	Depending on the module location, the DDT can be connected to the <code>STS</code> output parameter of the EFB: <ul style="list-style-type: none"> <li>● <code>READ_STS_QX</code> when the module is located in Quantum EIO.</li> <li>● <code>READ_STS_MX</code> when the module is located in a M580 local rack or in M580 RIO drops.</li> </ul>
T_M_SIGN_CPT_STD_CH_PRM	Structure for adjustment parameters of a channel of a counting module (signed application specific function) in a M580 local rack.	The DDT can be connected to the <code>PARAM</code> output parameter of the EFB: <ul style="list-style-type: none"> <li>● <code>READ_PARAM_MX</code> to read module parameters.</li> <li>● <code>WRITE_PARAM_MX</code> to write module parameters.</li> <li>● <code>SAVE_PARAM_MX</code> to save module parameters.</li> <li>● <code>RESTORE_PARAM_MX</code> to restore the new parameters of the module.</li> </ul>
T_M_UNSIGN_CPT_STD_CH_PRM	Structure for adjustment parameters of a channel of a counting module (unsigned application specific function) in a M580 local rack.	
<p><b>NOTE:</b> Targeted channel address (<code>ADDR</code>) can be managed with <code>ADDMX</code> (see <i>EcoStruxure™ Control Expert, Communication, Block Library</i>) EF (connect the output parameter <code>OUT</code> to the input parameter <code>ADDR</code> of the communication functions).</p>		

The following table shows the structure of the T\_M\_CPT\_STD\_CH\_STS DDT:

Standard Symbol	Type	Bit	Meaning	Access	
CH_FLT [INT]	EXTERNAL_FLT_INPUTS	BOOL	0	external detected error at inputs	read
	EXTERNAL_FLT_OUTPUTS	BOOL	1	external detected error at outputs	read
	INTERNAL_FLT	BOOL	4	internal detected error: channel inoperative	read
	CONF_FLT	BOOL	5	hardware or software configuration detected error	read
	COM_FLT	BOOL	6	bus communication detected error	read
	APPLI_FLT	BOOL	7	application detected error	read
	COM_EVT_FLT	BOOL	8	communication event detected fault	read
	OVR_EVT_CPU	BOOL	9	CPU overflow event	read
	OVR_CPT_CH	BOOL	10	counter channel overflow	read
CH_FLT_2 [INT]	SENSOR_SUPPLY	BOOL	2	low input power supply for the sensors	read
	ACTUATOR_SUPPLY_FLT	BOOL	3	output power supply loss	read
	SHORT_CIRCUIT_OUT_0	BOOL	4	short circuit on output 0	read
	SHORT_CIRCUIT_OUT_1	BOOL	5	short circuit on output 1	read

The following table shows the structure of the T\_M\_SIGN\_CPT\_STD\_CH\_PRM DDT:

Standard Symbol	Type	Bit	Meaning	Access
MODULO_VALUE	DINT	-	Modulo value	read/write
PRESET_VALUE	DINT	-	Preset value	read/write
CALIBRATION_FACTOR	INT	-	Adjust the value from - 10 % to + 10 %, unit = 0.1 %	read/write
SLACK_VAL	INT	-	Hysteresis	read/write

The following table shows the structure of the T\_M\_UNSIGN\_CPT\_STD\_CH\_PRM DDT:

Standard Symbol	Type	Bit	Meaning	Access
MODULO_VALUE	UINT	-	Modulo value	read/write
PRESET_VALUE	UINT	-	Preset value	read/write
CALIBRATION_FACTOR	INT	-	Adjust the value from - 10 % to + 10 %, unit = 0.1 %	read/write
SLACK_VAL	INT	-	Hysteresis	read/write

---

## MOD\_FLT Byte Description

### MOD\_FLT Byte in Device DDT

MOD\_FLT byte structure:

Bit	Symbol	Description
0	MOD_FAIL	<ul style="list-style-type: none"><li>● 1: Internal detected error or module failure detected.</li><li>● 0: No detected error</li></ul>
1	CH_FLT	<ul style="list-style-type: none"><li>● 1: Inoperative channels.</li><li>● 0: Channels are operative.</li></ul>
2	BLK	<ul style="list-style-type: none"><li>● 1: Terminal block detected error.</li><li>● 0: No detected error.</li></ul> <p><b>NOTE:</b> This bit may not be managed.</p>
3	–	<ul style="list-style-type: none"><li>● 1: Module in self-test.</li><li>● 0: Module not in self-test.</li></ul> <p><b>NOTE:</b> This bit may not be managed.</p>
4	–	Not used.
5	CONF_FLT	<ul style="list-style-type: none"><li>● 1: Hardware or software configuration detected error.</li><li>● 0: No detected error.</li></ul>
6	NO_MOD	<ul style="list-style-type: none"><li>● 1: Module is missing or inoperative.</li><li>● 0: Module is operating.</li></ul> <p><b>NOTE:</b> This bit is managed only by modules located in a remote rack with a BME CRA 312 10 adapter module. Modules located in the local rack do not manage this bit that remains at 0.</p>
7	–	Not used.



---

# Part V

## Quick Start: Example of Counting Module Implementation

---

### Subject of this Part

This part presents an example of implementation of the counting modules.

### What Is in This Part?

This part contains the following chapters:

Chapter	Chapter Name	Page
14	Description of the Application	207
15	Installing the Application Using Control Expert	209
16	Starting the Application	231



---

# Chapter 14

## Description of the Application

---

### Overview of the Application

#### At a Glance

The application described in this document is used for sticking labels on boxes.

The boxes are carried on a conveyor. A label is stuck onto the box when the latter passes by the two dedicated points.

A sensor placed below the conveyor detects any new incoming box. The boxes should arrive at constant intervals.

The conveyor motor is fitted with an encoder connected to a counting input module. Any process deflection is monitored and displayed.

The application's control resources are based on an operator screen displaying all box positions, the number of labeled boxes and the deflection monitoring.

#### Illustration

This is the application's final operator screen:

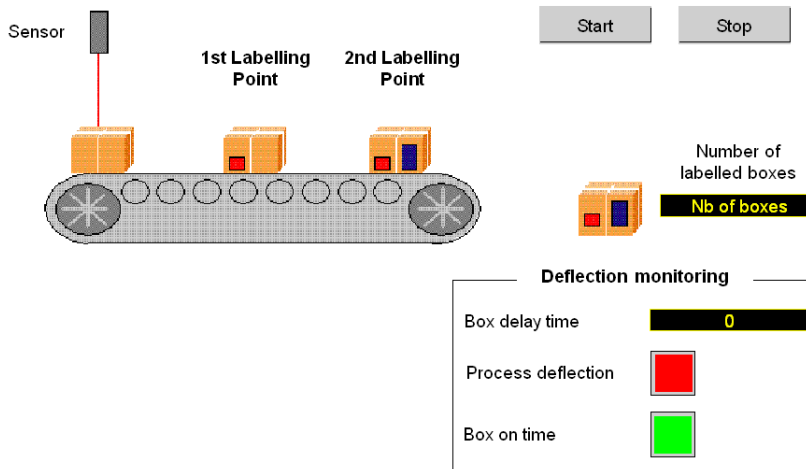

## Operating Mode

The operating mode is as follows:

- A **Start** button is used to start the labelling process.
- A **Stop** button interrupts the labelling process.
- When the box arrives at the right time, the **Box on time** indicator lights on.
- In case of process deflection, the box delay time is displayed. If this time has been too long, a **Process deflection** indicator lights on.



---

# Chapter 15

## Installing the Application Using Control Expert

---

### Subject of this chapter

This chapter describes the procedure for creating the application described. It shows, in general and in more detail, the steps in creating the different components of the application.

### What Is in This Chapter?

This chapter contains the following sections:

Section	Topic	Page
15.1	Presentation of the Solution Used	210
15.2	Developing the Application	213

# Section 15.1

## Presentation of the Solution Used

---

### Subject of this section

This section presents the solution used to develop the application. It explains the technological choices and gives the application's creation timeline.

### What Is in This Section?

This section contains the following topics:

Topic	Page
Technological Choices Used	211
Process Using Control Expert	212

## Technological Choices Used

### At a Glance

There are several ways of writing a counter application using Control Expert. The one proposed, uses the Modulo Loop Counter Mode available in the BMX EHC 0200 counting input module.

### Technological Choices

The following table shows the technological choices used for the application.

Objects	Choices used
Counter mode	<p>Use of the Modulo Loop Counter Mode. This mode counts the encoder input pulses. The modulo value is the defined counting limit. When the counting reaches the modulo value, the counter restarts from 0.</p> <p>A positive transition of the capture signal triggers the count value capture in the capture register and the counter restarts from 0.</p> <p>In this application, the modulo value is the constant interval between boxes and the capture signal is sent by the sensor.</p> <p>The module reflex outputs are triggered when the counting exceeds defined thresholds.</p>
Supervision screen	Use of elements from the library and new objects.
Main supervision program	<p>This program contains two sections.</p> <ul style="list-style-type: none"> <li>• The first one, which initiates and uses the Modulo Loop Counter Mode functions, is developed using a Structured Text language (ST).</li> <li>• The Application section, which allows operators screen animation, is created in Ladder Diagram (LD) language.</li> </ul>

## Process Using Control Expert

### At a Glance

The following logic diagram shows the different steps to follow to create the application. A chronological order must be respected in order to correctly define all of the application elements.

### Description

Description of the different types:

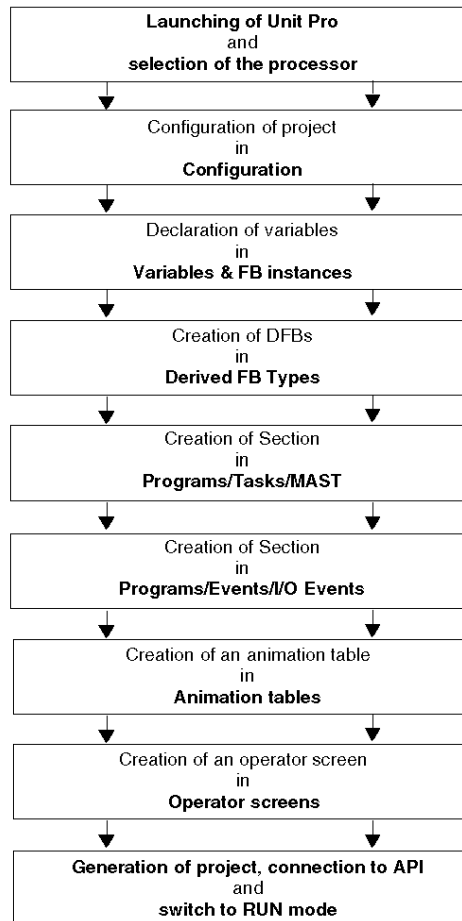

---

## Section 15.2

### Developing the Application

---

#### Subject of this Section

This section gives a step-by-step description of how to create the application using Control Expert.

#### What Is in This Section?

This section contains the following topics:

Topic	Page
Creating the Project	214
Configuration of the Counting Module	215
Declaration of Variables	218
Creating the Program for Managing the Counter Module	220
Creating the Labelling Program in ST	222
Creating the I/O Event Section in ST	224
Creating a Program in LD for Application Execution	225
Creating an Animation Table	228
Creating the Operator Screen	229

## Creating the Project

### At a Glance

Developing an application using Control Expert involves creating a project associated with a PLC.

### Procedure for Creating a Project

The table below shows the procedure for creating the project using Control Expert.

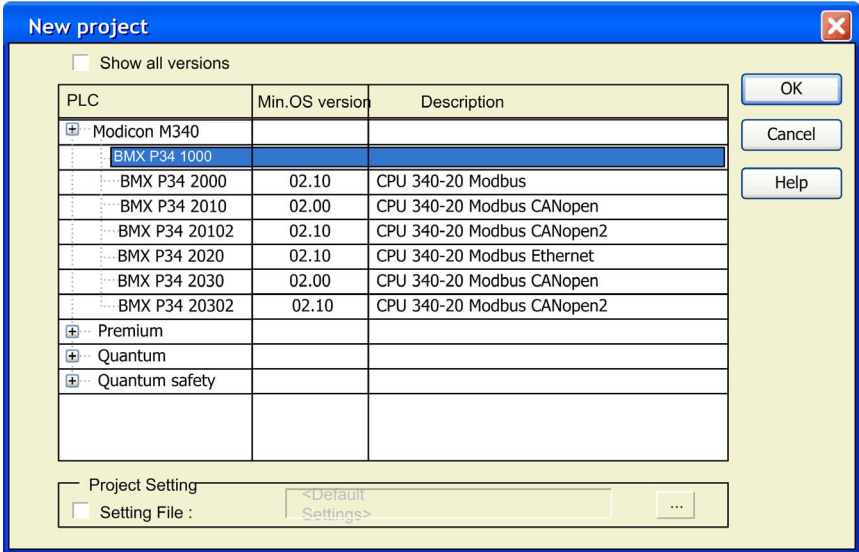
Step	Action
1	Launch the Control Expert software.
2	<p>Click on File then New to select a PLC.</p> 
3	To see all PLC versions, click on the box Show all versions.
4	Select the processor you wish to use from those proposed.
5	To create a project with specific values of project settings, check the box <b>Settings File</b> and use the browser button to localize the .XSO file (Project Settings file). It is also possible to create a new one. If the <b>Settings File</b> box is not checked, default values of project settings are used.
6	Terminate your configuration, insert a BMX EHC 0200 input module.
7	Confirm with OK.

## Configuration of the Counting Module

### At a Glance

Developing a counting application involves choosing the right module and appropriate configuration.

### Module Selection

The table below shows the procedure for selecting the counting input module.

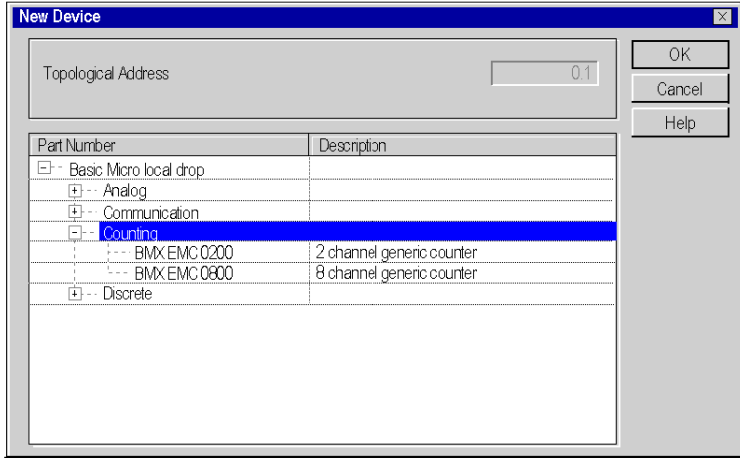
Step	Action
1	In the Project browser double-click on Configuration then on 0:Bus X and on 0:BMX XBP ... (Where 0 is the rack number)
2	In the Bus X window, select a slot (for example slot 1) and double-click
3	Choose the BMX HEC 0200 counting input module 
4	Confirm with OK.

### Counting Module Configuration

The table below shows the procedure for selecting the counting function and configuring the module reflex outputs.

Step	Action
1	In the Bus X window, double-click on the BMX EHC 0200 counting input module
2	Select a channel (for example Counter 0) and click
3	Select the module function Modulo Loop Counter Mode
4	In the Config tab, configure the OutputBlock 0 reflex output with a pulse when the counting is greater than the Lower Threshold (Pulse = greater than LT) and the OutputBlock 1 reflex output with a pulse when the counting is greater than the Upper Threshold (Pulse = greater than UT). Then click on the Event value and select Enable.
5	Click on the Adjust tab and enter the modulo value (for example 50).

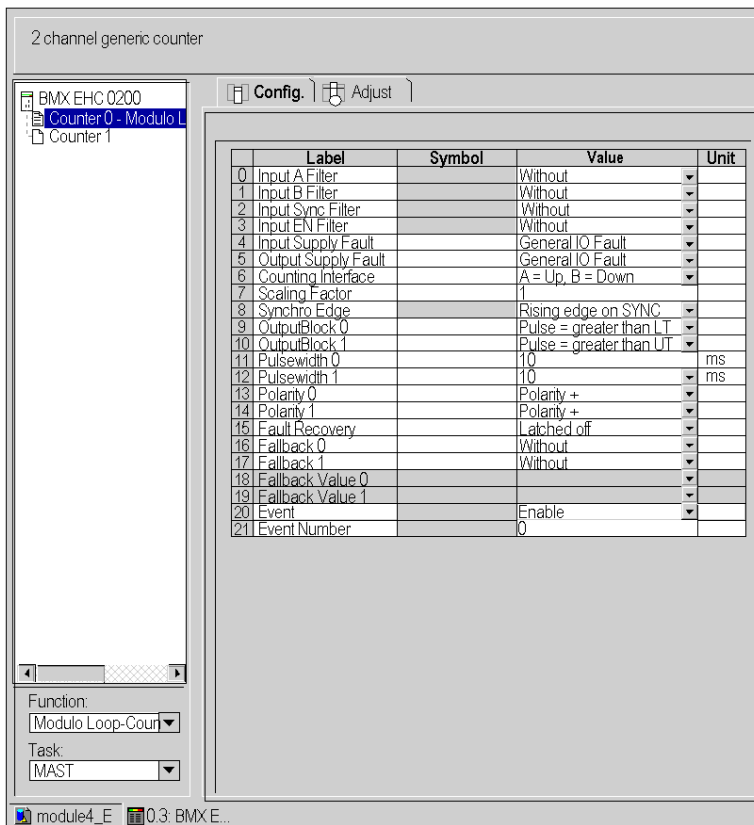



## Declaration of I/O objects

The table below shows the procedure for declaring the I/O Derived Variable

Step	Action
1	In the BMX EHC 0200 window, click on the BMX EHC 0200 and then on the I/O objects tab
2	Click on the I/O object prefix address %CH then on the Update grid button, the channel address appears in the I/O object grid
3	Click on the line %CH0.1.0 and then enter a channel name in the Prefix for name zone
4	Now click on different Implicit I/O object prefix addresses then Update grid button to see the names and addresses of the implicit I/O objects.

	Address	Name
1	%CH0.1.0	Without
1	%CH0.1.0	Encoder
2	%Q0.1.0	Encoder.OUTPUT
3	%Q0.1.0.1	Encoder.OUTPUT
4	%Q0.1.0.2	Encoder.OUTPUT
5	%Q0.1.0.3	Encoder.OUTPUT
6	%Q0.1.0.4	Encoder.FORCE
7	%Q0.1.0.5	Encoder.FORCE
8	%Q0.1.0.6	Encoder.FORCE
9	%Q0.1.0.7	Encoder.FORCE
10	%Q0.1.0.8	Encoder.SYNC R
11	%Q0.1.0.9	Encoder.MODUL
12	%IWO.1.0	Encoder.COUNT
13	%IWO.1.0.1	Encoder.COMPA
14	%IWO.1.0.10	Encoder.EV1_S0
15	%IWO.1.0.11	
16	%QD0.1.0.2	Encoder.LOWER
17	%QD0.1.0.4	Encoder.UPPER
18	%QD0.1.0.6	Encoder.PWM F

## Declaration of Variables

### At a Glance

All of the variables used in the different sections of the program must be declared.

Undeclared variables cannot be used in the program.

**NOTE:** For more information, refer to chapter *Data Editor* (see *EcoStruxure™ Control Expert, Operating Modes*).

### Procedure for Declaring Variables

The table below shows the procedure for declaring application variables.

Step	Action
1	In Project browser / Variables & FB instances, double-click on Elementary variables
2	In the Data editor window, select the box in the Name column and enter a name for your first variable.
3	Now select a Type for this variable.
4	When all your variables are declared, you can close the window.

### Variables Used for the Application

The following table shows the details of the variables used in the application.

Variable	Type	Definition
Run	EBOOL	Startup request for the labelling process.
Stop	EBOOL	Stop the labelling process.
Last_Box_late	BOOL	The process is in deflection.
Nb_Box	DINT	Number of labelled boxes.
Position_0	BOOL	Box at the beginning of the conveyor.
Position_1	BOOL	Box with the first label.
Position_2	BOOL	Box with the two labels.
First_Labelling_Point	DINT	Lower Threshold value.
Second_Labelling_Point	DINT	Upper Threshold value.
Deflection_Parameter	DINT	Deflection alarm triggering value.
Waiting_First_Part	BOOL	The first box is waited.
Waiting_Other_Parts	BOOL	The first box has already passed.

The following screen shows the application variables created using the data editor :

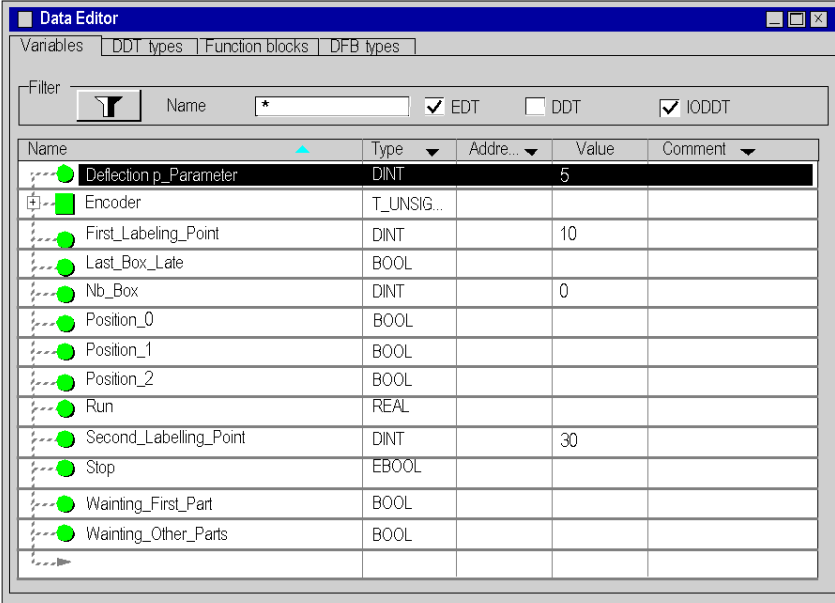

The screenshot shows the 'Data Editor' window with a table of variables. The table has columns for Name, Type, Address, Value, and Comment. The 'Encoder' variable is expanded to show its I/O objects.

Name	Type	Address	Value	Comment
Deflection p_Parameter	DINT		5	
Encoder	T_UNSIG..			
First_Labeling_Point	DINT		10	
Last_Box_Late	BOOL			
Nb_Box	DINT		0	
Position_0	BOOL			
Position_1	BOOL			
Position_2	BOOL			
Run	REAL			
Second_Labeling_Point	DINT		30	
Stop	EBOOL			
Waiting_First_Part	BOOL			
Waiting_Other_Parts	BOOL			

**NOTE:** Click on  in front of the derived variable **Encoder** to expand the I/O objects list.

## Creating the Program for Managing the Counter Module

### At a Glance

Two sections are declared in the MAST task:

- The `Labelling_Program` section (See *Creating the Labelling Program in ST*, [page 222](#)), written in ST, initiates and uses the Modulo Loop Counter Mode functions and I/O objects,
- The `Application` section (See *Creating a Program in LD for Application Execution*, [page 225](#)), written in LD, executes the counting start-up and the operator screen animation.

### Process Chart

The following screen shows the process chart.

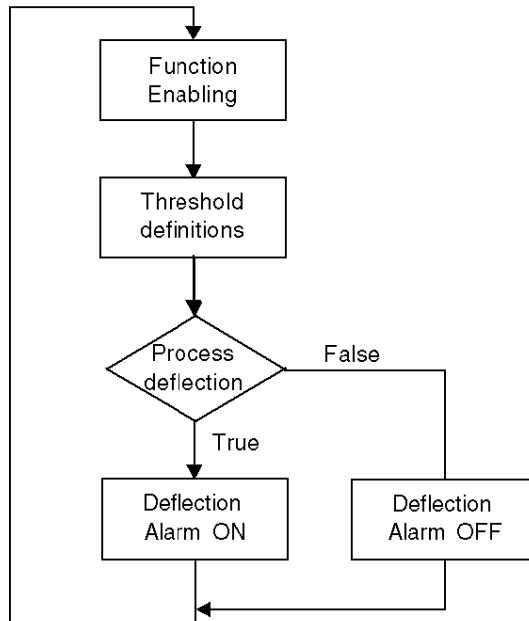

### Description of the Labelling \_Program Section

The following table describes the different steps of the process chart.

Step	Description
Functions enabling	Enables the Modulo Mode functions used in the application.
Threshold definitions	The values of the thresholds, on which depend the reflex outputs, are defined in this step.
Process deflection	Test if the capture value is greater than the deflection parameter
Deflection Alarm ON	If the result of the process deflection test is true, the alarm is ON.
Deflection Alarm OFF	If the result of the process deflection test is false, the alarm is OFF.

## Creating the Labelling Program in ST

### At a Glance

This section initiates and uses the Modulo Loop Counter Mode functions and objects.

### Illustration of the Labelling \_Program Section

This section below is part of the MAST task. It has no condition defined for it so it is permanently executed:

```
(*Functions Enabling*)
(*Authorizes Input SYNC to synchronize and start the counting function*)
Encoder.VALID_SYNC:=Waiting_First_Part;
IF Waiting_First_Part
  THEN nb_box := 0;
END IF;
(*Once the first part has passed below the sensor, the other functions
are enabled.*)
IF Waiting_Other_Parts
  THEN
    (*Authorizes captures into the Capture 0 register*)
    Encoder.VALID_CAPT_0:=1;
    (*Authorizes comparators to produce its results*)
    Encoder.COMPARE_ENABLE:=1;
    (*Call Event task when Counter Roll over*)
    Encoder.EVT_MODULO_ENABLE:=1;
    (*Enable the output block functions*)
    Encoder.OUTPUT_BLOCK_0_ENABLE:=1;
    Encoder.OUTPUT_BLOCK_1_ENABLE:=1;
  ELSE
    (*Function disabling when the conveyor is stopped*)
    Encoder.VALID_CAPT_0:=0
    Encoder.COMPARE_ENABLE:=0
    Encoder.EVT_MODULO_ENABLE:=0
    Encoder.OUTPUT_BLOCK_0_ENABLE:=0
    Encoder.OUTPUT_BLOCK_1_ENABLE:=0
```



```

END IF
(*Definition of the lower and upper threshold values*)
Encoder.LOWER_TH_VALUE:=First_Labelling_Point;
Encoder.UPPER_TH_VALUE:=Second_Labelling_Point;
(*Process Deflection Watching*)
IF Encoder.CAPT_0_VALUE>deflection_parameter=true
    THEN last_box_late:=1; (*Default light set ON*)
    ELSE last_box_late:=0; (*Default light set OFF*)
END IF
(*If the next part arrives just in the right time, the green indicator
lights on*)
IF Encoder.CAPT_0_VALUE = 0
    THEN Last_Box_On_Target :=1 (*Green light set ON*)
    ELSE Last_Box_On_Target :=0 (*Green light set OFF*)
END IF

```

### Procedure for Creating an ST Section

The table below shows the procedure for creating an ST section for the application.

Step	Action
1	In Project Browser\Program\Tasks, double-click on MAST,
2	Right-click on Section then select New section. Give your section a name and select ST language.
3	The name of your section appears and can now be edited by double-clicking on it.
4	To use the I/O object, right-click in the editor then click on Data selection and on  . Click on  on the front of the I/O derived variable Encoder and the list of the I/O objects appears. Click on the one you need and confirm with OK.

**NOTE:** In the Data selection windows, the IODDT checkbox must be checked to have access to the I/O derived variable Encoder.

## Creating the I/O Event Section in ST

### At a Glance

This section is called when the modulo value is reached.

### Illustration of the Event Section

The section below is part of the Event task:

```
(*Number of labelled boxes is incremented at the Modulo Event *)  
INC (Nb_Box) ;
```

### Procedure for Creating an ST Section

The table below shows the procedure for creating an I/O Event.

Step	Action
1	In Project Browser\Program\, double-click on Events
2	Right click on I/O Events then select New Event section. Give your section a number, for this example select 0, and then select ST language
3	Confirm with OK and the edition window appears.



## Creating a Program in LD for Application Execution

### At a Glance

This section executes the counting start up and the operator screen animation.

### Illustration of the Application Section

The section below is part of the MAST task:

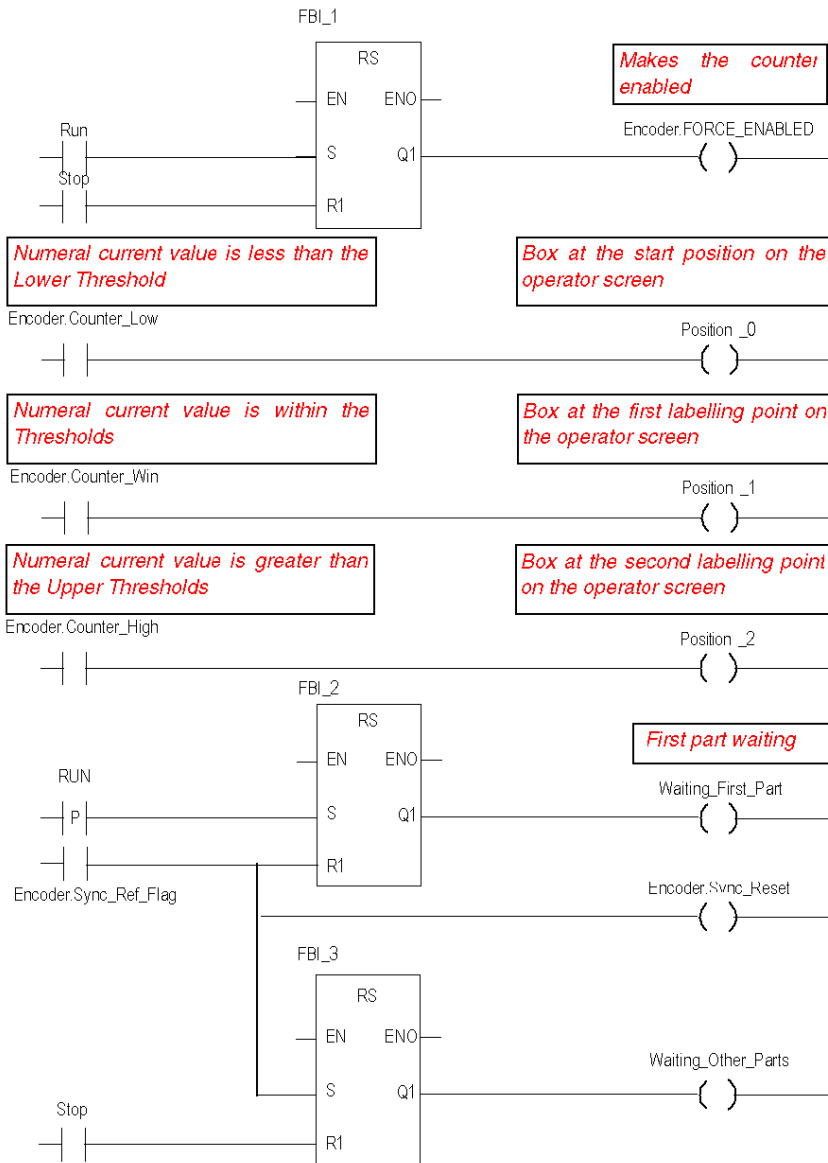





## Description of the Application Section

- The first line is used to command the counter.
- The other three lines are used to simulate the different box positions on the conveyor.
- The last part is used to control the variables which allow the function enabling (See *Illustration of the Labelling\_Program Section, page 222*)
- When Run switches to '1', `Waiting_First_Part` is set to '1'.
- A sensor signal triggers the flag `Sync_ref_flag` which resets `Waiting_first_part` to '0' and sets `Waiting_other_parts` to '1'.

## Procedure for Creating an LD Section

The table below describes the procedure for creating part of the **Application** section.

Step	Action
1	In <code>Project Browser\Program\Tasks</code> , double-click on <code>MAST</code> .
2	Right click on <code>Section</code> then select <code>New section</code> . Name this section <code>Application</code> , then select the language type <code>LD</code> . The Edit window opens.
3	To create the contact <code>Encoder.Sync_Ref_Flag</code> , click on  then place it in the editor. Double-click on this contact then on  . The <code>Instance Selection</code> window opens. Validate the <code>Inside structure</code> checkbox and click on <input type="checkbox"/> in front of the <code>Encoder</code> variable and select <code>Sync_Ref_Flag</code> in the list. Confirm with OK.
4	To use the RS block you must instantiate it. Right click in the editor then click on <code>Select data</code> and on  . Click on the <code>Function and Function Block Types</code> tab. Click on <code>Libset</code> and select the RS block in the list then confirm with OK and position your block. To link the <code>Encoder.Sync_Ref_Flag</code> contact to the <code>S Rnput</code> of the RS block, align the contact and the input horizontally, click on  and position the link between the contact and the input.

**NOTE:** For more information on creating an LD section, refer to chapter *LD Editor*.

## Creating an Animation Table

### At a glance

An animation table is used to monitor the values of variables, and modify and/or force these values. Only those variables declared in `Variables` & `FB` instances can be added to the animation table

**NOTE: Note:** For more information, refer to chapter *Animation Tables (see EcoStruxure™ Control Expert, Operating Modes)*.

### Procedure for Creating an Animation Table

The table below shows the procedure for creating an animation table.

Step	Action
1	In the <code>Project</code> browser, right click on <code>Animation tables</code> . The edit window opens.
2	Click on first cell in the <code>Name</code> column, then on the <code>...</code> button, and add the variables you require.

### Animation Table Created for the Application

The following screen shows the animation table used by the application:

Name	Value	Type	Comment
Encoder.CAPT_0_VALUE		DINT	
Encoder.COUNTER_CURRENT_VALUE		DINT	
Encoder.EVT_MODULO_ENABLE		BOOL	
Encoder.COMPARE_ENABLE		BOOL	
Encoder.LOWER_TH_VALUE		DINT	
Encoder.UPPER_TH_VALUE		DINT	
First_Labelling_Point		DINT	
Second_Labelling_Point		DINT	
Position_0		BOOL	
Position_1		BOOL	
Position_2		BOOL	
Nb_Box		DINT	

**NOTE:** The animation table is dynamic only in online mode (display of variable values)

## Creating the Operator Screen

### At a Glance

The operator screen is used to animate graphic objects that symbolize the application. These objects can belong to the Control Expert library, or can be created using the graphic editor.

**NOTE:** For more information, refer to chapter *Operator screens (see EcoStruxure™ Control Expert, Operating Modes)*.

### Illustration on an Operator Screen

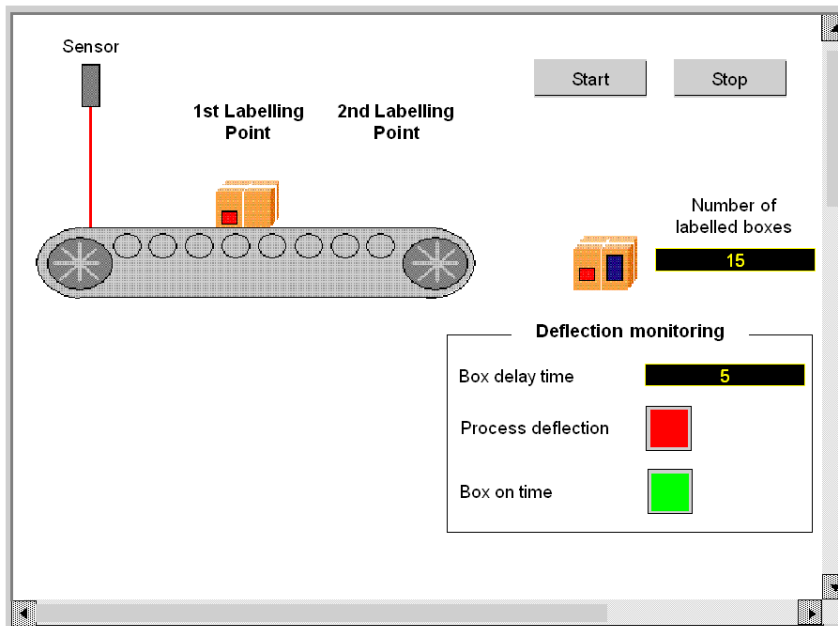

The following illustration shows the application operator screen:





**NOTE:** To animate objects in online mode, you must click on . By clicking on this button, you can validate what is written.

## Procedure for Creating an Operator Screen

The table below shows the procedure for creating the Start button.



Step	Action
1	In the <code>Project browser</code> , right click on <code>Operator screens</code> and click on <code>New screen</code> . The operator screen editor appears.
2	Click on the  and position the new button on the operator screen. Double click on the button and in the <code>Control</code> tab, select the <code>Run</code> variable by clicking the button  and confirm with <code>OK</code> . Then, enter the button name in the text zone.

The table below shows the procedure for inserting and animating the conveyor.

Step	Action
1	In the <code>Tools</code> menu, select <code>Operator screens Library</code> . Double click on <code>Machine</code> then <code>Conveyor</code> . Select the dynamic conveyor from the runtime screen and <code>Copy (Ctrl+C)</code> then <code>Paste (Ctrl+V)</code> it into the drawing in the operator screen editor.
2	The conveyor is now in your operator screen. You now need a variable to animate the wheels. Select your conveyor then click on  . A line on the wheel is selected. Press enter and the object properties window opens. Select the <code>Animation</code> tab and enter the concerned variable, by clicking on  (in the place of <code>%MW0</code> ). In our application, this will be <code>Encoder.INPUT_A</code> , the physical input A state. Confirm with <code>Apply</code> and <code>OK</code> .
3	Click on  to select the other lines one by one and apply the same procedure.

**NOTE:** In the `Instance Selection`, tick the `IODDT` checkbox and click on  to access the I/O objects list.

The table below shows the procedure for inserting and animating a display.

Step	Action
1	Click on  and position it on the operator screen. Double click on the text and select the <code>Animation</code> tab.
2	Tick the <code>Animated Object</code> checkbox, select the concerned variable by clicking on  and confirm with <code>OK</code> .

---

# Chapter 16

## Starting the Application

---

### Execution of Application in Standard Mode

#### At a Glance

Standard mode working requires the use of a PLC and a BMX EHC 0200 with an encoder and a sensor linked to its inputs.

#### Outputs wiring

The actuators are connected as follow:

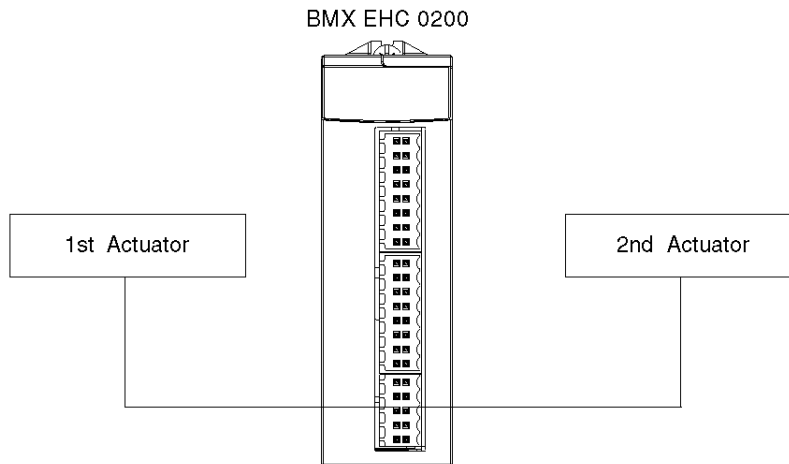

The assignment of the 10 pins connector is as follow:

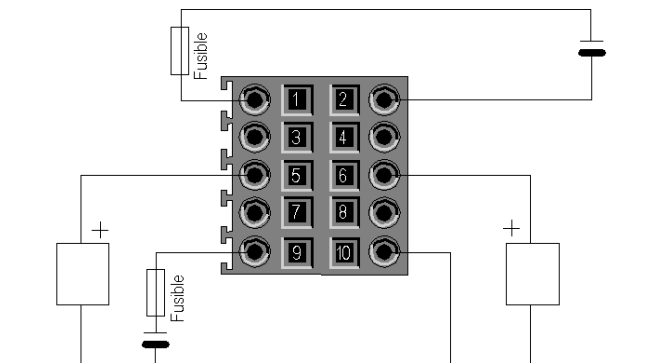

Pin description:

Pin number	Symbol	Description
1	24V_IN	24 VDC input for input supply
2	GND_IN	0 VDC input for input supply
5	Q0-1	Q0 output for counting channel 1
6	Q0-0	Q0 output for counting channel 0
7	Q1-1	Q1 output for counting channel 1
8	Q1-0	Q1 output for counting channel 0
9	24V_OUT	24 VDC input for output supply
10	GND_OUT	0 VDC input for output supply



## Inputs Wiring

The encoder and the sensor are connected as follows:

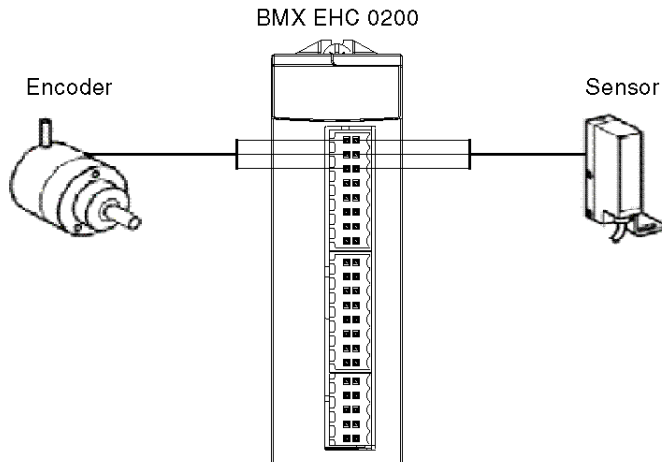

The assignment of the 16 pins connector is as follows:

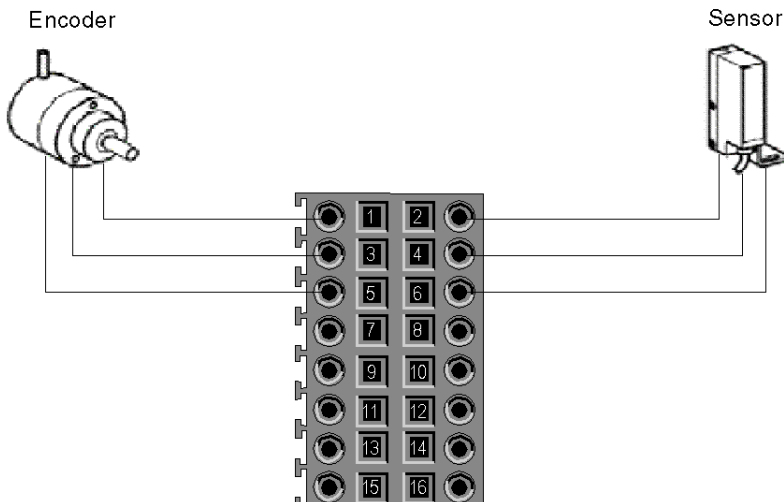

Description:

Pin number	Symbol	Description
1, 2, 7, 8	24V_SEN	24 VDC output for sensor supply
5, 6, 13, 14	GND_SEN	0 VDC output for sensor supply
15, 16	FE	Functionnal ground
3	IN_A	Input A
4	IN_SYNC	Synchronization input
9	IN_B	Input B
10	IN_EN	Enable input selected
11	IN_REF	Homing input
12	IN_CAP	Capture input

### Application Execution

The table below shows the procedure for launching the application in standard mode:

Step	Action
1	In the PLC menu, click on <code>Standard Mode</code> ,
2	In the <code>Build</code> menu, click on <code>Rebuild All Project</code> . Your project is generated and is ready to be transferred to the PLC. When you generate the project, you will see a results window. If there is an error in the program, <code>Control Expert</code> indicates its location if you click on the highlighted sequence.
3	In the PLC menu, click on <code>Connection</code> . You are now connected to the PLC.
4	In the PLC menu, click on <code>Transfer project to PLC</code> . The <code>Transfer project to PLC</code> window opens. Click on <code>Transfer</code> . The application is transferred to the PLC.
5	In the PLC, click on <code>Execute</code> . The <code>Execute</code> window opens. Click on <code>OK</code> . The application is now being executed (in RUN mode) on the PLC.



## B

BMXEHC0200, *22*  
BMXXSP0400, *50*  
BMXXSP0600, *50*  
BMXXSP0800, *50*  
BMXXSP1200, *50*

## C

certifications, *36*  
channel data structure for all modules  
    T\_GEN\_MOD, *192, 192*  
channel data structure for counting modules  
    T\_SIGNED\_CPT\_BMX, *185, 190*  
    T\_UNSIGNED\_CPT\_BMX, *185, 190*  
configuring, *119*  
Counting Events, *79*

## D

debugging, *151*  
diagnosing, *67*

## E

event counting, *84*

## F

filtering, *58*  
free large counter, *99*  
frequency mode, *83*  
functions, *56*

## G

grounding accessories, *50*  
    BMXXSP0400, *50*  
    BMXXSP0600, *50*  
    BMXXSP0800, *50*  
    BMXXSP1200, *50*  
    STBXSP3010, *50*  
    STBXSP3020, *50*

## I

input interface blocks, *57*  
installing, *27, 109*

## M

MOD\_FLT, *203*  
modulo loop counter, *95*

## O

one shot counter, *92*

## P

parameter settings, *173*  
period measuring, *86*  
pulse width modulation, *107*

## Q

quick start, *205*

## R

ratio, *89*

## S

settings, *143*

standards, *36*  
STBXSP3010, *50*  
STBXSP3020, *50*

## T

T\_GEN\_MOD, *192, 192*  
T\_M\_CPT\_STD\_IN\_2, *195*  
T\_M\_CPT\_STD\_IN\_8, *195*  
T\_SIGNED\_BMX, *185*  
T\_SIGNED\_CPT\_BMX, *190*  
T\_UNSIGNED\_CPT\_BMX, *185, 190*  
terminal blocks  
    connecting, *27*  
    installing, *27*

## W

wiring accessories, *27*