



METER

WP4C



TABLE OF CONTENTS

1. Introduction.....	1
2. Operation	2
2.1 Installation	2
2.2 Preparing Samples.....	3
2.3 Checking Sample Temperature	4
2.4 Taking a Reading	4
3. System.....	6
3.1 Specifications.....	6
3.2 Components	8
3.2.1 Sample Chamber.....	9
3.2.2 LED	10
3.2.3 Buttons	10
3.2.4 Display Screen	11
3.2.5 Reading Modes	14
3.2.6 Computer Interface.....	15
3.3 Theory.....	16
3.3.1 Defining Water Potential	16
3.3.2 Measuring Water Potential	17
4. Service.....	19
4.1 Calibration	19
4.1.1 Verification Standards	19
4.1.2 Calibration Process.....	20
4.2 Maintenance	21
4.3 Cleaning.....	22

4.4 Repair	26
4.5 Troubleshooting.....	27
4.6 Customer Support.....	29
4.7 Terms and Conditions	29
Further Reading.....	30
Appendix A. Preparing Salt Solutions.....	31
Appendix B. Temperature Correction for METER Verificaton Standards	32
Index	33

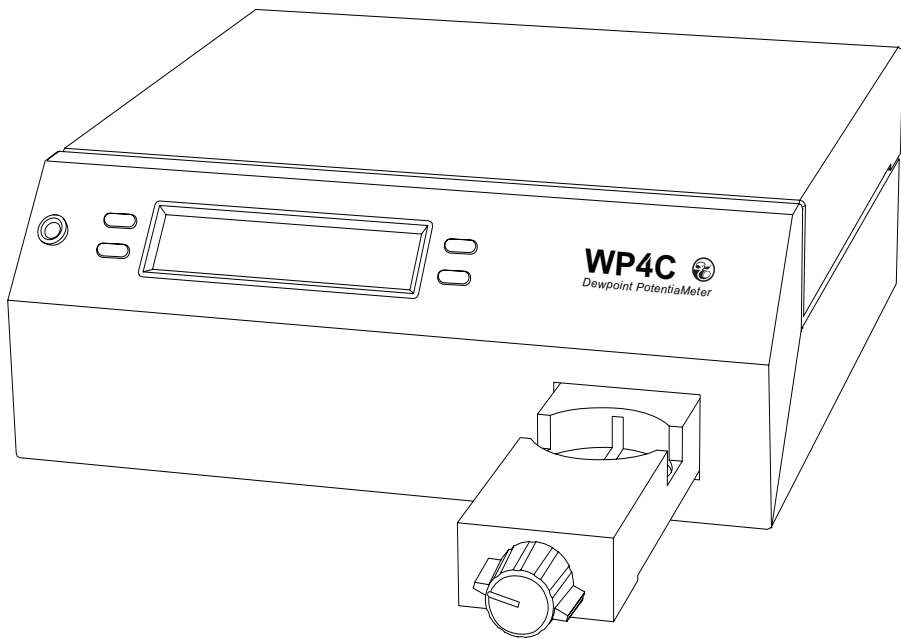

1. INTRODUCTION

Thank you for choosing the WP4C Dewpoint Potential Meter from METER Group.

WP4C is a fast, accurate, and reliable way to measure water potential using the chilled-mirror dew point technique. This manual includes instructions for setting up, calibrating, and maintaining the WP4C. This manual also explains the basic concepts of water potential.

Verify all WP4C components are included and appear in good condition:

- WP4C unit
- Power cord
- RS-232 to USB cable
- 50 plastic sample cups and lids
- 10 stainless steel sample cups
- 12 vials of 0.50 mol/kg potassium chloride (KCl) verification standard
- Cleaning kit

2. OPERATION

Please read all instructions before operating the WP4C to ensure it performs to its full potential.

PRECAUTIONS

METER instruments are built to the highest standards, but misuse, improper protection, or improper installation may damage the sensor and possibly void the manufacturer's warranty. Before setting up the WP4C, follow the recommended installation instructions and arrange proper protections to safeguard the instrument from damage.

2.1 INSTALLATION

Follow the steps listed in [Table 1](#) to set up the WP4C.

Table 1 Installation

Tools Needed	Portable 12-V power inverter (field installation)
Preparation	<p>Select Clean, Level Location Select a location where the temperature remains fairly stable to avoid temperature changes that can affect accuracy (away from air conditioner and heater vents, open windows, etc.). If in the field, a Styrofoam box, for example, can help minimize temperature effects.</p> <p>Observe clean practices to prevent contamination of the sample chamber.</p> <p>Maintain a level surface to reduce the chance of spilling sample material and contaminating the sample chamber.</p> <p>Remove Sample Cup Pull open the sample drawer by turning the knob to the OPEN/LOAD position. Remove the empty upside-down disposable sample cup (used to protect the drawer during shipment) and set aside.</p>
Installation (continued)	<p>Plug In Instrument Plug the power cord into the back of the WP4C unit and an outlet. Use only the supplied power cord.</p> <p>If in the field, plug the instrument into a 12-V portable power inverter that plugs into the 12 V output of a vehicle. The inverter should have a continuous output of at least 140 W.</p> <p>NOTE: When the instrument is on, it draws up to 1 A. Check the battery rating to determine how long it will power the instrument (for example, if the battery is rated for 60 Ah, it will work for 60 h when the vehicle is not running).</p> <p>WARNING: An incorrect main power voltage can damage the instrument.</p> <p>Turn the Unit ON. The ON/OFF switch is located on the lower right corner of the WP4C back panel. Allow the WP4C a 15- to 30-min warm-up period to ensure accurate readings. Check the calibration of the instrument (Section 4.1).</p>

2.2 PREPARING SAMPLES

Proper sample preparation is important to keep the WP4C internal sensors clean and achieve repeatable results. Carefully prepare and load samples to lengthen the time between cleanings and help avoid downtime. Be consistent in sample preparation methods to obtain reproducible results.

Considerations regarding sample temperature are discussed in [Section 2.3](#).

NOTE: Calibrate the WP4C ([Section 4.1](#)) using the same type of sample cup that will be used for subsequent measurements.

Follow the steps listed below to prepare samples.

1. Choose an appropriate sample cup.

METER recommends using stainless steel cups because stainless steel cups come to temperature equilibrium with the sample block more quickly, leading to a more accurate measurement. Only use disposable plastic cups for dry samples.

NOTE: Soil samples can be oven dried directly in the stainless steel cups to determine water content gravimetrically, which is convenient if generating soil moisture characteristic curves.

2. Place the sample in the sample cup.

- a. Completely cover the bottom of the cup, if possible, to provide enough sample to get an accurate reading.

The WP4C may not be able to accurately measure a sample that does not (or cannot) cover the bottom of the cup. A larger sample surface area speeds up the reading by shortening the time needed to reach vapor equilibrium. It also increases instrument accuracy by providing more stable infrared sample temperature measurements.

- b. Do not fill the sample cup more than half full.

Overfilled cups may contaminate the sensors in the chamber.

3. Wipe any excess sample material from the rim of the cup with a clean KIMWIPES® tissue.

Material left on the rim or the outside of the cup will prevent a vapor seal with the sensor block and will contaminate subsequent samples.

4. If a sample cannot be read immediately, put the disposable sample cup lid on the cup to restrict water transfer.

For longer term storage, seal the lid by placing tape or Parafilm® laboratory film completely around the cup to lid junction.

Thoroughly clean the stainless steel cups using deionized water between uses to prevent solutes from contaminating subsequent samples and causing artificially negative osmotic potential.

The WP4C can be used to measure the water potential of leaves and plant material. Refer to the application note [Easy, accurate measurement of leaf water potential using the WP4C \(metergroup.com/environment/articles/measurement-leaf-water-potential-using-wp4c/\)](http://metergroup.com/environment/articles/measurement-leaf-water-potential-using-wp4c/).

2.3 CHECKING SAMPLE TEMPERATURE

For an accurate measurement, the sample temperature (T_s) should be close to the sample block temperature (T_b). WP4C displays the temperature difference in the sample temperature screen.

If a sample is warmer than the sample chamber ($T_s - T_b$ is a positive number), condensation may occur and moisture may condense inside the block, which will adversely affect readings.

If a sample is colder than the sample block temperature ($T_s - T_b$ is a negative number), the WP4C will wait to start a reading until its temperature increases to 1 °C below sample block temperature. The closer the sample temperature is to the sample block temperature (i.e., closer to equilibrium), the less time is need for a reading.

To ensure the sample is at the correct temperature, use the following steps.

1. Place the sample in the chamber and close the drawer.
2. Press the lower right button to access the sample temperature screen and view the temperature difference.
3. If the sample temperature difference is between -0.5 and 0 , the sample can be used to begin a reading ([Section 2.3](#)).
If the sample temperature difference is a positive number, remove the sample immediately.
4. Set the sample on a cold surface and cover with the cup lid to preserve the moisture. Leave for approximately 1 min.
Do not cool the sample too much or the equilibrium time will be lengthened.
5. Place the sample back in the chamber and note the temperature difference again.
If it is between -0.5 and 0 , begin the reading ([Section 2.4](#)).

2.4 TAKING A READING

Observe the following cautions and use the following steps to take a reading.

CAUTIONS

- Ensure that the physical temperature of the WP4C is between 5 °C and 40 °C.
- Do not measure a sample that has a temperature greater than the WP4C chamber ([Section 2.3](#)). Remove the sample until it is at room temperature.
- Do not move the sample drawer too quickly when loading or unloading samples to avoid spilling.
- Never try to move the instrument after a sample is loaded. Movement may cause the sample material to spill and contaminate the sample chamber.
- Never leave a sample in the WP4C after a reading has finished. The sample may spill and contaminate the instrument chamber if the instrument is accidentally moved or jolted.

- Consult troubleshooting ([Section 4.5](#)) if the triangular warning symbol appears in the top right corner of the display ([Figure 1](#)).

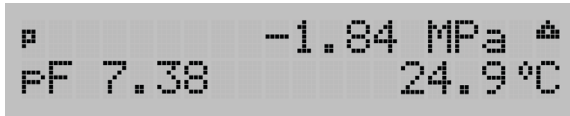

Figure 1 Triangular warning sign

Perform the following steps to take a reading.

1. Turn the drawer knob to OPEN/LOAD and pull the drawer out.
2. Place the sample in the sample drawer and carefully slide the drawer closed to avoid spilling solution and contaminating the chamber.
3. Check to be sure the sample temperature is below chamber temperature (lower right button).
4. Turn the drawer knob to the READ position.

A notification that the measurement is starting will appear ([Figure 2](#)).



Figure 2 Measurement starting notification

Values display the initial measurements being taken and the Main screen will update values throughout the reading. WP4C signals when it reaches the final values by a green LED flash and an audible notification (if enabled). The WP4C will display the final water potential and temperature of the sample ([Figure 3](#)).



Figure 3 Results screen

3. SYSTEM

This section describes the specifications, components, and theory of the WP4C instrument.

3.1 SPECIFICATIONS

MEASUREMENT SPECIFICATIONS

Water Potential

Range	0 to -300 MPa
Resolution	NA
Accuracy	± 0.05 MPa from 0 to -5 MPa 1% from -5 to -300 MPa

NOTE: All vapor pressure instruments (including the WP4C) are limited by accuracy in the wet end of the water potential range. The range of 0 to -5 MPa has an accuracy of ± 0.05 MPa. For example, a measurement of -0.1 MPa has an accuracy of $\pm 50\%$ of the measurement and a measurement of -1 MPa has an accuracy of $\pm 5\%$. The WP4C will not measure water potential accurately near field capacity (-0.033 MPa).

Temperature

Range	15-40 °C
Resolution	0.1 °C
Accuracy	± 0.2 °C

Read Time

Soil sample	~10–15 min (precise mode)
	<5 min (fast mode)
NOTE: WP4C will display updated measurements approximately every 5 min until stopped.	
Plant sample	~20 min

PHYSICAL SPECIFICATIONS

Case Dimensions

Length	24.1 cm (9.5 in)
Width	22.9 cm (9.0 in)
Height	8.9 cm (3.5 in)

Case Material

Powder painted aluminum

Sample Cup Capacity

15 mL (0.5 oz) full
7 mL (0.25 oz) recommended

Weight

3.2 kg (7.1 lb)

Display

20 x 2 alphanumeric LCD with backlighting

Sensor Types

Chilled-mirror dew point sensor
Infrared temperature sensor

Operating Temperature

Minimum	5 °C
Typical	NA
Maximum	40 °C

Data Communications

RS-232A serial
8-data bit ASCII code
9,600 baud, no parity
1 stop bit

Interface Cable

Standard RS-232 to USB cable (included)

Power

110–220 VAC
50/60 Hz

COMPLIANCE

Manufactured under ISO 9001:2015
EM ISO/IEC 17050:2010 (CE Mark)
Compatible standard: ASTM D6836-07

3.2 COMPONENTS

The WP4C uses the chilled-mirror dew point technique to measure the water potential of a sample. In an instrument that uses the dew point technique, the sample is equilibrated with the headspace of a sealed chamber that contains a mirror and a means of detecting condensation on the mirror. At equilibrium, the water potential of the air in the chamber is the same as the water potential of the sample.

The WP4C main components include the display screen and sample chamber (Figure 4 and Figure 5). A power cord and RS-232 communication cable can be plugged into the back of the unit.

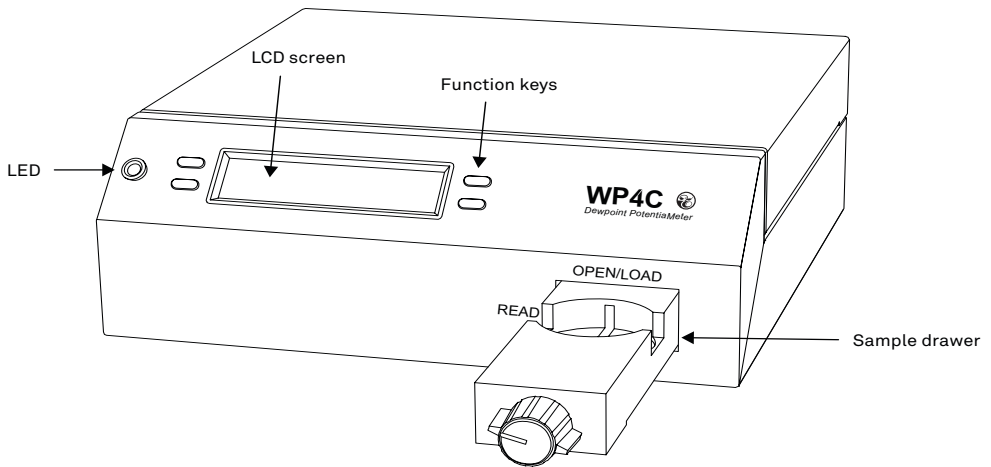

Figure 4 Front view

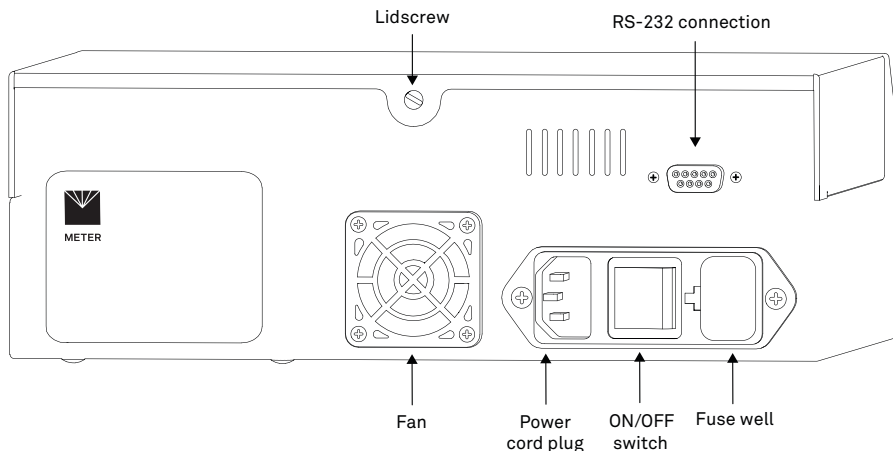

Figure 5 Back view

3.2.1 SAMPLE CHAMBER

The sample chamber has many components (Figure 6). An internal thermoelectric module equilibrates the sample temperature to the headspace of the chamber.

A thermoelectric (Peltier) cooler controls the mirror temperature. A photoelectric cell detects the exact point when condensation first appears on the mirror by measuring a reflected beam of light with a photodetector. The photodetector senses the change in reflectance when condensation occurs on the mirror. A thermocouple attached to the mirror records the temperature when condensation occurs.

An internal fan circulates the air within the sample chamber to reduce time to equilibrium. Both dew point and sample surface temperatures are simultaneously measured, eliminating the need for complete thermal equilibrium.

SYSTEM

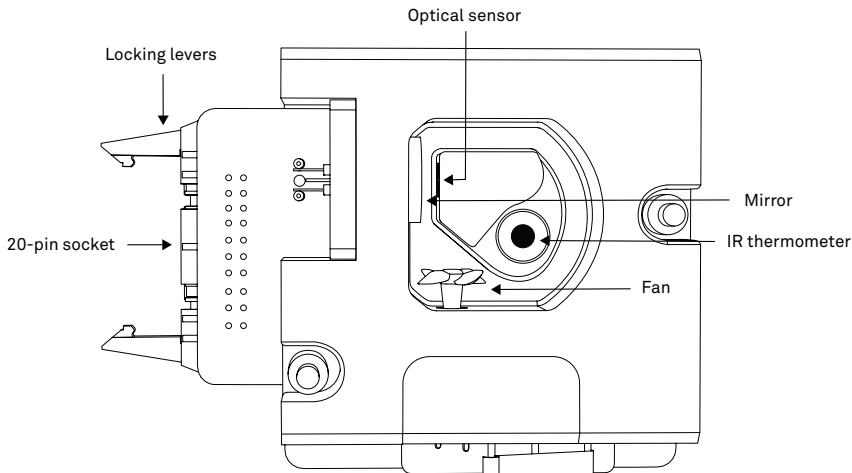

Figure 6 Sample chamber

3.2.2 LED

A flashing green LED, located on the left front corner of the WP4C case, blinks to notify the user of different settings.

The LED flashes once when a sample reading starts. In Fast and Precise reading modes, the LED will flash continuously when the sample reading is finished until the sample drawer knob is moved to the OPEN/LOAD position. The LED settings cannot be changed or turned off.

3.2.3 BUTTONS

Four buttons flank the LCD screen (Figure 7). The function of each button changes depending on the current screen (Section 3.2.4).

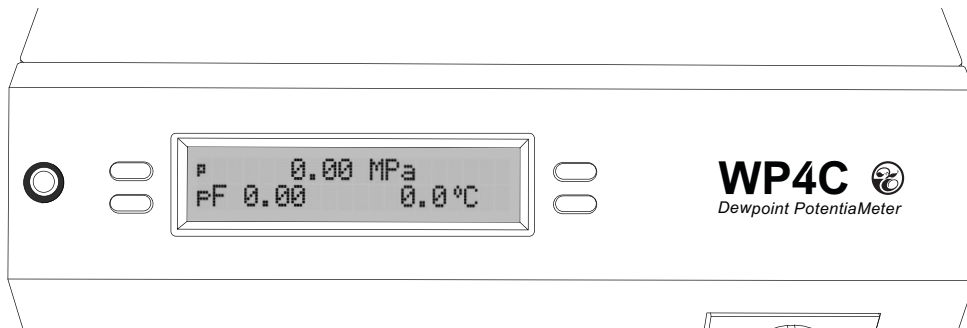

Figure 7 Buttons

3.2.4 DISPLAY SCREEN

The WP4C has five different screens to display data and change settings.

3.2.4.1. MODEL INFORMATION SCREEN

The Model Information screen (Figure 8) will appear for approximately 3 s after turning the WP4C on, immediately followed by the Main screen.



Figure 8 Model Information screen

3.2.4.2. MAIN SCREEN

The Main screen (Figure 9) displays the water potential in both megapascals and log-scaled pF values. The sample temperature is displayed in degrees Celsius. The values on this screen will update during measurements. A small letter in the top left indicates the reading mode.

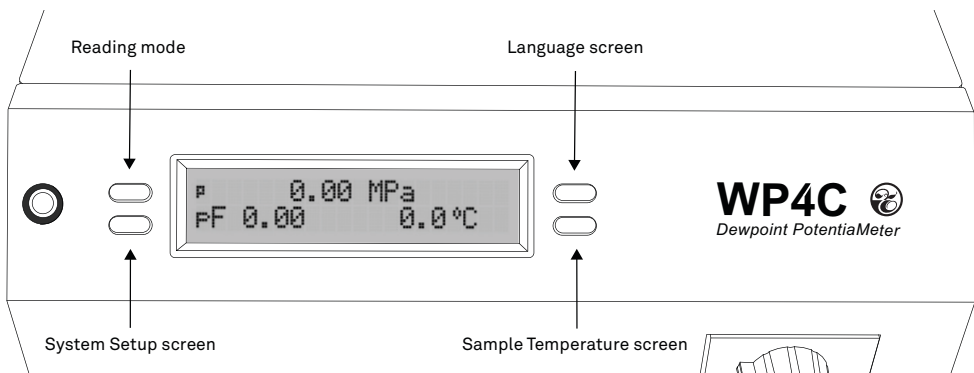

Figure 9 Main Menu screen and button functions

Pressing the upper left button will change the reading mode (Section 3.2.5). The symbol on the screen will toggle between p, c, or f to indicate if WP4C is reading in Precise, Continuous, or Fast mode.

Press the upper right button to change the WP4C language (Section 3.2.4.3).

Press the lower right button to show sample temperature information (Section 3.2.4.4).

Press the lower left button to bring up system setup options (Section 3.2.4.5).

NOTE: WP4C will not allow button selections while the unit is reading a sample.

3.2.4.3. LANGUAGE SCREEN

The Language screen shows the current selected language for the unit. English is the WP4C default on-screen language. The on-screen user language can be changed to any one of the following languages: German, French, Spanish, Italian, Swedish, Danish, Norwegian, Czech, Portuguese, Japanese, Polish, or Finnish.

From the Main screen, press the upper right button. The Language screen (Figure 10) with default English will appear. Continue pressing the upper right button to scroll through the language options. When the preferred language is reached, press the lower left button to exit.



Figure 10 English screen

3.2.4.4. SAMPLE TEMPERATURE SCREEN

The Sample Temperature screen (Figure 11) displays the sample temperature (T_s) and the temperature difference between the WP4C sample and the sample block ($T_s - T_b$). Use this screen to quickly check if the sample is too hot, which may cause condensation inside the chamber.

NOTE: It is important that $T_s - T_b$ is negative in order to prevent condensation inside the sample chamber.

From the Main screen, press the lower right button to bring up the Sample Temperature screen. Press either of the lower buttons to exit.

NOTE: The sample drawer knob must be in the OPEN/LOAD position to access the Sample Temperature screen.



Figure 11 Sample Temperature screen

3.2.4.5. SYSTEM SETUP SCREEN

The System Setup screen is used to change how the WP4C signals after each reading, enter the Calibration Menu, and set the Temperature (set T) (Figure 12).



Figure 12 System Setup screen

From the Main screen, press the bottom left button to access this menu. Use the buttons to select the desired setting to configure: audible notification, calibration, and temperature.

Press the upper left button to toggle adjust the audible notification at the end of a reading. Three icons represent the three options: no notification (0x), beep momentarily before stopping (4x), or beep continuously until the sample drawer knob is turned to the OPEN/LOAD position.

NOTE: The audible notification is not changed by turning the instrument off and on.

Press the upper right button to go to start calibration ([Section 4.1](#)).

Press the lower right button to set WP4C temperature ([Section 3.2.4.6](#))

Press the lower left button to exit back to the Main menu at any time.

3.2.4.6. TEMPERATURE SET SCREEN

The default temperature of the WP4C sample block temperature is 25 °C. The Temperature Set screen allows the sample block temperature to be set manually ([Figure 13](#)). The sample block temperature roughly corresponds to the temperature needed to read the sample.

To access this screen from the Main menu, press the lower left button, followed by the lower right button (next to set T) on the System setup screen.



Figure 13 Temperature Set screen

The index number can be adjusted between 15 and 40 °C. Use the right buttons next to the + and - symbols to adjust the sample block temperature value in increments of 0.1 °C.

NOTE: Holding down the button will rapidly increment the value.

The temperature control can be disabled by pressing the - button after reaching 15 °C. Reenable temperature control by pressing the + button to bringing the sample block temperature back into its controllable range.

After adjusting the sample block temperature, wait 15 min before taking a measurement to allow the sample block to reach the new temperature.

3.2.4.7. PERFORMANCE EVALUATION SCREEN

The Performance Evaluation screen needs to be accessed only if one of the components of the WP4C may be causing a measurement error. Before accessing this screen, ensure the instrument has been cleaned ([Section 4.3](#)) and other troubleshooting steps have been

reviewed (Section 4.5). Values on this screen cannot be changed, but they will indicate component performance. If any of these values are not what they should be, contact [Customer Support](#).

To access this screen, hold down the lower right button while turning on the instrument. After the instrument initializes, the Performance Evaluation screen will appear, providing four values (Figure 14).



sensors	3.36	0.030
-Exit-	23.52	1.072

Figure 14 Example Performance Evaluation screen

- The top left value is the value the thermocouple is reading—the temperature difference between the sample block and the mirror. If this is 0, there is something wrong with the thermocouple.
- The top right value is the value read by the thermopile—the temperature difference between the sample block and the sample. This value is variable but should never be 0.
- The bottom left value is the sample block temperature. This value should be around ambient temperature.
- The bottom right value is the mirror reflectance voltage, in volts. This value should normally be around 0.5 or above, but if it drops below 0.3, there is something wrong.

Press the button next to -Exit- to bring up the Main menu.

3.2.5 READING MODES

WP4C has three reading modes: precise, continuous, or fast. The display will show a small p, c, or f to the left of the water potential readings (Figure 15) indicating which mode is selected. To change the mode, navigate to the Main screen and press the upper left button.

NOTE: WP4C will not allow button selections while the unit is reading a sample.



c	0.00 MPa
PF	0.00 0.0 °C

Figure 15 Main Menu with Continuous mode enabled

PRECISE MODE

Precise mode is the default WP4C mode. WP4C repeats sample measurements until successive readings agree within a preset tolerance (0.03 MPa for $\Psi > -40$ MPa; otherwise 0.3 MPa). For most accurate results, run most soil samples in Precise mode. Typical read times are within 10 to 15 min.

CONTINUOUS MODE

Continuous mode measures the water potential of the sample continuously until the drawer knob is turned back to the OPEN/LOAD position. The WP4C will measure the sample, display the water potential and sample temperature, then begin another read cycle. WP4C will signal the end of a reading with an LED flash and audible notification (if enabled).

Continuous mode is recommended for samples that take a long time (20 to 30 min) to come to vapor equilibrium, such as plant samples and wet soil samples with water potential >-0.5 MPa. METER recommends using Continuous mode and logging data to determine when equilibrium conditions are reached. It may be helpful to connect the WP4C to a computer while in Continuous mode in order to log and store data over time ([Section 3.2.6](#)).

FAST MODE

Fast mode measures the sample once. Read time is typically 3 to 5 min. Readings are less precise, particularly in the wet range.

Fast mode is recommended for dry soil samples with water potential <-40 MPa. For samples with very little water holding capacity (i.e., dry sand samples), small leaks in the sample chamber can cause water potential to drift down over time.

3.2.6 COMPUTER INTERFACE

The WP4C can connect to a computer to send water activity data to a computer for further analysis and storage. An RS-232-to-USB serial cable is included for this purpose. The interface is run through the AquaLink 4 Software or a terminal communication program.

NOTE: If the computer does not have a USB port, use a USB-to-RS-232 adapter.

There are several terminal program options. METER has its own terminal program (DecaTerm) that can be downloaded from metergroup.com/wp4c-support. Two other options are TeraTerm, a free program that can be found on the internet, and Hyperterminal, the standard program with Microsoft® Windows® prior to Windows 7 software.

To integrate a terminal program with WP4C, use the following steps:

1. Power on the WP4C.
2. Connect the USB interface cable to the computer.
3. Follow the instructions for the program with the following settings:
 - c. Choose correct COM Port.
 - d. Set or verify COM Properties.
 - e. Bits per second (Baud rate): 9,600
 - Data: 8 bit
 - Parity: none
 - Stop: 1 bit
 - Flow control: none

Upon successful completion of a water activity reading, the data in the terminal program displays measurement time (in minutes), sample temperature, and water potential (in both MPa and pF). Figure 16 shows a sample return.

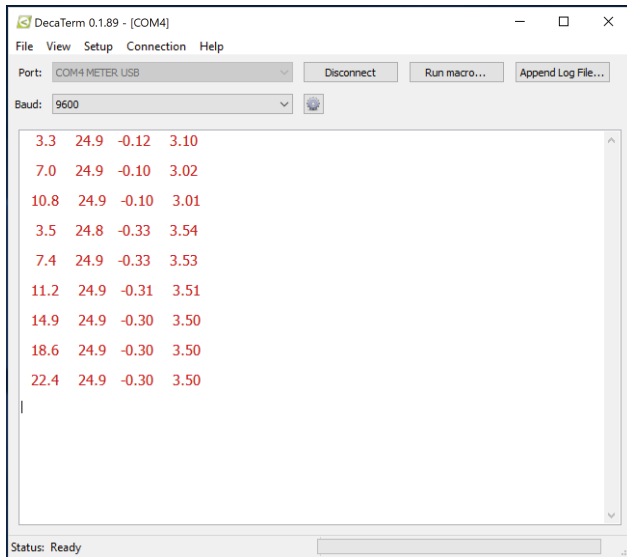

Figure 16 Sample data return

3.3 THEORY

Water potential is a measurement of the energy status of the water in a system. It indicates how tightly water is bound, structurally or chemically, within a substance. Water potential is defined as the potential energy per unit volume of water in a sample.

3.3.1 DEFINING WATER POTENTIAL

The total water potential of a sample is the sum of four component potentials: gravitational, matric, osmotic, and pressure. Gravitational potential depends on the position of the water in a gravitational field. Matric potential depends on the adsorptive forces binding water to a matrix. Osmotic potential depends on the concentration of dissolved substance in the water. Pressure potential depends on the hydrostatic or pneumatic pressure on the water.

The WP4C measures the sum of the osmotic and matric potentials in a sample. Often one or the other of these potentials will be the dominant factor in determining the total potential. For example, solutions like the KCl calibration standard have only an osmotic component. Soils bind water mainly through matric forces and therefore have mainly a matric component (though salt-affected soils can have a significant osmotic component).

WP4C computes water potential from the vapor pressure of air in equilibrium with the sample in the sealed sample chamber. Large temperature differences between the sample and sample block will cause longer reading times, since a complete and accurate reading will not be made until the difference between the sample temperature and the sample block temperature is <1.0 °C.

To monitor the temperature difference between the sample and the block, access the Sample Temperature screen ([Section 3.2.4.4](#)).

3.3.2 MEASURING WATER POTENTIAL

The water potential of a solid or liquid sample can be found by relating the sample water potential reading to the saturation vapor pressure of air in equilibrium with the sample. The relationship between the sample water potential (Ψ) and the saturation vapor pressure of the air is determined using [Equation 1](#):

$$\Psi = \frac{RT}{M_w} \ln \frac{e_s(T_d)}{e_s(T_s)} \quad \text{Equation 1}$$

where

- $e_s(T_d)$ is the saturation vapor pressure of the air at dew point temperature,
- $e_s(T_s)$ is the saturation vapor pressure at sample temperature,
- R is the gas constant, 8.31 J/(mol × K),
- T is the Kelvin temperature of the sample, and
- M is the molecular mass of water, 18.01528 g/mol.

In the WP4C, the sample cup is sealed against a sensor block, while a fan speeds equilibration of the sample with the headspace vapor and controls the boundary layer conductance of the dew point mirror. The dew point mirror measures the dew point temperature of the air, and an infrared (IR) thermometer measures the sample temperature. From these measurements, the WP4C computes the vapor pressure of the air in the headspace as the saturation vapor pressure at dew point temperature. When the water potential of the sample and the headspace air are in equilibrium, the measurement of the headspace vapor pressure and sample temperature (from which saturation vapor pressure is calculated) gives the water potential of the sample.

In addition to equilibrium between the liquid phase water in the sample and the vapor phase, the internal equilibrium of the sample itself is important. If the sample is not at internal equilibrium, one might measure a steady vapor pressure (over the period of measurement) which is not the true water potential of the sample.

3.3.2.1. TEMPERATURE EFFECTS

Temperature plays a critical role in water potential determinations. Most critical is the measurement of the difference between sample and dew point temperature. For water potential measurements to be accurate to 0.05 MPa, temperature difference measurements need to be accurate to 0.006 °C.

The WP4C IR thermometer measures the difference in temperature between the sample surface and the sample block. The thermometer is carefully calibrated to minimize temperature errors; however, achieving 0.006 °C accuracy is difficult when temperature differences are large. Most accurate measurements are obtained when the sample is near block temperature.

Another effect of temperature on water potential occurs with samples that are near saturation (like many soil samples). A sample that is close to 0.00 MPa and is only slightly warmer than the sensor block will condense water within the block. This will cause errors in the measurement and in subsequent measurements until the condensation disappears.

There is a linear relationship between the sample dew point temperature and its water potential. The dew point decreases -0.12 °C/MPa. For example, a very dry sample at -40 MPa can be 4.8 °C (-0.12×-40) above the block temperature without condensing. A sample at -1 MPa (fairly dry for most soils) can be 0.12 °C above the block temperature without condensing. Therefore, if the general range of the sample water potential is known, the temperature it will condense moisture can be determined. Monitor the temperature difference between the sample and the block using the Sample Temperature screen to ensure the sample will not condense on the sensor block (Section 3.2.4.4).

3.3.2.2. OSMOTIC EFFECTS

The WP4C measures the sum of osmotic and matric potential. An approximate value for the osmotic potential can be found by measuring the electrical conductivity (EC) of the saturation extract of the soil. The osmotic potential of the saturation extract is computed using Equation 2:

$$\Psi_{os} \text{ (MPa)} = -0.036EC \text{ (ds/m)} \quad \text{Equation 2}$$

The osmotic component of the water potential is then computed using Equation 3:

$$\Psi = \Psi_{os} \frac{\theta}{\theta_s} \quad \text{Equation 3}$$

where θ is the volumetric water content of the sample and θ_s is the volumetric water content at saturation. The matric potential is the total potential minus the osmotic.

4. SERVICE

This section describes the calibration and maintenance of the WP4C. Troubleshooting solutions and customer service information are also provided.

4.1 CALIBRATION

The WP4C uses the chilled mirror dew point technique for measuring water potential. METER adjusts the calibration slope during factory calibration. The user can adjust the zero offset and calibrate successfully with any solution of known water potential ([Section 4.1.1](#)). Calibration can also be checked by measuring distilled water, but this is often not a good choice. When using distilled water, the humidity of the chamber approaches 100%, which can cause condensation to occur if the sample is warmer than the chamber. METER recommends using the 0.5 mol/kg KCl verification standard available from METER.

The WP4C calibration should be checked before each use and at regular intervals. This will alert the user to the possibility of contamination of the unit or shifts in the calibration from other causes. The WP4C calibration should also be checked after cleaning to identify any change that may have occurred during cleaning procedures.

If a change has occurred, refer to [Section 4.1.2](#) for steps to correct the calibration. If the instrument continues to read incorrectly, contact [Customer Support](#).

NOTE: METER recommends factory calibration of the WP4C every 2 years to maintain optimal performance and accuracy. High usage instruments should be calibrated annually.

4.1.1 VERIFICATION STANDARDS

Verification standards are specially prepared salt solutions that have a specific molality and water potential. METER recommends using potassium chloride (KCl) verification standards. The KCl standards are accurate, easy to use, and readily available from METER, which greatly reduces preparation errors.

The standards are produced under a strict quality assurance regime and are shelf stable for 1 year. If for some reason verification standards are not available from METER, instructions for making a salt solution for verification are located in [Appendix A](#).

NOTE: To avoid inaccurate water activity readings, verification standards should be used once immediately after opening and not stored in sample cups for repeated use.

4.1.2 CALIBRATION PROCESS

Since errors in the calibration values result in errors in all values subsequently measured, carefully follow the calibration instructions to get accurate values.

NOTE: The WP4C will automatically shift to Precise mode for calibration.

1. Check to be sure the sample temperature is below sample block temperature (lower right button).
2. Press the lower left button to access the System Setup screen.
3. Press the upper right button to begin calibration.
Instructions will appear (Figure 17).

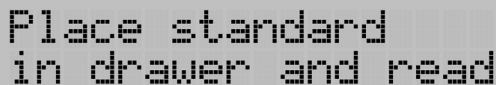

Place standard
in drawer and read

Figure 17 Onscreen instructions

4. Empty the whole vial of KCl solution into a sample cup.
NOTE: Use the same type of sample cup (plastic or stainless steel) that will be use in subsequent measurements.
5. Place the standard in the sample drawer and carefully slide the drawer closed to avoid spilling solution and contaminating the chamber.
6. Turn the drawer knob to the READ position.

A notification that the measurement is starting will appear (Figure 18).

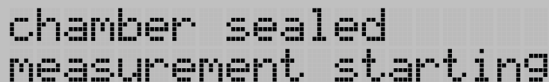

chamber sealed
measurement starting

Figure 18 Measurement starting notification

When the reading is complete, a Results screen will appear (Figure 19).



P -2.12 MPa
PF 4.33 24.8 °C

Figure 19 Results screen

The reading should be within ± 0.05 MPa of the correct reading of the KCl standard at that temperature (Table 2). Results for other standards are in Appendix B.

Table 2 Water potential of 0.50 mol/kg KCl salt standard

Temperature (°C)	0.50 mol/kg KCL
15	-2.14
20	-2.18
25	-2.22
30	-2.26
35	-2.29
40	-2.33
50	-2.41

- If the WP4C is reading within 0.05 MPa of the standard, press –Exit– and proceed with sample readings.

If the reading is not within 0.05 MPa of the standard, a change in calibration may have occurred or the sensor chamber may be contaminated. Clean the chamber (Section 4.3) and repeat calibration from step 1.

If, after this process, readings consistently differ from the correct water potential of the standard by more than ± 0.05 MPa, a change in calibration has probably occurred. To correct the change, use the following steps.

- On the Results screen, press the upper right or lower right button to move the value up (+) or down (-), respectively.
- When the correct value for the verification standard is reached, press the –Exit– button. The value will be stored as a linear offset.
- Take a normal measurement of the standard. It should read the proper value.

NOTE: Ensure that the block is properly cleaned before adjusting the WP4C calibration. Adjusting the calibration without thoroughly cleaning the block can shift the calibration to a point where it cannot be properly calibrated after cleaning.

If results are still incorrect, contact [Customer Support](#).

4.2 MAINTENANCE

The WP4C may be returned to METER for maintenance in the following areas: system inspection, parts replacement, and instrument cleaning. Replacement parts can also be ordered from METER. Contact [Customer Support](#) for more information.

4.3 CLEANING

Cleanliness of the WP4C is vital for accurate readings. Dust and sample debris can contaminate the sampling chamber so regular cleaning is essential. The WP4C ships with a cleaning kit that should last through about 1 year of regular cleanings. New cleaning kits can be ordered from METER.

The KIMWIPES strips included in the cleaning kit are ideal for cleaning because they leave very little lint residue and do not have compounds in the tissue that may contaminate the WP4C sensors. Never use cotton swabs to clean the block sensors, as these contain adhesives and other compounds that cause contamination.

To clean the WP4C, carefully follow the instructions in this section. The procedure to clean the WP4C involves washing, rinsing, and drying each area.

NOTE: Wash hands with soap and water, and wear clean gloves before starting the cleaning procedure. This prevents oils from contaminating the cleaning materials, the sample chamber, and the sensors.

NOTE: Isopropyl alcohol can be substituted for the cleaning solution.

1. Turn the WP4C power OFF.
2. Unplug the WP4C.
3. Remove the lid screw located on the back panel (Figure 20).

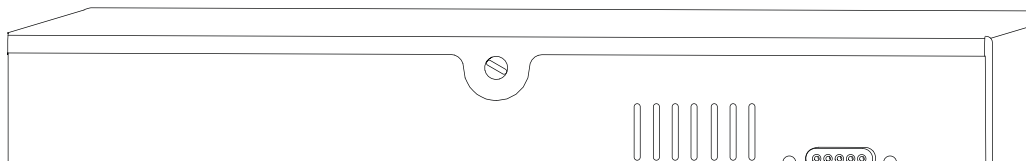

Figure 20 Lid screw

4. Carefully remove the lid by pulling the back of the lid upward and then sliding the lid back (away from the front of the case) and off the unit completely.
5. Remove black foam (Figure 21).

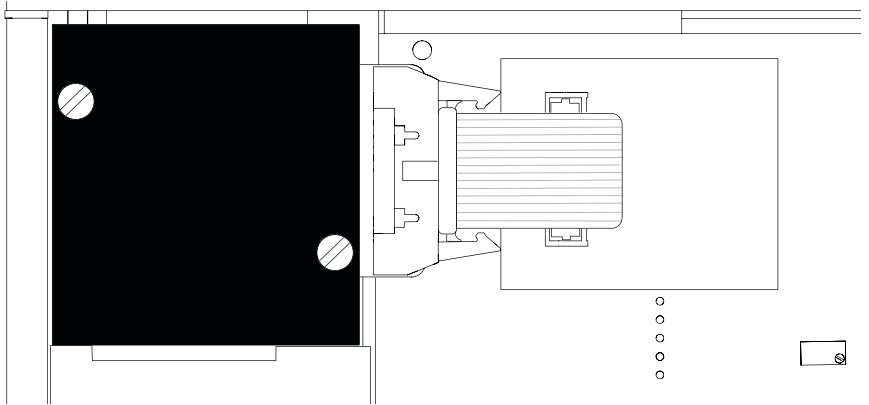

Figure 21 Black foam

6. Unscrew the two thumb screws that secure the sensor block (Figure 22).

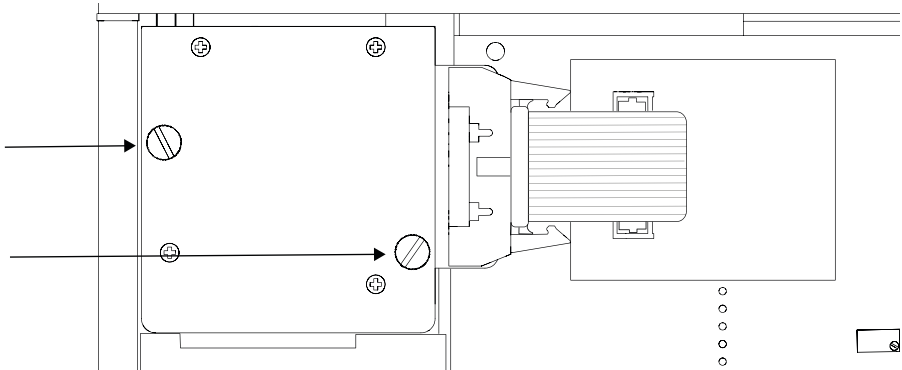

Figure 22 Thumb screws

7. Pull out the two locking levers on either side of the 20-pin socket. Carefully pull out the blue pin connector (Figure 23).

SERVICE

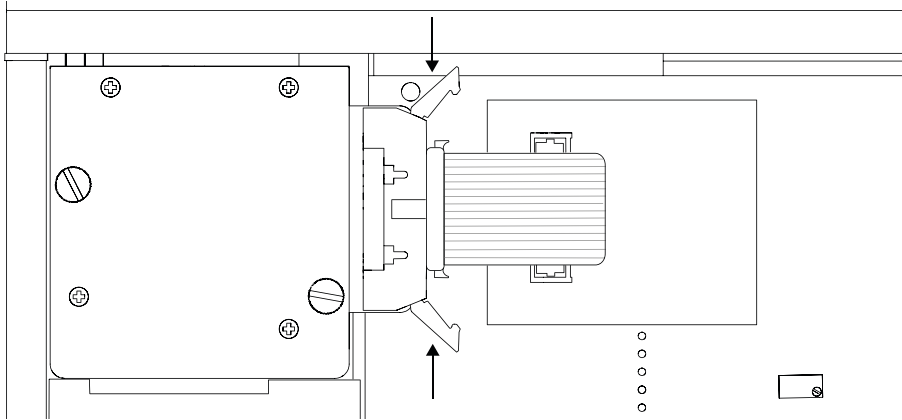

Figure 23 Pull out levers prior to pulling out cable

8. Carefully lift the block straight up from its mount.
9. Turn the block over to expose the chamber cavity (Figure 24) and set it onto the work area carefully.

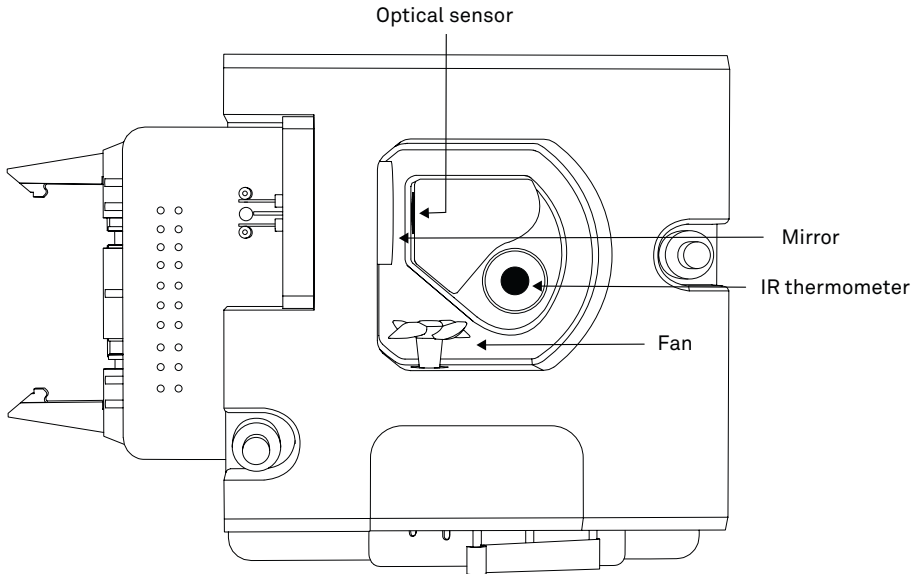

Figure 24 View of inside block

10. Clean the sample chamber.
 - a. Remove any debris that may have collected within or around the sample chamber.
 - b. Wrap a new KIMWIPES strip around the end of the spatula and moisten it with cleaning solution.

NOTE: Do not dip used strips into the container of IPA or cleaning solution (the IPA or cleaning solution will become contaminated).
 - c. Clean all surface edges of the sample chamber including the edge where the sample cup seals to the chamber block. Replace the strip if it becomes too dirty during this process.

NOTE: Do not damage the fragile fan blades. If a fan blade breaks, the WP4C will not work properly.
 - d. Repeat [step c](#) using new KIMWIPES strip moistened with deionized water instead of cleaning solution.
 - e. Repeat [step c](#) using new, dry KIMWIPES strip to remove any moisture remaining from the cleaning.
 - f. Visually inspect the sample chamber for cleanliness. Clean again if necessary.

NOTE: Do not reuse strips.
11. Clean the mirror and optical sensor.
 - a. Wrap a new KIMWIPES strip around the end of the spatula and moisten it with cleaning solution.
 - b. Carefully clean the mirror with the KIMWIPES strip.
 - c. Repeat [step b](#) using new KIMWIPES strip moistened with deionized water instead of cleaning solution.
 - d. Repeat [step b](#) using new, dry KIMWIPES strip to help remove any moisture remaining from the cleaning.
 - e. Visually inspect the mirror for cleanliness. Clean again if necessary.
12. Clean the IR thermometer.
 - a. Wrap a new KIMWIPES strip around the end of the spatula and moisten it with cleaning solution.
 - b. Swipe the KIMWIPES across IR thermometer.

A single swipe is usually sufficient to remove contaminants.
 - c. Repeat [step b](#) using new KIMWIPES moistened with deionized water instead of cleaning solution.
 - d. Repeat [step b](#) but use a new, dry KIMWIPES to help remove any moisture remaining from the cleaning.
 - e. Visually inspect the IR thermometer for cleanliness. This sensor must be free of all dirt and lint. Clean again if necessary.

13. Clean inside the case.
 - a. Remove any debris that may have collected within the case.
 - b. Wrap a new KIMWIPES strip around the end of the spatula and moisten it with cleaning solution.
 - c. Clean all surface edges of the case. Replace the strip if it becomes too dirty during this process.
 - d. Repeat [step c](#) using new KIMWIPES strip moistened with deionized water instead of cleaning solution.
 - e. Repeat [step c](#) using new, dry KIMWIPES strip to remove any moisture remaining from the cleaning.
 - f. Visually inspect the sample chamber for cleanliness. Clean again if necessary.
14. Ensure there is no contamination of the sample chamber cavity.
15. Replace the block, and insert the ribbon cable socket into to the 20-pin plug on the block.
16. Lock the block into place with the locking levers.
17. Screw the thumb screws on the block back in until they are hand-tight.
18. Replace the case lid and secure the lid screw.

4.4 REPAIR

METER repairs manufacturer defects and instruments within the 1-year warranty at no charge. Repairs outside of the warranty window are charged based on cost of parts, labor, and shipping. An extra fee may be charged for rush work. Contact [Customer Support](#) for an estimated repair cost.

METER has loaner instruments available for a fee while the WP4C is being serviced.

All WP4C units returning to METER for servicing must be accompanied with a Return Merchandise Authorization (RMA) number. Prior to shipping the instrument, contact [Customer Support](#) to obtain an RMA number.

The following steps will help to ensure the safe shipping and processing of the WP4C:

1. Place the WP4C in a plastic bag to avoid disfiguring marks from the packaging.
2. Do not ship the power cord, serial cable, or any other accessories.
3. Ship the WP4C in its original cardboard box with suspension packaging
If the original packaging is not available, use a box with at least 4 in of packing material (e.g., Styrofoam™ peanuts or bubble wrap) between the instrument and each wall of the box, ensuring the instrument is suspended in the packing material.

4. On the RMA form, please verify the ship to and bill to information, contact name, and problem description. If anything is incorrect, please contact [Customer Support](#).
5. Tape the box in both directions for added support.
6. Include the RMA number in the attention line on the shipping label.

A Certificate of Calibration will be issued upon completion of the work.

4.5 TROUBLESHOOTING

WP4C is a high-performance instrument, designed to have low maintenance and few problems if used with care. Unfortunately, sometimes even the best operators using the best instruments encounter technical difficulties. [Table 4](#) lists common problems and their solutions. If the problem is not listed or these solutions do not solve the issue, contact [Customer Support](#).

Table 4 Troubleshooting the WP4C

Problem	Possible Solutions
<p>WP4C does not turn on</p>	<p>Ensure power cord is securely attached to the back of the instrument and plugged into the power outlet.</p> <p>A power surge may have caused a fuse to blow. To change the fuses:</p> <ul style="list-style-type: none"> • Unplug the power cord. • Locate the panel where the power cord plugs in. The fuse box is on the right side of that panel. • Press the release tab and pull the fuse-holder out. • Pull the broken fuse out. • Replace the broken fuse with a 1.25-A, 250-V fuse. <p>CAUTION: Do not use any other kind of fuse to avoid risk of damaging the instrument or voiding the warranty.</p> <ul style="list-style-type: none"> • Replace the fuse holder and push it into the fuse well until the release tab snaps in place. • Connect the power cord and turn the instrument on. <p>If the fuse blows again, a failed component may be causing the problem.</p> <p>Contact Customer Support to make arrangements for repairs if the problem persists.</p>

Table 4 Troubleshooting the WP4C (continued)

Problem	Possible Solutions
Long read time	<p>The sample chamber may be dirty. Refer to Section 4.3 for directions on cleaning the sample chamber.</p> <p>Some samples absorb or desorb moisture very slowly, causing measurements to take longer than usual, and nothing can be done to speed up the process. Refer to Section 2.2 for further explanation.</p> <p>The fan blade inside the block chamber may be broken. If even the KCl standard takes a long time to read, and the sample chamber is clean, the chamber fan blade may be broken or bent. This is likely if the instrument chamber has just been cleaned. Contact Customer Support for details on replacement.</p>
Readings on KCl standards are too high/low to adjust	<p>The thermopile in the chamber (measures sample temperature), may have become contaminated. Refer to Section 4.3 for directions on cleaning.</p> <p>If the KCl verification standards from METER are not being used, high readings may indicate that the salt solution being using is not in equilibrium.</p>
Reading message appears < -301.8 MPa	<p>The sample is too dry for the instrument to read accurately.</p> <p>If the sample has a water potential that is above the detection limits of the instrument, this message will appear. It means that there is not enough sample moisture to condense on the mirror and provide a reading.</p> <p>The mirror may be dirty. Cleaning the mirror and chamber and measure the sample again (Section 4.3).</p>
Triangle appears in upper right corner	<p>This triangle is a mirror performance indicator.</p> <p>Clean the mirror and the rest of the sample chamber.</p> <p>When the WP4C senses that the mirror performance has dropped to unacceptable levels, it will display the triangular warning sign after measuring the sample. When this appears, stop sampling and clean the chamber. If the triangle is still on the screen after cleaning, the mirror is most likely still dirty and will need to be cleaned until the triangle disappears.</p>
Block Failure appears on screen after turning on unit	<p>The block is not plugged in to the motherboard.</p> <p>Open the case.</p> <p>Check that the small ribbon cable that connects the block to the motherboard is snapped and locked in place.</p> <p>One or more components has failed on the block circuit board.</p> <p>If the block is properly plugged in to the motherboard and this message appears, it is likely that one or more of the components have failed on the block circuit board.</p>

Table 4 Troubleshooting the WP4C (continued)

Problem	Possible Solutions
Set T option no longer appears on System Configuration menu	The temperature control module inside the WP4C is broken or not functioning correctly. When the instrument senses that there is a problem with the temperature control module, it removes that function as an option as a precaution. Contact Customer Support .

4.6 CUSTOMER SUPPORT

NORTH AMERICA

Customer service representatives are available for questions, problems, or feedback Monday through Friday, 7:00 am to 5:00 pm Pacific time.

Email: support.food@metergroup.com
sales.food@metergroup.com

Phone: +1.509.332.5600

Fax: +1.509.332.5158

Website: metergroup.com

EUROPE

Customer service representatives are available for questions, problems, or feedback Monday through Friday, 8:00 to 17:00 Central European time.

Email: support.europe@metergroup.com
sales.europe@metergroup.com

Phone: +49 89 12 66 52 0

Fax: +49 89 12 66 52 20

Website: metergroup.de

If contacting METER by email, please include the following information:

Name	Email address
Address	Instrument serial number
Phone	Description of the problem

NOTE: For products purchased through a distributor, please contact the distributor directly for assistance.

4.7 TERMS AND CONDITIONS

By using METER instruments and documentation, you agree to abide by the METER Group, Inc. USA Terms and Conditions. Please refer to metergroup.com/terms-conditions for details.

FURTHER READING

Brye, K. R. (2003) "Long-Term Effects of Cultivation on Particle Size and Water-Retention Characteristics Determined Using Wetting Curves." *Soil Science* 168 (7): 459–468.

Campbell, Eric C., Gaylon S. Campbell, and Wayne K. Barlow (1973). "A Dewpoint Hygrometer for Water Potential Measurement." *Agricultural Meteorology*, 12: 113–121.

Gee, G. W., M. D. Campbell, Gaylon S. Campbell, and J. H. Campbell (1992). "Rapid Measurement of Low Soil Water Potentials Using a Water Activity Meter." *Soil Science Society of America Journal* 56(4): 1068–1070.

METER Group, Inc. "How To Create a Full Moisture Release Curve Using the WP4C and HYPROP." <https://www.metergroup.com/environment/articles/create-full-moisture-release-curve-using-wp4c-hyprop/>

Papendick, R. I. and Gaylon S. Campbell (1981). "Theory and Measurement of Water Potential." In *Water Potential Relations in Soil Microbiology*, SSSA Special Publication 9, edited by J. F. Parr, W. R. Gardiner, and L. F. Elliott, 1–22. Madison: Soil Science Society of America.

APPENDIX A. PREPARING SALT SOLUTIONS

Verification standards are specially prepared, unsaturated salt solutions with a specific molality and water potential value that are accurately measurable. METER has verification standards that are produced under a strict quality assurance regimen. It is also possible to make verification standards that can read accurately if proper care is taken while preparing the salt solutions. [Table 5](#) shows the necessary concentrations to mix salt solutions to achieve ranging water potentials. It is important to use ultrapure water when preparing your own unsaturated salt solutions.

[Table 5](#) show the water potential at given concentrations of sodium chloride (NaCl) and potassium chloride (KCl) at 20 °C.

Table 5 Water potential of NaCl and KCl

Concentration (mol/kg)	NaCl (MPa)	KCl (MPa)
0.05	-0.232	-0.232
0.10	-0.454	-0.452
0.20	-0.901	-0.888
0.30	-1.349	-1.326
0.40	-1.793	-1.760
0.50	-2.242	-2.190
0.60	-2.699	-2.622
0.70	-3.159	-3.061
0.80	-3.618	-3.501
0.90	-4.087	-3.931
1.00	-4.558	-4.372

APPENDIX B. TEMPERATURE CORRECTION FOR METER VERIFICATION STANDARDS

Table 6 provides the temperature correction for multiple verification standards available from METER.

Table 6 Temperature correction of verification standards

Temperature (°C)	Water	0.50 mol/kg KCl	2.33 mol/kg NaCl	6.00 mol/kg NaCl	8.57 mol/kg LiCl	13.41 mol/kg LiCl	17.18 mol/kg LiCl
15	0	-2.14	-10.66	-36.32	-94.32	-190.89	-261.45
20	0	-2.18	-10.99	-37.13	-94.86	-190.28	-261.24
25	0	-2.22	-11.47	-37.76	-95.37	-190.75	-261.03
30	0	-2.26	-11.67	-38.39	-95.86	-191.18	-260.83
35	0	-2.29	-11.86	-39.03	-96.32	-191.02	-260.61
40	0	-2.33	-11.89	-39.66	-96.74	-191.38	-260.39
50	0	-2.41	-16.71	-44.90	-98.38	-192.53	-262.51

INDEX

A

accuracy 6
 AquaLink 15
 audible notification 13

B

buttons 10

C

calibration 2, 3, 13, 27
 cleaning 22–26
 components
 buttons 10
 dew point sensor 7
 display screen 8, 11–14
 fan 9
 LED 10
 power cord 2
 RS-232 cable 7
 sample chamber 9–10
 shipped 1
 thermocouple 7, 9–10, 14
 computer interface 15–16
 customer support 29–30

D

DecaTerm 15
 dew point temperature 17, 18

G

gravitational potential 16

I

installation 2

K

KCl standard 1, 16, 19

L

LED 10

M

maintenance 21
 matric potential 16, 18
 measurement 4–5

O

osmotic potential 16, 18

P

pressure potential 16

R

reading mode 14–15, 20
 continuous 14, 15
 fast 10, 14, 15
 precise 10, 14
 selecting 11
 repair 26–27

S

sample cup 1, 3, 7, 20
 sample preparation 3
 sample storage 3
 sample temperature 4, 12, 14, 17
 screens
 Language 11
 Main 11
 Model Information 11
 Performance Evaluation 13–14
 Sample Temperature 12–16
 Temperature Set 13
 settings
 audible notifications 13
 language 12
 reading modes 14–15
 temperature 13
 specifications
 compliance 7
 measurement 6
 physical 6–7
 power voltage 7
 read time 6–8

sample cup 7
temperature 6, 7
water activity 6

T

terms and conditions 29
theory
 osmotic effects 18
 temperature effects 18
 water potential 16–17
troubleshooting 13–14, 27–29

V

vapor pressure 17
verification standards 19, 31

W

water potential 3, 16–18

METER Group, Inc. USA

2365 NE Hopkins Court Pullman, WA 99163
T: +1.509.332.2756 F: +1.509.332.5158
E: info@metergroup.com W: metergroup.com

METER Group AG

Mettlacher Straße 8, 81379 München
T: +49 89 1266520 F: +49 89 12665220
E: info.europe@metergroup.com W: metergroup.de

