

USER'S MANUAL

modular V



Programming:

Robert Bocquier
Nicolas Bronnec
Pierre-Jean Camilieri
Thomas Diligent
Sylvain Gubian
Xavier Oudin
Gilles Pommereuil
Cedric Rossi

Graphics:

Yannick Bonnefoy
Thomas & Wolfgang Merkle [Bitplant]

Manual:

Antoine Back (V5.6)
Silvère Letellier (V2.6)
Tomoya Fukuchi
Tom Healy
Sadahiro Nakano
Xavier Oudin
Cedric Rossi
Takashi Uesugi
Yuji Sano

Sound Designers:

Wally Badarou
Jean-Michel Blanchet
Celmar Engel
Michel Geiss
Christoff Harbonier
Mateo Lupo
Hideki Matsutake
Scot Solida
Katsunori Ujiie

Very special thanks to:

Robert A. Moog and Isao Tomita

Thanks to:

Michael Adams, Bruno Begani, Ned Bouhalassa, Geoff Downes, Clay Duncan, Pavle Kovacevic, Roger Luther, Sadahiro Nakano, Fabrice Paumier, Ben Turl, Peter Willems, and the numerous beta testers.

© ARTURIA SA – 1999-2014 – All rights reserved.
30, Chemin du Vieux Chêne
38240 Meylan
FRANCE
<http://www.arturia.com>

Information contained in this manual is subject to change without notice and does not represent a commitment on the part of Arturia. The software described in this manual is provided under the terms of a license agreement or non-disclosure agreement. The software license agreement specifies the terms and conditions for its lawful use. No part of this manual may be produced or transmitted in any form or by any purpose other than purchaser's personal use, without the express written permission of ARTURIA S.A.
Other products, logos or company names quoted in this manual are trademarks or registered trademarks of their respective owners.

November 2014 edition

Introduction to the Modular V manual

The first version of the Modular V was commercialized in March 2003 having been announced at the NAMM show of the same year.

It quickly became popular being the first to offer an emulation of a modular synthesizer.

The name Robert A. "Bob" Moog was obviously a trigger as for many it remains synonymous with the golden age of vintage synthesizers. But strong interest from well-known musicians such as Isao Tomita, Klaus Schultze, Geof Downes, Stevie Wonder, Herbie Hancock and many others helped create a real buzz around the launch of the Modular V.

At Arturia, we have received many messages of congratulations as well as requests for the evolution and modifications for upcoming versions of the synthesizer.

Version 2 of the Modular V has taken many of these requests into account and brings many unexpected developments.

Firstly, as you will see when you launch the program, is a new means of viewing the synthesizer giving an overview of the entire instrument if your computer can support the resolution. On screens with lower resolutions, by using the "scroll" command, it becomes possible to access all of the modules on the same screen, a feature that will delight many musicians.

We have also broadened the configuration possibilities for the synthesizer. Some modules can now be interchanged, which brings the Modular V closer to the original instruments.

Improvements have also been made to the audio, making use of the evolution of our TAE® technology which has seen improvements during the year. We have answered a frequent request in relation to Audio-in so that you can now use the Modular V filters or sequencer on an external source.

Of course, we have also developed new modules, six to be precise. The 928 (Sample and Hold) and 912 (Envelope Follower) were popular demands and can be found in this new build.

Also added are very rare modules such as the 1630 Bode Frequency Shifter – around a dozen models produced - or completely new modules such as the Formants Filter

Last but not least is the addition of 200 new presets to this version. They make use of the new options offered by the Modular V, and will be a great starting point for those who wish to discover this new version. Go to the last part of Chapter 7 if you wish to jump into using the new modules offered.

Hoping that you enjoy this evolution, we wish you the greatest pleasure in your use of the Modular V

The Arturia team

TABLE OF CONTENTS

1	Introduction	7
1.1	The birth of the Bob Moog's modular systems.....	7
1.2	A modular synthesizer, why?	11
1.3	A better emulation thanks to TAE®.....	11
1.3.1	Aliasing-free oscillators:	12
1.3.2	Better reproduction of analog wave forms:.....	12
1.3.3	Better reproduction of analog filters	13
1.3.4	Implementation of soft clipping.....	14
2	ACTIVATION & FIRST START	16
1.1	Register & Activate	16
3	Quick Start	17
3.1	The 4 sections of the Modular V.....	17
3.1.1	The synthesis section	17
3.1.2	The other three sections	18
3.1.3	Reduced view of the keyboard and the real time controllers.....	19
3.2	Using presets.....	19
3.3	Modular synthesizer	21
3.3.1	First connections	21
3.3.2	Description of the synthesis section modules	25
3.4	The other sections	29
3.4.1	The sequencer.....	29
3.4.2	The effects.....	32
3.5	the virtual keyboard and its real time controllers	37
3.5.1	The keyboard	37
3.5.2	The keyboard controllers	38
3.5.3	The play modes	39
3.5.4	The sound design controllers	40
4	The interface	43
4.1	Using the presets	43
4.1.1	Choice of bank, sub-bank, preset.....	43
4.1.2	Creation of a bank, sub-bank, preset.....	44
4.1.3	Saving a user preset	45
4.1.4	Import / Export of a preset bank.....	45
4.2	Work pages	46
4.2.1	The complete view	46
4.2.2	The reduced usage page	47
4.3	Using controllers	47
4.3.1	Knobs	47
4.3.2	Joysticks	48
4.3.3	Selectors	48
4.3.4	Keyboard.....	49
4.3.5	MIDI control.....	49
4.4	Using cables	52
4.4.1	Audio and modulation connections	52
4.4.2	Modifying a connection	54
4.4.3	Modulation level setting	54
4.4.4	Cable display options	54
4.4.5	Trigger connections.....	55
4.4.6	Synchronization connections	56
4.4.7	Key follow or sequencer connections	56
5	The modules	58
5.1	Programming section	58
5.1.1	Description	58
5.1.2	Oscillators	58

5.1.3	Filters	62
5.1.4	Modulation envelopes	67
5.1.5	Output amplifiers (VCA).....	68
5.1.6	Low frequency oscillators (LFO)	69
5.1.7	Controlled amplifiers / Mixers	70
5.1.8	Trigger delay.....	71
5.1.9	Noise generator.....	73
5.1.10	Sample and hold.....	74
5.1.11	Envelope follower.....	75
5.1.12	Ring modulator.....	76
5.1.13	Formant filter	77
5.1.14	Bode Frequency Shifter.....	77
5.2	Second section.....	78
5.2.1	Description	78
5.2.2	Resonant filter bank.....	79
5.2.3	Chorus	80
5.2.4	Phaser	81
5.2.5	Stereo Delay	82
5.2.6	Sequence generator	83
5.3	Third Section	86
5.4	Fourth section.....	86
5.4.1	Keyboard follow management	87
5.4.2	General settings	88
6	The basics of subtractive synthesis.....	89
6.1	The three main modules.....	89
6.1.1	The oscillator or VCO.....	89
6.1.2	The filter or VCF	92
6.1.3	The amplifier or VCA	96
6.2	Complimentary modules.....	96
6.2.1	The keyboard	96
6.2.2	The envelope generator.....	97
6.2.3	The low frequency oscillator	97
7	A few elements of sound design	99
7.1	Modular sound synthesis	99
7.1.1	Simple patch #1	99
7.1.2	Simple patch #2.....	100
7.1.3	Complex patch #1	103
7.1.4	Complex patch #2	107
7.2	The sequencer	110
7.2.1	Sequence #1	110
7.2.2	Sequence #2	112
7.2.3	Sequence #3	115
7.3	Bonus features.....	116
7.3.1	Creative use of key follows.....	116
7.3.2	Creative use of triggers and trigger delays	118
7.3.3	Stereo without the effects	120
7.4	using the new Modular V 2.0 modules	121
7.4.1	The Bode Frequency Shifter	121
7.4.2	The Envelope Follower.....	124
7.4.3	The sample and hold.....	127
8	Modes of operation	130
8.1	Standalone	130
8.1.1	Launch the application.....	130
8.1.2	Configuration of the instrument	130

8.2	VST 2	131
8.3	VST 3	131
8.4	RTAS	131
8.5	AU.....	131
8.6	64 bit compatibility	131
8.7	Use in Cubase/Nuendo (VST)	132
8.7.1	Instrument use in VST mode	132
8.7.2	Rescan the plug-in directory in Cubase	133
8.7.3	Saving of presets.....	133
8.8	Using in Pro Tools (RTAS)	133
8.8.1	Opening of the plug-in.....	133
8.8.2	Saving the presets	134
8.8.3	Automation under Pro Tools	134
8.9	Using in Logic, Mac OS X (AU).....	135
8.10	Using in Ableton Live (AU and VST).....	136
9	MODULAR V END USER LICENSE AGREEMENT	137

1 INTRODUCTION

1.1 The birth of the Bob Moog's modular systems

Robert A. Moog was born in May 1934 in New York. A passionate for music (he took piano lessons for 12 years), he was introduced to electronics by his father, an engineer in this domain. During his adolescence, he discovered the Thereminvox plan, invented during the 30's by a Russian engineer, Leon Theremin (or more exactly Lev Sergeivitch Termen). Seduced by this instrument with its never before heard sounds, he began to produce his own models and founded his own company in 1954.

Frequenting musical professionals, and in particular electronic and concrete music, R. Moog realized that there was a real demand for electronic instruments of a higher quality.

One of the first clients to come to Robert Moog, the professor of music Herbert A. Deutsch, asked him to listen to a song he had composed. Bob Moog is immediately convinced and they decided to associate their work. Their co-operation produced the first voltage controlled oscillator (VCO).

In 1964, the first prototype of a synthesizer designed by Bob Moog was produced. It was a modular system with a voltage controlled filter (VCF), an envelope generator, a white noise generator, a trigger and two keyboards each with a generator module (sawtooth, triangle and impulsion) as well as a voltage controlled amplifier module (VCA).



The first modular system by Bob Moog (1964) (Courtesy of Roger Luther, MoogArchives.com)

Then other musicians helped Robert Moog in creating different modules:

Walter Carlos (who later became Wendy) helped for elaboration of a sequencer. He also pushed Bob Moog to lend his name to his machines.

Vladimir Ussachevsky, who was one of the professors of de W. Carlos, specified the 4 parts of the envelope generator (ADSR), allowing the accomplishment of the VCA and gave him the idea for the envelope follower.

Gustave Ciomaga helped with the creation of the first tension controlled low-pass filter.

A second prototype, regrouping the all of the new modules, was built during the summer of 1964 and was presented during the AES show (Audio Engineering Society), where Bob Moog worked from an unused stand. This new product generated a huge amount of interest, but he did not yet realize the commercial punch of his machines. Two or three orders were obtained at AES and kept the company busy for several months. In 1965, after the success at the show, Bob Moog decided to release the 900 series for commercial sale.

The first client to buy the full modular system was choreographer Alwin Nikolais. Also among the first users were composers Eric Siday and Chris Swansen. The first commercial uses of the synthesizers were done in advertising. They were also used for jingles and in recording studios.

In 1967, Bob decided to release different machines each with a certain number of modules. This marked the birth of modular systems I, II and III. This same year, Paul Beaver for the first time used a modular system of the brand on a record.

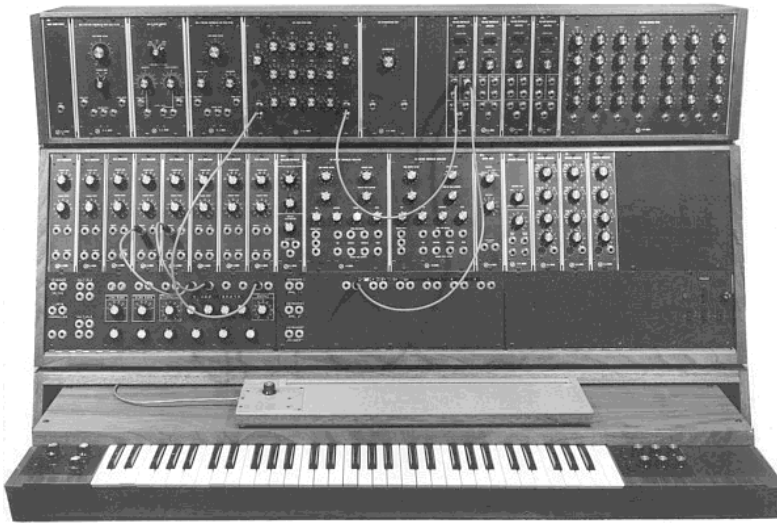

The modular system III (1967)
(Courtesy of Roger Luther, MoogArchives.com)

In 1968, worldwide recognition came with the success of "Switched-On Bach" by W. Carlos. This album, where classical music is played on a modular system, sold over one million copies as it was bought both by classical music fans (it was in the American "Classical" charts for 94 weeks) and fans of pop. It won three Grammy awards.



"Switched-On Bach" by W. Carlos

A little later, Keith Emerson, keyboard player for the groups Nice and ELP (Emerson, Lake and Palmer), was he himself to become an ambassador for the brand. He was one of the first to play a Modular on stage during a tour (A 3C system). Jan Hammer was also one of the first users of modular systems. Big groups like Tangerine Dream, the Beatles or the Rolling Stones, would also become modular system owners.



*The 3C modular system (1969)
(Courtesy of Roger Luther, MoogArchives.com)*

In 1969-70, the company which now has around forty employees was building up to three modulars per week and the order book was always full. The modular had 5 years of high sales, and sold around 200 models in the United States.

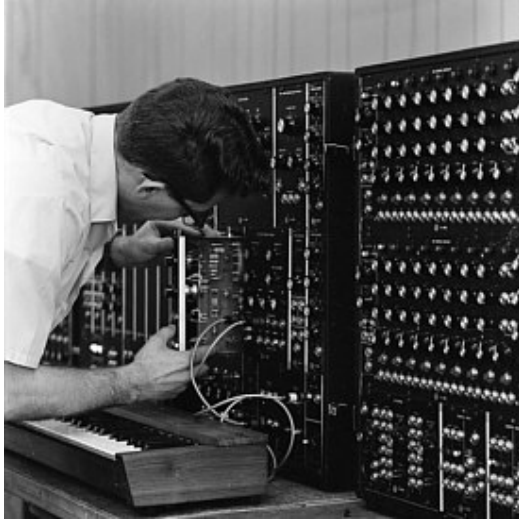

*Construction and testing of a modular system
(Courtesy of Roger Luther, MoogArchives.com)*

In 1969, Bob Moog received demands for a more compact instrument that could be transported more easily, directed more to stage than studio. With the help of an engineer from Berkley, Jim Scott, and the advice from numerous musicians he was about to create another mythic synth: its famous 1971 monosynth...

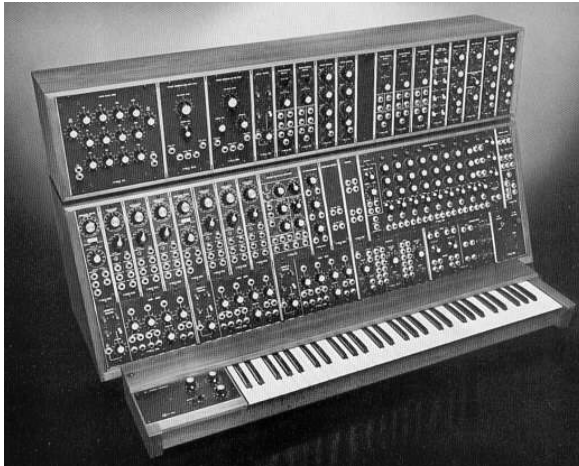

*System 55, the last version of the Modular (1974)
(Courtesy of Roger Luther, MoogArchives.com)*

1.2 **A modular synthesizer, why?**

Why create a modular synthesizer, that is to say comprised of independent modules that we must connect ourselves, sometimes with difficulty, before obtaining a sound?

The answer, as you can imagine, is very simple: the modularity brings immense possibilities for the creation of sound.

To convince you, let's look at some basic concepts.

Sound synthesis is essentially based on the use of generators and filters. From these components, the sound designer must create sounds that can be used by musicians. To succeed, the different parameters that we have access to (height of note, filter cut-off frequency, output volume, wave form...) must evolve in time. And for this, we must link different modules between each other.

Let's take an example: an oscillator, which has inputs to modulate each of its parameters. Let's connect the output of an envelope generator to the oscillator frequency modulation input, and there we get a signal depending on the use of a keyboard. Now we'll connect a low frequency generator to the impulse width modulation input and here we have the waveform, which will evolve in time.

But why not have internal cables, fixed from the start?

Here again, another example will help. Let's take an envelope and two oscillators. The latter possess three modulation inputs: a frequency modulation, an impulse width modulation and a volume modulation.

Effecting every combination with fixed connections would oblige us to have six independent buttons for the modulation of the parameters.

If we now take 9 oscillators, 6 envelopes, a modulation wheel and a velocity setting, we would need... 216 setting buttons.

What can we therefore say for the Modular V, which on top of this has three filters, a noise generator, a sequencer and two control pads?

Connections in a modular synthesizer can sometimes seem difficult, but the often-unexpected results are always a source of great musical inspiration.

Either way, don't worry, the presets created by experienced musicians will allow you, if necessary, a gentle introduction to the art of sound creation.

This new version presents new modules and a notable improvement to the sound quality and synthesis possibilities. As was the case with the previous versions, it remains faithful to the original Modulares and offers the possibility to organize the arrangement of certain modules. Ergonomically this version remains very close to the previous so as not to lose time learning the different functions again.

1.3 A better emulation thanks to TAE®

TAE® - standing for True Analog Emulation - is a new technology dedicated to the digital reproduction of analog circuits.

When implemented in software code, TAE's algorithms guaranty the respect of hardware specifications. This is why your Modular V offers an unparalleled quality of sound.

In detail, TAE means:

1.3.1 Aliasing-free oscillators:

Standard digital synthesizers produce aliasing in high frequencies, and when using Pulse Width Modulation or FM.

TAE® allows the production of totally aliasing-free oscillators in all contexts (PWM, FM...), and at no extra CPU cost.

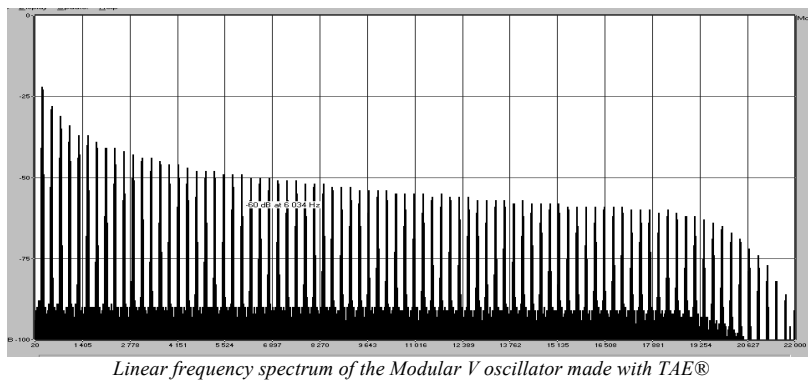
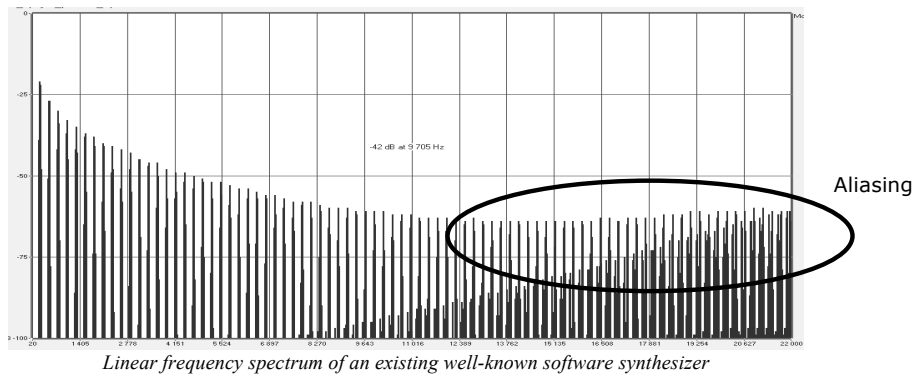

1.3.2 Better reproduction of analog wave forms:

Original analog oscillators used condensers' unloading to produce common wave shapes (saw tooth, triangle, square). This means that waveforms were slightly curved. TAE® allows the reproduction of Condenser's Unload.

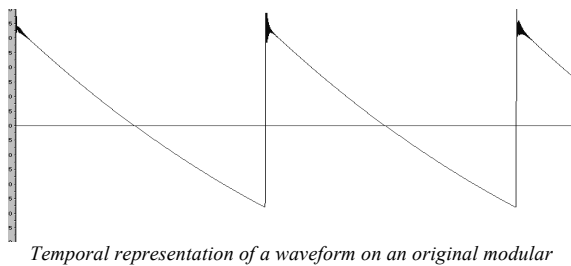

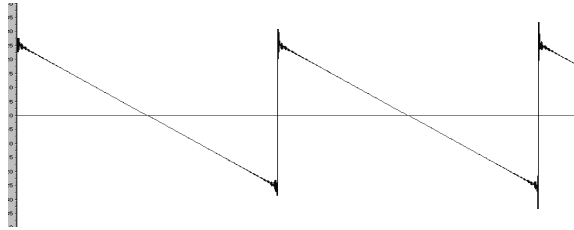

Temporal representation of the waveform of an existing emulation

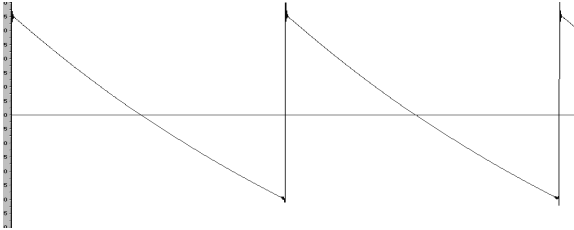

Temporal representation of the Modular V waveform thanks to TAE

In addition, original analog oscillators were unstable. Actually, their wave shape was always slightly different from one period to another. In addition, due to analog hardware sensitivities, new period trigger times varied with the temperature and other environmental conditions.

TAE simulates the instability of oscillators, helping to create warmer and fatter sounds.

1.3.3 Better reproduction of analog filters

TAE allows the emulation of analog-designed filters in a much more precise way than any existing digital filter. In particular, TAE has managed to reproduce the legendary 24dB low-pass resonant filter equipping Bob Moog's synthesizers with great respect towards the original.

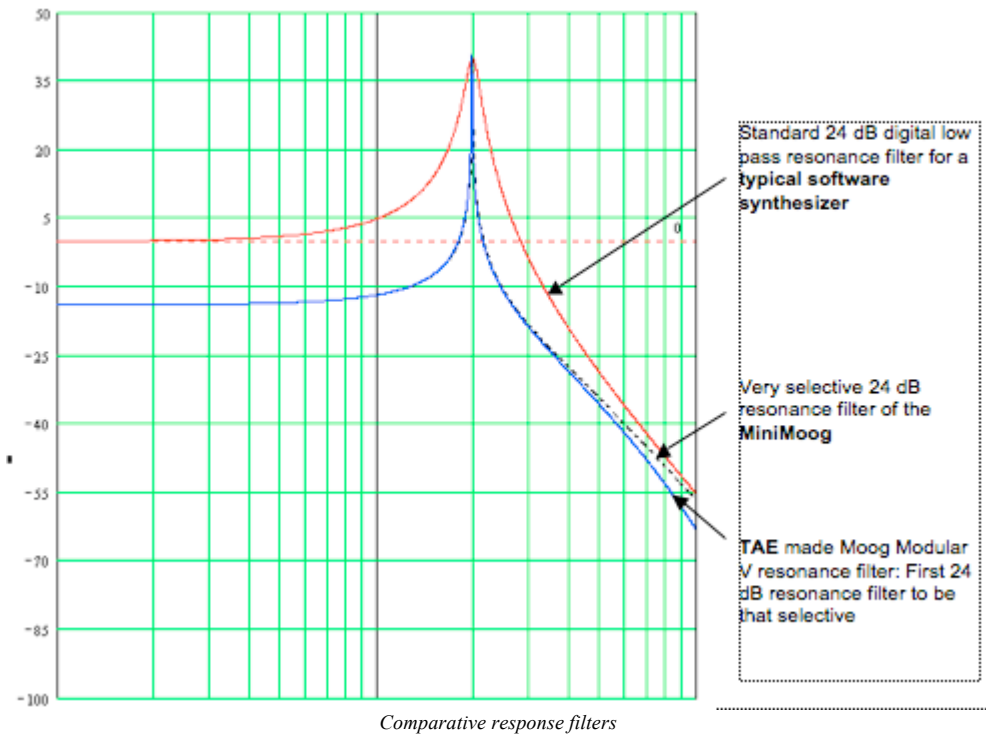

1.3.4 Implementation of soft clipping

In analog synthesizers, the resonant filter uses a current limiting function, preventing the signal from being too loud (soft clipping).

TAE reproduces this current limiting function, making the sound more natural. It also allows filters to enter self-oscillation like original hardware synthesizers do.

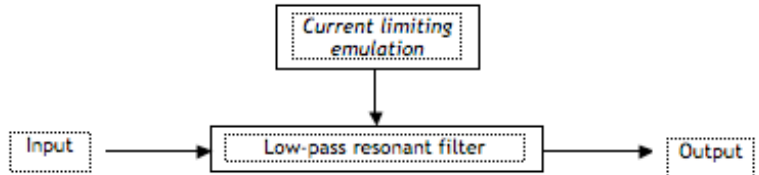

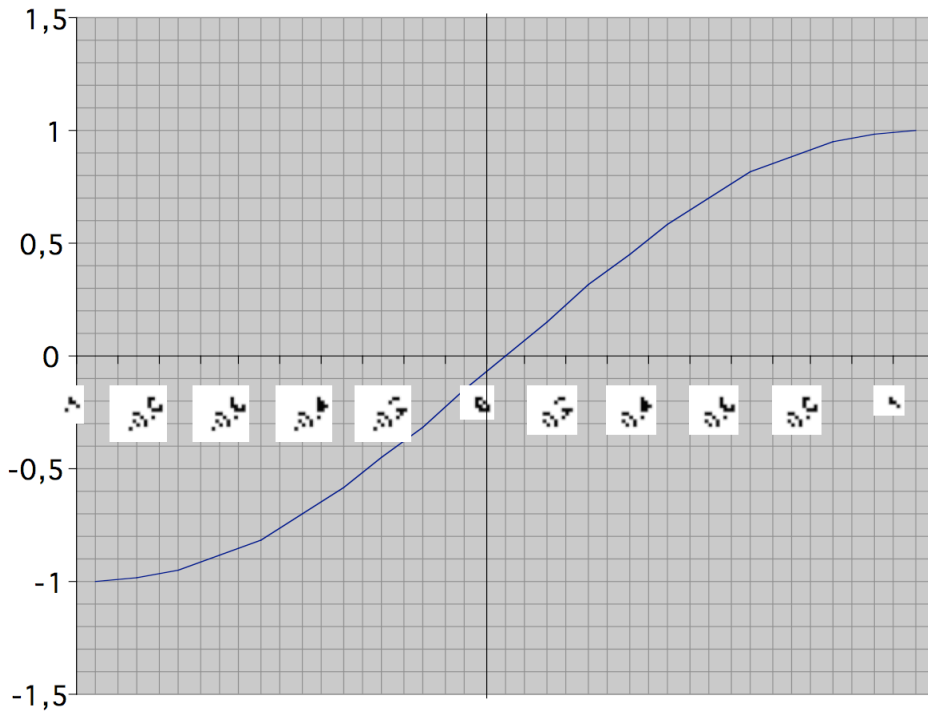

Soft-clipping transfer function

2 ACTIVATION & FIRST START

Modular V works on computers equipped with Windows 7 or 8 and Mac OS X 10.7 or later. You can use the stand-alone version or use **Modular V** as an Audio Units, AAX, VST2 or VST3 instrument.



Register & Activate

Once the Modular V has been installed, the next step is to register the software.

The registration process will require you to enter the serial number and the unlock code you received with the product.

In order to proceed, go to this web page and follow the instructions:
<http://www.arturia.com/register>

Note: If you don't have an Arturia account yet, you will need to create one. The process is quick, but it does require that you can access your e-mail address during the registration process.

Once you have acquired an Arturia account you will be able to register the product.

3 QUICK START

This section of the manual will allow you to learn the general principles of how the Modular V works. This will be a presentation of the different views available, the modules and signals used while using the program for the first time. You will find a detailed and precise description of all of the modules and controllers visible on the screen in the following chapters.

The Sound Design chapter located in the second half of this manual is also recommended for users who have never used a modular system before, and who wish to learn the fundamentals of this domain.

1.4 **The 4 sections of the Modular V**

The Modular V is made up of four distinct sections:

- The first at the top holds a sequencer and a certain number of effects.
- The second, underneath, is for working on the sound synthesis with the different inter-connectable modules.
- The third is an extension allowing us to regroup the different external input-outputs and some internal cables.
- The fourth holds the virtual keyboard, as well as a section dedicated to the key follows and essential controllers.

It is possible to keep only the fourth section on the screen, by clicking on the Keyb icon on the toolbar.

When the whole synthesizer is displayed, we can move it vertically by using the icons that represent the different views or by clicking and dragging the background.



1.4.1 **The synthesis section**

Visible as soon as the synthesizer is opened, it is made up of two parts (cabinets). It integrates the 33 modules necessary for the creation of sounds. The modules in the upper part can be exchanged via the menu that appears when their name has been clicked. It is thus possible to replace an envelope with a ring modulator, a filter with a frequency translator.

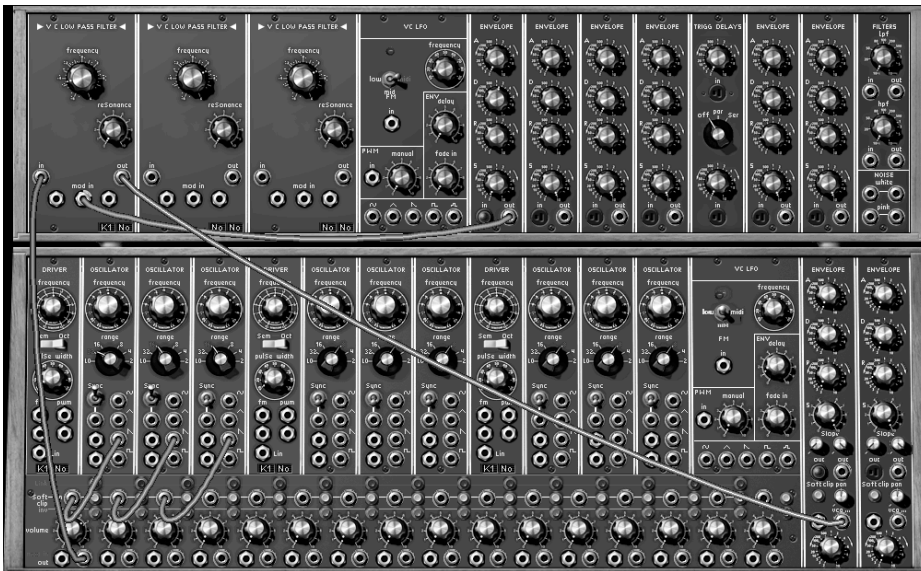

The first section composed of 2 cabinets

1.4.2 The other three sections

The first, situated at the top of the synthesizer, contains the step sequencer and 4 effects (the right hand effect can be either a chorus or phaser). The two others are found under the synthesis section. One is a small extension containing the internal cables, while the other holds the virtual keyboard and its assignable controllers.



The second section composed of a sequencer and effects



The virtual keyboard and extensions section

1.4.3 Reduced view of the keyboard and the real time controllers

You also have the possibility to only keep the keyboard and its assignable controllers visible on the screen. The goal is to have quick access to all of the important real time controllers and sound presets all while having a smaller work surface.



Reduced view of the keyboard

1.5 Using presets

Using presets is one of the main areas of evolution of the Modular V when compared to its predecessor, which did not save sound.

A preset contains all of the inter module connection information and the different controller settings needed to reproduce an identical sound.

To make you familiar with the different sounds contained in the Modular V, we will select the preset Bass1.

- ▶ For this, click on the button above the LCD screen indicating "C.Engel" (this screen presents the name of the bank currently being used). By clicking, you will see a scrolling menu appear which will indicate a list of the available banks. Choose the bank named "JM.Blanchet". Now click on the button above the second LCD screen presenting the word "Leads" (this screen indicates the name of the sub-bank currently being used). Choose "Basses". Do the same thing on the 3rd LCD screen and select "Bass1".

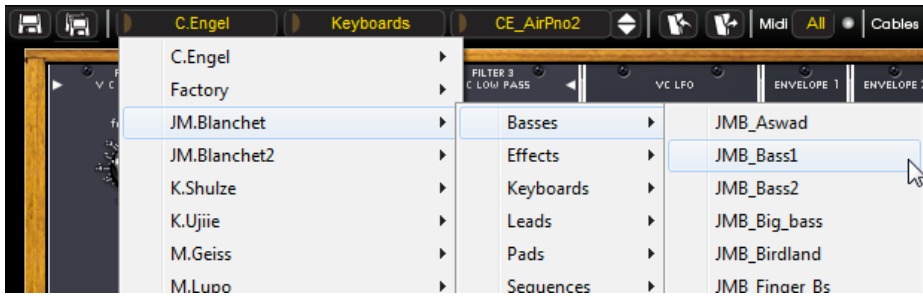

Select the preset bass1

⚠ The presets, located on the Modular V toolbar, are classed in "banks" and "sub-banks". Each bank contains a certain number of sub-banks, which determine in general a type of sound: sub-bank "basses", sub-bank "sound effects", etc. Each sub-bank contains a certain number of presets. The Modular V is supplied with 800 additional "factory" sound banks, which allow you to get acquainted with more sounds and sequences of the synthesizer. A bank called "User" offers a selection of presets allowing you to begin from a base configuration to start the programming of a sound (for example the sound "1 oscillator" comes with an oscillator pre-connected to the first filter – a low pass-, the signal then goes to VCA1).

- ▶ Now let's modify this preset. To do this, we will start with a simple manipulation. Modify the cut-off frequency of filter1, the first module on the top left of the synthesizer (a low-pass resonant filter). Turn the "frequency" button in the direction of the hands of a watch. The sound becomes increasingly "brilliant". Set this knob as it pleases you.



The setting of filter1 cut-off frequency

By performing this first setting, you have already modified the preset "Bass1". We will now save the sound that you have created.

- ▶ To save this newly created sound among the user presets, click on the Save icon in the toolbar: the sound setting being used will be saved in the currently selected preset.

If the current preset is a "factory" preset, the factory preset will not be replaced (the "save" icon will not be available). To choose another destination for this sound, click on the "Save as" icon and choose the location. Select, for example, "new" in the choice of banks ("bank"). 2 new bank and sub bank ("Sub bank") locations and a new preset are created the names "default0", "default0" and "default0" will appear in their respective displays (if other default names exist, then the number is incremented). Click on each one to modify the name of the 3.



Saving a preset

1.6 **Modular synthesizer**

The modular synthesizer cabinet contains 28 modules, which will help you to create an infinite variety of sounds. These 28 modules can be broken down into different categories and will be connected by cables.

1.6.1 **First connections**

Let's see how to quickly create an evolving polyphonic sound:

- ▶ To correctly understand the programming of the Modular V, select the "Blank_ synth" preset in the "User" / "Blank" bank. It holds no connections and thus produces no sound.
- ▶ Take the "saw" output of oscillator2 and connect it to the audio input of filter1 (low-pass 24 dB). To do this click on the output jack of the waveform (a cable will appear) and drag it to the filter1 input "in". Once the cable has been released in the input jack, the connection has been made.



Connection between oscillator 1 and filter 1

⚠ You can also create a connection by choosing the cable destination with a menu with a right click (or shift click) on the output jack.
To delete a cable, click on it, it will then appear in a clearer color to show that it is selected. Press the "DEL" key on the keyboard to remove the connection.

- ▶ Now connect the audio output of this filter to the VCA1 (voltage controlled amplifier) audio input. Once the connection has been made, you can "play the sound" on your MIDI keyboard or the virtual keyboard offered by the Modular V.

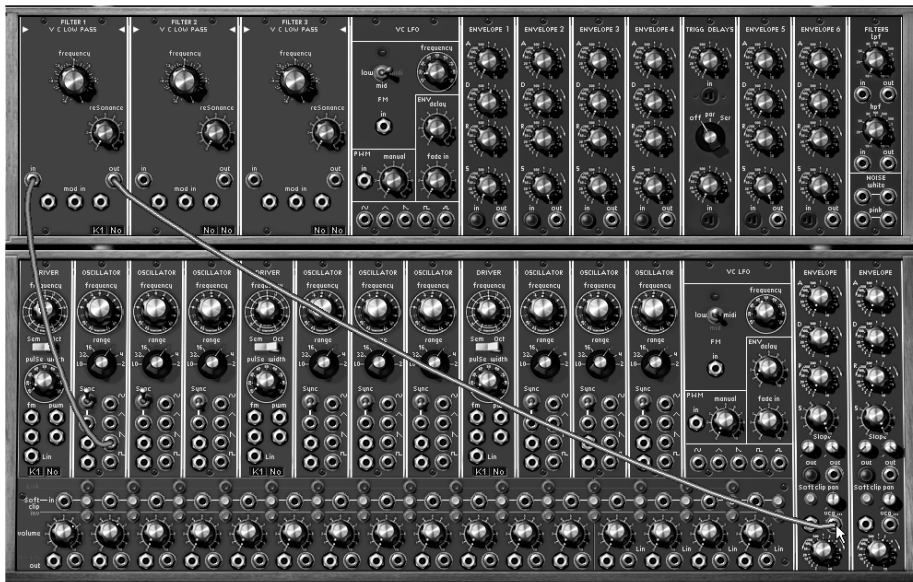

Connection of the filter1 audio output to the VCA1 audio input

Once you have obtained a basic sound, you can add elements to enrich the sound.

- ▶ Take the "saw" output of oscillator2 and connect it to the audio input of filter2.



Connection between oscillator 2 and filter 2

- ▶ Next connect the audio output of this filter to the VCA2 audio input.



Connection of the VCA2 audio input

- ▶ Slightly detune the pitch of the second oscillator by turning the "frequency" button. You will obtain a sound that is more "alive" and "thick".



Detune the pitch of the second oscillator

- ▶ Continue to complete the sound with modifications acting on the 2 filters. For this, connect the "sin" output of LFO1 (placed next to the 3 filter modules) to one of the modulation inputs of filter1.



The LFO1 module

- ▶ Turn the jack ring (transformed to a knob after the cable connection) to change the level of modulation. If you turn to the right, the modulation will be positive, and if you turn to the left negative.



Turn the jack ring

⚠ On the original Modular, it was not possible to directly set the value of the modulation input signal. To do this we needed to go through controllable VCAs or dampening modules of which there were not very many. On the virtual synthesizer, it is possible to control the input modulation level (once the connections have been made) by turning the ring of the connected jack – this ring will “transform” virtually into a knob.

- ▶ You can repeat these operations with filter2 (you can use the audio outputs as many times as you like, one of the miracles of computers.)
- ▶ To obtain a different modulation to the one applied on filter1 (all while remaining synchronous), turn the jack ring of filter2 in the opposite direction of what you had previously done with filter1.
- ▶ Set the attack of the output VCA envelopes to 10 o’clock so that the sound will arrive progressively when you press keys on your MIDI keyboard.



The Attack (A) settings for the output VCS envelopes

- ▶ To finish, turn the panoramic knobs on the 2 output VCAs, the first to the left and the second to the right. You will obtain a very natural stereo without the use of external effects.
- ▶ Don’t forget to save your preset in a bank to your name and a sub-bank with the name “Pads”. Then, enter the preset name “Stereo_Pad”.

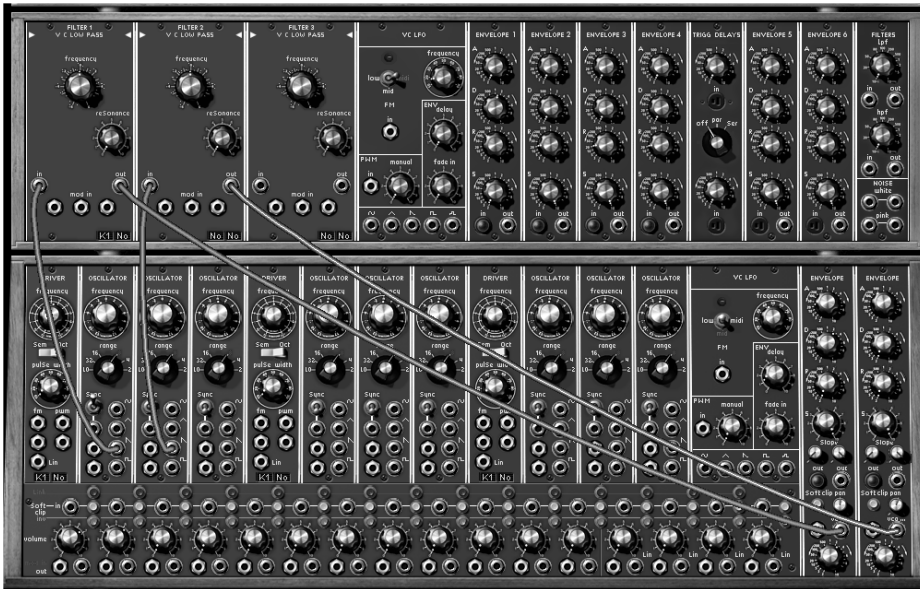

The final patch

1.6.2 Description of the synthesis section modules

1.6.2.1 The oscillators

They are 9 in total, regrouped in threes like the original modular system: 1 "Driver" oscillator: allow the management of the frequency and impulse width of the 3 "slave" oscillators. These 3 "slave" oscillators can be tuned and modulated separately. They deliver 4 waveforms that can be simultaneously used.



An oscillator bank: 1 "driver" and 3 "slave oscillators"

1.6.2.2 The white and pink noise generator

To the oscillators previously described we add a white or pink noise generator. It is accessible in the form of 4 outputs. This mode also has two 6 dB/oct. filters: a low-pass (LPF) and a high-pass (HPF). With these, you can, for example, change the nature of the noise to make it more or less brilliant



White and pink noise generator

1.6.2.3 The filters

The Modular V possesses 3 filters. Each of these filters can be chosen between 4 types:

- Low pass 24 dB/octave (type 904A)
- High pass 24 dB/octave (type 904B)
- Band pass and band reject 24 dB/octave (type 904C)
- Multi-modes 12 dB/octave (low-pass, high-pass, band pass, band reject, bell, shelf).

The type change is done by clicking on the title of the filter type and by selecting the desired filter in the proposed menu.



The 4 filter types

1.6.2.4 The auxiliary ADSR modulation envelopes

They are 6 in total, allowing the evolution of the sound in time.



The auxiliary envelope

1.6.2.5 The dual trigger delay

A module with two trigger delays allows the management of the signals used to trigger envelopes and sequencer.



The trigger delays

1.6.2.6 The LFOs

Two low frequency oscillator modules ("Low Frequency Oscillator") are used to create a cyclic modulation on one (or several) sound setting.

⚠ The "slave" oscillators can also be used as LFOs when they are brought to low frequency positions when they are switched in low frequencies ("low freq"). This gives a total availability of 11 LFO modules.



The LFO module

1.6.2.7 The VCAs

There are two output amplifiers (VCA), each with an individual envelope. We can imagine placing a VCA on the right and one on the left to create a stereo effect.



An output VCA

1.6.2.8 Mixers and amplifiers

16 independent amplifiers are at your disposal. Each has its own volume setting with the rotating "level" button and amplitude modulation input.

These amplifiers can be regrouped to create mixers. To regroup two amplifiers simply click on the "link" button that separates them.

When two amplifiers are regrouped, the output signal of the first corresponds to the sum of the output signals of the two amplifiers, while the second remains as it was before the regrouping.



The mixer VCAs

1.7 The other sections

1.7.1 The sequencer

This module conforms to the original model while simplifying the programming with internal connections.

It is with this module that you can create melodic sequences or sequences applied to a parameter (a sequence line applied to the opening of the frequency can, for example, be very efficient).

⚠ The sequencer has 3 sections:

Low frequency oscillator controls the timing of passage from one sequence to another. Its speed can be set statically with the "frequency" button and dynamically with the modulation input on the first page. Two buttons, "on" and "off" respectively start and stop this generator.

Eight-step sequence manager. Each step defines 3 levels of output modulations, using 3 knobs. The manager moves from one step to another on each pulse from the low frequency generator. The 3 rows of sequence can also be chained to create a longer sequence (up to 24 steps)

The output controller allows the management of the 4 modulation outputs for the current step. The first 3 outputs take their values from the rotating buttons of the current step (on the corresponding line), eventually with a configurable smoothing through the "smooth" buttons. The fourth output, for which the smoothing can also be set through the "smooth" button, is managed in the following manner. It takes the value from one of the 3 outputs in function with the current step and the type of progression specified with the "Chain" selector: This allows the linking sequences to create variations. For example to link lines 1, 2 and 3 to obtain a 24 step on the same controller.

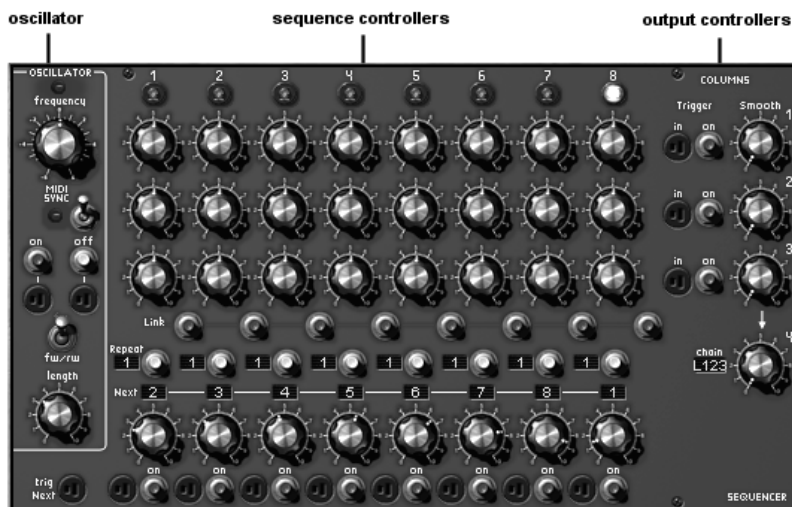

The sequencer sections

To create an 8-step note sequence from the sound you have previously edited ("bass1"):

- ▶ Assign "Driver" oscillators to one of the 4 sequence lines. For this, on the sequencer screen click a few times on the corresponding LCD display on the bottom of the "Driver", (on the right) to select the sequence line :L1, 2, 3 or 4.



Validation of a sequence line on the "Driver" oscillator

- ▶ On the 2 VCAs, click on the "trigg out" plug to apply a "trigg", corresponding to the sequencer output ("Sequencer trigger"), so that it can be taken into account and freely react, without the help of a keyboard trigger. The sequencer will work on its own when you start it.

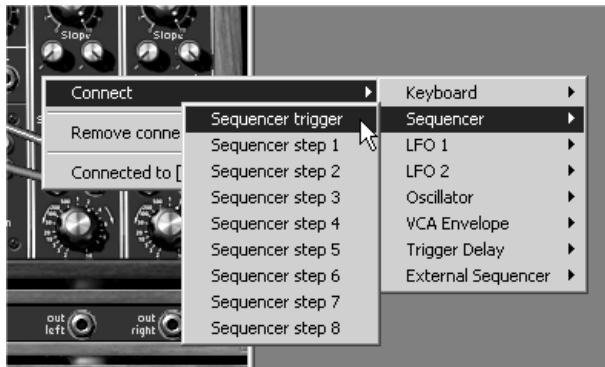

Apply a sequencer output to the VCA (here VCA2)

- ▶ Now go to the second screen and click on the "On" button situated in the "Oscillator" of the sequencer. This will play the sequence in a loop.



Click on "on" to start the sequencer

- ▶ Set the pitch of each note in turning the knobs of the sequence row applied to the Driver oscillator.



Setting of the values corresponding to the pitch of the oscillators

- ▶ Also set the length of the notes with the "length" knob



Set the length of each note

- ▶ You can add a little portamento by turning the "smooth" knob on the right of the line corresponding to your sequence.



Turning the "smooth" knob

- ▶ It is also very easy to rhythmically enrich the sequence by linking ("link" button) or repeating certain notes (select the number of repetitions by clicking several times in the LCD display beside the "repeat" button and click on the latter to confirm the repetition of the notes)



Click on the "repeat" button

- ▶ If you wish to add more steps to your sequence, 16 for example, select "L4" in the LCD display below the oscillator "Driver" of the sequencer. Now select "L12" in the LCD display on the right of the sequencer ("chain"). To have 24 steps, select "L123".



To have 24 steps, select "L123"

1.7.2 The effects

The second section also has three effects, which will allow you to bring more color and space to your sound or sequence.

These are on the right of the sequencer; the chorus can be replaced by a phaser.



The 3 effect modules

- **Resonant filter bank** (Fixed Filter bank): affects equalization to the outgoing signal coming from the 2 output amplifiers in function with the state of the interrupters "VCA1" and "VCA2". This equalization is done with the help of resonant filters with 12 band-pass filters; each of the bands has a level (positive or negative) and bandwidth setting. This module also possesses a low-pass filter (80 Hz) and a fixed high-pass (12 kHz).
- **Chorus**: the chorus module allows a frequency modulation where the rapidity can be set with the rotating "rate" button, the amplitude with the rotating "amount" button, and the width by the rotating "delay" button.
- **Stereo delay** (Dual Delay): allows the repetition of the incoming signal independently for the left and right, which explains the presence of 2 control columns, one for each side.

1.7.2.1 *The fixed filter bank*



The fixed filter bank

- ▶ To add a complex filtering with the fixed filter bank, start by activating the 2 switches "VCA1" and "VCA2". This will connect the effect to the two VCA outputs.
- ▶ Modify the filter frequency bands by turning the gain knobs. This will increase (to the right) or reduce (to the left) the gain corresponding to these frequencies.



Increase the gain of the chosen frequency

- ▶ You can refine the equalization with the bandwidth knob corresponding to the frequency you have chosen. If you turn the knob (underneath the frequency gain setting) to the right, you will reduce the bandwidth around the central frequency to make the equalization setting increasingly precise. On the other hand, by turning it to the left, you will increase the bandwidth, making the equalization less precise.



Set the frequency band width

- ▶ If you have applied several strong equalizations, (with very pronounced band reductions for example) you run the risk of having a consequential decrease in volume. To regain a normal volume level, turn the "gain" knob (on the bottom right of the filter bank) towards the right. Watch out for saturation.



Filter bank output gain

⚠ Thanks to MIDI, it is possible to record frequency gain and band width knob movement (with the MIDI sequencer). This will make the sound "speak" or evolve in a manner that synthesizer filters cannot. Try it for yourself.

1.7.2.2 The "Dual delay"

You can also enrich your sound and give it more stereo space; for this, add stereo delay.



The delay effect

As is the case for all of the Modular V effects, the Dual Delay works in “real” stereo in the sense that it possesses an independent input and output for both sides.

- ▶ To activate the delay effect, begin by triggering the 2 “VCA1” and “VCA2” switches. This will commute the action of the effect to the 2 audio outputs of the sequencer.

⚠ *It is also possible to keep a part of the sound effect free by deactivating one of the two VCA switches. This can be very interesting when using the synthesizer for multiple tones (for example, a bass sound played on the keyboard coming out to the VCA1 which is set without effect and an arpeggio sound played by the sequencer which will be directed to the VCA2 where the effects will be activated)*

- ▶ On the delay, set the time between repetitions (“time” buttons) for each side of the stereo (“L” left and “R” Right)

If you wish to get a stereo echo, apply a different setting for the repetition of the left and right. So that the delay is synchronous, activate the “Sync” switch at the top of the module.



Set the time between repetitions

- ▶ To control the repetitions reinsertion intensity, increase or decrease the value on the 2 “feedbacks”. Do the same thing for the “crossed” repetitions (one on the left and one on the right “Cross feedback” buttons).



The "feedback" settings

- ▶ Now, set the balance between the sound without effect ("dry" knob) and the delay return ("wet" knob).



The "dry" and "wet" settings

1.7.2.3 The chorus

Chorus is used to create a doubling effect on a sound; this will give it more width and "thickness". If you accentuate the effect intensity, you will obtain a very discordant sound.



The chorus effect

- ▶ Like the other effects, activate the VCA1 and VCA2 switches to commute the action of the effect to the 2 audio outputs of the synthesizer.

- ▶ To correctly hear the different modulation depths, simply increase the value of the “amount” knob. The higher the value, the more discordant the sound.



The “amount” parameter

- ▶ Set the modulation rate by turning the “rate” knob. The faster the speed, the quicker the detuning.
- ▶ You can also widen the stereo action field by increasing the value of the “stereo width” knob.

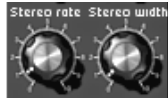

The stereo settings

⚠ With chorus, it is also possible to obtain the stereo sweeping of the sound by decreasing the “amount” knob and working only on the value of the “stereo width” (depth) and “stereo rate” (oscillation speed) knobs. This will create an “auto pan” effect. The effect will be even more present if you lower the level of the signal without effect (“Dry”), leaving only the effect return (“wet”).

1.8 the virtual keyboard and its real time controllers

A virtual keyboard is used to control the synthesizer notes and add supplementary real time modulation settings. It can either be coupled with the sequencer section and the effects or used alone to save space.

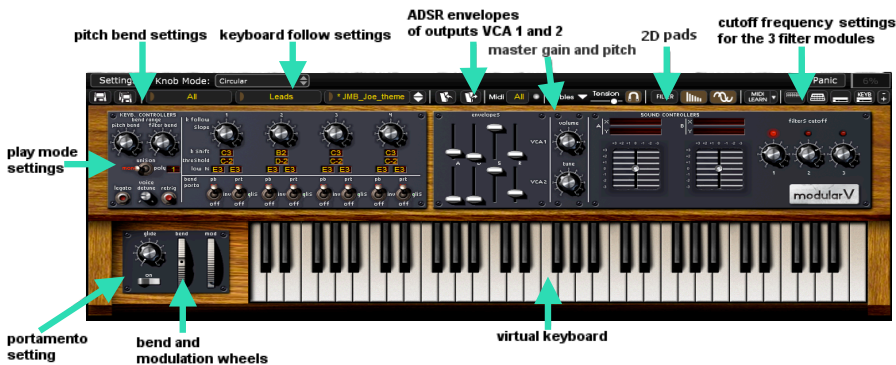

The keyboard and its controllers

1.8.1 The keyboard

The virtual keyboard situated on the bottom of the second screen, allows the quick testing of the sounds of the presets, or the sound that you are editing, and this without the need for an external MIDI keyboard.

The pitch bend and modulation dials are also available for height (affected to the oscillator or filters) and modulation settings (affected to any of the synthesizers modulation sources). The connections are made by cables on the first screen.

1.8.2 The keyboard controllers

The different settings concerning the real time controllers affected to the keyboard can be found on the left, above the virtual keyboard.

Here you will find all of the settings applied to the 4 key followers, the pitch bend and modulation wheels, as well as velocity and aftertouch.

- ▶ Before using them, go back to the module section to define the parameters, which will be modulated by these controllers. The connection jacks are found underneath the modular synthesizer section.



The controller connection jacks

- ▶ For this example, let's take the "stereo_pad" sound created earlier. Connect the output of the modulation dial "mod" (at the bottom of this section) to the filter1 cut-off frequency modulation input. Set the amount parameter of this modulation to your liking so that it can be taken into account by the wheel. Now test by turning the dial on your MIDI keyboard or the virtual keyboard.



Connections for modulation and velocity outputs on the frequency modulation of filters 1 and 2

- ▶ Now do the same thing, connecting the velocity output ("vel") to the filter2 cut-off frequency modulation input. To test velocity settings, use your MIDI keyboard, the virtual keyboard naturally is not sensitive to velocity.

4 independent key follows: apply a continuous change of a modulation parameter in relation to the scale of the keyboard (tune the oscillators for example).

The pitch bend and modulation dials: add a modulation to the parameter(s) connected to its source.

The portamento ("Glide"): adds a frequency smoothing (portamento) between 2 notes.

The velocity: adds a modulation to the parameters, which are affected by the force with which the key is played on the MIDI keyboard.

Aftertouch: adds a modulation to the parameters connected to its source by a variation in the force used on the keys of the MIDI keyboard.

You can continue the experience with one of the four key follow outputs. There are two means of connecting a key follow modulation:

- The simplest and fastest is the automatic connection through the LCD displays situated on the "drivers" oscillators and on the 3 filters. This method produces a perfect pitch for all the scale of the keyboard.
- A cable connection gives you the possibility to have finer but more complex settings. We recommend this type of modulation for non "tuned" parameters, like an impulse width modulation ("PWM") on the "driver" oscillators, or simply the volume of a VCA.



The key follow settings

1.8.3 The play modes

The play modes provide a choice between the different manners of playing the MIDI keyboard. These different settings are situated underneath the pitch bend settings.



The play mode parameters

- ▶ The "mono/unison/poly" switch lets you choose: a monophonic playing mode (a single note played at a time, chords cannot be produced in this mode. This mode corresponds to the mode used in the original Modular), a polyphonic mode (several notes can be played at the same time to form a chord). The maximum number of voices is displayed in the corresponding window. The unison mode is identical to the monophonic, but there are as many voices played at the same time as the polyphonic voices.
- ▶ The "legato" button, active when the synthesizer is in monophonic mode, allows the activation of the portamento – or "glide" in English – freely on all of the notes when it is active. If you wish to only use portamento on notes that are linked, deactivate the legato mode.

▶ The “retrig” button, also active when the synthesizer is in monophonic mode, allows the systematic re-triggering of the envelopes, even if you link the notes in your playing sequence. If, on the other hand, you don’t wish to re-trigger the envelopes when 2 notes are linked, leave the button raised.

▶ When the synthesizer is in polyphonic mode, 1 LCD display on the right of the switch allows the setting of the maximum number of notes that can be played simultaneously (“poly” screen). This setting can limit the CPU load provoked by each simultaneous note played on your MIDI keyboard or sequencer.

▶ To activate the portamento mode, click on the “ON” button under the portamento intensity knob (“glide”), situated next to the 2 dials, on the right of the virtual keyboard.



The portamento settings

1.8.4 The sound design controllers

Three control surfaces allow the modulation of the sound parameters in a fast and intuitive manner:

- Eight sliders that allow control of the envelopes of the output VCA 1 and 2
- Two 2D controllers that can be assigned to the parameters of your choice
- Three knobs for the setting of cut-off frequency off the 3 filters.

1.8.4.1 The envelope control sliders

The two envelopes are directly linked to those of the VCAs: if you modify one of the parameters (Attack, Decay, Sustain or Release – the 2 slope parameters are not represented here for simplicity), the modification will automatically and identically be taken to the synthesizer. The opposite is also true.

1.8.4.2 The 2D Pads

Now try to use one of the 2D controllers to modulate the cut-off frequency (to X) and the resonance of filter1 (to Y).

▶ For this, go back to the first screen to assign the 2 parameters to the 2D controller #1 outputs. The output connections can be found at the bottom of the synthesizer section (2D pad X /Y).

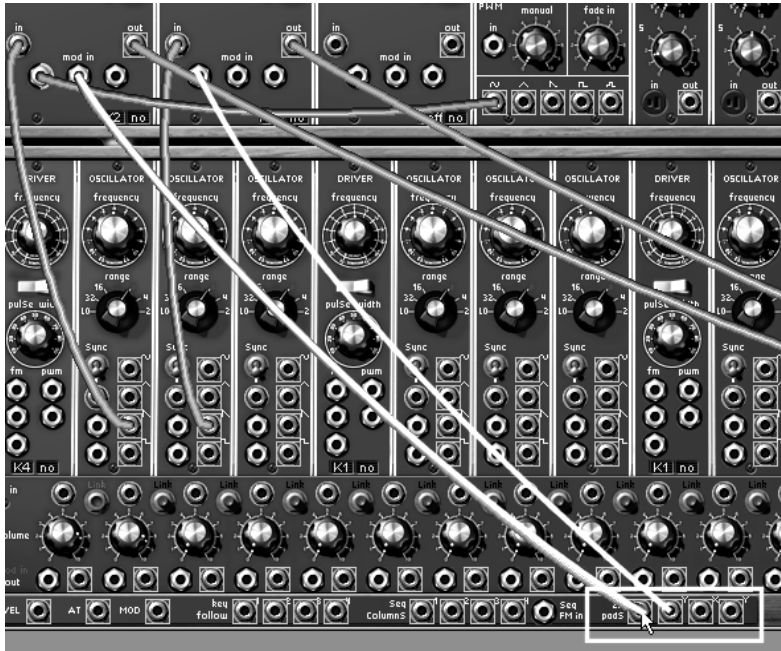

The connection of modulation inputs of filter 1 to the 2D controller

- ▶ Return to the second screen and manipulate the 2D controller handle vertically (X) or horizontally (Y) to hear the result of the modulation.

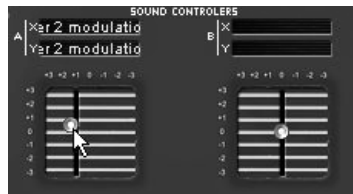

Using the 2D controller

⚠ To have access to these 2 modulation inputs on a low-pass resonant, it is essential to change the filter type (the low-pass 24dB does not possess a modulation input in the resonance.) Take the multimode filter and set it to low-pass mode, if it isn't already the case.

1.8.4.3 The filter cutoff frequency controller

On the right of the 2D Pads you will find controls for the cutoff of the 3 filters modules. These will only be active if the filters are used in the current sound (a diode above each knob indicates if it is active)

In our ("Stereo pad") example the first two filters are used, you will notice that the first 2 knobs are active.

Simply try to change the settings and you will immediately hear the result on your sound.

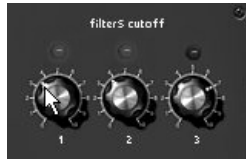

The three filter cutoff frequency controllers

This chapter has given you a look at some of the many aspects of the Modular V. Now try to go a little deeper using the rest of the documentation. You will find all of the details concerning the modules, the sequencer and the many different modes of use of the Modular V.

4 THE INTERFACE

1.9 Using the presets

The presets memorize the Modular V sounds. A preset contains all of the inter module connections and the different controller information necessary for the recreation of an identical sound. In the Modular V, presets are classed in "banks" and "sub-banks". Each bank contains a certain number of sub-banks, which determine a type of sound: sub-bank "basses", sub-bank "sound effects", etc. Each sub-bank contains a certain number of presets.

The Modular V comes with several "factory" sound banks. It is possible to create new "user" sound banks, each containing an unfixed number of sub-banks and presets. For security, the "factory" settings are not directly modifiable. It is, however, possible to modify a sound on the base of a factory preset and to record it to a "user" bank.

1.9.1 Choice of bank, sub-bank, preset

The banks, sub-banks and presets being currently used are always displayed in the synthesizer toolbar.

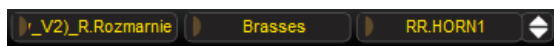

Display of bank, sub-bank, and preset being used

To choose a preset in the current sub-bank, click on the button on the left of the current preset, a drop-down menu appears with a list of presets from the same sub-bank. You can choose another preset in the menu by selecting the corresponding line. Once the preset has been chosen, you can play the new sound from your MIDI keyboard or sequencer.

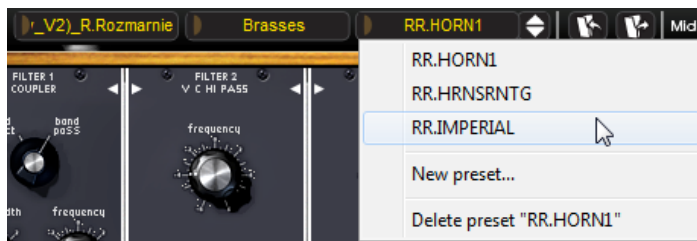

Choice of preset in the same sub-bank

To choose a preset in the same main bank, but in a different sub-bank, click on the button on the left of the current sub-bank, a drop-down menu will appear with the list of sub-banks contained in the same main bank. Each sub-bank in the menu allows you to open a sub-menu containing its presets. A click on a preset lets you directly choose a preset in the new sub-bank.

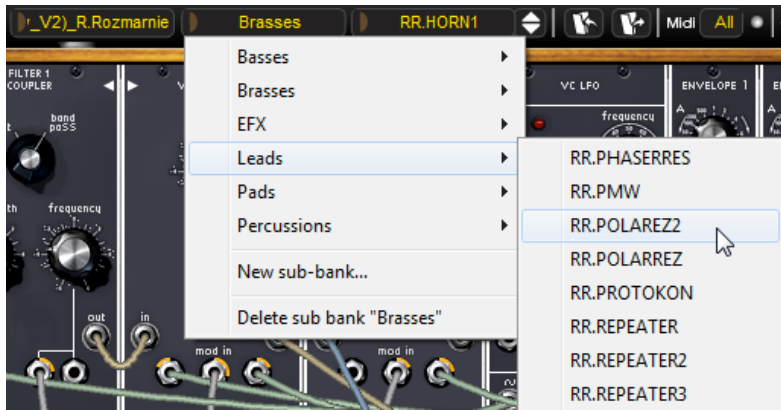

Choice of preset in another sub-bank

To choose a preset in another main bank, click on the button on the left of the name of the current bank. A drop-down menu appears with the choice of the main banks that are available, and the sub-lists corresponding to the sub-banks defined in each main bank and the presets contained in each sub-bank. You can now freely choose a preset by clicking on its name.

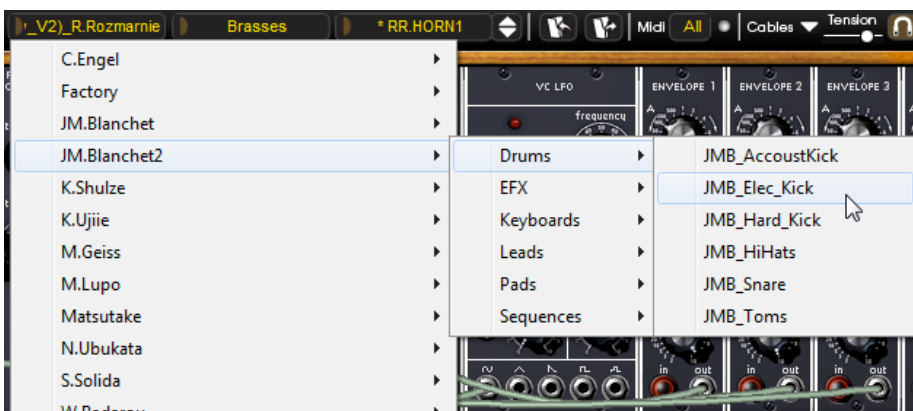

Choice of a preset in another main bank

Once a preset has been changed (modification of a controller or connection), an asterisk appears next to its name in the tool bar.

1.9.2 Creation of a bank, sub-bank, preset

To create a new bank of sounds, click on the button on the left of the current bank. In the drop-down menu, select "New bank..." to create a new bank of sounds. You can then change the name of this bank by clicking on its name in the toolbar and typing the new name.

To create a new sub-bank, again just click on the button on the left of the current sub-bank, and select "New sub bank...". You can also change the name of the new sub-bank.

Finally, to create a new preset, click on the button on the left of the name of the current preset and select "New preset...". The new preset is created using the current Modular V settings (controllers and connections). You can then work on the settings of the sound, and save it by clicking on the save button (see the next paragraph). You can also change the new preset name by clicking on its name.

1.9.3 Saving a user preset

To save your current settings under the current preset, click on the “Save” button on the Modular V toolbar.



“Save” button on the toolbar

If you want to save your preset under a different preset name, click on the “Save As” button in the toolbar. A drop-down menu will appear allowing the choice of either an existing preset (in this case, the preset contents will be replaced by the current setting), or to save your preset as a new preset (in this case, click on “New Preset...” in the sub-bank of your choice).

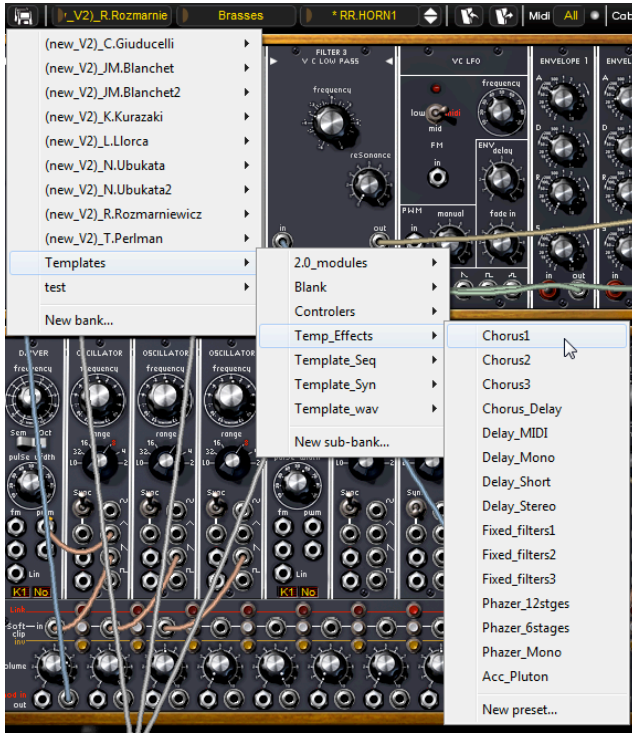

“Save As” menu on the toolbar

When you are working on a factory preset, which cannot be erased, clicking on the “Save” button will not replace the current factory setting, but will automatically open the “Save As” function to save the current setting as a user preset.

1.9.4 Import / Export of a preset bank

It is possible to import new preset banks created for the Modular V. To import a new bank of presets, click on the preset bank import button in the toolbar:



Preset bank import button on the toolbar

When you click on this button, a dialog appears allowing the choice of Modular V preset bank files (*.amb). Choose the file that you want to import, and click on "Open". The new preset bank will automatically appear in the available banks.

The Modular V also offers the option to export your own sound banks to save them, use them on another machine, or share them with other users. It is possible to export a preset, a sub-bank, or a complete bank. To export a bank, sub-bank, or current preset, click on the export preset bank button on the toolbar:



Current preset bank export button in the toolbar

Select the type of export that you wish to perform (bank, sub-bank or preset) from the list and a window will appear prompting you to choose a destination folder and a name for the file you are about to export.

1.10 Work pages

The Modular V offers 2 work pages. The first contains the 4 Modular V sections, and the second holds the keyboard and shortcuts to the main controls.

1.10.1 The complete view



Complete view

The complete view contains all of the Modular V sections. The full interface being too big to be displayed on a single screen, a scroll function allows you to move to the desired section. Simply click on the background of the synthesizer and drag the mouse up and down to move it.



The '+' and '-' buttons in the toolbar let you make the plug-in window bigger or smaller so as to adapt to your screen and resolution. The size will automatically be saved as a plug-in preference, and will be reused upon next launch.

1.10.2 The reduced usage page

The last shortcut button on the toolbar will take you to the reduced view.

The reduced usage page contains the keyboard and the main controls. In this mode, the Modular V is ready for immediate use of the presets of recorded sounds, with quick access to all of the major real-time controllers. The Modular V window is smaller, but the sequencer and effects cannot be directly accessed.



Reduced usage page of the Modular V

1.11 Using controllers

1.11.1 Knobs

The knobs are the most numerous controllers of your Modular V. They can be controlled in different manners, which are explained in detail underneath:

1.11.1.1 Mouse control (linear)

Certain sequencers allow the knob mode of functioning to be changed with the mouse by moving to linear mode. In linear mode, the knob can be set only by moving the mouse vertically, without going around it. The linear mode can sometimes be simpler to use than the rotation mode. It can, at the same time, be less precise (the precision is limited by the number of vertical pixels contained in the screen on which the mouse movements are being evaluated). The linear mode can be accessed in the sequencer options. In Cubase™, for example, the choice can be accessed through the "Edit/Preferences" menu, and can be found in the "General" tab in the dialog window.

1.11.1.2 Mouse control (higher linear precision)

The Modular V allows access to a higher level of precision when adjusting the knobs with the mouse, with the use of the right click (or [Shift]+click). In this mode, the precision of movement is multiplied by 4 in relation to the normal linear mode. This mode can be accessed no matter which mode has been chosen on the sequencer (circular or linear).

1.11.1.3 Mouse control (circular)

Click on the knob and turn in a circle around it to change the value of the controller. The rotation mode gives a higher level of precision in the manipulation of controls: the farther the mouse goes from the knob, the higher the precision of the setting.

1.11.2 Joysticks

The usage page of the Modular V offers two 2 dimensional control joysticks. The outputs can be used as a source of modulation for all of the synthesizer's modules. The utility of these joysticks is that they simultaneously give control of two parameters to the mouse, with great ease. The 2 joystick outputs are visible in the conception page:

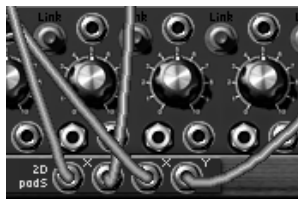

The control joystick outputs are available in the conception page

When the joysticks are connected, the names of the concerned modulation inputs appear in the digital displays above the joysticks.

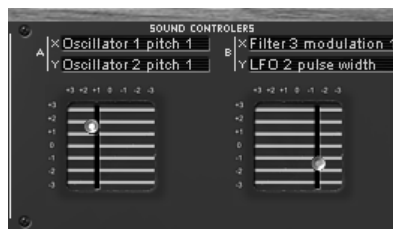

The names of the connected modulation inputs appear above the joysticks

1.11.3 Selectors

The Modular V presents selectors of several types:

- **The "switch" type selectors:** simply click on these selectors to change their state.



"Switch" type selectors

- **Rotating selectors:** used like knobs (by click and drag with the mouse)



Rotating selectors

- **The digital displays:** They are notably used in the sequencer. We can manipulate by click and drag (like the knobs), or by a simple click: a left click increments the value, while a right click ([Shift]+click for Mac) decrements the value.



Digital displays

1.11.4 Keyboard

The keyboard lets us listen to the synthesizer sounds without having to use an external master MIDI keyboard, and without programming a melody in the sequencer. Simply click on a key to hear the corresponding sound. The keyboard also has a modulation wheel and a pitch-bend wheel, which can be moved with the mouse.

1.11.5 MIDI control

Most of the knobs, sliders and switches on the Modular V can be manipulated with external MIDI controllers. Before anything else, make sure that the MIDI device that you wish to use is correctly connected to the computer, and that the sequencer or the Modular V application is correctly configured to receive MIDI events coming from the device.

1.11.5.1 Learn menu

A new button and menu have been introduced in Modular V 2.6.1. The button and menu provides access to MIDI assign functionalities.

The left part of the button activates the MIDI learn mode, while the right part (small down arrow) opens the control management menu.

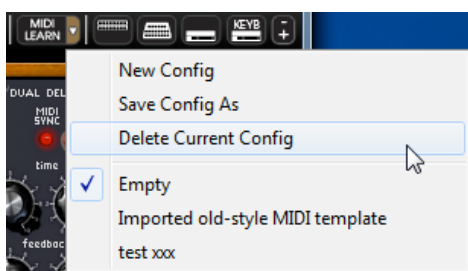

“Learn” Menu



“Learn Mode” Button

The “Learn” Menu is composed of 2 sections:

- First section provides
 - “New Config” creates a new control set

GLEN DARCEY 7/11/2011 18:32
Deleted: se
GLEN DARCEY 7/11/2011 18:31
Deleted: ation

- “Save Config As” saves current configuration to a new one
- “Delete Current Config” removes current configuration from list
- The second section contains the list of existing configurations
 - The **checked** one is the **currently selected MIDI map**,
 - Click on a configuration to load it

GLEN DARCEY 7/11/2011 18:36
 Deleted: ti
 GLEN DARCEY 7/11/2011 18:36
 Deleted: one

1.11.5.2 Assigning MIDI controls

In order to start assigning MIDI controls, click the “Midi Learn” button (left part). The button remains highlighted to indicate that the “learn mode” is ON.

Click on a controller of the GUI to open the MIDI assignment popup.

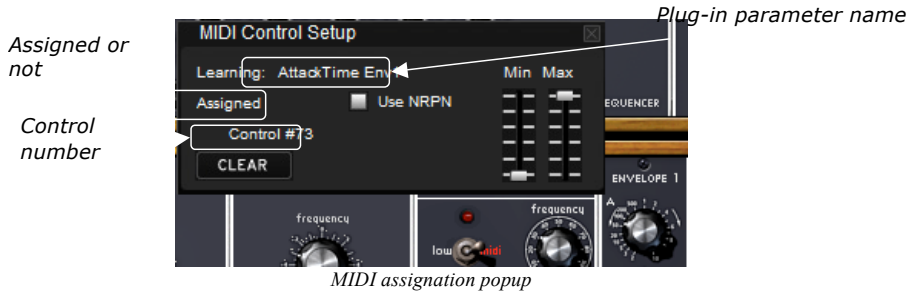

GLEN DARCEY 7/11/2011 18:37
 Deleted: ation

- Learn assignment

The **fastest** and easiest way to assign a control is to move **the fader, knob or button** for it to be recognized by Modular V.

GLEN DARCEY 7/11/2011 18:37
 Deleted: ation

- Manual assignment

It is also possible to change the assigned MIDI control number by clicking on Control#xx and select another value.

GLEN DARCEY 7/11/2011 18:37
 Deleted: irst

- Support for NRPN

In addition to MIDI Control Change messages, NRPNs are supported: either send NRPN MIDI control messages to Modular V, or check NRPN, then select LSB# and MSB# numbers:

GLEN DARCEY 7/11/2011 18:38
 Deleted: it

GLEN DARCEY 7/11/2011 18:38
 Deleted: ation

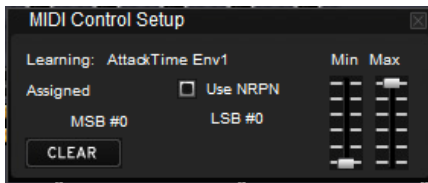

MIDI assignment popup, NRPN activated

- Remove assignment

Assignments can be removed by clicking the “Clear” button. The message “Unassigned” will then be displayed.

GLEN DARCEY 7/11/2011 18:38
 Deleted: nation

GLEN DARCEY 7/11/2011 18:40
 Deleted: ations

Continue selecting the parameters you want to map to create a complete configuration.

GLEN DARCEY 7/11/2011 19:25
 Deleted: All these operations deal with a single plug-in parameter. In order to setup a complete configuration, a set of parameters should be configured.

1.11.5.3 Manage configurations

New in Modular V 2.6: the possibility to maintain multiple configurations.

- Default configuration

By default, Modular V loads [the](#) configuration for Arturia Analog Experience keyboards.

- Select one configuration

A configuration is loaded by clicking the corresponding entry in bottom part of "Learn menu".

- Create a new configuration

A new configuration can be created by clicking on the "Learn menu", "New Config" entry. [This will open a popup](#); enter the name [you want to call](#) your configuration [and click on the "SAVE" button](#). A new entry for your configuration now exists in the list of available configurations.

You may now fill in this initially empty configuration by performing [the assignment](#) operations described in the previous section.

- Copy a configuration

It is possible to copy a configuration by loading it and then clicking on "Save Config As".

A popup opens: enter the name of your configuration. A new entry for your configuration now exists in the list of available configurations.

- Remove a configuration

It is possible to remove a configuration by [first](#) loading it and then clicking on "Delete Current Config".

1.11.5.4 Minimum and maximum [ranges](#)

For each [assignment](#), a minimum [range](#) value and a maximum [range](#) value can be set. [This allows you to limit how much the controller will affect the parameter on Modular V.](#)

- [The assigned parameter will have the configured minimum value when the controller will be at its lowest position](#)
- [The assigned parameter will only reach the configured maximum value when the controller will be at its highest position](#)
- You can invert (Negative Slope) [the](#) Min and Max so that parameter will have minimum value when control has the highest value, and parameter will have maximum value when control has the lowest value

$$\text{parameter_value} = \text{MIN} + (\text{MAX} - \text{MIN}) * \text{control_value}$$

1.11.5.5 Multiple assigned parameters

It is possible to assign [multiple parameters](#) [to](#) a single control. [This allows you to change many parameters with one fader or knob.](#)

- Activate "Learn" mode, select a parameter (GUI control)
- Tweak control to assign it (optionally setup minimum and maximum)
- Select a second parameter
- And tweak the same control
- Deactivate "Learn" mode

Tweaking assigned control should modify both parameters with regards to assignation setup (Min, Max).

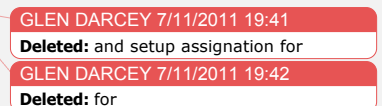
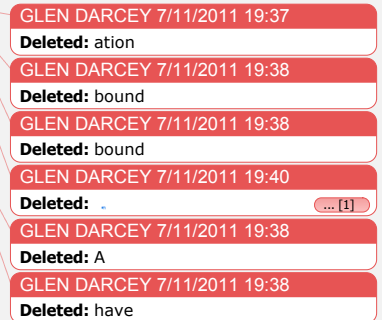
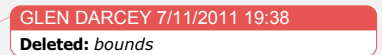

1.11.5.6 Tricks

- **The Oscillator 1 to 9 tune controls have** two parameters: FINE and COARSE tune. If "Learn" mode is ON, clicking on control provides access to the assignation of the FINE parameter, shift+clicking on control provides access to assignation of the COARSE parameter.

1.12 Using cables

The connection of different modules is the base work of creating a new patch. The Modular V owes its creative possibilities in no small part to the innumerable connections possible between modules. On the original system, all of the connections were made with cables of two types:

- ▶ Audio and modulation cables (which allow for example the connection of an oscillator sawtooth signal to a filter input).
- ▶ The trigger cables (which allow for example the connection of the keyboard to auxiliary envelopes). The trigger cables transport trigger information for envelopes or the sequencer for example.

In the Modular V, for ergonomics and graphical readability, only part of the connections is displayed on the screen in cable form. The other connections are made either by menus, or with digital displays on which we can click.

The different types of connections we can use on the Modular V are as follows:

Audio connections / modulation connections: these connections are made with cables that are visible on the screen.

Trigger connections: these connections are only done through menus.

Synchronization connections: these connections are only done through menus.

Key follow or sequencer connections: these connections are available and can be modified through visible digital displays on the filters and drivers modules.

1.12.1 Audio and modulation connections

The audio connections allow, for example, the routing of a sound to the VCA/mixers or to the inputs of different filters. The modulation connections allow, for example, routing of an LFO output or an envelope generator to an oscillator PWM or VCA modulation input. These audio and modulation signals are totally compatible, the only difference being that the audio signals are "audible" if you connect them directly to an output VCA, while the modulation signals are generally not audible (as the frequency is too low for the human ear). Modulation signals are thus generally used to program "slow" variations on certain synthesis parameters, like the cut-off frequency of a filter for example.

The audio output and input connectors, and the modulation output connectors are identical in the graphical interface:



Audio input or output connectors, or modulation output connectors

The modulation input connectors are graphically distinguished from the other connectors as they include an extra function: a modulation level setting, described later in this paragraph.



Modulation input connectors

To connect a module's output to the input of another module, click on the output and drag it to the target input while holding down the mouse button. When you are above the input, the connector lights up. In this case, you just need to release the mouse button to link a cable between the selected output and input.

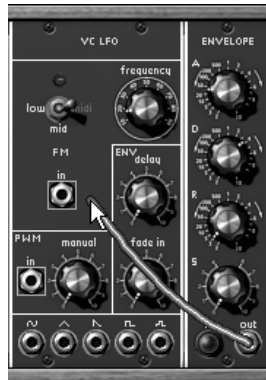

Creating a new cable and finding an appropriate input, by click and drag

Another means is to right click (or [Shift]+click for Mac) on the input or output of a module. In this case, a menu appears with a list of possible connection points for this output/input. It can happen that the input/output is already connected to certain modules, and in this case, the already selected connection points appear in the menu. Simply select one of the connection points in the "Connect to" menu to create a connection. It is also possible to delete all of the connections by choosing the "Remove connections" option or delete one of the connections by clicking on it in the menu.



Input/output connection menu appears after a right click (or [Shift]+click)

⚠ The module inputs can only be connected to one output connector. On the other hand, each output connector can be connected to any number of input connectors, which allows, for example, the use of the same modulation signal to modify several synthesis settings.

1.12.2 Modifying a connection

To disconnect the end of a cable at input connector level, and reconnect it to another input, click on the end of the cable concerned and hold down the mouse button. You can now drag the end of the cable to another input with the mouse and release the button.

To delete a connection, you can use the menu available with a right click (or [Shift]+click). Another method is to click on the cable to select it, upon which the cable will appear in a lighter color to show that it is selected, and press the "DEL" button on the keyboard to delete the connection.

⚠ You will have a lot of trouble clicking on a cable if the "Move away cables" option is active. In this mode, the cables will automatically flee the mouse pointer. To avoid this, deactivate this option before trying to select a cable (see 1.4.4.3)

1.12.3 Modulation level setting

As explained above, the modulation input connectors have an interesting feature: they allow the setting of a modulation level (from -100% to +100%) directly at connector level, and so without passing by a VCA which is normally needed to set the amplitude of the modulation signal. When the modulation input connector is connected, click on one of the edges of the nut and drag the mouse up or down to change the quantity of modulation.



Setting the modulation quantity

By using a right click (or [Shift]+click) instead of the left click, you will obtain a higher precision.

⚠ If you click on the center of a connector, you will select the cable end to change the connection. To access the modulation setting, make sure you click on the connector device (the nut). In the same manner, if you right click (or [Shift]+click) on the center of the connector, you will open the connection menu instead of accessing the modulation quantity setting.

1.12.4 Cable display options

1.12.4.1 Cable display filter

The Modular V displays the cables in several colors depending on their type. The cable type is determined in relation to the input to which it is connected. Here is the list of colors and the corresponding cable type:

- **Red cable** : audio cable coming from an oscillator.
- **Yellow cable** : audio cable coming from a filter.
- **Green cable** : modulation cable coming from an LFO or auxiliary envelope.

- **Blue cable** : cable coming from a VCA / Mixer.
- **White cable** : other cables.

The cable display filter allows the display of a section of existing cables in a given patch, depending on their type. The cable display filter is controlled by the buttons on the Modular V toolbar:

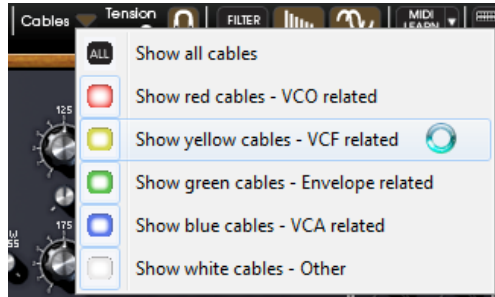

The cable display filter menu

When a button is selected (pressed), the cables of the corresponding color are displayed. If the "ALL" option is selected, all of the cables are visible despite the state of the color filters.

1.12.4.2 Cable tension

It is possible to set the Modular V cable "tension" by using the knob in the toolbar of the synthesizer. Modifying the cable tension can help you to discover a region on the synthesizer that had previously been hidden by cables, without using the cable display filter.



Setting cable tension

1.12.4.3 Spreading the cables

Visualizing the different cables existing between modules is very useful for the creation of a patch on the Modular V. At the same time, cables can sometimes hide access to useful settings on different modules. So that you are not bothered by this, it can be useful to activate the "Move away cables" mode. In this mode, the cables will automatically move when the mouse comes across them, leaving a clear path for the modification or visualization of a knob. Don't forget to deactivate this mode when you want to select a cable with the mouse to delete it.

1.12.5 Trigger connections

The trigger signals transport trigger information to the envelopes of the sequencer etc. Connecting the keyboard trigger output to an envelope, for example, allows the triggering of the envelope signal each time a key is pressed on the keyboard.

The only trigger connections visible on the screen are trigger inputs. The output connectors are not displayed, their presence is implicit. When we click on a trigger input, the following menu appears:



Trigger type input connection menu

This menu tells us to which module a trigger input is connected, and allows us to create a new connection or delete an existing one. When a trigger input is connected, its graphical aspect changes, and this tells us if a module is connected without checking the menu:



Trigger input disconnected – Trigger input connected

1.12.6 Synchronization connections

Synchronization connections are used to activate the synchronization of one of the nine oscillators available to another oscillator.



Synchronization input

The same as for the trigger connectors, here, only the input connectors are visible, the existence of outputs is implicit, and the connections can only be made through the menus:

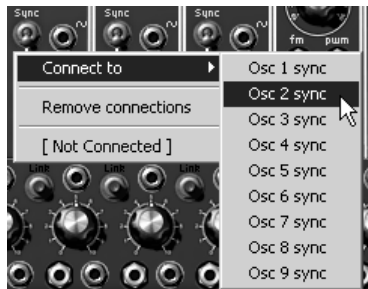

Synchronization input connection

1.12.7 Key follow or sequencer connections

The Modular V oscillators generate periodic signals in which the frequency varies in function with the note played on the keyboard. It is this difference in frequency, which allows us to recognize two different notes. To determine the ideal frequency related to a note played on the keyboard, the oscillator refers to a key follow. The function of the key follow is to convert a

key on the keyboard to a Hertz frequency value that can be used by the oscillator. The Modular V has four different key follows. The default setting for each key follow is that of the Western tempered (scale of twelve equal semi-tones). It is possible to set the key follows differently to create other types of scales (scale of quarter tones, tones, etc.). The key follows can be edited in the keyboard page of the synthesizer. At the level of each driver module and each filter, a digital display allows the selection of one of the four available key follows, by a simple click, as well as one of the 4 sequencer follows.

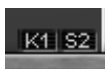

Key follow digital display on a driver module or filter module

The sequencer follow allows the easy creation of melodies with the sequencer, staying in the tempered intervals (semi-tones), which is more practical than using a sequencer output as a continuous oscillator pitch modulation, often difficult to tune.

The following table explains the signification of the different values displayed:

Key follow

Driver Oscillator		Filter	
K1	Key follow No 1	K1	Key follow No 1
K2	Key follow No 2	K2	Key follow No 2
K3	Key follow No 3	K3	Key follow No 3
K4	Key follow No 4	K4	Key follow No 4
No	No key follow	No	No key follow
LFO	No key follow, or trigger from the keyboard; the oscillator works permanently on a polyphonic track (LFO mode)		

Sequencer follow

Driver Oscillator		Filter	
S1	Follow of line 1 of the sequencer	S1	Follow of line 1 of the sequencer
S2	Follow of line 2 of the sequencer	S2	Follow of line 2 of the sequencer
S3	Follow of line 3 of the sequencer	S3	Follow of line 3 of the sequencer
S4	Follow of line 4 of the sequencer	S4	Follow of line 4 of the sequencer
No	No sequencer follow	No	No sequencer follow

5 THE MODULES

The Modular V can be broken down into 4 parts, from top to bottom, a section containing sequencer and effects, a section dedicated to the sound programming, a small extension where the external cables are regrouped (velocity, after-touch, external signals...) and finally a section containing the keyboard and different play settings.

1.13 Programming section

1.13.1 Description

The programming section gathers all of the modules, which need to be connected by cables. It is on this screen that the different connections (Patch) needed for the programming of the sound will be made.

It is sometimes necessary to connect a module in the programming section to a module in the sequencer section. To simplify connections between the 2 screens, the inputs and outputs of the sequencer section are grouped on a small extension under the sound programming section.

The sound programming section contains:

- Nine oscillators, grouped in threes, which can also be used as modulation source.
- Two low frequency oscillators dedicated to modulations.
- Three filters.
- Six envelopes dedicated to modulations.
- Two envelopes dedicated to output amplifiers.
- A dual trigger delay.
- A noise generator and the associated filters.
- 1 ring modulator
- 4 envelope followers
- 2 sample and holds
- 1 frequency translators
- 1 formant filter
- A set of amplifiers, which can be grouped to form mixers.

The number of spaces at the upper part of the section being inferior to the number of modules, the choice is made through a menu. It is thus possible to organize them at your convenience.

1.13.2 Oscillators

The oscillators, nine in total are regrouped in threes. Each group has a 921A type controller and three 921B type slave oscillators.

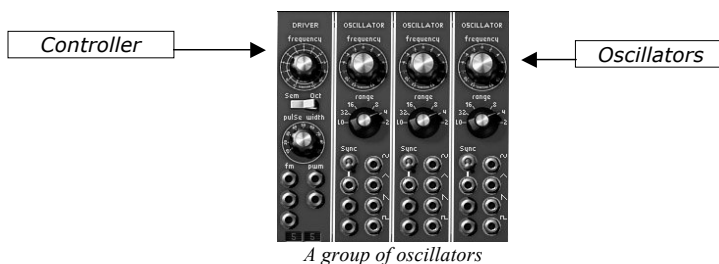

The controller is for the management of the impulse frequency and width of the 3 slave oscillators. It can be used either statically with the knobs or thanks to the modulation inputs, which can be connected to the output of any module (envelope, oscillator, modulation dial...). The slave oscillators can equally be tuned and modulated separately with a knob and a range selector. These oscillators provide four waveforms that can be used simultaneously.

This method of organizing the oscillators, typical of Modular synthesizers, helps to rapidly obtain a very rich tone. The three oscillators tuned separately and waveforms mixed give very dense tones. This tone can then easily be modulated with the controller. Adding a vibrato effect on this sonority is immediate using a modulation input of the controller. This would not be the case if each of the modulation inputs of the slave oscillators had to be set.

1.13.2.1 Controller 921A

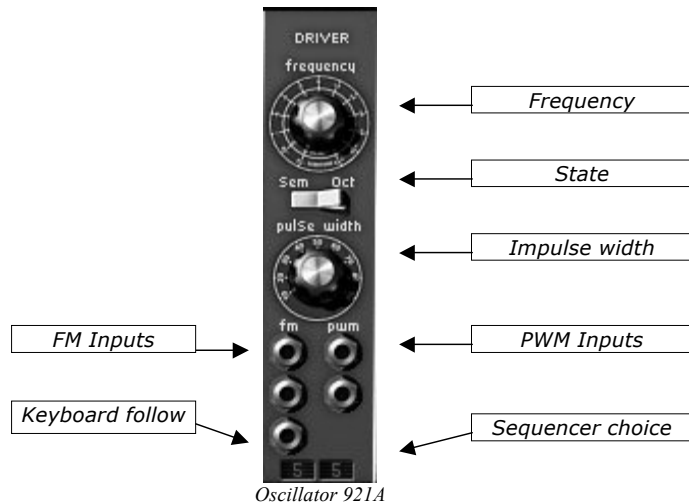

Oscillator 921A

- Frequency** General tuning of the 3 slave oscillators
- State** General tuning mode choice (by 1/2 tone, by octave)
- Impulse width** Signal impulse width "Sawtooth", "Square", "Triangle"
- FM Inputs** Frequency modulation input connection jacks
- WPM Inputs** Pulse width modulation connection jacks
- Keyboard follow** Keyboard follows choice tuning the master oscillator (off, no, follow 1, 2, 3 or 4).
- Sequencer Choice** Choice of the sequencer output tuning the master oscillator (no sequencer, sequencer 1, 2, 3 or 4).

The general tuning of the 3 slave oscillators is done with the "Frequency" knob. Depending on the position of the "State" interrupter, the range of the knob is +/- an octave by semitone or +/- six octaves par fifth and quarter.

The impulse width affected to the "sawtooth", "triangle" and "square" signals of the 3 slave oscillators is modified with the "Width" knob.

Three frequency modulation inputs and 2 impulse width modulation inputs allow the control of these parameters thanks to the outputs of the other modules.

When one of these inputs is connected, a click on the Jack will modify the amplitude of the modulation. The Jack knob functions like a rotating dial where the position for inactivity (no modulation) is at the center. The modulation can thus be positive (button turned to the right) or negative (button turned to the left).

 The first two frequency modulation inputs work in an **exponential** mode, while the third, "Lin" works in a **linear** mode.

Connected directly to a generator (envelope, oscillator, sequencer...), the maximum amplitude of the modulation is of +/- 4 octaves. When it is necessary to have a stronger modulation, an amplifier module must amplify the signal of the generator.

A certain number of internal connections simplify the use of the keyboard follow, sequencer, portamento and pitch bend.

To avoid having to manage the tuning of the keyboard follow with the amplitude of the modulation input, with a visualizer we can choose which keyboard follow (from 1 to 4) is to be used. This keyboard follow is directly configured to tune the oscillator in function to the note played.

The functioning is the same for the sequencer outputs (1 to 4) controlling the tuning of this group of oscillators. In the "no" follow position, the oscillator is set to the note C3, irrespective of the keyboard notes. In the same manner, when set to the "no" sequencer position, this group of oscillators is disconnected from the sequencer output.

A keyboard follow can of course be connected to modulation input. In that way, the pitch of each notes can be adjust very fine. We can then simulate the non-linearity of analog keyboard.

The "LFO" position of the display indicates that the oscillator group is no longer dependant of the keyboard. That is to say, it permanently functions on a monophonic voice. This function is especially useful when we want to use this oscillator group as source of low frequency modulation.

Furthermore, each of the keyboard follows can activate the response of oscillators and filters to portamento and pitch bend.

1.13.2.2 Slave oscillator 921B

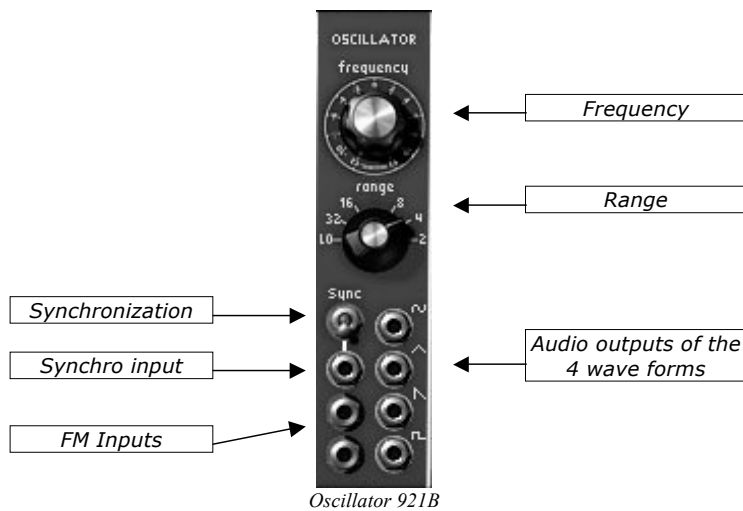

Oscillator 921B

- Frequency** Sets the frequency of the oscillator. By left click, setting by semi-tone, by right click fine setting.
- Range** Setting of the oscillator range. (low, 32, 16, 8, 4, 2)
- Synchronization** Synchronization interrupter Soft/Hard
- Synchro input** Menu to select the synchronization oscillator
- FM Inputs** Frequency modulation input connection jacks
- Outputs** Connection jacks for the four oscillator outputs

The 921B type slave oscillators possess four outputs that can be used simultaneously: sawtooth, sinusoid, triangle, square.

There is also an output generating a trigger signal synchronous with the square signal and with an identical width, which lets us trigger envelopes and sequencer in a cyclic manner. This output is visible only at trigger input menu level.

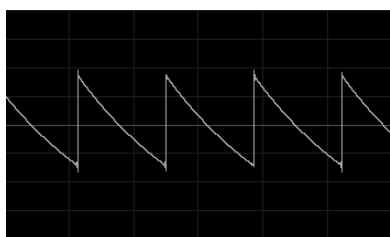

Sawtooth

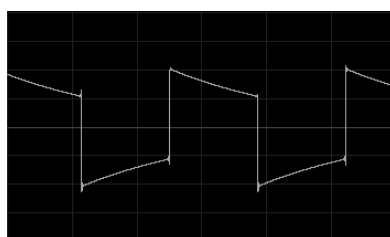

Square

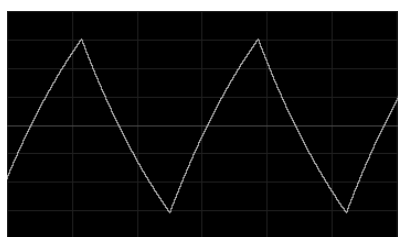

Triangle

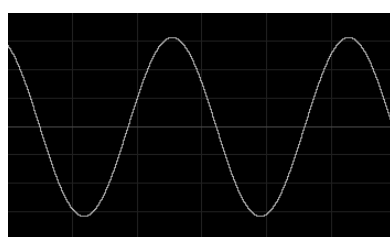

Sinusoid

These oscillators are independently tuned with the "frequency" knob. This button possesses a coarse +/- an octave per semi-tone setting with a left click and a fine tune setting +/- a semi-tone with a right click.

The "range" selector allows the setting of oscillator range on 6 positions: Low, 32, 16, 8, 4 and 2. With the Low position the oscillator can be used at a very low frequency (on a cycle of more than 6 minutes). The other positions set the oscillator to octaves 1,2,3,4 and 5. That is to say the note C3 is played respectively on C1, C2, C3, C4 and C5.

 *At the Low position the oscillators perform modulations using lower calculation power than the other positions.*

Two modulation inputs allow the separate setting of each of the oscillators in the group. They are very useful for modifying the tuning between oscillators thanks to a low frequency oscillator, a keyboard follow or other modulation source.

Like the controller modulation inputs, they can be connected to the output of another module. Connected to an oscillator functioning in the same audible spectrum, they can obtain sonorities with FM characteristics.

A synchronization input and the associated interrupter allow the synchronization of the slave oscillator on one of the other oscillators. In this case, the synchronizing oscillator will be heard while the synchronized oscillator will improve the tone.

In the low position, the synchronization is said to be "hard", which is to say that the synchronized oscillator will restart a cycle for every cycle on the synchronizing oscillator.

In the high position, the synchronization is said to be "soft", and in this case, the synchronized oscillator will only restart its cycle if it is coming to the end of the cycle when the synchronizing oscillator begins its cycle.

⚠ A connected oscillator is active and consumes calculation power. It is therefore necessary to verify that the connected oscillators are in use. Similarly, a group of oscillators disconnected from the keyboard by the "keyb" interrupter is permanently active.

1.13.3 Filters

The Modular V possesses 3 filter modules. It is possible to choose one of four types of filter for each of the modules: a low-pass 24 dB/octave (type 904A), a high-pass 24dB/octave (type 904B), a band-cut and band-pass 24 dB/octave (type 904C) and finally a multi-mode 12 dB/octave filter. Clicking on the name of the module and selecting the filter from the menu proposed does the type change.

All of these filters possess internal connections to simplify the use of keyboard follows, portamento, pitch bend and sequencer.

To avoid having to manage the tuning of the keyboard follow with the amplitude of the modulation input, with a display we can choose if a keyboard follow is to be used and which one. This keyboard follow is done to get a correct pitch from the keyboard. Depending on the configuration of the chosen keyboard follow, the portamento and the pitch bend will be applied or not to this filter.

The functioning is the same for the sequencer outputs (1 to 4) controlling the tuning of the cut-off frequency of this filter. In the "no" follow position, the filter is independent of the notes played on the keyboard. In the same manner, set to the "no" sequencer position, the filter is disconnected from the sequencer output.

It is still possible to connect a keyboard follow or a sequencer output to a modulation input obtaining a tuning as fine as necessary.

1.13.3.1 Low pass 24 dB/octave filter (904A)

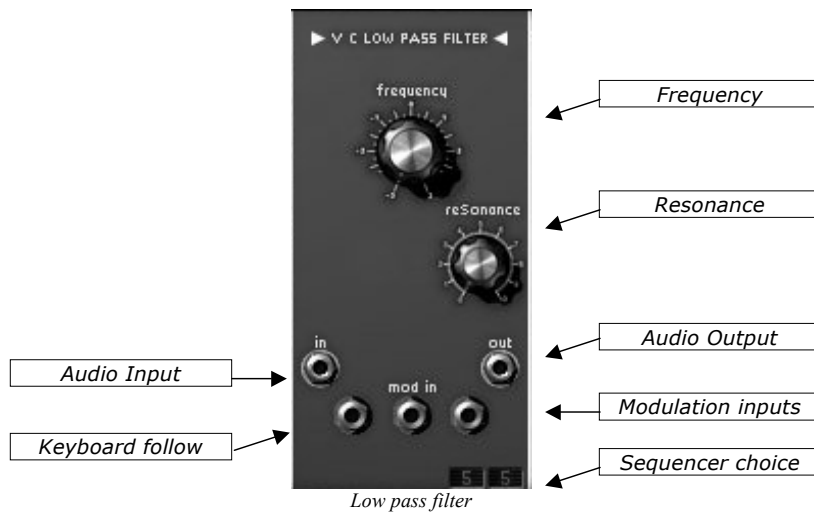

- Frequency** Sets the filter cut-off frequency
- Resonance** Sets the filter resonance
- Audio Output** Filter output connection jack
- Audio Input** Filter input connection jack
- Modulation inputs** Frequency modulation input connection jacks
- Keyboard follow** Keyboard follow choice tuning the filter (no follow, follow 1, 2, 3 or 4).
- Sequencer choice** Choice of the sequencer output tuning the filter (no sequencer, sequencer 1, 2, 3 or 4).

The low-pass 24 dB/octave filter is typical of Bob Moog's synthesizers. It has a setting for the cut-off frequency and a setting for the resonance. Only connecting the output of any module to one of the 3 modulation inputs can dynamically modulate the cut-off frequency.

Like all of the modulation inputs, once connected, turning the dial of the jack with a right click sets its amplitude. Receiving a modulation directly from the output of a generator (envelope, oscillator, and sequencer), the maximum modulation amplitude is of +/- 9 octaves. When it is necessary to have a stronger modulation, an amplifier module must amplify the signal of the generator.

The following image represents the spectrum of a low-pass resonant filter with a cut-off resonance of 500 Hz.

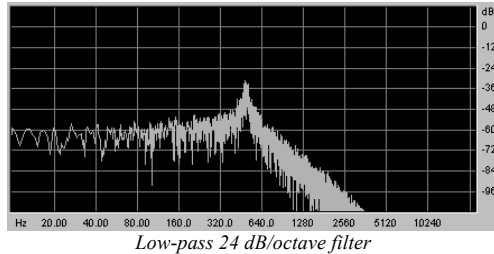

1.13.3.2 *High-pass 24 dB/octave filter (904B)*

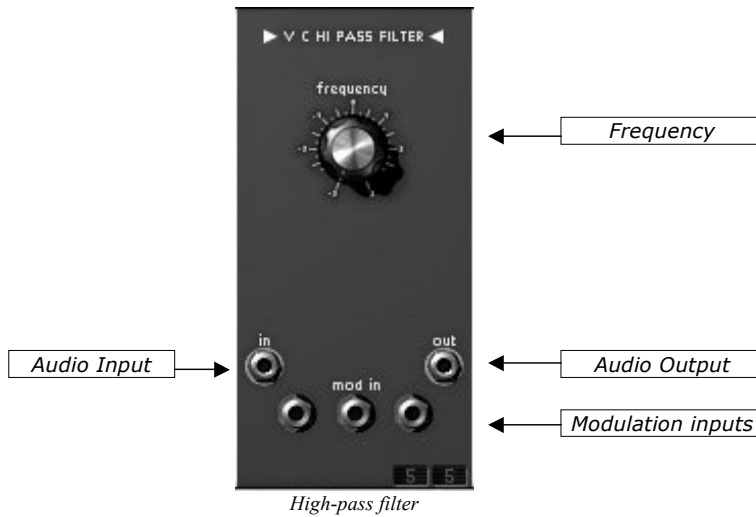

- Frequency** Sets the filter cut-off frequency
- Audio Output** Filter output connection jack
- Audio Input** Filter input connection jack
- Modulation inputs** Frequency modulation input connection jacks
- Keyboard Follow** Keyboard follow choice tuning the filter (no follow, follow 1,2,3 or 4).
- Sequencer Choice** Choice of the sequencer output tuning the filter (no sequencer, sequencer 1, 2, 3 or 4).

Unlike the low-pass 904A filter, the high-pass 904B filter does not possess resonance. The cut-off frequency can be set with the rotating "frequency" dial or by the 3 modulation inputs which function in the same manner as the inputs of the low-pass.

The following image represents the spectrum of a high-pass filter with a cut-off frequency of 500 Hz.

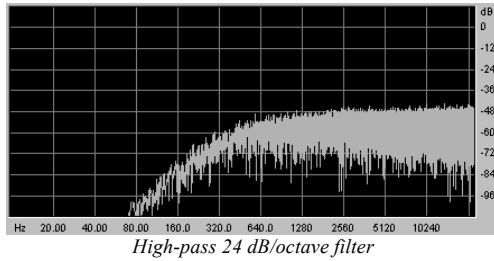

1.13.3.3 *Band-pass 24 dB/octave filter (904C)*

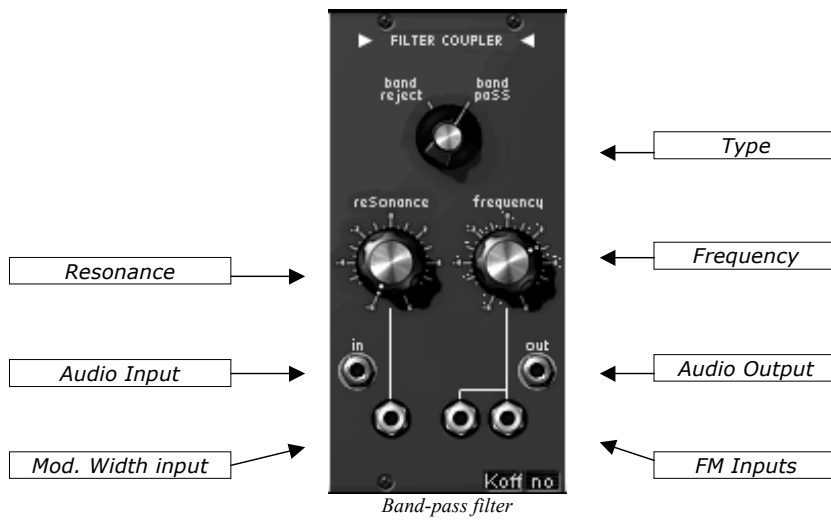

- Frequency** Sets the filter cut-off frequency
- Resonance** Sets the bandwidth of the filter
- Type** Choice of filter type (band reject or band pass)
- Audio Output** Filter output connection jack
- Audio Input** Filter input connection jack
- FM Inputs** Frequency modulation input jacks
- Mod. Width input** Bandwidth modulation input connection jack
- Keyboard follow** Keyboard follows choice tuning the filter (no follow, follow 1, 2, 3 or 4).
- Sequencer Choice** Choice of the sequencer output tuning the filter (no sequencer, sequencer 1, 2, 3 or 4).

The 24dB band pass filter resembles the 904C filter, but the difference from it is that while the 904C is a pairing of the 2 associated low-pass and high-pass filters, this one is independent of the 2 other filters. The central frequency can be set with the rotating "Frequency" button, the

bandwidth, of 1/3 octave to 3 octaves with the "Resonance" knob. The first modulation input allows the dynamic modification of the bandwidth, the 2 others, the central frequency.

A "type" selector provides a choice of filtering, band pass or band reject.

The following images represent the spectrum of the band-pass and band-reject filters where the central frequency is 500 Hz.

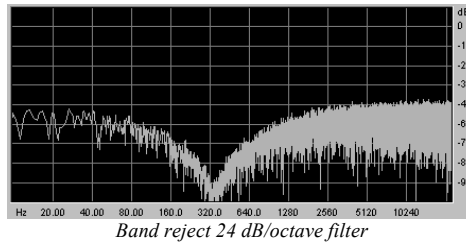
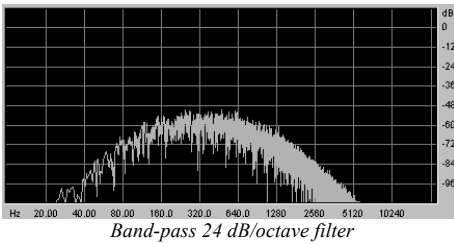

1.13.3.4 Multi-mode 12 dB/octave filter

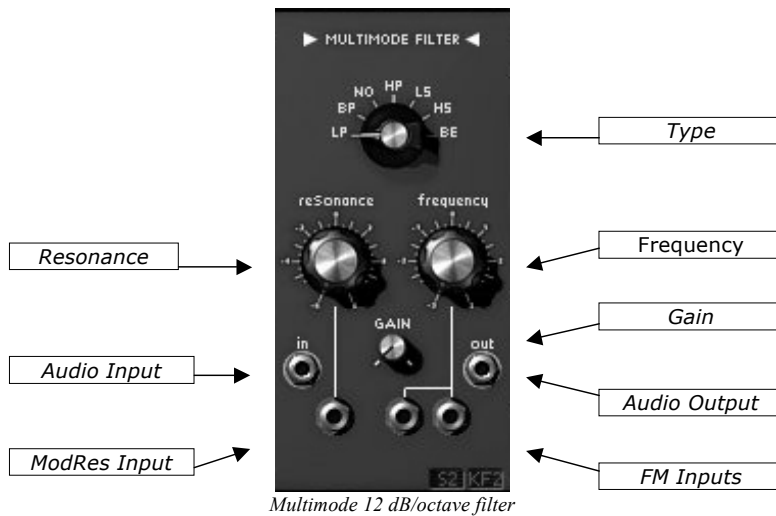

- Type** Choice of filter type
- Frequency** Sets the filter cut-off frequency
- Resonance** Sets the resonance of the filter
- Gain** Sets the gain for bell, shelf High and Low.
- Audio Output** Filter output connection jack
- Audio Input** Filter input connection jack
- FM Inputs** Frequency modulation input jacks
- ModRes Input** Resonance modulation input connection jack
- Keyboard follow** Keyboard follow choice tuning the filter (no follow, follow 1, 2, 3 or 4).
- Sequencer Choice** Choice of the sequencer output tuning the filter (no sequencer, sequencer 1, 2, 3 or 4).

The multi-mode 12 dB/octave filter has different types of filtering that the original Modular synthesizers could not offer. The selector holds six types of filtering: low-pass, band-pass, notch, high-pass, low-shelf, high-shelf, bell.

The 3 knobs "Frequency", "Resonance", and "Gain" respectively set the cut-off frequency, the resonance, and the gain (used only for the shelf and bell)

Three modulation inputs allow the dynamic modification of the cut-off frequency.

The following images represent the different spectrum of the different filters, the cut-off frequency is constant at 500 Hz.

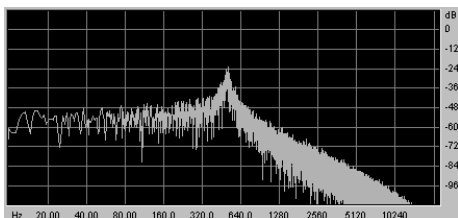

Low-pass 12 dB/octave

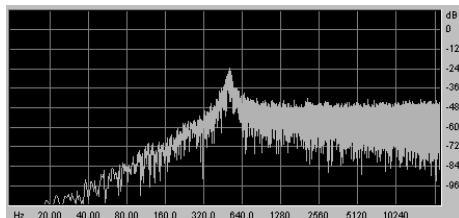

High-pass 12 dB/octave

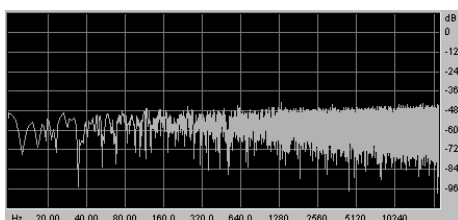

Notch 12 dB/octave

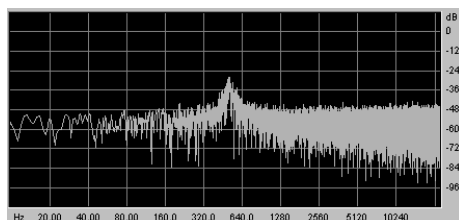

Bell 12 dB/octave

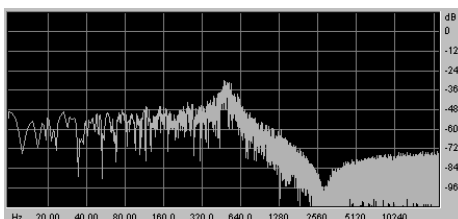

Low-shelf 12 dB/octave

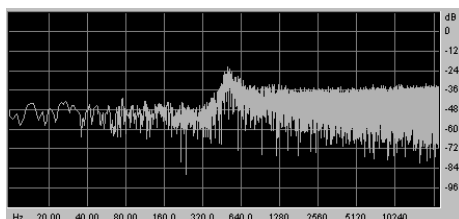

High-shelf 12 dB/octave

1.13.4 Modulation envelopes

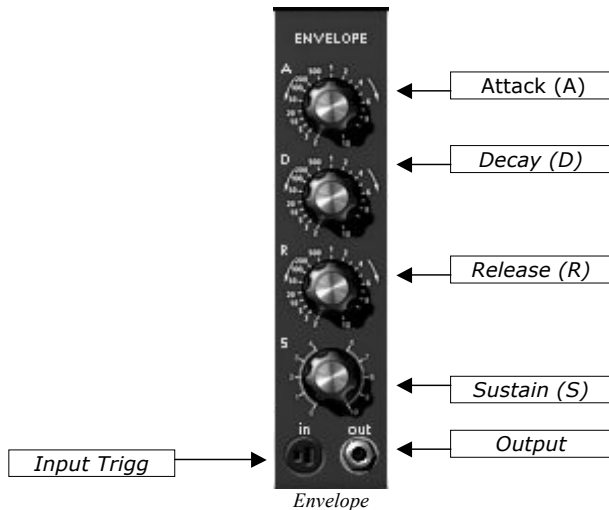

- Attack** Sets the attack time (Attack)
- Decay** Sets the decay time
- Release** Sets the release time
- Sustain** Sets the sustain level
- Input Trigg** Trigger signal input connection
- Output** Envelope output signal

Six in total, the modulation envelopes make the sonority evolve in function with time. An envelope possesses four sequentially following temporal periods: attack, decay, sustain and release. When the input trigger goes from an inactive to an active state, the envelope launches its sequences "attack" followed by "decay" and remains in the "sustain" state as long as the input trigger remains active. When it goes to an inactive state, the envelope begins the "release" sequence. If the input trigger becomes inactive before the first 2 sequences have finished, the envelope goes directly to the "release" phase.

The input trigger can be connected to the output trigger coming from the keyboard, the trigger delay module, the oscillators trigger output, or from the sequencer.

The time of the different periods are controlled by the "Attack", "Decay" and "Release" knobs. The "Sustain" knob is to set the level of the envelope output during the sustain period.

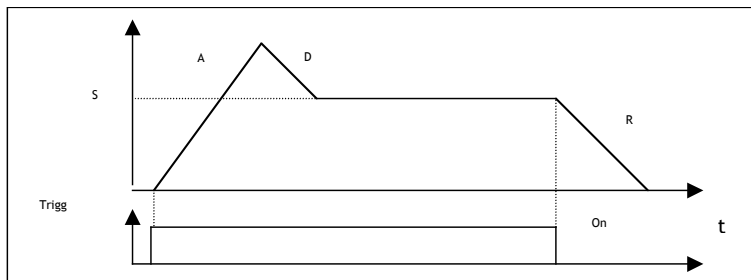

Representation of the envelope

1.13.5 Output amplifiers (VCA)

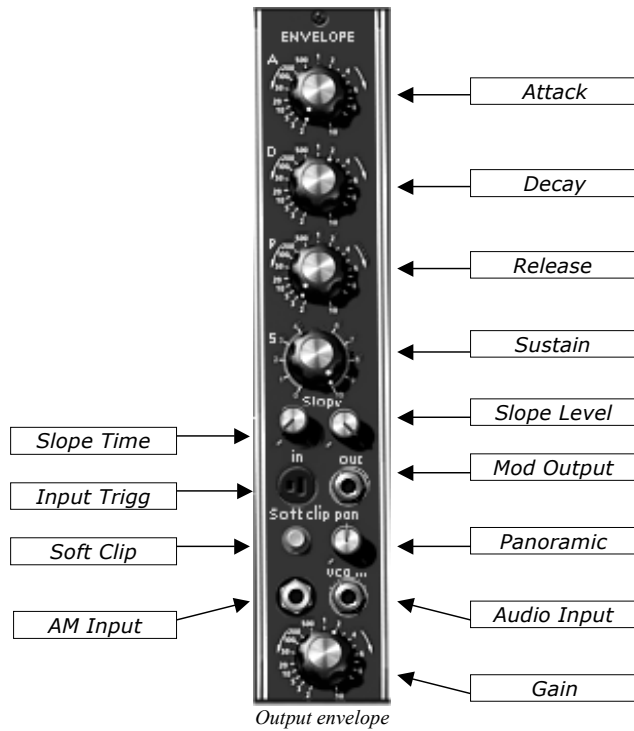

- Attack** Sets the attack time
- Decay** Sets the decay time
- Release** Sets the release time (release)
- Sustain** Sets the sustain level
- Slope Time** Sets the intermediate decay time
- Slope Level** Sets the intermediate decay level
- Input Trigg** Input trigger signal connection jack
- Envelope out** Envelope out connection jack
- Audio Input** VCA input connection jack
- Panoramic** Sets the position in stereo space
- Soft Clip** Use of gentle saturation
- AM Input** Audio modulation Input jack

There are 2 output amplifiers, each possessing its own envelope. These amplifiers are internally linked to a panoramic manager, which allows, through the “panoramic” knob, to position the output in stereo space.

These amplifiers are the last step in the generation of a sound. The associated envelope sculpts the temporal form of the signal at the end of the sequence after the application of all of the other modulations. Unlike the modulation envelopes, it has an extra period between the “attack” and “decay” sequences, called “slope”. The time and level can be set for this period and allows the envelope to move from the high point after attack to slope before moving to the decay:

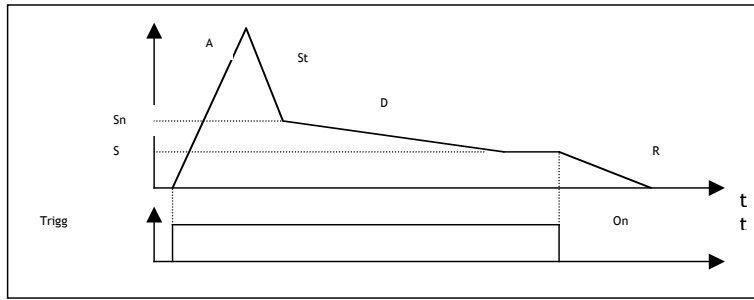

Representation of the output VCA envelope

The output amplifier internally connected to this envelope has volume “gain” and amplitude input modulation settings.

The input trigger can be connected to the output trigger coming from the keyboard, the trigger delay module, the oscillators or LFO trigger output, or from the sequencer.

Each of the two amplifiers possesses a trigger output, which is activated when the signal level is cancelled. This output can be very useful for stopping the sequencer for example.

A jack allows the connection of the output of the associated envelope to other modulation inputs.

A button applies the simulation of the current regulation present in the original amplifiers (soft clipping).

⚠ Soft saturation is heavy on CPU calculation.

1.13.6 Low frequency oscillators (LFO)

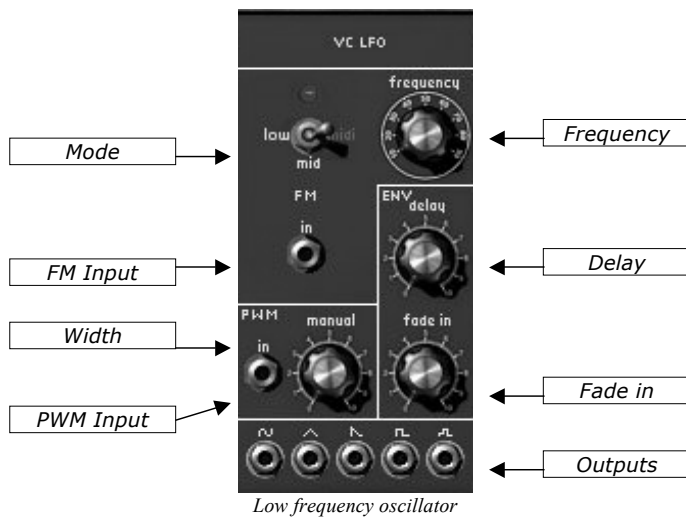

Low frequency oscillator

Frequency	Sets the oscillation frequency
Delay	Delay time setting after a keyboard trigger
Mode	Choice of frequency setting: low, mid, synchronized on the MIDI tempo
Fade in	Sets the time constant for the increase of modulation
Width	Sets the impulse width
PWM Input	Input connection for the impulse width modulation
FM Input	Frequency modulation input connection
Outputs	Connection jacks for the different outputs

The use of a low frequency generator as a modulation source is typical. It allows the gentle evolution of the tone of a sound or to simulate vibrato and tremolo.

Even though the oscillators can be used at very low frequencies, there are 2 modules specifically for this purpose, which allow the oscillators to be kept for use in the audible domain.

These oscillators possess five outputs that can be used simultaneously: sawtooth, sinusoid, triangle, square, random.

The oscillation frequency can be statically set with the rotating "frequency" button dynamically with the associated modulation input. The impulse width can also be statically set with the "width" button and by its modulation input.

The "mode" interrupter synchronizes the oscillation frequency with the tempo of the host sequencer. In this mode, the rotating button chooses a frequency depending on the application's tempo (multiple or sub multiple).

Two other buttons are affecting a delay and a fade in at the output of this generator. Initialized on a keyboard trigger, the generator output will only begin to oscillate when the internal counter reaches a time value set with the "delay" knob. This oscillation will gently increase following the time constant set with the rotating "fade in".

There is also an output generating a trigger signal synchronous with the square signal and with an identical width, which lets us trigger envelopes and sequencer in a cyclic manner. This output is visible only visible at trigger input menu level.

1.13.7 Controlled amplifiers / Mixers

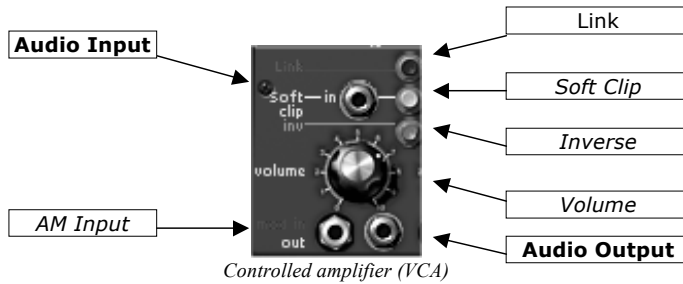

Audio Input	Amplifier input connection jack
Audio Output	Amplifier output connection jack
AM Input	Amplitude modulation input connection jack
Volume	Input gain setting
Soft Clip	Use of soft clipping
Inverse	Request inversion of the input signal
Link	Next amplifier mixing

There are 16 independent amplifiers. Each has its own volume setting with the rotating "level" button and its amplitude modulation input.

These amplifiers can be regrouped to form mixers. To group 2 amplifiers, just click on the "Link" button separating them.

When 2 amplifiers form a group, the output signal of the first corresponds to the sum of their collective outputs, whereas the output of the second remains identical to the signal before grouping.

To restore their independence, just click on the "Link" button.

It is possible to add as many amplifiers as necessary. In this case it is still the output of the first amplifier, which will have the signal corresponding to the sum of all of the amplifiers of the group, the others retaining their independence.

Thanks to this method, with 16 amplifiers to begin with, it is possible to create a large range of mixing while keeping a few amplifiers available for modulation.

We can, for example, form a group of the first six amplifiers to mix the first six oscillators, then a group with the next 3 to mix the 3 last oscillators, and finally a group with the next 2 to mix the outputs of 2 filters which will respectively treat the output of the first amplifier and the output of the seventh. There are 5 remaining amplifiers for modulation or other mixes.

Each amplifier possesses a current limiting function allowing a soft clipping. This function is activated with the "clip" button. The "inv" button lets you invert the signal, as input to the corresponding amplifier..

The four right VCA are modulated with a linear function, on the contrary, the other are modulated with a exponential function.

1.13.8 Trigger delay

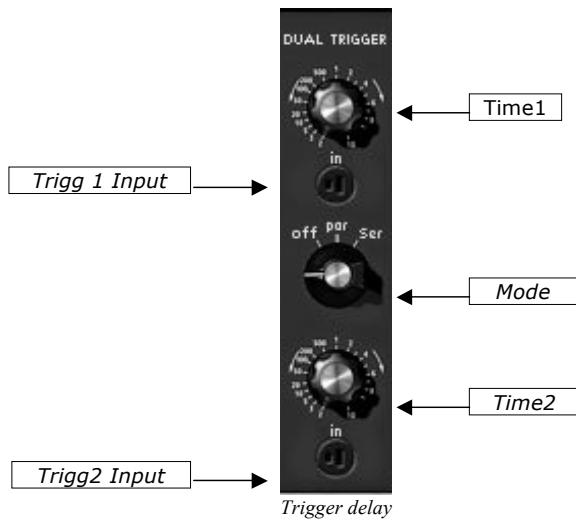

- Time 1** Sets the time for the first delay
- Trigg 1 Input** Choice of trigger input for the first delay
- Mode** Choice of mode (independent, parallel, series)
- Time 2** Sets the time for the second delay
- Trigg 2 Input** Choice of trigger input for the second delay

A trigger delay module manages the signals used for triggering envelopes and sequencer. There are 2 delays, which can function independently, in series or parallel following the setting on the "mode" selector.

Set to the "off" position, the 2 delays are independent. When their trigger input moves to an active state, their internal counter is initialized. The output will move to an active state when their internal counter reaches the value specified by the rotating "time" button. When the trigger input returns to an inactive state, the output immediately goes to an inactive state.

Set to the "parallel" position, the 2 internal counters start at the same time when the trigger input of the first delay goes to an active state. Each manages its output in function with its time setting.

In the series position, the second counter only begins when the output of the first delay moves to an active state.

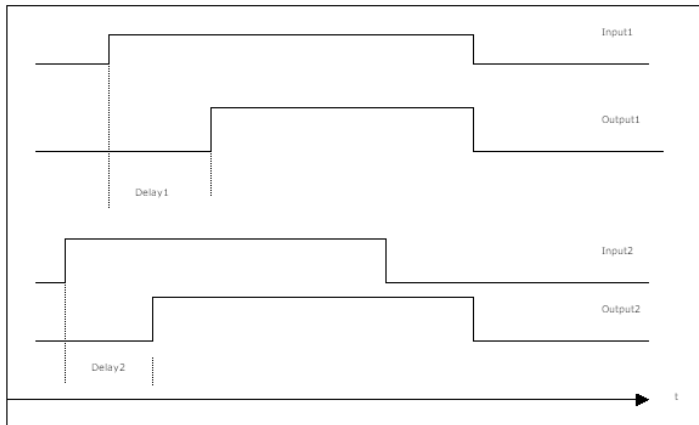

Independent mode

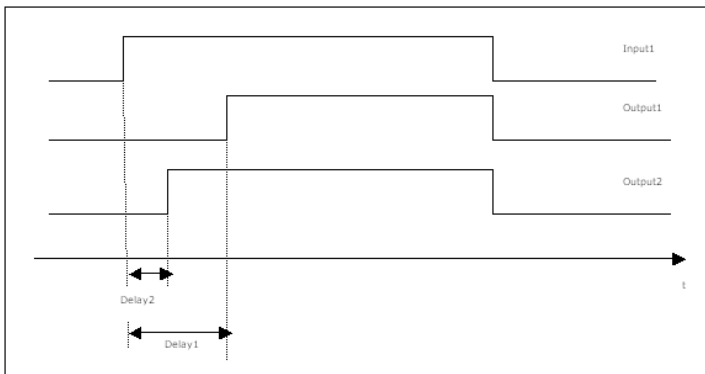

Parallel mode

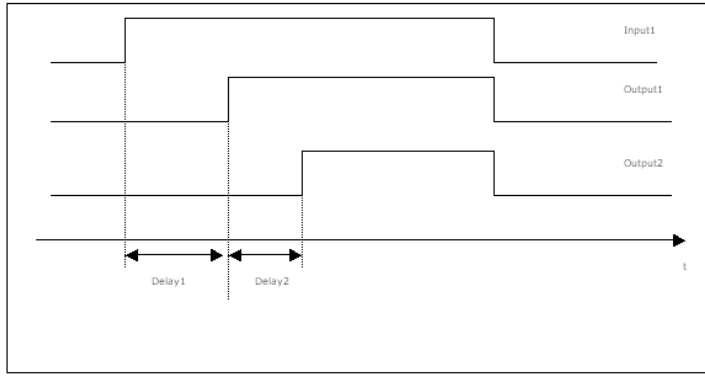

Serial mode

1.13.9 Noise generator

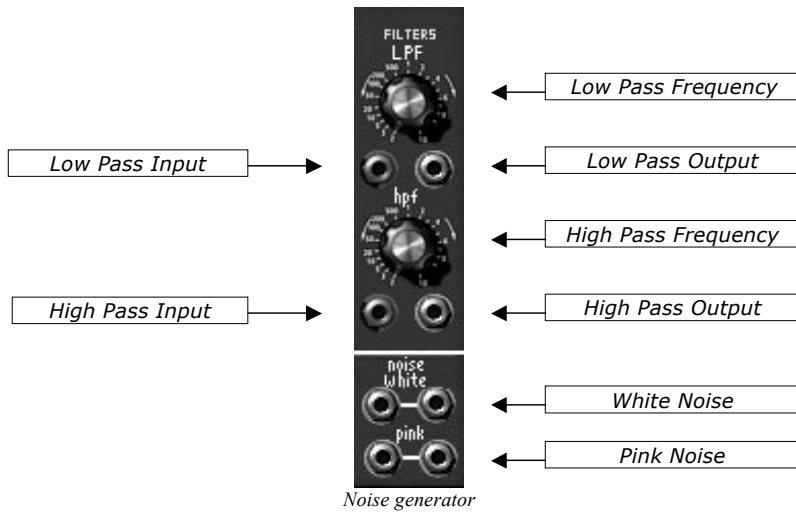

Noise generator

- Low Pass Frequency** Sets the low-pass filter cut-off frequency
- Low Pass Input** Low Pass filter input connection jack
- Low Pass Output** Low Pass filter output connection jack
- Low Pass Frequency** Sets the Low Pass filter cut-off frequency
- High-pass Output** High-pass filter output connection jack
- High-pass Input** High-pass filter input connection jack
- White Noise** White noise output connection jack
- Pink Noise** Pink noise output connection jack

The noise generator allows the simultaneous management of a white and pink noise. It also possesses a low-pass and a high-pass of the first order (6 dB/octave) in which the cut-off frequency can be statically set with the "frequency" knobs.

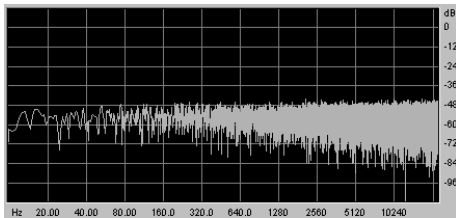

White noise spectrum

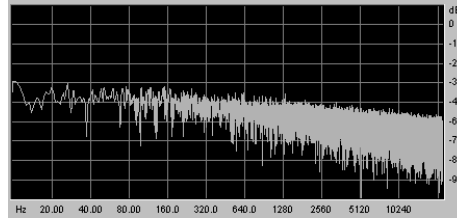

Pink noise spectrum

Whether it is for white or pink noise, the two output jacks correspond to two independent noise generators.

1.13.10 Sample and hold

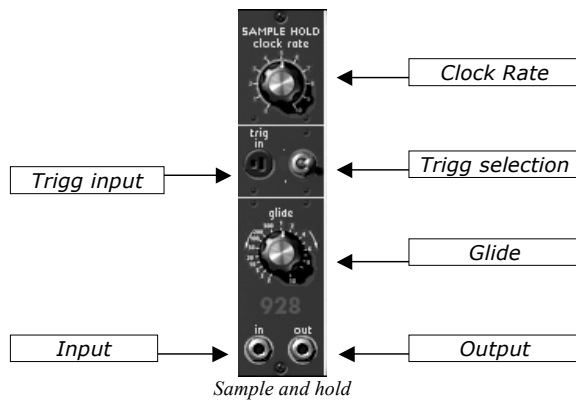

- Clock Rate** Sets the internal clock frequency
- Trigg Input** Menu selecting the choice of external input used to trigger the sampling
- Trigg Selection** Choice source of external trigger for sampling
- Glide** Sets output glide
- Output** Output connection jack
- Input** Input connection jack

This module lets you sample the signal connected as input. The values are taken for every trigger where the source can be external (trigger source connected to the Trigg input) or internal, clock where the frequency is set with the "Clock Rate" dial. The choice is made with the "Trigg selection" interrupter.

The values sampled are presented as output, with more or less glide, set with the "Glide" dial.

It is this module, when sampling noise, which is used to product random modulations.

1.13.11 Envelope follower

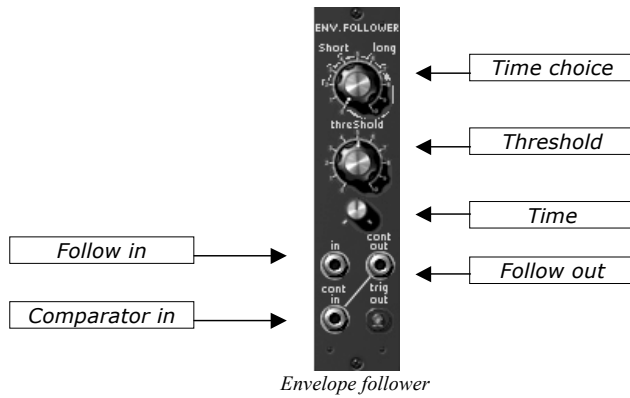

- Time choice** Selection of follow mode
- Time** Sets the constant time of the level measurement
- Threshold** Sets the threshold of comparator
- Follower out** Envelope follow output connection jack
- Follower in** Envelope follow input connection jack
- Comparator in** Comparator input connection jack

This module possesses two functions. The first generates an envelope from the audio signal connected to "Follower in". The "Time" setting determines the detail for the envelope follower. The lower the value, the more the input signal variations will be respected. This setting relies on the "Time Choice" which can be "short" or "long". In the first case, the analysis of the input signal will be very precise, generating a signal with fast variation. The calculation power required is thus heavier than the second position, where the output signal will have slow variation.

This module also allows you to generate a trigger signal. The triggering is calculated in relation to a certain threshold set with the "Threshold" dial and the signal connected to the "Comparator in". If no signal is connected to this input, an internal connection will link the follow output to the comparator.

This module generates two types of trigger, a positive trigger, and a negative. When the comparator input signal exceeds the threshold, the positive trigger is activated, while the negative trigger is cancelled. When the input signal goes below the threshold, the opposite happens. A lighting indicator allows the observation of the positive trigger signal.

1.13.12 Ring modulator

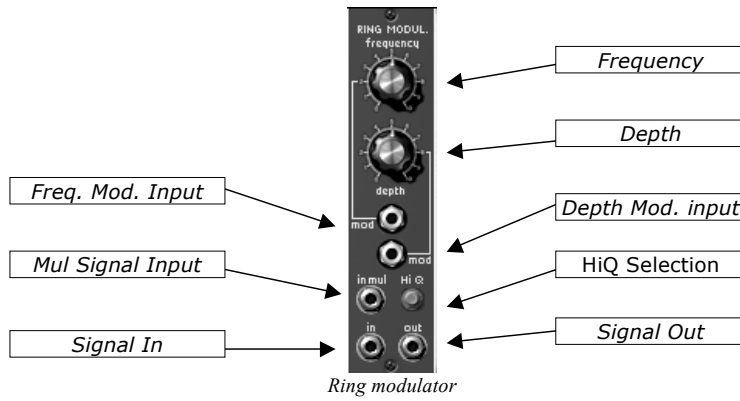

Frequency	Sets the frequency of the multiplicative sinusoid
Depth	Sets the amplitude for the multiplication of signals
HiQ Selection	High quality selection
Freq. Mod. Input	Frequency modulation connection jack
Depth Mod. Input	Depth modulation connection jack
Mul Signal Input	Multiplicative signal connection jack
Signal Input	Input jack for signal to be treated
Signal output	Output jack for treated signal

The ring modulator multiplies two signals to create non-harmonics frequency. It is then easy to produce metallic sounds.

When "Mul Signal Input" is not connected, the input signal is multiplied by an internally generated sinusoid signal for which the frequency can be set with the "Frequency" button. The modulation amplitude and subsequently the effect amplitude obtained can be set with the "Depth" button. Once connected, "Mul Signal Input" becomes the source of the multiplicative signal.

The depth and the frequency of the internal sinusoid can be modulated with the corresponding modulation inputs.

The "HiQ" interrupter, at the cost of an increase in calculation load, increases the quality of the sound.

1.13.13 Formant filter

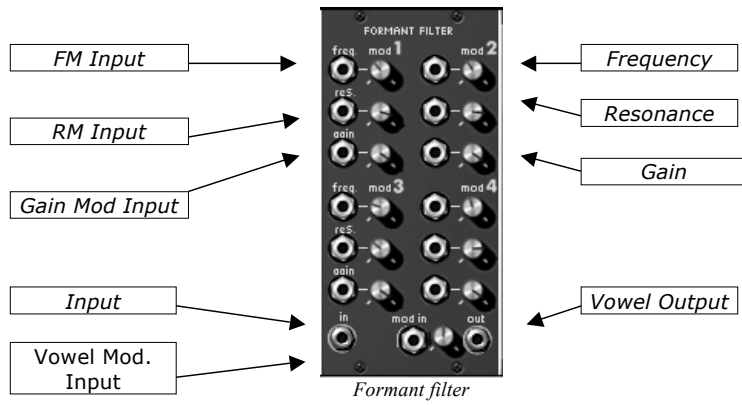

- Frequency** Sets the frequency
- Resonance** Sets the resonance
- Gain** Sets the gain
- FM Input** Frequency modulation connection jack
- RM Input** Resonance modulation connection jack
- GM Input** Gain modulation connection jack
- Vowel** setting of a pre-selected vowel
- VM Input** Connection jack for the modulation of the vowel pre-selections

This module regroups four bell filters connected in a series. Each filter can be set and modulated, independently of the others, in frequency, gain and resonance (or bandwidth). It is possible to preset these four filters to reproduce the formation of a particular vowel with the "vowel" selection window. This preselection can also be modulated with the associated modulation input. The preselection is done before the filter settings. It is thus possible, during a modulation, to make the vowel evolve, and to gently change the settings.

1.13.14 Bode Frequency Shifter

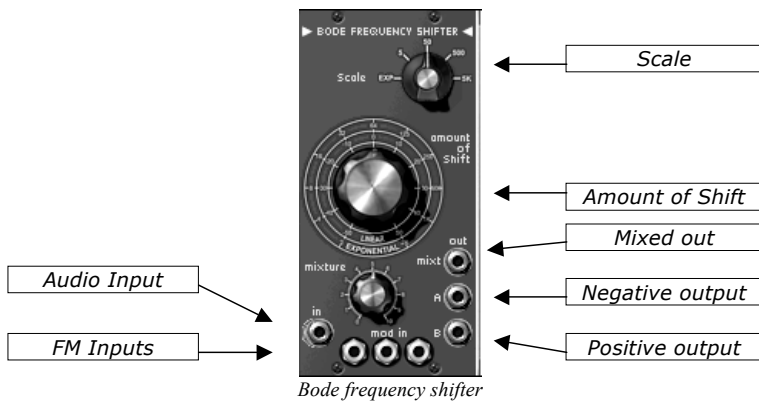

Scale	Sets the scale frequency
Amount of Shift	Sets the frequency transition
Mix	Mix between the positive and negative translations
Mixed output	Mix of negative and positive translations output connection jack
Positive output	Positive translation output jack
Negative output	Negative translation output jack
FM Input	Frequency modulation connection jack
Audio Input	Input signal connection jack

This module is used for a linear translation of the frequencies contained in the input signal. Because of this linearity, the initial harmonic relations are totally modified.

It is easy with this module, to produce metallic sounds.

There are three available outputs: two for each of the translations possible (negative and positive), the other for a mix of the two, the mix is set with the "Mix" button.

The translation rate, which is to say the difference in frequencies, is set with the "frequency" button. Following the selected scale ("scale" selector), the button will give a different gap. The scale also influences the amplitude and type of modulation.

In the exponential position, the translation goes from 2 Hz to 1024 Hz, the modulation being exponential. In the other positions (5,50,500,5k), the translation will be of a maximum of 5 Hz, 50 Hz, 500 Hz or 5000 Hz, in positive or negative.

1.14 **Second section**

1.14.1 **Description**

The second section of the Modular V regroups all of the effect modules and the sequencer. The outputs and inputs of this page needing connections with the modules of the first section are moved to the latter, in a small extension.

This section contains a module for equalization through a bank of resonant filters, a chorus module, a phaser, a stereo delay module, and a type 960 sequencer.

The 3 effect modules, filter bank, chorus and stereo delay are applied to the signal of the output amplifiers in function with the interrupters "VCA1" and "VCA2". They are applied in the predefined order.

The choice between the chorus and the phaser is done through a menu displayed by clicking on the name of the module.

1.14.2 Resonant filter bank

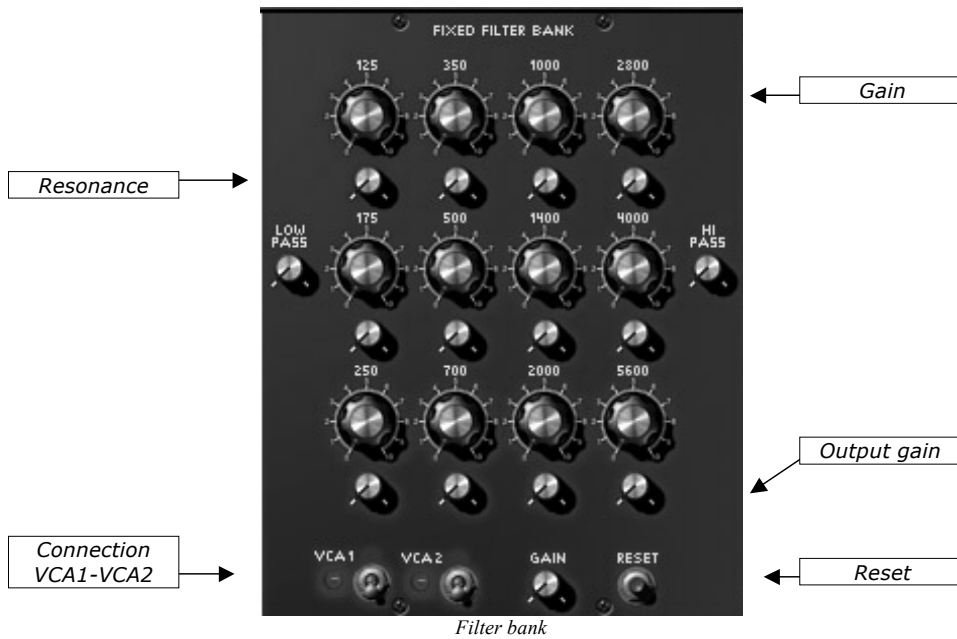

Gain	Sets the band level to positive or negative
Resonance	Sets the bandwidth
Connection VCA1-VCA2	Connection of the filter bank to the VCA1 or VCA2 output
Output Gain	Sets the output gain
Reset	Resets the filter bank

This module allows the equalization of the signal coming from the 2 output amplifiers in function with the state of the interrupters "VCA1" and "VCA2".

This equalization is done with the help of the resonant filters and has 14 bands. Each has a level (amplification and alleviation) and bandwidth setting, excepting the first and last bands, which are respectively, the low-pass and high-pass filters.

The cut-off frequencies of these filters are fixed at the following values: 80 Hz, 125 Hz, 175 Hz, 250 Hz, 350 Hz, 500 Hz, 700 Hz, 1000 Hz, 1400 Hz, 2000 Hz, 2800 Hz, 4000 Hz, 5600 Hz and 6400 Hz.

A button allows the resetting of the default values and a rotating button sets the output level after filtering.

1.14.3 Chorus

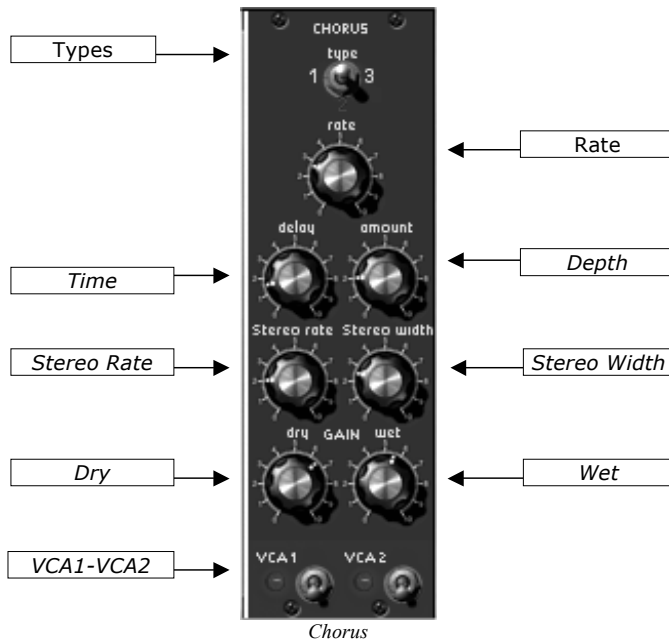

Types	Sets the 3 chorus Types
Rate	Sets the chorus rate
Depth	Sets the depth of the chorus action
Time	Sets the delay applied to the input signal
Stereo Rate	Sets the speed of the stereophonic evolution
Stereo Width	Sets the width of the stereophonic space
Dry	Sets the gain applied to the input signal
Wet	Sets the gain applied to the treated signal
VCA1-VCA2	Connection of the chorus to the output of VCA1 or VCA2

A Chorus module allows the treatment of the signal coming from the 2 output amplifiers, eventually treated by the equalizer, in function with the state of the interrupters "VCA1" and "VCA2".

The chorus module allows a frequential blurring where the speed is set by the "speed" knob, the amplitude by the "depth" and the width with the "Delay". This frequency blurring is different for the left and right tracks. This allows us to get a stereophonic signal from a monophonic signal. The difference between the 2 tracks can be set with the "stereo width" and the speed of the left right rotation with the "stereo rate" knob.

A selector presents the choice of chorus type: simple, medium, complex.

The input signal level and treated signal can be respectively set with the "gain direct" and "gain effect" knobs.

1.14.4 Phaser

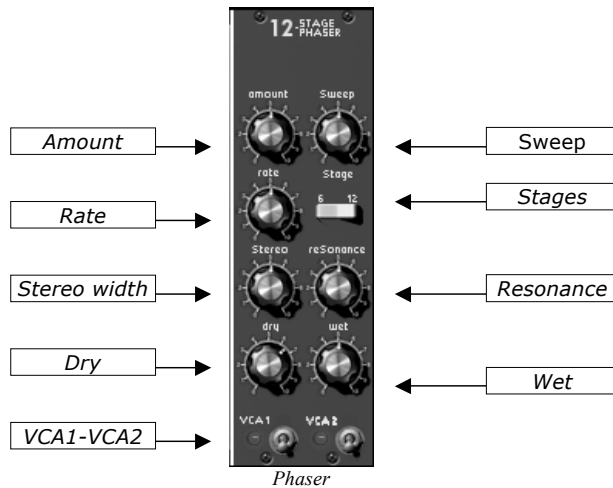

- Amount** Sets the depth of the phaser action
- Rate** Sets the speed of the phaser
- Sweep** Sets the phaser resonance
- Stereo width** Sets the width of the stereo space
- Dry** Sets the gain applied to the input signal
- Stages** Sets the phaser type (6 or 12 stages)
- Wet** Sets the gain applied to the treated signal
- VCA1-VCA2** Connects the phaser to the VCA1 or VCA2 output

The phaser module treats the signal coming from the 2 output amplifiers, eventually treated by an equalizer, in function with the state of the 2 "VCA1" and "VCA2" interrupters.

The action consists of dephasing the input signal and combining it with the original signal. Thus we can have a filter that combs (with notches) the frequency spectrum to the rhythm of an oscillator which follows the frequency set with the "rate" button. The "depth" button sets the amplitude for the action of the filtering, while "Resonance" amplifies certain harmonics. The rotating "stereo width" button sets the amplitude of the stereophonic aspect of the phaser. When the "stereo width" is set to 0, the left and the right channel are in phase. When it is set to 0.5, the sound seems to rotate, and when it is set to 1, the sound seems to go from one side to another.

There are two types of phaser, one has 6 levels, the other has 12, set with the "type" selector. A 6-stage phaser has 3 notches, and a 12-stage has 6.

The rotating "dry" and "wet" buttons are respectively used to set the amplitude of the original signal and the treated signal.

1.14.5 Stereo Delay

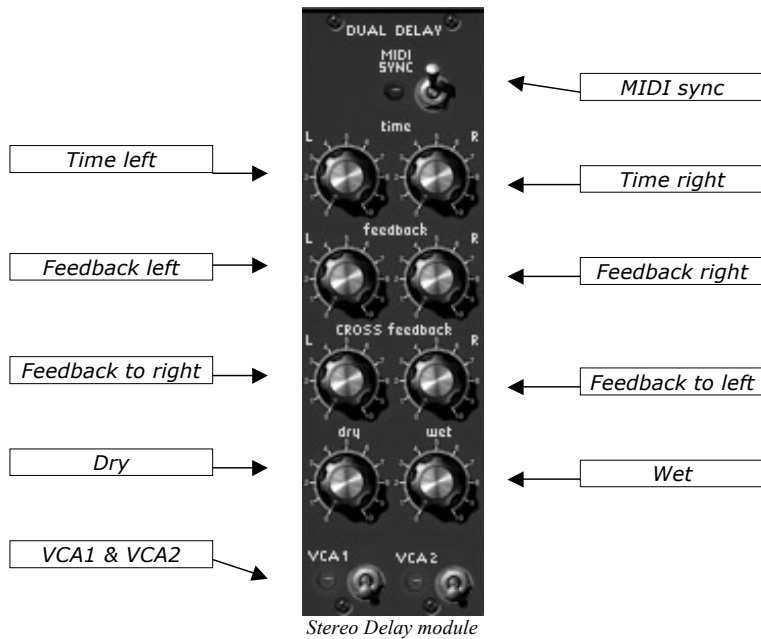

Stereo Delay module

MIDI sync	Synchronizes delay with the tempo of the host application
Time left	Sets the time of the right track
Time right	Sets the time of the left track
Feedback left	Sets the feedback gain for the right track
Feedback right	Sets the feedback gain for the left track
Feedback to left	Sets the feedback gain of the right track towards the left track
Feedback to right	Sets the feedback gain of the left track towards the right track
Dry	Sets the gain applied to the input signal
Wet	Sets the gain applied to the treated signal
VCA1-VCA2	Connection of the delay to the output of VCA1 or VCA2

A stereo delay module treats the signal coming from the 2 output amplifiers, eventually treated by the equalizer and chorus, in function with the state of the interrupters "VCA1" and "VCA2".

This module allows the repetition of the input signal independently on the left and right tracks, which explains the presence of 2 columns of controls.

The repetition speed can be set with the "time" knob, while the level of the repetitions, and eventually the number of audible repetitions is set with the "feedback" knob. The third knob sends a part of the treated signal to the other track.

The repetition speed can be synchronized with the tempo of the host application, and in this case, the "time" knob selects the multiples and sub-multiples of this tempo.

The levels of the input and treated signals can be respectively set with the rotating "gain direct" and "gain effect" buttons.

1.14.6 Sequence generator

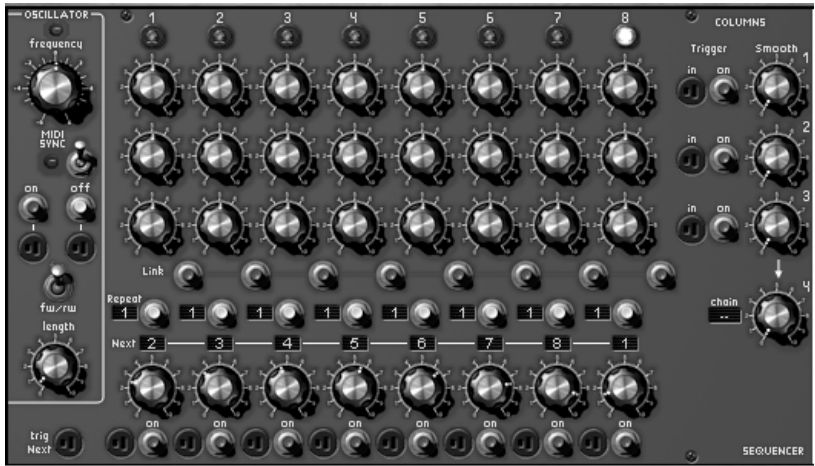

Sequencer

Also called sequencer, this module is similar to the original 960 sequencer while simplifying the programming with internal connections. This module has 3 parts: low frequency oscillator, the 8-step sequence manager and the output controller.

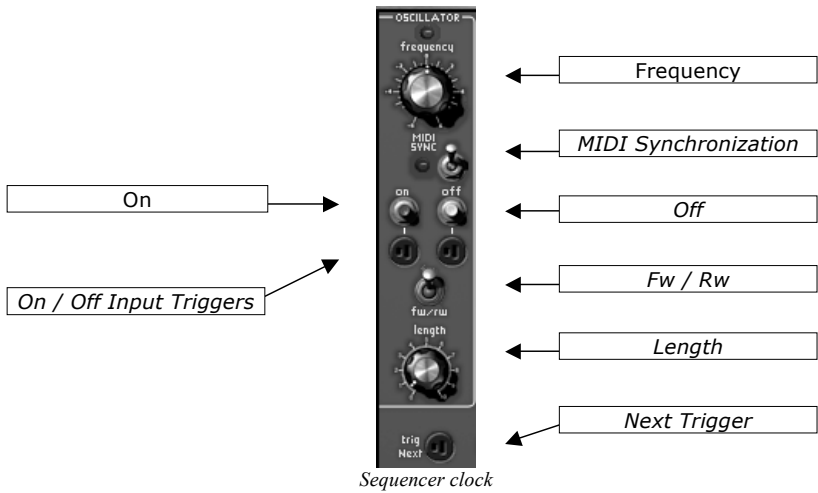

Sequencer clock

- Frequency** Sets the sequencer clock speed
- On** Starts the sequencer
- Off** Stops the sequencer
- On Input Trigger** Connection of a trigger signal to start the sequencer
- Off Input Trigger** Connection of a trigger signal to stop the sequencer
- Length** Length of the trigger signal generated by the sequencer
- MIDI Synchronization** Synchronization of delay with host application tempo
- Next Trigger** Connection of a trigger signal for the passage to the next step
- Fw - Fw/Bw** Select the sequencer mode (forward, or forward/backward)

The low frequency oscillator gives rhythm to the passage from one sequence to another. The speed can be statically set with the "frequency" knob and dynamically with the modulation input situated on the first section. The "synchronization" interrupter synchronizes this generator on the tempo of the host application. In this case, the "frequency" knob selects multiples and sub-multiples of this tempo.

The passage from one step to the next can also be done by the means of a trigger signal (from the keyboard for example) connected to the "next trigger" input.

The two "On" and "Off" button start and stop this generator. When it starts, it resets the sequence manager on the first step.

The starting and stopping can be done dynamically with the associated trigger inputs.

The "length" knob sets the trigger signal width coming from the sequencer.

The "backward" interrupter allows a round-trip progression, instead of a progression indicated by the next step indicators.

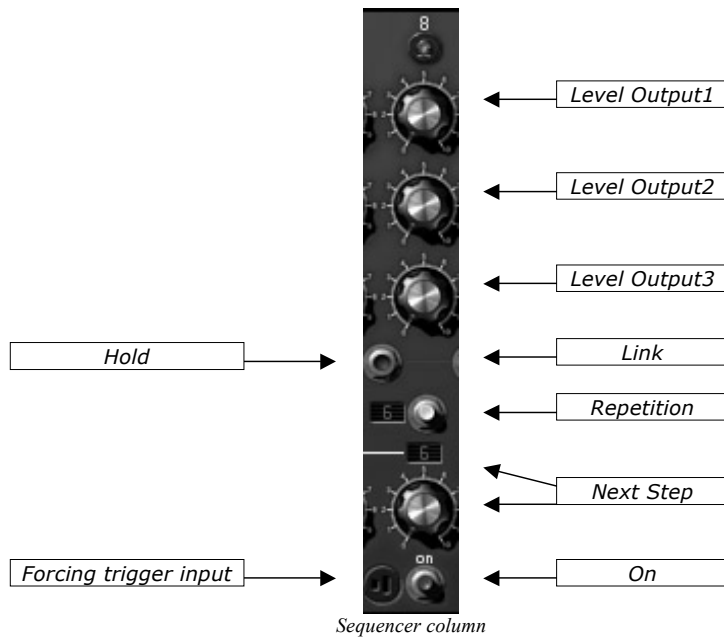

- Level Output1** Sets the level of modulation or tuning for output1
- Level Output2** Sets the level of modulation or tuning for output2
- Level Output3** Sets the level of modulation or tuning for output3
- Link** Link to the previous step (no trigger)
- Hold** Number of clock beats of hold on this step
- Repetition** Request for output trigger for each held clock beat
- Next Step** Selects the next step
- On** Forcing step
- Forcing trigger input** Forcing input or not

The sequencer has 8 steps. Each step defines 3 output levels with the help of 3 rotating buttons. The manager moves from one step to another at each impulse of the sequencer clock or upon the reception of a signal on the trigger input "next trigger". The led above each of the steps lights up when active.

It is possible to force the sequencer to initialize itself on a particular step, either by clicking on the "Forcing" button of the desired step, or through a signal in the associated input trigger.

Every time the sequencer comes to a step, the corresponding trigger output is activated, allowing the start-up of certain envelopes.

It is possible to remain on a particular step by modifying the "Hold" display. In this case, we need a certain number of clock impulses from the sequencer (or from the trigger input) equal to the number indicated to go to the next step.

The rotating selector indicates the next step. It possesses 10 positions, the first 8 represent the next steps, the ninth is a random selection, and the last is the generator stop.

When this last position is chosen on a step, the sequencer clock is stopped, the manager is reset on the first step and the outputs set to zero.

At every change of step, a general trigger signal from the sequencer is activated. This output will be activated at every clock impulse if the "repetition" interrupter is active. In the same manner, there is no activity from this signal if the "link" interrupter is inactive.

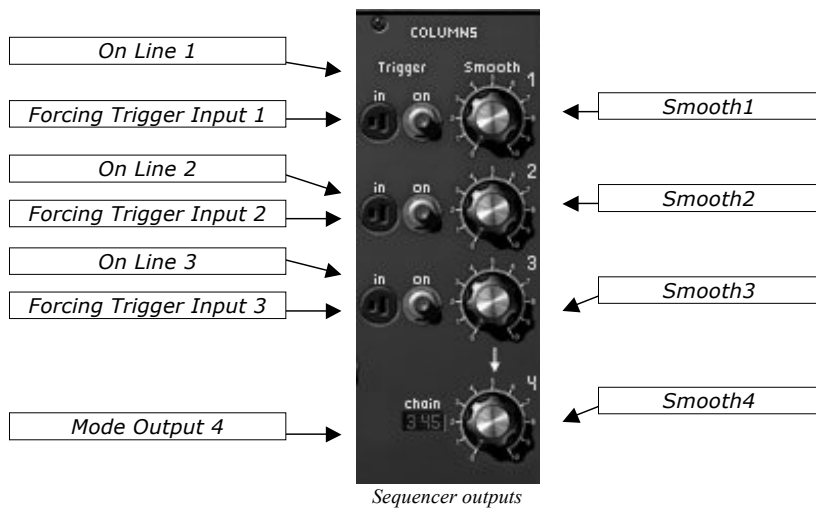

Sequencer outputs

- Smooth 1** Sets smooth for output 1
- Smooth 2** Sets smooth for output 2
- Smooth 3** Sets smooth for output 3
- Smooth 4** Sets smooth for output 4
- On Line1** Forcing of the selection from output 4 to output 1
- Forcing Trigger Input 1** Forcing trigger input of the selection from output 4 to output 1
- On Line2** Forcing of the selection from output 4 to output 2
- Forcing Trigger Input2** Forcing trigger input of the selection from output 4 to output 2
- On Line3** Forcing of the selection from output 4 to output 3
- Forcing Trigger Input3** Forcing trigger input of the selection from output 4 to output 3
- Mode Output4** Choice of progression mode of output 4

The control section of the sequencer outputs allows the management of four outputs in function with the current step. The first outputs take their values from the values specified by the rotating buttons of the current step, eventually with a smooth that can be set with the "smooth".

The fourth output, for which the smooth can also be set with a "smooth" knob, is managed in the following manner. It takes the value of one of the 3 outputs in function with the current step and the type of progression specified by the "Mode output 4" selector.

When placed in the "none" position, the fourth output takes the output value selected by the "Forcing Line" button and its corresponding trigger input. It is therefore possible to have 3 different sequences, activated either manually by a click or dynamically by a trigger.

When the "Mode Output 4" selector is placed on the "L123" position, the fourth output will automatically cross outputs 1,2 and 3 each time the current step arrives on the eighth step. In this manner, it is possible to have a 24-step sequence. Placed at the "L321" position, the lines will be done in the inverse order. In the same manner, on the "L12" "L13" or "L23" positions, the fourth output will cover lines 1 and 2, or 1 and 3, or finally 2 and 3, thus obtaining 16 step sequences.

When the "Mode Output 4" selector is placed on the "C123" position, the fourth output covers lines 123, but the change takes place at every sequencer clock impulse. We just need to wait for 3 impulses at every step, to alternatively have lines 1,2 and 3 of each of the steps. The functioning is the same on positions "C321", "C12", "C13" and "C23".

On the "Rand" position, the choice of fourth output is random.

1.15 **Third Section**

A small section has been added below the connection section. It regroups all of the external input-outputs on the sequencer, and the key follow outputs. You will also find an interrupter which activates A440.

The output jacks "External audio" are used to treat the external signals and use the Modular V as an effect.

The "Out" jacks correspond to the two left and right output jacks on the Modular V. It is thus possible to loop it to itself and obtain special effects.



Internal connections

1.16 **Fourth section**

The fourth section contains a virtual keyboard, control for the 4 key follows, 2 modulation surfaces, and a few shortcuts to the most frequently used settings (Envelope for the 2 output VCA and cut-off frequency settings for the 3 filters). You will also find general settings like choice of Monophonic/polyphonic, the "retrigg" mode or "legato".

It is also in this mode that we find the volume control and general tuning.

1.16.1 Keyboard follow management

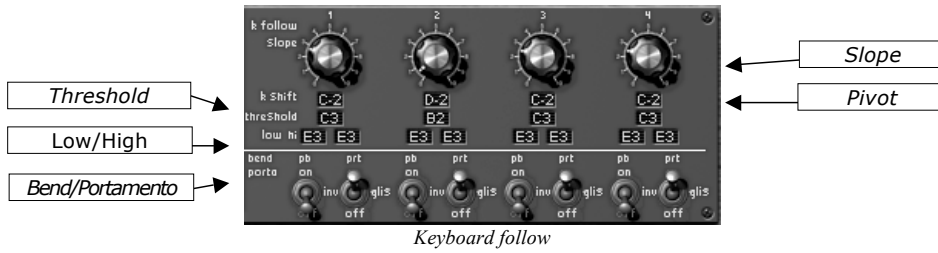

Keyboard follow

- Slope** Sets the slope of the keyboard follow
- Pivot** Selects the pivot note of the keyboard follow
- Threshold** Selects the threshold note of the keyboard follow
- Low/High** Selects the low (high) note of the generator for the trigger of the keyboard follow
- High** Selects the high note of the generator for the trigger of the keyboard follow which can also be inverted
- Bend/Portamento** Request for affectation of a pitch bend (portamento) or glissando to the keyboard follow

There are four independent keyboard follows. Each possessing a slope setting with the "Slope" knob, a pivot note chosen in the "pivot" display and a threshold note chosen with the "threshold" display begin from which the slope is null.

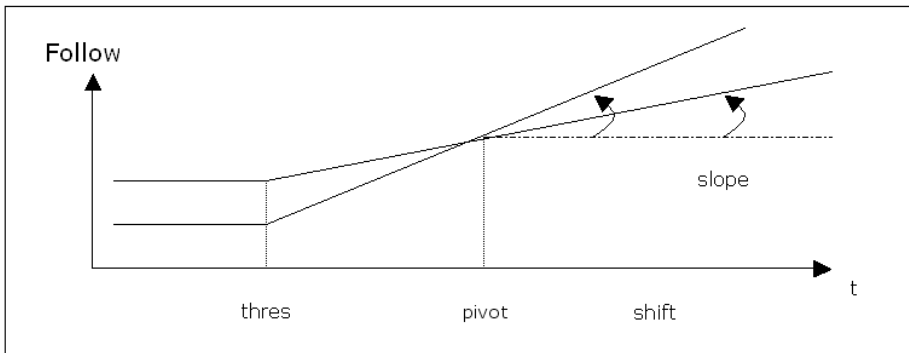

Keyboard follow management

Each of the keyboard follows can generate a trigger signal. Two displays allow the choice of a low and high note. When the keyboard detects a note between the 2 limits, the trigger signal is active as long as the note remains active. When the note is outside of the limits, the trigger signal remains inactive. If the notes selected for the upper and lower limits are such that the lower note is higher than the upper, then the note detected by the keyboard must be outside of the limits to activate the trigger signal.

The "Portamento" and "PitchBend" buttons of each of the keyboard follows allows the affectation of a portamento or pitch bend. The pitch bend can be inverted (the modulation is negative when the command is positive), which allows us, for example, to lower the filter cut-off frequency insofar as the tuning of the oscillators is raised.

It is also possible to replace the portamento (continuous glide of the frequency) with a glissando (frequency glide by semi-tone)

1.16.2 General settings

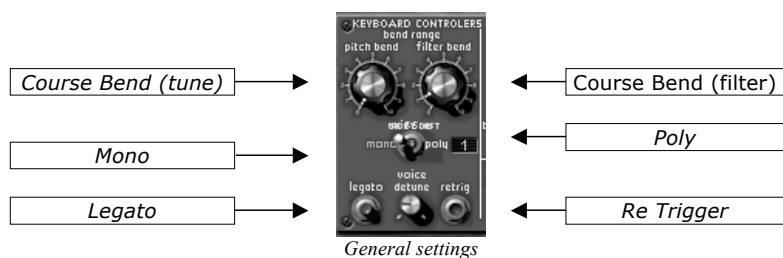

Course Bend (filter)	Filter coarse for the pitch bend wheel
Course Bend (accord)	Oscillator tuning coarse for the pitch bend wheel. (by semitone from 0 to 4 octaves)
MonoPoly	Selects synthesizer mode: (Monophonic, Unison or polyphonic)
Legato	Selects legato mode (the portamento is active when the notes are detached).
Re Trigger	Selects the re trigger mode (the keyboard generates a trigger when the notes are linked)
Nbr Release	Select the number of release notes
Poly	Gives the number of polyphonic tracks (16-32-64)

The Modular V responds to the pitch bend depending on the position of the "tune" selector. This selector sets the amplitude of this response to +/- four octaves per semi-tone. The knob close at hand noted "filter", allows the setting of the excursion of the response to the tuning wheel for the filter cut-off frequency,

The "MonoPoly" interrupter takes the synthesizer from monophonic to polyphonic mode. The Unison position allows us to play the indicated number of voices in parallel, while the playing mode remains monophonic.

In the monophonic mode, 2 interrupters allow the control of the triggering of the envelopes. The first, "re trigger" allows the reactivation of the trigger signal in the case where the notes are linked. The second, "legato" allows the affectation of frequency smoothing (portamento) whether the notes are linked or not.

The rotating "Volume" button sets the general volume of the Modular V, while the rotating "tune" button allows us to set the tuning with amplitude of 1 tone.

6 THE BASICS OF SUBRACTIVE SYNTHESIS

Of all of the forms of sound synthesis, subtractive synthesis is still one of the oldest and most frequently used today. This method was developed from the 60's on Bob Moog's analog synthesizers, and then later on ARP, Buchla, Oberheim, Sequential Circuits (Prophet series), Yamaha (CS series), Roland, Korg (MS and PS series) to name but a few. This synthesis technique is still used on most of the current digital synthesizers, added to sample reading or wave tables, which have progressively replaced analog oscillators since the 80's. The original modular systems, and your Modular V, represent the best illustration of the immense possibilities of subtractive synthesis.

Modular synthesizers use a certain number of base modules, placed in sections where the size varies in relation to the importance of the systems. These modules, once connected, allow the creation of a multitude of sounds.

1.17 The three main modules

1.17.1 The oscillator or VCO

The oscillator (Voltage Controlled Oscillator) can be considered as the starting module (with the noise module that we often class among the oscillators) for the creation of a sound on a modular system. It is here that the first sound signal is created and we can consider the oscillator like the strings of a violin which, when stroked or plucked, vibrates to create a sound.

The main oscillator settings are the pitch and the waveform.

The **pitch** is determined by the oscillation frequency. The oscillator frequency setting is done with two controllers: firstly the Range selector which mainly determines the fundamental frequency, often expressed in feet: 32,16,8,4,2 — the highest number (32) gives the deepest tone, and on the other hand, 2 gives the highest tone; Secondly, the frequency setting which will tune the oscillator more precisely.

The **waveform** determines the harmonic richness of the audio signal. 4 waveforms are available on the Modular V: **sawtooth**, **square/PW**, **triangle** and **sinus**.

- The **sawtooth** is the richest audio signal of the 4 available waveforms (it contains all of the harmonics at decreasing volume levels in high frequencies). Its "brassy" sound is ideal for brass sounds, striking bass sounds or rich accompaniments.

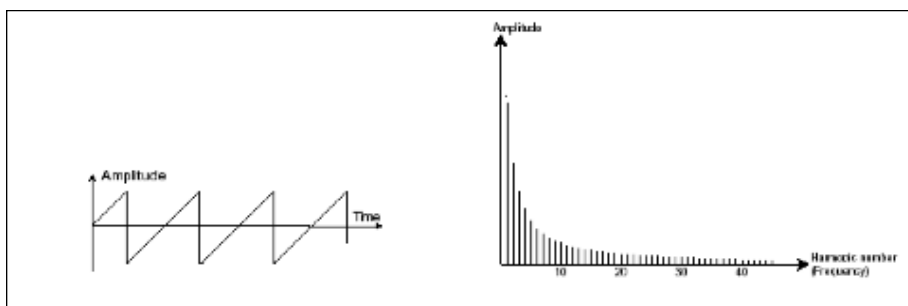

Sawtooth waveform

- The **square** possesses a more "hollow" sound than the sawtooth (it only contains impair harmonics) but nevertheless, its sonic richness (notably in the low frequencies) could be used for sub basses emphasized in the mix (the square oscillator should be

thus set an octave below the that of the saw tooth), wooden sounds (clarinet if the square signal is a little filtered), etc.

The **PWM** (Pulse Width Modulation) is a setting which allows the modification of the square wave form cycle (or wave width). This can be done manually with the "PW" knob or through modulation (using an envelope or a LFO). This variation of impulse width is translated by a spectrum modification, not unlike a waveform change.

 Unlike classic analog synthesizers, the Modular V allows you to change the impulse width through not only the square waveform, but also the sawtooth and triangle. This offers a large number of sonorities on top of the base signals.

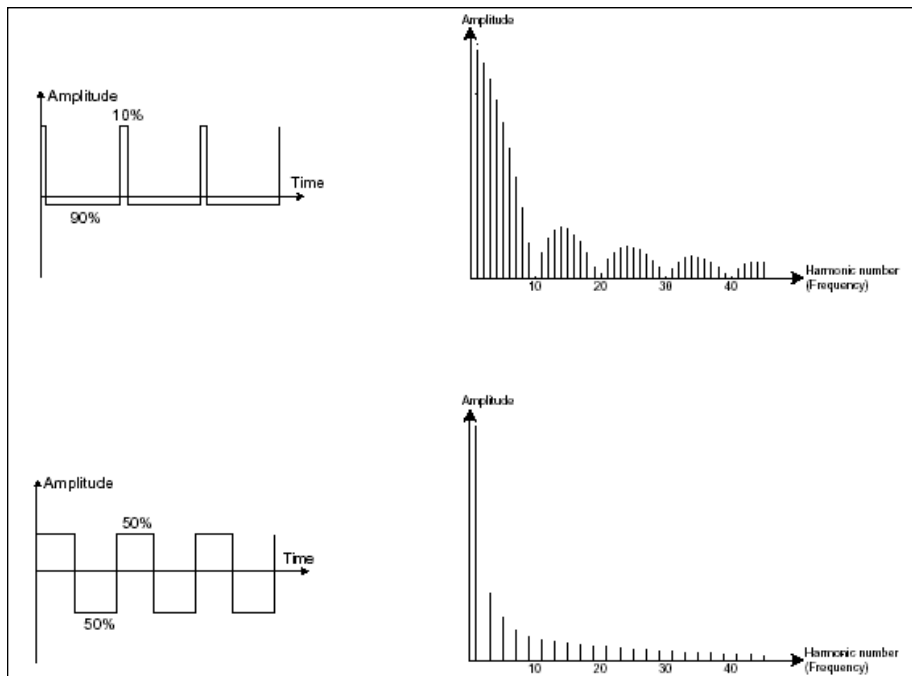

Square waveform

- The **triangle** could be considered like a much-filtered square signal (thus very soft). It is very poor in harmonics (impair equally) and will be very useful for creating sub basses, flute sounds, etc.

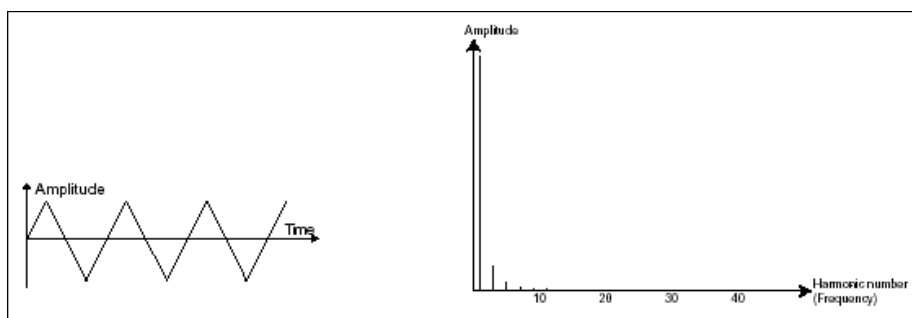

Triangle waveform

- The **sinusoid** is the purest waveform of them all. It is composed of a single fundamental harmonic and produces a very “damper” sound (the tonality of a telephone is sinusoid). It will be used to reinforce the low frequencies of a bass sound or as a frequency modulator in order to create harmonics that do not exist in the original waveforms.

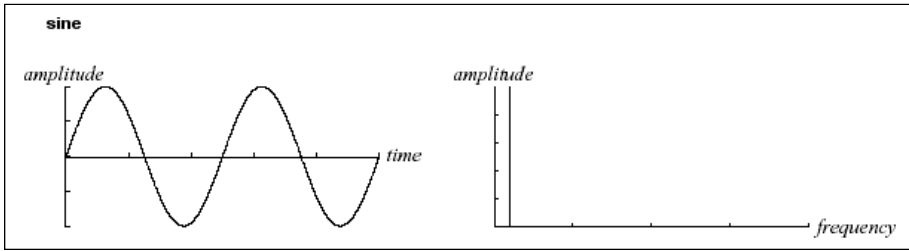

Sinusoid waveform

A **frequency modulation (FM)** can be created between 2 oscillators by connecting the audio output from a first sinusoidal oscillator to the modulation input of a second oscillator. On the Modular V, if you turn the modulation rate ring, you will obtain a sound richer in harmonics. If you introduce a square or sawtooth signal, the result can be quickly distorted... but interesting for inharmonic sonorities like bell sounds or special effects for example.

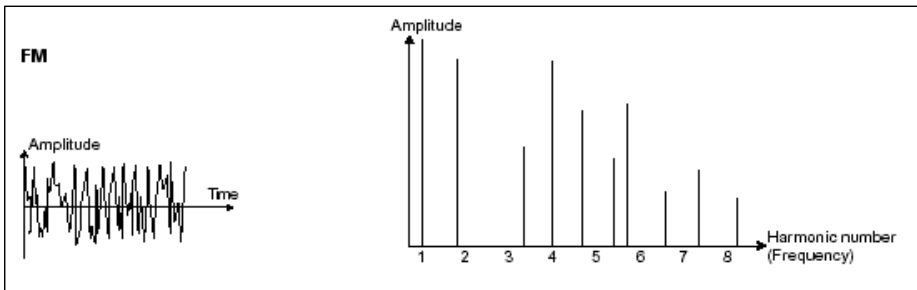

Frequency Modulation

The **synchronization** of an oscillator on another brings about complex waveforms. If, for example, you synchronize oscillator2 on oscillator1, oscillator2 will restart another period each time the first oscillator accomplishes a complete period, even if oscillator2 has not completed a full period (which signifies that it is not tuned to the same tonality.) The higher you tune oscillator2, the more you will obtain composite waveforms.

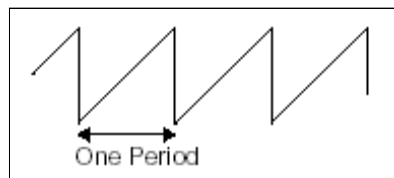

The complete cycle of a wave form (sawtooth) = one period

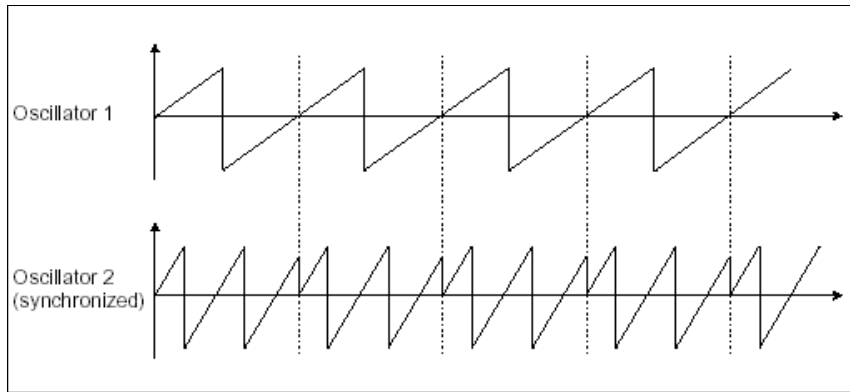

Oscillator synchronization: the second is synchronized on the first one

In the image above, oscillator2 is synchronized with the first, and then tuned to a frequency with double the tonality.

The **noise** module: the noise signal spectrum possesses all frequencies at the same volume. For this reason, the noise module is used to create different noises like the imitation of wind or a breath, or even special effects. White noise is the richest of noises. Pink noise is also commonly present on synthesizers. It is not as rich in high frequencies as white noise, having received a low pass filtering.

Also, note that the audio output of the noise can be used as a modulation signal (specially when it is heavily filtered) to create random cyclic variations.

On pre-cabled synthesizers, the noise module is either integrated into the oscillator, (its audio output being placed as a complement on top of the wave form outputs) or the mixer directing the signals to the filter. On the other hand, on modular synthesizers, it is an independent module.

1.17.2 The filter or VCF

The audio signal generated by an oscillator (the wave form) is generally directed towards a filter module (Voltage Controlled Filter). It is this module that allows the modeling of the sound by filtering (by subtraction, explaining the name of this type of synthesis) the harmonics situated around a cut-off frequency. It can be considered like a sophisticated equalizer, which reduces, depending on the case, the low or high frequencies of a sound.

The removal of unwanted frequencies from a cut-off frequency is not sudden, but is done progressively, depending on the filter slope. This filter slope is expressed in dB/octave. The filters used in classic analog synthesizers have slopes of 24 dB/octave or 12 dB/octave.

The 24 dB/octave offers a more efficient filtering than the 12 dB/octave.

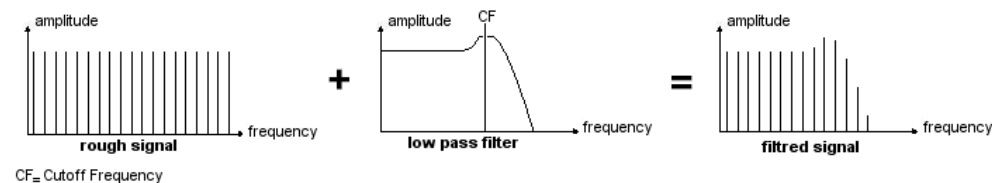

On the Modular V, you have access to 7 different types of filtering. Let's have a look at their respective properties.

The **low-pass filter (LPF)** deletes the high frequencies from a frequency limit (the famous cut-off frequency) and only allows low frequencies to pass. Depending on the setting, we will hear the sound becoming more or less “brilliant”, or more or less “thick”. This is the type of filtering that you will commonly find on synthesizers using subtractive synthesis. It is equally present on analog synthesizers as well as the most recent digital models.

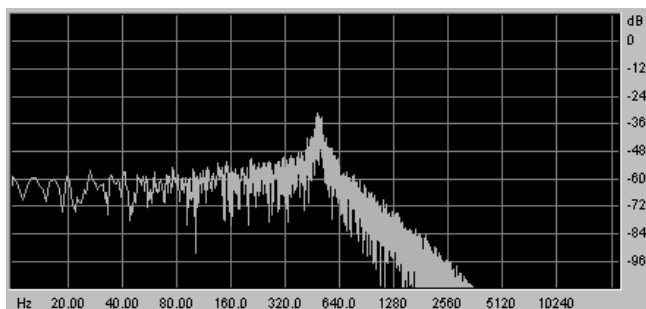

Low-pass filter

The **high-pass filter (HPF)**, as opposed to the low-pass, eliminates low frequencies and only allows high frequencies past. The sound will thus become “finer”. It is very useful for removing redundant low frequencies.

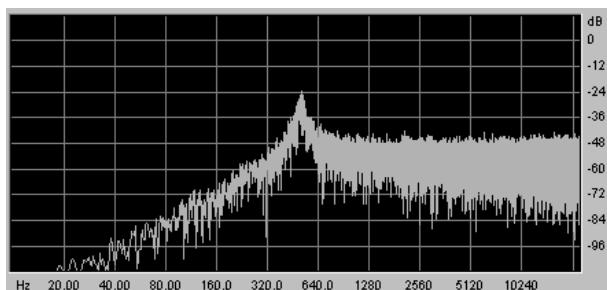

High-pass filter

The **band-pass filter (BPF)** eliminates the frequencies situated on either side of the cut-off frequency. Use it to make a certain band of frequencies that you wish to emphasize appear. This will make the sound more “pinched”.

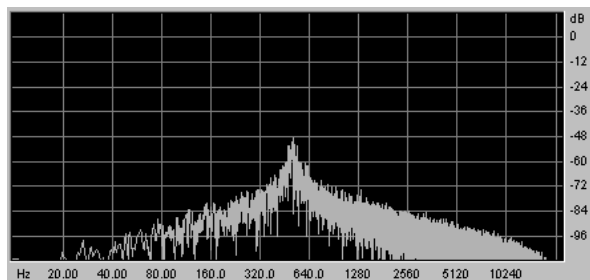

Band-pass filter

The **band-reject filter (notch)** eliminates the frequencies inside a band of frequencies. This filter is above all else interesting when we want to vary this band of frequencies (with the "frequency" on the Modular V filters or the modulation of an LFO on this same parameter). You will thus obtain a sound close to a "phasing" effect.

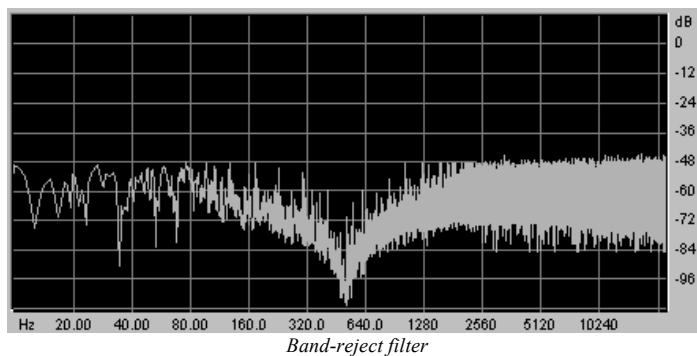

These 4 types of filtering are more often used on analog synthesizers. The Modular V offers 3 other types of filters, unheard of on synthesizers, but very much used on high quality mixing consoles or professional equalization modules:

The **bell filter** amplifies or dampens a frequency band (in function with the gain knob).

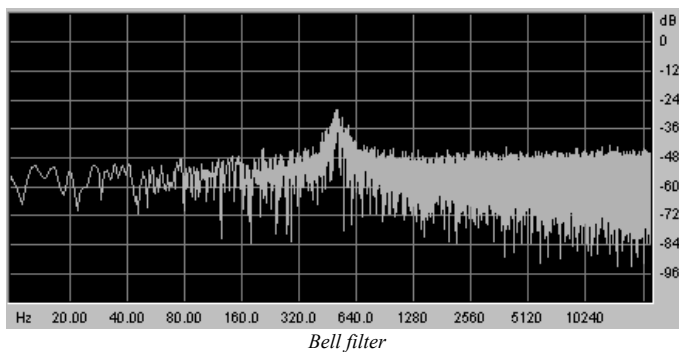

The **low-shelf filter** amplifies or dampens the frequencies under the cut-off frequency (with the action of the gain knob).

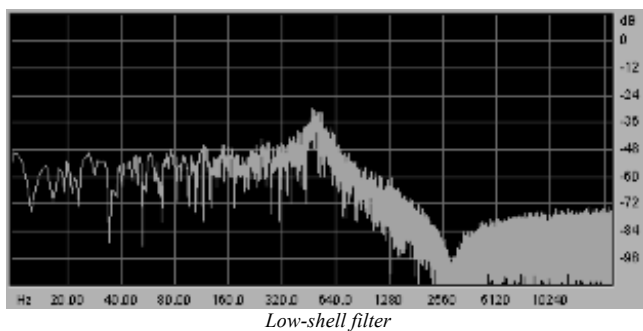

The **high-shell filter** increases or decreases the frequencies above the cut-off frequency (with the action of the gain knob).

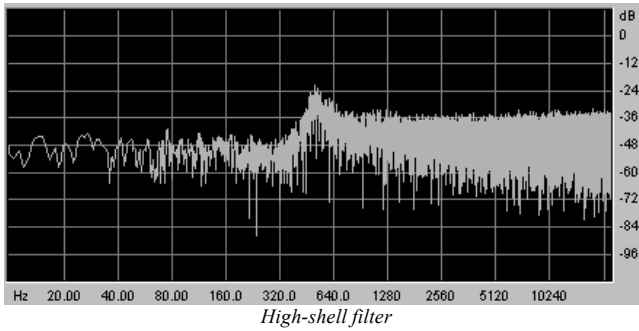

A second setting completes the cut-off frequency: the **resonance**. You will also find it under the terms "emphasis" or "Q" – as a "filtering **quality factor**".

The resonance amplifies the frequencies close to the cut-off frequency; the other remaining frequencies are unchanged (before the cut-off frequency) or diminished (after the cut-off frequency).

You can increase the rate of resonance by simply turning the resonance knob.

When you increase the resonance, the filter becomes more selective, the cut-off frequency is amplified, and the sound begins to "whistle".

With a high level of resonance, the filter will begin to oscillate on its own, producing a sound close to a sinusoidal waveform. At this stage, the use of a key follow is very important as you can create a melody by tuning the filter cut-off frequency with the frequency of the oscillators.

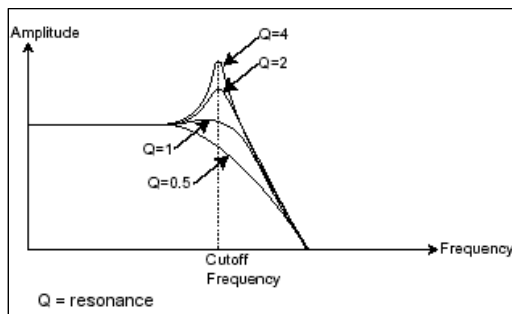

Filter resonance, noted as "Q"

1.17.3 The amplifier or VCA

The amplifier (Voltage Controlled Amplifier) is charged with receiving the audio signal coming from the filter (or directly the one from the oscillator if it is not filtered) to adjust its volume with a knob, before the signal is directed to the speakers.

In conclusion, here is a scheme that may help you to understand the composition of a basic sound:



1.18 Complimentary modules

1.18.1 The keyboard

If we hold down a key at this stage, the sound you will get from the speaker will be uniform, without life and without end. In fact, the oscillator delivers a continuous signal (the audio output of a wave form) of a fixed pitch. In the scheme above, the only means of stopping this sound that quickly becomes unsupportable is by lowering the filter cut-off frequency so that it becomes more and more thick until it disappears; or more simply, to lower the volume of the amplifier.

To trigger and stop this sound, and this, at the tone that we want, we use a keyboard, which will be connected to the oscillator. This will “play” as soon as a key is pressed and will mute it as soon as released. Of course, this connection is made through MIDI (it replaces the “gate” type connection of analog synthesizers, which triggers the sound when the key is pressed and stops when released).

In the second case, so that the sound is correctly tuned with the keyboard notes, we need to apply a key follow modulation (replacing the 1Volt/octave control present on most analog synthesizers).

 To play the Modular V with a MIDI keyboard, click on the “trigg in” plug of the output VCA and select the “keyboard trigger” function. For more detail, see chapter 5 paragraph 1.1.5 “Output Amplifiers (VCA)”. Next select one of the 4 key follow settings in the display “S1...4, off” on each “Driver” oscillator.

If you don’t have a keyboard, you can play on the Modular V virtual keyboard.

1.18.2 The envelope generator

The envelope generator, connected to the amplifier, is used to “sculpt” the form of a sound during a cycle, which begins when we press a note on the keyboard, and ends when we release.

The most current envelope modules use 4 settings that we can vary:

- The **Attack** is the *time* that the sound will take to reach its maximum volume once the key has been pressed on the keyboard.
- The **Decay** is the *time* that the sound will take to decline after the key is played.
- The **Sustain** is the maximum *level* of volume that the sound will reach when a key is pressed.
- The **Release** is the decline *time* after the key has been released.

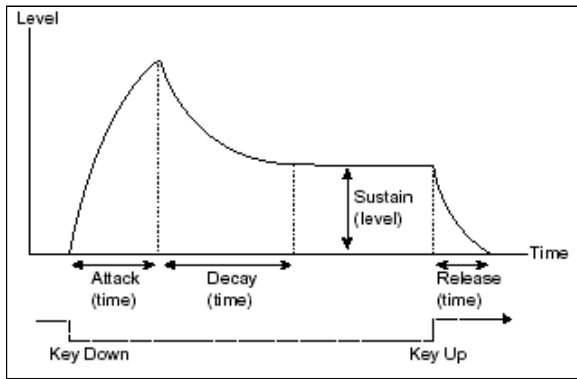

The ADSR envelope

On the two VCA of the Modular V, the envelopes include 2 supplementary settings:

The **Slope Time** is the *time* of intermediary decline situated after the decay, once a key is pressed.

The **Slope Level** is the *level* of intermediary decline situated after the decay, once a key is pressed.

The envelope generator can also be used to modulate other settings like the cut-off frequency of a filter or an oscillator for example.

1.18.3 The low frequency oscillator

The LFO (Low Frequency Oscillator) possesses, among other things, the same characteristics as classic oscillator but does produce frequencies inferior to 20 Hz. In other terms, you won't hear the sound if you connect the audio output of an LFO in an amplifier.

Not being used to produce a sound, it can be used to create a cyclic modulation on the parameter on which it is connected.

For example: if you connect an LFO to the modulation input of an amplifier, the sound volume will increase and disappear in an alternate manner depending on the speed (the frequency) of this LFO. This will create a *tremolo* effect.

To produce a *vibrato* effect, simply connect the sinusoid output of an LFO to the modulation input of an oscillator. The frequency of this oscillator will thus be modulated up and then down.

Finally, try to connect an LFO output to the modulation input of a lightly resonant low-pass filter and you will obtain a *wah-wah* effect.

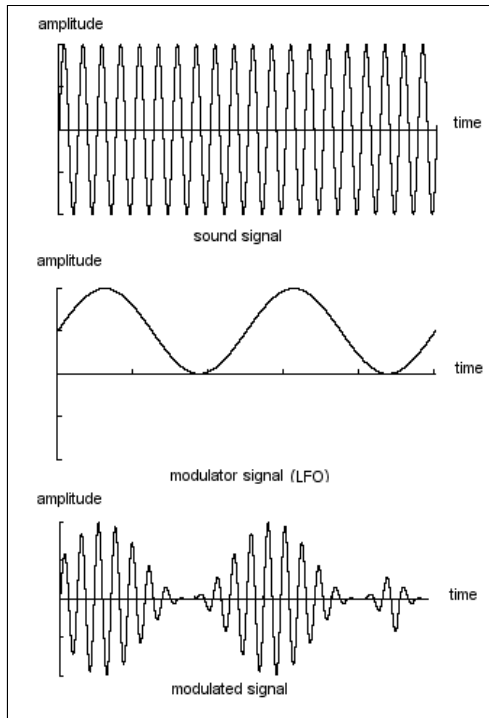

VCA modulated by a LFO

Now to finish, the scheme of a full synthesizer containing:

- 3 oscillators (VCO)
- 1 noise module
- 1 mixer (mixing the 3 VCO and the noise module towards 2 filters)
- 2 filters (VCF)
- 2 amplifiers (VCA, can be placed in stereo with the pan knobs)
- 3 envelopes (ADSR)
- 3 LFO
- 1 keyboard

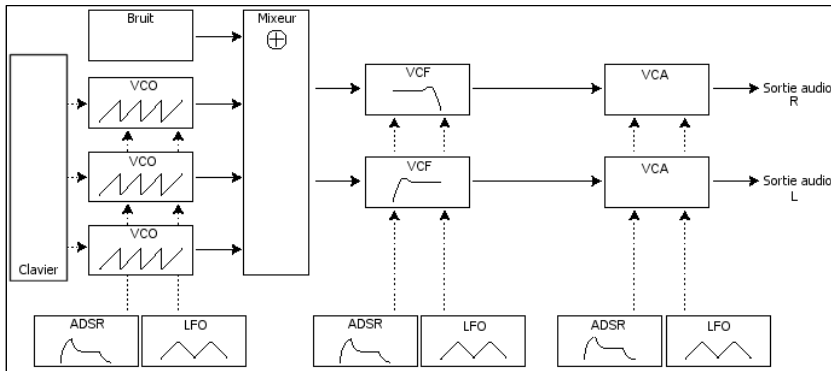

Synthesizer scheme

7 A FEW ELEMENTS OF SOUND DESIGN

Here is a series of examples designed to guide you through the creation of a sound and a sequence. They are classed in order of complexity beginning with the easiest, and are organized into 4 parts:

The first part will teach you the basics of modular sound synthesis. For this you will go from the most basic patch (Make a VCO oscillator "ring" in an output VCA amp) to programming a richer sound (several VCO sources, VCF filters, VCA envelopes...)

The second will help you to use all of the different aspects of the sequencer

The third will show you tips on the creative use of the key follows, triggers and the creation of a stereophonic sound without using extra chorus and delay effects.

The fourth and last part will guide you through the use of three of the new modules in the Modular V 2.0: the Bode Shifter, the envelope follower and the Formant Filter.

1.19 **Modular sound synthesis**

1.19.1 **Simple patch #1**

To begin, we will learn how to program an elementary monophonic sound. It will be composed of 4 modules:

- an oscillator
- a low pass filter
- an output VCA
- the envelope corresponding to the output VCA.

You will thus obtain the base patch of subtractive synthesis.

*⚠ If you click on one of the "Inv" buttons on the mixer VCAs, this will not change the base tone of the preset but will invert the signal connected to this VCA. (For example, a descending "sawtooth" signal will become ascending)
In addition, if you apply soft clipping (light distortion) on one of the VCA, the operation will most likely use more CPU load than before.*

The following figure shows the connections for this sound as well as the position of the different knobs:

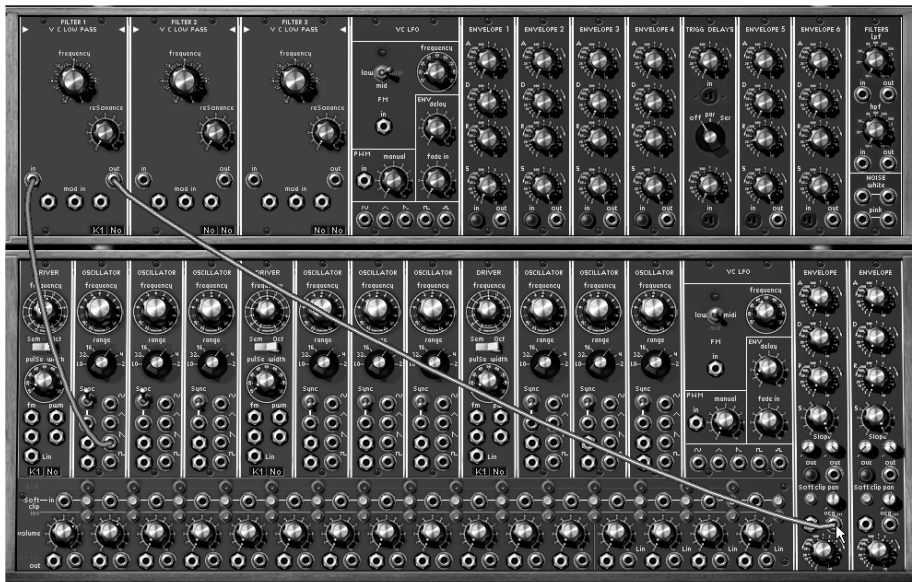

Simple patch #1

- ▶ To begin, load the "Blank_Synth" preset in the "User" / "Blank". You will notice that it has no cable connection and it delivers no sound. This is normal, it is from this preset that you will program your sounds from scratch.
- ▶ Choose a sound source on the first oscillator situated in the lower section: take the audio output of the saw-tooth waveform by clicking on the jack . This wave form produces the richest noise signal out of the 5 wave forms proposed. It will be ideal for creating a "brassy" sound, for example.
- ▶ Direct the cable to the input of the first filter ("VC Low Pass Filter") by dragging it to the "In" jack. This first cable will come confirming the connection.
- ▶ Now direct the audio output from this filter ("Out" jack) to the (jack "vca in") input of "VCA1" (output amplifier). Make sure that the trigg input of the output amplifier (VCA1) selects "keyboard trigger"
- ▶ Now play on your MIDI keyboard and you will hear the sound from your first patch.

We recommend that you save it as it is as it will come in useful for programming basic bass or lead sounds. (See the "saving a sound" chapter)

Turn the filter cut-off frequency button progressively to the left to change the brilliance of the sound. It will become increasingly "soft".

1.19.2 Simple patch #2

The sound of your first patch may seem a little empty. Here is how to make the sound more interesting and "fatter". This patch will use:

- 2 oscillators
- 1 low pass filter
- 1 output VCA

- 1 envelope
- 1 LFO

It will more or less constitute the classic composition of a basic synthesizer. You will be able to regularly reuse this patch, don't erase it.

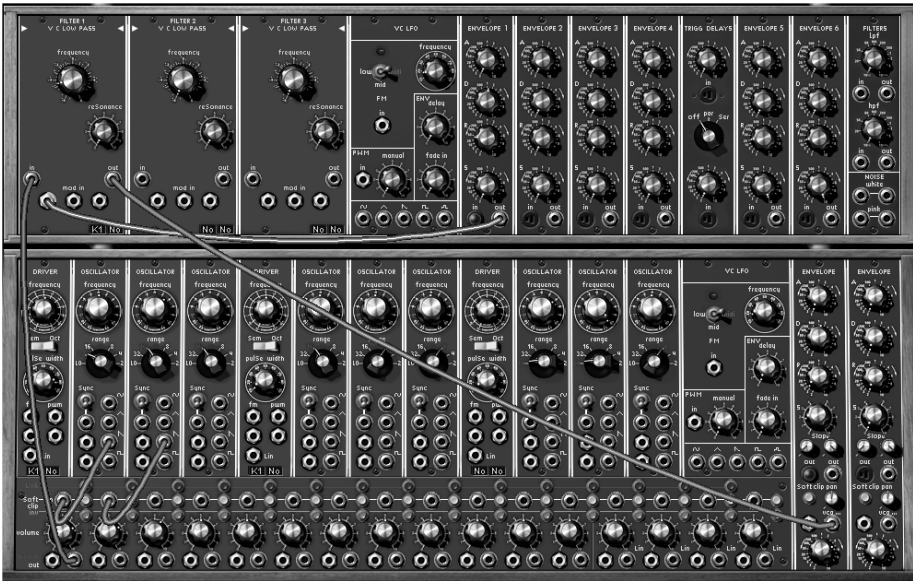

Patch #2 complete

- ▶ For more clarity, reuse the "Blank" preset.
- ▶ As previously, connect the "saw" output of oscillator1 to the first mixer VCA input. Next, connect the oscillator2 "saw" waveform to the second VCA.



Connection of oscillators to mixer

- ▶ Create a link between these 2 VCA by clicking on the "link" button situated between the first and second VCA. This will allow you to mix these 2 sources before directing them towards the audio input of filter1.



Click on the link button to create a link between the 2 VCA

- ▶ To connect the audio output coming from the 2 mixed VCA to the filter1 input, drag a cable from the first VCA "out" to the filter1 "in".



Link towards filter1

- ▶ As was the case with the previous patch, direct the filter output towards the audio input of the output VCA 1.
- ▶ Now increase the volume of these 2 VCA (volume knobs) so as to hear the sound coming from the 2 oscillators.



Setting of the volume of the 2 mixer VCA

► To give more life to your sound, click on the “frequency” knob on the first oscillator with the right click of the mouse (“Fine tune” position) then lightly turn towards the right (to increase the height of its tone) or the left (to decrease it). You will thus progressively hear a beating resulting from the light difference in tuning of the 2 oscillators. This beat will create a chorus effect, which will give more life and “warmth”.



Detuning of oscillator 1

► Hone this sound by applying light cyclic variations on the filter cut-off frequency. Choose, for example, the “Sin” output of LFO1 and direct it to the first modulation input (“Mod In”) of filter1. Click again on this jack and lightly turn it towards the right (to 2 o’clock for example). This will dose the modulation input to the cut-off. Finally, lower the cut-off frequency to hear the oscillation of the sound.



Connection of LFO to filter 1

💡 Turn the resonance button to the right to create a supplementary “brilliance” that is very “electronic” in your sound. By increasing the oscillation speed of LFO1 (“frequency” button), you will thus obtain a typical 70’s “wah-wah” effect.

1.19.3 Complex patch #1

Let’s continue with a more complex sound using:

- 3 oscillators
- the mixer
- 2 low pass filters
- 2 VCA
- 2 envelopes (1 on each filter)
- 2 LFO

This sound will be polyphonic and constitute a good example of accompaniments with subtle stereo evolutions.



The complete patch

For the conception of this sound, you can complete the previous patch.

- ▶ Start by clicking on the “link” button between the second and third mixer VCA to create the link between these 3 VCA.
- ▶ Then, on this third slice, connect the audio output of the square waveform of the third oscillator.

Notice that filter1 is still connected to the audio output of the first slice of the mixer. As a result, it now receives the signals coming from the 3 oscillators.

- ▶ Again, drag a cable from this same slice towards filter2. This of course was not possible on the original synthesizer, but here, we can have several connections from the same output.



Connection towards the second filter

- ▶ Change the second filter type: for example, select the 12 dB multi-mode filter by clicking on the button on the top left of the module.
- ▶ Choose the low pass mode. Its filtering characteristics allow us to obtain a different color from the other filter (a 24 dB band-pass). This will be very useful for the creation of interesting stereo effects for your accompaniment sound.
- ▶ Connect the audio output of this filter to the input of the second output VCA and turn the pan buttons of VCA1 to 9 o'clock and those of VCA2 to 3 o'clock to widen the stereo field.



The connections to the two VCA

- ▶ You make your sound fuller, lightly detune the frequencies of the 3 oscillators by turning their respective "Fine Tune" buttons (by clicking with the right mouse button) to create a chorus effect.
- ▶ Connect the envelope1 output to the first modulation input of filter1. Click again on the jack and turn it lightly (to 2 o'clock for example) towards the right. This will dose the

modulation input directed towards the cut-off. Do the same thing on filter2 using envelope2.

If you do not hear the sound, make sure with a right click on the "trigg" inputs of these 2 envelopes that "keyboard trigger" has been selected.

▶ Apply light cyclic variations on the filter1 cut-off frequency. Choose the "Sin" output of LFO1 and direct it to the first modulation input of filter1. Lightly turn the jack to the right (to 2 o'clock for example), this will dose the modulation input directed towards the cut-off. Lower the cut-off frequency to clearly hear the oscillation of the sound.

▶ Do the same thing with filter2 by choosing the triangular waveform of LFO1. To create subtle evolutions of stereo sound, turn the modulation jack ring in the opposite direction of filter1.



LFO1 to the filters link

- ▶ If you wish to change the LFO oscillation speed, simply turn the "Frequency" button.
- ▶ You can also create light fluctuations in the change of speed of LFO1. For this, connect the LFO2  output to the "FM" input (Frequency Modulation) of LFO1. Turn the jack ring to dose the modulation. The evolution of the 2 filters will be less linear.
- ▶ An accompaniment sound has a fairly slow attack, set the 2 VCA envelopes so that the sound appears more slowly when you press the keys of your keyboard. Turn the 2 attack buttons ("Attack" — A) to the right: set them to 2 seconds for example.
- ▶ Hone the setting of these envelopes by prolonging the decay of the sound: turn the 2 release buttons ("Release" — R) lightly increasing them (to 500 millisecond for example)



The setting of the VCA envelopes

1.19.4 Complex patch #2

This fourth example will let you go a little further in the approach of different types of modulations. It contains:

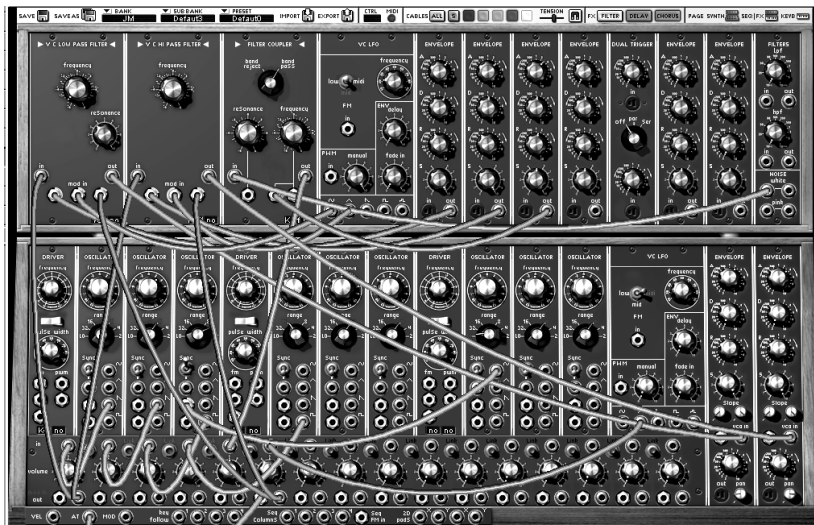

- 4 oscillators (the second being in "synchro" mode with the third)
- 1 white noise
- 3 filters (1 LP, 1 HP & 1 BP)
- 2 VCA (in stereo)
- 3 auxiliary envelopes
- 3 LFO (the 2 principal LFO + 1 low frequency)

This sound is stereo and uses delay and chorus effects. It can be as easily used in monophonic and polyphonic mode to create a very expressive ambient sound.



The complete patch

For this example, we recommend that you start over with the patch #2 base.

- ▶ Successively connect the outputs of the waveforms  of oscillators 3 and 4 to the VCA inputs 3 and 4 of the mixer.
- ▶ Set the "Range" of oscillator 3 to 16. It will play 1 octave upper than the 3 others
- ▶ Connect the white noise output to the third filter and choose the third type of filter on this (the Filter Coupler). It will be very useful in creating a resonance particular to white noise. For this set it to Band Pass mode.
- ▶ Connect the audio output of this filter to the audio input of the fifth mixer VCA.
- ▶ Connect envelope1 to one of the filter3 modulation inputs and set the modulation level to your liking.
- ▶ Increase the attack time of the envelope to 2 o'clock in order to make the sound progressively appear in the global sound.
- ▶ Now let's make another modulation appear given by the  of LFO2 which will be provoked by the aftertouch. For this, connect the "Tri" output of this LFO to the sixth audio input of the mixer.
- ▶ Connect the "Aftertouch" output to the "Mod" input of this same slice, and direct its output to the second "Mod" input of filters1 & 2, without forgetting to increase the 2 modulation levels.



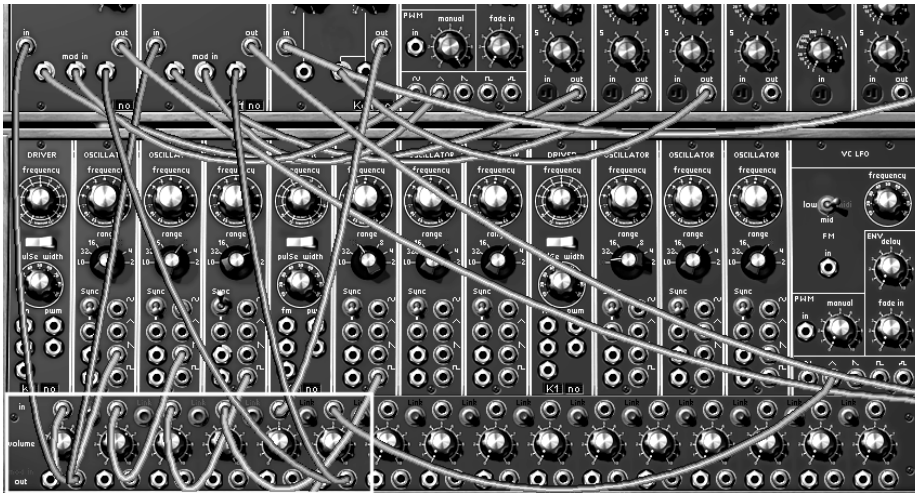

The white noise module connected to the band pass filter

- ▶ Set the third filter output towards the fifth slice of the mixer and link slices 3, 4 and 5 to direct them towards the first and second filters.



The mixing

- ▶ On the fourth oscillator, set the “synchro” mode to “ON” and to “Hard” type. Then, turn the “frequency” button to find the color and height of the sound that you like. This will also be modulated by a third LFO (for this take the “Sin” output of oscillator 7 and set it to “Low” mode so that it acts as a LFO).
- ▶ To save on CPU load, also click on the “Key F” (for Key Follow) button to deactivate the keyboard connection mode. The frequency will thus be fixed.
- ▶ Modify the waveform width for  and  on the first 3 oscillators by connecting the triangle output of LFO2 to the impulse modulation input (“PWM”) of the first “driver” oscillator. This will add new harmonic colors typical of analog synthesizers. Set the Pulse Width knob value towards the middle so that the sound does not disappear when the pulse width is at 10% (equivalent to the closed position of this knob).



Manual pulse width setting

- ▶ Set the resonance button of the first 2 filters to 9 o’clock and connect the “Sin” wave forms of LFO1 to one of their modulation inputs.
- ▶ Next set the 2 modulation levels and the LFO speed to your liking.

- ▶ Finally, set the 2 output VCA envelopes as you wish, while trying to keep the same values on the 2 envelopes.

 If you apply several modulations provoked by the different LFOs and on different destinations (filter "Cutoff", FM, PWM etc...), try to vary the different levels of modulation in order to create as many different variations in the evolution of the final sound. This is one of the strongest points of modular synthesizer.

1.20 The sequencer

1.20.1 Sequence #1

Now let's take a more detailed look at the use of the sequencer. We'll start by creating a simple sequence of notes with an oscillator. Take, for example, patch #1 from this chapter as the starting point.

- ▶ At the bottom of the first "Driver" oscillator, click once on the sequence display (situated next to the one for the key follows): the display indicates "S1". This activates the connection towards the first line of sequence on the sequencer.



Connection of the "driver" oscillator to the first sequence line

- ▶ Select the "Seq Trig" output by clicking on the "Trig" input of VCA1.

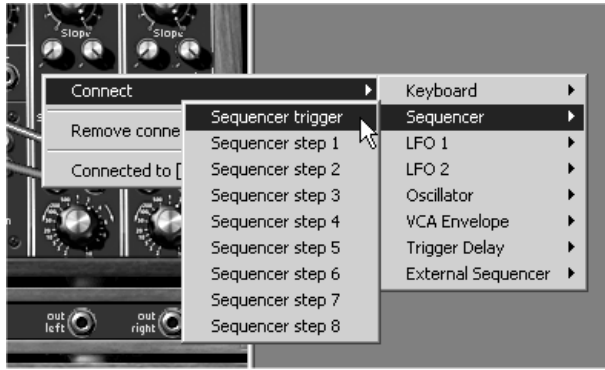

Selection of Sequencer trigger

- ▶ Now move to the second screen and click on the “ON” button situated in the “Oscillator” module. The sequencer starts up but you only hear the same pitch for all the steps. This is normal.



Start the sequencer

- ▶ Set each knob corresponding to the first sequencer line (the one to which the sequencer oscillator had been directed). You can now hear a melody.



Set the knobs of the first line of sequence

- ▶ Set the impulse width of the square signal of the sequencer oscillator with the “Length” knob. This will vary the length of the notes played.



Set the "Length" knob

- ▶ To stop the sequencer click on the "OFF" button.

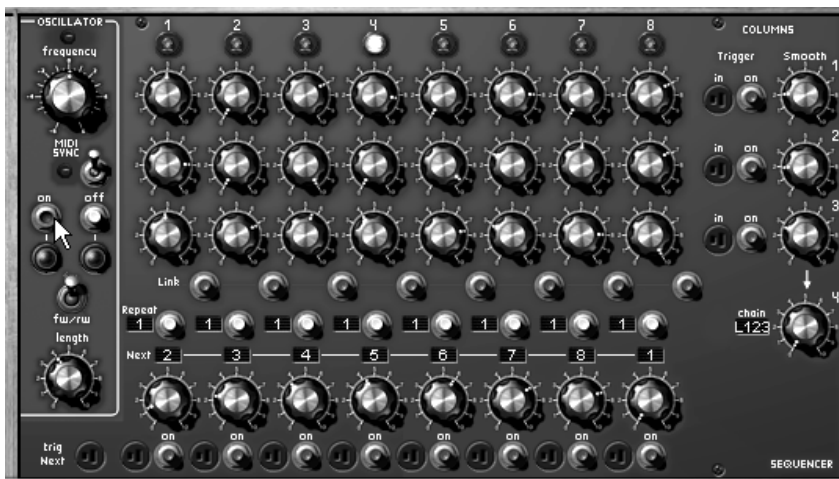

Sequence 1

1.20.2 Sequence #2

Now let's see how to use the different combinations between knobs (by lines or columns to create 8, 16 or 24 step sequences). This will allow you to quickly have very different sequence lines available which although different will harmonize perfectly together. We will also look at the possibilities for the creation of ternary sequences (for example: 6, 12 or 18 steps).

To begin, reuse the previous sequence...

- ▶ Click 4 times on the sequence display at the bottom of the first "Driver" oscillator (the display indicates "S4"). This will connect the latter to the fourth sequence output. This will allow us to create knob line or column combinations.
- ▶ Select the "L1-2" function on the line selector on the right of the sequencer. Once you have created a melody on the second line, you will alternately hear the melodies played by these two lines.



Select the function "L1-2"

▶ Do the same thing for the third line. To hear it, select "L1-2-3" and try the other selections and the columns (3 knobs per column) by activating "C1-2-3". With the "AI" position, the playing will be done randomly between each line and column.

▶ Now let's look at the creation of ternary sequences. For this, choose step 1 on the "Next" step selector of the seventh line. This will force the sequence to reset at the sixth column. You will thus have a 6 times sequence which can be synchronized with the MIDI tempo of the host sequencer (VST for example).



Choose step 1 on the seventh line

▶ We can now go much further by moving the sixth time towards the eighth column. For this, return to the initial order of the sequence (2, 3, 4, 5, 6, 7, 8, 1) and set the eighth "Next" selector to 3. This time the sequence limits will be moved three steps forward all while producing the same number of steps.

▶ Try playing on 12 and then 18 steps choosing the "L1-2" and "L1-2-3" functions or by column ("C1-2-3" etc...) or randomly with the "AI" position. The sequence playing will always be ternary all while creating multiple variations on the melody.

▶ Now try to "force" the trigger of a step by clicking on the "ON" button underneath. The sequence will interrupt its course and continue from this one. This is interesting for creating other types of sequences.



"Force" the triggering of a step

- ▶ You can also "trigger" one of these steps using a MIDI keyboard by selecting "Keyboard Trigger" on the "Trigg" output above the "ON" button. The sequence will be triggered when you press one of the notes. In the same manner, you can switch lines or columns by selecting the same function on the "Trigg" "Chain" output.

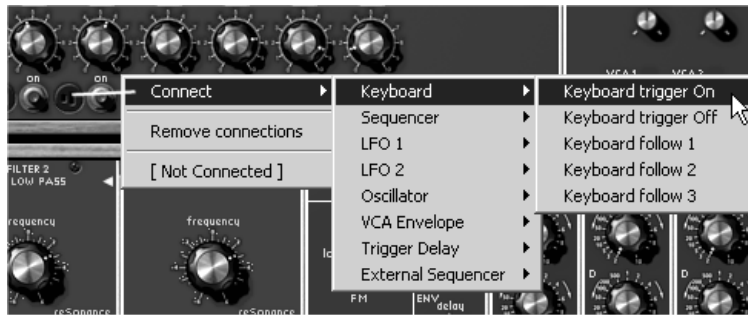

Select "Keyboard trigger" on the "Trigg" output

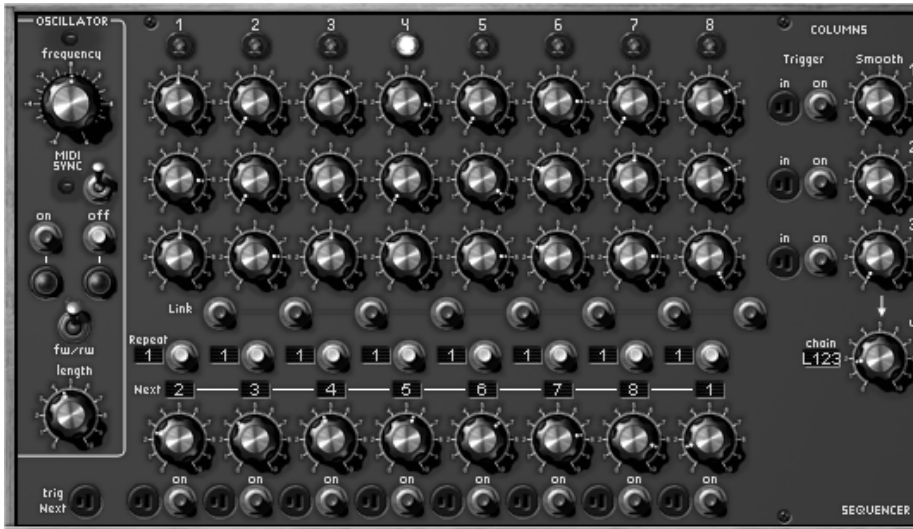

Sequence 2 complete

1.20.3 Sequence #3

Reuse again the melodic sequence #1 and complete it by adding another type of modulation. For example, make a variation on the opening frequency of filter1 ("frequency"), which will be managed by the second line of knobs. Then the third line on a second VCO and finally the fourth on the opening frequency of filter2.

- ▶ Connect the square of the fourth oscillator (in order to create a second melodic sequence, different from the first) to the audio input of filter2 and choose the "Low Pass Filter" type for this filter.
- ▶ Place filter 1 on the "S2" output of the sequencer: click several times in the small display at the bottom of the module to show its characters.



Filter1 on the "S2" sequencer output

- ▶ Place the second "driver" on the "S3" sequencer output.

- ▶ Now connect the L4 sequencer output (at the bottom of the section) to the first modulation input of filter2. You can also try a positive or negative value.
- ▶ Select the "Seq Trig" output by clicking on the "Trig" input of VCA2 and separate the knobs of the 2 VCA in order to create an evolving stereo sequence.
- ▶ Move to the second section, click on the sequencer "on" button and set the 2 knobs lines corresponding to filter1 and VCO4. Finally, choose the type of sequence chaining with the fourth column.
- ▶ If you wish to add a little "portamento" to a melodic line, turn the "Smooth" knob corresponding to your sequence line.



Turn the "Smooth" knob

- ▶ to complete the evolution of the sound in stereo, you can apply modulations to the cut-off frequencies of the 2 filters using a LFO. To make this effect more apparent, turn the level of the modulation input of filter1 to the left (negative value) and of filter2 to the right (positive value). By applying a slow rotation speed to the LFO, you will get the linking of the 2 sequences in stereo space, brought about by the opening of the 2 cut-off frequencies.

1.21 **Bonus features**

1.21.1 **Creative use of key follows**

The Modular V provides you with settings for 4 independent key follows. These key follows are mainly used to tune the oscillators in relation to the keyboard range but can also be used for different applications.

- ▶ Try, on a filter1 cut-off frequency, opening (click several times on the key follow display situated at the bottom of the filter to select the "K2" key follow). It will become increasingly brilliant when the height is increased of the follow slope is positive and the contrary if it is negative.



Click several times on the key follow display

► You can also try another type of VCA control, PWM, oscillator fine tune, LFO speed... by selecting one of the 4 key follows in one of the modulation inputs.



Connection of the PWM to the key follow input 1 (key follow 1)

► Now move to the second screen to set the slope and the notes that will separate the key follow actions. For this example, choose key follow #1.

► Turn knob "k. follow slope 1" to determine the slope of this key follow. The more you increase the value, the more important the slope and the faster the opening of the filter will be performed when the keyboard range is played.



Setting of the key follow slope

- ▶ To obtain an inverted slope (the higher you go in the scale on your keyboard, the faster the filter will close), connect the key follow1 output to the filter modulation input and turn the modulation jack ring counter clockwise.



Turn the modulation jack ring counter clockwise.

- ▶ Each of the key follows also allows the generation of a trigger signal when the selected note is between 2 limits. Because of this, certain envelopes can be triggered in function of notes or particular sections of the keyboard.



Setting the limits for the key follows

1.21.2 Creative use of triggers and trigger delays

All of the Modular V envelopes are triggered by specific signals. These signals can be generated by the keyboard (note On, note Off), by each of the 4 key follows, by the sequencer or by the trigger delay module.

- ▶ Simply click on the trigg "in" plug on the envelope to choose a trigger mode.

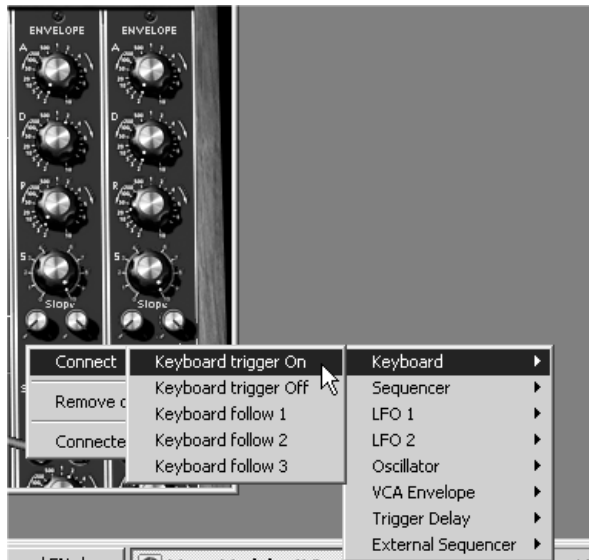

Click on the trigg “in” plug on the envelope

- ▶ Generally the envelope is triggered by the keyboard. The use of a trigger delay allows you to make the modulation appear after a determined time, as long as the note is still active. You will obtain a different sound depending on the length of the note.

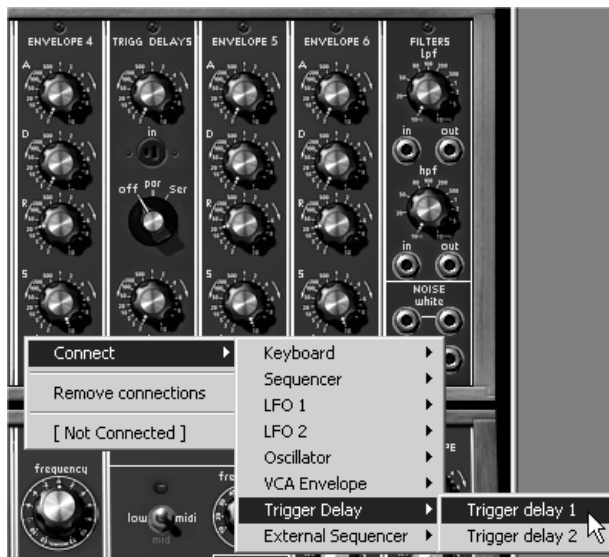

Choose the “dual trigger” option on the envelope

- ▶ The starting and stopping of the sequencer can also be done using a trigger signal. Triggered by the keyboard the sequencer is initialized on every On note. You will obtain trigger synchronization by playing the MIDI keyboard. Triggered by a particular note, the sequencer can appear only after an introduction for example.

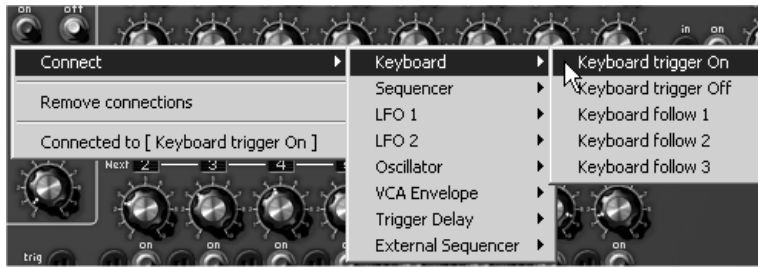

Sequencer startup through a MIDI keyboard

1.21.3 Stereo without the effects

Obtaining a stereo sound comes down to treating 2 independent channels. Each of the output VCA is positioned in stereo space using the "pan" knob.

- ▶ Set the VCA1 "pan" to the left, and the VCA2 to the right to create 2 independent channels needed for convincing stereo.



Setting the output VCA panoramic

- ▶ Connecting a different oscillator to each of the VCA allows you to obtain a very wide space. To make it evolve, apply a light detuning to one of the oscillators using a LFO or an envelope. The sound will seem like it's turning in space, or in the second case, passing from one point to another.
- ▶ To keep the stereo space very wide, it is essential to keep the 2 channels independent. It is thus necessary to use a filter for each of them. These filters can then be modulated in an identical manner, or differently without interfering with the stereo space.
- ▶ For a right to left movement, you can also modulate the output VCA with an auxiliary envelope, once connected, set the modulation level to a positive value for one and negative for the other.

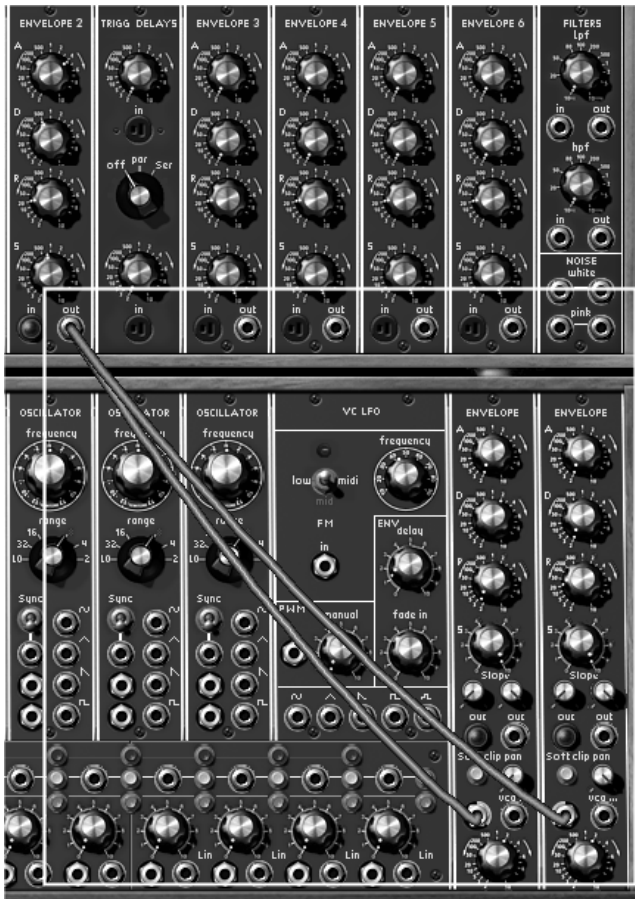

Connection of an auxiliary envelope for the output VCA

These patches, you will have noticed have very different levels of difficulty. We hope that they will have allowed you to see some of the possibilities that the Modular V has to offer. But don't hesitate in testing the programming yourself, this is how we learn and progress and develop more originality.

1.22 using the new Modular V 2.0 modules

1.22.1 The Bode Frequency Shifter

The Bode Frequency Shifter was certainly one of the most coveted modules while at the same time one of the least known in the Bob Moog's modular galaxy. There were around 10 sold across the world.



The bode Shifter module

It allows the creation of a huge number of unique sounds, which we will see, in the two following examples:

1.22.1.1 *More stereo width*

Obtain more stereo width by slightly dephasing the pitch of the sound. Take as an example the preset "Bode_Bass" (in the "Factory" bank).

For this very simple preset, we will use an oscillator where the "sawtooth" signal will be directed straight to the Bode Frequency Shifter audio in.

- ▶ The A and B outputs on the Bode Shifter are directed towards the inputs for VCA1 and 2. The panoramic knobs are turned to the left for VCA1 and to the right for VCA2 to obtain a stereo sound.
- ▶ The main tuning frequency on the Bode Shifter is placed at 0.000 Hz ("amount of shift" knob centered). The "Scale" setting is placed to position "5" (the variations in height are very weak). Also, leave the "Mixture" setting at the center (it won't be used in this example)
- ▶ A slow modulation is applied to the Bode Shifter frequency thanks to the sine signal of a LFO.

The modulation phase being inverted on outputs A and B, you obtain a very natural dephasing between the left and right signals.

This effect could be compared to a short reverberation effect if the modulation rate is weak or "chorus" if we increase the modulation rate.



The "Bode-Bass" patch

1.22.1.2 Electronic percussion sequence

- ▶ For this example we will use the sequencer to create a simple melody with the Bode Shifter. Sequence lines 1 and 2 will modulate the height of the Bode frequency ("Frequency shifter modulation").
- ▶ Take the preset "Sequences" > "Bode_Seq" in the "Factory" bank. The composition of modules is about the same as the previous example. A low pass 24dB filter has been added to filter undesirable high-pitched harmonics as output from the Bode Shifter.
- ▶ The first two sequencer lines modulate two Bode Shifter modulation inputs (the first at a value of 0.3247 and the second at - 0.4588). The two sequences complement one another setting the "amount of shift" parameter.
- ▶ The Bode Shifter possesses a sound close to a Ring Modulator; the resulting sound is slightly metallic. We can direct the signal to a low pass filter (LP filter 24 dB) to dampen certain high frequencies.

 It is also possible to use a waveform that is not as rich in harmonics on the oscillator (the triangle, for example) if we don't want to filter the sound coming from the Bode Shifter.



The "Bode_Seq" patch

We are not obliged to use a sequencer as source of frequency modulation for the Bode Shifter. More subtle modifications are also possible with a LFO or a key follow.

1.22.2 The Envelope Follower

The envelope follower is a module favored by aficionados of modular synthesizers with the goal of modulating the envelope with an external signal. (A drum line is very appropriate for this type of use.) The result: obtain a complex envelope following the evolution of an audio signal.

It is also possible to connect any other source of modulation to the envelope follow input: An envelope for example. The course of the latter can be modified with the envelope follower parameters.



The “envelope follower” module

Let’s have a closer look at these two situations:

1.22.2.1 Trig by an external audio source.

In the first case, the Modular V will be used as a VST insert effect for an audio track in Cubase SX.

If you don’t have Cubase, know that the procedure remains globally the same for any other sequencer.

- ▶ Firstly, place a sample (preferably a drum loop) on an audio track on the sequencer.
- ▶ Open a VST “Insert” effect on this track by choosing “Modular V2 FX”.
- ▶ On a MIDI track, choose the Modular V2 FX as MIDI control output. It will thus be controlled by your master keyboard or by a sequence recorded in the arrangement. This point is essential for generating the sound of the Modular V.

 It is also possible to create a continuous note (hold) so that the Modular signal doesn’t stop. For this, set the “Release” knob on the VCA1 envelope fully to the right (in the direction of the hands of a clock).

- ▶ On the Modular, choose the “EFX/ Ext_In” preset in the “Factory” bank. The “Ext Left” audio in (on the lower section) is connected to the envelope follower audio in. This indicates that the audio signal will guide the envelope.



The "Ext_In" preset

- ▶ This module will be used to modulate the low pass filter frequency (LP Filter 24 dB). After "opening" the modulation rate, the filter cut-off frequency will be modified by the dynamic evolutions of the audio signal when the Modular is played through MIDI.
- ▶ You can modify the curve of the envelope with the "Time Follower" setting situated under the "Threshold" knob.

1.22.2.2 Create your LFO form

Here we will see how you can create your own complex LFO waveform.

- ▶ Use the preset "Pads / Env_Follow" in the "Factory" bank. It has two oscillators as sound source, a low pass filter (LP Filter 24dB), an envelope follower and 3 oscillators (two sine and one sawtooth) which are used as a base for creating a complex wave form that will modulate the filter cut-off frequency.



The preset "Pads / Env_Follow"

- ▶ To modify this wave form, we will connect the result of the mixing of the 3 oscillators as source of modulation to the input of the envelope follower. Click on the audio out of the first VCA (going from the left).
- ▶ Turn the "Time Follower" knob (below the "Threshold" knob) to modify the amplitude.

1.2.2.3 The sample and hold

The Modular sample and hold module was only introduced on the last modular systems (1974). It is widely used for the creation of random modulations (the famous sounds from R2D2 in Star Wars were created in this manner). It can also be used for more rhythmic cyclic modulations.



The sample and hold module

Here we will look at creating a random modulation.

- ▶ Use the "Pads / Slow_SH" preset from the "Factory" bank for this example. It is made up of 3 oscillators, a low pass filter (LP Filter 24dB), a noise module and a Sample and Hold.



The "Slow_SH_Pad" preset

The pink noise output is filtered by a low pass filter (6 dB/oct) and directed to the sample & hold audio in. The audio out of the latter is connected to one of the 3 cut-off frequency modulation inputs of the low pass filter.

- ▶ The result is random changes to the filter cut-off frequency.

- ▶ Now set the modulation rate by turning the "Clock rate" knob on the Sample and Hold module.
 - By setting the filter cut-off frequency on the "Noise" module, the high-pitched frequencies will be filtered. The variations in modulation will be "softened" in this manner.
- ▶ By using the "Glide" knob on the "Sample and Hold" module, these modulation If you want to soften these variations there are two solutions:
 - variations will be smoother.

The new modules included with the Modular V 2.0 will add a large number of editing possibilities. They were difficult to create (impossible in some cases) before. Don't hesitate to experiment in new editing methods.

8 MODES OF OPERATION

1.23 STANDALONE

The Modular V can be used as an instrument independently from a sequencer software (Standalone mode).

This allows you launch the application as a single instrument, and to play it using an external MIDI keyboard.

1.23.1 **Launch the application**

To launch the Modular V application,

- on Windows, go to the menu Start > Programs > Arturia > Modular V, and choose "Modular V".
- on Macintosh, open the finder > Applications > Arturia and double-click on the Modular V application icon.

1.23.2 **Configuration of the instrument**

Click on the "Settings" button on the Modular V toolbar. It will show the following "Audio MIDI Settings" dialog box.

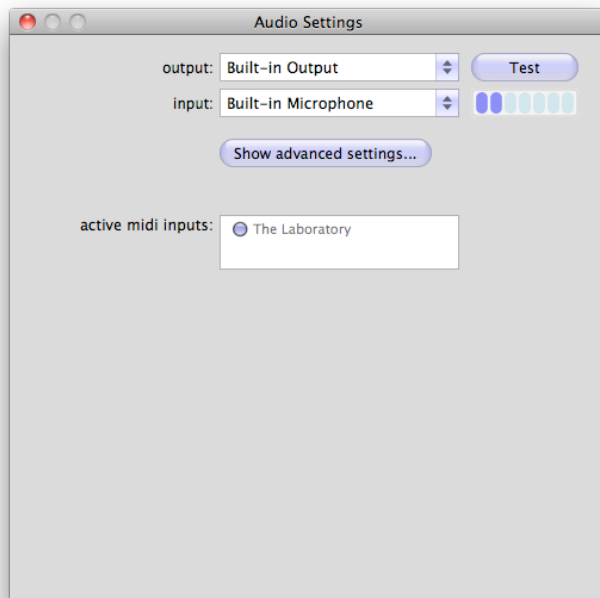

In this option menu you can:

- Set the audio output port
- Choose the audio interface
- Choose memory buffer size (smaller size will increase the load on the CPU but will reduce latency, and reciprocally)
- Choose sample rate between 44100 Hz and 96000 Hz
- Choose one or several active MIDI input port(s)

1.24 **VST 2**

VST (Virtual Studio Technology) is a plug-in standard created by Steinberg. It allows you to integrate software audio synthesizers and effect plug-ins with audio DAWs and host software. VST is supported by a large number of audio applications like Cubase, Nuendo, Wavelab, FL Studio, Audacity, Samplitude, Sonar, Audition, Live, etc.

The VST interface was updated to version 2 in 1999. One of the additions was the ability for plug-ins to receive MIDI data. This allowed for the introduction of VSTi (Virtual Studio Technology Instrument) format plug-ins.

1.25 **VST 3**

VST3 is a new update of VST audio plugins protocol. It was updated in 2008. This has improved performance over previous versions of VST and has many new features as well. Cubase 6 and Nuendo 5 are using this new protocol.

With VST3 on Windows, users do not have to choose a folder path to install the plug-in. The installer will put VST3 files automatically into the appropriate directory on your hard drive.

1.26 **RTAS**

RTAS, short for Real-Time AudioSuite is an audio plug-in developed by Digidesign (AVID technology) for their Pro Tools systems.

1.27 **AU**

AU for Audio Units is a plug-in protocol developed by Apple Computer. It used by Apple applications such as GarageBand, Soundtrack Pro, Logic Express, Logic Audio, Final Cut Pro, Mainstage, Ardour, Ableton Live, REAPER and Digital Performer.

1.28 **64 BIT COMPATIBILITY**

The Modular V is optimized for both 32-bit and 64-bit modes. If you have a 64-bit operating system and a 64-bit digital audio workstation, you should use 64-bit version of the plug-in (for Windows).

Usually on 32-bit Windows, all 32-bit programs are installed in C:\Program Files. However on 64-bit Windows, you can find the 64-bit programs in C:\Program Files\ and the 32-bit programs in C:\Program Files (x86)\.

Mac users don't have to bother with this, because the same plug-in file contains both the 32-bit and the 64-bit versions, and the host automatically chooses the better one.

1.29 **USE IN CUBASE/NUENDO (VST)**

1.29.1 **Instrument use in VST mode**

The opening of the Modular V VST plug-in is the same as opening all other VST plug-ins. Please consult the instruction manual of your host sequencer for more specific information. Under Cubase/Nuendo, create a new "Instrument" track, and choose Modular V in the rack.

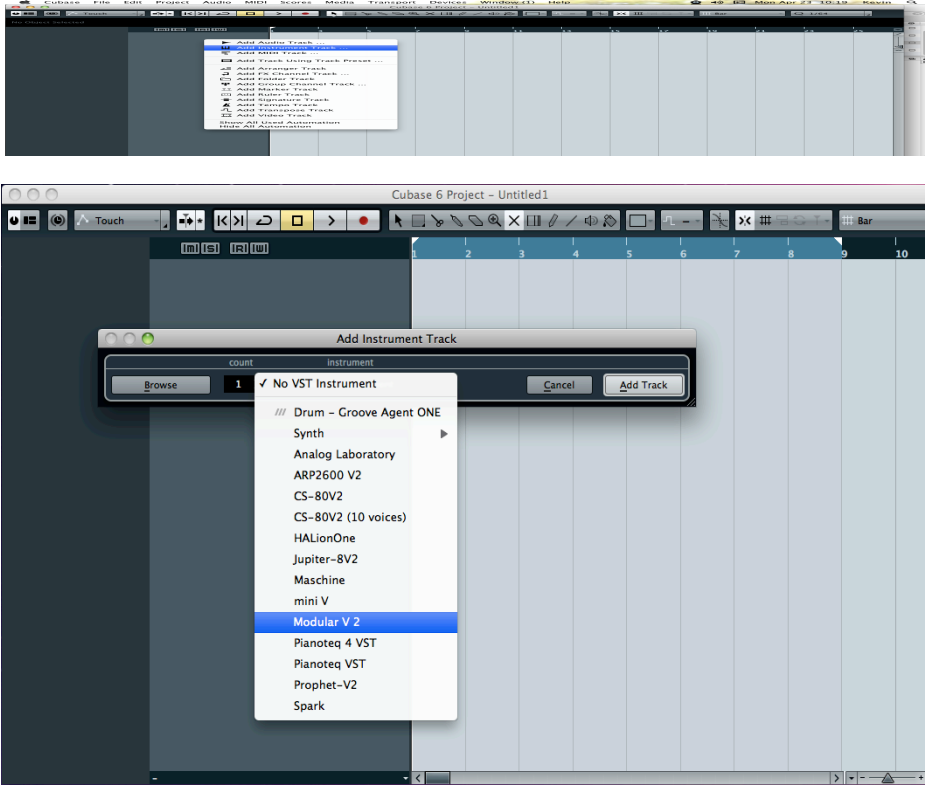

1.29.2 **Rescan the plug-in directory in Cubase**

If the Modular V does not appear in the list of VST plug-ins, you can perform a "rescan" of the plug-in directory.

1.29.3 **Saving of presets**

When the session/project is saved, the Modular V is saved in its last mode of operation, with all modifications intact. For instance, if you were working on a "P1" preset in which you had modified parameters (without saving them as a separate preset within the plug-in itself), the next time you open the project, the Modular V will load the "P1" preset plus the modifications you made previously.

The drop-down menu in which the VST sequencer allows you to save a new preset is of course usable with the Modular V. However, it is highly advised to use the Modular V internal menu: the presets saved in this way are usable in any other mode (standalone or with other sequencers), they can be exported and exchanged more easily, and they will remain compatible with the Modular V future versions.

1.30 USING IN PRO TOOLS (RTAS)

1.30.1 Opening of the plug-in

Access to the Modular V plug-in is like all other plug-ins in Pro Tools, via a new Instrument Track creation:

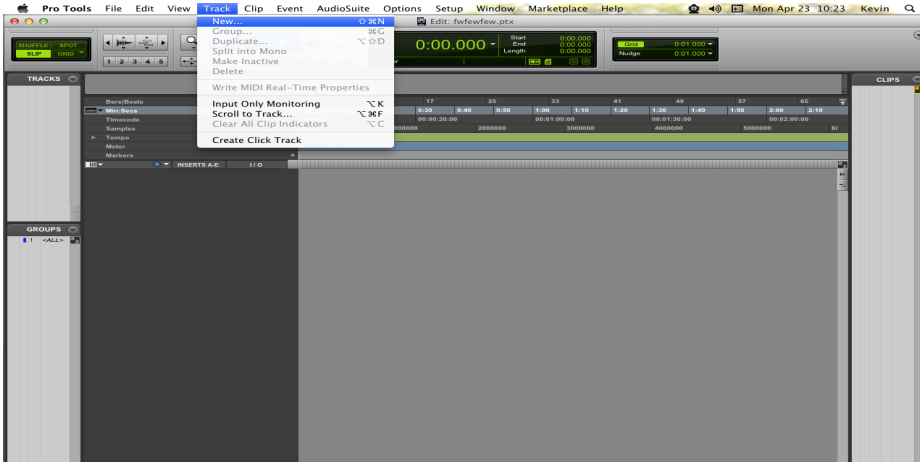



The Modular V must be loaded on an instrument stereo track. We can now make the Modular V sound by playing with the mouse on the virtual keyboard.

1.30.2 Saving the presets

When the session is saved, the status of the Modular V is saved as it is, even if its programming does not correspond to the preset. For example, if you are working on a preset "P1" in which you have modified the parameters (without saving them in the plug-in itself), the next time you open the session, Modular V will load the "P1" preset plus the modifications you made to it. The "Librarian Menu" of Pro Tools can be used with the Modular V like with all other plug-ins.

Nevertheless it is highly recommended to use the internal Modular V menu: with the presets saved like this, they are usable no matter which mode is chosen (standalone or other sequencer), and they can be exported, exchanged more easily, and will stay compatible with future versions of Modular V.

1.30.3 **Automation under Pro Tools**

The automation function with the Modular V functions like with all RTAS/HTDM plug-ins (check the Pro Tools documentation for more details on plug-in automations).

1.31 **USING IN LOGIC, MAC OS X (AU)**

Make sure the plug-in has been tested OK in the Logic Audio Units Manager. To launch it, click on the menu "Preferences > Start Logic AU Manager".

Create a new Software Instrument track.

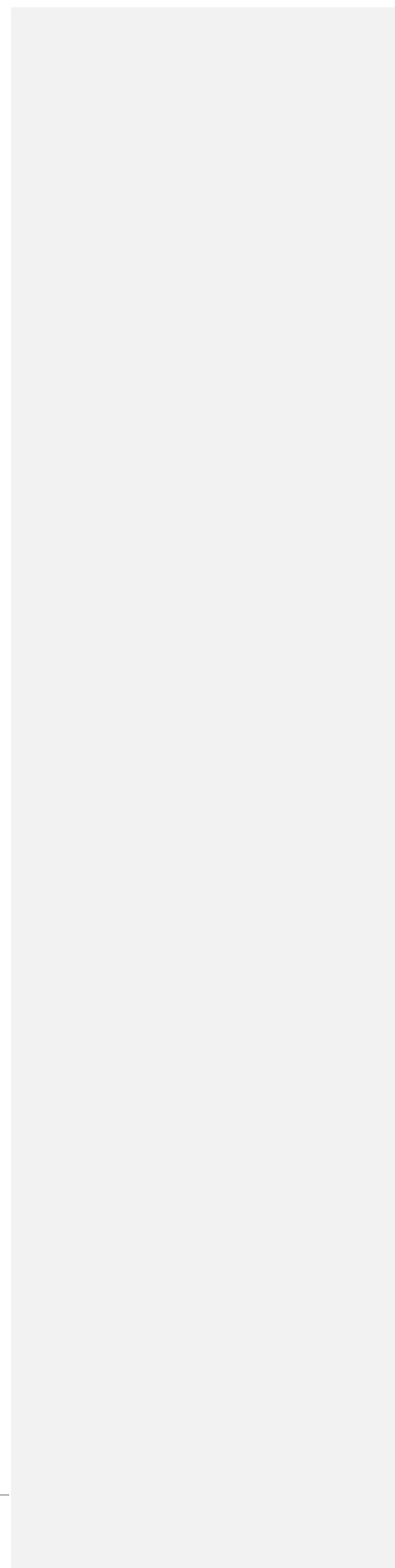
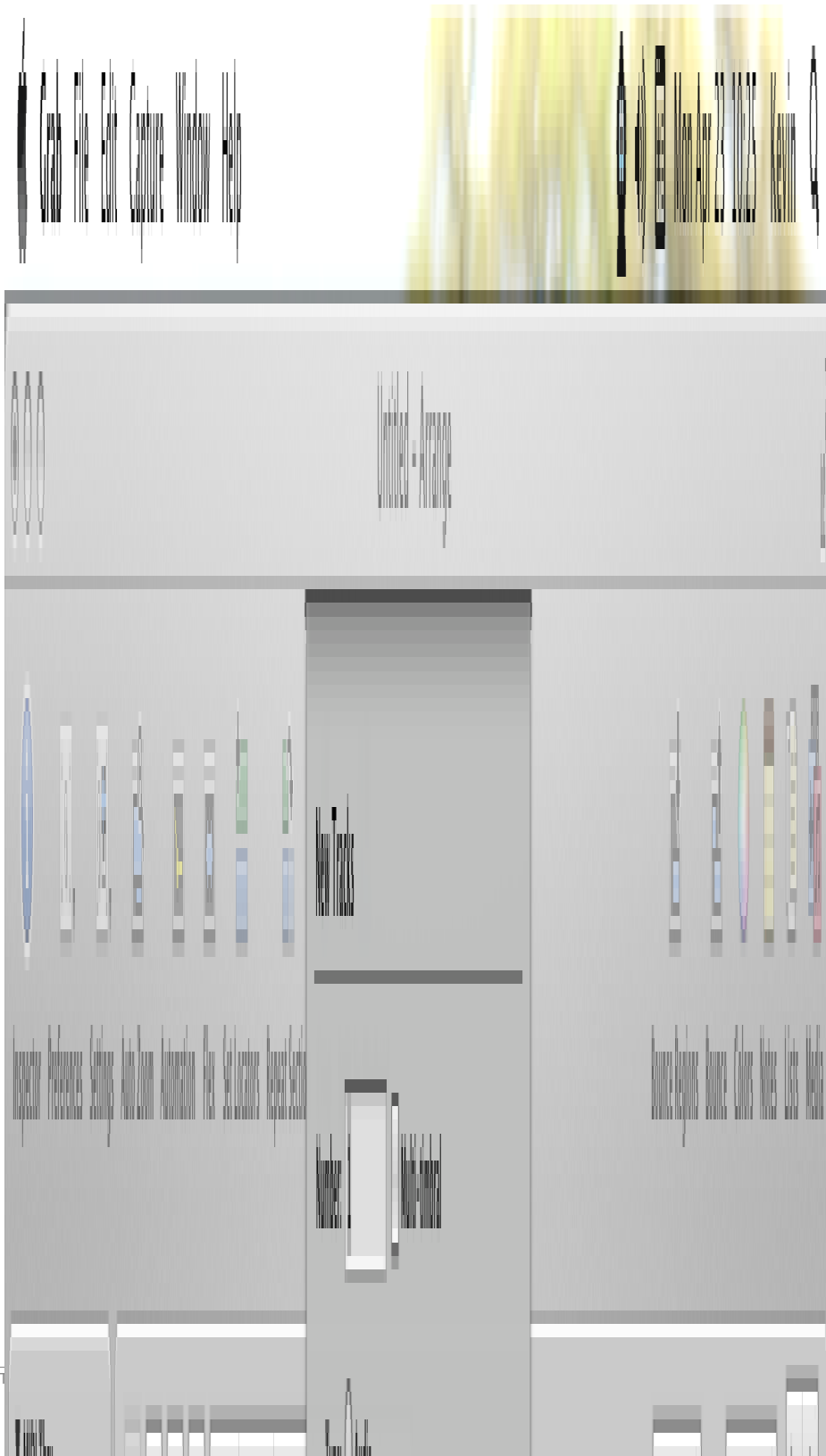

On the channel of the mixer corresponding to the selected track, click on the button “I/O” to list the available plug-ins, then select “AU Instruments > Arturia > Modular V > Stereo”.

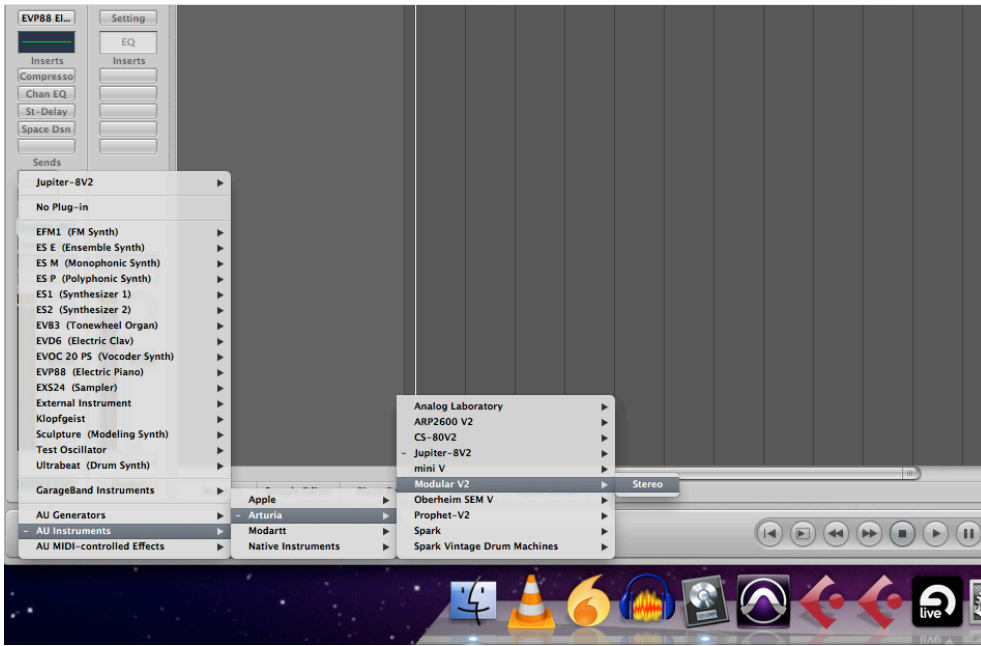

1.32 USING IN ABLETON LIVE (AU AND VST)

From the plug-ins tab, simply double click on the Modular V VST or AU icon, or drag-and-drop the plug-in into a MIDI track:

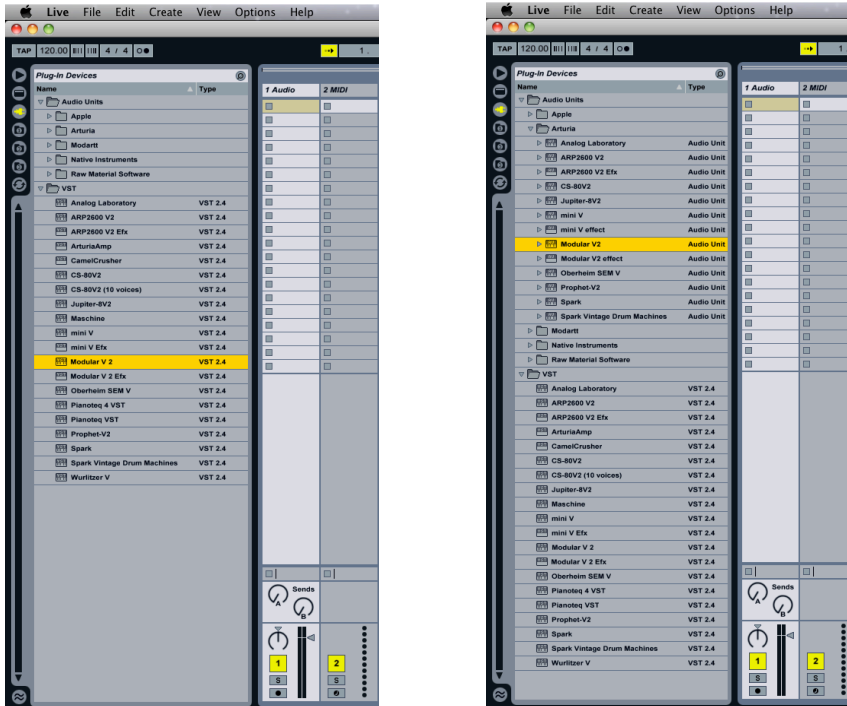

If necessary, you can perform a rescan of the plug-in directory in the Preferences, "File Folder" tab: press the "Scan" button, or press "Scan" while holding the [Alt] key for a full rescan.

9 MODULAR V END USER LICENSE AGREEMENT

1. General

1.1 In consideration of payment of the Licensee fee, which is a portion of the price you paid, Arturia, as Licensor, grants to you (hereinafter termed "Licensee") a nonexclusive right to use this copy of the Matrix 12 V (hereinafter the "Product"). All intellectual property rights in the software belong to Arturia SA (hereinafter: "Arturia").

1.2 The following editions of the Product are available: "**Demo**", "**Standard**", "**EDU**" and "**NFR**". Whilst each edition equips the User with the same software, the editions vary as regards both the scope of functions activated in the Product, and the rights of use granted under this EULA.

1.3 By installing the software on your computer you agree to these terms and conditions. If you do not approve these terms and conditions, you must not install this software.

1.4 If you do not approve these terms and conditions, please return the complete Product (including all written matter, packaging and similar material) to the dealer from whom it was originally bought within 14 (fourteen) days after the day of purchase. For purchases from the Arturia Online Store, please contact Arturia on the internet website: www.arturia.com/support/askforhelp/purchase.

1.4 Arturia reserves all rights not expressly granted in the EULA.

2. Right of use

2.1 The Product is protected by copyright. The Licensee may not lease, loan or sub-license the software. The Licensee is not authorized to modify the software.

2.2 Owning any product provided to the Licensee as "**Standard**" version grants the Licensee a non-exclusive right to use the Product in perpetuity including commercial purposes. The Licensee can activate the Product on up to five computers, as long as only one installation is used at any given time. The Licensee must register the Product to Arturia to get access to client support, and to activate his Product. (An internet connection is required to register and activate the Product, either on the computer on which the Product is installed, either on another device able to exchange files with the computer on which the Product is installed). Owning a license of the Products entitles the Licensee to get access to the future updates of this Product.

2.3 Any Products provided to you as "**NFR**" (Not For Resale) version grants the Licensee a non-exclusive right to use the Product for a limited period of time. The Product shall only be used for demonstration, testing and evaluation purposes. NFR Products must not be used for commercial purposes, and must not be resold or transferred. The Licensee can activate the Product on up to five computers, as long as only one installation is used at any given time. The Licensee must register the Product to Arturia to get access to client support, and to activate his Product. (An internet connection is required to register and activate the Product, either on the computer on which the Product is installed, either on another device able to exchange files with the computer on which the Product is installed). NFR Products are exempt from update, upgrade or crossgrade offers, and cannot be purchased with or exchanged for vouchers or coupons. Furthermore, as an owner of a NFR Product, you are not entitled to any vouchers that ship with the standard version of the Product.

2.4 Any Products labelled or otherwise provided to you as an **“Educational”** version grants the Licensee a non-exclusive right to use the Product in perpetuity. The Product shall only be used by students or those working in educational institutions. This definition includes students, faculty, staff and administration attending and / or working at an educational institutional facility: private / public schools, colleges, universities and similar. These Products must not be used for commercial purposes, and must not be resold or transferred. The Licensee can activate the Product on up to five computers, as long as only one installation is used at any given time. The Licensee must register the Product to Arturia to get access to client support, and to activate his Product. (An internet connection is required to register and activate the Product, either on the computer on which the Product is installed, either on another device able to exchange files with the computer on which the Product is installed). These Products are exempt from upgrade or crossgrade offers, and cannot be purchased with or exchanged for vouchers or coupons. Furthermore, as an owner of an educational Product, you are not entitled to any vouchers that ship with the standard version of the Product.

2.5 Any Products labelled or otherwise provided to you as a **“Demo”** version grants the Licensee a right to use the Product only for demonstration and evaluation purposes. These Products must not be used for commercial purposes, and must not be resold or transferred. These Products are exempt from upgrade or crossgrade offers, and cannot be exchanged for vouchers or coupons.

3. No Unbundling

Bundles (product bundles are an association of software and hardware or software-only products) can only be resold / transferred as a whole. The individual components of a bundle must not be resold / transferred separately.

4. Resell

4.1 Renting or lending the licensed Software to a third party is expressly forbidden. Apart from that and if not provided otherwise within this EULA.

4.2 Except if otherwise stated within this EULA, Licensee may resell the software to a third party or transfer the software permanently free of charge, provided the third party agrees in writing with this EULA and Licensee ceases all use of the software, completely removes all installed copies of the software from his computers and – if the software was not purchased via download – deletes or transfers the original media delivered with the software to the third party. In addition, Licensee is required to de-register the purchased software with Arturia (more information available on www.arturia.com).

5. In case a sound library is part of the purchased Product the following shall apply in addition to the EULA

The provided samples, instruments and presets can be used for commercial or non-commercial music and audio Productions without the prior permission from Arturia under the terms of this Agreement. The usage of this Product (in particular samples, instruments and presets) for the creation of a sound library or as a sound library for any kind of synthesizer, virtual instrument, sample library, sample-based Product or other musical instrument is strictly prohibited. Individual samples, sound sets or audio loops may not be distributed (commercially or otherwise) standalone. Furthermore these samples, sound sets or audio may not be repackaged in whole or in part as audio samples, sound libraries or sound effects.

6. Data Protection

Arturia attaches great importance to compliance with legislation on data protection. The User data collected are used exclusively for performing its contractual obligations. No data is passed on to third parties. Further information can be obtained from our Privacy Policy at www.arturia.com/privacy.

7. Limited Warranty

Arturia warrants that the physical media on which the software is provided is free from defects in materials and workmanship under normal use for a period of thirty (30) days from the date of purchase. The Licensee's invoice shall be evidence of the date of purchase. Any implied warranties on the software are limited to thirty (30) days from the date of purchase. Some states do not allow limitations on duration of an implied warranty, so the above limitation may not apply to the Licensee in this case. All programs and accompanying materials are provided "as is".

8. No Liability for Consequential Damages

Neither Arturia nor anyone else involved in the creation, production, or delivery of this Product shall be liable for any direct, indirect, consequential, or incidental damages arising out of the use of, or inability to use this Product (including without limitation, damages for loss of business profits, business interruption, loss of business information and the like) even if Arturia was previously advised of the possibility of such damages. Some states do not allow limitations on the length of an implied warranty or the exclusion or limitation of incidental or consequential damages, so the above limitation or exclusions may not apply to the Licensee in this case. This warranty gives the Licensee specific legal rights, and the Licensee may also have other rights which vary from state to state.