

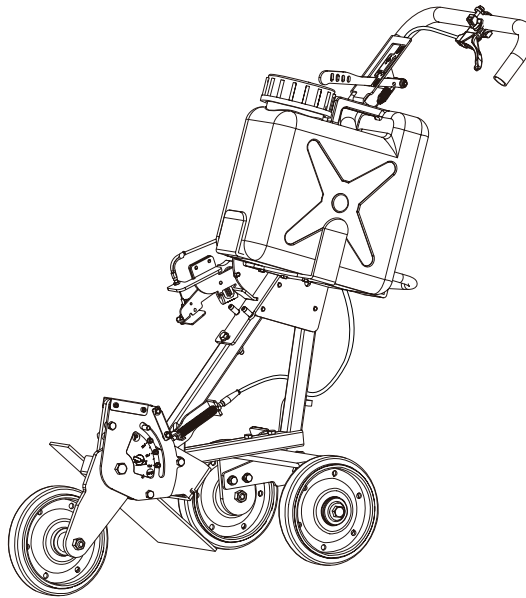

GB ENGLISH

ES ESPAÑOL

FR FRANÇAIS



OPERATOR'S MANUAL

CSG CART

CWT-7410



WARNING



Read the instructions carefully and follow the rules for safe operation.

Failure to do so could result in serious injury.

IMPORTANT INFORMATION

Please ensure that you read the operator's manual before using your product.

○ Intended use of this product

- This product is for mounting a cut-off saw, which is made for cutting surface of the ground, such as concrete.
- Do not use this unit for any purpose other than aforementioned.

○ Users of the product

- You should not use this product until you have read the operator's manual carefully and fully absorbed its content.
- This product should not be used by anyone who has failed to read the operator's manual properly, is suffering from a cold, tiredness or otherwise in poor physical condition, or children.
- Keep in mind that the operator or user is responsible for accidents or hazards occurring to other people or their property.

○ About your operator's manual

- This manual contains necessary information about the operation and maintenance of your product. Please read it carefully and absorb its contents.
- Always keep your manual in a place where it is readily accessible.
- If you have lost your manual or it is damaged and no longer readable, please purchase a new one from your DEALER.
- The units used in this manual are SI units (International System of Units). Figures in parentheses are reference values, and there may be a slight conversion error in some cases.

○ Loaning or assigning your product

- When loaning the product described in this manual to another party, ensure that the person borrowing and working with the product receives the operator's manual along with the product. If you assign your product to another party, please enclose the operator's manual with the product when handing it over.

○ Enquiries

- Please contact your DEALER for requests regarding information about your product, the purchase of consumables, repairs, and other such enquiries.

○ Notices

- The content of this manual may be changed without notice for the purpose of upgrades to the product. Some of the illustrations used may differ from the product itself in order to make the explanations clearer.
- Please consult your DEALER if anything is unclear or of concern.

CONTENTS

IMPORTANT INFORMATION.....	2
SYMBOLS AND SIGNS.....	4
PACKING LIST.....	5
NOMENCLATURE OF PARTS.....	6
OPERATOR SAFETY PRECAUTIONS.....	7
OPERATOR SAFETY.....	8
BEFORE YOU START.....	9
OPERATION.....	14
MAINTENANCE AND CARE.....	16
STORAGE AFTER USE.....	18
TECHNICAL DATA.....	18
NOTES.....	19

Specifications, descriptions and illustrative material in this literature are as accurate as known at the time of publication, but are subject to change without notice.

Illustrations may include optional equipment and accessories, and may not include all standard equipment.

SYMBOLS AND SIGNS

DANGER

The safety alert symbol accompanied by the word “DANGER” calls attention to an act or condition which **WILL** lead to serious personal injury or death if not avoided.

WARNING

The safety alert symbol accompanied by the word “WARNING” calls attention to an act or condition which **CAN** lead to serious personal injury or death if not avoided.

CAUTION

The safety alert symbol accompanied by the word “CAUTION” calls attention to an act or condition which may lead to minor or moderate personal injury if not avoided.



CIRCLE AND SLASH SYMBOL

This symbol means the specific action shown is prohibited. Ignoring these prohibitions can result in serious or fatal injury.









NOTICE

This enclosed message provides tips for use, care and maintenance of the unit.

IMPORTANT

The enclosed message provides information necessary for the protection of the unit.

SYMBOL FORM

Symbol form/shape	Symbol description/application	Symbol form/shape	Symbol description/application
	Carefully read the operator's manual.		Wear eyes, ears, nose, mouth and head protection
	Safety / Alert		Parking position
	Do not lift the cut-off saw by the front handle		Locked
	Reverse mounting of cutter arm prohibited		Unlocked and Free to move

DECALS

Part Number X505-011460

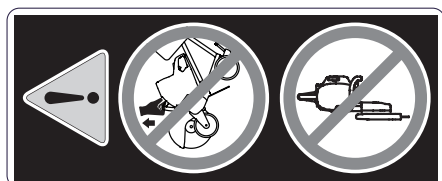

Locate this safety decal on your unit. The complete unit illustration found in the “NOMENCLATURE OF PARTS” section will help you locate them. Make sure the decal is legible and that you understand and follow the instructions on it. If a decal cannot be read, a new one can be ordered from your ECHO dealer.

PACKING LIST

The ECHO product you purchased has been factory pre-assembled for your convenience. Due to packaging restrictions, guide bar and saw chain installation and other assembly may be necessary.

After opening the carton, check for damage. Immediately notify your retailer or ECHO dealer of damaged or missing parts. Use the packing list to check for missing parts.

Cart

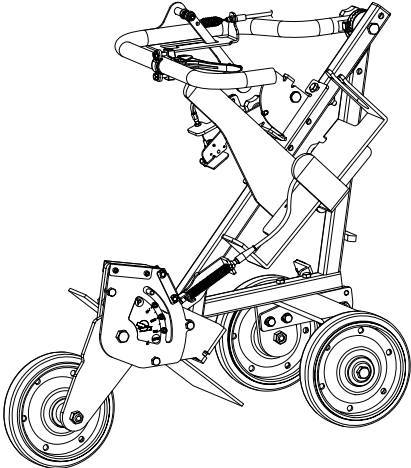

Water tank

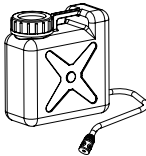

Bolts



13 x 19 mm T-wrench

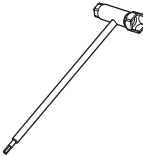

Operator's manual

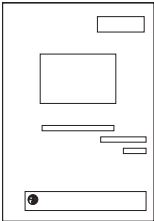

NOMENCLATURE OF PARTS

Part number
X505-011460

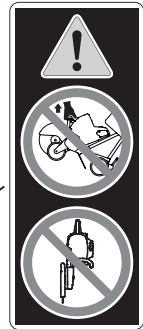
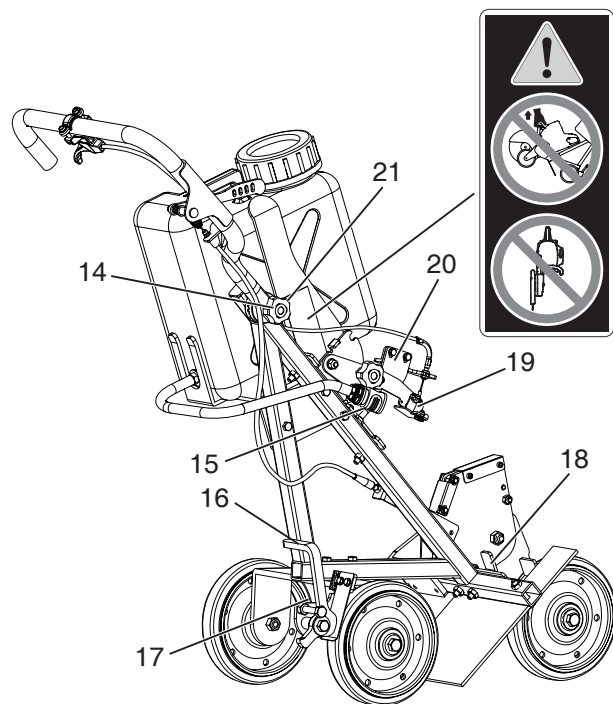
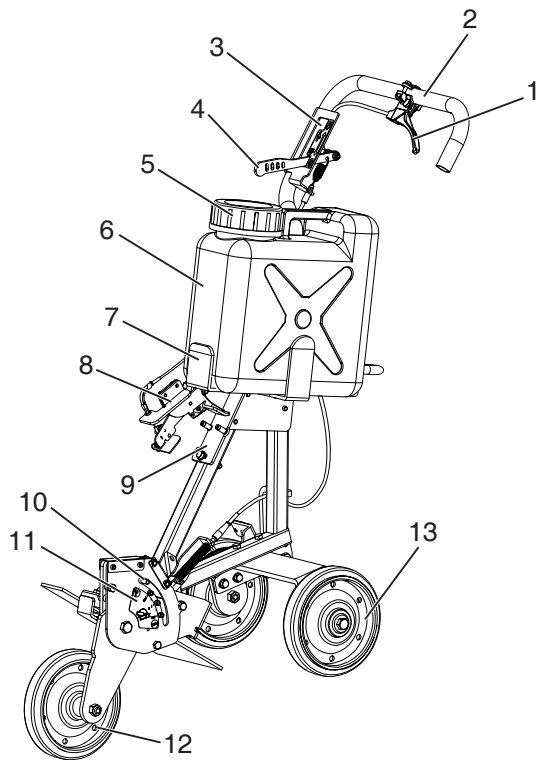

1. Throttle lever
2. Cart handle
3. Operation label - X532-005990
4. Depth adjustment lever
5. Water tank cap
6. Water tank
7. Water tank platform
8. Rear handle plate
9. Rear handle mount
10. Depth adjustment indicator
11. Operation label - X524-007730
12. Front wheel
13. Rear wheel

14. Handle lock knob
15. Coupler
16. Wheel brake
17. Operation label - X532-006000
18. Front handle receiver plate
19. Throttle plate
20. Cutter lock knob
21. Type and serial number

OPERATOR SAFETY PRECAUTIONS

HANDLING THE PRODUCT

OPERATOR'S MANUAL

- Be careful to read the operator's manual properly before using your product in order to ensure correct operation.
- ◆ Failure to do so could lead to an accident or serious injury.



COMPLY WITH ALL LOCAL AND NATIONAL LAWS AND REGULATIONS

Local or National regulation can restrict the use of this cutoff saw.

DO NOT USE THE PRODUCT FOR ANYTHING OTHER THAN ITS INTENDED PURPOSE

- You must not use the product for any purpose other than those described in the operator's manual.
- ◆ To do so could lead to an accident or serious injury.

DO NOT MODIFY THE PRODUCT

- You must not modify the product.
- ◆ To do so could lead to an accident or serious injury. Any malfunction resulting from a modification to the product will not be covered by the manufacturer's warranty.

DO NOT USE THE PRODUCT UNLESS IT HAS BEEN CHECKED AND MAINTAINED

- You must not use the product unless it has been checked and maintained. Always ensure that the product is checked and maintained on a regular basis.
- Replace cracked guards and broken guards before use.
- ◆ Failure to do so could lead to an accident or serious injury.

LOANING OR ASSIGNING YOUR PRODUCT

- When loaning your product to another party, ensure that the person borrowing the product receives the operator's manual along with it.
- If you assign your product to another party, please enclose the operator's manual with the product when handing it over.
- ◆ Failure to do so could lead to an accident or serious injury.

BEING PREPARED IN CASE OF AN INJURY

In the unlikely event of an accident or injury, please ensure that you are prepared.

- First aid kit
- Towels and wipes (to stop any bleeding)
- Whistle or mobile phone (for calling outside help)
- ◆ If you are unable to perform first aid or call for outside help, the injury could worsen.

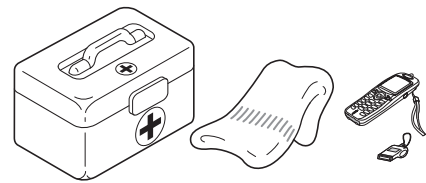

OPERATOR SAFETY

WEAR PROTECTIVE GEAR

- Always wear the following protective gear when working with the cut-off saw. Above all, make sure to wear safety goggles, a dust mask, and ear muffs at all times while working.
- ◆ Without the protective gear, you could inhale the debris or dust blown away or get them in your eyes, which could lead to an accident or injury.
 - a. **Head protection (helmet):** Protects the head
 - b. **Ear muffs or ear plugs:** Protect the hearing
 - c. **Safety goggles:** Protect the eyes
 - d. **Dust mask:** Protects the breathing apparatus
 - e. **Safety gloves:** Protect the hands from cold and vibration
 - f. **Work clothes that fit (long sleeves, long trousers):** Protect the body
 - g. **Heavy duty, non-slip protective boots (with toecaps) or non-slip work shoes (with toecaps):** Protect the feet
- ◆ Failure to observe these precautions could result in damage to your sight or hearing, or lead to a serious injury.

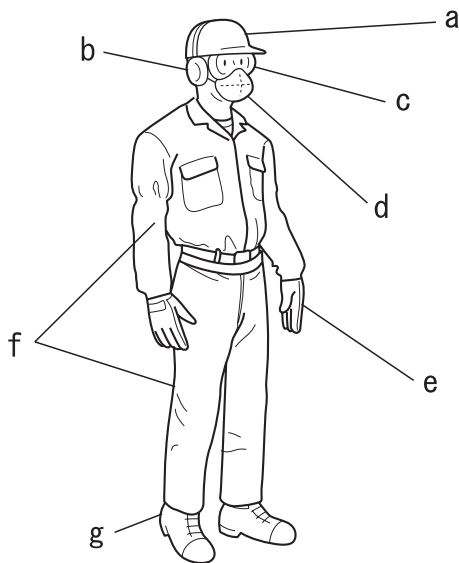

WEAR PROPER CLOTHING

- Secure hair so it is above shoulder length.
- Do not wear ties, jewellery, or loose, dangling clothing which could be caught in the unit.
- Do not wear open toed footwear, or go barefoot or barelegged.
- ◆ Failure to observe these precautions could result in damage to your sight or hearing, or lead to a serious injury.

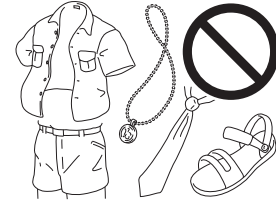

BEFORE YOU START

ASSEMBLY

WARNING

- Hold the water tank platform firmly when removing the bolts on the water tank platform.
- ◆ The water tank platform may fall and cause injury.
- When mounting the water tank platform, it may turn unexpectedly, so take care not to get your fingers caught.

CAUTION

If used while the throttle cable is caught on other parts, neither the throttle nor the depth adjustment will work properly.

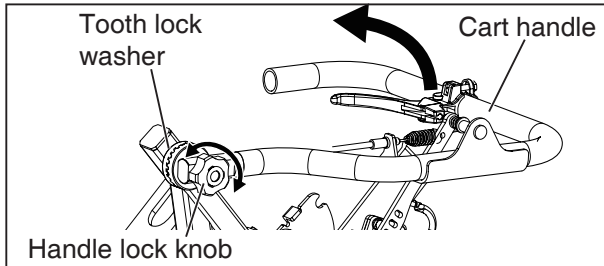

1. Loosen the handle lock knob, rotate the cart handle to its position for use, and then tighten the handle lock knob to secure it. When doing so, make sure the teeth of the tooth lock washers mate. Take care that the throttle cable does not get caught on any parts when rotating the handle into position.

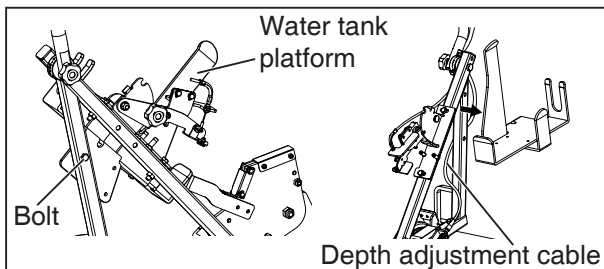

2. The water tank platform is stowed out of the way when shipped. While holding the water tank base firmly, loosen and remove the bolt shown in the illustration. When removing the water tank platform, be careful not to damage the cable.

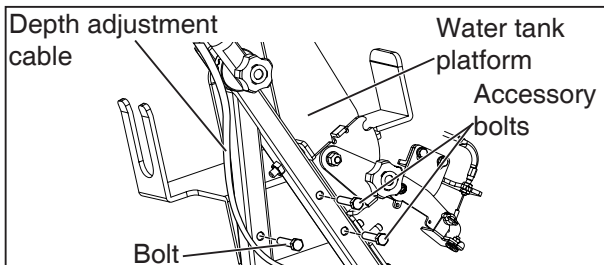

3. Align the tank base and tighten the three bolts. (Fastening torque: 10 to 14 N•m (90 to 120 in. lb.)). Route the cable under the water tank platform.

PROCEDURE FOR MOUNTING THE ENGINE CUT-OFF SAW

⚠ WARNING

- Tighten the cutter lock knob all the way in.
- ◆ If not tightened sufficiently, the engine cut-off saw may come off during use or transport.

IMPORTANT

- Do not install the cut-off saw with the reverse mounting cutter arm.
- The anti-vibration parts of the cut-off saw deteriorate faster.

⚠ CAUTION

- Use the wet cutting wheel recommended for our engine cut-off saw.
- Do not use the abrasive wheel.
- ◆ Using a cutting wheel not made for the application will lead to problems.
- Do not mount a water tank with water in it on the cart before mounting the engine cut-off saw.
- ◆ Doing so disrupts the balance of the cart and it may fall over.

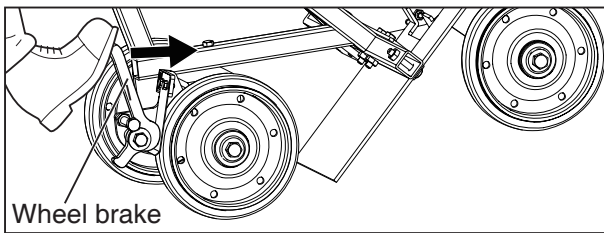

1. Before mounting the cut-off saw on the cart, install the wet cutting wheel appropriate to the job.

2. Apply the wheel brake.
(Pushing it forward engages the brake.)

*The wheel brake can be operated with a foot.

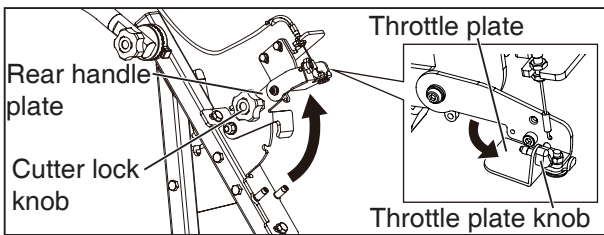

3. Before mounting the engine cut-off saw on the cart, clean off any dirt or debris on the cart or engine cut-off saw.

4. Loosen Throttle plate knob and Cutter lock knob. Turn the throttle plate counter-clockwise to open it. Lift the rear handle plate upwards.

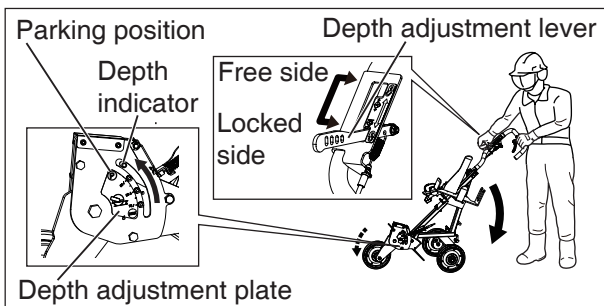

5. Set the cart depth adjustment plate to the parking position (with the front wheel in its lowest position). Using the rear wheel as a fulcrum, lift up the front of the cart so the front wheel leaves the ground and put the depth adjustment lever on the free side, allowing the front wheel to move up/down.

Once the depth adjustment indicator is in the parking position, return the depth adjustment lever to the locked side to secure it in the parking position.

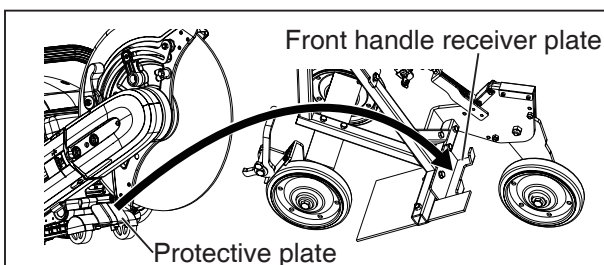

6. Insert the engine cut-off saw so the protective plate on the front of its handle fits in the middle of the front handle receiver plate.

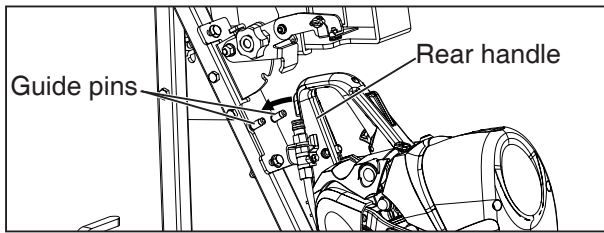

7. Fit the bottom rear of the handle of the engine cut-off saw between the guide pins

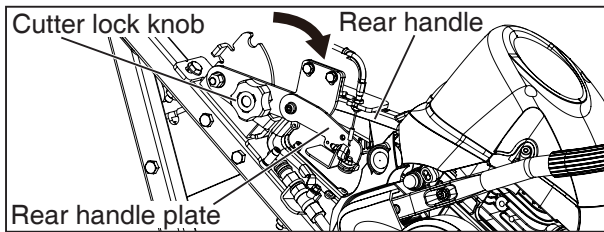

8. While holding the rear handle of the engine cut-off saw down with the rear handle plate, tighten the cutter lock knob until it seats.

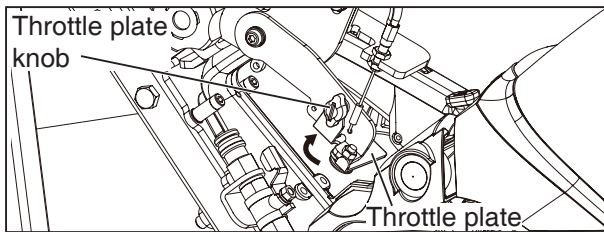

9. Turn the throttle plate clockwise and push it in. Tighten Throttle plate knob. Make sure the throttle lever of the cart is linked with the throttle trigger of the engine cut-off saw and they are operating smoothly together.

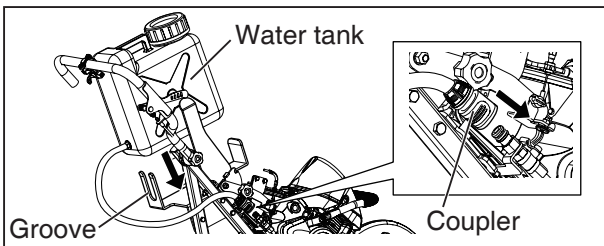

10. Align the hose of the water tank with the groove in the water tank platform and mount the water tank on the cart. Be careful not to pinch your hands when installing Water tank.

11. Put the liquid cock of the engine cut-off saw in the closed position. Connect the coupler to the joint of the engine cut-off saw.

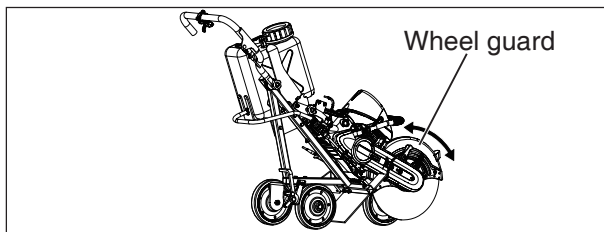

12. Make sure the throttle cable is in the correction position.

13. Adjust the angle of rotation of the wheel guard to the point where the wheel guard is not obstructed by the ground even when at the maximum depth of the cut. (Refer to the operator's manual of the engine cut-off saw for how to adjust the wheel guard.).

PROCEDURE FOR REMOVING THE ENGINE CUT-OFF SAW

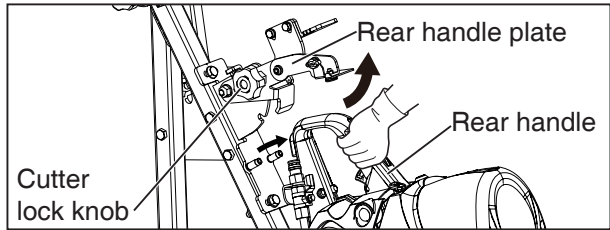
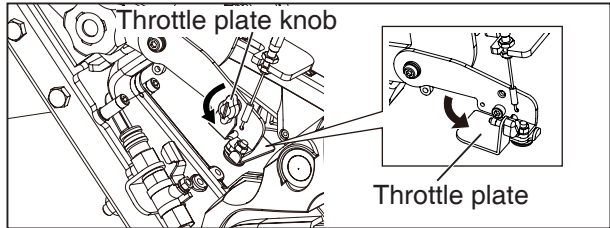
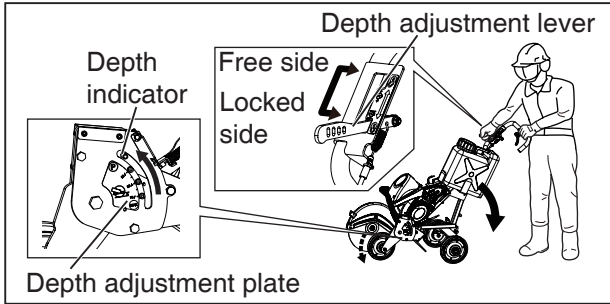

1. Set the depth adjustment indicator to parking position on the depth adjustment plate. (See page 10.)
2. Apply the wheel brake on flat ground.
3. Disconnect the coupler and remove the water tank from the cart. (The cart is prone to tipping over if a water tank with water in it is on the cart.)
4. Loosen the throttle plate knob. Turn the throttle plate counter-clockwise and open it.
5. While holding the rear handle of the engine cut-off saw down, loosen the cutter lock knob and open the rear handle plate upwards. If the rear handle is not held down, it will lift up and the cutting wheel may hit the ground, resulting in damage.
6. Lift up the engine cut-off saw and remove it from the cart. Be careful not to touch any hot parts, such as the muffler or cylinder head when doing so.

FUEL SUPPLY

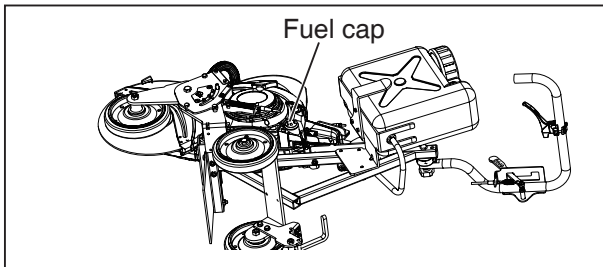

CHANGING THE WHEEL

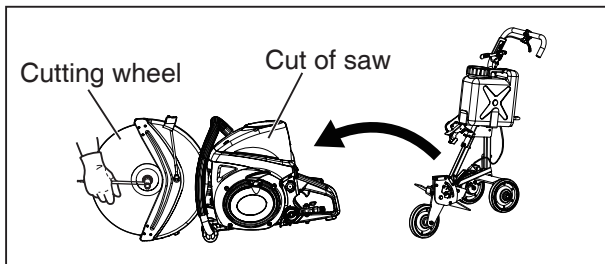

⚠ CAUTION

- When laying the cart on its side, do so slowly and carefully to avoid any shocks to the cart.
- Fuelling the cut-off saw with the cart on its side on a slope or uneven ground may result in spilling fuel if the cart shifts during refuelling.

To refuel the machine, carefully lay the entire cart on its side in a flat location with the fuel cap facing up.

- Take care when laying the cart on its side as water from the tank may leak.
- After refueling, securely tighten the fuel cap and return the cart to its upright stance.

⚠ CAUTION

- Changing the cutting wheel with the cut-off saw on the cart may result in the cart tipping over and causing an accident.

1. To change the cutting wheel, first remove the engine cut-off saw from the cart.
2. Follow the instructions in the operator's manual of the engine cut-off saw to change the cutting wheel.

OPERATION

CUTTING GUIDE

WARNING

- Before use, make sure functions such as of the throttle lever, depth adjustment and wheel brake are working correctly.
- If any functions are not working properly, contact the sales outlet for repairs.
- Remove any obstacles from the cutting path.
- If the engine is started with the cutting wheel on the ground, it may drive the cart and cause an accident.
- When the engine is started in the latched condition, wheel rotates at high speed at the same time as the start. Immediately release the latch by holding the throttle lever once.
- Always apply the wheel brake when starting the engine, and when not using the cut-off saw.

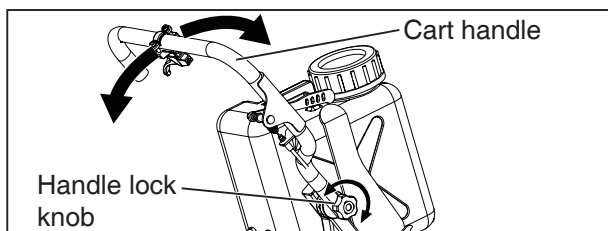

CAUTION

- Always use the water-flushing function when using the cart for cutting.
- Use clean water for flushing the cut. If dirty water is used, it will cause problems.
- If the cutting wheel is held locked while cutting with the throttle fully open, it may cause damage.

1. Apply the wheel brake on flat ground.
2. Loosen the handle lock knob and adjust the height of the cart handle to an easy to use position. Fully retighten the handle lock knob after adjusting the height. (When doing so, make sure the teeth of the tooth lock washers mate.)
3. Completely fill the water tank. The hose joint can be disconnected and the water tank removed and taken to a water tap to fill it.
*If water is put in the tank, but the hose joint is not connected, water will leak from the hose joint, so put the hose joint at a position higher than the water level.
4. Before starting the engine, check and make sure the depth adjustment indicator of the cart is on parking position and that the cutting wheel is not touching the ground.
5. Hold the front handle of the engine cut-off saw and start the engine. Follow the instructions in the operator's manual of the engine cut-off saw to start the engine. As soon as the engine starts, take hold of the cart handle.
6. Open the liquid cock of the engine cut-off saw so the water starts flowing. (Follow the instructions in the operator's manual of the engine cut-off saw to operate the liquid cock.)

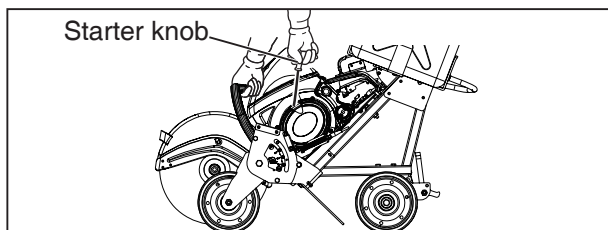

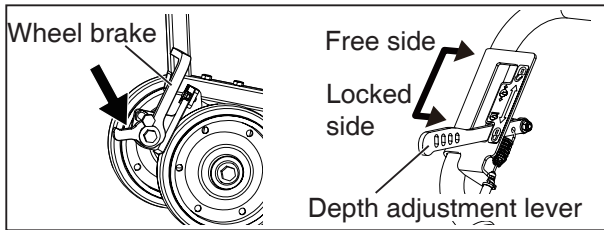

7. Release the wheel brake. Turn depth adjustment lever to free side while lifting the cut-off saw with the cart-handle. Ground wheel to the floor and gradually raise the engine speed. Use the cart handle to adjust the load on the cutting edge so a load is not put on it suddenly, and start cutting little by little.

*At the beginning of cutting, the cart will try to move forward, so hold the cart firmly while cutting.

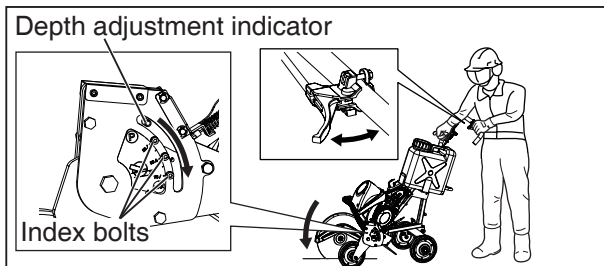

8. Cut down to the required depth and shift the depth adjustment lever to the locked side. Continuing the cut as-is will result in a cut at a uniform depth. Refer to the index bolts when determining the depth of the cut.

Cut depth guide (for reference)
Depth with a 350 mm (13.8 in.) blade

Label indication	Cut depth
25%	Approx. 30 mm (1.18 in.)
50%	Approx. 60 mm (2.36 in.)
75%	Approx. 90 mm (3.54 in.)
MAX	Approx. 120 mm (4.72 in.)

- Pay close attention while proceeding with a cut to both the sound of the engine and the speed of the cutting wheel to prevent overloading the engine.
- If the cutting wheel slows down, relax the forward pressure on the handle and back it off slightly; wait for the engine RPM to recover and then press down again.
- If the cutting wheel locks, release the throttle lever and lift the cutting wheel up from the ground. Grip the throttle lever again to raise the RPM and start cutting. If the throttle is held in the fully open position when the cutting wheel locks, it may damage the engine cut-off saw.
- Pay particular attention when making maximum depth cuts as the cutting wheel is then most prone to locking. Not cutting any deeper than necessary increases work efficiency and saves on cutting wheels.
- Do not intentionally cut curves. Doing so puts stress on the cutting wheel and makes it prone to locking.

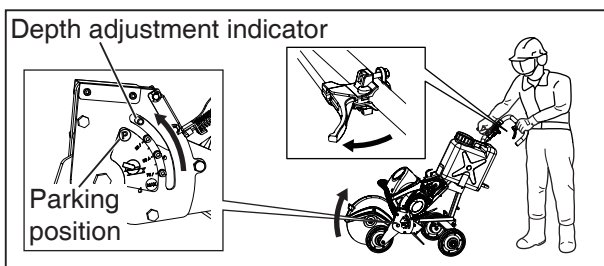

9. After finishing a cut, first lift the cutting wheel and then release the throttle lever.

10. Shift the depth adjustment lever to the free side and after putting the depth adjustment indicator in the parking position, shift the depth adjustment lever to the locked side to lock it.

11. Stop the engine and close the liquid cock to stop it from flowing.

12. Always apply the wheel brake before leaving the cart. If the cart is left on a slope, it may move before it is noticed and cause an accident.

MOVING THE CART

WARNING

- Remove the engine cut-off saw from the cart before loading it onto the bed of a vehicle.
- If lifting the cart with the engine cut-off saw mounted on it, do not lift it by the handle of the engine cut-off saw.
- If the rear handle plate unlocks suddenly, the cart may fall and cause an injury.

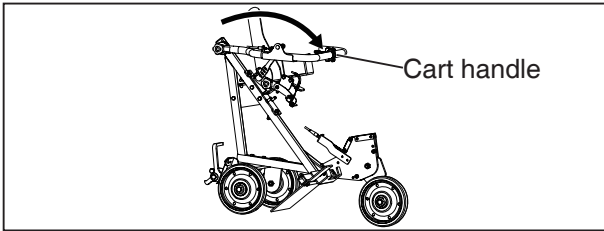

CAUTION

- If the throttle cable is not in the correct position, the depth adjustment lock may come unlocked.

1. When pushing the cart to move it, lift the cutting wheel when going over different levels in the surface to keep the cutting wheel from hitting them.
2. Always stop the engine before moving the cart.
3. Pushing the handle forward makes the cart smaller, which helps in loading it into a vehicle.

MAINTENANCE AND CARE

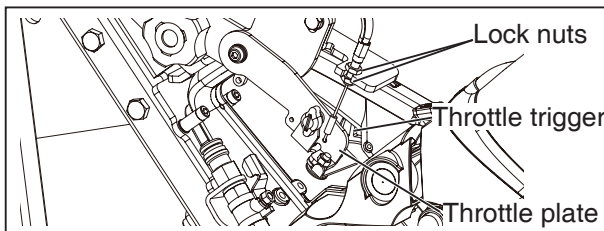

THROTTLE CABLE

1. Loosen the two lock nuts.
2. Adjust so that the throttle trigger is fully opened when the throttle lever is gripped.
3. Adjust so that there is a gap between the throttle trigger and the throttle plate when the throttle lever is released.
4. Tighten the two lock nuts.

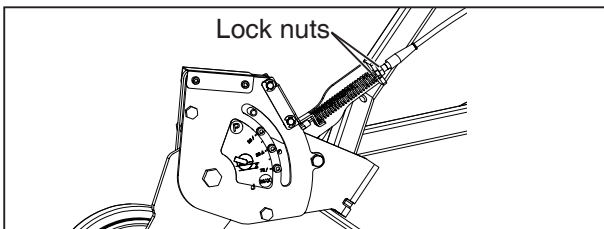

DEPTH ADJUSTMENT CABLE

1. Pull the cart handle forward.
2. Loosen the two lock nuts.
3. Move Depth adjustment lever to lock side and free side to check the position where it operates.
4. Tighten the two lock nuts.

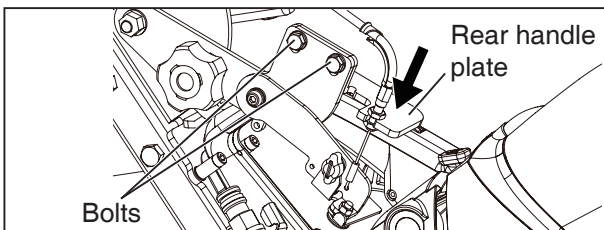

REAR HANDLE

1. If there is a gap in the grip of the rear handle, loosen the bolt and then reduce the size of the gap by pressing the rear handle plate down to the rear handle.

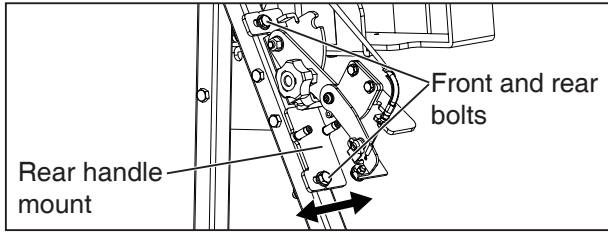

CART

* When the cart pulls to one side.

1. Loosen the front and rear bolts on the rear handle mount of the engine cut-off saw and move the mount left or right to correct the pulling.
2. If the cart pulls to the right, move the mount of the rear handle to the right; if it pulls to the left, correct it by moving it to the left.

* When adjusting the rear handle mount left/right, make small adjustments in line with the amount of pull.

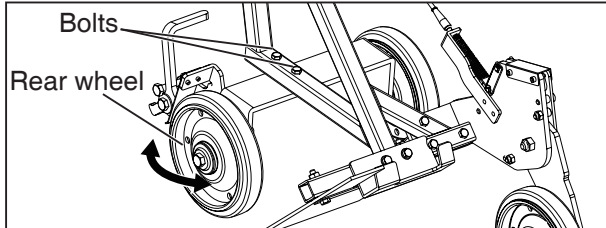

* If the cart bends when driving.

1. Loosen the two bolts.
2. Adjust the direction of the rear wheel.
3. Tighten the two bolts.

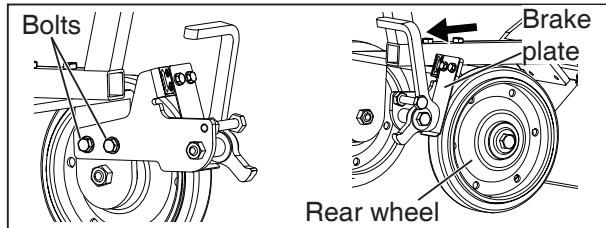

WHEEL BRAKE

• When the wheel brake becomes less effective

1. Loosen the two bolts and adjust the clearance with the wheel.
2. Set the clearance between the rear wheel and the brake plate to 1.0 mm (0.04 in.) at the lever position where the wheel brake is released.
3. Tighten the two bolts.

STORAGE AFTER USE

⚠ WARNING

Always apply the wheel brake before any inspections, maintenance or for storage.

STORAGE

When storing the product for long periods of time (30 days or more), ensure that the following preparations for storage are carried out.

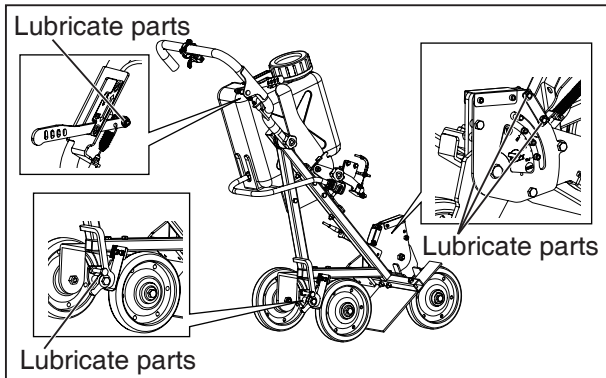

- Remove dirt and store it after the work of the day is finished.
- If left as-is, it will harden and be difficult to remove, and may cause trouble later. If water is used to for washing, dry it off afterwards.
- Check that the screws, bolts and nuts are tightened. Tighten up any that are loose.
- For long-term storage, remove the engine cut-off saw from the cart. Follow the instructions in the operator's manual of the engine cut-off saw for storage.
- Lubricate moving parts before long-term storage.

TECHNICAL DATA

Model		CWT-7410	
Mountable products		CSG-7410	
Dimension	L x W x H	mm	1162 x 442 x 1069 (45.7 in. x 17.4 in. x 42.1 in.)
Mass	Unit Weight (Without engine cutter, no water in tank)	kg	29.5 (65 lb.)
Water Tank	Type	Gravity Supply	
	Volume	l	10 (338.14 US.fl.oz.)
Maximum Depth		mm	120 (4.7 in.) (with 350 mm (13.8 in.) diameter cutting wheel)
Depth Adjustment		with (hand lever, 6 stages)	
Wheel Brake		Foot Operated	
Handle		Variable (15 Degree Increments)	

*Technical data subject to change without notice.

NOTES

ECHO, INCORPORATED

400 Oakwood Road, Lake Zurich, Illinois 60047-1564
Phone : 847-540-8400



GB X750 395-530 0

PRINTED IN JAPAN

COPYRIGHT©2021 YAMABIKO CORPORATION ALL RIGHTS RESERVED