



Your **definitive** source
for quality pre-owned
equipment.

Artisan Technology Group

(217) 352-9330 | sales@artisantg.com | artisantg.com

Full-service, independent repair center
with experienced engineers and technicians on staff.

We buy your excess, underutilized, and idle equipment
along with credit for buybacks and trade-ins.

Custom engineering
so your equipment works exactly as you specify.

- Critical and expedited services
- In stock / Ready-to-ship
- Leasing / Rentals / Demos
- ITAR-certified secure asset solutions

Expert team | Trust guarantee | 100% satisfaction

All trademarks, brand names, and brands appearing herein are the property of their respective owners.

Find the *Lockheed Martin / Sippican / ZEEMET W-9000* at our website: **Click [HERE](#)**

Sea-Air Systems Division
Sippican, Inc.

W-9000

Meteorological Processing System Operator's Manual

Document Number 9010-412 Version 4.2



Sippican, Inc.

W-9000

Operator's Manual

Document Number 9010-412 Version 4.2

SEA-AIR SYSTEMS DIVISION
SIPPICAN, INC.
SEVEN BARNABAS ROAD
MARION, MASSACHUSETTS 02738
U. S. A.

PHONE: 508-748-1160
FAX: 508-748-3626

Version 4.2, November, 1997

Copyright ©1997 by Sippican, Inc..

Printed in the United States of America. All rights reserved. This addendum or parts thereof may not be reproduced in any form without permission of the publisher.

Copyright ©1997 by Sippican, Inc. of all W-9000 System Software included with the sale or distribution of the W-9000 Meteorological Processing System.

The owner of a W-9000 system is granted a license to use the W-9000 software in that system only. Sippican, Inc. retains full and exclusive ownership of the software. The software may be used or copied only in accordance with the terms of the license. Use of the software in other computers or systems is not permitted without the express written consent of the Sippican, Inc. The purchaser may make copies of the software for backup purposes. Copies of the software may not be distributed to others.

ZEEMET and MICROSONDE are trademarks of Sippican, Inc.

Document by Beinstein Associates, Incorporated, 272 Titus Avenue, Warrington, PA 18976-2436

ZEEMET and MICROSONDE are trademarks of Sippican, Inc.

Document by Beinstein Associates, Incorporated, 272 Titus Avenue, Warrington, PA 18976-2436

Contents

	Preface.....	Preface-1
	About This Manual	Preface-1
	The Readme File	Preface-1
	Contents of this Manual	Preface-1
	Other Documentation	Preface-3
	Reader's Comments	Preface-3
Chapter 1.	Introduction.....	1-1
	1.1 General Description.....	1-1
	1.2 System Components	1-1
	Hardware	1-1
	Software.....	1-3
	1.3 Software Overview	1-3
	Software Options	1-5
	Refractivity Display Option.....	1-5
	Ozone Processing Option	1-5
	Graphs Option.....	1-5
	Reports Option.....	1-5
	WMO Coding Option	1-5
	Climate TEMP Coding Option	1-5
	NCDC Reporting Option	1-5
	Military Coding Option	1-5
	1.4 The START Command.....	1-6
	1.5 Computer Keyboard	1-6
	Standard Keys.....	1-7
	Enter 1-7	
	ESC 1-7	
	Cursor Movement Keys	1-7
	Numeric Keypad Keys.....	1-8
	Function Keys	1-8
	1.6 Standard Editing Screen	1-8
	Scratch Pad	1-8
	Types of Data	1-8
	Action Keys	1-9
	Data Entry Modes.....	1-10
	Over-Type Mode.....	1-10
	Insert Mode.....	1-10
	1.7 Environment Variables.....	1-10
	FLTDATAPATH Environment Variable.....	1-10
	SIMDATAPATH Environment Variable.....	1-10
	CALDATAPATH Environment Variable.....	1-10

Chapter 2.	Software Installation	2-1
	2.1 Computer Requirements	2-1
	2.2 Software Installation Tasks	2-1
	2.3 Preparing the Computer	2-2
	2.4 Formatting the Fixed Disk	2-3
	2.5 Installing System Software	2-3
	2.6 Configuring System Software	2-3
	2.7 Installing System Software Updates	2-4
	2.8 The README File	2-4
	2.9 Setting System Time and Date	2-4
	2.10 Printer Configuration	2-5
Chapter3.	System Setup Utilities.....	3-1
	3.1 System Setup Overview	3-1
	3.2 Station Installation	3-2
	Customer Name	3-3
	System Name	3-3
	Latitude	3-4
	Longitude	3-4
	Station Height	3-4
	Surface Data Timer	3-4
	Sonde Type	3-4
	PTU Selection	3-4
	End Flight Automatically.....	3-5
	Language.....	3-5
	Geoid Separation.....	3-5
	Automatic Flight Save	3-5
	3.3 Military Message Coding Parameters	3-5
	Octant of the Globe.....	3-6
	Coded Position.....	3-6
	Military Cloud Code	3-6
	Validity periods.....	3-6
	3.4 WMO message Coding Parameters	3-6
	Maximum Number of Tropopause	3-6
	Lowest Tropopause Pressure	3-6
	Local Station ID.....	3-7
	WMO Station Number.....	3-7
	WMO Sounding System Used	3-7
	Sea Station	3-7
	Mobile Land Station	3-7
	Ship Call Sign and Mobile Station country/town code.....	3-7
	Number of Groups per Line.....	3-8
	Number of Blank Lines Between Messages	3-8
	Include Significant Winds (PPBB and PPDD)	3-8
	Include Last Wind in PILOT Section 4	3-8
	Replace / with 0 in PPBB station elevation	3-8

	Do not generate 41414 in TTBB	3-8
	Do not generate 52525 in TTBB (Region II)	3-8
	Add WMO number before first group.....	3-8
	Change height coding units to 500 M after 30,000 M.....	3-8
	Ignore wind direction changes during calm winds.....	3-8
	Incremental Level Selection	3-9
3.5	Receiver Installation	3-9
	Receiver Type.....	3-10
	AFC Reference Value.....	3-10
	Starting Search Frequency.....	3-10
	Ending Search Frequency.....	3-10
	Default Receiver Volume	3-11
3.6	Event Manager Configuration	3-12
3.7	Wind Finding Installation.....	3-13
	Loran Tracker	3-14
	Enabling PVT GPS Operation.....	3-16
	Enabling Differential GPS Operation.....	3-16
3.8	Wind Computation Setup	3-17
	Selecting the Basis for a Wind Interval.....	3-18
	Wind Interval Data Fields	3-18
	Section Start (Seconds).....	3-18
	Section Start (Meters).....	3-18
	Smoothing Length (Seconds)	3-18
	Minimum Good Data Samples	3-19
	Computation Interval (Seconds).....	3-19
	Interval Selection by Time	3-19
	Interval Number 1.....	3-19
	Interval Number 2.....	3-19
	Interval Selection by Height.....	3-20
	Interval Number 1.....	3-20
	3-19
	Interval Number 2.....	3-20
	Interval Number 3.....	3-20
	Default Wind Interval Selection-Loran	3-21
	Wind Parameter Setting.....	3-21
	Curve Fit Variance Limit.....	3-22
	Raw Wind Sampling Interval	3-22
3.9	Loran Chain File.....	3-22
	Edit a Loran Chain.....	3-23
	Add a Loran Chain	3-24
	Print Loran Chain Data to file	3-25
3.10	Antenna Configuration	3-26
	Electronic Antenna Description	3-26
	Rotor Antenna Description.....	3-26
	Antenna Mode	3-26
	Antenna Selection.....	3-27

	Antenna System	3-27
	Antenna Switch Over	3-27
	Cycle Time (Rotor Only)	3-27
	Most Probable Sonde Azimuth (Rotor Only)	3-30
	Initialization (Rotor Only)	3-30
	Orientation (Rotor Only).....	3-30
3.11	Transmission Parameters	3-32
3.12	Serial Interface Parameters	3-32
3.13	Load ZEEMET Rack	3-33
	ZEEMET Rack Configuration Screen	3-33
	Introduction to Downloading.....	3-33
	When to Download	3-34
	Selecting a Module to Download.....	3-34
	Downloading Operation.....	3-34
3.14	Print Configuration	3-35
3.15	Printer Definition	3-35
Chapter 4	Starting up the W-9000 System.....	4-1
4.1	Summary	4-1
4.2	Powering Up the System Equipment	4-1
4.3	Starting System Programs.....	4-2
4.4	Running the System Setup Utilities	4-3
4.5	Starting a Radiosonde Flight.....	4-3
	New Flight	4-3
	Simulated Flight.....	4-4
Chapter 5	Flight Preparation	5-1
5.1	Introduction.....	5-1
5.2	Overview of Flight Preparation	5-1
	Entering a Sonde Serial Number.....	5-2
	Entering a Flight Ascension ID.....	5-2
5.3	Flight Preparation Display	5-3
	Preflight Menu	5-3
	Flight Information Windows.....	5-4
	PTU Data	5-4
5.4	Navaid Status	5-4
	Differential GPS Status.....	5-4
	PVT GPS Status.....	5-5
	Loran Status	5-6
	Key.....	5-7
	Status.....	5-7
	Time of Arrival (TOA)	5-7
	Time Difference (TD).....	5-7
	Signal to Noise Ratio (SNR).....	5-7
	State.....	5-7
	Signal Source Message	5-8

	Restarting Navaid Lockup	5-8
	Radar Status	5-8
5.5	Surface Data	5-9
	Entering Surface Data	5-9
	Humidity Calculation	5-10
	WMO Message coding Parameters	5-10
	WMO Cloud Code	5-11
	Standard Day and Hour	5-11
	Transmission ID	5-11
	Military Message Coding Parameters	5-11
5.6	Calibration Data	5-11
	Calibration Functions	5-11
	Calibration Overview	5-11
	Calibration Menu	5-12
	Calibration Data Entry	5-12
	Calibration Data Source	5-13
	Calibration, Pressure Offset	5-13
	Entered Surface Data Window	5-14
	Current Offset Information Window	5-14
	PTU Data window	5-14
	Offsets Window	5-14
5.7	Receiver Display	5-14
5.8	Arm for Launch	5-14
5.9	Flight Utilities	5-14
5.10	Flight Identifier Initialization	5-15
5.11	Exit System	5-15
Chapter 6	Flight Operations	6-1
6.1	Flight Display	6-1
	Flight Menu Window	6-2
	Flight Information Window	6-2
	PTU Data window	6-2
	Wind Data Window	6-3
6.2	Wind Finding Status, Omega	6-3
6.3	Surface Data Entry	6-3
6.4	Data Display Menu	6-4
6.5	PTU Versus Time Display	6-4
	Concurrent Plot	6-5
	Point Select and Data Display	6-6
6.6	Skew-T Display	6-7
6.7	Refractivity Display	6-7
	Tabular Format	6-8
	Pre-flight (Launch not detected)	6-8
	In-flight (Launch detected)	6-8
	End-of-flight (End of flight detected)	6-9

	Graphic Format	6-10
	Pre-flight (Launch not detected)	6-10
	In-flight (Launch detected)	6-10
	End-of-flight (End of flight detected)	6-10
6.8	Sonde View	6-11
	Raw Sonde data Display	6-12
	Processed sonde Data Display	6-12
	Tabular Display Attributes.....	6-13
	Pre-flight (Launch not detected)	6-14
	In-flight (Launch detected)	6-14
	End-of flight (End of flight detected)	6-14
6.9	Global Positioning system (GPS) Operation	6-15
6.10	Report Generator.....	6-15
	Report Selection Menu.....	6-16
	Report Browsing.....	6-17
	Report Definition.....	6-17
6.11	Graph Generator.....	6-19
	Graph Selection Menu	6-20
	Viewing a Graph.....	6-21
	Graph Definition	6-22
	Entering and Editing Fields	6-23
	Graph Name and Graph Title Fields	6-23
	Y-Axis Field.....	6-23
	Red, Yellow, Green, Blue Fields	6-23
6.12	Wind Speed and Direction Graphs	6-23
	Viewing.....	6-24
	Wind Editing.....	6-24
	Axis Adjustment	6-25
6.13	Wind Vector Components.....	6-26
6.14	Data Analysis	6-26
6.15	Flight Utilities	6-26
6.16	Edit launch or End Time	6-26
6.17	Exit system.....	6-28
6.18	End Flight.....	6-29
Chapter 7	Data Analysis	7-1
7.1	Introduction.....	7-1
7.2	Data Analysis Output.....	7-3
7.3	Report Printing.....	7-3
7.4	Serial Output	7-3
7.5	PTU Summary	7-4
7.6	Wind Summary	7-5
7.7	Analysis Summary	7-5
7.8	Standard Isobaric Surfaces.....	7-6
7.9	Met Significant Levels.....	7-7
7.10	Wind Significant Levels	7-8

7.11	Regional Wind Levels	7-8
7.12	Freezing Levels	7-10
7.13	NCDC Data Files.....	7-10
7.14	Monthly Means.....	7-11
7.15	Code and Process Messages	7-12
7.16	Compute WMO Message	7-13
7.17	Code New Military Messages	7-14
7.18	Edit Message	7-16
7.19	Edit coded Messages	7-18
7.20	Edit	7-18
	Moving the Editing Cursor	7-18
	Typeover and Insert Modes	7-19
	Deleting Characters	7-19
7.21	Transmit Coded WMO Messages	7-19
7.22	Transmit Coded Military Messages.....	7-21
7.23	Set Transmit Data Parameter.....	7-22
7.24	Report Files	7-22
Chapter 8	Flight Utilities	8-1
8.1	Introduction	8-1
8.2	Save Flight Data to Disk.....	8-1
8.3	Restoring Flight Data from Disk	8-3
8.4	ZEEMET Rack Communications.....	8-4
8.5	Version Identifier Commands	8-6
8.6	Normal Operational Commands.....	8-7
	<i>(See the "Command Index" following the "List of Figures"</i>	
	<i>and on page 8-39 for commands and page locations.)</i>	
8.7	403 MHz Receiver Commands	8-14
8.8	Decoder Commands	8-20
8.9	Antenna Commands	8-23
8.10	Coded Message Transmission Commands.....	8-27
8.11	Maintenance Commands	8-31
8.12	Error Messages	8-31
8.13	Receiver.....	8-31
	Receiver Status Display.....	8-31
	Sonde Search	8-32
	Location Status	8-32
	Sonde Serial No.....	8-32
	Serial No. Status	8-32
	Min. Search Freq.	8-33
	Max Search Freq.....	8-33
	Current Frequency	8-33
	Signal Strength	8-33
	Audio Level.....	8-33

(continued)

	Preamp	8-33
	AFC.....	8-33
	AFC Reference.....	8-33
	Receiver Action Keys	8-33
	Receiver Spectrum Display.....	8-34
	Receiver Tune Display.....	8-35
	Automatic Frequency Control.....	8-35
	Receiver Volume Control	8-36
8.14	Antenna.....	8-36
8.15	Print Setup Configuration	8-38
8.16	Station Installation	8-38
8.17	Event Manager Configuration.....	8-38
8.18	Wind Computation Setup.....	8-38
8.19	Sonde View.....	8-38
8.20	View Journal File.....	8-38
8.21	Acknowledge Alarm Event.....	8-39
8.22	Index to ZEEMET Rack Commands	8-39
Chapter 9	Off-Line Utilities.....	9-1
9.1	Introduction to Off-Line Utilities.....	9-1
9.2	Off-Line Utility Menu.....	9-1
	Flight Archive Utility.....	9-2
	Report Generator.....	9-2
	Graph Generator.....	9-2
	Captured Screen Review	9-2
9.3	The Binary File Utilities Program.....	9-4
	Introduction to the Binary File Utilities Program	9-4
	Command Line Mode	9-4
	Input File Specification.....	9-4
	Output File Specification	9-5
	Options.....	9-5
	Interactive Mode	9-6
9.4	The AVGMET Program	9-10
	AVGMET Command Line Syntax	9-11
9.5	The Capture Program.....	9-11
	Simulated Terminal Operation.....	9-12
	Capture Data to disk.....	9-13
	Configure COM Ports	9-14
9.6	The Grapher Program	9-14
Chapter 10	Flight Data Management	10-1
10.1	Introduction to Data Management	10-1
10.2	W-9000 System Directory Structure.....	10-1
10.3	Files Used to Store Flight Data.....	10-5
	Raw Flight Data Files	10-5
	Processed Flight Data Files.....	10-6
	Control Files.....	10-6

	Sonde Calibration Files	10-7
	Summary and Message Coding Files	10-7
	Miscellaneous Files	10-8
10.4	Disk Space Management	10-9
	Copying Flight Data to Diskette	10-10
	Copying Flight Data From Diskette	10-10
	Deleting Flight Data From Hard Disk	10-11
	Restoring an Archived Flight	10-11
	Viewing the Files of an Archived Flight	10-11
Appendix A	Mark II Sonde Preparation.....	A-1
	A.1 Unpacking and Assembling.....	A-1
	A.2 Tuning the MICROSONDE	A-2
	A.3 Final Check and Launches.....	A-2
Appendix B	W-9000 Error Codes.....	B-1
	B.1 Introduction	B-1
	B.2 Journal File Entries.....	B-1
	B.3 Basic Run Time Error Codes.....	B-3
	B.4 List of W-9000 System Errors.....	B-3
	B-5 List of W-9000 ZEEMET Rack Errors	B-9
Appendix C	Navigation Status Information	C-1
	C.1 General Information	C-1
	C.2 Operating Parameters	C-1

Figures

Figure	Title	Page
1-1	W-9000 Block Diagram	1-2
1-2	W-9000 System with a Radar/Radiotheodolite Global Positioning System	1-2
1-3	W-9000 System with a Global Positioning System	1-3
1-4	Software Overview Map	1-4
1-6	W-9000 System Software Map	1-6
1-6	Standard 101 Key Keyboard	1-6
3-1	Map of System Setup Utilities	3-1
3-2	Setup Menu	3-2
3-3	Station Installation Menu	3-2
3-4	Station Installation	3-3
3-5	Military Message Coding Parameters	3-5
3-6	WMO Message Coding Parameters	3-6
3-7	WMO Message Parameters 2	3-7
3-8	Receiver Installation	3-9
3-9	Event Manager Configuration	3-11
3-10	Wind Finding Installation Menu	3-12
3-11	Loran Chain Window	3-13
3-12	Loran Station Window	3-14
3-13	Omega Station Window	3-15
3-14	Wind Interval Setup	3-16
3-15	Wind Interval Selection, Loran	3-16
3-16	Wind Interval Selection by Time	3-18
3-17	Wind Interval Selection by Height	3-19
3-18	Loran Default Wind Interval Selection	3-20
3-19	Omega Default Wind Interval Selection	3-21
3-20	Wind parameter Setting	3-21
3-21	Loran Chain Data	3-23
3-22	Loran Chain Selection	3-23
3-23	Edit a Loran Chain	3-24
3-24	Add a Loran Chain	3-24
3-25	Print Loran Chain Data to File	3-25
3-26	Antenna Configuration	3-26
3-27	Introductory Help Screen	3-28
3-28	Interface Module Version Check	3-28
3-29	Move Antenna to Start Position	3-29
3-30	Start Antenna Timing	3-29
3-31	Stop Antenna Timing	3-30
3-32	Antenna Orientation Help Screen 1	3-31
3-33	Antenna Orientation Help Screen 2	3-31
3-34	Message Transmission Parameters	3-32
3-35	ZEEMET Rack Configuration Screen	3-33

Figure	Title	Page
4-1	Front View, Display Monitor	4-1
4-2	ZEEMET Rack Back View	4-2
4-3	System Computer Front Panel	4-2
4-4	W-9000 Command Summary	4-3
4-5	ZEEMET Logo Display	4-5
4-6	System Configuration Display	4-5
4-7	ZEEMET Rack Configuration	4-6
5-1	Flight Preparation Map	5-1
5-2	Flight Identifier Initialization	5-2
5-3	Flight Preparation	5-3
5-4	Omega Status	5-4
5-5	Three Frequency Omega Status	5-5
5-6	Loran Status	5-6
5-7	Normal Omega Lockup	5-8
5-8	Invalid Omega Lockup	5-8
5-9	Radar Status	5-9
5-10	Surface Data Entry	5-10
5-11	Calibration menu	5-12
5-12	Calibration Data Entry	5-12
5-13	Pressure Offset Display	5-13
6-1	Map of Flight Functions	6-1
6-2	Flight Display	6-2
6-3	Flight Display with Wind Data Window	6-3
6-4	Data Display Menu	6-4
6-5	Concurrent Plot	6-5
6-6	Point Select	6-6
6-7	Skew-T Display	6-7
6-8	Refractivity Display Menu	6-8
6-9	Tabular Refractivity Format	6-9
6-10	Graphic Refractivity Format	6-10
6-11	Sonde View Menu	6-11
6-12	Raw Sonde Data Display	6-12
6-13	Processed Sonde Data Display	6-13
6-14	GPS Navaid Display Screen	6-15
6-15	Report Selection Menu	6-16
6-16	Report Definition	6-17
6-17	Report Definition Menu	6-19
6-18	Graph Selection Menu	6-20
6-19	Graph Selection Menu	6-21
6-20	Graph Definition	6-21
6-21	Wind Speed and Direction Graph	6-24

Figure	Title	Page
6-22	Wind Vector Components	6-26
6-23	Edit Launch/End Time	6-28
6-24	End Flight	6-29
7-1	Data Analysis Map	7-1
7-2	Process Coded Messages Map	7-2
7-3	Data Analysis Output	7-3
7-4	PTU Summary	7-4
7-5	Summary of Browser Commands	7-4
7-6	Wind Summary	7-5
7-7	WMO Message Data Analysis	7-6
7-8	Standard Isobaric Surfaces	7-7
7-9	Met Significant Levels	7-7
7-10	Wind Significant Levels	7-8
7-11	Regional Wind Levels by Height	7-9
7-12	Regional Wind Levels by Pressure	7-9
7-13	Freezing Levels	7-10
7-14	NCDC Summary	7-11
7-15	CLIMAT TEMP Monthly Means	7-11
7-16	Process Coded Messages	7-12
7-17	Compute WMO Message	7-13
7-18	Computed TEMP B Message	7-14
7-19	Code New Military Messages Menu	7-15
7-20	Sample Computer Message	7-15
7-21	Sample Message Generation Report	7-16
7-22	Edit Coded Messages Menu	7-18
7-23	Transmit Coded WMO Messages Menu	7-19
7-24	Transmit Coded WMO Messages	7-20
7-25	Transmit Coded WMO Messages	7-20
7-26	Transmit Coded Military Messages Menu	7-21
8-1	Flight Utilities Menu	8-1
8-2	Save Flight Data to Disk	8-2
8-3	Save Flight Data to Disk	8-2
8-4	Restore Flight Data Menu	8-3
8-5	Flight Data Restored	8-4
8-6	ZEEMET Rack Communication	8-5
8-7	Receiver Status Display	8-32
8-8	Receiver Spectrum Display	8-34
8-9	Receiver Tune Display	8-35
8-10	Antenna Display	8-36
8-11	Antenna Display	8-37

Figure	Title	Page
9-1	Post-Flight Utilities Menu	9-1
9-2	Screen Review and Print Utility	9-3
9-3	Binutil Default File Extensions	9-5
9-4	Binutil File Specifications	9-6
9-5	Binutil Options	9-7
9-6	File Conversion Taking Place	9-7
9-7	Enter Field Number(s) Option	9-8
9-8	Enter Reject Bad Records Option	9-9
9-9	Input Binary Data File	9-9
9-10	Capture Menu	9-12
9-11	Simulated Terminal Operation	9-12
9-12	Capture Data	9-13
9-13	Configure COM Ports	9-14
10-1	System Directory Structure	10-1
10-2	c:\w 9000 Sub-Directories	10-2
10-3	c:\programs Subdirectories	10-3
10-4	c:\flights Subdirectories	10-4
10-5	Flight Data File Management Menu	10-9
A-1	Preparing a Radiosonde for a Flight	A-1
B-1	Sample Journal File Error Entry	B-2

Commands

Note that all page numbers are in Chapter 8 (that is, 8-).

COMMAND	PAGE	COMMAND	PAGE	COMMAND	PAGE
AB	23	IMC	29	XGY	15
AC	24	IMH	12,23	XH	16
AD	24	IMP	30	XJN	16
AH	26	IMS	29	XJY	16
AI	25	IN	9	XL	16
AL	26	IOH	12	XMA	16
AM	24	IS	7	XMB	17
AN	26	IT	9,22	XMD	17
AO	24	IV	5	XMH	17
AP	24	IWT	10	XMN	17
AR	26	IZ	8,22	XMS	17
AS	26	LD	8	XNN	18
AT	26	LF	10	XNY	18
AW	27	LH1	13	XO1	18
AY	24	LH2	13	XO2	18
CA1	31	LR2	11	XPN	18
CH	31	MM	31	XPY	18
DA	20	OF	10	XQ	18
DH2	21	OM	11	XRD	19
DN	21	OS	10	XRN	19
DP	20	R	11	XRY	19
EF	11	RF	11	XS	7
F	8	RO	12	XT	19
G	8	XA	14	XU	19
IBA	27	XCN	14	XV	6,20
IBB	27	XCY	14	XW	20
IBC	28	SDN	14	XY	21
IBM	28	XDY	14	XZ	21
IBO	28	XEN	14		
IBP	30	XEY	14		
IBS	28	XFN	15		
IC2	9,22	XFY	15		
II	9	XGD	15		
IL	9,22	XGN	15		

Preface

About This Manual

This manual explains how to use the W-9000 Meteorological Processing System to record and evaluate meteorological data. The manual primarily addresses the needs operators who are responsible for gathering meteorological data at weather stations.

The formatting in this manual is designed to show the differences between text that appears on the screen or is entered by the operator, and text that is part of the manual. Any keys or series of keys that you are to enter are shown in bold text. Text that represents one or more keyboard keys is shown in bold text surrounded by angle brackets. Keys with a printed name on their face are shown exactly as they appear on the computer keyboard. Some examples are <Home>, <Enter>, and <Esc>.

Keys that do not have printed names are given standard names that are used throughout the manual. The standard names are as follows:

<Space Bar>
<Up Arrow>, <Down Arrow>
<Left Arrow>, <Right Arrow>

If two or more keys need to be pressed at the same time, all of the key names will be shown within brackets separated by hyphens. For example, if you are required to press the <Alt> key and the <A> key at the same time, this will be shown as <Alt-A>.

Text that is output on the printer or on the monitor is shown in bold text, for example **Is This Data Correct? (Y/N/<Esc>)**.

The Readme File

This manual documents the W-9000 Meteorological Processing System running software version 4.2. This software contains a file called readme.dat, which notifies you of any updates made to the software after this manual was printed. Review this file carefully before operating the W-9000 System software. To display the readme.dat file, first install the W-9000 System Software as outlined in the instructions that came with the system. At the DOS command line type **README** <Enter>. The contents of the file will be displayed on the screen. The <Home>, <End>, <PgUp>, <PgDn>, <Up Arrow>, and <Down Arrow> keys can be used to move through the file. Press the <Esc> key to return to the DOS command line.

Contents of This Manual

The information in this manual is arranged in the order that is typically followed for the launch of a weather balloon. However, the software is flexible, allowing each specific site to adopt an operating routine that meets their own needs.

This manual is divided into ten chapters and three appendixes as follows.

Chapter 1. Introduction

Describes the W-9000 system and its capabilities and explains some of the conventions you need to know to use the system efficiently.

Chapter 2. Software Installation

Provides instructions for installing the system software on the hard disk of the system computer.

Chapter 3. System Setup Utilities

Explains the purpose and operation of utility programs that allow the user to initialize parameters that are unique to each station.

Chapter 4. Starting up the W-9000 System

Lists the tasks that have to be performed to start up the W-9000 system.

Chapter 5. Flight Preparation

Provides instructions for preparing the system for a flight. These steps are generally done for each flight.

Chapter 6. Flight Operations

Describes met and wind data display and edit functions that can be used following launch or after a flight has ended.

Chapter 7. Data Analysis

Describes the data analysis and message coding functions of the system.

Chapter 8. Flight Utilities

Explains the purpose and operation of utility programs that allow the user to perform such tasks as saving and restoring flight data, and troubleshooting the system. The end of this chapter contains a list of all of the W-9000 System software commands.

Chapter 9. Off-Line Utilities

Describes several utility programs for working with the data files produced by the system during flights and for working with system hardware. Also covers how to access and use the Report Generator and Graphic Display Generator software packages when the system is off-line (not running a flight).

Chapter 10. Flight Data Management

Instructions on the management of the space on system computer's hard disk to store flight data files. How to find the files, how to save them on other media, how to restore them to the hard disk if needed. How to make the data available for use by other software that is not part of the W-9000 System Software.

Appendix A. Mark II Radiosonde Preparation Instructions

Instructions on setting up the Mark II MICROSONDE for flights.

Appendix B. W-9000 Error Codes

List of the errors that may be generated by the W-9000 Software when it detects a hardware, software, or configuration error.

Appendix C. U.S. Naval Observatory Information

Contains instructions for contacting the U.S. Naval Observatory in Washington D.C. to obtain the most recent information on Loran-C chains.

Other Documentation

In addition to this manual, you will receive the following documentation.

- DOS Reference Manual
- PKZIP Reference Manual
- Grapher Reference Manual
- W-9000 System Schematic Drawing Set
- W-9000 System Technical Reference Manual
- Troubleshooting manuals These manuals explain how to install, set up, and troubleshoot system hardware. Together, they make up your library of reference materials. Familiarize yourself with them before you begin operations.

Reader's Comments

The Sippican Engineering Department is very interested in your comments concerning this manual. You will be able to help us improve the product and manual by sending any comments or suggestions you may have to the following address:

**Director of Engineering
Sippican, Inc.
Seven Barnabas Road
Marion, MA 02738
U.S.A.**

This page intentionally left blank.

Chapter 1. Introduction

1.1 General Description

The ZEEMET W-9000 Meteorological Processing System is a highly sophisticated set of integrated modular hardware and software that provides the user with high resolution meteorological profiles through the use of telemetered radiosonde data and hyperbolic, as well as other navigation techniques.

When optional WMO and/or military message coding is installed, radiosonde flight data can be further processed into coded messages that can then be transmitted. The W-9000 graphically displays all levels selected as significant allowing the operator to apply additional quality control to the coded messages.

The system has been designed to allow the addition of custom software and hardware that can be made via arrangements with the Sippican marketing department.

The system generates data in the following formats:

- Tabular and optional graphic displays on the system display monitor
- Printed reports generated by the system printer
- Files of data stored on the hard disk of the system computer

1.2 System Components

Hardware

Several hardware configurations are possible because the W-9000 system is extremely modular in its design. The following list shows some of the available hardware components:

- Preamplifier/Antenna
- Local Navaid Antenna and coupler
- Local GPS Antenna
- ZEEMET Rack. This is a specially designed rack with a P90 bus back plane and a power supply. The back plane has multiple slots to receive plug in modules. A standard system contains the following modules:
 - ◇ Interface
 - ◇ 403 MHz Synthesized Receiver
 - ◇ 403 MHz Antenna Controller
 - ◇ LORAN-C or Amplifiers
 - ◇ LORAN-C Notch Filters
 - ◇ Navaid Tracker(s)
 - ◇ GPS Module
- System computer with keyboard, fixed disk drive, and two diskette drives
- Color graphic display monitor

- Printer

Figure 1-1, 1-2, and 1-3 shows the W-9000 system with several hardware configuration options.

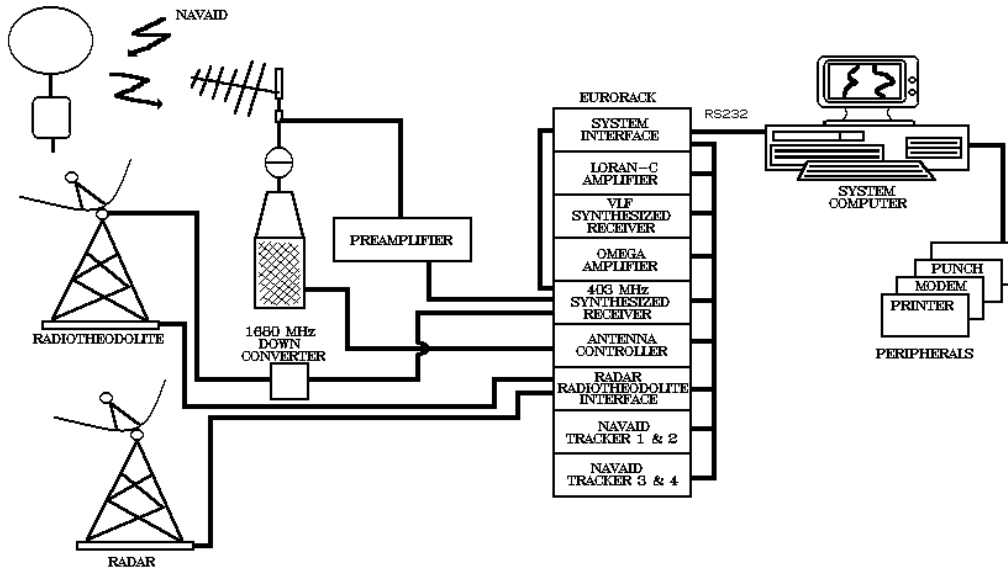

Figure 1-1. W-9000 Block Diagram

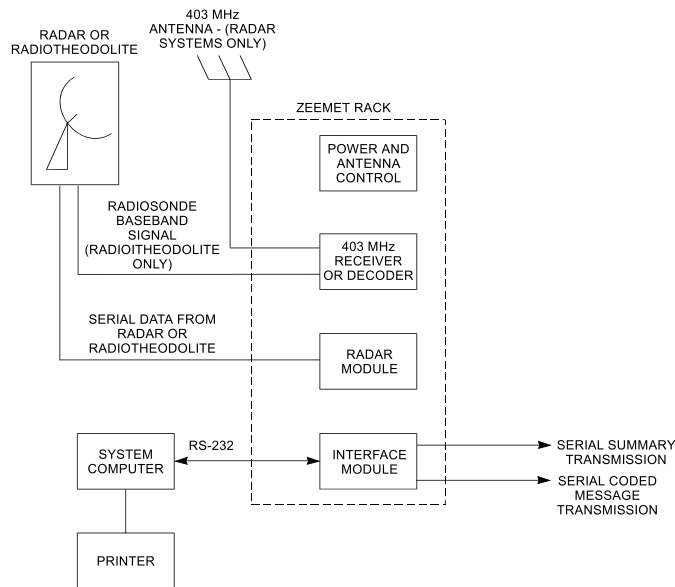

Figure 1-2. W-9000 System with a Radar/Radiotheodolite Interface

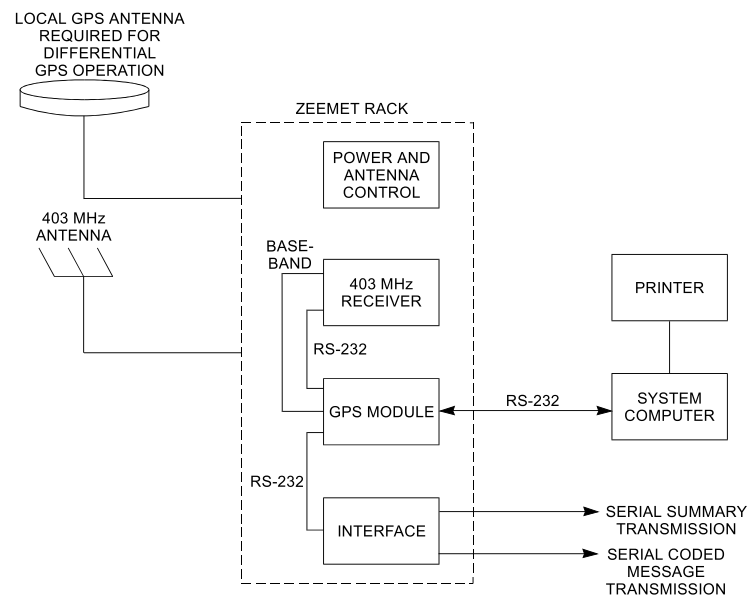

Figure 3. W-9000 System with a Global Positioning System

Software

- Software for the W-9000 system consists of the following modules.
- W-9000 System Software and Options
- DOS (Disk Operating System)
- PKWARE PKZIP.EXE
- CarbonCopy from Microcom Inc.
- Grapher from Golden Software Inc.

All of the software modules listed above are factory installed on the system computer fixed disk drive. W-9000 software is menu-driven, which means that the information needed to operate the system is presented on the screen as a series of choices. You select the task you want to perform, the system executes your instructions, and the screen displays your next series of choices. This type of system is easy to learn and use; consequently, there is a reduced opportunity for error.

In addition to the system software being installed on the fixed disk, all of the software for the system is supplied on diskettes should it ever need to be re-installed. It is a good idea to keep these diskettes in a safe place. From time to time, you may receive new diskettes containing software updates to the W-9000 system software.

1.3 Software Overview

This section introduces the overall structure of the system software. It explains the major functional blocks that can be used and how they relate to each other. The general flow of the software is illustrated using block diagrams. More specific details on the use of the programs introduced here are presented in later chapters.

Figure 1-4 shows the general operation of the W-9000 system software starting from when power is turned on. First, a small batch program called autoexec.bat runs automatically to initialize the computer for use by the W-9000 system software. Then the operating system prompt, C:\>, is displayed with a

blinking underline cursor. The blinking cursor indicates that the computer is ready for the entry of commands. This state is often referred to as the *DOS command line* in this manual.

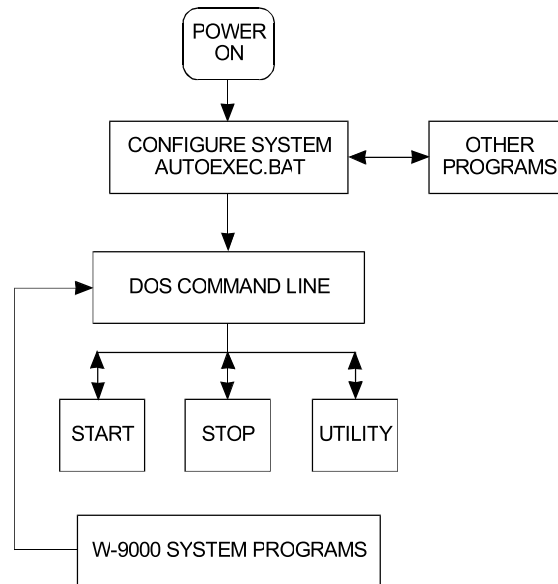

Figure 1-4. Software Overview Map

The following W-9000 system software programs can be run from the DOS command line:

- **START.** To run the W-9000 system software for a new radiosonde flight or review the data of a past flight.
- **SETUP.** To edit or review the W-9000 system configuration. This program configures the W-9000 system for a particular ground station location, radiosonde type, and for the ground equipment hardware being used. **SETUP** also permits the user to customize receiver operation, antenna operation, wind computation, and automatic message coding.
- **UTILITY.** To run off-line utilities that manage flight files, generate reports and graphs, and print captured screens.

As shown in Figure 1-4, any program installed in the computer can be started from the DOS command line. This includes programs obtained from other sources and installed by the system owner. Note that DOS is supplied with the system software, so any of the standard DOS commands can be entered when the DOS command line is displayed. See the DOS reference manual for documentation on the available commands.

Software Options

Throughout the operators' manual, references are made to items that appear in menus or options that are available because a software option is installed. Information on software options is available from your Marketing Representative. W-9000 Options are listed and described in this section.

Refractivity Display Option

This option will cause an additional menu selection to appear in the Data Display Menu. The menu selection gives access to a graphical and tabular display of refractivity data for the flight.

Ozone Processing Option

This option allows you to fly Sippican Mark II Ozone sondes with your W-9000 System.

Graphs Options

This option allows definition and generation of custom graphs of numerous meteorological parameters versus time, height, or pressure.

Reports Option

This option allows definition and generation of custom reports of numerous meteorological parameters versus standard pressure levels, or even increments of time, height, or pressure.

WMO Coding Option

This option allows for coding of WMO TEMP and PILOT messages.

CLIMAT TEMP Coding Option

This option allows for coding of a WMO CLIMAT TEMP message. This option requires the WMO Coding Option.

NCDC Reporting Option

This option allows for generation of data files for transmission to the U.S National Climatic Data Center. This option requires the WMO Coding Option.

Military Coding Option

This option allows for coding of STANAG messages.

1.4 The START Command

Use the **START** command to start the W-9000 system for a new flight. Figure 1-5 is a block diagram of the W-9000 system software showing the general operational flow before and during a radiosonde flight. Later chapters of this manual describe the operations in each block in more detail.

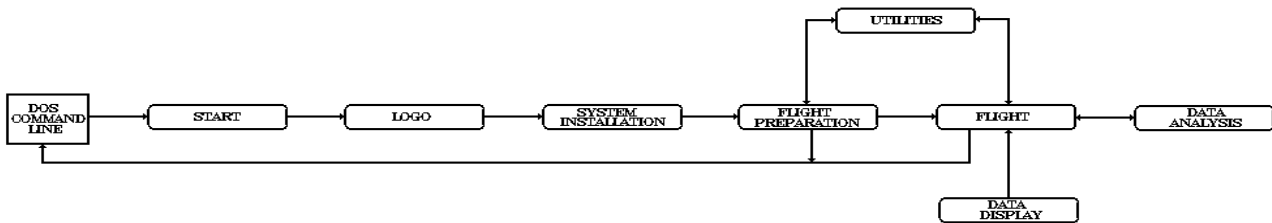

Figure 1-5. W-9000 System Software Map

As shown in Figure 1-5, when the user enters the **START** command, the ZEEMET logo is the first display on the screen. You may press any key while this display is on to immediately continue on to the flight identifier screen. This screen allows you to enter the flight ascension identifier and the radiosonde serial number. After the flight identifiers have been entered, the software enters the preflight program that allows access to all functions required to prepare for a radiosonde flight.

When all of the preflight activities have been completed, the user selects Arm for Launch from the preflight menu to access the flight program. The system will stay in the flight menu and its submenus throughout the flight. The flight menu allows access to data analysis (message coding), the graphic flight data displays, and other utilities. You can return to the DOS command line from either the flight menu or the flight preparation menu by selecting Exit System.

1.5 Computer Keyboard

If you are unfamiliar with DOS or the system computer, read the DOS manual and the system computer operators' manual before you attempt to operate the system. This W-9000 manual provides only a brief description of the keyboard and short explanations of the functions certain keys perform in your system.

An example of a standard 101 key keyboard usually used for the system computer is shown in Figure 1-6. Some systems have keyboards that differ in arrangement but still have the same basic keys, and they perform the same functions as discussed below. The keyboard consists of four groups of keys: standard keys, cursor movement keys, numeric keypad keys, and function keys.

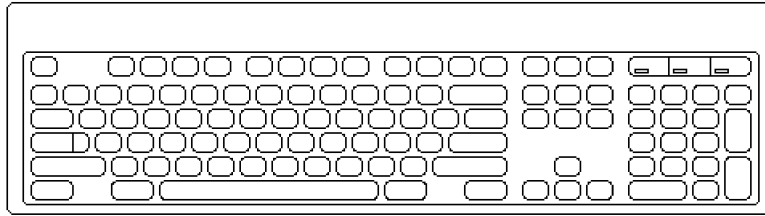

Figure 1-6. Standard 101 Key Keyboard

Standard Keys

For the most part, these keys function in the same way as their counterparts on a standard typewriter. A few distinctions for the operation of your W-9000 system are worth noting.

Enter

In addition to performing a function similar to the carriage return key on a standard typewriter, this key sends the characters already typed to the computer for processing. The **Enter** key also moves the cursor from one data field to another. You can use it to move from field to field while editing data, or you can use it to accept a previously entered value in a field.

Esc

This key is used to terminate the current function and go to the next function as determined by the design of the executing program. In most cases, the **Esc** key is used to exit from the current screen and return to the previous screen. For example, if you are in the Navaid display and want to return to the Flight menu, press **Esc**.

Cursor Movement Keys

The cursor movement keys are located to the right of the standard keys. The cursor is a blinking white line or block on the display screen. It indicates where the next input from the computer or the keyboard will appear. You can move the cursor up and down or left and right by pressing the up and down and left and right cursor movement keys. Generally, the cursor advances automatically to the next field on the screen after you enter the necessary data. If the data you enter is incomplete (for example, it contains an insufficient number of characters), the cursor will not advance.

Some data fields are required; others are optional. If you attempt to skip over a required field, the cursor will not advance. The W-9000 system needs this information to process data it receives from the sonde.

Numeric Keypad Keys

The numeric keypad is located to the right of the function keys. Located on the numeric keypad are the **PgUp** and **PgDn** keys. Use these keys to move more rapidly up and down through a display.

Function Keys

There are 12 function keys on the keyboard labeled **F1** through **F12**. These keys are programmable, which means that the designers of the W-9000 system software have assigned certain tasks to them. For example, when an error message is generated by the system, you can clear it from the screen after reading it by pressing the **Alt** key, and, while holding it down, pressing the **F10** key. This **Alt-F10** keystroke is used to acknowledge an error and remove the error message from the bottom of the screen. Additional function keys are explained where appropriate throughout the rest of the manual.

1.6 Standard Editing Screen

Most of the data entry screens in the W-9000 System operate using a standard data entry interface, so there is a standard appearance, methodology, and definition of keys. This makes the system easier to learn and use.

Scratch Pad

The standard editing screens use a *scratch pad* concept. The scratch pad is a small work area at the lower left side of the screen. It allows an item to be changed while still having the previous value of the item visible in the main window on the screen. Pressing **Enter** allows the change to be provisionally accepted. When you have finished editing, press **Esc**, and the following prompt will appear:

Accept displayed values? (Y/N/<Esc>)

Pressing **Y** accepts the changes and exits the program. Pressing **N** allows you to continue editing. Pressing **Esc** exits the screen without accepting any of the changes.

All of the items that are part of the editing display are listed in the confines of a double-lined data entry window.

Types of Data

There are two types of data listed in a data entry window: data that can be edited and data that cannot be edited. The data that can be edited is displayed in dull white with the currently selected item shown in bright white. The bright white item is then said to be *highlighted*. This makes it easy to see which field is in the scratch pad. The data that cannot be edited (for example, a field computed by the system) is displayed in blue. On a monochrome screen, the changeable and non-changeable fields are not distinguished from each other. The currently selected item on a monochrome screen is shown in high intensity.

At the end of the scratch pad line, there is either a value present with a small white blinking cursor, or there is a series of small blocks with a blinking cursor on one of them. The blocks indicate the maximum

size of the data that can be entered. Pressing the up and down arrow keys determines which item goes in the scratch pad.

Movement through an editing window and in the scratch pad area is performed using the following keys.

Action Keys

Up Arrow

This key highlights the item in a menu above the currently highlighted item. The highlighted item is the one selected when you press **Enter**.

Down Arrow

This key highlights the item in a menu below the currently highlighted item. The highlighted item is the one selected when you press **Enter**.

Backspace

This key erases the character to the left of the cursor position and moves one position to the left. It pulls all data to the right of the cursor one position to the left, filling the space left by the erased character. Known as a destructive backspace.

Del

This key erases the character currently under the cursor position. It collapses data to the right one position toward the left, filling the space left by the deleted character. Different than the backspace key, the cursor does not retreat one block to the left; it stays on the same editing block.

Left Arrow

This key moves the cursor one position to the left. It is non-destructive; it does not erase any characters in the process of moving one position to the left.

Right Arrow

This key moves the cursor one position to the right.

Enter

This key accepts data in the editing field as input, subject to verification when exiting the program.

Esc

This key exits the data entry screen and displays the previously mentioned **Accept displayed values? (Y/N/<Esc>)** prompt.

F2

This key places the current value of the data item into the scratch pad. This is useful if you only want to make a slight change to a data item.

Data Entry Modes

There are two modes of operation in the standard data entry screen: The over-type mode and the insert mode. The insert key acts as a toggle between these two modes.

Over-Type Mode

When starting in the over-type mode, characters to the right of the cursor are deleted when you enter the first character. The over-type mode is useful for entering data that is completely different from the existing data in the field, as it saves having to erase the previous data.

Insert Mode

If you are in over-type mode and you need to insert an item and don't want to lose the data to the right of the cursor, then activate the insert mode by pressing the insert key. While in the insert mode, characters to the right of the cursor move one position to the right to make room for the new character. If the last character is currently at the last available position (no editing blocks visible) then the editing field locks; it can't expand without exceeding the maximum allowable size for the item being worked on. In this case first delete any unwanted characters to make room for additional characters.

1.7 Environment Variables

The W-9000 system software uses several DOS environment variables to store a variety of system data including directory names used by the software. In this manual, these directory names are commonly referred to by their environment variable names or by other frequently used terms. This section is used to explain the most commonly used environment variables and how they are referenced throughout the manual. Refer to your DOS manual for more information about environment variables.

The W9000 environment variable specifies the directory which is used to store most of the executable programs and data files of the W-9000 system software. It is commonly referred to as the *W9000 directory* or the *system directory*.

FLTDATAPATH Environment Variable

This variable specifies the working directory which is used to store data files during a flight. Under normal operation, this directory will be c:\flights\new. This directory is erased each time a new flight is started.

SIMDATAPATH Environment Variable

This variable specifies the directory which contains the flight data files for the current flight simulation. This directory is commonly referred to as *simulation directory*.

CALDATAPATH Environment Variable

This variable specifies the directory in which calibration files are stored. Under certain configurations of the W-9000 system, calibration files may be required for processing the radiosonde data. This directory is usually referred to as "the calibration directory."

Chapter 2. Software Installation

2.1 Computer Requirements

The W-9000 system software can be supported by most 80386, 80486, and Pentium microprocessor-based computers meeting minimum Sippican requirements that are capable of running DOS. Because of this versatility, a number of different types of computers are currently used in a variety of applications. A typical computer consists of:

- 80386, 80486, or Pentium Processor
- Math coprocessor
- 8 MB RAM (minimum)
- 40 MB Hard drive (minimum) with 20 MB free
- Color VGA monitor (minimum)
- One Serial port as COM1
- One parallel port as LPT1

Please note that many factors affect compatibility and performance. Proper selection of the computer and its component parts may dramatically effect performance. Sippican guarantees that the W-9000 software will operate on computers sold by Sippican. Customer-supplied computers will probably work, but operation cannot be guaranteed unless the units are sent to Sippican for evaluation and testing with the proper revision software. Arrangements can be made with Sippican for this type of integration and testing. The standard computers used in the W-9000 System are from DELL Computer Corporation. If a DELL computer is not used, other computer type interconnects are the same or similar.

2.2 Software Installation Tasks

The W-9000 System software is designed to run on drive C of the W-9000 System Computer. Although the system is delivered with the software already installed, this section is provided for several purposes.

1. For users who supply their own computer, it is necessary to prepare the hard drive and arrange the hard drive directory structure in such a way as to be compatible with the software when it is installed.
2. In the event that there is a problem with the hard drive, it may be necessary to reformat the drive and re-install DOS (the Disk Operating System) and the W-9000 System software.
3. From time to time, software updates, either an update to software that is already installed or a completely new version, may be delivered. In this case, the new software must be installed to update or replace the version that is presently running.

Software installation requires the following five tasks, each of which is described in detail in the remainder of this chapter. The tasks start with the most basic and progress through the installation and configuration of the software, to updating a presently installed version of the software.

Preparing the Computer

In the event of a fixed disk failure, it may be necessary to perform a low level format of the drive. This will destroy all information on the disk, including all partitioning information. After this has been done, the disk will have to be partitioned to tell DOS that it is a DOS drive.

Formatting the Fixed Disk

After the disk has been partitioned, it must be formatted for use as a DOS device. This is different from the low level formatting mentioned above.

Installing System Software

Software installation is in two parts. First the fixed disk is prepared as a *bootable* DOS disk with the DOS files installed, and then the W-9000 System is installed.

Configuring System Software

After the software is installed, the system software needs to be set up to match the hardware options that make up the system.

Installing System Software Updates

From time-to-time, enhancements or options for the version of software that is installed in the system may become available.

2.3 Preparing the Computer

The W-9000 System computer software is designed to run under Microsoft DOS. Fixed disk drives that run under DOS are prepared for use in the following three-step process.

1. Perform a low-level format. This is done by the drive manufacturer or computer supplier so there is normally no need to do it. However, sometime unrecoverable errors are seen on fixed disk drives, or the drive can fail completely. In this case, it may be necessary to perform this low-level format. This kind of format is best described as a surface analysis in which unusable sectors of the hard disk are flagged as bad. If this step is necessary, refer to the documentation that accompanied your computer, and perform the low-level format according to their instructions.
2. Partition the fixed disk so it can be formatted (using the DOS FORMAT command) for use as a DOS disk. MS-DOS 6.2, used for W-9000 Software starting with Version 3.3, can use the entire disk as a single partition, and the computer should be set up this way. The W-9000 Software expects to use a RAM DRIVE in drive D for certain operations. No second drive or alternate partitioning scheme can be used without consulting Sippican first. Partitioning is performed by the DOS FDISK program. Refer to your DOS manual on how to run the FDISK program.
3. Run the DOS FORMAT program on each logical drive. This operation is described in the next section.

2.4 Formatting the Fixed Disk

There are times when a fixed disk may need to be re-formatted to eliminate read/write errors or following a low-level format and running FDISK. Should this step become necessary, refer to your DOS documentation under the FORMAT command. If DOS was delivered with your system, you will have an installed DOS disk that can be used to do this. Be sure to use the /S option to make the hard disk a bootable drive.

NOTICE *On Sippican supplied DOS disks, the program FORMAT.COM has been renamed FORMATCO.COM and replaced with the file FORMAT.BAT that will only allow you to format floppy disks in drive A or drive B.*

To format the fixed disk, follow these instructions:

1. Place the ZEEMET W-9000 DOS DISK in drive A, and close the drive door.
2. Press **Ctrl-Alt-Del** to re-boot the computer.
3. At the DOS prompt, A:\>, type **FORMATCO C: /S Enter**. The /S switch tells the format program to install DOS, making drive C bootable.
4. After typing the above command, you will be warned that all data on the disk will be destroyed. If you wish to continue, type **Y Enter**.

The computer fixed disk is now ready for the installation of software as described in the next section.

2.5 Installing System Software

You need to install W-9000 system software if:

- You are installing the system software to a new computer for the first time.
- You are installing a new version of system software to replace a version that you were previously running.
- You are restoring a hard disk drive that needed to be re-formatted for one reason or another.

To install the W-9000 System software, refer to the letter supplied with the W-9000 installation diskettes. This letter describes, step by step, how to install software. There is a different installation letter for each version of the W-9000 software. Please note that these instructions assume that you have already formatted drive C and installed the DOS system files, as described earlier under “Formatting the Fixed Disk.” In the unlikely event that you receive an error while reading one of the disks, try the installation procedure again. If the error is repeated, contact your Sippican Technical Support Representative.

2.6 Configuring System Software

The system software must be configured to reflect your specific W-9000 configuration. To do this, refer to the System Setup Utilities described in Chapter 3 of this manual.

2.7 Installing System Software Updates

W-9000 System Software Diskettes are labeled as follows:

W-9000 System Programs
Ver. M.m System Disk 1

There are several important numbers to keep in mind here. M.m indicates indicate the major and minor Version of W-9000 Software. Pre-release versions of software would have an additional line stating "Pre-release M-m-rr," where rr is the revision identifier. The associated W-9000 Updates would be labeled as follows:

W-9000 Update Programs
Ver. M.m Update Disk 1

Updates must be installed in alphabetical order. The update in the example above is update A. If you receive update A, update B, and update C, install update A first and after that B and then C.

Software updates are installed in much the same way as the system software; although, they usually contain only one disk. Use the following procedure to install a system software update.

1. Boot the computer from the fixed disk.
2. Place Update Disk 1 for the update you wish to install in drive A and close the drive door.
3. At the DOS prompt, C:\>, type **A: Enter**.
4. At the DOS prompt, A:\>, type **INSTALL Enter**. The installation program will copy the files and directory structure of the disk in drive A to the fixed disk C. If there is more than one disk for the update being installed, you will be prompted to remove the first disk and put the second disk in the A drive. This process is repeated until all of the disks have been installed.

2.8 The README File

Every effort has been made to have the W-9000 Operator's Manual accurately reflect the System Software that you are running. There are times, either due to late changes or new features in system software updates, where there may be differences between the operation of the W-9000 software and its description in the manual. In this case, the system contains a README file that discusses these differences. This file is updated as necessary. To view this file, boot the computer from drive C. At the DOS prompt, C:\>, type **README Enter**. The README file will be displayed one screen at a time for you to read and make notes in your operator's manual as necessary.

2.9 Setting System Time and Date

The system time should be checked before every flight. If the time or date is not correct, these parameters should be fixed. This section discusses the procedure for changing the time and date. Before the procedure is discussed, note that the W-9000 system software assumes the time and date parameters are in GMT. It is imperative when using this procedure that the date and time be entered in GMT.

Date and time are set while in DOS. Use the following procedure to set the time.

1. Type **TIME Enter**. For example, if the current system time is set to 10:15 A.M., the computer will respond with the message **Current time is 10:15:00.00**.
2. Type the current time in GMT. For example, if the current time in GMT is 1:30 P.M., type **13:30 Enter**.

Use the following procedure to set the data.

1. Type in **DATE Enter**. If the current system date is set to Friday, October 23, 1992, the computer will respond with the message **Current date is Fri 10-23-92**.
2. Type current GMT date in the mm-dd-yy format. For example, if the current date in GMT is Saturday October 24, 1992, type **10-24-92 Enter**.

2.10 Printer Configuration

The W-9000 system uses a generic printer interface to allow graphics images to be output on a variety of printers. This requires that the system printer be defined so that graphics can be printed. The default system printer is a 9 pin Epson FX compatible printer. If the printer attached to your system is not a 9 pin Epson compatible printer, use the following procedure to select the proper printer.

1. Type **PRINTCFG Enter**. A file, GXPRINT.DAT in the current W9000 System directory, will be displayed showing a list of printers. Using the cursor movement keys, locate your printer and the resolution you want to use. For example, if you have a black and white HP LaserJet printer and you want it to print at 300 x 300 resolution, you would notice that the entry is HPLSRVH.PRD. If your specific printer is not listed, check your printer documentation and select the printer that most closely matches your printer.
2. Press **ESC**. The DOS EDIT program will load the file PRINTER.DEF in the current W9000 System directory.
3. The last line in the file will say something like **GRAPHICS: EPSON9M.PRD**. Change this to **GRAPHICS: HPLSRVH.PRD**. Save the changes.

This page intentionally left blank.

Chapter 3. System Setup Utilities

3.1 System Setup Overview

The System Setup Utilities are used to establish or modify system parameters which will be applied for subsequent radiosonde flights. These parameters allow the user to customize the W-9000 system according to the particular requirements of the station. Parameters changed using Setup are considered permanent and will be used as starting parameters for all flights. Some parameters can be changed during a flight using the Utilities menu and other displays. However, changes made outside of Setup are considered temporary and will only apply to the current flight.

Setup should be used to establish parameter values before typing Start in order to insure that system operation will be as required for the particular installation site. Run Setup by typing **SETUP Enter**.

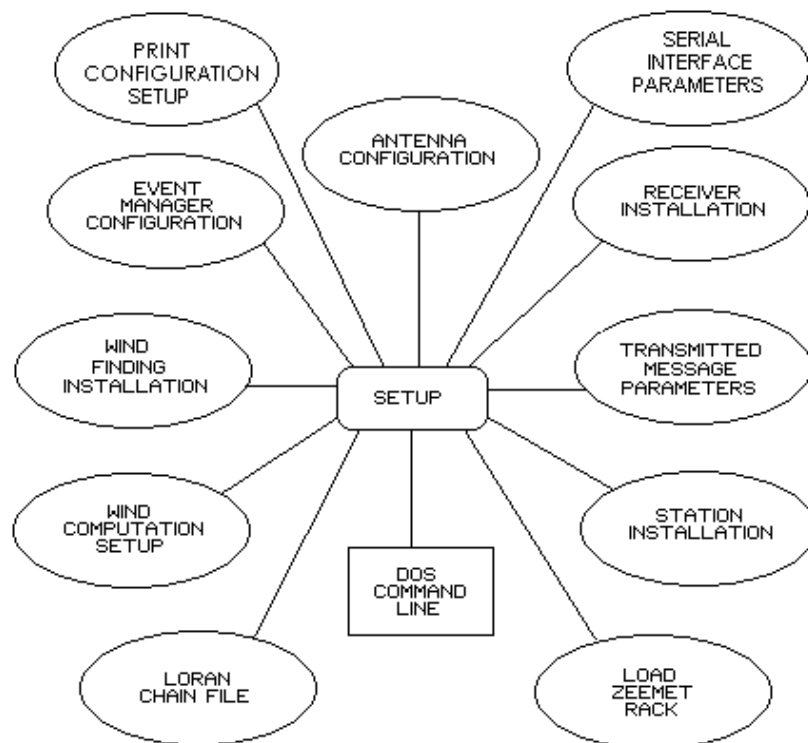

Figure 3 1. Map of System Setup Utilities

Figure 3-1 shows a map of the functions that are available from the Setup menu. As illustrated by the figure, after running a Setup utility, you are returned to the Setup menu. Press **Esc** to return to the DOS command line.

Figure 3-2 shows the Setup menu. To use any of the utility functions listed the operator presses the key that corresponds to the desired function. When the key is pressed, the selected utility will begin running and its display will appear on the screen. See the following paragraphs in this chapter for a description of the use of these displays and for recommendations on parameters. When finished, press the **Esc** key from the Setup menu to return to DOS.

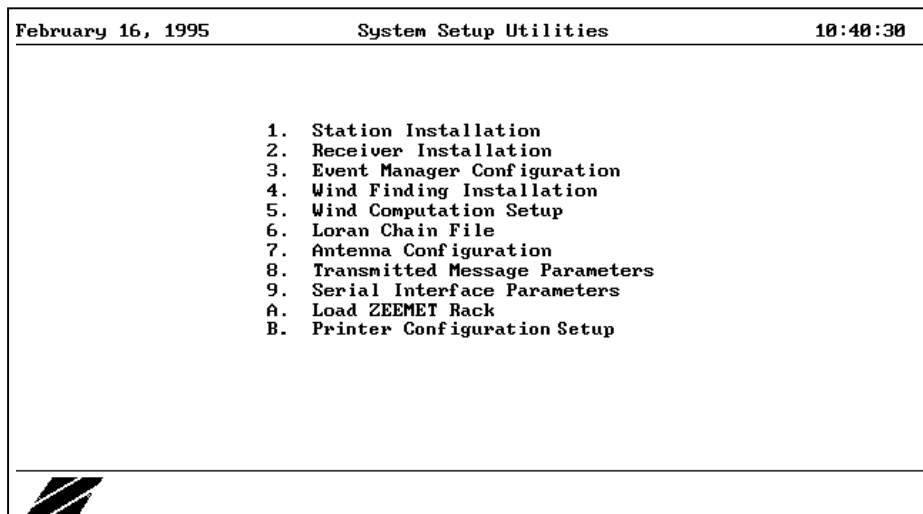

Figure 3-2. Setup Menu

3.2 Station Installation

Depending on the message coding options installed, a variant of the Station Installation Menu as seen in Figure 3-3 may appear when Station Installation is selected from the Setup Menu. The Military Message Coding Parameters selection is shown if the Military Coding Option is installed. The WMO Coding Option selections are available if the WMO Coding Option has been installed. If no message coding option is installed, selecting Station Installation from the Setup Menu will go directly to the Station Installation display, Figure 3-4.

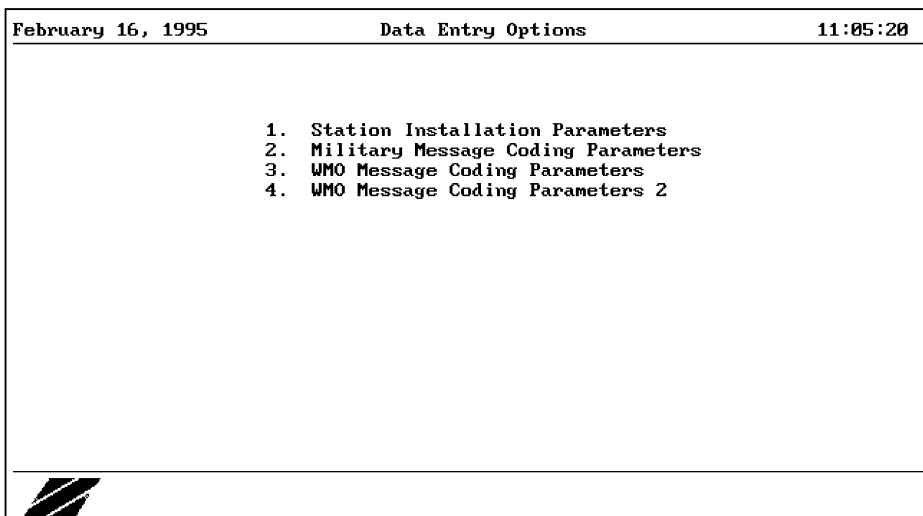

Figure 3-3. Station Installation Menu

Station Installation allows the user to configure the W-9000 system according to station specific parameters. Each station parameter is described below.

November 10, 1997			Station Installation			06:36:19		
Installation Parameters	Units	Value						
Customer Name	alphanumeric	fnh						
System Name	alphanumeric	173						
Latitude	dd mm ss.s H	40°02'30.0" N						
Longitude	ddd mm ss.s H	075°10'30.0" W						
Station Height	meters	85						
Surface Data Timer	minutes	0						
Sonde Type	1,2,B,0	2						
PTU Processing	Y,N	Y						
End Flight Automatically	Y,N	Y						
Humidity Cutoff Temperature	Degree C	-99						
Language	toggle	english						
Geoid Separation	meters	0						
Automatic Flight Save	Y,N	N						

Please Enter Customer Name: ■■■■



Figure 3-4. Station Installation

Customer Name

Identifies the customer by an alphanumeric name. This customer code is recognized by the software in order to perform certain functions for the indicated customer. The customer name can be a maximum of three characters.

System Name

Identifies the system by an alphanumeric name. The System Name is used as a prefix when forming the file names for flight data files. The System Name can be a minimum of zero characters to a maximum of three characters in length. If you want the System Name to be zero length enter three spaces in the System Name field.

The flight data files are given filenames according to the following format.

FILENAME = SYSTEMNAME + FLIGHTID + . + EXTENSION

The System Name, Flight ID, period, and extension are combined to form the filename. This filename is used for each of the flight data files. The name portion of the filename, which consists of the System Name plus the Flight ID, can have a maximum length of eight characters as set by the operating system. The files created during a flight are individually identified by the filename extension which can be up to 3 characters.

The System Name portion of the file name will be the same for all flights (unless changed using Setup) but the flight identifier should be unique for each flight for the system. If two or more systems are being used to monitor the same flight, the System Name in the filenames is used to distinguish the files of one system from another.

The Flight ID is entered by the user at the start of each flight. The maximum number of characters available for the Flight Id (F) is calculated according to the number of characters in the System Name (S).

F = 8 - S

If the System Name is entered as all spaces, effectively creating a zero length, System Name, the Flight ID may then be up to eight characters.

As an example, Sippican uses three-character system names, and four-character flight identifiers. The flight identifiers are simply increased by one for each flight. If a flight is reprocessed in simulation mode with different parameters, the new flight is given the same flight identifier with a one letter suffix. For example, if a flight using 3382 for the Flight Identifier is reprocessed in simulation, the simulated flight will be identified with a Flight ID of 3382A. Since several systems are used for each Sippican flight, the System Name is very useful in keeping the source of the data clear.

Latitude

The latitude where the ground station is based. Latitude is entered in Degrees, Minutes, Seconds, and Hemisphere. For north latitude, enter "N" for the hemisphere. For south latitude, enter "S" for the hemisphere.

Longitude

The longitude of the ground system. Longitude is entered in Degrees, Minutes, Seconds, and Hemisphere. For west longitude, enter **W** for the hemisphere. For east longitude, enter **E** for the hemisphere.

Station Height

The height of the station in meters above sea level. This value is critical to the computation of height data and should be entered as accurately as possible.

Surface Data Timer

The maximum time in minutes for which surface data is considered valid. The system records the time at which the surface data was entered during the Preflight. If the Surface Data Timer elapses, then the surface data is considered invalid and it must be reentered by the user. A question mark replaces the asterisk next the surface data menu item in the preflight menu.

Entering zero for the Surface Data Timer disables this feature. The surface data is then always considered to be valid after it is entered.

Sonde Type

Indicates the type of sonde being flown by the system. Enter the character corresponding to the type of radiosonde to be used. For example, the Mark II radiosonde is designated by a **2**; the B type radiosonde is designated by a **B**, and a Mark II Ozone sonde is designated by an **O**.

PTU Selection

Selects processing of PTU (Pressure, Temperature, and Humidity) data. If the PTU selection is **Y**, the PTU is processed by the system software. If the PTU selection is **N**, no PTU processing is performed by the system software. The N entry is used only for radar flights.

End Flight Automatically

If the End Flight Automatically option is selected, there are two conditions under which a flight will be automatically terminated by the system:

Condition 1. The flight will be automatically ended if the raw data pointer is within 10 records of the processed data pointer and there has been no new processed data for 15 minutes.

Condition 2. The flight will be automatically ended after four minutes of good descending data. The end of flight point is set to the burst point.

Language

For users who install alternate operating language files created with the W-9000 Language Utilities Option, pressing SPACE will toggle between available installed language files. After exiting the Station Installation Menu, the W-9000 System will operate using the information in the selected language file.

Geoid Separation

This is the difference between the mean sea level altitude of the local GPS antenna and the altitude of the antenna according to the WGS 84 model. This value is determined during the installation site survey.

Automatic Flight Save

When this is set to Y, an automatic Flight Save is performed when Exit to DOS is selected from the Flight Menu provided no Flight Save was done previously.

3.3 Military Message Coding Parameters

If your software includes the Military Message Coding option, parameters can be set by selecting Military Message Coding Parameters from the Station Installation Menu menu. The screen shown in Figure 3-5 will be displayed when the Military Message Coding Parameters option is selected.

February 16, 1995 Military Message Coding Parameters 11:49:06		
Military Coding Parameter	Units	Value
Octant of the Globe (0-7,9)	numeric	9
Coded Position	alphanumeric	////
Military Cloud Code	alphanumeric	///
Computer, Validity Period (0-9)	numeric	0
Ballistic-2, Validity Period (0-9)	numeric	0
Ballistic-3, Validity Period (0-9)	numeric	0
Sound Ranging, Validity Period (0-9)	numeric	0
Target Acquisition, Validity Period (0-9)	numeric	0
Nuclear Fallout, Validity Period (0-9)	numeric	0

Octant of the Globe (0-7,9) ■



Figure 3-5. Military Message Coding Parameters

Octant of the Globe

Enter the octant of the globe in which your station is located. Entering 9 indicates that your station location will be encoded by the Coded Position parameter.

Coded Position

When Octant of the Globe is entered as 9, this six character field is encoded for position instead of using latitude and longitude.

Military Cloud Code

Enter the appropriate cloud code as specified in Annex C to STANAG 4140 (Table 2).

Validity Periods

Each of the validity period parameters indicate the number of hours for which the indicated message is valid.

3.4 WMO Message Coding Parameters

If your software includes the WMO Message Coding option, you will be presented with several menu selections after you select Station Installation from the Setup menu. This menu will include a selection for viewing or editing the WMO Message Coding Parameters for your station. The screen shown in Figure 3-6 will be displayed when the WMO Message Coding Parameters option is selected.

WMO Message Coding Parameters		
July 25, 1996		13:42:31
WMO Coding Parameters	Units	Value
Maximum Number of Tropopauses	numeric	9
Lowest Tropopause Pressure	numeric	3
Local Station ID	alphanumeric	0000
WMO Station Number	numeric	0
WMO Sounding System Used	numeric	90
Sea Station	Y, N	N
Mobile Land Station	Y, N	N
Ship Call Sign or Mobile Station Country/Town Code	alphanumeric	

Please Enter Maximum Number of Tropopauses: ■

Figure 3-6. WMO Message Coding Parameters

Maximum Number of Tropopauses

Indicates the maximum number of tropopauses to be encoded in TEMP Section 3. All valid tropopauses will still appear in the MET Significant Levels summary regardless of the setting for this parameter.

Lowest Tropopause Pressure

Indicates the lowest pressure in millibars for which a tropopause would be encoded in TEMP Section 3. All valid tropopauses will still appear in the MET Significant Levels summary regardless of the setting for this parameter.

Local Station ID

Local identifier for the station to be used in coding messages.

WMO Station Number

Number identifying the station as a WMO station.

WMO Sounding System Used

The WMO sounding system used is described in the WMO Manual on Codes, 306, Volume I, code table 3685. The default is 49.

Sea Station

If the station is at sea, set Sea Station to **Y** (Yes) to generate TEMP SHIP and PILOT SHIP messages. Otherwise, set it to **N** (No). Setting this option to **Y** will allow the operator to enter the sea-surface temperature in the Surface Data Entry screen and include it in the WMO TEMP SHIP section of the coded message.

Mobile Land Station

If the station is mobile and on land, set Mobile Land Station to **Y** (Yes) to generate TEMP MOBILE and PILOT MOBILE messages. Otherwise, set it to **N** (No).

Ship Call Sign and Mobile Station Country/Town Code

If you have set Sea Station to **Y** (Yes), set Ship Call Sign and Mobile Station Country/Town Code to the ship's call sign. If you have set Mobile Land Station to **Y**, set Ship Call and Mobile Station Country/Town Code to the country and town code of the station's current location. Otherwise accept the default, because, in this case, this parameter is not used.

The screen shown in Figure 3-7 will be displayed when the WMO Message Coding Parameters 2 option is selected.

WMO Coding Parameters		Units	Value
Number of Groups per Line		numeric	10
Number of Blank Lines Between Messages		numeric	0
Include Significant Winds (PPBB and PPDD)		Y, N	Y
Include Last Wind in PILOT Section 4		Y, N	Y
Replace / with 0 in PPBB station elevation		Y, N	N
Do not generate group 41414 in TTBB		Y, N	N
Do not generate group 52525 in TTBB (Region II)		Y, N	N
Add WMO number before first group		Y, N	N
Change Height Coding Units to 500M after 30,000M		Y, N	N
Ignore wind direction changes during calm winds		Y, N	N
Incremental Level Selection		Y, N	N

Please Enter Number of Groups per Line: ■■

Figure 3-7. WMO Message Coding Parameters 2

Number of Groups per Line

Indicates the number of five character groups which are placed on each line of a message. The default value is 10.

Number of Blank Lines Between Messages

Indicates the number of blank lines which are placed between each message in a multi-message bulletin. The default value is 0.

Include Significant Winds (PPBB and PPDD)

An entry of Y specifies that significant winds will be encoded along with regional wind levels in PILOT Section 4.

Include Last Wind in PILOT Section 4

An entry of Y indicates that the last wind should be encoded in PILOT Section 4 when Include Significant Winds is set to N. This parameter is ignored if the Include Significant Winds parameter is set to Y.

Replace / with 0 in PPBB station elevation

In PPBB, when winds are coded in height units in section 4, setting this option to Y will cause u_1 to be encoded as 0 instead of / for the station elevation indicator.

Do not generate 41414 in TTBB

Setting this option to Y will cause Section 8, the cloud data, to be left out of TTBB.

Do not generate 52525 in TTBB (Region II)

Setting this option to Y will cause the 52525 group for Region II message coding to be left out of TTBB, Section 9.

Add WMO number before first group

Setting this option to Y will cause the WMO Station Number to be encoded on the first line of the message before the message name.

Change height coding units to 500 M after 30,000 M

The default for this option is N (No). This makes the height coding unit 300 meters. Changing it to Y (Yes) changes the height coding unit to 500 m for winds above 30,000 meters.

Ignore wind direction changes during calm winds

The default for this option is N (No). This causes the wind analysis program to flag all significant levels (including calm levels) caused by changes in wind direction that exceed a given limit. Changing it to Y (Yes) causes the wind analysis program to ignore wind direction changes when both the current wind and the previous wind are calm, that is less than 5 m/s.

Incremental Level Selection

To understand what this option does, it is important to understand the meaning of significant levels. Significant levels are used to characterize the MET and Wind data for an entire flight without having report the data at every single level. Only the data at significant points need be included in the coded message. The significant points are selected in such a way that, *within a specified tolerance*, the flight data between them lies on the straight line between consecutive significant points.

Certain levels are always considered significant by the W-9000 system and are called required significant levels. Examples of required significant levels include the start and end points of a flight, any tropopause level, and any levels defined as significant by the operator. There are three options in the Data Display menu (See the "Data Display" section of chapter 6) that can be used by the operator to edit significant levels.

In addition to required significant levels, the system can automatically locate the minimum number of other significant levels needed to characterize the flight within a given tolerance. The Incremental Level Selection option affects just how the W-9000 system calculates these automatically determined significant levels.

The default for Incremental Level Selection is N. In this case, the system deletes all previous automatically calculated significant points and recalculates them all from launch every time the operator selects one of the relevant options in the Data Display menu. It is highly recommended that you run only in this default mode.

When you select Y" instead of recalculating significant levels starting from launch, the system recalculates them beginning from the most recent significant level. This means that in this mode, every time the operator selects one of the three relevant options in the Data Display menu, a new significant level is determined at the level that is current at that time. This is because the last level is always declared significant by the system. This, in turn, affects how the system determines significant points near that level unless the operator explicitly deletes it at a later time.

3.5 Receiver Installation

Receiver Installation allows you to customize each of the receiver parameters. Upon entering Receiver Installation, the screen shown in Figure 3-8 is displayed.

Installation Parameters	Units	Value
Receiver Type	403/1680/Decoder/External	403
AFC Reference Value	0-255	170
Starting Search Frequency	MHz	395
Ending Search Frequency	MHz	410
Default Receiver Volume	0-255	200

Please toggle choice (Rx403 attached)

Figure 3-8. Receiver Installation

Receiver Type

Selection for the type of Receiver being used. Valid choices are **403** for a Sippican 403 MHz Receiver, **1680** for Sippican 1680 MHz hardware, **Decoder** for a Sippican Decoder used with an external receiver, and **External** to mean no Sippican Receiver or Decoder.

AFC Reference Value

Automatic Frequency Control reference value for the receiver. The default value is 170.

Starting Search Frequency

The starting frequency (MHz) at which to begin the search for the radiosonde. When the receiver is commanded to conduct a search for the sonde, the search will start at this frequency.

Ending Search Frequency

The ending frequency (MHz) at which to end the search for the sonde. When the receiver is commanded to conduct a search for the sonde, the search will end at this frequency.

The starting and ending search frequencies affect the search speed. The receiver module can complete a search pass through a narrower search band faster than through a wide band. If the radiosondes to be flown by a system are set to the same frequency, the search should work well if the search band limits are set to that frequency plus and minus 2 MHz. Note that other factors affect search time as well, including the presence of strong signals in the band that are not coming from the radiosonde.

During Flight Preparation the system will command the receiver to start a radiosonde search whenever it determines that the radiosonde is not located by the receiver and a search is not already in progress. There are no other places in the software that the search feature is used.

Default Receiver Volume

The system will issue a command to the ZEEMET Rack to set the receiver volume to this value during System Configuration. The range is 0-255, where a value of zero (0) is the maximum volume, and a value of 255 is the minimum volume.

3.6 Event Manager Configuration

Event manager configuration, Figure 3-9, allows you to specify criteria for automatically processing designated script files. Script files automatically process a series of message coding commands when the criteria for the automatic script have been met.

September 16, 1992		Event Manager Configuration		09:21:49	
Event Tests		Units		Value	
Test 1: Pressure < 500 mb RUN SCRIPT1		Y or N		N	
Test 2: Pressure < 65 mb RUN SCRIPT2		Y or N		N	
Test 3: End of Flight RUN SCRIPT3		Y or N		N	
Test 4: Time > T seconds RUN SCRIPT4		Y or N		N	
Test 5: Pressure < P mb RUN SCRIPT5		Y or N		N	
Test 6: Height > H meters RUN SCRIPT6		Y or N		N	
T (Time) for Test 4		seconds		08224	
P (Pressure) for Test 5		mb		8224	
H (Height) for Test 6		meters		08224	

Please Enter Test 1: Pressure < 500 mb RUN SCRIPT1: ☐

 Input Mode (Over Type)

Figure 3-9. Event Manager Configuration

Tests that are enabled are performed periodically during the flight. If and when a test becomes true, the corresponding script file is run. Tests are enabled by setting their value to **Y**.

Test 1 becomes true when there is complete meteorological data for the 500 mb surface. Complete meteorological data means that you have wind and PTU data for the 500 mb surface.

Test 2 becomes true when there is complete meteorological data for the 100 mb surface and PTU data is available for the 65 mb surface. PTU data to 65 mb insures that all tropopauses occurring before the 100 mb surface can be determined. If this test is enabled, SCRIPT2 will run if the flight ends before the conditions above are met.

Test 3 becomes true when end of flight is detected.

Test 4 becomes true when the time since arm for launch reaches the time specified.

Test 5 becomes true when the pressure reaches the specified pressure.

Test 6 becomes true when the height reaches the specified height.

If you are using message coding version less than 3.3, you must set all tests to a value of N. Otherwise some wind data may not be included in the coded message.

3.7 Wind Finding Installation

Wind Finding Installation allows you to select the wind finding method for the system as well as for each tracker installed in the ZEEMET Rack; refer to Figure 3-10.

February 16, 1995		Wind Finding Installation		14:43:38	
Target	Wind Finding Method				
ZEEMET System	Loran				
Chain 1	9960				
Chain 2	8970				

Figure 3-10. Wind Finding Installation Menu

Figure 3-10 shows a typical wind finding setup for the system, and for each tracker installed in the ZEEMET Rack. The selection made for the ZEEMET System determines the wind finding method used for all subsequent flights. The selection made for each tracker determines the wind finding software to be used, if any, in each of the tracker modules.

Changes may be made to the current wind finding selections by using the keystrokes indicated at the bottom of the display for the toggle data entry mode. Press the **Up Arrow** or **Down Arrow** keys to move the highlight to the desired item and then press the **Space Bar** to toggle through the available selections for the item.

Wind finding methods available for the ZEEMET System include Loran, PVT GPS, Differential GPS, Meisei Radiotheodolite, Plessey Radar, EEC Radar, and Gematronik Radar. See the W-9000 Installation Reference Manual to learn how to distinguish the particular wind finding method appropriate to your hardware. The Not in Use selection for the ZEEMET System should be used if no wind finding is to be used for subsequent flights. Once you have selected the desired wind finding for the system, you may select the wind finding method for the tracker modules. If the wind finding method selected for the ZEEMET System field does not require use of the tracker modules, the selections for the tracker(s) will not be displayed. Otherwise, follow the procedure outlined below for setting up each of the tracker modules.

The W-9000 System may be equipped with a single tracker or with two trackers in the ZEEMET Rack. Two trackers are supplied for Cross Chain Loran systems.

If one tracker is present in the system, set tracker 1 to the desired navaid, and set tracker 2 to Not in Use. If two trackers are present, set tracker 1 to the desired use and set tracker 2 to the desired navaid or Not in Use. Accordingly, for Cross Chain Loran configurations, both tracker 1 and tracker 2 will be set for their respective Loran chain.

The current selections available for the trackers include Loran or Not in Use for a Loran System, or Meisei Radiotheodolite, EEC Radar, or Plessey Radar when the tracker is being used as a Radar or Radiotheodolite Tracker.

Loran Tracker

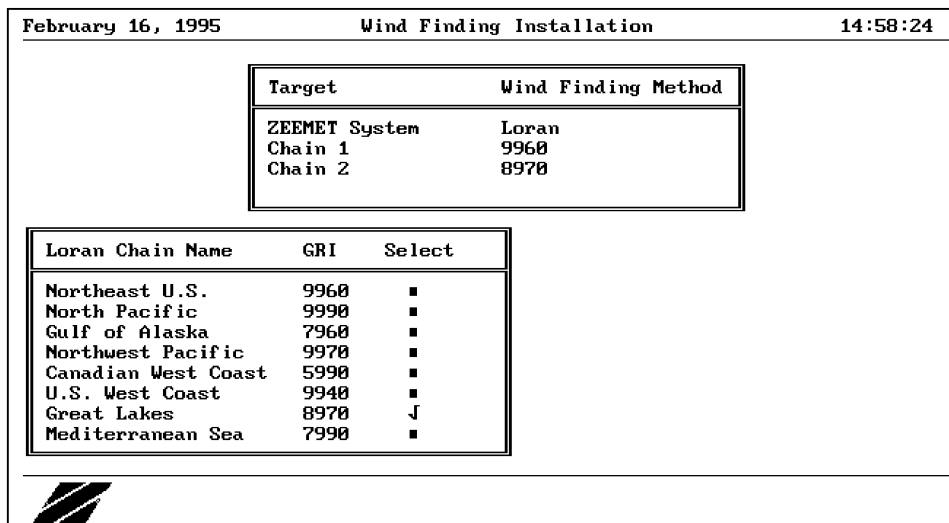

Figure 3-11. Loran Chain Window

Select Loran for the ZEEMET System and press the **Enter** key. Press the **Down Arrow** to highlight the Loran Chain for the desired tracker and press the **Enter** key. The window shown in Figure 3-11 shows all of the available Loran chains which may be selected for the current tracker with their corresponding GRI values. A check mark is placed next to the currently selected Loran chain. Once you have selected a Loran chain, press the **Enter** key to open the window shown in Figure 3-12.

February 16, 1995		Wind Finding Installation		14:58:24																												
		<table border="1"> <thead> <tr> <th>Target</th> <th>Wind Finding Method</th> </tr> </thead> <tbody> <tr> <td>ZEEMET System</td> <td>Loran</td> </tr> <tr> <td>Chain 1</td> <td>9960</td> </tr> <tr> <td>Chain 2</td> <td>8970</td> </tr> </tbody> </table>				Target	Wind Finding Method	ZEEMET System	Loran	Chain 1	9960	Chain 2	8970																			
Target	Wind Finding Method																															
ZEEMET System	Loran																															
Chain 1	9960																															
Chain 2	8970																															
<table border="1"> <thead> <tr> <th>Loran Chain Name</th> <th>GRI</th> <th>Select</th> </tr> </thead> <tbody> <tr> <td>Northeast U.S.</td> <td>9960</td> <td>■</td> </tr> <tr> <td>North Pacific</td> <td>9990</td> <td>■</td> </tr> <tr> <td>Gulf of Alaska</td> <td>7960</td> <td>■</td> </tr> <tr> <td>Northwest Pacific</td> <td>9970</td> <td>■</td> </tr> <tr> <td>Canadian West Coast</td> <td>5990</td> <td>■</td> </tr> <tr> <td>U.S. West Coast</td> <td>9940</td> <td>■</td> </tr> <tr> <td>Great Lakes</td> <td>8970</td> <td>J</td> </tr> <tr> <td>Mediterranean Sea</td> <td>7990</td> <td>■</td> </tr> </tbody> </table>						Loran Chain Name	GRI	Select	Northeast U.S.	9960	■	North Pacific	9990	■	Gulf of Alaska	7960	■	Northwest Pacific	9970	■	Canadian West Coast	5990	■	U.S. West Coast	9940	■	Great Lakes	8970	J	Mediterranean Sea	7990	■
Loran Chain Name	GRI	Select																														
Northeast U.S.	9960	■																														
North Pacific	9990	■																														
Gulf of Alaska	7960	■																														
Northwest Pacific	9970	■																														
Canadian West Coast	5990	■																														
U.S. West Coast	9940	■																														
Great Lakes	8970	J																														
Mediterranean Sea	7990	■																														

Figure 3-12. Loran Station Window

This window displays the Loran stations within the selected chain. Use the arrow keys and **Space Bar** to Include or Exclude the desired stations. Only the Master station and the stations set to **Include** will be used by the wind finding software to calculate wind data. The first station in the list will always be the Master station, and it cannot be changed by pressing the **Space Bar**.

You may also press the **PgUp** and **PgDn** keys while in the Loran station window. The **PgUp** and **PgDn** keys select another Loran chain without having to exit to the previous window containing the Loran chains. Pressing **PgUp** causes the check mark to move up to the previous chain, and the stations from the previous chain are displayed in the current window. The **PgDn** key performs the same function except that the next Loran chain is selected.

Once you have made the desired Include and Exclude selections, exit from the current window by pressing the **Esc** key. The current window is removed from the screen and you are placed in the previous window. All windows shown in Navaid Installation may be exited in the same manner.

Enabling PVT GPS Operation

PVT GPS is used when the system is mobile and the radiosonde contains a pressure sensor. PVT GPS operation will only work with PVT GPS radiosondes.

1. Run Setup.
2. From the Setup Menu, select Wind Finding Installation.
3. Select PVT GPS for the ZEEMET System.
4. Save the Changes.
5. From the Setup Menu, select Wind Computation Setup.
6. Select Wind Parameter Setting.
7. Set Raw Wind Sampling Interval to 1.00.
8. Save the changes.
9. Select Wind Interval Selection - PVT GPS. Sippican recommends an interval based on time, with a start at 0, a smoothing length of 60, minimum samples as 20, and 60 for the output interval.
10. Save the changes.

Enabling Differential GPS Operation

Differential GPS is used when the system is stationary and the radiosonde contains no pressure sensor. Differential GPS operation will only work with LOS GPS radiosondes.

1. Run Setup.
2. From the Setup Menu, select Wind Finding Installation.
3. Select Differential GPS for the ZEEMET System.
4. Save the Changes.
5. From the Setup Menu, select Wind Computation Setup.
6. Select Wind Parameter Setting.
7. Set Raw Wind Sampling Interval to 1.00.
8. Save the changes.
9. Select Wind Interval Selection - Differential GPS. Sippican recommends an interval based on time, with a start at 0, a smoothing length of 60, minimum samples as 20, and 60 for the output interval.
10. Save the changes.

3.8 Wind Computation Setup

Selecting Wind Computation Setup (option 5 in the Setup menu) brings up the Wind Interval Setup menu in Figure 3-14.

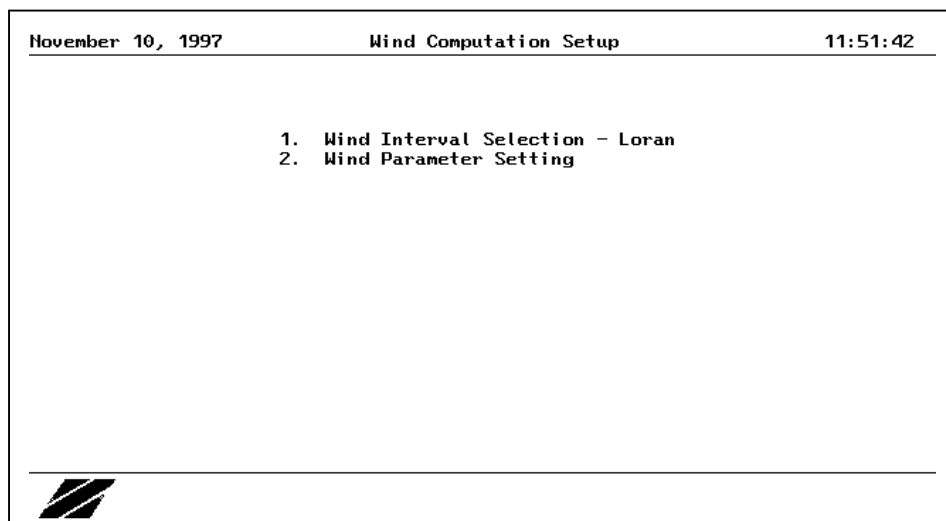

Figure 3-14. Wind Interval Setup

Selections in this menu allow you to customize how winds will be calculated during the flight.

Selecting option 1 in the Wind Interval Setup menu brings up a screen like Figure 3-15.

Section Start (seconds)	Smoother Length (seconds)	Minimum Interval Samples	Computation Interval (seconds)
1. 0	120	30	60
2.			
3.			
4.			
5.			
6.			

Figure 3-15. Wind Interval Selection, Loran

For wind calculation purposes, each flight can be divided into up to six consecutive, user-defined intervals or sections (numbered 1 to 6 in the left-most column). After indicating the start of an interval (second column), you can set three wind interval parameters (the three right-most columns) that tell the system how to calculate winds for each interval. The following sections describe in detail how to do this.

Selecting the Basis for a Wind Interval

You can define wind intervals or sections on the basis of either Time or Height. The default is **Section selection is by Time** as indicated on the menu (Figure 3-15) when it opens. You can change the basis for wind interval definition only when you first enter the menu (before pressing **Enter** or **Down Arrow**). To accept the default, press **Enter** or **Down Arrow**. To change to Height, press **H**; to change back to Time, press **T**. Or, you can press **Space Bar** to toggle between the two. Once you have the basis you want, press **Enter** or press **Esc** to end data entry and get a prompt to verify that you want to accept all the parameters as they are.

Wind Interval Data Fields

You can choose up to six wind calculation intervals or sections, each with its own start Time or start Height and set of three wind interval parameters.

Section Start (Seconds). When Time is selected as the Interval Selection basis, this field corresponds to the time, in seconds since release, when the system will stop using one set of interval selection parameters and begin to use the next. The start time of the first section must always be 0. The start time of the next section must always be greater than the one for the previous section. For example, if the start of the second section was entered as 1200 seconds, then the second set of wind interval parameters would be used for the wind at 1200 seconds (20 minutes) and would continue to be used until enough wind time had elapsed to reach the start of the third interval (if one is entered). Pressing **Del Enter** will erase the current interval data and all subsequent intervals. Pressing **Enter** with no section start entered or at the entry of the 6th interval signals the end of data entry and prompts you to accept the data.

Section Start (Meters). When Height is selected as the Interval Selection basis, this field corresponds to the height, in meters above mean sea level, where the system will stop using one set of interval selection parameters and begin to use another. The start of the first section must always be equal to 0 and the start of a subsequent section must always be greater than the previous section. For example, if the start of the second section was entered as 7000 meters, then the second set of wind interval parameters would be used for the first wind whose altitude is greater than 7000 meters and would continue to be used until an altitude greater than the start of the third interval (if one is entered) is reached. Pressing **Del Enter** will erase the current interval data and all subsequent intervals. Pressing **Enter** on any interval with no section start entered or at the entry of the 6th interval signals the end of data entry and prompts you to accept the data.

Smoothing Length (Seconds). This parameter is used to specify the amount of time, and therefore the number of samples, to be used as a smoothing interval. This parameter is used to specify the amount of time, and therefore the number of samples, to be used as a smoothing interval. The wind processing software will use this amount of time to determine which samples surrounding the wind time to be computed will be used in a fit of the raw data for each station. The maximum smoothing length is 540 seconds (9 minutes) for a total of 55 samples/station based on one new sample every 10 seconds.

Minimum Good Data Samples. This parameter is used to specify the minimum number of good data points for any included station that are required to use it. If, over the smoothing interval that is entered, there are not at least this minimum number of good data points, the station will not be used to compute the wind. If data from the ZEEMET tracker is set to update once every ten seconds, the Minimum Good Data Samples must be less than or equal to 1/10th of the Smoothing Length. You should not enter a number less than 2 or you may get very poor results.

Computation Interval (Seconds). This parameter specifies how often a wind will be computed during the interval. Please note that the system, in the summary and message coding portions, will use up to 900 computed winds. (Message coding versions before 3.3 use up to only 120 winds.) The 900 wind records allow complete wind processing for all flights of two and a half hours or less with one wind every 10 seconds. With message coding versions less than 3.3, if you choose a computation interval less than 60 seconds, and have a long flight, all of the computed wind points will be available in the .WND file but only the first 120 winds will be available to look at by the system. With message coding versions 3.3 or later the full 900 wind records are available.

Interval Selection by Time

Wind interval parameters, as shown in Figure 3-16, tell the system to do the following:

November 10, 1997		Wind Interval Selection - LORAN		11:59:12	
Interval selection is by Time					
	Section Start (seconds)	Smoothing Length (seconds)	Minimum Interval Samples	Computation Interval (seconds)	
1.	0	240	6	60	
2.	120	240	12	60	
3.					
4.					
5.					
6.					

Use Space Bar to Select Height or Time

Figure3-16. Wind Interval Selection by Time

Interval Number 1. For the first 120 seconds, winds will be computed every 60 seconds, using 240 seconds of raw data for the least squares fit. Any station with less than 6 good samples over the smoothing length will not be used.

Interval Number 2. Starting at 120 seconds, winds will be computed every 60 seconds, using 240 seconds of raw data for the least squares fit. Any station with less than 12 good samples over the smoothing length will not be used.

Interval Selection by Height

Wind interval parameters, as shown in Figure 3-17, tell the system to do the following:

November 10, 1997		Wind Interval Selection - LORAN		12:01:18	
Interval selection is by Height					
Section Start (meters)	Smoother Length (seconds)	Minimum Interval Samples	Computation Interval (seconds)		
1. 0	240	6	60		
2. 7000	240	12	60		
3. 20000	360	18	60		
4.					
5.					
6.					
Use Space Bar to Select Height or Time					

Figure 3-17. Wind Interval Selection by Height

Interval Number 1. For the first 7000 meters, winds will be computed every 60 seconds, using 240 seconds of raw data for the least squares fit. Any station with less than 6 good samples will not be used.

Interval Number 2. Starting at 7000 meters, winds will be computed every 60 seconds, using 240 seconds of raw data for the least squares fit. Any station with less than 12 good samples will not be used.

Interval Number 3. Starting at 20000 meters, winds will be computed every 60 seconds, using 360 seconds of raw data for the least squares fit. Any station with less than 18 good samples will not be used.

Default Wind Interval Selection - Loran

When you choose Wind Interval Selection - Loran (option 1 in Figure 3-14), you will see a screen similar to Figure 3-18.

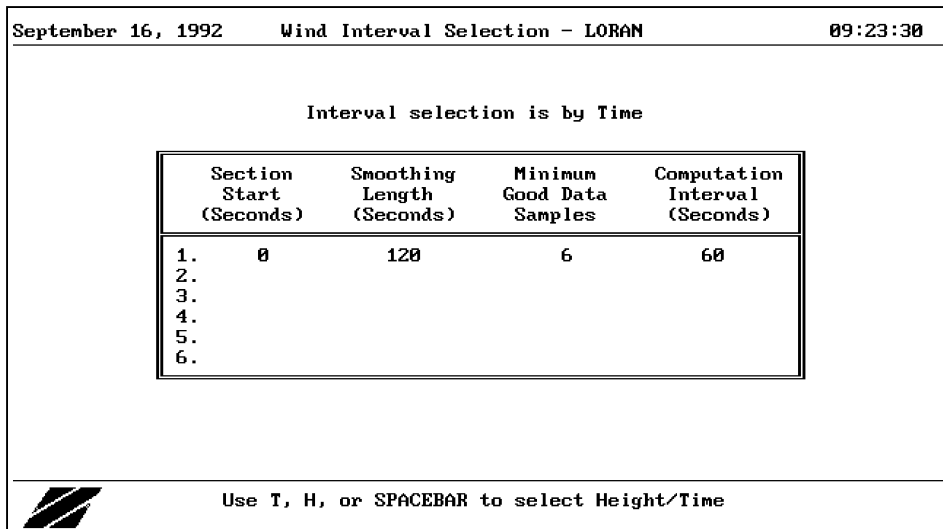

Figure 3-18. Loran Default Wind Interval Selection

When the raw sampling interval for Loran is set to 3 seconds (recommended) the default Wind Interval Selection for Loran is to compute winds every 60 seconds, using 120 seconds of raw data (40 frames) for the least squares fit. Any station with less than 30 good samples out of 40 (75%) will not be used.

Because of the increased accuracy of Loran, reasonably good winds can be expected even with Smoothing Lengths of less than 1 minute although Smoothing Lengths less than 30 seconds should not be used.

Wind Parameter Setting

Choosing option 3 in Figure 3-14 brings up the menu in Figure 3-20. This shows the Wind Parameter Setting menu with the default values.

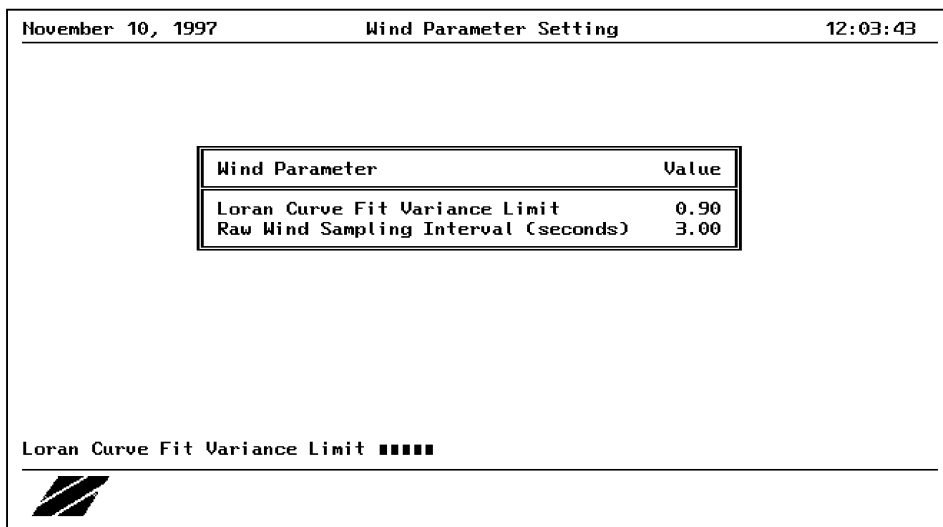

Figure 3-20. Wind Parameter Setting

Curve Fit Variance Limit

The curve fit variance limits have been derived by testing with a large cross section of flight data and should perform well under most conditions. Therefore, changes are only recommended for those with a thorough understanding of the effects that variance limit changes have on the wind data. Please consult with the Sippican technical support staff for recommendations on any proposed changes to the default values.

The Curve Fit Variance Limit for Loran establishes the limits for evaluating the quality of the raw data used for the wind computation. The variance limit and how it is used in evaluating the raw data is outlined in the following discussion. The discussion focuses on the case of Loran wind finding but can be extended for the case of Omega.

When enough time has passed to provide the smoothing interval data for the current wind computation, a second order curve fit is performed on all of the raw data within the smoothing interval for one Loran station. The point which deviates from the curve by the greatest amount in excess of the specified Curve Fit Variance is removed from the set of raw data. The curve fit is iterated in this manner until all resulting points are within the variance limit. The iteration of the curve fit will terminate if the resulting number of raw data points is less than the number of Minimum Good Data Samples specified in the Wind Interval Selection.

This procedure is performed for each of the included Loran stations in order to provide a complete raw data set for the wind computation.

When the ZEEMET System is set to RDF or Radar, the Menu Selection for Loran will change to Radar or RDF. Enter the appropriate values for these configurations using information supplied by Sippican for the supported wind finding methods.

Raw Wind Sampling Interval

The Raw Wind Sampling Interval is the rate at which raw data is acquired by the system computer from the ZEEMET Rack or another external device. If an external device is being used to provide the raw wind data, the Raw Wind Sampling Interval will have no effect since the software will automatically set the interval based upon the data rate of the device. Furthermore, the Raw Wind Sampling Interval will only affect the Loran wind finding since the sampling interval of Omega is fixed at 10 seconds.

For Loran wind finding, the Raw Wind Sampling Interval will be sent to the ZEEMET Rack during System Configuration in order set the output rate of the Loran tracker module. The acceptable range for the Loran Raw Wind Sampling Interval is 3 to 60 seconds.

3.9 Loran Chain File

The Loran chain file (LORCHAIN.DAT) contains information for every Loran chain throughout the world. This information is subject to change as new Loran chains are installed, or parameters for current chains are modified. This utility allows the user to: 1) edit an existing Loran chain, 2) add a new Loran chain and 3) print a text copy of the Loran chain file. Figure 3-21 shows the available options.

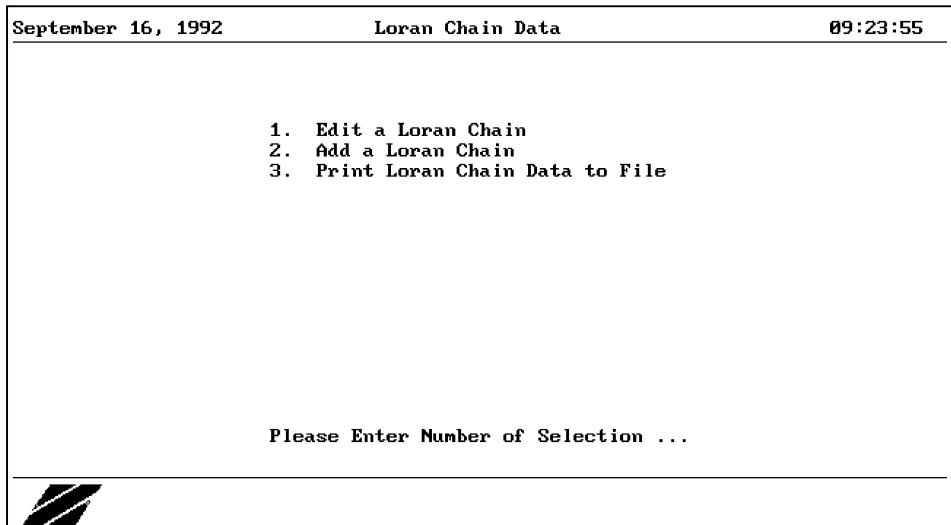

Figure 3-21. Loran Chain Data

Edit a Loran Chain

Select Edit a Loran Chain in order to edit an existing Loran chain. The screen shown in Figure 3-22 is displayed.

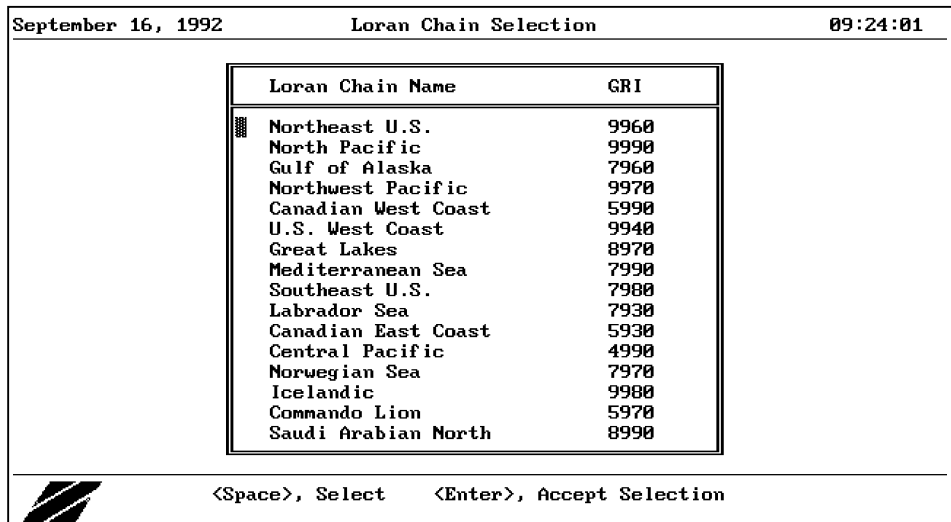

Figure 3-22. Loran Chain Selection

The window shows all of the Loran chains currently included in the Loran chain file. Press the **Up Arrow** and **Down Arrow** keys to scroll through the list of Loran chains and then press the **Space Bar** to select a Loran chain. After you have selected a Loran chain, press the **Enter** key to access the parameters for the selected chain. The screen shown in Figure 3-23 is displayed for the selected chain.

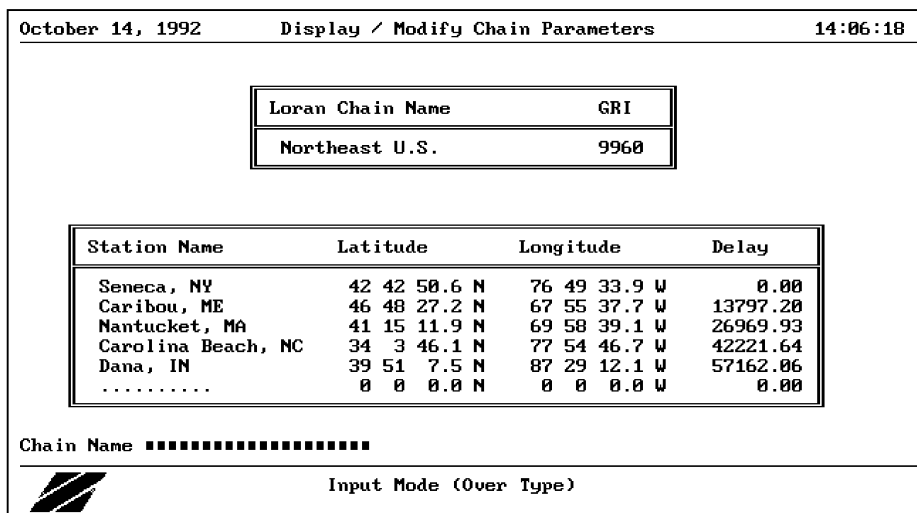

Figure 3-23. Edit a Loran Chain

Each station within the selected chain is shown as well as its Latitude, Longitude, and Delay. Use the **Up Arrow** and **Down Arrow** keys to move the highlight onto the parameter to be modified, enter the desired value and press **Enter**. When you have completed editing, press the **Esc** key to exit the edit mode and return to the menu. You will be prompted to accept the changes you have made. Entering **Y** accepts the displayed values, updates the lorchain.dat file, and returns you to the menu. Entering **N** does not accept the displayed values and keeps you in edit mode. Entering **Esc** returns you to the menu with no changes made.

Add a Loran Chain

Select Add a Loran Chain in order to add a new Loran chain (Figure 3-24).

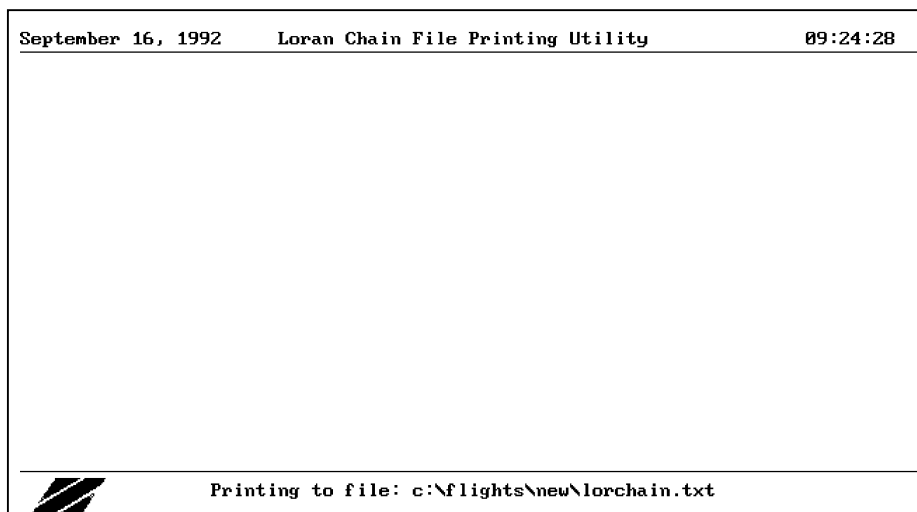

Figure 3-24. Add a Loran Chain

Use the **Up Arrow** and **Down Arrow** keys to move the highlight to each of the fields and enter the parameters for the new Loran chain. When all of the parameters have been entered press the **Esc** key to return to the menu. You will be prompted to accept the displayed values. Respond accordingly to return to the menu.

Print Loran Chain Data to File

Inside the W-9000 system the loran chain data is stored as an encoded data file. To convert the file to an ASCII text file, select option number 3 from the menu. The screen shown as Figure 3-25 is displayed. The contents of the lorchain.dat file is converted to a text format and written to a file named: c:\flights\new\lorchain.txt.

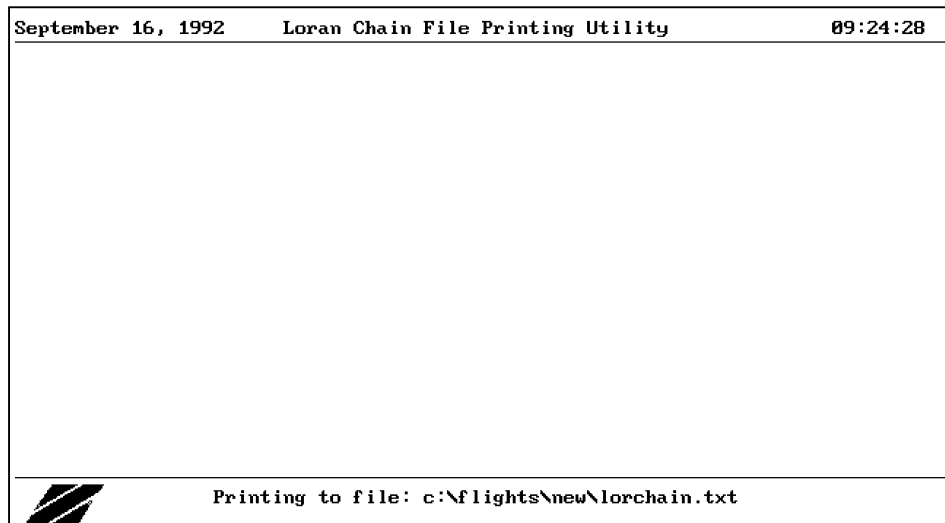

Figure 3-25. Print Loran Chain Data to File

This file may be viewed on the screen from the DOS command line using the DOS "TYPE" command by entering:

TYPE C:\FLIGHTS\NEW\LORCHAIN.TXT Enter

or the file may be printed on the system printer using the DOS PRIN" command by entering

PRINT C:\FLIGHTS\NEW\LORCHAIN.TXT Enter

3.10 Antenna Configuration

Antenna configuration is used to specify the type of antenna being used, the operating mode of the antenna and, if required, to determine operating parameters for the antenna. Some of the parameters in the antenna configuration screen (Figure 3-26) are only required for a specific type of antenna system. These are noted where appropriate.

August 08, 1996 Antenna Configuration 15:55:22		
Configuration Parameters	Units	Value
Antenna Mode	toggle	Auto
Antenna Selection	toggle	Omni
Antenna System	toggle	Rotor
Antenna Switch Over	meters	10000.0
Antenna Cycle Time (Rotor Only)	seconds.tenths	50.0
Most Probable Sonde Azimuth (Rotor Only)	degrees	90

Please Toggle Choice with Space Bar



Figure 3-26. Antenna Configuration

Electronic Antenna Description

The electronic antenna is a multi-element electronically switched antenna which does not require any user configuration once it has been properly assembled. Simply enter the Antenna System, Antenna Mode, and Antenna Select parameters from the Antenna Configuration screen. Each of these parameters is described in the following sections. Refer to the assembly instructions which came with your system.

Rotor Antenna Description

The rotor antenna consists of an omnidirectional antenna and one directional antenna element mounted on a rotor. The rotor requires user configuration because it can be used during flight operations. Refer to the assembly instructions which came with your system.

Antenna Mode

The Antenna Mode parameter allows you to select either automatic mode or manual mode. Automatic mode means that the antenna will be automatically pointed to the sonde during a flight assuming that there is current wind data. In manual mode all antenna pointing must be done manually by the user.

In automatic mode, commands are issued to the antenna by the system software to cause it to point to the azimuth indicated by the most recent wind data point. Also, when automatic mode is selected the switch over point between the omnidirectional antenna and the directional antenna is automatically made during a flight based on the value specified by the Antenna Switch Over (see below) parameter. Of course, if the Antenna System parameter (see below) indicates that there is only one antenna, then no switch will take place.

In manual mode, the user must use the Antenna program in order to move the position of the directional antenna and to switch from the omnidirectional antenna to the directional antenna.

Antenna Selection

The antenna select parameter allows the user to choose the omnidirectional antenna or the directional as the active antenna. This parameter is only in effect when the Antenna Mode is manual. If the Antenna Mode is automatic the system will switch from the omnidirectional antenna to the directional antenna at the range specified by the Antenna Switch Over parameter.

Antenna System

Use the **Space Bar** to toggle through the list of possible antenna systems until your specific antenna system is displayed.

Antenna Switch Over

The antenna switch over parameter determines when the active antenna switches from the omnidirectional antenna to the directional antenna in automatic mode. This point is determined by the horizontal distance between the ground station and the radiosonde in meters. The default value is 10,000 meters.

Cycle Time (Rotor Only)

This parameter is only used for rotor antenna systems since it specifies the time required for the rotor to pass through its full range of motion.

The antenna cycle time is used to accurately position the directional antenna. Therefore, the first step is to enter the antenna cycle time in seconds to the nearest tenth of a second. Since there are slight variations for each individual antenna rotor, the cycle time must be determined for each rotor. The Antenna Configuration software provides a mechanism, explained below, to simplify this process.

For a one man rotor antenna setup it is recommended, although not necessary, to have the antenna rotor in-sight of the system computer for cycle time determination. For multi-person setup the rotor can be mounted in its final location.

Moving the cursor to the antenna cycle time parameter will display a help prompt as shown in Figure 3-26. Hitting Y in response to this prompt displays a series of help screens which explain the process of determining the cycle time. The first help screen is shown in Figure 3-27.

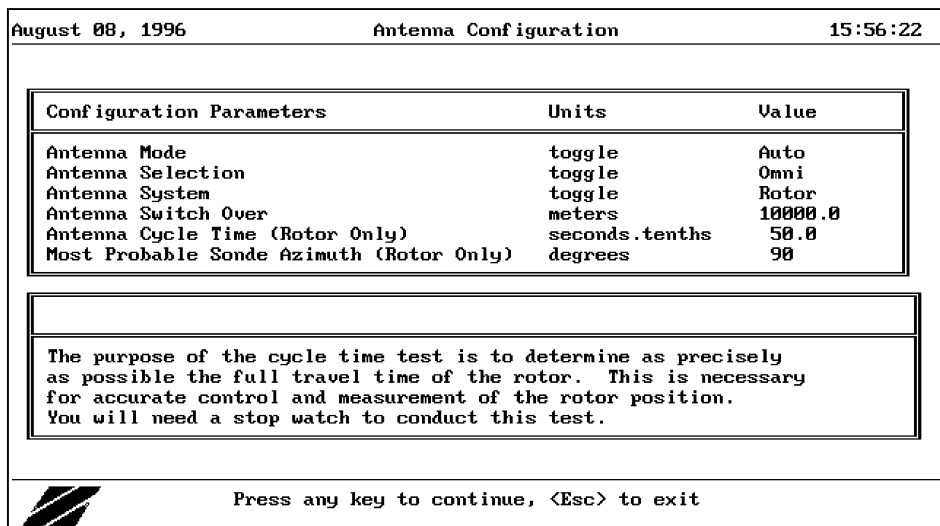

Figure 3-27. Introductory Help Screen

The screen shown in Figure 3-27 is primarily informational. It explains that a stop watch will be necessary to conduct the cycle time test. The next screen, shown in Figure 3-28, is a reminder to make certain that the correct version of software is installed in the ZEEMET Rack interface module.

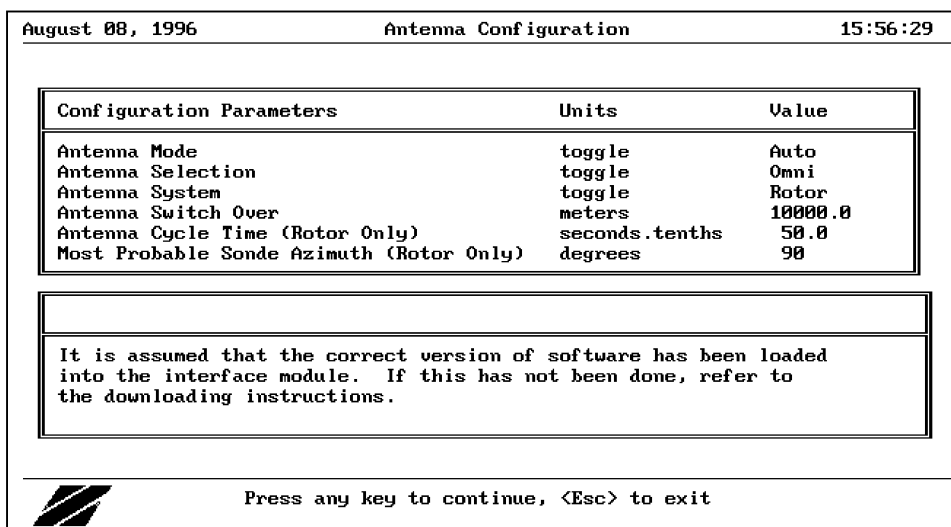

Figure 3-28. Interface Module Version Check

The screen shown in Figure 3-29 shows that the antenna is preparing for the timing test by moving all the way to one extreme end of its range. When the antenna is at one end of the range, the next screen (Figure 3-30) indicates that the system is ready to start the cycle time measurement.

August 08, 1996	Antenna Configuration	15:57:05																					
<table border="1"> <thead> <tr> <th>Configuration Parameters</th> <th>Units</th> <th>Value</th> </tr> </thead> <tbody> <tr> <td>Antenna Mode</td> <td>toggle</td> <td>Auto</td> </tr> <tr> <td>Antenna Selection</td> <td>toggle</td> <td>Omni</td> </tr> <tr> <td>Antenna System</td> <td>toggle</td> <td>Rotor</td> </tr> <tr> <td>Antenna Switch Over</td> <td>meters</td> <td>10000.0</td> </tr> <tr> <td>Antenna Cycle Time (Rotor Only)</td> <td>seconds.tenths</td> <td>50.0</td> </tr> <tr> <td>Most Probable Sonde Azimuth (Rotor Only)</td> <td>degrees</td> <td>90</td> </tr> </tbody> </table>			Configuration Parameters	Units	Value	Antenna Mode	toggle	Auto	Antenna Selection	toggle	Omni	Antenna System	toggle	Rotor	Antenna Switch Over	meters	10000.0	Antenna Cycle Time (Rotor Only)	seconds.tenths	50.0	Most Probable Sonde Azimuth (Rotor Only)	degrees	90
Configuration Parameters	Units	Value																					
Antenna Mode	toggle	Auto																					
Antenna Selection	toggle	Omni																					
Antenna System	toggle	Rotor																					
Antenna Switch Over	meters	10000.0																					
Antenna Cycle Time (Rotor Only)	seconds.tenths	50.0																					
Most Probable Sonde Azimuth (Rotor Only)	degrees	90																					
<p>Going beyond this screen will cause the antenna rotor to turn to its extreme counter clockwise position. It should take about 1 minute for this step to complete.</p>																							
 Press any key to continue, <Esc> to exit																							

Figure 3-29. Move Antenna to Start Position

The objective is to determine the exact time it takes the antenna to travel from one end position through the entire range of motion to the other end position. Therefore, at the same instant that you press a key on the keyboard to start the antenna moving, a signal should be given for the person watching the antenna rotor to start the stop watch.

Move to a position where you can view the movement of the directional antenna and note the exact time on the stop watch that the antenna stops moving. This time in seconds and tenths is the antenna cycle time that should be entered.

October 14, 1992	Antenna Configuration	14:09:12																					
<table border="1"> <thead> <tr> <th>Configuration Parameters</th> <th>Units</th> <th>Value</th> </tr> </thead> <tbody> <tr> <td>Antenna Mode</td> <td>toggle</td> <td>Auto</td> </tr> <tr> <td>Antenna Selection</td> <td>toggle</td> <td>Omni</td> </tr> <tr> <td>Antenna System</td> <td>toggle</td> <td>Rotor</td> </tr> <tr> <td>Antenna Switch Over</td> <td>meters</td> <td>10000.0</td> </tr> <tr> <td>Antenna Cycle Time (Rotor Only)</td> <td>seconds.tenths</td> <td>50.0</td> </tr> <tr> <td>Most Probable Sonde Azimuth (Rotor Only)</td> <td>degrees</td> <td>90</td> </tr> </tbody> </table>			Configuration Parameters	Units	Value	Antenna Mode	toggle	Auto	Antenna Selection	toggle	Omni	Antenna System	toggle	Rotor	Antenna Switch Over	meters	10000.0	Antenna Cycle Time (Rotor Only)	seconds.tenths	50.0	Most Probable Sonde Azimuth (Rotor Only)	degrees	90
Configuration Parameters	Units	Value																					
Antenna Mode	toggle	Auto																					
Antenna Selection	toggle	Omni																					
Antenna System	toggle	Rotor																					
Antenna Switch Over	meters	10000.0																					
Antenna Cycle Time (Rotor Only)	seconds.tenths	50.0																					
Most Probable Sonde Azimuth (Rotor Only)	degrees	90																					
<p style="text-align: center;">Cycle Time Determination Assistance</p> <p>The next step is to move the antenna through its whole range. Pressing any key will activate this process. Start your stop watch at the same time that you press the key.</p>																							
 Press <ENTER> to continue, <ESC> to exit																							

Figure 3-30. Start Antenna Timing

October 14, 1992		Antenna Configuration		14:09:22	
Configuration Parameters	Units	Value			
Antenna Mode	toggle	Auto			
Antenna Selection	toggle	Omni			
Antenna System	toggle	Rotor			
Antenna Switch Over	meters	10000.0			
Antenna Cycle Time (Rotor Only)	seconds.tenths	50.0			
Most Probable Sonde Azimuth (Rotor Only)	degrees	90			
Cycle Time Determination Assistance					
Go to a location where the antenna can be observed. Use the stop watch to note the time that the antenna stops turning. The seconds and tenths should be then entered at the cycle time prompt in the above display.					
 Press <ENTER> to continue, <ESC> to exit					

Figure 3-31. Stop Antenna Timing

Most Probable Sonde Azimuth (Rotor Only)

Once the cycle time has been entered, Antenna Configuration prompts for the most probable sonde azimuth to be entered. (This parameter is only used for the rotor antenna.) This is the heading in degrees that the radiosonde is most likely to take from the station. This is a function of the prevailing winds for your area.

Initialization (Rotor Only)

This is the final action required for configuration of a rotor antenna. Assuming you have determined and entered the antenna cycle time and all of the data has been entered on the Antenna Configuration screen, this final step can be completed.

Press **Esc** to leave the Antenna Configuration screen. If you have selected the rotor antenna as your Antenna System, then you will be asked if you would like to initialize the antenna. Responding **N** to the prompt skips the antenna initialization. Responding **Y** to the prompt causes the system computer to issue a command to the ZEEMET Rack to cause the antenna system to initialize. This will cause the rotor to make movements through its range and in a minute or two the antenna will come to a complete stop at the mid-point of its range. The directional antenna should now be pointed to the most probable sonde azimuth as discussed in the next section.

Orientation (Rotor Only)

After the antenna initialization process is complete and the antenna has stopped at the mid-point of its range, the following two screens will appear (Figures 3-23 and 3-33).

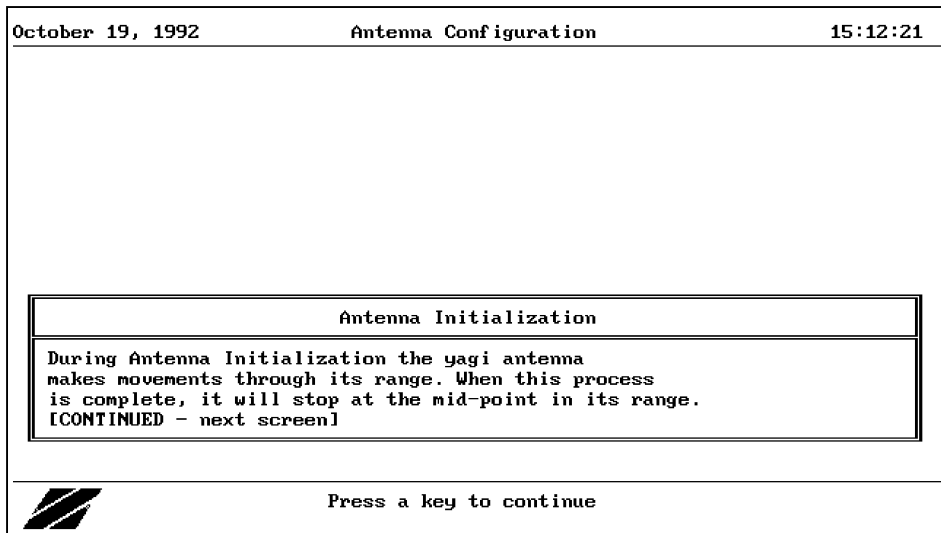

Figure 3-32. Antenna Orientation Help Screen 1

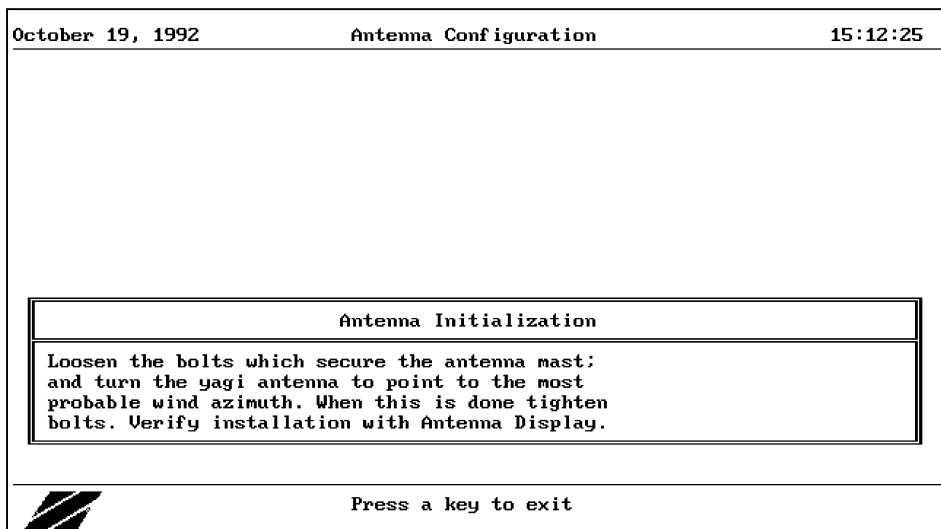

Figure 3-33. Antenna Orientation Help Screen 2

The bolts that secure the antenna mast should be loosened, and the directional antenna should be hand turned to point to the most probable radiosonde azimuth. Use a compass if necessary. When the directional antenna is oriented correctly, the bolts should be tightened.

At this point the rotor antenna configuration is complete. Use the antenna display program to verify that the antenna has been installed correctly. Using the display, move the antenna to various headings, and verify the antenna is pointing correctly.

3.11 Transmission Parameters

Transmitted Message Parameters is used to establish the communication parameters used for transmitting messages from the interface module (connector IJ4) to an external device.

August 07, 1996		Message Transmission Parameters		09:26:27	
Transmitted Data Format		Units		Value	
Speed		toggle		300	
Data Bit		toggle		7	
Stop Bit		toggle		2	
Parity		toggle		Space	
Enable		toggle		On	
Character		toggle		ASCII	

Please Select Speed with Space Bar

Figure 3-34. Message Transmission Parameters

The parameters, shown in Figure 3-34, can be set by first using the up and down arrow keys to highlight the value to be changed and then repeatedly pressing **Space Bar** until the desired value is visible. When all the parameters have the desired value, press **Esc** and respond to the prompt.

1. **Speed.** The speed is measured in bits-per-second. The settings which can be made using the speed option are: 50, 109, 135, 150, 300, 600, 1200, 1800, 2400, 3600, 4800, 7200, 9600, 19200, 38400.
2. **Data Bits.** The Data Bits setting refers to the number of bits used to represent a character. This can be set to either 5, 6, 7 or 8.
3. **Stop Bits.** The stop bits can be set to either 1 or 0.
4. **Parity.** The parity can be set to: Odd, Even, Mark, or Space.
5. **Enable.** Enable can be set to On or Off.
6. **Character.** Character can be set to either ASCII or Baudot.

3.12 Serial Interface Parameters

Serial Interface Parameters is used to establish the communication parameters used for transmitting summaries and reports from the interface module (connector IJ2) to an external device. Selections for this option are the same as listed above for Transmitted Message Parameters.

3.13 Load ZEEMET Rack

The Load ZEEMET Rack option of the Setup menu can be used to perform the following functions.

- Check and display the working status of each module.
- Load an application program into a ZEEMET Rack module. This capability is made available selectively for modules that need to be upgraded with newer software or for modules that are not currently installed but are required by the system setup. The programs are downloaded to the module through the system computer's COM1 port.

ZEEMET Rack Configuration Screen

The ZEEMET Rack downloading utility checks the status of the ZEEMET Rack modules and displays this and other information about the modules on the screen. A typical configuration and downloading screen is shown in Figure 3-35.

August 07, 1996		ZEEMET Rack Configuration			10:18:05	
Module	ZEEMET Rack		System Software		Status	
	MONITOR VERSION	APPLICATION VERSION	MONITOR VERSION	APPLICATION VERSION		
Interface	401	441	401	441	match	
403 Receiver	313	512 MK2	313	512 MK2	match	
Tracker 1 Omega	423	502	423	502	match	
Tracker 2 Omega	none	none	NA	NA	not in use	
Tracker 3 Omega	none	none	NA	NA	not in use	

 Select module to load. Press Enter to download, Esc to continue.

Figure 3-35. ZEEMET Rack Configuration Screen

If an error occurs during the status check, make certain that the cables are properly connected and turn the ZEEMET Rack off and then back on. Press **R** to try again, or press **Esc** to exit.

Introduction to Downloading

The ZEEMET Rack is an integral part of the W-9000 System. It includes several embedded intelligent microprocessor modules, such as the receiver module and the tracker module. There are also several non-intelligent modules, such as the navaid heads. Using these modules the ZEEMET Rack is able to track the radiosonde and to receive and buffer the data which the system computer processes.

The system computer communicates with the ZEEMET Rack through the COM1 serial communication cable. The standard configuration has the COM1 port of the system computer connected to the IJ1 port of the interface module.

When to Download

There are several reasons for loading software into the ZEEMET Rack. One reason is to update one or more ZEEMET Rack modules with the latest software release. Another is to change the context of a module, such as loading the Mark II receiver program into a receiver module which was previously running the Mark I program. In the same manner, a tracker can serve as either a Loran or Omega tracker. In addition, you may have to download a module which has been corrupted due to abnormal operation of the ZEEMET Rack. In this case, another download of the module should correct the problem. Only those modules that are required by the current system setup are made available for downloading.

Note that the ZEEMET Rack downloading utility is used by both the setup program and the main system software. For example, if you type "start" to do a real flight, and the setup that you have does not agree with the modules that are installed, the ZEEMET Rack Downloading utility is automatically run. You can then download the modules required for the current setup and continue with the flight, without having to exit and run the Setup program. Typically the modules installed and the setup will match when doing a real flight. In this case, when there is no apparent need to download modules, the main system software will display the ZEEMET Rack Configuration screen momentarily, but downloading is not made available.

Once you set up a new environment by loading software, all the ZEEMET Rack module application programs are maintained in memory after power off. It is not necessary to reload the programs each time the system is powered on.

In summary, ZEEMET Rack downloading is required when the system computer cannot communicate with the ZEEMET Rack or if there are updates requiring new configurations and/or installations. Then it shall be necessary to reload the ZEEMET Rack modules.

Selecting a Module to Download

In the ZEEMET Rack Configuration display, the first module that is available for downloading will be highlighted. Only those modules that have a status of "match" or "download" are able to be highlighted. Use the **Up Arrow** and **Down Arrow** keys to select the module that you wish to download. Press enter to begin downloading that module.

Downloading Operation

Once you select a module to download, a series of screen prompts will direct you through the whole process of downloading. During the course of the downloading operation, you will be required to move the COM1 cable from its normal operating position so the module to be downloaded, and then back again. The program will tell you when to switch the cable, and to which port.

The first thing you will be prompted to do is to move the COM1 cable to the port specified and then, once in place, press any key to continue. The program will attempt to interrogate the module to make sure you are connected to the correct module. After confirming that you are indeed connected to the correct module, the program will begin downloading the module software. A message to this effect will appear on the screen.

After the download is complete, you will be prompted to re-connect the COM1 cable to the Interface's IJ1 port. Remember to re-connect the receiver cable if you were downloading the receiver. Press any

key as directed. Next, the program will direct you to reset the ZEEMET Rack by turning the power on and off. Turn off the ZEEMET Rack and wait about five seconds, then turn it back on. Then press any key to continue. At this point the ZEEMET Rack status check will be performed again, and any change in the modules' status will be reflected on the screen. Now you can select another module for downloading if desired.

If the program determines that you were not connected to the correct module, or the download was unsuccessful, a message to this effect will appear on the screen. You will then be directed to perform steps consistent with the completion of a successful download as described above. You may then attempt to download the module again. Note that the primary Loran tracker is responsible for adjusting the notch filters if they are present. For roughly six minutes after power up the primary Loran will be unavailable for downloading.

After all of the desired modules are downloaded, simply press the **Esc** key to exit the ZEEMET Rack Configuration display. The program will do a final check to make sure that the modules that are installed agree with the system setup. If they do not, then an error message is displayed. You then have the opportunity to exit by pressing **Esc**, or check the cables and press **R** to retry. If the modules installed match the system setup, then the control returns to the calling program: either the Setup menu, or, the main system software.

3.14 Print configuration

The Print Configuration option in the Setup menu is used to print a report that gives the status of the currently selected options needed run a flight. This includes parameters specified using the following Setup Utilities and Flight menus: Station Installation, Antenna Configuration, Receiver Installation, Event Manager Configuration, Serial Interface, Wind Finding Installation, and Message Coding.

3.15 Printer Definition

The W-9000 system supports most printers via a generic software interface. The default is the 9-pin Epson printer. Which printer the system actually uses is determined by the last three lines in the printer definition file, PRINTER.DEF, in the W-9000 System directory. To view or change the printer defined for use with the W-9000 system, type **PRINTCFG [Enter]**. This will display the file, GXPRINT.DAT, which lists the supported printers. Use the cursor movement keys to go through the file and select the printer that best matches the printer attached to your system.

For systems using the 9-pin Epson compatible printer, edit the last three lines of the printer definition file to read:

```
COMPRESS: 015  
NORMAL80: 018  
GRAPHICS: EPSON9H.PRD
```

To increase the printing speed at the cost of printing quality, change the last line to GRAPHICS: EPSON9M.PRD.

For systems using the 24-pin Epson compatible printer, the last three lines of the printer definition file should read:

```
COMPRESS: 015  
NORMAL80: 018  
GRAPHICS: EPSON2H.PRD
```

To increase the printing speed at the cost of printing quality, change the last line to GRAPHICS: EPSON2M.PRD.

Epson compatible printers support other printer configurations than the ones mentioned here. For more details see the options for Epson printers in the file called C:\W9000\4-2-0\GXPRINT.DAT. This file may also be helpful should you want to try using printers not supported by the W-9000 system.

This page intentionally left blank.

Chapter 4. Starting Up The W-9000 System

4.1 Summary

This chapter describes how to start the W-9000 System. If setting up the W-9000 System for the first time, refer to the hardware instructions in the *W-9000 Installation Manual*, the software installation instructions in Chapter 2, and the setup instructions in Chapter 3 before continuing with this section.

This chapter explains how to power up the system equipment. Then there are instructions on how to initiate the operation of the system software packages and to set the optional modes of operation. Later chapters cover the details of using the optional packages.

4.2 Powering Up System Equipment.

These instructions for powering up your system assume you have connected and tested system components according to the installation instructions provided in Chapter 2 and the *W-9000 Installation Manual*.

Open the doors on Drive A and Drive B of your system computer to ensure that it boots from the hard disk drive.

Most systems are set up with a power strip that controls the power to all the system components. If your system has a power strip, the individual power switches are always left on, and the power is controlled via the power strip.

If your system does not have a power strip, turn on your system in the following order.

1. Turn on the power switch on the monitor. Refer to Figure 4-1. For Dell Super VGA Monitors, the power switch is located at the lower right of the front of the monitor.

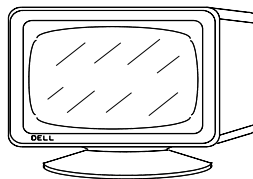

Figure 4-1. Front View, Display Monitor

2. Refer to Figure 4-2. Turn on power to the ZEEMET Rack (the red switch located in the back of the ZEEMET Rack at the top of the Antenna Module).

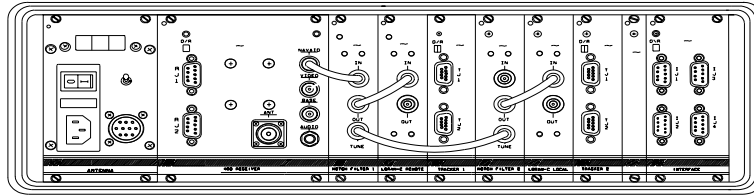

Figure 4-2 ZEEMET Rack Back View

3. Refer to Figure 4-3. Turn on the system computer power switch whose location is documented in the computer user's guide.

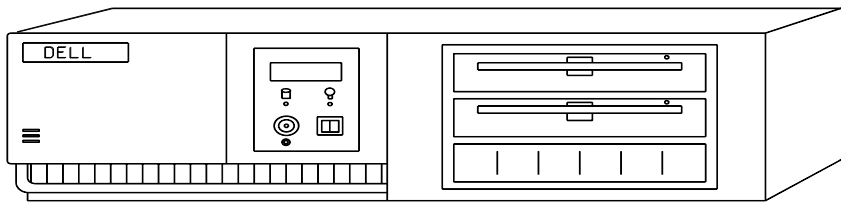

Figure 4-3 System Computer Front Panel

4. Turn on the power to the system printer power switch whose location is documented in the printer user's guide.

4.3 Starting System Programs

When power is first applied to the system computer it automatically runs the POST (Power On Self Test) program. About 15 seconds after you turn on the system computer it "beeps," and the system will *boot* itself up from the hard disk drive. Be sure that the doors on the A and B diskette drives are open.

When the *boot* process completes, the W-9000 Command Summary display will be on the screen followed by the DOS prompt message. Figure 4-4 shows the command summary. Note that the display indicates that the System Computer has been initialized, and it shows a tabulation of the W-9000 commands that can be entered from the DOS command line. Any software can be run from the DOS prompt, including the W-9000 System programs. The various W-9000 System options are presented in this chapter.

```
W-9000 Meteorological Processing System, (w9k2-9-8) Version 2.9
W-9000 Command Summary:
Initiate Real Flight,      Start [Enter]
Initiate Simulation,      Start [Flightid] [Filename] [Enter]
                           example: Start 4321 W9K4321 [Enter]
Demo Loran Flight,        Start1 [Enter]
Demo Omega Flight,        Start2 [Enter]
Fast Restore,             Start [restore or srestore] [Enter]
System Setup,             Setup [Enter]
Display Readme File,      Readme [Enter]
Serial Data Capture,      Capture [Enter]
File Conversion,          Binutil [Enter] or
                           Binutil [In file] [Out file] [Options] [Enter]
Copyright (C) 1992, VIZ Manufacturing Co., All Rights Reserved.

C:\>
```

Figure 4-4. W-9000 Command Summary

4.4 Running the System Setup Utilities

If you type **SETUP** <Enter>, you will run the System Setup Utilities described in Chapter 3.

4.5 Starting a Radiosonde Flight

At the DOS prompt you can either start a new flight (launching a radiosonde), or you can simulate or replay a past flight.

New Flight

System configuration files are copied from the W-9000 System directory to the flight data directory on the hard disk. Flight data is obtained from the modules in the ZEEMET Rack.

To set up for a new radiosonde flight, type **Start** <Enter>. The system computer will begin to initialize the hardware and software for a flight by copying data files customized during the Installation and Setup Routine from the W-9000 System directory on the hard disk to the flight data directory. Changes made to the system setup after this point are assumed to be specific to the flight only and are not saved in the W-9000 System directory. Permanent changes to the system setup must be entered by running the Installation and Setup programs (see Chapter 3), or they will have to be re-entered for each flight.

Simulated Flight

System configuration files are copied from the archived flight to the flight data directory on the hard disk. Flight data is obtained from files in the archived flight on the hard disk.

To run the W-9000 System in a simulated mode by replaying a previously saved flight, type

START <flight ID> <system name><flight ID> <Enter>.

In this command line, the flight ID and system name take on the following meanings:

<flight ID>

The flight ID is that of the flight you wish to run. This would be the flight ID that was entered when the flight was flown. For example, if you ran a flight and gave it a flight ID of 1234 when you first ran it, the flight ID would be 1234.

<system name>

The prefix to the <flight ID> on the filenames in the flight directory containing the files you wish to re-run. The <system name> is the 3 character name for the system whose flight you want replayed. This parameter is identical to the System Name in SETUP Station Installation (see "Station Installation" in Chapter 3).

For example, to run flight 1234 from system W9S you would type:

START 1234 W9S1234 <Enter>

This means that the W-9000 system programs would get the necessary configuration and flight data from the archive C:\FLIGHTS\ZIP\W9S1234.ZIP.

Flights that can be run in simulation are often included with the W-9000 System Software. For example, to start and run a Cross-Chain Loran-C simulation, type:

START1 <Enter>.

Other standard simulation flights may also be included in the system software.

During initialization, the Logo screen shown in Figure 4-5 is first displayed.

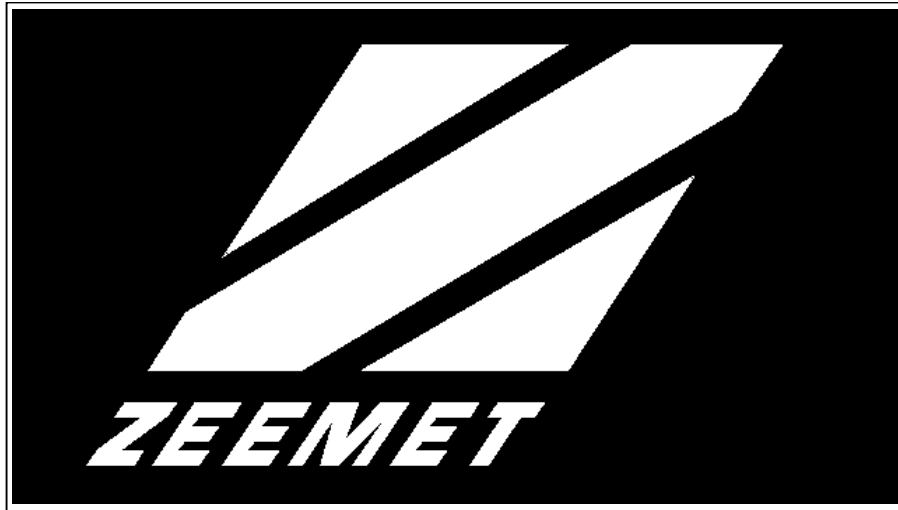

Figure 4-5. ZEEMET Logo Display

Further initialization takes place while the second screen, the System Configuration display (Figure 4-6) is displayed.

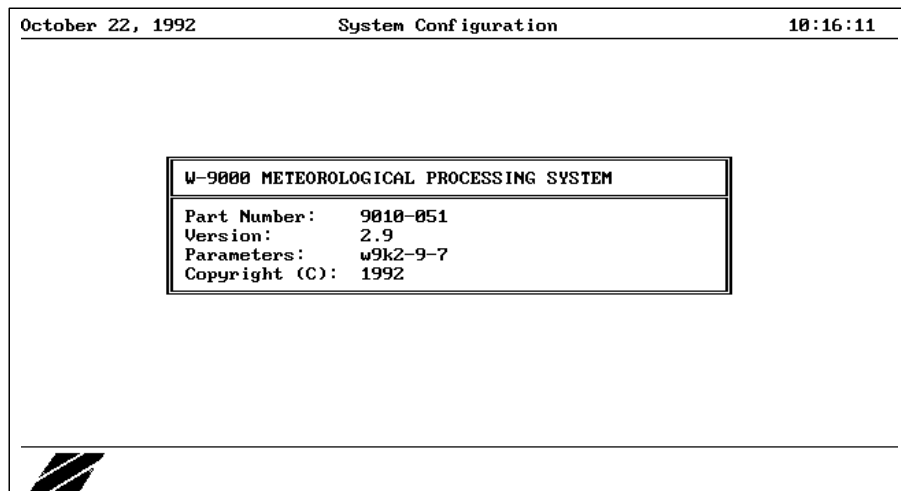

Figure 4-6, System Configuration Display

Finally the status and revision level of the ZEEMET Rack Software that is currently running is checked. The first three numbers of the version indicate the version of the monitor. The second three indicate the version of the software loaded by the monitor into RAM. The left-hand column indicates the software currently installed. The right-hand column indicates the software that should be installed, usually the latest release. Figure 4-7 shows the ZEEMET Rack Configuration screen.

Module		ZEEMET Rack		System Software		Status
	MONITOR VERSION	APPLICATION VERSION	MONITOR VERSION	APPLICATION VERSION		
Interface	401	435	401	435		match
403 Receiver	313	505 MK2	313	505 MK2		match
Primary Loran	423	436	423	436		match
Secondary Loran	423	436	423	436		match
Omega	none	none	NA	NA		not in use

Figure 4-7. ZEEMET Rack Configuration

If any of the ZEEMET Rack software is out of date, the ZEEMET Rack downloading utility is automatically run. See Chapter 3 for more on this utility. You can continue using the present software residing in the ZEEMET Rack (not recommended), or download the modules that are required. When the download completes, initialization for a flight will continue. To meet Navaid requirements for the flight, if any, it is critical that the software resident in the tracker modules in the ZEEMET Rack process the Navaid signals sent from the sonde. For example, if the flight is to be Omega, the tracker must have the Omega software rather than the Loran software.

Section 4.4 covers how to restore a previously flown flight via the system utility menu. Access to the restore function is handy when one is already in the system. However, if you want to restore a flight without going through the preflight initialization procedures, use one of the following commands from the DOS prompt:

START <restore> <Enter>

or

START <srestore> <Enter>

Typing START RESTORE at the DOS prompt initializes the ZEEMET Rack and brings you directly to the restore menu. This allows you to transmit messages, punch tape, or perform any other function that requires access to the ZEEMET Rack. Typing START SRESTORE does the same thing but without actually activating the ZEEMET Rack. In this case, the software simulates the ZEEMET Rack. For further instructions on the use of the restore function, see Chapter 8.

Chapter 5. Flight Preparation

5.1 Introduction

This chapter describes the flight preparation portion of the W-9000 system software. There are several steps involved in preparing for launch; these include:

- Entering flight identifiers.
- Checking Navaid status.
- Entering surface data.
- Checking or entering calibration data.
- Checking receiver status.

5.2 Overview of Flight Preparation

Figure 5-1 shows the flight preparation process in block diagram form. This chapter begins with Flight Identifier Initialization. The process before that is described in Chapter 4.

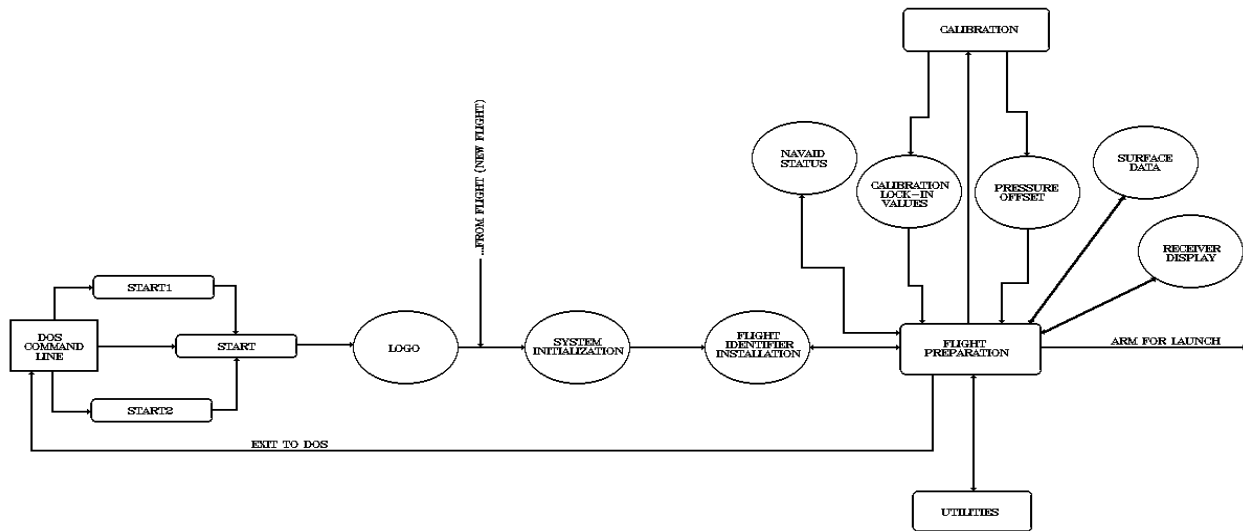

Figure 5-1. Flight Preparation Map

Figure 5-2 shows the Flight Identifiers Initialization. This screen allows you to enter the radiosonde serial number and the flight ascension identifier for the current flight. These values are entered using the rules of the standard editing screen.

Flight Identifiers	Values
Serial Number	535766
Ascension Identifier	0

Please Enter the Sonde Serial Number:

 Input Mode (Over Type)

Figure 5-2. Flight Identifier Initialization

After the flight identifiers have been entered, you enter the Flight Preparation display. You may, however, still change the flight identifiers at any time before a flight by selecting Change Flight Identifiers from the Preflight menu.

Entering a Sonde Serial Number

The W-9000 has an automatic tuning facility that requires the Mark II sonde serial number. The sonde serial number is located on the outside of the sonde case. Use the Flight Identifier Initialization menu to enter the serial number.

Entering a Flight Ascension ID

The Flight Ascension Identifier (Flight ID) is required to assign a unique alphanumeric label to the data for each flight. The number of characters available for the Flight ID (F) depends on the number of characters in the System Name (S) according to the formula $F = 8 - S$.

For example, to allow eight characters for the Flight ID, enter all spaces for the System Name in the Station Installation option of the System Setup Utilities menu. This effectively sets the length of System Name to zero, therefore allowing all eight characters to be used by the Flight Ascension Identifier.

5.3 Flight Preparation Display

After the Flight Identifiers have been entered, the Flight Preparation display in Figure 5-3 is shown on the screen. Flight preparation contains three main windows: Preflight menu, Flight Information Window, and PTU Data, each of which is described in this section.

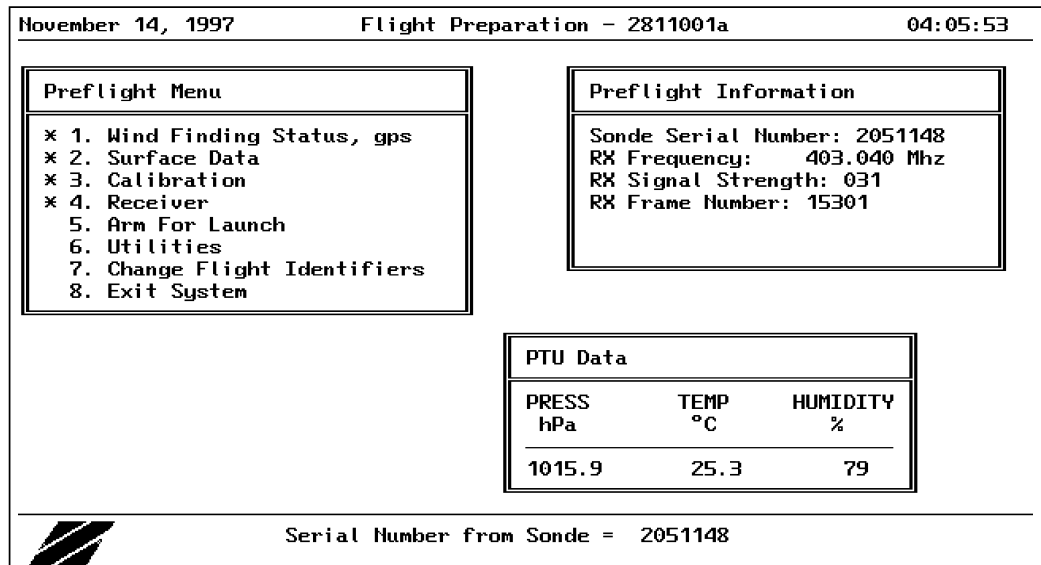

Figure 5-3. Flight Preparation

Preflight Menu

The Preflight menu offers the following choices:

- View or modify wind finding status.
- View or modify surface data
- View or modify calibration data.
- Tune the receiver.
- Arm the system for launch.
- Access the Utilities menu.
- Change the flight identifiers.
- Exit the system.

The Preflight menu also provides an indication of the status of these items. A question mark next to a menu item means that the item has yet to be processed. An asterisk next to an item means that the function represented by the menu item has been completed. Items that do not show a question mark or an asterisk are not required as part of the flight preparation.

A basic tenet of the preflight process is to automate as many steps as possible, while giving you overall control. Briefly put, when the menu is first entered, several processes are automatically initiated. The system will automatically initialize the wind finding hardware. The receiver will automatically tune to the correct sonde by searching for its serial number in any data streams encountered while sampling frequencies in the search band.

Note that the first four items on the Preflight menu (Navaid Status, Surface Data, Calibration, and Receiver) may be completed in any order. However, all four steps must be completed before arming the system for launch.

Flight Information Windows

The Flight Information window is the second in the Flight Preparation display. It contains information such as the sonde serial number, the current frequency of the receiver, and the signal strength measured at that frequency. It also contains the frame number of the latest sonde data frame received.

PTU Data

Finally, there is the PTU Data window that shows the last processed values of pressure, temperature, and humidity data received from the sonde. The PTU data window first appears when the receiver tunes to the correct sonde. There is no data in the window until the calibration data is received. When returning to this display from another module, it will take a few seconds for the data in the PTU window to reappear.

5.4 Navaid Status

Navaid status displays the status of the wind finding method currently in use.

Differential GPS Status

When the system is set up for Differential GPS flights, the Differential GPS Status screen appears. The example shown in Figure 5-4 shows four informational areas on the display. The main box at the top shows the status of different satellites by their satellite number. Data is displayed for various signal sources. The symbol “x” is used to indicate which satellites have data for which category.

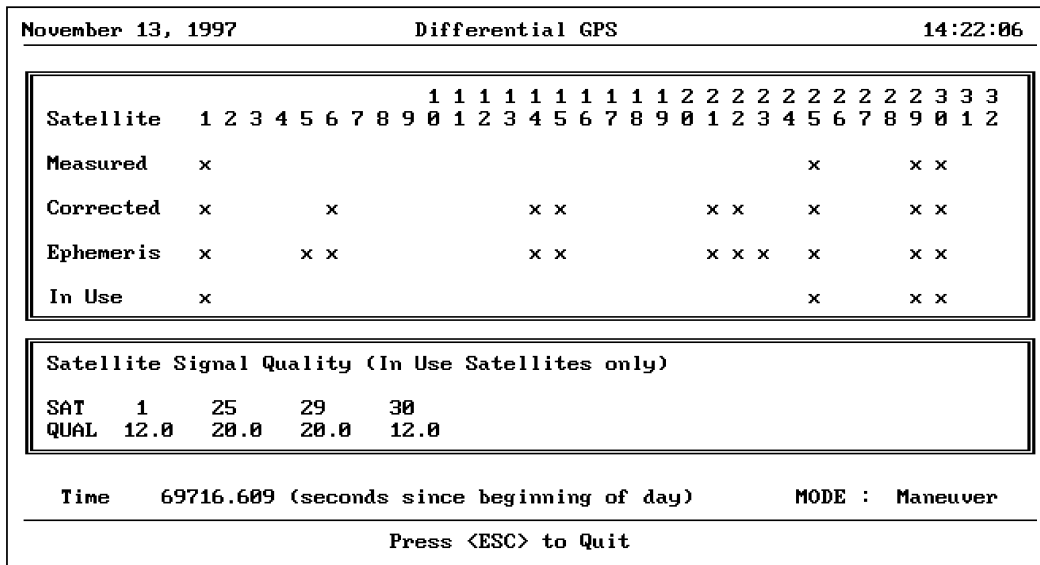

Figure 5-4. Differential GPS Status

Satellites are numbered across the top of the box.

Measured

The measured line shows the line of sight (LOS) data received by the radiosonde GPS receiver. This updates approximately once every second.

Corrected

Corrected shows the RTCM data for the local receiver. This updates approximately once every two seconds.

Ephemeris

Ephemeris shows the ephemeris data for the local receiver. This updates periodically as required. Ephemeris and corrected data from the local receiver are used to generate the differential corrections required.

In Use

In use shows the “In use” satellites for the current interval.

The second box shows the signal quality for the “In use” satellites for the current period. Below this signal quality box is a line shows the time of the data for the current values on the left, and the mode of operation on the right. There are four (4) modes.

Init

When the mode is init, the local receiver is being initialized.

Idle

When the mode is idle, the system is waiting for the sonde to complete its lockup process.

Ready

When the mode is ready, the local receiver and the sonde are locked onto the satellites and the system is ready to “Arm for Launch”.

NOTE: In version 4.2, the correct surface pressure, temperature, and humidity at the release point MUST be entered in the surface data display just prior to ARM for LAUNCH. These values are used to initialize the pressure computation for differential GPS operation.

Maneuver

When the mode is maneuver, launch has been detected and the system is computing pressure from the measured altitude along with Wind Speed and Direction.

PVT GPS Status

November 13, 1997		GPS NAVAID DISPLAY			14:10:58	
GPS RAW DATA						
UTC (sec)	Sats	Latitude (D M S)	Longitude (D M S)	SPEED (m / sec)	Direction (Deg)	
307085.9	6	-22 48 23.69	-43 14 9.38	0.3	200.4	
307086.9	6	-22 48 23.70	-43 14 9.38	0.3	199.9	
307087.9	6	-22 48 23.71	-43 14 9.39	0.3	200.4	
307088.9	6	-22 48 23.72	-43 14 9.39	0.3	201.3	
307090	6	-22 48 23.72	-43 14 9.40	0.3	200.7	
307091.9	6	-22 48 23.74	-43 14 9.42	0.3	203.7	
307092.9	6	-22 48 23.75	-43 14 9.43	0.3	205.0	
307093.9	6	-22 48 23.75	-43 14 9.43	0.3	205.3	
307094.9	6	-22 48 23.75	-43 14 9.44	0.7	215.1	
307097.9	6	-22 48 23.39	-43 14 9.81	7.3	306.8	

Figure 5-5. PVT GPS Status

Loran Status

When the system is set up for Loran flights, the Loran Status screen appears. The example shown in Figure 5-6 is that of the Navaid screen that comes up when the system has the optional cross-chain Loran configuration. The example shows two separate Loran chains that are used to determine the winds.

October 29, 1992		Navaid Status - Loran			10:57:42	
Northeast U.S.		GRI 9960	Tracker 1			
Station Name	Key	Status	TOA(µs)	TD(µs)	SNR	State
Seneca, NY	Master	*	10104.5	0.0	54	8
Caribou, ME	Include	*	26050.7	15946.2	38	8
Nantucket, MA	Include	*	37522.9	27418.4	59	8
Carolina Beach, NC	Include	*	53611.8	43507.3	53	8
Dana, IN	Include	*	69716.5	59612.0	27	8
Great Lakes		GRI 8970	Tracker 2			
Station Name	Key	Status	TOA(µs)	TD(µs)	SNR	State
Dana, IN	Master	*	10094.7	0.0	41	8
Malone, FL	Include	*	25439.6	15344.9	50	8
Seneca, NY	Include	*	38816.2	28721.5	77	8
Baudette, MN	Include	*	60397.4	50302.7	32	8
Boise City, OK	Include	*	78476.5	68381.8	19	8
		Tracker 1: Transferring To Sonde	Tracker 2: Transferring To Sonde			

Figure 5-6. Loran Status

Each Loran station name is shown in the window with a key value, Status, Time Of Arrival (TOA), Time Difference (TD), Signal to Noise Ratio (SNR), and State.

Key

The key value indicates whether the Loran station is Included, Excluded, or the Master station. Only stations that are the Master or Included are used for computing wind data.

Each key value for the Loran stations may be changed using the toggle data entry mode. In order to change the key values for the stations, use the <Up Arrow> and <Down Arrow> keys to move the highlight to the desired key value, and then press the <Space Bar> to toggle the key value. When the key values have been selected, press the <Esc> key to return to the Preflight menu. The standard acceptance prompt is displayed when the <Esc> key is pressed. Press <Y> if you wish to save the values, <N> to continue editing, and <Esc> to exit without having changed the values.

Changing the key status of any of the Loran stations while a flight is in progress causes a recalculation of the wind file (.WND). The wind file is deleted and then recalculated using the new key values for the Loran stations.

Status

The Status value indicates the lock condition of the Loran station. A Loran station gets a Status of "*" (locked) if it satisfies two conditions: (a) the TD value for the station is within 5000 microseconds of its delay value as stored in the Loran chain file (LORCHAIN.DAT); (b) the station has reached State value eight. If either of these conditions is not met, the station gets a "?" (unlocked) status value.

Time Of Arrival (TOA)

The Time Of Arrival value is the time in which a Loran station is detected relative to a reference point established by the ZEEMET Rack clock. The TOA value is in microseconds.

Time Difference (TD)

The Time Difference value is the Time Of Arrival of a slave station minus the Time Of Arrival of the master station. The TD value is in microseconds.

Signal to Noise Ratio (SNR)

The SNR value for each station indicates the relative signal strength of each Loran station and can be used to determine which stations should be Included or Excluded. The range of the SNR values is between 0 and 99. The Loran status display is updated with new SNR values at a rate according to the value specified for the Raw Wind Sampling interval from the Setup Utilities.

State

The Loran tracker begins to track the Loran signal when the ZEEMET Rack is powered on. At this time, the tracker begins a lockup cycle tracking according to current value of the Group Repetition Interval (GRI). During the lockup cycle, the tracker progresses through specific steps leading up to lockup of the Loran stations. These steps are defined through State values. The State value starts at zero at power on and proceeds through State eight when the tracker has locked up on the station.

Signal Source Message

The Navaid Status display for Loran presents a message at the bottom of the screen, which shows the source of the Loran signal. In the following discussion, each of the four possible messages will be described in detail. Whenever the term "local" appears, this refers to the Loran signal supplied by the Navaid whip antenna on the ground. The term "remote" refers to the Loran signal supplied by the radiosonde.

Local Navaid Signal. The Loran signal is supplied by the local antenna. This message is displayed during preflight operation.

Transferring to Sonde. The Loran signal is still supplied by the local antenna and the tracker is monitoring for the remote signal from the sonde. This condition occurs when the system is armed for launch.

Committing to Sonde. The Loran signal is supplied by the remote Loran signal from the sonde but it can still switch back to the local signal if the remote signal can no longer be found. This condition exists after the system has been armed for launch, but before launch has been detected.

Committed to Sonde. The Loran signal is being supplied by the remote Loran signal from the sonde and it cannot switch back to the local signal. This condition exists after launch has been detected.

Restarting Navaid Lockup

Under certain conditions, it is possible to receive an invalid Navaid lockup. An invalid lockup is a situation where the Navaid display will indicate lockup, but the data is not valid for wind computation. For Loran, an improper lockup may be evidenced by an invalid set of Time Difference (TD) data whose values differ from their typical values by 100 or more microseconds. In order to recognize an invalid Loran lockup, you should record typical TD values for several lockup sequences (10 or more) at your station. If a lockup sequence differs from these typical values by 100 microseconds or more, the lockup should be considered invalid and a restart should be initiated. The re-lock procedure is described below.

If you receive an invalid lockup for Loran, you can restart the lockup sequence for each tracker. Press <Alt-1> to restart tracker 1 and <Alt-2> to restart tracker 2. This will restart the lockup sequence for the corresponding tracker.

Radar Status

When Navaid Status is selected and the system is configured for radar flights, a Wind Status menu similar to Figure 5-9 is displayed. Each line of the display is a set of data received from the radar. The latest data is at the bottom.

February 17, 1995		Wind Finding Status - EEC Radar		10:33:19	
Track	Azimuth(deg)	Elevation(deg)	Range(meters)	Time(HH MM SS)	
227.85	7.20	819	0	2	21
227.97	7.52	834	0	2	23
228.09	7.84	849	0	2	25
228.21	8.16	864	0	2	27
228.45	8.80	894	0	2	31
228.57	9.12	909	0	2	33
228.69	9.44	924	0	2	35
228.93	10.08	954	0	2	39
229.05	10.40	969	0	2	41
229.17	10.72	984	0	2	43
229.29	11.04	999	0	2	45
229.41	11.36	1014	0	2	47
229.53	11.68	1029	0	2	49

Figure 5-9. Radar Status

5.5 Surface Data

Entering Surface Data

Surface Data can be changed or viewed using the Surface Data menu. The data is entered using standard screen editing procedures. The figure shows the measurements that can be entered.

It is recommended that the surface data be entered before launching the sonde, as a pre-flight procedure. However, this display can be accessed at any time by selecting Surface Data from the Preflight menu or the Flight menu. Note, however, that changing the surface data during a flight will cause a recalculation of the wind data file (.WND) and the meteorological data calculations file (.MDC). Figure 5-10 shows the Surface Data Entry screen.

Surface Measurement	Units	Value
Wind Speed	Knots	23.3
Wind Direction	Degrees	280
Pressure	Mbs	992.5
Dry Bulb Temperature	Deg. C	-2.0
Relative Humidity	%	40.0
Wet Bulb Temp. (optional)	Deg. C	0.0
WMO Cloud Code	NhClCmCh	////
Standard Day & Hour	DDHH	0000
Transmission Id.		000001

Wind Speed (knots)

 Input Mode (Over Type)

Figure 5-10. Surface Data Entry

Humidity Calculation

As a convenient aid in determining the relative humidity at the surface, an optional automatic humidity calculation is built in. To use this feature, first enter the surface pressure and surface dry and wet bulb temperatures. Once all three are entered, the following prompt appears:

Would you like humidity calculated? (Y/N)

If you answer <Y>, the humidity field on the display is automatically updated with the calculated humidity. Afterward, whenever any of these three values change, the opportunity for an updated automatic humidity calculation will present itself.

Since the wet bulb temperature is only used in this optional calculation, its value is not saved with the other surface data values. A record of the value is stored in the journal file (.JNL). If you do not wish to use this function, there is no need to enter a wet bulb temperature.

WMO Message Coding Parameters

If your software contains the WMO Message Coding option, you will have three additional parameters listed under the Wet Bulb Temperature in the Surface Data display: the WMO Cloud Code, the Standard Day and Hour, and the Transmission ID.

WMO Cloud Code

This code is used in the TEMP message Part B, Section 8. Refer to the WMO manual on Codes (Volume 1) for a complete description of this parameter.

Standard Day and Hour

The standard day and hour entry specifies the WMO day and hour when the radiosonde was released. This data will be included with the message head, message tail, or bulletins if these files contain symbolic information indicating that the Standard Day and Hour should be included.

Transmission ID

The Transmission ID is used to identify a station when a WMO message is transmitted. The Transmission ID will be sent with the message head or message tail if these files contain symbolic information indicating that the Transmission ID should be included.

Military Message Coding Parameters

If your software contains the Military Message Coding option, you will be presented with another menu when you select Surface Data from the Preflight menu. This menu will contain choices for Surface Data entry and Military Message Coding parameters. See Chapter 3 for a description of the Military Message Coding Parameters display.

5.6 Calibration Data

Calibration Functions

There are two calibration functions available. The first is the calibration data entry function. This allows you to view and edit the temperature and humidity sensor lock-in and ratio values, as well as view the pressure coefficients. The second is the pressure offset adjustment function.

Calibration Overview

The source of the calibration information (pressure coefficients, temperature and humidity lock-in values) used to process the meteorological data is transmitted from the Mark II sonde as part of its data stream.

The process of acquiring this calibration information begins just after the sonde serial number has been accepted as input from the Flight Identifier Initialization screen. At this point, the software automatically issues a command instructing the receiver to search for the desired sonde (automatic tuning). Once the sonde has been located and the data stream has been verified as coming from the correct sonde, the software automatically requests the calibration data.

As soon as the calibration data has been received and processed, an asterisk appears next to the calibration item on the Preflight menu. Once the asterisk is present, the pressure offset can be computed and entered. This is required for all radiosonde models except for the LOS GPS radiosonde. If the calibration information has not been received and verified, a question mark appears next to this menu item.

Calibration Menu

Entry to the calibration functions is achieved via the Calibration option of the Preflight menu. Figure 5-11 shows the calibration menu.

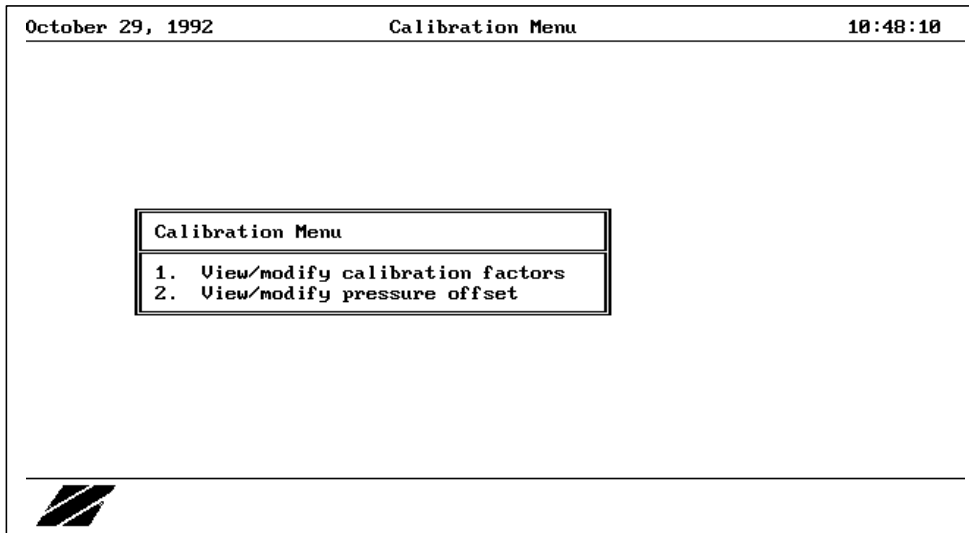

Figure 5-11. Calibration Menu

Calibration Data Entry

Figure 5-12 shows the Calibration Data Entry screen that displays the thermistor and hygistor lock-in values and ratios as well as the pressure calibration coefficients.

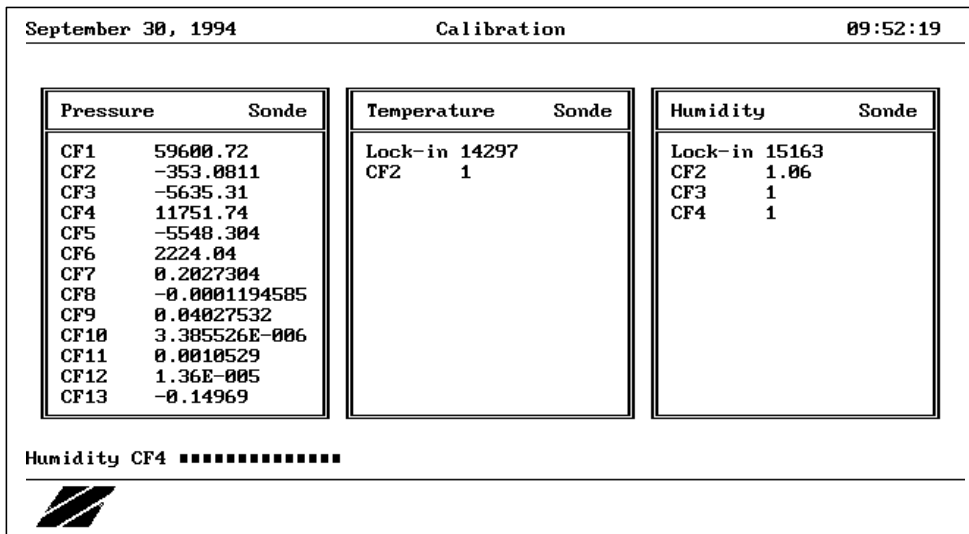

Figure 5-12. Calibration Data Entry

The temperature and humidity calibration values can be edited using the rules described in the Standard Data Entry Editing section of this manual. The pressure calibration data cannot be changed by the operator.

Calibration Data Source

The calibration data for the temperature element and the humidity element can come from three sources: default, sonde, or user.

- Default. Data was not received from the sonde, and you have not done any data entry in the field.
- Sonde. Data was received from the sonde, and you have not done any data entry in the field.
- User. The field was manually changed either before or after the calibration data was received from the sonde.

Under certain circumstances, you may want to enter new calibration values for either the temperature element or the humidity element or both. One such case is when you have replaced one of the sensors. When the temperature or humidity sensor is replaced, you must enter a new calibration value for the sensor that was replaced. The new calibration data for the replacement element should be entered into the appropriate field during the preflight procedures.

Calibration, Pressure Offset

Figure 5-13 shows the Pressure Offset display.

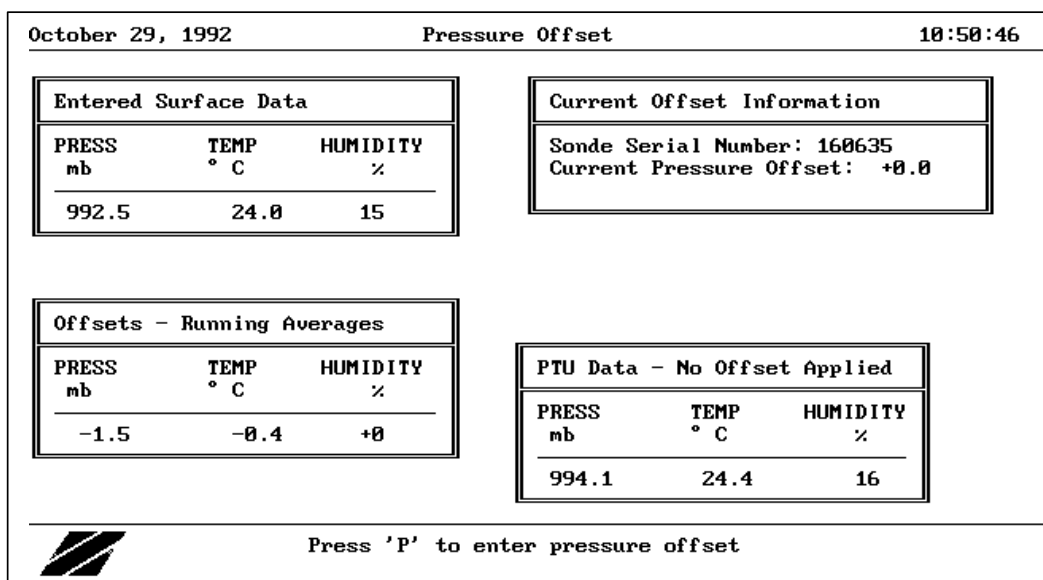

Figure 5-13. Pressure Offset Display

The Pressure Offset display allows you to enter an offset that represents the observed difference between the pressure measured by the surface sensors and the pressure measured by the sonde. The pressure measured by the surface sensors is entered in the surface data display. If the two pressure values agree, a pressure offset is not required.

The Pressure Offset display presents several data boxes to aid you in determining the best pressure offset value if one is required. Each data box is described in detail.

Entered Surface Data Window

This window shows the current values for the surface data. These are the values entered in the surface data display.

Current Offset Information Window

This window shows the current value of all offsets entered by the user as well as the sonde serial number.

PTU Data Window

The PTU Data window is located in the lower right portion of the screen. This shows the latest values of Pressure, Temperature, and Humidity with no offset applied.

Offsets Window

The Offsets Window in the lower left portion of the screen displays a running average of the offset values. These values are calculated by taking the difference between the surface data and a running average of all PTU data gathered while in the Pressure Offset display.

To enter a pressure offset value, press <P>. A data entry prompt appears at the bottom of the display for entering the pressure offset value. You may enter the current pressure offset value calculated in the Offset window, or enter another value. Once a pressure offset value has been entered, it appears in the Current Offset Information window. Return to the Flight Preparation display to see the pressure data with the current offset applied. The pressure value with the offset applied should now be in agreement with the entered surface value.

5.7 Receiver Display

There are three main functions available from the Receiver display: receiver status, receiver spectrum analysis, and receiver tuning. You can access these functions by selecting the Receiver display option from the Preflight menu. Refer to the description of the Receiver display in Chapter 8 for a complete description.

If an asterisk appears next to the Receiver display option of the Preflight menu, the receiver is in contact with the correct sonde. If a question mark appears next to the Receiver display option, the receiver has lost the sonde signal.

5.8 Arm for Launch

Select Arm for Launch from the Preflight menu once the Mark II sonde has been prepared, that is, wind finding is operating properly, the receiver is tuned, the calibration data is received, and the surface data is entered. This will bring up the Flight display. The balloon and sonde can be released when reasonable data is being received according Flight display. Further information about the flight phase of operation is in Chapter 6.

5.9 Flight Utilities

The Flight Utilities menu can be accessed from the Preflight menu at any time during flight preparation. See Chapter 8 for a complete description of the Flight Utilities menu.

5.10 Flight Identifier Initialization

The Flight Identifier Initialization screen may be accessed at any time during flight preparation by selecting Change Flight Identifiers from the Preflight menu. See section 5.2 for a complete description of the Flight Identifier Initialization screen.

5.11 Exit System

Selecting Exit System from the Preflight menu allows you to exit the W-9000 System Software and return to the DOS command line without saving any data. You are prompted for confirmation of the exit request before the system exits. Once you enter <Y> in response to the prompt, the system software exits to the DOS command line.

This page intentionally left blank.

Chapter 6. Flight Operations

6.1 Flight Display

After arm for launch the W-9000 program moves from the Flight Preparation to the Flight. This chapter describes the functions available from the Flight display. Figure 6-1 is a map of these functions.

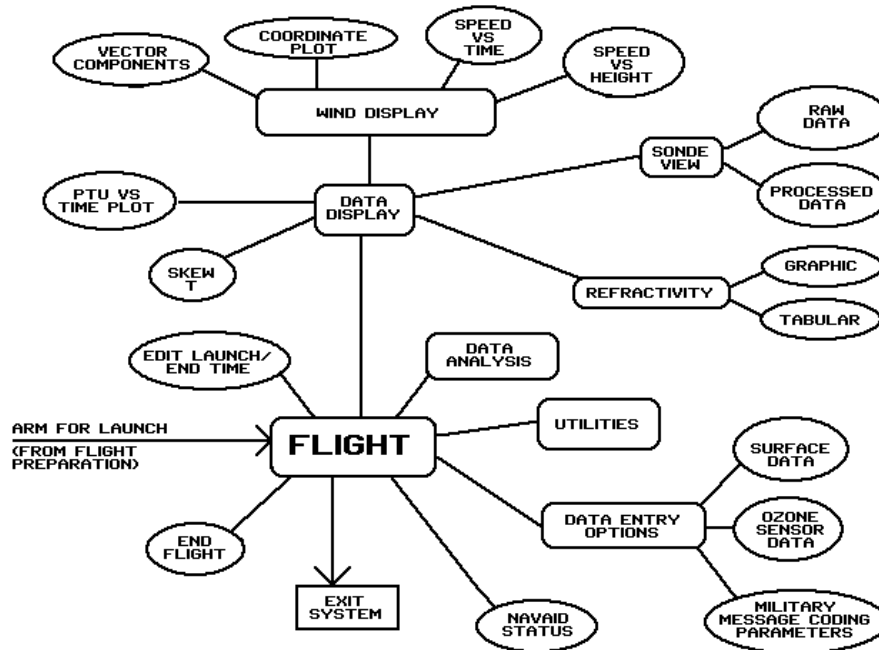

Figure 6-1. Map of Flight Functions

When first entered the Flight display will have the Monitoring for Launch message, as shown in Figure 6-2. The message line informs you of noteworthy events, such as launch detected and end of flight.

The other parts of the Flight display are the Flight Menu, the Flight Information, the PTU Data, and the Wind Data windows.

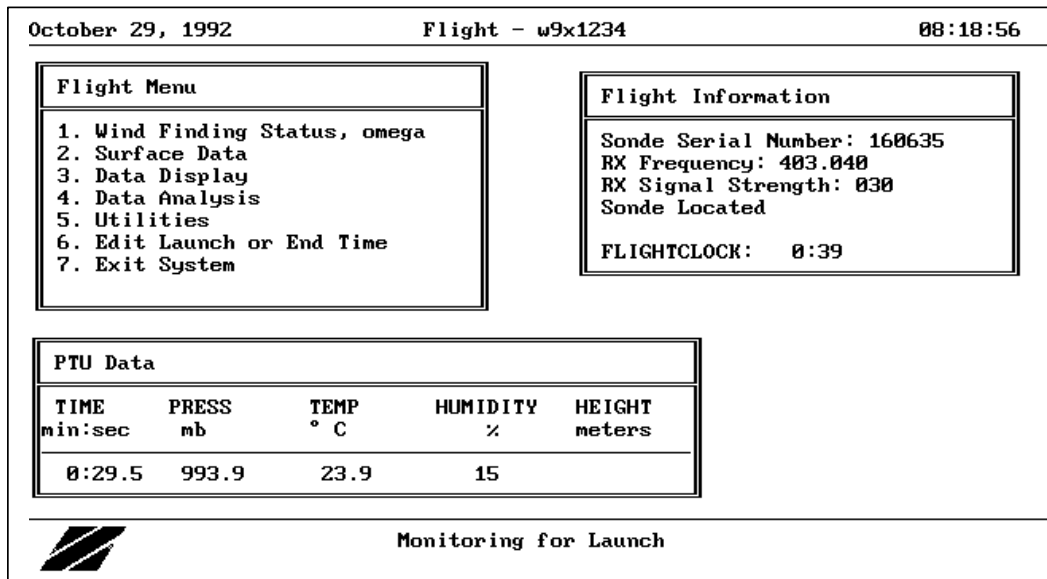

Figure 6-2. Flight Display

Flight Menu Window

The Flight Menu window shows the functions available from the Flight display. These menu options are discussed in the following sections of this chapter.

Flight Information Window

The Flight Information window displays critical flight parameters in real time. Some ZEEMET Rack configurations such as a ZEEMET Rack with an external receiver (for example, a radiothodolite) do not provide all information that this window normally displays. The Flight Information window contains blank lines in place of information that is unavailable.

- Line 1. The sonde serial number that the user has entered in Flight Identifiers Initialization.
- Line 2. The current frequency of the receiver.
- Line 3. The sonde signal strength received at the current frequency.
- Line 4. The location status indicates if the receiver has located the sonde.
- Line 5. The ascent rate of the sonde in Meters/Minute. This value appears after launch has been detected when the geopotential height calculation is caught up.
- Line 6. The flight clock. Before launch has been detected, this is the time since the system was armed for launch. After launch has been detected, it is the time relative to launch of the radiosonde.

PTU Data Window

The PTU Data window displays the latest pressure, temperature, humidity, and height processed by the system. The time shown in the PTU Data window that associated with the displayed PTU data. Before launch is detected, PTU time is the relative to arm-for-launch. After launch detection, it is the time of the last processed PTU data since launch.

Wind Data Window

The Wind Data window is not displayed until launch has been detected. The flight display with the Wind Data window is shown in Figure 6-3. The Wind Data window displays the latest wind speed and direction computed by the system. The time shown in this window is the time associated with the last processed wind data since launch.

August 08, 1996					Flight - 2044816			08:51:44																										
Flight Menu 1. Wind Finding Status, omega 2. Surface Data 3. Data Display 4. Data Analysis 5. Utilities 6. Edit Launch or End Time 7. Exit System					Flight Information Sonde Serial Number: 160635 RX Frequency: 403.040 RX Signal Strength: 030 Sonde Located FLIGHTCLOCK: 0:39																													
PTU Data <table border="1"> <thead> <tr> <th>TIME</th> <th>PRESS</th> <th>TEMP</th> <th>HUMIDITY</th> <th>HEIGHT</th> </tr> <tr> <th>min:sec</th> <th>HPa</th> <th>° C</th> <th>%</th> <th>meters</th> </tr> </thead> <tbody> <tr> <td>97:35.5</td> <td>5.89</td> <td>-32.5</td> <td>0</td> <td>34992.7</td> </tr> </tbody> </table>					TIME	PRESS	TEMP	HUMIDITY	HEIGHT	min:sec	HPa	° C	%	meters	97:35.5	5.89	-32.5	0	34992.7	Wind Data <table border="1"> <thead> <tr> <th>TIME</th> <th>SPEED</th> <th>DIR</th> </tr> <tr> <th>min:sec</th> <th>knots</th> <th>deg</th> </tr> </thead> <tbody> <tr> <td>97:00</td> <td>15.3</td> <td>60</td> </tr> </tbody> </table>						TIME	SPEED	DIR	min:sec	knots	deg	97:00	15.3	60
TIME	PRESS	TEMP	HUMIDITY	HEIGHT																														
min:sec	HPa	° C	%	meters																														
97:35.5	5.89	-32.5	0	34992.7																														
TIME	SPEED	DIR																																
min:sec	knots	deg																																
97:00	15.3	60																																
 Flight has ended at 97 minutes 35 seconds																																		

Figure 6-3. Flight Display with Wind Data Window

The wind data is displayed as soon as it is calculated. The wind computation is performed when the required number of wind samples have been received and the corresponding geopotential height has been computed. The time of calculation depends on the selections made in the Wind Computation Setup.

The wind computation parameters may be changed during a flight. However, this will cause a complete wind recalculation. The Wind Data window shows the re-computation as it starts at from the beginning of the flight and works its way through the flight data until it gets back to real time processing. From then on the wind data updates as new raw wind data is received.

6.2 Wind Finding Status

Select Wind Finding Status from the Flight Menu to get the latest navaid data. This is the same function as that available during Flight Preparation. Refer to Chapter 5 for a complete description. Changing station selections during a flight will cause re-computation of the wind.

6.3 Surface Data Entry

Select Surface Data from the Flight Menu to view or edit the Surface Data. Chapter 5 has the complete description of Surface Data entry.

Changing the surface data during a flight will cause re-computation of the geopotential height and the wind.

6.4 Data Display Menu

Select Data Display from the Flight Menu to access the Data Display menu shown in Figure 6-4. While exercising any option in the Data Display Menu, you can press <Print Screen> to save the current screen image. Every time this is done, an audible beep signals that the current screen image has been captured. See the section "Captured Screen Review" in Chapter 9 on how to use an Off-Line Utility to view the captured screen images that are saved at this point, give them a meaningful name, and print them.

You can use three menus to edit significant levels. MET data significant levels can be defined and deleted using the PTU versus Time Plot option. Wind data significant levels can be edited using either the Wind Speed and Direction versus Time or Wind Speed and Direction versus Height. See the "Incremental Level Selection" section of Chapter 3 for an important note relevant to editing significant levels.

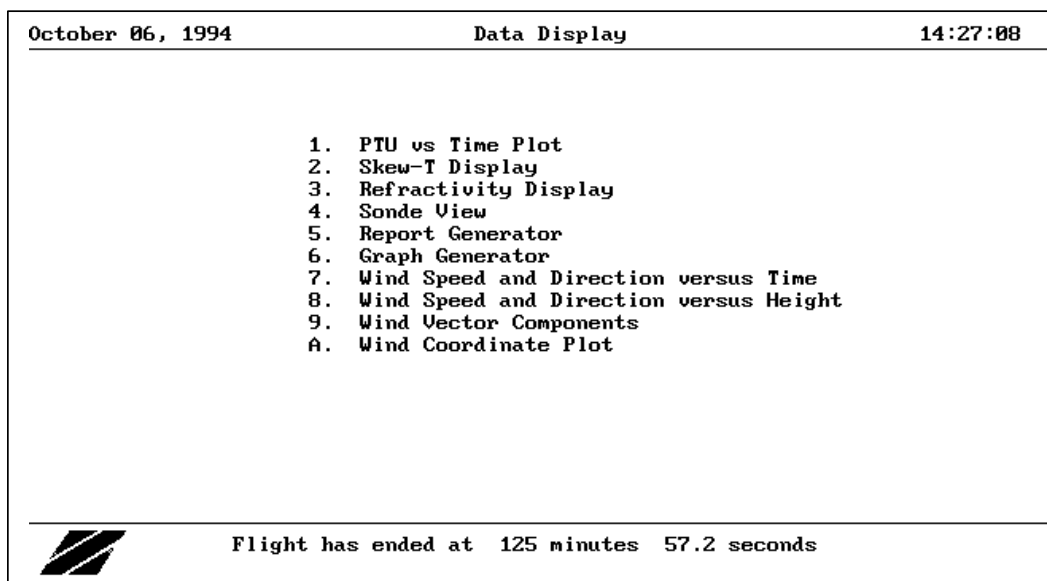

Figure 6-4. Data Display Menu

6.5 PTU Versus Time Display

Selecting PTU versus Time Plot graphs pressure, temperature, and humidity versus flight time as shown in Figure 6-5. On a color monitor the pressure is displayed in green, the temperature in yellow, and the humidity in dark blue. The temperature scale (yellow) runs along the bottom of the display. The relative humidity scale (blue) runs along the top left of the display. The pressure scale (green) is on the top right hand side of the display. The time since launch scale (red) is a vertical scale on the left hand side of the display. Time is delineated in whole minutes.

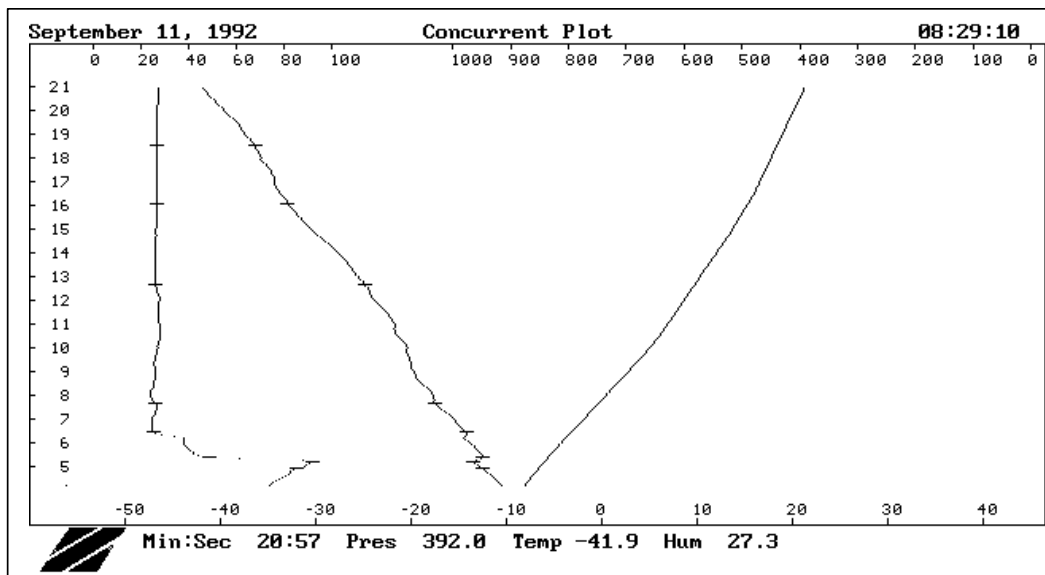

Figure 6-5. Concurrent Plot

A digital display of the latest MET data can be found on the bottom line of display. Time is displayed in minutes and seconds, pressure in millibars, temperature in Celsius, and relative humidity in percent. In the point select mode (described below) the digital display contains MET data values of the hairline.

The data shown in the graph comes from the Fine Structure Array (FSA) file. As radiosonde measurements are collected throughout the flight, they are stored in the FSA file. The W-9000 system software automatically calculates significant levels of temperature and humidity from the FSA file. Significant levels are designated on the graph by horizontal tick marks.

In some cases it is possible that some of the data traces can overlap. In such cases it sometimes helps to toggle off the pressure display. This can be done by first making sure that the <Caps Lock>, <Num Lock>, and <Scroll Lock> keys have been deactivated and then pressing <Alt-P>. Pressing <Alt-P> retrieves the pressure plot. Also, to get the pressure trace to appear, you may need to adjust the monitor contrast.

The PTU plot has three operating modes: Concurrent Plot, Data Display, and Point Select.

Concurrent Plot

Concurrent Plot is the default mode during a flight. It is illustrated in Figure 6-5. Concurrent mode displays the latest PTU data as it is collected and stored. The display continuously updates in this mode, always showing the latest 16 minutes of the flight. Since Concurrent Plot is a real time display, it is available only during the flight. After the end of a flight, the default mode is the Data Display mode.

Over the course of a flight, the temperature is likely to drop many degrees. An automatic offset feature prevents the temperature trace from leaving the left-hand portion of the display. When the temperature trace leaves the screen, the screen will clear, and temperature data will re-plot in a more central position.

Point Select and Data Display

Previous portions of a flight can be viewed in Data Display mode. Significant levels can be edited in Point Select mode. To reach these modes from Concurrent Plot press <F9>. <F9> toggles to and from Concurrent Plot.

During a flight Data Display mode appears when <F9> is pressed in Concurrent Plot. After a flight has ended Data Display mode is the default mode since Concurrent Plot is no longer available. Data Display begins with the first portion of the flight. Any portion of the flight can be viewed in Data Display. The <PgUp> and <PgDn> keys shift the displayed portion of the flight up or down by one full screen. The <Up Arrow> and <Down Arrow> keys shift the display up or down in one minute increments.

To edit the significant levels, use the <F1> key to enter Point Select. The <F1> key toggles between Data Display and Point Select. The lower right hand corner of the screen indicates the current display mode. Figure 6-6 shows a typical Point Select display.

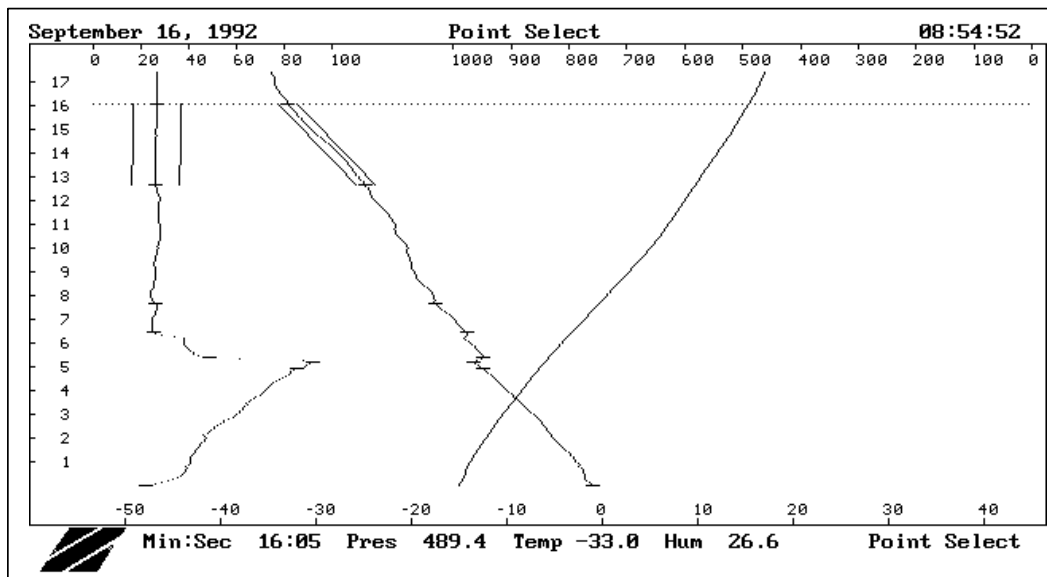

Figure 6-6 Point Select

Significant levels may be inserted with <F2> or deleted with <F4> at the light blue horizontal hairline. Pressing <F2> also inserts tolerance bars (see the <F3> discussion below). The <Up Arrow> and <Down Arrow> keys move the hairline up or down throughout the flight one data point at a time. To move more quickly, the <PgUp> and <PgDn> keys move the hairline five data points at a time. To edit a portion of the flight that is not displayed, go back to Data Display with the <F1> key, and move to the desired portion of the flight.

To assist in testing a level for significance, a set of tolerance bars can be placed on the display by pressing <F3>. The tolerance bars will appear as two light blue parallel lines that straddle the data between the point of interest and the previous significant level. This is illustrated in Figure 6-6.

Humidity points may be marked as missing by pressing <F6>. This will remove the significant level indication for that level if the significant level was due to humidity. If temperature or operator editing is

the cause of the significant level, it will remain marked as significant. The missing humidity point will not be plotted on the screen but will display as \\\ at the bottom of the display.

The <F8> key removes the effect of any operator editing from the point at the cursor position. For example, if you mark a humidity point as missing with the <F6> key, pressing <F8> will restore this value.

While automatic temperature trace offset is part of Concurrent Plot, manual temperature trace offset is available in Data Display and Point Select. If at some point the display becomes confusing due to overlapping lines, or if the temperature trace begins to move off the edge of the screen, <F5> can move the temperature trace to a more suitable location. When you press <F5>, you are prompted to enter an offset fraction in percent. This value can be between -99 to +99. The offset feature moves the temperature trace according to the percentage offset entered. The entire screen width is considered to be 100 percent. To move the temperature trace half-way across the screen to the left, enter an offset value of 50 percent. To move the trace half-way across the screen to the right, enter an offset of -50.

6.6 Skew-T Display

Select Skew-T from the Data Display Menu to display the meteorological data from the surface to 400 mb as a Skew-T diagram as shown in Figure 6-7.

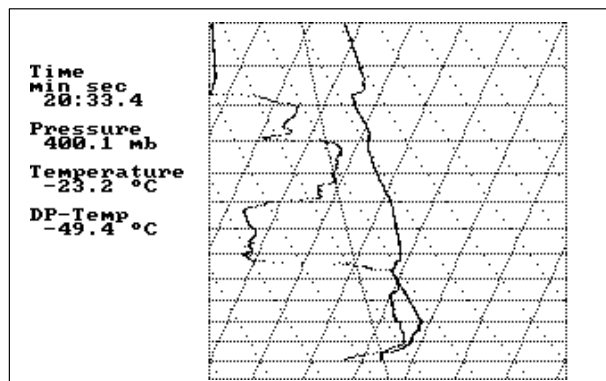

Figure 6-7. Skew-T Display

The chart vertical axis is log pressure with 1050 mb at the bottom, 400 mb at the top, and each horizontal line is a 50-mb increment.. Right diagonal lines represent temperature from -40° C to 40° C in 10° C increments. Plots are of temperature versus pressure and of dew point versus pressure.

6.7 Refractivity Display

The Refractivity Display program is an optional display of the W-9000 System Software. If the option is included, the Refractivity Display option appears as a menu choice on the Data Display Menu.

The Refractivity Display program displays the data from the .MDC (Meteorological Data Calculations) file in both a tabular and graphic format. Data acquisition and processing continue while the Refractivity Display program is running, so the displays are continuously updated with the latest data. The screen shown in Figure 6-8 is displayed when the Refractivity Display option is selected from the Data Display Menu. The Refractivity Display Menu shows the available display options for the refractivity data.

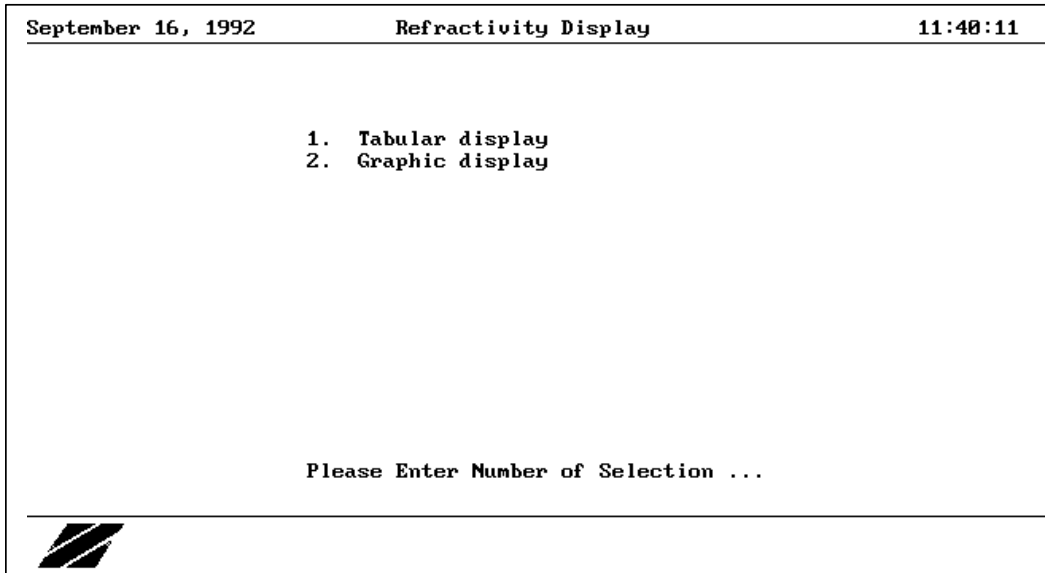

Figure 6-8. Refractivity Display Menu

Tabular Format

The tabular display (Figure 6-9) shows time, pressure, temperature, humidity, dew point temperature, geopotential height, N units, N per Km, M units, and refractive condition in a tabular format. Upon entering the tabular display the latest data is always displayed on the first line of the display area. The newly acquired data is then displayed after it is processed. When the entire screen is full of data, the top line of data scrolls off the screen, and a new line is inserted at the bottom of the screen.

The starting and ending data records which are available for the tabular display are determined by the flight status.

Pre-flight (Launch not detected)

Data is available from the beginning of the .MDC file up to the latest available data. The latest acquired data is scrolled on the screen as long as the last page of data is on the screen. The message **Launch not detected** is displayed at the bottom of the screen.

In-flight (Launch detected)

Data is available from the Launch record up to the latest available data. The latest acquired data is scrolled on the screen as long as the last page of data is on the screen. The message "Launch detected" is displayed at the bottom of the screen.

End-of-flight (End of Flight detected)

Data is available from the Launch record up to the record marked as the End of Flight. The message **End of Flight detected** is displayed at the bottom of the screen.

September 16, 1992			Refractivity Display					11:40:53		
TIME	PRESS	TEMP	RH	DEW PT	HEIGHT	REFRACT	REFRACT	REFRACT	REFRACT	
min:sec	mb	C	%	C	meters	N units	N/km	M units	condition	
0:19.5	982.2	-1.8	34.8	-15.3	178.4	290.3	333.4	318.3	SUB	
0:20.7	982.2	-1.8	35.4	-15.0	178.8	290.5	0.0	318.5	SUB	
0:21.9	981.8	-1.8	35.8	-14.9	181.9	290.5	-41.0	319.0	STANDARD	
0:23.2	981.1	-1.8	35.6	-15.0	187.7	290.2	-113.3	319.7	SUPER	
0:24.4	981.3	-1.8	36.3	-14.8	185.4	290.5	-7.4	319.6	STANDARD	
0:25.6	980.6	-1.8	36.9	-14.6	191.1	290.4	-6.6	320.4	STANDARD	
0:26.9	980.3	-1.8	37.2	-14.5	194.2	290.4	-9.7	320.9	STANDARD	
0:28.1	979.9	-1.8	37.4	-14.5	197.0	290.4	-26.9	321.3	STANDARD	
0:29.3	979.6	-1.9	37.5	-14.5	199.8	290.3	-19.5	321.7	STANDARD	
0:30.6	979.2	-1.9	37.6	-14.5	202.6	290.3	5.4	322.1	SUB	
0:31.8	978.9	-1.9	38.0	-14.4	205.5	290.3	-171.7	322.5	TRAP	
0:33.0	978.8	-2.0	37.7	-14.5	205.8	290.2	86.3	322.5	SUB	
0:34.2	978.8	-2.0	37.9	-14.5	206.3	290.3	-34.3	322.7	STANDARD	
0:35.5	978.0	-2.1	37.9	-14.5	212.2	290.1	-84.3	323.4	SUPER	
0:36.7	978.3	-2.1	38.3	-14.4	210.2	290.2	-46.5	323.2	STANDARD	
0:37.9	978.2	-2.0	38.3	-14.4	211.1	290.2	87.4	323.3	SUB	
0:39.1	978.1	-2.0	38.7	-14.2	212.0	290.3	11.6	323.5	SUB	
0:40.4	978.0	-2.1	38.8	-14.2	212.9	290.3		323.7		

 End of flight detected

Figure 6-9. Tabular Refractivity Format

The following keys are active in the Tabular Display:

<Home> displays the first available page of data.

<End> displays the last available data on the first line of the view window.

<PgUp> displays the previous page of data in the view window. An audible beep is heard if the topmost page of data is being displayed.

<PgDn> displays the next page of data in the view window. An audible beep is heard if the last page of data is being displayed.

<Up Arrow> scrolls the view window down one line and inserts a new line at the top of the view window. An audible beep is heard if the window cannot scroll any further.

<Down Arrow> scrolls the view window up one line and inserts a new line at the bottom of the view window. An audible beep is heard if the window cannot scroll any further.

<Esc> Returns you to the Refractivity Display menu shown in Figure 6-8.

Graphic Format

The graphic display (Figure 6-10) plots N units versus altitude, M units versus altitude, and duct location versus altitude. The starting and ending data points available for the graphic display are determined by the flight status.

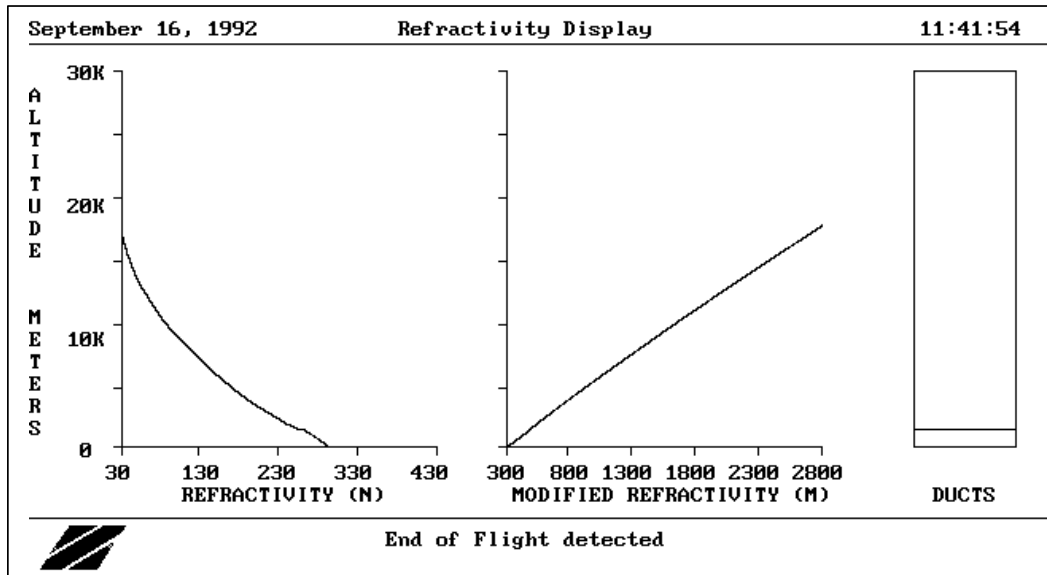

Figure 6-10. Graphic Refractivity Format

Pre-flight (Launch not detected)

No data is plotted on the graphs until launch has been detected. The message **Launch not detected** is displayed at the bottom of the screen.

In-flight (Launch detected)

Data is plotted from the Launch record up to the latest available data. The latest acquired data is plotted on the graphs as it is processed. The message **Launch detected** is displayed at the bottom of the screen.

End-of-flight (End of Flight detected)

Data is plotted from the Launch point up to the record marked as the End of Flight. The message **End of Flight detected** is displayed at the bottom of the screen.

The altitude of ducts in the atmosphere is plotted in the duct window on the right of the screen. The window is filled from the starting altitude of a duct to the ending altitude of a duct. The location of ducts is determined by examining the plot of M units versus altitude.

A *trapping layer* is formed when the M unit's value decreases with increasing altitude. Three successive decreasing M unit values must be observed in order for a trapping layer to be recognized. When the M unit values start to increase again with increasing altitude, this signifies the exit of the trapping layer and the exit of the duct. In order to establish the starting altitude of the duct, the M units versus altitude plot is examined. The starting altitude of the duct is found where the M units value is less than the M units value at the ending altitude of the duct. When this altitude is found, the duct is plotted by filling the duct window from the starting altitude to the ending altitude of the duct. This type of duct is called an *elevated duct*.

If no M units value can be found which is less than the M units value at the ending altitude of the duct, then the duct is called a "surface duct". In this case, the duct window is filled from the bottom of the duct window to the ending altitude of the duct.

The only active key in the graphic display is the <Esc> key which causes the Refractivity Display Menu in Figure 6-8 to be displayed.

6.8 Sonde View

Sonde View (Figure 6-11) displays raw and processed radiosonde data in a tabular format (Figure 6-12 and Figure 6-13). Access to Sonde View is provided during flight preparation as well as during the flight. During flight preparation Sonde View is accessed via the utilities option of the Flight Preparation menu. During flight Sonde View is accessed via the Data Display option of the Flight menu. Figure 6-11 shows the main Sonde View menu.

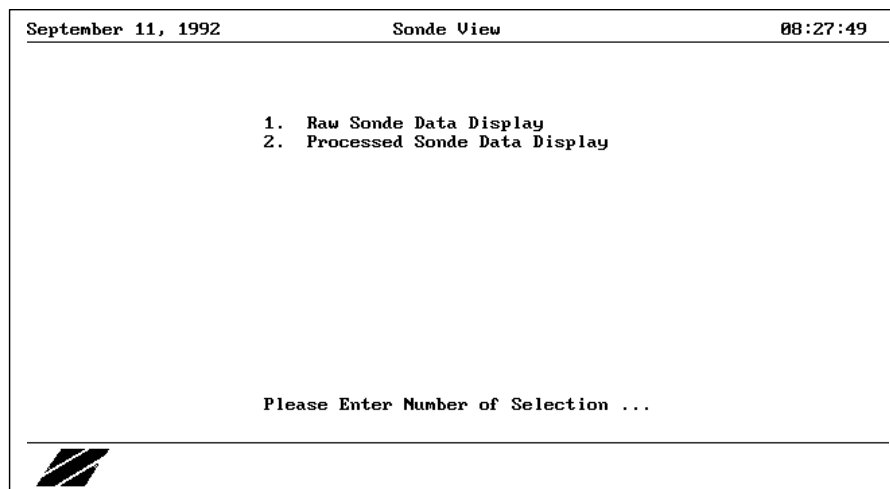

Figure 6-11. Sonde View Menu

September 11, 1992		Raw Sonde Data Display										08:28:05
TIME	RXCNT	SDCNT	REF	PRESS	TEMP	HUMID	SPR 1	SPR 2	SPR 3	SPR 4		
min:sec	count	count	count	count	count	count	count	count	count	count	count	
19:02.2	1196	2201	12958	12552	22030	6488	53297	53294	22028	53294		
19:03.5	1197	2202	1170	12557	22035	6488	53297	53297	22033	53296		
19:04.7	1198	2203	37427	12560	22046	6488	53297	53296	22049	53297		
19:05.9	1199	2204	8649	12562	22066	6489	53295	53296	22067	53297		
19:07.1	1200	2205	35300	12565	22081	6489	53296	53296	22085	53297		
19:08.4	1201	2206	1169	12568	22105	6488	53297	53296	22104	53296		
19:09.6	1202	2207	37426	12571	22119	6490	53297	53297	22117	53296		
19:10.8	1203	2208	53294	12574	22128	6491	53297	53296	22126	53296		
19:12.0	1204	2209	13027	12578	22133	6490	53297	53296	22136	53295		
19:13.3	1205	2210	1166	12580	22141	6490	53298	53296	22142	53296		
19:14.5	1206	2211	37426	12582	22156	6491	53298	53297	22157	53299		
19:15.7	1207	2212	8651	12586	22169	6491	53298	53297	22169	53296		
19:17.0	1208	2213	35303	12591	22188	6491	53298	53298	22190	53298		
19:18.2	1209	2214	1165	12592	22201	6493	53297	53297	22200	53297		
19:19.4	1210	2215	37424	12593	22210	6493	53297	53299	22205	53297		
19:20.7	1211	2216	53296	12597	22213	6493	53297	53297	22211	53296		
19:21.9	1212	2217	13031	1259								

 Launch Detected

Figure 6-12. Raw Sonde Data Display

Raw Sonde Data Display

Select Raw Sonde Data Display to view a tabular display of the raw data as illustrated in Figure 6-12. The raw sonde data display reads the raw radiosonde data and displays it in tabular columns. Each of the columns is defined as follows.

<TIME>. Time of the data displayed in minutes and seconds relative to launch of the radiosonde.

<RXCNT>. The receiver frame count. This is frame number as determined by the ZEEMET Rack Receiver. For every new frame received by the receiver the receiver frame count is incremented by 1.

<SDCNT>. The radiosonde frame count. Every new frame transmitted by the radiosonde is given a new count. The count starts at zero upon radiosonde power up and increments by 1 with each frame transmitted.

<REF>. The measurement count of the reference channel.

<PRESS>. The measurement count of the pressure channel.

<TEMP>. The measurement count of the temperature channel.

<HUMID>. The measurement count of the humidity channel.

<SPR 1>. The measurement count of first spare channel.

<SPR 2>. The measurement count of the second spare channel.

<SPR 3>. The measurement count of the third spare channel.

<SPR 4>. The measurement count of the fourth spare channel.

Processed Sonde Data Display

Select Processed Sonde Data Display from the Sonde View menu to display the processed radiosonde data. The screen shown in Figure 6-13 is displayed when this menu option is selected.

September 11, 1992		Processed Sonde Data Display					08:28:19	
TIME	PRESSURE	TEMP	HUMIDITY	SPR 1	SPR 2	SPR 3	SPR 4	
min:sec	hPa	°C	percent					
19:15.7	425.0	-37.8	26.7	53298.0	53297.0	22169.0	53296.0	
19:17.0	424.3	-37.9	26.7	53298.0	53298.0	22190.0	53298.0	
19:18.2	424.2	-37.9	26.8	53297.0	53297.0	22200.0	53297.0	
19:19.4	424.0	-38.0	26.7	53297.0	53299.0	22205.0	53297.0	
19:20.7	423.5	-38.0	26.7	53297.0	53297.0	22211.0	53296.0	
19:21.9	423.3	-38.0	26.7	53297.0	53297.0	22222.0	53296.0	
19:23.1	422.9	-38.0	26.7	53298.0	53299.0	22228.0	53297.0	
19:24.4	422.6	-38.0	26.7	53300.0	53298.0	22245.0	53297.0	
19:25.6	422.3	-38.1	26.7	53299.0	53299.0	22259.0	53299.0	
19:26.8	422.0	-38.1	26.8	53298.0	53298.0	22280.0	53299.0	
19:28.0	421.5	-38.2	26.7	53300.0	53298.0	22301.0	53299.0	
19:29.3	421.1	-38.2	26.8	53299.0	53299.0	22312.0	53299.0	
19:30.5	420.7	-38.3	26.7	53298.0	53298.0	22331.0	53298.0	
19:31.7	420.3	-38.3	26.7	53298.0	53299.0	22352.0	53298.0	
19:32.9	419.9	-38.4	26.8	53298.0	53299.0	22370.0	53298.0	
19:34.2	419.8	-38.4	26.8	53298.0	53298.0	22382.0	53299.0	
19:35.4	419.3	-38.5	26.8	53300.0	53299.0	22397.0	53298.0	

 Launch Detected

Figure 6-13. Processed Sonde Data Display

The processed sonde data display reads the processed data and displays it in tabular columns. Each of the columns is described below.

<TIME>. Time of the data displayed in minutes and seconds relative to launch of the radiosonde.

<PRESSURE>. Pressure in units of hPa (hecto Pascals).

<TEMP>. Temperature in units of degrees Celsius.

<HUMIDITY> Relative humidity expressed as a percentage.

<SPR 1>. Spare channel number 1.

<SPR 2>. Spare channel number 2.

<SPR 3>. Spare channel number 3.

<SPR 4>. Spare channel number 4.

Tabular Display Attributes

Data acquisition and processing continue while the sonde view program is running so the tabular displays are continuously updated with the latest data. Upon entering the tabular displays the latest data is always displayed on the first line of the view window. The newly acquired data is then displayed after it is processed. When the view window is full of data, the screen scrolls up one line and a new line is inserted at the bottom of the screen.

The following subsections describe the starting and ending data records, and the application messages for the tabular displays, as determined by the flight status.

Pre-flight (Launch Not Detected)

Data is available from the beginning of the file up to the latest available data. The latest data is scrolled on the screen as long as the last page of data is on the screen. After the system has been armed for launch, the message **Monitoring For Launch** is displayed on the application message line of the screen.

In flight (Launch Detected)

Data is available from the record marked as launch up to the latest available data. The latest acquired data is scrolled on the screen as long as the last page of data is on the screen. The message **Launch detected** is displayed on the application message line of the screen.

End-of-flight (End Of Flight Detected)

Data is available from the record marked as launch up to the record marked as the end of flight. The message **End of Flight detected** is displayed on the application message line of the screen.

The following keys are active while in the tabular displays.

<**Home**> displays the first available page of data.

<**End**> displays the latest available data on the first line of the view window.

<**PgUp**> displays the previous page of data in the view window. An audible beep is heard if the top-most page of data is being displayed.

<**PgDn**> displays the next page of data in the view window. An audible beep is heard if the last page of data is being displayed.

<**Up Arrow**> scrolls the view window down one line and inserts a new line at the top of the view window. An audible beep is heard if the window cannot scroll any further.

<**Down Arrow**> scrolls the view window up one line and inserts a new line at the bottom of the view window. An audible beep is heard if the window cannot scroll any further.

<**Esc**> returns the user to the main menu of the Sonde View program shown in Figure 6-11.

6.9 Global Positioning System (GPS) Operation

When the system is set to PVT GPS, the only difference seen in the operation of the software is the GPS display from the flight menu; see Figure 6-14. When this item is selected, the display will show the following items updated each second:

- Time
- Number of satellites
- Latitude and longitude
- Altitude
- Wind speed
- Wind direction

August 05, 1997		GPS NAVAID DISPLAY			15:02:15	
GPS RAW DATA						
UTC (sec)	Sats	Latitude (D M S)	Longitude (D M S)	SPEED (m / sec)	Direction (Deg)	
241459.969	06	40 2 31.37	-75 49 37.03	0.3	203.6	
241461.969	06	40 2 31.18	-75 49 37.07	0.3	207.1	
241462.984	06	40 2 31.08	-75 49 37.09	0.6	209.1	
241463.969	06	40 2 30.99	-75 49 37.10	0.3	210.2	
241467.969	06	40 2 30.67	-75 49 37.14	0.6	214.8	
241468.969	06	40 2 30.60	-75 49 37.15	0.3	215.8	
241469.969	06	40 2 30.53	-75 49 37.15	0.3	217.1	
241472.984	06	40 2 30.34	-75 49 37.16	0.3	219.5	
241473.984	06	40 2 30.28	-75 49 37.16	0.3	220.1	
241474.984	06	40 2 30.23	-75 49 37.16	0.3	220.6	

*Figure 6-14. GPS Navaid Display Screen,
Radiosonde GPS Receiver Continues to Acquire Satellites*

6.10 Report Generator

The Report Generator is an option of the W-9000 ground system software. When this option is installed it becomes one of the menu choices of the Data Display Menu. The Report Generator can also be accessed from the menu of the Utility program, which runs off-line.

The report generator provides the ability to make customized reports. The general format of a report is a table whose rows are the standard pressure levels or are even increments of time, pressure, or height. The columns of the report are data types selected by the user from the following: time, height, pressure, temperature, humidity, dew point, refractive index (n units), refractive index (m units), gradient of refractive index, wind speed, wind direction, potential temperature, virtual temperature, vapor pressure, saturated vapor pressure, air density, and sound speed. Up to 100 different report formats can be defined. All reports are displayed on the screen and written to a text file and can optionally be printed and/or output via the IJ2 serial port on the Interface Module.

Report Selection Menu

The Report Selection Menu is displayed when the report generator is selected from the Data Display Menu. The screen display of the Report Selection Menu is shown in Figure 6-15. This shows the default report format definitions as delivered from Sippican. The first menu option, DEFINE NEW REPORTS, which is initially highlighted, allows you to delete report definitions, permanently modify report definitions, and define new reports. To use the report selections, just press **<Enter>** upon entering the Report Selection Menu, and refer to the section "Report Definition" in this chapter for instructions.

July 31, 1996		Report Selection Menu		13:57:07									
Report Name:		Serial Output: NO											
Report Title:		Printer Output: NO											
Interval Type:		Interval Amount: 0.000		Tabular Data: 0									
<table border="1"> <tr> <td>NEW</td> <td>DEFINE NEW REPORTS</td> </tr> <tr> <td>PTUvT</td> <td>Pressure, Temperature, Humidity</td> </tr> <tr> <td>PTUvH</td> <td>Pressure, Temperature, Humidity</td> </tr> <tr> <td>TempvP</td> <td>Dewpoint, Virtual, Potential Temperature</td> </tr> </table>						NEW	DEFINE NEW REPORTS	PTUvT	Pressure, Temperature, Humidity	PTUvH	Pressure, Temperature, Humidity	TempvP	Dewpoint, Virtual, Potential Temperature
NEW	DEFINE NEW REPORTS												
PTUvT	Pressure, Temperature, Humidity												
PTUvH	Pressure, Temperature, Humidity												
TempvP	Dewpoint, Virtual, Potential Temperature												
ENTER>SelectRpt TAB=NxtField													

Figure 6-15. Report Selection Menu

The up and down arrow keys are used to select a previously defined format. To generate and view a report with a previously defined format, move the highlight to the desired format and press **<Enter>**. When you press **<Enter>**, the report will first be sent to the serial port and printer if their output fields are set to Yes. Then the report will be displayed for you to browse. Instructions for browsing are in the section titled "Report Browsing" in this chapter.

The highlight in the lower window is on the name and title of the currently selected report. The upper window shows more information about the currently selected report. In addition to the name and title, the interval type and interval amount are displayed, the status of the serial and printer output switches are displayed, and the number of columns of the report (Tabular Data) is shown.

The upper window can be used to temporarily change the selected report definition. The title, interval amount, serial output switch, and printer output switch can all be modified. Modifications made by this method are used only for the current invocation of the report and do not permanently affect the selected report definition. This is particularly useful for turning on the printer output or the serial output to get a permanent copy of a report without the danger of unexpectedly operating the printer or serial port when they are not desired. Changing the report title may also be useful to document or call attention to a particular feature represented in the data of the report.

To use the upper window for this purpose, first move the highlight in the lower window to the name and title of the desired report definition. Then press <Tab>, and the highlight moves to the upper window to highlight the report title field. An edit line with contents of the highlighted field appears at the bottom of the screen. Use the edit line to change the currently displayed field, or press the <Tab> key to go to the next field. Note that the status of the serial output and printer output field is changed by pressing the <Space Bar>. To generate the report with the modifications, use the <Tab> key to return to the lower window and press <Enter>.

Report Browsing

Reports are displayed after they are selected. There may be a significant delay before the report is displayed if serial port output or printer output was selected. The beginning of the report is initially displayed. Use the arrow keys and the <PgUp> and <PgDn> keys to view other portions of the report. When finished press <Esc> and the program exits back to the Data Display Menu.

Report Definition

The DEFINE NEW REPORTS option in the Report Selection Menu is used to define new report formats, permanently modify existing report formats, or to delete report formats. This option brings up the Report Definition display shown in Figure 6-16.

August 07, 1996	Report Definition	15:29:52															
Report Name: post		Serial Output: NO															
Report Title: pres vs time		Printer Output: NO															
Interval Type: Time (minutes)	Interval Amount: 1.000	Tabular Data: 0															
<table border="1"> <thead> <tr> <th>Tabular Data Selection</th> </tr> </thead> <tbody> <tr><td>Time (minutes)</td></tr> <tr><td>Geopotential Height (m)</td></tr> <tr><td>Pressure (hPa)</td></tr> <tr><td>Temperature (deg C)</td></tr> <tr><td>Relative Humidity</td></tr> <tr><td>Dewpoint (deg C)</td></tr> <tr><td>Refractive Index (N)</td></tr> <tr><td>Grad. Refract Index</td></tr> <tr><td>Mod. Refract Index (M)</td></tr> <tr><td>Wind Speed (knots)</td></tr> </tbody> </table>	Tabular Data Selection	Time (minutes)	Geopotential Height (m)	Pressure (hPa)	Temperature (deg C)	Relative Humidity	Dewpoint (deg C)	Refractive Index (N)	Grad. Refract Index	Mod. Refract Index (M)	Wind Speed (knots)	<table border="1"> <thead> <tr> <th>Data Selected</th> </tr> </thead> <tbody> <tr><td> </td></tr> </tbody> </table>	Data Selected		<table border="1"> <tr> <td>Report Width: 0</td> </tr> <tr> <td>Print Type: 80 Column Print</td> </tr> </table>	Report Width: 0	Print Type: 80 Column Print
Tabular Data Selection																	
Time (minutes)																	
Geopotential Height (m)																	
Pressure (hPa)																	
Temperature (deg C)																	
Relative Humidity																	
Dewpoint (deg C)																	
Refractive Index (N)																	
Grad. Refract Index																	
Mod. Refract Index (M)																	
Wind Speed (knots)																	
Data Selected																	
Report Width: 0																	
Print Type: 80 Column Print																	
Use Right/Left Arrow Keys to move between Selection & Selected Windows																	
F2=NextRpt F3=SaveRpt F4=DeleteRpt TAB=NxtField																	

Figure 6-16. Report Definition

When first entered the Report Definition display is ready to accept a new report definition. This is shown by the blank fields in the Report Definition window. To define the format of a new report, fill in the fields of this window one by one and then save the format by pressing <F3>.

If the Report Definition display is being used to modify or delete an existing report format, retrieve the desired report first by pressing <F2> until the desired report format is displayed. Then delete it by pressing <F4> or modify its fields and re-save it by pressing <F3>.

To exit from the Report Definition display press <Esc>.

Entering and Editing Fields

Movement between the fields is accomplished with the <Tab> or <Enter> keys. <Enter> updates the field that is currently displayed before advancing to the next field while <Tab> advances without saving. The fields of the report definition window are filled out differently.

Report Name and Report Title Fields

The report name is used by the program to distinguish which report definition is which and must therefore be unique for each definition. The report title is the title that appears at the beginning of the report and does not have to be unique. The report name and report title are entered by typing in the desired characters. The right and left arrow keys move the cursor along the typed text and are provided for editing purposes. Press <Enter> to accept the displayed text and move to the next field.

Interval Type Field

Reports show flight data at uniform intervals of pressure, time, or height. The interval type field selects which of these is used. In addition to the pressure, time, or height interval types there is the standard pressures interval type. Standard pressures reports the flight data at the standard isobaric levels instead of at constant intervals used by the other interval types. The interval type is selected from the list in the Interval Selection Window that appears when the Interval Type Field is highlighted. To select an interval type, move the cursor with the <PgUp>, <PgDn>, and up and down arrow keys to the desired type and press <Enter>.

Interval Amount Field

The interval amount specifies the interval between each row of the report. It is entered in minutes, millibars, or meters for interval types time, pressure, and height respectively. The interval amount is ignored when the standard pressure interval type is selected. The interval amount is entered by typing in the desired amount and the pressing <Enter>.

Serial Output and Printer Output Fields

These fields control sending reports generated by this definition to the serial port and/or the printer. With the default settings of NO, no such output will occur. Press the spacebar to toggle between NO and YES.

Tabular Data Field

Use this field to select the data types to be inserted into the report. When this field is selected three more windows are displayed as shown in Figure 6-17. Use the arrow keys to highlight the desired data type and press <Enter> to select it. An asterisk will appear in front of the selected data type and it will be added to the Data Selected Window on the right. Select as many data types in this way as you want in the report. To remove an already selected data type, highlight the item to be deleted, and press <Enter>. When finished, press <Tab> to move to the next field.

August 07, 1996		Report Definition		15:29:52																							
Report Name: post		Serial Output: NO																									
Report Title: pres vs time		Printer Output: NO																									
Interval Type: Time (minutes)		Interval Amount: 1.000		Tabular Data: 0																							
<table border="1"> <thead> <tr> <th>Tabular Data Selection</th> </tr> </thead> <tbody> <tr><td>Time (minutes)</td></tr> <tr><td>Geopotential Height (m)</td></tr> <tr><td>Pressure (hPa)</td></tr> <tr><td>Temperature (deg C)</td></tr> <tr><td>Relative Humidity</td></tr> <tr><td>Dewpoint (deg C)</td></tr> <tr><td>Refractive Index (N)</td></tr> <tr><td>Grad. Refract Index</td></tr> <tr><td>Mod. Refract Index (M)</td></tr> <tr><td>Wind Speed (knots)</td></tr> </tbody> </table>			Tabular Data Selection	Time (minutes)	Geopotential Height (m)	Pressure (hPa)	Temperature (deg C)	Relative Humidity	Dewpoint (deg C)	Refractive Index (N)	Grad. Refract Index	Mod. Refract Index (M)	Wind Speed (knots)	<table border="1"> <thead> <tr> <th>Data Selected</th> </tr> </thead> <tbody> <tr><td> </td></tr> <tr><td> </td></tr> <tr><td> </td></tr> <tr><td> </td></tr> <tr><td> </td></tr> <tr><td> </td></tr> <tr><td> </td></tr> <tr><td> </td></tr> <tr><td> </td></tr> <tr><td> </td></tr> </tbody> </table>			Data Selected										
Tabular Data Selection																											
Time (minutes)																											
Geopotential Height (m)																											
Pressure (hPa)																											
Temperature (deg C)																											
Relative Humidity																											
Dewpoint (deg C)																											
Refractive Index (N)																											
Grad. Refract Index																											
Mod. Refract Index (M)																											
Wind Speed (knots)																											
Data Selected																											
<table border="1"> <tr> <td>Report Width: 0</td> </tr> <tr> <td>Print Type: 00 Column Print</td> </tr> </table>						Report Width: 0	Print Type: 00 Column Print																				
Report Width: 0																											
Print Type: 00 Column Print																											
Use Right/Left Arrow Keys to move between Selection & Selected Windows																											
F2=NextRpt F3=SaveRpt F4=DeleteRpt TAB=NxtField																											

Figure 6-17. Report Definition Menu

6.11 Graph Generator

The Graph Generator is an option of the W-9000 ground system software. When this option is installed it becomes one of the menu choices of the Data Display Menu. The Graph Generator can also be accessed from the menu of the Utility program which runs off-line.

The graph generator provides the ability to make customized graphs. Up to four data types may be plotted on the same graph. They may be plotted versus time, pressure, or height. Up to 100 different graph formats can be defined. During a flight, new data is shown on the graph as it is collected. It is possible for the operator to change the scale used in drawing the graphs. When this is done, the new scale is the one used when Graph Generator is selected again later in the flight.

Graph Selection Menu

The Graph Selection Menu is displayed when the graph generator is selected from the Data Display Menu. The screen display of the Graph Selection Menu is shown in Figure 6-18. This shows the default graph format definitions as delivered from Sippican. The first menu option, DEFINE NEW GRAPHS, which is initially highlighted, allows the operator to delete graph definitions, permanently modify graph definitions, as well as define new ones. To run this just press **<Enter>** upon entering the Graph Selection Menu and refer to the section "Graph Definition" in this chapter for instructions.

July 31, 1996	Graph Selection Menu	13:57:30								
<table style="width: 100%; border: none;"> <tr> <td style="width: 60%;">Graph Name:</td> <td style="width: 40%;">Red:</td> </tr> <tr> <td>Graph Title:</td> <td>Yellow:</td> </tr> <tr> <td>Y-Axis:</td> <td>Green:</td> </tr> <tr> <td></td> <td>Blue:</td> </tr> </table>			Graph Name:	Red:	Graph Title:	Yellow:	Y-Axis:	Green:		Blue:
Graph Name:	Red:									
Graph Title:	Yellow:									
Y-Axis:	Green:									
	Blue:									
<pre> NEW DEFINE NEW GRAPHS PTUvT Pressure, Temperature, Humidity PTUvH Pressure, Temperature, Humidity TempvP Dewpoint, Potential, Virtual Temperature </pre>										
ENTER>SelectGph TAB=NxtField										

Figure 6-18. Graph Selection Menu

The **<Up Arrow>** and **<Down Arrow>** keys are used to select a previously defined graph. To generate and view such a graph, move the highlight to the desired graph and press **<Enter>**. When **<Enter>** is pressed the graph will generated from the flight data and displayed. A description of the graph display under the heading "Viewing a Graph" in this chapter.

The highlight in the lower window is on the name and title of the currently selected graph. The upper window shows more information about the currently selected graph. In addition to the name and title, the upper window shows what data types are plotted in the graph.

The upper window can be used to temporarily change the title of the selected graph. Modifications made by this method are used only for the current invocation of the graph and do not permanently affect the selected graph format. Changing the graph title may be useful to document or call attention to a particular feature represented in the data of the graph.

To use the upper window for this purpose, first move the highlight in the lower window to the name and title of the desired graph. Then press <Tab> and the highlight moves to the upper window to highlight the graph title field. An edit line with the prompt **Please Enter Data...:** appears at the bottom of the screen (see Figure 6-19). The current contents are highlighted. Use the edit line to change the currently display field and then press <Enter> to accept the edited title. To generate the graph with the modifications, press <Enter>.

```

July 31, 1996                Graph Selection Menu                13:57:30
-----
Graph Name: PTUvT                Red: Pressure [hPa]
Graph Title: Pressure, Temperature, Humidity          Yellow: Temperature [de
Y-Axis:                                Green:
                                           Blue: Relative Humidi
-----
NEW      DEFINE NEW GRAPHS
PTUvT   Pressure, Temperature, Humidity
PTUvH   Pressure, Temperature, Humidity
TempvP  Dewpoint, Potential, Virtual Temperature
-----
Please Enter Data...: Pessure, Temperature, Humidity
-----
ENTER>SelectGph  TAB=NxtField

```

Figure 6-19 Graph Selection Menu

Viewing a Graph

These graphs have a hairline (the dotted line at the top of the graph just below the 130.0 in Figure 6-20) that is used as a cursor. Move the hairline up and down with the <Up Arrow>, <Down Arrow>, <PgUp>, or <PgDn> keys. As the hairline moves the values of the plotted data types, shown on the left and right side of the graph change to show the values at the current hairline position. When the hairline is moved to a point with missing data, \\\\\\\ will be displayed as the value.

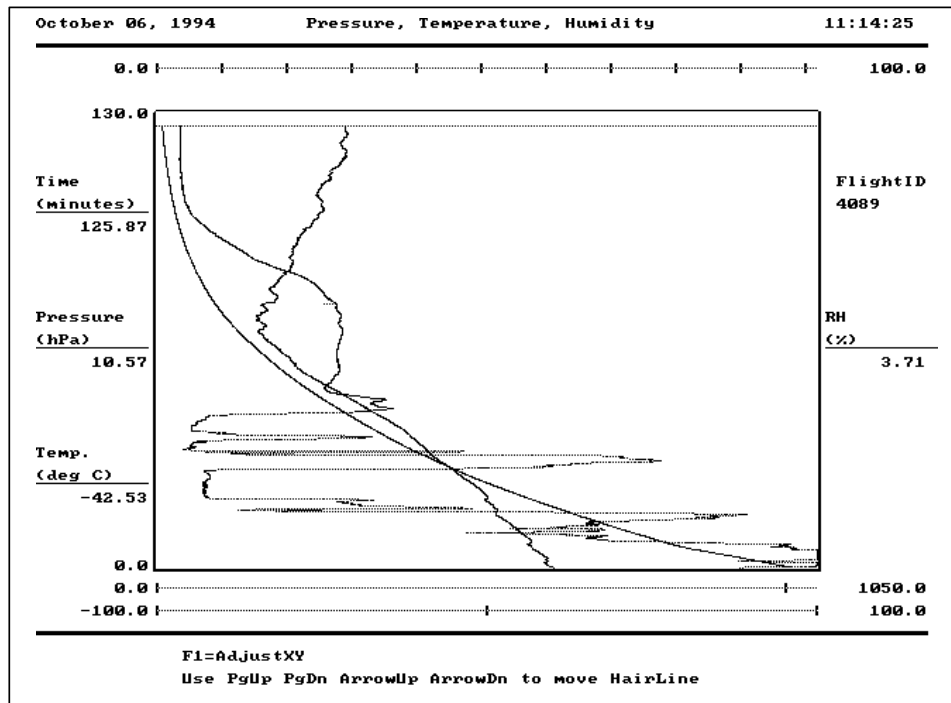

Figure 6-20 Graph Definition

The vertical and horizontal axis may be adjusted in the XY Adjust mode entered by pressing <F1>. In this mode the upper and lower limits of all the axis scales may be adjusted. Each scale can be adjusted in three ways; PAN, ZOOM MIN, and ZOOM MAX. Each horizontal scales - there can be up to four - may be adjusted independently. The <Tab> key selects each of the adjustment one at a time.

PAN adjustments change the minimum and maximum scale limits at the same time. ZOOM MIN adjustments will change only the minimum scale limit. ZOOM MAX adjustments will change only the maximum scale limit.

Once the desired adjustment method is selected with the <Tab> key, the arrow keys can be used to increase or decrease the selected scale limit(s).

There are three adjustment increments: small, medium, and large. The vertical scale (time, pressure, or height) is adjusted in the small increments with <Up Arrow> and <Down Arrow>, in the medium increments with the <Shift-Up Arrow> and <Shift-Down Arrow>, and in large increments with the <PgUp> and <PgDn> keys. The horizontal scales are adjusted independently one at a time. For these scales the <Right Arrow> and <Left Arrow> make the small increment adjustments, the <Shift-Right Arrow> and <Shift-Left Arrow> make medium adjustments, and the <Ctrl-Right Arrow> and <Ctrl-Left Arrow> make the large adjustments.

Graph Definition

The Graph Definition Program is used to define new graphs formats, permanently modify existing graph formats, or to delete graph formats. It is accessed by selecting DEFINE NEW GRAPHS in the Graph Selection menu.

Initially when entered the Graph Definition Program is ready to accept a new graph definition. This is shown by the blank fields in the graph definition window (see Figure 6-21). To define the format of a new graph, fill in the fields of this window one by one and then save it by pressing <F3>.

If the Graph Definition Program is being used to modify or delete an existing graph format, retrieve the desired graph first by pressing <F2> until the format of the desired graph is displayed. Then delete it by pressing <F4> or modify its fields and resave it by pressing <F3>.

To exit from the Graph Definition Program press <Esc>.

Entering and Editing Fields

Movement between the fields is accomplished with the <Tab> or <Enter> keys. <Enter> updates the field that is currently displayed before advancing to the next field while <Tab> advances without saving. The fields of the graph definition window are filled out differently.

Graph Name and Graph Title Fields

The graph name is used by the program to distinguish which graph format is which and must therefore be unique for each format. The graph title is the title that appears above the graph and does not have to be unique. The graph name and graph title are entered by typing in the desired characters. The <Right Arrow> and <Left Arrow> keys move the cursor along the typed text and are provided for editing purposes. Press <Enter> to accept the displayed text and move to the next field.

Y-Axis Field

The vertical scale or Y-axis the graphs is one of pressure, time, or height. The Y-axis field selects which of these is used. When this field is tabbed to another window appears with the three choices listed in it. To select an interval type, move the cursor with the <PgUp>, <PgDn>, <Up Arrow>, and <Down Arrow> keys to the desired type and press <Enter>.

Red, Yellow, Green, Blue Fields

Use these fields to select the data types that the graph will plot in that color. When this field is selected an additional window is displayed. Select data types by moving down through the displayed data types with the <Down Arrow>, <Up Arrow>, <PgDn>, and <PgUp>, to a desired data type and press <Enter>. Any of these fields can be left blank, in which case nothing will be plotted in that color. To leave a field blank press <Tab> to move to the next field.

6.12 Wind Speed and Direction Graphs

There are two graphs of wind speed and wind direction one versus time and the other versus height. With these the wind profile is graphically viewed and can also be edited. The Data Display Menu contains choice for Wind Speed and Direction vs. Time and also a choice for Wind Speed and Direction vs. Height.

When Wind Speed and Direction versus. Time is selected a graph similar to Figure 6-21 will be displayed. The graph versus height is the same except that the y-axis is in meters of geopotential height.

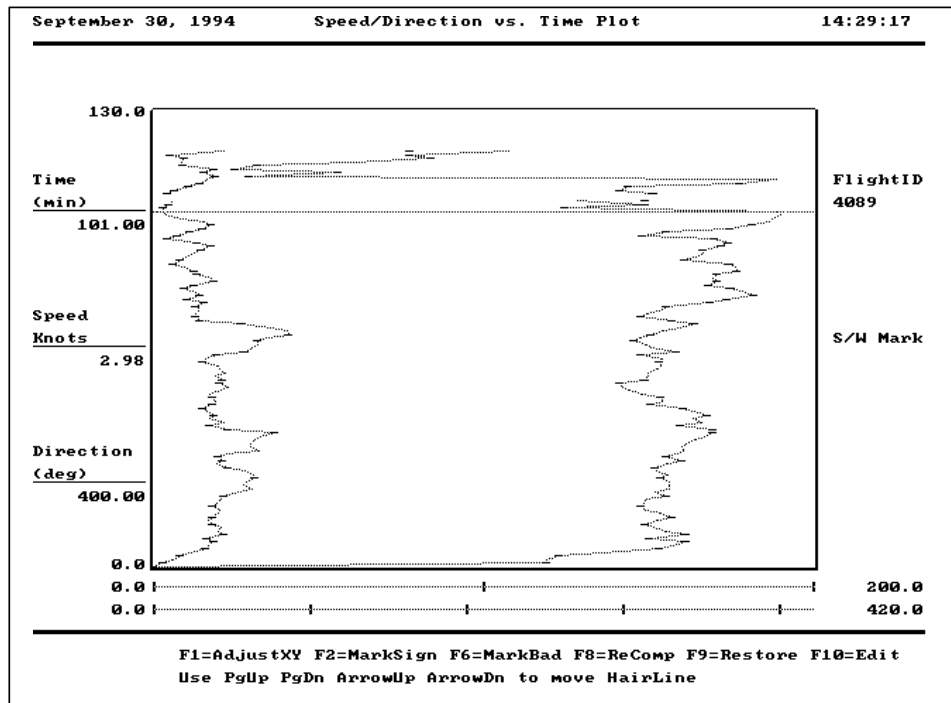

Figure 6-21. Wind Speed and Direction Graph

The scale for wind speed, in yellow along the horizontal axis at the bottom of the screen, is in knots. The scale for wind direction, in green along the horizontal axis at the top of the screen, is in degrees. The time scale in minutes (or the height scale in meters) is in white on the vertical axis on the left hand side of the screen. Data is plotted on the display as it is received and processed.

These graphs have two modes: viewing/editing mode and axis adjustment mode. When the graph is first presented it can be viewed and edited and the graph will be automatically updated as new wind data is collected. By pressing <F1> the graph changes to the axis adjustment mode. Subsequent pressing <F1> will toggle between the two modes.

Viewing

These graphs have a hairline that is used as a cursor for viewing and editing the wind profile. Move the hairline up and down with the <Up Arrow>, <Down Arrow>, <PgUp>, or <PgDn> keys. As the hairline moves the values of wind speed, wind direction, and time (or height) shown on the left side of the display change to show the values at the current hairline position. When the hairline is moved to a point with missing data, \\\\\\\ will be displayed as the value.

Wind Editing

The data at the hairline position may be modified in several ways. The <F10> key edits the wind value at the hairline position. This replaces the current wind value with a value interpolated from the point before and after. The <F10> key and cursor movement can be used repeatedly to edit a series of wind points. There must be a valid point (not missing) before and after the point being edited or else the <F10> key will have no effect.

The <F9> key returns the wind data at the current cursor position to its original unedited value. This can be done at any time during a sounding, on a point-by-point basis. The <Shift-F9> key will restore all the wind data to their original values.

Wind data can be marked as missing with the <F6> key on a point-by-point basis. Missing points are represented as // for their value and the graph lines to and from the missing point are removed. If a point has been previously marked as being bad by the operator, pressing <F6> take away its missing status and return the point to its previous value. <F6> has no affect on points marked missing by the computer.

You can mark points as significant with the <F2> key. This places a tick mark at the current wind data position and adds the point to the list of significant wind levels. If however there is already a tick mark on the currently selected point, the <F2> will remove the tick mark and take the point off the list of significant levels.

The <F8> key, when pressed, causes the computer to recalculate the significant levels. The previously described operator editing features effect which points of the flight are significant. For this reason, the significant levels need to be recalculated after any operator editing.

Axis Adjustment

Another mode of operation is available by pressing <F1>. In this mode the upper and lower limits of all the axis scales may be adjusted. Each scale can be adjusted in three ways; PAN, ZOOM MIN, and ZOOM MAX. Since the Wind Speed and Direction Graphs have two horizontal scales, the wind speed and wind direction scales, and one vertical scale, time or height; there are a total of nine adjustments. The <Tab> key selects each of the nine adjustments one at a time.

PAN adjustments change the minimum and maximum scale limits at the same time. ZOOM MIN adjustments will change only the minimum scale limit. ZOOM MAX adjustments will change only the maximum scale limit.

Once the desired adjustment method is selected with the <Tab> key, the arrow keys can be used to increase or decrease the selected scale limit(s).

There are three adjustment increments: small, medium, and large. The vertical scale (time or height) is adjusted in the small increments with <Up Arrow> and <Down Arrow>, in the medium increments with the <Shift-Up Arrow> and <Shift-Down Arrow>, and in large increments with the <PgUp> and <PgDn> keys. The horizontal scales (wind speed and wind direction) are adjusted independently one at a time. For these scales the <Right Arrow> and <Left Arrow> make small increment adjustments, the <Shift-Right Arrow> and <Shift-Left Arrow> make medium adjustments, and the <Ctrl-Right Arrow> and <Ctrl-Left Arrow> make the large adjustments.

6.13 Wind Vector Components

Select Vector Components to display the Northerly and Easterly vectors of the wind components as shown in Figure 6-23.

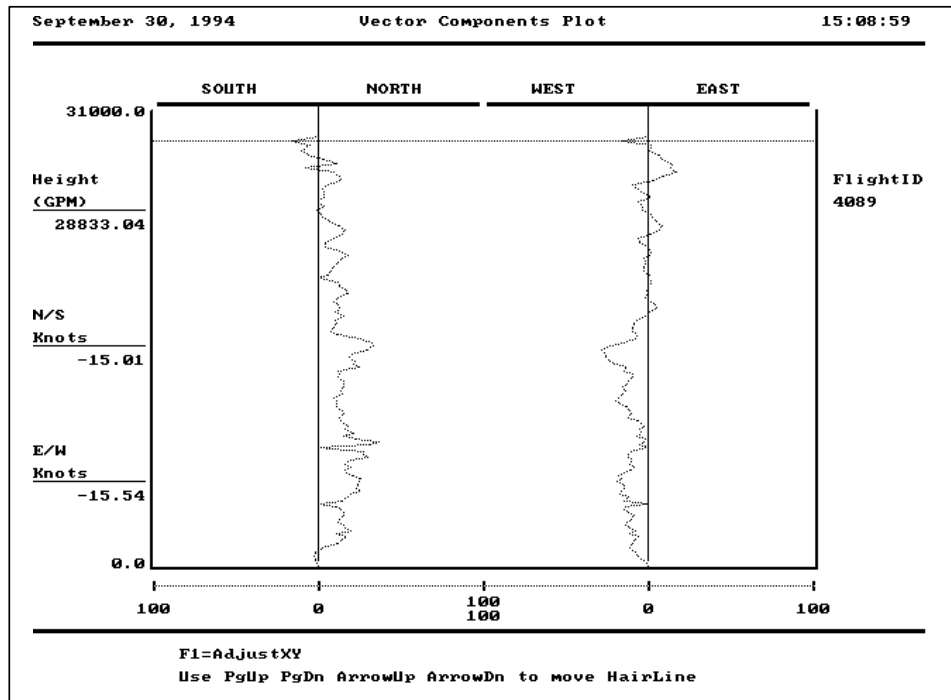

Figure 6-22. Wind Vector Components

In this graph the north/south wind vector component is plotted in yellow and the east/west vector component is plotted in green. The scale for the both vector components is located at the bottom of the screen. These scales are fixed. However the vertical scale for height (in white on the left) can be changed in the axis adjustment mode. The instruction for the axis adjustment mode are described above in the section for the Wind Speed and Direction Graphs.

6.14 Data Analysis

Refer to Chapter 7 for a complete description of Data Analysis.

6.15 Flight Utilities

Refer to Chapter 8 for a complete description of Flight Utilities.

6.16 Edit Launch or End Time

Select Edit Launch or End Time to edit the launch record or the end of flight record. As an overview, the Launch/End Flight Editing display can be thought of as a "window," gliding over the flight data in which up to 32 met frames (in two columns) can be viewed at any one time. The window is moved forwards or backwards through the flight data until the desired frame is in the window.

To set the launch and end records, move the cursor (small square window) next to the desired data record. Press <L> to select the current record as the launch record. Press <E> to select the current record as the end record. In addition, the following keys may be used in this display:

<**PgUp**> advances the window one column. If there is a full screen of data, this moves the screen 16 frames forward (towards the first frame in flight).

<**PgDn**> retreats the window one column. If there is a full screen of data, this moves the screen 16 frames backwards (towards the final frame).

<**Home**> moves the cursor to the currently selected launch point. If there is no launch point selected, the home key moves the cursor to the first data frame in the flight. The current launch frame is indicated by the letter "L" to the left of the frame.

<**End**> moves the cursor to the currently selected end-of-flight record. If there is no end-of-flight selected, the cursor will move to the last record available. The current end-of-flight frame is shown by the letter E to the left of the frame.

<**Tab**> advances the window in a nominal 5% increment from the current position. This is a fast way to move to any region of flight data. Each press of the tab key moves forward one unit on the relative position indicator, shown on the right side of the display.

<**Shift-Tab**> retreats the window in a nominal 5% decrement from current position. Has the opposite effect of the Tab key.

<**Up Arrow**> moves the cursor backward one record. If it is currently in the upper leftmost cell, then the whole window scrolls one position towards the first frame.

<**Down Arrow**> moves the cursor forward one record. If it is currently in the lower rightmost cell, then the whole window scrolls one position towards the last frame.

<**L**> selects the highlighted frame pointed to by the cursor as the new launch frame. An "L" will appear to the left of the data to mark the record as the launch record. The "L" marker is then removed from any previously selected launch record. The time of the newly selected launch frame is displayed as time zero (0). All other times are now displayed relative to this point.

<**E**> selects the frame at the cursor as the new end-of-flight point. An "E" marker is placed at the left of the selected frame to indicate this. This key can't be used to end a flight currently in progress; subsequently, this function is inhibited during a flight.

<**Esc**> exits the editing function

To assist in determining the optimum flight terminus, each displayed frame consists of the relative time of the frame since the last selected launch point (the selected launch point becomes time zero, and all flight times in the display are shown as their relative magnitude (+ or -) to this point), the pressure is shown in millibars, the temperature in degrees Celsius, and the humidity is shown as relative humidity. See Figure 6-23.

The flight frames are listed, in blue, in two columns of data. Using the cursor (white block), appearing at the leftmost position of the column, selects frames. The data pointed to by the cursor is listed in white.

September 11, 1992				Launch/End Flight Editing				08:26:38					
Time	Press.	Temp.	Humid.		Time	Press.	Temp.	Humid.		Time	Press.	Temp.	Humid.
-0:28.5	994.20	8.1	23		L 0:00.0	991.30	-0.9	22					
-0:27.2	994.21	8.3	25		0:01.0	990.66	-1.0	23					
-0:24.8	994.22	8.6	25		0:02.5	990.02	-1.1	24					
-0:23.6	993.89	8.6	24		0:03.5	989.38	-1.1	25					
-0:22.3	994.23	8.7	33		0:04.9	989.38	-1.2	26					
-0:21.1	993.93	8.5	29		0:05.9	988.39	-1.3	27					
-0:19.9	993.95	8.5	25		0:07.2	987.74	-1.3	28					
-0:18.7	993.98	8.3	23		0:08.4	987.04	-1.4	29					
-0:17.4	994.33	8.2	23		0:09.7	986.65	-1.5	29					
-0:16.2	994.02	7.9	21		0:10.9	986.27	-1.5	30					
-0:15.0	994.03	6.5	19		0:12.1	985.55	-1.6	31					
-0:13.7	994.05	5.5	21		0:13.3	985.16	-1.7	31					
-0:12.5	994.07	4.1	21		0:14.6	984.78	-1.8	32					
-0:11.3	993.75	3.1	19		0:15.8	984.07	-1.8	33					
-0:10.0	994.11	1.9	19		0:17.0	983.70	-1.8	33					
-0:08.8	993.80	1.2	17		0:18.2	983.33	-1.8	34					

Figure 6-23. Edit Launch/End Time

The relative position indicator is a vertical, solid blue bar, attached to the right side of the second column. The arrow displayed on this bar indicates the relative location, in the flight data, of the window listed on the screen. Each row (potential arrow position) on the indicator is equal to approximately 5% of the flight data. Thus, the position of the arrow on the blue bar corresponds to the relative position of the window within the flight data.

Upon exiting, an opportunity to save any edits is presented. Saving the edits causes a recalculation of height and wind data.

6.17 Exit System

When you select Exit System from the preflight menu, a verification message appears on the application line of the display to verify the exit request. This is the only warning the operator receives before exiting. All desired functions should be performed before exiting from the software, since once you verify that you wish to exit, the system software exits to the DOS command line.

6.18 End Flight

When End Flight is selected from the flight menu a data window is displayed on the screen showing the last processed data as shown in Figure 6-24. To end the flight at this point, enter <Y> at the prompt. This ends the flight and presents the "Edit Launch/End Flight" display which allows you to change the end record as discussed in section 6.7. Press <Esc> to return to the flight display.

Last Frame Processed	Units	Value
Met Time	Min:Sec	12:54.5
Pressure	mb	575.4
Temperature	Deg. C	-25.3
Humidity	%	26
Height	meters	1463.2
Wind Speed	Knots	25.0
Wind Direction	Degrees	280

 Terminate data acquisition at this point? (Y/N/<Esc>)

Figure 6-24. End Flight

This page intentionally left blank.

Chapter 7. Data Analysis

7.1 Introduction

Select Data Analysis from the Flight menu to access the meteorological data analysis computations, print flight data summaries, and gain entry to the message coding programs. The maps illustrated in Figures 7-1 and 7-2 show the complete Data Analysis structure. Note that some of the functions of the data analysis software shown in the map are separately purchased options. The optional items are WMO message coding, military message coding, and WMO CLIMAT messages. Also the organization of message coding may be configured to meet customer specific requirements. Subsequently, some systems may not have all of the facilities shown or the menu items may be different. For example, if bulletins are used for WMO messages, the bulletin identifiers will appear on the menus instead of individual WMO message identifiers.

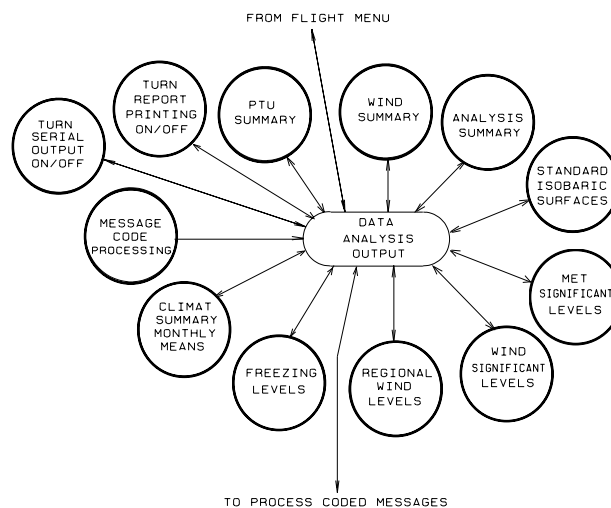

Figure 7-1. Data Analysis Map

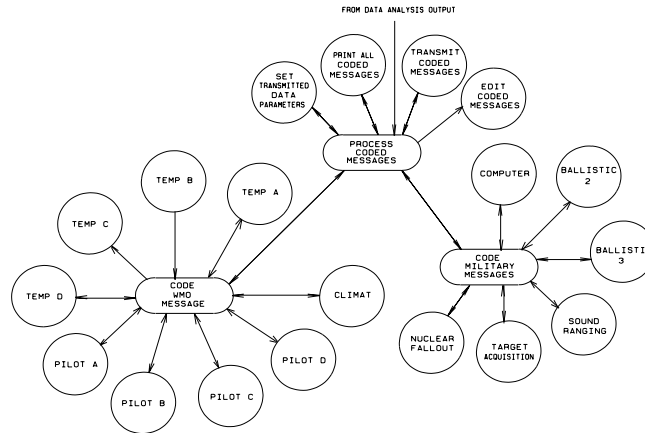

Figure 7-2. Process Coded Messages Map

As shown in Figure 7-1, the first thing that occurs after selection of Data Analysis is the computation of the complete set of data analysis output. This data is saved in memory to be available for the summaries and for the message coding programs.

First the total number of minutes of PTU and Wind data that is available for use by the Data Analysis programs is displayed. If there is not enough data available, a warning message will be displayed and the system will return to the Flight menu. Otherwise, the system will proceed with the full set of computations. As the computation proceeds, brief summary information is shown on the screen showing the progress of the computation and the types and totals of the resulting analysis data. This display is output in real-time as the related computations are done. This computational analysis summary data can be reviewed at any time from the Data Analysis Output menu by selecting the Analysis Summary item, as discussed in the section below. When the computations are complete the analysis summary is saved and the Data Analysis Output Menu is displayed.

These computations and summaries have two purposes. The first is to compute, store, and make available for printing in clear tabular format all of the data required for WMO and Military Message Coding. Accordingly the data selected and the computations done are designed in accordance with established message coding data requirements. The second purpose is to make available a broad selection of printed reports and data files for the data of a flight. All summaries which are selected for printing or viewing are also automatically sent to files. The last section of this chapter lists and describes these files.

As shown in Figure 7-2, Data Analysis is also the path into the Optional Message Coding Routines. If message coding software has been installed the user may select Process Coded Messages to enter into message coding. Within the message coding software the user can code, save, edit, print, and transmit WMO or military messages.

7.2 Data Analysis Output

The Data Analysis Output menu is shown in Figure 7-3. From this menu any of the various data summaries can be written to a disk file, displayed, and printed. Hitting <Esc> from here exits Data Analysis resulting in return to the Flight menu.

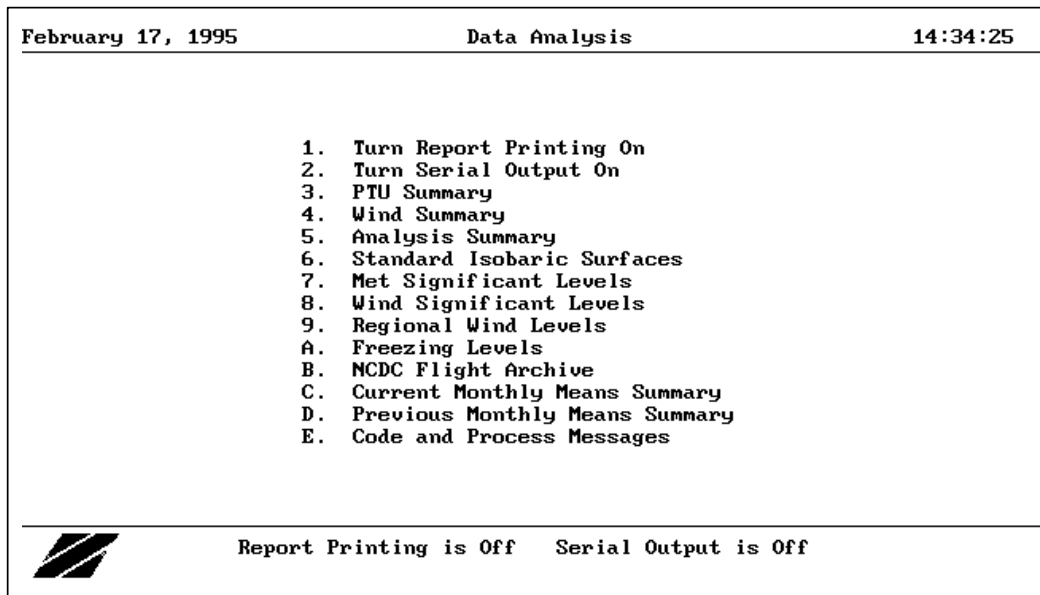

Figure 7-3. Data Analysis Output

7.3 Report Printing

By selecting Turn Report Printing ON or Turn Report Printing OFF the report printing option is activated or deactivated. Pressing the key with the number corresponding to this option toggles the printing mode between ON and OFF. If report printing is active, copies of various reports accessed while in this menu are sent to the printer. The current report printing status is displayed at the bottom of the menu as shown in Figure 7-3.

7.4 Serial Output

By selecting Turn Serial Output ON or Turn Serial Output OFF the report printing option is activated or deactivated. Pressing the key with the number corresponding to this option toggles the serial output mode between ON and OFF. If serial output is active, copies of various reports accessed while in this menu are sent out the serial port. The current serial output status is displayed at the bottom of the menu as shown in Figure 7-3.

7.5 PTU Summary

The PTU (pressure, temperature, humidity) Summary is shown in Figure 7-4. It is accessed by selecting PTU Summary from the Data Analysis Output menu.

September 30, 1994		PTU Summary			12:43:26	
Time (min)	Pressure (hPa)	Height (M-MSL)	Temp (deg C)	DP-Dep. (deg C)	Humidity (percent)	
0.00	1006.6	85	25.0	11.1	50.0	
4.26	835.7	1680	10.8	2.0	87.3	
6.39	771.8	2339	6.4	4.7	72.0	
9.32	713.1	2986	3.4	6.9	60.3	
11.99	657.7	3636	-1.3	13.4	35.8	
12.93	644.4	3798	-2.3	4.2	72.6	
13.85	633.2	3938	-2.6	11.4	41.5	
14.06	630.6	3971	-2.2	6.8	59.6	
15.39	614.2	4181	-3.4	7.3	56.8	
15.92	607.1	4272	-3.5	18.9	21.6	
16.33	601.4	4347	-3.8	15.6	28.9	
16.45	599.7	4369	-3.8	27.7	9.6	
21.45	519.3	5487	-12.2	12.2	35.9	
25.00	459.8	6406	-19.1	11.8	34.7	

Figure 7-4. PTU Summary

When displaying the PTU Summary, the first two lines list the column titles for the PTU data that follows. The data window lists the summary of meteorological parameters for all significant levels: time in minutes (relative to launch), pressure in millibars, geopotential height in geopotential meters above mean sea level, temperature in degrees Celsius, dew point depression in degrees Celsius, and relative humidity in percent.

The data is viewed in a collimated Browser format. Thus, you can scroll or page up or down through the rows of data, or move left and right across the columns using the page and cursor control keys. The control commands are summarized in Figure 7-5.

<Down Arrow>	Scroll down
<Up Arrow>	Scroll up
<PgDn>	Page down
<PgUp>	Page up
<Left Arrow>	Scroll left
<Right Arrow>	Scroll right
<Home>	Display the leftmost column
<Ctrl-PgUp>	Display the top row
<Ctrl-PgDn>	Display the bottom row
<ESC>	Return to previous menu

Figure 7-5. Summary of Browser Commands

The browser method of viewing data is common to viewing data for most options on the Data Analysis menu. It is also used at other places in the W-9000 system where selections to review data are available. You may press <Esc> at any time while browsing to return to the Data Analysis menu.

7.6 Wind Summary

The Wind Summary is shown in Figure 7-6. It can be accessed by selecting Wind Summary from the Data Analysis Output menu.

September 30, 1994		Wind Summary			12:43:37
Time (min)	Height (M-AS)	Direction (degrees)	Speed (knots)	Height (FT-MSL)	
0.00	0.0	0	0.0	278.9	
1.00	374.6	229	10.9	1507.8	
2.00	749.2	229	21.8	2736.8	
3.00	1123.7	245	17.2	3965.7	
4.00	1498.3	251	23.0	5194.6	
5.00	1824.5	319	14.1	6264.6	
6.00	2133.7	270	26.9	7279.2	
7.00	2388.9	300	17.8	8116.5	
8.00	2609.6	334	20.8	8840.4	
9.00	2830.2	257	55.6	9564.4	
10.00	3066.7	284	26.6	10340.1	
11.00	3310.6	264	44.2	11140.4	
12.00	3553.6	301	26.2	11937.6	
13.00	3724.2	278	31.9	12497.3	

Figure 7-6. Wind Summary

When displaying the Wind Summary the first two lines list the column titles for the wind data that follows. The data window lists the summary of wind data for each computed wind: time in minutes (relative to launch), height in meters above surface, wind direction in degrees, wind speed in knots or meters per second, and height in feet above mean sea level.

The data is displayed in a collimated Browser format. Refer to Figure 7-5 for a complete summary of the Browser commands.

You can press <Esc> at any time while browsing to return to the Data Analysis menu.

7.7 Analysis Summary

Select Analysis Summary from the Data Analysis Output menu in order to view the analysis summary data as shown in Figure 7-7.

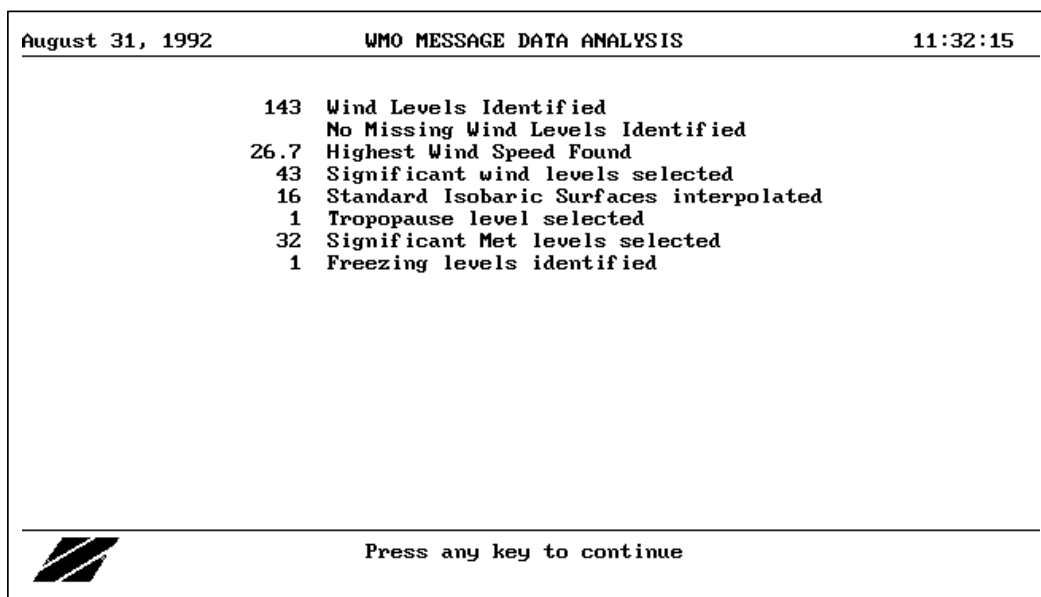

Figure 7-7. WMO Message Data Analysis

When Data Analysis is selected from the Flight menu, the W-9000 System software interpolates temperature, humidity, dew point, height, and wind data for all Standard Isobaric Surfaces reached, selects the Tropopause(s), computes data for the selected PTU levels, selects significant and maximum wind levels, determines the freezing level data and computes any specified Regional Winds. The number of occurrences for each type of level is displayed.

7.8 Standard Isobaric Surfaces

Select Standard Isobaric Surfaces from the Data Analysis Output menu to display the Standard Isobaric Surface data. Data similar to that seen in Figure 7-8 showing the standard isobaric surfaces appears on the screen. The following data is displayed for each Standard Isobaric Surface reached in the flight: pressure in millibars, height in meters above mean sea level, temperature in degrees Celsius, dew point depression in degrees Celsius, humidity in percent, wind direction in degrees, and wind speed in either knots or meters per second.

After browsing this data on the screen, press the <Esc> key to return to the Data Analysis Output menu.

August 31, 1992		STANDARD ISOBARIC SURFACES				11:32:33	
Pressure (mbs)	Height (meters)	Temperature (deg C)	Dew Pt. (deg C)	Humidity (%)	Direction (deg)	Speed (kts)	
1000	103	30.1	8.0	62	278	22	
925	792	23.2	6.4	67	289	30	
850	1526	18.7	8.1	59	267	35	
700	3165	10.0	27.1	13	275	36	
500	5877	-6.0	25.7	11	281	48	
400	7589	-17.5	24.6	10	267	41	
300	9675	-33.2	19.9	11	258	44	
250	10928	-42.4	18.5	11	248	48	
200	12405	-52.5	////	///	260	42	
150	14211	-63.2	////	///	263	36	
100	16645	-68.1	////	///	235	25	
70	18841	-61.1	////	///	96	6	
50	20968	-55.5	////	///	102	12	
30	24292	-47.7	////	///	116	17	
20	27001	-43.1	////	///	80	13	
10	31760	-33.0	////	///	136	35	

 Press any key to continue

Figure 7-8. Standard Isobaric Surfaces

7.9 Met Significant Levels

Select Met Significant Levels from the Data Analysis Output menu to view the Met Significant Levels. Data similar to that seen in Figure 7-9 showing the Met Significant Levels appears on the screen. These are the levels which will be coded. The following data is displayed for each Met Significant Level in the flight: pressure in millibars, height in meters above mean sea level, temperature in degrees Celsius, dew point depression in degrees Celsius, humidity in percent, and the reason it is selected as a significant level.

August 31, 1992		MET SIGNIFICANT LEVELS				11:33:16
Pressure (mbs)	Height (meters)	Temperature (deg C)	Dew Pt. Dep. (deg C)	Humidity (%)	Reason	
1002.0	85	32.0	10.0	55	Surface Data	
1002.3	82	30.0	8.4	60	Temperature	
1001.9	86	30.3	8.1	61	Temperature	
945.8	598	24.1	5.4	71	Required level	
878.5	1242	21.2	8.8	57	Temperature	
835.1	1678	17.3	7.7	60	Humidity	
805.5	1987	17.0	21.3	23	Humidity	
728.7	2831	11.8	26.7	14	Temperature	
653.8	3729	6.9	27.9	12	Temperature	
580.6	4695	1.0	27.0	11	Temperature	
522.4	5536	-3.9	26.0	11	Temperature	
458.9	6547	-10.0	25.0	11	Temperature	
396.0	7665	-18.1	24.6	9	Required level	
349.1	8593	-25.6	19.9	13	Temperature	
210.4	12077	-49.6	16.7	11	Required level	

 Press any key to continue

Figure 7-9. Met Significant Levels

After browsing this data on the screen, press the <Esc> to return to the Data Analysis Output menu.

7.10 Wind Significant Levels

Select Wind Significant Levels from the Data Analysis Output menu to view the Wind Significant Levels. Data similar to that seen in Figure 7-10 showing the Wind Significant Levels appears on the screen. The following data is displayed for each Wind Significant Level in the flight: time in minutes, height in meters and feet above mean sea level, wind direction in degrees, wind speed in knots or meters per second, and the reason it is selected as a significant level.

August 31, 1992		WIND SIGNIFICANT LEVELS				11:33:49
Time (mins)	Height (meters)	Height (feet)	Direction (deg)	Speed (kts)	Reason	
0	85	279	270	10	Surface Data	
1	84	276	231	15	Direction	
2	86	281	272	20	Direction	
4	518	1701	292	30	Speed	
9	1592	5222	267	35	Direction	
20	3610	11843	285	35	Direction	
26	4727	15508	276	47	Speed	
34	6157	20201	284	46	Direction	
45	8222	26974	259	38	Speed	
61	11421	37471	249	52		
68	13094	42960	268	50	Speed	
71	13773	45186	278	32	Speed	
72	13997	45921	263	32	Direction	
74	14546	47724	267	40	Speed	
76	15074	49456	278	25	Direction	

 Press any key to continue

Figure 7-10. Wind Significant Levels

After browsing this data on the screen, press the <Esc> key to return to the Data Analysis Output menu.

7.11 Regional Wind Levels

If a WMO Message Configuration Setup file is installed that defines regional wind levels to be encoded, select Regional Wind Levels from the Data Analysis Output menu to view the regional wind levels. Regional wind levels can be defined in units of pressure or height. Data similar to that seen in Figure 7-11 shows regional wind levels by height. When height units are used, the following data is displayed for each regional wind in the flight: height in meters and feet above mean sea level, wind direction in degrees, and wind speed in knots or meters per second.

October 30, 1992		REGIONAL WIND LEVELS			16:42:25
Height (meters)	Height (feet)	Direction (deg)	Speed (kts)		
300	980	303	24		
600	1970	292	22		
900	2950	281	24		
2100	6890	277	32		
2400	7870	277	35		
4200	13780	270	46		
6000	19690	264	47		
8100	26570	255	54		
18000	59060	252	60		
21000	68900	245	57		
24000	78740	245	74		

 Press any key to continue

Figure 7-11. Regional Wind Levels by Height

Data similar to that seen in Figure 7-12 shows regional wind levels by pressure. When pressure units are used, the following data is displayed for each regional wind in the flight: pressure in millibars, wind direction in degrees, and wind speed in knots or meters per second.

December 21, 1992		REGIONAL WIND LEVELS			12:25:41
Pressure (mbs)	Direction (deg)	Speed (kts)			
900.0	257	18			
800.0	235	28			
600.0	255	52			

 Press any key to continue

Figure 7-12. Regional Wind Levels by Pressure

After browsing this data on the screen, press the <Esc> key to return to the Data Analysis Output menu.

7.12 Freezing levels

Selecting Freezing Levels from the Data Analysis Output menu will display the freezing level data as shown in Figure 7-13. The example shows both a freezing level and a freezing layer. Altitude is given for the freezing level data in both meters on the left and in feet on the right. Note that a freezing layer would count as two freezing levels in the Analysis Summary. Press the <Esc> key when finished viewing the summary to return to the Data Analysis Output Menu.

```

December 21, 1992           Freezing Level(s)           10:34:42
-----
Freezing level height(s) in meters and feet

      1455                4774
      2016 to 2302        6616 to 7551

Note: In the analysis summary a freezing layer is counted as
      two levels, one for the bottom and one for the top

Press any key to continue

```

Figure 7-13. Freezing Levels

7.13 NCDC Data files

NCDC (National Climatic Data Center) flight archive data files can be generated from the Data Analysis Menu if the NCDC option of the Sippican Message Coding is installed. When selected from the menu two archive files are generated. The first is the header file containing general station, flight, and equipment information. The second file contains the data records for the flight - one data record for each level of the flight. These two files have the standard flight file name with extensions .cdh and .cdt respectively.

As well as generating files in the format specified by the NCDC, this menu option of Data Analysis also generates and displays a summary of the levels included in the NCDC record file. Figure 7-14 is an example of a screen from this summary.

February 17, 1995		NCDC Flight Archive						10:41:01	
Level Type	Time (sec)	Pres (hPa)	Height (m)	Temp (C)	RHum (%)	DewPnt (C)	WindDir (deg)	Speed (m/sec)	
Surface Data	0.00	1023.0	85	1.6	19	21.2	///.	///.	
Signif Temp	0.06	1016.6	136	1.3	15	23.6	///.	///.	
Mandatory	0.49	1000.0	266	-0.0	18	21.9	///.	///.	
Signif Temp	1.99	943.9	726	-4.7	28	16.0	///.	///.	
Mandatory	2.90	925.0	883	-6.2	31	14.8	///.	///.	
Signif RHum	5.80	867.0	1386	-10.8	41	10.8	///.	///.	
Mandatory	6.44	850.0	1539	-11.4	28	15.2	///.	///.	
Additional	6.72	842.6	1606	-11.6	23	17.1	///.	///.	
Signif Temp	7.05	833.6	1688	-8.8	5	33.0	///.	///.	
Additional	7.52	816.3	1851	-7.7	5	32.5	///.	///.	
Required	9.06	754.6	2460	-9.7	4	34.1	///.	///.	
Mandatory	10.65	700.0	3034	-13.9	8	27.4	///.	///.	
Additional	11.07	686.4	3183	-15.0	9	25.7	///.	///.	
Additional	12.67	649.2	3606	-13.7	6	30.0	///.	///.	

Figure 7-14. NCDC Summary

7.14 Monthly Means

Selecting Current Monthly Means or Previous Monthly Means from the Data Analysis Output menu will cause the system to search the climate data files directory and use all data files for the selected month to compute monthly means for the data for that month. The resulting data is formatted and output as shown in Figure 7-15. The month that the summary applies to is shown in the title block at the top of the summary. Press any key when finished viewing the summary to return to the Data Analysis Output Menu.

December 21, 1992		CLIMAT TEMP MONTHLY MEANS FOR 11/92							11:03:28	
Press (mb)	Height (m)	Temp (C)	D.P.D. (C)	Humid (%)	Speed (kts)	U Direct (deg)	U Speed (kts)	Stead (%)	MT (day)	MW (day)
1000	85	16.8	11.1	51	0.9					
850	1510	6.9	14.2	55	8.9	91	5.2	58	23	23
700	3084	-0.5	17.8	43	12.4	152	1.2	10	23	23
500	5695	-16.8	14.5	35	24.9	251	12.1	48	23	23
300	9329	-44.0	6.6	21	46.2	227	19.6	42	23	23
200	11964	-57.7	15.3	15	38.0	277	19.1	50	23	23
150	13777	-56.7	16.1	13	32.2	270	20.8	65	23	23
100	16341	-58.3	15.9	12	17.9	281	8.8	49	23	24
50	20711	-56.1	16.0	11	13.7	235	6.9	50	23	23
30	23992	-51.5	17.6	10	14.1	224	4.8	34	23	23

Press any key to continue

Figure 7-15. CLIMAT TEMP Monthly Means

A climate data file is created every time that Data Analysis is selected from the Flight menu. PTU and wind data for the current flight is saved in this file. During a single flight, repeatedly entering Data Analysis will cause the climate data file to be over written with more complete information about the flight. To guarantee that the climate data file includes information from the whole flight, this should be performed at the end of the flight. Note that climate data files are only saved with real flights, not restored or simulated flights.

The contents of the directory where the CLIMAT data files are stored is automatically managed by the software. Only files from the current month and the previous month are kept in the directory. The files that are from the month before last are deleted.

CLIMAT TEMP is an optional software package. It will not be included in the Data Analysis Output Menu unless the software for this option has been loaded.

7.15 Code And Process Messages

Selecting Code and Process Messages from the Data Analysis Output menu calls the optional Process Coded Messages menu. The Code and Process Messages menu item will only appear as part of the Data Analysis Output menu if either the WMO Message Coding option or the Military Message Coding option is installed as part of the W-9000 software. From the Process Coded Messages menu the various message coding routines can be accessed. This menu is shown in Figure 7-16

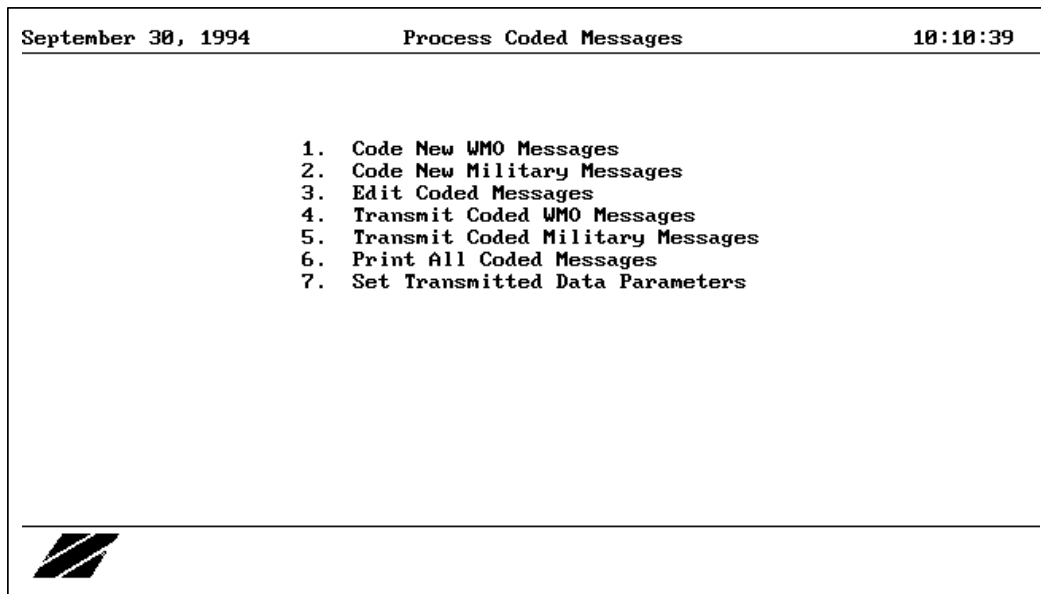

Figure 7-16. Process Coded Messages

From the Process Coded Messages menu, depending on the options installed, you can choose to code new WMO messages, code new military messages, edit coded messages, transmit coded messages, and print all coded messages. Message coding optional features that have not been installed will not appear in the menu. For example, if the military message coding option has not been installed it will not appear and the menu items that appear below its position in the menu will have lower numbers. The edit, transmit, and print items in the menu apply only to messages that have already been coded. It is also possible to set the transmit data parameters for transmission, although they will only be used for the flight in progress. These same parameters can be set permanently from the setup menu before starting any flight.

The design of the W-9000 System is to allow the operator to code messages, save them to disk, and then edit or transmit the messages that were saved. Although message editing is also available when coding new messages, messages can only be transmitted from the Process Coded Message menu. To exit from the Process Coded Messages menu press <Esc>. This will result in return to the Data Analysis Output menu. At this point if return to the Flight menu is desired press <Esc> again.

7.16 Compute WMO Message

Select Code New WMO Messages from the Process Coded Message menu to see the Compute WMO Message menu as shown below in Figure 7-17. In this menu, messages to encode are selected by pressing the number key associated with the desired message as displayed in the menu. Press <Esc> to return to the Process Coded Messages Menu. If the system setup is to use bulletins for WMO messages then this menu will present a list of available bulletins for selection instead of the list of basic WMO messages. If the CLIMAT option is installed then the final item available for selection will be for coding CLIMAT messages.

```
October 29, 1992                Compute WMO Message                14:13:47
-----
                                MESSAGES
                                1.  TEMP A
                                2.  TEMP B
                                3.  TEMP C
                                4.  TEMP D
                                5.  PILOT A
                                6.  PILOT B
                                7.  PILOT C
                                8.  PILOT D
                                9.  CLIMAT TEMP

                                Please Enter Number of Selection ...



```

Figure 7-17. Compute WMO Message

At this time you may code any of the WMO messages by pressing the number next to the desired message. As the coding programs progress through the building of the selected message each new group coded will be displayed on the screen. When the encoding of the message is finished it will be displayed within the Edit Message screen as shown below in Figure 7-18. See the Edit Message description below for a complete description of the use of this display. Normally the user will select Disk Save to save the message just coded and then <Esc> to return to the Compute WMO Message menu.

```

          EDIT MESSAGE
-----
TTBB 50009 00000 00002 32060 11946 24050 22878 21259 33835
17258 44805 17071 55729 11877 66654 06878 77581 01077 88522
03976 99459 10175 11396 18175 22349 25770 33210 49767 44189
559// 55133 683// 66106 719// 77103 719// 88101 691// 21212
00002 27010 11021 23015 22019 27020 33954 29030 44844 26535
55663 28535 66578 27547 77482 28546 88367 26038 99180 27050
11161 28032 22155 26532 33142 26540 44130 28025 55125 26520
66116 23030 77106 23031 31313 09019 80000 41414 /////  

1. Edit  
2. Hardcopy  
3. Disk Save  
Esc to Cont.

```

Figure 7-18. Computed TEMP B Message

7.17 Code New Military Messages

Select Code New Military Messages from the Process Coded Message menu to see the Code New Military Messages menu as shown in Figure 7-19.

```

          Code New Military Messages
-----
  

1. Computer  
2. Ballistic -2  
3. Ballistic -3  
4. Sound Ranging  
5. Target Acquisition  

Please select one...

```

Figure 7-19. Code New Military Messages Menu

The Code New Military Message menu allows the computation and encoding of any of the messages listed in the standard military format. To start the coding process select the required message. In this menu, messages to encode are selected by pressing the number key associated with the desired message as displayed in the menu. Press <Esc> to return to the Process Coded Messages Menu.

For example, encoding could be started by selecting the Computer message. Once this has been done the message will be encoded and the completed message will appear on the screen as in Figure 7-20.

```

                                EDIT MESSAGE
-----
METCM9 ////////////// 000000 000002
00480010 30821002          18451047 22830227
01481019 30600991          19469046 24130194
02519030 30190963          20486037 24390166
03499030 29890920          21479033 23680141
04476034 29600869          22427026 23200120
05475034 29230820          23422023 23560101
06476035 28850773          24546006 26170086
07481037 28610728          25167005 28360073
08500035 28250686          26227007 31370062
09504036 28020645          99999
10489042 27650607
11492047 27400570
12493048 26980519
13491040 26410457
14471040 25750400
15459044 24980349
16459044 24260304
17444045 23510263

                                1. Edit
                                2. Hardcopy
                                3. Disk Save
                                Esc to Cont.

```

Figure 7-20. Sample Computer Message

From the edit message screen you can return to the Code New Military Messages menu by selecting <Esc> after Disk Save, Edit, or Hard Copy as desired.

Upon returning to the Code New Military Messages menu from the Edit Message screen, an additional option will appear as the last item listed. This is the View Message Reports option. Press the number key associated with this additional option to see the View Military Message Reports menu.

The selections available on the View Military Message Reports menu are precisely those messages that have been generated by selection from the Code New Military Messages menu. Thus, if all available military messages have been chosen from the Code New Military Messages menu, then the View Military Message Reports menu will be identical to the Code New Military Messages Menu, with the exception of the View Message Reports option.

Upon the selection of an option listed on the View Military Message Reports menu, a message Generating Data report will appear on the screen and be available review in the Browser format. See Figure 7-5 for a summary of Browser commands. A sample message generation report is shown in Figure 7-21.

Nuclear Fallout Generating Data Report					
Zone Code	Height (meters)	x-Velocity (Knots)	y-Velocity (Knots)	Speed (Knots)	Direction (mils)
0	0	0.00	0.00	0.00	0
1	2000	-15.54	-4.59	16.21	4508
2	4000	-26.23	5.94	26.90	5027
3	6000	-29.14	3.61	29.36	4926
4	8000	-42.72	4.62	42.97	4910
5	10000	-60.61	-11.92	61.77	4602
6	12000	-55.52	-24.17	60.56	4382
7	14000	-751.05	-129.13	762.07	4627
8	16000	-198.32	-36.39	201.63	4615
9	18000	-5.39	19.66	20.39	6128
10	20000	-19.14	-8.63	21.00	4369
11	22000	-0.79	-5.31	5.37	3351
12	24000	2.87	-3.15	4.26	2447
13	26000	3.40	-1.99	3.94	2139

Figure 7-21. Sample Message Generation Report

The data contained in this report was that which was necessarily calculated to generate the military message it pertains to.

Press <Esc> to return to the View Military Message Reports menu. Press <Esc> from the View Military Message Reports menu to return to the Code New Military Messages menu.

7.18 Edit Message

After the selected WMO or military message has been encoded, the message is displayed within the Edit Message screen. This screen can also be reached as described below by selecting Edit Coded Messages from the Process Coded Messages menu. This screen allows the user to review the message as displayed on the screen and decide on further action. The message can be edited, printed, or saved to disk. See the description below under Edit Coded Message for instruction on the editing process.

If Hard Copy is selected the printer will feed to the top of the next page and print this message. Using this selection to print each message as it is coded will result in each message being printed on a separate page. To print all of the messages continuously, without starting each on a new page, use the Print All Coded Messages selection from the Process Coded Messages Menu after completing the coding and saving of all required messages.

To save the message for later use (printing, review, editing, or transmitting) select Disk Save from the menu. The message will be saved to a file on the hard disk and will appear in menus for the above functions. If the message is saved, it will overwrite any previously encoded and saved version of the same message if one exists. Normally right after coding a message the user will select Disk Save to save the message and <Esc> to return to the original menu.

To exit without saving the message press <Esc> without selecting Disk Save.

After selecting TEMP B from the Compute WMO Message menu, a TEMP B Message similar to Figure 7-18 will appear on the screen. Selecting Edit allows you to move the cursor on the screen to key-in changes in the message. Selecting Hard Copy will print a hard copy of the message that is on the screen. Selecting Disk Save permits you to save the message to hard disk to reference later for editing, printing, or transmission. Selecting <Esc> will return you to the Compute WMO Message menu. If the encoded message is not saved prior to pressing <Esc>, it will be discarded.

7.19 Edit Coded Messages

Select Edit Coded Messages from the Process Coded Messages menu to edit or view messages which were processed or edited and saved earlier. A screen similar to Figure 7-22 will appear. It will display a list of all messages that have previously been saved from the edit message screen.

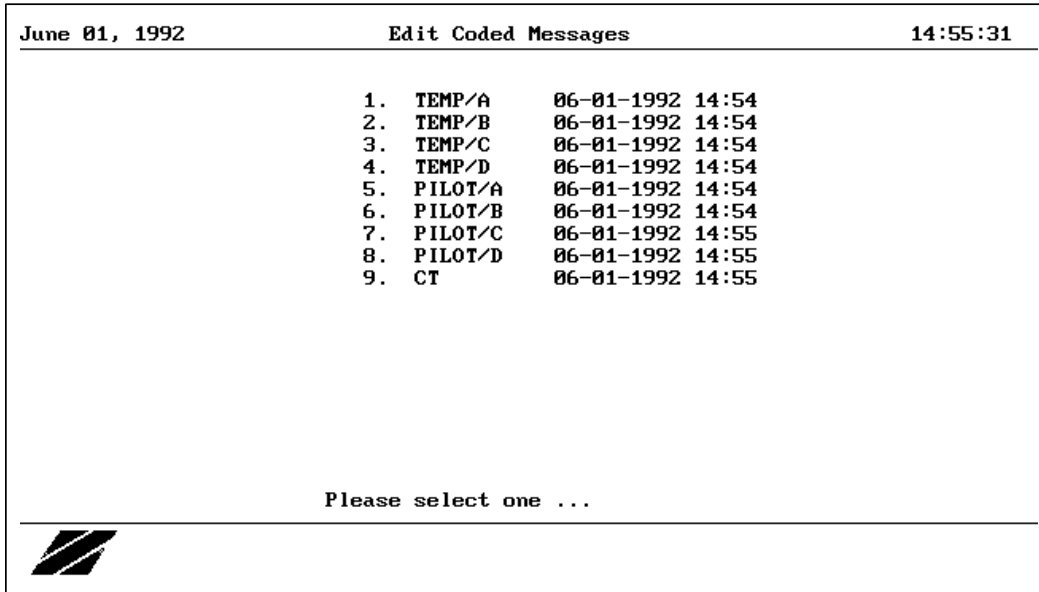

Figure 7-22. Edit Coded Messages Menu

Enter the number of the message that you wish to edit and the message will be displayed on the screen for editing or review as shown above in Figure 7-22.

7.20 Edit

Select Edit from the Edit Message display to begin the editing a message. After selecting Edit the menu will be removed from the screen and the edit portion of the screen will be displayed in reverse video. You can then move the cursor around the screen within the edit portion to position it to where changes are to be made and enter the changes as described below. Select the <Esc> key to exit the editing mode and return to the Edit Message menu.

To save your edited messages to disk, select Disk Save from the Edit Message menu after you have completed the editing process. If you do not save the message before pressing the <Esc> key again, any changes that were made while editing will be discarded.

Moving the Editing Cursor

Use the <Ctrl> key in conjunction with the left or right arrow key to move the cursor to the beginning of the adjacent group.

Use the <Home> key to move the cursor to the first character of the first group. Use the <End> key to move the cursor to the last character of the last group.

Use the arrow keys (left, right, up, and down) to move around one column or row at a time.

Typeover and Insert Modes

The normal key-in mode is typeover. In this mode when a character is keyed in it will appear on the screen in place of the character that was displayed at the cursor location. This is the mode normally used to change the information displayed in a group.

To switch to insert mode select the <Ins> key. While this mode is active the word "INSERT" is displayed in the upper right hand corner of the screen. In this mode, when a character is keyed in, all of the characters on the line the cursor is on, beginning with the character at the cursor position, are shifted to the right and the new character is displayed at the cursor position. The cursor will also shift one to the right staying with the character it was on as it is shifted. To return to normal typeover mode hit the <Ins> key again.

Deleting Characters

Use the key to delete the character at the current cursor position. Use the <Backspace> key to delete the character to the left of the cursor. When a character is deleted all of the characters to the right of it on the same line will shift one position to the left.

7.21 Transmit Coded WMO Messages

To select and transmit coded WMO messages choose Transmit Coded WMO Messages from the Process Coded Messages menu. All WMO messages which have been coded and saved will appear in the Transmit Coded WMO Messages menu as shown in Figure 7-23

June 01, 1992	Transmit Coded Messages	14:55:40
	1. TEMP/A 06-01-1992 14:54	
	2. TEMP/B 06-01-1992 14:54	
	3. TEMP/C 06-01-1992 14:54	
	4. TEMP/D 06-01-1992 14:54	
	5. PILOT/A 06-01-1992 14:54	
	6. PILOT/B 06-01-1992 14:54	
	7. PILOT/C 06-01-1992 14:55	
	8. PILOT/D 06-01-1992 14:55	
	9. CT 06-01-1992 14:55	



Figure 7-23. Transmit Coded WMO Messages Menu

Any WMO messages that have been already transmitted will be shown in the menu with a **T** next to them. Figure 7.24 shows the Transmit Coded WMO Messages menu with the messages all tagged as having been transmitted. This tag is for information only and does not prevent a message from being selected and transmitted again.

June 01, 1992	Transmit Coded Messages	14:56:13
	T 1. TEMP/A 06-01-1992 14:54	
	T 2. TEMP/B 06-01-1992 14:54	
	T 3. TEMP/C 06-01-1992 14:54	
	T 4. TEMP/D 06-01-1992 14:54	
	T 5. PILOT/A 06-01-1992 14:54	
	T 6. PILOT/B 06-01-1992 14:54	
	T 7. PILOT/C 06-01-1992 14:55	
	T 8. PILOT/D 06-01-1992 14:55	
	T 9. CT 06-01-1992 14:55	

Figure 7-24. Transmit Coded WMO Messages

Select the WMO messages that you wish to transmit. A asterisk (*) will appear next to each selected message. When all required messages have been selected enter <Esc>. You will be prompted to confirm that transmission of the selected messages is wanted as shown in Figure 7-25

June 01, 1992	Transmit Coded Messages	14:56:01
	* 1. TEMP/A 06-01-1992 14:54	
	* 2. TEMP/B 06-01-1992 14:54	
	* 3. TEMP/C 06-01-1992 14:54	
	* 4. TEMP/D 06-01-1992 14:54	
	* 5. PILOT/A 06-01-1992 14:54	
	* 6. PILOT/B 06-01-1992 14:54	
	* 7. PILOT/C 06-01-1992 14:55	
	* 8. PILOT/D 06-01-1992 14:55	
	* 9. CT 06-01-1992 14:55	

Enter Y to transmit selected message(s), Esc or N to quit

Figure 7-25. Transmit Coded WMO Messages

Enter <Y> to confirm and the selected WMO messages will be transmitted. Upon completion of the message transmission sequence the system will return to the Process Coded Messages menu. To exit without transmitting any messages hit <Esc> without selecting any messages or enter <N> when asked to confirm transmission.

The exact sequence and format of WMO message transmission is determined by parameters set via the system Setup Menu and Message Coding Configuration files. Messages are transmitted from the IJ4 port of the ZEEMET Rack Interface module. The serial port parameters of this port can be set during a flight from the Set Transmit Data Parameters item of the Process Coded Messages menu (see below) or in advance from the appropriate section of the Setup menu.

Sippican will supply custom message coding configuration file diskettes to meet established customer requirements as needed with each new W-9000 system. Contact Sippican marketing or technical support for information on obtaining your own copy or obtaining changes to an existing copy..

7.22 Transmit Coded Military Messages

To select and transmit coded military messages choose Transmit Coded Military Messages from the Process Coded Messages menu. All military messages which have been coded and saved will appear in the Transmit Coded Military Messages menu as shown in Figure 7-26.

September 30, 1994		Transmit Coded Messages		13:30:42
T	1.	MTCM	09-30-1994	13:29
T	2.	MTB2	09-30-1994	13:29
	3.	MTB3	09-30-1994	13:30
*	4.	MTSR	09-30-1994	13:30
T	5.	MTTA	09-30-1994	13:30
*	6.	MTFM	09-30-1994	13:30

 Transmit selected message(s)? (Y, N, <Esc>)

Figure 7-26. Transmit Coded Military Messages Menu

Military message transmission functions in a way similar to WMO message transmission. Thus, any messages that have been already transmitted will be shown in the menu with a **T** next to them and the selection of additional messages for transmission is performed by pressing the number key corresponding to each message, whereby an asterisk (*) will appear adjacent to the selection. Enter <Esc> then <Y> to confirm the transmission of the selected military messages.

Refer to the previous section, 7.21, “Transmit Coded WMO Messages,” for a more detailed explanation of message transmission. As with WMO message transmission, the exact sequence and format of military message transmission is determined by parameters set via the system Setup Menu and Message Coding Configuration files.

7.23 Set Transmit Data Parameter

To set the ZEEMET Rack Interface module IJ4 serial port parameters for message transmission, select Set Transmit Data Parameters from the Process Coded Message menu. Use of this display is described in detail in the chapter on Setup. It is included in the Process Coded Message menu for convenience. This allows entry of any last minute adjustments if needed during a flight. Normally these parameters are entered from the setup menu. Changes made at this point are saved and used only for the present flight. If permanent changes are desired, record the parameters that have been set and run the Set Transmit Data Parameters from the Setup menu as described in the chapter on setup.

7.24 Report Files

Copies of the reports generated in the Data Analysis Output menu are written to files if and only if a report is accessed from the menu. These files are given standard flight identifier file names with the file extensions listed below and are saved in the flight save directory for the flight when the flight data is saved.

FILE EXTENSION	REPORT
.SUM	PTU Summary
.WSM	Wind Summary
.CSM	Analysis Summary
.FLS	Freezing Level Summary
.RWL	Regional Wind Levels
.SMT	Significant PTU Levels
.SWD	Significant Wind Levels
.SIS	Standard Isobaric Surfaces
.CDS	NCDC Summary
.CMT	CLIMAT Temp Monthly Means

Chapter 8. Flight Utilities

8.1 Introduction

The W-9000 Flight Utilities consists of useful programs which configure, assist and control the operation of the system in various ways. Detailed descriptions of the purpose and use of these utilities are the subject of this chapter.

The Flight Utilities menu, Figure 8-1, can be accessed from either the Flight Preparation menu or the Flight menu. The rest of this chapter describes the utilities available using the menu in Figure 8-1.

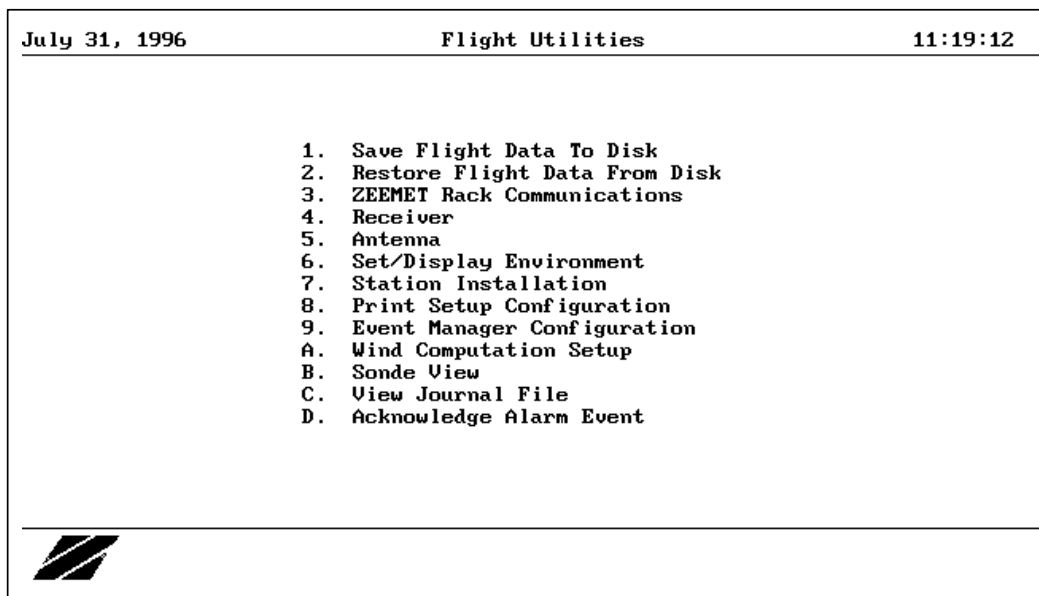

Figure 8-1. Flight Utilities Menu

8.2 Save Flight Data to Disk

All during the flight, data is being temporarily stored in the flights\new directory. All files in this directory will be erased before the start of the next flight. So it is important select this option to permanently save the flight data in the appropriate directories before exiting to the DOS command line; see Chapter 10 for details. Flights whose data has been saved in this way can be restored and simulated at a later time. See Section 8.3 and Chapter 9, Section 9.2, "Off-Line Utility Menu" for details. When the save is complete, a message will appear briefly on the screen telling you that the flight data save has been completed; see Figure 8-2.

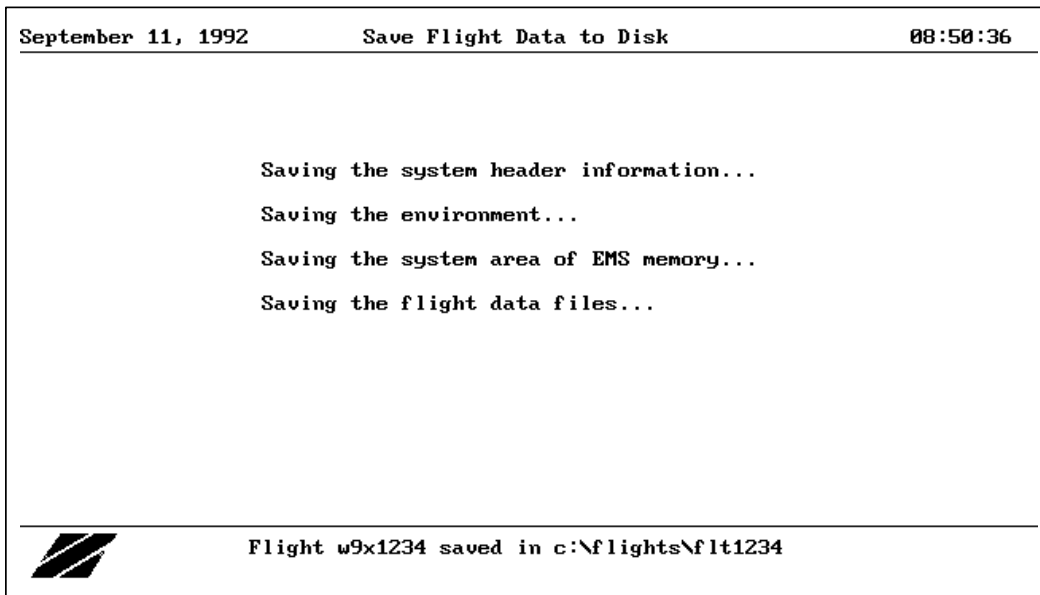

Figure 8-2. Save Flight Data to Disk

This option can be selected more than once and at any time during or after a flight. If used during a flight, only the data acquired up to that point would be saved. If the flight data has been saved previously the computer gives the opportunity to save the flight under a different flight identification number as shown in Figure 8-3.

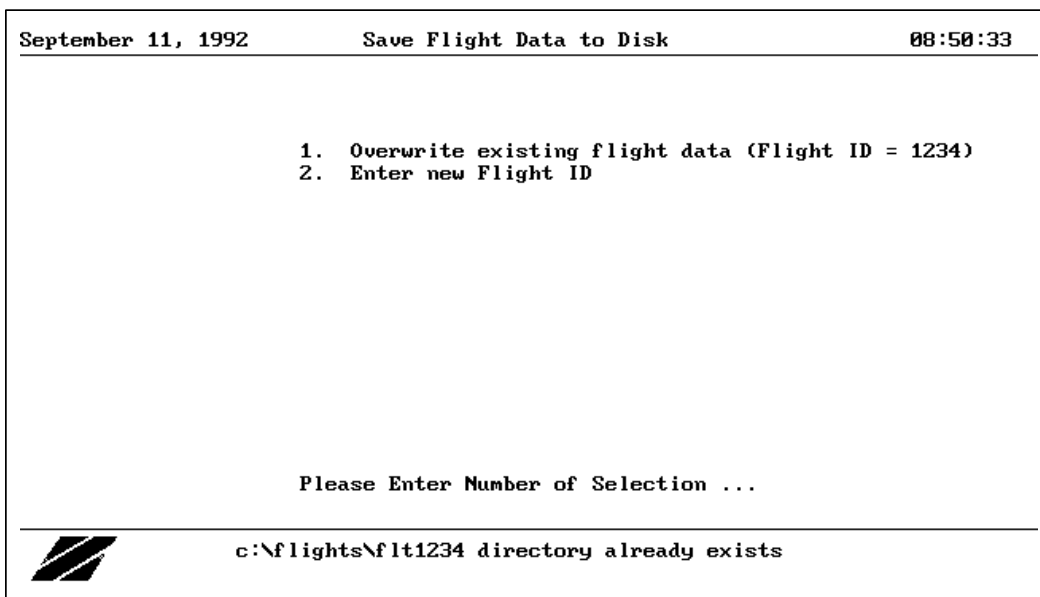

Figure 8-3. Save Flight data to Disk

8.3 Restoring Flight Data from Disk

You may select to restore the flight data of another flight for data analysis. This can be done whenever a real flight is not under way. Figure 8-4 shows a list of flights that are available for restoration. In order to be restored, flight data must be in a subdirectory of the flights directory. Also, there must be a .SAV file available for the flight, which means that the flight data for that flight had been saved previously through the Save Flight Data Utility. A flight is selected or de-selected by pushing the **<Space Bar>**.

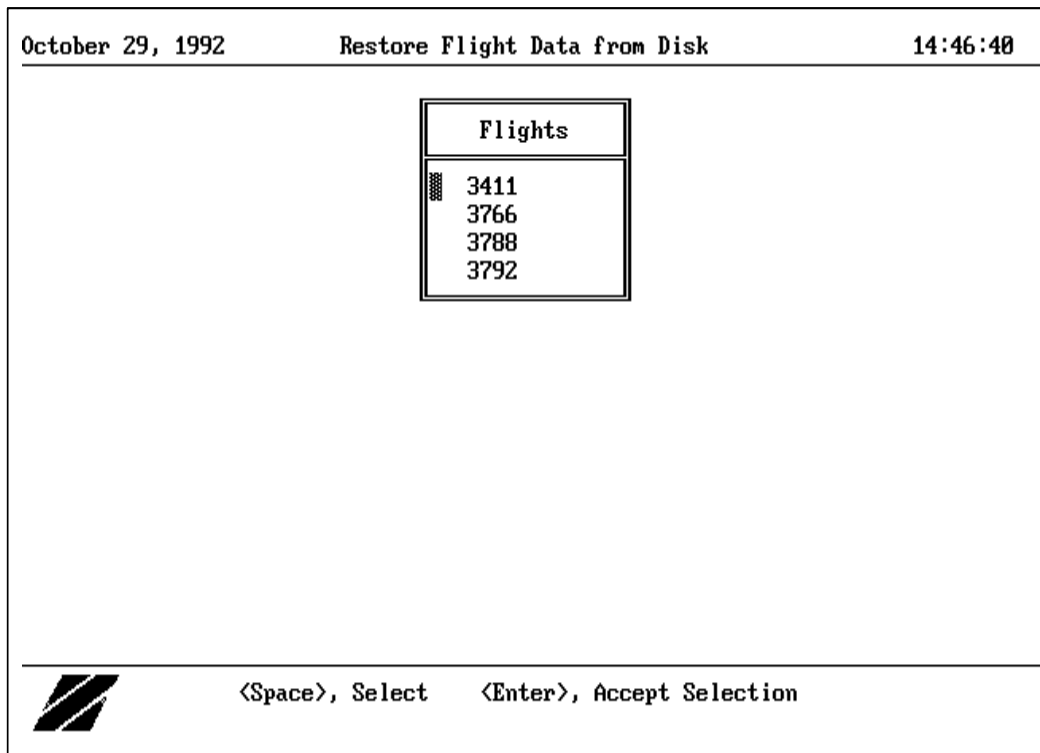

Figure 8-4. Restore Flight Data Menu

Figure 8-5 shows the results when it is done. At this point the system will be in a post-flight state. All normal post-flight data display, and editing functions are available.

```
October 29, 1992          Restore Flight Data from Disk          14:47:32

Restoring Flight 1433766 ...
Restoring a version 3 flight...
Restoring the environment...
Restoring the system area of EMS memory...
Restoring the flight data files...
Restoring the wind data...
Initializing the common area of EMS memory...

Flight 1433766 restored from c:\FLIGHTS\FLT3766\
```

Figure 8-5. Flight Data Restored

8.4 ZEEMET Rack Communications

The W-9000 software in the computer communicates with the ZEEMET Rack by using commands. These ZEEMET Rack commands control the operation of the ZEEMET Rack and get information about the flight from the ZEEMET Rack.

This section describes the various commands used to issue instructions or request information from the ZEEMET Rack. With this utility these commands can be entered via the keyboard, and the ZEEMET Rack response to the command is displayed.

NOTICE *ZEEMET Rack communications are used generally as a troubleshooting facility.*

This feature is not required during normal operation and should only be used by experienced operators. ZEEMET Rack communications can be used at any time—before, during, or after a flight. Some commands may cause improper system operation if they are not invoked at the proper time or in the correct sequence. For example, a flight would be prematurely terminated if the G or the IZ command is invoked to the ZEEMET Rack with the system is in flight mode.

Figure 8-6 illustrates the ZEEMET Rack communications display. A ZEEMET Rack command may be entered from this screen. The response status is 0 if the command is successfully received and processed by the ZEEMET Rack. To repeat a previous command, press the <Enter> key.

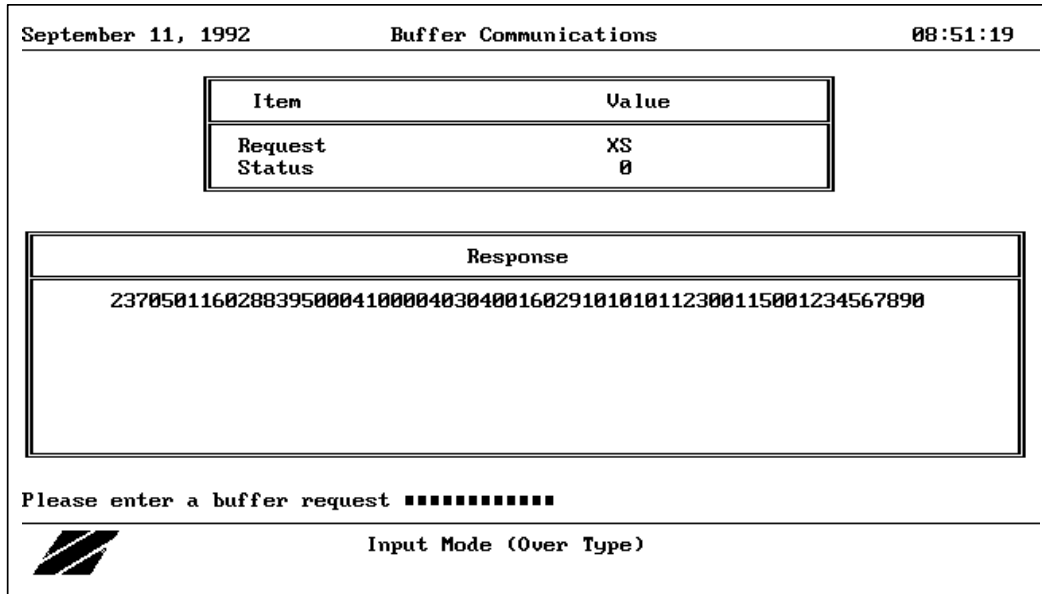

Figure 8-6. ZEEMET Rack Communication

The ZEEMET Rack communications utility is one of many ways to manually communicate with the ZEEMET Rack. Alternatively, communication with the ZEEMET Rack can be performed with a terminal emulation program. Also, the *Simulated terminal with COM1*, or *Simulated terminal with COM2* in the LOADZRCK utility portion of SETUP provides ZEEMET Rack communications.

All responses from the ZEEMET Rack have the command header removed before they are displayed. Also, this utility requires that the commands be in capital letters.

8.5 Version Identifier Commands

IV

Get the version number of the interface module and the tracker.

```
Request:  IV
Response: IVdmmmaaaxxxxx<sp>
          dmmmaaaxxxxx<sp>
          dmmmaaaxxxxx<sp>
          dmmmaaaxxxxx<sp>
          dmmmaaaxxxxx<sp>
          dmmmaaaxxxxx<sp>
          dmmmaaaxxxxx<sp>
          dmmmaaaxxxxx<sp>
```

Where:

```
d = module
  A = Interface
  B = Primary Loran,
  C = Secondary Loran
  D = Omega Tracker
mmm = monitor software version number
aaa = application software version number
xxxxx = special value with this module
```

This command provides the software version number of the interface module and all the tracker modules. The response from the interface module, for example, would be IVA40040000000 B31232009960 000000000000 000000000000 if the ZEEMET Rack has a primary Loran tracker and interface module with 9960 GRI, 3.12 monitor, 3.20 software in the Loran tracker and 4.00 monitor, 4.00 software in interface module itself.

XY

Get the software version and status of the receiver.

```
Request:  XY
Response: Xymmmpppssssss
```

Where:

```
mmm = monitor software version number
ppp = application software version number
ssssss = test status (reserved for future use)
```

For example, response XY312329000000 means monitor version 3.12 with application version 3.29.

X = 0 - sonde not found
1 - sonde found, right ID
2 - sonde found, wrong ID
3 - more than one sonde found with right ID and similar signal strength

bbb = baud rate

eee = AFC reading

ggggg = Sonde's data frame count

cccc = CRC error count

tttt = time in seconds, reset to 0 if over 9999

F

Begin to switch the Navaid tracking signal from local to remote.

Request: **F**

Response: **F**

This command resets real time clocks on the interface and tracker modules and starts the switching to the remote Navaid signal on the trackers.

LD

Allow the Loran trackers to commit to remote Navaid signal.

Request: **LD**

Response: **LD**

This command is sent automatically when launch is detected.

G

Switch the tracking signal to local.

Request: **G**

Response: **G**

This command is used to switch the tracking signal from the remote to the local Navaid signal and to reset the real time clocks in the interface and trackers.

IL

Launch (for the Mark II sonde).

Request: **IL**
Response: **IL** or **ILERR004**

This command resets the real time clock in the receiver module and arms it for a Mark II sonde launch. If at the time the IL command is issued, the receiver hasn't tuned in a sonde with a good data stream, then a ILERR004 is returned. This means that Mark II sonde is no longer transmitting or the receiver is not tuned properly.

II

Enter the ID of the sonde to be searched.

Request: **II#####**
Response: **II**

This command identifies the target Mark II sonde that the receiver searches for. If no sonde ID is entered, the receiver searches for the strongest Mark II sonde signal.

IN

Request the Mark II sonde ID.

Request: **IN**
Response: **IN#####** or **INERR001**

The ID returned is that of the Mark II sonde that is currently being received.

IC2

Request the Mark II calibration data.

Request: **IC2**
Response: **IC2#####.....(64X5 #'s)** or **IC2ERR001**

The calibration data from the Mark II Sonde data stream is saved when the sonde is tuned in. This calibration information is checked by the receiver to guarantee that it is error free.

IT

Request the current receiver module time.

Request: **IT**
Response: **IT#####**

The Mark II receiver responds to this command with the value of its real time clock in tenths of seconds.

IWT

Request the current interface module time.

Request: **IWT**
Response: **IWT#####**

This command returns the interface module's current time in tenths of seconds.

IZ

Initialize the receiver for Mark II flight.

Request: **IZ**
Response: **IZ**

This command resets the Mark II receiver. Once sent, the receiver synchronizes and processes the Mark II data stream if data exists when the command is issued.

LF

Loran flight command.

Request: **LF**
Response: **LF**

This command configures the tracker modules to send only Loran wind data to the interface module and configures the interface to dump Loran wind messages to the system computer.

OF

Omega flight command.

Request: **OF**
Response: **OF**

This command configures the tracker modules to send only Omega wind data to the interface module and configures the interface to dump Omega wind messages to the system computer.

OS

Collect Single Frequency Omega data command.

Request: **OS**
Response: **OS**

This command configures the tracker and interface modules to collect and send only 13.6 kHz Omega wind data to the system computer.

OM

Collect Multi-Frequency Omega data command.

Request: **OM**
Response: **OM**

This command configures the tracker and interface modules to collect and send 10.2 kHz and 11 1/3 kHz as well as 13.6 kHz Omega wind data to the system computer.

RF

Radar flight command.

Request: **RF**
Response: **RF**

This command configures the tracker modules to send only radar wind data to the interface module and configures the interface to dump radar wind messages to the system computer.

EF

End flight command.

Request: **EF**
Response: **EF**

Stops the dump of wind data from Port 1 of the interface module.

R

Set GRI value for primary Loran tracker.

Request: **R#####**
Response: **R**

This command changes the GRI value of the primary Loran tracker and causes it to begin lock up on the new chain.

LR2

Set GRI value of the secondary Loran tracker.

Request: **LR2#####**
Response: **LR2**

This command changes the GRI value of the secondary tracker and causes it to begin lock up on the Loran chain of that GRI.

LH1

Request latest primary Loran TOA.

Request: **LH1**

Response: **LH1tttttssnnccaaaaaassnnccaaaaa..ssnnccaaaaa** or **LH1ERR001**

Where:

tttttt = time in tenths of a second

ssnnccaaaaa = one of five sets of station information

ss = station status 00 to 10

nn = Navaid SNR 00 to 99

cc = Signal Source:

b* - local (ground) (b = blank)

*# - local, but waiting for remote

b# - remote, but not committed

bb - committed to remote

aaaaaa = time of arrival (TOA)

This command returns the latest time of arrival data collected by the primary tracker. If no data has been collected then the response is LH1ERR001.

The five data sets in this command are the arrival times (TOA) of the master station and up to four secondary stations. The data of a secondary station will be zeros if that station's signal is not fully acquired. The SNR value is a measure of the signal quality of the Loran station. The TOA, station status, and SNR signal are taken from the indicated signal source (local or remote).

LH2

Request the latest TOA from the secondary Loran tracker.

Request: **LH2**

Response: **LH2**(same as LH1 - see above)

The command gets from interface module the latest time of arrival data collected by the secondary tracker. See LH1 for details.

8.7 403 MHz Receiver Commands

XA

Set AFC reference level.

Request: **XA###**

Response: **XA**

Sets the reference level of the automatic frequency control operating point. **Normally, no change of this value is required.** Only trained technical personnel should use this command, since the value is set individually for each unit at the factory.

XCY/XCN

Enable/Disable receiver tuning.

Request: **XCY/XCN**

Response: **XCY/XCN** or **XCYERR003**

Automatic tuning continuously optimizes the reception of an already acquired sonde signal by matching the local oscillator frequency with the sonde frequency. Automatic tuning is enabled by default and should not be disabled except by trained technical personnel.

XDY/XDN

Enable/Disable diagnostic data output.

Request: **XDY/XDN**

Response: **XDY / XDN** or **XDYERR003**

Enable or disable the receiver to dump maintenance and debugging information to serial port 2. This is only for diagnostic purposes. The dump includes time, frequency, deviation, AFC reading, smoothed AFC values, baud rate, LO1 value and LO2 value.

XEY/XEN

Enable / Disable decode by Mark II data.

Request: **XEY/XEN**

Response: **XEY / XEN** or **XEYERR003**

Enables and disables the receiver ability to decode the raw Mark II data stream. By default it is enabled. This command is useful for problem checking and should be used by technical personnel only.

XFY/XFN

]Enable / Disable search by signal strength.

Request: **XFY/XFN**

Response: **XFY / XFN** or **XFYERR003**

Enable and disable the receiver to find the sonde signal that is greater than the default threshold. It will stop searching when it finds a suitable signal. Alternately the command, XFN, could be used to stop it before that. During the finding procedure the receiver dumps the status reports to serial port 2. This command is not for normal situations. It is recommended that only technical people could use this command because sonde data is lost during the signal search.

XGY/XGN

Disable/Enable Mark II sonde search.

Request: **XGY/XGN**

Response: **XGY / XGN** or **XGYERR003**

Enable and Disable a search for a sonde by scanning the frequency range. If the receiver has been given an ID number via the II command, that sonde is search subject. Otherwise the sonde of greatest strength is selected. The search of the frequency range takes 0.5 to 3 minutes, depending on the number of sonde signals and the threshold level for searching.

XGD

Request Scan data.

Request: **XGD#**

Response: **XGDffffffffffiiiiiiisssffffffiiiiiiisssc**, **XGDERR001** or **XGDERR004**

Where:

= nth pair, n=1,...,5

ffffff = frequency in kHz

iiiiiii = sonde ID, if Mark II

sss = signal strength

c = continuation flag: 1 for more; 0 for no more

Requests the nth pair of sonde information after the receiver has scanned the frequency range looking for Mark II sondes. If scan is not complete, XGDERR004 is returned. If no sondes are found, XGDERR001 is returned. Otherwise, the data is returned in pair-wise fashion.

XH

Set scan step size.

Request: **XH###**
Response: **XH**

This sets the receiver's frequency increment during scans. The increment is the specified number multiplied by 32 kHz. Don't use this command to change the default value (288KHz), because that will affect the scanning range of command XRY.

XJY/XJN

Enable/Disable MKII data demodulation.

Request: **XJY/XJY**
Response: **XJY / XJY** or **XJYERR003**

Enable and disable Mark II sonde data demodulation. This feature is enabled by default, so use of this command is not necessary and not recommended.

XL

Set lower search frequency boundary.

Request: **XL#####**
Response: **XL**

This command is to set the low boundary of the search frequency range. The default value is 395000 kHz. It is not necessary to use this command in normal situations.

XMA

Enable Port 2 buffered Mark II data dumping.

Request: **XMA**
Response: **XMA**

This enables automatic dump of the received Mark II sonde data stream to serial port 2 (RJ2). The output is in ASCII character format. Only validated sonde data frames are dumped.

XMB

Enable binary dumping with ACK/NAK handshake.

Request: **XMB**
Response: **XMB**

This enables the receiver to dump Mark II data to serial port 2 in binary format with hand-shake code. The total data length is 50 bytes per record. Each record has a 3-byte header (FF,FF,4D) and 2-byte tail (00, 01). Data is in the following order: time, rx cnt, sonde cnt, ref,P,T,U,4 spares, and stuffing bytes. The stuffing bytes are 00. All data fields are 2 bytes except that the time is 4 bytes.

XMD

Enable Port 1 buffered MKII data dumping.

Request: **XMD**
Response: **XMD**

This enables automatic dumping of the received Mark II sonde data stream to serial port 1 (RJ1). The output is in the ASCII character format. Only validated sonde data frames are dumped.

XMH

Enable hexadecimal raw met data dumping.

Request: **XMH**
Response: **XMH**

This enables the receiver to dump to serial port 2 the raw Mark II data frames in hexadecimal format.

XMN

Disable Port 2 data dumps.

Request: **XMN**
Response: **XMN**

This disables the receiver Port 2 dumps.

XMS

Disable Port 1 data dumps.

Request: **XMS**
Response: **XMS**

This disables the receiver Port 1 dumps.

XNY/XNN

Enable/Disable data formatting.

Request: **XNY/XNN**
Response: **XNY / XNN** or **XNYERR003**

Enable and disable the receiver to validate, format and store the sonde data stream. This feature is enabled by default and use of these commands is not recommended.

XO1/XO2

Set frequency of Local Oscillator.

Request: **XO1####** or **XO2####**
Response: **XO1** or **XO2**

There are two local oscillators, LO1 and LO2, that can be set by these receiver commands to specific frequencies. LO1 is varied in 512 kHz steps, while LO2 in 32 kHz step. It is strongly suggested that only technical people use these commands. The XQ command performs the same function.

XPY/XPN

Turn on/off preamplifier power.

Request: **XPY/XPN**
Response: **XPY / XPN**

Switches preamplifier power on and off; power on is the default.

XQ

Set the local oscillator frequency.

Request: **XQ#####**
Response: **XQsss**

Where:

sss = signal strength at the selected frequency
c = AFC on/off status

This sets the receivers frequency and gets the signal strength at that frequency. For example, command XQ403000 would set the receiver to 403MHz.

XRY/XRN

Enable/Disable spectrum scan.

Request: **XRY/XRN**
Response: **XRY / XRN** or **XRYERR003**

Enable and disable the receiver to scan the frequency range 395 to 410 MHz in 288 kHz steps. The signal strength is measured at every frequency. Data loss with XRY is unavoidable, since the receiver performs the scan periodically.

XRD

Request frequency spectrum.

Request: **XRD**
Response: **XRDffffffsssffffffsss...ffffffsss**

Where:

ffffff = frequency
sss = signal strength

Gets the result of the signal strength spectrum established by the XRY command. There are 53 records in total.

XT

Set signal strength threshold.

Request: **XT###**
Response: **XT**

This sets the receiver's threshold value used during tuning or searching. The default value is 30.

XU

Set highest search frequency.

Request: **XU#####**
Response: **XU**

This sets the high boundary of the frequency scan. The default values is 410000 kHz. Using this command is not recommended.

XV

Set audio level.

Request: **XV###**
Response: **XV**

The speaker in the ZEEMET Rack allows the operator to hear the received baseband signal. This command sets the volume of that speaker. The smaller the value, the louder the sound. The value range is 0 and 255.

XW

Get the times of the external launch signal.

Request: **XW**
Response: **XWPPPPP<sp>PPPPP<sp>....<sp>PPPPP<sp>**

Where **PPPPP** is time in tenths of a second units. There are 150 records total. The unused records are zero. An external signal may be used for either periodic synchronization or launch indicator. When the active-low signal comes, the receiver would records the time in the next location of the XW buffer.

8.8 Decoder Commands

Some systems have a Decoder instead of a RX403 receiver. These are the commands that can be used with the Decoder.

DP

Dump PTU Data.

Request: **DP#**
Response: **DP#**

Where # is 1 or 2 for Port 1 or Port 2.

Begin data dump in PTU format. Port 2 is enabled by default and Port 1 is not.

DA

Dump ASCII data.

Request: **DA#**
Response: **DA#**

Where # is 1 or 2 for Port 1 or Port 2.

Begin data dump in character based format. Neither port has this dump enabled by default.

DH2

Dump hexadecimal data.

Request: **DH2**

Response: **DH2**

Begin data dump in binary based format. Only Port 2 can dump in this mode. This dump is not enabled by default.

DN

Stop dump.

Request: **DN#**

Response: **DN#**

Where # is 1 or 2 for Port 1 or Port 2.

Stop data dump at port specified.

XY

Get the software version .

Request: **XY**

Response: **XYmmmPPSSSSSSSS**

Where:

mmm = monitor version

PPP = application version

SSSSSSS = test status (reserved for future use).

For example, response "XY3123290000000" means monitor version 3.12 with application version 3.29.

XZ

Send pressure offset .

Request: **XZ**

Response: **XZs#**

Where:

s = + (plus) or - (minus)

= offset in tenths of millibars

Modifies the calculation for the dumped pressure. For example, XZ+10 will increase the dumped pressure by one millibar.

IC2

Request the MK II calibration data.

Request: **IC2**
Response: **IC2#####.....(64X5 #s) or IC2ERR001**

The calibration data from the Mark II Sonde data stream is saved when the sonde data stream starts. This calibration information is checked to guarantee that it is error free.

IT

Request the current receiver time.

Request: **IT**
Response: **IT#####**

This is the time in tenths of a second since reset or launch.

IL

Launch the Mark II sonde.

Request: **IL**
Response: **IL or ILERR004**

This command arms for launch (Mark II sonde). "IL" resets the time, clears the received data buffer and starts to collect data records.

IZ

Initialize the receiver for Mark II flight.

Request: **IZ**
Response: **IZ**

This command is used to reset the Decoder.

AM/AY

Antenna selection.

Request: **AM/AY**
Response: **AM / AY**

This command activates either the Mono or the Yagi(s) antenna.

AO

Read the antenna status.

Request: **AO**
Response: **AODDDVVVLLLHHHWWCCCSFM**

Where:

DDD = current position in degrees
VVV = current voltage reading
LLL = table's lowest reading
HHH = table's highest reading
WWW = most likely wind azimuth
CCC = rotor cycle time in tenths of second
S = Initialization status
 0 = no initialization
 1 = successfully done
 2 = under initialization
F = Antenna type
 0 = Yagi
 1 = Omni
M = movement status
 0 = Antenna isn't moving
 1 = Antenna is moving

Only the F and M fields apply to electronic antennas.

AP

Move antenna to specific position (in degrees).

Request: **AP###**
Response: **AP** or **APERR004**

Where ### is 000 to 360 degrees.

This move the antenna to the specified position. If the antenna is a rotor type and initialization has not been done, APERR004 is returned.

AC

Set rotor cycle time.

Request: **AC###**

Response: **AC**

Where **###** is cycle time in tenths of a second.

This command is used to set the rotation time for antenna. The more accurate the values, the better the antenna positioning performance will be, since the ZEEMET Rack bases rotor rotation times on this value.

AD

Load the calibration table.

Request: **AD###...###(25 ###)**

Response: **AD**

This loads the calibration table that has been read previously and stored in system storage. The 25, 3 digit numbers are ADC readings of the rotor potentiometer at 15 degree increments.

AI

Antenna initialization.

Request: **AI**

Response: **AI** or **AIERR003**

This command is required when installing the system at a new site. It builds the table of voltage reading from the antenna rotor. Initialization takes two minute to complete. **AIERR003** is returned if initialization in progress. To properly calibrate the antenna during installation, follow this procedure:

1. Use the AO command to get the antenna status and check if initialization has been done
2. If initialization is not done, send the antenna rotation cycle time with the AC command; the default values is 504.
3. Send the AI command to initialize the antenna, and wait for completion—about 2 minutes.
4. Move the antenna by the stand so that it points in the most likely wind direction.
5. Secure the antenna stand,
6. Use the AN command to enter the degree of the most likely wind azimuth.

The direction must match the direction of the center of antenna rotator. After completing this initialization, the calibration table can be read for future table loading.

AL/AR

Move antenna left/right.

Request: **AL/AR**

Response: **AL/AR**

AL moves the antenna left and AR moves the antenna right. Movement stops at the rotor end or with command AS or AH.

AN

Set the most likely wind azimuth.

Request: **AN###**

Response: **AN**

This command is part of antenna installation. The purpose for this command is to set the rotor's center of movement to the most likely wind direction.

AH

Halt antenna movement.

Request: **AH**

Response: **AH**

S
tops the antenna and without turning on the brake.

AS

Stop antenna movement.

Request: **AS**

Response: **AS**

Stops the antenna and turns on the brake.

AT

Read calibration table.

Request: **AT**

Response: **AT###...###(25 ###)**

This reads the calibration table. The table is 0 before initialization.

AW

Read rotor voltage.

Request: **AW**
Response: **AWT###**

The rotor voltage measures the direction the rotor is pointing the antenna. The measurement is a three digit number from 0 to 256, which must be converted to degrees by the table of the AD/AT commands.

8.10 Coded Message Transmission Commands

Coded messages can be transmitted from the IJ4 port of the ZEEMET Rack interface module to other peripherals with serial communication capability, such as puncher, printer, and computer. The interface module has 2048 bytes available to store messages. The maximum individual message length is 80 bytes. Preamble and postamble character strings (up to 20 bytes each) can be specified. These are added to each message when transmitted. Different baud rates, data formats, and character sets are available. Also see “W9000 Coded Message Transmission” for reference.

IBA

Set message postamble.

Request: **IBAnn##...##**
Response: **IBA** or **IBAERR002** if nn is out of range

Where:

nn = value between 00 to 80
##...## are the postamble characters

This sets the postamble as the first nn bytes of the 80 byte string. Because of the System Computer uses a fixed length for every command, those unused characters are padded with '0' if the postamble is shorter than 80 bytes.

IBB

Set message preamble.

Request: **IBBnn##...##**
Response: **IBB** or **IBBERR002** if nn is out of range

Where:

nn is value between 00 to 80
##...## are the preamble characters

This sets the postamble as the first nn bytes of the 80 byte string. Because of the System Computer uses fixed lengths for every command, the message is padded with unused characters set to 0.

IBC

Clear message buffer.

Request: **IBC**
Response: **IBC**

This clears the 2048 byte message buffer.

IBS

Check message buffer status.

Request: **IBS**
Response: **IBSabcdefg**

Where:

- a** = 0 indicates message transmission still in progress
= 1 indicates message transmission is complete
- b** = 0 indicates message body has not all been sent
= 1 indicates message body has all been sent
- cdefg** = always 0 (reserved for future use)

IBM

Put message in buffer.

Request: **IBMnn##....##**
Response: **IBM** or
IBMERR002 if nn is out of range, or
IBMERR005 if the accumulated buffer is bigger than 2048 bytes

Where **nn** = number of bytes in the message, between 00 and 80

This puts the specified message in the buffer. Messages can be of any length up to 80 characters. The System Computer uses a fixed length for every command, so a message shorter than 80 characters should be padded with zeros. Padding characters are not stored in the buffer; just the message is stored. Also, all carriage return and line feed characters embedded in the message should be converted to 0xFE and 0xFD. The interface converts them back during transmission to the peripheral.

IBO

Initiate message output.

Request: **IBO**
Response: **IBO** or **IBOERR001** if no data in buffer

This starts the transmission of the messages that are in the interface's buffer.

IMC

Set output character coding.

Request: **IMC#**

Response: **IMC**

Where # is A for ASCII or B for Baudot.

This selects the character set used during message transmission. Two character sets, ASCII and Baudot, are provided.

IMS

Set output port parameter.

Request: **IMSnm**

Response: **IMS**

Where:

n = 00<bit5><bit4><bit3><bit2><bit1><bit0>

<bit5> = 1/0 for two or one stop bit

<bit4> = 1/0 for echo or no echo

<bit3><bit2><bit1><bit0> = baud rate:

0000 for 50

0001 for 109.2

0010 for 134.58

0011 for 150

0100 for 300

0101 for 600

0110 for 1200

0111 for 1800

1000 for 2400

1001 for 3600

1010 for 4800

1011 for 7200

1100 for 9600

1101 for 19200

1110 for 38400

1111 for extern clock

(continued)

IMS (continued)

m = 1<bit6><bit5><bit4><bit3><bit2><bit1><bit0>:
 <bit6><bit5> is the number of data bits:
 00 for 5
 01 for 6
 10 for 7
 11 for 8
 <bit4><bit3> = parity mode:
 00 for odd
 01 for even
 10 for mark
 11 for space
 <bit2> = parity enable - 1/0 for enable/disable
 <bit1> = DTR state - 1/0 for high/low
 <bit0> = RTS state - 1/0 for high/low

This sets the output port parameters, such as number of data bits, parity bit, and baud rate. For Puncher GNT 3601, those two bytes are 24 and DC (hex), respectively.

IBP

Select output port.

Request: **IB#**
 Response: **IBC**

Selects which port the data is transmitted from. Two ports are possible: use IBP4 to select IJ4, which is the standard message coding transmission port, and use IBP2 to select IJ2 the alternate serial port.

IMP

Set output protocol.

Request: **IMP##**
 Response: **IMP**

Where ## specifies which protocol is used for the message output. 00 is used for straight dumping without handshake. Other protocols will be added later, as required.

8.11 Maintenance Commands

CA1

Adjust the crystal frequency.

Request: **CA1** or **CA0**

Response: **CA1** or **CA0**

Adjusts the interface's crystal oscillator. CA1 increases and CA0 decreases the crystal's frequency. The accuracy of the crystal in the interface module is critical since the tracker modules use it as a reference when acquiring and measuring the Loran and Omega Navaid signals. Once the trackers have acquired the Loran signal, this adjustment is performed automatically. Manual adjustment requires the use of a calibrated high resolution counter.

CH

Set default Loran launch offset.

Request: **CH#**

Response: **CH**

When switching from the local Navaid signal to the remote, the Loran tracker compensates for the sonde transponder delay by offsetting the Loran acquisition time base by several 10-microsecond cycles. Any change to the default value (5 cycles for the Mark II sonde) is not recommended.

MM

Switch to monitor program.

Request: **MM**

Response: **MM**

This command halts all application software activity and initiates the underlying monitor program. It is the first step to download new application software. Use of this command renders the module inoperable and the only method of recovery is downloading.

8.12 Error Messages

The ZEEMET Rack responds with an error message if it process a received command. These messages are listed in Appendix B.

8.13 Receiver

The receiver display has three functions: receiver status, receiver spectrum analysis, and receiver tuning.

Receiver Status Display

Upon entering the Receiver utility, the Receiver Status is display as shown in the figure 8-7 below.

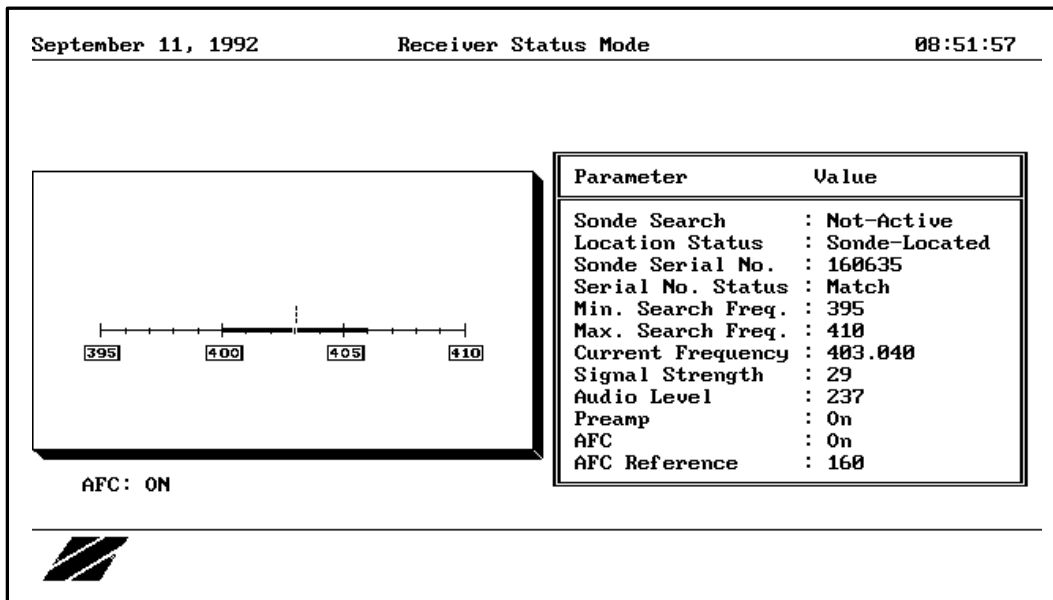

Figure 8-7. Receiver Status Display

The Receiver Status display provides information regarding the current state of the receiver. The left half of the display contains a graphic plot showing the current frequency and signal strength. This graphic is continuously updated.

The right half of the screen provides additional information regarding the current status of the receiver as follows:

Sonde Search

Indicates the current status of the automatic tune mode. If it says "Active" then the receiver is currently searching for the sonde. If it says "Not Active" then the automatic tune mode is no longer active. If it is not active, and the sonde transmission is no longer being received, then manual tuning is indicated.

Location Status

Indicates whether or not the receiver is currently detecting a sonde data stream. In the case of the Mark II sonde the value Located means the receiver is detecting the sonde with the specified sonde serial number.

Sonde Serial No.

Shows the serial number of the Mark II sonde that is currently being received.

Serial No. Status

Indicates if the sonde serial number entered in the flight identifier initialization screen matches the sonde serial number detected in the sonde data stream. If it does it will say "Match".

Min. Search Freq.

Tells the frequency that the automatic tune mode begins its search for the Mark II sonde. This value can be adjusted using the Station Installation Utility.

Max. Search Freq.

Is the frequency that the automatic tune mode ends its search for the sonde.

Current Frequency

Provides a digital indication of the frequency currently being monitored by the receiver.

Signal Strength

Provides a digital indication of the signal strength at the indicated frequency. The number is in the range of 0 to 255. It provides a measure of relative signal strength, with 255 representing the maximum signal strength.

Audio Level

Provides information regarding the current audio level of the receiver. The range is 0 - 255, with 255 being the maximum audio level. The audio level can be adjusted in the tune mode, using the up and down arrow keys. The audio level can sometimes be used as an aid when manually tuning the receiver.

Preamp

Provides feedback as to the state of the preamplifier. This state can be toggled in the receiver status display with <Alt-P>.

AFC

Indicates the current status of the AFC (Automatic Frequency Control). The AFC status can be toggled ON or OFF in the Status display by pressing <Alt-A>.

AFC Reference

Indicates the sensitivity of the AFC. This value should only be adjusted by a trained technician. The value can be adjusted in the Station Installation Utility.

Receiver Action Keys**<Esc>**

While in the Receiver Status display, returns to the Flight Preparation or Utility menus, depending on whether a flight is in progress.

<Alt-S>

Activate the Receiver Scan display.

<Alt-T>

Activates the receiver tuning display.

Receiver Spectrum Display

<Alt-S> invokes the Spectrum display. It provides a spectrum analysis from 395-410 MHz. The receiver samples each frequency in increments of 288 kHz and graphs the relative signal strength observed at each frequency with a yellow bar. Figure 8-7 shows this display.

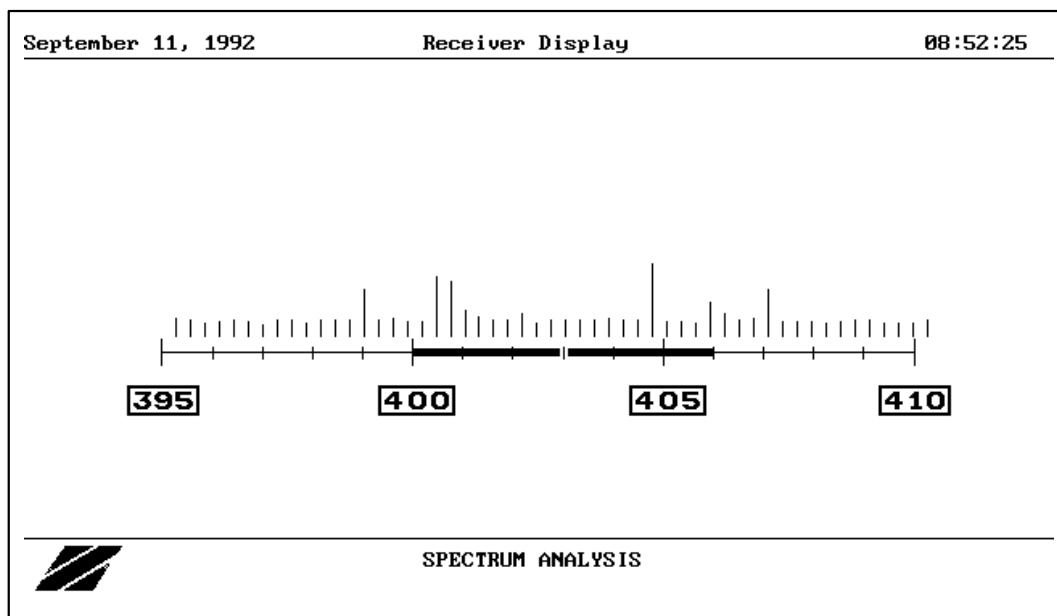

Figure8-8. Receiver Spectrum Display

A period of several seconds is required to provide a complete sweep of the spectrum. With each plotting cycle, it will only update a small section of the display.

The Spectrum display helps locate interfering transmissions that are active in the band. It is very useful in identifying the best frequency, to set the sonde, within the meteorological band (400 - 406 MHz). Once the sonde is transmitting, the signal will appear on the Spectrum display at the frequency at which it is transmitting as a cluster of signal strengths with relatively high values. To exit the Spectrum display press <Esc> to return to the Receiver Status display.

Receiver Tune Display

Figure 8-9 shows the receiver tune display.

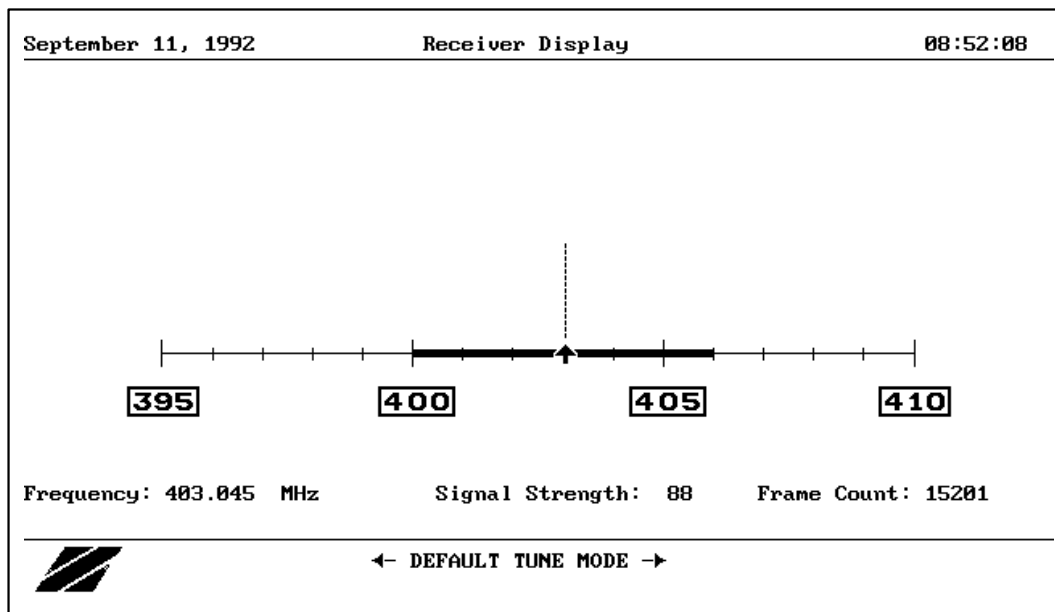

Figure 8-9. Receiver Tune display

Press <Alt-T> in either the Status display or the Spectrum display to activate the Tune display. When the Tune display is active, a tuning arrow appears on the screen. The tuning arrow points to the current frequency being monitored by the receiver. There is a precise digital indication of this frequency printed in the lower left region of the screen. This updates as you move the tuning arrow.

To tune to the frequency in which the sonde is transmitting, as indicated in the Spectrum display, move the arrow to the desired frequency. The left cursor arrow (cursor movement keys) moves the tuning arrow left to a lower frequency. The right cursor arrow moves the tuning arrow to the right to a higher frequency. On the default tuning display, each keystroke changes the location of the tuning arrow by 96 kHz. Should a finer adjustment be desired, the <F3> key toggles to a mode that allows the receiver to be tuned in 32 kHz steps.

In addition to calling the Scan display, you can control the volume and AFC status from the Tune display.

If a spectrum was done before entering the Tune Mode, you can still see the old data traces (yellow signal strength indications) plotted in gray to indicate that the spectrum information is old. To see these old traces, turn up the contrast on the monitor.

Automatic Frequency Control

Once the receiver has been tuned to the desired frequency, press <Alt-A> to turn on the Automatic Frequency Control. AFC enables the receiver to continue to track the sonde transmission automatically,

if its frequency starts to drift during the flight. The AFC can be toggled on or off in either the Status Mode or the Tune Mode by pressing <Alt-A>.

Receiver Volume Control

The audio level of the receiver can be toggled in the Tune display by using the up and down cursor arrow keys, which can be found on the numeric key pad. To exit the Tune display, press <Esc>. This will reactivate the Status display.

8.14 Antenna

The system can be configured to automatically adjust the antenna based on the azimuth information made available through processing wind data. Also, it can be manually controlled through the system software by selecting item #5 on the Utility menu. This invokes the antenna display, which is shown in Figure 810.

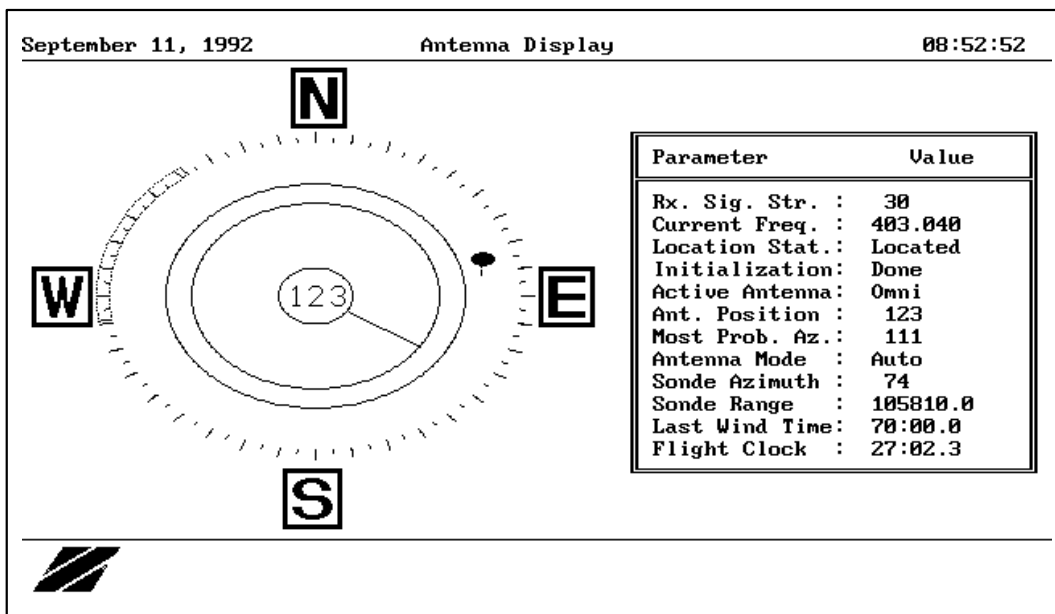

Figure 8-10. Antenna Display

The antenna display can be viewed within the context of a compass rose with north at the top of the screen. When available the orientation of the Yagi antenna in compass degrees relative to north is shown on the display as a red line (antenna position line) extending from the center most circle (heading circle).

In Figure 8-10, the antenna has a heading of 123 degrees. This is shown by the antenna position line as well as the digital value of the heading shown in the center heading circle.

The Yagi antenna is moved one degree at a time with each push of the left and right arrow keys; or, 45 degrees at a time with each push of the tab key. When one of these direction keys is pressed the green antenna pointing bar appears in the gray track. This is shown in Figure 8-11. The pointing bar will move in the track for as long as a direction key is pressed. The direction in which it is pointing will appear in the center most circle, just below the heading of the yagi antenna.

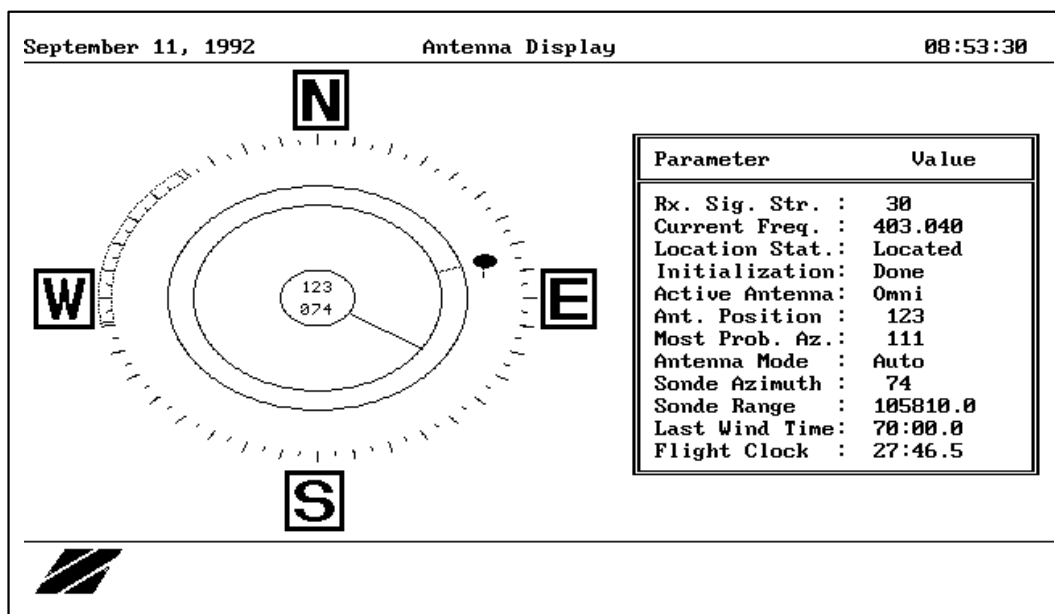

Figure 8-11. Antenna Display

In the example, the antenna is currently pointing to 123 degrees, while the antenna pointing bar has been moved to point to 74 degrees. Stop pressing the direction key when the green pointing bar is oriented in the desired antenna position and the antenna will move to that heading (or as close to that heading as possible). The antenna progress will update as it turns. Also, the pointing bar will no longer be displayed as soon as the antenna reaches its destination.

As an aid in determining where to point the antenna an icon of a balloon and sonde appears on the display at the last known azimuth to the sonde. The time of this information can be determined by looking at the last known wind time, which is shown in the antenna parameter box on the right hand side of the screen.

Antenna Action Keys

<Left Arrow>

Rotates green pointing bar counter-clockwise, one degree for each press.

<Right Arrow>

Rotates green pointing bar clockwise, one degree for each press.

<Tab>

Rotates green pointing bar clockwise, 45 degrees with each press. This allows rapid movement to any region in the antenna rose.

<Alt-A>

Antenna Select Toggle, toggles between the Yagi and the Omni Antenna.

<Alt-M>

Antenna Mode Toggle, toggles between automatic and manual mode.

<Alt-H>

Antenna Break, halts the antenna while it is turning.

<Esc>

Exit the Antenna Display

8.15 Print Setup Configuration

This option is used to print a status report on flight configuration parameters set while using the Setup utility and the Flight menu. These include parameters for Station, Receiver and Wind Finding Installation as well as for Antenna, Receiver and Event Manager Configuration.

8.16 Station Installation

This utility can also be accessed through the Setup menu. The difference is that the updates made through this flight utility only affect the current flight. Updates made through the Setup menu affect all flights afterwards. See Chapter 3 for details.

8.17 Event Manager Configuration

This utility can also be accessed through the Setup menu as well. The difference mentioned above applies here also. See Chapter 3 for details.

8.18 Wind Computation Setup

This utility can also be accessed through the Setup menu as well. The difference mentioned above applies here also. See Chapter 3 for details.

8.19 Sonde View

Sonde View displays raw and processed radiosonde data. Sonde View is included as a utility so that it can be accessed during flight preparation. During flight, Sonde View can also be accessed via the Data Display menu. See Chapter 6 for details.

8.20 View Journal File

The journal file records significant and unusual events during a flight. It also records configuration details. The journal file is used primarily as debugging tool when problems occur. Appendix B describes the format of error messages in the journal file.

8.21 Acknowledge Alarm event

In the event that radio contact with the sonde is lost, an audible alarm goes off. To turn off the alarm, select Acknowledge Alarm Event in the Flight menu.

8.22 Index to ZEEMET Rack Commands

The following index is for the ZEEMET Rack commands listed in Section 8.5. It consists of the command followed by the page number.

COMMAND	PAGE	COMMAND	PAGE	COMMAND	PAGE
AB	23	IMC	29	XGY	15
AC	24	IMH	12,23	XH	16
AD	24	IMP	30	XJN	16
AH	26	IMS	29	XJY	16
AI	25	IN	9	XL	16
AL	26	IOH	12	XMA	16
AM	24	IS	7	XMB	17
AN	26	IT	9,22	XMD	17
AO	24	IV	5	XMH	17
AP	24	IWT	10	XMN	17
AR	26	IZ	8,22	XMS	17
AS	26	LD	8	XNN	18
AT	26	LF	10	XNY	18
AW	27	LH1	13	XO1	18
AY	24	LH2	13	XO2	18
CA1	31	LR2	11	XPN	18
CH	31	MM	31	XPY	18
DA	20	OF	10	XQ	18
DH2	21	OM	11	XRD	19
DN	21	OS	10	XRN	19
DP	20	R	11	XRY	19
EF	11	RF	11	XS	7
F	8	RO	12	XT	19
G	8	XA	14	XU	19
IBA	27	XCN	14	XV	6,20
IBB	27	XCY	14	XW	20
IBC	28	SDN	14	XY	21
IBM	28	XDY	14	XZ	21
IBO	28	XEN	14		
IBP	30	XEY	14		
IBS	28	XFN	15		
IC2	9,22	XFY	15		
II	9	XGD	15		
IL	9,22	XGN	15		

This page intentionally left blank.

Chapter 9. Off-Line Utilities

9.1 Introduction to Off-Line Utilities

The W-9000 System software includes several utility programs for working with the data files produced during flights and for working with the system hardware. This chapter describes how to use these utility programs. These programs are called off-line utilities because they are used only during times that the system is not actively performing flight functions.

The utilities include the following:

- Utility - an off-line utility menu.
- Binutil - a binary file conversion utility.
- Avgmet - an averaging binary file conversion utility.
- Capture - a program for communication with the ZEEMET Rack via the computer serial ports.
- Grapher - a program package for making printed graphs of flight data.

9.2 Off-Line Utility Menu

The Off-Line Utility menu is a program that enables you to work with system flight data files without having to know the details of the files and without having to know how to use MS DOS commands. To start operation of the Off-Line Utility menu type:

utility <Enter>

In response, an Off-Line Utility menu like in Figure 9-1 will be displayed. Some items can be missing depending on your system options.

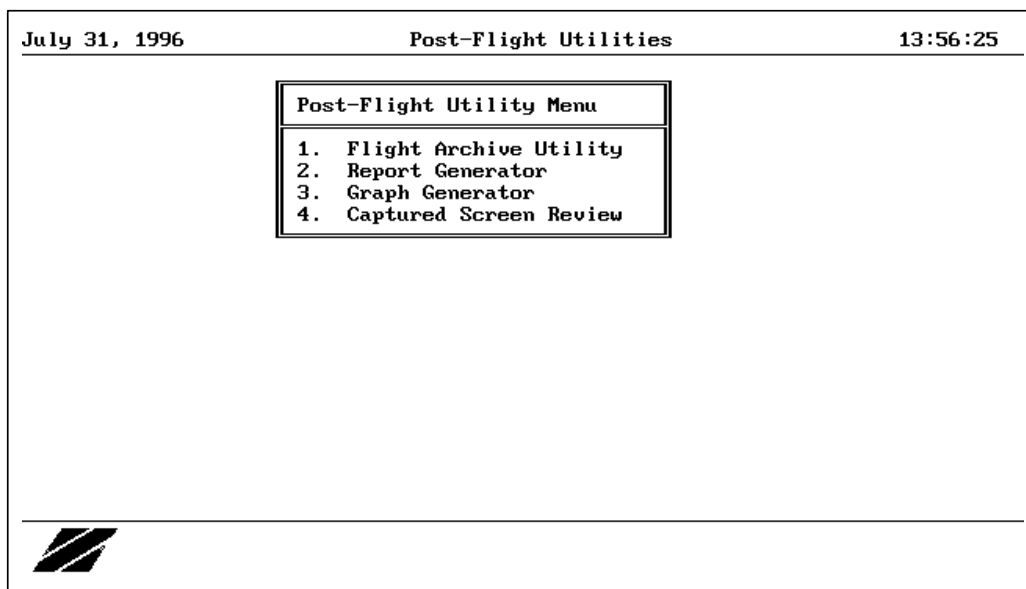

Figure 9-1. Post-Flight Utilities Menu

Flight Archive Utility

Selecting Flight Archive Utility runs the Flight Data Management Utility that is used to review the list of already saved (archived) flight data files, select one, and make it the currently active flight. Files containing active flight data can be: copied to diskette, copied from diskette, deleted from the hard disk, viewed on the screen, or restored as the active flight. Also, the active flight is that used when you select one of the other options in this menu. If you do not select this option, the active flight is the last flown, restored, or simulated.

Chapter 10 describes the W-9000 flight data files and how to use the Flight Management Utility. Refer to Chapter 10 for Flight Management Utility operating details.

Report Generator

Selecting Report Generator runs the Report Generator Utility. This software is an option of the W-9000 System software. Only if this option was purchased and installed will it appear in the menu.

Use Report Generator option to generate status reports on system configuration parameters for the active (restored) flight. To report data for a different flight:

1. Press <Esc> to return to the Off-Line Utility Menu
2. Select the first item (Flight Archive Utility)
3. Choose a flight and restore it (make it the active file).

Refer to “Data Display” in Chapter 6 for instructions on the use of the Report Generator Utility program.

Graph Generator

Selecting Graph Generator runs the Graphic Display Utility. This software is an option of the W-9000 System Software. Only if this option was purchased and installed will it appear in the menu.

When you select Graph Generator, a menu offering displays of flight data in graphic form will be presented. The graphic displays will use the data of the currently active, restored flight. To view data for a different flight:

1. Press <Esc> to return to the Off-Line Utility Menu
2. Select the first item (Flight Archive Utility)
3. Choose a flight and restore it (make it the active file).

Refer to “Data Display” in Chapter 6 for instructions on the use of the Graphic Display Utility program.

Captured Screen Review

When this item is selected, a menu similar to Figure 9-2 will be displayed. The upper window in the display shows the flight identifier entered by the operator when the active flight was underway. At any time during the flight, you could have pressed <Print Screen> and captured the then current image on the screen, thus saving it to a file (see “Data Display Menu” in Chapter 6). The lower box presents a list of the screen image files. It can be used to view the saved screen images and to print them.

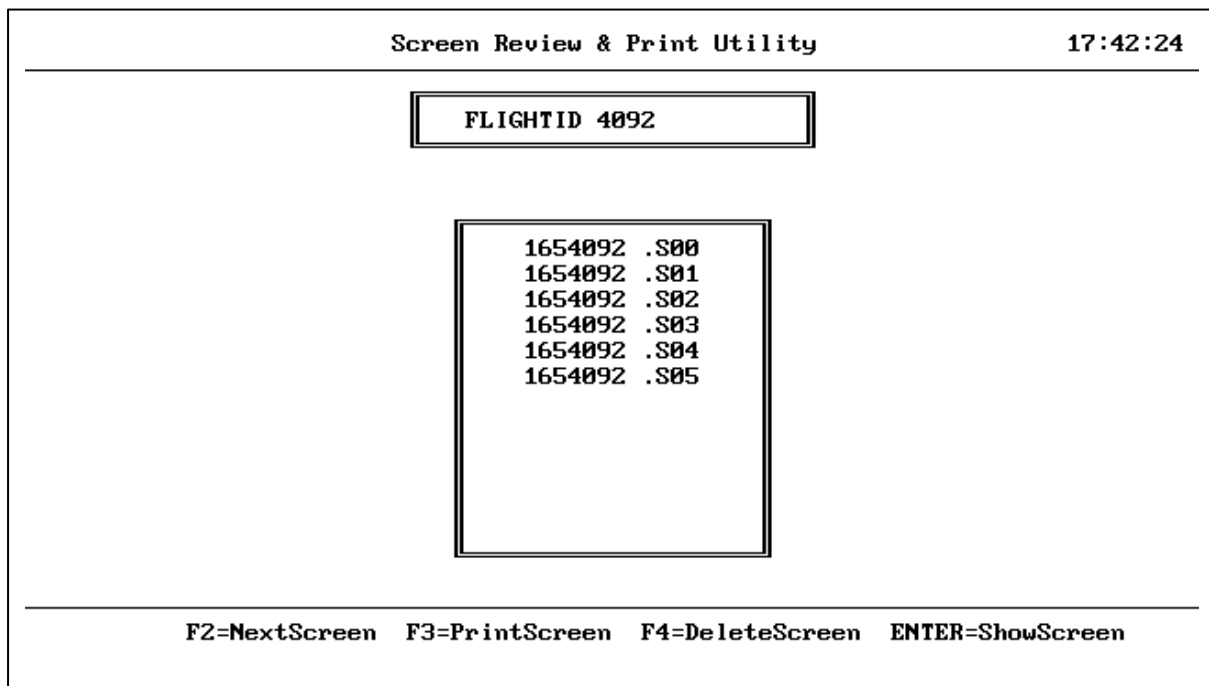

Figure 9-2. Screen Review and Print Utility

To use this utility, select a screen image file by using the **<Up Arrow>/<Down Arrow>** keys and the **<PgUp>/<PgDn>** keys. When the highlight is on the desired display, press **F3**, **F4**, or **<Enter>**:

F3 prints a copy of the selected screen image on the printer.

F4 deletes the selected file. You will be asked to confirm your intention to delete the file. To confirm, type **Y**; the file will no longer appear in the list of available files. If you want to keep the file, press **N** or **<Esc>**.

<Enter> is used to request display of the currently selected file. When you press the **<Enter>** key, the program reads the selected file and displays the image from within it on the screen. The screen will then look exactly as it did when the file was originally saved. Note that looking at these images can sometimes be confusing. They may be images of screens with menus or live data fields. Since these are static images, they will not update, and the program will not respond to any attempt to make menu selections.

<Esc> returns you to the menu.

<F2> selects the next file in the list and displays it.

A convenient way to quickly view all of the saved screen images is to select the first display and press **<Enter>**. Next, go through all of the displays by pressing **<F2>**. Press the **<Esc>** key while in the Screen Review and Print Utility to return to the Off-Line Utility menu.

9.3 The Binary File Utilities Program

Introduction to the Binary File Utilities Program

Binutil (Binary File Utilities) is an off-line program that provides the following functions for the W-9000 binary data files:

- Convert all fields from a W-9000 binary data file into an ASCII text file. This format can be read by many third party data analysis and editing programs.
- Convert selected fields and flags from a W-9000 binary data file into an ASCII text file. This format can be read by many third party data analysis and editing programs.
- View the contents of a W-9000 binary data file on the screen in a tabular format.

The Binutil program may be executed in Command Line Mode and Interactive Mode.

Command Line Mode

Command line mode is used exclusively to convert W-9000 binary data files into ASCII data files using parameters entered on the DOS command line. The syntax for running Binutil in this mode is:

BINUTIL <INPUT FILE SPECIFICATION> <OUTPUT FILE SPECIFICATION> <OPTIONS> <Enter>

Only the <INPUT FILE SPECIFICATION> is required in the Command Line mode and must be entered as the first command line parameter. The <OPTIONS> parameter can be one or more options that are used to customize the output text file. The specifications for each of the command line parameters is discussed in the following subparagraphs.

Input File Specification

The Input File Specification identifies the W-9000 input binary data file to be converted. The file specification may contain a drive letter and full DOS path name. In addition, the filename and/or file extension may be replaced by the DOS wildcard character, the asterisk (*). Examples of acceptable input file specifications are:

```
c:\flights\flt05789\w9c05789.mt2
c:\flights\flt05789\*.wnd
c:\work\*.*
viz4560.*
*.mdc
```

Output File Specification

This is the file specification for the W-9000 output ASCII data file. The file specification may contain a drive letter and full DOS path name. Also, the filename and/or file extension may be replaced by the DOS wild card character, the asterisk (*). Examples of acceptable output file specifications are:

```
c:\flights\flt05789\w9c05789.mtx
c:\flights\flt05789\*.prn
c:\work\*.*
viz4560.*
*.mdx
```

The output file specification may be omitted from the command line when running in the Command Line mode. When it is omitted, the Binutil program will create the output file specification in the following manner. The output path will be the default directory from which the Binutil program was executed. The output filename is the same as the input filename. The output extension is created from a data set of default ASCII file extensions for each binary data file extension. For example, if `c:\flights\flt4400\viz4400.mt2` has been entered as the input file specification, and the Binutil program was run from the root of the C drive, the default output file specification is `c:\viz4400.mtx`.

Figure 9-3 shows the complete list of default ASCII data file extensions for each binary data file. It is recommended that the default extensions be used for the ASCII data files so that they are readily distinguished from other data files stored on the hard disk.

BINARY DATA FILE EXTENSION	ASCII DATA FILE EXTENSION
.FSA	.FSX
.MDC	.MDX
.MT2	.MTX
.WND	.WNX

Figure 9-3. Binutil Default File Extensions

Options

Options may be specified on the command line in order to create a custom ASCII text file. The options are `/f<fields>` and `/r`.

The `/f<fields>` option specifies the data fields from the input binary data file that will be written to the output ASCII data file. If this parameter is omitted, all fields from the input binary data file are written to the output ASCII data file. The data fields are numbered sequentially starting with one as the leftmost field within each record. The `fields` parameter is entered by listing the desired field numbers separated by commas. In addition, the letter `f` may be included after a field number in order to also print the flag for that field.

As an example, enter the following values for fields 3 and 8 to print fields 1, 3, 6, and 8 as well as the flag values: **/f1,3f,6,8f**.

The fields may be entered in any order, but they will always be written to the output ASCII data file in ascending order from left to right. If you are unsure of what data values are in each of the fields, run the Binutil program in the interactive mode and view the binary file. The columns displayed on the screen are the fields of the data file.

Entering the **/r** (reject bad records) option on the command line specifies that any records containing one or more flag values with a bad quality indicator will not be written to the output ASCII data file.

Interactive Mode

The Interactive mode is used to invoke any of the binary file utilities from a menu-driven user interface. The syntax for running the Binutil program in this mode is **BINUTIL <Enter>**.

The Binutil program will display the screen shown in Figure 9-4. This prompts you to enter the input file specification and the output file specification. Enter the file specifications according to the same rules given above for the Command Line mode, except that the wildcard character (*) may not be used. Again, the output file specification is optional. Press the **<Esc>** key when the file specifications have been entered, and respond accordingly to the prompt.

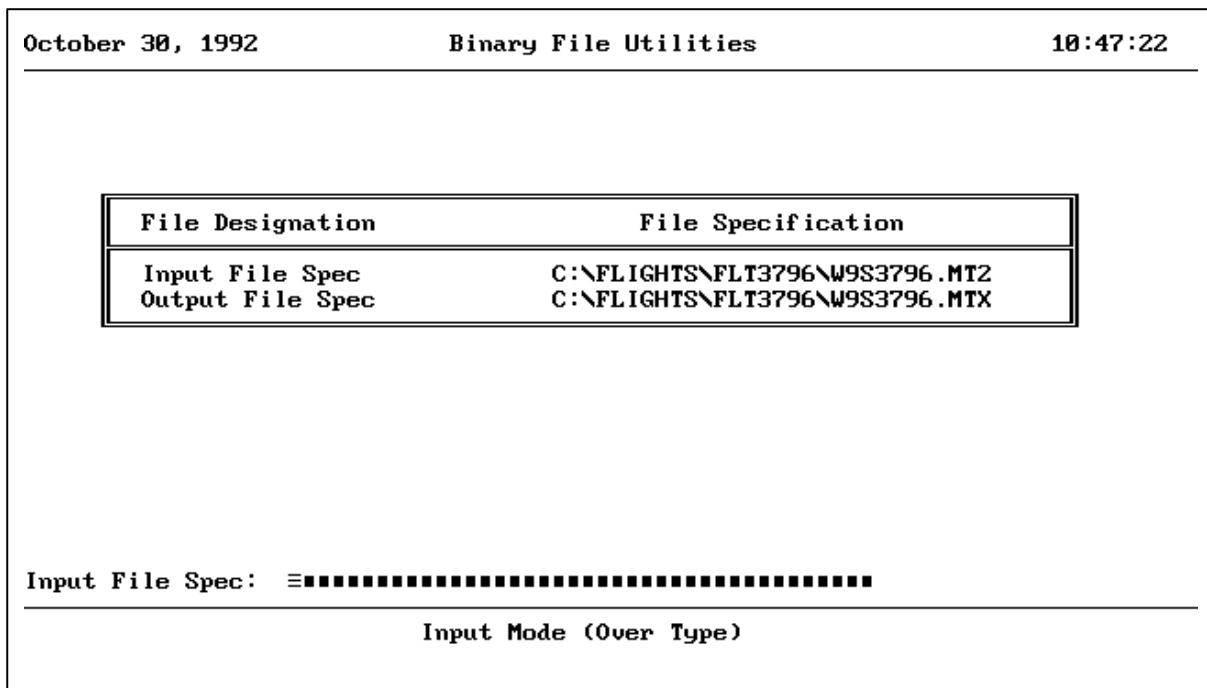

Figure 9-4. Binutil File Specifications

Once you have accepted the entered values, you will see the menu shown if Figure 9-5. Each menu option is discussed below.

```
October 30, 1992          Binary File Utilities          10:45:13
-----
1. Convert Input File to Text File
2. Convert Input File to Custom Text File
3. View Input File
4. Change Input/Output File Specs

Please Enter Number of Selection ...
-----
```

Figure 9-5. Binutil Options

Select Convert Input File to Text File to convert all fields from the input binary file to an ASCII file. In the .FSA, .MDC, and .MT2 files, any fields marked as bad will have values of -99 in the output text file. The screen in Figure 6-9 indicates that a conversion is taking place. As the conversion progresses, each file is checked off when it has been successfully converted. After the conversion has been completed, you will be returned to the menu in Figure 9-5.

```
October 30, 1992          Binary File Utilities          10:45:15
-----
Input file:  C:\FLIGHTS\FLT3796\W9S3796.MT2
Output file: C:\FLIGHTS\FLT3796\W9S3796.MTX

Total number of records: 5433
Reading record number: 241

----- List of input files -----

C:\FLIGHTS\FLT3796\W9S3796.MT2
-----
```

Figure 9-6. File Conversion Taking Place

Select Convert Input File to Custom Text File to convert selected fields and flags from the input binary file to the output ASCII file. After selecting this option you will see the screen shown in Figure 9-7. This allows you to enter the /f fields option.

```
October 30, 1992                Binary File Utilities                10:45:47
-----
This screen allows you to enter options which will customize the
output text file. You may enter the [fields] option and the
[reject bad records] option.

The [fields] option specifies which fields (columns) from the
input file are to be printed to the output file.
Each field value must be seperated with a space.

In addition, you may enter the letter 'f' after any field value
in order to print the data flag for that field to the output file.
Example: 1f 3 5f 7

fields: 1f 2 3 5f 6f 7f

Input file spec: C:\FLIGHTS\FLT3796\W9S3796.MT2
Output file spec: C:\FLIGHTS\FLT3796\W9S3796.MTX
-----
```

Figure 9-7. Enter Field Number(s) Option

The field values should be entered in the same manner as described in the command line mode except that spaces should be used between field values instead of commas and the /f should not be entered. If you are unsure of which fields to convert, run the View Input File option to display the binary file. The columns shown in the tabular display are the fields within the file. Just as in the command line mode, adding an f after any of the field number causes the flag for that field to be printed as well. Press the <Enter> key after entering the field number(s).

After pressing the <Enter> key, the screen shown in Figure 9-8 is displayed. This allows you to enter the /r (reject bad records) option. Enter <Y> if you want to reject bad records and <N> if you do not want to reject bad records followed by the <Enter> key.

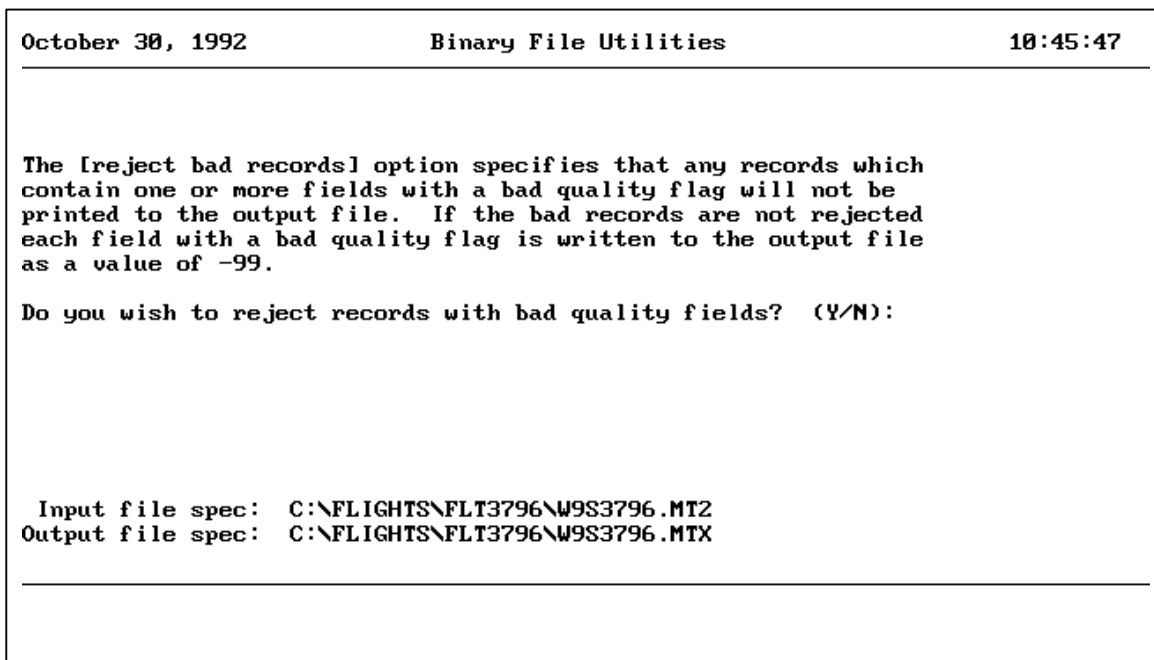

Figure 9-8. Enter Reject Bad Records Option

After the options have been selected, the screen shown in Figure 9-6 is again displayed during the file conversion process. You will be returned to the menu shown in Figure 9-5 when the conversion is complete.

Select View Input File to view the input binary data file. The input binary file is displayed in a tabular format on the screen. Figure 9-9 shows a tabular display of a .MT2 data file.

October 30, 1992		Binary File Utilities				10:47:15	
TIME	PRESSURE	TEMPERATURE	HUMIDITY	SPARE 1	SPARE 2	SPARE 3	SPARE 4
min:sec	mb	celcius	percent				
116:41.2	7.4	-41.2	5.5	53133.0	3012.0	5778.0	12.4
116:42.5	7.3	-41.1	5.5	53132.0	3013.0	5779.0	12.4
116:43.7	7.3	-41.1	5.5	53131.0	3012.0	5780.0	12.4
116:44.9	7.3	-41.1	5.5	53132.0	3012.0	5781.0	12.4
116:46.2	7.3	-41.1	5.5	53132.0	3012.0	5782.0	12.4
116:47.4	7.3	-41.2	5.5	53133.0	3012.0	5783.0	12.4
116:48.6	7.3	-41.1	5.5	53133.0	3012.0	5784.0	12.4
116:49.9	7.3	-41.1	5.4	53131.0	3012.0	5785.0	12.4
116:51.1	7.3	-41.2	5.4	53133.0	3012.0	5786.0	12.4
116:52.3	7.3	-41.1	5.5	53132.0	3013.0	5787.0	12.4
116:53.5	7.3	-41.2	5.5	53133.0	3012.0	5788.0	12.4
116:54.8	7.3	-41.2	5.5	53132.0	3012.0	5789.0	12.4
116:56.2	7.3	-41.2	5.5	53131.0	3012.0	5790.0	12.4
116:57.2	7.3	-41.2	5.4	53132.0	3012.0	5791.0	12.4
116:58.4	7.3	-41.2	5.5	53132.0	3012.0	5792.0	12.4
117:01.1	7.2	-41.2	5.5	53132.0	3013.0	5794.0	12.4
117:02.1	7.2	-41.1	5.4	53131.0	3012.0	5795.0	12.4
117:03.4	7.2	-41.0	5.5	53132.0	3011.0	5796.0	12.4

INPUT FILE SPEC: C:\FLIGHTS\FLT3796\W9S3796.MT2

Figure 9-9. Input Binary Data File

The following keys are active in the tabular display.

<Home>

Displays the first page of data in the file.

<End>

Displays the last record in the file on the first line of the view window.

<PgUp>

Displays the previous page of data in the view window. An audible beep is heard if the topmost page of data is being displayed.

<PgDn>

Displays the next page of data in the view window. An audible beep is heard if the last page of data is being displayed.

<Up Arrow>

Scrolls the view window down one line and inserts a new line at the top of the view window. An audible beep is heard if the window cannot scroll any further.

<Down Arrow>

Scrolls the view window up one line and inserts a new line at the bottom of the view window. An audible beep is heard if the window cannot scroll any further.

<Esc>

Returns the user to the menu in Figure 9-5.

Press the **<Esc>** key to exit the Binutil program and return to the DOS prompt.

9.4 The AVGMET Program

Like BINUTIL, the AVGMET program is a utility designed to make data from the system binary files available in text form for input to other programs or for printing. However, AVGMET is a time-oriented data format converter. You must supply the averaging interval, the file name used for the flight files, and a list of the meteorological data fields that you want as parameters. No file name extension is needed, since AVGMET will read the files it needs from the set of flight files available for the specified flight file name.

Using the specified averaging interval, AVGMET finds all data within each time interval of the specified length starting from launch. It then computes the average for each requested field and writes a record to its output file giving the average of each of the data fields over that time interval. Next, the cycle repeats, writing new records for each averaging interval until all available flight data for the specified time has been considered. The output file is named **filename.AVG**, where **filename** is the input flight file name parameter and **.AVG** is the file extension.

AVGMET is designed to work well in an MS DOS Batch file. For example, a batch file could call AVGMET to convert the data of a flight into text form and then call Grapher to prepare and print a graph of system flight data.

AVGMET Command Line Syntax

AVGMET <path>filename .MT2 fields .MDC fields <averaging interval>

Where:

filename does not include an extension.

.MT2 fields and **.MDC** fields are those to be included in the output file, expressed as integers of up to eight digits (for **.MT2**) and six digits (for **.MDC**), or the letter **n** to indicate that the corresponding file is not to be included.

<averaging interval> is an optional field expressed in whole seconds. If not specified, the default is 15 seconds.

Following entry of this command to DOS, AVGMET reads **filename.MT2** and **filename.MDC** files and produces the single ASCII text file **filename.AVG**. Data will be averaged according to the averaging interval parameter. AVGMET considers only records after launch and before the end of flight. AVGMET reads the **filename.SDT** file to acquire launch and end-of flight-information.

9.5 The Capture Program

The Capture program is distributed as part of the W-9000 System software. Its primary purpose is to emulate a terminal for ZEEMET Rack diagnostic purposes. It allows terminal emulation using COM1 or COM2 for communication with the ZEEMET Rack. The program can also capture data to a file.

To run the program type **CAPTURE <Enter>**. The Capture program displays the menu choices shown in Figure 9-10.

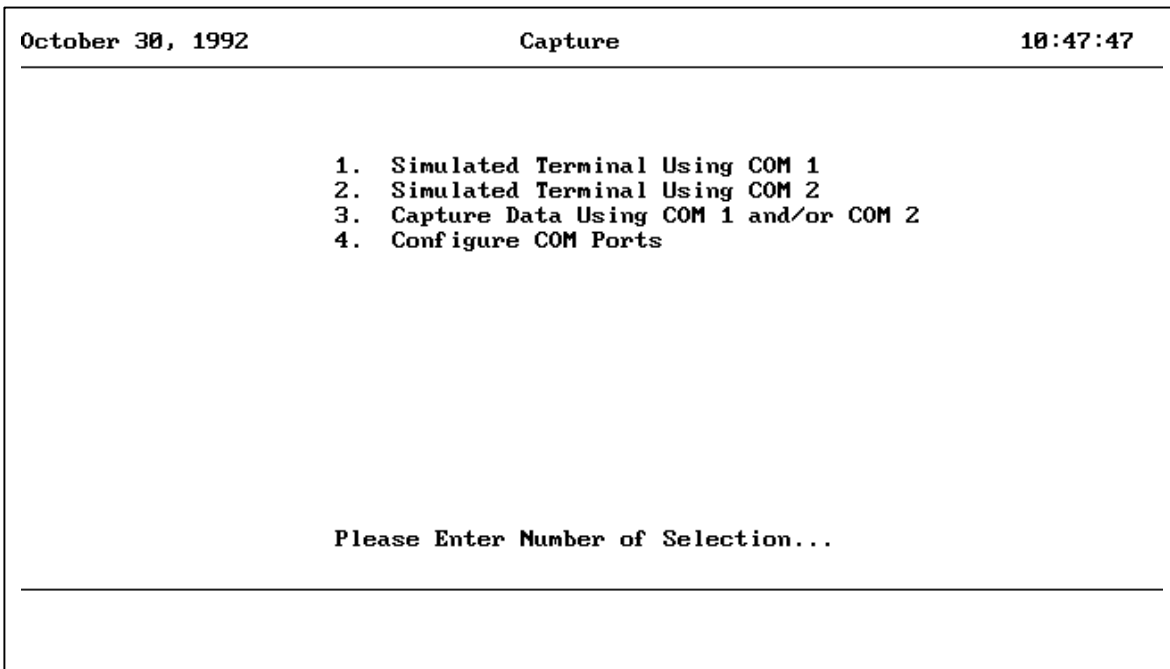

Figure 9-10. Capture Menu

Simulated Terminal Operation

The Simulated Terminal with COM 1 and Simulated Terminal with COM 2 options allow emulation of a terminal on COM 1 and COM 2 respectively using the configured setup for that port. This can be used to send commands to the ZEEMET Rack and receive the responses. The Simulated Terminal screen can be seen in Figure 9-11.

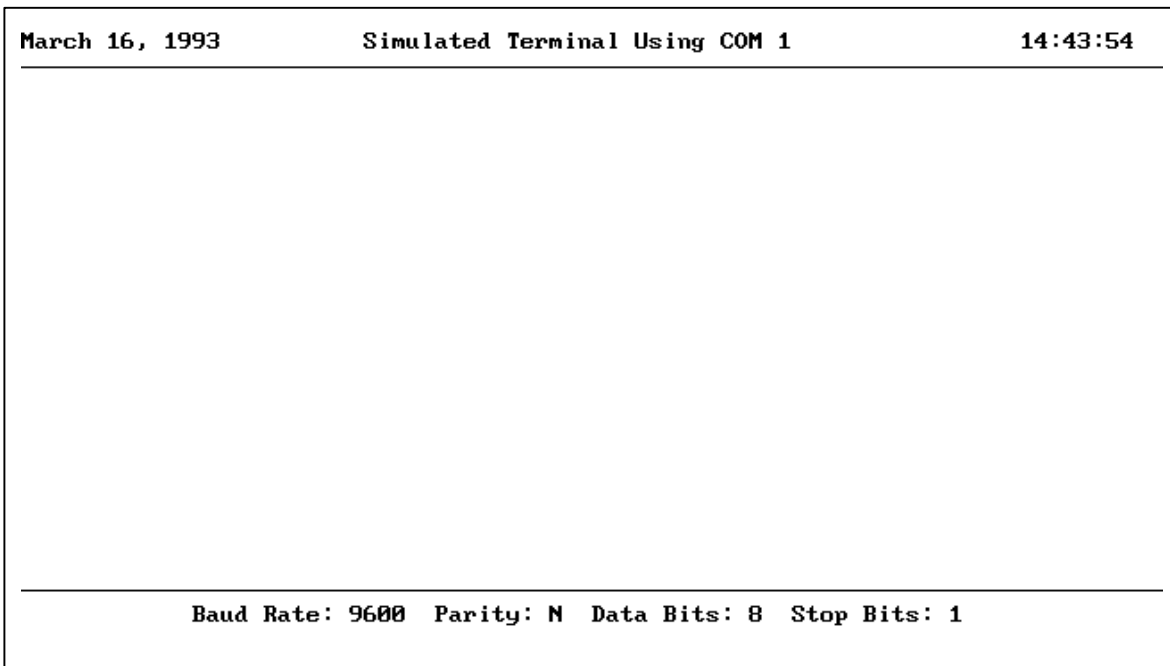

Figure 9-11. Simulated Terminal Operation

Capture Data to Disk

The Capture Data option allows the data being received to be captured to a file. When you select this option, you are prompted with **Capture Data using COM 1? (Y/N)**. If **Y**, you are prompted for a file name. The process is then repeated for COM 2. Figure 9-12 shows a capture for a two-port capture.

March 16, 1993	Capture Data Using COM 1 and/or COM 2	14:44:16
COM 1 Baud Rate: 9600 Parity: N Data Bits: 8 Stop Bits: 1		
COM 2 Baud Rate: 9600 Parity: N Data Bits: 8 Stop Bits: 1		
[F1] Select Active Port: 2		

Figure 9-12. Capture Data

Commands can be typed to the active port in all modes of the capture program. If the capture mode is being run on two ports at the same time, the active port can be changed using the <F1> key. When ready to exit capture mode, press <Esc> and answer <Y> to save the captured data to disk, or answer <N> to discard it.

Configure COM Ports

The Configure COM Ports option, shown in Figure 9-13 allows you to set the asynchronous data parameters of the COM Port. Pressing <F1> toggles the active port, that is, the port to be configured. Pressing <F2> selects communication profiles for various W-9000 System configurations. One of these profiles is USER DEFINED SETTINGS, which allows you to custom-configure the COM port speed, parity, data bits, and stop bits.

March 16, 1993	Configure COM Ports	14:44:23
COM 1 Configuration Parameters		
Baud Rate	9600	Data Bits 8
Parity	N	Stop Bits 1
COM 2 Configuration Parameters		
Baud Rate	9600	Data Bits 8
Parity	N	Stop Bits 1
[F1] Select Active Port: 2		
[F2] Select Parameter Set: Zeemet Rack		

Figure 9-13. Configure COM Ports

Press <Esc> from the main menu to return to the DOS command line.

9.6 The Grapher Program

Sippican supplies the Grapher program with W-9000 Systems as part of the system software package. Grapher is an independent software package which is designed to make high resolution printed graphs of data. Grapher can be used with the BINUTIL and AVGMET utilities to make printed graphs of W-9000 flight data. See the Grapher manual for details.

This page intentionally left blank.

Chapter 10. Flight Data Management

10.1 Introduction To Data Management

This chapter gives a general description of the data files produced by the W-9000 System during flight operations. The sections that follow explain where the system stores the data and how it is organized. It explains how to save the data in a special space saving compressed form to a special subdirectory area on the hard disk of the system computer which is reserved for saved flight data. There is also a description of how to copy flight data to floppy diskettes for saving or backing up the data external to the computer or for sending a copy of the data to be used in another computer. Finally there is a description of how to delete flight data files from the hard disk of the system computer in order to make space available for new data.

During each flight the W-9000 System Software automatically writes the data for that flight to the hard disk to preserve it. After the flight, you must determine what to do with the data that has been stored on the disk. This chapter explains the use of the W-9000 System utility programs to efficiently manage the hard disk space and to ensure that space is available for new flights. Several other utility programs are also discussed.

10.2 W-9000 System Directory Structure

In computer systems that run MS-DOS, files on the hard disk may be organized into separate areas called directories. The use of a well-structured design for directories and subdirectories makes working with the files of a system much more straight forward.

If you are not familiar with the concept of directories and subdirectories, you should review the MS-DOS user manual. The manual explains the advantages of directories and the DOS commands used with them. The most important commands to review are **DIR** (display directory), **CD** (change directory), and **XCOPY**. Note that the W-9000 System software configures MS-DOS to display the current directory as part of the command prompt, for example **c:\w9000>**.

Figure 10-1 shows the W-9000 System directory structure. Note that from the root directory of the hard disk (c:\), there are three subdirectories: **c:\w9000**, **c:\programs**, and **c:\flights**.

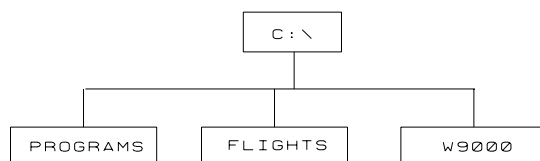

Figure 10-1. System Directory Structure

The c:\w9000 Subdirectory

The **c:\w9000** subdirectory is used to store the W-9000 System program and configuration files. Figure 10-2 shows the structure of the subdirectories used under the **c:\w9000** subdirectory. Note that the **c:\w9000\3-3-3** subdirectory shown is only an example. The **3-3-3** portion of the name identifies the specific version and subversion of the software that is installed. The actual subdirectory name used is automatically set at the time of software installation and may not be the same as this example.

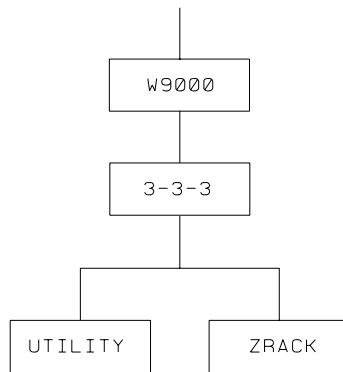

Figure 10-2. c:\w9000 Sub-Directories

The system programs, configuration files, and other files used by the system programs are stored the **c:\w9000\3-3-3** subdirectory.

The **c:\w9000\3-3-3\utility** subdirectory stores MS-DOS batch file programs and other programs that must be in the search path of the operating system. Since these batch file programs and other programs are located the search path, you do not need to enter path information when running the program.

The **c:\w9000\3-3-3\zrack** subdirectory stores the download image files for the W-9000 ZEEMET Rack modules. The download utility programs automatically get these files from this subdirectory when you request a download operation.

The c:\programs Subdirectory

The **c:\programs** subdirectory stores all other programs. Figure 10-3 shows the structure of the subdirectories used under the **c:\programs** subdirectory. The diskettes supplied with the system will automatically install all programs supplied into the proper subdirectory.

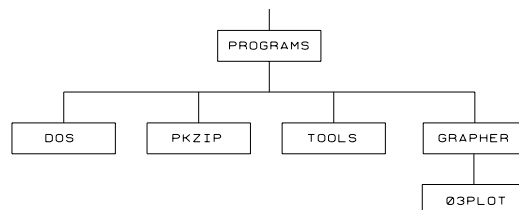

Figure 10-3. c:\programs Subdirectories

The **c:\programs** subdirectory assignments are as follows:

c:\programs\	Content
dos	MS-DOS files
pkzip	PKZIP and PKUNZIP utilities that compress and expand flight data files
grapher	Grapher utility files used for off-line printing of high resolution flight data graphics
tools	Various batch files and utility programs

MS-DOS uses a *path* to locate programs and data files in their directories and subdirectories. A special case of path is the automatic search path. The W-9000 installation programs automatically establish a search path that includes the following sub-directories: **c:**, **c:\programs\tools**, **c:\programs\dos**, **c:\programs\pkzip**, **c:\w9000\...\utility**. These are all of the search areas needed for correct operation of the W-9000 software. However, while the computer uses this search path, programs added to the computer located in other subdirectories may not be found. See the MS-DOS user manual for information on how to change the search.

It is recommended that if additional user developed or purchased programs are added to the W-9000 System Computer, they be placed into additional user created subdirectories of the **c:\programs** subdirectory.

The c:\flights Subdirectory

The **c:\flights** subdirectory is used to store flight data. Figure 10-4 shows the structure of the subdirectories used under the **c:\flights** subdirectory.

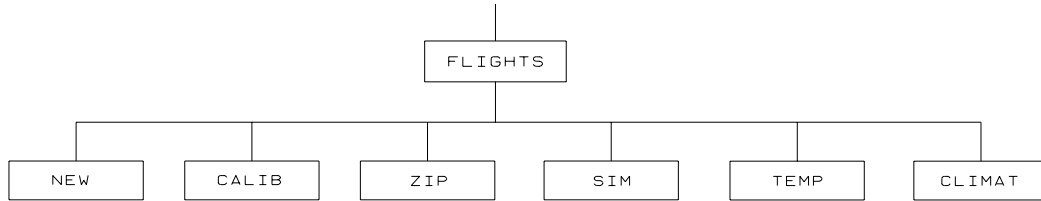

Figure 10-4. c:\flights Subdirectories

When a new flight is started the files stored in **c:\flights\new** subdirectory named deleted to make room for the new flight files. During flights all data that is written to files will be in that directory.

If you select the Save Flight Data to Disk option in the on-line flight utilities, a new flight archive is automatically created in the **c:\flights\zip** subdirectory. The following actions occur to create an archive file:

1. A new *.sav* file is created in **c:\flights\new**.
2. All appropriate files are copied from **c:\flights\new** to the **c:\flights\temp** subdirectory.
3. Some of the files in **c:\flights\temp** are renamed.
4. The pkzip utility program is run to make a new zip archive file in **c:\flights\zip** containing compressed copies of all of the files in the **c:\flights\temp** directory.

The archive flight data function requires that enough unallocated space be available on the hard disk to accommodate the files saved. The archived copy of the flight files are not subject to automatic deletion when a new flight is started. It is recommended that you routinely save flight data to make an archive before exiting from the system after a flight operation.

However, there is a limit to the number of flights that can be stored on the hard at the same time. Functions are included in the off-line utilities that can be used to save flight archive files to a diskette and then remove the original archive file from the hard disk. This should be routinely done in order to maintain sufficient available space for new flights.

Remember, if you exit from the W-9000 software, returning to the MS-DOS command line without running the flight save utility, the files will only be stored in the **c:\flights\new** directory. If you do not save files before exiting the W-9000 System, they will be automatically erased when the software is started again using the **START** command.

10.3 Files Used To Store Flight Data

The data for each flight and other information about the operation of the system is written to the hard disk automatically during each flight. In accordance with MS-DOS file-naming conventions, each file is given a two part name; the base name and the file name extension. In the W-9000 System, the base name for most of the data files of a flight is the same and is composed of the system name and the flight identifier. Refer to Chapter 3, Section 3.2, "Station Installation" and Chapter 5, section 5.2, "Overview of Flight Preparation" for explanations of the system name and the flight identifier.

The file name extension is composed of a period and from one to three characters. Note that MS-DOS allows file names without extensions, but the W-9000 System does not use this method. In the W-9000 System, the file name extension specifies the type of data contained in the file. Each flight will result in 10 or more separate files depending on the system configuration. The following is an example of a full file name specification for a W-9000 data file.

C:\FLIGHTS\NEW\W9P3389.WND

In this example **C:\FLIGHTS\NEW** is the directory used to store the files. The system name is **W9P**, and the flight identifier is **3389**. The **.WND** portion of the name indicates that the file contains computer wind data.

The "Raw Flight Data Files" in the next subsection provides a list of the file name extensions used by the W-9000 System Software to identify the data contents of files stored in the archive files of the **c:\flights\zip** subdirectory. Where files are renamed during the Save Flight Data process, the name of the file when it is in the **c:\flights\new** subdirectory is also given.

Raw Flight Data Files

- .im2 The raw (unprocessed) PTU channel and reference data for the flight. Stored in text format, each record is time tagged and includes one reference and 7 channel value samples. This data can be read from the RX403 module of the ZEEMET Rack using the IM2 command.
- .iwo Omega wind raw (unprocessed) data file stored in text format. Each record is in the format of the response of the system interface module to the IWO command. A new record is added to this file every 10 seconds. Each record contains the time, frame number and the data as received for each station in the past 10 second period. For each station the data includes the SNR (signal to noise ratio) and the relative phase in millicycles. This file is used only in omega wind flights.
- .vlf Omega wind raw (unprocessed) data file for 3 omega frequencies in text format. Each record is in the format of the response of the system interface module to the IWO command. One new record for each of the 3 omega frequencies used is added to this file every 10 seconds. Each record contains the time, frame number, frequency and the data as received for each station in the past 10 second period. For each station the data includes the SNR (signal to noise ratio) and the relative phase (in millicycles). This file is used only in VLF omega wind flights.
- .lw1 Loran wind raw data file from tracker 1. Stored in text format. Each record is in the format of the response of the system interface module to the LH1 command. A new record is added to the file at the rate specified by the user during Wind Computation Setup under Raw Wind Sampling

Interval. Normally this parameter is set to either 3 seconds or 10 seconds. The faster interval, 3 seconds, is the most common setup but uses more memory to store the data and the computation with the increased volume of data uses more computer time. Each record contains the time, frame number, and information about the stations in the chain being tracked. For each station the information includes the SNR (signal to noise ratio), state (lockup state, 8=locked up), and TOA (time of arrival (in microseconds)). This file is used only in loran wind flights.

- .lw2 Loran wind raw data file from tracker 2. The same as the .lw1 file except that the data is from tracker 2. This file is used only in cross chain loran wind flights.
- .rwd Raw wind data files with text format for radar and radiotheodolite flights. Each record contains four, 7-character fields, and a 2-character flag followed by CR and LF. The first four fields are each 6 digits followed by a space. They contain the time since launch in tenths of a second, the azimuth and elevation in hundredths of a degree, and the slant range in meters. For radiotheodolite flights the slant range is set to zero.

Processed Flight Data Files

- .mdc Meteorological Data Calculations File. Stored in binary format. Stores values computed from the data in the .mt2 file. Has one record for each entry in the .mt2 file which has the same position in the file and which has the same time as the corresponding .mt2 record.
- .mt2 Computed PTU and other data from the various data channels of the sonde. Stored in binary format. Includes a data quality indicator (flag value) for each channel value. Also includes the time for the samples.
- .fsa Fine Structure Archive file. Stored in the same binary format as the .mt2 file. However, it contains a reduced data set that captures the fine structure of the data in the .mt2 file with a data resolution equal to a nominal 25% of the size of the .mt2 file.
- .wnd Computed wind data file. Stored in binary format. Includes the present wind speed and direction, along with the computed wind speed and direction (they may be different due to data editing), quality indicators (flag values) and computation information regarding wind for each frame.

Control Files

- .ctd The CONTROL.DAT file in the FLTDATAPATH directory controls the sequence of operations performed to compute the .mt2 file from the .im2 file. Stored in text format.
- .omg This is the Wind Interval Selection file used for an Omega flight. The WINDAVG.OMG file is in the FLTDATAPATH directory. Stored in text format.
- .lor This is the Wind Interval Selection file used for a Loran-C flight. This file is named WINDAVG.LOR in the FLTDATAPATH directory. Stored in text format.

Sonde Calibration Files

- .cal Contains sonde calibration data for the flight, and stores operator entered sensor values or sensor values transmitted by the sonde. Stored in text format. This file is named CALIB.DAT in the FLTDATAPATH directory.
- .ic2 Mark II Sonde calibration data file. Stored in text format. This file is the response of the RX403 to the IC2 command after it has received the calibration data from the sonde data stream. It is an image in character form of the calibration data memory of the sonde. This data is used to calibrate the W-9000 software processing of the sonde data from the raw counts in the .im2 file to the processed values in the .mt2 file.

Summary and Message Coding Files

- .idx An index to the saved coded message files which also contains information on which files have been transmitted. This file is named CODEMSG.IDX in the FLTDATAPATH directory.
- .sum A text file of the PTU Summary.
- .wsm A text file of the Wind Summary.
- .csm A text file of the Analysis Summary.
- .fls A text file of the Freezing Levels.
- .rwl A text file of the Regional Wind Levels.
- .smt A text file of the Met Significant Levels.
- .swd A text file of the Wind Significant Levels.
- .sis A text file of the Standard Isobaric Surfaces.
- .cds A text file of the Climatic data Summary (for NCDC).
- .cmt A text file of the CLIMAT TEMP Monthly Means Summary.
- .pa Called PA.SAV in the FLTDATAPATH directory, this file is the saved PILOT A message.
- .pb Called PB.SAV in the FLTDATAPATH directory, this file is the saved PILOT B message.
- .pc Called PC.SAV in the FLTDATAPATH directory, this file is the saved PILOT C message.
- .pd Called PD.SAV in the FLTDATAPATH directory, this file is the saved PILOT D message.
- .ta Called TA.SAV in the FLTDATAPATH directory, this file is the saved TEMP A message.
- .tb Called TB.SAV in the FLTDATAPATH directory, this file is the saved TEMP B message.
- .tc Called TC.SAV in the FLTDATAPATH directory, this file is the saved TEMP C message.
- .td Called TD.SAV in the FLTDATAPATH directory, this file is the saved TEMP D message.
- .mcm Called MTCM.SAV in the FLTDATAPATH directory, this file is the saved Computer military message.
- .mb2 Called MTB2.SAV in the FLTDATAPATH directory, this file is the saved Ballistic, type 2, military message.
- .mb3 Called MTB3.SAV in the FLTDATAPATH directory, this file is the saved Ballistic, type 3, military message.
- .msr Called MTSR.SAV in the FLTDATAPATH directory, this file is the saved Sound Ranging military message.

- .mta Called MTTA.SAV in the FLTDATAPATH directory, this file is the saved Target Acquisition military message.
- .mfm Called MTFM.SAV in the FLTDATAPATH directory, this file is the saved Nuclear Fallout military message.
- .cdh NCDC header file.
- .cdt NCDC data file.

Miscellaneous Files

- .snn During W-9000 System Operation the Print Screen button on the keyboard is converted by software into a Capture Screen function. The program reads a copy of the screen image into memory and writes it to a file. The file name used is the standard file name as defined for all flight files. The file name extension for the first screen image is .s01 and the second is .s02. The nn shown as the file extension represents the two character numbers which are used in sequence for the saved images. These files are saved as part of the archive file for a flight at the time of a flight save. Utility functions are provided as part of the off-line utility programs (see Chapter 9) to view or print these saved images.
- .jnl The system journal file, called JOURNAL.TXT in the FLTDATAPATH directory. Stored in text format. This file contains a record of flight events and information about system operation and operator actions. Information summarizing operator entries, flight events (such as detection of launch), software version being used, and system errors is written to the file as the flight progresses. This file can be viewed from a on option on the flight utility menu, during a flight; or, after the flight, this file can be displayed or printed to review the events of the flight.
- .sav This is the flight save file created when the Save Flight Data to Disk option is run from the Flight Utilities menu. It contains, among other things, a current copy of the DOS environment, selected areas of system memory and EMS memory, and all the selected significant levels. This information is saved here so that it can be restored when the Restore Flight Data From Disk option is selected from the Flight Utilities menu.
- .sdt This file, called SYSDAT.DAT in the FLTDATAPATH directory, is the system data file. Stored in binary format. It contains most of the parameters from the System Setup/Installation programs, including the type of Navaid used, the Loran Chain or Chains, and selected Loran or Omega Stations. It also contains operator entered surface data.
- .xs The receiver status file. Stored in text format. Contains information about the status of the RX403 module throughout the flight. A new record is added to the file once each minute. Each record is the response of the RX403 module to the XS command. The information saved in this file includes the current frequency and signal strength.
- .xw A series of 150 six digit times in tenths of seconds, relative to ARM FOR LAUNCH, recorded by the receiver when a contact closure is seen on the optional W-9000 launch module. If the first entry is non-zero, it is used by the W-9000 System Software as the launch time. The additional times allow the user to record times for later extraction by off-line programs. This is particularly useful in system intercomparisons.

- .is The interface status file. Stored in text format. This file contains information about the status of the ZEEMET Rack modules from the point of view of the interface module throughout the flight. A new record of status information is added to the file once per minute throughout each flight. Each record is in the format of the response of the interface module to the .is command (see Chapter 8).

10.4 Disk Space Management

The first choice in the Off-Line Utility Menu described in Chapter 9 is Flight Data File Management. This section describes the utility functions provided when this menu item is chosen by the user. Figure 10-5 shows an example of the Flight Data File Management menu that will be displayed. Note that the various functions available are listed along the bottom of the screen with an indication of the function key that should be used to select the corresponding function. Note also that a list of the currently available archived flights is displayed on the left hand side of the display in a window under the heading Archived Flights. Each line in the Archived Flights window lists information about an archive file for separate flight. The information is arranged in three columns. The first column is the flight data file name. The second column is the size in bytes of the archive file. The third column is the date (month-day-year) that the archive file was created. Usually archive files are made at the end of a flight and the date corresponds to the date of the flight. However, as will be seen below, archive files can also be made at other times.

September 29, 1994		Flight Data File Management		17:40:05	
Archived Flights					
1654053	552,335	08-18-94			
1654054	446,032	08-19-94			
1654055	225,816	08-19-94			
1654056	653,218	08-19-94			
1654057	601,142	08-24-94			
1654060	683,336	08-26-94			
1654062	917,724	08-29-94			
1654064	508,101	08-30-94			
1654065	573,514	08-31-94			
1654066	620,978	08-31-94			
1654067	529,105	08-31-94			
1654068	637,960	08-31-94			
1654069	710,733	08-31-94			
1654070	621,310	09-01-94			
1654071	357,364	09-01-94			
		Flights: 52		7,912,801 bytes	
		Flight Disk Space:		8,241,280 bytes	
F2=CopyTo F3=CopyFrom F4=Delete F5=Archive F6=Restore F7=Files					

Figure 10-5. Flight Data File Management Menu

If there are more archived flights on the hard disk than can be displayed in the Archived Flights window at the same time then the PgUp and the PgDn keys can be used to move the display up and down the list of flights. One of the flights in the Archived Flights window will be highlighted (brighter in intensity) than the others. This flight is the selected flight. Other flights can be selected by using the up and down arrow keys. Certain of the functions that can be selected using the function keys require the selection of a flight archive. For example pushing F4 for Delete indicates that the user wishes to delete the currently highlighted flight archive file.

In the lower right hand corner of the Flight Data Management menu display there is a small box showing the total number of flight archive files saved on the hard disk and the total disk memory these flights are using on the first line. The second line shows the total free space available on the hard disk for new flight data or any other purpose.

The W-9000 System requires between 2 and 3 megabytes of free disk space to write flight data files and to run the Save Flight Data to Disk function. If flight data is routinely saved, it is necessary to routinely copy files from the hard disk to floppy diskette and delete the flight data from the hard disk to make room for new flights. The following sections outline procedures that can be used to: copy flight data to diskettes, copy flight data from floppies back to the hard disk, delete flight data from the hard disk, create or update a flight data archive, restore an archived flight, and view the files saved in a flight archive.

Copying Flight Data to Diskette

The F2 function key is used to request Copying flight data to diskette. This function copies the selected archive file for a flight from the hard disk to a floppy diskette. To use this function you must have a clean, formatted high density (1.2 megabyte 5.25 or 1.4 megabyte 3.5) diskette. If necessary refer to the DOS Manual for instructions on how to use the FORMAT command to format a diskette. Place the diskette in the A: drive or the B: drive and close the drive door. Use the keyboard to select the file to be copied. Then with the diskette in the drive press the F2 key. A message asking for the path to be used will be displayed. The default is A:. To use floppy diskette drive A: simply press Enter. To use floppy diskette drive B: change the display value to show B: and press Enter. The selected flight archive file will be copied to the floppy diskette mounted in the selected diskette drive.

Copying Flight Data From Diskette

The F3 function key is used to request copying flight data from a diskette. This function copies an archive file for a flight from a floppy diskette to the **c:\flights\zip** subdirectory on the hard disk. After the copy is completed the flight will appear in the Archived Flights Window and will also be available for other functions. To use this function place the diskette with the flight archive file on it in either the A: or B: diskette drive. Then press F3 key. A message asking for the path to be used will be displayed. The default is the A: drive. If B: is to be used, change the data in the data entry box from A: to B:. With the proper drive letter displayed press the Enter key. The archived flight file will be copied to the hard disk.

Deleting Flight Data From Hard Disk

After you have copied off the saved flight data to a floppy diskette, the flight data files can be deleted from the hard disk. The F3 function key is used to request deleting a flight data archive file from the

hard disk. This function deletes the selected flight archive file from the **c:\flights\zip** subdirectory of the hard disk. After the archive file has been deleted the flight archive file will no longer appear in the Archived Flights Window and the space that it used will be available as free space for new data.

To use this function select the flight archive file to be deleted by moving the highlight to its line in the display window. Then press the F3 key. A message will be displayed requesting confirmation of the deletion of the archive file. Enter Y if the confirmation message is correct, otherwise enter N or Esc.

Normally Flight Data Archive Files for a flight are made when the user selects Save Flight Data to Disk option in the on-line flight utilities menu. However in some cases while working with the flight data files off-line the user may wish to save the files into a new or updated archive file.

The flight data currently stored in the **c:\flights\new** subdirectory is the data that corresponds to the currently active flight data. The Graphing Utility and the Report Generator Utility, which can run both in the on-line and off-line mode, always work on the active flight data set that is stored in that directory. In some cases new files may be generated in the same directory for a report or a graph while the flight data is the active data set. In these cases the user may wish to re-save the flight data to include these new files.

The F5 function key is used to request that the current active data set be saved into a new flight archive file. To use this function press the F5 function key. If a flight archive for the same flight currently exists a message requesting confirmation of the overwrite of that file is displayed. If the information in the message is correct hit the Y key, otherwise hit the N or Esc key. After the archive function has completed the new or updated archive file will appear in the Archived Flights window.

Restoring an Archived Flight

The F6 function key is used to request that the flight data of an archived flight be moved to the **c:\flights\new** subdirectory and be made the active flight data set. This function includes reading the .sav file for the flight and updating EMS memory and the MS-DOS Environment Area with information about the flight. These memory areas are used by the Graphing and Report Generating software to find information concerning the flight data files.

To use this function select the flight to be restored as the active flight by moving the highlight to the line in the Archived Flights display window for that flight. Press the F6 key.

Viewing the Files of an Archived Flight

The F7 key is used to request viewing the files stored within a selected flight archive. To use this function move the highlight to the line in the Archived Flights window corresponding to the flight wanted. Then press the F7 key.

A new window will be opened which will list the files that are stored in the selected archive file. The cursor can be moved up and down using the arrow keys and the PgUP/PgDn keys. To view the contents of a file saved in text format hit the Enter key while the highlight is on that file. If the file is a text file the entire screen will be replaced with a display of the first portion of the selected file. To view other portions of the file use the up/down/left/right arrow keys, the PgUP/PgDn keys, and the Home/End keys. When finished hit the Esc key to return to the Flight Data File Management menu display.

Appendix A. Mark II Sonde Preparation

A.1 Unpacking and Assembling

This appendix discusses the procedure for preparing a Mark II MICROSONDE for a flight with the W-9000 system. Figure A-1 shows some of the typical steps needed to prepare the Mark II sonde. A similar figure can also be found on the radiosonde label.

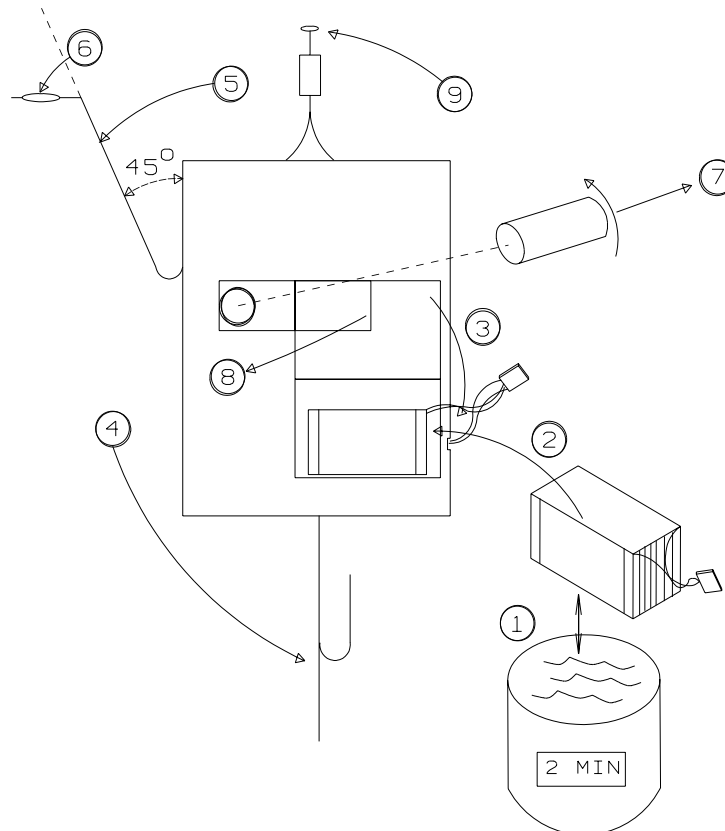

Figure A-1. Preparing a Radiosonde for a Flight

Current preparation instructions can be found in each case of radiosondes on drawing number 01-154395. Supplements may also be included. Please refer to these instructions to prepare the radiosonde.

The general steps to follow, described in detail on the instructions in the radiosonde box, is to unpack the sonde, activate the battery, deploy antennas and prepare temperature and humidity sensors. The system is started and tuned to the radiosonde, initialization of sondes (GPS) is done, pressure calibration (on sondes with a pressure sensor) is done, the flight preparation checklist is gone through. When the system and sonde are complete, the sonde is attached to the flight train, the system is prepared for release, and the sonde is released.

This page intentionally left blank.

Appendix B. W-9000 Error Codes

B.1 Introduction

This appendix lists and describes the errors that may be generated by the system. It is highly unlikely that a majority of these errors will ever happen; however, they are listed for the sake of completeness. Should there be a serious error, it should be reported to a Technical Service Representative at Sippican, Inc.

There are two classes of errors in the W-9000 system: Basic run-time errors and system errors. Basic run-time errors are detected by the run-time error trapping facility that is a standard part of the Basic programming language compiler that was used to develop the W-9000 software. Run-time errors occur when a program or module encounters a condition that was not expected. For example, if the result of processing some data causes a division by zero, then a division by zero error will be generated.

System errors are generated by the W-9000 software in response to unusual situations. System errors are caused by improper configurations, hardware problems, and incorrect operator data entry selections. System error numbers are determined by the application program; they are not part of the native error facility of the development environment that the program is written in.

ZEEMET Rack errors are system errors from the ZEEMET Rack. They are listed separately in the last section of this appendix.

System errors and basic run-time errors are often automatically handled by the software. However, there are some rare cases that are so severe that the software cannot recover from such an error.

B.2 Journal File Entries

The W-9000 system has been designed to be as fault tolerant as possible. A great deal of development emphasis has been placed on the ability to predict and prevent errors from happening; and to recover from a very high percentage of those that do happen. Further, the W-9000 system makes no attempt to conceal errors when they happen. Subsequently, a complete listing of errors - if any - that were encountered during a flight can be found in journal file.

If the system abnormally ends during a flight and you are at the DOS prompt then the journal file can be found in the **Flights/New directory (journal.txt)**. Otherwise, it is in the correct flight subdirectory with the .JNL extension.

Anytime during flight preparation or during a flight the journal file can be viewed by accessing the flight utility menu and selecting the View Journal File option.

Figure B-1 is a representative sample entry from the journal file. It illustrates the format of an entry that reports the occurrence of an error. The sample error was generated by issuing an invalid command (VU) to the ZEEMET Rack in the ZEEMET Rack Communication program.

The first line of each error reporting entry has the date and time that the error occurred. It also provides the error number. Looking up the error number (606) in the list below tells us that *a request was issued to the ZEEMET Rack that was not recognized.*

The second line indicates the severity of the error. The severity ranges from 0 for a very minor error to 10 for a severe error, which results in the termination of a flight. In this case, the severity is 8. This is a serious error in the sense that the action requested could not be carried out; however, a full recovery was made from the error, and it had no impact on the performance of the flight in any way.

The third line lists the program and/or module that reported the error. In the case, below the error was reported by a subprogram (searchtable) in the module COMEURO. Comeuro is the module that manages the communication with the ZEEMET Rack. The fourth line is a brief text description of the error message that is generated as a result of the error. In many cases this information saves having to refer to this section to gain insight into the nature of the error. The fifth line is the line in the program where the error occurs.

```
10-24-1989 08:38:41 System Error: 606
Severity: 8
Program: COMEURO:searchtable
ErrData: REQ$ <VU> NOT FOUND IN TABLE
ERL Line: 90
```

Figure B-1. Sample Journal File Error Entry

B.3 Basic Run Time Error Codes

CODE	MESSAGE	CODE	MESSAGE
01	<i>Next without FOR</i>	51	<i>Internal error</i>
02	<i>Syntax error</i>	52	<i>Bad file name or number</i>
03	<i>RETURN without GOSUB</i>	53	<i>File not found</i>
04	<i>Out of Data</i>	54	<i>Bad file mode</i>
05	<i>Illegal function call</i>	55	<i>File already open</i>
06	<i>Overflow</i>	56	<i>Field statement active</i>
07	<i>Out of memory</i>	57	<i>Device I/O error</i>
08	<i>Label not defined</i>	58	<i>File already exists</i>
09	<i>Subscript out of range</i>	59	<i>Bad record length</i>
10	<i>Duplicate definition</i>	61	<i>Disk full</i>
11	<i>Division by zero</i>	62	<i>Input past end of file</i>
12	<i>Illegal in direct mode</i>	63	<i>Bad record number</i>
13	<i>Type mismatch</i>	64	<i>Bad filename</i>
14	<i>Out of string space</i>	67	<i>Too many files</i>
16	<i>String formula too complex</i>	68	<i>Device unavailable</i>
17	<i>Cannot continue</i>	69	<i>Communication-buffer overflow</i>
18	<i>Function not defined</i>	70	<i>Permission denied</i>
19	<i>No RESUME</i>	71	<i>Disk not ready</i>
20	<i>RESUME without error</i>	73	<i>Feature unavailable</i>
24	<i>Device timeout</i>	74	<i>Rename across disks</i>
25	<i>Device fault</i>	75	<i>Path/File access error</i>
26	<i>FOR without NEXT</i>	76	<i>Path not found</i>
27	<i>Out of paper</i>	80	<i>Feature removed</i>
29	<i>WHILE without WEND</i>	81	<i>Invalid name</i>
30	<i>WEND without WHILE</i>	82	<i>Table not found</i>
33	<i>Duplicate LABEL</i>	83	<i>Index not found</i>
35	<i>Subprogram not defined</i>	84	<i>Invalid column</i>
37	<i>Argument-count mismatch</i>	85	<i>No current record</i>
38	<i>Array not defined</i>	86	<i>Duplicate value for unique index</i>
40	<i>Variable required</i>	87	<i>Invalid operation on null index</i>
50	<i>FIELD overflow</i>	88	<i>Database needs repair</i>

B.4 List of W-9000 System Errors**0 FLIGHTID**

Error from II Request: There was a status error returned from the ZEEMET Rack when the sonde serial was sent.

FLIGHT

Error from XS Request: There was a status error returned from the ZEEMET Rack in response to the XS command.

100 getput

Name = filename Bad file name: The root filename for system data files could not be constructed. The file name is made from the System Name and the Flight Id in the DOS environment. This is a fatal error causing the system to stop. Enter a valid System Name (using the program Setup) and a valid flight identifier. Also check to make sure that the correct version of the Start batch file is in use.

105 getput

FLTDATAPATH is not set: The path to the system data files could not be constructed because the Fltdatapath is equal to null in the environment. Check to make sure that the correct version of the Start batch file is in use.

200 NAVOID

GRI reset command not accepted by ZEEMET Rack. Check all cable connections from the computer to the ZEEMET Rack and try again. If this error repeatedly occurs re-load the loran tracker programs (using Setup).

242 MASTER

Operator Aborted Interface Status Check. The operator aborted the program during ZEEMET Rack Initialization.

244 MASTER

ZRACK Init. Failed On ZEEMET rack command. The ZEEMET rack failed to execute the specified command. Check the ZEEMET rack cable connections and turn the power off and then on.

246 MASTER

Incorrect Rx403 Firmware For MK1 Flight. A Mark I radiosonde requires Mark I decoder or receiver firmware in the ZEEMET Rack. Use the "Load ZEEMET Rack" option in the Setup program to load Mark I software to the receiver or decoder.

248 MASTER

Incorrect Rx403 Firmware For MK2 Flight. A Mark II radiosonde requires Mark II decoder or receiver firmware in the ZEEMET Rack. Use the "Load ZEEMET Rack" option in the Setup program to load Mark II software to the receiver or decoder.

250 MASTER

No Loran Tracker Found, Cant Run Loran. Loran wind finding requires Loran firmware in the ZEEMET Rack. Use the "Load ZEEMET Rack" option in the Setup program to load Loran software to the tracker(s).

252 MASTER

No Omega Tracker Found, Cant Run Omega. Omega windfinding requires Omega firmware in the ZEEMET Rack. Use the "Load ZEEMET Rack" option in the Setup program to load Omega software to the tracker.

- 254 MASTER**
Wind Only (PTU Selection=N) Valid Only for Radar. Invalid PTU or wind selection. Correct using Setup program.
- 255 master**
Filename not found. The given filename was not found by the master, the system initialization program. This error occurs when running a simulation flight. The file could not be found in the directory from which the simulation files are located. Check the simulation directory to make sure that all of the data files are present.
- 270 master**
Interrupt handler not found. The interrupt handler that receives input serial data could not be located.
- 512 CHAINER**
Stack Overflow.
- 513 CHAINER**
Pulling from empty stack, destination not defined.
- 530 NAVAID**
Invalid NAVAID specified in SYSDAT.DAT file. The navaid selection has been corrupted in the sysdat.dat data file. Run setup and select the desired navaid from the navaid installation program.
- 552 PFLIGHT (INITFILES)**
Fatal Error - Serial Communication Handler not Installed (COM 1). The interrupt handler that receives input serial data could not be located.
- 553 WINDINIT**
Wind smoothing interval too long - automatically shortened.
- 600 Comeuro**
Response Length Incorrect. The length of the response from the ZEEMET Rack does not match the expected length based on the request for information that was made. This can be caused by an occasional character dropping out due to a communication error. Also, it can be caused by using a comtable.dat which does not match the current revision level of the software.
- 601 COMEURO**
Command Retry Twice. Two attempts were made to issue a request to the ZEEMET Rack. This can be caused by communication errors.
- 605 Comeuro**
Time Out Error. There was a time out error because an unreasonable time period elapsed without a response from the device being accessed.

- 606 Comeuro**
Not Found in Table. A request was issued to the ZEEMET Rack that was not recognized. Either the request was ill formed, or a version of Comtable.dat is being used which does not match the system revision level.
- 607 Comeuro**
Request Length does not Match Table. A request was issued to the ZEEMET Rack that is not in the expected format. This format is defined in the Comtable.Dat file in the system directory. The request has either been ill formed, or the version of the comtable does not match the system version level.
- 608 Comeuro**
Invalid COM Port Number. A request for a COM port was made that was undefined to the system.
- 609 Comeuro**
Unexpected ZEEMET Rack Err Code. The ZEEMET error code (listed in below section) is undefined.
- 611 Comeuro**
Time Out on Sending Request
- 612 Comeuro**
Time Out on Receiving Response
- 613 Comeuro**
Fatal Error - Program for Handling Serial Communication is not Installed. The comxint program has not been executed. This may be due to starting the software incorrectly. Or, the comxint file may be missing.
- 614 Comeuro**
Not Found in Table. A request to the ZEEMET Rack was issued for which the response was ill-formed. It does not match the format defined in the Comtable.dat file. This is the result of either a communication problem or a mismatch between software and hardware revisions.
- 615 Comeuro**
Response Length Does not Match Table. A request to the ZEEMET Rack was made and a response was received by the system software. However, the length of the response was not the length expected. This is due to either an incorrect revision level of Comtable.dat in the system; or, it is due to a communication problem.
- 702 WINDREAD**
Incorrect Raw Wind Record Length - Not Saved. The PutRawWind sub program of windread has received raw data from the ZEEMET Rack that is not the correct length for the type of NAVAID being used. The data is NOT saved to the raw wind file, but is appended to the end of the error message.

703 WINDREAD

Invalid Time Relationship in Raw Wind Record - Not Saved. The PutRawWind sub program of windread has received raw data from the ZEEMET Rack that has time that is not valid when compared to records already stored. The new time is lower than the previous time, but time must always go up. The data is NOT saved to the raw wind file, but is appended to the end of the error message.

710 WINDREAD

Invalid Rad record. An invalid raw wind data record received.

711 WINDREAD

Invalid data: An invalid raw wind data record was received.

780 WINDINIT

Invalid Navaid Config. Loran Selected, but no tracker is Loran: The system has been configured to use Loran. However, no Loran Tracker was found.

781 WINDINIT

Invalid Navaid Config. Omega wind finding was selected but the Omega configuration is incorrect. Either there is no Omega Tracker, or no Omega common station was selected, or more than one Omega common station was selected. One and only one Omega station must be selected as common.

800 METREAD

Division by 0 - chigh freq = chigh value. A division by zero error has occurred during the frequency to pressure calculation. This is caused by the chigh value being equal to zero.

805 METREAD

Division by 0 - capsden = capsden value. A division by zero error has occurred during the frequency to pressure calculation. This is caused by the capsden value being equal to zero.

810 METREAD

Division by 0 - newL,newH,freq = newL value, newH value, freq value. A division by zero error has occurred during the frequency to pressure calculation. This is caused by the newL value or the newH value being equal to zero.

830 METREAD

Temperature measured temperature value is unreasonably high. The value calculated for temperature is above the upper limit of the acceptable range. The acceptable range for temperature is from -100 to 60 degrees Celsius.

835 METREAD

Temperature = temperature value; thermistor probably broken. The value calculated for temperature is below the lower limit of the acceptable range. The acceptable range for temperature is from -100 to 60 degrees Celsius.

- 840 METREAD**
Value of high frequency high frequency value is not greater than the value of low frequency low frequency value. The value of Clow is greater than the value of Chigh during the computation of frequency to pressure.
- 845 METREAD**
Value of *FREQ.TO.RESIST FOR.T* frequency value is not between low and high frequency. high frequency value low frequency value. The frequency value being used in the frequency to resistance computation for temperature is not between the values of the low and high reference frequency values.
- 850 METREAD**
Value of *FREQ.TO.RESIST FOR.U* frequency value is not between low and high frequency. high frequency value low frequency value. The frequency value being used in the frequency to resistance computation for humidity is not between the values of the low and high reference frequency values.
- 855 METREAD**
Process number is not implemented for mark II processing. A processing number has been specified in the control.dat file which has not been implemented in the computation software.
- 860 METREAD**
Error Computing Sensor Resistance. An error has occurred during the computation of frequency to resistance.
- 865 METREAD**
Data reasonability test failed. The data reasonability tests placed on the data have failed.
- 870 METREAD**
Could not read PTU record count from com port number. An attempt was made to read the number of frames from ems memory but the interrupt driver could not be found. This is a fatal error.
- 875 NAVAID**
Com 2 interrupt handler not found. The interrupt handler that receives input serial data could not be located.
- 876 WINDREAD**
Com 2 interrupt handler not found. The interrupt handler that receives input serial data could not be located.
- 880 SCRIPT**
Invalid Script file command received. The SCRIPT processing program received an invalid script command from the calling program.
- 890 SUMMARY**
Invalid re-entry into data analysis. An error condition occurred in message coding and the program returned to the SUMMARY program. See the journal file entry for more details.

895 DISPANAL

Invalid re-entry into data analysis. An error condition occurred in message coding and the program returned to the DISPANAL program. See the journal file entry for more details.

B.5 List of W-9000 ZEEMET Rack Errors**ERR001 Comeuro**

Buffer Empty. No information is available to fulfill the request sent to the ZEEMET Rack. For example, the latest MET data is requested when no MET data has been received.

ERR002 Comeuro

Invalid Command. The ZEEMET Rack does not recognize the command sent to it.

ERR003 Comeuro

Request for Service Already Underway. A request has been made to the ZEEMET Rack for a service that is currently in the process of being fulfilled. For example, a request for auto-tuning is received while auto-tuning is underway.

ERR004 Comeuro

Module not initialized. The module being accessed has not been initialized. For example, the antenna status is being requested from the interface module when the antenna has not been initialized.

This page intentionally left blank.

Appendix C. Navigation Status Information

C.1 General Information

Occasionally Navaid stations shut down for periodic maintenance or emergency repairs. A free service, called the Navigation Information Service Bulletin Board is offered to all modem users providing up-to-date information for your system. Their web site, <http://www.navcen.uscg.mil>, has the same information.

C.2 Operating Parameters

The Navigation Information Service Bulletin Board operates at full duplex, 300 - 14400 baud, no parity, 8 data bits, and 1 stop bit through a telephone line that is connected to a modem which is compatible with V.22 and V.32 standards. The Navigation Information Service Bulletin Board is available on a 24-hour basis by calling (USA)703-313-5910.

After making a connection, follow the prompts and instructions to register. Once registered, a series of choices are presented allowing access to information on Loran-C, along with other information of interest.

This page intentionally left blank.

Artisan Technology Group is an independent supplier of quality pre-owned equipment

Gold-standard solutions

Extend the life of your critical industrial, commercial, and military systems with our superior service and support.

We buy equipment

Planning to upgrade your current equipment? Have surplus equipment taking up shelf space? We'll give it a new home.

Learn more!

Visit us at artisanng.com for more info on price quotes, drivers, technical specifications, manuals, and documentation.

Artisan Scientific Corporation dba Artisan Technology Group is not an affiliate, representative, or authorized distributor for any manufacturer listed herein.

We're here to make your life easier. How can we help you today?

(217) 352-9330 | sales@artisanng.com | artisanng.com

