



**Horizon**

# BQ-270V

Perfect Binder

**Book thickness caliper allows true on demand production, where every book can be a different thickness.**



# BQ-270V for Variable Binding

## User-friendly and Highly Accurate Binder

Horizon's expertise in binding and advanced automation combine to allow even low-skilled operators to produce professional quality books. User-friendly operation and precision automation achieve short set-ups with little or no make-ready.

## Quick Setup

All setups can be done instantly by simply inputting book block and cover information into the 10.4" color touchscreen. A changeover from A4 to A5 size book can be completed in 10 seconds.

## High-speed Binding

Produce books up to 50 mm (2.0") thick at a maximum speed of 500 cycles<sup>1</sup> per hour.

## Accurate Binding

Strong, rigid nipping and cover scoring stations are comparable to larger industrial book binders, for strong, accurate binding.

## Variable Binding Compatibility

Book thickness caliper is provided as standard equipment. As one book is cycling, a subsequent book of different thickness can be measured, the data will be transferred, and the binder will begin the changeover. This allows true on demand production, where every book can be a different thickness. The BQ-270V provides greater production efficiency for variable binding with 30% less cycle time<sup>1</sup> than conventional models.

## Manage your bindery with pXnet

The optional pXnet bindery control system makes job scheduling and tracking for the BQ-270V super efficient, or accept JDF setup data from an upstream workflow.

<sup>1</sup> Cycle speed depends on the book block feeding time and the book block thickness.

# Professional quality from a binder that's simple to setup and easy to use. Automated book thickness caliper comes standard for greater production efficiency.

**Easy, intuitive operation requires no special operator skills to achieve superior quality from the first book.**

## 1 Color Touchscreen



The graphical icon-based touchscreen provides for quick and easy set-up. Almost all settings, including fine adjustments, can be set through the touchscreen.

## 2 Book Thickness Caliper



Book thickness is automatically measured by placing the book block into the digital caliper. Thickness data automatically begins set-up of the clamp, milling and adhesive application stations, nipper opening and cover scoring. This provides operating efficiency for short-run book production.

## 3 Carriage Clamp



Clamp pre-opening is automatically adjusted according to the book block thickness. A rigid clamp mechanism holds the book block firmly to produce quality books.

## 4 Delivery Section



The finished books are delivered to a vertical stacker located just below the book loading station. This allows a single operator to easily check the quality of finished books while continuing production.

## 5 Suction Cover Feeder

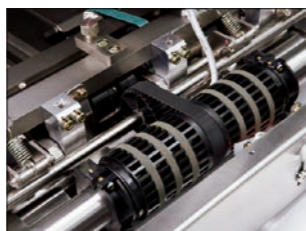

The advanced rotary suction feed system insures fast, smooth feeding of various stock types. Even sensitive stock and digitally imaged covers are fed without any marking.



**Book titles are accurately positioned on the spine. Professional quality book production with cover scoring.**

**Strong and beautiful quality book... The quality is equivalent with commercial size binding system.**

## 6 Cover Feed Table

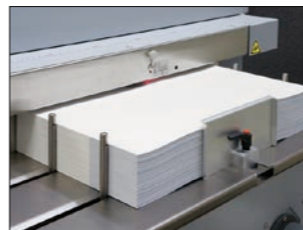

The top-feed cover station accommodates in-line scoring. Up to 70 mm (2.7") of cover stock can be loaded for operator efficiency and longer run length capability.

## 9 Milling Section



The rotary leveling and notching cutters mill the spine of a book block up to 50 mm (2.0") thick, for optimum glue penetration and adherence. Milling depth can be adjusted from 0 to 3 mm (0" to 0.12").  
Leveling Cutter: Mills the book spine.  
Notching Cutter: Cuts grooves on the book spine to insure strong book binding.

## 7 Cover Scoring



Scoring positions are automatically set to the input thickness. Scoring depth is easily adjusted to accommodate a wide range of cover stocks and thickness. This insures a professional bind quality with sharp, square spine corners.

## 10 Glue Tank



Dual application rollers and side gluing rollers ensure superior glue application to the spine for quality binding. The amount of glue applied and glue length can be adjusted through the color touchscreen.

## 8 Cover Registration



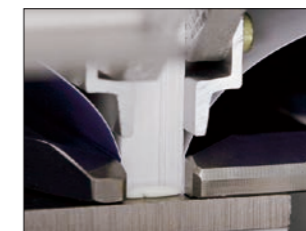

Top and bottom transport belts provide stable transportation of various cover types, and high-precision jog mechanisms register the cover securely for consistent, accurate binding.

## 11 Nipping Section



A strong, rigid nipping mechanism ensures binding quality equivalent with commercial-duty binding systems. Operators can select binding with or without milling and adjust the nipping height to achieve desired spine formation.



BQ-270V Major Specifications	
Binding Mode	Binding with milling, Binding without milling and Padding
Number of Carriage Clamp	1
Book Block Size (Top-Bottom x Fore-edge)	 Max. 320 x 320 mm (12.59" x 12.59") Min. 135 x 105 mm (5.32" x 4.14") A4 / A5 / A6 / B5 / B6
Book Thickness	1 to 50 mm (0.04" to 2.00")
Cover Size (Top-Bottom x Fore-edge)	 Max. 320 x 660 mm (12.59" x 25.98") (Up to 350 mm or 13.77" forwards from the clamp face) (Up to 310 mm or 12.20" backwards from the clamp face) Min. 135 x 230 mm (5.32" x 9.06") (Up to 120 mm or 4.73" forwards from the clamp face) (Up to 110 mm or 4.34" backwards from the clamp face)
Cover Weight Range	82 to 302 gsm (22 to 80 lb)
Cover Pile Height	Max. 70 mm (2.75")
Glue Temperature	120 to 180 degrees Celsius (248 to 356 degrees Fahrenheit) (To use the BQ-270V with the glue temperature 170 degrees Celsius or below, the setting is necessary by a service technician.)
Cycle Speed	With milling Max. 500 cycles/hr. Without milling Max. 500 cycles/hr. Padding Max. 500 cycles/hr.
Voltage / Frequency	3-Phase 200 / 208 / 220 / 230 / 240 / 400 V, 50 / 60 Hz
Power Consumption	200 V, 50 Hz, 2.7 kW / 60 Hz, 2.9 kW 208 V, 50 Hz, 3.29 kW / 60 Hz, 3.35 kW 220 / 230 / 240 V, 50 Hz, 2.9 kW / 60 Hz, 2.78 kW 400 V, 50 Hz, 3.1 kW / 60 Hz, 3.16 kW
Machine Dimensions	2,295(W) x 860(D) x 1,545(H) mm (90.4" x 33.9" x 60.9") (The parts projected from cover Not included) 2,430(W) x 910(D) x 1,545(H) mm (95.7" x 35.9" x 60.9") (The parts projected from cover included)
Machine Weight	Main Body: 900 kg (1,984.5 lb) Transformer: 80 kg (176.4 lb)

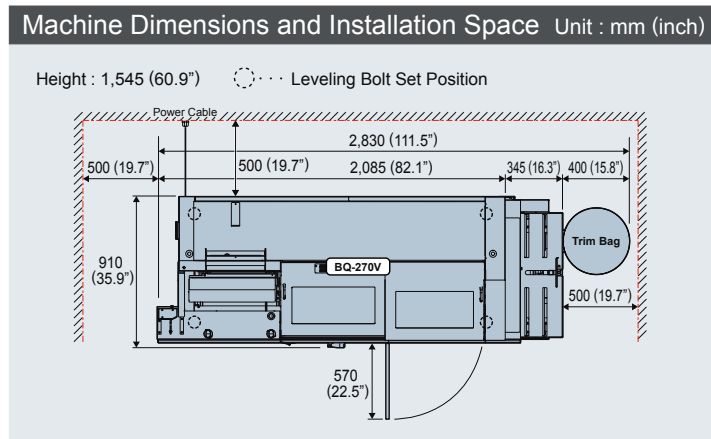

\*The machine design and specifications are subject to change without any notice.

## Options

### ■ Smoke Extractor VS-270V:

The strong blower provides constant fume extractions for a comfortable operating environment.  
 \*Sufficient space required for air circulation.



### ■ Weekly Timer T-270:

T-270 weekly timer automatically switches power on at pre-set times for quick make-ready. Time and day of the week can be set.



### ■ Delivery Conveyor DV-270:

The DV-270 high profile delivery unit is available for operator convenience. The conveyor lifts the books to a convenient height for easy unloading.



### ■ Lining Guide KG-270:

Reinforcing strips for case binding can be positioned in the correct location.

### ■ Barcode Verification System BC-BQ270:

Verify that cover and book block match by scanning with the BC-BQ270 barcode verification system.



### ■ Flap Cover Binding:

The fold line for flap covers can be scored in-line. Flap covers are then folded inward along the score line after binding.

\*Cover size: Top-bottom 320 x Fore-edge 660 mm (12.59" x 25.98")  
 (Up to 350 mm or 13.77" forwards from the clamp face)  
 (Up to 310 mm or 12.20" backwards from the clamp face)

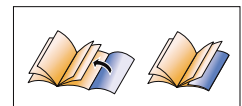

Distributed by

## HORIZON INTERNATIONAL, INC.

510 Kuze Ooyabu-cho, Minami-ku, Kyoto, 601-8206, Japan Phone : +81-(0)75-934-6700, Fax : +81-(0)75-934-6708, www.horizon.co.jp