

Art. 1198

D **Gebrauchsanweisung**
Automatischer Wasserverteiler

GB **Operating Instructions**
Automatic Water Distributor

F **Mode d'emploi**
Sélecteur automatique

NL **Gebruiksaanwijzing**
Automatische waterverdeler

S **Bruksanvisning**
Automatisk Vattenfördelare

I **Istruzioni per l'uso**
Distributore automatico d'acqua

E **Manual de instrucciones**
Distribuidor automático

P **Instruções de utilização**
Distribuidor automático de água

D
Inhalts-
verzeichnis

Seite 4 – 8

1. Hinweise zur Gebrauchsanweisung
2. Einsatzgebiet
3. Funktionsteile
4. Funktion
5. Maßnahmen vor Inbetriebnahme
6. Inbetriebnahme
7. Verwendung Feuchtesensor
8. Sicherheitshinweise
9. Wartung, Pflege, Aufbewahrung

GB
Contents

Page 9 – 12

1. Information concerning the operating instructions
2. Application
3. Functional parts
4. Function of the unit
5. Preparing the unit for operation
6. Operation
7. Application in conjunction with the Moisture Sensor
8. Safety hints
9. Maintenance, care, storage

F
Contenu

Page 13 – 17

1. Informations sur le mode d'emploi
2. Domaine d'utilisation
3. Descriptif
4. Fonctionnement
5. Conseils avant la mise en service
6. Mise en service
7. Utilisation du sélecteur avec la sonde humidité
8. Conseils de sécurité
9. Entretien et rangement

NL
Inhouds-
opgave

Pagina 18 – 22

1. Aanwijzingen bij de gebruiksaanwijzing
2. Gebruiksdoeleinden
3. Bedieningsonderdelen
4. Werkwijze
5. Maatregelen voor de ingebruikname
6. Ingebruikname
7. Gebruik vochtsensor
8. Veiligheidstips
9. Verzorging, onderhoud en opslag

S
Innehåll

Sida 23 – 26

1. Information
2. Användning
3. Tillhörande delar
4. Funktion
5. Förberedelser
6. Drift
7. Tillbehör: Fuktigheidsmätare
8. Säkerhetsråd
9. Underhåll, skötsel och förvaring

I
Indice

Pagina 27 – 30

1. Avvertenze
2. Modalità d'impiego
3. Parti funzionali
4. Caratteristiche operative
5. Operazioni preliminari
6. Messa in uso
7. Impiego con sensori di umidità/pioggia
8. Norme di sicurezza
9. Manutenzione, cura e ricovero

E
Índice

Página 31 – 35

1. Indicaciones sobre las instrucciones de uso
2. Campo de aplicación
3. Piezas de función
4. Funcionamiento
5. Medidas para antes de la puesta en marcha
6. Puesta en marcha
7. Uso del sensor de humedad
8. Advertencias de seguridad
9. Mantenimiento, cuidado y almacenamiento

P
Índice

Página 36 – 39

1. Informações sobre o funcionamento
 2. Campo de utilização
 3. Descritivo
 4. Funcionamento
 5. Ligação
 6. Funcionamento
 7. Aplicação: Sensor de humidade
 8. Conselhos de segurança
 9. Manutenção
-

A

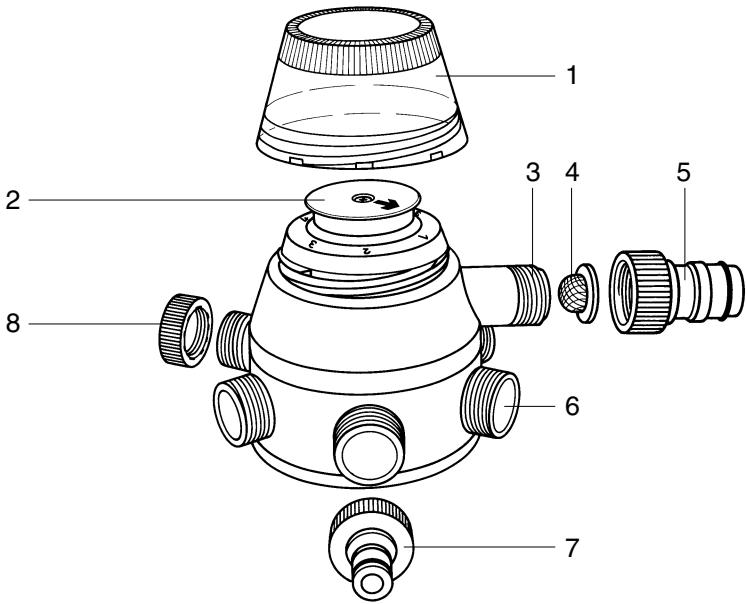

B

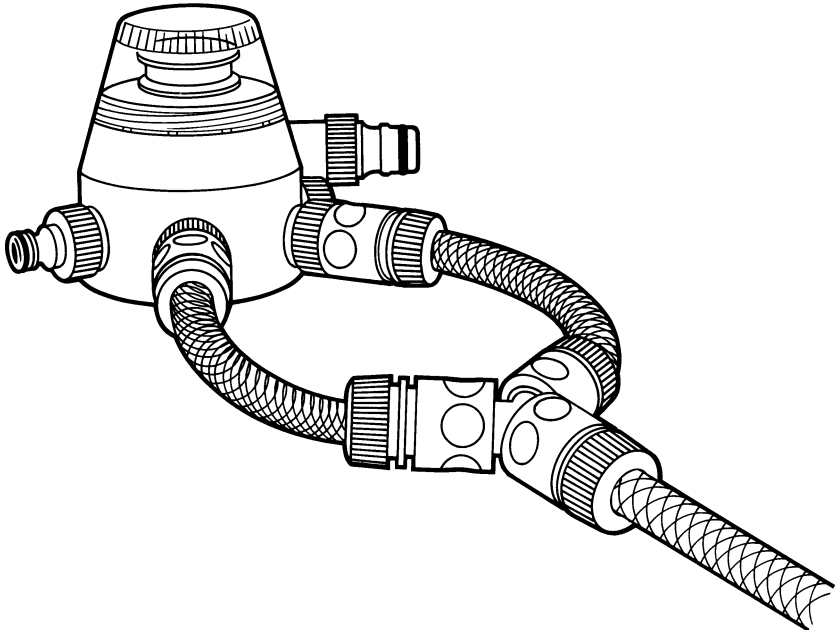

1. Information concerning the operating instructions

Please read the operating instructions carefully and use the unit accordingly. Use the operating instructions to get acquainted with the appliance, its proper use as well as the safety instructions.

 **For safety reasons children under the age of 16 and those unfamiliar with the instructions should not use the Automatic Water Distributor.**

Please keep the operating instructions and refer to them whenever a problem and/or questions arise.

2. Application

The Automatic Water Distributor is designed to provide fully automatic control of up to 6 individual water channels when used in conjunction with the GARDENA Water Computer 1060. The use of the Automatic Water Distributor is recommended if the simultaneous operation of watering system (i.e. Sprinkler System, several oscillating sprinklers, etc.) is impossible due to insufficient water pressure, or if various plant areas with different water requirements need to be served.

Of course, the Automatic Water Distributor can be operated not only fully automatically but also semi-automatically in combination with the GARDENA Watertimer or even manually by opening and shutting the water tap.

The Automatic Water Distributor is designed **for outdoor use only** in the private garden to control watering systems (sprinklers, watering systems).

 **The Automatic Water Distributor is not designed for industrial use or in connection with chemicals, food or any inflammable products.**

To operate the Automatic Water Distributor in accordance with these operating instructions is the basis for correct usage of the device.

3. Functional parts (ill. A)

- | | | |
|--------------------------------|---|--|
| 1. Protection cap | 4. Dirt filter | 7. Original GARDENA System Tap Connector |
| 2. Dial disc | 5. "Profi" Maxi-Flow System Tap Connector | 8. End caps |
| 3. Water inlet 26.5 mm (G 3/4) | 6. Water outlets 26.5 mm (G 3/4) | |

4. Function of the unit

The water outlets of the Automatic Water Distributor will, according to the specific programming of the Water Computers 1060/1030 or Watertimer electronic, be auto-

matically opened and shut sequentially.

Due to the individual operation of various channels larger watering systems or several watering

channels can be operated even at lower water pressure, controlled by a Water Computer/ Watertimer.

5. Preparing the unit for operation

The Automatic Water Distributor includes:
1 x GARDENA "Profi" Maxi-Flow System Tap Connector (5) (internal \varnothing 15 mm),

4 x Original GARDENA System Tap Connector (7) (internal \varnothing 9 mm),

and
3 x End cap (8)

5.1. Connection to the Water Computer 1060

The water inlet (3) can be fitted with the enclosed “Profi” Maxi-Flow System Tap Connector (5) or the Original GARDENA System Tap Connector (7).

When operating a **GARDENA Sprinkler System** the “Profi” Maxi-Flow System Tap Connector (5) should be used. The connection to the Water Computer/Watertimer is, in this instance, carried

out with a 19 mm (3/4”) hose and the “Profi” Maxi-Flow System Connector Set (Art. no. 1505).

If used in connection with **other watering systems or -accessories** (Micro-Drip-System or sprinklers), please use one of the enclosed Original GARDENA System Tap Connectors (7). The connection to the Water Computer/Watertimer is, in this

instance, carried out with a 13 mm (1/2”) hose and Original GARDENA Hose Connection System Parts.

To prevent any malfunction of the unit, please insert the enclosed dirt filter (4) into the water inlet and remove the washer of the threaded Tap Connector before connecting the tap connector..

5.2. Connection of watering accessories, watering system

The connection of the **GARDENA Sprinkler System** is carried out with a 19 mm (3/4”) hose and the “Profi” Maxi-Flow System Connector Set (Art. no. 1505).

If using the Sprinkler System Connector Art. 2761, the thread must be sealed with white teflon tape available from a from a good

DIY store (or GARDENA Teflon Tape Art. 7219).

If you connect **other watering systems or -accessories** (sprinklers, Micro-Drip-System), please use the enclosed Original GARDENA System Tap Connectors (7). Please close off unused water

outlets with the enclosed end caps (8).

If you require accessories in excess of the enclosed, please visit your GARDENA stockist.

6. Operation

Adjust the dial disc (2) to position 1. To accomplish this remove the protection cap (1) by turning the unit to the left. Pull the dial disc (2) slightly upwards and turn it to the right until the arrow points to water outlet 1. Then fix the protection cap (1) again.

Now program your GARDENA Water Computer 1060. Be sure to differentiate using the following text with regard to Automatic Water Distributor support between models **with** or **without** “**Special Program**”. When programming

the water computer **without the “Special Program”**, it is important that all 6 programmes are programmed and the numbers of the programmes (1–6) of the respective water outlets on the Automatic Water Distributor (1–6) are correctly ordered. **Ensure that with all 6 programmes the same watering days are entered.**

If you do not use all 6 water outlets, the unused outlets must still be programmed into the computer to ensure the Automatic Water Distributor returns to its original setting at all times. We recom-

mend a watering run time of 1 minute for all unused outlets.

Please also note the following hints:

 **To ensure correct function of the switch mechanism, please leave between the end of one programme and the beginning of the next a gap of 10 minutes. The time gap between each programme step increases to 30 minutes if you switch from a sealed unused outlet to the next outlet.**

Example:

Programme/ water outlet	Start Time	Run Time	Mo	Tu	We	Th	Fr	Sa	Su	2nd	3rd
1	19:00	0:30	X		X			X			
2	19:40	0:30	X		X			X			
3	20:20	0:30	X		X			X			
4	21:00	0:05	X		X			X			
5 } Sealed un-	21:15	0:01	X		X			X			
6 } used outlets	21:46	0:01	X		X			X			

When using the GARDENA Water Computer 1060 with **“Special Program”**, after activating this function and entering all data for the 1st programme, then all following programmes will automatically be programmed. Through that, every programme will be ordered to a definite water outlet of the Automatic Water Distributor without having to individually define all 6 programmes. The default settings (1 min watering run time, 30 min break between programmes) can be altered according to individual consumer requirements.

In combination with the GARDENA Water Computer 1030 or the GARDENA Watertimer electronic,

the Automatic Water Distributor switches 1 outlet further along for each watering activity. Both tools make it possible to activate a maximum of 3 waterings per day and in this limit the Automatic Water Distributor can open up to 3 outlets. The same outlet can therefore be opened max. every 2 days.

 **If the location of the Automatic Water Distributor is lower than all connected watering devices the maximum height difference should not exceed 1.5 m.**

If less than 6 water outlets are used there is the option to operate one or several water channel twice a day. Please connect the outlets

as shown in ill. B and programme the Water Computer according to your requirements.

The minimum water pressure for proper operation is 1 bar. If too many devices are connected to one line, the pressure may fall below 1 bar and will be insufficient for proper operation of all devices.

The switch mechanism of your Automatic Water Distributor is due to technical reasons designed in a way that during operation water flows not only through the activated outlet, but also in small quantities (some litres per hour) through the other outlets.

7. Application in conjunction with the Moisture Sensor

The GARDENA Moisture Sensor, art.no. 1187 can be used in connection with the Automatic Water Distributor **only** when using the Water Computer 1060 with **“Special Program”** mode. If the Moisture Sensor detects sufficient moisture, it automatically shortens the run time of the watering programme to the minimum watering run time of 30 seconds (Display: 1 min). In this way, the Automatic Distri-

butor switches to the next outlet. Thus the correct ordering of the individual watering programmes to their respective outlets of the Automatic Water Distributor is retained.

When using the Water Computer 1060 **without “Special Program”**, the Water Computer 1030 or the Watertimer electronic, programmes which have become active will not operate when the Moisture Sensor detects suffi-

cient moisture. In this case the ordering of the programmes is no longer answerable to the previously designated outlets of the Automatic Water Distributor.

 **There is a risk of damage if a desired programme is no longer connected with its respective water outlet – the program may run using another outlet of the Water Distributor.**

8. Safety hints

 **Please make sure that the programmes of the Water Computer and the individual water outlets of the Automatic Water Distributor are matched up according to your requirements and that the set watering days of all programmes are identical.**

 **If the water tap is shut, the Water Computer opens the integrated valve at the chosen times, but no water is produced!**

The Automatic Water Distributor can therefore not switch to the next outlet. In this case the ordering of the programmes is no longer answerable to the previously designated outlets.

 **If the Water Computer is operated manually (On/Off) whilst connected to the Automatic Water Distributor, the device will switch to the next outlet. Therefore, do not operate the Water Computer manually.**

If it is operated manually, please ensure the programmes are aligned afterwards to the water outlets according to the original setting.

 **To ensure correct function of the unit, please leave a time gap of 10 minutes between the end of each programme and the start of the next. The time gap between each programme step increases to 30 minutes if you switch from a sealed unused outlet to the next outlet.**

 By deactivating the programme (Bad Weather Function), it may be possible that the watering programmes no longer agree with the respective water outlets of the Automatic Water Distributor. Therefore avoid deactivation of the programmes or re-assemble respectively the correct sequence by turning the dial disc (after starting operation). Only for use in combination with

the Water Computer 1060 with “Special Program”, activation of this function is possible without changing the sequence of the watering programmes. Please note the advice given in the operating instructions of your tool!

 Operate the Automatic Water Distributor in connection with the GARDENA Moisture Sensor only when linked up to the Watering

Computer 1060 with “Special Program”. With tools without this function, the danger exists that, the ordering of the programmes to their specific outlets may be altered.

 Never press the dial disk during operation.

 The individual outlets can be operated one after the other, i.e. outlet 1, outlet 2 ...

9. Maintenance, care, storage

The Automatic Water Distributor is maintenance free, only the dirt filter (4) has to be cleaned from time to time. Please store the Automatic Water Distributor in a frost-resistant place before the first frost sets in.

We expressly point out – that in accordance with product liability law – we are not liable for damage caused by our equipment if it is due to improper repair or if parts have been exchanged not using our Original GARDENA parts or parts approved by us and if the repairs were not carried out

by the GARDENA Technical Service. The same applies to supplementary parts and accessories.

Should you have any further questions, please contact a GARDENA Service Centre (address on the rear).

EU-Certificate of Conformity

The undersigned

GARDENA Manufacturing GmbH · Hans-Lorensen-Str. 40 · D-89079 Ulm

hereby certifies that, when leaving our factory, the unit indicated below is in accordance with the harmonised EU guidelines, EU standards of safety and product specific standards.

This certificate becomes void if the unit is modified without our approval.

Description of the unit:
Automatic Water Distributor

Year of CE marking:
1994

Art. No.:
1198

Ulm, 15.05.2000

EU Directives:
Machinery Directive 98/37/EC



Thomas Heint
Technical Dept. Manager

Harmonised European Standards:
EN 292-1
EN 292-2

D

Garantie

GARDENA gewährt für dieses Produkt 2 Jahre Garantie (ab Kaufdatum). Diese Garantieleistung bezieht sich auf alle wesentlichen Mängel des Gerätes, die nachweislich auf Material- oder Fabrikationsfehler zurückzuführen sind. Sie erfolgt durch die Ersatzlieferung eines einwandfreien Gerätes oder durch die kostenlose Reparatur des eingesandten Gerätes nach unserer Wahl, wenn folgende Voraussetzungen gewährleistet sind:

- Das Gerät wurde sachgemäß und laut den Empfehlungen in der Gebrauchsanweisung behandelt.
- Es wurde weder vom Käufer noch von einem Dritten versucht, das Gerät zu reparieren.

Das Verschleißteil Dichtteller ist von der Garantie ausgeschlossen.

Diese Hersteller-Garantie berührt die gegenüber dem Händler/Verkäufer bestehenden Gewährleistungsansprüche nicht.

Im Servicefall schicken Sie bitte das defekte Gerät zusammen mit einer Kopie des Kaufbelegs und einer Fehlerbeschreibung per Abhol-Service (nur in Deutschland) oder frankiert an die auf der Rückseite angegebene Serviceadresse.

GB

Guarantee

GARDENA guarantees this product for 2 years (from date of purchase). This guarantee covers all serious defects of the unit that can be proved to be material or manufacturing faults. Under guarantee we will either replace the unit or repair it free of charge if following conditions apply:

- The unit must have been handled properly and in keeping with the requirements of the operating instructions.
- Neither the purchaser or a non-authorised third party have attempted to repair the unit.

The seal is a wearing part and is not covered by the guarantee.

This manufacturer's guarantee does not affect the user's existing warranty claims against the dealer/seller.

In case of claim, please return the faulty unit together with a copy of the receipt and a description of the fault, with postage paid to one of the GARDENA Service Centres listed on the back of these operating instructions.

F

Garantie

GARDENA accorde pour cet appareil une garantie contractuelle de 2 ans à compter du jour de l'achat. Elle comprend le remplacement gratuit des pièces défectueuses ou de l'appareil, le choix en étant laissé à la libre initiative de GARDENA. En tout état de cause s'applique la garantie légale couvrant toutes les conséquences des défauts ou vices cachés (article 1641 et suivants du Code Civil).

Pour que ces garanties soient valables, les conditions suivantes doivent être remplies :

- L'appareil a été manipulé de manière adéquate, suivant les instructions du mode d'emploi.
- Il n'y a eu aucun essai de réparation, ni par le client, ni par un tiers.

Le disque d'étanchéité est une pièce d'usure et est par conséquent exclu de la garantie.

Une intervention sous garantie ne prolonge pas la durée initiale de la garantie contractuelle.

Toutes les revendications dépassant le contenu de ce texte ne sont pas couvertes par la garantie, quel que soit le motif de droit.

Pendant la période de garantie, le Service Après-Vente effectuera, à titre payant, les réparations nécessaires par suite de manipulations erronées.

NL

Garantie

GARDENA geeft op dit product 2 jaar garantie (vanaf de aankoopdatum). Deze garantie heeft betrekking op alle wezenlijke defecten aan het toestel, die aanwijsbaar op materiaal- of fabricagefouten berusten. Garantie vindt plaats door de levering van een vervangend apparaat of door de gratis reparatie van het ingestuurde apparaat, naar onze keuze, indien aan de volgende voorwaarden is voldaan:

- Het apparaat werd vakkundig en volgens de adviezen in de gebruiksaanwijzing behandeld.
- Noch de koper, noch een derde persoon heeft getracht het apparaat te repareren.

De aan slijtage onderhevige afdichtschotel valt niet onder de garantie.

Deze garantie van de producent heeft geen betrekking op de ten aanzien van de handelaar/verkoper bestaande aansprakelijkheid.

In geval van reclamatie het defecte apparaat samen met de kassabon en een beschrijving van de storing gefrankeerd op naar het op de achterzijde aangegeven serviceadres opsturen.

Deutschland / Germany

GARDENA
Manufacturing GmbH
Service Center
Hans-Lorenser-Straße 40
D-89079 Ulm
Produktfragen:
(+49) 731 490-123
Reparaturen:
(+49) 731 490-290
service@gardena.com

Argentina

Argensem® S.A.
Calle Colonia Japonesa s/n
(1625) Loma Verde
Escobar, Buenos Aires
Phone: (+54) 34 88 49 40 40
info@argensem.com.ar

Australia

Nylex Consumer Products
50-70 Stanley Drive
Somerton, Victoria, 3062
Phone: (+61) 1800 658 276
spare.parts@nylex.com.au

Austria / Österreich

GARDENA
Österreich Ges.m.b.H.
Stettnerweg 11-15
2100 Korneuburg
Tel.: (+43) 2262 7 45 45 36
kundendienst@gardena.at

Belgium

GARDENA Belgium NV/SA
Sterrebeekstraat 163
1930 Zaventem
Phone: (+32) 2 720 92 12
Mail: info@gardena.be

Brazil

Palash Comércio e
Importação Ltda.
Rua Américo Brasiliense,
2414 - Chácara Sto Antonio
São Paulo - SP - Brasil -
CEP 04715-005
Phone: (+55) 11 5181-0909
eduardo@palash.com.br

Bulgaria

DENEX LTD.
2 Luis Ahalier Str. - 7th floor
Sofia 1404
Phone: (+359) 2 958 18 21
office@denex-bg.com

Canada

GARDENA Canada Ltd.
100 Summerlea Road
Brampton, Ontario L6T 4X3
Phone: (+1) 905 792 93 30
info@gardenacanada.com

Chile

Antonio Martinic y Cia Ltda.
Cassillas 272
Centro de Cassillas
Santiago de Chile
Phone: (+56) 2 20 10 708
garfar_cl@yahoo.com

Costa Rica

Compania Exim
Euroberoamericana S.A.
Los Colegios, Moravia,
200 metros al Sur del Colegio
Saint Francis - San José
Phone: (+506) 297 68 83
exim_euro@racsa.co.cr

Croatia

KLIS d.o.o.
Stanciceva 79
10419 Vukovina
Phone: (+385) 1 622 777 0
gardena@klis-trgovina.hr

Cyprus

FARMOKIPIKI LTD
P.O. Box 7098
74, Digeni Akrita Ave.
1641 Nicosia
Phone: (+357) 22 75 47 62
condam@spidernet.com.cy

Czech Republic

GARDENA spol. s r.o.
Řípská 20a, č.p. 1153
627 00 Brno
Phone: (+420) 800 100 425
gardena@gardenabrno.cz

Denmark

GARDENA Norden AB
Salgsafdeling Danmark
Box 9003
S-200 39 Malmö
info@gardena.dk

Finland

Habitec Oy
Martinkyläntie 52
01720 Vantaa

France

GARDENA
PARIS NORD 2
69, rue de la Belle Etoile
BP 57080
ROISSY EN FRANCE
95948 ROISSY CDG CEDEX
Tél. (+33) 0826 101 455
service.consommateurs@
gardena.fr

Great Britain

GARDENA UK Ltd.
27-28 Brenkley Way
Bleazard Business Park
Seaton Burn
Newcastle upon Tyne
NE13 6DS
info@gardena.co.uk

Greece

Agrokip
G. Psomadopoulos & Co.
33 A, Ifestou str. –
Industrial Area
194 00 Koropi, Athens
Phone: (+30) 210 66 20 225
service@agrokip.gr
www.agrokip.gr

Hungary

GARDENA
Magyarország Kft.
Késmárk utca 22
1158 Budapest
Phone: (+36) 80 20 40 33
gardena@gardena.hu

Iceland

Ó. Johnson & Kaaber
Tunguhalsi 1
110 Reykjavik
ooj@ojk.is

Ireland

Michael McLoughlin & Sons
Hardware Limited
Long Mile Road
Dublin 12

Italy

GARDENA Italia S.p.A.
Via Donizetti 22
20020 Lainate (Mi)
Phone: (+39) 02.93.94.79.1
info@gardenaitalia.it

Japan

KAJUCHI Co. Ltd.
Sumitomo Realty &
Development Kojimachi
BLDG., 8F
5-1 Nibannoyo, Chiyoda-ku
Tokyo 102-0084
Phone: (+81) 33 264 4721
m_ishihara@kaku-ichi.co.jp

Luxembourg

Magasins Jules Neuberg
Grand Rue 30
Boîte postale 12
L-2010 Luxembourg
Phone: (+352) 40 14 01
info@neuberg.lu

Netherlands

GARDENA Nederland B.V.
Postbus 50176
1305 AD ALMERE
Phone: (+31) 36 521 00 00
info@gardena.nl

Neth. Antilles

Jonka Enterprises N.V.
Sta. Rosa Weg 196
P.O. Box 8200
Curaçao
Phone: (+599) 9 767 66 55
pgm@jonka.com

New Zealand

NYLEX New Zealand Limited
Building 2, 118 Savill Drive
Mangere, Auckland
Phone: (+64) 9 270 1806
lena.chapman@nylex.com.au

Norway

GARDENA Norden AB
Salgskontor Norge
Karihaugveien 89
1086 Oslo
info@gardena.no

Poland

GARDENA Polska Sp. z o.o.
Szymanów 9 d
05-532 Baniocza
Phone: (+48) 22 727 56 90
gardena@gardena.pl

Portugal

GARDENA Portugal Lda.
Recta da Granja do Marquês
Edif. GARDENA Algueirão
2725-596 Mem Martins
Phone: (+351) 21 922 85 30
info@gardena.pt

Romania

MADEX INTERNATIONAL SRL
Soseaua Odaii 117-123,
Sector 1,
București, RO 013603
Phone: (+40) 21 352 76 03
madex@ines.ro

Russia / Россия

АО АМИДА ТТЦ
ул. Мосфильмовская 66
117330 Москва
Phone: (+7) 095 956 99 00
amida@col.ru

Singapore

Hy-Ray PRIVATE LIMITED
40 Jalan Pemimpin
#02-08 Tat Ann Building
Singapore 577185
Phone: (+65) 6253 2277
hyray@singnet.com.sg

Slovak Republic

GARDENA Slovensko, s.r.o.
Brohova č. 1
85101 Bratislava
Phone: (+421) 263 453 722
info@gardena.sk

Slovenia

Silk d.o.o.
Brodišče 15
1236 Trzin
Phone: (+386) 1 580 93 00
gardena@silk.si

South Africa

GARDENA
South Africa (Pty.) Ltd.
P.O. Box 11534
Vorna Valley 1686
Phone: (+27) 11 315 02 23
sales@gardena.co.za

Spain

GARDENA IBERICA S.L.U.
C/ Basauri, nº 6
La Florida
28023 Madrid
Phone: (+34) 91 708 05 00
atencioncliente@gardena.es

Sweden

GARDENA Norden AB
Försäljningskontor Sverige
Box 9003
200 39 Malmö
info@gardena.se

Switzerland / Schweiz

GARDENA (Schweiz) AG
Bitzberg 1
8184 Bachenbülach
Phone: (+41) 848 800 464
info@gardena.ch

Turkey

GARDENA / Dost Diş Ticaret
Mümesillik A.Ş. Sanayi
Çad. Adil Sokak No. 1
Kartal - İstanbul
Phone: (+90) 216 38 93 939
info@gardena-dost.com.tr

Ukraine / Україна

ALTSEST JSC
4 Petropavlivska Street
Petropavlivska
Borschahivka Town
Kyivo Svyatoslyn Region
08130, Ukraine
Phone: (+380) 44 459 57 03
upry@altsest.kiev.ua

USA

Melnor Inc.
3085 Shawnee Drive
Winchester, VA 22604
Phone: (+1) 540 722-9080
service_us@melnor.com

1198-20.960.11/0406

© GARDENA
Manufacturing GmbH
D-89070 Ulm
http://www.gardena.com