

ARCHON™



RISE™
explore-rise.com

INSTRUCTION MANUAL

WARNING

Please read and understand this manual, the operation and all safety aspects required for the safe operation of the product. Before use, if you feel that this product is not for you, please return it to the place of purchase.

Manual Specifications and Description Changes

The instruction manual, warranties, and other associated documentation are subject to change without notice. Horizon Hobby assumes no responsibility for inadvertent errors to this manual.



WARNING! This product includes a lithium polymer (LiPo) battery. Improper handling may result in FIRE! You are responsible for following all safety precautions as outlined in this instruction manual.

INTRODUCTION

Thank you for purchasing the Archon™ drone. We want the time you spend with your new R/C drone to be fun and successful so please read the entire manual before beginning setup. If for any reason you think this drone is not for you, return it to the dealer immediately. Your dealer cannot accept returns on any model after final assembly.

For the latest technical updates or manual corrections for the Archon drone please visit the RISE web site at www.explore-rise.com. If there is any new technical information, changes or important updates to this model, a “tech notice” box will appear on the page. Click the “tech notice” box to learn more.

SAFETY PRECAUTIONS



Failure to follow these safety precautions may result in injury to yourself and others.

- Keep your face and body as well as all spectators away from the rotating plane of the propellers whenever the battery is connected. Keep loose clothing, shirt sleeves, ties, scarfs, long hair or loose objects such as pencils or screwdrivers that may fall out of shirt or jacket pockets away from the propellers. The spinning propellers of a model quadcopter can cause serious injury. When choosing a flying site for your Archon drone, stay clear of obstacles, trees and power lines. **AVOID** flying in or near crowded areas. **DO NOT** fly close to people or pets. Maintain a safe distance from the quadcopter.
- Your Archon drone should not be considered a toy. Because of its performance capabilities, the drone, if not operated correctly, could cause injury to you or spectators and damage to property.
- **DO NOT** alter or modify the drone. Doing so may result in an unsafe or unflyable model.
- When and if repairs are necessary you must correctly install all components so that the model operates properly on the ground and in the air. Please check the operation of the model before every flight to ensure that all equipment is operating and that the model has remained structurally sound. Be sure to check the propellers before each flight. Replace them if they show any signs of wear or fatigue.

LITHIUM BATTERY WARNING!



This product includes a lithium polymer (LiPo) battery. Improper handling could result in **FIRE!** A lithium battery fire has the potential to ignite surrounding areas and may cause property damage or cause personal injury.

For safe LiPo handling, follow all of these guidelines. If you are unable to follow these guidelines, return this product to the place of purchase.

- **MOST IMPORTANT! NEVER** leave the charger and LiPo battery unattended while charging.
- Keep out of reach of children!
- **NEVER** charge a LiPo battery on a flammable surface or near combustible materials.
- **NEVER** charge inside a vehicle or at a location that could be damaged in the event of a LiPo fire.
- Do not charge or use a battery that is deformed, bent, crushed or has any type of visible damage.
- Only use the included factory approved charger with this LiPo battery.
- **ALWAYS** keep a supply of sand accessible when charging. Dumping sand on the battery will assist in extinguishing a LiPo chemical fire.
- It is normal for the charger to become warm to the touch. However, disconnect the battery and unplug the charger **immediately** if either becomes hot, begins to swell, or smoke!
- Disconnect the battery and unplug the charger if the charge time **exceeds 3 hours**.
- **ALWAYS** disconnect the battery and unplug the charger after the charge is complete.
- **ALWAYS** disconnect and remove the battery from your model **immediately** following operation.
- **ALWAYS** store/transport LiPo batteries in a **fireproof container** away from combustible materials.
- **NEVER** put a LiPo battery in the pocket of any clothing.
- Keep LiPo batteries out of reach of animals. A punctured battery may cause a fire.
- Do not use the included charger for any other battery other than the one included with this model.
- In the event of a crash, place the battery into a **fireproof container** immediately. Examine the battery for damage before further use.
- Only operate and store batteries between 40-110° F (4-43° C).
- **NEVER** allow the battery temperature to exceed 140° F [60° C] during operation.
- **NEVER disassemble or modify a battery**, its wiring, or puncture cells, as this may result in fire.
- Do not allow the battery to short circuit by touching exposed wires together.
- Stop the operation of your model immediately when the battery power is low. A battery failure can occur when attempting to recharge an over-discharged battery.
- LiPo batteries **must always** be recycled or disposed of properly.

CONTENTS

- RISE Archon FPV drone
- 2.4 GHz 6- Channel Transmitter
- Extra Propellers
- Prop Guards
- FPV Monitor with Antenna
- 2200 mAh 2S LiPo
- LiPo Charger w/ AC Charge Adapter
- 4 AA Batteries
- Screwdriver
- Instruction Manual

FEATURES

- Entry Level 370 mm GPS FPV drone
- Ready to Fly, no building required
- 200 mW VTX
- GPS Stability and Return-To-Home

DIMENSIONS

Size: 370 mm (14.6 in)
diagonally motor to
motor
Width*: 300 mm (11.8 in)
Length*: 304 mm (12.0 in)

Height: 110 mm (4.3 in)
Prop: 203 mm (8.0 in)
Empty Weight: 430.9 g (15.2 oz.)
without battery

*without prop guards

MONITOR SPECIFICATIONS

Input power: 5 volts
Channels: 40
Frequencies: 5.725 – 5.945 GHz
Charge jack: micro USB

Dimensions 150 x 79 x 13 mm
with case: (5.91 x 3.11 x 0.51 in)
Weight w/o
antenna: 145 g (5.11 oz.)

KNOW BEFORE YOU FLY

As a new owner of an unmanned aircraft system (UAS), you are responsible for the operation of this vehicle and the safety of those around you. Please contact your local authorities to find out the latest rules and regulations.



Federal Aviation Administration
faa.gov/uas

SETUP

Unboxing

Remove the contents of the box and become familiar with the included parts. To easily remove the transmitter from the packaging, push outward at the location shown while lifting up on the transmitter from the same side.



Battery Charging

Plug the AC wall adapter into a 120V outlet and connect the balance charger to the wall adapter. The power LED will illuminate solid **RED**. Plug the white balance plug on the battery to the 2S port on the charger. When charging, the charge status LED will illuminate solid **RED**. When charge is complete the LED will change to solid **GREEN**. Typical charge time of a depleted battery is approximately 2 hours.

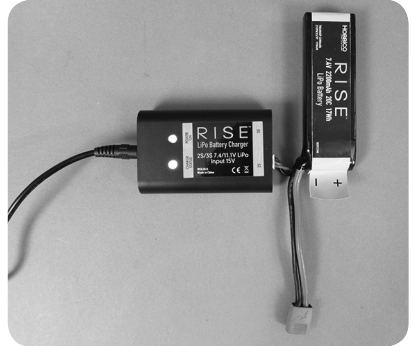

NOTE: A blinking red charge status LED indicates a charging error.

- **NEVER** leave the battery unattended while charging.
- **ALWAYS** unplug the charger from the outlet and the battery when charging is complete.
- **NEVER** charge a puffed or damaged battery.

NOTE: It is normal for the charger to get warm during the charging process.
🔥 See the battery precautions at the front of this manual.

Battery Installation

Insert the flight battery into the battery tray on the underside of the Archon drone. Be sure that the battery is slid as far back into the tray as allowed. A battery not properly installed may fall out during flight and may affect the center of gravity of the drone.

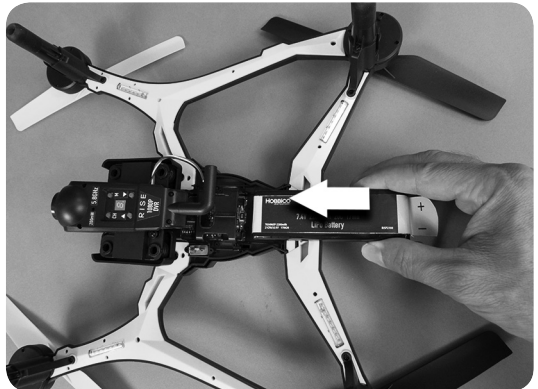

Prop Guard Installation

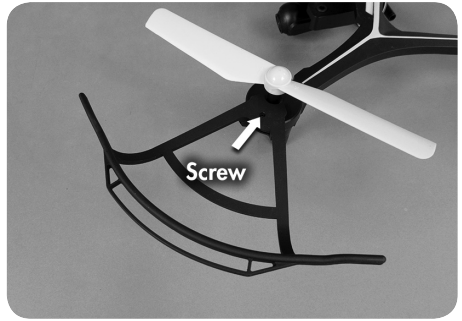
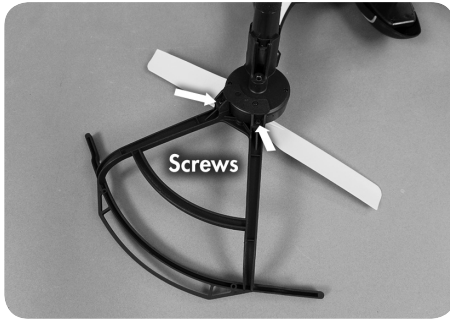

NOTE: Prop guards are included to help protect the propellers from accidental contact with obstacles. We recommend they be installed prior to your first flight.

Fit the bottom prop guard retainer over the alignment pin on the motor cover. Press the prop guard in place as shown with the pins in the alignment holes. It should fit snugly over the screw bosses on the retainer. Secure the prop guard and retainer using three screws included in the package. Repeat this procedure for the other three prop guards.

RADIO SYSTEM

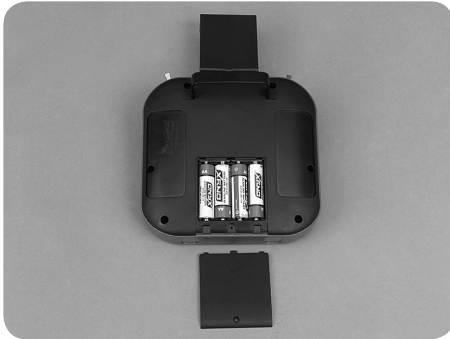

Remove the battery door screw and slide the door down to access the battery compartment. Install the included AA batteries and replace the door.

Flight Mode Switch

Altitude Hold sets the drone to just maintain its altitude when the left stick is centered. In this mode, the drone can drift with the wind. The right stick and the rotate control may be needed to keep the drone in position.

GPS Hold enables the GPS (Global Positioning System) system to keep the drone in position when the sticks are centered. The drone must be in an open area where it is receiving GPS signals for this function to work correctly.



Home enables the Return-To-Home function (RTH). When the switch is moved to Home, the drone will climb to 8 meters if at or below that altitude, fly back to the launch point, and then initiate auto-land. When it has completed the landing, the drone will stop the propellers.

D/R Switch

This switch controls the sensitivity of the controls. When the switch is pushed toward the back of the transmitter, the controls are in the high setting. This setting is recommended for flying in moderate winds (5+ mph) or higher.



Pull the switch forward to enter the low rate setting. This setting is best for calm conditions or when beginning pilots are learning to fly the drone.

Picture Button

Push this button to capture a still picture on a memory card (*not included) that has been installed in the camera.



Video Button

Push this button to record a video on a memory card (*not included) that has been installed in the camera.

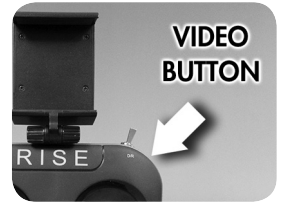

Transmitter LED Indicators

There are LED indicators on the transmitter and the drone. The behavior and color of the LEDs will communicate to you the current status of the drone. Read and understand the different LED behaviors before attempting to fly the drone. A quick reference chart is also provided for future use.

GPS - This LED will flash slowly when at least six satellites have been detected for GPS mode. The LED will remain off if there are not enough satellites to fly in GPS (Global Positioning System) mode.



*Memory card not included. Maximum storage 32GB. Class 10 or higher recommended.

TX - This LED is illuminated solid when the transmitter is turned on and the transmitter batteries have enough voltage to safely fly. This LED will flash and the transmitter will beep when the transmitter battery voltage reaches 4.5V. If this occurs during flight, land the drone and replace the transmitter batteries.

LVC - When the drone is powered on and the transmitter is on and properly linked to the drone, this LED will be solid as long as the battery voltage is above 7.5V. The LED will flash and the transmitter will continuously emit a series of beeps when the battery voltage falls below 7.5V. If flying in altitude mode, the drone will begin the auto-land feature in 3 seconds after LVC (Low Voltage Cutoff) occurs. If flying in GPS mode the drone will initiate the RTH (Return-to-Home) function which will cause it to fly back to the home point at 8 meters in altitude and in a direct line of flight at which point the drone will auto-land. **NOTE:** To cancel the RTH function when initiated by a low voltage cutoff condition, move the flight control switch to **ALTITUDE HOLD**. The drone will stop its flight back to the point and immediately descend straight down from its current position for landing.

PREPARING FOR FLIGHT

NOTE: Do not try to fly at this time. You must calibrate the Archon drone before your first flight.

Powering the Drone

1. Turn on the transmitter by pressing the power button. The TX and LVC LEDs will illuminate and the transmitter will emit a continuous series of beeps until the drone is powered.



2. Connect a charged battery to the drone. The transmitter will stop beeping when it detects the radio connection to the drone. If the transmitter continues to beep then the drone may not be linked to the transmitter. See **LINKING THE TRANSMITTER**.

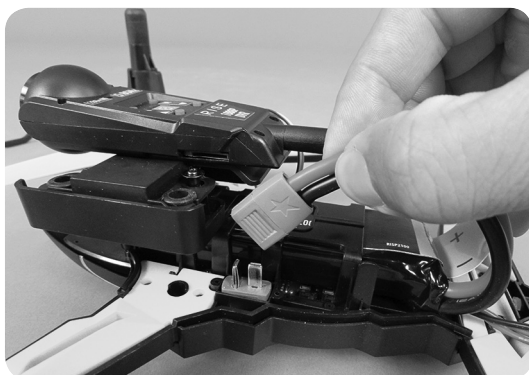

3. Place the drone in an open area free of any people or obstacles.

Rear Drone LED

The rear drone LED will relay the following information to the pilot:

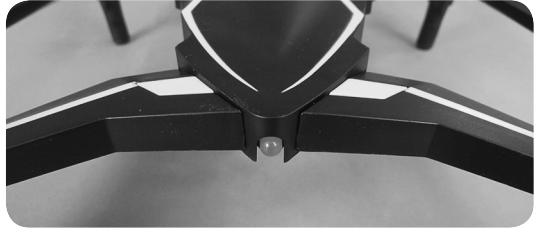

Pre-flight LED status



Fast Flash RED - Searching for GPS satellites.



Slow Flash RED - GPS acquired, home position not yet set.



Solid RED - GPS acquired and home position set.



Fast Flash GREEN - Begin compass calibration. See **Compass Calibration** for complete description.



Slow Flash GREEN - Awaiting vertical rotation for compass calibration procedure.

Compass Calibration

When the drone is powered on, it will automatically take magnetic readings of the surroundings and compare them to its current compass settings. If the drone determines that the compass needs to be calibrated, it will initiate the compass calibration procedure indicated by the drone rear LED flashing fast green. Compass calibration should be done in an open area, free of any large metal objects such as automobiles, fences, buildings, etc.

Fast Flash GREEN - The drone should be placed on a flat, level surface. Rotate the drone as shown while keeping it level until the LED changes to slow flash green.

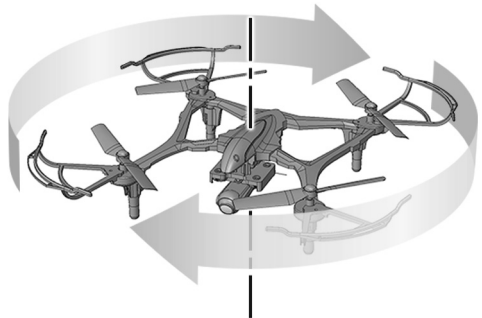

Slow Flash GREEN - Pick the drone up and hold it vertically with the nose pointing down. Rotate the drone as shown until the LED no longer flashes green.

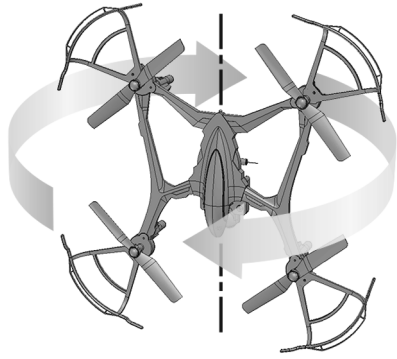

If at any time the drone appears to be flying erratically or is unable to maintain position during hover in GPS mode, compass calibration can be manually initiated when the drone and transmitter are powered on and propellers are un-armed (not rotating). Move both transmitter sticks simultaneously to the bottom left corners and hold until the drone rear LED flashes fast green. Release the sticks. Then, continue with the procedure described in this section.



Accelerometer Calibration

Accelerometer calibration can be performed whenever the drone is placed on a flat, level surface and the propellers are un-armed (not rotating). This calibration should be performed regularly to help ensure that the sensors are operating correctly during flight.

To perform accelerometer calibration, the drone and transmitter must be powered on and the propellers must be un-armed (not rotating). Place the drone on a flat, level surface and move both transmitter sticks to the bottom right corners and hold until the drone rear LED alternates quickly between red and green.



Motor Arming and Disarming

When you are ready for flight and the drone is in a safe, open area, arm the motors by moving both transmitter sticks to the bottom inside corners and hold until the propellers begin to rotate. **WARNING:** The props will rotate at a moderately slow, idle speed when armed. Moving the throttle stick above the middle stick position after the motors are armed will cause the propellers to accelerate for flight.



To stop the propellers from rotating after they have been armed, or at any time after landing if the propellers fail to automatically stop, you can disarm them by moving both transmitter sticks to the bottom outside corners and hold until the propellers stop.



Emergency Stop -

The emergency stop function can be used any time during flight to stop the motors from rotating. We recommend that the emergency stop function only be used when

necessary to preserve the safety of surrounding things and people or to prevent the imminent loss of your drone due to pilot error or malfunction.



To activate the Emergency Stop, press and hold the **PICTURE** and **VIDEO** buttons simultaneously for at least 2 seconds.

NOTE: The motors will stop spinning when the emergency stop is activated. This will cause the drone to fall freely to the ground. Care should be taken to ensure that causing the drone to fall to the ground uncontrolled, likely damaging both it (the drone) and possibly what it lands on, is preferable to a controlled descent and landing. Use the emergency stop only when necessary. The transmitter LEDs will indicate that the emergency stop was activated by flashing repeatedly in a consecutive order. This indication can be cancelled by arming the motors again or cycling the power of the transmitter.

FLYING THE ARCHON

Flight Modes

The drone can be flown with or without GPS assist. The altitude hold function is always operational regardless if GPS is assisting your flight.



Altitude Hold - Moving the flight mode switch to ALTITUDE HOLD disables GPS assist. In this mode the drone can be flown anywhere even if there is no GPS signal present. The barometric sensor will still provide information to the drone about its altitude which will allow it to automatically maintain the current altitude when the throttle stick (left stick) is released. Because GPS is not assisting with the flight, the drone is free to drift with the wind



or other external factors. In this mode, the pilot will need to continue to make corrections using the transmitter sticks in all directions in order to hold position (hover).

GPS Hold - With GPS assist turned on, the drone benefits from having its current position detected by satellites and therefore can automatically make the necessary control corrections to hold that position. When the sticks are released, wind will not cause the drone to move from its current position in this mode. (Some adjustment is to be expected in windy conditions as the drone makes the necessary pitch corrections to maintain position.) This mode is very useful when using the drone to take pictures or record video. In order for the drone to fly with GPS assist, it must be in an area free of any obstruction that would interfere with satellite communication as well as any large metal objects that might affect its geomagnetic readings.

HOME - The home function is used when you would like the drone to fly automatically to the position where the drone set the home point. When the flight mode switch is moved to Home, the drone will climb to 8 meters in altitude (if below 8 meters) and then fly a direct path to the position directly above the home point. The drone will then slowly descend straight down until touch down is detected at which point the drone will automatically stop the propellers. To cancel RTH (Return-To-Home), move the flight mode switch out of Home.

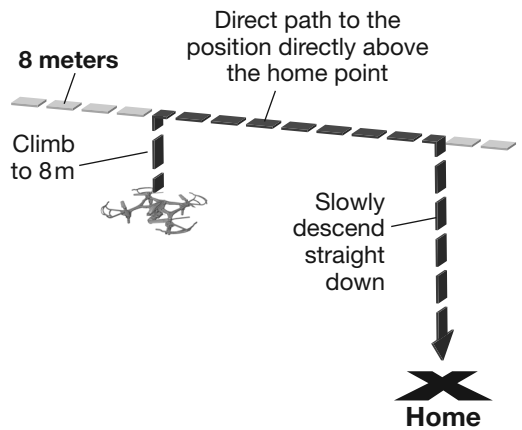

NOTE: If the GPS signal is lost or the motors were armed before the home point was set, then the drone cannot return to the set home point automatically.

Stick Controls

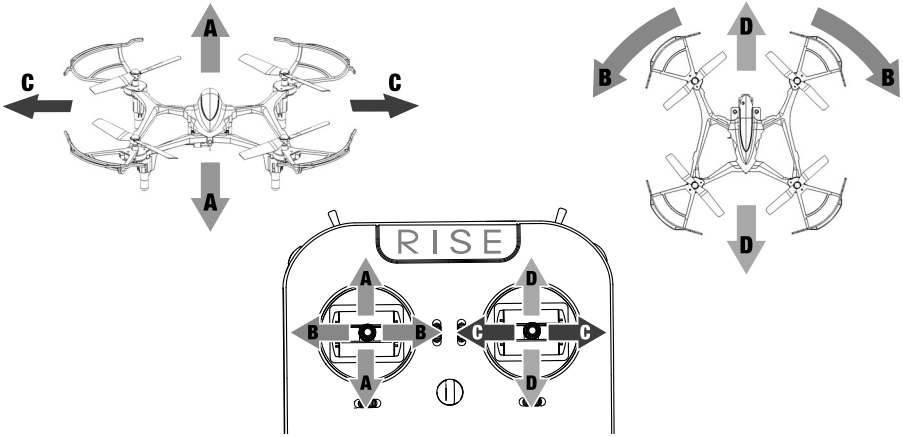

The **VERTICAL** movement of the **LEFT** stick controls the ascent/descent of the drone. When released, the left stick will return to the center neutral position and the drone will hold its current altitude. The stick deflection from the center position is proportional to the rate at which the drone ascends or descends.

The **HORIZONTAL** movement of the **LEFT** stick controls the direction the drone is pointing. Moving the left stick in the horizontal directions will cause the drone to rotate around its center axis (yaw). The stick deflection from the center position is proportional to the rate at which it rotates.

The **RIGHT** stick controls the pitch angle of the drone. The right stick is used to fly the drone in the direction that the right stick is moved. Moving the right stick up will cause it to move in the direction that the nose (camera) is pointing. This direction is considered **FORWARD** flight. Moving the right stick in any other direction will cause the drone to fly in that stick direction relative to the nose direction. Remember, if you rotate the drone using the left stick, moving the right stick up for forward flight will cause it to fly in the new direction the nose is pointing. This is common sense. However, it can be difficult to adapt to this during flight for beginner pilots. The stick deflection from the center position is proportional to the rate at which the drone flies.

Dual Rates (D/R)

The dual rate (D/R) switch on the transmitter adjusts the sensitivity of the stick controls. The low rate setting is with the switch toward the front of the transmitter. Low rates are recommended for calm winds and are desirable rates for smooth video recording. Low rates are also recommended for beginner pilots. The high rate setting is with the switch toward the back of the transmitter. High rates are recommended for winds greater than 5mph.

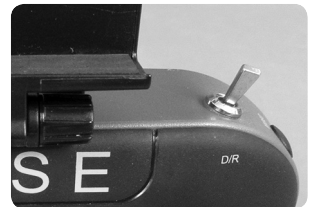

Trim Buttons

The trim buttons make small adjustments to the neutral position for each of the four corresponding stick directions. Because the Archon drone has accelerometers and a compass, it will automatically correct for any unintended pitch or rotation when the transmitter sticks are in the neutral position. So, it is unlikely that adjustments to the trim buttons from their default, centered location will improve flight performance. We recommend leaving the trim buttons in the centered location.

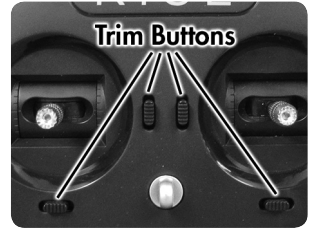

If your trim buttons have been moved from the centered location, use the image below to return them to the default position.



Altitude Holding

The Archon drone has a built-in barometer on the flight control board that detects the surrounding air pressure which enables it to maintain a set altitude automatically. After takeoff, the drone maintains the current altitude whenever the throttle stick is released to the center position. Move the throttle stick up or down to change the set altitude position. When the stick is released back to center, the drone's current height will be the new set altitude.

NOTE: It is normal to see slight deviations from the set altitude. Windy conditions or sensors that are out of calibration may increase the deviation from the set altitude. Recalibrate the accelerometers if the drone is flying erratically or does not appear to be maintaining altitude well.

Taking Off

ATTENTION! Before flying your drone for the first time, be sure that you have read this manual and are familiar with the operation of your drone or injury to yourself or others may result.

1. Ensure your flight battery is fully charged and your flying site is free of anything that may interfere with your intended flight path.
2. Turn on the transmitter and connect the flight battery to the drone.
3. **IMPORTANT!** If flying in a new area (or automatically initiated by the drone), perform compass calibration.
4. Perform accelerometer calibration.
5. Select your desired flight mode using the flight mode switch on the transmitter. If GPS mode is selected, the drone cannot be armed until the GPS signal has been acquired and the home point has been set (indicated by a solid red LED at the rear of the drone).

NOTE: It is recommended that you take off in GPS mode. You must wait to take off in GPS mode until GPS has been acquired and the home point is set (solid red LED at the rear of the drone). The drone will not be able to return to home automatically using the HOME function if you take off in Altitude Hold mode regardless of the GPS signal status.

6. Do a final check of your surroundings and confirm that it is safe to take off. The pilot (you) should be standing a safe distance from the drone of at least 15 feet (5 meters). Ideally you should be facing away from the sun.
7. Arm the motors by moving both sticks down and inward and hold them there until the motors start to rotate.
8. Slowly move the throttle stick (left transmitter stick) up to increase the propellers' rotation. The drone will then lift off the ground and climb in altitude as long as the throttle stick is up. Releasing the throttle stick to the center position will cause it to stop climbing and hover at its current altitude. Move the throttle stick down to cause the drone to descend.

Landing

Manual Landing - Move the throttle stick to its lowest position when the drone is hovering over your desired landing spot. It will descend until it detects that landing has occurred and will then automatically stop the propellers. Continue to hold the throttle stick in the lowest position until the propellers stop rotating.

RTH Landing - Move the flight mode switch to HOME. The drone will initiate the RTH function by climbing to 8 meters (if currently below that altitude), flying to the set home point, descending until landed, and then automatically stopping the propellers. If a home position was not set prior to takeoff or takeoff was done in Altitude Hold mode, the drone will not take any action in the HOME flight mode. Landing must be done manually.

NOTE: If the drone has landed but the propellers do not stop, move the transmitter sticks to the lowest, outside positions and hold until the propellers stop.



Transmitter Signal Failure

If at anytime during the flight the signal between the transmitter and the Archon drone is lost (external interference, loss of transmitter battery power, etc.), the drone will wait for 3 seconds to recover the signal. If there is still signal loss after 3 seconds it will automatically return to the set home position (see RTH landing details). If no home point was set or the drone does not have a GPS signal then it will descend straight down from its current position to land. If the signal is recovered during the automatic landing procedure, then the drone will cancel the RTH function and will stabilize itself in its current position where the transmitter signal was resumed.

MONITOR AND CAMERA

Battery Charging

This monitor has a micro USB charge port on the right side of the monitor to charge the internal battery. A micro-USB cable and an AC to USB adapter (not included) will be needed. Connecting the cable will start the charge process, as indicated by the glowing red LED which will turn off when charge is complete. For best results, use a 1 amp or larger adapter. The typical charge time will be around 3 hours.



WARNING! Charging lithium-polymer batteries poses a risk of FIRE! Follow all care and handling instructions in this manual to avoid severe and permanent damage to the batteries and all surroundings which could result quickly from improper use and function.

- Do not leave the monitor unattended while being charged!
- Immediately disconnect the USB charge cable if the monitor becomes hot (over 140°F, 60°C), begins to swell or emits smoke. Wear fire protective materials on your hands to move the monitor to a fireproof location as it may be hot! Leave the monitor until it cools.
- Always provide adequate ventilation around the monitor during charge.
- Always keep LiPo batteries away from children.
- Do not place the monitor on flammable surfaces or near combustible materials (carpet, paper, wood, plastic, vinyl, foam, etc.) while charging.

DVR

The FPV-RM2 monitor has a DVR that will record and playback avi format video clips. A memory card (not included) must be installed in the monitor before the DVR will operate. The DVR will save the video to the memory card every 4 minutes. A timer in the lower left corner of the screen will indicate the length of the video file being recorded. To avoid losing any part of the video file, always stop the recording and wait at least 15 seconds before turning off the monitor. The quality of the file recorded by the DVR will not be as sharp as a file recorded by an on-board camera because the data is compressed when transmitted to the FPV receiver.



Holding the M button puts the DVR in playback mode. Press the **↑** or **↓** buttons to select the video file to be played. Press the V button to start and stop playback of the selected video clip. Hold the M button for 2 seconds to exit the playback mode. The DVR will only recognize AVI files in the "Video" folder that are named "RECXXXXX" where XXXXX is a 5 digit number.

Receiver

The FPV-RM2 monitor has a 40 channel receiver that uses FPV bands A, B, E, F and R. A specific Band and Channel can be selected or the receiver can search for a nearby FPV signal.

BAND	CH1	CH2	CH3	CH4	CH5	CH6	CH7	CH8
A: FPV A Band	5865	5845	5825	5805	5785	5765	5745	5725
B: FPV B Band	5733	5752	5771	5790	5809	5828	5847	5866
C: FPV E Band	5705	5685	5665	5645	5885	5905	5925	5945
D: Fatshark Band	5740	5760	5780	5800	5820	5840	5860	5880
E: Raceband	5658	5695	5732	5769	5806	5843	5880	5917

Frequency in MHz

Monitor Control

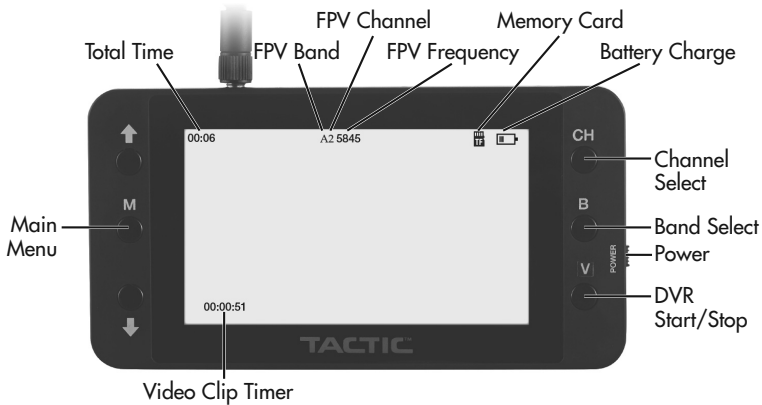

The screen has status indicators for

- Total Time the monitor has been on
- FPV Band
- FPV Channel
- FPV Frequency
- Memory Card is installed
- Battery Charge Level
- Video Clip Timer indicates the length of a video that has not been saved to the memory card.
- **POWER:** The On/Off switch is on the right side of the monitor
- **CH:** Press repeatedly to manually scroll through the 8 channels that are available for the current band. The current channel will be indicated at the top of the screen.
- **B:** Press repeatedly to manually scroll through the bands A – E shown at the top of the screen. Hold the button to scan all bands and channels for the strongest FPV signal.
- **V:** Press to start or stop the DVR.
- **M:** Press to access the Main Menu and see the functions listed below. Repeatedly press “M” to scroll through the list of options. Press the ↑ or ↓ to adjust the selected setting.
 - Brightness, Contrast, Color
 - Language (English or Chinese)
 - Backlight
 - Reset – all settings including frequency are reset

- Do not apply cleaning fluid to the monitor such as alcohol, ammonia-based cleaners such as window cleaning fluid, etc.
- Do not clean the monitor with paper towels, facial tissue, or materials which include abrasives such as nylon, polyester, etc. as it could scratch the screen.
- With the monitor off and the screen cool, lightly dust the screen with compressed air from a distance of at least 12 inches away. Then lightly wipe the screen with a micro-fiber cloth (not included). Wipe the screen slowly and in horizontal or vertical straight lines (not circular patterns).

Using the Monitor Cradle and Sun Shield

A cradle is included on the top of the transmitter to hold the monitor in place while you fly your Archon drone. The cradle acts like a spring clamp so the top section of the cradle must be pushed up to separate the grips far enough to fit the monitor between them. Release the grips and confirm the monitor is held securely in place.



A detachable sun shield is included to help shield the display from sunlight for optimum viewing. Align the tabs on the top and bottom of the sun shield with the notches on the monitor. Carefully press the tabs into place to affix the shield to the monitor.



The monitor cradle is adjustable so you can change the angle of the monitor to your liking. Use a screwdriver to loosen one of the plastic cradle nuts as shown. Adjust the angle of the cradle and then re-tighten the cradle nut.



CAMERA OPERATION

IMPORTANT NOTICE! The Archon drone with the 200mW VTX requires a HAM Technicians license to operate legally in the USA.



This involves a 35-question multiple-choice test and a small fee. You can contact an amateur radio club in your area for assistance or visit arrrl.org

Customers outside of the USA should understand and follow all telecommunications or other regulations in your area.

Camera Frequencies

The 1080P 200mW 5.8GHz camera can operate on any of 37 unique frequencies in 5 different bands.

Power output: 200mW

Frequency range: 5658-5917MHz

Available Frequencies, North America (MHz)

Band	CH 1	CH 2	CH 3	CH 4	CH 5	CH 6	CH 7	CH 8
A: Band A	5865	5845	5825	5805	5785	5765	5745	5725
B: Band B	5733	5752	5771	5790	5809	5828	5847	5866
C: Band E	5705	5685	5665	5665	5885	5905	5905	5905
D: FS/IRC	5740	5760	5780	5800	5820	5840	5860	5880
E: RaceBand	5658	5695	5732	5769	5806	5843	5880	5917

To operate this product in North America, you are required to have an Amateur Radio (HAM) license. Visit www.arrrl.org for more information.

The channel display screen on the camera always displays the current band and channel setting by alternating the display between the band letter designation and the channel number. Pressing the CH button on the camera will change either the channel band to the next letter or change the channel to the next number. When the last letter or channel has been reached (E or 8), pressing the CH button again will return that value back to the beginning of the list. Press CH and hold for 1.5 seconds to toggle between changing the band and channel values. The channel display screen will flash for 4 seconds to indicate the change.

CH Button



Short Press

Change Band Number or Channel Number

CH Button



Long Press

Toggle Between Band Change and Channel Number Change

Memory Card

The 1080P camera has the ability to save photos and video clips to a micro memory card (*not included). Playback of stored photos and videos can be seen on the included monitor (see **Playback**) or can be viewed on any other device that will read and display photos and videos from a micro card or USB memory card reader (**not included).

NOTE: Both the camera and the monitor have the ability to

record pictures and video to a micro card. It is preferable to use the camera to record because the recording quality of the monitor is limited to the reduced video transmission resolution and the clarity of the video signal between camera and monitor.

The micro memory card slot is located on the side of the camera as shown. Insert a memory card (not included) with the contact points facing the channel display screen. Push in on the memory card until you hear it click into place. **DO NOT FORCE THE CARD INTO THE MEMORY SLOT!** If there appears to be resistance when inserting the card, remove it and confirm that you are installing it in the correct orientation and you have the card properly positioned in the memory card slot. To eject the card from the memory card slot, push inward on the card until you hear a click and the card will spring outward some. You can now pull the memory card out of the memory card slot.



* Micro card not included. Maximum storage 32GB. Class 10 or higher recommended.

** Use DIDZ1501 for optional USB micro memory card reader.

Menu

Size
720P60
1080P
Audio Record
Off
On
Setup
Format
Cancel
Execute
Language
English
Chinese traditional
Chinese simplified
Francais
Deutsch
Italiano
Espanol
Portugues
Korean
TV Output
NTSC
PAL
Light Freq.
50Hz
60Hz
Sys. Reset
Cancel
Execute

The main menu can be accessed by a *long press* of the **M** button. Use the up ▲ and down ▼ buttons to scroll through the menu functions. A *short press* of the **M** button will select the highlighted menu function. A *long press* of the **M** button will back up a level in the menu structure or exit the menu when at the main menu screen. The description of each menu option and a menu map are listed below:

Size: 720P60 is 720 lines of progressive scan horizontal resolution with video recorded at 60 frames/second. This option is ideal for recording things in motion or to modify recorded footage such as slow motion. 1080P will provide 1080 lines of horizontal resolution at 30 frames/second. This will provide a larger field of view resulting in a larger image size. However, the recording will be made at an average frame rate.

Audio Record: This will toggle the microphone on/off. Because of the propeller noise the ideal setting for this function is OFF.

Setup ►

Format: Performing this function will format a memory card installed in the camera, preparing it for use. Note: this function will erase the contents of the card. Be sure that any data you wish to save that is currently stored on the card is backed up in a recoverable location. Typically, only new memory cards or a card that exhibits problems would need to be formatted.

Language: Changes the language displayed for all menu and playback text.

TV Output: Switches between television display formats **NTSC** and **PAL** (NTSC is default for North America)

Light Frequency: Switches refresh rate between **50Hz** and **60Hz** (60Hz is North American standard)

System Reset: This function will restore all camera settings to their default values.

Playback and File Management

To scroll through the pictures/videos (review mode) saved to the camera memory card, *long press* the up ▲ button. *Short press* the up ▲ or down ▼ buttons to scroll through the saved images. For video playback of a saved file (file name ends in .MOV) *short press* the **M** button.

Long press the **M** button when in review mode to enter the file management function page. To move back one menu level or to return to the review mode, *long press* the **M** button. *Short press* the **M** button to select a file management function. The functions and their descriptions are listed below:

Delete: Deletes contents on the camera memory card - the **Current** picture/video that was displayed on the monitor when the file management function was selected, or **All** pictures/videos saved on the camera memory card. Select **Cancel** to stop the delete function.

Protect: Safeguards pictures/videos stored on the camera memory card from accidental deletion. **Lock Current** will file lock the picture/video that was displayed on the monitor when the file management function was selected. **Unlock Current** will unlock the picture/video that was displayed on the monitor when the file management function was selected, if it has been previously locked. **Lock All** will file lock all the pictures/videos saved on the camera memory card. *Short press* the **M** button to select an option. **NOTE!** Locking pictures/videos using this camera function will not prevent them from being deleted when accessed through a card reader or other means. Important pictures/videos should be backed up to a secure location.

Thumbnail: Displays list of small thumbnail images for every picture/video saved to the camera memory card. *Short press* the up ▲ or down ▼ buttons to scroll through the thumbnails. *Short press* the **M** button to select a thumbnail to display in full size on the monitor.

Setup: This accesses the Setup function described in the **Menu** section.

Taking Pictures and Videos

Pictures and videos are taken (stored on optional memory card installed in the camera) using the buttons on the upper left and right corners of the transmitter.

To take a picture, press and release the picture button on the transmitter. The LED indicator on the camera will flash purple one time when a picture is taken. To take a video, press and release the video button on the transmitter to start a video recording. The LED indicator on the camera will continuously flash between orange and purple while the camera is recording video.

To stop video recording, press and release the video button on the transmitter. The LED indicator will change to solid orange indicating that video recording has stopped.

NOTE: The LED indicator on the camera will continuously flash between orange and purple if there is no memory card installed in the camera. The LED will remain solid orange when there is a memory card installed and the camera is not in the process of recording video. *Be sure to unplug the battery from the Archon before removing or installing a memory card into the camera.*



LINKING THE TRANSMITTER

The transmitter included with your Archon drone is linked at the factory so no action needs to be taken when you unbox it. If the transmitter is ever replaced or the transmitter is no longer linked to the drone for any reason, the transmitter can be linked to the drone with the following procedure:

Turn off the transmitter and unplug the battery to the Archon drone. With the transmitter OFF, press and hold the **PICTURE** button on the transmitter. While holding the button, turn the transmitter ON. The three LEDs on the transmitter will flash continuously indicating the transmitter is now in linking mode. Connect the battery to the drone and the transmitter will then link to it.

TROUBLESHOOTING

Flying Problems

PROBLEM: The drone will not respond to the transmitter.

SOLUTION: (1) Charge or change the battery in the drone.

(2) Turn off the transmitter and disconnect the battery from the drone. Re-link the drone and transmitter (the transmitter will beep continuously if not linked to the drone).

PROBLEM: 'TX' LED transmitter flashes with audible beeping when transmitter is powered on.

SOLUTION: Replace with new AA batteries.

PROBLEM: The balance charger charge status LED blinks when attempting to charge the battery.

SOLUTION: The battery voltage is too low to charge. The battery voltage may recover on its own with time in order to be safely charged. Wait 1 hour and try charging again. If the charger LED still blinks then you may need to replace the battery.

PROBLEM: The motors cannot be armed.

SOLUTION: (1) The flight mode is set to GPS mode but the GPS signal has not yet been acquired or the home point not set. Wait for the GPS signal to be acquired and the home point set which is indicated by a solid red rear LED on the drone. If there is an obstruction or interference in the area preventing the GPS signal from being acquired, switch to ALTITUDE HOLD mode or move the drone to a different area.

(2) Battery voltage is too low (indicated by a flashing LVC LED on the transmitter and a continuous beeping). Charge the flight battery.

(3) The drone has auto-initiated compass calibration. The calibration procedure must be completed before the motors can be armed (see **Compass Calibration**).

PROBLEM: The drone will not acquire GPS signal or set the home point.

SOLUTION: (1) Cycle the power on the drone and allow enough time for the GPS detection and home point setting to complete. In certain locations and conditions it may take several minutes to complete. The amount of time it takes will vary.

(2) Environmental conditions are preventing the drone from detecting GPS satellites. Move the drone to a different area.

PROBLEM: The motors will arm but the drone cannot take off.

SOLUTION: (1) Propellers incorrectly installed. See **Propeller Replacement** section.

(2) A motor may be defective. Look for a motor spinning slower than the others (or not spinning at all). Replace as necessary.

PROBLEM: The drone flies erratically.

SOLUTION: (1) The compass and/or accelerometers require calibration. Land the drone and perform compass calibration and accelerometer calibration.

(2) There is magnetic interference in the area. Take the drone to a new location being sure to perform compass calibration before flying.

(3) GPS signal is weak or intermittent. Take the drone to a new location, being sure to perform compass calibration before flying.

(4) Windy conditions make it difficult for the drone to maintain position and altitude. Wait for calmer conditions to fly.

PROBLEM: The drone is shaking.

SOLUTION: (1) Check the canopy, chassis, motors and propellers for damage.

(2) Windy conditions make it difficult for the drone to fly smoothly. Wait for calm conditions.

PROBLEM: The drone does not maintain altitude when the throttle stick is in the center position.

SOLUTION: (1) Perform accelerometer calibration.

(2) Windy conditions make it difficult for the drone to maintain altitude. Wait for calmer conditions.

PROBLEM: The drone does not RTH (Return-To-Home) when the flight mode is changed to HOME.

SOLUTION: (1) The motors were armed with the flight mode in ALTITUDE HOLD mode. Arming the motors in this mode will prevent the drone from setting a home point. In order to RTH automatically, be sure to arm the motors with the flight mode set to GPS mode. GPS signal must be acquired and the home point set (indicated by a solid red rear LED on the drone) before the motors can be armed in GPS mode.

(2) GPS signal was lost prior to changing the flight mode to HOME (loss indicated by the GPS LED on the transmitter turning off and a continuous beeping). Without GPS signal the drone cannot return to the home point automatically when switching to HOME mode. The drone must be flown and landed manually by the pilot or wait until GPS signal is re-acquired. When GPS signal is re-acquired the GPS LED on the transmitter will stop beeping and the GPS LED on the transmitter will resume flashing slowly.

PROBLEM: The drone cannot climb in altitude during flight.

SOLUTION: (1) A motor may be defective. Look for a motor spinning slower than the others (or not spinning at all). Replace as necessary.

(2) The drone has already reached its maximum altitude of 400 feet (122 meters) which is an FCC regulated altitude maximum.

Video Problems

PROBLEM: There are missing or corrupt files on the memory card.

SOLUTION: Test the camera and confirm that the camera LED behavior matches the description in the **Taking Pictures and Videos** section. If yes, try formatting the memory card or using a different memory card. If no, review the steps for taking pictures and videos. Contact product support if the problem continues.

PROBLEM: The monitor screen turns on but does not display video feed from the camera.

SOLUTION: (1) The monitor and camera are not operating on the same channel. Review the instructions for changing the monitor and camera channels and confirm both are operating on the same frequency.

(2) Confirm that the camera wire lead is secure to both the camera and drone.

PROBLEM: The FPV feed seen on the monitor is poor quality or intermittent during flight.

SOLUTION: (1) There may be interference in the area. Try flying in a different location.

(2) The practical range of the camera's video transmission has been exceeded. The range is dependent on outside factors such as the presence of power lines nearby, other radio controlled/FPV devices in the area, or any other possible source of electrical interference. Maintain a closer proximity to the monitor when flying.

(3) Try a different video band/channel (see **Monitor Control** and **Camera Frequencies** sections).

PROBLEM: You recorded videos/pictures but there are no files on the memory card.

SOLUTION: The memory card was incorrectly inserted into the camera. Refer to Memory Card for instructions on the proper installation.

PROBLEM: Horizontal scrolling lines appear in video or pictures.

SOLUTION: Avoid aiming the camera directly into the sun or reflected sunlight.

PROPELLER REPLACEMENT

1. Remove the screw that secures the propeller to the gear shaft.
2. Pull the propeller off the gear shaft.
3. Install the new propeller and secure it with the screw.



NOTE: The propellers have arrows that indicate which direction they rotate. Please refer to this diagram to verify that the correct replacement propeller is installed.

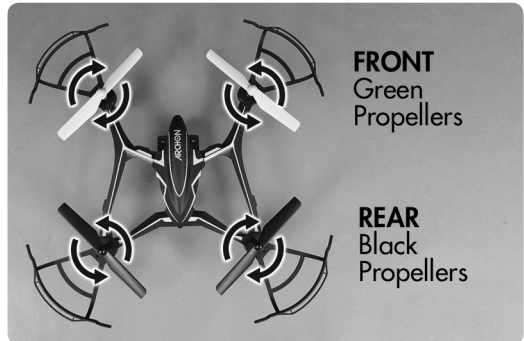

PROP SHAFT REPLACEMENT

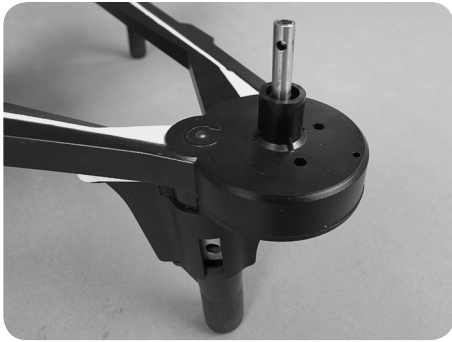

1. Remove the propeller from the prop shaft.
2. Remove the four screws from the black motor cover and lift it off the frame (if installed, the prop guard will also need to be removed before the motor cover can be removed). You do not need to disconnect the motor wires.
3. Slide the motor shaft out of the frame. Remove the screw securing the gear to the shaft. Slide the gear off the shaft.
4. Reinstall the parts in the same order in which they were removed.

NOTE: While the gear is out, check it carefully for any cracks or damage to the teeth.



MOTOR REPLACEMENT

1. Remove the four screws from the black motor cover and lift it off the frame (if installed, the prop guard will also need to be removed before the motor cover can be removed).
2. Disconnect the motor connector. Grasp the motor by the gear with your fingertips and slide the motor out of the cover.
3. Slide the rubber banding off of the old motor and onto your replacement motor.
4. Reinstall the parts in the same order in which they were removed.

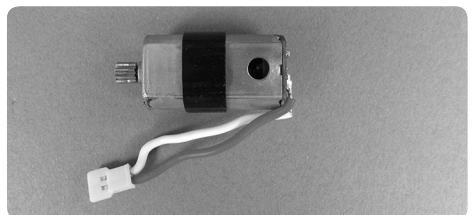

NOTE: There are clockwise and counter-clockwise rotating motors. Be sure that you are replacing a damaged motor with the correct part by confirming the wire colors of the replacement motor match the motor wires you are removing.

FLIGHT CONTROL BOARD REPLACEMENT

Replacing the flight control board is not a difficult procedure, but there are many screws that need to be taken out to remove the flight control board from the drone. Have a clean work space prepared and we recommend using a container to hold all the screws.

1. Remove the camera by pushing down on the camera retainer tab and sliding the camera forward. Disconnect the camera wire from the drone.



2. Remove the three camera mount screws and lift the camera mount off the frame.

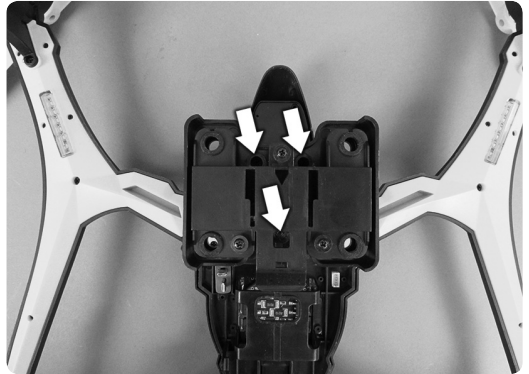

3. Remove the six screws securing the canopy and lift the canopy off the frame.

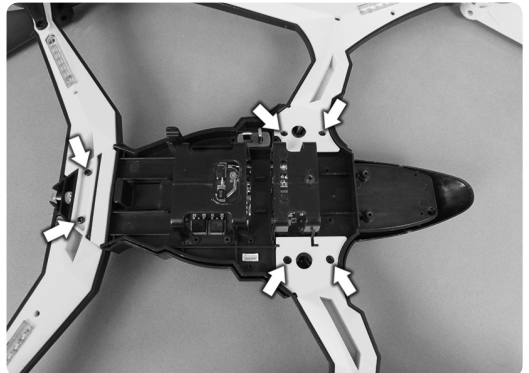

4. There are four screws holding each motor cover to the frame. Remove all four motor covers from the frame. The motors should come out with the covers. Disconnect the motors and set the covers aside. We recommend labeling each cover so they are installed back in the correct locations.



5. Remove the three frame bottom covers from the underside of the frame. Make note of the different screw sizes used when removing the covers. Carefully push the LED lenses out of the frame bottom covers.



6. Unscrew the camera connector and the battery connector from the frame.

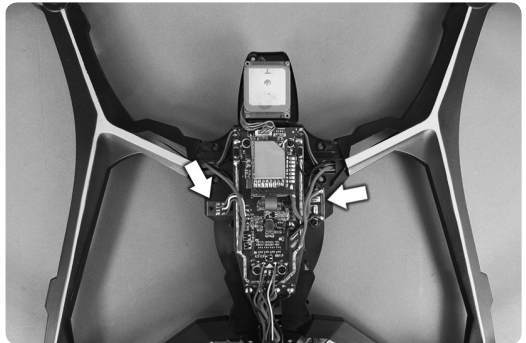

NOTE: Before moving on to step 7, take a close look at how the wires and LEDs are positioned in the frame. Take a picture if possible for future reference. The wires should be reinstalled with the new board as they are currently placed.

7. There are four screws that secure the flight control board to the frame. These screws are different than the other screws removed so far. Make sure you use them in the correct location during reassembly. Lift the board off the frame and start feeding the wires out through the holes in the frame. If the foam sleeves come off, slide them back on to the screw bosses.

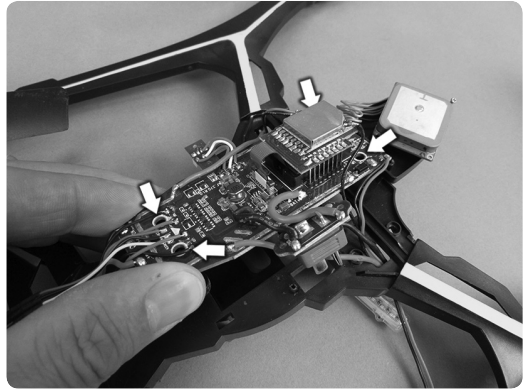

8. Reassembly is the reverse of steps 1-7. Take care when installing the covers to not pinch or sever the wires with screws. If a part does not feel like it is fitting back into place properly, do not force it. Check that the part is properly aligned and that the wires are not interfering with the installation.
9. Before attempting to fly your Archon drone, recalibrate the compass and accelerometers.

FCC IC PRECAUTIONS

Archon 370

Brand: RISE

Part number: RISE0222

FCC: IYF0300

IC: 11104A-0300

RISE J2020 Transmitter

Brand: RISE

Part number: RISJ2020

FCC: IYFJ2020

IC: 11104A-RISJ2020

IC RSS Warning

This device complies with Industry Canada licence-exempt RSS standard(s). Operation is subject to the following two conditions: (1) this device may not cause interference, and (2) this device must accept any interference, including interference that may cause undesired operation of the device.

IC Radiation Exposure Statement

This equipment complies with IC RF radiation exposure limits set forth for an uncontrolled environment. This transmitter must not be co-located or operating in conjunction with any other antenna or transmitter.

FCC Radiation Exposure Statement

This device complies with part 15.249 of the FCC rules. Changes or modifications not expressly approved by RISE will void the user's authority to operate this Tx. Operation is subject to the following two conditions:

- (1) This device may not cause harmful interference.
- (2) This device must accept any interference received, including interference that may cause undesired operation.

NOTE: This equipment has been tested and found to comply with the limits for a Class B digital device, pursuant to part 15 of the FCC Rules. These limits are designed to provide reasonable protection against harmful interference in a residential installation. This equipment generates uses and can radiate radio frequency energy and, if not installed and used in accordance with the instructions, may cause harmful interference to radio communications. However, there is no guarantee that interference will not occur in a particular installation. If this equipment does cause harmful interference to radio or television reception, which can be determined by turning the equipment off and on, the user is encouraged to try to correct the interference by one or more of the following measures:

- Reorient or relocate the receiving antenna.
- Increase the separation between the equipment and receiver.
- Connect the equipment into an outlet on a circuit different from that to which the receiver is connected.
- Consult the dealer or an experienced radio/TV technician for help.
- This equipment should be installed and operated with minimum distance 20cm between the radiator and your body.

EXPLODED VIEW

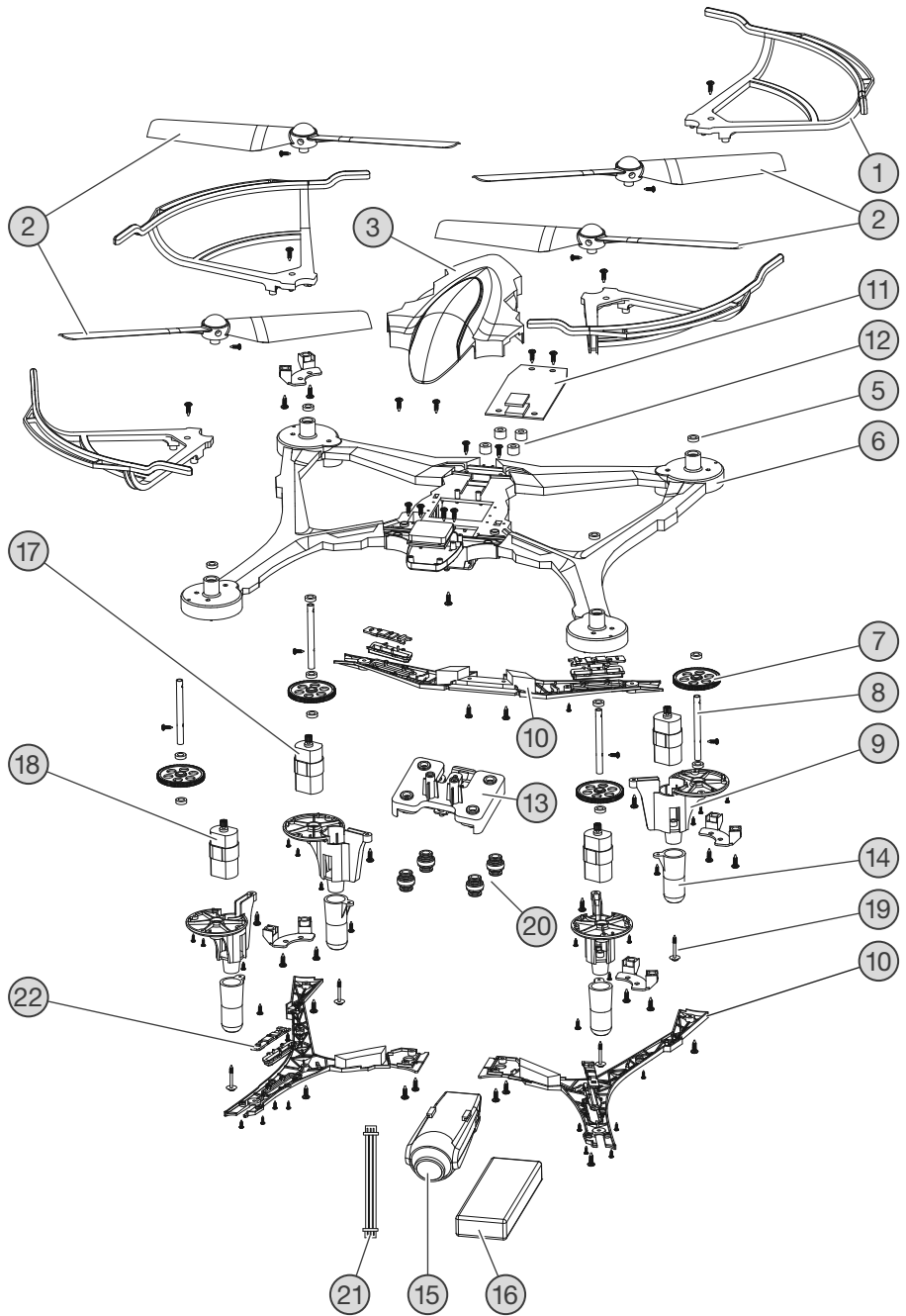

PARTS LIST

EVPL No.	Part No.	Description
1	RISE2110	Prop Guard Set
2	RISE2101	Prop Set
3	RISE2102	Canopy
5	RISE2104	Bearing Set
6	RISE2105	Main Frame
7	RISE2106	Spur Gear Set
8	RISE2107	Prop Shaft
9	RISE2108	Motor Cover
10	RISE2109	Bottom Frame Cover
11	RISE2113	E-Board with Barometer
12	RISE2111	E-Board Dampers
13	RISE2115	Camera Mount Assembly
14	RISE2116	Landing Pads
15	RISZ2120	1080P 5.8 GHz 200 mW FPV DVR Camera
16	RISPO223	LiPo 2S 7.4V 2200 mAh
17	RISE2117	Main Motors CW Left Front, Right Rear
18	RISE2118	Main Motors CCW Right Front, Left Rear
19	RISE2119	Screw Set
20	RISE2120	Camera Mount Dampers
21	RISE2114	Camera Power Wire
22	RISE2112	LED Covers
	RISJ2020	J2020 6-Channel Transmitter
	RISE2041	2S/3S Balance Charger
	RISE2024	A/C Balance Charger Adapter
	TACZ5161	FPV Wrist Monitor
	TACZ5200	FPV-G1 Goggles w/o Monitor optional
	TACZ1010	4G Class 10 Micro Memory Card optional
	TACZ5300	FPV 5.8 GHz RP-SMA TX Antenna Short 110mm 3 dBi
	TACZ5600	FPV-RM2 Sun Shield
	TACZ5602	FPV-RM2 Tripod Mount optional
	DIDZ1501	USB Micro SD Card Reader optional
	TACZ1003	USB Charge Cable optional
	TACZ5153	FPV-RM2 4.3 in. Monitor 5.8 GHz 40 CH

LIMITED WARRANTY

What this Warranty Covers

Horizon Hobby, LLC, (Horizon) warrants to the original purchaser that the product purchased (the "Product") will be free from defects in materials and workmanship at the date of purchase.

What is Not Covered

This warranty is not transferable and does not cover (i) cosmetic damage, (ii) damage due to acts of God, accident, misuse, abuse, negligence, commercial use, or due to improper use, installation, operation or maintenance, (iii) modification of or to any part of the Product, (iv) attempted service by anyone other than a Horizon Hobby authorized service center, (v) Product not purchased from an authorized Horizon dealer, (vi) Product not compliant with applicable technical regulations, or (vii) use that violates any applicable laws, rules, or regulations.

OTHER THAN THE EXPRESS WARRANTY ABOVE, HORIZON MAKES NO OTHER WARRANTY OR REPRESENTATION, AND HEREBY DISCLAIMS ANY AND ALL IMPLIED WARRANTIES, INCLUDING, WITHOUT LIMITATION, THE IMPLIED WARRANTIES OF NON-INFRINGEMENT, MERCHANTABILITY AND FITNESS FOR A PARTICULAR PURPOSE. THE PURCHASER ACKNOWLEDGES THAT THEY ALONE HAVE DETERMINED THAT THE PRODUCT WILL SUITABLY MEET THE REQUIREMENTS OF THE PURCHASER'S INTENDED USE.

Purchaser's Remedy

Horizon's sole obligation and purchaser's sole and exclusive remedy shall be that Horizon will, at its option, either (i) service, or (ii) replace, any Product determined by Horizon to be defective. Horizon reserves the right to inspect any and all Product(s) involved in a warranty claim. Service or replacement decisions are at the sole discretion of Horizon. Proof of purchase is required for all warranty claims. SERVICE OR REPLACEMENT AS PROVIDED UNDER THIS WARRANTY IS THE PURCHASER'S SOLE AND EXCLUSIVE REMEDY.

Limitation of Liability

HORIZON SHALL NOT BE LIABLE FOR SPECIAL, INDIRECT, INCIDENTAL OR CONSEQUENTIAL DAMAGES, LOSS OF PROFITS OR PRODUCTION OR COMMERCIAL LOSS IN ANY WAY, REGARDLESS OF WHETHER SUCH CLAIM IS BASED IN CONTRACT, WARRANTY, TORT, NEGLIGENCE, STRICT LIABILITY OR ANY OTHER THEORY OF LIABILITY, EVEN IF HORIZON HAS BEEN ADVISED OF THE POSSIBILITY OF SUCH DAMAGES. Further, in no event shall the liability of Horizon exceed the individual price of the Product on which liability is asserted. As Horizon has no control over use, setup, final assembly, modification or misuse, no liability shall be assumed nor accepted for any resulting damage or injury. By the act of use, setup or assembly, the user accepts all resulting liability. If you as the purchaser or user are not prepared to accept the liability associated with the use of the Product, purchaser is advised to return the Product immediately in new and unused condition to the place of purchase.

Law

These terms are governed by Illinois law (without regard to conflict of law principals). This warranty gives you specific legal rights, and you may also have other rights which vary from state to state. Horizon reserves the right to change or modify this warranty at any time without notice.

WARRANTY SERVICES

Questions, Assistance, and Services

Your local hobby store and/or place of purchase cannot provide warranty support or service. Once assembly, setup or use of the Product has been started, you must contact your local distributor or Horizon directly. This will enable Horizon to better answer your questions and service you in the event that you may need any assistance. For questions or assistance, please visit our website at www.horizonhobby.com, submit a Product Support Inquiry, or call the toll free telephone number referenced in the Warranty and Service Contact Information section to speak with a Product Support representative.

Inspection or Services

If this Product needs to be inspected or serviced and is compliant in the country you live and use the Product in, please use the Horizon Online Service Request submission process found on our website or call Horizon to obtain a Return Merchandise Authorization (RMA) number. Pack the Product securely using a shipping carton. Please note that original boxes may be included, but are not designed to withstand the rigors of shipping without additional protection. Ship via a carrier that provides tracking and insurance for lost or damaged parcels, as Horizon is not responsible for merchandise until it arrives and is accepted at our facility. An Online Service Request is available at http://www.horizonhobby.com/content/_service-center_render-service-center. If you do not have internet access, please contact Horizon Product Support to obtain a RMA number along with instructions for submitting your product for service. When calling Horizon, you will be asked to provide your complete name, street address, email address and phone number where you can be reached during business hours. When sending product into Horizon, please include your RMA number, a list of the included items, and a brief summary of the problem. A copy of your original sales receipt must be included for warranty consideration. Be sure your name, address, and RMA number are clearly written on the outside of the shipping carton.

NOTICE: Do not ship LiPo batteries to Horizon. If you have any issue with a LiPo battery, please contact the appropriate Horizon Product Support office.

Warranty Requirements

For Warranty consideration, you must include your original sales receipt verifying the proof-of-purchase date. Provided warranty conditions have been met, your Product will be serviced or replaced free of charge. Service or replacement decisions are at the sole discretion of Horizon.

Non-Warranty Service

Should your service not be covered by warranty, service will be completed and payment will be required without notification or estimate of the expense unless the expense exceeds 50% of the retail purchase cost. By submitting the item for service you are agreeing to payment of the service without notification. Service estimates are available upon request. You must include this request with your item submitted for service. Non-warranty service estimates will be billed a minimum of ½ hour of labor. In addition you will be billed for return freight. Horizon accepts money orders and cashier's checks, as well as Visa, MasterCard, American Express, and Discover cards. By submitting any item to Horizon for service, you are agreeing to Horizon's Terms and Conditions found on our website http://www.horizonhobby.com/content/_service-center_render-service-center.

ATTENTION: Horizon service is limited to Product compliant in the country of use and ownership. If received, a non-compliant Product will not be serviced. Further, the sender will be responsible for arranging return shipment of the un-serviced Product, through a carrier of the sender's choice and at the sender's expense. Horizon will hold non-compliant Product for a period of 60 days from notification, after which it will be discarded. 5/15

Warranty and Service Contact Information

Horizon Hobby Contact Information (if purchased in the United States of America)

Horizon Service Center servicecenter.horizonhobby.com/RequestForm/
(Repairs and Repair Requests)

Horizon Product Support productsupport@horizonhobby.com
(Product Technical Assistance) 877-504-0233

Sales websales@horizonhobby.com
800-338-4639

Horizon Hobby, LLC
1608 Interstate Dr
Champaign, IL 61822

CHARGERS

There are many chargers on the market that are capable of charging the LiPo included with the Archon as well as other battery sizes and chemistries.

DTXP4226 Duratrax Onyx 225 AC/DC
Advanced Charger



DTXP4256 Duratrax Onyx 255 AC/DC Dual Balancing
Charger

GPM3154 Great Planes ElectrifiFly
Triton EQ AC/DC Charger



DTXP4261 Duratrax Onyx 260 AC/DC Dual Touch Screen
Charger