

Operating Instructions

Steam Ironing System

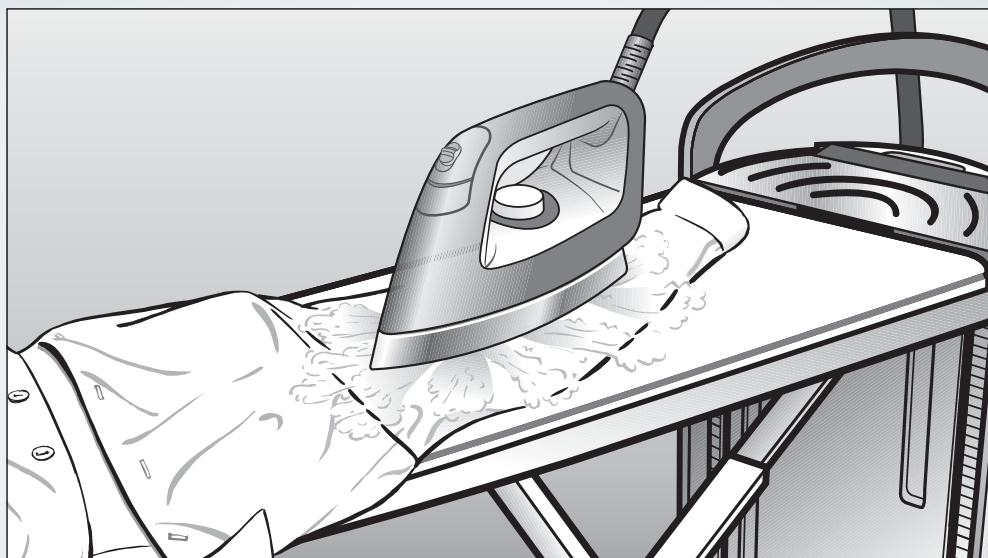

To prevent accidents and appliance damage, read these instructions **before** installation or use.

Caring for the environment

Disposal of the packing material

The cardboard box and packing materials protect the appliance during shipping. They have been designed to be biodegradable and recyclable.

Ensure that any plastic wrappings, bags, etc. are disposed of safely and kept out of the reach of children. Danger of suffocation!

Disposal of your old appliance

Electrical and electronic appliances contain valuable materials. They also contain certain substances, compounds and components which were essential for the proper functioning and safe use of the equipment. Handling these materials improperly by disposing of them in your household waste can be harmful to your health and the environment. Therefore, please do not dispose of your old appliance with regular household waste and follow local regulations on proper disposal.



Consult with local authorities, dealers or Miele in order to dispose of and recycle electrical and electronic appliances. Miele assumes no responsibility for deleting any personal data left on the appliance being disposed. Please ensure that your old appliance is kept away from children until removal. Observe safety requirements for appliances that may tip over or pose an entrapment hazard.

Caring for the environment	2
IMPORTANT SAFETY INSTRUCTIONS	6
Product description	13
Transport	16
Assembly	17
Adjusting the height	18
Connection	20
Plug in the power cord	20
Removing the iron and the steam hose holder	21
Connecting the steam hose	21
Before first use	23
Determining the water hardness	23
Using the test strips to determine the water hardness	23
Before using for the first time	24
Switch on the steam ironing system	24
Language setting.....	24
Setting the water hardness level	25
The steam ironing system is now set up for use	26
Switching on the appliance	27
Switch on the steam ironing system	27
Filling the water container	28
Removing the water container	28
Filling the water container	28
Steam operation	29
Water quality	29
Selecting the ironing temperature	30
CoolDown Function.....	32
Auto Off function	32
Ironing	33
Iron	33
Ironing with steam	34
Ironing without steam.....	35
Ironing with the non-stick soleplate	35
Attaching the non-stick soleplate.....	35
Removing the non-stick soleplate.....	36

Contents

Active iron board	36
Suction function	36
Inflation function	36
Automatic switch on/off	36
Memory function	37
Heated ironing surface	37
Steamer	38
Connecting the steamer	38
Using the steamer	40
Brush attachment.....	41
Connecting the brush attachment.....	41
Removing the brush attachment.....	41
Switching off	42
Dismantling	43
Set the ironing board at its lowest working height.....	43
Folding the ironing board	44
Disconnecting the steam hose.....	45
Storing the iron.....	45
Storing the steamer.....	45
Emptying the water container	46
Storing the steam ironing system.....	46
Cleaning and care	47
Automatic rinsing	47
Preparing for the rinsing process	47
Draining the residual water container	47
Descaling.....	48
Descaling warning	49
Starting the descaling process early	50
Descaling process.....	50
Cleaning the housing.....	56
Cleaning the soleplate of the iron.....	56
Cleaning or replacing the ironing board cover	57

Cleaning the water filter.....	58
Disconnect the power supply.....	58
Removing the water container	58
Removing the water filter cover.....	58
Removing the sealing ring.....	59
Pull out water filter.....	59
Cleaning the water filter.....	59
Inserting the water filter.....	60
Inserting the water container.....	60
Optional accessories	61
Accessories.....	61
Non-stick soleplate	61
Ironing board cover	61
Steamer	62
Care products.....	62
Descaling tablets for the steam ironing system	62
Frequently asked questions	63
Problem solving guide.....	64
Display messages	69
Technical service.....	73
Warranty conditions	73
Electrical connection	74
Technical data.....	75

IMPORTANT SAFETY INSTRUCTIONS

READ ALL INSTRUCTIONS BEFORE USE

This steam ironing system complies with all specified safety requirements. Inappropriate use can however lead to personal injury and damage to property.

To avoid the risk of accidents and damage to the steam ironing system, please read these instructions carefully before using it for the first time. They contain important information on its safety, installation, use and maintenance.

Keep these operating instructions in a safe place and pass them on to any future owner.

Intended use

- ▶ This steam ironing system is intended for use in domestic households and similar residential environments.
- ▶ The steam ironing system must be used only for ironing textiles which are suitable for ironing according to the care label.
- ▶ The steam ironing system is intended for domestic use only as described in these operating instructions. Any other use is not permitted. Miele cannot be held liable for damage resulting from incorrect or improper use or operation.
- ▶ Persons which lack physical, sensory or mental abilities or experience with the machine should not use it without supervision or instruction by a responsible person.
- ▶ The steam ironing system is not intended for outdoor use.
- ▶ To avoid the risk of electric shock, do not submerge the iron in water or other liquids.

IMPORTANT SAFETY INSTRUCTIONS

Safety with children

- ▶ Children must be kept away from the appliance unless they are supervised.
- ▶ Children must be supervised in the vicinity of the steam ironing system. Do not allow children to play with it.
- ▶ Make sure that children cannot access the steam hose or the power cable, either during use or while the steam ironing system is cooling down.
- ▶ **Danger of suffocation!**
Keep children away from any packing material.

IMPORTANT SAFETY INSTRUCTIONS

Technical safety

- ▶ Before setting up the steam ironing system, inspect it visually for any external damage. Do not use a damaged appliance. A damaged steam ironing system can be dangerous!
 - ▶ Check the iron of the steam ironing system for damage. Do not use the iron if it has been dropped, if there is any visible damage or if it is leaking.
 - ▶ Before connecting the power cable to the outlet, make sure that the connection data on the data plate (voltage and frequency) of the steam ironing system match the local power supply.
- If in doubt about your local power supply contact a qualified electrician. If it is connected to a supply that deviates from the data plate, this may lead to malfunctions or failure of the steam ironing system.
- ▶ Always remove and unwind the power cord of the steam ironing system completely from its (lower) storage compartment.
 - ▶ If the power cord is damaged, it must be replaced by Miele Technical Service. For safety reasons this must only be fitted by a Miele authorized service technician or the Miele service department.
 - ▶ Do not use the steam ironing system if the ironing board cover is damaged.

A damaged ironing board cover could be dangerous!

Do not use the steam ironing system without an ironing board cover.

The ironing board cover must be replaced with an original Miele cover.

IMPORTANT SAFETY INSTRUCTIONS

- ▶ The electrical safety of this steam ironing system can only be guaranteed if it is grounded properly. It is essential that this standard safety requirement is met. If in any doubt, please have building's wiring system inspected by a qualified electrician. Miele cannot be held liable for the consequences of an inadequate grounding system (e.g. electric shock).
- ▶ Do not use a power bar or an extension cord to connect the steam ironing system to the power supply. These devices do not guarantee the required safety of the appliance (e.g. danger of overheating).
- ▶ This steam ironing system complies with all relevant safety requirements. Unauthorized repairs could result in unforeseen dangers for the user, for which Miele cannot accept liability. Repairs should only be performed by a Miele authorized service technician, otherwise any subsequent damage will not be covered by the warranty.
- ▶ Faulty components must only be replaced by genuine Miele parts. Only when these parts are fitted can Miele guarantee the safety standards of the appliance.
- ▶ To avoid a circuit overload, do not operate an iron on the same circuit with another high wattage appliance.
- ▶ During repairs, installation and maintenance tasks, the steam ironing system must be disconnected from the power supply. The steam ironing system is only considered disconnected from the power supply if:
 - the power plug of the steam ironing system is unplugged or
 - the fuse is removed from the building wiring or
 - the circuit breaker has been tripped.
- ▶ Do not damage, remove or bypass the safety features and control elements of the steam ironing system.

IMPORTANT SAFETY INSTRUCTIONS

- ▶ Only use the steam ironing system when all removable outer panels are installed so that it is not possible to touch live components or moving parts.
- ▶ The steam ironing system must not be used in a non-stationary location (e.g. on a ship).

Correct use

 Emitted steam, the iron soleplate and the areas surrounding it on the iron and the steamer jets are very hot.
Danger of injury by burning!
Avoid direct contact with it.

- ▶ The steam ironing system is intended for domestic use only and is not designed for commercial purposes.
- ▶ Do not use a power washer or water hose when cleaning the steam ironing system.
- ▶ Clean the appliance only after it has cooled down.
- ▶ Danger of injury by crushing! Do not reach between moving parts when assembling, dismantling or adjusting the height of the appliance.
- ▶ The steam ironing system must be set up on a level surface having the appropriate load-bearing capacity. The appliance must only be used in a horizontal position.
- ▶ The steam ironing system must be assembled when ironing. However, the steamer can be used when the ironing board is in the upright position.
- ▶ Ensure that the power cord does not present a trip hazard when unwound.

IMPORTANT SAFETY INSTRUCTIONS

- ▶ Use caution when the appliance is heated, if you come in contact with the soleplate of the iron or the steamer jets you could be burned. The warning symbol "Hot surface" () on the iron indicates that it is hot.
- ▶ **Do not** use solely demineralized water (e.g. distilled, battery water) to fill the water container. This could cause the steam ironing system to malfunction.
- ▶ Always place the iron with its soleplate horizontally on the resting surface of the steam ironing system. Ensure the steam function is switched off and the soleplate does not protrude over the edges. Do not place the iron anywhere else as this presents a fire hazard!
- ▶ Risk of burning! If the iron remains on the resting surface for longer period of time, the surface will become hot. Avoid direct contact with the resting surface.
- ▶ Danger of burning! Never direct the steam or the steam jets or the steam nozzles of the iron or steamer at people, animals or electrical appliances of any kind.
- ▶ Risk of burning! Never point the steam jet at clothing while the clothes are being worn! The clothing will intensify burning of skin.
- ▶ Switch off the steam ironing system before disconnecting the power cable.
- ▶ Do not pull on the cord to withdraw the plug. Pull on the plug to withdraw the plug from the socket.
- ▶ Do not leave the appliance unattended when it is ready for use. Before you leave it, ensure you switch the steam ironing system off and then disconnect it from the power supply.
- ▶ Do not touch the power cord or the steam hose with the soleplate of the heated iron as this could result in damage.

IMPORTANT SAFETY INSTRUCTIONS

- ▶ While descaling the system, the iron or the steamer must not be connected to the steam ironing system. The appliance can be left unattended during this process.
- ▶ The iron must not be stowed in its storage compartment when it is **connected**. This could result in damage to the steam ironing system.
- ▶ Do not use the residual water container to store accessories or similar items. The residual water container should be used only to collect residual water.
- ▶ Do not plug any objects into the apertures on the steam ironing system. If an aperture is blocked, do not use the system.
- ▶ Do not hang items of laundry on the folded steam iron system. This may cause the steam ironing system to tip over.
- ▶ Avoid ironing across hard or sharp-edged items. These can leave marks on the soleplate.
- ▶ Do not store the steam ironing system near gasoline, kerosene or other highly flammable substances. Risk of fire and explosion!
- ▶ Only use the appliance inside buildings where the ambient temperature is between 50°F and 104°F.

Freezing temperatures, excessive heat and humidity will adversely affect the functionality of the steam ironing system.

- ▶ Do not store the appliance in a room where there is a risk of frost occurring. Frozen water in the water container, steam generator and steam hose will cause damage to the appliance.

Using accessories

- ▶ Accessory parts may only be fitted when expressly approved by Miele. If other parts are used or fitted, any claims from the warranty, warranty and/or product liability will be invalidated.

SAVE THESE INSTRUCTIONS

Product description

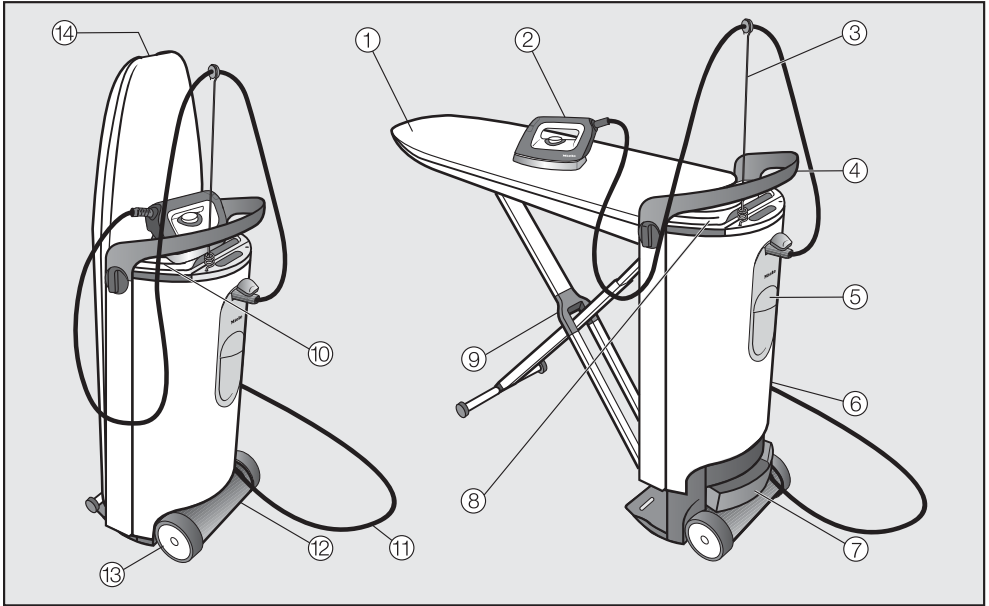

- ① Ironing board
- ② Iron with steam hose
- ③ Steam hose holder
- ④ Handle
- ⑤ Water container
- ⑥ Tower
- ⑦ Residual water container
- ⑧ Storage compartment (upper)
For the iron and the steam hose holder.
- ⑨ X-frame for the ironing board
- ⑩ Iron resting surface
- ⑪ Power cord
- ⑫ Storage compartment (lower)
For the power cord, the steamer*, the non-stick soleplate, and the holder for the power cord.
- ⑬ Wheels
- ⑭ Release handle
To setup the steam ironing system.

* Standard equipment for steam ironing system B 3847. Available as optional accessory for steam ironing system B 3312.

Product description

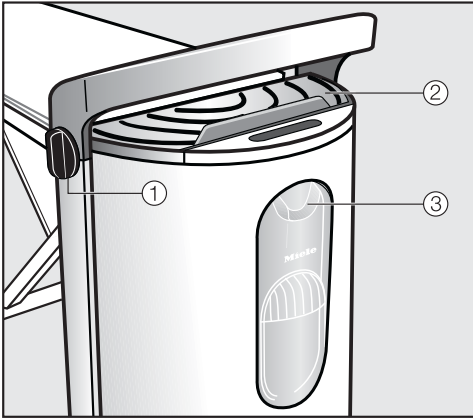

Tower

- ① Rotary dial for height adjustment and dismantling the appliance
- ② Iron resting surface
- ③ Steam connection

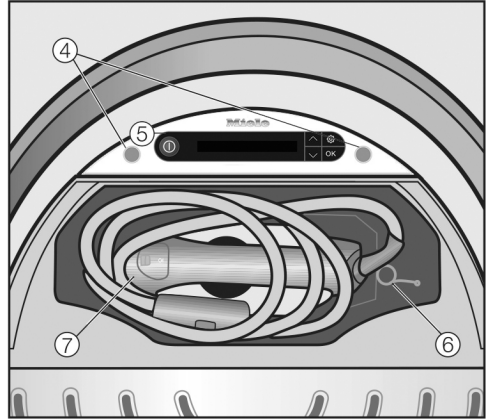

Tower (top view) with open storage compartment (top)

- ④ Steam hose holders
- ⑤ Control panel
- ⑥ Steam hose holder
- ⑦ Iron with steam hose

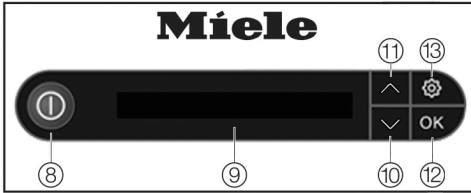

Some of the messages in the display are more than one line long. Touch the \downarrow or \uparrow button to read them in full.

Control panel on tower

- ⑧ On/Off button $\text{\textcircled{1}}$
Switches the steam ironing system on or off.
- ⑨ Display
Displays messages and instructions for the user.
- ⑩ Arrow button \downarrow
The key is illuminated if additional options are provided, or the display text exceeds the specified length of a line. Scrolls the selection down or reduces values.
- ⑪ Arrow button \uparrow
Is illuminated if additional options are provided or the display text exceeds the specified length of a line. Scrolls the selection up or increases values.
- ⑫ OK button
Acknowledges the selection or the information in the display.
- ⑬ $\text{\textcircled{⚙}}$ button
This button opens the settings menu. While in the settings menu, the language and the level of the water hardness can be adjusted or the descaling process can be started.

Transport

The steam ironing system is fitted with two wheels. This allows the appliance to be pulled across an even surface when folded up.

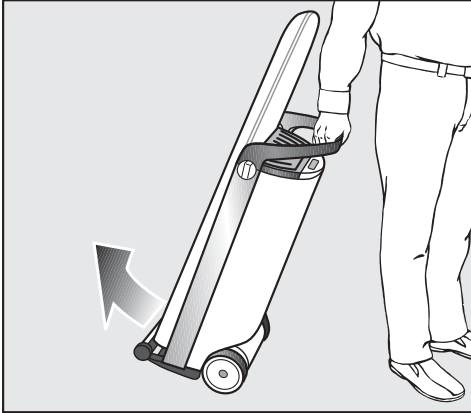

- Hold the steam iron system by its handle and tip it gently towards you until the wheels are free to roll.

This allows you to navigate easily across obstacles such as carpet edges, door sills or single steps.

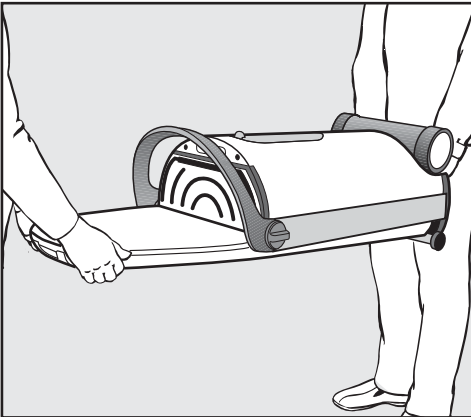

- Two people are required to carry the steam ironing system up or down stairs. When doing so, ensure the ironing board is at the bottom.

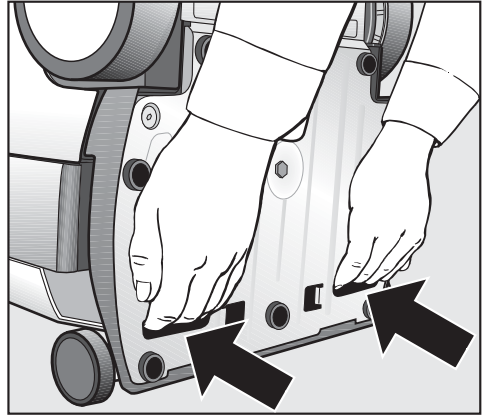

- When transporting the appliance, use both handles on the underside of the appliance.

⚠ The steam ironing system must only be transported or lifted when folded down!
The locking mechanism of the ironing board could release and cause injury or damage.

- Take the steam ironing system to its set up location.

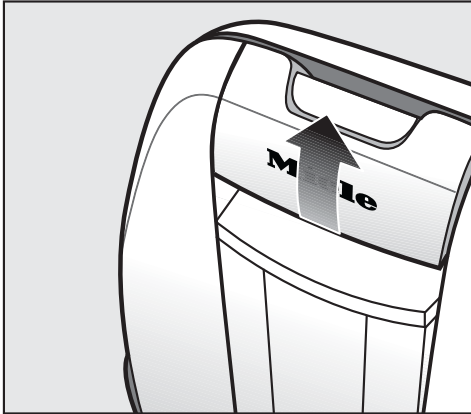

- Use one hand to pull the release mechanism upwards.

This releases the locking mechanism of the ironing board and the X-frame folds down.

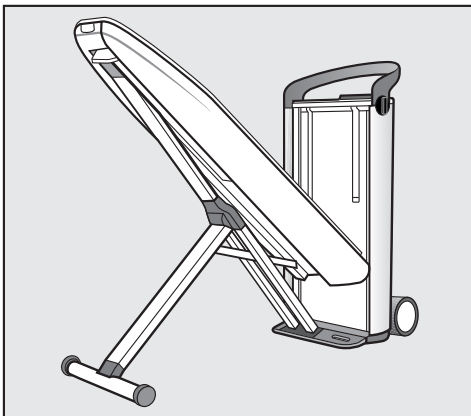

- Hold onto the release mechanism and guide the ironing board into a position of approx. 45°.

The ironing board remains in this position by itself.

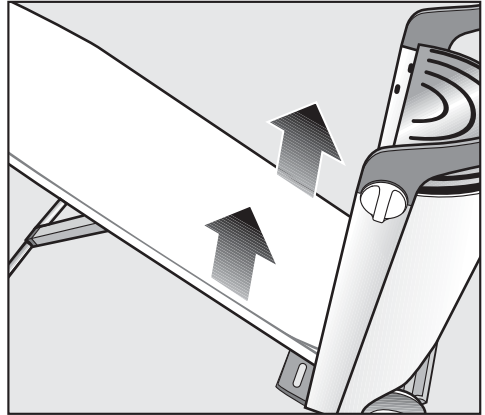

- Use both hands to pull the ironing board upwards into a horizontal position until this audibly clicks into place on both sides of the tower.

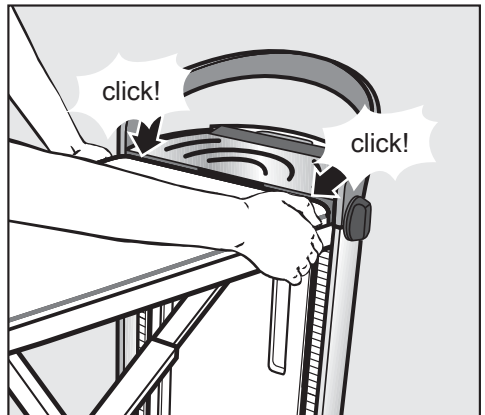

- Ensure the ironing board has locked into place on both sides of the tower.

The height adjustment only works if both sides of the appliance have locked into place.

Assembly

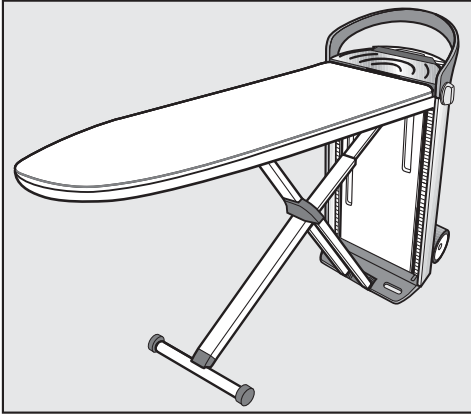

The steam ironing system is now assembled. This is its lowest working position of approx. 32¾" (83 cm) high.

Adjusting the height

The steam ironing system can be adjusted to suit your personal preference. The maximum working height is 40¼" (102 cm).

When adjusting the height, ensure the power cord does not become trapped in the mechanism.

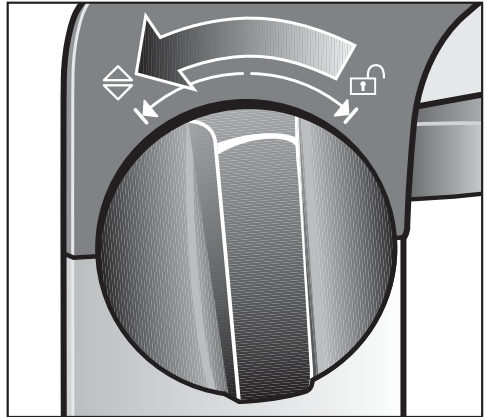

- Use one of the rotary dials located on the side of the tower handle. Turn the dial in the ↻ direction and hold the dial in position.

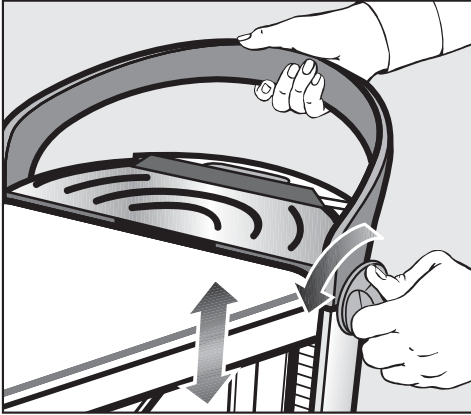

- At the same time, pull the handle on the tower upwards with the other hand up or press the handle down.

Do not push down on the ironing board while adjusting the height!
Always use the handle on the tower to do this.

- When you have reached your desired working height, release the rotary dial.

The rotary dial will spring back into the center position. The ironing board will remain at the adjusted height.

For additional stability, the ironing board locks into place under extra pressure with an audible click. Now the working height you selected is twice as secure.

Tip: Adjust your working position to approx. hip height for optimum comfort.

Connection

Plug in the power cord

The steam ironing system is designed for the connection to a properly installed grounded socket for AC 120 V, 15 A, 60 Hz.

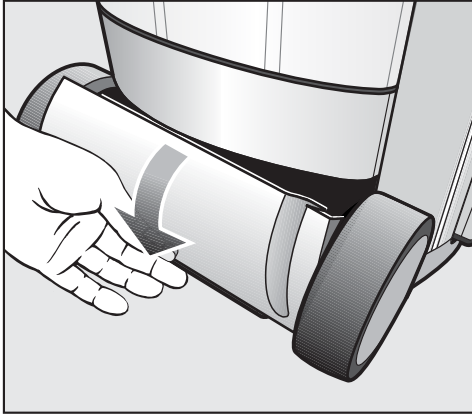

- Open the (lower) storage compartment by swinging the lid downwards.

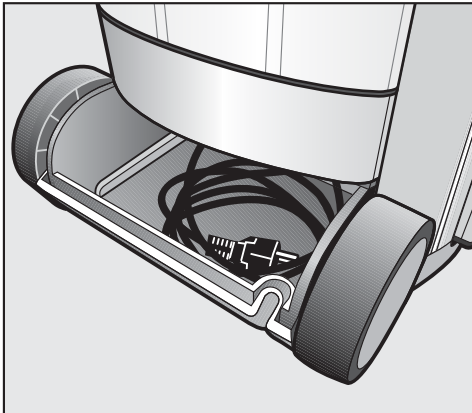

- Remove the power cord from the (lower) compartment.
- Insert the power plug into a suitable grounded outlet (see chapter "Electrical connection").

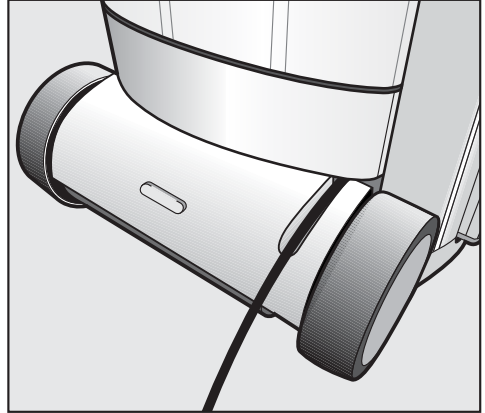

- Guide the power cord through the groove in the cover.
- Close the (lower) storage compartment.

When closing the compartment, ensure the power cord does not become trapped between the lid and the casing or between the wheels and the tower.

Removing the iron and the steam hose holder

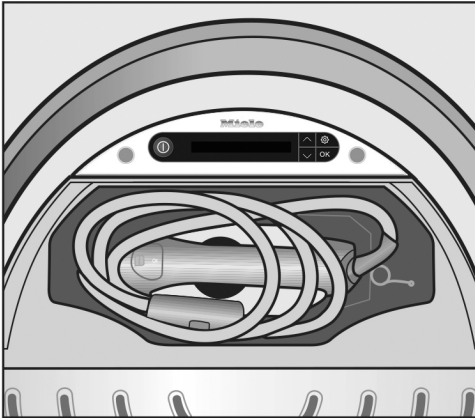

- Open the lid of the storage compartment (upper) on the tower.
- Take out the iron and the steam hose holder.
- Close the storage compartment lid.

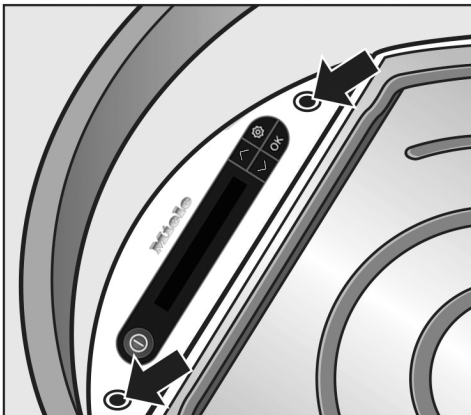

- Plug the steam hose holder into one of the sockets provided.

Tip: Use the socket on the side on which you are ironing.

The steam ironing system is suitable for right- or left-handed people. The operation is optimized for both sides.

Connecting the steam hose

- Lift the lid of the steam connection.

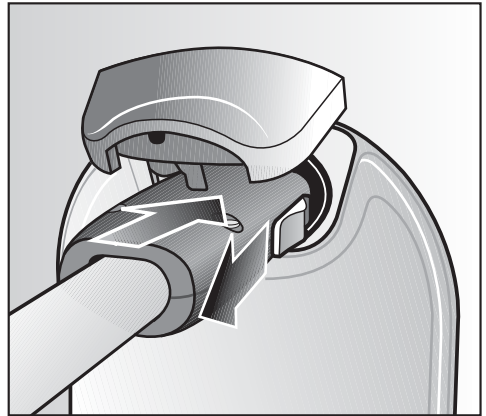

- Pull back the slider on the steam hose plug.
- Insert the plug into the steam connection.
- Release slider on the plug when it is locked into the steam connection.

The iron is now connected to the steam connection.

Connection

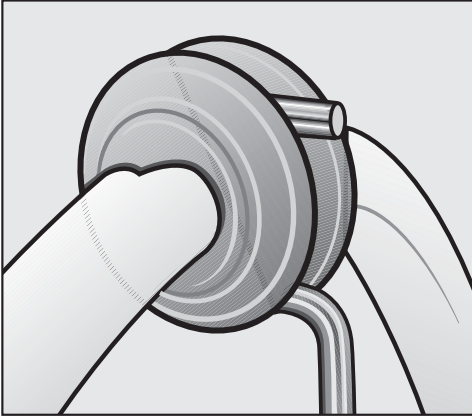

- Guide the steam hose on the rubber ring into the steam hose holder.

Ensure the steam hose fits tightly and is not twisted.

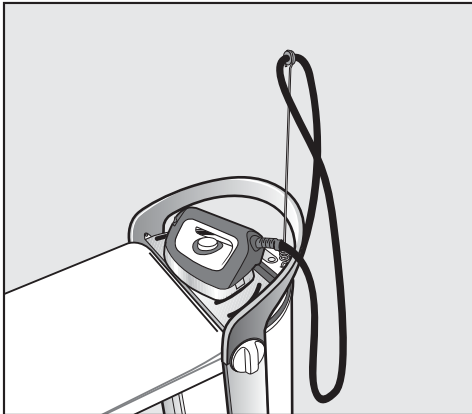

- Always place the iron on the resting surface before you start ironing and when you take a break from ironing. This prevents damaging or discoloration of the ironing board cover.

⚠ Do not place the iron in its up-right position!

It can easily tip over or fall to the floor.

Always place the iron onto the resting surface with its soleplate down.

⚠ If the iron remains on the resting surface for any length of time, the surface will become hot.

Avoid direct contact with the resting surface.

Only touch the handle.

Before turning off the iron, and before placing the iron down, make sure you switch off the continuous steam function.

If the continuous steam function is not switched off, the following message will appear in the display

⚠ Release stm. button.

To do this, unlock the  button by pushing the slider on the iron forward (see "Ironing").

Condensation can form on the resting surface. However, this does not affect the functioning of the steam ironing system.

- Before using the steam ironing system for the first time, remove all packaging (e.g., the protective foil from the tower).

Determining the water hardness

To ensure the steam ironing system will function properly and the descaling reminder appears at the appropriate time, the appliance must be set to the water hardness level of your local water supply.

The water hardness level indicates how much calcium is dissolved in the water. The higher the calcium content, the harder the water. The harder the water, the more often the appliance must be descaled.

Your local water supplier can inform you of the water hardness level in your area. This information can also be found on the internet and the home page of the relevant utility company.

As an alternative, you may also determine the approximate water hardness by using the test strips included in the delivery.

Using the test strips to determine the water hardness

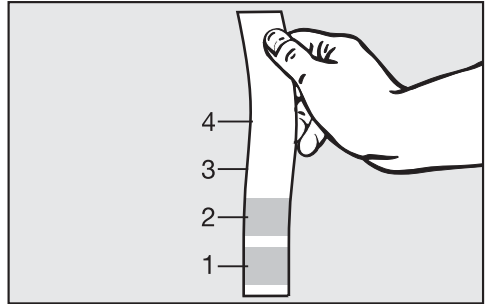

- Dip the test strip for approx. 1 second into the water.
- Remove the test strip from the water and shake the water off the test strip.

After approx. 1 minute, and based on the coloration, you will be able to read the water hardness from the table below:

Test strip	Water hardness
4 green areas	< 3 gpg (3 °dH)
1 red area	< 4 gpg (4 °dH)
2 red areas	< 7 gpg (7 °dH)
3 red areas	< 15 gpg (14 °dH)
4 red areas	< 22 gpg (21 °dH)

Tip: It is useful to know your water hardness so that you can provide the service technician with this information in the event of any service calls. Please note your water hardness level here:
..... gpg (..... °dH)

Before first use

Before using for the first time

- The following steps must be carried out before using the appliance for the first time:

Switch on the steam ironing system



- Press the  button on the control panel on the tower.



The Welcome screen appears for a few seconds in the display. The display will then guide you through the following settings:

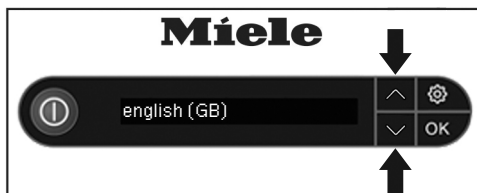

Language setting

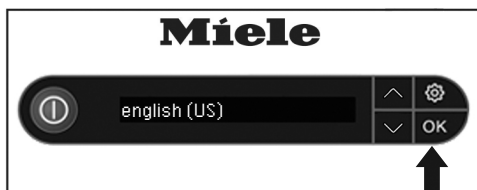

- Use the arrow buttons  or  to select your preferred language setting.



- To confirm your selection, press the OK button.

The language settings can be changed anytime by choosing the following setting menu () button, menu item Language .

Setting the water hardness level



Before the water hardness can be set, the display message **i** Set water hardness... must be acknowledged by pressing the OK button.

The steam ironing system gives you the option to set the water hardness level from 1-10.

Use the following table to determine the water hardness level that must be set for your steam ironing system:

°dH	gpg	Setting
1 - 4	1 - 4	Level 1
5 - 7	5 - 7	Level 2
8 - 11	8 - 11	Level 3
12 - 15	13 - 16	Level 4
16 - 20	17 - 21	Level 5
21 - 25	22 - 26	Level 6
26 - 30	27 - 31	Level 7
31 - 36	32 - 38	Level 8
37 - 45	39 - 47	Level 9
46 - 70	48 - 73	Level 10



- Use the arrow buttons \downarrow or \uparrow on the control panel to set the water hardness level in your household.

Tip: If the water hardness is fluctuating (e.g., 39 - 52 gpg/37 - 50 °dH), always set the highest value (in this example, 52 gpg/50 °dH = Level 10).

Make sure the correct water hardness level is set.

An incorrect setting will invalidate all warranty claims.

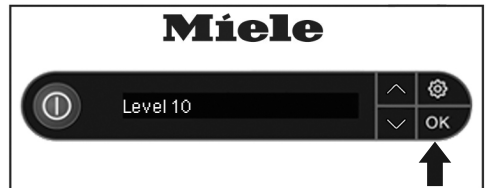

- Confirm your selection by pressing the OK button.

The steam ironing system is now set for the specified water hardness.

The water hardness level can be changed at any time via the settings menu (⚙️ button, menu option Water hardness).

Before first use

The steam ironing system is now set up for use

This completes the settings for using the appliance for the first time. The message **i** Initial set-up complete will appear in the display. Confirm this message by pressing the OK button.

The steam ironing system will normally run a rinse cycle automatically after it has been set up for use.

The steam ironing system can then be switched off or you can continue using it.

When using the appliance for the first time, a slight odor may be noticeable during the heating-up phase. This will dissipate with further use.

During operation of the steam ironing system pumping, boiling and knocking noises may be heard. These are normal noises and do not indicate a malfunction.



Switch on the steam ironing system





- Press the  button on the control panel of the tower to turn on the steam ironing system.

The  button is illuminated and the Welcome screen appears for several seconds in the display.

If the iron was not connected to the steam connection before switching it on, the message  Attach hose is displayed. In this case, the steam hose must be attached to the steam connection (see "Connection").

If the steam button  on the iron is locked when the steam ironing system is switched on,  Release stm. button will appear in the display. If this is the case, first unlock the steam button by pushing the slider on the iron forwards (see "Ironing").

Then the message  PreHeating phase will be displayed. The steam ironing systems starts heating up. During the heat-up phase, some steam may be discharged from the iron.

As soon as the steam ironing system is ready and steam is available, the message  Ready will be displayed.

Depending on the operating duration, immediately after switching the appliance on, the automatic rinse function can be started (see "Automatic rinsing") or you may start the descaling process (see "Descaling"). While the rinse and descaling processes are running, the steam ironing system is not available for ironing.

Switching on the appliance

Filling the water container

If the water container is empty or not installed in the tower, the message  Insert or refill the water container is displayed.

Removing the water container

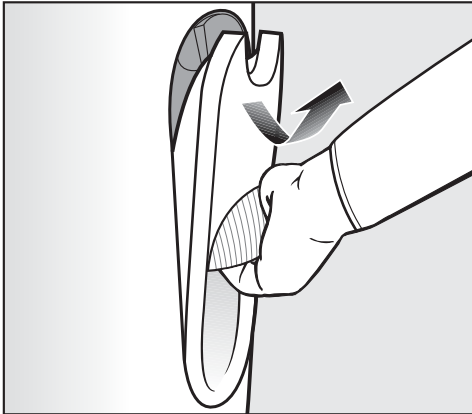

- Hold the water container by its handle.
- Pull the handle down.

The water container is released from the retainer.

- Pull the water container upwards and out.

You may notice some water dripping when removing the water container while the water container valves are closing.

Tip: The dripping can be prevented by removing the water container slowly.

Filling the water container

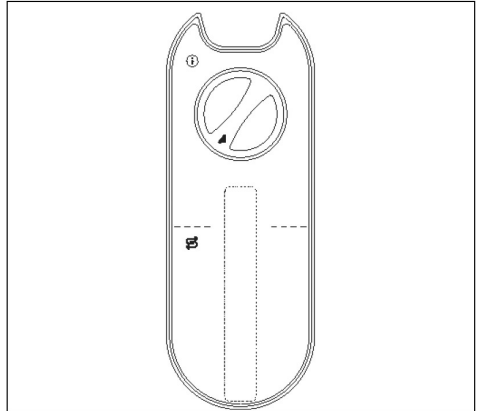

- Open the twist lock at the rear of the water container by turning the lock counterclockwise.
- Remove the twist lock.
- Use fresh tap water to fill the container (water temperature approx. 60 to 95°F / 15 to 35°C).

Tip: When placing the water container in the horizontal position, the water container can also be filled if the faucet is installed very low.

- Replace the twist lock in the opening of the water container.
- Close the twist lock by turning it clockwise as far as it will go.
- Put the water container back into the tower.

The water container can be removed and refilled at any time (even during the ironing process). The amount of water required will depend on how much steam is required.

Switching on the appliance

Steam operation



After inserting the water container, wait until the steam ironing system is ready to use steam. This is indicated by the Ready message in the display.

If the water container is filled during the ironing process, the steam generator may have to be reheated.

Tip: If you fill the water container as soon as the Fill water cont. message is displayed and the container is inserted into the tower there is no delay. The steam is immediately ready for use.

As long as the message Fill water cont. is shown in the display, the steam ironing system is not active. However, you may continue to use the iron.

Tip: You can save energy by ironing dry and without steam. To do this, remove the water container. In this case, the steam generator will not be heated and the inflation and suction function of the ironing board is not available (see "Active ironing board").

Water quality

- Use only fresh tap water.
- Water prepared using commercially available water filters may also be used.

For water hardness of more than 15 gpg (14°dH) you can use tap water mixed at a 1:1 ratio with distilled water. This halves the water hardness. Set the halved water hardness to the corresponding level of the steam ironing system (see "Setting the water hardness").

If your tap water has a water hardness of 63 gpg (60°dH), the mixing ratio of 1:1 with distilled water results in a water hardness of 31 gpg (30°dH). The water hardness level that must be set on your steam ironing system must now be Level 7.

Never attempt to use solely distilled water to fill the water container.

This can cause the steam ironing system to malfunction.

Do not use water from a water softener system.

Do not use condensate (e.g. from other appliances such as air conditioning units, dryers).

Never use rainwater.

Do not use additives, (e.g. perfumes, ironing water, starch, carbon dioxide).

Switching on the appliance

Selecting the ironing temperature

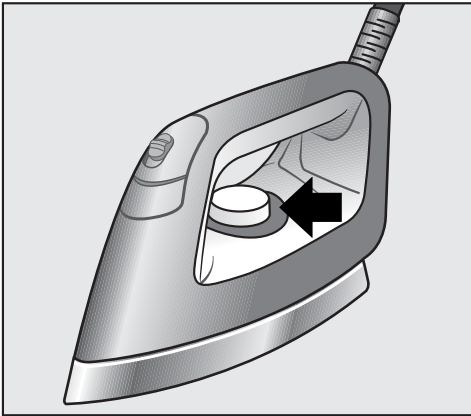

Use the temperature selector on the iron to set the ironing temperature.

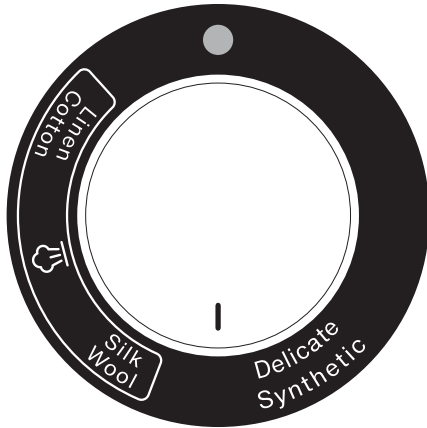

The temperature settings are indicated on the scale of the selector.

When selecting the temperature levels *Silk/Wool* (medium temperature) and *Linen/Cotton* (high temperature) you can use steam when ironing.

The temperature level *Delicate/Synthetic* (low temperature) indicates a temperature of the iron plate that is too low to iron with steam. If you use this temperature level, do not use the  steam button.

Otherwise, water will escape from the steam nozzles.







Tip: Sort your laundry according to the heat sensitivity of the fabric. This allows you to iron faster: First, iron your laundry that is made of heat sensitive fiber (e.g., synthetics) at temperature level *Delicate/Synthetic* (low temperature). Then, iron all laundry made of wool or silk, using the temperature level *Silk/Wool* (medium temperature). Finally, iron all laundry made of cotton and linen, using temperature level *Linen/Cotton* (high temperature).

- Set the temperature selector to the required temperature setting.

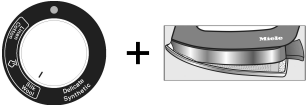
The indicator light on the temperature selector will light up yellow whilst the iron is heating up. It will go out once the set temperature has been reached.

The iron is then ready for use.

Switching on the appliance

Care label (on the garment)	Ironing with steam for best results (Material / Temperature setting)	Ironing without steam (Material / Temperature setting)
 Low temperature	<p>With non-stick soleplate (see "Ironing with non-stick iron soleplate") Minimum iron, synthetics, appliqués, prints, flocking, etc.</p> 	Minimum iron, synthetics 
 Medium temperature	Wool, silk 	
 High temperature	Linen, cotton 	
	Do not iron	

Switching on the appliance

CoolDown Function

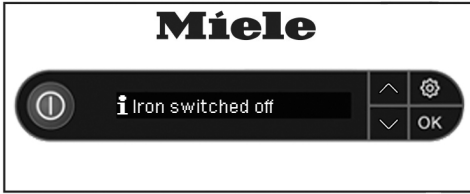

The iron will switch off automatically, if it has not been moved for more than 3 minutes. The following message will appear in the display **i** Iron switched off to let you know it has switched off. After a while steam will not be available either. The message **⚠** Release stm. button will appear in the display to let you know the steam button is locked. To release the steam button **☞**, push the slider on the iron forwards (see "Ironing").

⚠ The soleplate is still hot immediately after the heating is switched off! Avoid direct contact with it.

As soon as the iron is moved, or the steam button has been released, the iron will start heating up again automatically. The time taken for the steam to be available again depends on the length of time the heating was switched off.

When the steam ironing system is ready and steam is available, the following message **☞** Ready will be shown in the display on the tower.

⚠ Do not leave the steam ironing system unattended with the iron or steamer connected!
Always withdraw the plug from the outlet before leaving appliance.

Auto Off function

If the iron or the steamer is not used for approx. 25 minutes, the entire steam ironing system switches off automatically.







The system is switched on again by pressing the **⏻** button on the control panel.

Iron

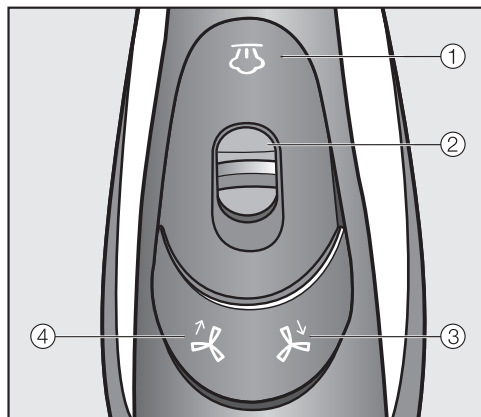
Depending on the model, your steam ironing system has one of the following irons:



Steam ironing system B 3312:

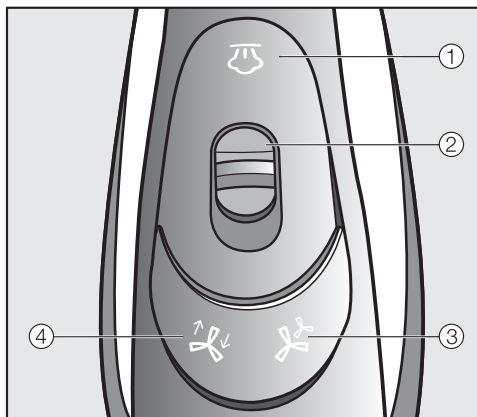

- ① "Steam" button 
- ② Slider for constant steam
- ③ "Suction" button 
- ④ "Inflation function" button 

Steam ironing system B 3847:





- ① "Steam" button 
- ② Slider for constant steam
- ③ "Power output" button 
- ④ "Inflation/suction button" 

Irons supplied with previous Miele steam ironing systems (B 1xxx/B 2xxx) cannot be used with this appliance.

Ironing

Ironing with steam

The steam of your ironing system is ready to be used if the  Ready is shown in the display. The burst of steam is controlled by the  button.

When pressing the  button, the fan on the underside of the ironing board starts automatically.



When the  button is released, the fan will also stop after a brief time delay.



When using the steam function for a long time, make sure the room is well ventilated, as high air humidity can develop.

Use short bursts of steam

- Briefly press the  button and release it again.

Using steam

- Press the  button and simultaneously pull the slide switch  back.
- Release the  button again.

While the slide switch  is pulled back, the  button remains in a locked position.

Steam is now emitted continuously.



Stopping the continuous steam function

- Push the  button forwards.

This will unlock the  button again and the steam burst function is ended.

The continuous bursts of steam must be finished before the iron is put back on the resting surface!

If the steam button was not unlocked before placing the iron down, steam will stop being produced after approx. 3 minutes and  Release stm. button will appear in the display.

When turning off the iron, unlock the  button by pushing the slide switch  forwards.

Filling the water container

- Fill the water container when the message  Fill water cont. appears in the display (see "Filling the water container").

When using the steam function for a long time during ironing, condensation can build up in the ironing board. Sensitive floors can be damaged by droplets of water.

If you notice condensate underneath the ironing board, use a cloth to wipe it off.

Tip: If you take a break from ironing, condensate may collect in the steam hose. When the  button is pressed, the condensate is expelled from the hose. To avoid damp spots on your clothes, do not direct the first burst of steam onto the garment after a break from ironing.

Ironing without steam

- Remove the water container from the steam ironing system if you would like to iron without steam.

This will not heat the steam generator, which also saves energy at the same time.

Ironing with the non-stick soleplate

There is a non-stick soleplate in the (lower) compartment. Simply clip the soleplate onto the iron.

With the non-stick soleplate you can iron appliqués, printed or flocked textiles etc. No need to turn the garment inside out. This soleplate also reduces or eliminates the formation of shiny patches on dark textiles.

Always try it first on an inconspicuous part of the fabric.

 The iron soleplate gets very hot during use!
Avoid direct contact with it.

Attaching the non-stick soleplate

- Place the tip of the iron inside the non-stick soleplate.

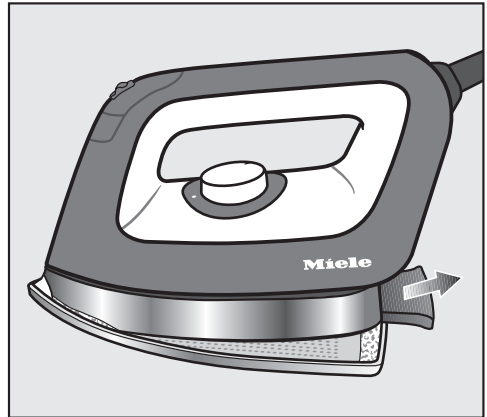

- Pull the tab, which is located at the rear end of the non-stick soleplate, to the back.
- Hold the tab in this position.
- Push the iron completely onto the non-stick soleplate.
- Release the tab again.

The non-stick soleplate is now secured onto the iron.

- Before you start ironing, let the non-stick soleplate heat up for approx. 1 minute until it has reached the ironing temperature.

The iron is now ready for use.

Ironing

Removing the non-stick soleplate

- Hold the handle of the iron.

⚠ The non-stick soleplate is still very hot after ironing!
Avoid direct contact with it.
Only touch the tab of the non-stick soleplate.

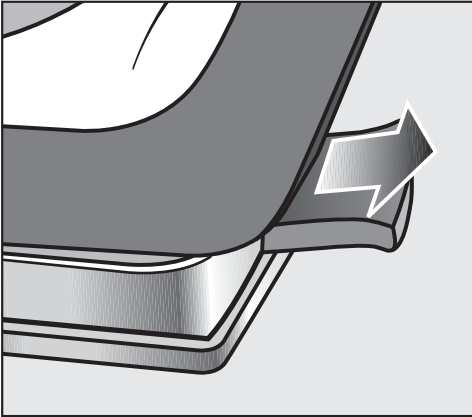

- Pull back the tab on the rear of the non-stick soleplate.
- Remove the iron from the non-stick soleplate.
- Only store the non-stick soleplate in the storage compartment (lower) after the soleplate has cooled down.

Active iron board

The steam ironing system uses a fan that sucks away the steam or uses the inflation function to inflate the ironing board for optimum positioning while ironing garments.

The or buttons on the iron control the fan in the ironing board.

Suction function

The suction function ensures the steam permeates the textiles in an optimal way. At the same time, the suction avoids the formation of condensation on the ironing board. The suction function holds the garment in place and ensures it does not shift on the ironing board.

Inflation function

The inflation function forms a cushion of air between the fabric and the ironing board. This helps prevent seams being pressed into the garment. The inflation function allows you to iron without flattening the fabric.

Tip: The inflation function also assists with ironing ruffles and sequins.

Automatic switch on/off

The automatic switch on/off feature ensures that the fan starts at exactly the right moment. If the steam function is being used, the fan starts automatically.

If steam is no longer needed, the fan will stop after a short run-on time.

Memory function

The memory function saves the fan direction and the power setting used last with your steam ironing system. When you use the appliance the next time, you do not need to set it again.

Heated ironing surface

When the iron is connected and the appliance is switched on, the surface of the ironing board will heat up automatically. This function reduces the formation of condensation on the ironing board.

If the steamer is connected to the appliance, the surface of the ironing board will not be heated.

Fan control for the B 3312:

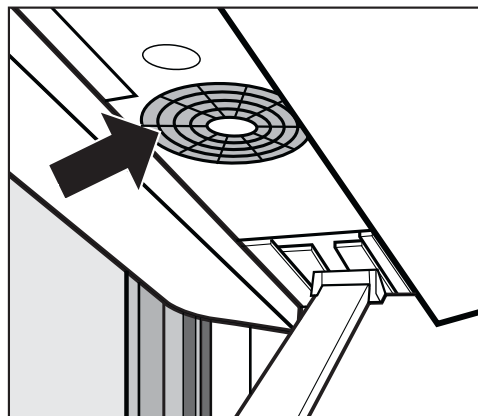



The  button activates the inflation function.

The  button activates the suction function.

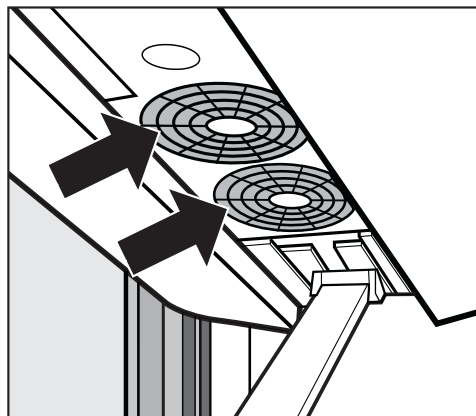

Fan control for the B 3847:



Activating the inflation and suction function

Press the  button to switch between the inflation function and the suction function. Use the  button to activate the function.

Setting the power output level

When using the  button, you can switch between both power output levels of the fan. Each press of the  button switches between the following power output levels:

- Power setting 1 = 1 fan active
- Power setting 2 = 2 fans active

Steamer

The B 3847 steam ironing system is equipped with a steamer in addition to the iron. The steamer is available as an optional accessory for the B 3312 steam ironing system.

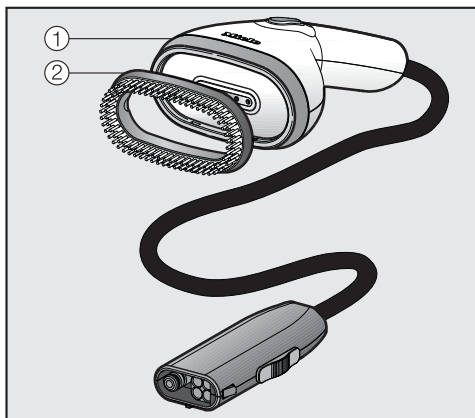

The steamer ① makes ironing hanging textiles easier, e.g. dresses and jackets. It comes with a removable brush attachment ② for lifting the fibers.

The steamer weighs less than the iron and also does not have a hot soleplate, therefore eliminating the risk of shiny patches if it accidentally comes into contact with the fabric.

The steamer can also be used when the appliance is folded up.

The steamer supplied with earlier steam ironing systems (B 1xxx/B 2xxx) cannot be used with this appliance.

Connecting the steamer

You can also plug the steamer into the steam connection of the ironing system as an alternative to the iron.

Disconnect the iron from the steam connection

 The iron soleplate is still very hot after use!
Avoid direct contact with it.
Place the iron on its resting surface and let it cool down completely before you store it away.

Do not pull on the steam hose!
Always pull on the plug at the end of the steam hose when disconnecting it from the steam hose connection.

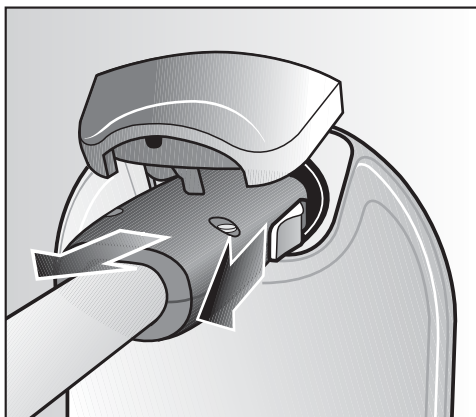

- Pull back the slider located on the side of the steam hose plug.
- Hold the slider back.
- Withdraw the plug from the steam connection.

Now you can connect the steamer to the steam connection.

Attaching the steamer to the steam connection

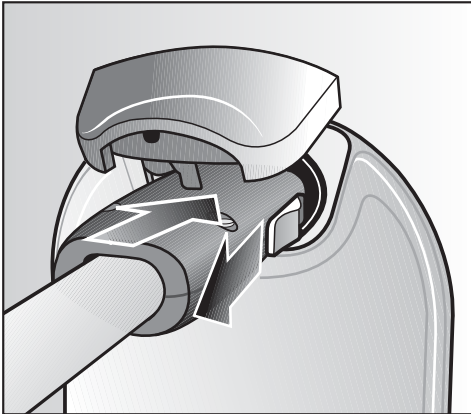

- Pull back the slider located on the side of the steam hose plug.
- Insert the steam hose plug into the steam connection on the tower.
- Release the slider when it has locked into place in the steam connection.

The steamer is now attached to the steam connection.

You can at any time plug the iron into the steam connection as an alternative to the steamer.

You do not need to switch off the steam ironing system to do this.

After switching between the iron and the steamer, there is a short interval before the steam is ready. This ensures that sufficient steam is available.

The steamer is ready when the message  Ready is shown in the display.

Steamer

Using the steamer

⚠ Danger of burning due to hot steam!

Never direct the steam or the steam jets at people, animals or electrical appliances of any kind.

Never point the steam jet on clothing while the clothes are being worn! The clothing will cause intensified burning of the skin.

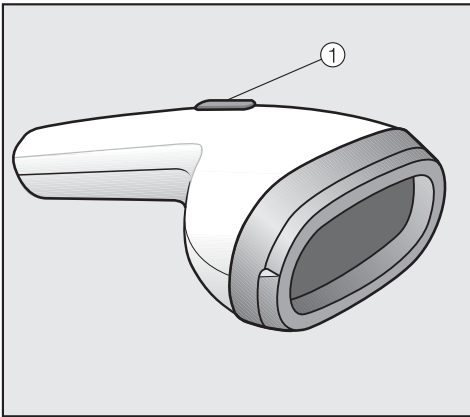

The burst of steam is controlled by the ① button on the steamer.

Tip: Always steam the fabric in the direction of the fibers.

Use short bursts of steam

- Briefly press the ① button.
- Then release the button again.

Using steam

- Press the ① button.
- Keep the button depressed.

Stopping the continuous steam function

- Release the ① button again.

If you take a break from ironing, condensate may collect in the steam hose. When pressing the ① button, the condensate is expelled from the hose as well.

The optimum distance between the steamer and the fabric depends on the sensitivity of the fabric and can vary from one fabric to another. Always try it first on an inconspicuous part of the fabric.

Brush attachment

The steamer comes with a brush attachment which can be clipped on. The brush attachment helps to raise the fibers.

You can hold the steamer directly onto the fabric while the brush attachment is in place.

Always try it first on an inconspicuous part of the fabric.

Connecting the brush attachment

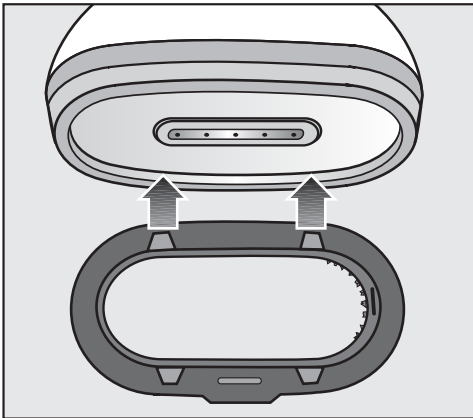

- Hold the brush attachment in front of the steamer so that the lugs on one side fit into the notches on the steamer.
- Press the side of the brush attachment against the steamer until the lugs snap into place.

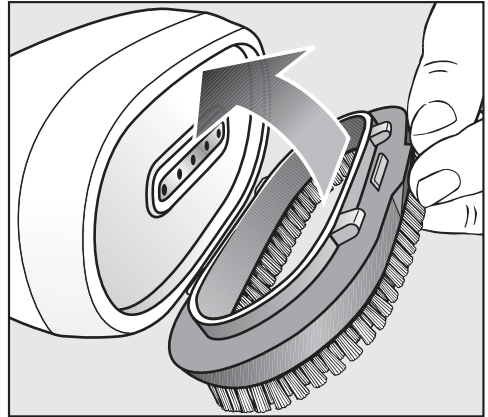

- Guide the brush attachment into the notches on the opposite side.
- Press the brush attachment against the steamer until the lugs snap into the notches.

The brush attachment is now connected to the steamer and can be used.

Removing the brush attachment

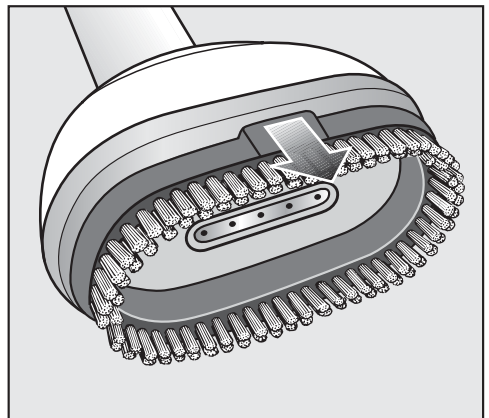

- To remove the brush attachment, pull it off the steamer by the raised section.

Switching off



- To switch off the steam system, press the ① button on the control panel.

The illuminated ① button goes out.

The steam system is now switched off. The last selected fan settings are saved and are available for the next time you switch on the steam ironing system.

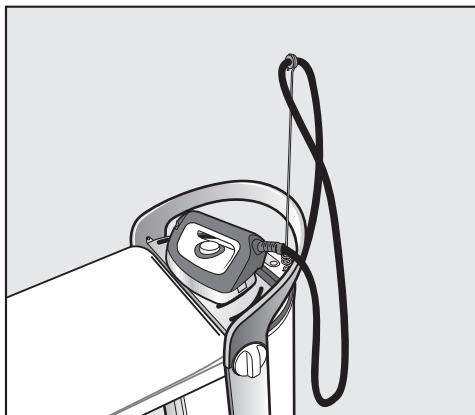

- Place the iron on the resting surface until it is cooled down.

The steam ironing system can be dismantled while the iron is cooling down (see "Dismantling").

- Unplug the power cord from the outlet.

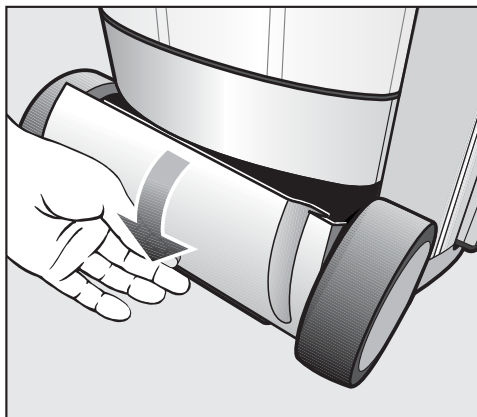

Storage compartment (lower)

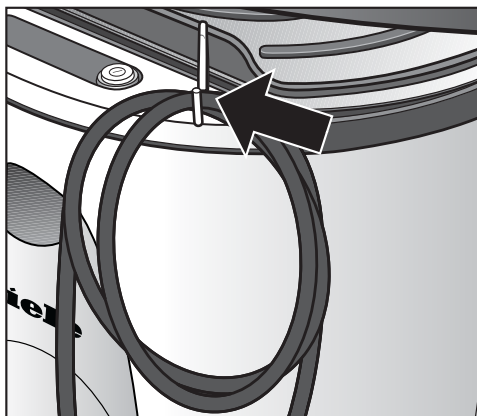

Clip for the power cord



- Store the power cord in the (lower) compartment or hang it up on the cord clip.

The cord clip can be found the (lower) compartment and can be pushed into one of the sockets for the steam hose holder.

Set the ironing board at its lowest working height

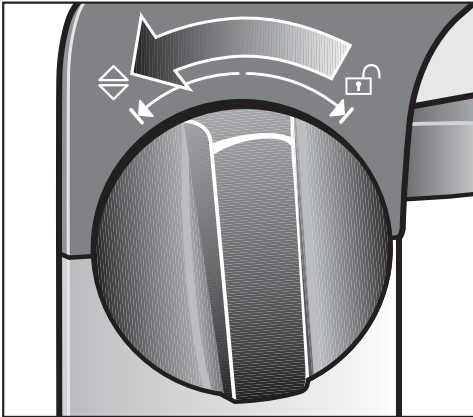
To dismantle the steam ironing system, the ironing board must first be placed at its lowest working height. Make sure you do not trap the power cord in the system. Ensure the residual water container is completely emptied, pushed in and locked in place.



- Turn one of the rotary dials on the side of the tower handle as far as it will go in the  direction.
- Hold the rotary dial in the  position. The height of the ironing board can now be adjusted.

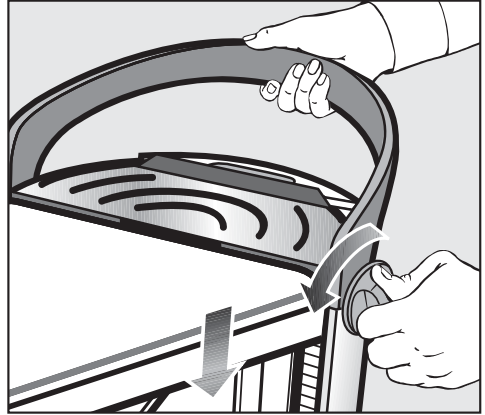

- Keep holding the rotary dial in the  position and, simultaneously, use the handle of the tower to push the ironing board down as far as possible.

Never push on the ironing board to push it down. Use only the handle of the tower to push the ironing board down.

- Release the rotary dial.

The rotary dial will spring back into the center position.

The ironing board is now at its lowest working height and can be folded.

After withdrawing the plug, drops of water can escape from the steam hose.

Dismantling

Folding the ironing board

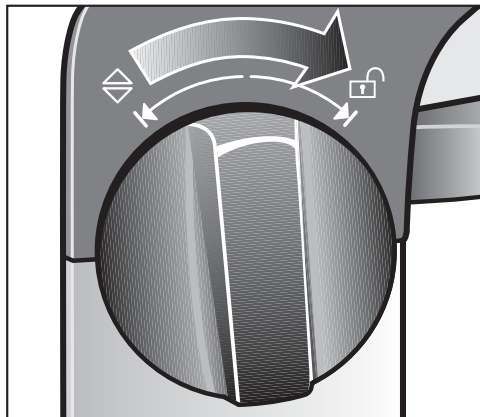

- Turn one of the two rotary dials to the  position as far as it will go.

The ironing board is now unlocked.

- Release the rotary dial.

The rotary dial will spring back into the center position.

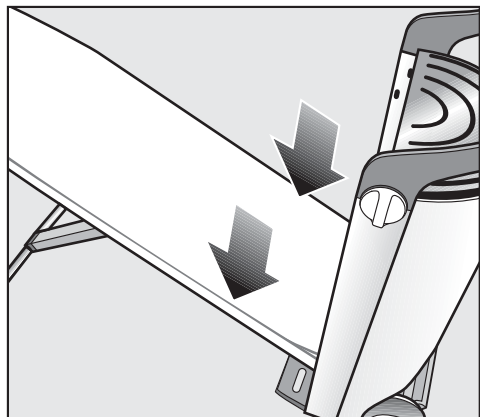

- Guide the ironing board downwards or allow it to slide down by itself.

The ironing board will remain in this position by itself.

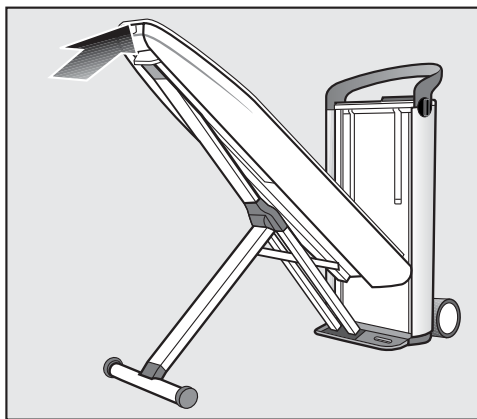

- Push the ironing board up by the tapered end until it is upright and locks into position on the tower.

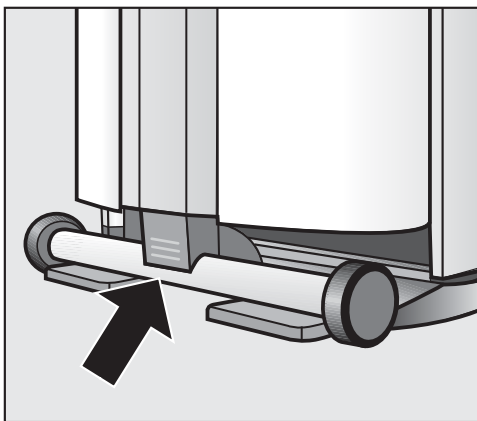

- Push the protruding end of the X-frame onto the ironing board until the frame locks into place.

Disconnecting the steam hose

Do not pull on the steam hose!
Hold the plug at the end of the steam hose. The plug may still be warm immediately after use.

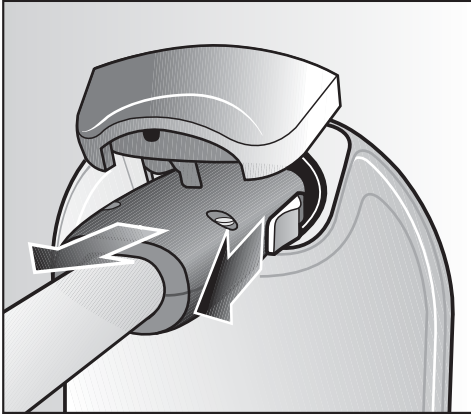

- Pull back the slider located on the side of the steam hose plug.
- Hold the slider back.
- Withdraw the plug from the steam connection.

After withdrawing the plug, drops of water can escape from the steam hose.

Storing the iron

 The iron soleplate is still very hot after use!
Avoid direct contact with it.
Allow the iron to cool down after use.
Never stow the iron away while it is still attached to the steam connection.

- Place the iron on the resting surface on the tower and let the iron cool down.
- Store the iron and the steam hose holder in the (upper) storage compartment.

Storing the steamer

Never put the steamer away while it is still connected to the steam system.

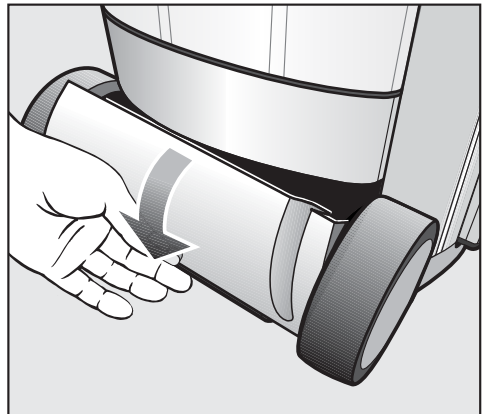

- Store the steamer in the (lower) storage compartment.

Dismantling

Emptying the water container

Empty the water container if the steam ironing system will not be used for a long period of time.

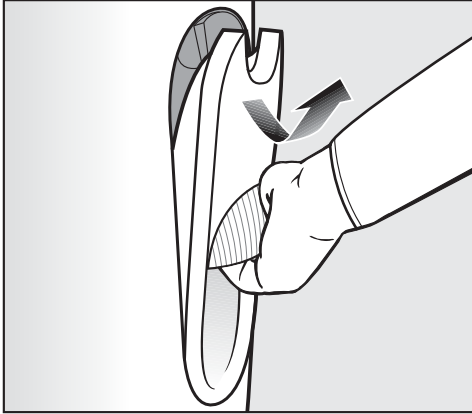

- Remove the water container (see "Filling the water container").
- Make sure the water container is completely emptied.

Storing the steam ironing system

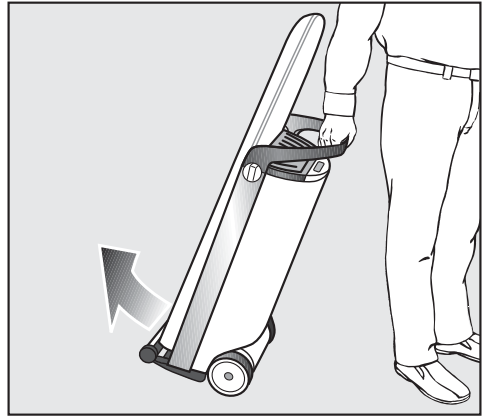

- Take the appliance to its storage place.

Do not store the appliance in a room where temperatures below freezing may occur.

Frozen water can cause damage to the water container, steam generator and steam hose.

Automatic rinsing

The automatic rinse function clears the steam generator of mineral deposits from the evaporated water.

After approx. 0.8 gal (3 liters) of water have been passed through the system, and after the steam ironing system has been turned on, the rinse process starts automatically.

The rinsing process takes several minutes. Steam escapes and splashing noises can be heard. At the same time, the message  Appliance rinsing will be shown in the display on the tower.

The iron cannot be used while the rinsing process is in progress. The steam ironing system can only be used again once the automatic rinsing process is completed.

Preparing for the rinsing process

- Set the appliance to its highest working position to allow the removal of the residual water container later (see "Height adjustment").
- If the message  Fill water cont. is shown in the display, fill the water container (see "Filling the water container").

Draining the residual water container

After the rinsing process is completed, the residual water container must be emptied. The message  Empty drawer appears in the display on the control panel when the residual water container needs to be emptied. The residual water container can be removed from the tower when the steam ironing system is set at its highest working level.

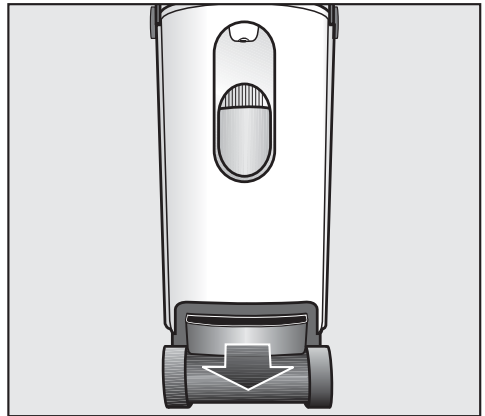

- Only remove the residual water container from the tower when prompted to do so by the message  Empty drawer in the display.

The residual water may still be warm after the rinsing process.

- Drain the residual water container.

As long as the residual water container is not inserted into the tower, the display will show the following message  Insert drawer.

- Cleaning and drying the residual water container.

Cleaning and care

The residual water container is dishwasher-safe or can be washed by hand using warm water and a little washing-up liquid.

Make sure the metal disks (contacts) at the top of the residual water container are clean and dry. These metal disks send a signal to the steam ironing system when the residual water container is full or if it is inserted into the tower.

The disks will not function correctly if they are dirty or damp.

- Slide the residual water container back into the tower until the container clicks into place.

Steam cannot be produced until the empty residual water container is replaced in the tower. Steam is only available again when the message  Ready appears in the display .

Descaling

The steam ironing system must be descaled regularly to ensure that it functions correctly. The appliance has an automatic descaling function to assist you.

The interval for descaling depends on the water hardness level set. Descaling is required more frequently with hard water than with soft water.

We recommend to use the Miele "FashionMaster descaling tablets". These have been specially developed for use with Miele appliances to optimize the descaling process. Other descaling agents, which contain other acids besides citric acid and/or other undesirable substances, such as chlorides for example, could damage the steam ironing system. Moreover, the descaling effect required could not be guaranteed.

You will need 1 descaling tablet for each descaling process.

Miele descaling tablets are available to order from Miele or the Miele website. (see "Optional accessories").

The ironer or steamer must not be connected during descaling. The appliance can be left unattended during descaling providing the iron or steamer is not connected.

Descaling warning

☞ Descal soon will appear in the display the next time you switch the steam ironing system on if there are only about 2 hours of ironing available before the system needs descaling.

You can start the descaling process whilst the system is cold via the Settings menu (see "Starting the descaling process early") or you can press the OK button to confirm the message in the display and continue ironing as normal. The ☞ symbol will continue to show in the display until descaling is carried out.

After the remaining operating hours have elapsed, the descaling process must be carried out before the steam ironing system can be used again.

The time to start the descaling process can be set individually at any time and started as required (see "Starting the descaling process early").

You can interrupt the descaling process by switching the steam ironing system off and pressing the ⏻ button. When you turn the system back on, descaling will start again from the point where the process was interrupted.

The messages in the display will guide you through the descaling process. The entire descaling process takes approx. 90 minutes.

Follow the required procedures when prompted by the messages in the display. After starting the descaling process, you must be present after approx. 20 minutes and subsequently after an additional 60 minutes. During the remaining time, the steam ironing system can be left unattended.

Tip: To optimize the descaling process, start the procedure while the system is still cold after switching on the steam ironing system on. This way, you avoid a delay of up to 3 hours that may be caused by the cool-down phase.

Cleaning and care



Starting the descaling process early



- If the steam ironing system is still switched on, press the  button on the control panel.

You are now in the setting menu. Use the arrow buttons to select the individual menu items.



- Use the arrow buttons  or  to select the **Descal** menu item.



- Confirm your selection by pressing the **OK** button.
- Select the following menu option **Start descaling**.
- Confirm your selection by pressing the **OK** button.

The descaling process starts now.

Descaling process

The following display messages will guide you through the entire descaling process. Only proceed with the required action if you are prompted to do so by the appropriate message in the display.

i Detach hose

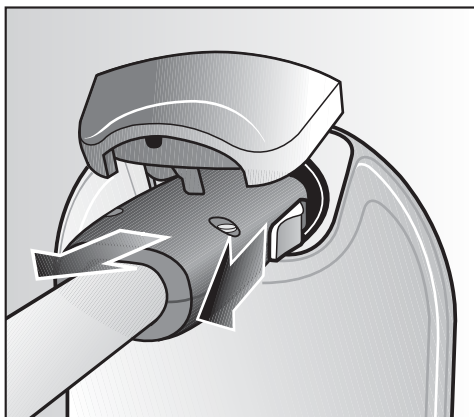

- Remove the steam hose of the iron or the steamer from the steam connection on the tower.

The iron or the steamer must not be attached to the steam connection during the entire descaling process.

Fill water container to the mark

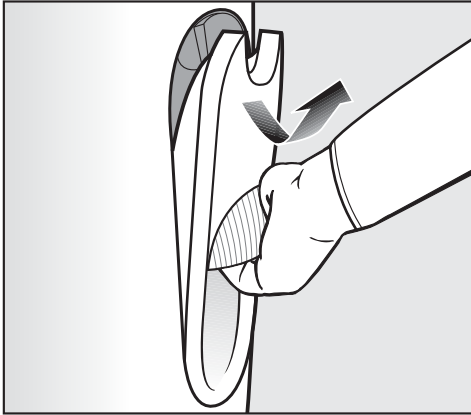

- Hold the water container by its handle.
- Pull the handle down.

The water container is released from the retainer.

- Pull the water container upwards and out.

You may notice some water dripping when removing the water container while the water container valves are closing.

Tip: The dripping can be prevented by removing the water container slowly.

After removing the water container, the following message **i** Add descaler will be shown in the display.

i Add descaler

- Turn the twist lock on the rear of the water container counterclockwise and remove the twist lock.

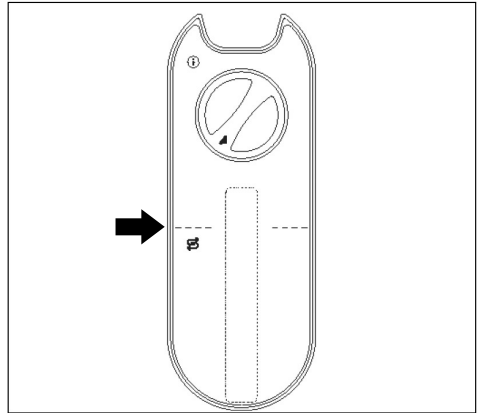

Level marking on the water container

- Use fresh tap water to fill the water container (water temperature approx. 15 to 35 °C) to the level marking line. It is important not to use more or less water to fill the water container.
- Add 1 descaling tablet to the water container.
- Replace the twist lock in the opening of the water container.
- Turn the twist lock clockwise until it stops.

The twist lock is now closed.

Cleaning and care



- Press the OK button to display the next process step.

The message  Insert water cont. is now shown in the display.

Insert water cont.

- Put the water container back into the tower.

After about 10 minutes (the time it takes for the descaling tablet to dissolve), the descaling process begins automatically. Messages in the display will tell you when to empty the residual water container or when to fill the water container.

If the water container becomes empty during descaling or if it is removed from the tower unprompted, the message  Insert or refill the water container will appear.

During the descaling process, water is pumped into the steam generator at various times and is drained back again into the residual water container. Some steam will escape and splashing noises can be heard during this process.

Empty drawer

This message may be displayed after inserting the water container with the descaling tablet. If you do not see this message, you can skip the following steps and continue as soon as you see the  Pre-rinse message in the display.

- Set the steam ironing system to its highest working position to remove the residual water container later (see "Height adjustment").

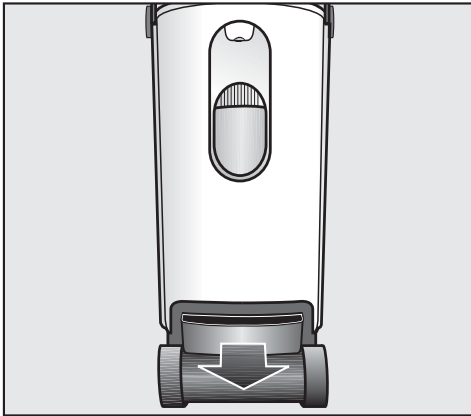

- Remove the residual water container from the tower.

The residual water may still be warm after the rinsing process.

- Drain the residual water container.

As long as the residual water container is not inserted into the tower, the display will show the following message

 Insert drawer.



Insert drawer

- Slide the residual water container back into the tower until the container clicks into place.

Pre-rinse

If the steam ironing system is still from the previous use, the cool down phase will start first. This may take up to 3 hours.

The pre-rinse phase then follows (duration approx. 20 minutes). During this time, a portion of the descaling solution is pumped into the steam generator.

After the pre-rinse phase you will be prompted to carry out further actions. This will be shown for a few seconds before the pre-rinse phase starts and will be indicated by the message  In 20 min. .

Cleaning and care

Rinse water container and fill to the mark

- Pull the residual water container out of the tower.

As long as the water container is not inserted into the tower, the display will show the following message  Insert water cont..

- Open the twist lock.
- Rinse the water container thoroughly. Make sure there are no residues of the descaling tablets remaining in the water container.
- Fill the water container with fresh water at least up to the level marking.
- Close the twist lock.
- Put the water container back into the tower.

Empty drawer

- Remove the residual water container from the tower.

The message  Insert drawer is shown in the display.

- Drain the residual water container.
- Slide the residual water container back into the tower until the container clicks into place.

Descale

After an activation period of approx. 1 hour, the descaling solution is drained from the steam generator into the residual water container.

The steam generator is then rinsed with water. This rinse cycle takes approx. 5 minutes. During this time, the  Rinsing (5 min) message is displayed.

During the rinse cycle the  Rinsing message is displayed.

As soon as the rinse cycle is completed, the water is drained completely into the residual water container and the message  Empty drawer is displayed.

Empty drawer

- Remove and empty the residual water container.

The message  Insert drawer is now shown in the display.

- Rinse the residual water container thoroughly.

The residual water container is dishwasher-safe or can be washed by hand using warm water and liquid dish soap.

- Dry the residual water container. Make sure that the metal contact disks (contacts) at the top of the residual water container are cleaned and dried properly.
- Slide the residual water container back into the tower until the container clicks into place.

The message  Descaling finished is shown in the display.

- Press the OK button.

The descaling process is now completed. You can attach the iron or the steamer back on to the steam connection on the tower.

Cleaning and care

Cleaning the housing

⚠ Before cleaning the casing, the power cord must be removed from the wall socket!

Depending on the level of soiling, use a dry or damp soft cloth to clean the housing.

Do not use abrasive agents.

Cleaning the soleplate of the iron

⚠ The soleplate of the iron remains hot after ironing.

Danger of injury by burning!

Remove the power plug from the wall socket and let the soleplate of the iron cool down before you start the cleaning process.

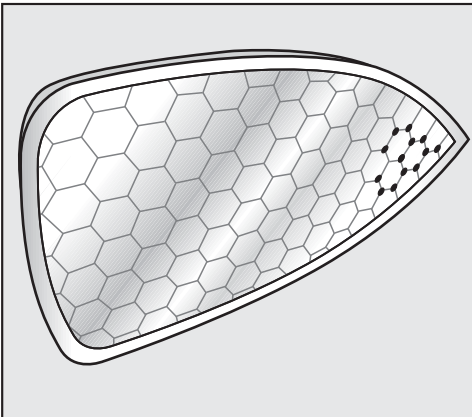

■ Depending on the level of soiling, use a dry or damp microfiber cloth to clean the iron soleplate.

Only use the microfiber cloth to clean the iron soleplate!

- To avoid damaging the surface of the soleplate, **do not use** the following cleaning agents:
 - abrasive cleaning agents, (e.g., powder cleaners and cream cleaners, chrome polish, eraser sponges).
 - hard, abrasive brushes or sponges, (e.g., pot scourers), or sponges which have been previously used and still contain abrasive cleaning agents.
 - pointed objects.

Cleaning or replacing the ironing board cover

If the ironing board cover is soiled, you can wash and dry it. If the ironing board cover is damaged, it must be replaced before using the steam ironing system again.

! When removing the ironing board cover, always ensure the steam ironing system is switched off and the power cord is removed from the wall socket.

Wait until the ironing board has cooled down.

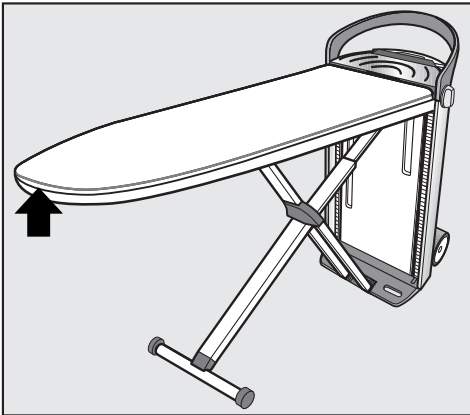

- Pull the fastener of the ironing board cover out of the cavity at the tapered end of the ironing board.
- Open the ironing board cover fastener. To do this, push the small grooved wheel at the center of the fastener outwards.
- Remove the cover in the direction of the tower.

The felt pad remains on the ironing board.

- Wash and dry the ironing board cover according to the care label or replace the cover if it is damaged.

Never use the steam ironing system without the ironing board cover in place!

- Put the dry or new cover onto the ironing board from the tower end first and draw it down toward the tapered end of the ironing board.
- Use the cord to pull the cover taut. Ensure the cover is secure.
- Close the fastener of the cover by pushing the small grooved wheel of the fastener to the middle.
- Push the fastener back into the cavity at the tip of the ironing board.

Cleaning and care

Cleaning the water filter

The water filter prevents foreign objects in the water from entering the steam ironing system and causing damage.

The water filter can be cleaned if it is dirty or clogged. You will notice if the water filter is dirty since this will cause more frequent pumping noises from the water feed pump.

Disconnect the power supply

- Unplug the appliance from the outlet before cleaning the water filter.

Removing the water container

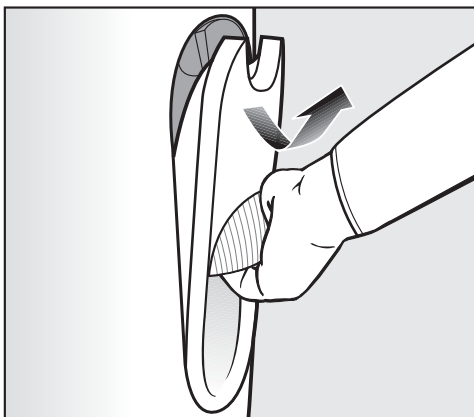

- Hold the water container by its handle.
- Pull the handle down.

The water container is released from the retainer.

- Pull the water container upwards and out.

Removing the water filter cover

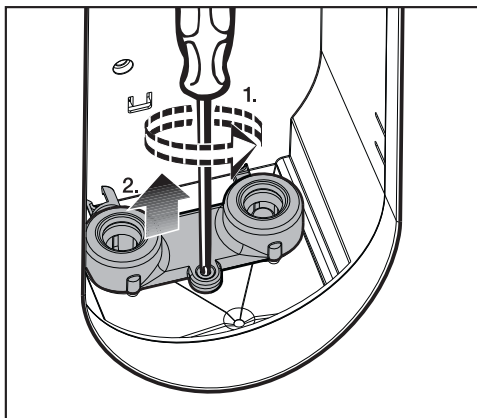

- Use a Phillips-head screwdriver to remove the screw of the water filter cover.
- Pull the water filter cover upwards.

The water filter must be taken out of the right hand socket for cleaning. There is a hook and a round tool at the sides of the water filter cover. Use these to remove the sealing ring from the socket and pull out the water filter.

Removing the sealing ring

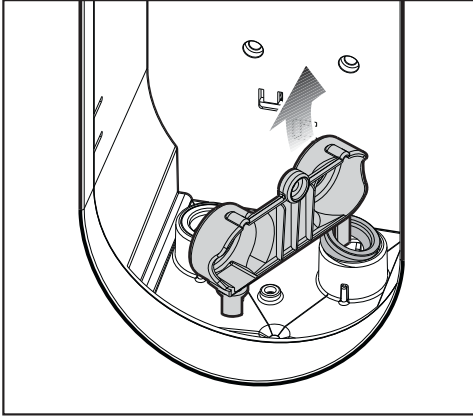

- Use the hook on the water filter cover to pull the sealing ring up and out of the right-hand socket.

Please note that the top of sealing ring looks different to the bottom of it. The top has a smooth surface all round and the bottom has a narrow ridge around it. After cleaning the water filter make sure that the seal is replaced with the ridge facing downwards.

Pull out water filter

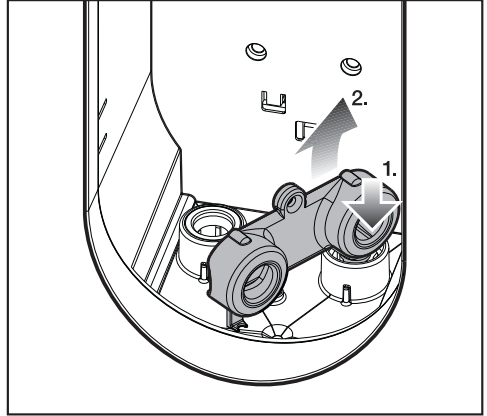

- Push the round tool on the water filter cover onto the water filter from above.

The round retainer tool will click into the water filter.

- Pull the water filter out of the socket.

Cleaning the water filter

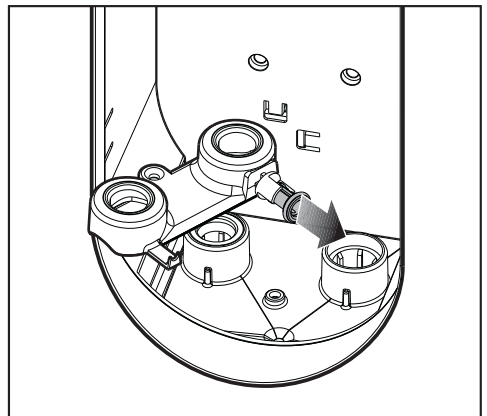

- Detach the water filter from the round retainer tool.
- Clean the water filter thoroughly under running water.

Cleaning and care

Inserting the water filter

- Position the water filter with the small seal facing downwards.
- Press the water filter fully into the right-hand socket.
- Then replace the seal in the right-hand socket. The side with the ridge must face downwards.

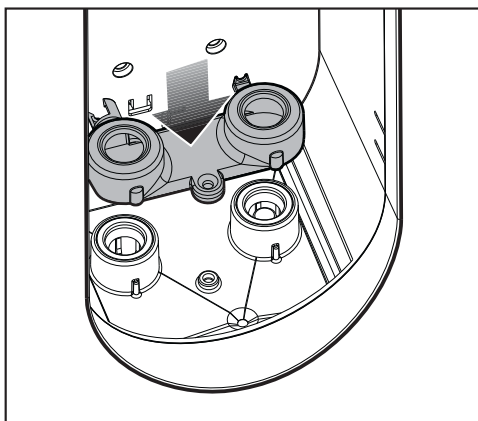

- Then replace the water filter cover over both sockets.

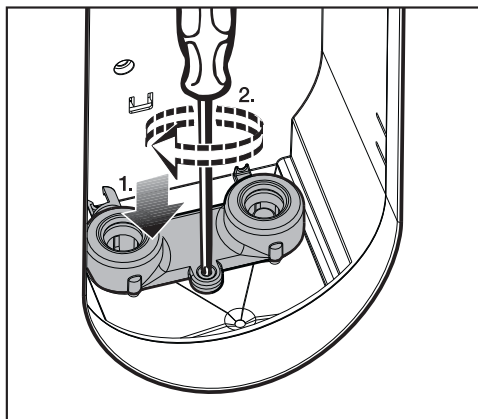

- Use a Phillips-head screwdriver to tighten the screw.

Inserting the water container

- Replace the water container in the retainer in the tower.

The steam ironing system is now ready for use again.

If the water filter is not inserted, the steam ironing system will not work. The water filter must be replaced if it is worn or damaged. Replacement filters are available from your Miele retailer or Miele Service.

Miele appliances are designed to achieve the best possible results and to provide uncompromising satisfaction for as long as possible. To achieve this, all factors must interact perfectly with one another. Therefore Miele offers a comprehensive range of accessories that harmonize with Miele appliances for optimum performance.

The following items are just a few examples from our broad range of products which is available to order from our Miele online store or Miele.

Accessories

Non-stick soleplate

With the non-stick soleplate you can iron appliqués, printed or flocked textiles etc. No need to turn the garment inside out. This soleplate also reduces or eliminates the formation of shiny patches on dark textiles.

The non-stick soleplate can be used with all Miele steam ironing system irons.

Ironing board cover

Miele ironing board covers are very durable and highly water-absorbent. The separate needle felt under the separate pad is steam-permeable and pleasantly cushioned.

The ironing board covers can be used for any Miele steam ironing system, regardless of model.

Basic ironing board cover

The standard ironing board cover is made of 100 % cotton, and can be washed if necessary at 105°F / 40 °C.

Color: Heather gray

Premium ironing board cover

The premium ironing board cover is very heat-resistant and durable. It consists of 100% cotton and can be washed at 104°F if required.

Color: Charcoal gray

Optional accessories

Steamer

The steamer makes ironing hanging textiles easier, e.g. dresses and jackets. It comes with a removable brush attachment for lifting the fibers.

The steamer can be used with any Miele steam ironing system, regardless of model.

Care products

The Miele care product range has been developed specially to clean your appliance thoroughly and gently.

Descaling tablets for the steam ironing system

Miele descaling tablets guarantee the best cleaning result when descaling your Miele steam ironing system.

One tablet is required for each descaling process.

Frequently asked questions

With the help of the following notes minor faults in the performance of the appliance, some of which may result from incorrect operation, can be put right without contacting Miele. Please note the following though:

 Repair work to electrical appliances must only be carried out by a suitably qualified person in strict accordance with current local and national safety codes. Repairs and other work by unqualified persons could be dangerous.

Some of the messages in the display are more than one line long. Touch the \vee or \wedge button to read them in full.

Frequently asked questions



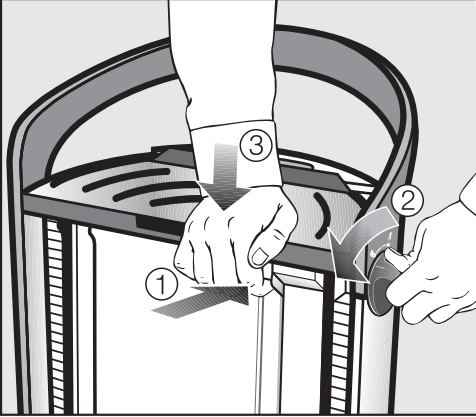

Problem solving guide

Problem	Possible cause and solution
The steam ironing system cannot be switched on.	<p>The appliance does not have any power.</p> <ul style="list-style-type: none">■ Check whether<ul style="list-style-type: none">– the plug is inserted into the wall socket.– the fuse in your fuse panel is OK.
After a power outage, the steam ironing system does not work anymore.	<p>The steam ironing system is switched off</p> <ul style="list-style-type: none">■ Use the Ⓜ button on the control panel to switch the steam ironing system on. <p>If a power outage occurred during the automatic rinse, the process will be repeated when the appliance is switched on again.</p> <p>If the power outage occurred during descaling, the process will be resumed from the stage at which it was interrupted when the appliance is switched on again.</p>
The height of the ironing board cannot be adjusted.	<p>The ironing board is not locked into place on both sides of the tower.</p> <ul style="list-style-type: none">■ Use both hands to pull the ironing board up and into the horizontal position until the locking mechanism audibly clicks into place on both sides of the tower (see "Assembly").
The steam ironing system cannot be dismantled.	<p>The appliance is not in its lowest working position.</p> <ul style="list-style-type: none">■ Adjust the appliance to its lowest working height (see "Dismantling").
	<p>The residual water container is not inserted completely and is not locked in place.</p> <ul style="list-style-type: none">■ Push the residual water container back into the tower until the container locks into place.■ Then adjust the steam ironing system to its lowest working height (see "Dismantling").

Frequently asked questions

Problem	Possible cause and solution
<p>The ironing board cannot be set in the final position during assembly or dismantling.</p>	<p>The ironing board became dislodged from the latching mechanism when the board was not in its lowest position.</p>  <p>⚠ The resting surface of the iron remains hot after ironing. Danger of injury by burning! Unplug the power cord from the outlet. Let the iron and the resting surface cool down before removing the iron from the resting surface and proceed with the following steps.</p> <ul style="list-style-type: none">■ Press and hold the release button on the tower (①).■ At the same time, turn one of the rotary dials on the side of the tower as far as it will go in the direction of ↺ and hold the dial in this position (②).■ Push the tower down as far as possible (③).■ Then let go of the rotary dial on the side and subsequently release the unlocking button on the tower. <p>Now the ironing board can either be folded away or brought into its working position.</p> <ul style="list-style-type: none">■ If the ironing board still will not lock into place, contact Miele service.





Frequently asked questions

Problem	Possible cause and solution
The iron does not heat up.	The appliance is switched off. ■ Use the  button on the control panel to switch the steam ironing system on.
	The steam hose is not plugged in properly. ■ Plug the steam hose into the steam connection on the tower again (see "Connection").
	The iron has not been used for some time. ■ Move the iron or activate the steam button  .
	The steam button  is locked. ■ Unlock the steam button by pushing the slider on the iron forward.
	The temperature set on the temperature controller has already been reached. ■ Set the temperature controller to a higher temperature, if necessary.
	The appliance is rinsing. ■ Wait until the rinsing process has been completed (see "Automatic rinsing").
	The display is indicating a malfunction. ■ Rectify the indicated malfunction and proceed as described in the following pages (see "Display messages").
	The steam ironing system is damaged. ■ Contact Miele Service.
The ironing board does not heat up.	Steam has not been used for a while. ■ Press the steam button  . This will activate the ironing board's heating system.
	The steamer is attached to the steam connection on the tower. ■ The ironing board does not heat up when the steamer is connected.
	The ironing board is not locked into place on both sides of the tower. ■ Ensure the ironing board locks into place on both sides of the tower (see "Assembly")
	The steam ironing system is damaged. ■ Contact Miele Service.







Frequently asked questions

Problem	Possible cause and solution
<p>The temperature of the iron is always high.</p>	<p>There is a fault.</p> <ul style="list-style-type: none"> ■ Contact Miele.
<p>The cover of the ironing board is damp.</p>	<p>There is a fault.</p> <ul style="list-style-type: none"> ■ Remove the ironing board cover and allow it to dry. ■ Put the dry ironing board cover back on (see "Cleaning or replacing the ironing board cover"). <p>If the ironing cover gets damp again, contact Miele Service.</p>
<p>Water is leaking from the steam ironing system at the height of the water container when it is being moved.</p>	<p>The frequent removal and replacement of the water container may cause water droplets to collect in the area under the water container.</p> <ul style="list-style-type: none"> ■ Use a cloth to dry the area underneath the water container.
<p>The fan on the ironing board is not running.</p>	<p>Steam was not used.</p> <ul style="list-style-type: none"> ■ The fan only runs when the steam function on the iron is activated. <p>The steam is not ready yet.</p> <ul style="list-style-type: none"> ■ Wait until the message  Ready is displayed to indicate that steam is ready. <p>The water container is empty or missing.</p> <ul style="list-style-type: none"> ■ Fill the water container with fresh tap water and insert it into the appliance. <p>The steamer is connected.</p> <ul style="list-style-type: none"> ■ The fan only runs when the iron is connected. Connect the iron. <p>There is a fault.</p> <ul style="list-style-type: none"> ■ Contact Miele Service.







Frequently asked questions

Problem	Possible cause and solution
<p>The steam function on the iron or the steamer is not working.</p>	<p>The steam ironing system is not connected to the wall socket.</p> <ul style="list-style-type: none"> ■ Insert the plug into the electrical socket. ■ Use the  button on the control panel to switch the steam ironing system on.
	<p>The iron or the steamer is not connected.</p> <ul style="list-style-type: none"> ■ Attach the steam hose of the iron or the steamer to the steam connection of the tower.
	<p>The water container is empty or missing.</p> <ul style="list-style-type: none"> ■ Fill the water container with fresh water. ■ Insert the water container into the tower. ■ Wait until the message  Ready is displayed.
	<p>The steam is not ready yet.</p> <ul style="list-style-type: none"> ■ Wait until the message  Ready is displayed.
	<p>The display is indicating a malfunction.</p> <ul style="list-style-type: none"> ■ Rectify the indicated malfunction and proceed as described in the following pages (see "Display messages"). <p>If there is still no steam, contact Miele service.</p>
	<p>When using the steam button  on the iron, drops of water or white deposits escape from the steam jets.</p>
<p>The iron has not yet reached the selected temperature.</p> <ul style="list-style-type: none"> ■ Wait until the selected ironing temperature has been reached (see "Selecting the ironing temperature"). 	
<p>During a longer ironing break, condensation has accumulated in the steam hose.</p> <ul style="list-style-type: none"> ■ After a break in ironing, do not direct the first burst of steam onto the garment. 	









Display messages

Problem	Possible cause and solution
<p>Message in the display:  Drain valve closing</p>	<p>When the steam ironing system was switched on, the steam generator drain was open. The drain is closed automatically during this message.</p>
<p>Message in the display:  Drain valve fault Switch Off/On</p>	<p>The descaling or rinsing processes have not been not carried out properly.</p> <ul style="list-style-type: none"> ■ Press the  button to switch the steam ironing system off and then back on again. ■ If the fault message continues to be displayed, contact Miele Service.
<p>Message in the display:  Memory fault Switch Off/On</p>	<p>There is a fault.</p> <ul style="list-style-type: none"> ■ Press the  button to switch the steam ironing system off and then back on again. <p>The steam ironing system must now be reset.</p> <ul style="list-style-type: none"> ■ Complete the steps required before using for the first time (see "Before using for the first time"). ■ If the fault message continues to be displayed, contact Miele Service.
<p>Message in the display:  Remove the plug</p>	<p>Electronic fault.</p> <ul style="list-style-type: none"> ■ Unplug the power cord from the outlet. ■ Wait a while and then insert the plug back in the socket and switch on. ■ Press the  button to switch the steam ironing system back on again. <p>The steam ironing system will attempt to correct the fault itself.</p> <ul style="list-style-type: none"> ■ If the fault message continues to be displayed, switch off at the wall socket and withdraw the plug. Contact Miele Service.

Frequently asked questions

Problem	Possible cause and solution
<p>Message in the display:  Intake fault, Boiler Switch Off/On</p>	<p>There is a fault.</p> <ul style="list-style-type: none"> ■ Press the  button to switch the steam ironing system off and then back on again. <p>After the cool-down phase, the appliance is carrying out an additional rinse function and is attempting to correct the fault itself. The cool-down phase may take up to 3 hours.</p> <ul style="list-style-type: none"> ■ Remove the residual water container if you are prompted to do so by the appropriate message in the display. ■ Empty and dry the residual water container. ■ Push the residual water container back in the tower until it clicks into place. <hr/> <p>There is a fault.</p> <ul style="list-style-type: none"> ■ If the fault message continues to be displayed, contact Miele Service.
<p>Message in the display:  Pressure switch fault. Switch Off/On</p>	<p>There is a fault.</p> <ul style="list-style-type: none"> ■ Press the  button to switch the steam ironing system off and then back on again. ■ If the fault continues to be displayed, contact Miele Service.
<p>Message in the display:  Boiler fault, warm Switch Off/On</p>	<p>There is a fault.</p> <ul style="list-style-type: none"> ■ Press the  button to switch the steam ironing system off and then back on again. ■ If the fault continues to be displayed, contact Miele Service. <hr/> <p>The steam generator is contaminated with water containing too much lime scale or salt.</p> <ul style="list-style-type: none"> ■ Start the descaling process (see "Starting the descaling process early"). To avoid this problem in the future, the preset water hardness level can be set one level higher, e.g., from Level 4 to Level 5 (see "Water hardness setting"). ■ If the fault continues to be displayed, contact Miele Service.

Frequently asked questions

Problem	Possible cause and solution
<p>Message in the display:  Boiler fault, cold Switch Off/On</p>	<p>There is a fault.</p> <ul style="list-style-type: none"> ■ Press the  button to switch the steam ironing system off and then back on again. ■ If the fault continues to be displayed, contact Miele Service.
<p>Message in the display:  Release stm. button</p>	<p>The iron has switched itself off because it has not been used for a period of time and the steam button  has locked.</p> <ul style="list-style-type: none"> ■ Unlock the steam button  by pushing the slider for continual steam on the iron forwards.
<p>Message in the display:  Drainage fault Switch Off/On</p>	<p>The residual water container has not been detected.</p> <ul style="list-style-type: none"> ■ Press the  button to switch the steam ironing system off and then back on again. <p>After switching the steam ironing system off and back on, the residual water container has not been detected.</p> <ul style="list-style-type: none"> ■ Press the  button to switch the appliance off. ■ Clean and dry the metal disks (contacts) on the residual water container. ■ Use the  button to switch the steam ironing system back on and follow the instructions shown in the display: ■ Remove the residual water container and fill it with fresh tap water. ■ Put the filled residual water container back in the tower. ■ Remove the residual water container again when you are prompted to do so and the appropriate messages are shown in the display. ■ Empty and dry the residual water container. ■ Put the empty residual water container back in the tower. <p>The steam ironing system is ready for use again and continues with the process that had been started when the fault was detected.</p> <p>There is a fault.</p> <ul style="list-style-type: none"> ■ If the fault message continues to be displayed, contact Miele Service.

Frequently asked questions

Problem	Possible cause and solution
Fault code: F38: ELP/EW/LNG F44 F45: LNG F47	There is an internal fault. ■ Press the Ⓛ button to switch the steam ironing system off and then back on again. The steam ironing system will try and rectify the fault itself. If the fault message continues to be displayed, contact Miele Service.

After sales service

In the event of a fault that you cannot correct yourself, please contact

- Your Miele dealer
- or
- Miele Technical Service

The telephone number for Miele is listed at the back of these instructions.

Technical service requires the **model** and **serial number** of your appliance. The information can be found on the data plate which is located on the tower behind the water container.

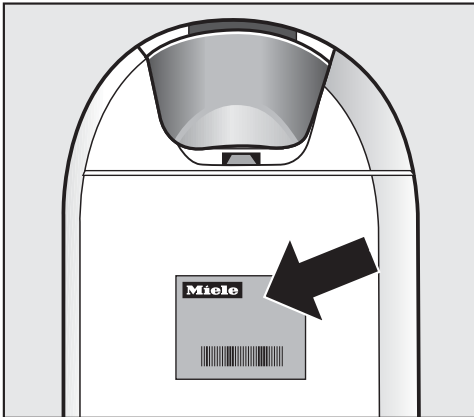

Warranty conditions

For more information please refer to the warranty conditions supplied.

Electrical connection

Verify that the voltage, load and circuit rating information found on the data plate match the household electrical supply. This data must match to prevent damage to the steam ironing system. If in doubt, consult a licensed electrician.

All electrical work should be performed by a qualified electrician in strict accordance with national and local safety regulations. Installation, repairs and other work by unqualified persons could be dangerous.

You will find the necessary connection data on the data plate, which is located in the tower behind the water container.

The socket should be next to the appliance and easily accessible.

The plug must be plugged into an outlet that is properly installed and grounded. If the power cord is defective, it must only be replaced by a qualified electrician.

Do not use a power bar or an extension cord to connect the steam ironing system to the power supply.

Extension cords or power bars do not guarantee the required safety of the appliance (e.g. danger of overheating).

Do not connect the steam ironing system to an off-grid inverter. These devices are used for autonomous power supply, e.g. a solar power system.

Power surges could trigger a safety shutdown. This could damage the electronic system.

Do not use the appliance with what is referred to as energy saving devices.

These reduce the energy supply to the appliance, which could generate excessive heat.

 **WARNING: THIS APPLIANCE MUST BE GROUNDED!**

If there is any question concerning the electrical connection of this appliance to your power supply, please consult a licensed electrician or contact Miele's Technical Service Department.

Technical data

Dismantled dimensions (H x W x D)	50 3/8" x 18 1/2" x 14 9/16" (1280 x 470 x 370 mm)
Assembled dimensions (H x W x D)	38 3/16" x 18 1/2" x 58 1/4" (970 x 470 x 1480 mm)
Weight	64 lb (29 kg)
Voltage	See data plate
Power consumption	See data plate
Fuse rating	≥ 10 A
Steam pressure for B 3312	50.76 psi (3.5 bar)
Steam pressure for B 3847	58.01 psi (4 bar)
Steam output	100 g/min
Capacity of water container	42 oz (1.25 l)
Length of power cord	98 7/16" (2.5 m)
Length of steam hose	70 7/8" (1.8 m)
Height of ironing board	32 11/16" - 40 3/16" (830 - 1020 mm)
Length of ironing board	47 1/4" (1200 mm)
Width of ironing board	15 3/4" (400 mm)
Test certificates awarded	See data plate





Please have the model and serial number
of your appliance available before
contacting Technical Service.

The Miele logo consists of the word "Miele" in a bold, white, serif font, set against a solid black rectangular background.

U.S.A.

Miele, Inc.

National Headquarters

9 Independence Way
Princeton, NJ 08540
Phone: 800-843-7231
Fax: 609-419-4298
www.mieleusa.com

Technical Service & Support

Nationwide

Phone: 800-999-1360
Fax: 888-586-8056
TechnicalService@mieleusa.com

International Headquarters

Miele & Cie. KG
Carl-Miele-Straße 29
33332 Gütersloh
Germany

Canada

Importer
Miele Limited

Headquarters and Miele Centre

161 Four Valley Drive
Vaughan, ON L4K 4V8
www.miele.ca

Customer Care Centre

Phone: 800-565-6435
905-532-2272
customercare@miele.ca

FashionMaster



en - US, CA

M.-Nr. 10 462 410 / 01