

ATX™ FNES LED Series Self-Contained Emergency Lighting

Zone 2 - 21 and 22. With Self-Test System

ATEX/IECEX:
Zone 2 - 21 and 22
II 2 D and II 3 GD
IP66/67 - IK10

Applications

- Provides adequate lighting and/or visual indication of access and exit routes during an evacuation in a hazardous environment.
- Can be installed in hazardous areas designated as Zone 2 – 21 and 22.
- Typical applications include oil refineries, petrochemical plants, pulp, paper mills and silos.

Features

- Power supply 230 Vac, 50/60 Hz.
- 1 hour duration (emergency).
- Non-maintained.
- Operates in any position.
- Battery pack.
 - Escape route lighting: 2.4 V - 1.5 Ah (2 cells - Nicd).
 - Space lighting: 7.2 V - 2.2 Ah (6 cells - NiMh) - Flameproof.
- Open and close using an Allen key (size 10) or a 6 mm flat screwdriver.
- Connection to plug-in terminal block via 2 x 5 x 2.5 mm² (0.003 x 0.008 x 0.004 in²) terminals.
- Two M20 clearance holes supplied with one cable gland – diameter 6.5 to 14.5 mm (0.26 to 0.57 in), one blanking plug and two locknuts.
- Charge indicator by green LED (lifetime over 10 years).
- Automatic built-in self-test system (SATI) with memorization of tests indicated by LEDs .
- Using a microprocessor and an internal clock, the unit will carry out automatic tests.
- Weekly test: Lamp check duration 6 seconds.
- Quarterly test: Emergency operation and lamp check for 1 hour.
- Can be remotely controlled and checked without switching the mains off with remote control unit from Legrand (Catalog Number 03901) or URA (Catalog Number 095448 and 095450) manufacturers.
- The remote control unit installed in a safe area or inside a flameproof box allows manual switching of all the units (max. 300 units) for visual inspection of their operation.
- Escape route lighting: 55 lumens, 0.50 wattage.
- Space lighting: 540 lumens, 0.95 wattage.

Standard Materials

- Body: fiberglass reinforced polyester
- Diffuser (hinged to body): polycarbonate
- Gasket: elastomer
- Fixing brackets: zinc plated steel, gray painted aluminum or 316 stainless steel
- Cable gland and blanking plug: polyamide
- Locknut: nickel-plated brass

Options

- Addressable versions:
 - Operates without additional control lines. Communication between units and the control system is realized via mains borne signals that utilize the existing electrical wiring.
 - Standard control system capacity: one control system for up to 200 emergency lighting units.



FNES LED

- Optional increased control system capacity: booster (repeater unit) is used to increase the length of the network allowing up to 1000 emergency lighting units to be on one control system. This allows for the use of a single computer to centralize the management of the facilities emergency lighting system. For more information, please contact your local sales representative.
- Addressable monitoring software is available, please consult your local sales representative.
- Low temperature application, please consult your local sales representative.

ATEX/IECEX Certifications and Compliances

- Certification Type: FLn
 - Gas: Zone 2
 - Conforming to ATEX 94/9/CE: Ⓢ II 3 G
 - Type of Protection 'nA': Type of Protection 'nA'
 - Type of Protection 'nR': Ex nR IIC T4 Gc
 - Temperature class: T6 (nA) or T4 (nR)
 - Ambient Temperature: -20 °C to +55 °C (-4°F to +131 °F) ①
 - Dust: Zone 21
 - Conforming to ATEX 94/9/CE: Ⓢ II 2 D
 - Type of Protection: Ex tD A21
 - Surface Temperature: T75 °C (T167 °F)
 - Ambient Temperature: -40 °C to +55 °C (-40 °F to +131 °F) ①
 - Dust: Zone 22
 - Conforming to ATEX 94/9/CE: Ⓢ II 3 D
 - Type of Protection: Ex t IIIC Dc
 - Surface Temperature: T75 °C (T167 °F)
 - Ambient Temperature: -20 °C to +55 °C (-4°F to +131 °F) ①
- CE Declaration of Conformity: 50212
- ATEX Certificate: LCIE 03 ATEX 6072 (Zone 2-22), LCIE 02 ATEX 6067 (Zone 21)
- IECEx Certificate: IECEx LCI 04.0021 (Zone 2-22)
- Index of Protection according EN/IEC 60529: IP66/67
- Impact Resistance (shock): IK10
- Conforming to NF AEAS

EURASEC Certification

- EURASEC N° TC RU C-FR.Г505.B.00912

Other Certification

- INMETRO Certificate: BVC11.0815 ②

Related Products

- For labels see *Labels for Emergency Lighting Units, ATX Self-Adhesive Signaling Labels for Emergency Lighting Units.*

① Optimum operating temperature for battery is -5 °C to +30 °C (+23 °F to +86 °F).

② Inmetro certification available on special request only. Contact your local sales representative for more information.

ATX™ FNES LED Series Self-Contained Emergency Lighting

Zone 2 - 21 and 22. With Self-Test System

ATEX/IECEX:
 Zone 2 - 21 and 22
 Ⓢ II 2 D and II 3 GD
 IP66/67 - IK10

Catalog Numbering Guide

FNES
 |
 Series:
 FNES - FNES Series
 Zone 2 and 22: ATEX/IECEX
 Certified
 Zone 21: ATEX Certified

LED
 |
 Lamp Type:
 LED

SL
 |
 SL - Space Lighting
 E - Escape Route Lighting

U
 |
 Cable Entry:
 A - Armored M20
 U - Unarmored M20
 N - Unarmored M25

A
 |
 Options:
 A - Addressable
 W - With Switch
 (Automatic mains cut-off)

Unswitched Version – 1 hour duration - Non-maintained - Two Unarmored M20 clearance entries

Type	Lamp Type	Lumen Output	Weight kg (lb)	Volume dm ³ (in ³)	Catalog Number
Space Lighting	LED Array	540 lm	7.2 (15.87)	32.3 (1971.1)	FNESLEDSLU
Escape Route Lighting	LED Array	55 lm	7.2 (15.87)	32.3 (1971.1)	FNESLEDEU

LED/ATEX/IECEX BULKHEAD





Appleton®

ATX™ FNES LED Series Self-Contained Emergency Lighting

Zone 2 - 21 and 22. With Self-Test System

ATEX/IECEX:
 Zone 2 - 21 and 22
 II 2 D and II 3 GD
 IP66/67 - IK10

Accessories

	Description	Catalog Number
	Half Clamps Brackets - Set of Two	
	Diameter for 1-1/4 to 1-1/2" pole: 42 mm (1.65 in) to 49 mm (1.93 in)	
	Zinc plated steel	FEHC49Z
	316 stainless steel	FEHC49S
	Diameter for 2" pole: 60 mm (2.36 in)	
	Zinc plated steel	FEHC60Z
	316 stainless steel	FEHC60S
	M8 Ring Bolts - Set of Two	
	Zinc plated steel	FERBM8Z
	Hinged Brackets - Set of two brackets for adjusting luminaire when wall-mounted	
	Aluminium (gray painted)	FEHBA
	316 stainless steel	FEHBS
	Brackets for Surface Mounting - Set of two	
	Aluminium (gray painted)	FESBA
	316 stainless steel	FESBS
	Fixing Brackets - Set of two brackets for ease of surface installation	
	Zinc plated steel	FEFBZ
	316 stainless steel	FEFBS

LED/ATEX/IECEX BULKHEAD

Appleton®

ATX™ FNES LED Series Self-Contained Emergency Lighting

Zone 2 - 21 and 22. With Self-Test System

ATEX/IECEX:
 Zone 2 - 21 and 22
 II 2 D and II 3 GD
 IP66/67 - IK10

Electrical Wiring Diagram

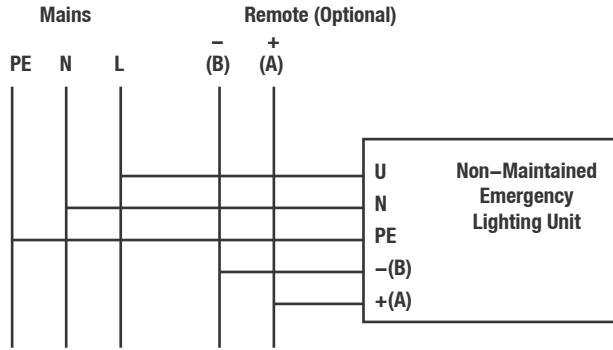

LED Indicator

Main Status	Non Maintained	
	Space Lighting	Escape Route Lighting
Switched On	☀ ● ● ● ● ● ● ☀	● ✕ ✕ ✕ ✕ ✕ ✕ ●
Switched Off	● ☀ ☀ ☀ ☀ ☀ ☀ ●	● ☀ ☀ ☀ ☀ ☀ ☀ ●

- OFF
- ☀ ON (high lighting power)
- ✕ ON (low lighting power)

Battery not Connected or Faulty	Main Power ON	
	Space or Escape Route Lighting	
SATI	⦿ ⦿ ● ● ● ● ● ● ⦿	
Addressable	⦿ ● ● ● ● ● ● ● ●	

- OFF
- ⦿ ON – Flashing – White LED
- ⦿ ON – Flashing – Amber LED

Dimensions in Millimeters (Inches)

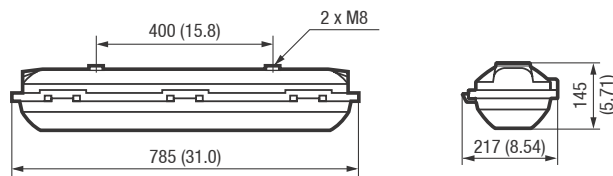

LED/ATEX/IECEX BULKHEAD

Appleton