

Nikon

Autofocus Speedlight

SB-910

User's Manual



Nikon Manual Viewer 2

Install the Nikon Manual Viewer 2 app on your smartphone or tablet to view Nikon digital camera manuals, anytime, anywhere. Nikon Manual Viewer 2 can be downloaded free of charge from the App Store and Google Play.

En

About the SB-910 and This User's Manual

A

Thank you for purchasing the Nikon Speedlight SB-910. To get the most out of your Speedlight, please read this user's manual thoroughly before use. Keep this manual handy for quick reference.

Preparation

How to find what you are looking for

 **Table of contents** (□A-11)

You can search by item, such as operation method, flash mode or function.

 **Q&A index** (□A-9)

You can search according to objective without knowing the specific name or term of an item.

 **Index** (□H-22)

You can search using the alphabetical index.

 **Troubleshooting** (□H-1)

This is handy when there is a problem with your Speedlight.

For your safety

Before using the Speedlight for the first time, read the safety instructions in "For Your Safety" (□A-14 – A-18).

Included items

Check that all items listed below are included with the SB-910. If any items are missing, inform the store where the SB-910 was purchased or the seller immediately.

- Speedlight Stand AS-21
- Nikon Diffusion Dome SW-13H
- Fluorescent Filter SZ-2FL
- Incandescent Filter SZ-2TN
- Soft Case SS-910
- User's manual (this manual)
- A collection of example photos
- Warranty card

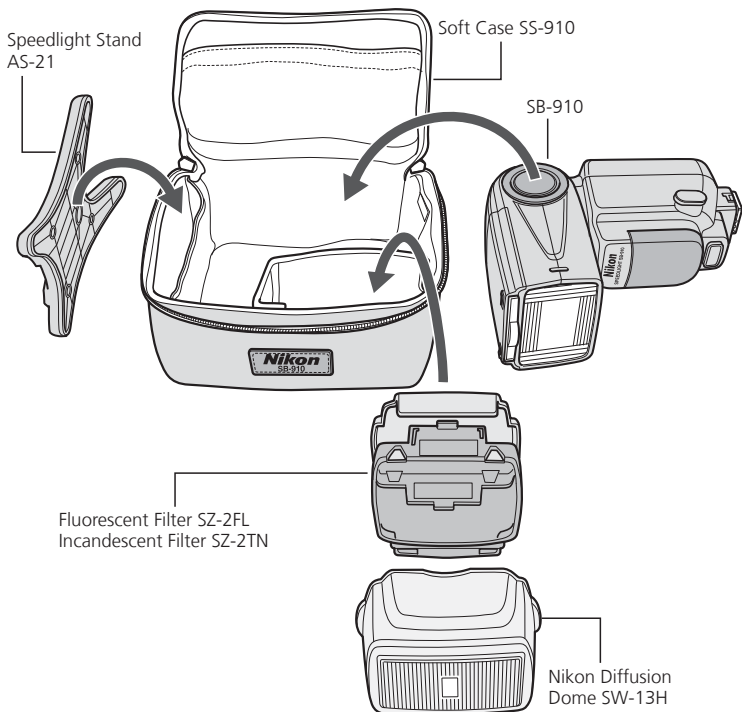

About the SB-910 and This User's Manual

A

Preparation

About the SB-910

The SB-910 is a high-performance Speedlight compatible with Nikon Creative Lighting System (CLS) with a guide number of 34/48 (ISO 100/200, m) (111.5/157.5, ft) (at the 35 mm zoom head position in Nikon FX format with standard illumination pattern, 20 °C/68 °F).

CLS-compatible cameras

Nikon digital SLR (Nikon FX/DX format) cameras (except D1 series, D100), F6, COOLPIX cameras (A, P7800, P7700, P7100, P7000, P6000)

About this user's manual

This manual has been compiled with the assumption that the SB-910 will be used in combination with a camera compatible with CLS and a CPU lens (□A-5). To get the most out of your Speedlight, please read this user's manual thoroughly before use.

- For use with non-CLS-compatible SLR cameras, see "For Use with Non-CLS-compatible SLR Cameras." (□F-1)
- For use with i-TTL-compatible COOLPIX cameras (P5100, P5000, E8800, E8700, E8400), see "For Use with COOLPIX Cameras." (□G-1)
- The separate "A collection of example photos" provides an overview of the SB-910's flash photography capabilities with example photos.
- For camera functions and settings, see the camera user's manual.

Icons used in this manual

- ✓ Describes a point to which you should pay particular attention in order to avoid Speedlight malfunctions or mistakes.
- ✍ Includes information or tips to make Speedlight use easier.
- 📖 Reference to other pages in this manual

Tips on identifying CPU NIKKOR lenses

CPU lenses have CPU contacts.

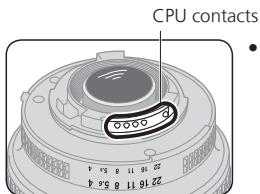

- The SB-910 cannot be used with IX-Nikkor lenses.

Terminology

■ **Default settings**

Function and mode settings at the time of purchase

■ **Nikon Creative Lighting System (CLS)**

A lighting system that enables various flash photography functions with improved communication between Nikon Speedlights and cameras

■ **Illumination patterns**

Control types of light falloff at edges; the SB-910 provides three illumination patterns, standard, even and center-weighted.

■ **FX format/DX format**

Nikon digital SLR camera image area types (FX format: 36 × 24, DX format: 24 × 16)

■ **Guide number (GN)**

The amount of light generated by a flash unit; GN = flash-to-subject distance (m or ft) × aperture f-number (ISO 100)

■ **Zoom head position**

Position of a Speedlight zoom head; the angle of coverage changes as the zoom head position changes.

■ **Effective flash output distance**

Flash-to-subject distance with correctly adjusted flash output

■ **Effective flash output distance range**

Range of effective flash output distance

■ **Flash compensation**

Intentional flash output change to obtain the desired subject brightness

■ i-TTL mode

Flash mode in which the Speedlight fires monitor pre-flashes and the camera measures the reflected light and controls the Speedlight flash output

Monitor pre-flashes

Scarcely visible flashes emitted before actual firing that enable the camera to measure the light reflected on a subject

i-TTL balanced fill-flash

i-TTL mode type in which flash output level is adjusted to well-balanced exposure of the main subject and background

Standard i-TTL

i-TTL mode type in which flash output level is adjusted to the correct exposure of the main subject regardless of background brightness

■ Auto aperture flash mode

Non-TTL auto flash mode with aperture priority; the Speedlight measures the reflected flash and controls the flash output according to the reflected flash data and the lens and camera information

■ Non-TTL auto flash mode

Auto flash mode without TTL; the Speedlight measures the reflected flash and controls the flash output according to the reflected flash data

■ Distance-priority manual flash mode

Manual flash mode with distance priority; the flash-to-subject distance is set and the Speedlight flash output level is adjusted in accordance with the camera settings.

■ Manual flash mode

Flash mode in which the flash output level and aperture are manually set to obtain the desired exposure

■ Repeating flash mode

Flash mode in which the Speedlight fires repeatedly during a single exposure to create stroboscopic multiple effects

About the SB-910 and This User's Manual

A

Preparation

■ Step

A unit of the shutter speed or aperture change; a change of one step halves/doubles the amount of light entering the camera

■ EV (Exposure Value)

Each increment of 1 in exposure value corresponds to a one-step change in exposure, which is made by halving/doubling shutter speed or aperture

■ Wireless multiple flash-unit photography

Flash photography with multiple wireless flash units simultaneously firing

Master flash unit

The flash unit that commands remote flash units in multiple flash-unit photography

Remote flash unit

A flash unit that fires following commands from the master flash unit

Advanced Wireless Lighting

Wireless multiple flash-unit photography with CLS; multiple remote flash unit groups can be controlled with the master flash unit.

SU-4 type wireless multiple flash-unit photography

Wireless multiple flash-unit photography suited to taking picture of a fast-moving subject; the master and remote flash units fire almost simultaneously because the master flash unit does not emit monitor pre-flashes.

Q&A Index

You can search for specific explanations according to objective.

Flash photography 1 (with SB-910 mounted on camera)

Question	Key phrase	□
Which flash mode can I take pictures with?	Flash modes	C-1
How can I take pictures in the simplest way?	Basic operation	B-6
How can I take formal group shots?	Illumination pattern: Even	E-2
How can I take portrait photos emphasizing the main subject?	Illumination pattern: Center-weighted	E-2
How can I take pictures with soft shadows cast on a wall?	Bounce flash operation	E-4
How can I confirm lighting conditions?	Modeling illumination	E-21
How can I take brighter (or darker) pictures of the subject?	Flash compensation	E-17
How can I take pictures under fluorescent light and incandescent light and balance the lights' color effects?	Color compensation filters	E-12
How can I take pictures adding specific color to the light of Speedlight?	Color filters	E-12
How can I use autofocus in dim lighting?	AF-assist illumination	E-19
How can I take pictures of both the subject and background at night?	Slow sync	E-25
How can I take pictures without the subject's eyes appearing red?	Red-eye reduction	E-25
How can I take pictures of a moving subject with stroboscopic multiple-exposure effects?	Repeating flash mode	C-18
How can I use the SB-910 with a non-CLS-compatible SLR camera?	Non-CLS-compatible SLR camera	F-1
How can I use the SB-910 with a COOLPIX camera?	COOLPIX camera	G-1

A**B****C****D****E****F****G****H**

Flash photography 2 (with wireless SB-910)

Question	Key phrase	📖
How do I take pictures using multiple flash units?	Advanced Wireless Lighting	D-1
How do I take pictures of a fast-moving subject using wireless multiple flash-unit photography?	SU-4 type wireless multiple flash-unit photography	D-12
How do I take pictures with the SB-910 and a COOLPIX camera compatible with wireless multiple flash-unit photography?	CLS-compatible COOLPIX camera	G-1

Settings and operations

Question	Key phrase	📖
What kind of batteries do I use in the Speedlight?	Compatible battery	B-7
How long is the recycling time and how many flashes are possible with each fresh set of batteries?	Min. number of flashes/ recycling time for each battery type	H-21
How can I change the settings of functions?	Custom settings	B-13
How can I reset various settings?	Two-button reset	B-12
How can I lock the dial and buttons of the Speedlight to prevent accidental use?	Key lock	B-4
How can I update the Speedlight firmware?	Firmware update	H-9

Table of Contents

A

Preparation

About the SB-910 and This User's Manual.....	A-2
Q&A Index.....	A-9
For Your Safety.....	A-14
Check before Use.....	A-19

B

Operation

Speedlight Parts.....	B-1
Function Buttons.....	B-5
Basic Operations.....	B-6
Settings and the LCD.....	B-12
Custom Functions and Settings.....	B-13

C

Flash Modes

i-TTL Mode.....	C-1
Auto Aperture Flash Mode.....	C-5
Non-TTL Auto Flash Mode.....	C-8
Distance-priority Manual Flash Mode.....	C-12
Manual Flash Mode.....	C-15
Repeating Flash Mode.....	C-18

D

Wireless Multiple Flash-unit Photography

SB-910 Wireless Multiple Flash-unit Photography Setup.....	D-1
SB-910 Wireless Multiple Flash-unit Functions.....	D-4
Setting the Master Flash Unit.....	D-6
Setting the Remote Flash Unit.....	D-7
Advanced Wireless Lighting.....	D-8
SU-4 Type Wireless Multiple Flash-unit Photography.....	D-12
Remote Flash Units.....	D-17
Checking Status in Wireless Multiple Flash-unit Photography.....	D-20

A

B

C

D

E

F

G

H

Table of Contents

E

Functions

Switching Illumination Patterns	E-2
Bounce Flash Operation	E-4
Taking Close-up Photographs.....	E-9
Flash Photography with Color Filters	E-12
Flash Photography Support Functions.....	E-17
• Flash compensation	E-17
• Power zoom function	E-18
• AF-assist illumination	E-19
• ISO sensitivity manual setting.....	E-21
• Test firing	E-21
• Modeling illumination.....	E-21
• Standby function	E-22
• Thermal cut-out.....	E-23
Functions to Be Set on the Camera	E-24
• Auto FP high-speed sync.....	E-24
• Flash value lock (FV lock)	E-25
• Slow sync	E-25
• Red-eye reduction/red-eye reduction slow sync	E-25
• Rear-curtain sync	E-26

F

For Use with Non-CLS-compatible SLR Cameras..... F-1

G

For Use with COOLPIX Cameras..... G-1

H**Tips on Speedlight Care and Reference Information**

Troubleshooting	H-1
Guide Number, Aperture and Flash-to-subject Distance	H-4
Tips on Speedlight Care	H-5
Notes on Batteries.....	H-7
About the LCD Panel	H-8
Updating Firmware	H-9
Optional Accessories	H-10
Specifications.....	H-13
Index	H-22

A**B****C****D****E****F****G****H**

For Your Safety

A

Preparation

Before using your product, please read the following safety precautions carefully and thoroughly to ensure correct and safe use and to help prevent damage to your Nikon product or injury to yourself or others.

For quick reference by those who use the product, please keep these safety instructions near the product.

In this manual, safety instructions are indicated with these symbols:

WARNING

Disregarding instructions marked with this symbol could result in personal injury, or death and property damage.

CAUTION

Disregarding instructions marked with this symbol could result in property damage.

WARNINGS for Speedlights

- 1. If corrosive liquids seep from the batteries and get in your eyes, immediately wash your eyes with running water and consult with a doctor.** Your eyes could be seriously damaged if they are not treated quickly.
- 2. If corrosive liquids seep from the batteries and come in contact with your skin or clothes, wash immediately with running water.** Prolonged contact could injure your skin.
- 3. Never attempt to disassemble or repair the flash unit by yourself,** as this could result in you receiving an electric shock and could also cause the unit to malfunction; such malfunction could lead to personal injury.
- 4. If the flash unit is dropped and damaged, do not touch any exposed interior metal parts.** Such parts, especially the Speedlight's capacitor and associated parts, could be in a high-charge state and if touched could cause an electric shock. Disconnect the power or remove the batteries and be sure that you do not touch any of the product's electrical components, and then bring the flash unit to your local Nikon dealer or authorized service center for repair.
- 5. If you detect heat, smoke or notice a burning smell, immediately stop operation and remove the batteries** to prevent the unit from catching on fire or melting. Allow the flash unit to cool down so that you can safely touch it and remove the batteries. Then bring the unit to your local Nikon dealer or authorized service center for repair.

- 6. The flash unit should never be submerged in liquid or exposed to rain, saltwater or moisture unless it is properly protected from the liquids and moisture. Underwater use requires a certified underwater housing.** If water or moisture gets inside the unit, this could cause the unit to catch on fire or cause an electric shock. In such instances you should immediately remove the batteries from the Speedlight and then bring the unit to your local Nikon dealer or authorized service center for repair.

Note: *electronic devices that are penetrated by water or moisture are often not economically repairable.*

- 7. Do not use the unit in the presence of flammable or explosive gas.** If the flash unit is operated in areas where there is a flammable gas, including propane, gasoline and dust, it could cause an explosion or fire.
- 8. Do not fire the flash unit directly at the driver of a moving car,** as this could temporarily impair the driver's vision and cause an accident.
- 9. Do not fire the flash unit directly into the eyes of someone that is at close range,** as it could damage the retinas of their eyes. Never fire the flash unit closer than 1 meter from infants.
- 10. Do not fire the unit while the flash head is touching a person or object.** Such use can result in the person being burned, and/or their clothes igniting from the heat of the flash's firing.
- 11. Keep small accessories out of the reach of children** to avoid the possibility of the accessory being swallowed. If an accessory is accidentally swallowed, immediately consult with a doctor.
- 12. Use only the batteries specified in this user's manual.** Batteries other than those specified could leak corrosive liquids, explode or catch on fire or otherwise not perform satisfactorily.
- 13. Do not mix battery types, brands or old and new batteries,** as the batteries could leak corrosive liquids, explode or catch on fire. When using more than one battery in a product, always use identical batteries that were purchased at the same time.
- 14. Non-rechargeable batteries such as manganese, alkaline and lithium batteries should never be charged in a battery charger** because they could leak corrosive liquids, explode or catch on fire.
- 15. When using standard size (AA, AAA, C, D) or other common rechargeable batteries such as Ni-MH batteries, or when recharging them, be sure to use only the battery charger specified by the battery maker and read the instructions thoroughly. Do not recharge these batteries with their terminals reversed in the charger or before the batteries have cooled off sufficiently** because they could leak corrosive liquids, explode or catch on fire. The same caution also applies to using the rechargeable batteries that may be supplied by the photo product's manufacturer.

For Your Safety

A

Preparation

CAUTIONS for Speedlights

1. **Do not touch the flash unit with wet hands**, as this could cause an electric shock.
2. **Keep the flash unit away from children to prevent them from putting the unit in or near their mouth, or otherwise touching a dangerous part of the product**; as such contact could cause an electric shock.
3. **Do not apply strong physical shocks to the unit**, as this could cause a malfunction that could cause the unit to explode or catch on fire.
4. **Never use active agents that contain flammable substances such as paint thinner, benzene or paint remover to clean the unit, never use insect deterrent spray on the unit, and never store the unit in locations containing chemicals such as camphor and naphthalene**, as this could damage the plastic case, cause a fire or cause an electric shock.
5. **Remove any batteries from the unit before storing the unit for a long time** to prevent the unit from catching on fire or leaking corrosive liquids.

WARNINGS for Batteries

1. **Never heat or throw batteries into a fire**, as this could cause the batteries to leak corrosive liquids, generate heat or explode.
2. **Do not short-circuit or disassemble the batteries** because this could cause the batteries to leak corrosive liquids, generate heat or explode.
3. **Do not mix battery types, brands or old and new batteries**, as this could cause the batteries to leak corrosive liquids, generate heat or explode.
4. **Do not install batteries in the reverse direction as this could cause the batteries to leak corrosive liquids, generate heat or explode. Even if only one battery is installed in reverse it will cause the Speedlight to malfunction.**
5. **Be sure to use the battery charger specified by the battery maker** to avoid the possibility of batteries leaking corrosive liquids, generating heat or exploding.
6. **Do not carry or store batteries along with metallic materials such as necklaces and hair pins** because such materials could cause the batteries to short-circuit, leading to battery leakage, heat generation or an explosion. **In addition, especially when carrying a quantity of batteries, place them carefully in a storage case that prevents the battery terminals from touching another battery's terminals** because if they touch in reverse order it could also cause the batteries to short-circuit, leading to battery leakage, heat generation or an explosion.

7. **If corrosive liquids seep from the batteries and get in your eyes, immediately wash your eyes with running water and consult with a doctor.** Your eyes could be seriously damaged if they are not treated quickly.
8. **If corrosive liquids seep from the batteries and come in contact with your skin or clothes, wash immediately with running water.** Prolonged contact could injure your skin.
9. **Always follow the warnings and instructions printed on the batteries** to avoid activities that could cause the batteries to leak corrosive liquids, generate heat or catch on fire.
10. **Be sure to use only batteries specified in this user's manual,** to avoid the possibility of batteries leaking corrosive liquids, generating heat or exploding.
11. **Never open the casing surrounding batteries or use batteries whose casing has been breached** as such batteries could leak corrosive liquids, generate heat or explode.
12. **Keep batteries out of the reach of children** to help avoid the possibility of them being swallowed. If a battery is accidentally swallowed, immediately consult with a doctor.
13. **Batteries should not be submerged in water, exposed to rain, moisture or saltwater unless they are properly protected from the wet environment.** If water or moisture gets inside the batteries, this could cause them to leak corrosive liquids or generate heat.
14. **Do not use any battery that appears abnormal in any way, including a change in color or shape.** Such batteries could leak corrosive liquids or generate heat.
15. **Stop recharging rechargeable batteries if you notice that recharging is not completed within the specified time** to help prevent the possibility of the battery leaking corrosive liquids or generating heat.
16. **When recycling or disposing of batteries, be sure to insulate their terminals with tape.** If the battery's positive and negative terminals short-circuit after coming into contact with metallic objects, it could cause fire, heat generation or an explosion. Dispose of used batteries in accordance with local government regulations.
17. **Non-rechargeable batteries should never be charged in a battery charger** because they could leak corrosive liquids or generate heat.
18. **Remove dead batteries from your equipment immediately,** as they could leak corrosive liquids, generate heat or explode.
19. **Be careful when replacing batteries after continuous flash use,** because batteries may generate heat during continuous flash photography.

For Your Safety

A

Preparation

CAUTION for Batteries

Do not throw or apply strong physical shocks to the batteries as this could cause batteries to leak corrosive liquids, generate heat or explode.

Notice for customers in Europe



This symbol indicates that electrical and electronic equipment is to be collected separately.

The following apply only to users in European countries:

- This product is designated for separate collection at an appropriate collection point. Do not dispose of as household waste.
- Separate collection and recycling helps conserve natural resources and prevent negative consequences for human health and the environment that might result from incorrect disposal.
- For more information, contact the retailer or the local authorities in charge of waste management.

Check before Use

Tips on using the Speedlight

Take trial shots

Take trial shots before photographing important occasions such as weddings or graduations.

Have Nikon spot-check your Speedlight regularly

Nikon recommends that you have your Speedlight serviced by an authorized dealer or service center at least once every two years.

Use your Speedlight with Nikon equipment

The Nikon Speedlight SB-910's performance has been optimized for use with Nikon brand cameras/accessories including lenses.

Cameras/accessories made by other manufacturers may not meet Nikon's criteria for specifications, and incompatible cameras/accessories could damage the SB-910's components. Nikon cannot guarantee the SB-910's performance when used with non-Nikon products.

Life-long learning

As part of Nikon's "life-long learning" commitment to ongoing product support and education, continually updated information is available online at the following websites:

- For users in the United States:
<http://www.nikonusa.com/>
- For users in Europe and Africa:
<http://www.europe-nikon.com/support/>
- For users in Asia, Oceania and the Middle East:
<http://www.nikon-asia.com/>

Visit these sites to keep up to date with the latest product information, tips, answers to frequently-asked questions (FAQs), and general advice on digital imaging and photography. Additional information may be available from the Nikon representative in your area. See the URL below for contact information:

<http://imaging.nikon.com/>

Speedlight Parts

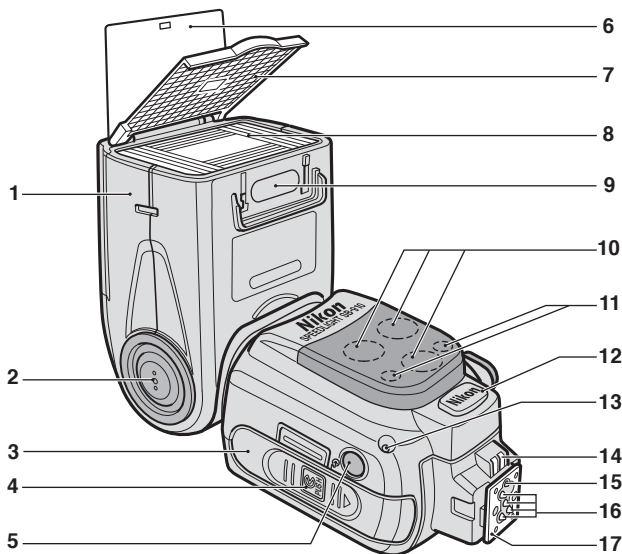

- | | |
|--|---|
| 1 Flash head | 10 AF-assist illuminator (☐E-19) |
| 2 Flash head tilting/rotating lock release button (☐B-9) | 11 Flash-ready indicator (in remote mode) (☐D-20) |
| 3 Battery chamber cover | 12 External power source terminal (supplied with cover) (☐H-11) |
| 4 Battery chamber cover lock release (☐B-6) | 13 Light sensor for non-TTL auto flash (☐C-5, C-8) |
| 5 Light sensor window for wireless remote flash (☐D-17) | 14 External AF-assist illuminator contacts |
| 6 Built-in bounce card (☐E-8) | 15 Locking pin |
| 7 Built-in wide panel (☐E-10) | 16 Accessory shoe contacts |
| 8 Flash panel | 17 Mounting foot |
| 9 Filter detector (☐E-14) | |

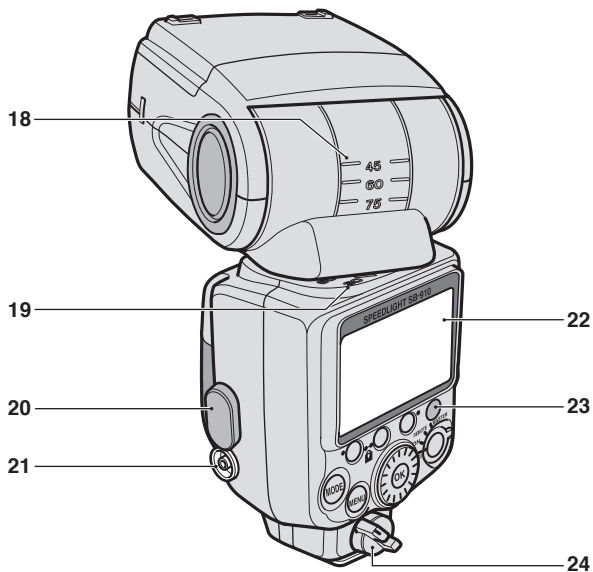

- 18 Flash head tilting angle scale
(□E-4)
- 19 Flash head rotating angle scale
(□E-4)
- 20 Sync terminal cover
- 21 Sync terminal
- 22 LCD panel (□B-12)
- 23 Flash-ready indicator
(□B-11, D-20)
- 24 Mounting foot lock lever (□B-8)

Speedlight Parts

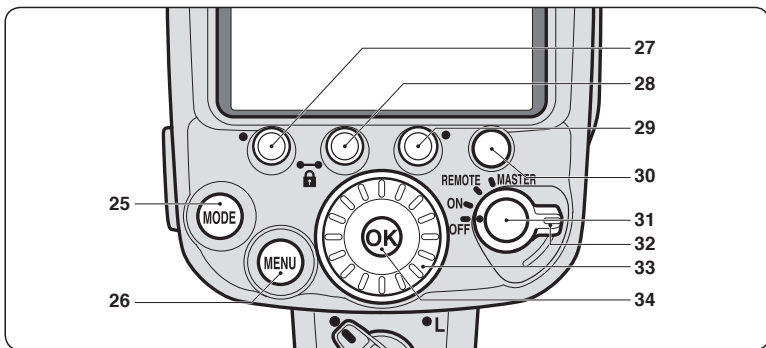

25 [MODE] button

Selects flash mode (□B-11)

26 [MENU] button

Displays custom settings (□B-13)

27 Function button 1

28 Function button 2

29 Function button 3

- Selects item to be configured
- The assigned function or setting for each button differs according to the flash mode and settings of the SB-910. (□B-5)

30 Test firing button

- Controls test firing (□E-21) and modeling illumination (□E-21)
- The button function, test firing and modeling illumination can be changed in the custom settings. (□B-17)

31 Lock release

To set wireless mode for multiple flash units, rotate the power switch/wireless mode switch for multiple flash units while holding down the lock release in the center of the switch. (□D-6, D-7)

32 Power switch/wireless mode switch for multiple flash units

- Rotate to turn power on and off.
- Selects the master or remote mode in wireless multiple flash-unit photography (□D-6, D-7)

33 Selector dial

Rotate to change selected item. The selected item is highlighted on the LCD. (□B-12)

34 [OK] button

Confirms selected setting (□B-12)

Activating key lock

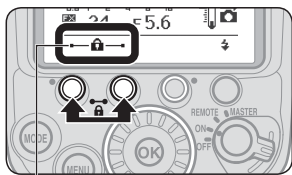

Key lock icon

Press function buttons 1 and 2, between which a lock icon is printed, simultaneously for 2 seconds. The key lock icon appears on the LCD and the dial and buttons are locked.

- The power switch/wireless mode switch for multiple flash units and the test firing button remain unlocked.
- To cancel key lock, press function buttons 1 and 2 again simultaneously for 2 seconds.

Function Buttons

The assigned function or setting for each button differs according to the flash mode and settings of the SB-910.

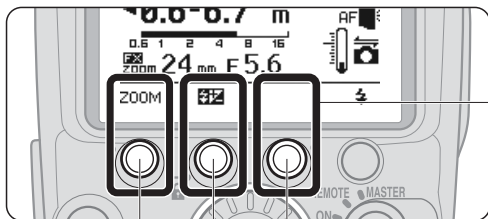

- The assigned function or setting for each button is indicated by an icon.
- When no function is assigned to a button, no icon appears above the button on the LCD.

Function button 1

Function button 2

Function button 3

Functions and settings icons

ZOOM	Zoom head position
	Flash compensation value
M	Flash output level in manual flash mode
	Amount of underexposure due to insufficient flash output in i-TTL mode
FNo	Aperture
m	Flash-to-subject distance (in distance-priority manual flash mode)
Times / Hz	Number and frequency of flash firings
SEL	Change setting items
	Illumination pattern
zoom	Activate power zoom function

[With wireless multiple flash-unit photography] (C-D-1)

CH	Channels
	Sound monitor

[In custom settings] (C-B-13)

	Go to previous page
	Go to next page
	Display My Menu or Full Menu
	Change My Menu items
	End changing My Menu items

Basic Operations

This section covers basic procedures in i-TTL mode in combination with a CLS-compatible camera.

✓ Notes on continuous flash photography

- To prevent the SB-910 from overheating, allow it to cool down for at least 10 minutes after 15 times of continuous firing.
- When continuous flash firing is repeated in quick succession, the internal safety function adjusts the recycling time by up to 15 seconds. If flash firing continues, the thermal cut-out indicator appears on the LCD and all operations except power ON/OFF and custom settings are suspended. (☐E-23) Allow it to cool down for several minutes to disable this function.
- The conditions under which the internal safety function is activated differ depending on the temperature and the SB-910 flash output level.
- For use with High-performance Battery Pack SD-9 (optional), see "Using High-performance Battery Pack SD-9." (☐H-11)

B

Operation

STEP 1 Inserting the batteries

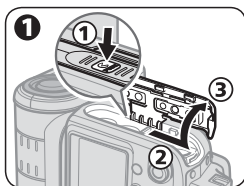

- 1** Slide the battery chamber cover open while pressing the battery chamber cover lock release.

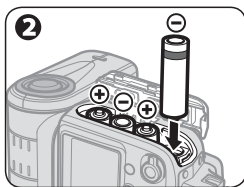

- 2** Insert the batteries following the [+] and [-] marks.

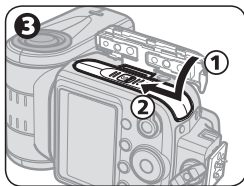

- 3** Close the battery chamber cover.

Compatible batteries and replacement/recharging

When replacing batteries, use four fresh AA-size batteries of the same brand. Refer to the following table to determine when to replace batteries with fresh ones or recharge batteries according to how long the flash-ready indicator takes to come on.

Battery type	Time the flash-ready indicator takes to come on
1.5 V LR6 (AA-size) alkaline battery	20 seconds or more
1.5 V FR6 (AA-size) lithium battery	10 seconds or more
1.2 V HR6 (AA-size) rechargeable Ni-MH battery	10 seconds or more

- For minimum recycling time and number of flashes for each battery type, refer to “Specifications.” (□H-21)
- Alkaline battery performance may vary greatly depending on the manufacturer.
- 1.5 V R6 (AA-size) carbon-zinc batteries are not recommended.
- Using an optional external power source increases the number of flashes and provides shorter recycling times. (□H-11)

Additional precautions regarding batteries

- Read and follow battery warnings and cautions (□A-14 – A-18).
- Be sure to read and follow the warnings for the battery on the section, “Notes on Batteries” (□H-7), before using the battery.
- The recycling time can be longer when FR6 (AA-size) lithium batteries are used because they incorporate a function that suppresses the output current when heat is generated in the batteries.

Low battery power indicator



When battery power is low, the icon shown at the left appears on the LCD and the SB-910 stops functioning. Replace or recharge batteries.

STEP 2 Attaching the SB-910 to the camera

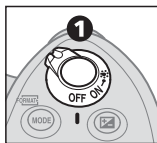

1 Make sure the SB-910 and the camera body are turned off.

2 Make sure the mounting foot lock lever is on the left (white dot).

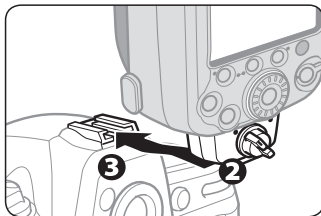

3 Slide the SB-910's mounting foot into the camera's accessory shoe.

4 Turn the lock lever to "L."

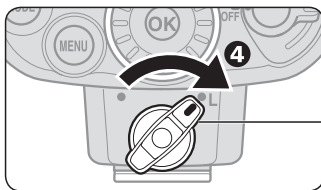

✓ Lock the Speedlight in place

Turn the lock lever clockwise until it stops at the mounting foot lock index.

Basic Operations

Detaching the SB-910 from the camera

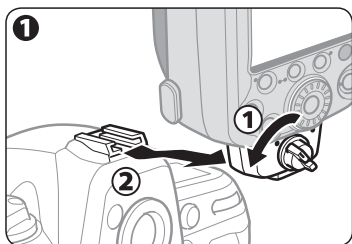

- 1 Make sure the SB-910 and the camera body are turned off, turn the lock lever 90° to the left, and then slide the SB-910's mounting foot from the camera's accessory shoe.

- If the SB-910's mounting foot cannot be removed from the camera's accessory shoe, turn the lock lever 90° to the left again, and slide the SB-910 slowly out.
- Do not forcibly remove the SB-910.

STEP 3 Adjusting the flash head

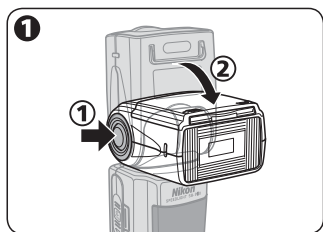

- 1 Adjust the flash head to the forward-facing position while holding down the flash head tilting/rotating lock release button.

- The flash head is locked when tilted 90° up or set in the forward-facing position.

LCD indicator for flash head status

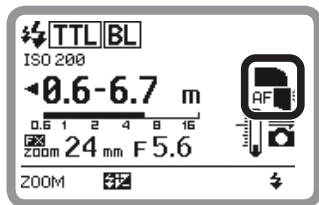

- Flash head is set in the forward-facing position.

- Flash head is set at angle. (Flash head is tilted up or rotated to the right or left.)

- Flash head is tilted down.

STEP 4 Turning the SB-910 and camera on

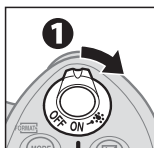
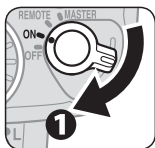

① Turn the SB-910 and the camera body on.

LCD example

- The image below is the SB-910 LCD example under the following conditions:
flash mode: i-TTL mode; image area: FX format; illumination pattern: standard;
ISO sensitivity: 200; zoom head position: 24 mm; aperture f-number: 5.6
- Icons on the LCD may differ depending on the SB-910 settings and the camera and lens in use.

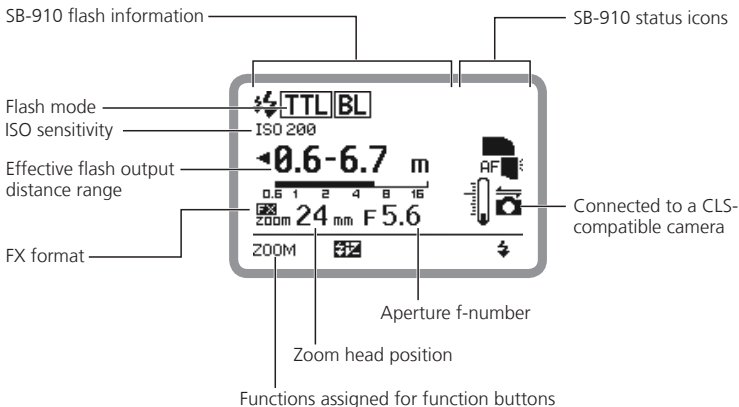

STEP 5 Selecting the flash mode

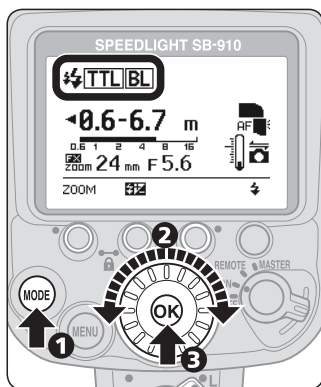

- ① Press the [MODE] button to highlight the flash mode.
- ② Rotate the selector dial to display **TTL|BL**.
- ③ Press the [OK] button.

Changing the flash mode

Rotate the selector dial clockwise to display icons of available flash mode on the LCD.



- Only available flash modes are displayed on the LCD.
- The flash mode can also be selected with the [MODE] button.

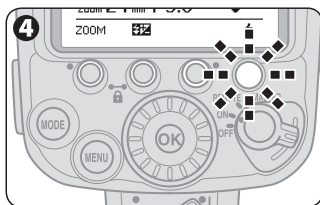

- ④ Make sure that the flash-ready indicator on the SB-910 or in the camera's viewfinder is on before taking a picture.

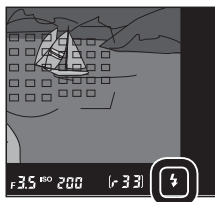

Settings and the LCD

Icons on the LCD show the status of settings. Displayed icons vary according to selected flash modes and settings.

- The basic control of SB-910 functions is as follows:

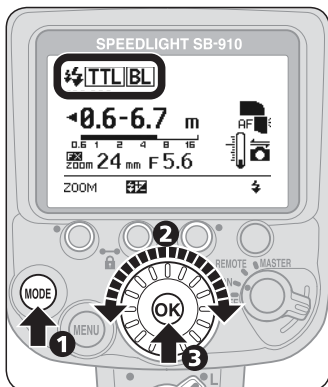

- 1 Press a button to highlight the selected item.
- 2 Change the setting by rotating the selector dial.
- 3 Press the [OK] button to confirm setting.

- Once confirmed, the highlighted item returns to normal display.
- If the [OK] button is not pressed, the highlighted item is confirmed and returns to normal display after 8 seconds.

Two-button reset



Press function buttons 1 and 3 (a green dot is printed by each button) simultaneously for 2 seconds to reset all settings except custom settings to default.

- When the reset completes, the LCD is highlighted and then returns to normal display.

Custom Functions and Settings

Various operations for the SB-910 can be easily set using the LCD.

- Displayed icons vary according to the combination of camera and status of the SB-910.
- Functions and settings indicated with grid boxes do not function even though they can be configured and set.

Custom settings

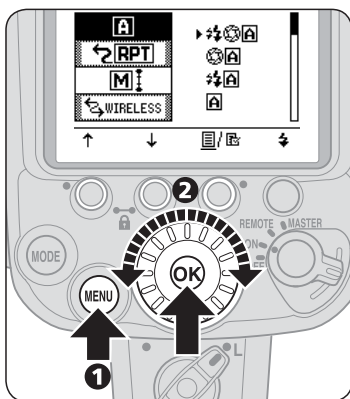

- 1 Press the [MENU] button to display the custom settings.
- 2 Rotate the selector dial to choose an item, and then press the [OK] button.
 - The highlighted item can be configured.

Item being configured

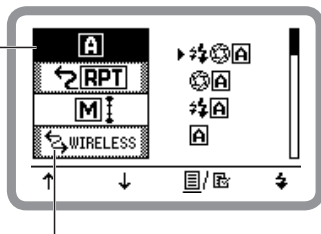

Items indicated with grid boxes can be configured but do not effect flash operation.

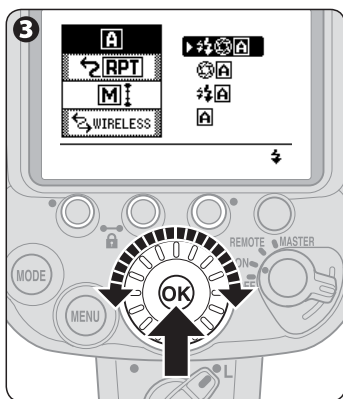

3 Rotate the selector dial to highlight the chosen setting, and then press the [OK] button.

- Highlighted while selected
- Press the [OK] button to return display to item selection.

4 Press the [MENU] button to return to normal display.

- The LCD returns to normal display.

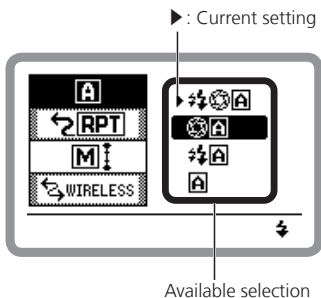

Custom Functions and Settings

Setting My Menu

When a custom settings page is displayed, only the custom settings items that are set as My Menu are displayed on the LCD.

- My Menu items can be changed any time.
- To display all items, select "FULL" in the My Menu setting in the custom settings.

B
Operation

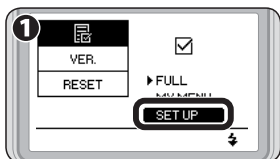

1 Select "SET UP" in My Menu setting in the custom settings, and press the [OK] button.

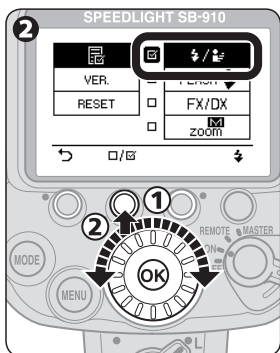

2 Select custom settings item to be set as My Menu with the selector dial, and press function button 2.

- The selected item will have a ticked check box ().
- No check box appears for an item that cannot be selected.
- To untick a check box, press function button 2 again.
- To return to My Menu setting without saving, press function button 1.

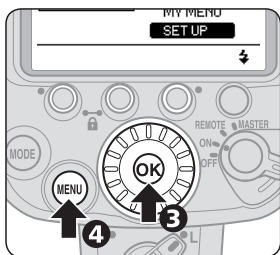

3 Repeat procedure **2** to set all desired items, and then press the [OK] button to return to My Menu setting.

4 Press the [MENU] button to close custom settings.

- The LCD returns to normal display.

Custom settings page display function and display mode

Page display function

Custom settings pages can be changed with function buttons 1 and 2.

- The number of pages displayed varies from one to five depending on the settings.
- The position of the displayed page is indicated in the bar.

Display mode



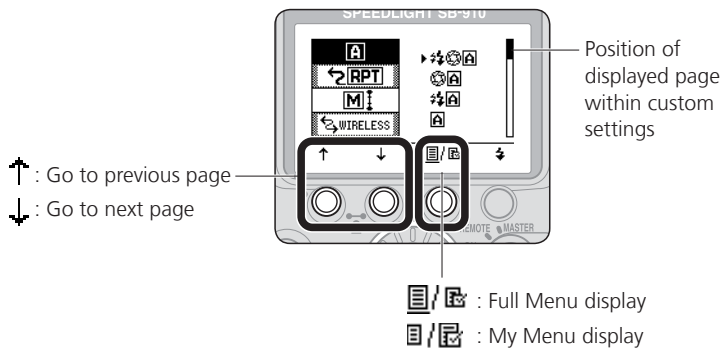





The custom settings display mode, My Menu or Full Menu, can be changed with function button 3.



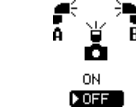

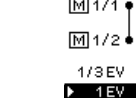
Custom Functions and Settings









Available custom functions and settings

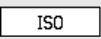
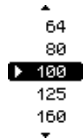
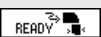

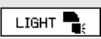
(**Bold:** default)

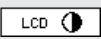
	Non-TTL auto flash mode option (☐C-5, C-8)
	Auto aperture flash with monitor pre-flashes Auto aperture flash without monitor pre-flashes Non-TTL auto flash with monitor pre-flashes Non-TTL auto flash without monitor pre-flashes
	Master flash unit repeating flash mode (☐D-10)
	ON: Repeating flash mode on OFF: Repeating flash mode off
	Flash compensation step in manual flash mode (☐C-17) Setting flash compensation step between M1/1 and M1/2 in manual flash mode
	1/3 EV: Compensation with 1/3 EV step 1 EV: Compensation with 1 EV step
	Wireless mode for multiple flash units (☐D-1)
	Advanced: Advanced Wireless Lighting SU-4: SU-4 type wireless multiple flash-unit photography
	Test firing button (☐E-21)
	FLASH: Test firing MODELING: Modeling illumination

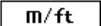
<div style="border: 1px solid black; padding: 2px; margin-bottom: 5px;">FLASH </div> <div style="border: 1px solid black; padding: 2px; margin-bottom: 5px;">▶ M1/128</div> <div style="border: 1px solid black; padding: 2px; margin-bottom: 5px;">M1/32</div> <div style="border: 1px solid black; padding: 2px; margin-bottom: 5px;">M1/1</div>	<p>Test firing flash output level in i-TTL mode (☞E-21)</p> <p>M1/128: Approx. 1/128 M1/32: Approx. 1/32 M1/1: Full</p>
<div style="border: 1px solid black; padding: 2px; margin-bottom: 5px;">FX/DX</div> <div style="border: 1px solid black; padding: 2px; margin-bottom: 5px; text-align: center;">M zoom</div> <div style="border: 1px solid black; padding: 2px; margin-bottom: 5px;">▶ FX ↔ DX</div> <div style="border: 1px solid black; padding: 2px; margin-bottom: 5px;">FX</div> <div style="border: 1px solid black; padding: 2px; margin-bottom: 5px;">DX</div>	<p>FX/DX format selection (☞A-6)</p> <p>When the zoom head position is manually set, image area settings can be selected.</p> <p>FX↔DX: Automatically set according to the camera's image area FX: Nikon FX format (36 × 24) DX: Nikon DX format (24 × 16)</p>
<div style="border: 1px solid black; padding: 2px; margin-bottom: 5px; text-align: center;">M zoom</div> <div style="border: 1px solid black; padding: 2px; margin-bottom: 5px; text-align: center;">zoom</div> <div style="border: 1px solid black; padding: 2px; margin-bottom: 5px; text-align: center;">ON</div> <div style="border: 1px solid black; padding: 2px; margin-bottom: 5px;">▶ OFF</div>	<p>Canceling power zoom function (☞E-19)</p> <p>Activating or canceling power zoom function</p> <p>ON: Power zoom function canceled OFF: Power zoom function activated</p>
<div style="border: 1px solid black; padding: 2px; margin-bottom: 5px;">AF </div> <div style="border: 1px solid black; padding: 2px; margin-bottom: 5px; text-align: center;">AF</div> <div style="border: 1px solid black; padding: 2px; margin-bottom: 5px;">▶ ON</div> <div style="border: 1px solid black; padding: 2px; margin-bottom: 5px;">OFF</div> <div style="border: 1px solid black; padding: 2px; margin-bottom: 5px;">AF ONLY</div>	<p>AF-assist illumination/canceling flash function (☞E-20)</p> <p>Activating or canceling AF-assist illumination and flash function</p> <p>ON: Both AF-assist illumination and flash function activated OFF: AF-assist illumination canceled, flash function activated AF ONLY: AF-assist illumination activated, flash function canceled (only AF-assist illuminator lights up)</p>
<div style="border: 1px solid black; padding: 2px; margin-bottom: 5px;">STBY </div> <div style="border: 1px solid black; padding: 2px; margin-bottom: 5px;">▶ AUTO</div> <div style="border: 1px solid black; padding: 2px; margin-bottom: 5px; text-align: center;">40</div> <div style="border: 1px solid black; padding: 2px; margin-bottom: 5px; text-align: center;">80</div> <div style="border: 1px solid black; padding: 2px; margin-bottom: 5px; text-align: center;">160</div> <div style="border: 1px solid black; padding: 2px; margin-bottom: 5px; text-align: center;">300</div> <div style="border: 1px solid black; padding: 2px; margin-bottom: 5px; text-align: center;">---</div>	<p>Standby function (☞E-22)</p> <p>Adjusting the time before the standby function is activated.</p> <p>AUTO: Standby function activated when the camera's exposure meter is turned off 40: 40 seconds 80: 80 seconds 160: 160 seconds 300: 300 seconds ---: Standby function canceled</p>

Custom Functions and Settings

	ISO sensitivity manual setting (☞E-21) Setting ISO sensitivity within the range of between 3 and 8000.
	100: ISO 100
	Flash-ready indicator in remote mode (☞D-20) Selecting which flash-ready indicator to blink/light up in remote mode to save power
	REAR, FRONT: Back indicator lights up, front indicator blinks in remote mode REAR: Only back indicator lights up FRONT: Only front indicator blinks in remote mode
	LCD panel illumination (☞H-8) Activating or canceling LCD panel illumination
	ON: Activated OFF: Canceled
	LCD panel contrast (☞H-8) Contrast levels are displayed on the LCD in a nine-step graph.
	5 levels in 9 steps
	Measurement unit (m/ft)
	m: meters ft: feet

	<p>Zoom head position manual setting with broken built-in wide panel (□E-11)</p> <p>Selecting whether the zoom head position can be manually set or not when the built-in wide panel is broken.</p>
<p>zoom $14\frac{1}{2}$mm</p> <p>ON ▶ OFF</p>	<p>ON: Zoom head position can be manually set</p> <p>OFF: Zoom head position cannot be manually set</p>
	<p>My Menu setting (□B-15)</p> <p>Selecting custom settings display mode</p>
<p>▶ FULL MY MENU SET UP</p>	<p>FULL: All items displayed</p> <p>MY MENU: Items set as My Menu displayed</p> <p>SET UP: Select items to be set as My Menu</p>
<p>VER.</p>	<p>Version of firmware (□H-9)</p>
<p>7.XXX</p>	
<p>RESET</p>	<p>Reset custom settings</p> <p>Reset custom settings to default except measurement unit (m/ft) and My Menu settings.</p>
<p>YES NO</p>	<p>YES: Reset to default</p> <p>NO: Do not reset</p>

i-TTL Mode

Information obtained by monitor pre-flashes and exposure control information is integrated by the camera to automatically adjust flash output levels.

- To take pictures using the SB-910 set in i-TTL mode, see “Basic Operations” (□B-6).
- Either the i-TTL balanced fill-flash mode or the standard i-TTL mode option is available.

i-TTL balanced fill-flash

The flash output level is automatically adjusted for well-balanced exposure of the main subject and background. **TTL|BL** appears on the LCD.

Standard i-TTL

The main subject is correctly exposed regardless of background brightness. This is useful when you want to highlight the main subject. **TTL** appears on the LCD.

Camera's metering mode and i-TTL mode

- When the camera's metering mode is changed to spot metering while i-TTL balanced fill-flash is in use, the i-TTL mode automatically changes to the standard i-TTL mode.
- The i-TTL mode automatically changes to i-TTL balanced fill-flash, after changing the camera's metering mode to matrix or center-weighted.

Setting i-TTL mode

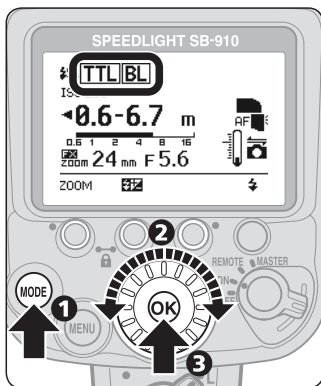

- ❶ Press the [MODE] button.
- ❷ Rotate the selector dial to display **TTL|BL** or **TTL**.
- ❸ Press the [OK] button

i-TTL mode LCD example

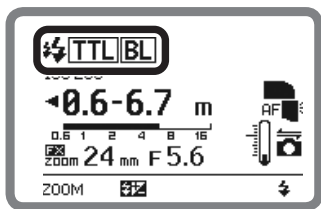

-  : Monitor pre-flashes
- TTL** : i-TTL
- BL** : Balanced fill-flash

i-TTL Mode

Effective flash output distance range in i-TTL mode

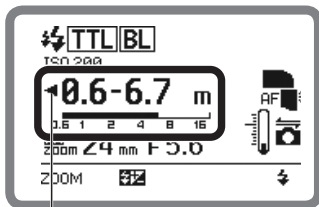

This icon means that the flash output cannot be effectively adjusted for a shorter distance.

The effective flash output distance range is indicated by numbers and a bar chart on the LCD.

- The actual flash-to-subject distance should be within the range displayed.
- The range varies depending on the camera's image area setting, illumination pattern, ISO sensitivity, zoom head position and aperture. For more information, see "Specifications." (C-15)

Auto setting of ISO sensitivity, aperture and focal length

When using the SB-910 with a CLS-compatible camera and a CPU lens, ISO sensitivity, aperture and focal length are automatically set according to the lens and camera information.

- For more information about ISO sensitivity range, see the camera user's manual.

✓ When insufficient flash output for correct exposure is indicated

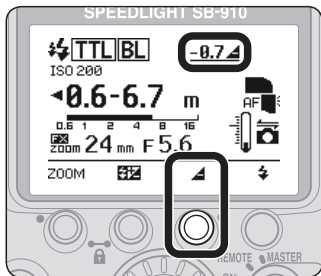
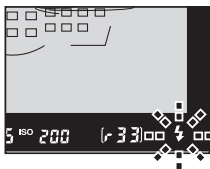
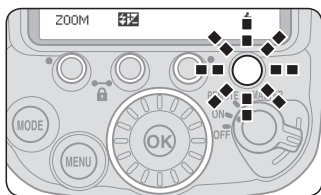

- When the flash-ready indicators on the SB-910 and in the camera's viewfinder blink for approx. 3 seconds after a picture is taken, underexposure due to insufficient flash output may have occurred. To compensate, use a wider aperture or higher ISO sensitivity, or move the flash unit closer to the subject and reshoot.
- Amount of underexposure due to insufficient flash output is indicated by the exposure value (-0.3 EV to -3.0 EV) on the SB-910's LCD panel for approx. 3 seconds.
- Press function button 3 to redisplay exposure value.

Auto Aperture Flash Mode

The SB-910's light sensor for non-TTL auto flash measures the flash that is reflected on the subject, and the SB-910 controls the flash output level according to the lens and camera information transmitted to the SB-910, including ISO sensitivity, exposure compensation value, aperture and lens focal length.

Setting auto aperture flash mode

Auto aperture flash mode is non-TTL auto flash mode with aperture priority. It can be set as a non-TTL auto flash mode option in the custom settings. (C-B-17)

- Auto aperture flash with monitor pre-flashes is the default setting of the non-TTL auto flash mode option.
- When no aperture information is transmitted to the SB-910, the flash mode is automatically set to non-TTL auto flash.

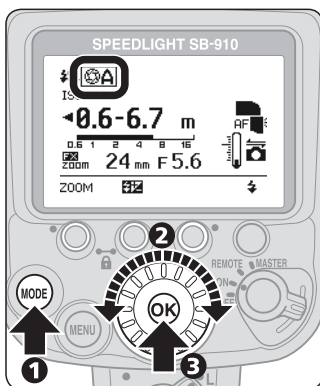

- 1 Press the [MODE] button.
- 2 Rotate the selector dial to display .
- 3 Press the [OK] button.

Auto aperture flash mode LCD example

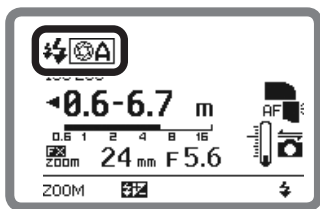

-  : Monitor pre-flashes
 : Auto aperture flash

Monitor pre-flashes

- Monitor pre-flashes can be activated or canceled as a non-TTL auto flash mode option in the custom settings. (□B-17)
- Flash output is controlled more accurately with monitor pre-flashes. The SB-910 emits monitor pre-flashes before actual firing to obtain reflected flash data.
- Monitor pre-flashes should be activated when auto FP high-speed sync (□E-24) or FV lock (□E-25) is used.

Effective flash output distance range in auto aperture flash mode

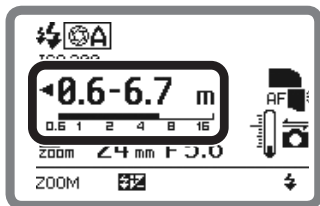

The effective flash output distance range is indicated by numbers and a bar chart on the LCD.

- The actual flash-to-subject distance should be within the range displayed.
- The range varies depending on the camera's image area setting, illumination pattern, ISO sensitivity, zoom head position and aperture. For more information, see "Specifications." (□H-15)

Auto Aperture Flash Mode

Taking a picture in auto aperture flash mode

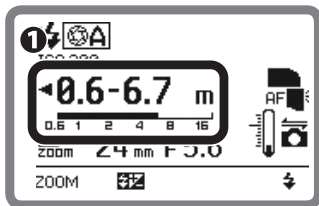

- 1 Make sure the actual flash-to-subject distance is within the effective flash output distance range.
- 2 Confirm the flash-ready indicator is on, and then shoot.

When insufficient flash output for correct exposure is indicated

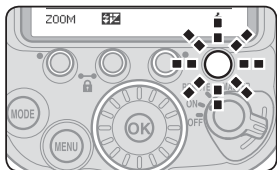

When the flash-ready indicators on the SB-910 and in the camera's viewfinder blink for approx. 3 seconds after a picture is taken, underexposure due to insufficient flash output may have occurred. To compensate, use a wider aperture or higher ISO sensitivity, or move the flash unit closer to the subject and reshoot.

Checking exposure before taking a picture



Test fire the Speedlight under the same conditions and with the same Speedlight and camera settings before taking the actual picture.

- When the flash-ready indicators blink after test firing, underexposure due to insufficient flash output may have occurred.

Non-TTL Auto Flash Mode

The SB-910's light sensor for non-TTL auto flash measures the flash that is reflected on the subject, and the SB-910 controls the flash output level according to the reflected flash data.

Setting non-TTL auto flash mode

Non-TTL auto flash mode can be set as a non-TTL auto flash mode option in the custom settings. (C-17)

- The default setting of the non-TTL auto flash mode option is auto aperture flash (non-TTL auto flash with aperture priority) with monitor pre-flashes.

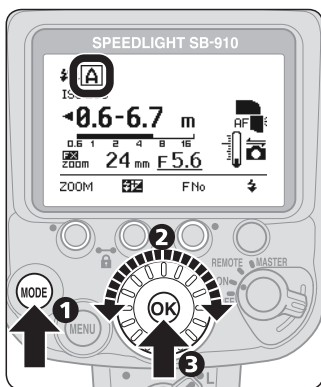

- 1 Press the [MODE] button.
- 2 Rotate the selector dial to display [A].
- 3 Press the [OK] button.

Non-TTL auto flash mode LCD example

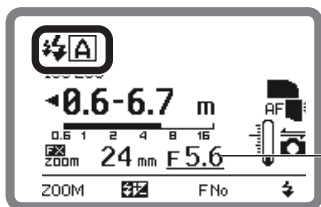

- ⚡ : Monitor pre-flashes
- [A] : Non-TTL auto flash

Aperture; underlined when aperture is set on the SB-910

Non-TTL Auto Flash Mode

Monitor pre-flashes

- Monitor pre-flashes can be activated or canceled as a non-TTL auto flash mode option in the custom settings. (□B-17)
- Flash output is controlled more accurately with monitor pre-flashes. The SB-910 emits monitor pre-flashes before actual firing to obtain reflected flash data.
- Monitor pre-flashes should be activated when auto FP high-speed sync (□E-24) or FV lock (□E-25) is used.

Effective flash output distance range in non-TTL auto flash mode

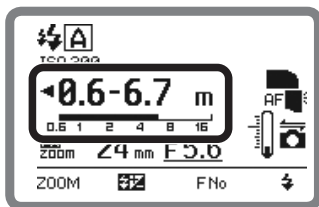

The effective flash output distance range is indicated by numbers and a bar chart on the LCD.

- The actual flash-to-subject distance should be within the range displayed.
- The range varies depending on the camera's image area setting, illumination pattern, ISO sensitivity, zoom head position and aperture. For more information, see "Specifications." (□H-15)

Taking a picture in non-TTL auto flash mode

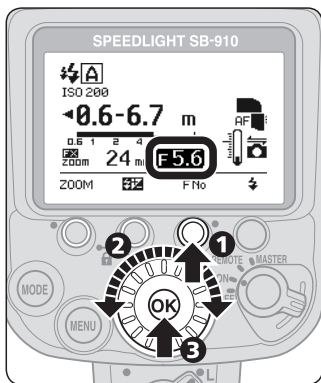

- ❶ Press function button 3 to highlight the aperture.
- ❷ Rotate the selector dial to set aperture. Note that the effective flash output distance range varies depending on aperture.
 - Aperture can be changed with function button 3.
 - Correct exposure can be obtained when the actual flash-to-subject distance is within the effective flash output distance.
- ❸ Press the [OK] button.
- ❹ Set the same aperture in the lens or camera as the Speedlight.
- ❺ Confirm the flash-ready indicator is on, and then shoot.

✓ When insufficient flash output for correct exposure is indicated

When the flash-ready indicators on the SB-910 and in the camera's viewfinder blink for approx. 3 seconds after a picture is taken, underexposure due to insufficient flash output may have occurred. To compensate, use a wider aperture or higher ISO sensitivity, or move the flash unit closer to the subject and reshoot.

Non-TTL Auto Flash Mode

Checking exposure before taking a picture

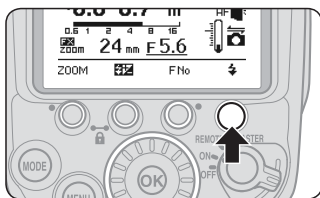

Test fire the Speedlight under the same conditions and with the same Speedlight and camera settings before taking the actual picture.

- When the flash-ready indicators blink after test firing, underexposure due to insufficient flash output may have occurred.

Distance-priority Manual Flash Mode

In this flash mode, when the flash-to-subject distance value is entered, the SB-910 automatically controls flash output level according to the camera settings.

Setting distance-priority manual flash mode

Distance-priority manual flash is not possible when the SB-910's flash head is tilted up or rotated to the right or left.

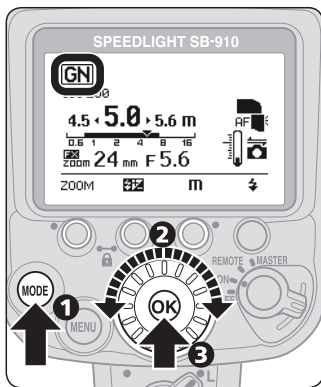

- 1 Press the [MODE] button.
- 2 Rotate the selector dial to display GN.
- 3 Press the [OK] button.

Distance-priority manual flash mode LCD example (at flash-to-subject distance of 5 m)

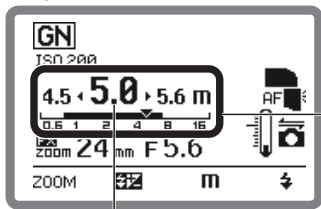

Flash-to-subject distance
(numerical indicator)

Flash-to-subject distance (▼) and effective flash output distance range indicator (bar)
When the flash-to-subject distance appears on the effective flash output distance range indicator, the SB-910 fires with appropriate flash output.

Distance-priority Manual Flash Mode

■ Taking a picture in distance-priority manual flash mode

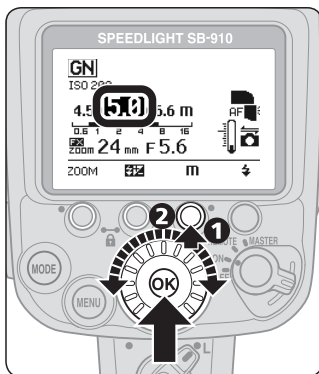

- 1 Press function button 3 to highlight flash-to-subject distance.
- 2 Set the flash-to-subject distance with the selector dial, and then press the [OK] button.
 - The flash-to-subject distance can be set with function button 3 as well.
 - The flash-to-subject distance varies depending on ISO sensitivity within a range of between 0.3 m and 20 m.
- 3 Confirm the flash-ready indicator is on, and then shoot.

Flash-to-subject distance range in distance-priority manual flash mode

- Flash-to-subject distance range of between 0.3 m and 20 m
- If the desired flash-to-subject distance is not displayed, select a shorter flash-to-subject distance. E.g., if the flash-to-subject distance is 2.7 m, select 2.5 m.

✓ When insufficient flash output for correct exposure is indicated

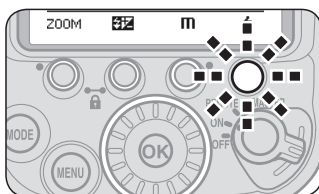

When the flash-ready indicators on the SB-910 and in the camera's viewfinder blink for approx. 3 seconds after a picture is taken, underexposure due to insufficient flash output may have occurred. To compensate, use a wider aperture or higher ISO sensitivity and reshoot.

When the SB-910's flash head is tilted or rotated while in distance-priority manual flash mode

- When the Speedlight is used in distance-priority manual flash mode and the flash head is tilted up or rotated to the right or left, the flash mode will automatically change to auto aperture flash mode or non-TTL auto flash mode.
- In this case, the flash mode automatically returns to distance-priority manual flash mode when the flash head is adjusted to the forward-facing position or tilted down.

Manual Flash Mode

In manual flash mode, aperture and flash output level are manually selected. This allows for control of exposure and flash-to-subject distance.

- The flash output level can be set from M1/1 (full output) to M1/128 to suit creative preferences.
- Underexposure due to insufficient flash output is not indicated in manual flash mode.

Setting manual flash mode

- 1 Press the [MODE] button.
- 2 Rotate the selector dial to display **M**.
- 3 Press the [OK] button.

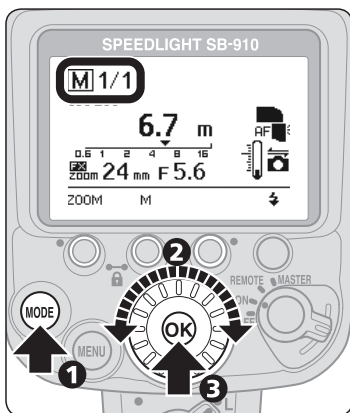

Manual flash mode LCD example

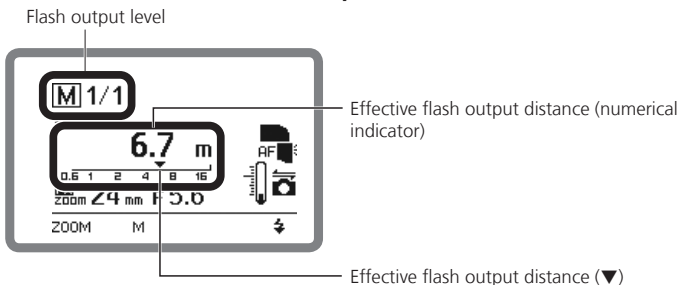

Taking a picture in manual flash mode



- 1 Press function button 2 to highlight the flash output level.
- 2 Set the flash output level by rotating the selector dial, and then press the [OK] button.
 - Flash output level can be set with function button 2 as well.
 - Make the flash-to-subject distance equal to the effective flash output distance indicated.
- 3 Confirm the flash-ready indicator is on, and then shoot.

When no lens aperture information is transmitted

When lens aperture information is not transmitted to the SB-910, aperture can be set with function button 3.

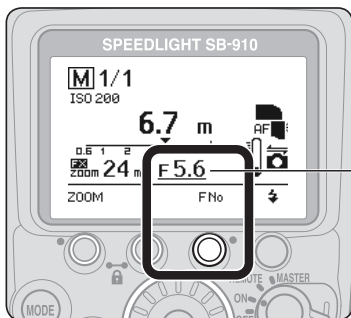

Aperture; underlined when aperture is set on the SB-910

Manual Flash Mode

■ Setting the flash output level

Highlight the flash output level, and then rotate the selector dial to change the flash output level.

Selector dial rotated
counterclockwise

Selector dial rotated
clockwise

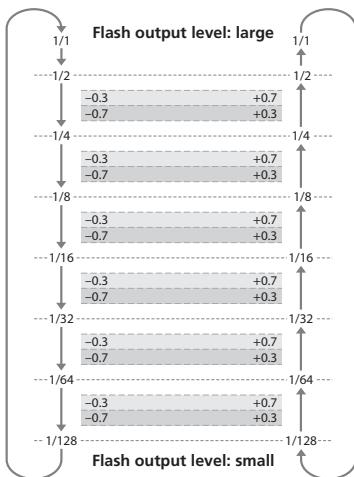

- When the selector dial is rotated counterclockwise, the indicated denominator increases (flash output level decreases). When the selector dial is rotated clockwise, the indicated denominator decreases (flash output level increases).
- The flash output level changes in $\pm 1/3$ EV steps except between 1/1 and 1/2. 1/32 -0.3 and 1/64 $+0.7$ represent the same flash output level.
- In default setting, the flash compensation step between 1/1 and 1/2 is ± 1 EV step. This step can be changed to $\pm 1/3$ EV steps in the custom settings (□B-17). With some cameras, and when using higher shutter speeds with a flash output level higher than M1/2, actual flash output may decrease to M1/2 level.

Repeating Flash Mode

In repeating flash mode, the SB-910 fires repeatedly during a single exposure, creating stroboscopic multiple-exposure effects.

- Be sure to use fresh or fully charged batteries and allow enough time for the flash unit to recycle between each repeating flash session.
- Because of the lower shutter speeds, use of a tripod is recommended to prevent camera/flash unit shake.
- Insufficient flash output for correct exposure is not indicated in repeating flash mode.

Setting repeating flash mode

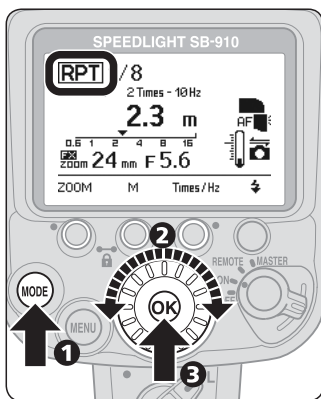

- 1 Press the [MODE] button.
- 2 Rotate the selector dial to display [RPT].
- 3 Press the [OK] button.

Repeating flash mode LCD example

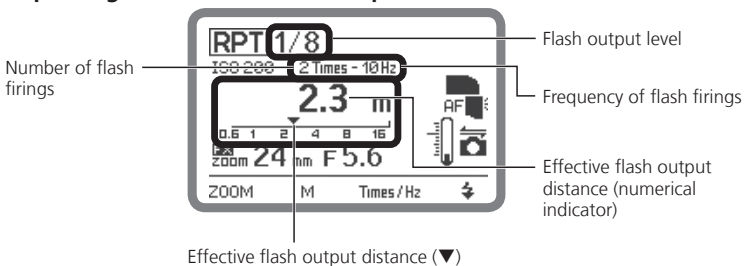

Repeating Flash Mode

Setting flash output level, number and frequency of flash firings

- The number of flash firings is the number of times the flash fires per frame.
- The frequency of flash firings is the number of times the flash fires per second.
- The number of flash firings is the maximum number of times the Speedlight fires when the camera's shutter is open. This number cannot be achieved with a high shutter speed and low flash firing frequency.
- The maximum number of flash firings differs depending on flash output level and flash firing frequency. See the table below for the maximum number of flash firings.

Maximum number of flash firings

Frequency	Flash output level												
	M1/8	M1/8 -1/3EV	M1/8 -2/3EV	M1/16	M1/16 -1/3EV	M1/16 -2/3EV	M1/32	M1/32 -1/3EV	M1/32 -2/3EV	M1/64	M1/64 -1/3EV	M1/64 -2/3EV	M1/128
1 Hz	14	16	22	30	36	46	60	68	78	90	90	90	90
2 Hz	12	14	18	30	36	46	60	68	78	90	90	90	90
3 Hz	10	12	14	20	24	30	50	56	64	80	80	80	80
4 Hz	8	10	12	20	24	30	40	44	52	70	70	70	70
5 Hz	6	7	10	20	24	30	32	36	40	56	56	56	56
6 Hz	6	7	10	20	24	26	28	32	36	44	44	44	44
7 Hz	5	6	8	10	12	14	24	26	30	36	36	36	36
8 Hz	5	6	8	10	12	14	22	24	28	32	32	32	32
9 Hz	4	5	6	8	9	10	20	22	26	28	28	28	28
10 Hz													
20 Hz													
30 Hz													
40 Hz													
50 Hz													
60 Hz	4	5	6	8	9	10	12	14	18	24	24	24	24
70 Hz													
80 Hz													
90 Hz													
100 Hz													

Taking a picture in repeating flash mode



1 Press function button 2 to highlight the flash output level.

2 Rotate the selector dial to choose the flash output level, and then press the [OK] button.

- Flash output level can be changed with function button 2.
- Flash output level can be set between M1/8 and M1/128.

3 Press function button 3 to highlight the number of flash firings, rotate the selector dial to choose the number, and then press the [OK] button.

4 Press function button 3 to highlight the frequency of flash firings, rotate the selector dial to choose the frequency, and then press the [OK] button.

5 Determine the guide number according to the flash output level and the zoom head position.

- For more information, see "Specifications." (□H-18)

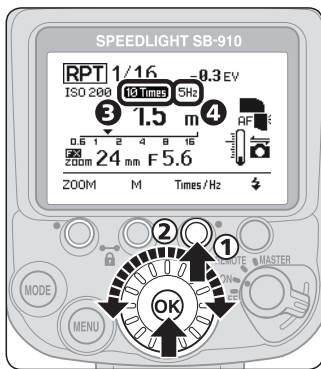

Repeating Flash Mode

Camera's LCD

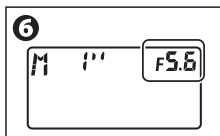

Camera's LCD

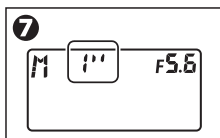

⑥ Calculate the aperture f-number from the flash-to-subject distance and the guide number, and set the camera's aperture accordingly.

- To determine the f-number, see "Guide Number, Aperture and Flash-to-subject Distance." (□H-4)
- Aperture cannot be set with the SB-910.
- The effective flash output distance that matches the flash output level and aperture is displayed.

⑦ Set the camera shutter speed.

- Determine the shutter speed with the equation below, and set a lower camera shutter speed than the calculated shutter speed.

$$\text{Shutter speed} = \frac{\text{number of flash firings}}{\text{frequency of flash firings}}$$

- If the number of flash firings is 10 (times) and the frequency of flash firings is 5 (Hz), set the shutter speed for longer than 2 seconds.
- Bulb can be also set.

⑧ Confirm the flash-ready indicator is on, and then shoot.

✎ Checking flash operation before taking a picture

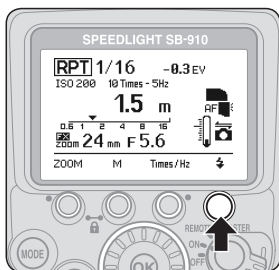

Test fire the Speedlight under the same conditions and with the same Speedlight and camera settings before taking the actual picture.

✓ Exposure compensation in repeating flash mode

- Overexposure occurs in repeating flash mode when the actual flash-to-subject distance is equal to the effective flash output distance determined using the f-number in the procedure ⑥. This is because the correct exposure is achieved with a single flash firing.
- To prevent overexposure, choose a larger f-number on the camera.

SB-910 Wireless Multiple Flash-unit Photography Setup

With the SB-910, Advanced Wireless Lighting and SU-4 type wireless multiple flash-unit photography are possible. The SB-910's default wireless mode for multiple flash units is Advanced Wireless Lighting.

- Advanced Wireless Lighting is recommended for standard multiple flash-unit photography.
- The wireless mode for multiple flash units, Advanced Wireless Lighting and SU-4 type wireless multiple flash-unit photography can be changed in the custom settings. (□B-17)

Advanced Wireless Lighting

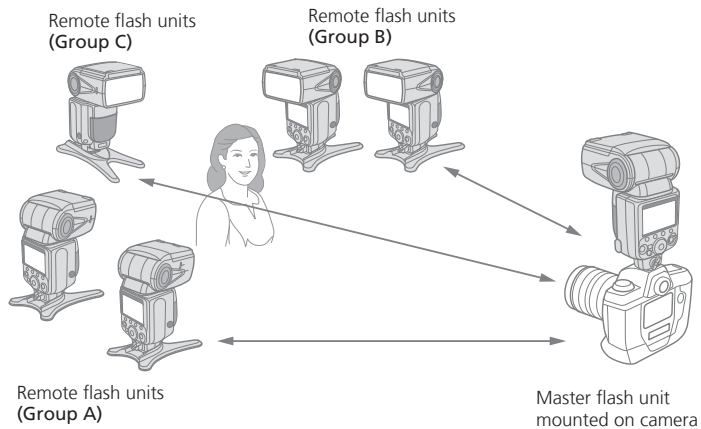

- ① The master flash unit commands the remote flash units to fire monitor pre-flashes.
- ② The camera measures the reflected light.
- ③ The camera activates the flash units.

- The SB-910 mounted on a camera is the master flash unit.
- Up to three groups (A, B, C) of remote flash units can be set up.
- Single or several remote flash units can be allocated for one group.
- The master flash unit and each remote flash unit group can operate with a flash compensation value and a flash mode that is different to the other flash units or groups.

SB-910 Wireless Multiple Flash-unit Photography Setup

SU-4 type wireless multiple flash-unit photography

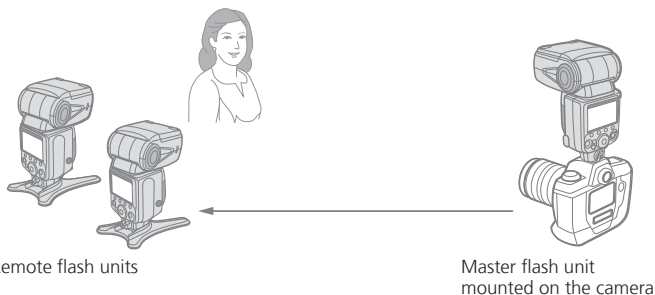

- ① Remote flash units start firing triggered by the master flash unit firing (in AUTO mode or M mode).
- ② Remote flash units stop firing when the master flash unit stops firing (in AUTO mode).

- The Speedlight mounted on the camera or the camera's built-in flash can be used as the master flash unit.
- Be sure to cancel the master flash unit monitor pre-flash function or select a master flash unit flash mode that does not activate monitor pre-flashes.
- The flash mode is set on each flash unit. Set the same flash mode on each remote flash unit.

SB-910 Wireless Multiple Flash-unit Functions

		When used in master mode MASTER	When used in remote mode REMOTE
Flash photography with Advanced Wireless Lighting	Flash mode	<ul style="list-style-type: none"> • i-TTL • Auto aperture flash*¹ • Non-TTL auto flash*¹ • Manual flash • Flash function canceled 	The flash mode is set on the master flash unit (each group can fire with a flash mode different to other groups)
	Repeating flash photography	Possible, set in the custom settings	Possible
	Flash compensation	Possible	The flash compensation value is set on the master flash unit (each group can fire with a compensation value different to other groups)
	Group	Up to 3 groups (A, B, C)	
	Channel* ²	4 channels (1 – 4)	
SU-4 type wireless multiple flash-unit photography	Flash mode	<ul style="list-style-type: none"> • Auto aperture flash*¹ • Non-TTL auto flash*¹ • Distance-priority manual flash • Manual flash 	<ul style="list-style-type: none"> • AUTO (auto) • M (manual) • OFF (flash function canceled)
	Flash compensation	Possible	–

*1 The SB-910 operates in auto aperture flash mode irrespective of the non-TTL auto flash mode option set in the custom settings. The SB-910 operates in non-TTL auto flash mode when no lens information, such as focal length and aperture, is available.

*2 One of four channels can be used. Remote flash units can be triggered by other master flash units. Use a different channel number if another photographer is using the same type of wireless remote flash setup close by.

☑ Notes on canceling the master flash unit flash function

When the master flash unit flash function is canceled and only the remote flash units fire, the master flash unit emits a number of weak light signals to trigger the remote flash units. This operation will normally not affect the correct exposure of the subject, although the exposure might be affected if the subject is close and a high ISO sensitivity has been set. To limit this effect, bounce the light by tilting up the master flash unit's flash head.

Setting the Master Flash Unit

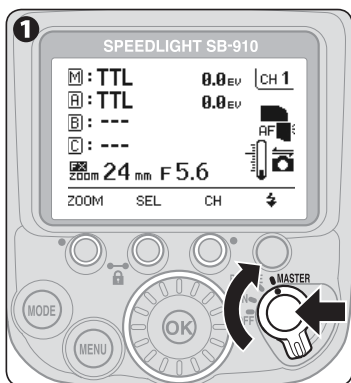

1 Set the power switch/
wireless mode switch for
multiple flash units to
[MASTER].

- Turn the switch while holding down the lock release in the center.

Master mode LCD example (i-TTL mode)

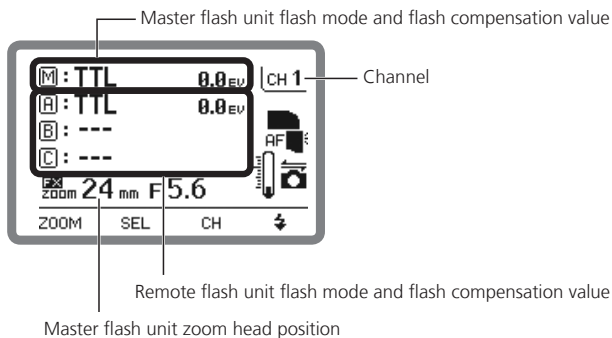

Setting the Remote Flash Unit

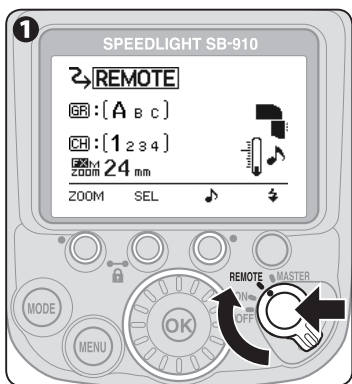

1 Set the power switch/
wireless mode switch for
multiple flash units to
[REMOTE].

- Turn the switch while holding down the lock release in the center.

Remote mode LCD example (Advanced Wireless Lighting)

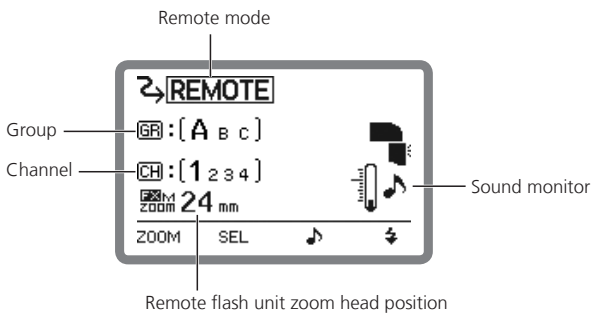

Advanced Wireless Lighting

Taking a picture with Advanced Wireless Lighting

1. Master flash unit setting (flash mode, flash compensation value and channel)

[Setting i-TTL mode and channel 1 (example)]

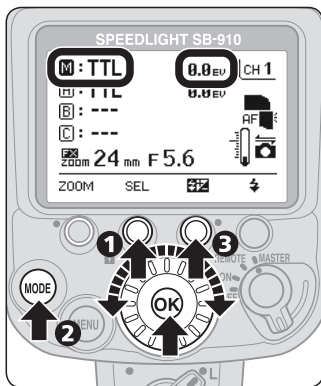

1 Press function button 2 to highlight **M**.

2 Press the [MODE] button, choose [TTL] with the selector dial, and then press the [OK] button.

3 Press function button 3, choose a flash compensation value with the selector dial, and then press the [OK] button.

4 Press function button 2 to highlight **A** for remote flash unit group.

- Other remote flash unit groups can be chosen with the selector dial.

5 Repeat procedures 2 and 3 to set the flash mode and flash compensation value of the remote flash unit group A.

6 Repeat procedures 4 and 5 to set the remote flash unit groups B and C.

7 Press function button 3, choose "CH 1" with the selector dial, and then press the [OK] button.

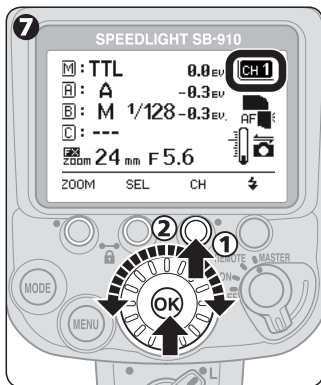

Advanced Wireless Lighting

2. Remote flash unit setting (group, channel and zoom head position)

[Setting group A and channel 1 (example)]

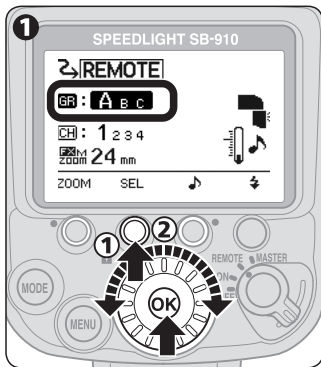

1 Press function button 2 to highlight the group, choose "A" for group with the selector dial, and then press the [OK] button.

- Group name and channel number being set appears larger.

2 Press function button 2 to highlight the channel, choose "1" for channel number with the selector dial, and then press the [OK] button.

- Be sure to choose the same channel number as set on the master flash unit.

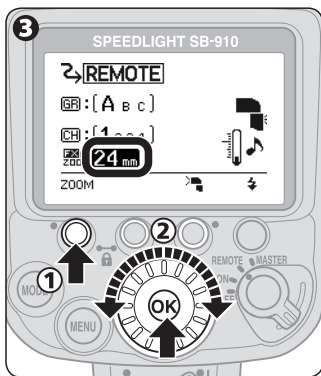

3 Press function button 1 to highlight the zoom head position, choose a zoom head position with the selector dial, and then press the [OK] button.

4 Confirm the flash-ready indicator is on, and then shoot.

Repeating flash photography

Repeating flash photography is possible in Advanced Wireless Lighting.

- Repeating flash mode can be activated in the custom settings. (□B-17)

Repeating flash mode LCD example

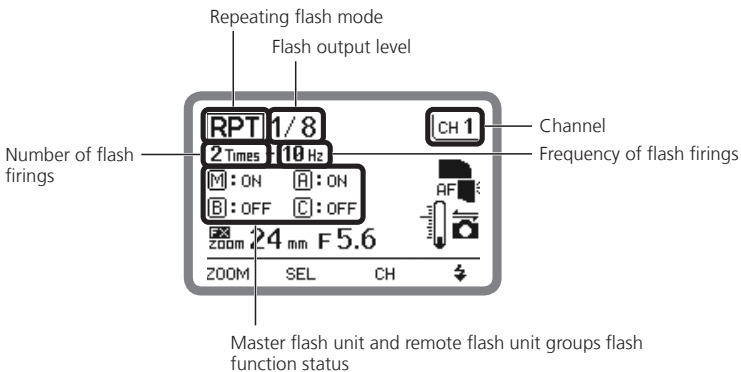

Advanced Wireless Lighting

Setting repeating flash photography

- When the SB-910 operates in repeating flash mode, the flash function can be activated (ON) or canceled (OFF). There is no other repeating flash mode option.
- The master flash unit and remote flash units operate with the same flash output level, number and frequency of flash firings.
- To set the flash output level, number and frequency of flash firings, see “Repeating Flash Mode.” (C-19)

1. Master flash unit setting

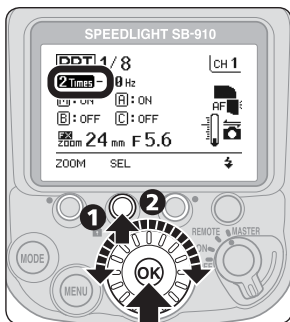

- 1 Press function button 2 to highlight the selected item.
- 2 Change the setting with the selector dial, and then press the [OK] button.

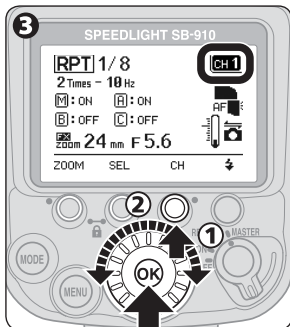

- 3 Press function button 3 to highlight the channel, choose a channel with the selector dial, and then press the [OK] button.

2. Remote flash unit setting

- 1 Set the remote flash unit group, channel and zoom head position.
 - For more details, see D-9.

SU-4 Type Wireless Multiple Flash-unit Photography

SU-4 type wireless multiple flash-unit photography is particularly suited to photographing fast-moving subjects.

Setting SU-4 type wireless multiple flash-unit photography

- 1 Set the SU-4 type wireless multiple flash-unit photography in custom settings. (□B-17)
- 2 Set the power switch/wireless mode switch for multiple flash units to [MASTER] or [REMOTE].
 - Turn the switch while holding down the lock release in the center.

Master mode LCD example

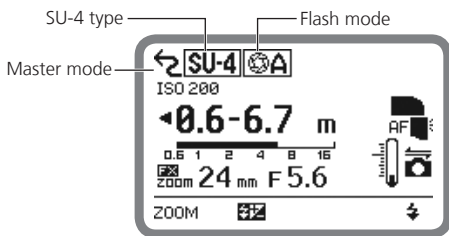

Remote mode LCD example

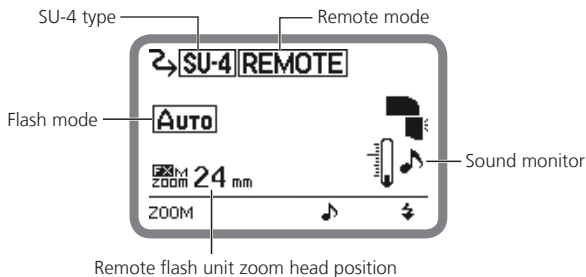

SU-4 Type Wireless Multiple Flash-unit Photography

Flash modes for the master flash unit

When used in master mode, the SB-910 can operate in auto aperture flash, non-TTL auto flash, distance-priority manual flash and manual flash modes. (D-4)

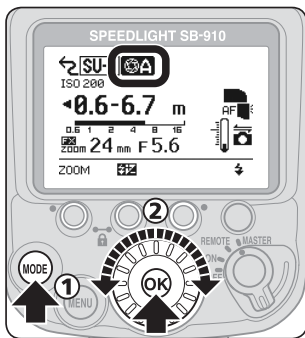

To set the flash mode, press the [MODE] button, choose the flash mode with the selector dial, and then press the [OK] button.

Canceling the master flash unit monitor pre-flash function

Correct exposure cannot be obtained when the master flash unit emits monitor pre-flashes with SU-4 type wireless multiple flash-unit photography.

- The SB-910 does not emit monitor pre-flashes when used in master mode.
- When the master flash unit is not the SB-910, make sure the master flash unit monitor pre-flash function is canceled. See the master flash unit user's manual for instructions on how to cancel this function.

Flash modes for remote flash units

When used in remote mode, the SB-910 can operate in AUTO (auto), M (manual) and OFF (flash function canceled) modes.

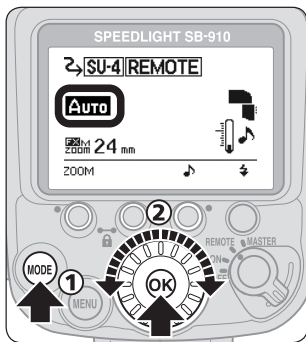

To set the flash mode, press the [MODE] button, choose the flash mode with the selector dial, and then press the [OK] button.

AUTO (auto) mode:

- In AUTO mode, the remote flash units start and stop firing in sync with the master flash unit.
- Total flash output level of the master and remote flash units is controlled.
- The maximum distance the SB-910's light sensor can detect is approx. 7 m (23 ft) in front of the master flash unit.

M (manual) mode:

- In M mode, the remote flash units start firing in sync with the master flash unit, but do not stop firing in sync with the master flash unit.
- Flash output levels of the master and remote flash units are separately set.
- The maximum distance the SB-910's light sensor can detect is approx. 40 m (131 ft) in front of the master flash unit.
- The flash output level can be set from M1/1 to M1/128.

OFF (flash function canceled) mode:

Remote flash units do not fire, even when the master flash unit fires.

SU-4 Type Wireless Multiple Flash-unit Photography

To prevent the remote flash units from firing accidentally

Do not leave the remote flash units' power on. Ambient electrical noise caused by static electricity or other such electromagnetic waves can trigger them to fire accidentally. Always turn the power off when not in use.

Taking a picture with SU-4 type wireless multiple flash-unit photography

1. Remote flash unit setting (flash mode and zoom head position)

[Setting AUTO mode (example)]

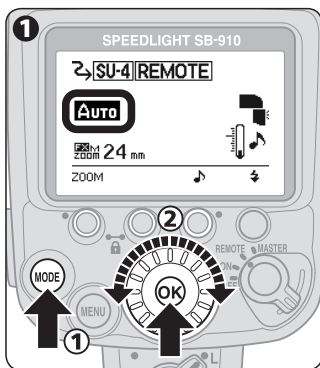

1 Press the [MODE] button, choose "AUTO" with the selector dial, and then press the [OK] button.

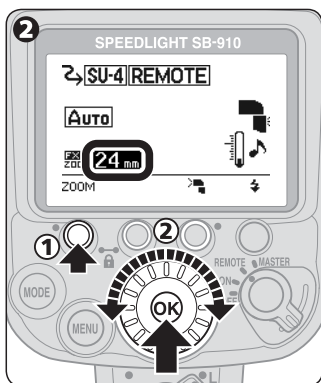

- Press function button 1 to highlight the zoom head position, choose a zoom head position with the selector dial, and then press the [OK] button.

Setting flash output level in M mode

In M mode, set the flash output level with function button 2.

2. Master flash unit setting (flash mode)

[Setting auto aperture flash mode (example)]

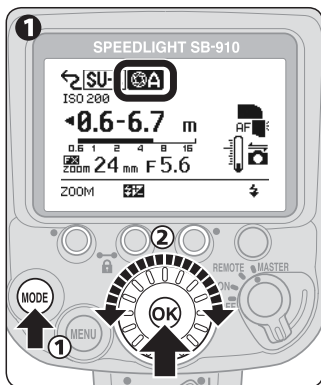

- Press the [MODE] button, choose  with the selector dial, and press the [OK] button.
 - When the remote flash unit flash mode is AUTO (auto), set the master flash unit flash mode to auto aperture flash, non-TTL auto flash, distance-priority manual flash or manual flash. (D-4)
 - When the remote flash unit flash mode is M (manual), set the master flash unit flash mode to manual flash.
- Confirm the flash-ready indicator is on, and then shoot.

Remote Flash Units

Remote flash unit setting

- The standby function of the SB-910, SB-900, SB-800, SB-700, SB-600, SB-500 and SB-R200 is canceled when remote mode is set. Make sure that there is sufficient battery power.
- Set the zoom head position of the remote flash units wider than the angle of view, so that the subject will receive sufficient illumination even when the angle of the flash head is off axis from the subject. When the flash-to-subject distance is very short, set the zoom head position wide enough to achieve sufficient light.

Setting up the remote flash units

- In most cases, position the remote flash units closer to the subject than the camera, so that light from the master flash unit can reach the light sensor window for wireless remote flash of the remote flash units. This is particularly important when holding a remote flash unit in the hand.

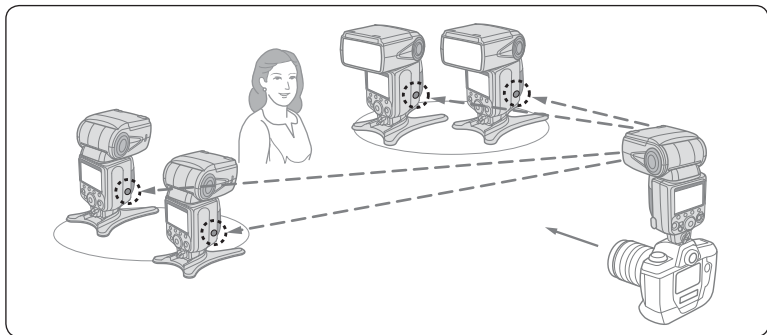

- As a basic guide, the effective distance between the master and remote flash units is approx. 10 m (33 ft) or less in the front position, and approx. 7 m (23 ft) at both sides (in Advanced Wireless Lighting). These ranges vary slightly depending on ambient light.
- There is no limit to the number of remote flash units that can be used together. However, when using many remote flash units, light may be unintentionally picked up by the light sensor of the master flash unit and interfere with correct functioning. The practical number of remote flash units for wireless multiple flash-unit photography is three. In Advanced Wireless Lighting, for practical purposes, the number of remote flash units should be limited to three for one group.
- Place all remote flash units in the same group close together and facing the same direction.

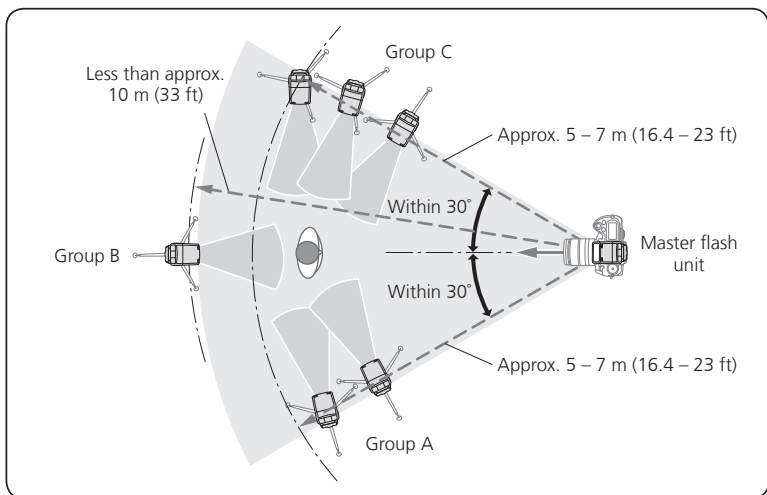

Remote Flash Units

- An obstacle between the master flash unit and remote flash units can interfere with transmission of data.
- Take care not to let light from the remote flash units enter the camera lens or the master flash unit light sensor for non-TTL auto flash.
- Use the provided Speedlight Stand AS-21 for stable placement of remote flash units. Attach and detach the SB-910 to and from the AS-21 in the same way it is attached to/detached from the camera's accessory shoe.



- Be sure to press the master flash unit test firing button to test fire remote flash units after setting up.
- Be sure to confirm the remote flash unit flash-ready indicator is on before photographing.

Checking Status in Wireless Multiple Flash-unit Photography

The flash-ready indicator on the SB-910 and the sound monitor can be used to check that wireless multiple flash-unit photography is operating during and after taking a picture.

- The sound monitor can be used to check the operational status of a remote flash unit. This function can be activated or canceled with function button 3.
- When the SB-910 is used in remote mode, either of the flash-ready indicators can be turned off in the custom settings to reduce power consumption. In default setting, the back flash-ready indicator lights up and the front flash-ready indicator blinks. (□B-19)

Checking flash operation using the flash-ready indicator or sound monitor

Master flash unit	Remote flash unit		Speedlight status
Flash-ready indicator	Flash-ready indicator	Sound monitor	
Lights up	The back indicator lights up and the front indicator blinks.	One beep	Ready to fire
Goes out and lights up when ready to fire	The back indicator lights up and the front indicator blinks or goes out.	Two short beeps	Fired properly
Blinks for approx. 3 sec.	Quickly blinks for approx. 3 sec.	Three long beeps for approx. 3 sec.	Insufficient flash output for correct exposure ^{*1} Underexposure due to insufficient flash output may have occurred. To compensate, use a wider aperture or higher ISO sensitivity, or move the flash unit closer to the subject and reshoot.

Checking Status in Wireless Multiple Flash-unit Photography

Master flash unit	Remote flash unit		Speedlight status
Flash-ready indicator	Flash-ready indicator	Sound monitor	
Goes out and lights up when ready to fire	Quickly blinks for approx. 6 sec.	Three long beeps for approx. 3 sec. (The beep of each remote flash unit group differs in sound.)	The remote flash unit light sensor has failed to receive the command light from the master flash unit. This is because the light sensor cannot detect when to stop firing in sync with the master flash unit, either due to a reflection from the remote flash unit itself or light from another remote flash unit that may have entered the light sensor window. Change the direction or position of the remote flash unit and reshoot.

D

Wireless Multiple Flash-unit Photography

*1 Indicators shown below appear when underexposure due to insufficient flash output may have occurred.

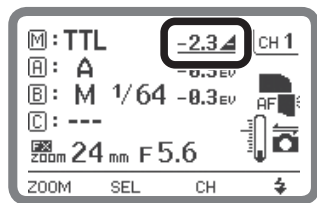

Master flash unit

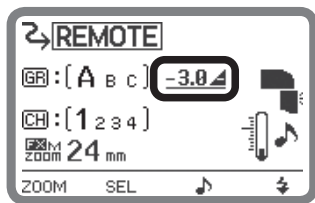

Remote flash unit

This section explains the SB-910 functions that support flash photography and camera functions.

- For detailed information regarding camera functions and settings, refer to the camera user's manual.

Switching illumination patterns (☐E-2)	
Bounce flash operation (☐E-4)	
Taking close-up photographs (☐E-9)	
Flash photography with color filters (☐E-12)	
Flash photography support functions (☐E-17)	Flash compensation Power zoom function AF-assist illumination ISO sensitivity manual setting Test firing Modeling illumination Standby function Thermal cut-out
Functions to be set on the camera (☐E-24)	Auto FP high-speed sync FV lock Slow sync Red-eye reduction/red-eye reduction slow sync Rear-curtain sync

Switching Illumination Patterns

In flash photography, the center of the image is most illuminated, while the edges are darker. The SB-910 provides three types of illumination patterns with different light falloff at edges. Select the suitable pattern according to the photography environment.

Standard



The basic illumination pattern for common flash photography environments

Even



The light falloff at the edge of the image is less than with the standard illumination pattern.

- Suitable for group photographs, in which sufficient light is required without light falloff at the edges.

Center-weighted



The center-weighted pattern provides larger guide numbers at the center of the image than the standard illumination pattern (the light falloff at the edge will be greater than the standard illumination pattern).

- Suitable for shots, such as portraits, in which the light falloff at the edge of an image can be ignored.

Setting the illumination pattern

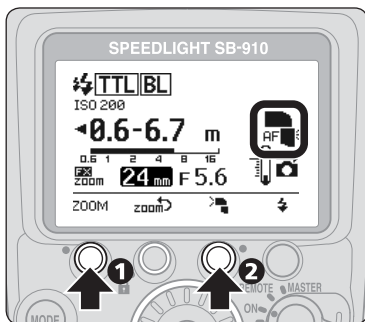

- 1 Press function button 1 to highlight the zoom head position.
- 2 Press function button 3 to change the illumination pattern.

- The selected illumination pattern is indicated with an icon on the LCD.

	Standard
	Even
	Center-weighted

When the Nikon Diffusion Dome is attached or the built-in wide panel is in use

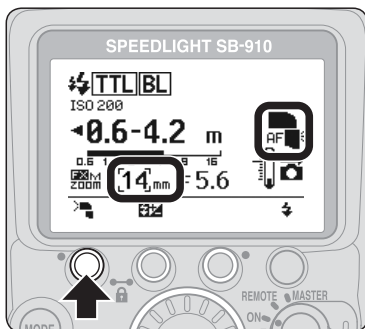

Press function button 1 to change the illumination pattern.

- The zoom head position also changes in accordance with the illumination pattern.

Bounce Flash Operation

Bounce flash is a photographic technique using light that is bounced off a ceiling or wall using a tilted or rotated flash head. This provides the effects listed below compared to those with direct light from a flash unit:

- Overexposure to a subject that is closer than other subjects can be reduced.
- Background shadows can be softened.
- Overexposure of faces, hair and clothes can be reduced.
- The shadows can be softened further using the Nikon Diffusion Dome.
- For more details and comparative example photos, see the separate booklet "A collection of example photos."

Setting the flash head

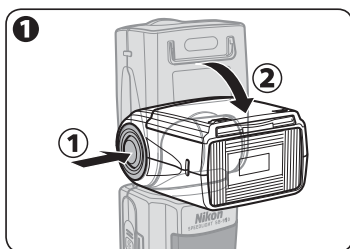

1 Tilt or rotate the SB-910's flash head by holding down the flash head tilting/rotating lock release button.

- The SB-910's flash head tilts up 90° and down 7°, and rotates horizontally 180° to the left and right.
- Set the flash head at a click stop at the angles shown.

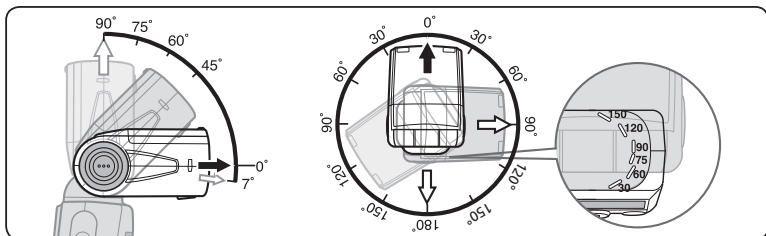

Setting flash head tilting/rotating angles, and choosing a reflecting surface

- Good results are most easily achieved when the flash head is tilted up to use the ceiling as a reflecting surface.
- Rotate the flash head horizontally to get the same effect when the camera is held in the vertical position.
- Illumination can be softened further when the light is bounced off a ceiling or wall behind the camera, as opposed to in front of the camera.
- Select white or highly reflective surfaces to bounce the light off. Otherwise, image colors will be influenced by the color of the reflecting surface.
- Take care not to let light from the flash unit illuminate the subject directly.
- The effective distance between the flash head and the reflecting surface is approx. 1 m to 2 m (3.3 ft to 6.6 ft) depending on photographic conditions.
- If the reflecting surface is not close enough, a piece of A4-size white paper can be used instead. Please check the subject is exposed to the bounced light before taking a picture.

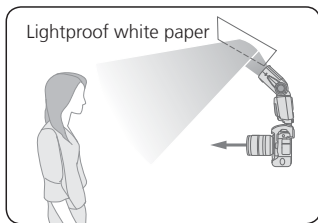
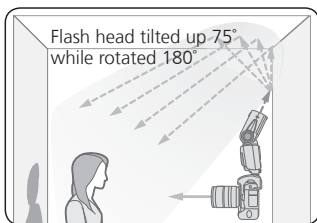
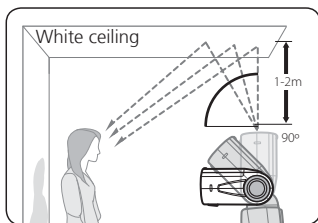

Bounce Flash Operation

Nikon Diffusion Dome

- By attaching the included Nikon Diffusion Dome over the flash head, light can be further diffused during bounce flash photography to create extremely soft light with virtually no shadow.
- The same effect can be achieved with the camera in either horizontal or vertical position.
- Light is more effectively diffused when the built-in wide panel is used. (E-10)

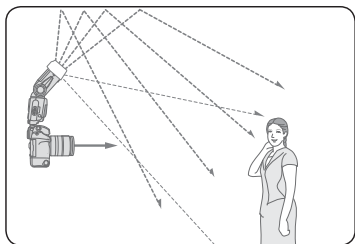

Attaching the Nikon Diffusion Dome

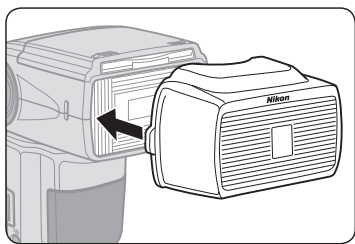

Attach the Nikon Diffusion Dome as shown in the diagram, with the Nikon logo facing up.

Zoom head position indicator

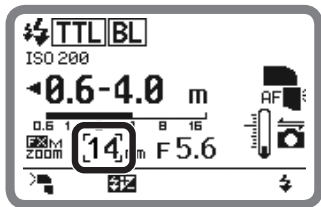

- When the Nikon Diffusion Dome is attached, the zoom head position is automatically set depending on the camera's image area and illumination pattern. The zoom head position is set at 12 mm, 14 mm or 17 mm in FX format, and 8 mm, 10 mm or 11 mm in DX format. (☞H-17)
- The illumination pattern can be changed with function button 1. (☞E-3)

Taking a picture with bounce flash

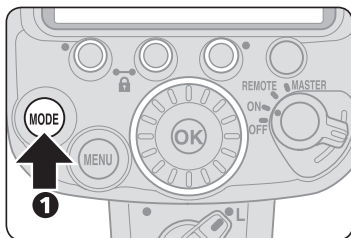

1 Set the flash mode.

- Set the flash mode i-TTL, auto aperture flash or non-TTL auto flash.

Camera's LCD

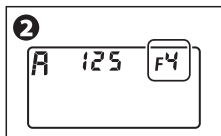

2 Set the camera's aperture, shutter speed, etc.

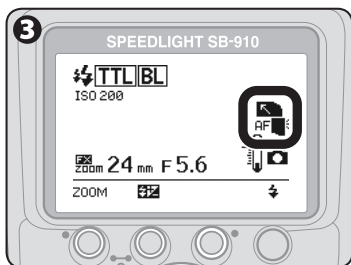

3 Adjust the flash head and shoot.

- Refer to "Setting the flash head." (☞E-4)

Bounce Flash Operation

Setting the aperture in bounce flash operation

- In bounce flash, there is a light loss compared with normal flash photography (with flash head adjusted to the forward-facing position). Therefore, a two- or three-step wider aperture (smaller f-number) should be used. Adjust according to results.
- When the flash head is adjusted to other than the forward-facing position, the SB-910 LCD does not display the effective flash output distance range indicator. To ensure correct exposure, first confirm the effective flash output distance range and aperture with the flash head in the forward-facing position. Next, set this aperture on the camera.

Using the built-in bounce card

- In bounce flash photography, use the SB-910's built-in bounce card to make a portrait subject's eyes look more vibrant by reflecting the light in them.
- Tilt the flash head up 90°. Refer to "Setting the flash head." (E-4)

Setting the built-in bounce card

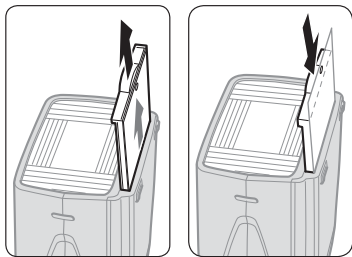

Pull out the bounce card and the built-in wide panel and, while holding the bounce card, slide the built-in wide panel back into place inside the flash head.

- To insert the bounce card, pull out the built-in wide panel again and slide both back into place together.

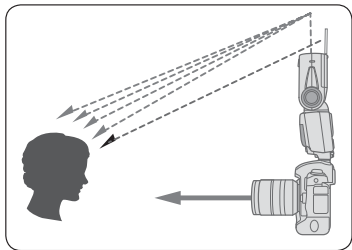

Taking Close-up Photographs

When the flash-to-subject distance is less than approx. 2 m (6.6 ft), tilting down the flash head is recommended to ensure sufficient illumination of the lower part of the subject in close-up photography.

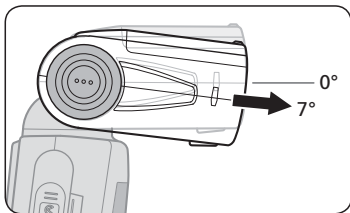

Bounce-down icon

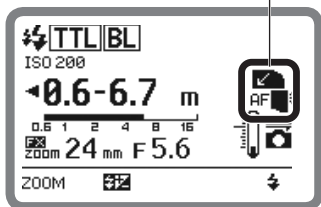

- The bounce-down icon appears when the flash head is tilted down.
- With the built-in wide panel, the flash from the SB-910 is diffused. This softens shadows and prevents overexposure on faces, etc.
- When using a long lens, be careful that the light from the flash is not obstructed by the lens barrel.
- Vignetting may occur in close-up flash photography due to the illumination pattern, lens in use, focal length setting, etc. Therefore, make test shots if taking an important picture.

Taking Close-up Photographs

Setting the built-in wide panel

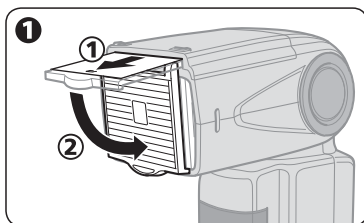

- 1 Carefully pull the built-in wide panel all the way out and position it over the flash panel.

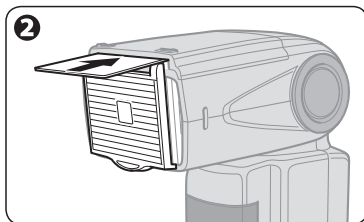

- 2 Slide the bounce card back into place inside the flash head.

- To replace the built-in wide panel, lift it up and slide it into the flash head as far as it will go.

Zoom head position indicator

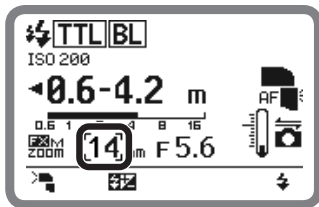

- When the built-in wide panel is attached, the zoom head position is automatically set depending on the camera's image area and illumination pattern. The zoom head position is set at 12 mm, 14 mm or 17 mm in FX format, and 8 mm, 10 mm or 11 mm in DX format. (□H-17)
- The illumination pattern can be changed with function button 1. (□E-3)
- In the event that the built-in wide panel breaks, the zoom head position can be set manually. This is done by selecting the "WP  " icon in the custom settings (□B-20) and choosing "ON."

Taking close-ups with bounce-down flash

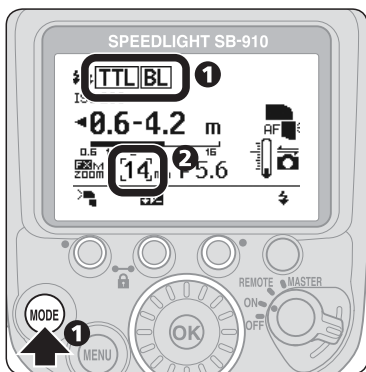

- 1 Set the SB-910's flash mode.
- 2 Position the built-in wide panel.

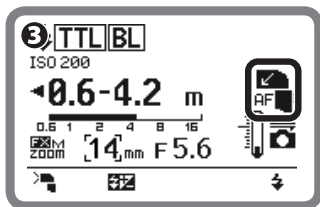

- 3 Tilt the flash head down.
- 4 Confirm the flash-ready indicator is on, and then shoot.

If the built-in wide panel is broken

- The built-in wide panel may break if subjected to strong knocks while on the flash head.
- In this case, contact your retailer or Nikon representative.

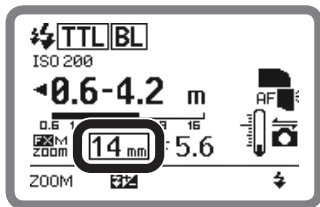

- If the built-in wide panel is broken, the zoom head position cannot be set to the desired position. The setting for manual positioning of the zoom head can be found in the custom settings. (C-B-20)
- When the zoom head position is manually set, the indicator is displayed within a box.

Flash Photography with Color Filters

Color compensation filters, a fluorescent filter and an incandescent filter, are included with the SB-910 for use with flash photography under incandescent/tungsten and fluorescent lighting.

- For more details on color compensation filter effects, see the separate booklet "A collection of example photos."
- Color filters (Color Filter Set SJ-3 and Color Filter Holder SZ-2) that change the color of the light emitted by the SB-910 are available separately. (CQH-10)

Using color compensation filters and color filters

Filters	Purpose
Fluorescent filter (Fluorescent Filter SZ-2FL), included	Balance the color of light from the flash to match that of fluorescent lighting
Incandescent filter (Incandescent Filter SZ-2TN), included	Balance the color of light from the flash to match that of incandescent or tungsten lighting
Color filters (Color Filter Set SJ-3), optional	Create interesting effects by changing the color of the light emitted by the flash

Color compensation with included and optional filters

The included Incandescent Filter SZ-2TN and the optional SJ-3 incandescent filters TN-A1 and TN-A2 differ in color compensation. The color of images taken with the SZ-2TN and SJ-3 incandescent filters are slightly different even when the same light source is used. The color can be adjusted with the camera's white balance fine tuning. For details, see E-16.

How to attach color compensation filters (included)

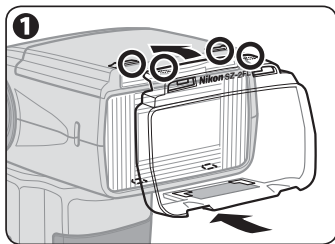

1 Place the filter on the flash head and insert into the slit at the top.

- Place the filter with the Nikon logo facing up, as shown in the diagram.

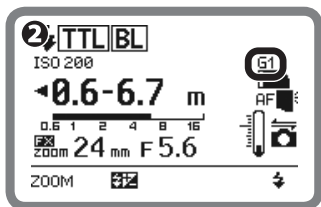

G1	Fluorescent filter
A1	Incandescent filter

2 Check the LCD.

- Filter type is displayed.
- The information is transmitted from the SB-910 to the camera.

How to attach SJ-3 color filters (optional)

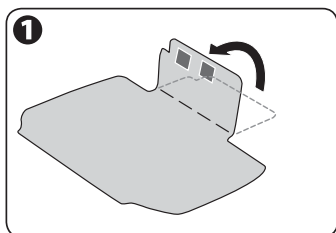

1 Fold along the line marked on the filter.

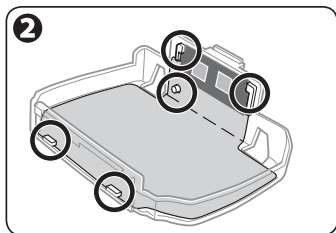

2 Attach the filter to Color Filter Holder SZ-2 (optional) as shown in the diagram.

- Insert the filter edges into the slits on the holder, and then align the filter positioning hole with the holder pin.
- Align the filter identification code (silver marks) with the black bar on the holder.
- Attach the filter to the filter holder without creasing the filter or leaving any gaps.

Flash Photography with Color Filters

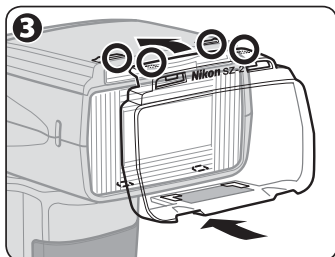

- 3** Place the filter holder on the flash head with the Nikon logo facing up, as shown in the diagram, and insert it into the slit at the top.

- Be sure to attach the filter to the filter holder before placing the filter holder on the flash head.

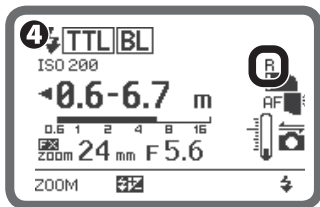

- 4** Check the LCD.

- The filter type is displayed.
- Be sure that nothing obstructs the filter detector.

Red filter is attached

G1	FL-G1 (fluorescent filter)	R	RED
G2	FL-G2 (fluorescent filter)	B	BLUE
A1	TN-A1 (incandescent filter)	Y	YELLOW
A2	TN-A2 (incandescent filter)	A	AMBER

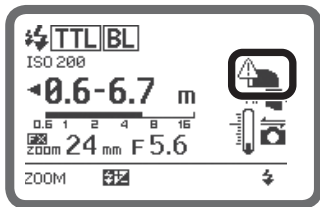

Warning indicator

- When the filter is not properly attached, the warning indicator shown left appears. Remove the filter and reattach.

Notes on using SJ-3 color filters

- These filters are consumable items. Replace them when they deteriorate or their colors fade.
- The heat generated from the flash head can warp the filters. However, this will not affect their performance.
- Scratches on the filters will have no effect on performance unless the filters fade in color.
- To remove dust or dirt, wipe the filter lightly with a soft, clean cloth.

Balancing light from the flash using color compensation filters and color filters

When a color compensation filter is attached to the SB-910 while the camera's white balance is set to auto or flash, filter information is automatically transmitted to the camera, and the camera's optimum white balance is automatically adjusted to give the correct color temperature.

- When an SJ-3 color filter is attached to the SB-910, set the camera's white balance to auto, flash or direct sunlight.
- When using the SB-910 with a camera not equipped with filter detection (D2 series, D1 series, D200, D100, D80, D70 series, D60, D50, D40 series), set the camera's white balance according to the filter in use while referring to the following table.
- For more details on white balance, see your camera user's manual.

Flash Photography with Color Filters

■ White balance depends on camera in use

Camera / Filter	Camera	Filter	White Balance
	D4S, D4, D3X, D3S, D3 ^{*1} , Df, D810, D800 series, D750, D700, D610, D600, D300S, D300 ^{*2} , D90, D7200, D7100, D7000, D5500, D5300, D5200, D5100, D5000, D3300, D3200, D3100, D3000		D1, D50
SZ-2FL	Auto, flash		Not recommended
SZ-2TN	Auto, flash ^{*3}		Incandescent
FL-G1, FL-G2	Auto, flash		Not recommended
TN-A1	Auto, flash		Incandescent (fine tune +3), +1.0 EV ^{*4}
TN-A2			Direct sunlight (fine tune +3), +0.3 EV ^{*4}
Color filters (RED, BLUE, YELLOW, AMBER)	Auto, flash, direct sunlight		Auto, flash, direct sunlight (+0.7 EV ^{*4} with AMBER)

*1 D3 camera with firmware A and firmware B version 2.00 or later.

*2 D300 camera with firmware A and firmware B version 1.10 or later.

*3 To match the compensation effects of the SZ-2TN and the TN-A1 or TN-A2, set auto or flash in the camera's white balance and A6 in the fine tuning.

*4 Set the camera's white balance and flash compensation value.

- Please check the image results and adjust the flash compensation value and other settings accordingly.

Flash Photography Support Functions

Flash compensation

Exposure compensation for a flash-illuminated subject without affecting background exposure can be achieved by adjusting the SB-910's flash output level.

- Some plus compensation may be necessary to make the main subject brighter, and some minus compensation to make it darker.
- Flash compensation is possible in i-TTL, auto aperture flash, non-TTL auto flash and distance-priority manual flash modes.

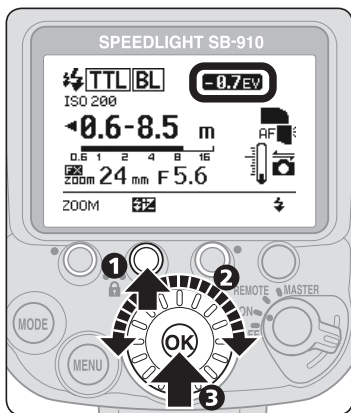

- 1 Press function button 2 to highlight the flash compensation value.
- 2 Rotate the selector dial to set desired flash compensation value.
 - The compensation value can be set in 1/3 EV steps from +3.0 EV to -3.0 EV.
- 3 Press the [OK] button.

Canceling flash compensation

- To cancel, rotate the selector dial to return the compensation value to "0."
- Flash compensation cannot be canceled by simply turning the SB-910 off.

For digital SLR cameras with a built-in flash featuring the flash compensation function

- The flash compensation can also be set on the digital SLR camera with a built-in flash. For details, see the camera user's manual.
- If the flash is compensated on both the camera and the Speedlight, the flash output is modified by the sum total of both compensation values. In this case, the SB-910's LCD panel shows only the compensation value set on the SB-910.

Flash Photography Support Functions

Power zoom function

The SB-910 automatically adjusts the zoom head position to match the lens focal length.

- Zoom head positions automatically adjusted differ depending on the settings. For more details, refer to “Specifications.” (□H-17)

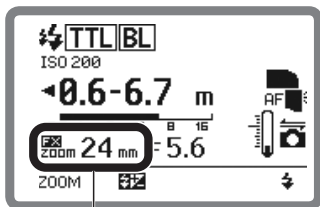

Power zoom function activated

zoom	Power zoom function activated
zoom	Zoom head position manually set
zoom	Power zoom function canceled (zoom head position must be manually set)
14mm	Nikon Diffusion Dome attached Built-in wide panel in use
17mm	Zoom head position at the maximum wide-angle position
200mm	Zoom head position at the maximum telephoto position

Setting the zoom head position manually

In order to change the zoom head position to one that does not match the focal length, the zoom head position must be adjusted manually.

- An “**M**” above the “**zoom**” indicator appears on the LCD panel when the zoom head position is set manually.
- Press function button 1 to highlight the zoom head position and then rotate the selector dial to set the zoom head position.
- Rotate the selector dial clockwise to increase the value, and counterclockwise to decrease the value.
- The zoom head position can also be adjusted with function button 1. In this case, the value increases each time function button 1 is pressed. Note that the value returns to the widest angle value after the highest telephoto value has been reached.
- In order to reactivate the power zoom function, press function button 1 to display “**zoom** ” and then press function button 2.

■ Power zoom function canceled

Power zoom function can be canceled in the custom settings. (□B-18)

- An “**PM**” above the “**zoom**” indicator appears on the LCD panel when the power zoom function is canceled.
- The zoom head position must be manually set. The zoom head position does not automatically change when the lens focal length is changed, the lens is replaced or the Speedlight is turned off/on.
- To set the zoom head position manually, see “Setting the zoom head position manually” above.

■ AF-assist illumination



When light is too low for normal autofocus operation, the SB-910's AF-assist illumination enables autofocus photography.

- The SB-910's AF-assist illumination is compatible with the multi-point AF system.
- AF-assist illumination cannot be used with non-CLS-compatible cameras and COOLPIX cameras.

■ Notes on using the AF-assist illumination

- AF-assist illumination can be used if an AF lens is mounted and the camera's focus mode is set to S (single-servo AF with focus priority), AF-A, or AF.
- The effective flash-to-subject distance with AF-assist illumination is approx. 1 m to 10 m (3.3 ft to 33 ft) for the center of the image with a 50 mm f/1.8 lens. The flash-to-subject distance varies depending on lens in use.
- Suitable lens focal length is between 17 mm and 135 mm. Focus points for each focal length in which autofocusing is possible are:

D3 series camera focus points

17 – 19 mm	20 – 105 mm	106 – 135 mm
		

- AF-assist illuminator will not light up if the camera's focus is locked or the SB-910's flash-ready indicator does not come on.
- Refer to the camera user's manual for more information.

Flash Photography Support Functions

■ AF-assist illumination/canceling flash function

AF-assist illumination can be activated or canceled in the custom settings. The flash function can also be canceled in the custom settings while AF-assist illumination is activated. (□B-18)



AF-assist illumination activated while flash function activated (Default)



AF-assist illumination canceled while flash function activated. No "AF" appears.



AF-assist illumination activated while flash function canceled

E

Functions

✓ When autofocus is not possible while using the AF-assist illumination

If the focus indicator does not appear in the camera's viewfinder even though AF-assist illuminator lights up, focus manually.

✎ Using the SB-910 off-camera

When using the SB-910 off-camera with the TTL Remote Cord SC-29, autofocus in low light is possible because the SC-29 features an AF-assist illumination function. (□H-10)

✎ For cameras with a built-in flash

- Even when the camera's AF-assist illumination is set to activate, the SB-910's AF-assist illumination is given priority and the camera's AF-assist illuminator does not light up.
- The camera's AF-assist illuminator lights up only when the SB-910's AF-assist illumination is canceled.

ISO sensitivity manual setting

ISO sensitivity can be set manually in the custom settings. (□B-19)

- ISO sensitivity can be set at from 3 to 8000. Note that the camera's ISO sensitivity setting is given priority.

Test firing

Pressing the test firing button determines whether the SB-910 fires properly.



- Test firing and modeling illumination can be selected in the custom settings. (□B-17)
- The flash output level during test firing varies depending on settings and flash mode.
- Test firing is not possible when the SB-910 is used in master mode.

Modeling illumination

When the test firing button is pressed, the flash fires repeatedly at a reduced flash output level. This is useful for checking the illumination and shadows cast on a subject before actually taking the picture.



- Test firing and modeling illumination can be selected in the custom settings. (□B-17)
- The flash fires as a modeling illuminator for up to approx. 1.5 seconds.
- When the depth-of-field preview button on a camera compatible with modeling illumination is pressed, modeling illuminator fires even when the SB-910 is not set to modeling illumination. For details, see the camera user's manual.

Advanced Wireless Lighting (□D-8)

- When the master flash unit's test firing button is pressed, activated flash units fire as modeling illuminators at the fixed flash output level.
- When the camera's depth-of-field preview button is pressed, the master flash unit (with the flash function activated) and all other remote flash units fire as modeling illuminators at the set flash output level at the selected mode.

Flash Photography Support Functions

■ SU-4 type wireless multiple flash-unit photography (D-12)

- When the camera's depth-of-field preview button is pressed, only the master flash unit fires as the modeling illuminator.
- The remote flash units also fire according to the modeling illumination of the master flash unit, but these are not modeling illuminations.

■ Standby function

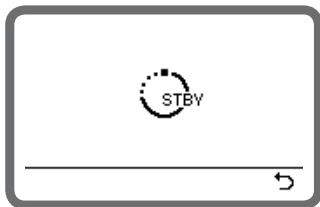

If the SB-910 and camera are not used for a specified time, the standby function is automatically activated to conserve battery power.

- The standby function is activated when the camera's exposure meter is turned off (default setting).
- The standby activation lead time can be adjusted with the custom settings (B-18).

To cancel standby

- Press the camera's shutter-release button halfway.
- Turn the power switch/wireless mode switch for multiple flash units to [OFF], and then turn to [ON], [REMOTE] or [MASTER].
- Press the test firing button.

Thermal cut-out

The SB-910 features a function that offers protection against damage to the flash panel and body from overheating. This function does not stop the flash head temperature rising. Be careful not to let the SB-910 overheat during continuous flash use.

- The thermal cut-out indicator appears when the temperature of the flash panel and body rises as a result of the flash being fired numerous times in quick succession, and all operations except power ON/OFF and custom settings are suspended before the heat can damage the flash panel and body.

LCD at normal temperature

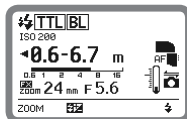

Thermal cut-out indicator



High temperature

- Wait until the SB-910 cools down.
- Operation can be resumed once the warning is no longer displayed.
- On rare occasions, the thermal cut-out indicator might appear or disappear without the temperature changing depending on the zoom head position. This is not a malfunction.

Functions to Be Set on the Camera

The following functions are available when used with cameras so equipped. Set these functions on the camera. They cannot be set on the SB-910 directly.

- For detailed information regarding camera functions and settings, refer to the camera user's manual.

Auto FP high-speed sync

High-speed flash synchronization at a compatible camera's highest shutter speed is possible.

- Auto FP high-speed sync mode is automatically set when the shutter speed exceeds the camera's highest flash sync speed.
- This is useful even in daylight when a wider aperture is required to achieve shallow depth of field to blur the background.
- Auto FP high-speed sync also operates in Advanced Wireless Lighting.
- Available flash modes are i-TTL, auto aperture flash with monitor pre-flashes, non-TTL auto flash with monitor pre-flashes, distance-priority manual flash and manual flash.
- For effective flash output distance range for i-TTL mode and the guide numbers for auto FP high-speed sync, refer to "Specifications." (□H-20)

Flash value lock (FV lock)

The SB-910 sets the flash output to locked flash exposure. This maintains the subject's illumination, even if the composition changes.

- The flash exposure level (brightness) remains the same even when the aperture is changed or lens is zoomed in and out, because the flash output level automatically changes.
- Several frames can be shot during FV lock operation.
- FV lock also functions in Advanced Wireless Lighting.
- The available flash modes are i-TTL, auto aperture flash with monitor pre-flashes and non-TTL auto flash with monitor pre-flashes.
- FV stands for flash value, meaning flash illuminated subject exposure.

Slow sync

The flash is controlled at a low shutter speed to obtain the correct exposure for both the main subject and background in low-light situations.

- Since low shutter speeds are normally used, use of a tripod is recommended to prevent camera shake.

Red-eye reduction/red-eye reduction slow sync

To prevent a subject's eyes from appearing red in color pictures shot in low light, the SB-910 fires three flashes at reduced output moments before the picture is taken.

- With red-eye reduction slow sync, red-eye reduction is combined with slow-sync flash.
- Since low shutter speeds are normally used in red-eye reduction slow sync, use of a tripod is recommended to prevent camera shake.

Functions to Be Set on the Camera

■ Rear-curtain sync

In normal flash photography, when photographing fast-moving subjects at low shutter speeds at night, pictures can appear unnatural because the subject frozen by the flash appears behind or within the blurred movement. Rear-curtain sync flash creates a picture in which the blur of a moving subject appears behind the subject and not in front.

- In front-curtain sync, the flash fires immediately after the front curtain is fully open; in rear-curtain sync, the flash fires moments before the rear curtain starts to close.
- Since low shutter speeds are normally used, use of a tripod is recommended to prevent camera shake.
- Rear-curtain sync does not operate in repeating flash mode.

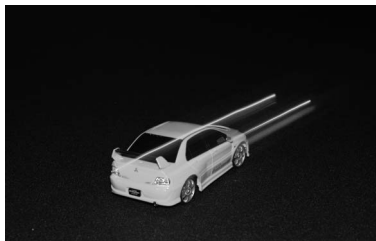

Front-curtain sync



Rear-curtain sync

Using the SB-910 with non-CLS-compatible SLR cameras is possible, although some functions may not be operable.

- Operable SB-910 functions vary depending on camera in use.
- See the camera user's manual as well.

Differences between CLS-compatible and non-CLS-compatible cameras

	CLS-compatible cameras	Non-CLS-compatible cameras
Camera communication icon 	Displayed	Not displayed
Operable flash mode	<ul style="list-style-type: none"> • i-TTL • Auto aperture flash • Non-TTL auto flash • Distance-priority manual flash • Manual flash • Repeating flash 	<ul style="list-style-type: none"> • Non-TTL auto flash • Distance-priority manual flash • Manual flash • Repeating flash
ISO sensitivity	Automatically set	Set in the custom settings
Operable wireless multiple flash-unit photography	<ul style="list-style-type: none"> • Advanced Wireless Lighting • SU-4 type 	<ul style="list-style-type: none"> • SU-4 type
Flash photography using color filters	Possible (filter information transferred to the camera compatible with filter detection)	Possible (filter information not transferred)
FV lock	Possible	Not possible
Auto FP high-speed sync	Possible	Not possible
Red-eye reduction	Possible	Not possible
Rear-curtain sync	Possible	Possible
AF-assist illumination	Possible (supporting multi-point AF)	Not possible
Firmware update	Possible (with compatible cameras only)	Not possible

G For Use with COOLPIX Cameras

Using the SB-910 with COOLPIX cameras listed below is possible, although some functions may not be operable.

CLS-compatible COOLPIX cameras (A, P7800, P7700, P7100, P7000, P6000)

i-TTL-compatible COOLPIX cameras (P5100, P5000, E8800, E8700, E8400)

- See the camera user's manual as well.

Flash modes and functions when used with COOLPIX cameras

	CLS-compatible COOLPIX cameras	i-TTL-compatible COOLPIX cameras
Operable flash mode	<ul style="list-style-type: none">• Standard i-TTL• Auto aperture flash• Non-TTL auto flash• Distance-priority manual flash• Manual flash• Repeating flash	
Operable wireless mode for multiple flash units*1	<ul style="list-style-type: none">• Advanced Wireless Lighting• SU-4 type	<ul style="list-style-type: none">• SU-4 type
FV lock	Not possible	
Auto FP high-speed sync	Not possible	
AF-assist illumination	Not possible	
Firmware update	Not possible	

*1 Note that wireless multiple flash-unit photography using the COOLPIX's built-in flash as a master flash unit and the SB-910 as a remote flash unit is not possible.

CLS-compatible COOLPIX cameras

- Wireless multiple flash-unit photography is possible when an SB-910, SB-900, SB-800, SB-700 or Wireless Speedlight Commander SU-800 is mounted on the COOLPIX camera accessory shoe as the master flash unit or commander, and flash units such as the SB-910, SB-900, SB-800, SB-700, SB-600 and SB-500 are set to remote mode.
- For more information of camera settings, see the camera user's manual.

Adjusting the zoom head position when used with CLS-compatible COOLPIX cameras

The power zoom function automatically adjusts the zoom head position to match the lens focal length. In this case, “**zoom AUTO**” appears on the LCD panel, but the zoom head position does not appear on the LCD panel.

This section explains troubleshooting, Speedlight care, specifications and optional accessories.

Troubleshooting



If a warning indicator appears, use the following chart to determine the cause of the problem before taking the Speedlight to a retailer or Nikon representative for repair.

Problems with the SB-910



Problem	Cause	Solution	☐
The power cannot be turned on.	The batteries are not correctly installed.	Insert the batteries correctly.	B-6
	Battery power is weak.	Replace the batteries.	B-7
The flash-ready indicator does not light up.	The standby function is activated.	<ul style="list-style-type: none"> Press the camera shutter-release button halfway. Turn the SB-910 on. 	E-22
	Battery power is weak.	Replace the batteries.	B-7
The SB-910 does not fire.	The flash function is canceled in the custom settings	Activate the flash function in the custom settings.	B-18
The effective flash output distance range does not appear.	The flash head is not set to the forward-facing position.	Set the flash head to the forward-facing position.	B-9
	Aperture and ISO sensitivity information has not been received from the camera.	<ul style="list-style-type: none"> Check camera settings. Detach and reattach the SB-910 to the camera. 	—
	The SB-910 cannot receive focal length information from the camera.	Turn the SB-910 and camera off, and then turn them on again.	—
Zoom head position is not set automatically.	The built-in wide panel is in use or the Nikon Diffusion Dome is attached.	<ul style="list-style-type: none"> Remove the built-in wide panel or the Nikon Diffusion Dome. Allow the zoom head position to be manually set in the custom settings. 	B-20 E-6 E-10
	Power zoom function is canceled.	Activate the power zoom function.	E-19

Problem	Cause	Solution	
Remote flash unit does not fire.	The distance between the master flash unit and the remote flash unit is too long, or there is an obstacle between them.	Redo the setup of the master flash unit and remote flash units.	D-17
	The light from the master flash unit does not enter the remote flash unit light sensor window for wireless remote flash.		
The SB-910 does not work properly.	Microcomputer may have malfunctioned if this occurs even when fresh batteries are properly installed.	<ul style="list-style-type: none"> • Replace the batteries while the SB-910 is on. • If the problem continues, contact your retailer or Nikon representative. 	B-6
Nonstandard display			
Dials or buttons do not operate.	Key lock is activated.	Cancel key lock.	B-4
The SB-910 does not operate.	Thermal cut-out is active.	Wait until the SB-910 cools down.	E-23

Warning indicators

Warning indicator	Cause	Solution	
 Low battery power indicator appears.	All operations have stopped due to low battery power.	Replace the batteries.	B-7
 Thermal cut-out indicator appears.	The flash function is canceled, and all operations except power ON/OFF and custom settings have been suspended because the SB-910 has overheated and could become damaged.	Allow the SB-910 to cool down.	E-23

Troubleshooting

Warning indicator	Cause	Solution	
 Safety circuit activation indicator appears.	All functions other than the power switch are inoperable because of power abnormalities.	Turn off the power, remove the batteries, and contact your retailer or Nikon representative.	—
The flash-ready indicator blinks after firing.	Underexposure may have occurred.	Use a wider aperture or move the flash unit closer to the subject and reshoot.	C-4 C-7 C-10 C-13 D-20
The remote flash unit beeps for approx. 3 seconds.	Underexposure may have occurred.	Use a wider aperture, move the flash unit closer to the subject or change the position of the flash unit and reshoot.	D-20
 Filter detection failure indicator appears.	The attached color filter has not been detected.	Confirm whether the color filter is correctly attached.	E-14
F 5.6	There is no flash output that corresponds with the camera aperture used.	Reset the aperture.	—
F EE	The aperture is not at its maximum f-number.	Set the maximum f-number.	—
F	The camera is turned off.	Turn the camera on.	—
zoom Err	Power zoom function does not work properly.	<ul style="list-style-type: none"> • Turn the SB-910 off and on again. • If the warning indicator remains, contact your retailer or Nikon representative. 	—

Guide Number, Aperture and Flash-to-subject Distance

The guide number (GN) indicates the amount of light generated by a flash unit. As the number increases, the flash output becomes greater and the light extends further.

There is a relation represented by an equation, guide number (m or ft; for ISO 100) = flash-to-subject distance (m or ft) \times aperture f-number. The SB-910's guide number is 34 m (111.5 ft) (for ISO 100, zoom head position: 35 mm, FX format, illumination pattern: standard, temperature: 20 °C/68 °F). When ISO sensitivity is 100 and aperture f-number is 8, the illumination of the SB-910 reaches 4.25 m (13.9 ft), which is determined by the equation, flash-to-subject distance (4.25 m or 13.9 ft) = guide number (34 m or 111.5 ft) / aperture f-number (8).

- For ISO sensitivities other than 100, multiply the guide number by the factors (ISO sensitivity factors) shown in the table below.

ISO	25	50	100	200	400	800	1600	3200	6400
Factor	0.5	0.71	1	1.4	2	2.8	4	5.6	8

- See "Specifications" for more details. (□H-18)

Determining aperture and flash-to-subject distance for correct exposure

Aperture f-number

$$\begin{aligned} &= \text{guide number (GN for ISO 100; m or ft)} \\ &\quad \times \text{ISO sensitivity factor / flash-to-subject distance (m or ft)} \end{aligned}$$

Flash-to-subject distance (m or ft)

$$\begin{aligned} &= \text{guide number (GN for ISO 100; m or ft)} \\ &\quad \times \text{ISO sensitivity factor / aperture f-number} \end{aligned}$$

Tips on Speedlight Care



WARNING

Never use thinner, benzene or other active agents when cleaning the Speedlight, as this may damage the Speedlight or cause it to catch fire. Using these agents may also impair your health.

Cleaning

- Dirt on the flash panel can cause it to break when the flash is fired. Clean the flash panel regularly.
- Use a blower brush to remove dirt and dust from the SB-910 and clean it with a soft, clean cloth. After using the SB-910 near saltwater, wipe the flash unit with a soft, clean cloth moistened slightly with plain water to remove the salt, then dry it using a dry cloth.
- On rare occasions, the LCD may turn on or go dark, due to static electricity. This is not a malfunction. The display will soon return to normal.
- Do not drop the SB-910 or hit it against a hard surface, as this may damage its precision mechanisms. Do not apply strong pressure to the LCD panel.

Storage

- Store the SB-910 in a cool, dry place to prevent malfunctions due to high humidity, as well as the growth of mold or mildew.
- Keep the SB-910 away from chemicals such as camphor or naphthalene. Avoid exposing the SB-910 to magnetic waves from TVs and radios.
- Do not use or leave the SB-910 in locations subject to high temperatures such as those encountered near a heater or stove, as this may cause damage.
- When not using the SB-910 for more than two weeks, be sure to remove the batteries to prevent malfunctions due to battery leakage.
- Take the SB-910 out once a month, insert the batteries and fire the unit several times to refresh the capacitor.

Operating location

- An extreme temperature change can cause condensation to form inside the SB-910. When subjecting the SB-910 to sudden and extreme temperature changes, place it inside an airtight container such as plastic bag. Leave it inside the container for a while before exposing it gradually to the outside temperature.
- Avoid exposing the SB-910 to strong magnetism or radio waves from TVs or high-voltage power transmission towers, as this may cause it to malfunction.

Notes on Batteries

- Because flash consumes a large amount of battery power, batteries may not operate properly before reaching the end of their stated lifespan or the number of charges/discharges as specified by the battery manufacturer.
- When installing batteries, turn off the power of the Speedlight and never reverse the polarity of the batteries.
- If the battery terminals become soiled, remove dirt and smudges before use, as this may cause malfunction.
- Depending on battery specifications, when batteries become hot, the SB-910's safety circuits are activated, cutting off power. This often occurs when the flash unit is operated repeatedly. Battery power will recover when the temperature returns to normal.
- Battery power tends to weaken as the temperature drops. It also gradually decreases when batteries are not used for a long time and recovers after a short break following intensive use. Be sure to check battery power and replace the batteries with fresh ones if you notice any delays in the recycling time.
- Do not store batteries in locations subject to high temperatures and high humidity.
- Be sure to read the user's manuals for your rechargeable batteries and battery charger for detailed information on how to handle and recharge the batteries.
- Never attempt to charge batteries that are not rechargeable batteries, as they could explode.



Recycling rechargeable batteries

To protect the environment, do not dispose of used rechargeable batteries yourself. Instead, take these batteries to your nearest recycling center.

About the LCD Panel

Characteristics of the LCD panel

- Due to the directional characteristics of LCDs, the LCD panel is difficult to read when viewed from above. However, it can be seen clearly from a somewhat lower angle.
- The LCD panel becomes darker at high temperatures (approx. 60 °C/140 °F), but returns to normal at normal temperatures (20 °C/68 °F).
- The LCD's response time slows down at low temperatures, but returns to normal at normal temperatures (20 °C/68 °F).

LCD panel illuminator ON/OFF

Any button or switch will activate the SB-910 illuminator (when the SB-910 power is on) to make the LCD panel easier to read.

- The illuminator goes off if the SB-910 is not operated for 16 seconds.
- The LCD panel illumination can be canceled in the custom settings. (□B-19)
- Even when the LCD panel illumination is canceled in the custom settings, the SB-910's LCD panel illuminator lights up when the camera's control panel illuminator lights up. The LCD panel illuminator lights up when the custom settings are displayed in the LCD.

Adjusting the LCD panel's contrast

The contrast of the LCD panel can be adjusted in the custom settings (□B-19).

- There are nine contrast levels.

Updating Firmware

The latest Nikon firmware can be downloaded from the Nikon website. Firmware is updated through a camera compatible with SB-910 firmware updates.

- For users in the U.S.A.:

<http://www.nikonusa.com/>

- For users in Europe and Africa:

<http://www.europe-nikon.com/support/>

- For users in Asia, Oceania and the Middle East:

<http://www.nikon-asia.com/>

- Additional information may be available from the Nikon representative in your area. See the URL below for contact information:

<http://imaging.nikon.com/>

- SB-910 firmware can be updated through a D3 camera with firmware A and firmware B version 2.00 or later.
- SB-910 firmware can be updated through a D300 camera with firmware A and firmware B version 1.10 or later.
- See the custom settings section to determine which version of firmware you are using (□B-20).
- If your camera is not compatible with firmware updates, please contact a Nikon representative in your area.

Cameras not compatible with SB-910 firmware updates

D2 series, D1 series, D200, D100, D80, D70 series, D60, D50, D40 series

Optional Accessories

■ Speedlight Stand AS-21

Same as that provided with this SB-910.



■ Color Filter Set SJ-3

A total of 20 filters in eight colors are included. These are used with the separately available Color Filter Holder SZ-2.

- FL-G1 (fluorescent filter)
- FL-G2 (fluorescent filter)
- TN-A1 (incandescent filter)
- TN-A2 (incandescent filter)
- RED
- BLUE
- YELLOW
- AMBER

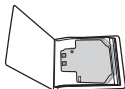

■ Color Filter Holder SZ-2 (included with the SB-900)

Used with SJ-3 color filters

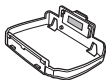

■ Water Guard WG-AS1, WG-AS2, WG-AS3

Used to protect the camera's accessory shoe contact when the SB-910 is mounted on a Nikon digital SLR camera

WG-AS1: for D3 series

WG-AS2: for D300 series

WG-AS3: for D700



■ Wireless Slave Flash Controller SU-4

Useful for wireless multiple flash-unit photography, the SU-4 features a built-in, movable light sensor and an accessory shoe for attachment of a remote flash unit. The SU-4's light sensor triggers the remote flash unit to fire in sync with the master flash unit.



■ TTL Remote Cord SC-28/17 (approx. 1.5 m/4.9 ft)

The SC-28/17 enables i-TTL mode when the SB-910 is used off-camera. The flash shoe comes with a tripod socket.

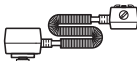

■ TTL Remote Cord SC-29 (approx. 1.5 m/4.9 ft)

The SC-29 enables i-TTL mode when the SB-910 is used off-camera. The SC-29 features an AF-assist illumination function.

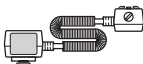

Optional Accessories

External power source

Use of an optional external power source provides a stable power supply, increases the number of flashes and shortens recycling time.

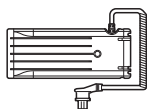

Nikon High-performance Battery Pack SD-9

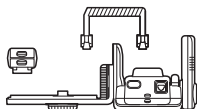

Power Bracket Unit SK-6/
SK-6A

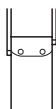

Nikon DC Unit
SD-7

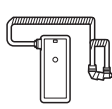

Nikon High-performance Battery Pack SD-8A

- Batteries are required in the SB-910 body even when an external power source is used.
- Use of other external power source brands may cause accidents, or could damage the Speedlight components. Nikon cannot guarantee the Speedlight performance when used with non-Nikon products.

Connecting to an external power source

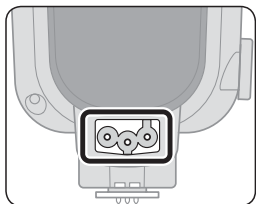

To use an external power source, remove the external power source terminal cover and connect the power cord to the terminal.

- Do not use Power Cord SC-16 when connecting the SB-910 to the Nikon DC Unit SD-7; use the SC-16A instead.

Using High-performance Battery Pack SD-9

- Conducting continuous flash photography at 8 fps using the SD-9 with eight batteries can cause the front part of the flash head to heat up.
- In flash photography, attaching the SD-9 to the camera may cause some lineal noise to appear in the image. If this is the case, set a lower ISO sensitivity or detach the SD-9 from the camera and use separately.

Specifications

External power source	Batteries	Min. recycling time (approx.)* ¹	Min. number of flashes* ¹ / recycling time* ¹
Nikon High-performance Battery Pack SD-9* ²	1.5 V LR6 (AA-size) alkaline × 4	1.9 sec.	280/1.9 – 30 sec.
	1.5 V FR6 (AA-size) lithium × 4	2.4 sec.	500/2.4 – 120 sec.
	1.2 V HR6 (AA-size) rechargeable Ni-MH (eneloop) × 4	1.2 sec.	350/1.2 – 30 sec.
	1.5 V LR6 (AA-size) alkaline × 8	1.2 sec.	450/1.2 – 30 sec.
	1.5 V FR6 (AA-size) lithium × 8	1.6 sec.	840/1.6 – 120 sec.
Power Bracket Unit SK-6/SK-6A* ²	1.2 V HR6 (AA-size) rechargeable Ni-MH (eneloop) × 8	0.8 sec.	520/0.8 – 30 sec.
	1.5 V LR6 (AA-size) alkaline × 4	2.2 sec.	190/2.2 – 30 sec.
	1.5 V FR6 (AA-size) lithium × 4	3.2 sec.	420/3.2 – 120 sec.
	1.2 V HR6 (AA-size) rechargeable Ni-MH (2600 mAh) × 4	1.9 sec.	240/1.9 – 30 sec.
Nikon DC Unit SD-7	1.2 V HR6 (AA-size) rechargeable Ni-MH (eneloop) × 4	1.9 sec.	230/1.9 – 30 sec.
	1.5 V LR14 (C-size) alkaline × 6* ³	2.0 sec.	320/2.0 – 30 sec.
	1.2 V HR14 (C-size) rechargeable Ni-MH × 6* ⁴	1.5 sec.	280/1.5 – 30 sec.
Nikon High-performance Battery Pack SD-8A* ²	1.2 V HR14 (C-size) rechargeable Ni-MH × 6* ⁵	1.5 sec.	260/1.5 – 30 sec.
	1.5 V LR6 (AA-size) alkaline × 6	2.0 sec.	300/2.0 – 30 sec.
	1.5 V FR6 (AA-size) lithium × 6	2.2 sec.	550/2.2 – 120 sec.
	1.2 V HR6 (AA-size) rechargeable Ni-MH (2600 mAh) × 6	1.5 sec.	260/1.5 – 30 sec.
	1.2 V HR6 (AA-size) rechargeable Ni-MH (eneloop) × 6	1.5 sec.	250/1.5 – 30 sec.

*¹ The Speedlight fires at full output once every 30 seconds (120 seconds with lithium batteries).

*² The same type of batteries used with both the SB-910 and the external power source

*³ 1.5 V LR6 (AA-size) alkaline batteries used with the SB-910

*⁴ 1.2 V HR6 (AA-size) rechargeable Ni-MH batteries (2600 mAh) used with the SB-910

*⁵ 1.2 V HR6 (AA-size) rechargeable Ni-MH batteries (eneloop) used with the SB-910

- With fresh batteries. Performance may vary depending on remaining battery power or battery specifications.
- When the SB-910 is used with the SD-8A or SK-6/SK-6A, the modeling illuminator lights up using power provided only by the batteries in the SB-910 and not from the SD-8A or SK-6/SK-6A. This is not a malfunction.

Specifications

Electronic construction	Automatic Insulated Gate Bipolar Transistor (IGBT) and series circuitry
Guide number (at 35 mm zoom head position, in FX format, standard illumination pattern, 20 °C/68 °F)	34/111.5 (ISO 100, m/ft), 48/157.5 (ISO 200, m/ft)
Effective flash output distance range (in i-TTL, auto aperture flash or non-TTL auto flash mode)	0.6 m to 20 m (2 ft to 66 ft) (varies depending on camera's image area setting, illumination pattern, ISO sensitivity, zoom head position, and lens aperture in use)
Illumination pattern	There are three illumination patterns: standard, even, center-weighted The light distribution angle is automatically adjusted to the camera's image area in both FX and DX formats
Available flash mode	<ul style="list-style-type: none">• i-TTL• Auto aperture flash• Non-TTL auto flash• Distance-priority manual flash• Manual flash• Repeating flash
Other available functions	Test firing, monitor pre-flashes, AF-assist illumination for multi-point AF and modeling illumination
Nikon Creative Lighting System	A number of flash operations are available with compatible cameras: i-TTL mode, Advanced Wireless Lighting, FV lock, flash color information communication, auto FP high-speed sync and AF-assist illumination for multi-point AF
Multiple flash-unit photography operation	<ul style="list-style-type: none">• Advanced Wireless Lighting• SU-4 type wireless multiple flash-unit photography
Flash exposure control set on the camera	Camera's sync modes: slow sync, red-eye reduction slow sync, front-curtain sync, rear-curtain sync, rear-curtain slow sync Photography functions: auto FP high-speed sync, FV lock, red-eye reduction

Bounce capability	Flash head tilts down to 7° or up to 90° with click-stops at -7°, 0°, 45°, 60°, 75°, 90° Flash head rotates horizontally 180° to the left and right with click-stops at 0°, 30°, 60°, 75°, 90°, 120°, 150°, 180°
Power ON/OFF	Rotate the power switch/wireless mode switch for multiple flash units to turn the SB-910 on or off Standby function can also be set
Power source	Use four AA-size batteries of the same brand from any of the following types: <ul style="list-style-type: none"> • 1.5 V LR6 (AA-size) alkaline batteries • 1.5 V FR6 (AA-size) lithium batteries • 1.2 V HR6 (AA-size) rechargeable Ni-MH batteries For minimum number of flashes and recycling time for each battery type, see H-21
Flash-ready indicator	The SB-910 is fully recycled: lights up Insufficient flash output for correct exposure (in i-TTL, auto aperture flash, non-TTL auto flash or distance-priority manual flash mode): blinks
Flash-ready indicator (in remote mode)	The SB-910 is fully recycled: blinks Insufficient flash output for correct exposure (in i-TTL, auto aperture flash or non-TTL auto flash mode, or AUTO mode in SU-4 type wireless multiple flash-unit photography): blinks
Flash duration (approx.)	1/880 sec. at M1/1 (full) output 1/1100 sec. at M1/2 output 1/2550 sec. at M1/4 output 1/5000 sec. at M1/8 output 1/10000 sec. at M1/16 output 1/20000 sec. at M1/32 output 1/35700 sec. at M1/64 output 1/38500 sec. at M1/128 output
Mounting foot lock lever	Provides secure attachment of the SB-910 to camera's accessory shoe using locking plate and locking pin to prevent unintentional detachment

Specifications

Flash compensation	-3.0 EV to +3.0 EV in increments of 1/3 EV steps in i-TTL, auto aperture flash, non-TTL auto flash or distance-priority manual flash mode
Custom settings	19 items
Other functions	ISO sensitivity manual setting, redisplay of underexposure amount from insufficient flash output in i-TTL mode, reset to the default settings, key lock, thermal cut-out, firmware update
Dimensions (W × H × D)	Approx. 78.5 × 145 × 113 mm (3.1 × 5.7 × 4.4 in.)
Weight	Approx. 510 g (18 oz) (with four 1.5 V LR6 (AA-size) alkaline batteries) Approx. 420 g (14.8 oz) (Speedlight only)
Accessories supplied	Speedlight Stand AS-21, Nikon Diffusion Dome SW-13H, Fluorescent Filter SZ-2FL, Incandescent Filter SZ-2TN, Soft Case SS-910

- These performance specifications are applicable when fresh batteries are used at normal temperatures (20 °C/68 °F).
- Specifications and design are subject to change without any notice.
- Products and brand names are trademarks or registered trademarks of their respective companies.

Effective flash output distance range (for i-TTL mode, auto aperture flash mode, non-TTL auto flash mode)

The effective flash output distance range of the SB-910 is between 0.6 m and 20 m (2 ft and 66 ft). The effective flash output distance range differs depending on the camera's image area, illumination pattern, ISO sensitivity, zoom head position and aperture.

- The following table is for FX format and standard illumination pattern.
- The effective flash output distance range for each setting can be seen on the LCD panel.

■ In FX format, standard illumination pattern

Aperture (f)	ISO sensitivity								Zoom head position (mm)																Effective flash output distance range (m)
	12800	6400	3200	1600	800	400	200	100	14BA/WP	14BA	14WP	17	18	20	24	28	35	50	70	85	105	120	135	180	
4	2.8	2	1.4						2.3-2.0	2.9-2.0	3.1-2.0	3.9-2.0	4.1-2.0	4.3-2.0	4.8-2.0	5.4-2.0	6.1-2.0	7.1-2.0	7.8-2.0	8.2-2.0	8.7-2.0	9-2.0	9.1-2.0	9.2-2.0	9.4-2.0
5.6	4	2.8	2	1.4					1.7-2.0	2-2.0	2.2-2.0	2.8-2.0	2.9-2.0	3-2.0	3.4-2.0	3.8-2.0	4.3-2.0	5-2.0	5.5-2.0	5.8-2.0	6.2-2.0	6.4-2.0	6.4-2.0	6.5-2.0	6.7-2.0
8	5.6	4	2.8	2	1.4				1.2-1.8	1.5-2.0	1.6-2.0	2-2.0	2.1-2.0	2.2-2.0	2.4-2.0	2.7-2.0	3.1-2.0	3.6-2.0	3.9-2.0	4.1-2.0	4.4-2.0	4.5-2.0	4.6-2.0	4.6-2.0	4.7-2.0
11	8	5.6	4	2.8	2	1.4			0.9-1.3	1-1.6	1.1-1.7	1.4-2.0	1.5-2.0	1.5-2.0	1.7-2.0	1.9-2.0	2.2-2.0	2.5-2.0	2.8-2.0	2.9-2.0	3.1-2.0	3.2-2.0	3.2-2.0	3.3-2.0	3.4-2.0
16	11	8	5.6	4	2.8	2	1.4		0.6-9.1	0.8-11.3	0.8-12	1-15.5	1.1-16.2	1.1-16.9	1.2-19	1.4-20	1.6-20	1.8-20	2-20	2.1-20	2.2-20	2.3-20	2.3-20	2.3-20	2.4-20
22	16	11	8	5.6	4	2.8	2		0.6-6.5	0.6-8	0.6-8.5	0.7-11	0.8-11.5	0.8-12	0.9-13.5	1-15	1.1-17	1.3-20	1.4-20	1.5-20	1.6-20	1.6-20	1.6-20	1.7-20	1.7-20
32	22	16	11	8	5.6	4	2.8		0.6-4.5	0.6-5.6	0.6-6	0.6-7.7	0.6-8.1	0.6-8.4	0.6-9.5	0.7-10.6	0.8-12	0.9-14.1	1-15.5	1.1-16.2	1.1-17.3	1.2-17.8	1.2-18	1.2-18.3	1.2-18.7
	32	22	16	11	8	5.6	4		0.6-3.2	0.6-4	0.6-4.2	0.6-5.5	0.6-5.7	0.6-6	0.6-6.7	0.6-7.5	0.6-8.5	0.6-10	0.7-11	0.7-11.5	0.8-12.2	0.8-12.6	0.8-12.7	0.9-13	0.9-13.2
		32	22	16	11	8	5.6		0.6-2.2	0.6-2.8	0.6-3	0.6-3.8	0.6-4	0.6-4.2	0.6-4.7	0.6-5.3	0.6-6	0.6-7	0.6-7.7	0.6-8.1	0.6-8.6	0.6-8.9	0.6-9	0.6-9.1	0.6-9.3
			32	22	16	11	8		0.6-1.6	0.6-2	0.6-2.1	0.6-2.7	0.6-2.8	0.6-3	0.6-3.3	0.6-3.7	0.6-4.2	0.6-5	0.6-5.5	0.6-5.7	0.6-6.1	0.6-6.3	0.6-6.3	0.6-6.5	0.6-6.6
				32	22	16	11		0.6-1.1	0.6-1.4	0.6-1.5	0.6-1.9	0.6-2	0.6-2.1	0.6-2.3	0.6-2.6	0.6-3	0.6-3.5	0.6-3.8	0.6-4	0.6-4.3	0.6-4.4	0.6-4.5	0.6-4.5	0.6-4.6
					32	22	16		0.6-0.8	0.6-0.9	0.6-1	0.6-1.3	0.6-1.4	0.6-1.5	0.6-1.6	0.6-1.8	0.6-2.1	0.6-2.5	0.6-2.7	0.6-2.8	0.6-3	0.6-3.1	0.6-3.1	0.6-3.2	0.6-3.3
						32	22		0.6	0.6-0.7	0.6-0.7	0.6-0.9	0.6-1	0.6-1	0.6-1.1	0.6-1.3	0.6-1.5	0.6-1.7	0.6-1.9	0.6-2	0.6-2.1	0.6-2.2	0.6-2.2	0.6-2.2	0.6-2.3
							32		0.6	0.6	0.6	0.6	0.6-0.7	0.6-0.7	0.6-0.8	0.6-0.9	0.6-1	0.6-1.2	0.6-1.3	0.6-1.4	0.6-1.5	0.6-1.5	0.6-1.6	0.6-1.6	0.6-1.6

BA: With the Nikon Diffusion Dome attached
 WP: With the built-in wide panel in place

Specifications

Angle of coverage (in FX format)

Zoom head position set	Angle of coverage (°)	
	Vertical	Horizontal
12 (BA/WP) ^{*1}	120	130
14 (BA/WP) ^{*2}	110	120
17 (BA/WP) ^{*3}	100	110
17 ^{*4}	77	96
18 ^{*4}	74	93
20 ^{*4}	69	87
24	60	78
28	53	70
35	45	60
50	34	46
70	26	36
85	23	31
105	20	27
120	18	25
135	17	24
180 ^{*5}	15	21
200 ^{*5}	14	20

Angle of coverage (in DX format)

Zoom head position set	Angle of coverage (°)	
	Vertical	Horizontal
8 (BA/WP) ^{*1}	120	130
10 (BA/WP) ^{*2}	110	120
11 (BA/WP) ^{*3}	100	110
12 ^{*4}	74	93
14 ^{*4}	66	85
16	60	78
17	57	75
18	55	72
20	50	67
24	44	58
28	39	52
35	32	44
50	25	34
70	20	27
85	17	24
105 ^{*5}	16	22
120 ^{*5}	15	21
135 ^{*5}	14	20
180 ^{*5}	13	19
200 ^{*5}	13	18

BA: With the Nikon Diffusion Dome attached

WP: With the built-in wide panel in place

*1 Center-weighted illumination pattern

*2 Standard illumination pattern

*3 Even illumination pattern

*4 Standard or center-weighted illumination pattern

*5 Standard or even illumination pattern

Guide number table

The SB-910 guide numbers differ depending on the camera's image area, illumination pattern, ISO sensitivity, zoom head position and flash output level.

ISO 100; m

Zoom head position (mm)	FX format			DX format		
	Standard illumination	Even illumination	Center-weighted illumination	Standard illumination	Even illumination	Center-weighted illumination
8 (BA+WP)	–	–	–	–	–	13
8 (BA)	–	–	–	–	–	16
8 (WP)	–	–	–	–	–	17
10 (BA+WP)	–	–	–	13	–	–
10 (BA)	–	–	–	16	–	–
10 (WP)	–	–	–	17	–	–
11 (BA+WP)	–	–	–	–	13	–
11 (BA)	–	–	–	–	16	–
11 (WP)	–	–	–	–	17	–
12 (BA+WP)	–	–	13	–	–	–
12 (BA)	–	–	16	–	–	–
12 (WP)	–	–	17	–	–	–
12	–	–	–	23	–	26
14 (BA+WP)	13	–	–	–	–	–
14 (BA)	16	–	–	–	–	–
14 (WP)	17	–	–	–	–	–
14	–	–	–	25	–	29
16	–	–	–	27	22	32
17 (BA+WP)	–	13	–	–	–	–
17 (BA)	–	16	–	–	–	–
17 (WP)	–	17	–	–	–	–
17	22	–	25	29	23	33
18	23	–	26	30	24	34
20	24	–	27	31	25	36
24	27	22	32	34	32	39
28	30	24	36	36	33	42.5
35	34	31	39	40	37	46
50	40	36	45	45	43	49.5
70	44	41	49	49	47	52
85	46	44	51.5	50.5	49	54.5
105	49	47	52	51.5	50	–
120	50.5	48	53.5	52	51	–
135	51	49	54.5	53	51.5	–
180	52	51	–	53.5	52	–
200	53	51.5	–	54	52.5	–

BA: With the Nikon Diffusion Dome attached

WP: With the built-in wide panel in place

Specifications

Guide number table (in FX format)

Standard illumination pattern, at ISO 100; m/ft

Flash output level	Zoom head position (mm)																
	14			17	18	20	24	28	35	50	70	85	105	120	135	180	200
	WP +BA	BA	WP														
1/1	13/42.7	16/52.5	17/55.8	22/72.2	23/75.5	24/78.7	27/88.6	30/98.4	34/111.5	40/131.2	44/144.4	46/150.9	49/160.8	50.5/165.7	51/167.3	52/170.6	53/173.9
1/2	9.1/29.9	11.3/37.1	12/39.4	15.5/50.9	16.2/53.1	16.9/55.4	19/62.3	21.2/69.6	24/78.7	28.2/92.5	31.1/102	32.5/106.6	34.6/113.5	35.7/117.1	36/118.1	36.7/120.4	37.4/122.7
1/4	6.5/21.3	8/26.2	8.5/27.9	11/36.1	11.5/37.7	12/39.4	13.5/44.3	15/49.2	17/55.8	20/65.6	22/72.2	23/75.5	24.5/80.4	25.2/82.7	25.5/83.7	26/85.3	26.5/86.9
1/8	4.5/14.8	5.6/18.4	6/19.7	7.7/25.3	8.1/26.6	8.4/27.6	9.5/31.2	10.6/34.8	12/39.4	14.1/46.3	15.5/50.9	16.2/53.1	17.3/56.8	17.8/58.4	18/59.1	18.3/60	18.7/61.4
1/16	3.2/10.5	4/13.1	4.2/13.8	5.5/18	5.7/18.7	6/19.7	6.7/22	7.5/24.6	8.5/27.9	10/32.8	11/37.7	11.5/40	12.2/41.3	12.6/41.7	12.7/42.7	13/43.3	13.2/43.3
1/32	2.2/7.2	2.8/9.2	3/9.8	3.8/12.5	4/13.1	4.2/13.8	4.7/15.4	5.3/17.4	6/19.7	7/23	7.7/25.3	8.1/26.6	8.6/29.2	8.9/29.5	9/29.5	9.1/30.5	9.3/30.5
1/64	1.6/5.2	2/6.6	2.1/6.9	2.7/8.9	2.8/9.2	3/9.8	3.3/10.8	3.7/12.1	4.2/13.8	5/16.4	5.5/18.7	5.7/20	6.1/20.7	6.3/20.7	6.3/21.3	6.5/21.7	6.6/21.7
1/128	1.1/3.6	1.4/4.6	1.5/4.9	1.9/6.2	1.9/6.6	2/6.9	2.1/7.5	2.3/8.5	2.6/9.8	3/11.5	3.5/12.5	3.8/13.1	4/14.1	4.3/14.4	4.5/14.8	4.5/14.8	4.6/15.1

Guide number table (in DX format)

Standard illumination pattern, at ISO 100; m/ft

Flash output level	Zoom head position (mm)																			
	10			12	14	16	17	18	20	24	28	35	50	70	85	105	120	135	180	200
	WP +BA	BA	WP																	
1/1	13/42.7	16/52.5	17/55.8	23/75.5	25/82	27/88.6	29/95.1	30/98.4	31/101.7	34/111.5	36/118.1	40/131.2	45/147.6	49/160.8	50.5/165.7	51.5/169	52/170.6	53/173.9	53.5/175.5	54/177.2
1/2	9.1/29.9	11.3/37.1	12/39.4	16.2/53.1	17.6/57.7	19/62.3	20.5/67.3	21.2/69.6	21.9/71.8	24/78.7	25.4/83.3	28.2/92.5	31.8/104.3	34.6/113.5	35.7/117.1	36.4/119.4	36.7/120.4	37.4/122.7	37.8/124	38.1/125
1/4	6.5/21.3	8/26.2	8.5/27.9	11.5/37.7	12.5/41	13.5/44.3	14.5/47.6	15/49.2	15.5/50.9	17/55.8	18/59.1	20/65.6	22.5/73.8	24.5/80.4	25.2/82.7	25.7/84.3	26/85.3	26.5/86.9	26.7/87.6	27/88.6
1/8	4.5/14.8	5.6/18.4	6/19.7	8.1/26.6	8.8/28.9	9.5/31.2	10.2/33.5	10.6/34.8	10.9/35.8	12/39.4	12.7/41.7	14.1/46.3	15.9/52.2	17.3/56.8	17.8/58.4	18.2/59.7	18.3/60	18.7/61.4	18.9/62	19/62.3
1/16	3.2/10.5	4/13.1	4.2/13.8	5.7/18.7	6.2/20.3	6.7/22	7.2/23.6	7.5/24.6	7.7/25.3	8.5/27.9	9/29.5	10/32.8	11.2/36.7	12.2/40	12.6/41.3	12.8/42	12.8/42.7	13/43.3	13.2/43.3	13.5/44.3
1/32	2.2/7.2	2.8/9.2	3/9.8	4/13.1	4.4/14.4	4.7/15.4	5.1/16.7	5.3/17.4	5.4/17.7	6/19.7	6.3/20.7	7/23	7.9/25.9	8.6/28.2	8.9/29.2	9.1/29.9	9.1/29.9	9.3/30.5	9.4/30.8	9.5/31.2
1/64	1.6/5.2	2/6.6	2.1/6.9	2.8/9.2	3.1/10.2	3.3/10.8	3.6/11.8	3.7/12.1	3.8/12.5	4.2/13.8	4.5/14.8	5/16.4	5.6/18.4	6.1/20.7	6.3/21	6.4/21.3	6.5/21.7	6.6/21.7	6.6/22	6.7/22
1/128	1.1/3.6	1.4/4.6	1.5/4.9	2/6.6	2.2/7.2	2.3/7.5	2.5/8.2	2.6/8.5	2.7/8.9	3/9.8	3.1/10.2	3.5/11.5	3.9/12.8	4.3/14.1	4.4/14.4	4.5/14.8	4.5/14.8	4.6/15.1	4.7/15.4	4.7/15.4

BA: With the Nikon Diffusion Dome attached
 WP: With the built-in wide panel in place

Guide number table (for auto FP high-speed sync)

■ Standard illumination pattern, at ISO 100; m/ft (in FX format)

Flash output level	Zoom head position (mm)																		
	14			17	18	20	24	28	35	50	70	85	105	120	135	180	200		
	WP +BA	BA	WP																
1/1	4.7/15.4	5.8/19	6.2/20.3	8.1/26.6	8.5/27.9	8.8/28.9	10/32.8	11.1/36.4	12.6/41.3	14.8/48.6	16.3/53.5	17/55.8	18.1/59.4	18.7/61.4	18.9/62	19.2/63	19.6/64.3		
1/2	3.3/10.8	4.1/13.5	4.3/14.1	5.7/18.7	6/19.7	6.2/20.3	7/23	7.8/25.6	8.9/29.2	10.4/34.1	11.5/37.7	12/39.4	12.7/41.7	13.2/43.3	13.3/43.6	13.5/44.3	13.8/45.3		
1/4	2.3/7.5	2.9/9.5	3.1/10.2	4/13.1	4.2/13.8	4.4/14.4	5/16.4	5.5/18	6.3/20.7	7.4/24.3	8.1/26.6	8.5/27.9	9/29.5	9.3/30.5	9.4/30.8	9.6/31.5	9.8/32.2		
1/8	1.6/5.2	2/6.6	2.1/6.9	2.8/9.2	3/9.8	3.1/10.2	3.5/11.5	3.9/12.8	4.4/14.4	5.2/17.1	5.7/18.7	6/19.7	6.3/20.7	6.6/21.7	6.6/21.7	6.7/22	6.9/22.6		
1/16	1.1/3.6	1.4/4.6	1.5/4.9	2/6.6	2.1/6.9	2.2/7.2	2.5/8.9	2.7/10.2	3.1/12.1	3.7/14.8	4/15.4	4.2/16.1	4.5/17.5	4.7/18.7	4.8/19.7	4.9/21.1	5.1/16.1		
1/32	0.8/2.6	1/3.3	1/3.3	1.4/4.6	1.5/4.9	1.5/5.6	1.7/7.2	1.9/8.5	2.2/10.2	2.6/13.8	2.8/14.8	3/16.1	3.1/17.5	3.2/18.7	3.3/19.8	3.3/20.8	3.4/21.2		
1/64	0.5/1.6	0.7/2.3	0.7/2.3	1/3.3	1/3.3	1.1/3.6	1.2/4.3	1.3/4.9	1.5/5.6	1.8/6.6	2/7.2	2.1/7.5	2.2/8.1	2.3/8.7	2.3/9.1	2.4/9.7	2.4/10.1		
1/128	0.4/1.3	0.5/1.6	0.5/1.6	0.7/2.3	0.7/2.3	0.8/2.6	0.8/3	0.9/3.6	1.1/4.3	1.3/4.6	1.5/4.9	1.5/5.2	1.6/5.6	1.6/5.6	1.6/5.6	1.7/5.6	1.7/5.6		

■ Standard illumination pattern, at ISO 100; m/ft (in DX format)

Flash output level	Zoom head position (mm)																			
	10			12	14	16	17	18	20	24	28	35	50	70	85	105	120	135	180	200
	WP +BA	BA	WP																	
1/1	4.7/15.4	5.8/19	6.2/20.3	8.5/27.9	9.2/30.2	10/32.8	10.7/35.1	11.1/36.4	11.4/37.4	12.6/41.3	13.3/43.6	14.8/48.6	16.6/54.5	18.1/59.4	18.7/61.4	19/62.3	19.2/63	19.6/64.3	19.8/65	20/65.6
1/2	3.3/10.8	4.1/13.5	4.3/14.1	6/19.7	6.5/21.3	7/23	7.5/24.6	7.8/25.6	8/26.2	8.9/29.2	10.4/34.1	11.7/38.4	12.7/41.7	13.2/43.3	13.4/44	13.5/44.3	13.8/45.3	14/45.9	14.1/46.3	
1/4	2.3/7.5	2.9/9.5	3.1/10.2	4.2/13.8	4.6/15.1	5/16.4	5.3/17.4	5.5/18	5.7/20.7	6.3/21.7	7.4/24.3	8.3/27.2	9/29.5	9.3/30.5	9.5/31.2	9.6/31.5	9.8/32.2	9.9/32.5	10/32.8	
1/8	1.6/5.2	2/6.6	2.1/6.9	3/9.8	3.2/10.5	3.5/11.5	3.7/12.1	3.9/12.8	4/13.1	4.4/14.4	5.2/17.1	5.7/19	6.3/20.7	6.6/21.7	6.7/22	6.7/22	6.9/22.6	7/23	7/23	
1/16	1.1/3.6	1.4/4.6	1.5/4.9	2.1/6.9	2.3/7.5	2.5/8.2	2.6/8.5	2.7/8.9	2.8/9.2	3.1/10.2	3.3/11.1	3.7/12.1	4.1/13.5	4.5/14.8	4.6/15.1	4.7/15.4	4.8/16.1	4.9/16.1	5/16.4	
1/32	0.8/2.6	1/3.3	1/3.3	1.5/4.9	1.6/5.2	1.7/5.6	1.8/5.9	1.9/6.2	2/6.6	2.2/7.5	2.3/8.5	2.6/9.9	3.1/10.2	3.3/10.8	3.3/10.8	3.3/10.8	3.4/11.2	3.5/11.5	3.5/11.5	
1/64	0.5/1.6	0.7/2.3	0.7/2.3	1/3.3	1.1/3.6	1.2/3.9	1.3/4.3	1.3/4.6	1.4/4.9	1.5/5.2	1.6/5.6	1.8/6.6	2/7.5	2.2/8.1	2.3/8.7	2.3/9.1	2.4/9.7	2.4/10.1	2.5/10.7	
1/128	0.4/1.3	0.5/1.6	0.5/1.6	0.7/2.3	0.8/2.6	0.8/2.6	0.9/3	0.9/3	1/3.3	1.1/3.6	1.3/4.3	1.5/4.9	1.6/5.2	1.6/5.2	1.6/5.2	1.6/5.2	1.6/5.6	1.7/5.6	1.7/5.6	

- Guide numbers in the above tables are for when the SB-910 is used with a D3 camera with a 1/500 sec. shutter speed.
- Guide number for auto FP high-speed sync varies depending on the camera's shutter speed. For example, when the shutter speed is changed from 1/500 sec. to 1/1000 sec., the guide number decreases 1 step. The higher the shutter speed, the smaller the guide number.

BA: With the Nikon Diffusion Dome attached

WP: With the built-in wide panel in place

Specifications

■ Min. number of flashes/recycling time for each battery type

Batteries	Min. recycling time (approx.)*	Min. number of flashes* / recycling time*
LR6 (AA-size) alkaline (1.5 V)	4.0 sec.	110/4.0 – 30 sec.
FR6 (AA-size) lithium (1.5 V)	4.5 sec.	230/4.5 – 120 sec.
HR6 (AA-size) rechargeable Ni-MH (2600 mAh)	2.3 sec.	190/2.3 – 30 sec.
HR6 (AA-size) rechargeable Ni-MH (eneloop)	2.3 sec.	165/2.3 – 30 sec.

* When firing the Speedlight at full output once every 30 seconds (120 seconds with lithium batteries).

- While AF-assist illumination, power zoom and LCD panel illumination are off.
- With fresh batteries. Performance may vary depending on remaining battery power or battery specifications.

Index

- Refer to “Speedlight Parts” (B-1) for names of parts.

A

Accessories H-10
Advanced Wireless Lighting D-2, D-8
AF-assist illumination E-19
AF-ILL ONLY E-20
Amount of underexposure C-4
Angle of coverage H-17
Aperture C-3, H-4
AUTO (auto) mode D-14
Auto aperture flash mode C-5
Auto FP high-speed sync E-24

B

Batteries B-7, H-7
Bounce flash operation E-4
Bounce-down flash E-11
Built-in bounce card E-8
Built-in wide panel E-10

C

Canceling flash function E-20
Center-weighted (illumination pattern) E-2
Channel D-4
Close-up photography E-9
CLS A-6
CLS-compatible cameras A-4
CLS-compatible COOLPIX cameras G-1
Color compensation filter E-12
Color filter E-12
Color Filter Holder SZ-2 E-13, H-10
Color Filter Set SJ-3 H-10
Continuous flash firing B-6

COOLPIX G-1
CPU lens A-5
Custom settings B-13

D

Default settings A-6
Distance-priority manual flash mode C-12
DX format A-6, B-18

E

Effective flash output distance A-6
Effective flash output distance range A-6
Effective flash output distance range table H-15
EV (exposure value) A-8
Even (illumination pattern) E-2
External power source H-11

F

Filter detector E-14
Firmware update H-9
Firmware version B-20
Flash compensation E-17
Flash compensation value E-17
Flash function canceled D-14
Flash head B-9, E-4
Flash head tilting/rotating lock release button B-9, E-4
Flash mode B-11, C-1, D-4
Flash output level C-17, C-19
Flash-ready indicator B-11, D-20

Index

Flash-ready indicator (in remote mode).....D-20
Fluorescent filter.....E-12
Frequency of flash firings.....C-19
Front-curtain sync.....E-26
Full Menu.....B-16
Function button.....B-3
FV lock.....E-25
FX format.....A-6, B-18
FX/DX format (image area).....A-6

G

GN (distance-priority manual flash mode).....C-12
GN (guide number).....H-4
Group.....D-4
Guide number.....H-4
Guide number table.....H-18

H

Highlighted item.....B-12

I

Icons.....B-5
Illumination pattern.....E-2
Image area (FX/DX format).....A-6
Incandescent filter.....E-12
Insufficient flash output for correct exposure...C-4, C-7, C-10, C-13, D-20
ISO sensitivity.....C-3, E-21
ISO sensitivity factors.....H-4
i-TTL balanced fill-flash.....C-1
i-TTL mode.....C-1
i-TTL-compatible COOLPIX cameras.....G-1

K

Key lock.....B-4

L

LCD panel.....H-8
LCD panel illuminator.....H-8
Light sensor for non-TTL auto flash.....C-5, C-8
Light sensor window for wireless remote flash.....D-17
Lock release.....B-3
Low battery power indicator.....B-8

M

M (manual) mode.....D-14
Manual flash mode.....C-15
MASTER.....D-6
Master flash unit.....A-8, D-6, D-13
Master mode.....D-4, D-6, D-12
Menu button ([MENU] button).....B-13
Min. number of flashes.....H-21
Min. recycling time.....H-21
Mode button ([MODE] button).....B-3
Modeling illumination.....E-21
Monitor pre-flashes.....C-6, C-9
Mounting foot.....B-8
Mounting foot lock lever.....B-8
Multiple flash-unit photography.....D-1
My Menu.....B-15

N

Nikon Creative Lighting System (CLS).....A-6
Nikon Diffusion Dome.....E-6
Non-CLS-compatible SLR camera.....F-1

Non-TTL auto flash mode..... C-8
Number of flash firings C-19

O

OFF (flash function canceled)
mode..... D-14
OK button ([OK] button)B-3

P

Power switchB-3
Power zoom function.....E-18

R

Rear-curtain syncE-26
Recycling time..... H-21
Red-eye reduction.....E-25
Red-eye reduction slow syncE-25
REMOTE D-7
Remote flash unit..... A-8
Remote modeD-4, D-7
Repeating flash modeC-18, D-10
Replacing batteries.....B-7

S

Selector dialB-3
Slow sync.....E-25
Sound monitor..... D-20
Speedlight Stand AS-21 D-19
Standard (illumination pattern).....E-2
Standard i-TTL..... C-1
Standby functionE-22
Standby function settingB-18
SU-4 type wireless multiple
flash-unit photography.....D-3, D-12

T

Test firingE-21
Thermal cut-out.....E-23
TTL remote cord..... H-10
Two-button reset.....B-12

W

Warning indicator H-2
Water guard H-10
White balance.....E-15
Wireless mode switch for
multiple flash units.....D-6, D-7
Wireless multiple flash-unit
photography D-1
Wireless Slave Flash Controller
SU-4 H-10

Z

Zoom head positionE-18

Nikon

No reproduction in any form of this manual, in whole or in part (except for brief quotation in critical articles or reviews), may be made without written authorization from NIKON CORPORATION.



AMA14349

NIKON CORPORATION

Printed in Europe

© 2011 Nikon Corporation

TT5E05(11)
8MSA4511-05