

料号: 1.005.014.232

材质: 120g哑粉纸/四色印刷/风琴折叠/尺寸: 82*82mm

VEATOOL E3 User Manual

TRUE WIRELESS EARBUDS

Packing List

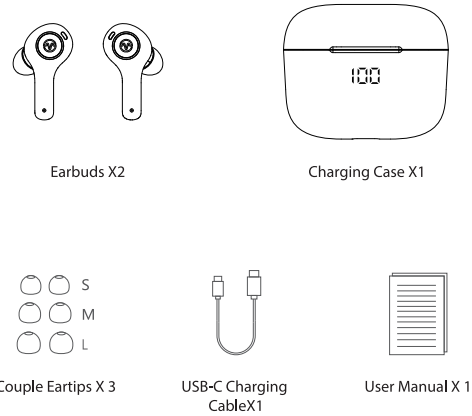

Note: The medium-sized eartips are pre-mounted on the earbuds.

01

Product Overview

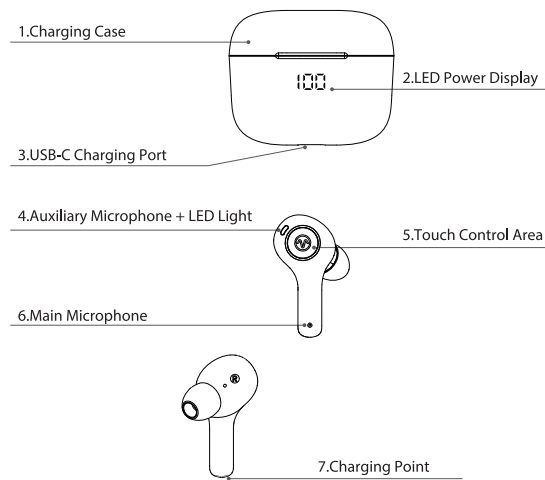

02

Wear

Step1: Choose the comfortable eartips



Step2: Wear it in ear and adjust to a comfortable position
(Please put the right and left headphones on the correct ear)



03

Power On

Auto Power On:
When opening the charging case and taking out the earphones.
The earphones will automatically turn on and start pairing.

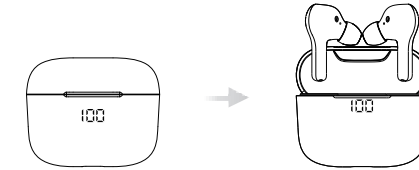

Manual Power On:
In the shutdown status and when the earphones are not in the charging case, press and hold the MFB of earbuds for 1.5 seconds to power on.

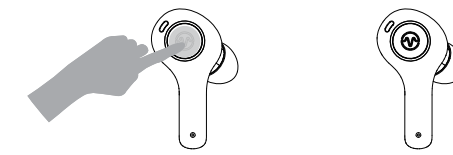

Note: When the pairing is successful, the red and white lights will be on for 2 second at the same time.

04

Power Off

Method 1
Put the earphones back in the charging case and close the case to turn them off.

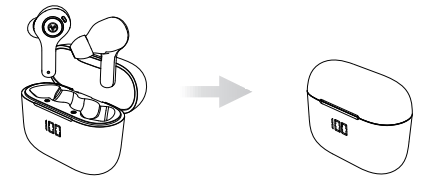

Method 2
If the earphones are not in the charging case, just press and hold the MFB of the earbuds for 3 seconds to power them off.



05

Pairing

Stereo Mode

Open the charging case and take out the earphones. They will automatically enter the pairing mode. In this mode, turn on the Bluetooth of the phone and select "VEATOOL E3".



Single Earbud Mode

1. Take one earbud (L/R) out from the charging case and close the case.
2. Turn on Bluetooth of your phone and choose "VEATOOL E3". Earbud can pair with your phone.

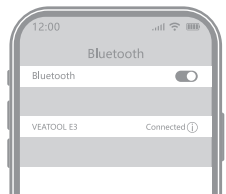

06

Phone Calls Control

Answer



Tap once (L/R)



Reject



Long-press (L/R) 2 sec



Hang Up



Double-tap (L/R)



Activate Siri



Triple-tap (L/R)



07

Music

Play/Pause



Tap once (L/R)



Previous Track



Double-tap (L)



Next Track



Double-tap (R)



Volume Up



Long-press (R)



Volume Down



Long-press (L)



08

Charging

Earbuds Charging

Put both earbuds into charging case and close case, earbuds are being charged and led power display on case will move.

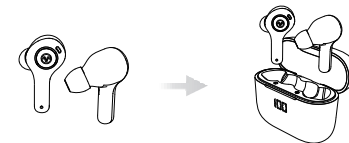

Charging for the case.

Method 1: Use USB C charging cable (Provided) to connect an adapter (not provided) your charging case.

Method 2: Put the charging case on wireless charger (not provided). Please keep Led power display facing up, case can be charged automatically.

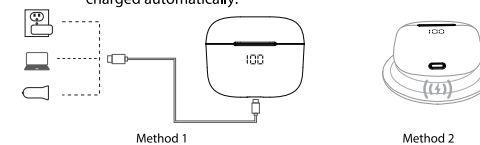

Note: for method 2, please place the charging case on the wireless charger until the LED power display flashes, which indicates case is being charged.

09

Safety Instruction

- Using earphone at high to moderate volumes for extended periods of time will result in permanent hearing damage. It is advised you keep volume levels moderate to low at times for your safety.
- Do not use while driving a car, cycling, operating machinery, or performing other activities that require hearing surrounding sounds.
- Do not use earphone in thunderstorm weather, the earphone may not work properly in the condition, and increase the risk of being hit by lightning.
- Earphone may not work properly under high temperature or high humidity conditions. Do not use any corrosive cleaner/oil to clean the earphone.
- If the earphone comes in contact with liquids, quickly wipe away.
- If submerged in water, do not turn the earphone on until completely dried. (Tips: liquid submersion voids the warranty.)
- Keep the earphone and packaging out of reach of children.
- Please use the original charging cable provided by the earphone manufacturer for charging and choose the.

10

FAQ

- Q: Why these earbuds can not pair with my mobile phones?
A: 1. Please make sure the earbuds are full charged and power on.
2. Please make sure the bluetooth of your phone is turned on.
3. If above 2 points have no problem, please put earbuds into the case again and close the case, hold on for 1min, then open the charging case and reconnect earbuds with your phone.
- Q: Why does the music cut in or cut out?
A: First, please do not let the distance between these earbuds and your phone more than 33 feet (without obstacle). If the distance is less than 33 feet, please note 2 tips as below:
1. Please make sure there is no obstacle between the earbuds and your device.
2. Please make sure there is no Microwave oven/Wifi transmitter around you, which are more likely to produce electromagnetic interference and result in signal interruption.
- Q: Why does the earbuds can not be charged and not disconnected with my phone even earbuds are put into case and I have closed the case?
A: Please make sure the charging case are not in low battery, earbuds can not be charged and not disconnected even though they are in case. So, please use the type-c cable to charge the case fully.
- Q: How to contact VEATOOL Customer service?
A: VEATOOL offers a one-year replacement warranty if there is an issue with your VEATOOL E3, please don't hesitate to contact us, we will reply within 24 hours and resolve it 100%.

Customer Support:
Email: E3@veatool.cn
Web: veatool.cn

11