



SmartLi 2.0

User Manual

Issue 07

Date 2021-03-22

Copyright © Huawei Technologies Co., Ltd. 2021. All rights reserved.

No part of this document may be reproduced or transmitted in any form or by any means without prior written consent of Huawei Technologies Co., Ltd.

Trademarks and Permissions



HUAWEI and other Huawei trademarks are trademarks of Huawei Technologies Co., Ltd.

All other trademarks and trade names mentioned in this document are the property of their respective holders.

Notice

The purchased products, services and features are stipulated by the contract made between Huawei and the customer. All or part of the products, services and features described in this document may not be within the purchase scope or the usage scope. Unless otherwise specified in the contract, all statements, information, and recommendations in this document are provided "AS IS" without warranties, guarantees or representations of any kind, either express or implied.

The information in this document is subject to change without notice. Every effort has been made in the preparation of this document to ensure accuracy of the contents, but all statements, information, and recommendations in this document do not constitute a warranty of any kind, express or implied.

Huawei Technologies Co., Ltd.

Address: Huawei Industrial Base
Bantian, Longgang
Shenzhen 518129
People's Republic of China

Website: <https://e.huawei.com>

About This Document

Purpose

This document describes the SmartLi in terms of its features, performance specifications, working principles, appearance, structure, installation, and operation and maintenance (O&M).



Intended Audience



This document is intended for:

- Sales engineers
- Technical support engineers
- System engineers
- Hardware installation engineers
- Commissioning engineers
- Data configuration engineers
- Maintenance engineers

Symbol Conventions

The symbols that may be found in this document are defined as follows.

Symbol	Description
	Indicates a hazard with a high level of risk which, if not avoided, will result in death or serious injury.
	Indicates a hazard with a medium level of risk which, if not avoided, could result in death or serious injury.
	Indicates a hazard with a low level of risk which, if not avoided, could result in minor or moderate injury.

Symbol	Description
 NOTICE	Indicates a potentially hazardous situation which, if not avoided, could result in equipment damage, data loss, performance deterioration, or unanticipated results. NOTICE is used to address practices not related to personal injury.
 NOTE	Supplements the important information in the main text. NOTE is used to address information not related to personal injury, equipment damage, and environment deterioration.

Change History

Changes between document issues are cumulative. The latest document issue contains all the changes made in earlier issues.

Issue 07 (2021-03-22)

- Updated the requirements on the extinguishant charging pressure of the fire cylinder.
- Added the description about communications port mapping.
- Added the appearance and technical specifications in the 7+7 and 7+0 scenarios.

Issue 06 (2021-01-10)

- Added the transportation requirements and the descriptions about storage and recharge.
- Updated the fuse specifications.

Issue 05 (2020-11-20)

Deleted the description about the combiner cabinet.

Issue 04 (2020-09-28)

Updated the safety information.

Issue 03 (2020-08-07)

Added the description about the combiner cabinet.

Issue 02 (2020-05-17)

Updated related descriptions.

Issue 01 (2019-11-29)

This issue is the first official release.

Contents

About This Document.....	ii
1 Safety Information.....	1
1.1 General Safety.....	1
1.2 Personnel Requirements.....	4
1.3 Electrical Safety.....	4
1.4 Installation Environment Requirements.....	6
1.5 Mechanical Safety.....	8
1.6 Battery Safety.....	10
1.7 Others.....	13
2 Overview.....	14
2.1 Positioning and Features.....	14
2.1.1 Positioning.....	14
2.1.2 Features.....	14
2.2 Application Scenarios.....	15
2.3 Model Number Description.....	16
2.4 Overview.....	17
2.4.1 Appearance.....	17
2.4.2 Structure.....	18
2.4.3 Battery Module.....	19
2.4.4 BCU.....	21
2.4.5 Monitoring Interface Unit.....	22
2.4.6 MDU.....	24
2.4.7 Fire Detection and Extinguishing Equipment.....	26
2.5 Optional Component.....	27
2.5.1 Fire Extinguishing Cabinet.....	27
3 Installation.....	31
3.1 Installation Preparations.....	31
3.1.1 Site.....	31
3.1.1.1 Installation Environment.....	31
3.1.1.2 Installation Clearances.....	31
3.1.2 Tools and Instruments.....	32
3.1.3 Preparing Power Cables.....	34

3.1.4 Unpacking and Checking.....	34
3.2 Installing a Fire Cylinder and Cabinets (Without a Fire Extinguishing Cabinet).....	35
3.2.1 Installing a Fire Cylinder.....	35
3.2.2 Installing Cabinets.....	40
3.3 Installing a Fire Cylinder and Cabinets (With a Fire Extinguishing Cabinet).....	43
3.3.1 Installing a Fire Cylinder.....	44
3.3.2 Installing Cabinets.....	48
3.4 Installing Cables.....	56
3.4.1 Cable Connection Reference.....	56
3.4.2 Installing a PE Cable.....	57
3.4.3 Installing Battery Modules and Cables.....	58
3.4.4 Remote EPO.....	65
3.4.5 Installing Output Cables.....	66
3.5 Installation Verification.....	71
4 User Interface.....	74
4.1 Login.....	74
4.2 LCD Interface.....	76
4.2.1 Main Menu Screen.....	76
4.2.2 System Status.....	77
4.2.2.1 Battery Cabinet.....	77
4.2.2.2 Runn Info.....	78
4.2.2.3 Alarms.....	81
4.2.2.4 Settings.....	82
4.2.2.5 Maintenance.....	88
4.2.2.6 About.....	89
4.2.3 Common Functions.....	90
4.3 WebUI.....	90
4.3.1 Home.....	90
4.3.2 Monitoring.....	91
4.3.3 Query.....	91
4.3.4 System Settings.....	92
4.3.5 Maintenance.....	92
5 Operations.....	93
5.1 Powering On Batteries.....	93
5.2 Powering Off Batteries.....	96
5.3 Performing EPO.....	97
5.4 Clearing the EPO State.....	97
5.5 Adding a SmartLi.....	98
5.6 Removing a SmartLi.....	100
5.7 Removing a Battery Module.....	102
5.8 Testing Batteries.....	105
5.8.1 Shallow Discharge Test.....	105

5.8.2 Capacity Test.....	107
5.8.3 Test Data Download.....	108
5.8.4 Low-Temperature Application.....	108
5.8.5 Storage with Low SOC.....	108
5.9 Exporting Data.....	109
6 Battery Recharge.....	111
6.1 Check Before Recharge.....	111
6.2 Battery Recharge Methods.....	111
7 Transportation and Storage.....	115
7.1 Transportation Requirements.....	115
7.2 Storage Requirements.....	116
8 Routine Maintenance.....	118
9 Troubleshooting.....	120
10 Parts Replacement.....	121
10.1 Replacing an MDU.....	121
10.2 Replacing a BCU.....	122
10.3 Replacing a Battery Module.....	123
10.4 Replacing a SmartLi Fuse.....	124
10.5 Upgrading Software.....	125
10.6 Replacing a Fire Cylinder (Without a Fire Extinguishing Cabinet).....	129
10.7 Replacing a Fire Cylinder (With a Fire Extinguishing Cabinet).....	136
11 Technical Specifications.....	142
A Alarm List.....	146
B Common Criteria.....	155
C Warranty Rules.....	157
D Acronyms and Abbreviations.....	159

1 Safety Information

1.1 General Safety

Statement

Before installing, operating, and maintaining the equipment, read this document and observe all the safety instructions on the equipment and in this document.

The "NOTICE", "CAUTION", "WARNING", and "DANGER" statements in this document do not cover all the safety instructions. They are only supplements to the safety instructions. Huawei will not be liable for any consequence caused by the violation of general safety requirements or design, production, and usage safety standards.

Ensure that the equipment is used in environments that meet its design specifications. Otherwise, the equipment may become faulty, and the resulting equipment malfunction, component damage, personal injuries, or property damage are not covered under the warranty.

Follow local laws and regulations when installing, operating, or maintaining the equipment. The safety instructions in this document are only supplements to local laws and regulations.

Huawei will not be liable for any consequences of the following circumstances:

- Operation beyond the conditions specified in this document
- Installation or use in environments which are not specified in relevant international or national standards
- Unauthorized modifications to the product or software code or removal of the product
- Failure to follow the operation instructions and safety precautions on the product and in this document
- Equipment damage due to force majeure, such as earthquakes, fire, and storms
- Damage caused during transportation by the customer
- Storage conditions that do not meet the requirements specified in this document

General Requirements

- Do not install, use, or operate outdoor equipment and cables (including but not limited to moving equipment, operating equipment and cables, inserting connectors to or removing connectors from signal ports connected to outdoor facilities, working at heights, and performing outdoor installation) in harsh weather conditions such as lightning, rain, snow, and level 6 or stronger wind.
- Before installing, operating, or maintaining the equipment, remove any conductive objects such as watches or metal jewelry like bracelets, bangles, and rings to avoid electric shock.
- When installing, operating, or maintaining the equipment, wear personal protective equipment such as insulation gloves, goggles, and safety clothing, helmet, and shoes, as shown in the following figure.

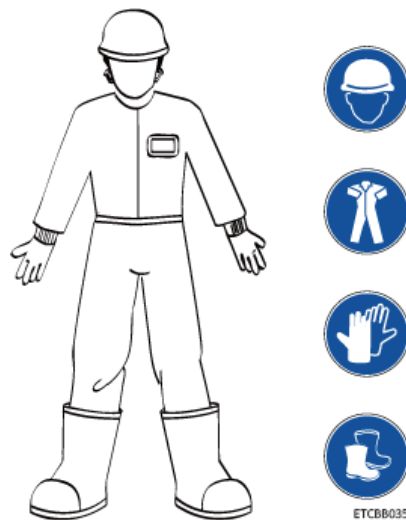

- Follow the specified procedures for installation, operation, and maintenance.
- Before handling a conductor surface or terminal, measure the contact point voltage and ensure that there is no risk of electric shock.
- After installing the equipment, remove idle packing materials such as cartons, foam, plastics, and cable ties from the equipment area.
- In the case of a fire, immediately leave the building or the equipment area, and turn on the fire alarm bell or make an emergency call. Do not enter the building on fire in any case.
- Do not stop using protective devices. Pay attention to the warnings, cautions, and related precautionary measures in this document and on the equipment. Promptly replace warning labels that have worn out.
- Keep irrelevant people away from the equipment. Only operators are allowed to access the equipment.
- Use insulated tools or tools with insulated handles, as shown in the following figure.

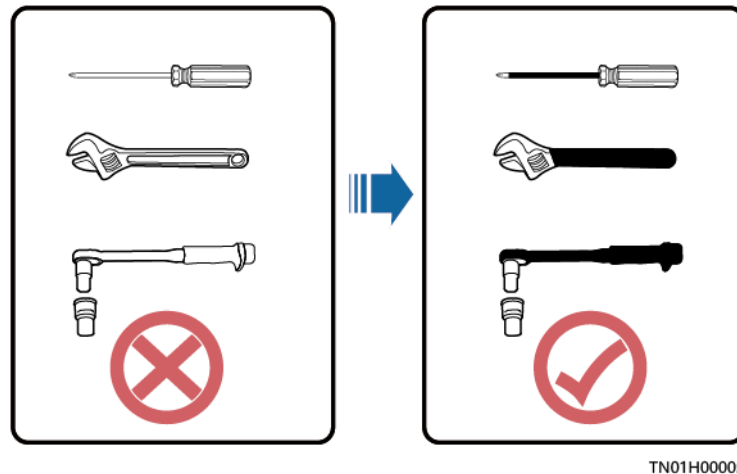

- All cable holes should be sealed. Seal the used cable holes with firestop putty. Seal the unused cable holes with the caps delivered with the cabinet. The following figure shows the criteria for correct sealing with firestop putty.

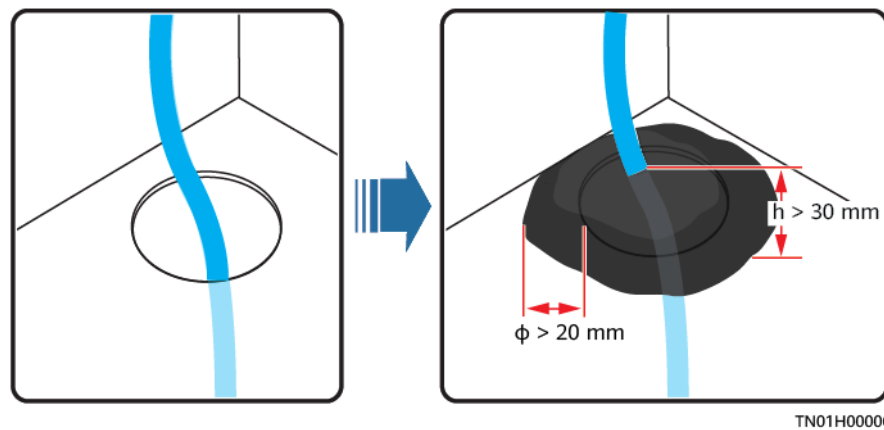

- Do not scrawl, damage, or block any warning label on the equipment.
- When installing devices, use a torque wrench with a proper measurement range to tighten bolts. Ensure that the wrench is not skewed and the torque error does not exceed 10%.
- Do not work with power on during installation.
- Repaint any paint scratches caused during equipment transportation or installation in a timely manner. Equipment with scratches cannot be exposed to an outdoor environment for a long period of time.
- Before operations, ensure that the equipment is firmly secured to the floor or other solid objects, such as a wall or an installation rack.
- Do not use water to clean electrical components inside or outside of a cabinet.
- Do not change the structure or installation sequence of equipment without permission.
- Do not touch a running fan with your fingers, components, screws, tools, or boards before the fan is powered off or stops running.

Personal Safety

- If there is a probability of personal injury or equipment damage during operations on the equipment, immediately stop the operations, report the case to the supervisor, and take feasible protective measures.
- To avoid electric shock, do not connect safety extra-low voltage (SELV) circuits to telecommunication network voltage (TNV) circuits.
- Do not power on the equipment before it is installed or confirmed by professionals.

1.2 Personnel Requirements

- Personnel who plan to install or maintain Huawei equipment must receive thorough training, understand all necessary safety precautions, and be able to correctly perform all operations.
- Only qualified professionals or trained personnel are allowed to install, operate, and maintain the equipment.
- Only qualified professionals are allowed to remove safety facilities and inspect the equipment.
- Personnel who will operate the equipment, including operators, trained personnel, and professionals, should possess the local national required qualifications in special operations such as high-voltage operations, working at heights, and operations of special equipment.
- Professionals: personnel who are trained or experienced in equipment operations and are clear of the sources and degree of various potential hazards in equipment installation, operation, maintenance
- Trained personnel: personnel who are technically trained, have required experience, are aware of possible hazards on themselves in certain operations, and are able to take protective measures to minimize the hazards on themselves and other people
- Operators: operation personnel who may come in contact with the equipment, except trained personnel and professionals
- Only professionals or authorized personnel are allowed to replace the equipment or components (including software).

1.3 Electrical Safety

Grounding

- For the equipment that needs to be grounded, install the ground cable first when installing the equipment and remove the ground cable last when removing the equipment.
- Do not damage the ground conductor.
- Do not operate the equipment in the absence of a properly installed ground conductor.
- Ensure that the equipment is connected permanently to the protective ground. Before operating the equipment, check its electrical connection to ensure that it is securely grounded.

General Requirements

Use dedicated insulated tools when performing high-voltage operations.

AC and DC Power

 DANGER

Do not connect or disconnect power cables with power on. Transient contact between the core of the power cable and the conductor will generate electric arcs or sparks, which may cause fire or personal injury.

- If a "high electricity leakage" tag is attached on the equipment, ground the protective ground terminal on the equipment enclosure before connecting the AC power supply; otherwise, electric shock as a result of electricity leakage may occur.
- Before installing or removing a power cable, turn off the power switch.
- Before connecting a power cable, check that the label on the power cable is correct.
- If the equipment has multiple inputs, disconnect all the inputs before operating the equipment.
- A circuit breaker equipped with a residual current device (RCD) is not recommended.
- A damaged power cable must be replaced by the manufacturer, service agent, or professionals to avoid risks.
- High voltage operations and installation of AC-powered facilities must be performed by qualified personnel.

Cabling

- When routing cables, ensure that a distance of at least 30 mm exists between the cables and heat-generating components or areas. This prevents damage to the insulation layer of the cables.
- Do not route cables behind the air intake and exhaust vents of the equipment.
- Ensure that cables meet the VW-1 or ZB flame spread rating requirements or higher.
- Bind cables of the same type together. When routing cables of different types, ensure that they are at least 30 mm away from each other.
- If an AC input power cable is connected to the cabinet from the top, bend the cable in a U shape outside the cabinet and then route it into the cabinet.
- When the temperature is low, violent impact or vibration may damage the plastic cable sheathing. To ensure safety, comply with the following requirements:
 - Cables can be laid or installed only when the temperature is higher than 0°C. Handle cables with caution, especially at a low temperature.
 - Cables stored at subzero temperatures must be stored at room temperature for at least 24 hours before they are laid out.

- Do not perform any improper operations, for example, dropping cables directly from a vehicle.
- When selecting, connecting, and routing cables, follow local safety regulations and rules.

ESD

NOTICE

The static electricity generated by human bodies may damage the electrostatic-sensitive components on boards, for example, the large-scale integrated (LSI) circuits.

- Wear ESD gloves or a well-grounded ESD wrist strap when touching the device or handling boards or application-specific integrated circuits (ASICs).
- When holding a board, hold its edge without touching any components. Do not touch the components with your bare hands.
- Package boards with ESD packaging materials before storing or transporting them.

Figure 1-1 Wearing an ESD wrist strap

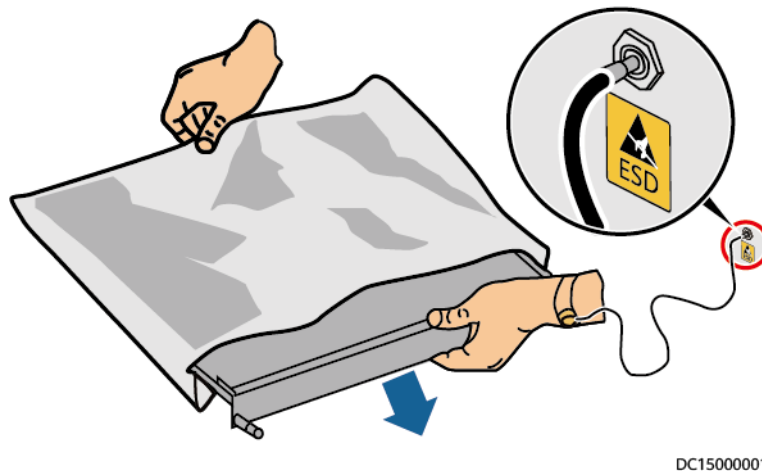

Neutral-Ground Voltage

It is recommended that the three-phase loads be equalized and the neutral-ground voltage be kept at less than 2 V to meet power distribution requirements.

1.4 Installation Environment Requirements

- To prevent fire due to high temperature, ensure that the ventilation vents or heat dissipation system are not blocked when the equipment is running.
- Install the equipment in an area far away from liquids. Do not install it under areas prone to condensation, such as under water pipes and air exhaust vents, or areas prone to water leakage, such as air conditioner vents, ventilation

vents, or feeder windows of the equipment room. Ensure that no liquid enters the equipment to prevent faults or short circuits.

- If any liquid is detected inside the equipment, immediately disconnect the power supply and contact the administrator.
- Do not expose the equipment to flammable or explosive gas or smoke. Do not perform any operation on the equipment in such environments.
- Ensure that the equipment room provides good heat insulation, and the walls and floor are dampproof.
- Install a rat guard at the door of the equipment room.

Installation at Heights

- Working at heights refers to operations that are performed at least 2 meters above the ground.
- Do not work at heights if the steel pipes are wet or other potential danger exists. After the preceding conditions no longer exist, the safety director and relevant technical personnel need to check the involved equipment. Operators can begin working only after obtaining consent.
- When working at heights, comply with local relevant laws and regulations.
- Only trained and qualified personnel are allowed to work at heights.
- Before working at heights, check the climbing tools and safety gears such as safety helmets, safety belts, ladders, springboards, scaffolding, and lifting equipment. If they do not meet the requirements, take corrective measures or disallow working at heights.
- Wear personal protective equipment such as the safety helmet and safety belt or waist rope and fasten it to a solid structure. Do not mount it on an insecure moveable object or metal object with sharp edges. Make sure that the hooks will not slide off.
- Set a restricted area and eye-catching signs for working at heights to warn away irrelevant personnel.
- Carry the operation machinery and tools properly to prevent them from falling off and causing injuries.
- Personnel involving working at heights are not allowed to throw objects from the height to the ground, or vice versa. Objects should be transported by tough slings, hanging baskets, highline trolleys, or cranes.
- Ensure that guard rails and warning signs are set at the edges and openings of the area involving working at heights to prevent falls.
- Do not pile up scaffolding, springboards, or other sundries on the ground under the area involving working at heights. Do not allow people to stay or pass under the area involving working at heights.
- Inspect the scaffolding, springboards, and workbenches used for working at heights in advance to ensure that their structures are solid and not overloaded.
- Any violations must be promptly pointed out by the site manager or safety supervisor and the involved personnel should be prompted for correction. Personnel who fail to stop violations will be forbidden from working.

1.5 Mechanical Safety

Hoisting Devices

- Do not walk under hoisted objects.
- Only trained and qualified personnel should perform hoisting operations.
- Check that hoisting tools are available and in good condition.
- Before hoisting objects, ensure that hoisting tools are firmly secured onto a load-bearing object or wall.
- Ensure that the angle formed by two hoisting cables is no more than 90 degrees, as shown in the following figure.

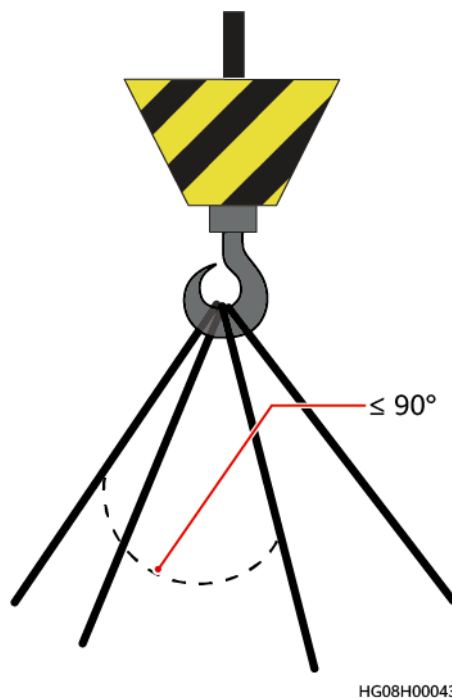

- Do not drag steel ropes and hoisting tools or bump hoisted objects against hard objects during hoisting.

Using Ladders

- Use wooden or fiberglass ladders when you need to perform live working at heights.
- When a step ladder is used, ensure that the pull ropes are secured and the ladder is held firm.
- Before using a ladder, check that it is intact and confirm its load bearing capacity. Do not overload it.
- Ensure that the ladder is securely positioned. The recommended angle for a ladder against the floor is 75 degrees, as shown in the following figure. An angle rule can be used to measure the angle. Ensure that the wider end of the ladder is at the bottom, or protective measures have been taken at the bottom to prevent the ladder from sliding.

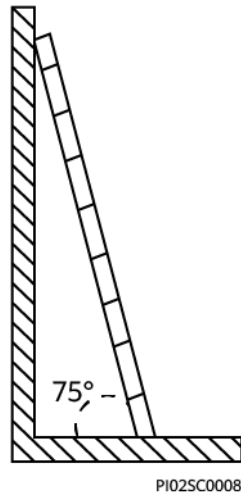

- When climbing a ladder, take the following precautions to reduce risks and ensure safety:
 - Keep your body steady.
 - Do not climb higher than the fourth rung of the ladder from the top.
 - Ensure that your body's center of gravity does not shift outside the legs of the ladder.

Drilling Holes

When drilling holes into a wall or floor, observe the following safety precautions:

NOTICE

Do not drill holes into the equipment. Doing so may affect the electromagnetic shielding of the equipment and damage components or cables inside. Metal shavings from drilling may short-circuit boards inside the equipment.

-
- Obtain the consent from the customer and subcontractor before drilling.
 - Wear goggles and protective gloves when drilling holes.
 - When drilling holes, protect the equipment from shavings. After drilling, clean up any shavings that have accumulated inside or outside the equipment.

Moving Heavy Objects

DANGER

When removing a heavy or unstable component from a cabinet, be aware of unstable or heavy objects on the cabinet.

-
- Be cautious to avoid injury when moving heavy objects.

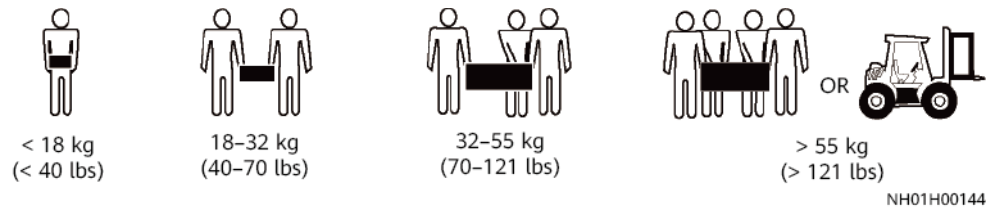

- When moving the equipment by hand, wear protective gloves to prevent injuries.
- Move or lift the equipment by holding its handles or lower edges. Do not hold the handles of modules (such as power supply units, fans, and boards) that are installed in the equipment because they cannot support the weight of the equipment.
- Avoid scratching the cabinet surface or damaging cabinet components and cables during equipment transportation.
- When transporting the equipment using a forklift truck, ensure that the forks are properly positioned to ensure that the equipment does not topple. Before moving the equipment, secure it to the forklift truck using ropes. When moving the equipment, assign dedicated personnel to take care of it.
- Choose railways, sea, or a road with good condition for transportation to ensure equipment safety. Avoid tilt or jolt during transportation.
- Move a cabinet with caution. Any bumping or falling may damage the equipment.

1.6 Battery Safety

Basic Requirements

Before operating batteries, carefully read the safety precautions for battery handling and master the correct battery connection methods.

 **DANGER**

- Do not expose batteries at high temperatures or around heat-generating devices, such as sunlight, fire sources, transformers, and heaters. Excessive heat exposure may cause the batteries to explode.
 - Do not burn batteries. Otherwise, the batteries may explode.
 - To avoid leakage, overheating, fire, or explosions, do not disassemble, alter, or damage batteries, for example, insert sundries into batteries or immerse batteries in water or other liquids.
-
- Wear goggles, rubber gloves, and protective clothing to prevent skin contact with electrolyte in the case of electrolyte overflow. If a battery leaks, protect the skin or eyes from the leaking liquid. If the skin or eyes come in contact with the leaking liquid, wash it immediately with clean water and go to the hospital for medical treatment.
 - Use dedicated insulated tools.
 - Move batteries in the required direction. Do not place a battery upside down or tilt it.

- Keep the battery loop disconnected during installation and maintenance.
- Use batteries of specified models. Using batteries of other models may damage the batteries.
- Dispose of waste batteries in accordance with local laws and regulations. Do not dispose of batteries as household waste. If a battery is disposed of improperly, it may explode.
- The site must be equipped with qualified fire extinguishing facilities, such as firefighting sands and powder fire extinguishers.

NOTICE

To ensure battery safety and battery management accuracy, use batteries provided with the UPS by Huawei. Huawei is not responsible for any battery faults caused by batteries not provided by Huawei.

Battery Installation

Before installing batteries, observe the following safety precautions:

- Install batteries in a well-ventilated, dry, and cool environment that is far away from heat sources, flammable materials, moistures, extensive infrared radiation, organic solvents, and corrosive gases. Take fire prevention measures.
- Place and secure batteries horizontally.
- Note the polarities when installing batteries. Do not short-circuit the positive and negative poles of the same battery or battery string. Otherwise, the battery may be short-circuited.
- Check battery connections periodically, ensuring that all bolts are securely tightened.
- When installing batteries, do not place installation tools on the batteries.

Battery Short Circuit

DANGER

Battery short circuits can generate high instantaneous current and release a great amount of energy, which may cause equipment damage or personal injury.

To avoid battery short-circuit, do not maintain batteries with power on.

Flammable Gas

NOTICE

- Do not use unsealed lead-acid batteries.
- To prevent fire or corrosion, ensure that flammable gas (such as hydrogen) is properly exhausted for lead-acid batteries.

Lead-acid batteries emit flammable gas when used. Ensure that batteries are kept in a well-ventilated area and take preventive measures against fire.

Battery Leakage

NOTICE

Battery overheating causes deformation, damage, and electrolyte spillage.



WARNING

When the electrolyte overflows, absorb and neutralize the electrolyte immediately. When moving or handling a battery whose electrolyte leaks, note that the leaking electrolyte may hurt human bodies.

-
- If the battery temperature exceeds 60°C, check for and promptly handle any leakage.
 - Electrolyte overflow may damage the equipment. It will corrode metal parts and boards, and ultimately damage the boards.
 - If the electrolyte overflows, follow the instructions of the battery manufacturer or neutralize the electrolyte by using sodium bicarbonate (NaHCO₃) or sodium carbonate (Na₂CO₃).

Lithium Battery

The safety precautions for lithium batteries are similar to those for lead-acid batteries except that you also need to note the precautions described in this section.



WARNING

There is a risk of explosion if a battery is replaced with an incorrect model.

-
- A battery can be replaced only with a battery of the same or similar model recommended by the manufacturer.
 - When handling a lithium battery, do not place it upside down, tilt it, or bump it with other objects.

- Keep the lithium battery loop disconnected during installation and maintenance.
- Do not charge a battery when the ambient temperature is below the lower limit of the operating temperature (charging is forbidden at 0°C). Low-temperature charging may cause crystallization, which will result in a short circuit inside the battery.
- Use batteries within the allowed temperature range; otherwise, the battery performance and safety will be compromised.
- Do not throw a lithium battery in fire.
- When maintenance is complete, return the waste lithium battery to the maintenance office.

1.7 Others

- This is a category C3 product for commercial and industrial application in the second environment – installation restrictions or additional measures may be needed to prevent disturbances.
- Exercise caution when manually shutting down the UPS inverter for transferring to bypass mode, or when adjusting the UPS output voltage level or frequency. Doing so may affect the power supply to equipment.
- Exercise caution when setting battery parameters. Incorrect settings will affect the power supply and battery lifespan.

2 Overview

The SmartLi provides lithium battery backup power for medium- and high-power UPSs. It is compatible with UPSs with or without a battery neutral wire. The lithium battery cabinet supports power backup, battery management, and intelligent current management. When multiple battery strings are connected in parallel, the output of each battery string is balanced and reliable protection is achieved.

2.1 Positioning and Features

2.1.1 Positioning

The SmartLi is a battery energy storage system solution developed for Huawei UPS. The product provides cabinet-level battery management, and up to eight cabinets can be connected in parallel to meet the requirements for MW-level UPS backup power. The product uses lithium cells with superior charge and discharge characteristics and high cycle performance. The modular design of key components facilitates replacement and greatly reduces O&M costs.

The lithium battery system applies to the following scenarios:

- Large-sized data centers
- Small- and medium-sized data centers
- Rail transits
- State grids

2.1.2 Features

- Easy capacity expansion: Batteries can be added along with load increase by stages. New and old battery cabinets can be connected in parallel.
- Easy maintenance: Batteries can be swapped for maintenance due to the modular design.
- High cycle performance of cells: 25°C, 0.5C charging/1C discharging, 50% depth of discharge (DOD), 5000 cycles at 70% end of life (EOL).
- High reliability: Current equalization control technology is used for cabinets connected in parallel to keep current imbalance within 2%.

2.2 Application Scenarios

Single-Cabinet Scenario

Figure 2-1 Single-cabinet scenario

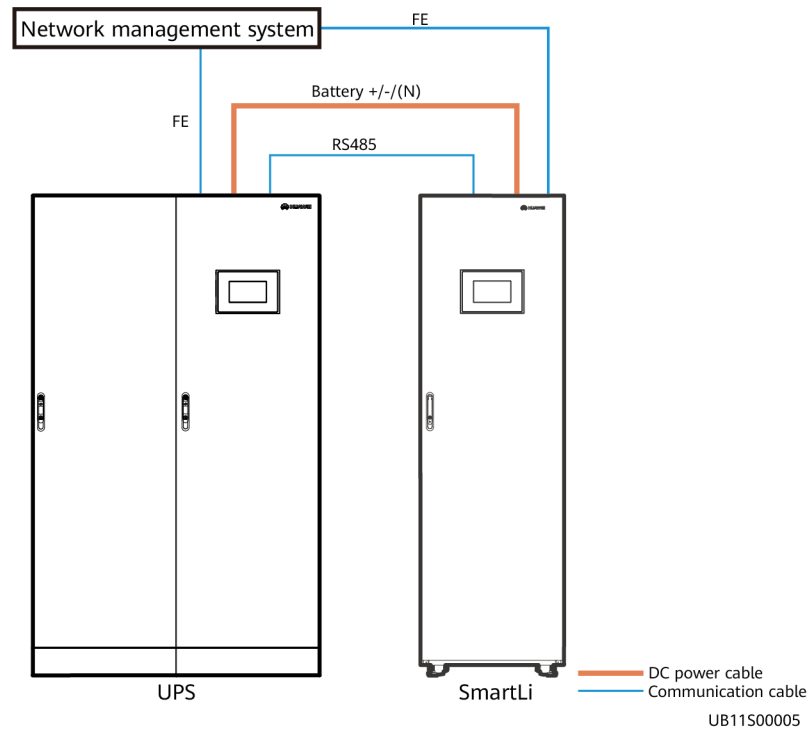

Multi-Cabinet Scenario

Figure 2-2 Multi-cabinet scenario

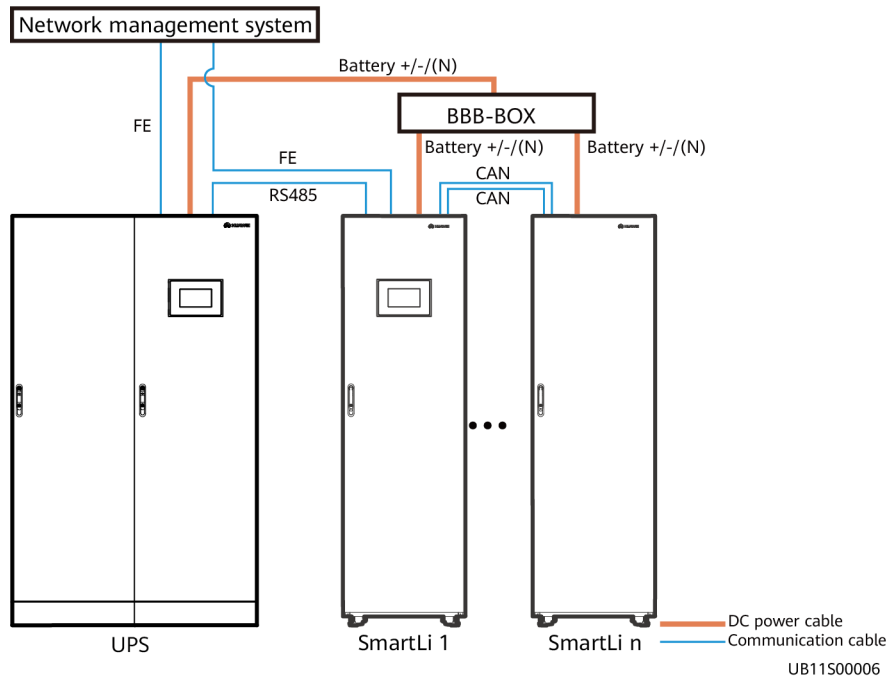

NOTE

- The SmartLi supports a maximum of eight cabinets connected in parallel.
- When multiple cabinets are connected in parallel, only the master cabinet has an LCD.

2.3 Model Number Description

Figure 2-3 Model number

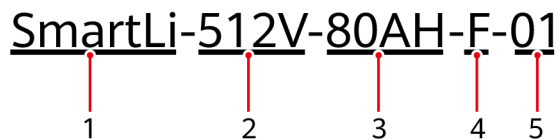

Table 2-1 Model number description

No.	Item	Description
1	Product category	SmartLi
2	Product subcategory	512 V
3	Capacity	80AH: battery capacity being 80 Ah

No.	Item	Description
4	Configuration type	<ul style="list-style-type: none"> • F: with an LCD (master cabinet) • S: without an LCD (slave cabinet)
5	Version	01

2.4 Overview

The SmartLi system consists of the battery modules, battery control unit (BCU), monitoring interface unit, power distribution unit (PDU), and monitoring display unit (MDU), which are integrated into a standard cabinet.

Battery modules are connected in series to provide energy. The BCU provides centralized battery management. The PDU connects power cables and disconnects the power circuit in case of exceptions. The MDU allows you to set parameters and query status.

When multiple battery cabinets are connected in parallel, the BCU balances the loads between cabinets to improve system reliability. The master battery cabinet provides an LCD that displays battery running information in real time and allows users to set battery parameters. Battery cabinets can connect to the UPS and network management system (NMS) for intelligent management.

2.4.1 Appearance

Figure 2-4 Appearance

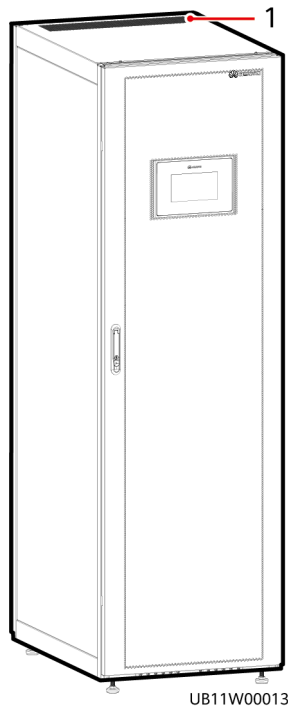

(1) Air vent

2.4.2 Structure

The battery cabinet consists of 16 or 14 battery modules, which are divided into two parallel strings. Eight or seven battery modules are connected in series in each string. The battery modules occupy the entire cabinet.

Alternatively, the battery cabinet can consist of eight or seven battery modules in one string. The battery modules occupy half of the entire cabinet.

Figure 2-5 Front view of a single cabinet

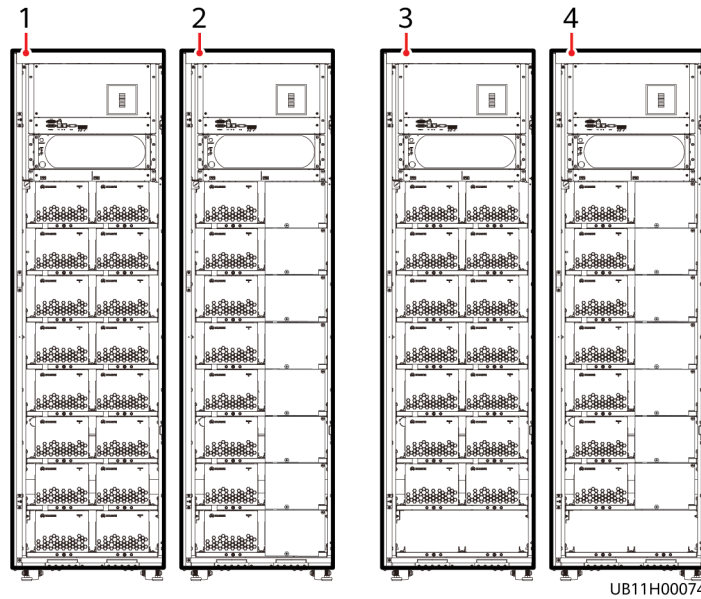

- (1) Full-capacity cabinet (8+8 scenario) (2) Half-capacity cabinet (8+0 scenario) (3) Full-capacity cabinet (7+7 scenario) (4) Half-capacity cabinet (7+0 scenario)

Figure 2-6 Structure of a single cabinet (full-capacity cabinet, using the 8+8 scenario as an example)

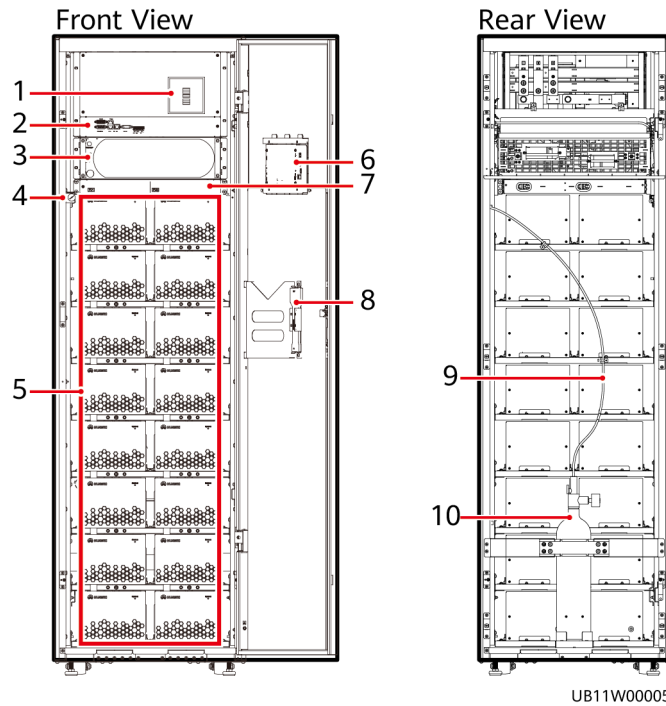

- | | | |
|-----------------------------|-------------------------------|--------------------------------|
| (1) Battery circuit breaker | (2) Monitoring interface unit | (3) Battery control unit (BCU) |
| (4) End pressure gauge | (5) Battery modules | (6) Monitor display unit (MDU) |
| (7) Fuse | (8) MCCB auxiliary lever | (9) Fire-trace tube |
| (10) Fire cylinder | | |

2.4.3 Battery Module

The battery module consists of 40 electrochemical cells (two connected in parallel and 20 connected in series).

The electrochemical cells are made of lithium iron phosphate.

All external ports of the module are located on its front panel for ease of installation and maintenance.

Figure 2-7 Battery module

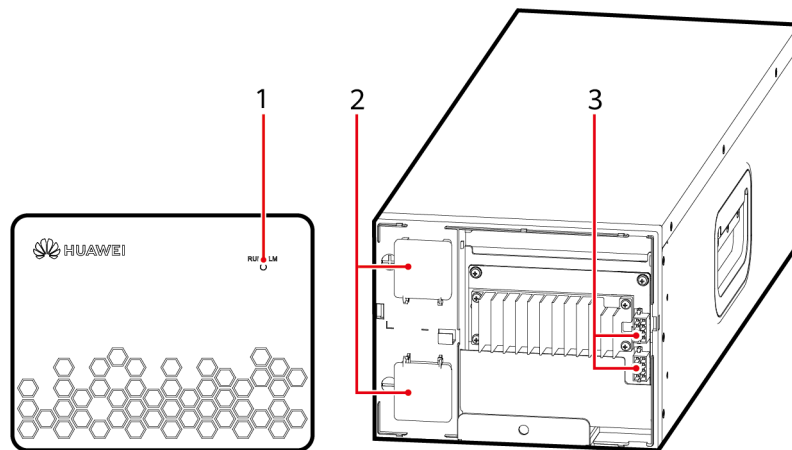

UB11W00002

(1) Running indicator

(2) Battery wiring terminals

(3) Battery communication cascading ports

Table 2-2 Indicator description

Indicator	Status	Color	Description
Indicator	On	Green	The battery module is normal.
		Red	The battery module is faulty.
	Off	-	The communications cable to the battery module is not connected.

Function

Each battery module has a built-in battery management unit (BMU) that monitors battery information such as voltage and temperature, provides relevant alarms, and manages battery balancing. The BMU provides the following functions:

- Battery voltage measurement and alarm
- Battery temperature measurement and alarm
- Battery voltage balancing
- CAN communication between battery modules

Specifications

- Dimensions (H x W x D): 157 mm x 200.5 mm x 592 mm
- Weight: ≤ 35 kg
- Rated voltage: 64 V
- Rated capacity: 40 Ah
- Rated discharge current: 240 A

2.4.4 BCU

The BCU is swappable and supports power conversion, current equalization, and BCU (intra-cabinet BMS) management.

Figure 2-8 BCU

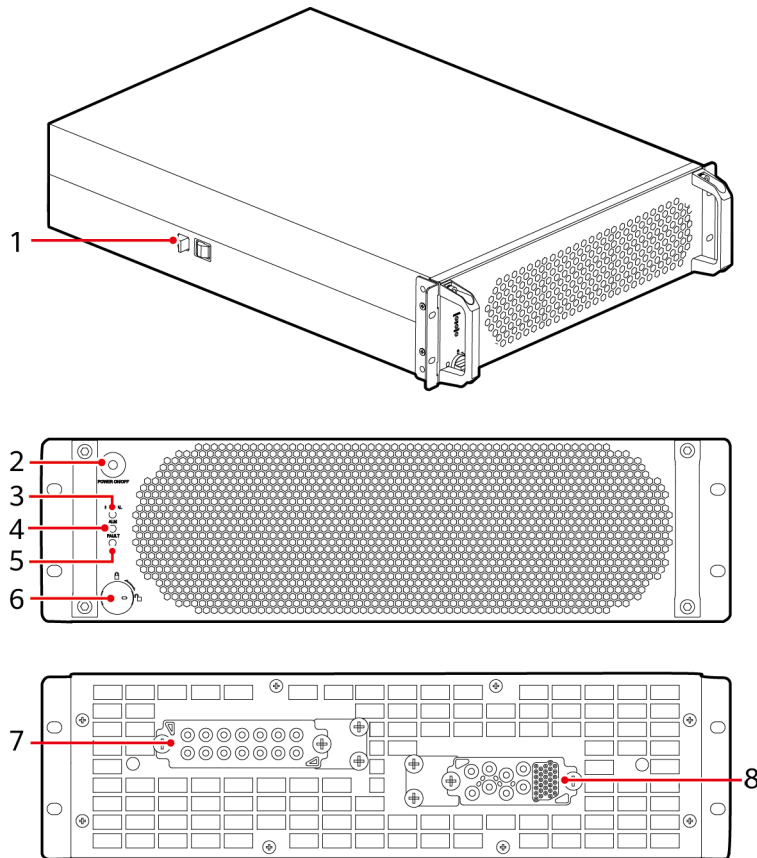

UA32W00001

- (1) Positioning lock (2) Power switch (3) Running indicator (4) Alarm indicator
(5) Fault indicator (6) Ready switch (7) Output ports (8) Input ports

Table 2-3 Indicator description

Status	Color	Description
On	Green	The battery cabinet is working properly.
	Yellow	The battery cabinet generates a minor alarm.
	Red	The battery cabinet generates a critical alarm.
Off	-	The battery cabinet is shut down.

Functions

- The BCU converts the battery string power. When the consistency between battery strings is poor, the BCU controls the current balance between battery strings through voltage boosting and balance adjustment to ensure reliable system operation.
- The BCU implements communication inside a battery cabinet, between cabinets, and between the UPS and NMS, and provides battery management and protection against exceptions.

Specifications

- Dimensions (H x W x D): 130 mm x 442 mm x 550 mm
- Weight: ≤ 35 kg

2.4.5 Monitoring Interface Unit

The monitoring interface unit includes the battery cabinet parallel ports, FE port, RS485 port, and EPO port.

Figure 2-9 Monitoring interface unit

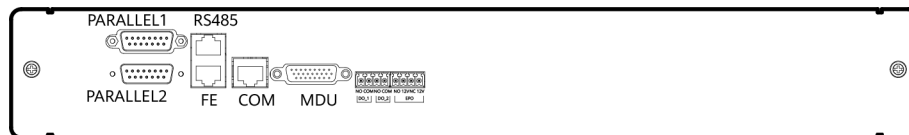

UB11W00009

Table 2-4 Port description

Port	Silkscreen	Description
Parallel port	PARALLEL1	Indicates parallel signal port 1 between racks.
Parallel port	PARALLEL2	Indicates parallel signal port 2 between racks.
Network port	FE	Network port, connecting to the northbound network management device or the customer's web service.
Northbound communications port	RS485	Connects to a third-party network management device over two wires.
Northbound communications port	COM	Connects to an UPS.
DB26	MDU	Supports FE, RS485, I2C, CAN, and other signals.
DO_1	DO_1	Output dry contact 1 function setting for the lithium battery cabinet
DO_2	DO_2	Output dry contact 2 function setting for the lithium battery cabinet

Port	Silkscreen	Description
EPO	NO	If the normally open (NO) port is connected to the EPO_12V port, emergency power-off (EPO) is triggered.
	12V	
	NC	If the normally closed (NC) port is disconnected from the EPO_12V port, EPO is triggered.
	12V	

Figure 2-10 COM pins

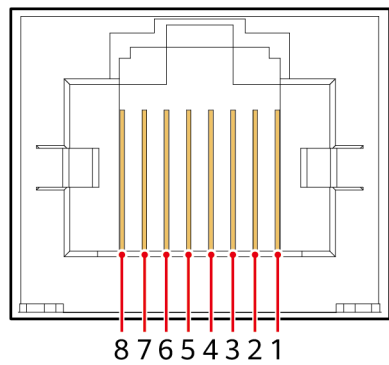

UA18W00015

Table 2-5 COM pin definition

Pin	Description
1	RS485+
2	RS485-
3	-
4	RS485+
5	RS485-
6	GND
7	CANH0
8	CANL0

Figure 2-11 RS485 pins

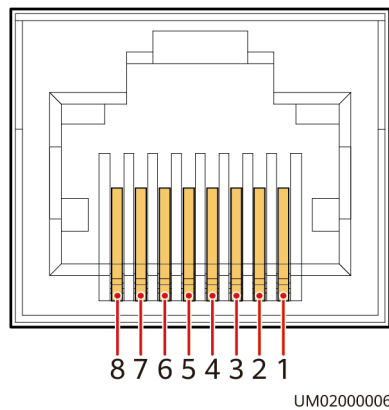

Table 2-6 RS485 pin definition

Pin	Description
1	RS485_T+
2	RS485_T-
3	-
4	RS485_R+
5	RS485_R-
6	GND
7	-
8	-

2.4.6 MDU

The MDU interworks with the monitoring interface unit to implement SBCU management functions.

Figure 2-12 MDU

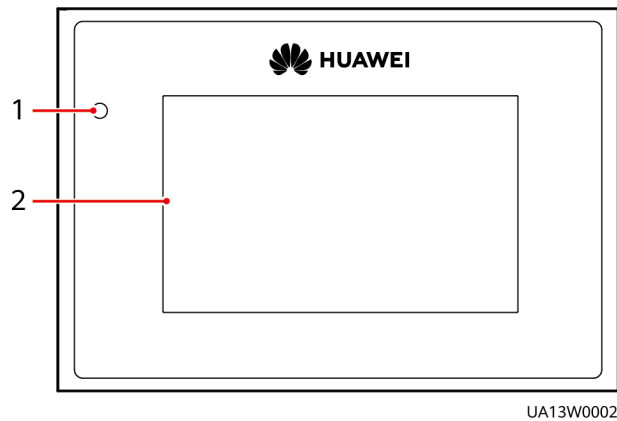

UA13W00024

(1) Status indicator

(2) LCD touchscreen

Table 2-7 Indicator status

Status	Color	Meaning
On	Red	A critical alarm has been generated, and the buzzer sounds continuously.
	Yellow	A minor alarm has been generated, and the buzzer buzzes intermittently at 2 Hz.
	Green	The SmartLi is running properly or a warning has been generated.
Off	-	The SmartLi display panel is powered off.

The ports of the MDU are located at the side of the display panel.

Figure 2-13 MDU ports

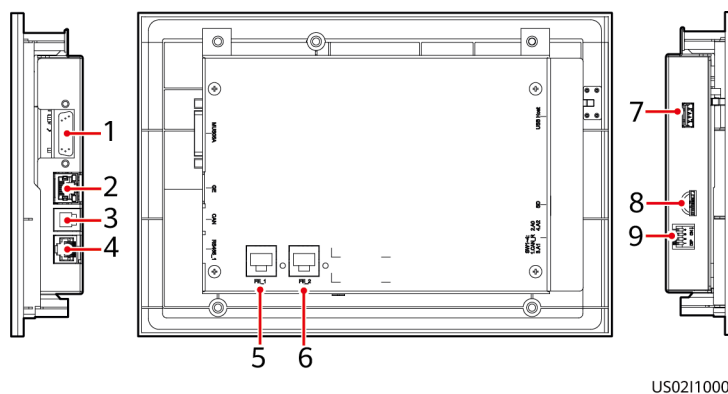

US02110005

Table 2-8 MDU port description

No.	Port Name	Description
1	MUS05A (DB26)	Connects to the MDU and monitoring interface card.
2	GE	Network port
3	CAN	Reserved
4	RS485_1	Reserved
5	FE_1	Reserved
6	FE_2	Reserved
7	USB Host	Insert a USB flash drive, import or export the configuration file, export fault information, upgrade the BSP and software, and remove the USB flash drive.
8	SD	Reserved
9	DIP switch	Implements specific functions by using the DIP switch and specific buttons; controls the CAN communication build-out resistor in a parallel system.

Functions

Provides a display panel over which you can control SmartLi operations, view the running status and alarms, and set parameters.

- Displays the total voltage, SOC, SOH, current, and temperature of the battery system and battery information of each battery cabinet.
- Data storage function: Receives common parameters such as the battery voltage, temperature, current, SOC, and SOH reported by each BCU, saves data locally, receives alarms and protection events reported by the BMS, and records events locally.
- Communicates with the UPS, provides man-machine interaction and communication interfaces for local and remote operations, manages rights, sets battery management system parameters, and upgrades programs.

Specifications

Dimensions (H x W x D): 175 mm x 264 mm x 40 mm

2.4.7 Fire Detection and Extinguishing Equipment

The fire detection and extinguishing equipment consists of a pressurized container filled with extinguishant, a valve, and a fire-trace tube that can release extinguishant. It can detect and extinguish fire at the initial stage quickly, accurately, and effectively.

Figure 2-14 Appearance

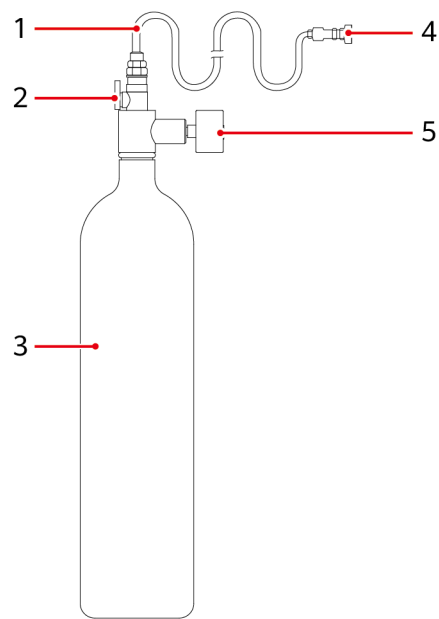

UB11W00006

- | | | |
|------------------------|--------------------|---------------------------|
| (1) Fire-trace tube | (2) Valve | (3) Pressurized container |
| (4) End pressure gauge | (5) Pressure gauge | |

Specifications

Recommended extinguishant: heptafluoropropane or perfluorohexanone

Extinguishant amount: 3 kg

Operating temperature: 0°C to 50°C

2.5 Optional Component

2.5.1 Fire Extinguishing Cabinet

When the SmartLi is installed against a wall, a fire cylinder can be placed in the fire extinguishing cabinet to facilitate front maintenance.

Dimensions (H x W x D): 2000 mm x 300 mm x 850 mm

Figure 2-15 Fire extinguishing cabinet

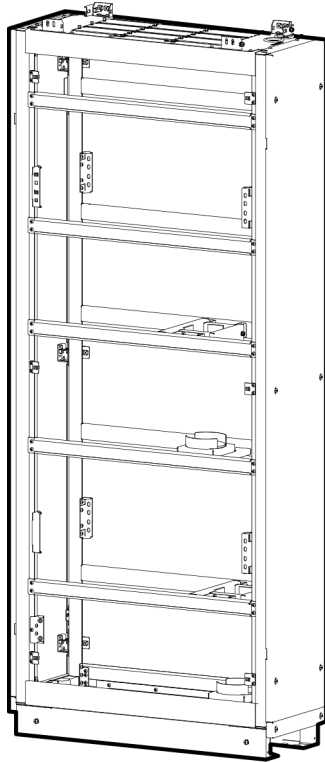

UB11W00016

Application Scenarios

Figure 2-16 One SmartLi cabinet and one fire extinguishing cabinet

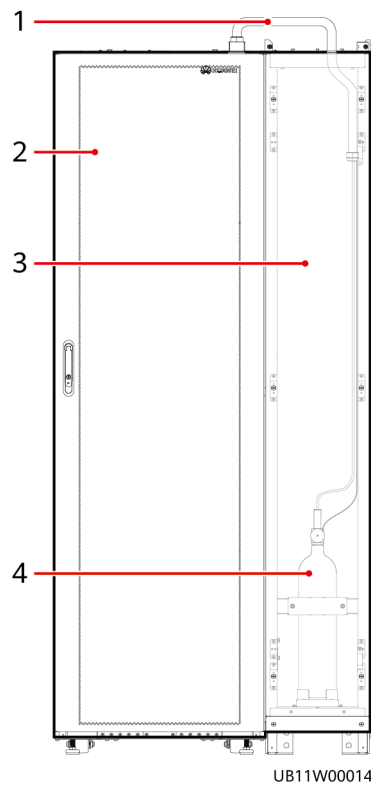

- (1) Corrugated pipe (2) SmartLi cabinet (3) Fire extinguishing cabinet (4) Fire cylinder cabinet

Figure 2-17 Two SmartLi cabinets and one fire extinguishing cabinet

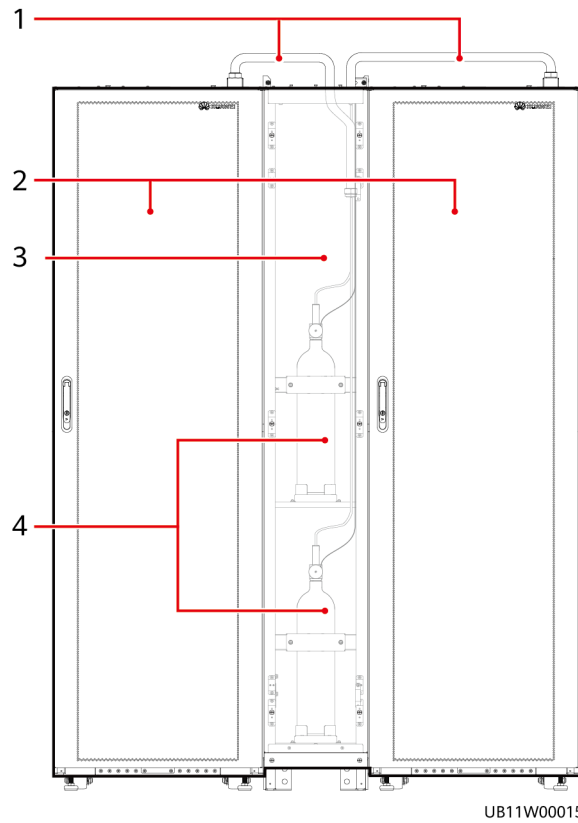

- (1) Corrugated pipe (2) SmartLi cabinets (3) Fire extinguishing cabinet (4) Fire cylinders

3 Installation

3.1 Installation Preparations

3.1.1 Site

3.1.1.1 Installation Environment

- Do not install the SmartLi in high temperature, low temperature, or damp environments.
- Install the SmartLi away from water sources, heat sources, and flammable or explosive materials.
- Keep the SmartLi away from direct sunlight, dust, volatile gases, corrosive materials, and air dense with salt particles.
- Do not install the SmartLi in environments with conductive metal scraps in the air.

3.1.1.2 Installation Clearances

Reserve the following clearances around the cabinet to facilitate operations and ventilation:

- Reserve at least 800 mm from the front of the cabinet.
- Reserve at least 500 mm from the top of the cabinet.
- The SmartLi can be installed against a wall and no space needs to be reserved at the rear.
- If an antiseismic kit is deployed, at least 500 mm space should be reserved at the rear for operations.

Figure 3-1 Reserved clearances (unit: mm)

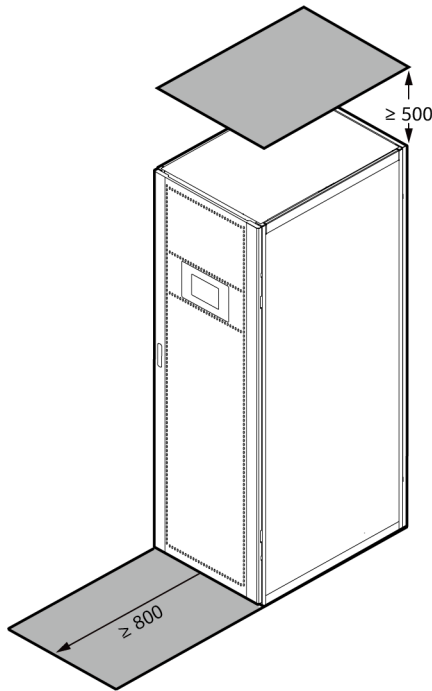

UA11S00004



3.1.2 Tools and Instruments







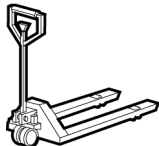



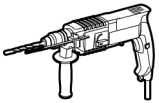
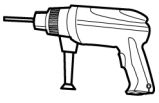
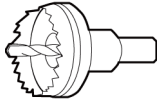
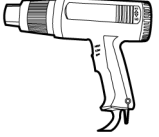
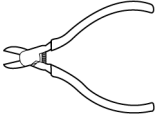
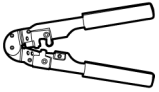
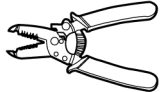

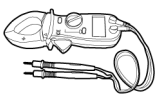
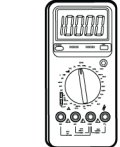

⚠ CAUTION

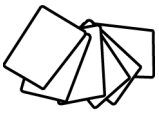

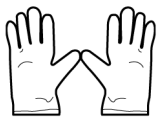
Insulate installation tools to prevent electric shocks.

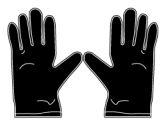
Prepare the following tools and meters indicated in [Table 3-1](#) for installation.

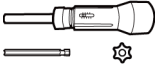
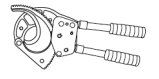
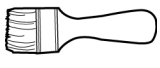
Table 3-1 Tools and meters

Tools and Meters			
Electric pallet truck	Manual pallet truck	Ladder	Rubber mallet
			
Hammer drill and drill bit $\Phi 16$	Hand-held electric drill	Alloy hole saw	Heat gun

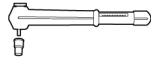
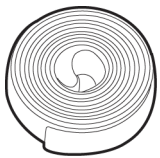
Tools and Meters			
			
Diagonal pliers	Crimping tools	Wire stripper	Electric hydraulic pliers
			
Clamp meter	Multimeter	Cable tie	Level instrument
			
Insulation tape	Cotton cloth	Adjustable torque wrench	Electrician's knife wrench
			
Electrostatic discharge (ESD) gloves	Protective gloves	Insulated gloves	Insulation protective shoes
			
Torque screwdriver	Cable cutter	Brush	Flat-head screwdriver (2-5 mm)
			

Tools and Meters			
Phillips screwdriver (M3/M4/M5/M6/M8)	Insulated torque wrench (M6/M8/M12/M16)	Heat shrink tubing	Insulated adjustable wrench
			

 **NOTE**

Table 3-1 lists only the common tools for installation and cable connection. For more dedicated tools required, see the corresponding component manuals. Prepare tools based on site requirements.

3.1.3 Preparing Power Cables

Table 3-2 Recommended cross-sectional areas for power cables

Item			Description
Battery	Recommended cross-sectional area (mm ²)	+	<ul style="list-style-type: none"> 120 (The load of a single battery cabinet is less than or equal to 150 kW, you are advised to set the I1 value of the battery circuit breaker to the MIN value.) 150 (The load of a single battery cabinet is greater than 150 kW.)
		N	
		-	
		PE	70

- When selecting, connecting, and routing power cables, follow local safety regulations and rules.
- When the external conditions change, for example, the cable layout or ambient temperatures, perform verification in accordance with the IEC-60364-5-52 or the local regulations.
- Cable type: single-core 90°C soft power cable with a copper conductor.

3.1.4 Unpacking and Checking

Context

NOTICE

- To prevent the SmartLi from falling over, secure it to a pallet truck using ropes before moving it.
- To prevent shocks or falls, move the SmartLi gently. After placing the SmartLi in the installation position, unpack it and take care to prevent scratches. Keep the SmartLi steady during unpacking.
- To prevent dust from settling on the SmartLi, leave the original plastic coat on until installation is required.
- Battery modules are transported separately.

Procedure

- Step 1** Use a pallet truck to transport the SmartLi to the installation position.
- Step 2** Remove the SmartLi outer packing and take out the fittings box.
- Step 3** Check that the SmartLi is intact.
1. Visually inspect the SmartLi appearance for shipping damage. If it is damaged, notify the carrier immediately.
 2. Check that all fittings comply with the packing list. If some fittings are missing or do not comply with the packing list, record this information and contact your local Huawei office immediately.
- Step 4** After confirming that the cabinet is intact, remove the L-shaped bracket that secures the cabinet and the pallet, and secure the sliding plate to the pallet using the two M12 bolts that you have removed.
- Step 5** Raise the four anchor bolts to the highest position using an adjustable wrench.
- Step 6** Push the cabinet along the sliding plate to the floor.
- End

3.2 Installing a Fire Cylinder and Cabinets (Without a Fire Extinguishing Cabinet)

3.2.1 Installing a Fire Cylinder

Procedure

- Step 1** Remove the rear panel of the cabinet.
- Step 2** Observe the pressure gauge on the fire cylinder.
- If the pointer reading is 0 MPa, the fire cylinder is empty. Perform steps 3–10 to fill extinguishant onsite.

- If the pointer reading is greater than 1.1 MPa, the fire cylinder is filled with extinguishant. In this case, perform steps 8–10.

Step 3 Remove the fire cylinder and dry contact cable.

1. Remove the dry contact cable from the fire cylinder.
2. Remove the fire cylinder fastener.
3. Take out the fire cylinder.

Figure 3-2 Removing the fire cylinder

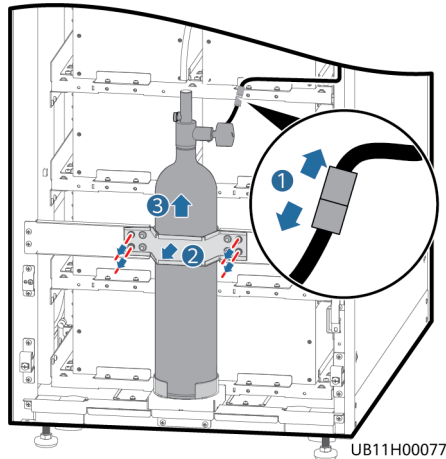

Step 4 Check the fire cylinder and all components for any damage, abrasion, or corrosion. If there is any visible abrasion or corrosion, replace the damaged components and all corroded components.

Step 5 Send the fire cylinder to the gas station to fill extinguishant. Heptafluoropropane or perfluorohexanone is recommended. The required amount is 3 kg.

NOTICE

- In the process of assembling and filling, ensure that the valve, container, and other parts are clean and not polluted.
- The internal impurities of the fire cylinder have been cleaned and the container valve has been sealed. Do not remove the container valve and its components. For other operations, see the related filling specifications.

1. Connect the extinguishant filling port of the container valve to the extinguishant filling device. The thread specification of the extinguishant filling port is M10x1.
2. Remove the valve positioning kit, open the valve, and fill 3 kg extinguishant. Close the valve after filling the extinguishant.
3. Connect the filling port of the container valve to the nitrogen filling device, open the valve, and fill nitrogen until the filling pressure reaches the specified value. After filling nitrogen, close the valve.
4. Shake the cylinder for 10 times and then fill nitrogen until the pressure reaches the specified value. Repeat this step for two to three times until the pressure does not change. Then install the valve positioning kit. After 12

hours, observe the pressure again. If the pressure does not reach the value listed in the following table, add nitrogen until the pressure reaches the required value.

Table 3-3 Mapping between temperatures and pressures

Temperature (°C)	Recommended Pressure	Allowed Pressure Range
0	12 bar (1.2 MPa)	11–13 bar (1.1–1.3 MPa)
10	14 bar (1.4 MPa)	13–15 bar (1.3–1.5 MPa)
20	17 bar (1.7 MPa)	16–18 bar (1.6–1.8 MPa)
25	18.5 bar (1.85 MPa)	17.5–19.5 bar (1.75–1.95 MPa)
30	20 bar (2.0 MPa)	19–21 bar (1.9–2.1 MPa)
40	23 bar (2.3 MPa)	22–24 bar (2.2–2.4 MPa)

5. After the filling is complete, check for leakage according to the procedure of the filling station.

Step 6 Check the status of the fire cylinder after filling extinguishant. If the fire cylinder is not installed in the cabinet immediately after extinguishant is filled, check the status of the fire cylinder again before installation.

- Check that the valve is closed (vertical to the cylinder).
- Check that the value of the pressure gauge on the fire cylinder is within the allowable pressure range (1.6–1.8 MPa at 20°C) specified in [Table 3-3](#).

Step 7 Install the fire cylinder and dry contact cable.

NOTICE

- Keep the fire cylinder upright.
 - Ensure that the front of the pressure gauge faces the right side of the cabinet (as shown in the figure) and that the cylinder does not interfere with the battery trays and the rear cover of the cabinet.
-

Figure 3-3 Installing the fire cylinder and dry contact cable

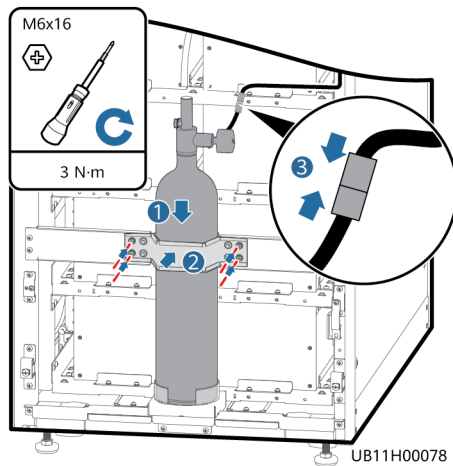

Step 8 Install the fire-trace tube.

NOTICE

Do not bend or twist the fire-trace tube or bind the tube using cable ties. Otherwise, the extinguishant may leak.

-
1. Clamp the end of the fire-trace tube to the threaded nozzle using a pipe holder or slip-proof gloves.

NOTICE

Hold the pipe holding device close to the end to avoid bending the tube during pipe insertion.

Figure 3-4 Installing a fire-trace tube

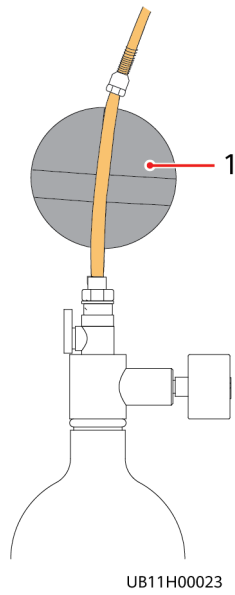

(1) If the pipe holding device is slip-proof gloves, install the fire-trace tube using slip-proof gloves.

2. Tighten the connection nut to 7 N·m using an adjustable torque wrench.

Step 9 Remove the valve positioning kit, open the valve, reinstall the positioning kit, and secure it.

NOTICE

Slowly open the valve. To avoid unexpected blowout, do not quickly open the valve.

Figure 3-5 Opening the valve

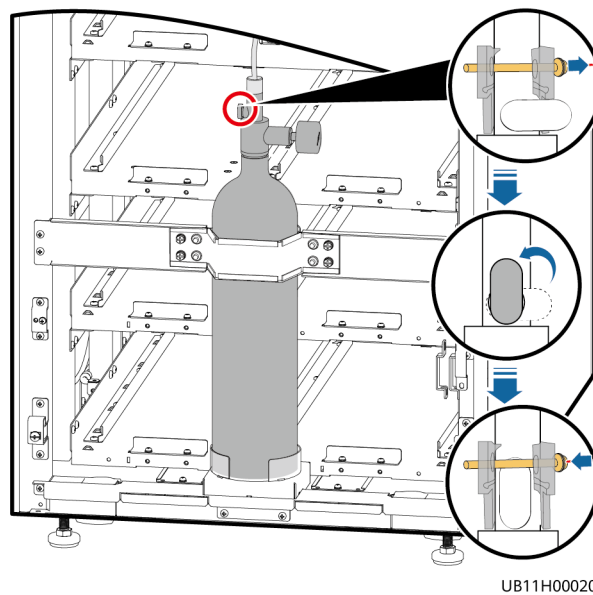

- Step 10** Observe the pressure gauge on the front of the cabinet. The value of the pressure gauge should be within the allowable pressure range (1.6–1.8 MPa at 20°C) specified in [Table 3-3](#), and record the position of the pressure gauge pointer. After 8 hours, observe the pressure gauge again. The position should remain unchanged.

----End

3.2.2 Installing Cabinets

Securing Installation

- Step 1** Determine the cabinet installation position. Draw mounting holes in the installation position according to the drawing.

Figure 3-6 Mounting holes (unit: mm)

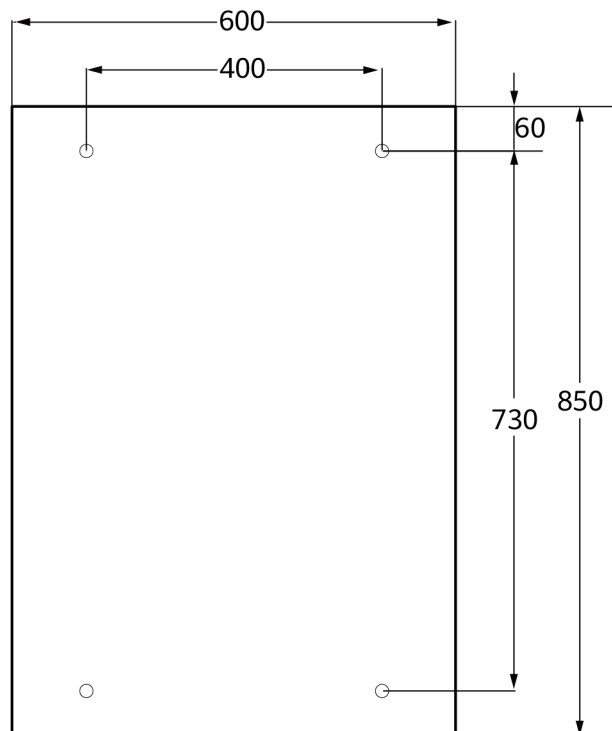

UA07500004

- Step 2** Use a hammer drill to drill holes for installing expansion bolts and then install expansion sleeves in the holes.
1. Drill holes into the concrete floor using a hammer drill. The hole depth ranges from 52 mm to 60 mm.
 2. Slightly tighten the expansion bolt and vertically insert it into the hole. Knock the expansion bolt using a hammer until the expansion sleeve is fully inserted into the hole.
 3. Partially tighten the expansion bolt.
 4. Remove the bolts, spring washers, and flat washers.

NOTICE

Knock the expansion bolt into the hole until the expansion tube completely fits into the hole. The expansion sleeve must be completely buried under the ground to facilitate subsequent installation.

Figure 3-7 Drilling a hole and installing an expansion sleeve

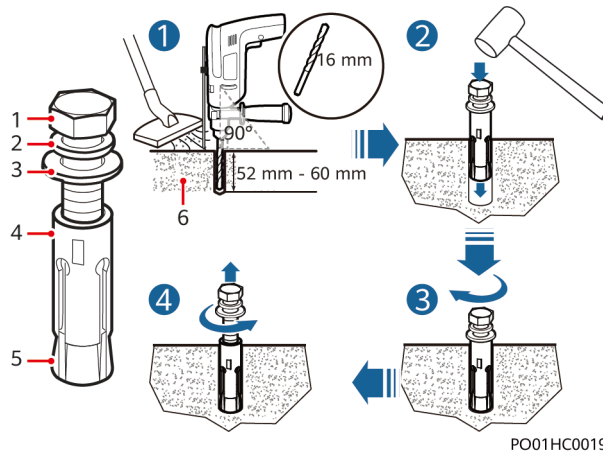

- (1) M12 bolt
- (2) Spring washer
- (3) Flat washer
- (4) Expansion sleeve
- (5) Expansion nut
- (6) Concrete floor

Step 3 Wheel the cabinet to the installation position.

Step 4 Open the front door and remove the four plugs from the bottom of the cabinet.

Figure 3-8 Removing plugs

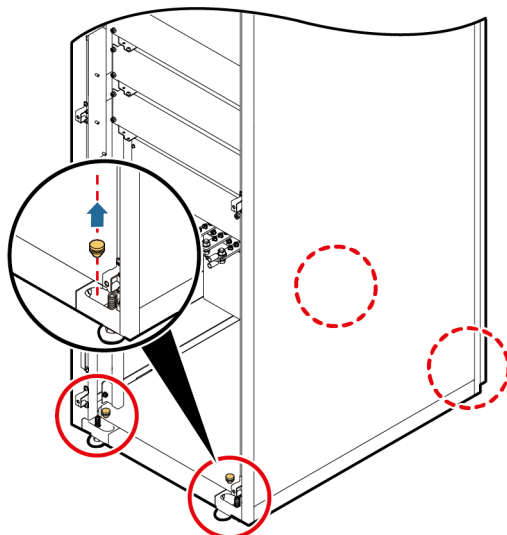

Step 5 Insert expansion bolts into the expansion bolt holes in the floor, and tighten the expansion bolts.

NOTICE

- If the cabinet is installed on a steel floor, M12x45 screws are used.
- If the cabinet is installed against a wall, only the front screws need to be installed.

Figure 3-9 Tightening expansion bolts

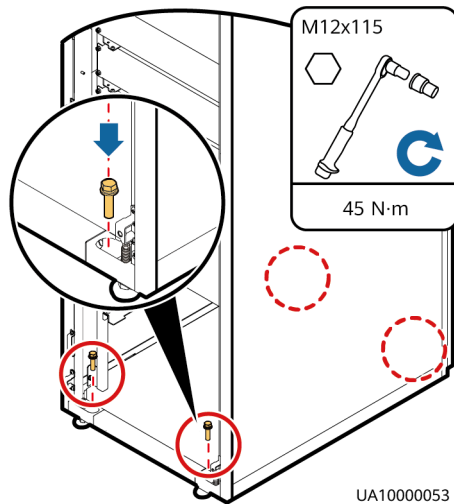

----End

Non-Secured Installation

- Step 1** Adjust the four anchor bolts at the bottom of the cabinet until all the four castors at the bottom hang in the air and the anchor bolts bear all of the cabinet weight.

Figure 3-10 Castors hanging in the air

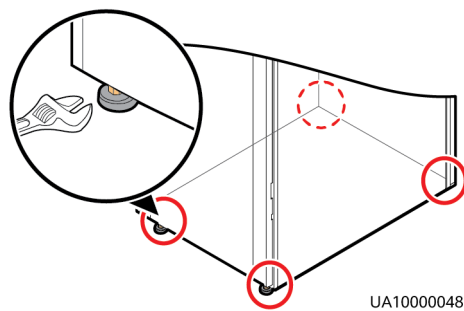

- Step 2** Check the cabinet levelness using a level instrument. If the cabinet is not level, wrench the anchor bolts.

----End

Combining Cabinets

NOTICE

When cabinets are combined, a battery bus bar box (BBB box) is required. For details about how to install a BBB box, see *PDU8000-(0630, 1250, 2000) DCV8-BGA001 BBB Box User Manual*.

If the cabinet is installed against a wall, only the front connecting plates need to be installed.

Step 1 Install each cabinet in sequence according to the installation method of a single cabinet.

Step 2 Combine cabinets.

Figure 3-11 Installing connecting kits

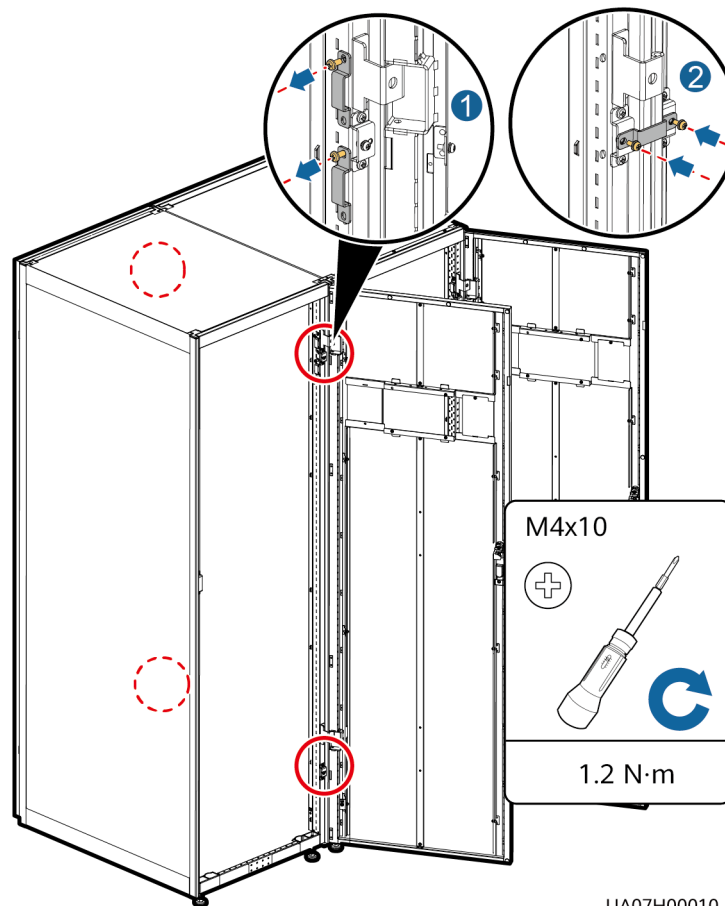

----End

3.3 Installing a Fire Cylinder and Cabinets (With a Fire Extinguishing Cabinet)

3.3.1 Installing a Fire Cylinder

Context

NOTICE

- When removing the fire-trace tube and dry contact cable, exercise caution and do not scratch them.
- Do not bend or twist the fire-trace tube or bind the tube using cable ties. Otherwise, the extinguishant may leak.

Procedure

- Step 1** Remove the rear cover from the SmartLi cabinet.
- Step 2** Remove the dry contact cable from the fire cylinder.

Figure 3-12 Disconnecting dry contact cable terminals

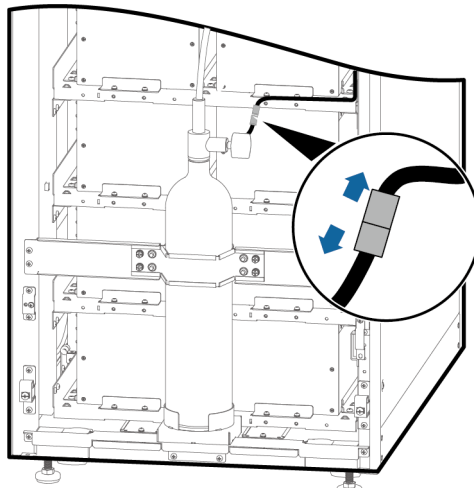

UB11140017

- Step 3** Remove the fire cylinder.
1. Remove the fire cylinder fastener.
 2. Take out the fire cylinder.

Figure 3-13 Removing the fire cylinder

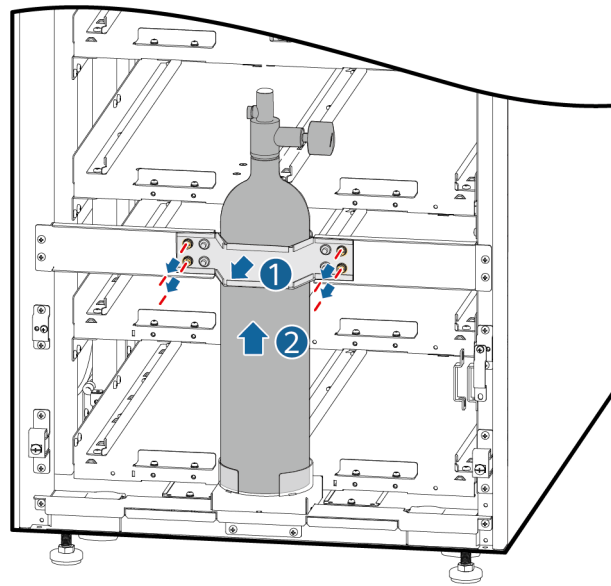

UB11H00035

- Step 4** Check the fire cylinder and all components for any damage, abrasion, or corrosion. If there is any visible abrasion or corrosion, replace the damaged components and all corroded components.
- Step 5** Observe the pressure gauge on the fire cylinder.
- If the pointer reading is 0 MPa, the fire cylinder is empty. Fill extinguishant onsite and perform the following steps in sequence.
 - If the pointer reading is greater than 1.1 MPa, the fire cylinder is filled with extinguishant. In this case, skip steps 6 and 7.
- Step 6** Send the fire cylinder to the gas station to fill extinguishant. Heptafluoropropane or perfluorohexanone is recommended. The required amount is 3 kg.

NOTICE

- In the process of assembling and filling, ensure that the valve, container, and other parts are clean and not polluted.
- The internal impurities of the fire cylinder have been cleaned and the container valve has been sealed. Do not remove the container valve and its components. For other operations, see the related filling specifications.

1. Connect the extinguishant filling port of the container valve to the extinguishant filling device. The thread specification of the extinguishant filling port is M10x1.
2. Remove the valve positioning kit, open the valve, and fill 3 kg extinguishant. Close the valve after filling the extinguishant.
3. Connect the filling port of the container valve to the nitrogen filling device, open the valve, and fill nitrogen until the filling pressure reaches the specified value. After filling nitrogen, close the valve.
4. Shake the cylinder for 10 times and then fill nitrogen until the pressure reaches the specified value. Repeat this step for two to three times until the

pressure does not change. Then install the valve positioning kit. After 12 hours, observe the pressure again. If the pressure does not reach the value listed in the following table, add nitrogen until the pressure reaches the required value.

Table 3-4 Mapping between temperatures and pressures

Temperature (°C)	Recommended Pressure	Allowed Pressure Range
0	12 bar (1.2 MPa)	11–13 bar (1.1–1.3 MPa)
10	14 bar (1.4 MPa)	13–15 bar (1.3–1.5 MPa)
20	17 bar (1.7 MPa)	16–18 bar (1.6–1.8 MPa)
25	18.5 bar (1.85 MPa)	17.5–19.5 bar (1.75–1.95 MPa)
30	20 bar (2.0 MPa)	19–21 bar (1.9–2.1 MPa)
40	23 bar (2.3 MPa)	22–24 bar (2.2–2.4 MPa)

5. After the filling is complete, check for leakage according to the procedure of the filling station.

Step 7 Check the status of the fire cylinder after filling extinguishant. If the fire cylinder is not installed in the cabinet immediately after extinguishant is filled, check the status of the fire cylinder again before installation.

- Check that the valve is closed (vertical to the cylinder).
- Check that the value of the pressure gauge on the fire cylinder is within the allowable pressure range (1.6–1.8 MPa at 20°C) specified in [Table 3-4](#).

Step 8 Install the fire cylinder in the fire extinguishing cabinet.

1. Remove the front door panel from the fire extinguishing cabinet.
2. Install the fire cylinder.

NOTICE

- Keep the fire cylinder upright.
 - Ensure that the front of the pressure gauge faces the front door panel of the cabinet, as shown in the figure.
-

Figure 3-14 Installing a fire cylinder (one SmartLi cabinet and one fire extinguishing cabinet)

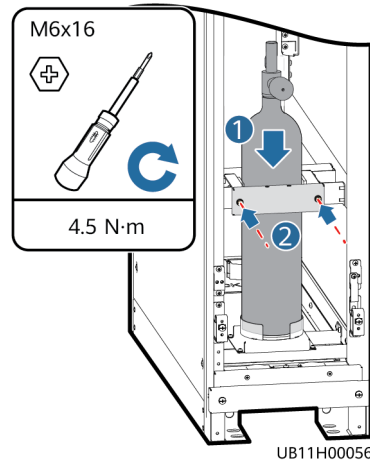
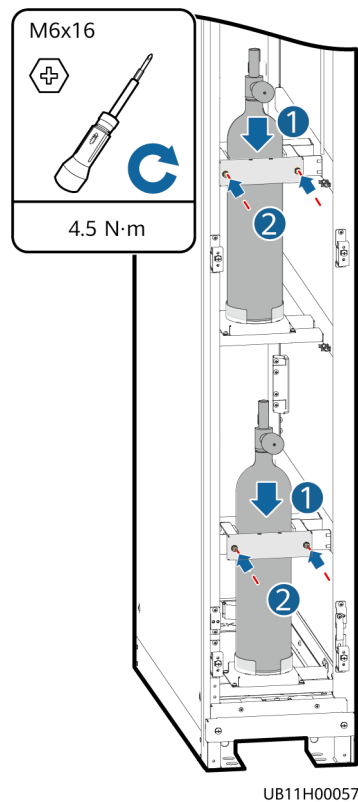

Figure 3-15 Installing fire cylinders (two SmartLi cabinets and one fire extinguishing cabinet)



Step 9 Remove the fire-trace tube and dry contact cable from the rear of the SmartLi.

NOTE

Store the removed cable clips in a proper place for future use.

1. Cut off the cable ties that secure the fire-trace tube.
2. Remove the cable clips that secure the fire-trace tube and dry contact cable.

3. Place the fire-trace tube and dry contact cable on the battery tray at the first layer.

Figure 3-16 Removing the fire-trace tube and dry contact cable

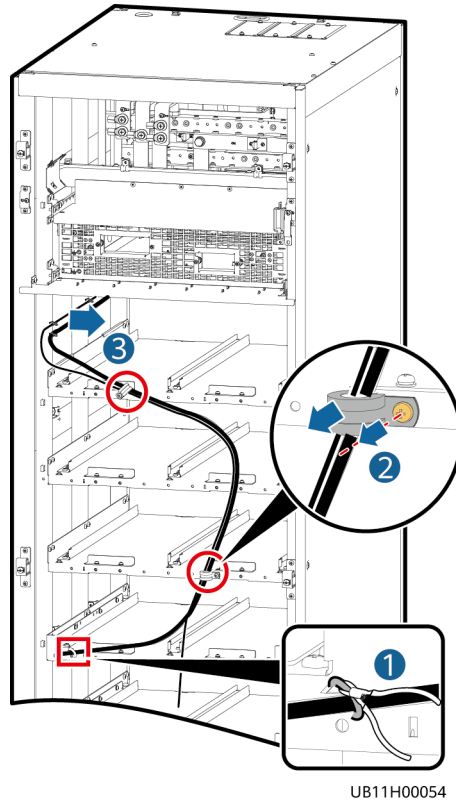

Step 10 Reinstall the rear cover for the SmartLi.

----End

3.3.2 Installing Cabinets

Context

NOTICE

- When routing and installing the fire-trace tube and dry contact cable, exercise caution and do not scratch them.
- Do not bend or twist the fire-trace tube or bind the tube using cable ties. Otherwise, the extinguishant may leak.

Procedure

- Step 1** Determine the cabinet installation position. Draw mounting holes in the installation position according to the drawing.

Figure 3-17 Mounting holes (unit: mm, one SmartLi cabinet and one fire extinguishing cabinet)

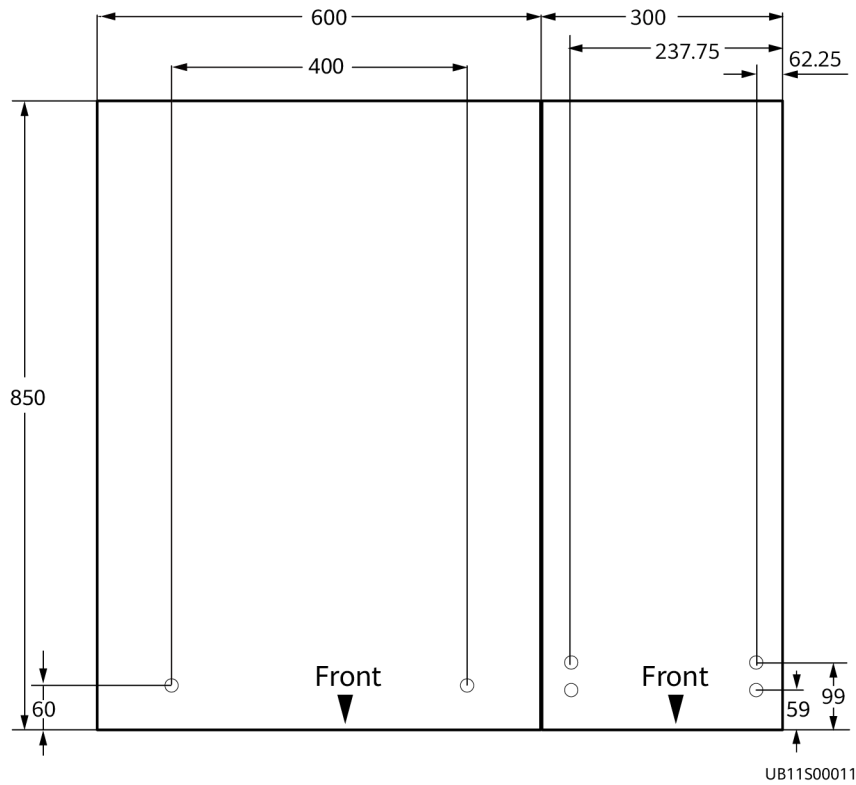
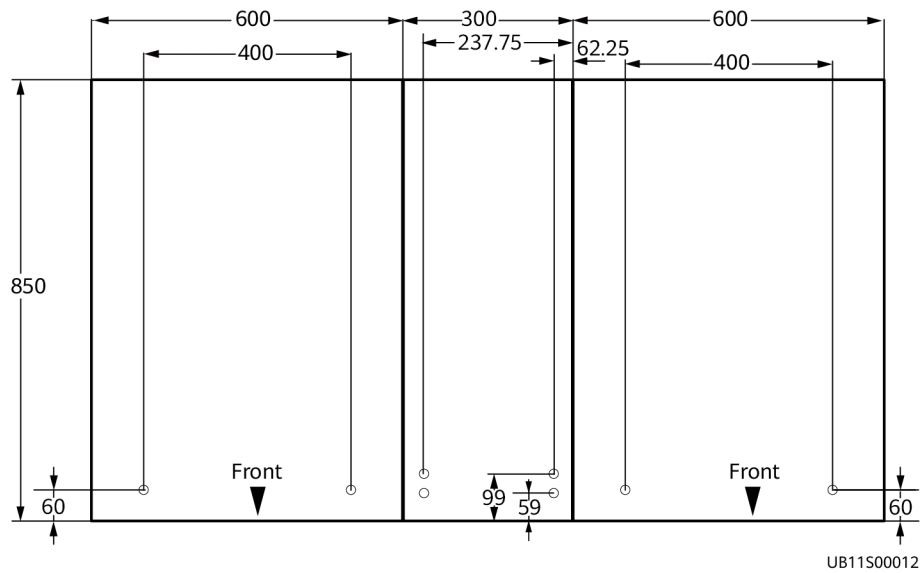

Figure 3-18 Mounting holes (unit: mm, two SmartLi cabinets and one fire extinguishing cabinet)



Step 2 Use a hammer drill to drill holes for installing expansion bolts and then install expansion bolts in the holes.

1. Drill holes into the concrete floor using a hammer drill. The hole depth ranges from 52 mm to 60 mm.

2. Partially tighten the expansion bolts and vertically insert them into the holes. Knock the expansion bolts using a rubber mallet until the expansion sleeves are fully inserted into the holes.
3. Partially tighten the expansion bolts.
4. Remove the bolts, spring washers, and flat washers.

Step 3 Move the cabinets to the installation positions.

1. Wheel the SmartLi cabinet to the installation position.
2. Move the fire extinguishing cabinet to the installation position.

Step 4 Secure the cabinets.

1. Install connecting plates between cabinets.
2. Remove the two plugs from the bottom of the SmartLi cabinet.
3. Secure the SmartLi using M12x115 bolts, and secure the fire extinguishing cabinet using M12x60 bolts.

Figure 3-19 One SmartLi cabinet and one fire extinguishing cabinet

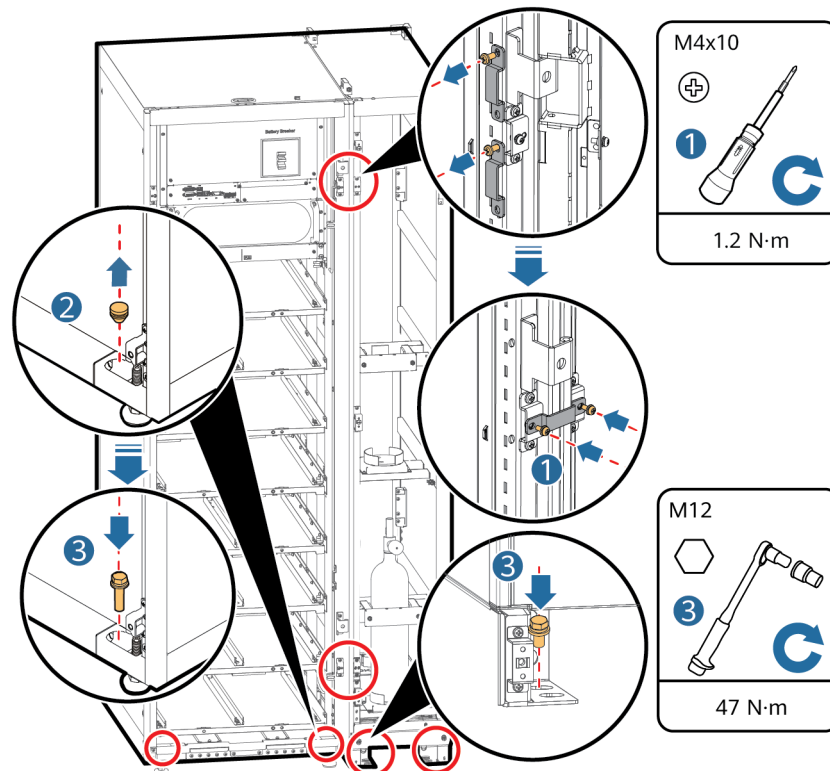

UB11H00066

Figure 3-20 Two SmartLi cabinets and one fire extinguishing cabinet

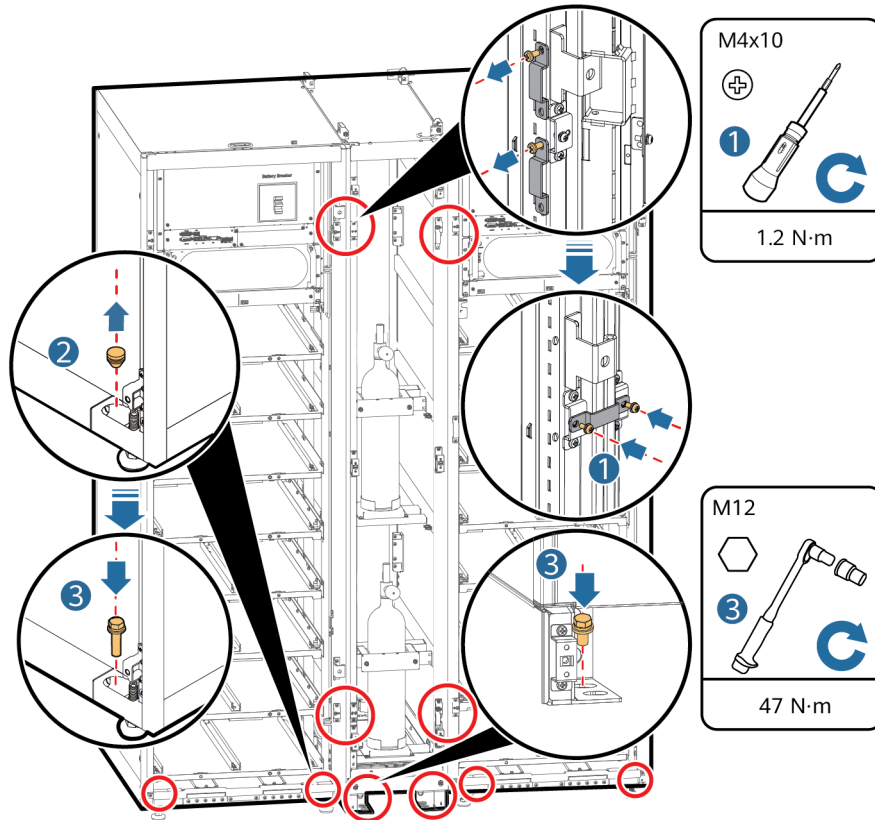

UB11H00058

Step 5 Route the fire-trace tube and dry contact cable in the SmartLi.

1. Loosen the cable clip at position A so that the fire-trace tube can be routed smoothly, and take out the fire-trace tube and dry contact cable reserved on the side.
2. Route the fire-trace tube and dry contact cable along the path shown in the figure, and route them through the hole on the top of the cabinet.
3. Secure all cable clips, and arrange the fire-trace tube and dry contact cable.

Figure 3-21 Routing the fire-trace tube and dry contact cable

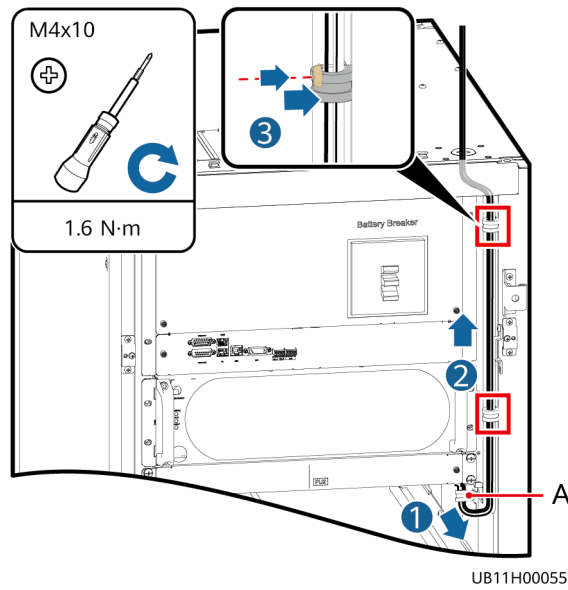

Step 6 Secure the corrugated pipe, and route the fire-trace tube and dry contact cable in the fire extinguishing cabinet.

1. Route the fire-trace tube and dry contact cable through the corrugated pipe, and secure the ends of the corrugated pipe.
2. Route the corrugated pipe, fire-trace tube, and dry contact cable through the hole in the fire extinguishing cabinet.
3. Secure the corrugated pipe and dry contact cable using cable ties.
4. Secure the fire-trace tube to the buckle.

Figure 3-22 Securing the corrugated pipe and routing the fire-trace tube and dry contact cable (one SmartLi cabinet and one fire extinguishing cabinet)

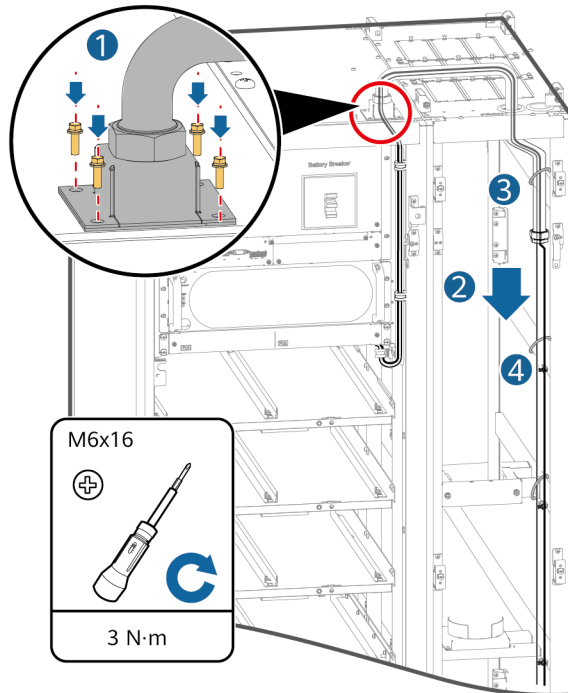

UB11H00059

Figure 3-23 Securing the corrugated pipes and routing the fire-trace tubes and dry contact cables (two SmartLi cabinets and one fire extinguishing cabinet)

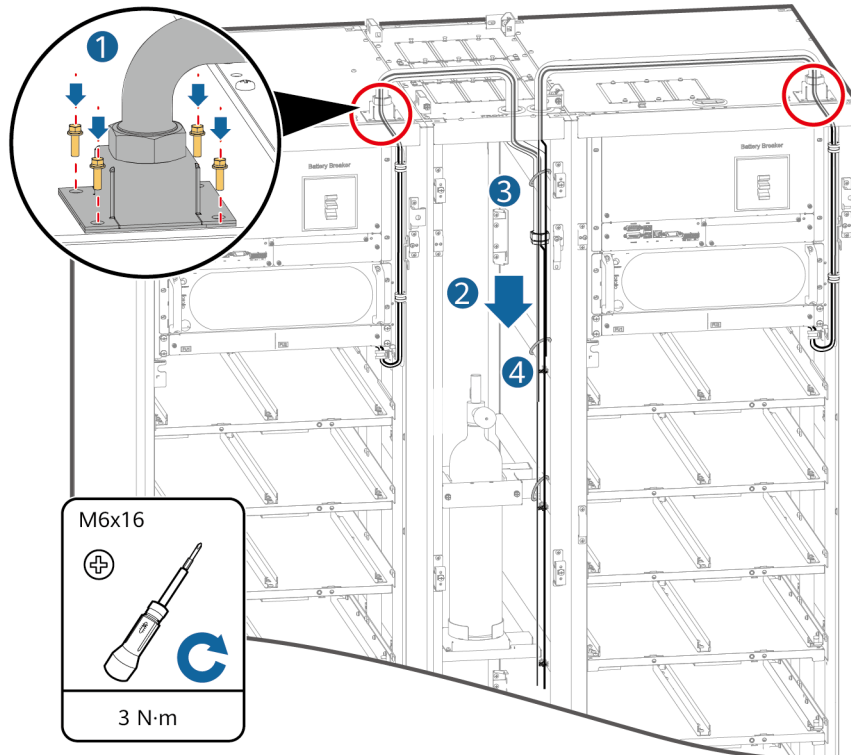

UB11H00060

Step 7 Install the fire-trace tube.

NOTICE

If two SmartLi cabinets and one fire extinguishing cabinet are configured, connect the fire-trace tube in the left SmartLi to the lower fire cylinder, and connect the fire-trace tube in the right SmartLi to the upper fire cylinder.

1. Clamp the end of the fire-trace tube to the threaded nozzle using a pipe holder or slip-proof gloves.

NOTICE

Hold the pipe holding device close to the end to avoid bending the tube during pipe insertion.

Figure 3-24 Installing a fire-trace tube

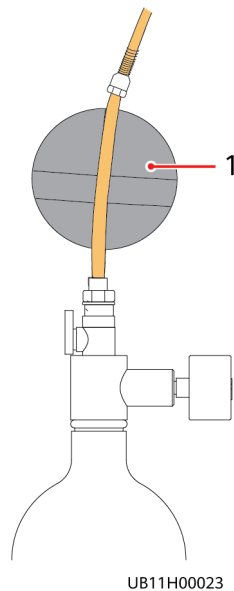

(1) If the pipe holding device is slip-proof gloves, install the fire-trace tube using slip-proof gloves.

2. Tighten the connection nut to 7 N·m using an adjustable torque wrench.

Step 8 Remove the valve positioning kit, open the valve, reinstall the positioning kit, and secure it.

NOTICE

Slowly open the valve. To avoid unexpected blowout, do not quickly open the valve.

Figure 3-25 Opening the valve

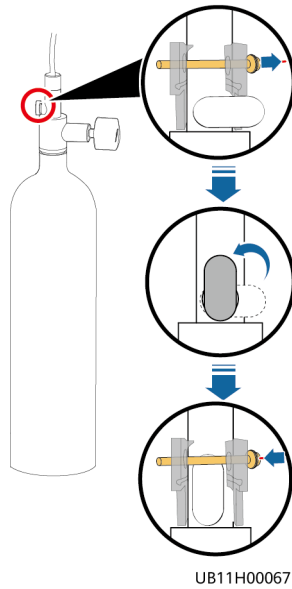

Step 9 Connect the dry contact cable to the fire cylinder.

NOTICE

If two SmartLi cabinets and one fire extinguishing cabinet are configured, connect the dry contact cable in the left SmartLi to the lower fire cylinder, and connect the dry contact cable in the right SmartLi to the upper fire cylinder.

Figure 3-26 Connecting dry contact cable terminals

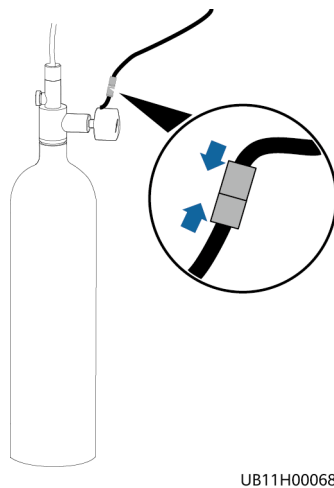

Step 10 Observe the pressure gauge on the front of the cabinet. The value of the pressure gauge should be within the allowable pressure range (1.6–1.8 MPa at 20°C) specified in [Table 3-4](#), and record the position of the pressure gauge pointer. After 8 hours, observe the pressure gauge again. The position should remain unchanged.

----End

3.4 Installing Cables

3.4.1 Cable Connection Reference

Context

WARNING

- Keep away from cabinets when preparing cables to prevent cable scraps from entering the cabinets. Cable scraps may cause ignition during power-on and result in personal injury and device damage.
- After installing cables, clean the cabinet top, bottom, copper bar wiring positions, and other positions. Ensure that there is no dust or scraps inside and around cabinets.
- Prepare terminals onsite. The length of the copper wire should be the same as that of the part of the terminal that covers the conductor.

Procedure

- Step 1** Route a cable into the cabinet and bind it to a nearby beam.
- Step 2** Pull the cable to the copper bar to which the cable is to be connected, determine the cable length, and mark the cable at the position where the cable is to be cut.
- Step 3** Pull the marked cable out of the cabinet, cut the cable from the marked position, strip the cable, and crimp a terminal.

Figure 3-27 Preparing a cable terminal outside the cabinet

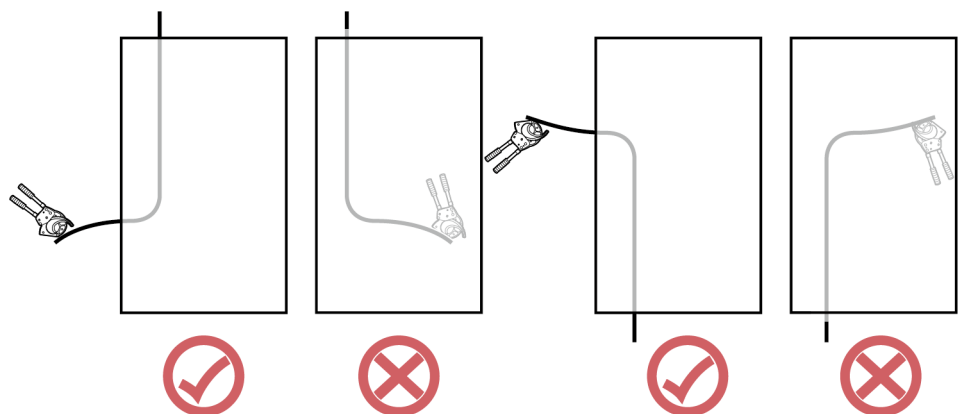

UA21110068

NOTE

Choose an appropriate cabling route based on the actual situation. The figure is for reference only.

Step 4 Connect the cable with a crimped terminal to the corresponding copper bar.

Step 5 Clean foreign matter inside the cabinet.

----End

3.4.2 Installing a PE Cable

Procedure

Step 1 Remove the cover from the PDU.

Figure 3-28 Removing the cover

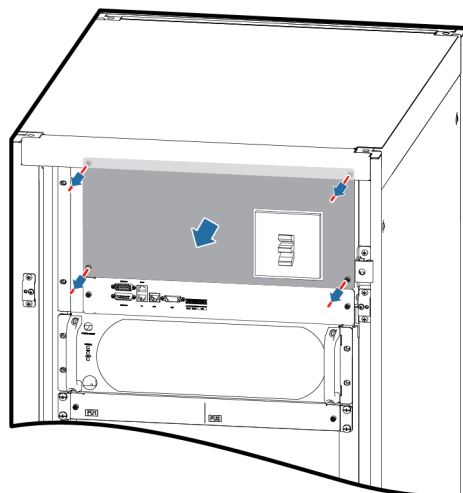

UB11H00030

Step 2 Remove the top cover from the cabinet based on cable routes and dimensions.

Figure 3-29 Removing the top cover

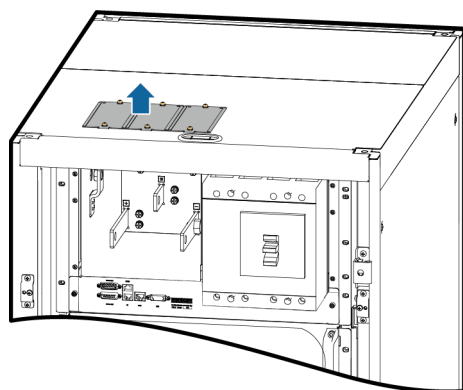

UB11H00025

Step 3 Install a PE cable.

Figure 3-30 Installing a PE cable

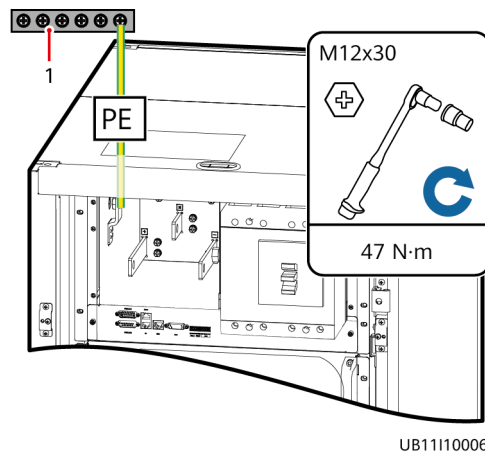

(1) Site ground bar

----End

3.4.3 Installing Battery Modules and Cables

Context

⚠ DANGER

- Before installing batteries, carefully read the battery safety precautions.
 - During installation, wear insulation gloves and use insulated tools.
 - Place the batteries correctly to prevent vibrations and shocks.
 - Install the battery modules from bottom to top and from left to right to prevent falling over due to imbalance.
 - Two persons are required to install the battery modules.
-

Procedure

Step 1 Pull out the BCU for about 10 cm.

Figure 3-31 Pulling out the BCU

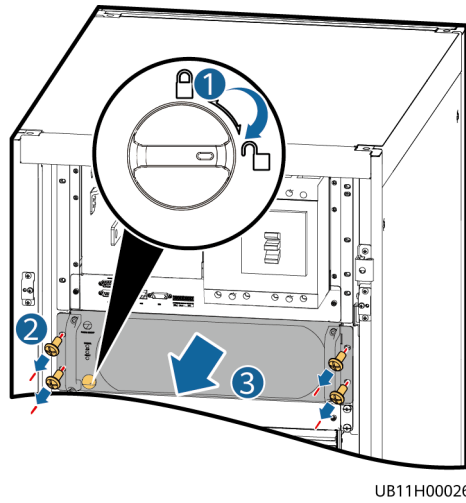

Step 2 Install battery modules and covers.

NOTE

- If half-capacity cabinet configuration is adopted, install filler panels at the positions where battery modules are not installed.
- In the 8+0 scenario, the lowest filler panel can be installed only after battery communications cables are installed.

Figure 3-32 Installing battery modules and covers

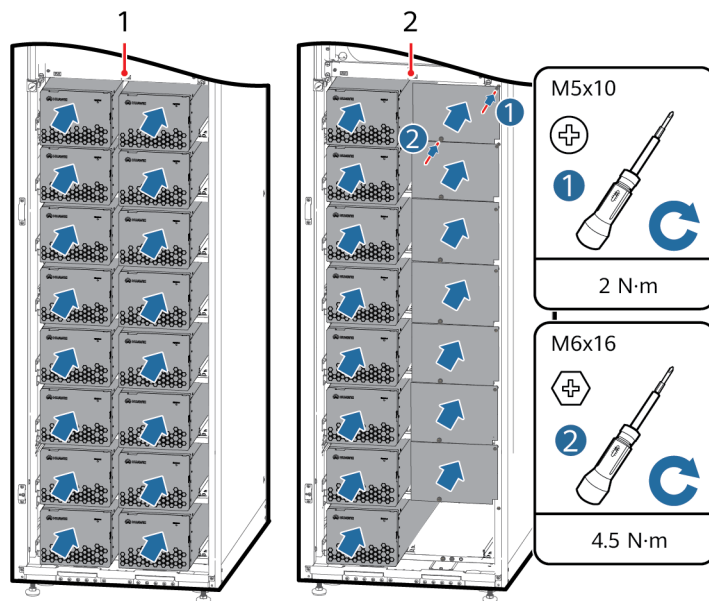

(1) Full-capacity cabinet (8+8 scenario)

(2) Half-capacity cabinet (8+0 scenario)

Figure 3-33 Installing battery modules and covers

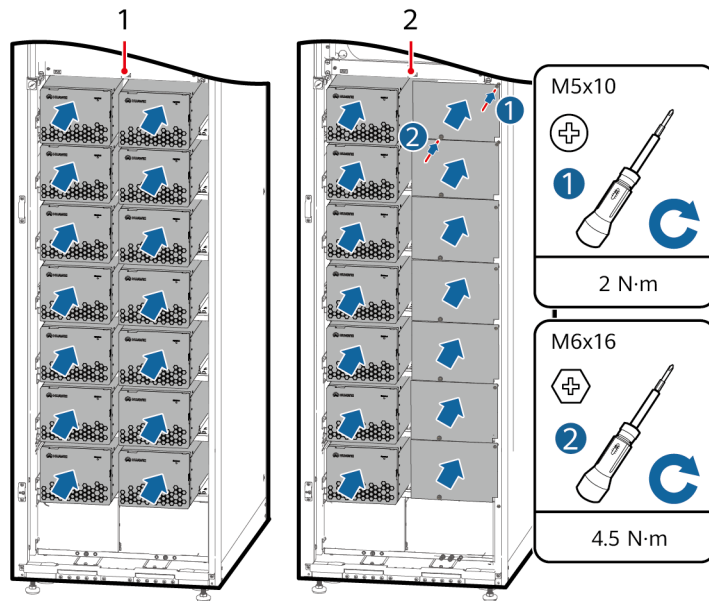

UB11H00061

(1) Full-capacity cabinet (7+7 scenario)

(2) Half-capacity cabinet (7+0 scenario)

Step 3 Remove the fuse cover and the front covers of the battery modules, and then install the battery baffle plates.

Figure 3-34 Removing the fuse cover

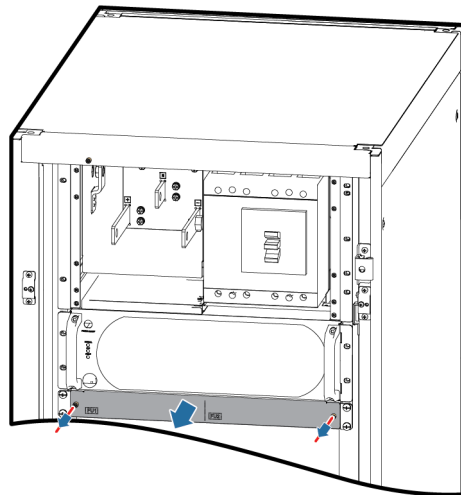

UB11H00096

Figure 3-35 Installing battery baffle plates (using the 8+8 scenario as an example)

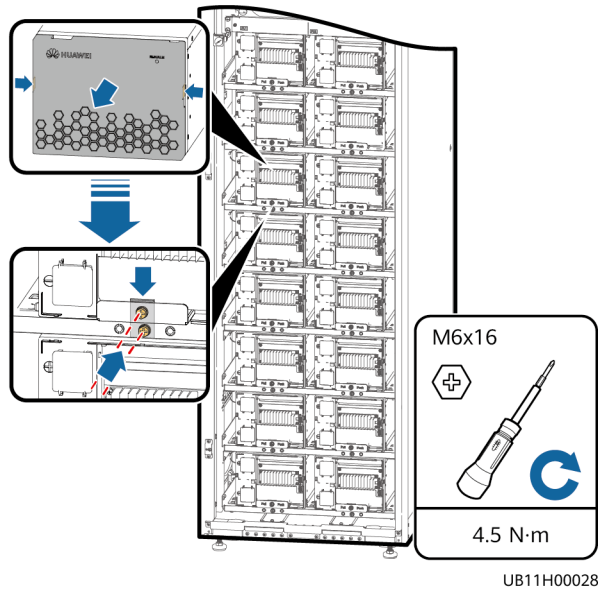

NOTE

Place the front covers properly to prevent the light pipes from falling off.

Step 4 Install battery communications cables.

Figure 3-36 Installing battery communications cables

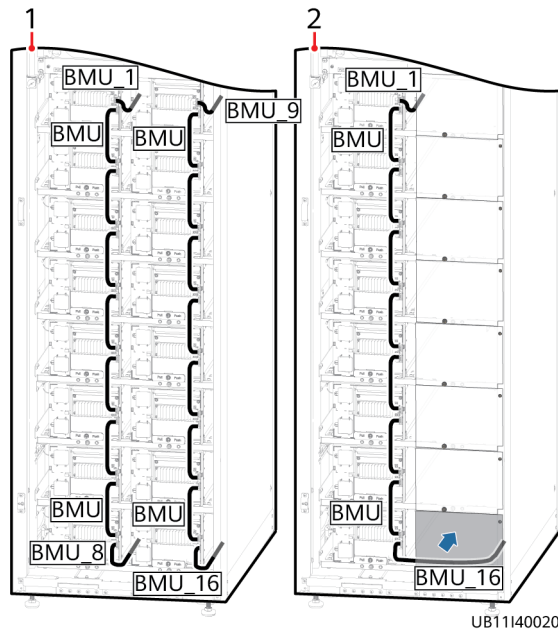

(1) Full-capacity cabinet (8+8 scenario)

(2) Half-capacity cabinet (8+0 scenario)

Figure 3-37 Installing battery communications cables

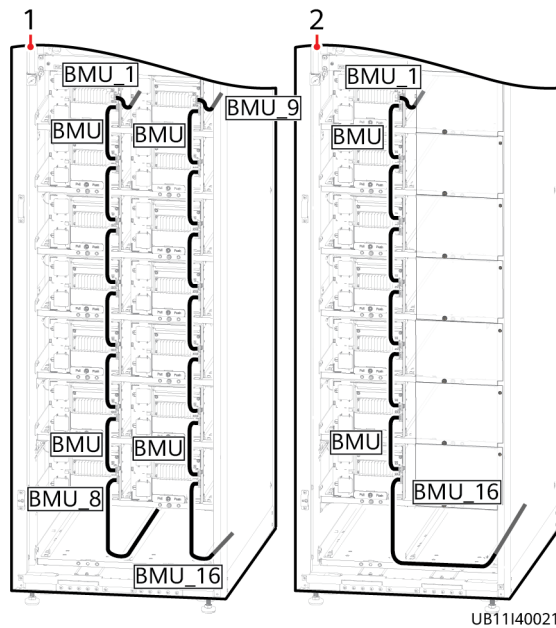

(1) Full-capacity cabinet (7+7 scenario)

(2) Half-capacity cabinet (7+0 scenario)

Step 5 Install battery copper bars and power cables.

1. Open the terminal protective covers, install copper bars between battery modules, and close the terminal protective covers.
2. Open the terminal protective covers, install copper bars between battery modules and fuses, and close the terminal protective covers.
3. Open the terminal protective covers, install the battery power cables reserved in the cabinet, and close the terminal protective covers.

NOTICE

- When installing a copper bar, connect the part with a round hole to the upper battery module, and connect the part with a slotted hole to the lower battery module. Install the part with a round hole first, and then the part with a slotted hole.
- Excessive bolts will be used as spare parts.

WARNING

After removing the safety cap from the power cable of the battery at the bottom layer, install the cable immediately to prevent the exposed terminal from touching the shell, which may cause sparks or burns.

Figure 3-38 Installing battery copper bars and power cables (using the 8+8 scenario as an example)

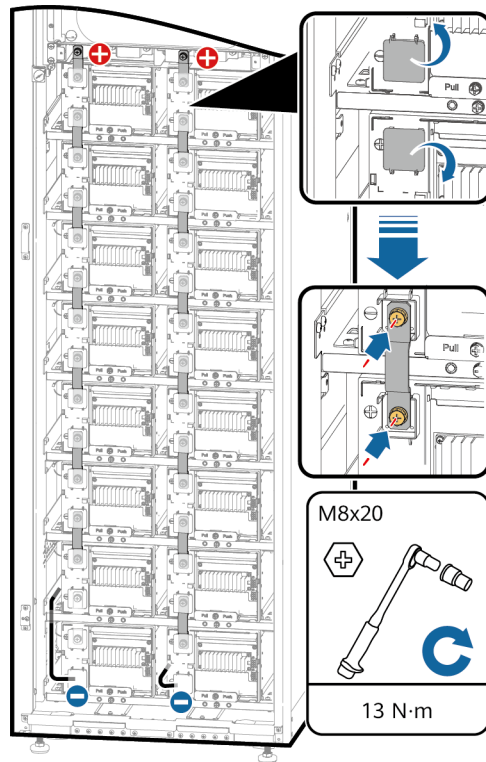

UB11130010

Figure 3-39 Installing battery copper bars and power cables (7+7 scenario used as an example)

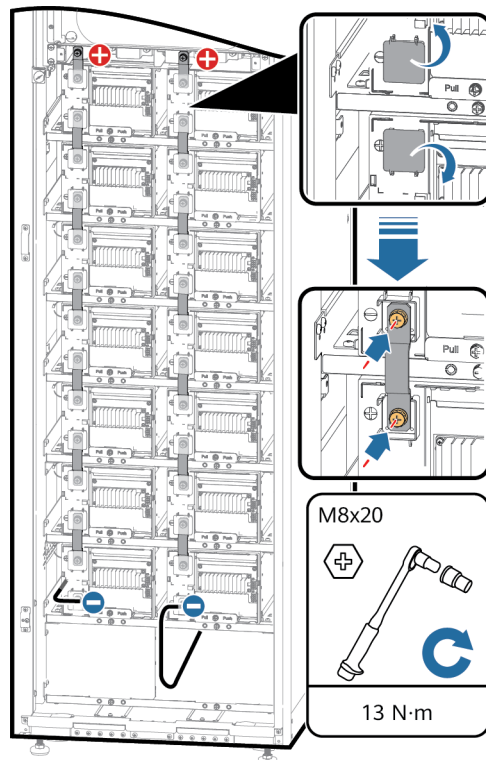

UB11130020

Step 6 Install the battery module covers and fuse cover.

NOTE

Place the cables at the notches and ensure that the covers do not press the cables.

Figure 3-40 Installing covers

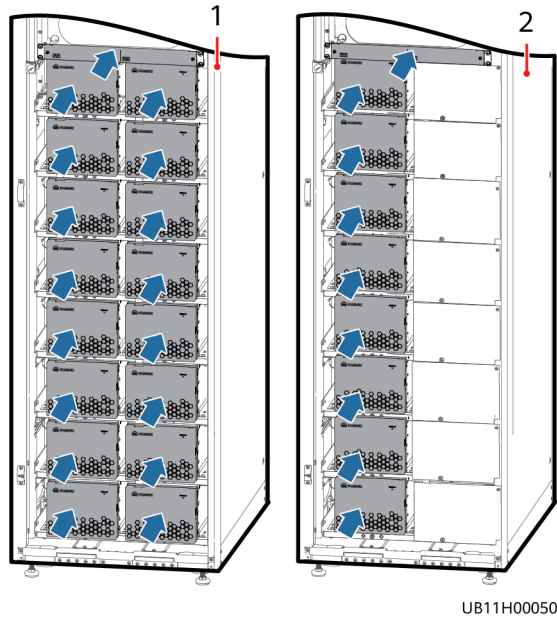

(1) Full-capacity cabinet (8+8 scenario)

(2) Half-capacity cabinet (8+0 scenario)

Figure 3-41 Installing covers (7+7 scenario)

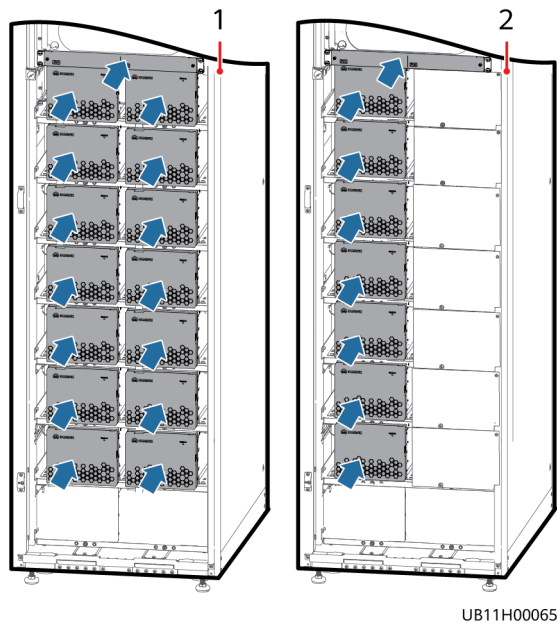

(1) Full-capacity cabinet (7+7 scenario)

(2) Half-capacity cabinet (7+0 scenario)

Step 7 Reinstall the BCU.

Figure 3-42 Installing the BCU

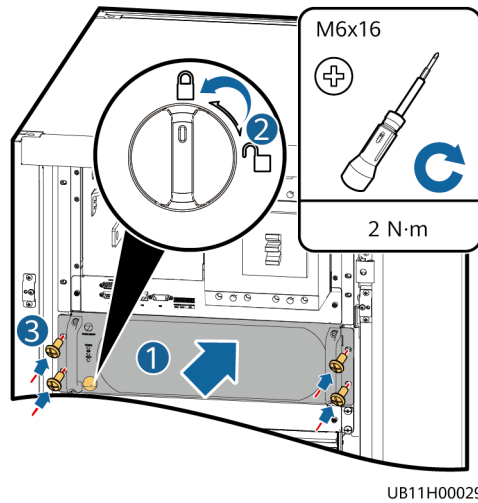

Step 8 Select the corresponding model on the nameplate of the cabinet based on the number of installed battery modules. (The figure uses 16 battery modules as an example.)

Figure 3-43 Selecting a model

<input checked="" type="checkbox"/>	SmartLi-512V-80AH-F-01-16	Charging: 80 A	Discharging: 500 A
	IFpP/23/101/146/(((2P20S)8S)2PJM/0+50/70	Rating: = 512 V; 80 Ah	
<input type="checkbox"/>	SmartLi-512V-80AH-F-01-14	Charging: 80 A	Discharging: 500 A
	IFpP/23/101/146/(((2P20S)7S)2PJM/0+50/70	Rating: = 448 V; 80 Ah	
<input type="checkbox"/>	SmartLi-512V-80AH-F-01-8	Charging: 40 A	Discharging: 250 A
	IFpP/23/101/146/(((2P20S)8S)JM/0+50/70	Rating: = 512 V; 40 Ah	
<input type="checkbox"/>	SmartLi-512V-80AH-F-01-7	Charging: 40 A	Discharging: 250 A
	IFpP/23/101/146/(((2P20S)7S)JM/0+50/70	Rating: = 448 V; 40 Ah	

UB11H00097

----End

3.4.4 Remote EPO

NOTICE

- Huawei does not provide the EPO switch or cable. If the cable is required, the recommended cable is 22 AWG.
- Equip the EPO switch with a protective cover to prevent misoperations, and cover the cable with protective tubing.

Connect the EPO button to the EPO port on the SmartLi using the cable.

Figure 3-44 Cable connection for an NO EPO switch

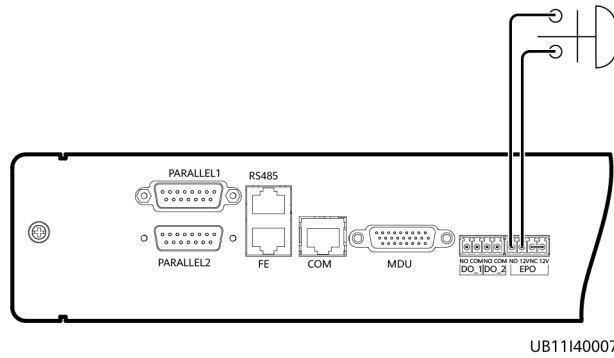
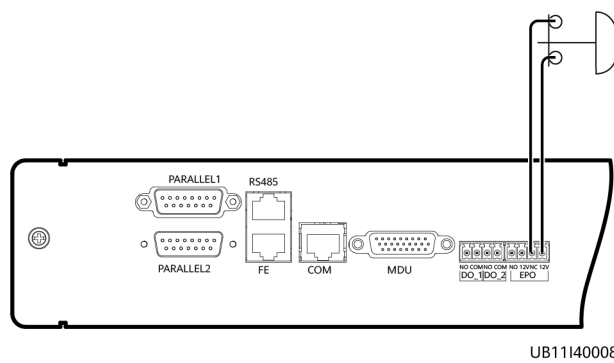

Figure 3-45 Cable connection for an NC EPO switch



NOTE

- When the EPO switch is in the NC state, remove the jumper between EPO_NC and EPO_12V before connection. When the EPO switch is turned off, EPO is triggered.
- When the EPO switch is in the NO state, ensure that the jumper is connected between EPO_NC and EPO_12V. When the EPO switch is turned on, EPO is triggered.

3.4.5 Installing Output Cables

Context

NOTICE

If the load of a single battery cabinet is less than or equal to 150 kW, you are advised to set the I1 value of the battery circuit breaker to the MIN value shown in the figure and use cables with a cross-sectional area of 120 mm². If the load of a single battery cabinet is greater than 150 kW, you are advised to use cables with a cross-sectional area of 150 mm².

Figure 3-46 Setting I1 to MIN for the battery circuit breaker

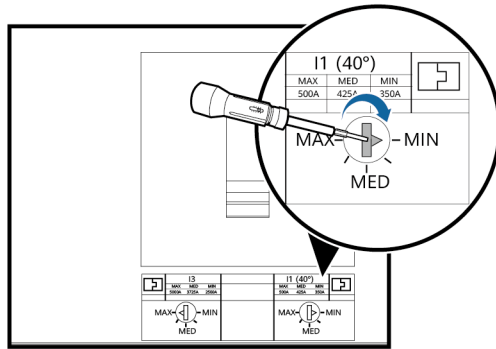

UB11H00037

Procedure

Step 1 Install cables to the UPS.

Figure 3-47 Installing cables (UPS5000-H/S)

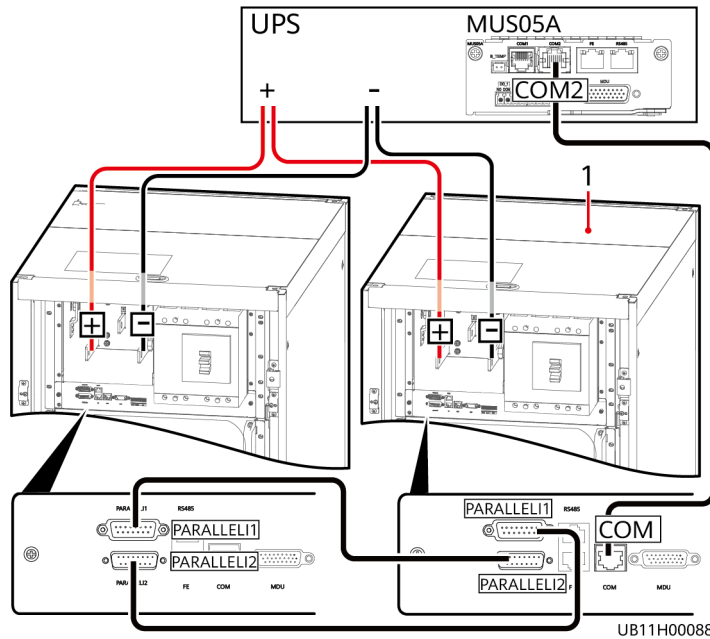

UB11H00088

(1) Master SmartLi cabinet

Figure 3-48 Installing cables (UPS5000-E)

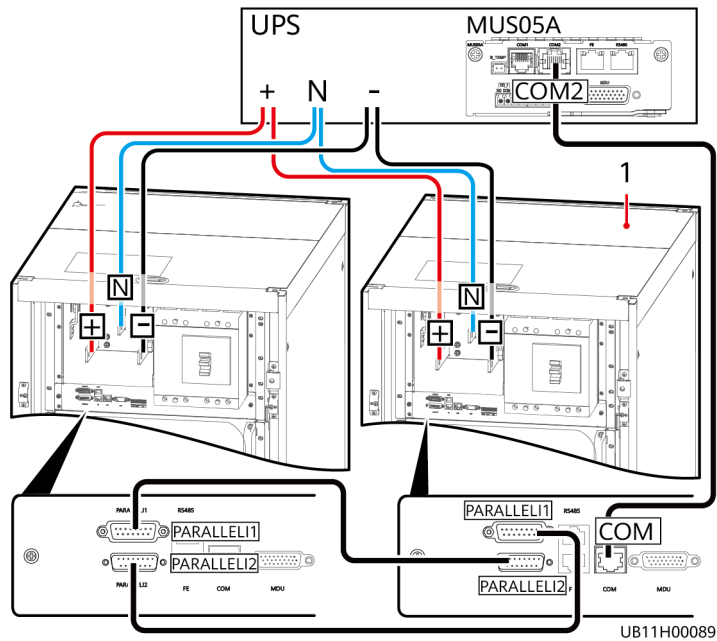

(1) Master SmartLi cabinet

Figure 3-49 Installing cables (Integrated UPS)

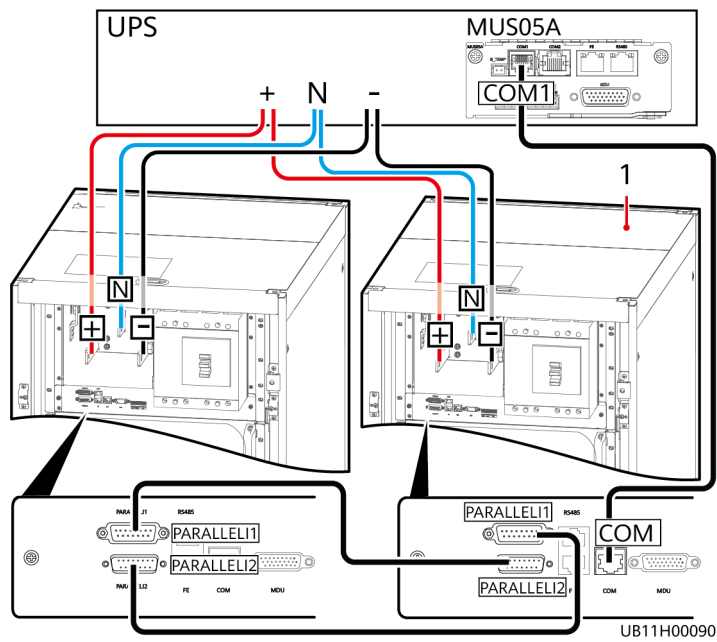

(1) Master SmartLi cabinet

Figure 3-50 Installing cables (UPS5000-S-1200 kVA)

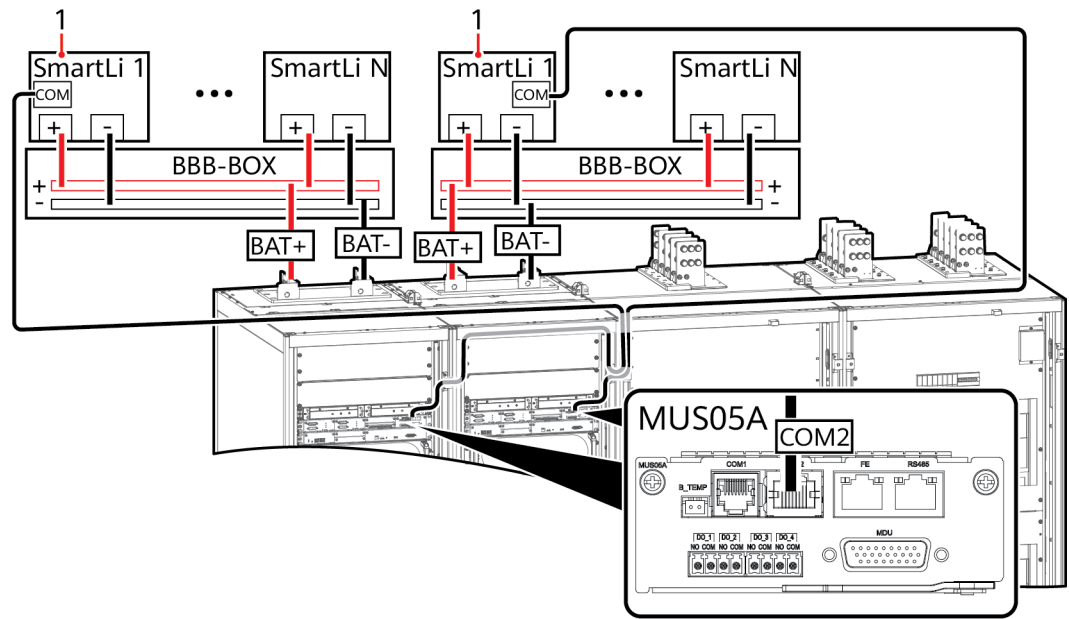

UB11H00093

(1) Master SmartLi cabinet

Figure 3-51 Installing cables (UPS5000-S-1600 kVA)

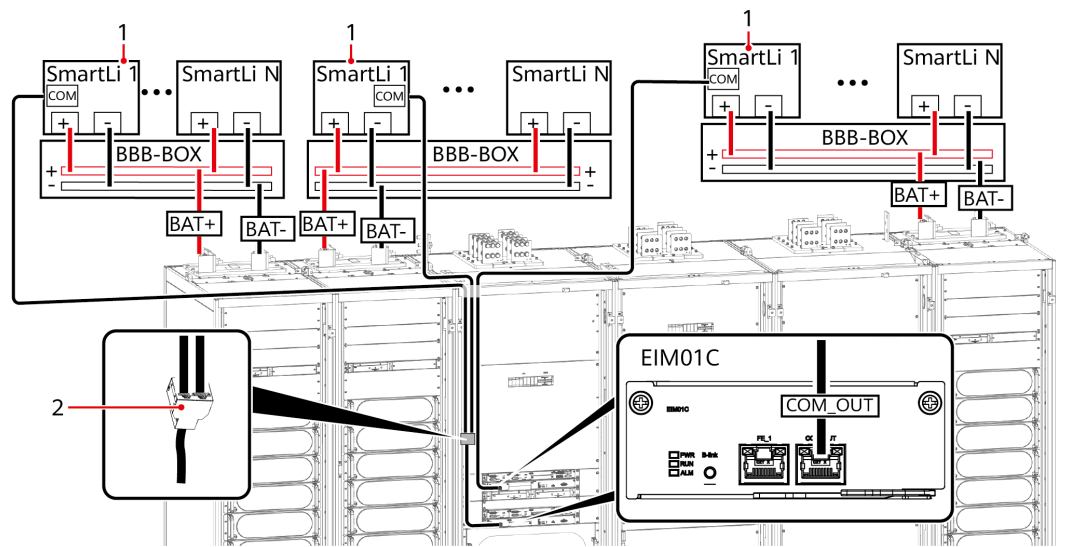

UB11H00094

(1) Master SmartLi cabinet

(2) Two-in-one adapter

Figure 3-52 Installing cables (BBB box, without neutral wires)

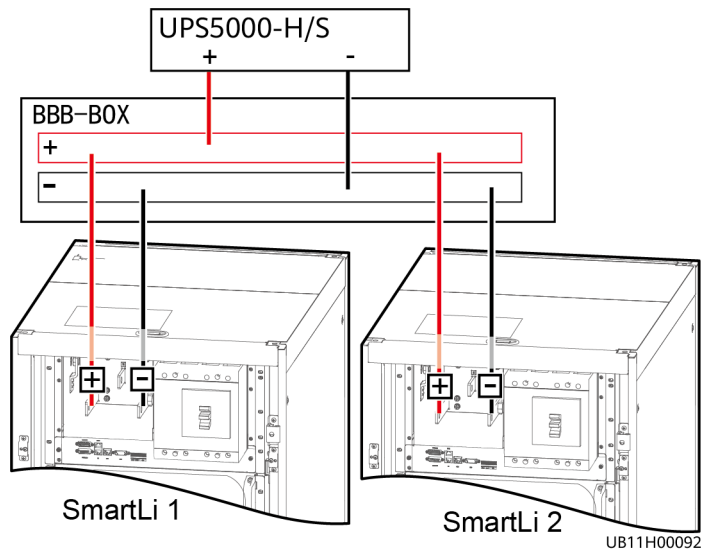
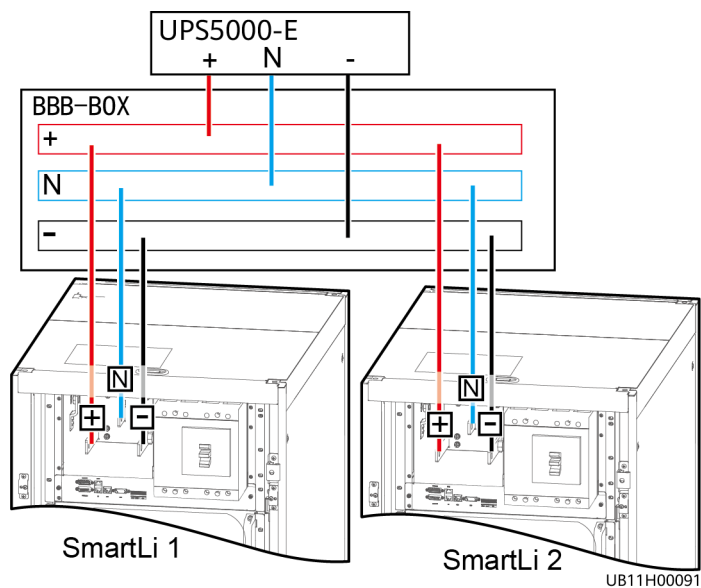

Figure 3-53 Installing cables (BBB box, with neutral wires)



NOTICE

- The following figure shows how to connect a communications cable between the SmartLi and the integrated UPS.
 - W1 and W2, and W3 and W4 respectively use a group of twisted-pair cables, and other redundant core wires are cut off.
 - The cable colors in the figure are for reference only. The actual cable colors may vary.
- Communications cables between the SmartLi and other UPS models are connected using standard network cables.

Figure 3-54 Communications cable between the SmartLi and the integrated UPS

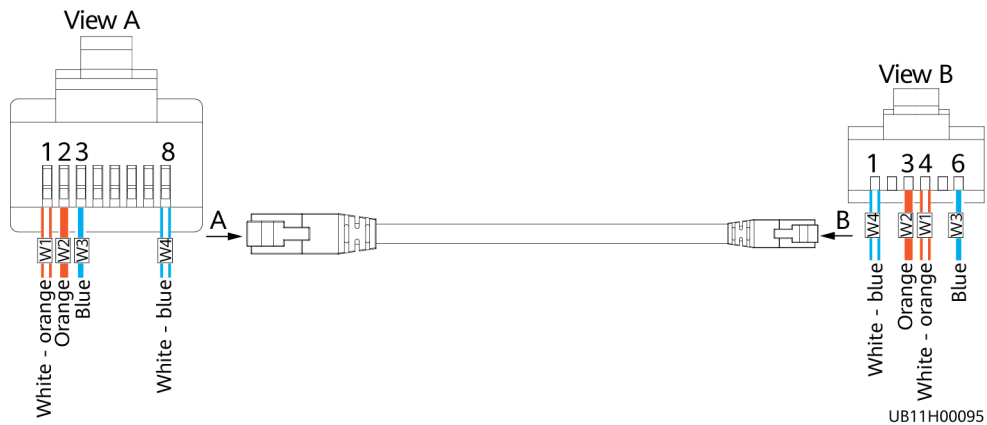

----End

3.5 Installation Verification

Table 3-5 Check items and acceptance criteria

No.	Item	Acceptance Criteria
01	SmartLi installation	The SmartLi is securely installed and does not tilt due to vibration.
02	Neat arrangement	The SmartLi and its adjacent cabinets are neatly arranged and secured with connecting plates.
03	Cable layout	Cables are routed properly and cable routing meets customer requirements.
04	Cable labels	Both ends of a cable are labeled. Labels are concise and easy to understand.
05	Cable ties	Cable ties are secured evenly and no burr exists.
06	Cable connections	The output, and battery cables are securely connected. For the cables secured by screws, the spring washers are flattened.
07	Grounding	The resistance between the SmartLi ground bar and the equipment room ground bar is less than 0.1 ohm.
08	Battery cable connections	The SmartLi is correctly connected to the UPS.
09	Checking the pressure gauge	The pressure gauge pointer reading is greater than 1.6 MPa at 20°C.

No.	Item	Acceptance Criteria
10	Foreign matter cleaning inside the cabinet	<p>The inside and outside of the cabinet, and other operating components, are free from conductive dust.</p> <ol style="list-style-type: none"> 1. There is no foreign matter (such as copper wires and screws) on the top of the cabinet. 2. There is no foreign matter on the copper bar terminals. 3. There is no foreign matter around switch terminals. 4. There is no foreign matter on the bottom plate of the cabinet. 5. There is no foreign matter on the rear module subrack.

NOTE

1. In the scenarios where covers are removed for routing cables, after routing cables and checking cable connections, use sealing putty to fill in the gap between the cables and the cabinet.
2. After verifying the installation, reinstall all the covers.
3. Do not remove the dustproof cover before power-on to prevent dust inside the UPS.

Figure 3-55 Fill the holes with sealing putty

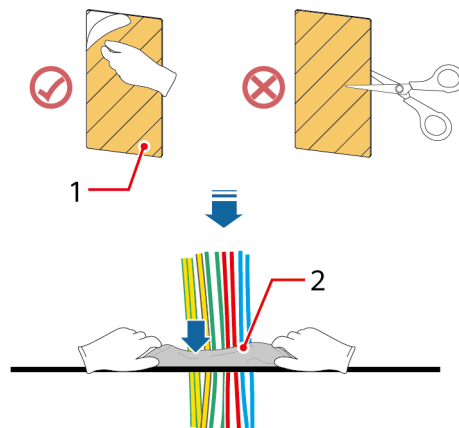

UA15H00029

(1) Paper protective film

(2) Sealing putty

Figure 3-56 Dustproof cover

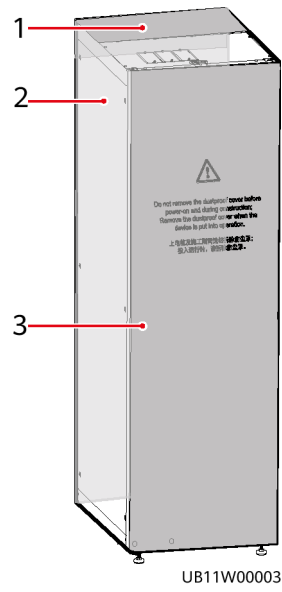

(1) Top dustproof cover

(2) Rear dustproof cover

(3) Front dustproof cover

4 User Interface

4.1 Login

Context

Internet Explorer 11 is used as the example browser.

Table 4-1 User description

Default User	Preset Password		User Rights
admin (system administrator)	LCD	000001	Performs all operations on the LCD and WebUI, including system running information browsing, system information (historical alarms, logs, e-labels, and fault information) exporting, parameter setting, system control, system configuration (network parameters, user management, time and date, and site information), and system maintenance.
	WebUI	Changeme	
operator (common user)	LCD	000001	Browses system running information, clears faults, and controls the buzzer. Other control and maintenance functions that may affect system operation are unavailable to this role and parameters cannot be set.

Default User	Preset Password		User Rights
	WebUI	Changeme	Browses system running information, exports system information (including historical alarms, logs, and electronic labels) except fault data, and clears faults. Other control and maintenance functions that may affect system operation are unavailable to this role and parameters cannot be set.

NOTE

- If an incorrect password is entered five consecutive times, the account will be logged out for 5 minutes.
- After a user logs in to the WebUI, if another user logs in with the same user name, the current account will be logged out.
- Change the password after your first login to prevent unauthorized access. You can change the password over the user management menu on the configuration page.

Procedure

- Step 1** Connect the network port of the PC to the FE port of the monitoring interface unit using a network cable
- Step 2** Open the browser and choose **Tools > Internet Options**.
- Step 3** Click the **Advanced** tab, check that **Use TLS 1.0** and **Use TLS 1.1** are selected, and click **OK**.

Figure 4-1 Settings in the Internet Options dialog box

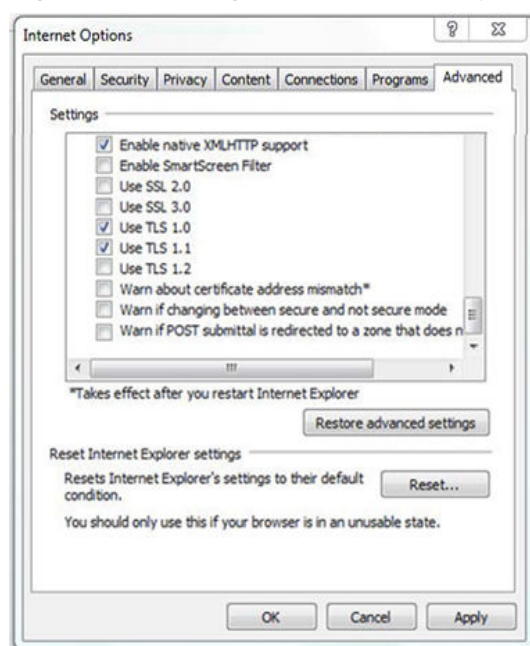

Step 4 Enter **https://SmartLi IP address** in the address box of the browser, select a language, set **User name** and **Password**, and click **Login**. The system supports Internet Explorer 11 and Firefox 31.0.

NOTE

The preset SmartLi IP address is 192.168.0.10. You can set the SmartLi Ethernet IP address on the LCD or WebUI. The value range is 1.0.0.0-223.255.255.255.

----End

4.2 LCD Interface

4.2.1 Main Menu Screen

NOTICE

User interfaces provided in this document correspond to the MDU version V100R003C20 and are for reference only.

The LCD screen is divided into three parts: status bar, alarm bar and information area.

Figure 4-2 Main menu screen

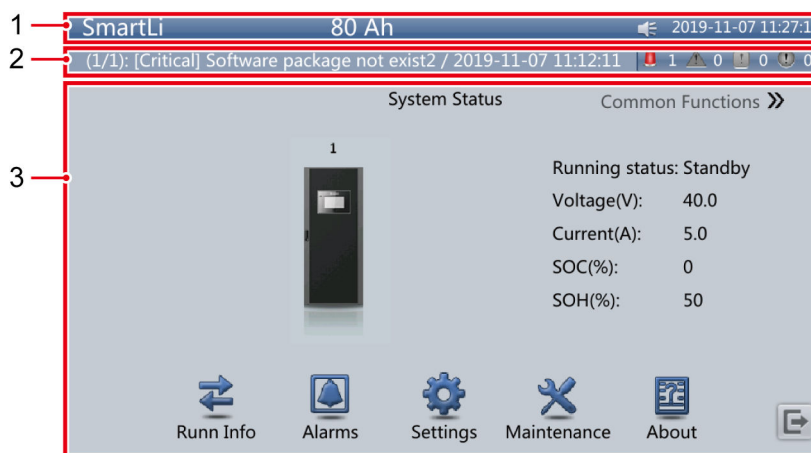







Table 4-2 Main menu description

No.	Area	Function
1	Status bar	Displays the SmartLi model, current date and time, USB flash drive status, and buzzer status.
2	Alarm bar	Displays active alarms in a scrolling list and the number of active alarms based on severity. Tap the alarm icon area to open the active alarm page.

No.	Area	Function
3	Information area	Displays system information.

Table 4-3 Functions of common buttons

Button	Function
	Returns to the main screen.
	Scrolls the page down.
	Scrolls the page up.
	Returns to the upper-level menu.
	Logs a user out.

4.2.2 System Status

On the main menu screen, **System Status** is displayed in the information area.

Figure 4-3 System Status



4.2.2.1 Battery Cabinet

On the **System Status** screen, tap the battery cabinet image. The **Battery Cabinet** screen is displayed. You can view the battery cabinet, module and cell information.

Figure 4-4 Battery Cabinet

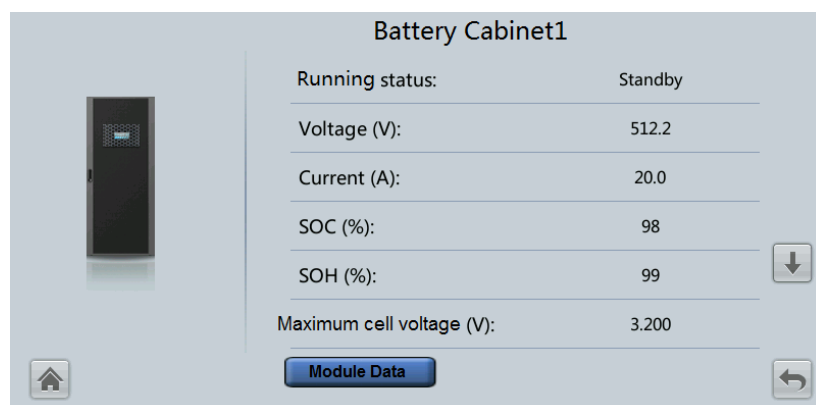

4.2.2.2 Runn Info

On the **System Status** screen, tap the **Runn Info** icon. The **Runn Info** screen is displayed. You can query information about battery systems and battery cabinets.

Figure 4-5 Runn Info

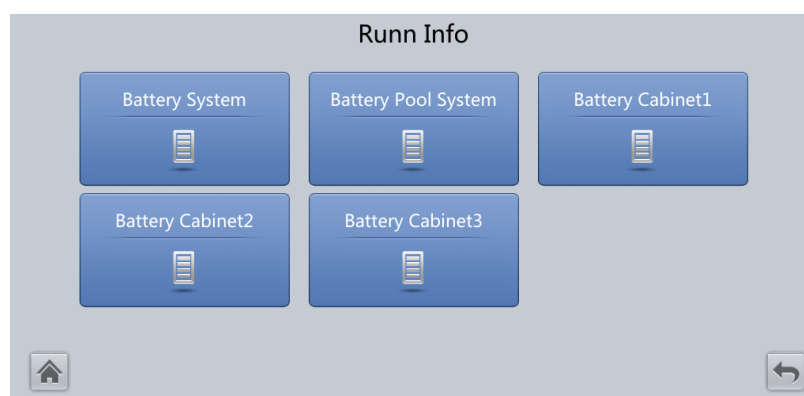

Table 4-4 Battery System

Item	Description
Running status	Running status of the battery system
Voltage (V)	Battery system voltage
Current (A)	Battery system current
SOC (%)	Battery state of charge (SOC)
SOH (%)	Battery state of health
Maximum cell voltage (V)	Maximum battery cell voltage in the battery system
Minimum cell voltage (V)	Minimum battery cell voltage in the battery system

Item	Description
Maximum cell temperature (°C)	Maximum battery cell temperature in the battery system
Minimum cell temperature (°C)	Minimum battery cell temperature in the battery system
Total discharge times	Total discharge times of the battery system
Total discharge capacity (Ah)	Total discharge capacity of the battery system

Table 4-5 Battery Cabinet

Item	Description
Running status	Battery cabinet running status
Voltage (V)	Battery cabinet voltage
Current (A)	Battery cabinet current
SOC (%)	State of charge (SOC)
SOH (%)	State of health
Maximum cell voltage (V)	Maximum battery cell voltage in the battery cabinet
Minimum cell voltage (V)	Minimum battery cell voltage in the battery cabinet
Maximum cell temperature (°C)	Maximum battery cell temperature in the battery cabinet
Minimum cell temperature (°C)	Minimum battery cell temperature in the battery cabinet
Total discharge times	Total discharge times of the battery cabinet
Total discharge capacity (Ah)	Total discharge capacity of the battery cabinet
Online status	-

Table 4-6 Battery Pool System

Item	Description
Running status	Running status of the battery pool system
Voltage (V)	Voltage of the battery pool system

Item	Description
Current (A)	Current of the battery pool system
SOC (%)	SOC value
SOH (%)	SOH value
Maximum cell voltage (V)	Maximum cell voltage of the battery pool system
Minimum cell voltage (V)	Minimum cell voltage of the battery pool system
Maximum cell temperature (°C)	Maximum cell temperature of the battery pool system
Minimum cell temperature (°C)	Minimum cell temperature of the battery pool system
Battery capacity (Ah)	Battery capacity of the battery pool system

Table 4-7 Battery Module

Item	Description
Voltage (V)	Battery module voltage
SOC (%)	State of charge (SOC)
SOH (%)	State of health
Maximum cell voltage (V)	Maximum battery cell voltage in the battery module
Minimum cell voltage (V)	Minimum battery cell voltage in the battery module
Maximum cell temperature (°C)	Maximum battery cell temperature in the battery module
Minimum cell temperature (°C)	Minimum battery cell temperature in the battery module
Total time for max. cell temperature [60,125]°C (h)	Total time when the cell temperature is in the range of [60,125]°C
Total time for max. cell temperature [50, 60)°C (h)	Total time when the cell temperature is in the range of [50, 60)°C
Total time for max. cell temperature [40,50)°C (h)	Total time when the cell temperature is in the range of [40,50)°C

Item	Description
Total time for max. cell temperature [10,40)°C (h)	Total time when the cell temperature is in the range of [10,40)°C
Total time for max. cell temperature [0,10)°C (h)	Total time when the cell temperature is in the range of [0,10)°C
Total time for max. cell temperature [-40,0)°C (h)	Total time when the cell temperature is in the range of [-40,0)°C
Total cell overvoltage alarms	Total number of cell overvoltage alarms
Total cell undervoltage alarms	Total number of cell undervoltage alarms
Total high temperature alarms (charge)	Total number of high temperature alarms (charge)
Total high temperature alarms (discharge)	Total number of high temperature alarms (discharge)
Total low temperature alarms (charge)	Total number of low temperature alarms (charge)
Total low temperature alarms (discharge)	Total number of low temperature alarms (discharge)

Table 4-8 Cell Data

Item	Description
Voltage (V)	Battery cell voltage
Temperature (°C)	Battery cell temperature

4.2.2.3 Alarms

On the **System Status** screen, tap the **Alarms** icon. The **Alarms** screen is displayed. You can query active and historical alarms, disable the buzzer, clear faults, and enable twinkling.

Tap the ID of an active alarm. The alarm details are displayed.

Figure 4-6 Alarms



4.2.2.4 Settings

On the **System Status** screen, tap the **Settings** icon. The **Settings** screen is displayed.

Figure 4-7 Settings screen 1

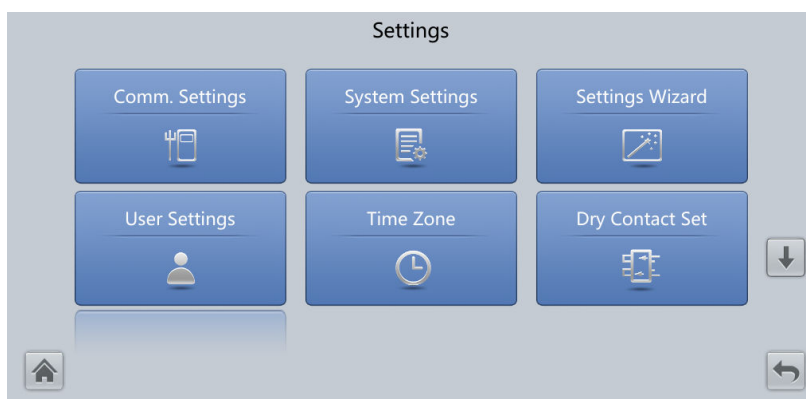

Figure 4-8 Settings screen 2

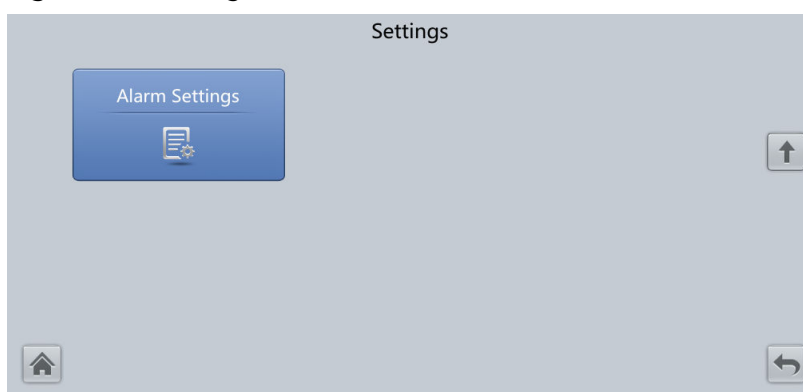

Table 4-9 Comm. Settings

Item	Description	Default Value	Value Range
IP address allocation	Specifies the IP address allocation.	Automatic	Manual, Automatic
IP address	Specifies the IP address for the Ethernet.	192.168.0.5	1.0.0.0–223.255.255.255
Subnet mask	Specifies the subnet mask of the Ethernet.	255.255.255.0	0.0.0.0–255.255.255.255
Gateway	Specifies the Ethernet gateway.	192.168.0.1	1.0.0.0–223.255.255.255
RS485 port address	Specifies the address for RS485 communication.	1	1–254
RS485 port baud rate	Matches the user's network management conditions onsite.	9600	4800, 9600, 19200, 115200
COM port address	Specifies the address for COM communication.	80	1–254
COM port baud rate	Matches the user's network management conditions onsite.	9600	4800, 9600, 19200, 115200
ModbusTCP encryption	If Modbus TCP is used for communication, communication links do not implement encryption or implement encryption based on the selected encryption mode.	Disable	Disable, Enable
SSH	Refers to a secure encrypted transmission protocol used to access the UPS with a terminal tool. Disable: The SSH port is disabled and cannot be accessed. Enable: The SSH port is enabled and can be accessed.	Disable	Disable, Enable

IP address allocation

- If the MDU is directly connected to a computer, the IP address can only be allocated manually. The IP addresses of the MDU and computer must be in the same network segment, and must be different.

- If the MDU is connected to a computer through a LAN switch or router with the DHCP function, the IP address can be allocated manually or automatically. Manual allocation is used by default.
 - **Manual:** Check that their IP addresses are two different values on the same network segment. Set the UPS IP address to be in the same subnet as the PC IP address. Perform the bitwise AND operation for the UPS IP address and the PC IP address with the subnet mask respectively. If the operation results are the same, the two IP addresses are in the same subnet.
AND operation rule: 1 AND 1 = 1, 1 AND 0 = 0, 0 AND 1 = 0, 0 AND 0 = 0. That is when the corresponding bits are both 1, the result is 1. In other cases, the result is 0.

Table 4-10 Bitwise AND operation example

-	PC IP address (182.98.225.125)	UPS IP address (182.98.225.112)
PC IP address/SmartLi IP address	10110110.01100010.11100001.01111101	10110110.01100010.11100001.01110000
Subnet mask (255.255.255.192)	11111111.11111111.11111111.11000000	11111111.11111111.11111111.11000000
Bitwise AND operation result	10110110.01100010.11100001.01000000	10110110.01100010.11100001.01000000

- **Automatic:** The MDU automatically searches for available IP addresses in the connected network. Ensure that the MDU and PC are on the same network segment.

NOTE

- After you restart the device, **IP address allocation** changes back to **Manual**. The IP address is set to the IP address set previously.
- Ensure that the UPS IP address is unique on the network segment. Otherwise, the WebUI display function may not function properly.

Table 4-11 System Settings

Item	Description	Default Value	Value Range
Battery cabinet quantity	Specifies the number of battery cabinets connected in parallel.	1	1-15
Pooling	If this parameter is set to Disable , the system does not allow battery pooling. If this parameter is set to Enable , the system allows battery pooling.	Disable	Disable, Enable

Item	Description	Default Value	Value Range
Number of pool systems	Number of battery systems in the pooling scenario.	2	1~8
Pooling system No.	ID of a battery system in the pooling scenario.	1	1~2
Charging mode	<p>Mode 1 can meet the requirements of most customers.</p> <p>Mode 2 meets the requirements for charging batteries immediately after discharging is complete at a high temperature.</p>	Mode 1	Mode 1, Mode 2
Cell undervoltage protection threshold (V)	You can adjust the EOD threshold as required.	2.5	2.5~2.9
Battery undervoltage protection time (h)	Maximum battery discharge time.	48	24~3000

Table 4-12 Settings Wizard

Item	Description	Remarks
Language	English, Chinese	Set based on site requirements.
Time	Date format, YYYY-MM-DD, time zone, city, and time	Set based on site requirements.
Network Param.	IP address allocation, IP address, subnet mask, and gateway	Set based on site requirements.
System Param.	Battery cabinet quantity, charging mode, cell undervoltage protection threshold, and battery undervoltage protection time	Set based on site requirements.
Alarm Settings	Battery cabinet EPO, copper bar overtemperature, abnormal pressure of fire gas cylinder, battery overcurrent (discharge), and battery overtemperature	Set based on site requirements.

Table 4-13 User Settings

Item	Description	Default Value	Value Range
Language	Thirteen languages are supported.	English	Chinese, English, Russian, Spanish, Portuguese, French, Italian, German, Turkish, Dutch, Polish, Swedish, and Japanese
Date format	Specifies the date format.	-	-
YYYY-MM-DD	Set based on site requirements.	-	-
Time	Set based on site requirements.	-	-
Password	The password can be changed.	000001	-
password complexity check	If the password complexity check is disabled, the user password is required to be a string of six to eight digits. If the password complexity check is enabled, the password is required to be a string of 6–20 characters and contain at least two types of characters.	Enable	Disable, Enable
Key update interval (d)	Prompt the user to update the key.	180	90–1095

Table 4-14 Time Zone

Item	Description	Remarks
Time zone	Set the local time zone.	Set based on site requirements.

Item	Description	Remarks
City	Set the local city.	Set based on site requirements.

Table 4-15 Dry Contact Set

Item	Description	Default Value	Value Range
DO_1	Output dry contact 1 function setting for the lithium battery cabinet	Fire control started	<ul style="list-style-type: none"> • None • Critical alarm • Minor alarm • Fire control started • Battery temp. abnormal • Battery EOD • Battery undervoltage
DO_1 Action	Output dry contact 1 action setting for the lithium battery cabinet	Close	<ul style="list-style-type: none"> • Close • Open
DO_2	Output dry contact 2 function setting for the lithium battery cabinet	None	<ul style="list-style-type: none"> • None • Critical alarm • Minor alarm • Fire control started • Battery temp. abnormal • Battery EOD • Battery undervoltage
DO_2 Action	Output dry contact 2 action setting for the lithium battery cabinet	Close	<ul style="list-style-type: none"> • Close • Open

Table 4-16 Alarm Settings

Item	Description	Default Value	Value Range
Battery cabinet EPO	Emergency power-off (EPO) is performed only when this parameter is set to Enable and the EPO switch is triggered. When the value is changed from Disable , check that the EPO cable is connected correctly.	Disable	Disable, Enable
Copper bar overtemperature	If this parameter is set to Enable , an alarm is reported when the copper bar is overheated.	Enable	Disable, Enable
Abnormal pressure of fire gas cylinder	If this parameter is set to Enable , an alarm is reported when the fire cylinder pressure is abnormal.	Enable	Disable, Enable
Battery overcurrent (discharge)	If this parameter is set to Disable , no alarm is reported when battery overcurrent occurs during discharging. If this parameter is set to Enable , an alarm is reported when battery overcurrent occurs during discharging.	Disable	Disable, Enable
Battery overtemperature	If this parameter is set to Disable , no alarm is reported when battery overtemperature occurs. If this parameter is set to Enable , an alarm is reported when battery overtemperature occurs.	Disable	Disable, Enable

4.2.2.5 Maintenance

On the **System Status** screen, tap the **Maintenance** icon. The **Maintenance** screen is displayed.

Figure 4-9 Maintenance

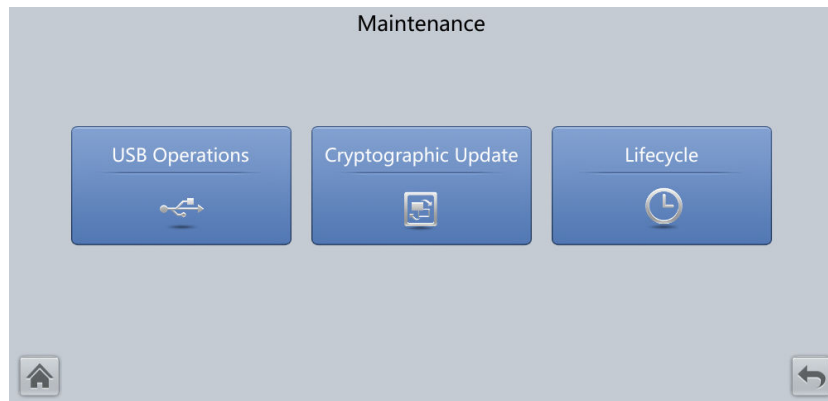

Figure 4-10 USB Operations



Figure 4-11 Lifecycle

The screenshot shows a 'Maintenance > Lifecycle' screen. The title 'Maintenance > Lifecycle' is centered at the top. Below the title, there is a table with the following data:

Device	First Power-on	Arrival Date	Service Life (y)
Monitoring	2020-07-15	N/A	N/A

At the bottom right corner, there is a back arrow icon.

4.2.2.6 About

On the **System Status** screen, tap **About**. The **About** screen is displayed. You can view information about the model, manufacturer, and product version.

Figure 4-12 About



4.2.3 Common Functions

On the main menu screen, choose **Common Functions**. The **Common Functions** screen is displayed. You can disable the buzzer and query historical alarms.

Figure 4-13 Common Functions

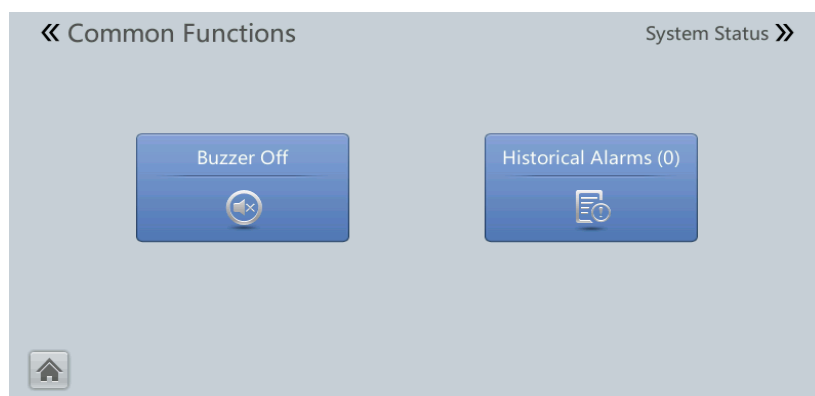

4.3 WebUI

4.3.1 Home

The **Home** page displays the system overview, active alarms, and others.

Figure 4-14 Home

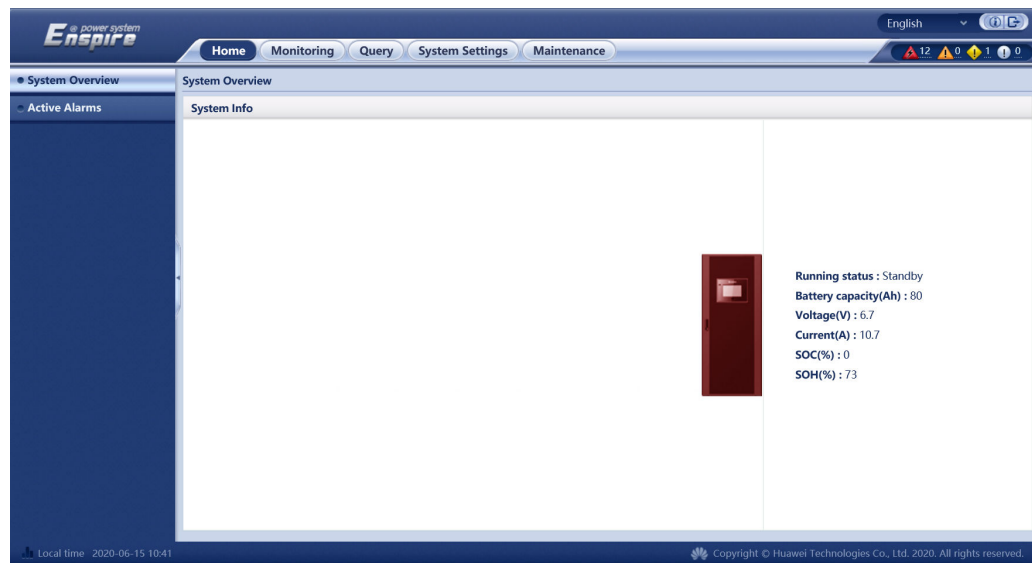

4.3.2 Monitoring

Figure 4-15 Monitoring

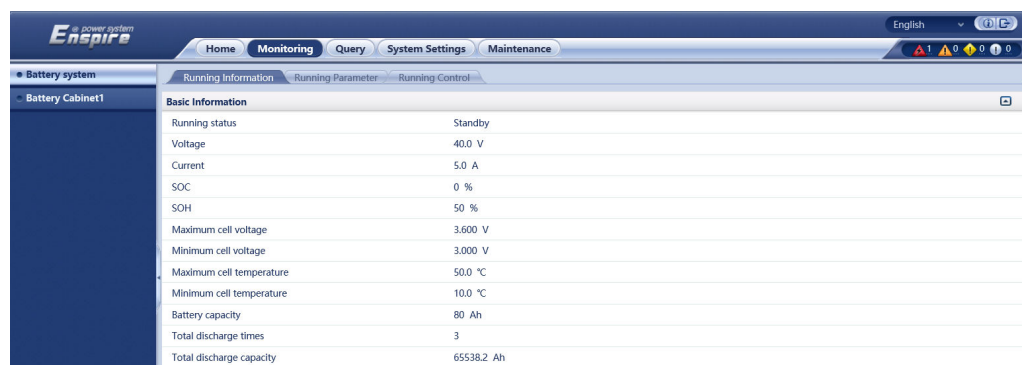

- Running Information: displays the running information about the battery system, battery cabinets, and battery modules.
- Running Parameter: sets system, dry contact, communications, alarm, and network security parameters.
- Running Control: clears faults.

4.3.3 Query

On the home page, choose the **Query** tab. The query options include **Historical Alarm**, **Performance Data**, and **Export Data**.

Figure 4-16 Query

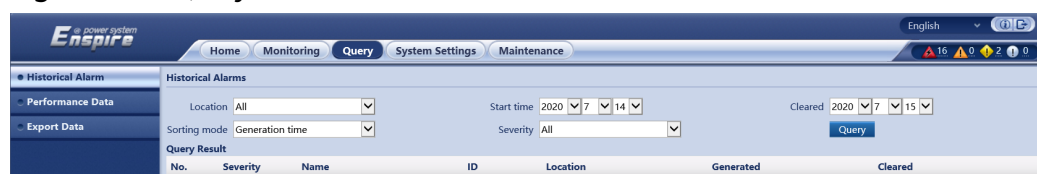

4.3.4 System Settings

On the home page, select the **System Settings** tab. The system settings include **Site Configuration**, **Time**, **IP Address**, **Configuration File**, and **SNMP**.

Figure 4-17 System Settings



4.3.5 Maintenance

NOTE

Non-professional engineers should exercise caution when operating the maintenance page. If the user name is **admin**, only the administrator permission can be assigned to the user.

On the homepage, choose the **Maintenance** tab. The maintenance functions include **Software Upgrade**, **Version Information**, **E-Label**, **User Management**, **Fault Information**, **BSP Upgrade**, and **Lifecycle**.

Figure 4-18 Maintenance

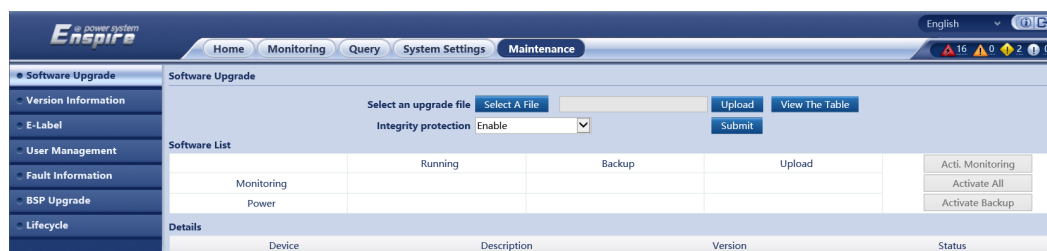

5 Operations

5.1 Powering On Batteries

Prerequisites

- Turn on the ready switch on the BCU.
- Ensure that the UPS runs stably in normal mode and the rectifier in the energy flow diagram is started.

Context

Table 5-1 Status of Indicators on the BCU

Status of Indicators on the BCU	Description
The green indicator blinks at 4 Hz (at short intervals).	Status after the switch button is pressed.
The green indicator blinks on for 1s and off for 4s (intermittently).	The SmartLi circuit breaker cannot be switched on, and the UPS cannot be cold started.
The green indicator blinks at 10 Hz (blinking at super short intervals), and the red indicator is steady on.	The SmartLi circuit breaker can be switched on, but the UPS cannot be cold started.
The green indicator blinks at 1 Hz or is steady on (blinking at long intervals).	The UPS can be cold started.

Procedure

- Step 1** On the UPS LCD screen, set **System Info > Settings > Battery Settings > Battery Type** to **Lithium battery**.

NOTICE

The UPS software needs to be upgraded to the version that supports lithium battery connection. See *UPS5000 The Relationship of Software Version* to check the version number.

Step 2 Press and hold the POWER ON/OFF button on the BCU for more than 2s. The green indicator of the BCU blinks at short intervals.

NOTICE

- The **BCB off** alarm (the red indicator is steady on) is displayed on the UPS LCD and SmartLi LCD. No action is required. After the battery circuit breaker is switched on, the alarm is automatically cleared.
- The green indicator blinks intermittently. After 1 minute, the BCU starts. The green indicator blinks at super short intervals and the red indicator is steady on.
- If multiple SmartLi cabinets are combined, press and hold the POWER ON/OFF button on the BCU of the master cabinet for more than 2s to power on the master cabinet. Then, power on slave cabinets one by one in the same way.

Step 3 Set the language, time, date, network parameters, and system parameters on the **Settings Wizard** screen of the SmartLi.

Figure 5-1 Settings Wizard

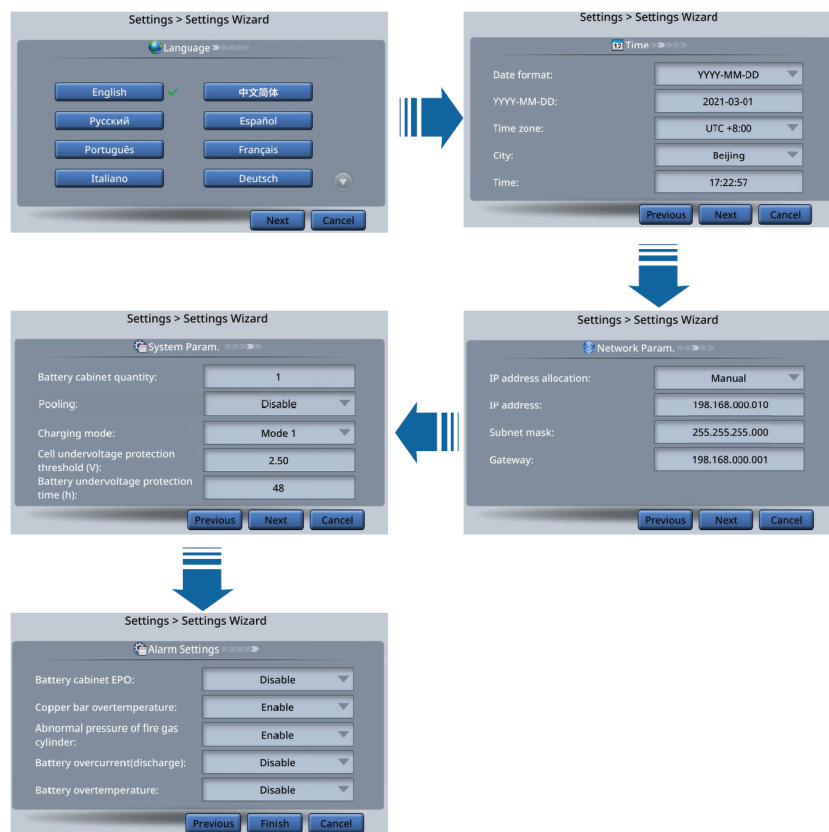

Table 5-2 System Param.

Item	Description	Default Value	Value Range
Battery cabinet quantity	Total number of battery cabinets.	1	1-15
Pooling	If this parameter is set to Enable , the system allows battery pooling. Currently, the system does not support pooling. Retain the default value Disable .	Disable	Disable, Enable
Charging mode	Mode 1 can meet the requirements of most customers. Mode 2 meets the requirements for charging batteries immediately after discharging is complete at a high temperature.	Mode 1	Mode 1, Mode 2
Cell undervoltage protection threshold	You can adjust the EOD threshold as required.	2.5	2.5-2.9
Battery undervoltage protection time (h)	Maximum battery discharge time.	48	24~3000

Table 5-3 Alarm Settings

Item	Description	Default Value	Value Range
Battery cabinet EPO	Emergency power-off (EPO) is performed only when this parameter is set to Enable and the EPO switch is triggered. When the value is changed from Disable to Enable , check that the EPO cable is connected correctly.	Disable	Disable, Enable

Item	Description	Default Value	Value Range
Copper bar overtemperature	If this parameter is set to Enable , an alarm is reported when the copper bar is overheated.	Enable	Disable, Enable
Abnormal pressure of fire gas cylinder	If this parameter is set to Enable , an alarm is reported when the fire cylinder pressure is abnormal.	Enable	Disable, Enable
Battery overcurrent (discharge)	If this parameter is set to Disable , no alarm is reported when battery overcurrent occurs during discharging. If this parameter is set to Enable , an alarm is reported when battery overcurrent occurs during discharging.	Disable	Disable, Enable
Battery overtemperature	If this parameter is set to Disable , no alarm is reported when battery overtemperature occurs. If this parameter is set to Enable , an alarm is reported when battery overtemperature occurs.	Disable	Disable, Enable

Step 4 After the green indicator of the BCU blinks at super short intervals, switch on the battery circuit breaker on the SmartLi.

Step 5 When multiple SmartLi cabinets are combined:

1. If the green indicator of one BCU blinks at super short intervals, switch on the battery circuit breaker on any SmartLi. In this case, the green indicators of all BCUs blink intermittently, and you cannot switch on the battery circuit breakers on other SmartLi cabinets or start the UPS in cold mode.
2. Wait for about 15s. After the green indicators of other BCUs blink at super short intervals, switch on the battery circuit breaker on the SmartLi where the BCU blinks at super short intervals one by one.

----End

5.2 Powering Off Batteries

Procedure

- Step 1** Switch off the SmartLi battery circuit breaker. (Perform this operation for multiple SmartLi cabinets one by one.)
- Step 2** Press and hold the POWER ON/OFF button on the BCU for more than 5s. (Perform this operation for multiple SmartLi cabinets one by one.)

NOTICE

If batteries are powered off and will not be charged for more than a month, remove the BCU.

----End

5.3 Performing EPO

NOTICE

- After EPO is triggered, there is no SmartLi output.
 - After EPO is triggered, the system reports a **Battery cabinet shutdown** alarm.
-

Press the external EPO switch that connects to the dry contact card or remove the 4-pin terminal on the EPO port of the dry contact card of the bypass unit.

5.4 Clearing the EPO State

Procedure

- Step 1** Clear the EPO state. Ensure that the EPO button connected to the external EPO is not in the EPO state.
- Step 2** On the LCD screen, choose **System Status > Alarms > Clear Faults**. In the displayed dialog box, tap **Yes**. The **Battery cabinet shutdown** alarm is cleared successfully.

Figure 5-2 Clear Faults



Step 3 View active alarms and ensure that the **Battery cabinet shutdown** alarm has disappeared from the alarm list.

----End

5.5 Adding a SmartLi

Prerequisites

For online capacity expansion, you need to configure an external circuit breaker to control the battery loop.

Context

This section describes how to add a SmartLi to four cabinets in parallel.

Figure 5-3 Adding a SmartLi

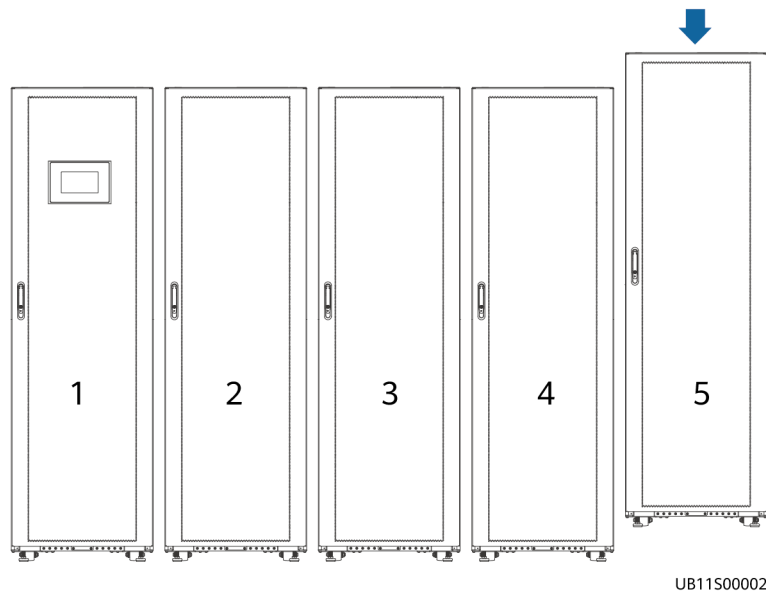

Procedure

Step 1 Install the new SmartLi.

Step 2 Remove the terminal of parallel port 1 on SmartLi 4 and connect the terminal to parallel port 1 on SmartLi 5.

 **NOTE**

On the monitoring module, **PARALLEL1** is above **PARALLEL2**.

Step 3 Connect parallel port 1 on SmartLi 4 to parallel port 2 on SmartLi 5.

Figure 5-4 Connecting control cables

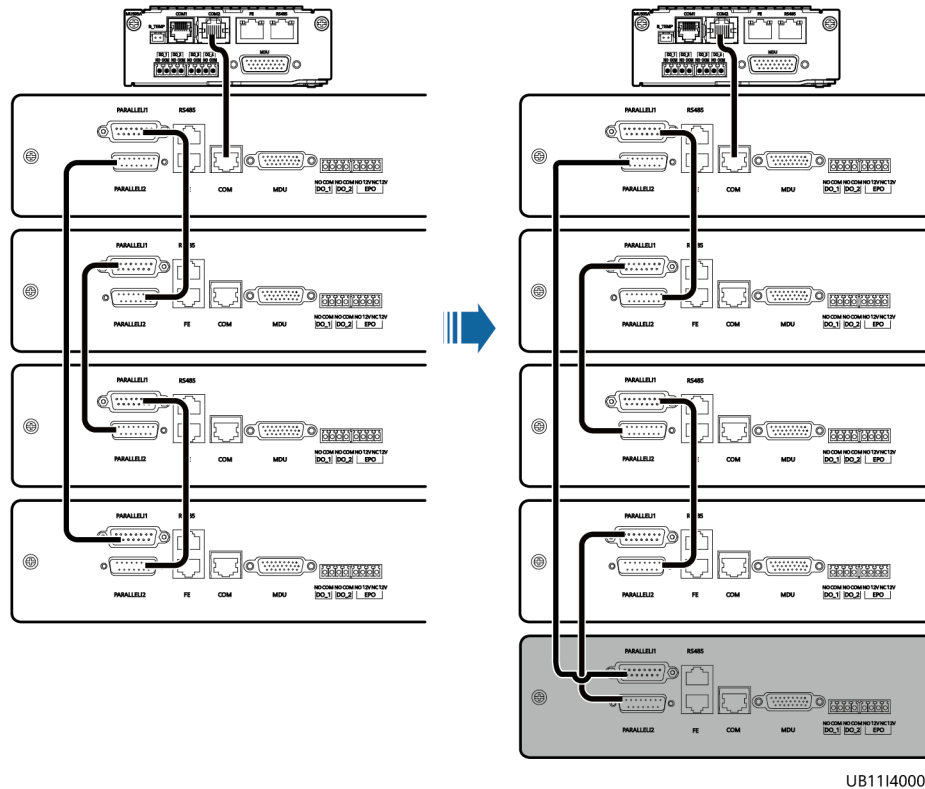

UB11140005

Step 4 On the LCD home screen, choose **Settings > System Settings**, and set **Battery cabinet quantity** to 5.

NOTE

In this case, the **Cabinet quantity mismatch** alarm is generated.

Step 5 Power on the new SmartLi by referring to **5.1 Powering On Batteries**.

NOTICE

After pressing and holding the POWER ON/OFF button on the BCU of the new SmartLi for more than 2s, you need to confirm that the **Cabinet quantity mismatch** alarm is cleared before switching on the battery circuit breaker.

----End

5.6 Removing a SmartLi

Context

This section describes how to remove a SmartLi by using five cabinets in parallel as an example. The original system consists of five combined cabinets. Now, you need to remove SmartLi 3.

Figure 5-5 Removing a SmartLi

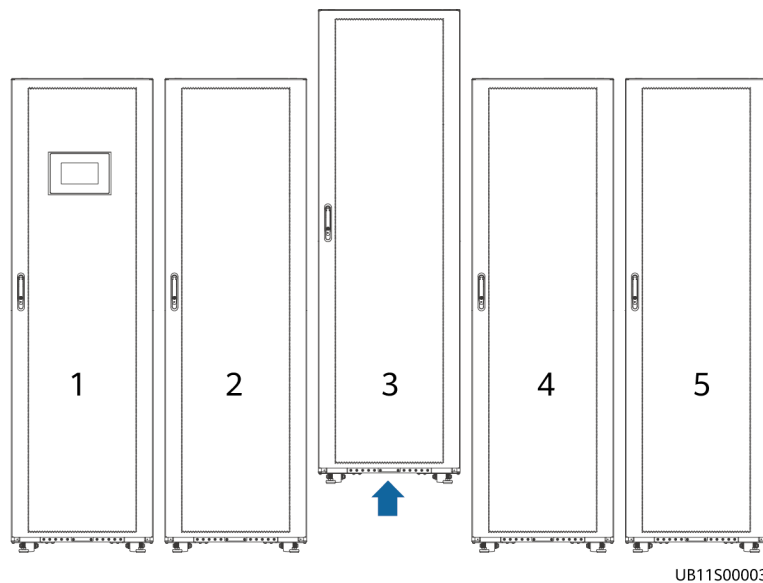

Procedure

- Step 1** Switch off the battery circuit breaker on SmartLi 3.
- Step 2** Press and hold the POWER ON/OFF button on the BCU for more than 5s.
- Step 3** Remove the parallel cable between SmartLi 3 and SmartLi 4.
- Step 4** Remove the terminal from parallel port 2 on SmartLi 3 and connect the terminal to parallel port 2 on SmartLi 4.

Figure 5-6 Removing cables

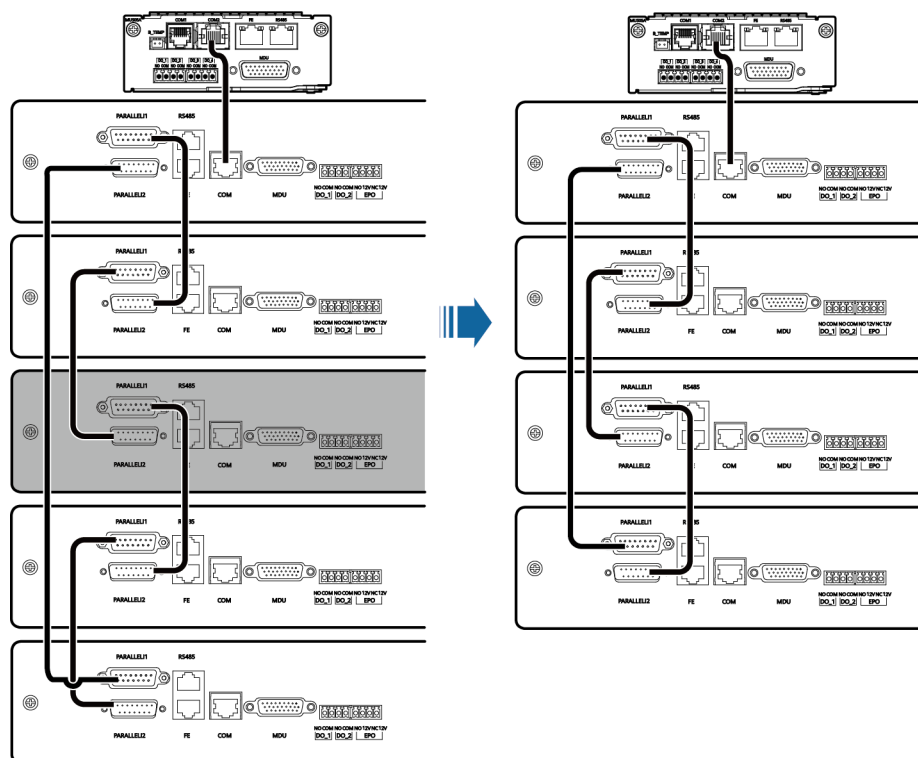

UB11140004

Step 5 On the LCD home screen, choose **Settings > System Settings**, and set **Battery cabinet quantity** to 4.

----End

5.7 Removing a Battery Module

Context

If a battery module is damaged, remove the damaged module, move the left battery module at the bottom layer to the position where the damaged module was located, and reconnect the cables.

NOTICE

The following describes only the replacement solution. For details about how to replace a battery module, see section 8.3 "Replacing a Battery Module."

Procedure

- Step 1** Switch off the battery circuit breaker. Press and hold the POWER ON/OFF button on the BCU for more than 5s to power off the cabinet.
- Step 2** Turn off the ready switch on the BCU.

- Step 3** Remove the bolts that secure the BCU and pull out the BCU for about 10 cm.
- Step 4** Remove the faulty battery module.

 **CAUTION**

- When removing and installing battery modules, wear insulation gloves and use insulated tools.
- Two persons are required to install battery modules.
- Dispose of waste battery modules in accordance with local laws and regulations. Do not dispose of battery modules as household waste.

Figure 5-7 Removing a faulty battery module (8+8 scenario)

Battery module	Battery module
Battery module	Battery module
Battery module	Battery module
Battery module	Battery module (faulty)
Battery module	Battery module
Battery module	Battery module
Battery module	Battery module
Battery module	Battery module
Battery module	Battery module

UZ02140011

Figure 5-8 Removing a faulty battery module (7+7 scenario)

Battery module	Battery module
Battery module	Battery module
Battery module	Battery module
Battery module	Battery module (faulty)
Battery module	Battery module
Battery module	Battery module
Battery module	Battery module
Battery module	Battery module

UZ02140021

Step 5 Remove the left battery module at the bottom layer (put the removed cables and copper bars in the document holder on the front door for future use), and install it at the position where the faulty battery module was located.



After removing a battery power cable, install a safety cap on the wiring terminal to prevent the exposed terminal from touching the shell, which may cause sparks or burns.

Figure 5-9 Moving the battery module (8+8 scenario)

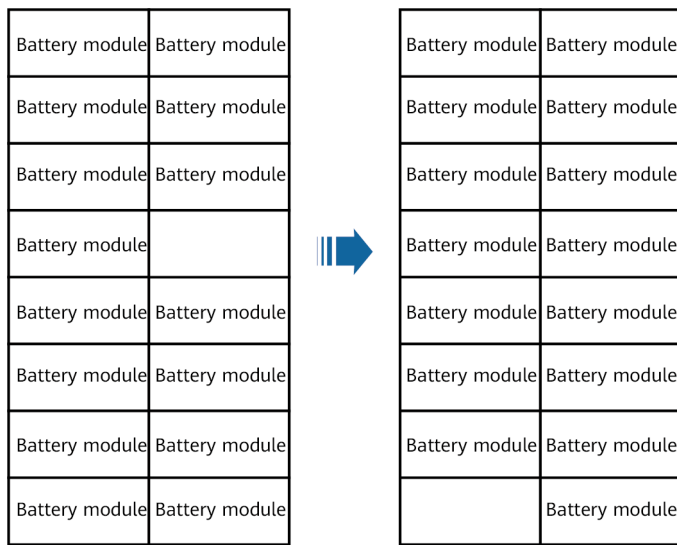

UZ02140017

Figure 5-10 Moving the battery module (7+7 scenario)

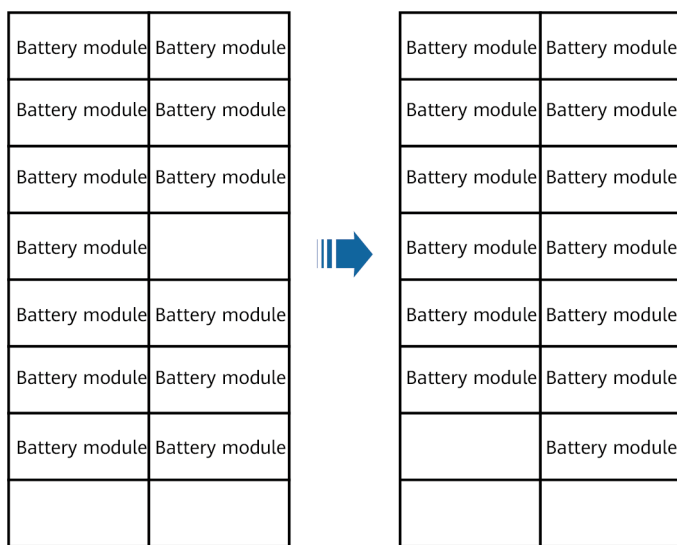

UZ02140020

Step 6 Connect the cables to the corresponding terminals on the upper layer.

Figure 5-11 Installing cables (8+8 scenario)

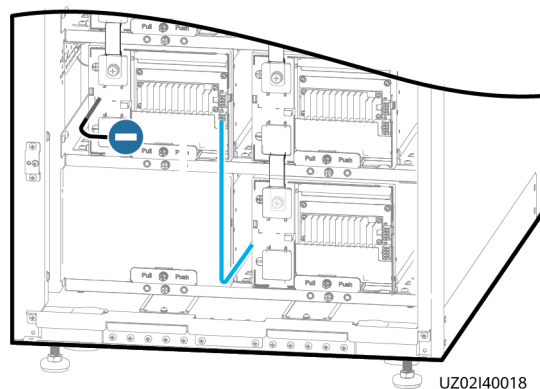
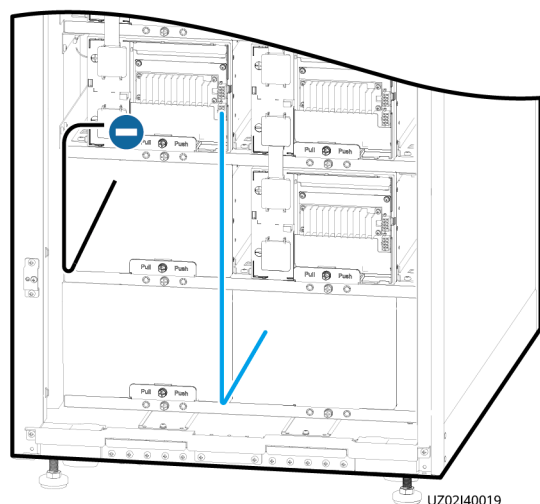

Figure 5-12 Installing cables (7+7 scenario)



Step 7 Reinstall the BCU.

Step 8 Press and hold the POWER ON/OFF button on the BCU for more than 2s. The green indicator of the BCU blinks at 4 Hz.

Step 9 After the green indicator of the BCU blinks at 10 Hz, switch on the battery circuit breaker on the SmartLi.

----End

5.8 Testing Batteries

5.8.1 Shallow Discharge Test

NOTICE

Before performing a shallow discharge test, ensure that:

- The UPS is working in normal mode; float charging or hibernation has lasted for 2 hours after the state of charge (SOC) reaches 100%; and the load ratio fluctuation is less than 10%.
- The UPS generates no battery overtemperature, overvoltage, or overcurrent alarm. No generator is connected to the UPS.
- The mains, batteries, charger, and discharger are normal. No overload alarm is generated.
- The SmartLi has generated no alarms related to lithium batteries.

Automatic Shallow Discharge Test

1. On the home screen of the UPS LCD, choose **System Info > Settings > Battery Settings** and set **Sched. shallow dis. test** to **Enable**.
2. Set **Sched. shallow dis. test time** and **Sched. shallow dis. test interval** as required. After setting is complete, the system will perform automatic shallow discharge tests based on the settings.

Manual Shallow Discharge Test

1. On the home screen of the UPS LCD, choose **System Info > Maintenance > Battery Maint.**
2. Tap **Start** next to **Shallow Dis. Test** to start a shallow discharge test.

Figure 5-13 Starting a shallow discharge test

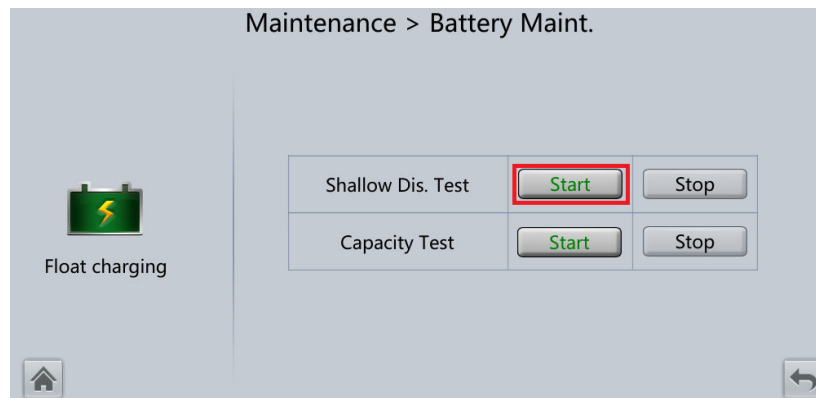

 **NOTE**

When the battery test is complete, the test data is used as common test data. Record the data obtained from the latest five tests.

The shallow discharge test automatically stops in any of the following cases:

- The battery discharge capacity reaches the specified value (10%–50%, 20% by default).
- The discharge voltage reaches the warning threshold (calculated in real time).
- The load ratio fluctuation exceeds 10%.
- An alarm is generated.

5.8.2 Capacity Test

Context

NOTICE

Before a capacity test, ensure that:

- The UPS is working in normal mode; float charging or hibernation has lasted for 2 hours after the state of charge (SOC) reaches 100%; and the load ratio fluctuation is less than 10%.
- The UPS has generated no battery overtemperature, overvoltage, or overcurrent alarm. No generator is connected to the UPS.
- The mains, batteries, charger, and discharger are normal. No overload alarm is generated.
- The SmartLi has generated no alarms related to lithium batteries.

Procedure

Step 1 On the home screen of the UPS LCD, choose **System Info > Maintenance > Battery Maint.**

Step 2 Tap **Start** next to **Capacity Test** to start a capacity test.

Figure 5-14 Starting a capacity test

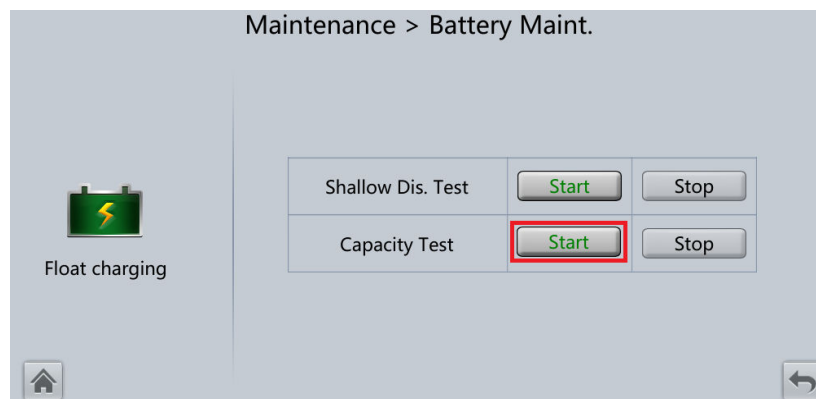

NOTE

The capacity test automatically stops in any of the following cases:

- The minimum cell voltage reaches 2.65 V.
- The load fluctuation exceeds 10%.
- An alarm is generated.

The test is complete when the minimum cell voltage reaches 2.65 V. A maximum of recent 36 capacity test records can be saved.

----End

5.8.3 Test Data Download

1. On the UPS WebUI, choose **Query > Battery Test Records**, choose logs that need to be queried from the **Log** drop-down list box, and click **Query**.

Figure 5-15 Operation Log

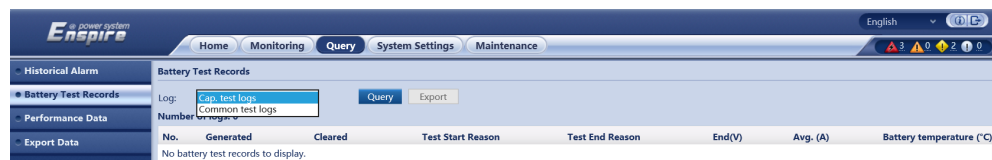

2. Choose logs that have been queried from the **Log** drop-down list box, and click **Export**.

5.8.4 Low-Temperature Application

- Low temperature charging:
 - a. A battery module does not support battery charging at a temperature below 0°C. When the battery temperature is below 0°C, the battery module will shut down the charging loop to disable charging.
 - b. When the battery module is used in an environment below 0°C, a heater needs to be added in the cabinet, and batteries can be charged after the battery temperature rises to 3°C or above.
- Low-temperature discharging:
 - a. A battery module does not support battery discharging at a temperature below -20°C. When the battery temperature is below -20°C, the battery module will shut down the discharging loop to disable discharging.
 - b. When the battery module is used in an environment below -20°C, a heater needs to be added in the cabinet, and batteries can be discharged after the battery temperature rises to -17°C or above.

5.8.5 Storage with Low SOC

Battery modules have static power consumption and self-discharge loss after the battery cabinet is powered off. In actual application scenarios, avoid storing battery modules with low SOC. Promptly recharge battery modules after the storage. Otherwise, the battery modules may be damaged due to overdischarge, which requires replacing the battery modules.

Storage with low SOC may be triggered in the following scenarios:

1. The cabinet is powered off after commissioning and cannot be charged.
2. After the cabinet is discharged, the power grid does not supply power for a long time and batteries cannot be charged in time.
3. After the cabinet is discharged, it cannot enter the charging state due to a system fault.
4. Other scenarios that may trigger storage with low SOC

Regardless of scenarios involving storage with low SOC, charge battery modules within the maximum interval corresponding to the SOC when the cabinet is completely powered off. If the maximum interval is exceeded, the battery modules may be damaged due to overdischarge.

Maximum recharge interval corresponding to the SOC upon power-off:

- SOC \geq 10%: 30 days
- $8\% \leq$ SOC < 10%: 25 days
- $6\% \leq$ SOC < 8%: 20 days
- $4\% \leq$ SOC < 6%: 10 days

If the cabinet cannot be charged for a long time, power off the cabinet completely and recharge the battery modules at the maximum interval corresponding to the SOC. If the SOC is less than or equal to 4%, the battery modules need to be recharged immediately.

5.9 Exporting Data

Prerequisites

You have logged in to the WebUI.

Context

The following data can be exported:

- Historical alarms
- Active alarms
- Performance data
- Operation logs
- E-label
- Fault information

NOTE

This procedure describes how to export historical alarms.

Procedure

- Step 1** Choose **Query > Export Data > Export Historical Data**, set **Encryption Password for Export**, and select **Historical Alarm** from the **Data Type** drop-down list.

Figure 5-16 Exporting historical data

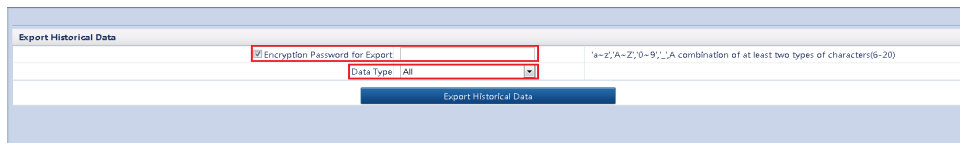

Step 2 Click **Export Historical Data** and save the displayed webpage.

----End

6 Battery Recharge

6.1 Check Before Recharge

Before recharging a battery, you need to check its appearance. Recharge the battery if it is qualified.

Check the appearance of a battery module. The battery module is qualified if it is free from bulging, damage, misshaping, and leakage. Dispose of the battery module if any of the preceding exceptions occurs.

6.2 Battery Recharge Methods

CAUTION

- Ensure that the charge process is supervised to prevent any abnormality.
- If a battery experiences an abnormality such as bulging or smoking, stop charging immediately and dispose of it.
- Ensure that only trained professionals perform recharge operations.

Currently, two charging methods are available. Select one based on site requirements.

SmartLi Recharge Method

NOTICE

- Before removing the BCU, confirm with the customer that services will not be affected.
 - Before removing the BCU, ensure that the lithium battery cabinet is powered off.
-

- Step 1** Identify the battery module qualified for recharge.
- Step 2** Pull out the BCU and install the battery module and cables.
- Step 3** Reinstall the battery management module. Turn the ready switch on the battery management module to the ready state. Press and hold the POWER ON/OFF button on the battery management module for more than 2s. The green indicator of the battery management module blinks at 4 Hz.
- Step 4** Set the language, time, date, network parameters, and system parameters on the touchscreen **Settings Wizard**.
- Step 5** After the green indicator of the BCU blinks at 10 Hz and the yellow indicator is steady on, switch on the battery circuit breaker.
- Step 6** Ensure that the lithium battery charging status is monitored in real time until the charging ends.

Table 6-1 Conditions for judging charging termination

Termination Condition	Method for Measuring Battery Charge Current
The charging time is longer than 10 minutes and the battery current is less than 0.02C (C is the rated battery capacity measured in A).	<ul style="list-style-type: none"> • Use a clamp meter to measure the current of the negative battery cable. • View the battery current displayed on the LCD.

- Step 7** After the charging is complete, remove the BCU, measure the battery voltage, and check whether the batteries are qualified.

Table 6-2 Qualification standard for recharge

Lithium Battery Model	Required Recharge End Voltage	Voltage Requirement After Staying in Open-Circuit State for 10 Minutes Subsequent to Recharge	Method for Measuring Battery Voltage
ESM-6440P1	≥ 66.6 V	≥ 64 V	<ul style="list-style-type: none"> • Use a voltmeter to measure the voltage between the positive and negative terminals of the battery. • View the battery voltage displayed on the LCD.

NOTE

- If the battery is qualified after recharge, remove cables, place it in the original packing case, and update the latest charge time and next recharge time on the recharge label of the original packing case. The battery should be used as soon as possible.
- If the battery is not qualified after recharge, recharge it again. If the battery is still not qualified, dispose of it.

----End

Recharge with a Battery Charger/Discharger

- Step 1** Identify the battery module qualified for recharge.
- Step 2** Install cables between the portable battery charger/discharger and the battery module.

Figure 6-1 Recharge diagram

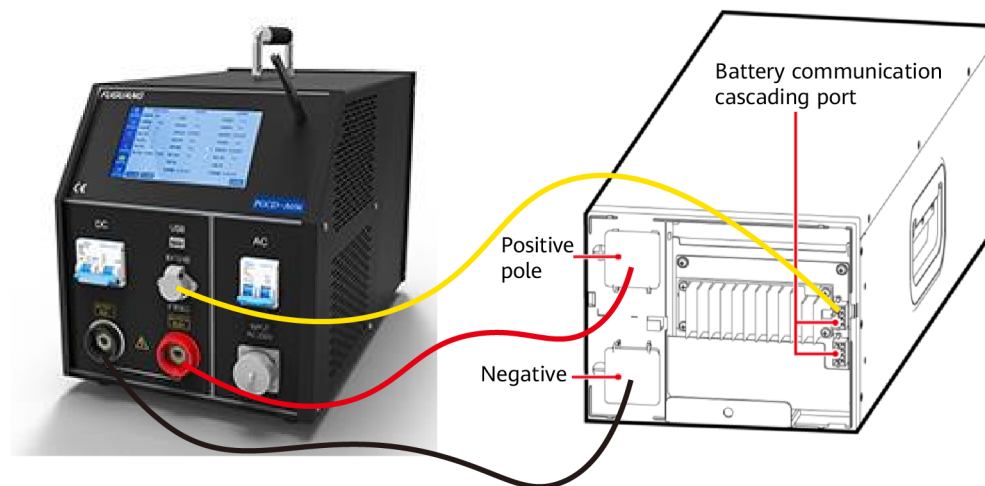

UB111400010

- Step 3** Tap the charge button on the screen of the portable battery charger/discharger to begin charging. The cell voltage of the battery module can be monitored in real time during the recharge, and the charging can be terminated based on the preset parameters. The cell overcharge/overdischarge protection function is also provided.
- Step 4** Through extended communication, the cell voltage and temperature can be read to prevent overvoltage, overtemperature, undervoltage, and undertemperature, thereby ensuring the safety of battery module charge and discharge.
- Step 5** The recharge data can be stored in the portable battery charger/discharger.

Table 6-3 Conditions for judging charging termination

Termination Condition	Method for Measuring Battery Charge Current
The charging time is longer than 10 minutes and the battery current is less than 0.02C (C is the rated battery capacity measured in A).	<ul style="list-style-type: none"> • Use a clamp meter to measure the current of the negative battery cable. • View the battery current displayed on the LCD.

Table 6-4 Qualification standard for recharge

Lithium Battery Model	Required Recharge End Voltage	Voltage Requirement After Staying in Open-Circuit State for 10 Minutes Subsequent to Recharge	Method for Measuring Battery Voltage
ESM-6440P1	≥ 66.6 V	≥ 64 V	<ul style="list-style-type: none"> • Use a voltmeter to measure the voltage between the positive and negative terminals of the battery. • View the battery voltage displayed on the LCD.

 **NOTE**

- If the battery is qualified after recharge, remove cables, place it in the original packing case, and update the latest charge time and next recharge time on the recharge label of the original packing case. The battery should be used as soon as possible.
- If the battery is not qualified after recharge, recharge it again. If the battery is still not qualified, dispose of it.

----End

7 Transportation and Storage

7.1 Transportation Requirements

The product passes the certifications of the UN38.3 (UN38.3: Section 38.3 of the sixth Revised Edition of the Recommendations on the Transport of Dangerous Goods, Manual of Tests and Criteria) and SN/T 0370.2-2009 (Part 2: Performance Test of the Rules for the Inspection of Packaging for Exporting Dangerous Goods). This product belongs to class 9 dangerous goods.

The product can be delivered to the site directly and transported by land and water. The packing case must be secured for transportation, compliant with related national standards, and printed with marks such as anti-collision and moisture prevention. Affected by external environment factors, such as temperature, transportation, and storage, the product specifications at the delivery date prevail.

Loading requirements for packages and common goods:

- Unless otherwise specified, dangerous goods cannot be mixed with goods containing food, medicine, animal feed, and their additives in the same vehicle or container.
- Unless otherwise specified, when dangerous goods packages are loaded in the same vehicle or container as ordinary goods, they should be separated in either of the following ways:
 1. Use a spacer that is as high as the packages.
 2. Keep a distance of at least 0.8 m around.

NOTICE

Protect the packing case with the product from the following situations:

- Being dampened by rains, snows, or falling into water
 - Falling or mechanical impact
 - Being upside-down or tilted
-

7.2 Storage Requirements

1. When storing battery modules, ensure that the packing cases are intact and correctly placed according to the label on the packing cases. Do not put them upside down or sidelong.
2. Stack battery module packing cases by complying with the stacking requirements on the external package.
3. The storage environment requirements are as follows:
 - Ambient temperature: 0–40°C, recommended storage temperature: 20–30°C
 - Relative humidity: ≤ 95%
 - Dry and clean environment with proper ventilation
 - Away from corrosive and organic substances (including gas)
 - Away from direct sunlight
 - At least 2 meters away from heat sources (such as a heater)
4. The warehouse keeper should collect battery module storage information every month and periodically report the battery module inventory information to the planning department. The battery modules that have been stored overdue should be recharged in a timely manner.
5. Regional offices or organizations should not store battery modules or communication equipment configured with battery modules. Prior approval should be obtained for any requirements on battery module storage.
6. Battery modules should be delivered based on the "first in, first out" rule.
7. Install battery modules in a dry, clean, and ventilated environment that is free from sources of strong infrared radiation, organic solvents, and corrosive gases. Do not expose the battery modules to sunlight or water and keep them far away from sources of ignition.

Conditions for Judging Overdue Storage

It is recommended that batteries not be stored for a long period. They should be used soon after being deployed onsite. The batteries should be handled according to the following requirements.

Table 7-1 Lithium battery recharge interval

Storage Temperature	Storage Duration												
	0–3 months	3–4.5 months	4.5–9 months	9–12 months	12–18 months	18–24 months	24–36 months	36–54 months	54–72 months	72–90 months	90–108 months	> 108 months	
0–40°C	No action is required. Use the battery module as soon as possible.				First recharge	Second recharge		Third recharge	Fourth recharge	Fifth recharge	Sixth recharge	Dispose of it.	

Irreversible capacity loss may occur during storage. The following table lists the details for reference.

Table 7-2 Mapping between capacity loss and storage temperature

Temperature	Storage at 0–40°C for 18 months
Irreversible Capacity Loss	2%~12%

 **NOTE**

- If batteries have been stored overdue, promptly report the event to the department leader.
- Dispose of deformed, damaged, or leaking batteries directly irrespective of how long they have been stored.
- The storage duration starts from the latest charge time labeled on the battery package. If a battery is qualified after recharge, update the latest charge time and the next recharge time (next recharge time = latest charge time + recharge interval) on the label.
- The total storage duration should not exceed the warranty period.

8 Routine Maintenance

- Before performing operations on batteries, read through the battery user manual and pay attention to safety precautions and connection methods.
- Before battery maintenance, get the tools insulated.
- Keep the battery switch off during installation and maintenance.
- Before installing and maintaining the battery modules, remove the BCU, and reinstall the BCU after the installation or maintenance is complete.
- When moving batteries, handle batteries gently, and pay attention to personal safety.
- Never use any organic solvent to clean batteries.
- Never smoke or have an open flame around batteries.
- After battery discharge, charge the battery in time to maintain a good service life.
- Only professionals are allowed to perform the maintenance tasks.

Table 8-1 Routine Maintenance

Maintenance Interval	Check Item	Measure
Monthly	Operating environment	Keep the SmartLi far away from heat sources and avoid direct exposure to sunlight.
	Appearance	If a battery module experiences damage, leakage, or deformity, disconnect, take pictures, and then replace the battery module.
	Checking the pressure gauge	If the pressure gauge pointer reading is less than 1.6 MPa at 20°C, contact Huawei technical support.
Quarterly	Cleanliness	Clean the battery module exterior using cotton cloth. Exercise caution when cleaning a battery module because its voltage is high.

Maintenance Interval	Check Item	Measure
	Connection	Check the bolt at every terminal and tighten any loose bolt.
Yearly	Voltage	<ul style="list-style-type: none"> • Measure and record the busbar voltage, and the positive and negative voltages of the SmartLi when charging is about to complete. Ensure that the voltages are the same. If the voltages are different, check for cable faults and rectify them. • In the first year, collect real-time data when discharging is about to complete at least once every six months. • From the second year, check the capacity quarterly.

9 Troubleshooting

⚠ CAUTION

Do not clear alarms by reinstalling modules.

Table 9-1 Troubleshooting

Case	Symptom	Possible Cause	Measure
Battery module abnormal	The indicator of the battery module is red or off.	The battery module is faulty.	Replace the battery module.
		The communications cable to the battery module is not connected.	Reconnect the communications cable.
BCU abnormal	The indicator is yellow or red.	The battery cabinet generates a minor alarm.	Handle the alarm according to the alarm reference.
		The battery cabinet generates a critical alarm.	

📖 NOTE

For details about component replacement and maintenance involved in Troubleshooting and Alarm List, consult Huawei maintenance engineers.

10 Parts Replacement

NOTICE

Before transporting or moving a cabinet, remove battery modules.

10.1 Replacing an MDU

Prerequisites

- Tools: Phillips screwdriver, key to the cabinet door
- Materials: a new and intact MDU

NOTICE

- The MDU can be replaced online without cutting off the power supply to the SmartLi.
- Before the replacement, ensure that the load services are not affected or obtain written consent from the customer.

Procedure

Step 1 Export the monitoring configuration of the SmartLi.

NOTE

If the MDU is damaged and the WebUI is still operational, you can export the MDU configuration on the WebUI. Skip this step if both the MDU and WebUI are not operational.

Step 2 Remove the communications cable from the MDU and mark the connection position

Step 3 Remove the four screws from the MDU using the Phillips screwdriver and set them aside.

Step 4 Hold the MDU front panel by one hand, and push out the MDU from the fastener on the front panel by the other hand.

- Step 5** Install the new MDU and secure it.
- Step 6** Reinstall the communications cable to the new MDU.
- Step 7** Upload the software package and click **Activate All**.
- Step 8** Set parameters.
- Method 1: Power on the MDU, tap **Settings** on the home screen of the LCD, and enter the initial password to log in. Tap **System Settings** and set parameters as required.
 - Method 2: Import the configuration file. On the MDU home screen, choose **Maintenance > USB Operations** and select **Load Config**.
- End

10.2 Replacing a BCU

Prerequisites

- Tools: Phillips screwdriver, key to the cabinet door
- Material: a new and intact BCU

NOTICE

Before the replacement, ensure that the load services are not affected or obtain written consent from the customer.

Procedure

- Step 1** Switch off the battery circuit breaker. Press and hold the POWER ON/OFF button on the BCU for more than 5s to power off the cabinet.
- Step 2** Turn off the ready switch on the BCU.
- Step 3** Remove the bolts that secure the BCU and pull out the BCU.
- Step 4** Install the new BCU and secure it.
- Step 5** Turn on the ready switch on the BCU.
- Step 6** Press and hold the POWER ON/OFF button on the BCU for more than 2s. The green indicator of the BCU blinks at 4 Hz.

NOTICE

If the **Version incompatible** alarm is generated, you need to upgrade the version before switching on the battery circuit breaker.

Step 7 After the green indicator of the BCU blinks at 10 Hz, switch on the battery circuit breaker on the SmartLi.

----End

10.3 Replacing a Battery Module

Prerequisites

- Tools: insulated socket wrench, insulation gloves, Phillips screwdriver, key to the cabinet door
- Materials: a new and intact battery module

NOTICE

Before the replacement, ensure that the load services are not affected or obtain written consent from the customer.

WARNING

After removing a battery power cable, install a safety cap on the wiring terminal to prevent the exposed terminal from touching the shell, which may cause sparks or burns.

Procedure

Step 1 Switch off the battery circuit breaker. Press and hold the POWER ON/OFF button on the BCU for more than 5s to power off the cabinet.

Step 2 Turn off the ready switch on the BCU.

Step 3 Remove the bolts that secure the BCU and pull out the BCU for about 10 cm.

Step 4 Remove the front covers from the faulty battery module and the battery modules below and above the faulty one.

NOTE

- If the faulty module is at the top layer, remove the front cover from the faulty module and the battery module below, and the fuse cover plate above.
- If the faulty module is located at the bottom layer, remove the covers from the faulty module and the battery module above.

Step 5 Remove the cables and copper bars that are connected to the faulty battery module.

Step 6 Remove the battery baffle plate and pull out the faulty battery module.

Step 7 Install the new battery module and secure the baffle plate.

Step 8 Reinstall the cables, copper bars, and front covers to the battery modules.

Step 9 Reinstall the BCU and turn on the ready switch.

Step 10 Press and hold the POWER ON/OFF button on the BCU for more than 2s. The green indicator of the BCU blinks at 4 Hz.

NOTICE

If the **Version incompatible** alarm is generated, you need to upgrade the version before switching on the battery circuit breaker.

Step 11 After the green indicator of the BCU blinks at 10 Hz, switch on the battery circuit breaker on the SmartLi.

----End

10.4 Replacing a SmartLi Fuse

Prerequisites

- Tools: insulated socket wrench, insulation gloves, Phillips screwdriver, key to the cabinet door
- Material: a new fuse

Procedure

Step 1 Open the front door of the cabinet and switch off the battery circuit breaker. Press and hold the POWER ON/OFF button on the BCU for more than 5s to power off the cabinet.

Step 2 Turn off the ready switch on the BCU, remove the bolts that secure the BCU, and pull it out for about 10 cm.

Step 3 Remove the fuse cover.

Step 4 Remove the screws that secure the fuse and replace the faulty fuse with a new one.

Figure 10-1 Replacing a fuse

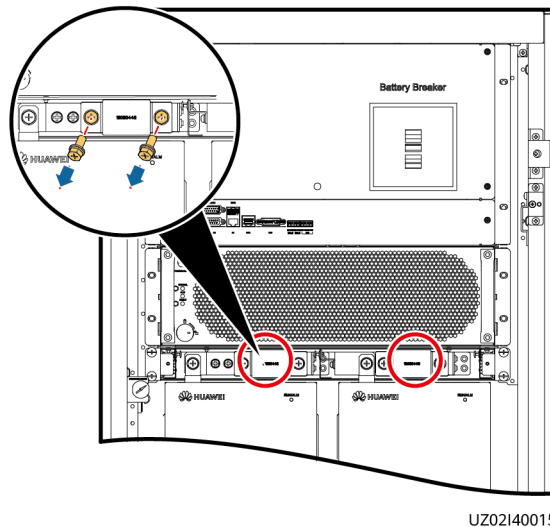

Step 5 Reinstall the fuse cover.

Step 6 Reinstall the BCU.

Step 7 Press and hold the POWER ON/OFF button on the BCU for more than 2s. The green indicator of the BCU blinks at 4 Hz.

Step 8 After the green indicator of the BCU blinks at 10 Hz, switch on the battery circuit breaker on the SmartLi.

----End

10.5 Upgrading Software

NOTICE

- If a **Version incompatible** alarm is generated during the replacement of the MDU, battery module, or BCU, upgrade the software version.
- Ensure that the software of the required version is available before upgrading the software.
- When upgrading the software on the LCD, save the software to a USB flash drive and connect it to the USB port on the MDU.
- When upgrading the software on the WebUI, save the software to a portable computer and log in to the WebUI.
- Perform the upgrade when the system is not in discharge state and the BCB status is the same (all are closed or open).
- Before the upgrade, ensure that the load services are not affected or obtain written consent from the customer.

WebUI

Choose **Maintenance > Software Upgrade**, select **Select a file**, find the correct package in the corresponding path, click the file, choose **Open**, and click **Upload**.

After the upload is complete, choose **Activate All** in the **Software List** and perform operations as prompted.

Figure 10-2 Uploading and activating the software (the BCB of a single battery cabinet is ON)

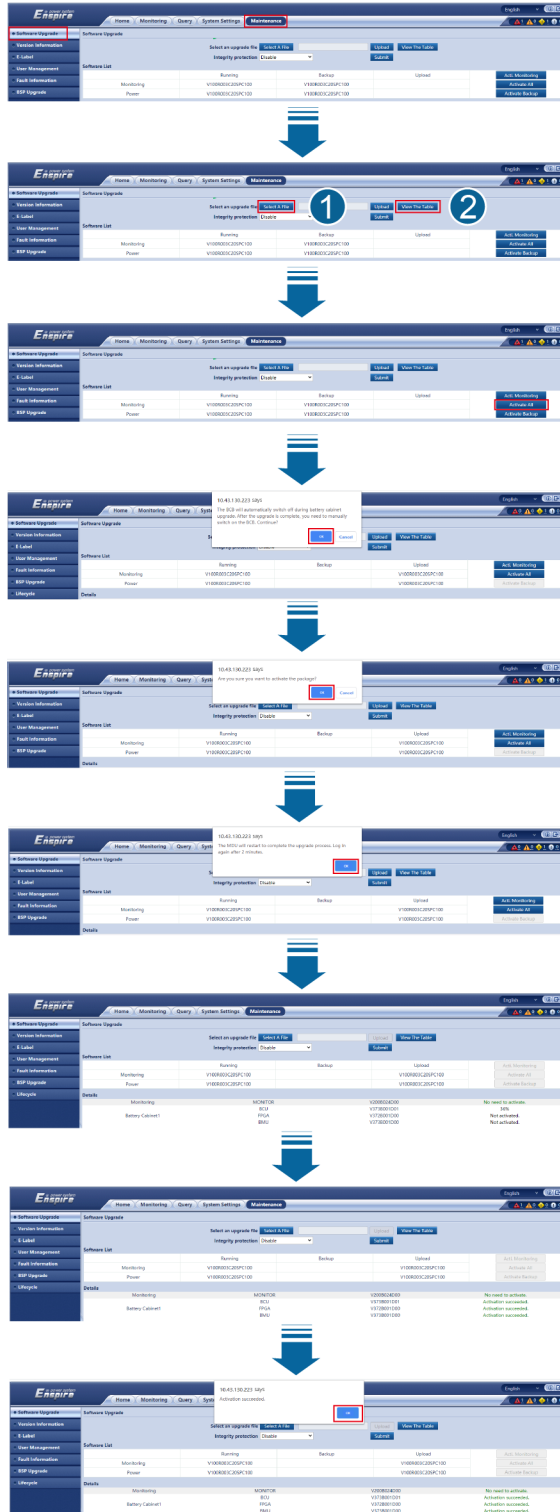
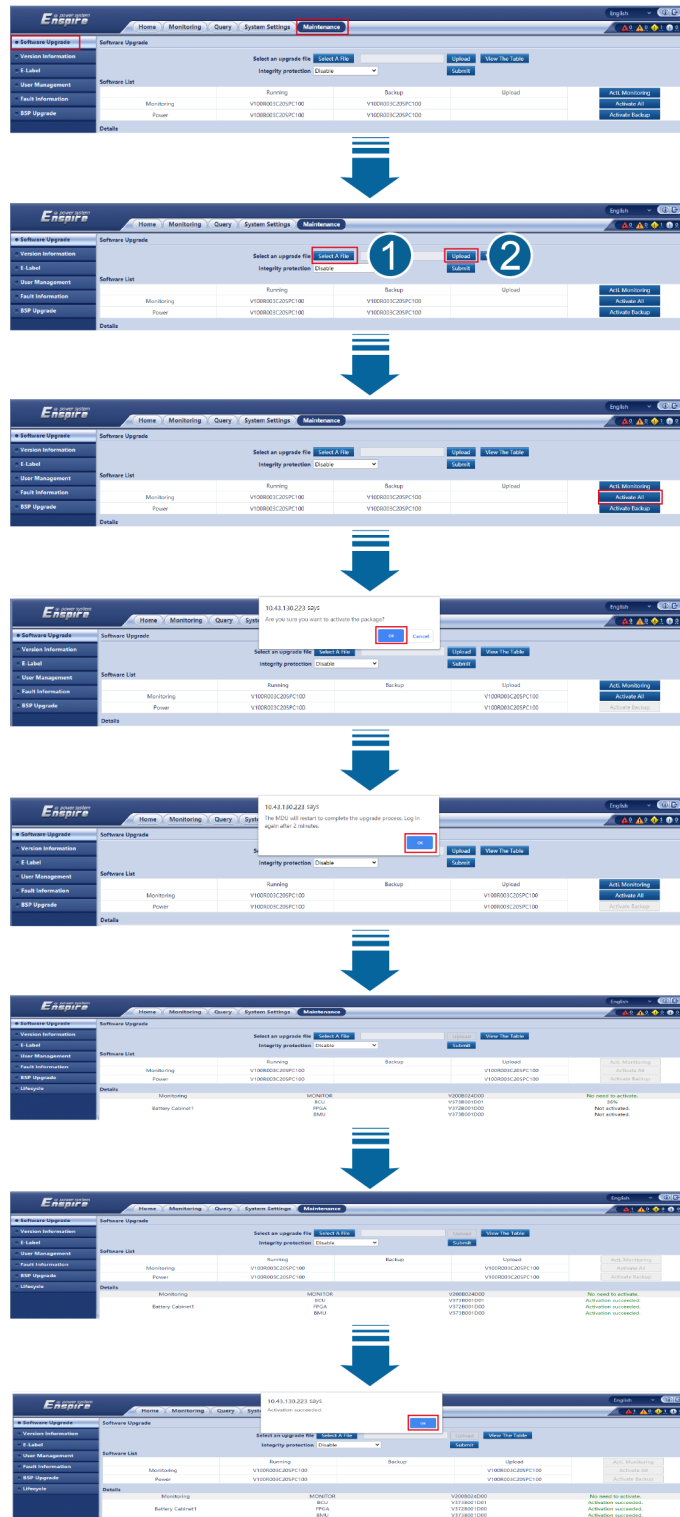

Figure 10-3 Uploading and activating the software (the BCB of a single battery cabinet is OFF)



NOTE

1. The method for uploading and activating the software when the BCBs of all battery cabinets in a parallel system are ON or OFF is the same as the method for uploading and activating the software when the BCB of a single battery cabinet is OFF.
2. The system starts the upgrade process. If the BCBs of all battery cabinets are OFF before the start, the MDU and all the battery cabinets are upgraded concurrently. If the BCBs of all battery cabinets are ON before the start, the MDU and the battery cabinets (battery cabinet 1, battery cabinet 2, ..., and battery cabinet N) are upgraded one by one. The upgrade progress is displayed in the **Status** column. During the upgrade of the MDU, the message "The MDU will restart to complete the upgrade process. Log in again after 2 minutes." is displayed. Click **OK**. The MDU will restart to complete the upgrade process. Wait for about 2 minutes and log in to the WebUI again.

LCD

Choose **System Status > Maintenance > USB Operations > Upgrade Software**, tap **Upload**, and find the correct package in the corresponding path. After the upload is complete, tap **Details**. On the screen displayed, select **All**, tap **Activate**, and perform operations as prompted.

Figure 10-4 Uploading and activating the software (the BCB of a single battery cabinet is ON)



Figure 10-5 Uploading and activating the software (the BCB of a single battery cabinet is OFF)

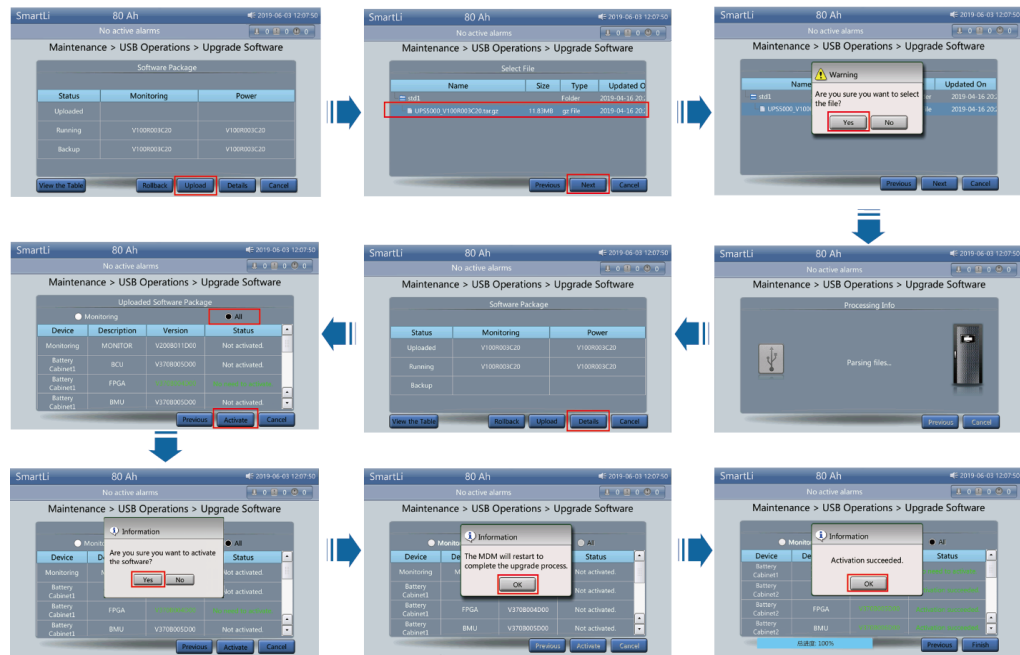

NOTE

1. The method for uploading and activating the software when the BCBs of all battery cabinets in a parallel system are ON or OFF is the same as the method for uploading and activating the software when the BCB of a single battery cabinet is OFF.
2. The system starts the upgrade process. If the BCBs of all battery cabinets are OFF before the start, the MDU and all the battery cabinets are upgraded concurrently. If the BCBs of all battery cabinets are ON before the start, the MDU and the battery cabinets (battery cabinet 1, battery cabinet 2, ..., and battery cabinet M) are upgraded one by one. The upgrade progress is displayed in the **Status** column. During the upgrade of the MDU, the message "The MDU will restart to complete the upgrade process. Log in again after 2 minutes." is displayed. Tap **OK**. The MDU restarts to complete the upgrade task. After about 2 minutes, the default screen is displayed. Choose **System Status > Maintenance** and log in on the LCD again.

10.6 Replacing a Fire Cylinder (Without a Fire Extinguishing Cabinet)

Prerequisites

- Tools: insulated socket wrench, insulation gloves, Phillips screwdriver, key to the cabinet door, torque wrench, pipe cutter, and pipe holder
- Materials:
 - Check the fire cylinder and all components for any damage, abrasion, or corrosion. If there is any visible abrasion or corrosion, replace the damaged components and all corroded components.
 - Check that the valve is closed (vertical to the cylinder).
 - Recommended extinguishant: heptafluoropropane or perfluorohexanone

NOTICE

Before the replacement, ensure that the load services are not affected or obtain written consent from the customer.

Procedure

- Step 1** Check the new fire cylinder.
- Check that the valve is closed (vertical to the cylinder).
 - Check that the reading of the pressure gauge on the fire cylinder is greater than 1.1 MPa.
- Step 2** Open the front door of the SmartLi cabinet and switch off the battery circuit breaker. Press and hold the POWER ON/OFF button on the BCU for more than 5s to power off the cabinet.
- Step 3** Remove the fire cylinder based on the cabinet installation mode.
- If the cabinet is installed against a wall, remove the fire cylinder from the front of the SmartLi cabinet by performing steps 4–17.
 - If the cabinet is not installed against a wall, remove the rear cover from the SmartLi cabinet and remove the fire cylinder from the rear of the SmartLi cabinet by performing steps 7–13 and 16–17.
- Step 4** Turn off the ready switch on the BCU, remove the bolts that secure the BCU, and pull it out for about 10 cm.

Figure 10-6 Pulling out the BCU

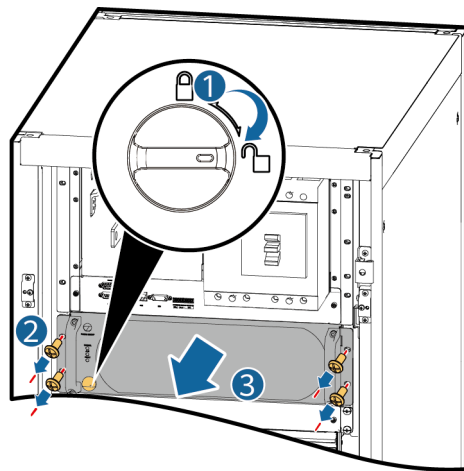

UB11H00026

- Step 5** Remove the battery modules, copper bars, and cables from the lower four layers.

WARNING

After removing a battery power cable, install a safety cap on the wiring terminal to prevent the exposed terminal from touching the shell, which may cause sparks or burns.

Figure 10-7 Removing the battery modules

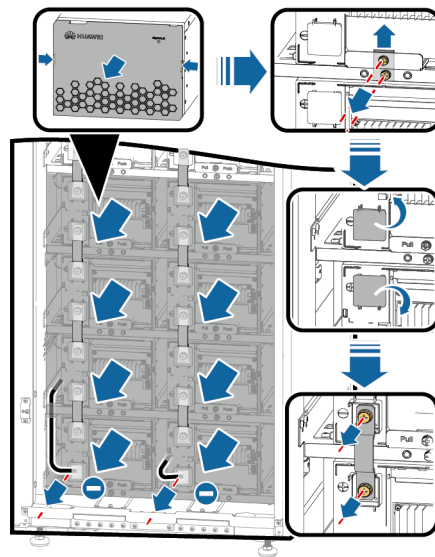

UB11H00047

Step 6 Remove the battery trays from the lower second, third, and fourth layers.

Figure 10-8 Removing battery trays (secured by screws)

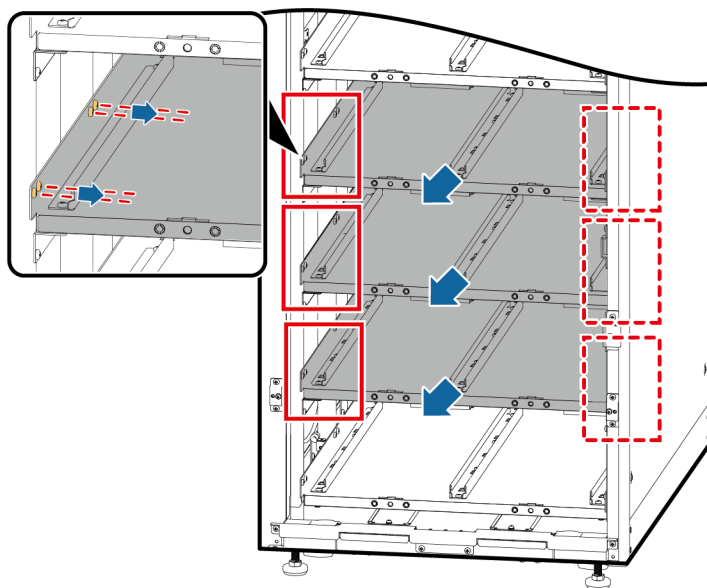

UB11H00018

Figure 10-9 Removing battery trays (secured by spring pins)

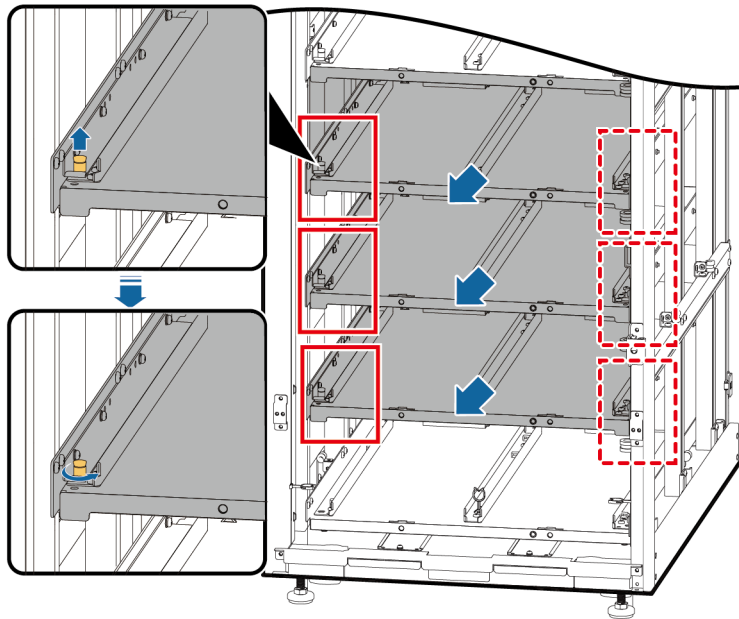

UB11H00072

Step 7 Remove the positioning kit, close the valve, reinstall the positioning kit, and secure it.

Figure 10-10 Closing the valve

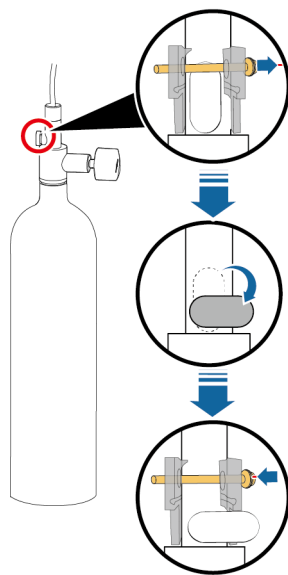

UB11H00069

Step 8 Remove the fire cylinder.

1. Remove the terminals interconnecting the dry contact cable of the fire cylinder and the cable reserved on the side of the cabinet.
2. Remove the connection nut.

NOTICE

The fire-trace tube may contain high-pressure extinguishant. Loosen the connection nut slowly; otherwise, extinguishant may be released unexpectedly.

3. Remove the fire-trace tube.
4. Remove the fire cylinder fastener.
5. Take out the fire cylinder.

Figure 10-11 Removing the fire cylinder

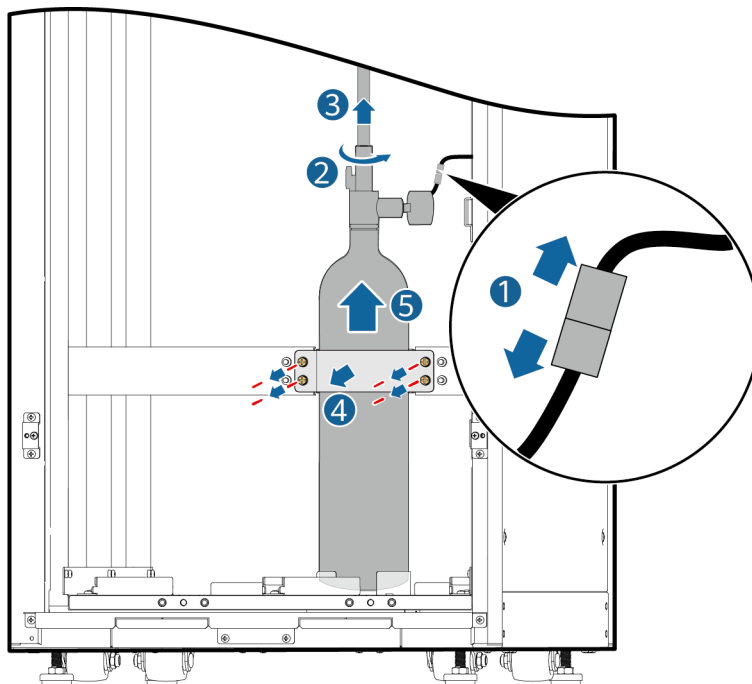

UB11H00038

NOTE

The methods for removing the fire cylinder from the front and rear of the SmartLi cabinet are the same. This figure shows how to remove the fire cylinder from the front of the SmartLi cabinet.

Step 9 Install a new fire cylinder. Keep it upright.

Step 10 Install the fire-trace tube on the fire cylinder.

NOTICE

Do not bend or twist the fire-trace tube or bind the tube using cable ties. Otherwise, the fire cylinder may fail.

1. Cut off the end of the fire-trace tube evenly.

NOTICE

- Ensure that the wall thickness at the end of the fire-trace tube is consistent.
- Ensure that the fire-trace tube, threaded nozzle, and end adapter are clean and free of dust.

Figure 10-12 Cutting off the end of the fire-trace tube



2. Clamp the end of the fire-trace tube to the threaded nozzle using a pipe holder or slip-proof gloves.

NOTICE

Hold the pipe holding device close to the end to avoid bending the tube during pipe insertion.

Figure 10-13 Installing a fire-trace tube

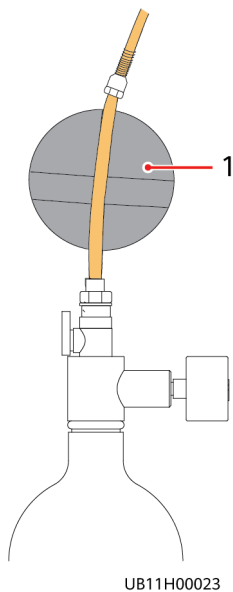

- (1) If the pipe holding device is slip-proof gloves, install the fire-trace tube using slip-proof gloves.

3. Tighten the connection nut to 7 N·m using an adjustable torque wrench.

Step 11 Remove the valve positioning kit, open the valve, reinstall the positioning kit, and secure it.

NOTICE

Slowly open the valve. To avoid unexpected blowout, do not quickly open the valve.

Figure 10-14 Opening the valve

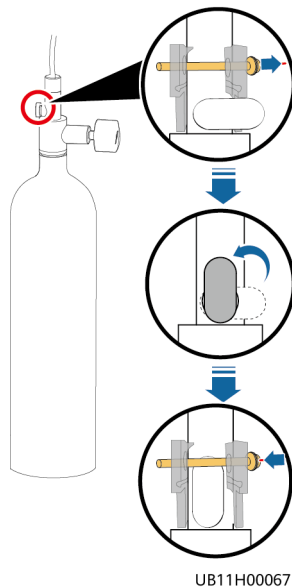

- Step 12** Interconnect the dry contact cable of the fire cylinder and the cable reserved on the side of the cabinet.
- Step 13** Observe the pressure gauge on the front of the cabinet. The value of the pressure gauge should be within the allowable pressure range (1.6–1.8 MPa at 20°C) specified in [Table 3-3](#), and record the position of the pressure gauge pointer. After 8 hours, observe the pressure gauge again. The position should remain unchanged.
- Step 14** Reinstall the battery modules, baffle panels, copper bars, cables, and front panel in sequence.
- Step 15** Reinstall the BCU.
- Step 16** Press and hold the POWER ON/OFF button on the BCU for more than 2s. The green indicator of the BCU blinks at 4 Hz.
- Step 17** After the green indicator of the BCU blinks at 10 Hz, switch on the battery circuit breaker on the SmartLi.

----End

10.7 Replacing a Fire Cylinder (With a Fire Extinguishing Cabinet)

Prerequisites

- Tools: insulated socket wrench, insulation gloves, Phillips screwdriver, key to the cabinet door, torque wrench, pipe cutter, and pipe holder
- Materials:
 - Check the fire cylinder and all components for any damage, abrasion, or corrosion. If there is any visible abrasion or corrosion, replace the damaged components and all corroded components.
 - Check that the valve is closed (vertical to the cylinder).
 - Recommended extinguishant: heptafluoropropane or perfluorohexanone

NOTICE

Before the replacement, ensure that the load services are not affected or obtain written consent from the customer.

Procedure

- Step 1** Check the new fire cylinder.
- Check that the valve is closed (vertical to the cylinder).
 - Check that the reading of the pressure gauge on the fire cylinder is greater than 1.1 MPa.
- Step 2** Open the front door of the SmartLi cabinet and switch off the battery circuit breaker. Press and hold the POWER ON/OFF button on the BCU for more than 5s to power off the cabinet.
- Step 3** Remove the front door panel of the fire extinguishing cabinet and the positioning kit, close the valve, reinstall the positioning kit, and secure it.

Figure 10-15 Closing the valve

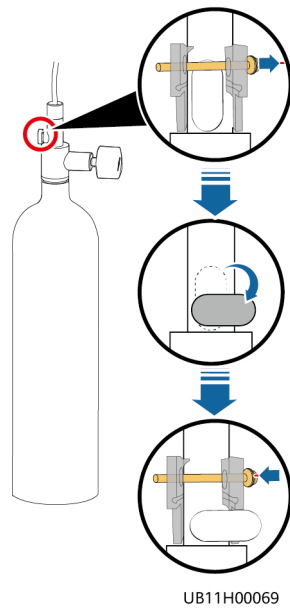

Step 4 Remove the fire cylinder.

1. Remove the dry contact cable from the fire cylinder.
2. Remove the connection nut.

NOTICE

The fire-trace tube may contain high-pressure extinguishant. Loosen the connection nut slowly; otherwise, extinguishant may be released unexpectedly.

3. Remove the fire-trace tube.
4. Remove the fire cylinder fastener.
5. Take out the fire cylinder.

Figure 10-16 Removing a fire cylinder (one SmartLi cabinet and one fire extinguishing cabinet)

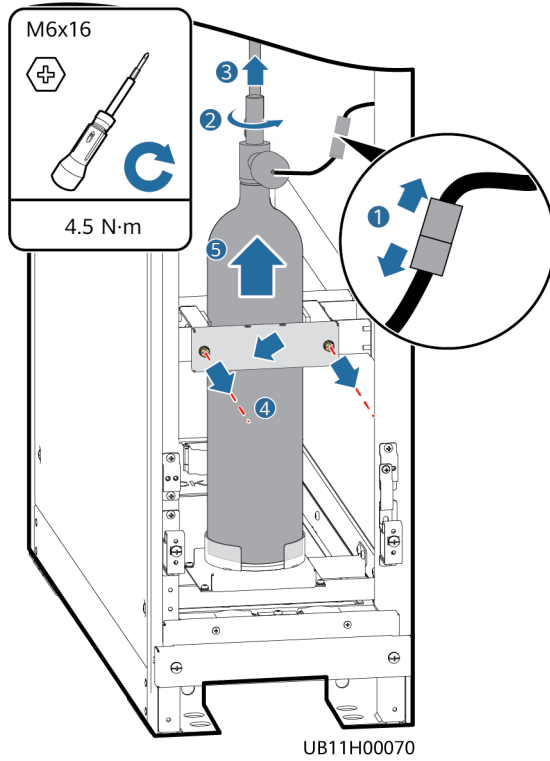
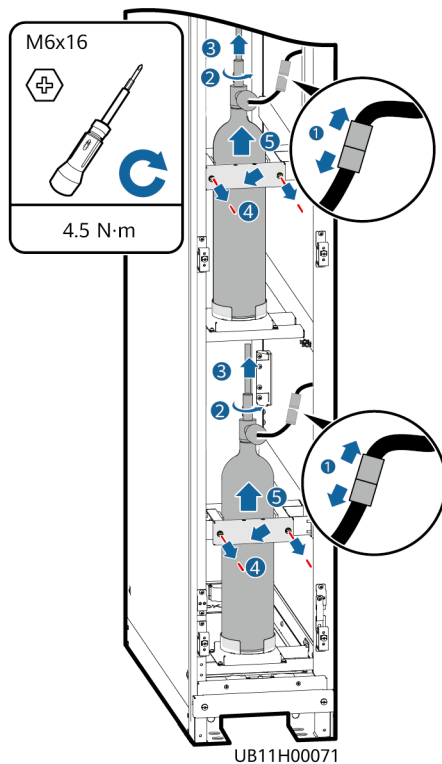

Figure 10-17 Removing fire cylinders (two SmartLi cabinets and one fire extinguishing cabinet)



Step 5 Install a new fire cylinder. Keep it upright.

Step 6 Install the fire-trace tube on the new fire cylinder.

NOTICE

Do not bend or twist the fire-trace tube or bind the tube using cable ties. Otherwise, the fire cylinder may fail.

1. Cut off the end of the fire-trace tube evenly.

NOTICE

- Ensure that the wall thickness at the end of the fire-trace tube is consistent.
 - Ensure that the fire-trace tube, threaded nozzle, and end adapter are clean and free of dust.
-

Figure 10-18 Cutting off the end of the fire-trace tube



2. Clamp the end of the fire-trace tube to the threaded nozzle using a pipe holder or slip-proof gloves.

NOTICE

Hold the pipe holding device close to the end to avoid bending the tube during pipe insertion.

Figure 10-19 Installing a fire-trace tube

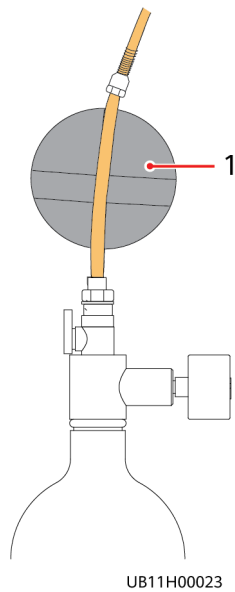

(1) If the pipe holding device is slip-proof gloves, install the fire-trace tube using slip-proof gloves.

3. Tighten the connection nut to 7 N·m using an adjustable torque wrench.

Step 7 Remove the valve positioning kit, open the valve, reinstall the positioning kit, and secure it.

NOTICE

Slowly open the valve. To avoid unexpected blowout, do not quickly open the valve.

Figure 10-20 Opening the valve

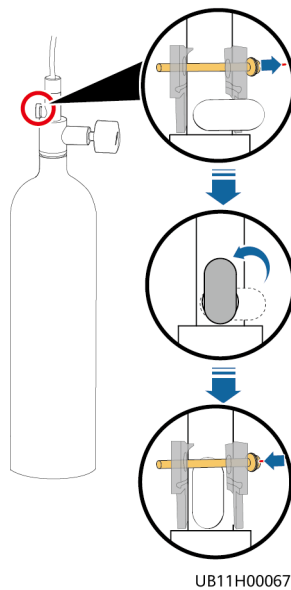

- Step 8** Connect the dry contact cable to the fire cylinder.
- Step 9** Observe the pressure gauge on the front of the cabinet. The value of the pressure gauge should be within the allowable pressure range (1.6–1.8 MPa at 20°C) specified in [Table 3-3](#), and record the position of the pressure gauge pointer. After 8 hours, observe the pressure gauge again. The position should remain unchanged.
- Step 10** Press and hold the POWER ON/OFF button on the BCU for more than 2s. The green indicator of the BCU blinks at 4 Hz.
- Step 11** After the green indicator of the BCU blinks at 10 Hz, switch on the battery circuit breaker on the SmartLi.

----End

11 Technical Specifications

Table 11-1 Physical specifications of a single cabinet

Item	Specifications
Cabling	Cables can be routed in and out from the top.
IP rating	IP20
Dimensions (H x W x D)	2000 mm x 600 mm x 850 mm
Communication	Supports RS485 and FE.
Weight	< 800 kg
Circuit breaker specifications	690 V AC/750 V DC, 500 A, 4P
Fuse specifications	800 V DC, 315 A (one fuse for each battery string)

Table 11-2 Environmental specifications

Item	Specifications
Operating temperature	0°C–40°C
Storage temperature	0°C–40°C
Relative humidity	5%–95% RH (non-condensing)
Altitude	0–1000 m When the altitude is greater than 1000 m but less than 4000 m, the rated power should be derated. For details, see IEC 62040-3.

Table 11-3 Safety and EMC

Item	Specifications	
Safety compliance	CE	EN 62619 EN 62040-1
	CB	IEC 62619 IEC 62040-1
EMC	Conducted emission (CE)	EN/IEC 62040-2
	Radiated emission (RE)	EN/IEC 62040-2
	Low-frequency signal interference	IEC 61000-2-2
	Electrostatic discharge immunity	IEC 61000-4-2
	Conducted susceptibility	EN/IEC 62040-2 EN/IEC 61000-4-6
	Radiated susceptibility	EN/IEC 62040-2 EN/IEC 61000-4-3
	Electrical fast transient (EFT)	EN/IEC 62040-2 IEC 61000-4-4
	Surge protection	EN/IEC 62040-2 IEC 61000-4-5
	Power frequency magnetic field	IEC 61000-4-8

Table 11-4 Electrical specifications of a single cabinet

Item	8+8 scenario (SmartLi-512V-80AH-F-01-16/ SmartLi-512V-80AH-S-01-16)	8+0 Scenario (SmartLi-512V-80AH-F-01-8/ SmartLi-512V-80AH-S-01-8)	7+7 Scenario (SmartLi-512V-80AH-F-01-14/ SmartLi-512V-80AH-S-01-14)	7+0 Scenario (SmartLi-512V-80AH-F-01-7/ SmartLi-512V-80AH-S-01-7)
Rated voltage	512 V (3.2 V/cell)		448 V (3.2 V/cell)	
Charge voltage	544 V (3.4 V/cell)		476 V (3.4 V/cell)	
Rated capacity	80 Ah	40 Ah	80 Ah	40 Ah

Item	8+8 scenario (SmartLi-512V-80AH-F-01-16/ SmartLi-512V-80AH-S-01-16)	8+0 Scenario (SmartLi-512V-80AH-F-01-8/ SmartLi-512V-80AH-S-01-8)	7+7 Scenario (SmartLi-512V-80AH-F-01-14/ SmartLi-512V-80AH-S-01-14)	7+0 Scenario (SmartLi-512V-80AH-F-01-7/ SmartLi-512V-80AH-S-01-7)
Energy	40.96 kWh	20.48 kWh	35.84 kWh	17.92 kWh
Charge current	≤ 80 A, 40 A by default (The actual charge current depends on the UPS charge capability.)	≤ 40 A, 20 A by default (The actual charge current depends on the UPS charge capability.)	≤ 80 A, 40 A by default (The actual charge current depends on the UPS charge capability.)	≤ 40 A, 20 A by default (The actual charge current depends on the UPS charge capability.)
Rated discharge current	500 A	250 A	500 A	250 A
Battery neutral wire connected	Supported			
Battery neutral wire not connected	Supported			
Parallel system	The SmartLi supports a maximum of eight cabinets connected in parallel.			
Number of battery modules	16	8	14	7

Table 11-5 Protection function

Item	Specifications
Battery overvoltage protection	<ul style="list-style-type: none"> Cell: level-1 protection: > 3.65 V; level-2 protection warning: > 3.8 V; level-2 protection: > 3.9 V Battery string: level-1 protection: > 564 V; level-2 protection warning: > 568 V; level-2 protection: > 580 V
Battery undervoltage protection	<ul style="list-style-type: none"> Cell: undervoltage warning: < 2.6 V; level-1 protection: < 2.5 V; level-2 protection: < 2.3 V Battery string: undervoltage warning: < 448 V; protection: < 408 V
Overtemperature protection	> 67°C
Undertemperature protection	< -5°C

Item	Specifications
Overcurrent protection	<ul style="list-style-type: none">• Charge: level-1 protection: > 96 A; level-2 protection: > 200 A• Discharge: level-1 protection: > 500 A; level-2 protection: > 520 A
EPO protection	You can trigger the SmartLi EPO protection by performing EPO on the UPS or over the specified dry contact of the SmartLi.

 **NOTE**

When the UPS5000-E is used with the SmartLi, the maximum half-wave load capacity is 5% of the rated load.

A Alarm List

Alarm ID (Alarm ID- Cause ID)	Alarm Name	Severi ty	Cause	Solution
0612-1	Battery module fault	Critica l	<ul style="list-style-type: none">• The sampling connector is not firmly connected.• The board sampling circuit of the battery module is faulty.• The battery module is faulty.	Replace the faulty battery module.
0612-2	Battery module fault	Critica l	<ul style="list-style-type: none">• The sampling connector is not firmly connected.• The board sampling circuit of the battery module is faulty.• The battery module is faulty.	Replace the faulty battery module.
0021-5	Battery EOD	Critica l	The battery voltage reaches the EOD threshold due to continuous discharge.	<ol style="list-style-type: none">1. Check the status of the battery cabinet and turn on the BCB switch.2. Check the mains and charge batteries in a timely manner.

Alarm ID (Alarm ID- Cause ID)	Alarm Name	Severi ty	Cause	Solution
0024-2	Battery undertemper ature	Minor	The cell temperature is too low.	Take measures to increase the ambient temperature.
0023-2	Battery overtempera ture	Minor	The cell temperature is too high.	Take measures to reduce the ambient temperature.
0025-2	Battery overvoltage	Minor	The cell voltage is too high.	1. Check the UPS status. 2. Check the lithium battery cabinet status.
0026-4	Battery undervoltage	Minor	The cell voltage is too low.	Restore the mains input to the UPS and start the charger to charge the battery.
0616-1	Battery undertemper ature protection	Critica l	The battery temperature is too low.	Take measures to increase the ambient temperature.
0031-2	Battery overtempera ture protection	Critica l	The battery temperature is too high.	Take measures to reduce the ambient temperature.
0032-3	Battery overvoltage protection	Critica l	The voltage of a single cell is too high.	1. Check the UPS status. 2. Check the lithium battery cabinet status.
0617-1	Battery undervoltage protection	Critica l	The cell is overdischarged.	Check the mains and charge batteries in a timely manner.
0612-5	Battery module fault	Critica l	<ul style="list-style-type: none"> • The sampling connector is not firmly connected. • The board sampling circuit of the battery module is faulty. • The battery module is faulty. 	Replace the faulty battery module.

Alarm ID (Alarm ID- Cause ID)	Alarm Name	Severi ty	Cause	Solution
0612-6	Battery module fault	Critical	<ul style="list-style-type: none"> The sampling connector is not firmly connected. The board sampling circuit of the battery module is faulty. The battery module is faulty. 	Replace the faulty battery module.
0612-7	Battery module fault	Critical	<ul style="list-style-type: none"> The sampling connector is not firmly connected. The board sampling circuit of the battery module is faulty. The battery module is faulty. 	Replace the faulty battery module.
0025-3	Battery overvoltage	Minor	The battery voltage reaches the high-voltage alarm threshold.	<ol style="list-style-type: none"> Check the UPS status. Check the lithium battery cabinet status.
0027_2	Battery overcurrent	Minor	The battery charge current reaches the overcurrent alarm threshold.	<ol style="list-style-type: none"> Check the UPS charger status. Check the lithium battery cabinet status.
0026-5	Battery undervoltage	Minor	<ul style="list-style-type: none"> The battery voltage reaches the low-voltage alarm threshold. The input fuse is blown. 	<ol style="list-style-type: none"> Check the mains and charge batteries in a timely manner. Check whether the input fuse is normal.

Alarm ID (Alarm ID- Cause ID)	Alarm Name	Severi ty	Cause	Solution
0027-3	Battery overcurrent	Minor	The battery discharge current reaches the overcurrent alarm threshold.	<ol style="list-style-type: none"> 1. Check whether the UPS is overloaded. Reduce the UPS load to a proper range. 2. Check the lithium battery cabinet status.
0617-2	Battery undervoltage protection	Critical	The battery string overdischarges.	Check the mains and charge batteries in a timely manner.
0621-3	Battery overcurrent protection	Critical	The battery charge or discharge current reaches the protection threshold.	<ol style="list-style-type: none"> 1. Check whether the load of UPS exceeds the battery configuration. 2. Replace the BCU.
0032-5	Battery overvoltage protection	Critical	The battery voltage exceeds the overvoltage protection threshold.	<ol style="list-style-type: none"> 1. Check whether the battery voltage is normal. 2. Replace the BCU.
0620-6	BCU fault	Critical	The BCU is abnormal.	Replace the BCU.
0620-7	BCU fault	Critical	The BCU is abnormal.	Replace the BCU.
0620-8	BCU fault	Critical	The BCU is abnormal.	Replace the BCU.
0625-1	Inter-battery cabinet parallel cable alarm	Minor	The communications cable between cabinets is not properly connected.	Check the cable connection of the inter-rack parallel cable.
0635-1	Battery module not detected	Critical	The BCU does not receive an online query response from the battery module.	<ol style="list-style-type: none"> 1. Check whether the signal terminal of the battery module is properly connected. 2. Replace the battery module.
0619-1	BCB tripping fault	Critical	The BCB box is faulty.	<ol style="list-style-type: none"> 1. Check whether the BCB box runs properly. 2. Check whether the connection between the BCB box and the board is normal.

Alarm ID (Alarm ID-Cause ID)	Alarm Name	Severity	Cause	Solution
0362-4	BCB off	Critical	<ul style="list-style-type: none"> The BCB switch is turned off. The BCB switch status signal cable is abnormal. 	<ol style="list-style-type: none"> Turn on the BCB switch. Check whether the BCB switch status signal cable is properly connected.
0620-1	BCU fault	Critical	The relay of the BCU arcs.	Replace the BCU.
0620-2	BCU fault	Critical	The auxiliary power supply of the BCU is abnormal.	Replace the BCU.
0620-3	BCU fault	Critical	The balanced circuit works abnormally.	Replace the BCU.
0620-4	BCU fault	Critical	The balanced circuit works abnormally.	Replace the BCU.
0043-14	Abnormal fan	Critical	The fan is abnormal.	Replace the BCU.
0621-1	Battery overcurrent protection	Critical	The charger of the BCU is faulty.	Replace the BCU.
0621-2	Battery overcurrent protection	Critical	<ul style="list-style-type: none"> The load exceeds the upper threshold. The BCU is damaged. 	<ol style="list-style-type: none"> Check whether the load of UPS exceeds the battery configuration. Replace the BCU.
0623-1	Battery cabinet EPO	Critical	The emergency shutdown signal of the battery cabinet is activated.	Manually clear the EPO state.
0624-4	Not ready	Critical	The ready switch is not turned off.	Turn on the ready switch.
0620-5	BCU fault	Critical	The hardware overtemperature protection signal is valid.	<ol style="list-style-type: none"> Check whether the ambient temperature is too high. Replace the BCU.

Alarm ID (Alarm ID- Cause ID)	Alarm Name	Severi ty	Cause	Solution
0032-4	Battery overvoltage protection	Critica l	<ul style="list-style-type: none"> The battery string is abnormal. The BCU is abnormal. 	<ol style="list-style-type: none"> Check the battery voltage. Replace the BCU.
0628-1	Abnormal signal board	Critica l	The signal transfer board is faulty.	<ol style="list-style-type: none"> Check the cable connection to the signal transfer board. Replace the signal transfer board.
0629-1	Abnormal inter-battery cabinet parallel cable	Critica l	The inter-rack parallel system CAN is faulty.	<ol style="list-style-type: none"> Check whether the inter-rack parallel cable is loose. Replace the inter-rack parallel cable. Replace the BCU or signal transfer board.
0629-2	Abnormal inter-battery cabinet parallel cable	Critica l	<ul style="list-style-type: none"> The inter-rack parallel cable is not properly connected. 1# BCU is faulty or 2# BCU connected is faulty. 	<ol style="list-style-type: none"> Check whether the inter-rack parallel cable is loose. Replace the inter-rack parallel cable. Replace the BCU or signal transfer board.
0630-1	Abnormal intra-battery cabinet parallel cable	Critica l	The intra-rack parallel CAN is faulty.	<ol style="list-style-type: none"> Check whether the cable to the signal transfer board is loose. Replace the parallel cable between the battery module and the signal transfer board. Replace the BCU or signal transfer board.
0630-2	Abnormal intra-battery cabinet parallel cable	Critica l	The RS485 communications cable in the rack is faulty.	<ol style="list-style-type: none"> Check whether the cable to the signal transfer board is loose. Check whether the signal terminal between the battery modules is properly connected. Replace the parallel cable between the battery module and the signal transfer board. Replace the BCU or signal transfer board.

Alarm ID (Alarm ID- Cause ID)	Alarm Name	Severi ty	Cause	Solution
0630-3	Abnormal intra-battery cabinet parallel cable	Critical	The BCU is not properly connected to the signal transfer board.	<ol style="list-style-type: none"> 1. Check that the cable between the BCU and the signal transfer board is properly connected. 2. Replace the BCU or signal transfer board.
0620-9	BCU fault	Critical	The intra-rack parallel cable is faulty.	Replace the BCU.
0631-2	Version incompatible	Critical	The DSP software version of the BCU does not match.	Load the software.
0631-3	Version incompatible	Critical	The FPGA software version of the BCU does not match.	Load the software.
0631-4	Version incompatible	Critical	The battery module software is incompatible.	Load the software.
0631-1	Version incompatible	Critical	The software version of the BCU does not match.	Load the software.
0632-1	Lithium battery system communication failure	Minor	The communication between the UPS monitoring unit and the lithium battery is interrupted.	Check the cable between the UPS monitoring unit and the lithium battery.
0174-2	Software package not exist	Critical	The package of the power unit or module does not exist in the monitoring system.	Upload the software packages of the power unit or module and MDU, and activate all the packages.
0246-2	Cabinet quantity mismatch	Minor	The configured number of battery cabinets does not match the actual available number.	<ol style="list-style-type: none"> 1. Set the number of battery cabinets to be the same as the actual number. 2. Check the parallel cable connection.

Alarm ID (Alarm ID- Cause ID)	Alarm Name	Severi ty	Cause	Solution
0633-1	Lithium battery capacity mismatch	Minor	The number of configured UPS modules exceeds the upper limit supported by the lithium battery cabinet.	Reduce the number of UPS modules or add a lithium battery cabinet.
0636-1	Battery module balance alarm	Minor	<ul style="list-style-type: none"> • There is no enough time for cell balancing. • The cell balancing cable is faulty. 	<ol style="list-style-type: none"> 1. Start the UPS charger to charge batteries for balancing for 3 days, and then check whether the alarm disappears. 2. Replace the battery module.
0636-2	Battery module balance alarm	Minor	The electrochemical cell temperature consistency is poor.	Replace the battery module.
0620-10	BCU fault	Critical	The voltage sampling circuit is faulty.	Replace the BCU.
0620-11	BCU fault	Critical	The current CT sampling circuit is faulty.	Replace the BCU.
0620-12	BCU fault	Critical	<ul style="list-style-type: none"> • The battery input cable is not connected. • The battery input fuse is open-circuited. • The BCU is faulty. 	<ol style="list-style-type: none"> 1. Check the battery cable connection. 2. Replace the input fuse. 3. Replace the BCU.
0021-6	Battery EOD	Critical	The battery voltage reaches the EOD threshold due to continuous discharge.	Check the mains, turn on the BCB switch and charge batteries in time.
0220-3	Abnormal SOH	Minor	The state of health of a battery is abnormal.	Fully charge the batteries, and perform a capacity test. Replace the abnormal battery module.

Alarm ID (Alarm ID- Cause ID)	Alarm Name	Severi ty	Cause	Solution
0651	Firefighting action	Critica l	<ul style="list-style-type: none"> • The fire cylinder in the battery cabinet is triggered. • The fire cylinder in the battery cabinet leaks. 	<ol style="list-style-type: none"> 1. Check that the end pressure gauge of the fire extinguisher in the battery cabinet is normal. 2. Replace the fire cylinder in the battery cabinet.

B Common Criteria

Safety Precautions

- Avoid skin contact with electrolyte overflow. Before installing or maintaining battery modules, wear goggles, rubber gloves, and protective clothing.
- Keep the battery module loop disconnected during installation and maintenance.
- Secure battery module cables with a torque specified in the battery module documentation. Loose connections will result in excessive voltage drops or cause battery modules to burn out when the current is high.
- Protect your skin and eyes from battery module electrolyte leakage. If your body comes in contact with electrolyte leakage, wash with clean water immediately and visit a doctor if the situation is serious.
- Avoid ingestion of battery module components or substances.
- Protect battery modules from mechanical vibration, collision, punctures, and strong impact. Otherwise, the battery modules may catch fire.
- Do not throw battery modules in fire because this may cause the battery modules to ignite.
- Do not immerse battery modules in water or expose them to rain.
- Replacing a battery module with an incorrect model may cause cross current and bias current, which will trigger lithium battery protection. Long-time operation with an incorrect model will result in cell or board faults, which may cause risks such as fire.
- If the battery module loop is short-circuited, lithium battery protection will be triggered and lithium batteries cannot be charged or discharged. Long-time frequent short circuiting can result in cell or board faults, which may cause risks such as fire.
- Dispose of waste battery modules in strict accordance with local laws and regulations.

Misoperations

Avoid misuse of battery modules under the following conditions (including but not limited to):

Misoperation	Protection Description
Reverse connection	If terminals are connected with reverse polarity, the battery module will not start and will stay in sleep mode. If you hold down the MANUAL ON/OFF button to activate the battery module, it will report a protection alarm and the ALM indicator will be lit.
External short circuit	If the battery module loop is short-circuited, lithium battery protection will be triggered and lithium batteries cannot be charged or discharged. Long-time frequent short circuiting can result in cell or board faults, which may cause risks such as fire.
Parallel connection	Battery modules cannot be directly connected in parallel. If they are forcibly connected in parallel, an excessive current may cause abnormal arcing and sparking, resulting in safety risks.

- Under the preceding conditions, if the system circuit breaker is switched off and the auxiliary power supply is powered off, a battery module can be stored for 10 months with self power consumption of the system. If the battery module is not charged beyond this period, the cells of the entire lithium battery system may overdischarge, resulting in irreversible capacity loss. In this case, the battery module needs to be replaced.
- Provide that a battery module is discharged for a long period and not charged. If the charging device is damaged or the battery module cannot be charged or recharged for a long period (30 days) after the system is powered off due to EOD, the cells of the entire lithium battery system may overdischarge due to power consumption of circuits such as the auxiliary power supply of the BCU in the cabinet, resulting in irreversible capacity loss. In this case, the battery module needs to be replaced.
- [Scenario to be avoided]: Lithium batteries are started, but the charging device such as the UPS is not powered on, or the loop between the UPS and the lithium battery cabinet is disconnected. As a result, the lithium batteries cannot be recharged in a timely manner to ensure full charge.

Gas Composition

- A battery module is an enclosed battery system and will not release any gases under normal operations.
- If the battery module is severely misused, for example, being burned or thunderstruck, the battery may be damaged, resulting in electrolyte leakage. Because the electrolyte is of organic carbonate nature, it may produce CO₂, CO, and N₂ after being burned.

C Warranty Rules

- **Huawei will not be liable for any damage to Huawei battery modules caused by force majeure:**
 - Natural disasters such as earthquakes, volcanic eruptions, and landslides
 - Fires
 - Wars
 - Lightning strikes
- **Huawei will not be liable for any damage to Huawei battery modules caused by the following events:**
 - Damage such as breakage and leakage is caused to battery modules due to misoperations or incorrect connections during battery module transportation and installation performed by the customer.
 - Capacity loss or irreversible damage is caused to battery modules because they are not charged in a timely manner and stored over due to customer reasons.
 - After battery modules are installed at a site and connected to the system, they are damaged due to overdischarge because they are not powered on in a timely manner due to customer reasons.
 - Battery modules are damaged because they are not accepted in a timely manner due to customer reasons.
 - Battery modules are damaged because the operating environment or external power specifications do not meet environmental requirements. For example, the operating temperature is poor, power outages occur frequently, battery modules are frequently overdischarged due to improper maintenance, the capacity of a customer site is expanded, or battery modules are not fully charged for a long period.
 - No air conditioner is available onsite, or the ambient humidity is too high. As a result, the PCB and components are corroded, affecting the product reliability and quality. The product cannot be used properly or is even damaged.
 - The customer changes the application scenarios of battery modules without notifying Huawei.

- Battery modules are damaged due to the reasons of the customer or a third party, such as reallocating or reinstalling battery modules without following Huawei's requirements.
- The customer incorrectly sets operating management parameters for battery modules. The parameters include but are not limited to battery module capacity, quantity, equalized charging voltage, float charging voltage, charge current limit, and disconnection voltage.
- The customer fails to follow the *Quick Guide* or *User Manual* in battery module maintenance. For example, the customer does not periodically check whether the terminal screws of battery modules are tightened.
- The customer connects extra loads to battery modules.
- The customer uses the battery modules provided by Huawei together with other battery modules, which causes the acceleration of capacity decrease. For example, the customer uses Huawei's battery modules together with battery modules of other brands, with battery modules of different rated capacity, or with old battery modules.
- The warranty period of battery modules has expired.

D Acronyms and Abbreviations

B

BMS	battery management system
BCU	battery control unit

C

CE	Conformite Europeenne
-----------	-----------------------

D

DOD	depth of discharge
------------	--------------------

E

EOD	end of discharge
EOL	end of life

I

IEC	International Electrotechnical Commission
------------	---

L

LCD liquid crystal display

M

MDU monitoring display unit

N

NMS network management system

P

PE protective earthing

R

RS485 Recommended Standard 485

S

SOC state of charge

SOH state of health

SBCU system battery management unit

U

UPS uninterruptible power system