



WIRELESS QUARTER

**HIDE AND SEEK:**  
TURNING UP THE  
HEAT ON ASSET  
THIEVES

**FINDING RIO:**  
THE FAST WAY  
TO LOCATE A KIA  
AMONG THOUSANDS



# No Handset Required

How the IoT is transforming  
the cellular chip supply model

# Contents

News	
World's first dual ARM M33 SoC	3
News Extra	
Cellular IoT eSIMs explained	7
Analysis	
micro:bit teaches digital skills	8
Comment	
Should IoT devices carry a security star rating?	9
Cover Feature	
No Handset Required	10
Feature	
Hide and Seek	14
Feature	
Finding Rio	18
Nordic Inside	
TASER Pulse+	20
Case Study	
Remotely monitoring health of industrial assets	22
Nordic People	
Kaja Sørbotten	23
Tech Zone News	
Speeding cellular IoT product development	24
Tech Briefing	
Inside the nRF52833 SoC	25
Tech Perspective	
Lifecycle protection for IoT devices	26
Nordic Product Summary	28



# Welcome

Svein-Egil Nielsen  
Chief Technology Officer



Nordic Semiconductor's leadership in ultra low power wireless technology stretches back nearly two decades. But even with years of involvement in the development of the technology we are continuously amazed at its success.

And it is some success; for example, earlier this year, the Bluetooth SIG estimated that by 2023, [more than 1.6 billion](#) Bluetooth LE devices will ship each year.

A major driving force behind Bluetooth LE's triumph is its interoperability with smartphones. But things are changing; according to analyst ABI, the IoT will overtake smartphone-centric products as Bluetooth LE tech's main market by 2024.

Nordic was the first company to market a commercial Bluetooth LE connectivity IC and first again to bring a Bluetooth SoC to market, with a hardware architecture many others have since mimicked. Nordic's Bluetooth stacks have been proven in millions of devices over many years and are admired in the industry for their maturity and robustness.

But in a sector with several ambitious rivals there's no time to stand still. That's why I'm proud to announce the launch of the Nordic [nRF5340](#), the industry's first dual Arm Cortex-M33 processor Bluetooth LE SoC. The SoC features one powerful Arm processor dedicated to application software and a second low power consumption Arm network processor dedicated to the RF protocol. The SoC also supports [Bluetooth 5.1](#) and [Bluetooth mesh](#) (and other mesh protocols such as Thread and Zigbee, concurrently with Bluetooth LE if required), and Zephyr RTOS.

The nRF5340 has the capability to underpin short range wireless applications previously not possible and will push Nordic's Bluetooth LE tech into yet more sectors. (See [opposite page](#).)

“The nRF5340 has the power to underpin short range wireless applications that were previously not possible”

Wireless Quarter is published on behalf of Nordic Semiconductor by Ecritech  
[www.ecritech.com](http://www.ecritech.com)

**Editor**  
Steven Keeping [sk@ecritech.tech](mailto:sk@ecritech.tech)

**Assistant Editor**  
Chris Williams [cw@ecritech.tech](mailto:cw@ecritech.tech)

**Production Editor**  
Andrew Woolls-King [awk@ecritech.tech](mailto:awk@ecritech.tech)

**Creative Director**  
Sam Grimmer

**Image Editors**  
Nathan Sargent, Neale Hobday

**Print & Distribution**  
Printech Europe



The Bluetooth® word mark and logos are registered trademarks owned by the Bluetooth SIG, Inc. and any use of such marks by Nordic Semiconductor is under license.

© Nordic Semiconductor 2019



To subscribe to WQ visit [www.nordicsemi.com/wqmag](http://www.nordicsemi.com/wqmag)

# News

The latest developments from Nordic Semiconductor

## World's first dual Arm Cortex-M33 CPU wireless SoC

Nordic Semiconductor has launched the world's first dual Arm Cortex-M33 processor wireless SoC. The [nRF5340](#) combines a high performance application processor with a fully programmable, ultra low power network processor, plus advanced root-of-trust and trusted execution security features, into a low power multiprotocol SoC ready for complex IoT applications.

The nRF5340 builds on Nordic's proven and globally adopted nRF51 and nRF52 Series SoCs while introducing flexible, dual-processor hardware. The SoC supports all major RF protocols including Bluetooth 5.1/Bluetooth LE, Bluetooth mesh, Thread, and Zigbee.

The nRF5340 offers extended operating temperature up to 105°C, which together with its multiprotocol support makes it suited for [professional lighting](#) and industrial applications. The SoC also meets the demands of advanced wearables with its high performance application processor matched to 1 MB Flash and 512 KB RAM.

The nRF5340 incorporates Arm CryptoCell-312 and Arm TrustZone technology, and Secure Key Storage for the highest level of security.

The nRF5340 incorporates a new, power optimized multiprotocol 2.4 GHz radio with a TX current of 3.2 mA and RX current of 2.6 mA. Sleep current is as low as 1.1 µA. The nRF5340's SDK, the nRF Connect SDK, integrates the Zephyr RTOS, a Bluetooth LE protocol stack, application examples, and hardware drivers. The SoC is accompanied by the nRF5340 PDK, an affordable, preview development kit.



The nRF5340 meets the demands of next generation sophisticated wearables with its high performance application processor. (Inset: nRF5340 PDK)

“Developers are already working on tomorrow's commercial products based on highly complex applications,” says Kjetil Holstad, Director of Product Management at Nordic Semiconductor. “These demand greater computational power with high security, yet developers expect Nordic's wireless solutions to remain compact and highly energy-efficient. The nRF5340 SoC meets these needs.”

Nordic also released the [nRF52833](#) SoC (see [pg25](#)), a 105°C temperature-qualified Bluetooth 5.1 SoC enabling a wider range of concurrent multiprotocol Bluetooth LE, Bluetooth mesh, Zigbee and Thread applications. The SoC is designed for professional lighting and other industrial applications that require a multiprotocol solution with high-temperature capability, direction finding, and robust coverage.

## Nordic targets \$1bn by 2024

Nordic Semiconductor intends to become a \$1 billion company within five years, CEO Svinn-Tore Larsen announced at the company's Capital Markets Day in October. He said the target was based on a growth outlook for both the company's short range and long range business segments.

Nordic [reported](#) full 2018 revenue of \$272 million, but with anticipated annual revenue growth of between 20 and 30 percent for Bluetooth LE and multiprotocol products, and the expectation that the company's fledgling cellular IoT business will match the short range wireless business within five years, Larsen said the company was already on its way to meeting this goal.

“These are the key goals [for] the company,” Larsen told attendees at the Capital Markets Day event. “It's possible. We are on a good way to reach it.”

## Colgate aims to consign more manual toothbrushes to history

Global oral hygiene giant, Colgate, is targeting people still using manual toothbrushes with a new, affordable electric brush and the promise of perfect brushing.

Using a Nordic Semiconductor [nRF52832](#) SoC to provide Bluetooth LE wireless connectivity to a free partner smartphone app, the Colgate Electric Toothbrush shows how well the user is brushing.

“The average [manual brush] user simply does not brush well,” says Derek Gordon, Colgate's Head of Global Toothbrush Division. “Until now there has not been an affordable connected toothbrush that can teach users via precision brush coaching how to brush their teeth perfectly. The Colgate Electric Toothbrush is being launched to address this. Colgate's ultimate goal is to improve the world's oral health, and this connected brush is very much part of that.”

In operation, the Colgate Electronic Toothbrush is paired to the free Colgate Connect app which the user activates each time they brush their teeth to track precisely how well they brushed. Colgate says this will improve brushing behavior almost immediately by encouraging people to spend more time brushing and improving brushing coverage, bringing them more in line with dentist recommendations.

“It's not often that a semiconductor company helps enable a product that could genuinely help improve the health of millions of people worldwide, but this is one of those products,” says Geir Langeland, Nordic Semiconductor Director of Sales & Marketing.



Sports & Fitness

# Smart cricket ball tracks delivery speed and movement data

An Australian [sports technology](#) start-up has released a smart cricket ball that uses an embedded device to track speed, position, and movement data, allowing players, coaches, fans and officials to track and analyze data in training and during matches.

The Sportcor Smartball uses an inertial movement system comprising two accelerometers, a gyroscope and a magnetometer, along with proprietary algorithms, to capture data including the speed and spin rate of the ball at any time. This data is relayed to a smartphone app using Bluetooth LE wireless connectivity provided by Nordic's [nRF52840](#) SoC.

The first commercial application of the product is a smart cricket ball developed by Sportcor in partnership with leading cricket ball manufacturer Kookaburra Sports.

The device replaces the traditional core of a cricket ball and sits in a silicone composite protective housing that allows it to withstand repeated impacts from use in games and training.

The SmartBall can instantly collect and communicate statistical data on the movement of the ball, including revolutions and speed at the bowler's release point, pre-bounce and post-bounce.



As soon as the movement data is gathered by the built-in sensors, relevant information is transmitted via the Nordic SoC enabled Bluetooth LE link to an iOS compatible app.

The nRF52840 SoC's Bluetooth 5 Long Range capability enables the Sportcor Smartball to achieve a wireless range of over 70 meters between ball and smartphone or

tablet, and over 150 meters when using a dedicated receiver, without the need for a booster or power amplifier.

The ball uses a rechargeable CR2032 coin cell battery that can be recharged at any time by placing the ball in its cradle. The battery achieves approximately 40 hours of active use and months between recharge.

Logistics & Transport

## Digital tag makes travel easy

U.S. based Viewtag has launched a smart luggage tag designed to replace the disposable paper based tags currently used by airlines. Aimed at frequent travelers, the smart tag provides a permanent digital tag for attachment to all types of luggage.



When traveling with a partner airline, passengers can check in remotely via the airline's smartphone app, and the flight information is then sent to and displayed on the smart luggage tag using Bluetooth LE wireless connectivity enabled by Nordic's [nRF52840](#) SoC. Once at the airport, users are then able to drop off their luggage without needing to use a check-in kiosk. Users can also track their bags throughout the airport handling process via the airline app.

Education

## Smart robot brings STEAM support to young children

Global education solution provider, Makeblock, has announced the launch of its mTiny connected robot and tap pen controller. The smart robot is designed to provide young children with STEAM (science, technology, engineering, arts, math) educational skills.

mTiny is a screen free smart education robot designed to help children aged as young as four learn basic coding principles. The connected robot also encourages logical thinking, and interactively solving problems through language, math and music using a tap pen controller, the robot and an interactive map.

The interactive mTiny platform can be used to play a variety of multisensory educational and coding [games](#).

Both the tap pen controller and the



robot feature optical identification, a six-axis gyroscope, and Nordic's [nRF52832](#) SoC, enabling the pen to wirelessly send commands to the robot over Bluetooth LE connectivity, up to a range of approximately 10 meters in open areas.

mTiny uses a 1800 mAh Li-Po rechargeable battery in the robot and a 300 mAh Li-Po rechargeable battery in the pen to provide around two-and-a-half hours of battery life before recharge.

Internet of Things

# Development board makes cellular IoT prototyping simple

Dutch IoT R&D startup, Actinius, is shipping a 'plug & play' development board and firmware that the company claims is the simplest and easiest path into global cellular IoT prototyping. By early next year this product will be further enhanced with full Cloud connectivity.

The tiny Actinius Icarus IoT Board with Adafruit FeatherWing compatibility retails for around \$100 and employs a Nordic Semiconductor [nRF9160](#) SiP to offer low power GPS and global multimode LTE-M and NB-IoT cellular IoT operation.

The Nordic SiP features a 64 MHz Arm Cortex-M33 processor supported by 1 MB of Flash and 256 KB of RAM memory; support for both Nano SIM and eSIM technology; Arm Trustzone and Arm Cryptocell 310 security, and an OTA-DFU support. The Icarus IoT Board ships with fully developed, customizable firmware. It also includes a solar panel connection which could enable solar energy to supply most of the power, depending on

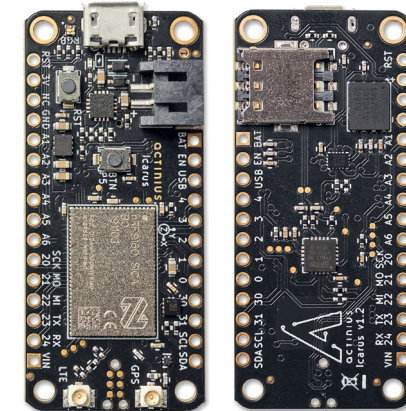

application and its duty cycle.

"Most third party development kits use proprietary form factors to try to lock users into a specific ecosystem of sensor and board add-ons," says Actinius Founder & CTO, Alex Tsamakos. "We wanted to take a much more open approach without imposing any unnecessary restrictions on developers.

"This gives them the freedom to take their cellular IoT prototype and pilot projects wherever they want to go in the quickest and easiest way."

"Nordic Semiconductor built its leadership in Bluetooth wireless technology by abstracting away all unnecessary design complexity from the developer," adds Geir Langeland, Nordic Semiconductor Director of Sales & Marketing. "In the IoT world we see an even greater need for this kind of simplification due to the vast range of companies and equally vast range of products and applications now relevant to the IoT."

By the Numbers

**\$82.2 million** in revenue

Nordic Semiconductor has [reported](#) Q3 2019 revenue of \$82.2 million, the first time the company has recorded quarterly revenue in excess of \$80 million. The result represented a year-on-year increase of 4.4 percent over Q3 2018, and came on the back of double digit percentage growth in Bluetooth revenue to \$62.2 million. Nordic also recognized \$600,000 in cellular IoT revenue in the quarter, consisting of a mix of development kits and production variants for its nRF9160 SiP that has entered production ramp phase.

**1 billion** smart meters by 2020

According to research firm IoT Analytics' *Smart Meter Market Report 2019-2024*, the estimated installed base of smart electricity, gas and water meters will surpass the one billion mark within the next two years. The analyst says just under 132 million [smart meters](#) were shipped worldwide in 2018, with global penetration having surpassed 14 percent last year. Shipments are expected to grow 7 percent per year to exceed 200 million by 2024, the report claimed. Smart meters enable both consumers and utilities to improve energy management.

In Brief

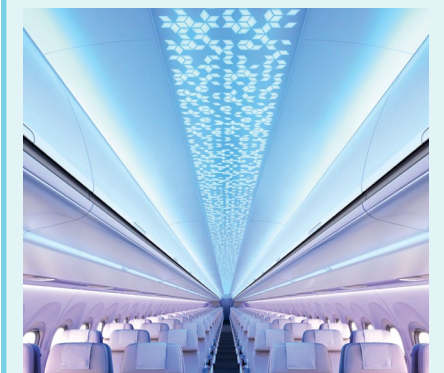

### AIRBUS TRIAL SEES IoT TAKE FLIGHT

Airbus has begun in-flight trials of technology which connects passengers and crew to elements of the plane including the seats and cargo. The IoT platform links real-time information from cabin components, including the meal trolleys and overhead bins, to crews and passengers aboard the flight in order to create a more personalized experience. According to Airbus, the platform will allow, for example, flight crews access to information like meal and seat preferences in one place, while overhead luggage bins could be linked to sensors which indicate to passengers which spaces are free.

### NORDIC WINS MAJOR NORWEGIAN TECH PRIZE

Nordic Semiconductor has won the [main prize](#) in the annual Norwegian Technical Awards 2019 organized by technical media publication, *Teknisk Ukeblad*. The prize was awarded in recognition of Nordic's 'cutting-edge' technical development of its nRF9160 SiP with integrated LTE-M/NB-IoT modem and GPS for cellular IoT applications. The main prize is granted to the company that presents a good engineering solution, project or breakthrough on a technological or societal problem.

### MICRO:BIT BECOMES SUPER:BIT IN NORWAY

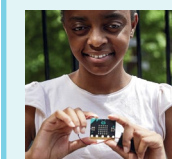

[micro:bit](#), the tiny Nordic Semiconductor powered programmable computer that was launched in the UK in 2015 to help schoolchildren learn coding skills, is now being rolled out in Norway by manufacturer Farnell under a program called 'super:bit'. The project is a collaboration between the national science centers in Norway, the organization 'Teach kids code', and Norwegian national broadcaster NRK, and will provide a classroom kit of technology to each of the 2400 secondary schools in Norway, over two years, starting from September 2019.

Beacons

# Tile unveils latest Nordic based asset tracking range

Tile, the manufacturer of the world's largest selling Bluetooth tracking device, has released a new range including the Tile Sticker, Tile Slim, Tile Pro and Tile Mate devices. Tiles are designed to be attached or paired with anything a user wants to keep track of such as wallets, purses, backpacks, luggage or car key fobs.

Once activated, the Tile is attached to an item and wirelessly connected to the user's smartphone or tablet using Nordic's nRF52810 SoC. The device then uses the smartphone or tablet's location services to communicate its location information anonymously to the app.

Other features of the Tile app include the ability for the user to 'ring' their lost item. If in range the device will play a loud tune to aid location. The app also automatically records the last time and place it located

the user's item, so the user knows where to look first. In the event the user can't find their smartphone, pressing the button on any of their connected tiles will make the smartphone ring, even if it is on silent.

"Tile's battery life guarantee is an absolutely integral component of our value proposition and commitment to our customers, so battery life and quality was at the very top of the requirements list when deciding which SoC to use," says Sarah Davis, Head of Communications, Tile.

"Nordic has worked with Tile since it launched its very first device in 2014," says Geir Langeland, Nordic Semiconductor's Director of Sales & Marketing. "The company's growth demonstrates the obvious demand for consumer asset tracking solutions in the increasingly portable world in which we live."

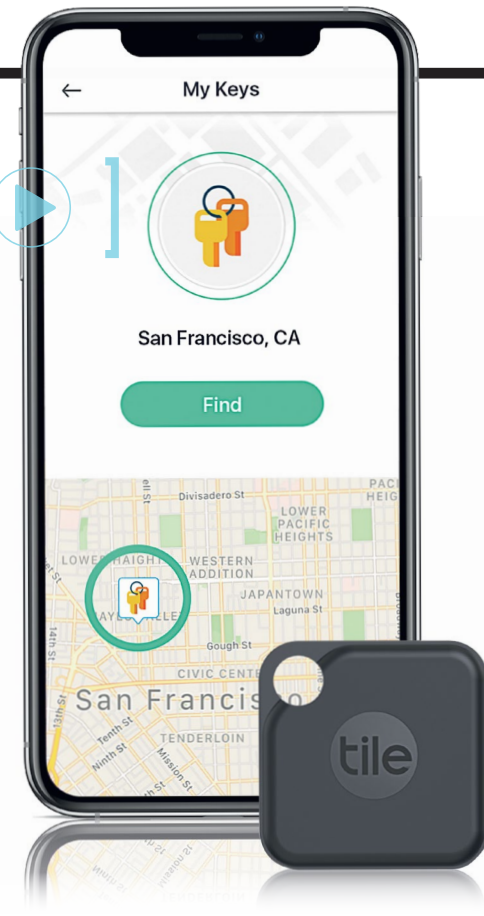

Sport & Fitness

# Smart bike helmet keeps riders cool

A researcher at Deakin University in Victoria, Australia has designed a new generation of smart bicycle helmet that can automatically adjust its ventilation to suit various race conditions. The prototype helmet, dubbed Dynaero, is equipped with Bluetooth LE technology to connect to sensors and computers embedded in high performance bikes, as well as the rider's smartphone. The helmet does the "thinking" for the cyclists, adjusting its air vents in response to temperature, speed and other factors.

Deakin University School of Engineering research fellow Dr James Novak used 3D printing to develop the helmet and said it had the potential to boost performance in bike races like the Tour de France. "Most helmets are static products and don't change to suit the race conditions," says Dr Novak. "Specialist time trial helmets are designed with almost no ventilation to minimize drag forces but, as a result, they can only be worn for short periods before the athlete risks overheating."

"In races like the Tour de France, where each stage lasts four to six hours, helmets have to strike a



balance between aerodynamic performance and ventilation; they are not optimized for either extreme."

The prototype helmet integrates an Arduino Uno, a micro servo, and Bluetooth LE wireless connectivity, enabling the device to connect to an app on the user's smartphone. The app uses the smartphone's accelerometer to determine the rider's speed and control the opening and closing of the helmet's vents. Future versions of the helmet will also be connected to a range of sensors.

"The Dynaero is a highly responsive helmet and will close ventilation during fast downhill descents or finish line sprints [maximizing the cyclist's aerodynamics]," says Dr Novak. "When aerodynamics are less critical ... the vents open to increase air flow and keep the cyclist cool."



# Nordic's Legal Director elected to FSA Board

Marianne Frydenlund, Nordic Semiconductor's Legal Director, has been elected to serve on the Board of the European standard essential patents (SEP) watchdog for wireless technology, the [Fair Standards Alliance \(FSA\)](#).

The FSA was created in 2015 to strengthen the voice of innovative technology companies to ensure that licensing of SEPs for wireless products such as smart devices is done on a fair, reasonable and non-discriminatory basis.

"It's unfortunate that the major cellular SEP owners do not offer licensing of their patent portfolios to component manufacturers such as Nordic Semiconductor," comments Frydenlund. "Left unopposed this could exert a major drag on the cellular IoT industry."

The FSA's mission is "to contribute to building a balanced framework for sustainable licensing of SEPs that fosters creativity, innovation and job creation". The FSA says licenses for SEPs should be available at any point in the value chain. "I'm extremely excited to be joining the Board of the FSA," adds Frydenlund. "I see it as a vital component in protecting innovation and fair play in the cellular IoT industry as it evolves and grows."

News Extra

# Cellular IoT eSIM questions answered

Using Nordic's cellular IoT solution, iBasis demonstrates how an eSIM enables cellular IoT connectivity in 30 countries

A key advantage of cellular IoT (LTE-M and NB-IoT) LPWANs comes from its use of existing telecoms infrastructure. According to analyst Counterpoint Research, such support will drive five-billion cellular IoT connections by 2025. In contrast, competing LPWANs rely on the expensive and time-consuming construction of new networks. However, because the cellular spectrum is licensed and regulated, devices must be identified and authorized before accessing any cellular IoT network.

Conventional SIMs handle this process in smartphones but are a poor choice for cellular IoT because of the SIM's association with a single operator; this makes it impractical for a cellular IoT device that's required to operate anywhere in the world.

An embedded SIM (eSIM) overcomes this problem. While consumer versions of eSIM are grabbing the headlines, the GSMA, the trade body representing the interests of mobile network operators worldwide, developed M2M versions of the specification well before consumer versions were considered. The eSIM comes in the form of a chip (known as an embedded Universal Integrated Circuit Card (eUICC)) that becomes part of the cellular device's electronic assembly. The eSIM holds multiple local network operator credentials and ensures a cellular IoT device is ready to deploy anywhere network coverage exists. If a device crosses networks, its profile can be updated quickly and securely. ([See WQ Summer 2019, pg25.](#))

Because eSIMs are a new technology, questions were asked about how well eSIMs operate in practice. Those questions have now been comprehensively answered by iBasis, one of the world's leading providers of communications solutions, after successful field tests spanning 30 countries including the U.S, Canada, France, Australia, Japan, and South Korea for LTE-M; and the U.S., France and Finland for NB-IoT.

## Evolutionary milestone

The company says the field testing represents a critical milestone in the evolution of both cellular IoT wireless technologies because it represents the first successful large-scale field testing of LPWAN cellular connectivity using a single eSIM. In turn, the field tests demonstrate that standards-based LTE-M and NB-IoT cellular technologies are ready for massive IoT deployments.

"The time for eSIM has arrived in the IoT market and we expect it to dominate future growth of IoT cellular connections over the coming years," says Robin Duke-Woolley, CEO of specialist IoT analyst firm, Beecham



“The time for eSIM has arrived in the IoT market and we expect it to dominate future growth of IoT cellular connections over the coming years

Research. "This achievement of iBasis and Nordic is most welcome and will significantly aid market growth of NB-IoT and LTE-M in the crucial high volume, low data rate segment of the IoT market."

iBasis' tests used a single GSMA-compliant eSIM card. Assessments were performed by configuring the Nordic nRF9160 (a low power SiP with integrated LTE-M/NB-IoT modem and GPS) in a [Nordic Thingy:91](#) IoT cellular IoT prototyping platform via the Nordic LTE Link Monitor application, with AT commands used to switch between different networks and select/force different bands. AT commands were also used to switch between LTE-M and NB-IoT. Where supported, Power Saving Mode (PSM) was tested, as well as IP-based data delivery in the core network together with data transfer optimization over the S11u interface for the NB-IoT use case. "[Following] our [successful integration](#) of the industry's only open eSIM with Nordic's leading [nRF9160 SiP], we have demonstrated the first successful execution of LTE-M and NB-IoT cross markets with a single eSIM," says Ajay Joseph, CTO at iBasis. "This is critical to support the increasing demand for ... cellular connectivity for LPWAN devices globally."

"It is good to see that iBasis is putting a lot of effort into making both LTE-M and NB-IoT work on the same SIM," says Jan Willem Smeenk, CEO of SODAQ, a Dutch IoT company. "Not all countries support both networks, [so] it is crucial to have a partner that supports both types."

The testing removes any doubt that Nordic nRF9160 SiP customers will be able to connect and monitor their cellular IoT devices globally using iBasis' Open eSIM and without needing to use a different SIM card for each country.

"This is a very exciting development for Nordic," says Nordic CEO, Svønn-Tore Larsen. "It's another important step in our journey to create the absolute best customer experience by driving simplicity, flexibility, and performance in all aspects of cellular IoT for the broadest array of devices deployed across the IoT ecosystem."

The field testing was completed over six months and iBasis says the solution is now ready for general release.



## Tech Check

The Nordic Thingy:91s supplied with a Nano (4FF) eSIM from iBasis preloaded with 10 MB of data to enable out-of-the-box cellular LTE-M/NB-IoT connectivity and roaming in a growing list of countries

## Education

# micro:bit teaches digital skills to 20 million and counting

Less than four years since its ambitious launch across UK schools, the Nordic-powered BBC micro:bit has made an enormous impact on global education systems

When the British Broadcasting Corporation (BBC) delivered up to one million Nordic-powered micro:bits—tiny yet powerful programmable pocket computers—to Year 7 school students across the UK in March 2016, the overarching objective was to encourage children to be not only safe and savvy technology users, but active participants in the technologies of tomorrow. (See [WQ Summer 2016, pg10](#).) Those behind the ambitious initiative—including experts from Nordic Semiconductor, BBC Research, university academics in the field of educational technologies, and the wider tech industry—hoped the computer would introduce a new generation of digital pioneers to the world of coding and ICT. Not quite four years later, the micro:bit appears on track to reach those lofty expectations.

The device is now influencing STEAM (science, technology, engineering, arts, and mathematics) education platforms and other worthwhile programs around the globe. Today there are 4.5 million micro:bits available in over 60 countries, including 33 large scale national and regional projects led by, for example, national broadcasters or NGOs.

"This has resulted in an estimated 20 million children having learnt digital skills through the micro:bit," says Gareth Stockdale, CEO of the not-for-profit Micro:bit Educational Foundation. "That's one percent of all the children on the planet!"

The variety and depth of projects so far created by young people using micro:bits has been both fascinating and exciting. Almost immediately following the original release, students from Rishworth School in West Yorkshire launched a micro:bit on a helium balloon to a height of just over 32 km into the stratosphere. The students used this 'space module' to simulate a flight path and take spectacular aerial pictures of the Earth. More recently, two girls developed an upgrade to the pedestrian crossing outside their school, while the micro:bit also helped facilitate an exchange between schools in India and Canada.

## Going global

As part of the hugely successful three-year Danish ultra:bit campaign to transform students from passive technology consumers to digital pioneers, one initiative in Denmark has seen 64,287 micro:bits distributed amongst 1,447 schools across the country. Ninety-five percent of 330 surveyed teachers felt that Danish Year 4 students found it easier to code after working with the micro:bits, while 96 percent thought students wanted to learn more about coding and technology since using the devices (according to an August 2018 study by the Center for Evaluation and Development of Science Education (NEUC)

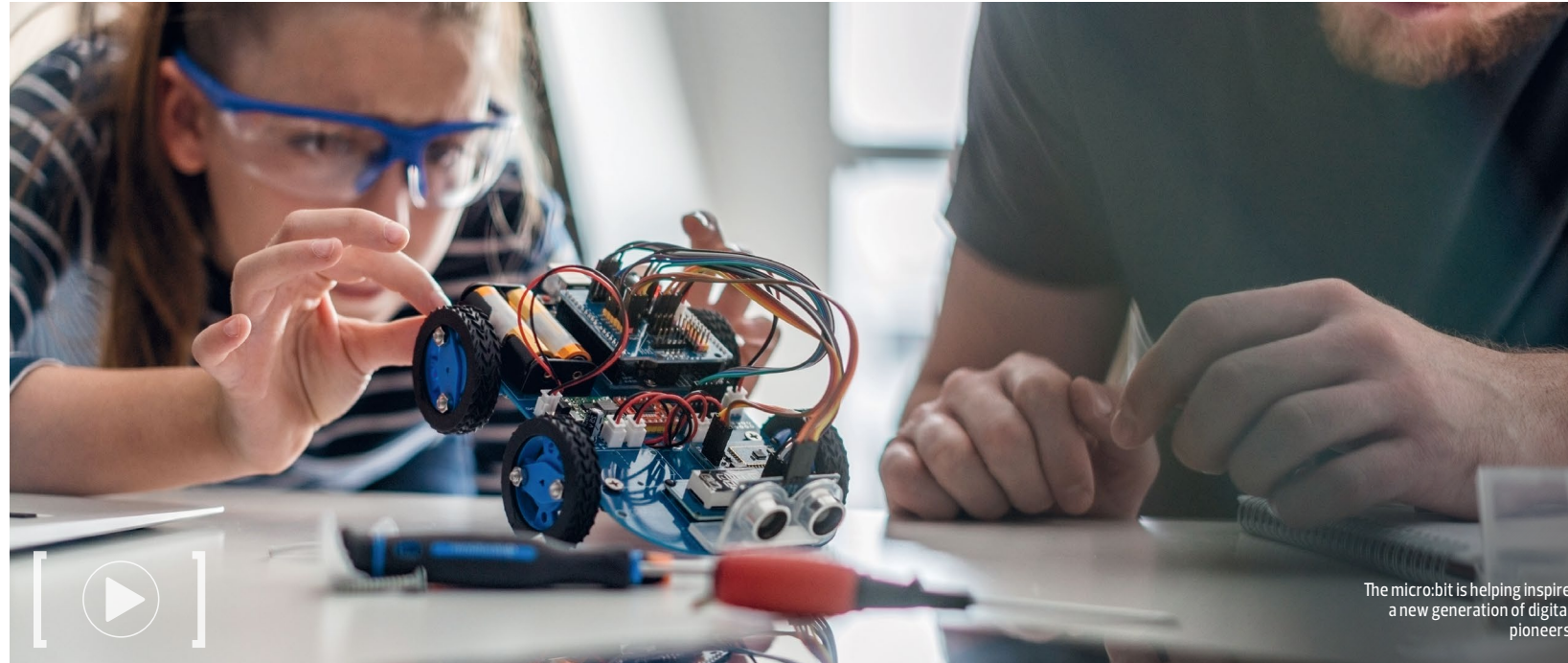

The micro:bit is helping inspire a new generation of digital pioneers

on behalf of the Danish Broadcasting Corporation (DR)).

Meanwhile, the three-year UK Foreign Office Funding Project in the Western Balkans, launched in March 2019 with the provision of 123,000 micro:bits, is already generating similarly positive feedback. Among the 19,000 participating teachers, 90 percent of those surveyed believe the micro:bit will inspire students about computing and coding outside the classroom. This sentiment mirrors findings from earlier BBC research conducted in the UK one year after the launch of the original BBC micro:bit project, in which 90 percent of students given a micro:bit agreed the device helped to show them that anyone can code.

The Micro:bit Educational Foundation is hardly resting on its laurels; the organization recently held its first 'micro:bit Live!' event in Manchester, UK which was attended by over 200 professionals in the fields of education and education technology. The event demonstrated that while the micro:bit is most typically being used as a contemporary teaching tool, its benefits are certainly not limited to formal education settings.

"Our key audience is 8-to-14 year-olds primarily in education within both formal and informal environments. We are seeing the device integrated into school systems and curricula around the world. At the same time, many of our ideas and innovations come from working with the hobbyist community," says Stockdale.

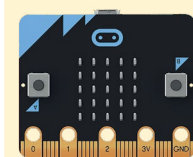

## Tech Check

Consisting of a small circuit board about half the size of a credit card, the micro:bit has everything kids need to build complex projects. At the heart of the micro:bit is Nordic's nRF51822 SoC. Code written by the user runs on the SoC's Arm Cortex M0 processor, and the chip's Bluetooth LE connectivity allows micro:bits to communicate with each other or a smartphone



We are seeing the device integrated into school curricula around the world. At the same time, many of our ideas come from the hobbyist community

## Helping the underprivileged

Stockdale explains that the organization's aim now is to "get more girls and underrepresented groups to have the opportunity to learn these foundation skills for the 21st century. We work with many partners to achieve this, for example the British Council, and bring coding to underprivileged children in emerging countries."

One such example of these global philanthropic efforts can be seen in refugee camps in Greece, where the British Council's Coding for Refugees initiative is supporting young refugees entering the Greek school system. As part of the program, the micro:bit gives refugee youths confidence in digital literacy and prepares them for life outside these camps—a significant undertaking given that 1.1 million refugees have passed through Greece since 2014 with around 18,000 children currently living in camps throughout the country.

So what comes next for this tiny piece of technology doing big things for the world's future coders? "The micro:bit as it stands is a brilliant teaching tool that is having great impact. Keeping stability for teachers is key for us and any future developments will be driven by the needs of our key user base of educators and students," says Stockdale. "We continue to work with educators around the world to create and curate great free resources and keep the micro:bit software editors working with partners."

Svein-Egil Nielsen

CTO: Nordic Semiconductor



## Should IoT devices carry a security star rating?

A simple rating system would indicate to consumers how well their connected device is protected



Until recently the security of connected devices has been something of an afterthought. Things are improving but the industry is still a long way from the level of security that's trusted by end users as much as, for example, SSL certificates are for websites. A good place to focus improvement would be to address the security issues exploited by the most well-publicized hacks to date.

Some industry initiatives are underway. For example, Arm, an embedded processor vendor whose technology is used in many IoT devices, is leading a cross industry initiative called Platform Security Architecture (PSA), in partnership with Nordic and others. PSA aims to design-in security from the silicon level upwards. It targets four broad sources of insecurity: Communications, silicon, product lifecycle, and software (the most common vulnerability of all). A similar model could work for the industry as a whole.

But manufacturers complain it's expensive and time consuming to ensure connected products address all security concerns. And the makers say consumers who are comfortable with taking some risk will buy less secure devices if the price is right. But how do consumers know what they're getting for their money?

Moves are already afoot to answer this question. For example, a U.S. consumer rights organization, Public Knowledge, has urged the country's government to mandate some kind of cybersecurity rating to denote the protection status of a connected device.

## Simple and effective

"Star" indication works well for energy efficiency rating (consider Energy Star in the U.S.) and crash

safety (for example, Euro NCAP in Europe). It's also worth considering for communicating the security status of a connected device too.

Star ratings are simple to adopt and effective in promoting competition and product improvement. Nobody buys a car with a 1/5 safety rating, which is why car manufacturers don't build inherently unsafe vehicles. The same would apply to connected devices; IoT device manufacturers would quickly struggle to sell devices that are granted a lowly status. Star ratings also allow consumers to choose to pay more for products with higher ratings if they want peace of mind or select to save money if security is less of a problem to them.

Achieving high ratings won't be easy though. To get five stars, security must be built in at every stage of the design. Further, a device manufacturer should be able to update or patch any security loopholes that may appear once the device is in the field—that means support for over-the-air firmware updates. Security must also be maintained for the life of the product—just because a smart device ages is no excuse for increased vulnerability.

The future growth of the connected device industry will be hampered until the security question is answered. Part of that answer is a star rating. We need one soon.

# No Handset Required

Without reliance on smartphones, cellular IoT will demand a completely different semiconductor supply model to the traditional telecoms market

## In Short

The smartphone has been the key driver for a cellular semiconductor supply chain that sees few companies supplying few handset makers

The advent of cellular IoT—fueled by compact, efficient LTE-M/NB-IoT products and rapid network rollout by major operators worldwide—is encouraging the emergence of new silicon suppliers and companies employing the technology

Cellular technology is notoriously difficult so OEMs are working with suppliers that can assist in design of prototypes

Lack of standard essential patent licensing to component makers could slow the pace of cellular IoT adoption

From the earliest first generation networks to today's rapidly maturing 4G and fledgling 5G infrastructure the telecom industry has evolved to serve the needs of the smartphone consumer. That's a particularly demanding market. For example, by 2020, it's forecast that 3.8 billion people will own a mobile. That's as close as makes no difference to one smartphone for every two people across the entire planet.

Smartphone subscriptions outstrip even handset sales; according to GSMA Intelligence, by the end of 2018 almost [seven in ten people](#) had subscribed to a mobile service. An increasing proportion of the world holds a gateway to the Internet and the benefits that brings to areas like education, healthcare, entertainment and banking.

It's little surprise then that the smartphone has been the driver for the cellular semiconductor supply chain. That chain is very big business; while exact numbers for cellular semiconductors are hard to find, according to analyst The Linley Group, the market for cellular baseband processors—a key component for smartphones—was worth \$21.4 billion back in 2015 and is certain to be worth a great deal more now.

Aggressive tactics by companies looking to grab a share of such a booming sector resulted in mergers and acquisitions and a pooling of design talent. Today a multi-billion dollar conventional cellular business comprises a handful of archival cellular semiconductor giants selling to a handful of archival smartphone giants. While painful for the losers, for the consumer fierce competition has delivered incrementally better high-end products year-on-year while bringing the benefit of cellular technology to developing continents such as Africa through the advent of budget models.

But change is afoot — driven primarily by carriers looking to generate new revenue streams to offset the huge costs incurred by when buying the licenses to the parts of the RF spectrum that support cellular. Specifically, carriers are keen to encourage the low-power, low-data rate devices of the IoT to exploit spare bandwidth available across cellular

networks alongside that dedicated to the conventional high demand traffic transported over their networks.

Cellular gains a competitive edge on other LPWAN wireless technologies by offering a ready-made solution for directly connecting the IoT sensors of long-range, low power wide area networks (LPWANs) to the Cloud. The 3rd Generation Partnership Project (3GPP)—a collaboration of telecoms standard associations—was quick to encourage companies to take advantage of this benefit by introducing a specification for two forms of low power LTE—LTE-M and NB-IoT—in Release 13 of its standard. The release was adopted in 2015 and has enabled the development of 4G LTE support for IoT applications.

The impact is already being felt. Recent research by global telco infrastructure leader Ericsson predicts a boom in the number of cellular IoT connections to 4.1 billion by 2024 (of which LTE-M and NB-IoT technologies will account for 45 percent). ([See WQ Issue 3, 2019, pg8.](#))

These low data rate devices have no requirement for the complex and expensive cellular chipsets at the heart of handsets — opening up the market to new vendors developing small, streamlined and efficient cellular modems for the IoT and disrupting the established cellular semiconductor supply chain.

## ENCOURAGING NEW ENTRANTS

Among these vendors is Nordic Semiconductor. The European company is already seeing the IoT demanding a semiconductor supply model almost the complete opposite of that feeding the cellular smartphone market.

"In terms of end products and applications, the IoT—both consumer and industrial—is coming to be dominated by a large number of smaller companies and startups," says Peder Rand, Product Manager — Cellular IoT with the company. "Certainly, there are large customers looking to apply cellular IoT to optimize large-scale operations, and these will be vitally important to the long-term success of cellular IoT wireless technology. But the typical company in the cellular IoT space now is new to cellular and looking to add it to an existing IoT product to replace, for example, Wi-Fi, or develop a brand new IoT application with global connectivity that can optimize operational efficiencies and reduce costs.

"The cellular IoT market has far more in common with the traditional Bluetooth and ultra-low power wireless semiconductor markets that are dominated by small companies and startups."

Nordic, for example, has sampled its [nRF9160 SiP](#) to over 220 companies to date, and announced around ten cellular

The typical company in the cellular IoT space is new to cellular and looking to add it to an existing IoT product or develop a brand new IoT application with global connectivity

IoT customer products and applications that have already come to market. Of these ten IoT products and applications, almost all of them have originated from smaller companies and startups. These companies frequently cite technical support as a key enabling factor for successful commercialization.

This trend is backed up by a recent study from analyst IoT Analytics ([IoT Startups Report & Database 2019](#)) that verified and classified a total of 1,018 upcoming IoT startups and smaller companies operating around the world today of which none are more than six years old. Adding existing SMEs to the mix sees the market for cellular IoT semiconductor modules set to run into thousands of companies worldwide.

It's a similar story on the supply side: The cellular IoT semiconductor market today comprises several vendors such as Nordic supplying to those thousands of customers, many of which are smaller companies or start-ups. And many of which require close support to get to grips with the intricacies of cellular IoT in order to build prototypes and then bring new products to market. Contrast that with the existing cellphone market—dominated by a few suppliers and a few smartphone makers with cellular expertise—and it becomes clear why a new business model is emerging.





### HIDING THE COMPLEXITY

Nordic's Rand concurs that a characteristic of the smaller companies integrating cellular IoT into their products is that they need all the technical support they can get to quickly bring a new LTE-M or NB-IoT product or application to market.

Unsurprising, perhaps, given the notorious complexity of cellular's underlying wireless technology. According to Nordic's CTO, Svein-Egil Nielsen: "Designing a traditional cellular modem into a smartphone is an extremely complex task and beyond the engineering capabilities of most companies." This goes a long way towards explaining why there are so few companies building today's handsets.

Nielsen says Nordic recognized very early on it had to find a way to shield its customers from the complexity of cellular wireless technology otherwise they would struggle to get started, let alone develop commercially successful products. However, the company did have a trick up its sleeve derived from its large market share in Bluetooth LE.

"Nordic helped facilitate the rapid adoption of Bluetooth across a wide range of applications by abstracting away all unnecessary technical complexity [with its Bluetooth LE software architecture and development kits] so the developer could focus on their application instead of the intricacies of RF technology," explains Nielsen.

"Our typical customers in the cellular IoT space need

exactly the same simplified approach. The nRF9160 SiP and [development tools](#) were created to support this strategy."

Nordic has also worked hard to gain certification for its SiP with major carriers across the globe (and continues to do so) such that its customers can offer their products into many international markets.

Further, the company has collaborated with eSIM supplier iBasis (See [pg7](#)) to ensure that companies employing the nRF9160 have a built in solution for instant network access.

But Nielsen cautions that there are some headwinds that threaten to stall rapid adoption of cellular IoT. First he notes that solutions competing with Nordic tend to assume a high degree of cellular expertise from the developer limiting the number of companies that can take advantage of their solutions. But Nielsen says technical complexity isn't the only factor that could impede future growth, patent licensing is another.

Nordic is working with others to forge a solution. "The major cellular standard essential patents owners do not offer licensing of their patent portfolios to component manufacturers such as Nordic Semiconductor," says Nordic's Legal Director, Marianne Frydenlund. "Left unopposed this could exert a major drag on the cellular IoT industry and is one of the reasons I recently [joined the](#)

[board](#) of the wireless technology patents watchdog, the Fair Standards Alliance." (See sidebar [Working towards fair patent licensing](#).)

### IN AT THE DEEP END

What's life like for firms new to cellular IoT? From Nordic's perspective, product and application development with the company's cellular IoT solution is proving extremely robust with a range of innovative products being brought rapidly to market across many industry sectors.

One example is a battery powered all-in-one LTE-M smart home alarm. In this product application LTE-M connectivity replaces previously used Wi-Fi to send instant alerts to the homeowner's smartphone no matter where they are in the world.

Another example is a cellular IoT panic alarm. Designed to protect people in vulnerable situations such as lone professionals at risk of physical attack or isolated accident, and seniors living at home, the alarm requires no user set-up. Activation is via a double button press that then notifies an emergency response center of the user's identity (via a unique user ID) and their GPS location.

Customer reaction to Nordic's solution has proved very positive: "I was really impressed with the overall commitment Nordic as a company have made to cellular IoT," says one. "Nordic has adopted a strategy that matches how cellular IoT is changing the cellular sector and I respect how much R&D investment Nordic put into developing its cellular IoT solutions for years before commercialization. They're taking this very seriously. And they've made good on all their promises too, not least of which was providing us with excellent technical support."

### MOVE OVER SMARTPHONES

The early product applications demonstrate how cellular IoT is opening up new opportunities for companies adopting the technology for applications beyond the conventional smartphone market. The list of potential applications are also truly enormous and likely to touch every major sector including agriculture; automotive; infrastructure; building maintenance; consumer electronics; energy and utilities; healthcare; industrial, and security applications. This growing list of emerging IoT applications demand a different business model for cellular IoT. But this list is only the start and doesn't include the new applications that cellular IoT will now make commercially viable.

However, cellular IoT wireless technology will not exist in isolation; it will need to co-exist with a wide range of other wireless technologies underpinning the IoT such as the short-range, low power protocols Bluetooth LE, Bluetooth mesh, Thread and Zigbee. In complementing other IoT technologies, cellular IoT will be further drawn into the established supply chain for that sector's silicon, further upsetting the existing cellular supply chain status quo.

Smartphone modems were designed to meet the needs of a specific application—high throughput cellular communication—and a handful of equipment makers. Cellular IoT, in contrast, must meet the needs of thousands of applications and thousands of customers. And that's a different ball game entirely.

### By the Numbers

By 2024 there will be  
**1.9 billion**  
 5G connections and  
**4.1 billion**  
 cellular IoT connections



Source: Ericsson

### Working towards fair patent licensing



The [Fair Standards Alliance](#) (FSA) was created in 2015 to strengthen the voice of innovative technology companies of all sizes to ensure that licensing of standard essential patents (SEPs) for wireless products such as smart devices are completed on a fair, reasonable and non-discriminatory basis (FRAND).

The stated mission of the Fair Standards Alliance is: "To contribute to building a balanced framework for sustainable licensing of standard essential patents that fosters creativity, innovation and job creation in Europe and beyond."

The FSA says it enjoys a broad and diverse membership, ranging in size from multinationals to SMEs, and coming from different levels of the value chain across a diversity of industry sectors. Within the EU alone, FSA members employ more than 390,000 people and have more than 164,000 patents that are either granted or pending.

"Standards are important enablers for a competitive and dynamic European market where innovation and interoperability go hand in hand," says the FSA in a positioning white paper. "In order for standards to be successful and widely taken up by the market, the Alliance believes it is crucially important to ensure that not only are SEP holders appropriately compensated for their contributions to innovation, but also that there are fair, balanced, and rational practices in the licensing of standards-essential patents."

In practice the FSA says this means licenses for standard essential patents should include "reasonable royalty rates that reflect the value of the invention only, no more, no less". The FSA continues to state that "licenses for SEPs should be made available at any point in the value chain" and that "transparency should be encouraged to create greater predictability and avoid discrimination".

This includes a "FRAND rate that takes into account the overall royalty that could be reasonably charged for all SEPs" and a "FRAND commitment that should not be compromised because a standard essential patent is sold to another company". And finally, the FSA states that "injunctions and similar legal threats should be a last resort".

### Need to Know

Nordic Semiconductor's cellular IoT team was recruited after staff streamlining in Finland up until 2014 within companies such as Nokia, Microsoft, Broadcom and ST-Ericsson. Nordic's superior heritage in cellular wireless technology is built in to the nRF9160 SiP

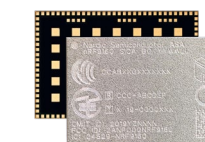

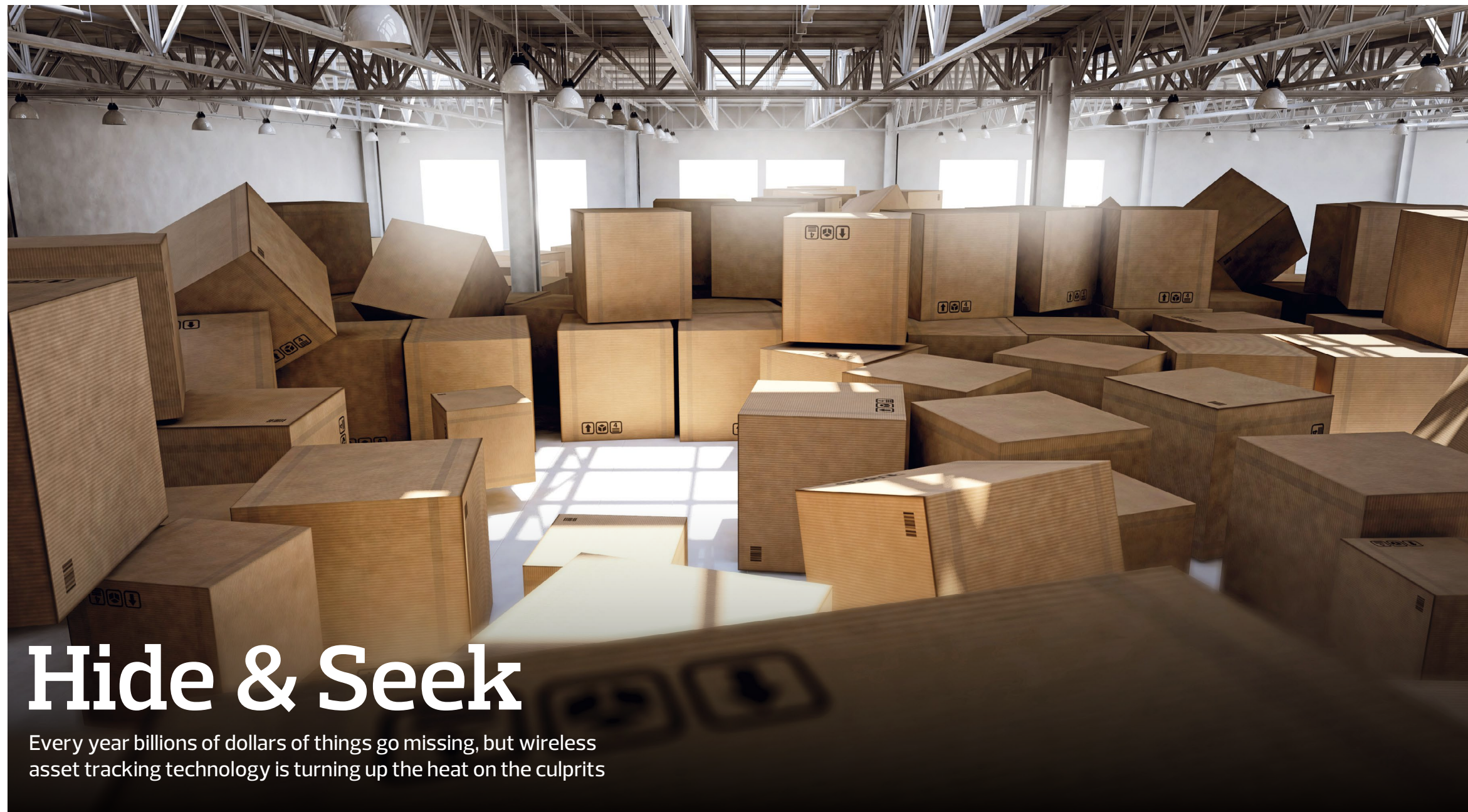

**In Short**

Organizations big and small must manage a vast array of physical assets that can get lost, stolen, or forgotten about

However the availability of inexpensive, reliable wireless asset tracking solutions can help turn the tide on inefficient asset management

Wireless technologies such as RFID have helped but have their drawbacks.

Bluetooth 5 addresses these drawbacks and offers inexpensive and low maintenance asset tracking solutions

Bluetooth 5.1 Direction Finding will offer centimeter precise location in 2 or 3-D significantly extending applications for tracking assets

# Hide & Seek

Every year billions of dollars of things go missing, but wireless asset tracking technology is turning up the heat on the culprits

In the retail sector it is politely referred to as 'shrinkage', in the hospitality industry they prefer 'souveniring', to the rest of us it is more commonly known as theft. Whatever you call it, it happens a lot, and not just in retail and hospitality. Things go astray, and not only because someone "forgot" to pay for an item or "accidentally" packed a bath robe at the hotel in which they were staying, but equally as a result of clerical errors, unintentional damage, or the misplacement of expensive assets in a facility that could span several square kilometers – think hospitals, industrial facilities, prisons and so on.

Misplacement is costly, but even more serious are the instances where keeping track of assets could even be a matter of life and death. One major city hospital in Sydney, Australia, took receipt of a new \$70,000 portable X-ray machine that was unpacked from its crate, and then left in a corridor along with its discarded packing materials. The cleaners dutifully disposed of the packing materials – but unfortunately the X-ray machine too. Thankfully it was saved from the waste room in the nick of time. On another

occasion they weren't so lucky. A mobile C-arm—an intraoperative imaging device—was left in a corridor while an operating theater was being refurbished. It also ended up in the waste room, in a skip, that was hauled away to the tip before anyone noticed. A \$240,000 piece of equipment – gone. These are but two extreme examples of the countless ways, in every workplace, that equipment goes missing – whether through a deliberate act or a genuine mistake, and it's costing a fortune.

According to a study by insurance provider Hiscox, in the U.S. alone, [employee theft](#) costs U.S. businesses in the region of \$50 billion a year, with the theft of company property the third most common offence behind only billing fraud and theft of cash. Add in assets that are simply lost or go missing, and that figure could be doubled, but no one really knows because the data is too difficult to accurately compile due to the nature of the "crime". Australian telco giant, Telstra, simply claims "billions", and highlights the cascading business impact. "One company spent AUS\$750,000 [US\$506,000] a year on hiring equipment

because their own assets were either missing or couldn't be shared efficiently between sites," Praveen Senadheera, an IoT Senior Specialist at Telstra, said in a statement. And with much asset tracking still performed manually, errors, he said, are compounded. "One council, for example, found that mistakes in its handwritten tracking records led to a loss of AUS\$800,000 [US\$541,000] worth of missing assets over three years." Little wonder then that sprouting from the enormous network that is the IoT, is a new branch dubbed the "LoT" for the Location of Things.

**THE LOCATION OF THINGS**  
Defined as connected devices with the capability of monitoring and communicating their geographic location, the LoT sector is still emerging, but it's moving rapidly. According to analyst, Research and Markets, the sector was valued at \$19 billion last year, and is expected to reach \$128.75 billion by 2027, growing at a remarkable Compound Annual Growth Rate (CAGR) of 24.5 percent.

For those well assimilated with applications such as

“ One company spent \$506,000 a year hiring equipment because their own assets were either missing or couldn't be shared efficiently between sites

Google Maps and Uber, this might sound like old news. However, while the LoT may have had its genesis in GPS, they are not the same thing, and LoT technology is going places GPS (literally) can't. While GPS, broadly speaking, can confirm the position of a 'thing' to within an accuracy of approximately 5 meters, put a bridge, tree, some clouds, or a building in the way and that accuracy gets fuzzy, depending on the degree of signal interference. Walk indoors, and GPS is less useful than the smoke signals of old to identify the location of either us, or our assets.

In the predigital age, tracking assets indoors was a laborious manual process, involving paper based systems and plenty of human error. Items were signed in and out, records were kept in rows upon rows of filing cabinets, and in the event something went astray it could in theory be tracked, perhaps not to its actual location but at least back to the person whose signature had last claimed responsibility for it.

RFID tags as part of an RFID asset tracking system provide another option, and while passive RFID tags—those with no internal power source—are inexpensive and widely used, what they don't do is actively track the movement of an asset in 'real time'.

The other drawback of passive RFID is range. A passive system may only be able to trigger on a tag between one and seven meters away depending on environmental conditions. This might be sufficient to know when an asset has passed through a 'chokepoint', for example left a room or a building, but the tag-reading infrastructure that would enable it to do so is expensive. Active RFID systems use battery powered RFID tags that can be used as beacons to accurately track real time location and at a much longer read range than passive tags, but they are also much more expensive and, with a battery that would require replacement anywhere between every three and five years, not always practical.

The ubiquity of Wi-Fi access points in buildings has also seen Wi-Fi based positioning systems grow in popularity. In such systems, the asset tag includes a Wi-Fi radio that relays data to multiple readily available access points that in turn can use certain parameters of the received signals to identify an asset's location. Accuracy is between five and 15 meters, but the tags are power hungry and expensive, making the tracking of less-valuable or -critical assets unrealistic.

**BETTER WITH BLUETOOTH**  
For some time, Bluetooth LE has catered for low power real time indoor positioning and item finding solutions using the protocol's Received Signal Strength Indication (RSSI) to estimate the distance of a transmitting device from a known fix point such as a beacon or locator. Accuracy is between one and 10 meters depending on conditions. However, before the introduction of [Bluetooth 5](#) in mid-2016, range was a drawback, demanding the installation of a relatively large number of fixed locators or beacons to ensure all tags remained in communication throughout a facility. Bluetooth 5 offered an increase in range up to four times that possible with Bluetooth 4.2 and its additional data payload ensured information beyond an asset's



approximate location could also be provided. As such, the use of Bluetooth for indoor asset proximity tracking applications has multiplied.

For example, Indian tech company WaveNet Solutions recently released a [Bluetooth mesh-based asset tracking](#) solution that enables 'live' monitoring of up to 65,000 assets in healthcare, manufacturing, hospitality, as well as numerous other sectors. The "Wi." asset tracking management system employs Nordic Semiconductor-powered Bluetooth LE tags, nodes and a gateway to provide 'live' indoor navigation, tracking, analytics and location-based services for equipment. The system delivers business owners immediate access to automatically updated asset location information, enabling inventory management and prevention of loss or theft. In operation, the system tracks tagged assets by broadcasting their location to mesh-networked nodes. Multiple nodes are placed throughout the facility enabling them to receive the data from the tags and transmit the RSSI data along with the node ID to a central gateway. The gateway sends the location of the assets to a Cloud-based server, allowing the business owner to remotely monitor asset movement and access analytics and reports from an Internet-based dashboard.

"It is too easy for electronic devices, hospital equipment, IT assets, or machinery to easily disappear without a trace or be mistakenly overlooked," says Sanjay Bisen, CEO and Co-founder of WaveNet Solutions. "As a business owner do you know how much your assets are costing you? Are you one of 68 percent of businesses that use inefficient manual methods, or don't even track assets at all? The fact is nearly 55 percent of losses are due to theft or mismanagement which is costing companies a huge amount."

Israel-based APS is another company offering a Bluetooth LE-based platform to enable real time asset

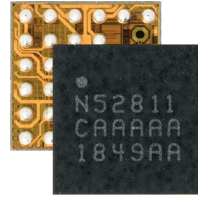

**Tech Check**

Nordic Semiconductor offers three SoCs that support Bluetooth 5.1 Direction Finding, the recently released nRF5340 and nRF52833, as well as the established nRF52811 SoC. All three SoCs promise precise, Bluetooth LE-based wireless positioning with centimeter levels of precision for asset tracking, location finding, indoor positioning and item finding applications

tracking, for both 'things' and workers. Designed for construction sites where Ethernet or Wi-Fi is impractical, the [employee and asset tracking system](#) comprises wearable tags, Bluetooth mesh-networked controllers, and a gateway enabling management to keep track of employees or assets in real time, via an Internet-based dashboard, as they move about the construction site. The system has already been deployed for employee tracking inside several stations under construction as part of the new Tel Aviv Light Rail system in Israel but could equally be used to track valuable equipment as it moves about a construction site.

**PINPOINT ACCURACY**

While Bluetooth 5 positioning systems can achieve meter-level accuracy when determining the physical location of an object, the introduction of [Bluetooth 5.1 Direction Finding](#) in January 2019, improved location accuracy in two- or three-dimensions down to the centimeter-level. The technology uses not only RSSI but also the actual direction of a signal using 'Angle-of-Arrival' (AoA) and 'Angle of Departure' (AoD) methods to deliver pinpoint levels of precision. (See [WQ Q2 Summer 2019, pg26.](#))

"Bluetooth 5.1 Direction Finding is a very important addition to the technology," says John Leonard, Senior Product Marketing Manager with Nordic Semiconductor. "Nordic believes it can have a similar impact for indoor situations as GPS did for outdoor positioning. Where GPS has fundamentally changed the world on a macro scale for cars, people and objects, Direction Finding will have a similar impact on the micro scale inside buildings."

"Location services is one of the fastest growing solution areas for Bluetooth technology, and is forecasted to reach over 400 million products per year by 2022," Mark Powell, Bluetooth SIG Executive Director, said in a statement. "This is great traction and the Bluetooth community continues



**Lost and found:**  
The cost of asset mismanagement

Every year billions of dollars of assets go missing, sometimes lost, frequently stolen, often just completely forgotten about because a company's asset tracking systems are based on outmoded paper-based systems prone to human error. Australian telco giant Telstra recently commissioned a [survey of Australian businesses](#) that put the figure on lost assets at AU\$4.3 billion (\$2.92 billion) per annum. Extrapolate that figure out globally and the numbers are eye-watering. But the cost goes far beyond the financial impact of replacing the asset. Factor in the productivity loss when the tool needed to do a job goes missing, or the time spent searching for the lost item and it becomes clear that looking after physical assets should be as critical a business process as looking after an organization's human assets - for which entire departments exist.

Despite the numbers, wireless tracking technologies are still hugely underutilized. According to the Telstra research, only three in five businesses perform regular audits of physical assets, while more than 50 percent of business leaders admit there is no adequate process in their business to identify the cause of lost assets, and one in three claim there is no adequate process to improve asset management. No fewer than 50 percent of businesses still have people manually logging assets into a record system.

Businesses know they need asset tracking solutions to improve their bottom line—with more than half of leaders claiming their business is dependent on asset utilization and the efficiency of asset management—yet counterintuitively they admit they are slow to prioritize it, either because the company as a whole is lagging behind in digital transformation, the perceived or actual high cost of solutions, and a general lack of awareness of lower cost options. As the research says: "Including asset management as a strategic business enabler requires a rethink and culture change for businesses".

Asset tracking technology is available in many forms, and while solutions based on GPS, 3G/4G, Wi-Fi and RFID are already widely understood and in use, many business leaders are still not aware that organizations can track and monitor assets using a mix of other cost effective technologies including Bluetooth LE, although the knowledge gap is closing. For example, the Telstra research said, Bluetooth asset tracking solutions now had a higher awareness than RFID options.

A new generation of technologies are allowing companies of all sizes to track and monitor their assets, and if business leaders treat asset tracking as critical, optimize processes, develop guidelines and empower staff, and above all elevate asset tracking to a digital priority with a wireless solution, then step change is possible.



to seek ways to further grow this market with technology enhancements that better address market needs, demonstrating the community's commitment to driving innovation and enriching the technology experience of users worldwide."

Bluetooth 5.1 Direction Finding promises to significantly extend applications designed to track assets. The technology can also enrich the consumer experience in proximity-based retail or educational applications. The powerful processors at the heart of Nordic's SoCs are also capable of supporting inputs from numerous sensors such as accelerometers and temperature monitors. So not only will it be possible to see where an asset sits at any time it will also be possible to track how it's handled. If damage occurs knowing where and when that happened will make it much easier to chase compensation.

But with billions of dollars of equipment going missing every year, and thousands of staff hours being lost looking for them, Real Time Location Systems (RTLS) may well be the star of the show once the latest iteration of the Bluetooth spec finds its way into commercial products. When it does, there will be nowhere left to hide.

“Are you one of 68 percent of businesses that use inefficient manual methods, or don't even track assets at all?”

**State of Play**

**The reasons organizations lose physical assets**

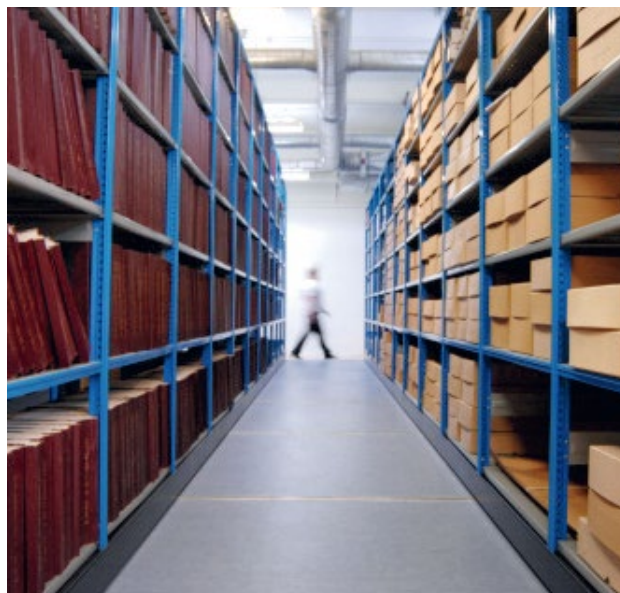
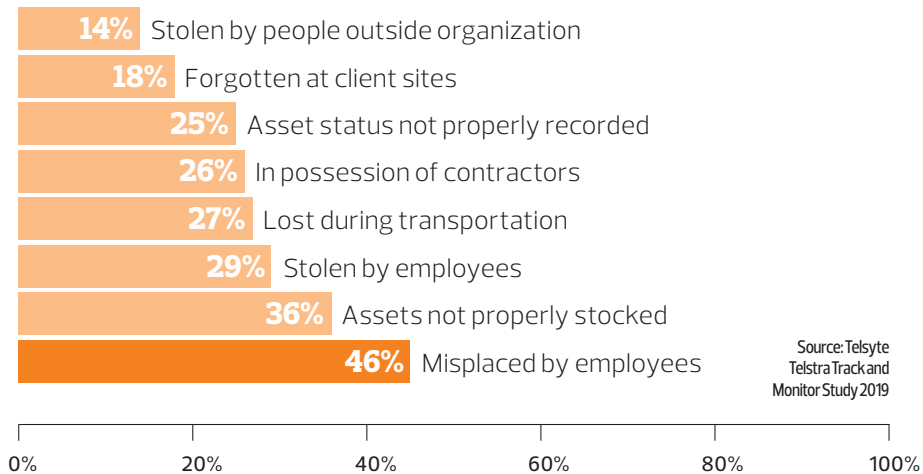

# Finding Rio

Looking for a Kia parked among 10,000 identical models all without license plates? Here's how to do it in seconds

The shiny new car in the dealer's showroom might not be quite as new as you think. It could be over a year since it rolled off the production line.

Car manufacturing is located in hotspots around the world and finished vehicles are shipped across the oceans to the destination country. But while those journeys might take weeks, they're not where the majority of the unsold vehicle's time is spent; most of that happens in the bonded lot where a car can sit for months.

"According to our research, the businesses involved in finished vehicle logistics now realize that inefficiencies occur not so much [during transport] as they do in the manufacturing facility, [bonded lot] or distribution center," explains Gil Messerman, CTO with Sogo Services, an Israeli software services company. "And when [the inefficiencies] do occur, the entire supply chain is affected, as yard managers cannot handle them effectively due to no real-time and accurate information throughout the entire facility, unoptimized processes or a lack of staff."

South Korean auto maker Kia Motors produces more than 1.4 million vehicles a year at 14 manufacturing and assembly operations in eight countries. For example, the company's popular [Rio](#) model, now in its fourth generation, is assembled in South Korea and Mexico to be shipped across the globe. The Rio models are sold and serviced through a network of more than 3,000 distributors and dealers covering 172 countries.

One such distributor is Tel Aviv-based Kia Israel. The company was determined to significantly improve the efficiency of its supply chain and issued Sogo a challenge: Come up with a system to reduce the time it takes to locate a specific vehicle among the thousands in the bonded lot to minutes, without adding scanners, gates, base stations or other expensive infrastructure.



The elegance of the solution is that it lends itself to tracking any asset, not just cars

## Need to Know

Beacons periodically broadcast small amounts of data, such as a unique ID, when a smartphone moves close. The data is sent on Bluetooth LE tech's advertising channels and no pairing is solicited. In the case of the ViLOG app, the broadcast data is captured and forwarded to the server, where it is processed with other contextual information into location data relevant to all users

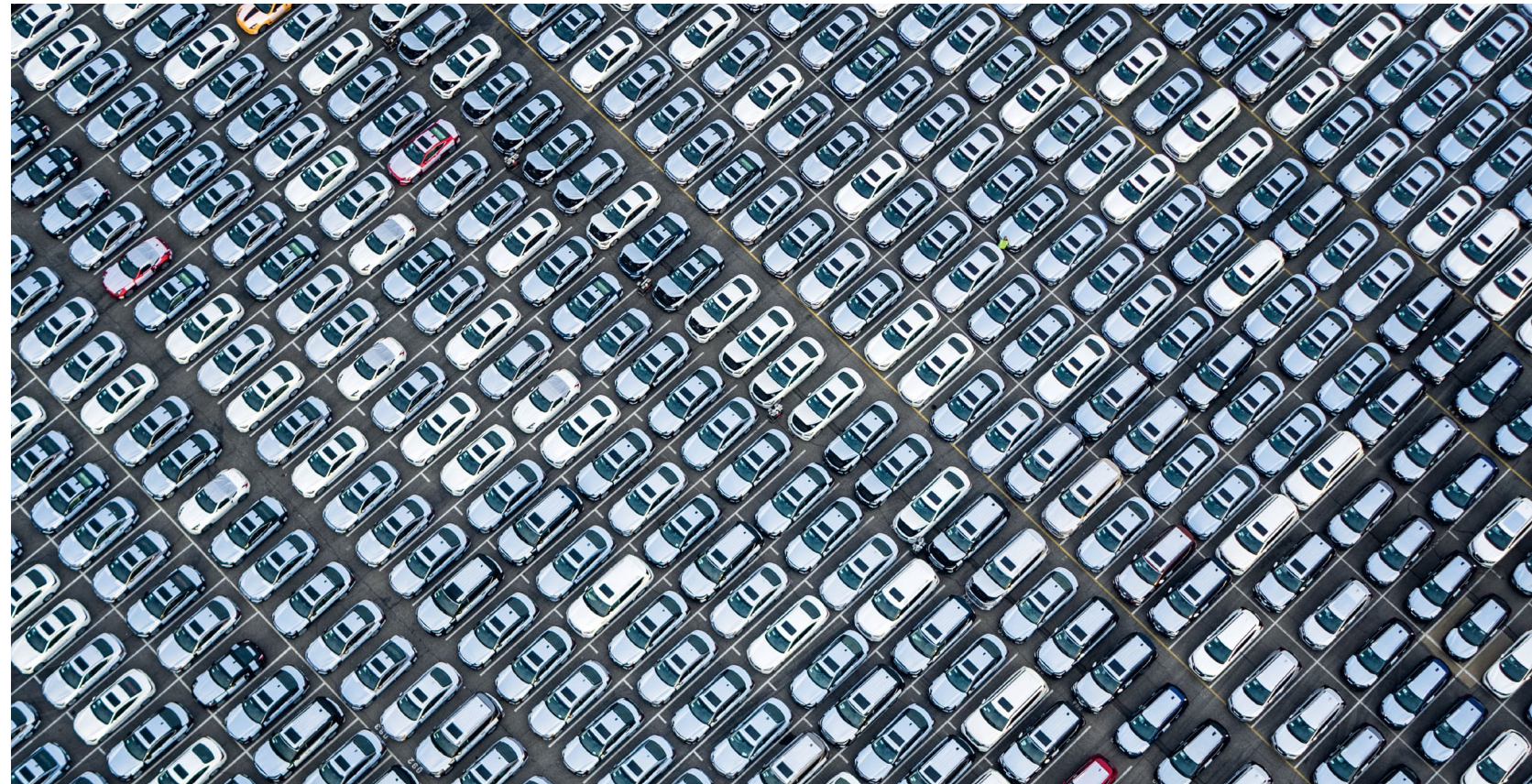
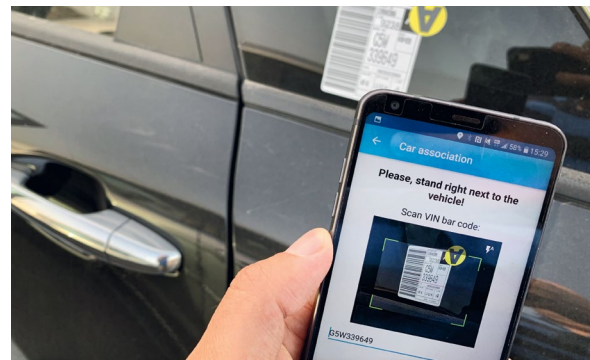

It was a problem Sogo took on with relish, and innovatively solved with the help of its Cloud-computing and AI expertise, and Nordic Semiconductor-powered Bluetooth LE wireless technology.

## NEEDLE IN A HAYSTACK

A bonded lot is typically situated near the unloading dock and accommodates thousands of vehicles prior to customs clearance. Security is tight and access restricted. When a customer enters the dealer and orders a car, the dealer contacts the distributor for delivery of a vehicle from the stock at the bonded lot. The car is then registered, passes through customs and is shipped to the dealer's showroom.

Managing a bonded lot is no trivial task. Conventional working practice is to write down the location of the vehicle once it's parked. But that system is flawed, particularly because it relies on humans. First off, it's all too easy for workers to write down the wrong location. Next, the vehicles are packed in tight to make the most of the space in the lot so extricating one can mean moving three or four others - which are often not returned to their allotted space.

If a vehicle is not where it should be, workers have to wander around the approximate location scanning all the vehicle identification numbers (VIN) as the cars have no license plates, in the hope they can find the misplaced one. And while possibly exaggerated, industry insiders tell stories of occasions when many staff have searched for several days to locate cars. Apart from being a tedious task for the people involved, this is not an efficient way to conduct a car distribution operation.

While this is far from how Kia Israel conducts its business, the company was keen to keep improving. So it engaged Sogo to find a way to locate an individual vehicle "within minutes and without installing new infrastructure".

That discounted options like fixed cameras, scanners

or drones. Instead, with its experience of the IoT, Sogo explored the option of wireless asset tracking. Cellular was dismissed as too expensive to put in every vehicle, and Wi-Fi required too much battery power. Short range wireless proved both inexpensive and battery friendly.

## COME AND GET ME

Bluetooth LE won out over the other short range options because of its interoperability with smartphones, which, conveniently, every worker in Kia Israel's operation already carried in their pockets.

The foundation of Sogo's solution—branded [ViLOG](#)—is formed by Bluetooth LE beacons (from a third party manufacturer, MokoSmart) equipped with Nordic nRF52 Series Bluetooth 5 SoCs. (See "Need to know".) Each vehicle is 'tagged' with a battery-powered beacon which is coupled with the car's VIN.

When a staff member initially parks the car in the bonded lot, information is sent from the beacon via its Bluetooth LE link to the associated smartphone app - eliminating paperwork and human error. By referencing the smartphone's GPS, the app then sends the vehicle's positional information to a Cloud-based database. If the car is moved to process it or access other vehicles nearby its new position is immediately sent to the server, removing the need to park it back in the same spot.

But the real beauty of the system is how it maximizes Bluetooth LE tech's interoperability with smartphones; not only are vehicle positions determined when they're moved, but the locations of all of them are continually 'calibrated' as workers move around the lot, via the app on the smartphones in their pockets.

"The standard beacon power is sufficient such that the worker doesn't have to be directly by the vehicle. They could even be driving a vehicle nearby," explains

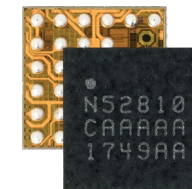

## Tech Check

Nordic's [nRF52810](#) combines the good performance and competitive price demanded of an application based on wide beacon deployment. The SoC is a Bluetooth 5 device offering ultra low power consumption, good range and an enhanced channel selection algorithm, improving the ability to coexist with other beacons in a restricted area

Messerman. "The phones can gather signals from thousands of beacons as people move around the parking lot. The beacons simply broadcast their ID which is referenced to a specific vehicle by ViLOG servers. Because no vehicle's sensor information or location is transmitted, the power efficiency of the beacon is maximized."

When a worker needs to find a car, it's simply a case of typing the VIN into the app which will then guide them to the precise spot in just the time it takes to walk there.

The system even includes an option to use beacons in fixed locations for triangulation when GPS is inaccessible, such as within indoor parking lots.

According to Messerman, the system brings many advantages beyond the elimination of costly infrastructure. A key advantage is low maintenance because the ultra low power characteristics of the Nordic SoC extend the battery life for up to a year, not to mention the SoC's 85°C maximum temperature rating which helps it keep working inside a car parked in the intense Mediterranean sun.

"We chose Nordic's technology because it's proven and mature," adds Messerman. "That's very important because we're a software company and need 'fit and forget' hardware. But in the rare case there might be a failure we've implemented a 'last known position' feature which at least narrows down the vehicle's possible location."

The system is working well. "With ViLOG, Kia Israel significantly improved inventory turnover. We know exactly where each of our 10,000 cars is located, and waste no time tracking the 700 cars [we move] daily," said one Kia Israel Executive.

Sogo has completed its own analysis of the effectiveness of ViLOG and found vehicles were located virtually instantly leading to a reduction in vehicle processing time of 20 to 40 percent, labor costs by 50 percent and storage costs by 25 to 40 percent. And perhaps most importantly of all, time for processing and delivery to customers is reduced by two days per vehicle.

ViLOG also allows distributors to improve future operations thanks to the power of 'big data'. Analysis of such information enables customers to continuously optimize how they run their operations. "The system enables well-informed process optimization thanks to better visibility into such metrics as storage and processing time per vehicle and allows for improved resource planning thanks to historical insights," explains Messerman.

## TRACK ANY ASSET

Such is the success of ViLOG that Sogo has big plans for the technology. In the first instance that includes other bonded parking lots. "We're working with two other large European car distributors as a result of our success with the Kia Israeli importer," says Messerman.

The elegance of the solution is such that it lends itself to tracking of any asset. In the same way historical data from car logistics can be used to enhance operations so the modest beacon can be used to keep track of raw materials in a factory, refrigerated produce in a supermarket freezer or priceless exhibits in a museum.

The prospects for the technology are inviting. So inviting that Sogo plans to spin-off ViLOG with big plans to export Israeli IoT-based asset tracking technology to the world.

Personal Protection

# TASER Pulse+

This Bluetooth LE TASER device automatically alerts emergency services to the presence of danger when deployed by a user

The public and personal safety market is forecast to reach \$518 billion by 2023 with North America the key market, according to analyst, Market Research Future. The company said technological advancements alongside demand for more efficient and responsive connected devices, as well as user-friendly, advanced safety systems was behind the anticipated market growth



When the user deploys the TASER Pulse+, the device sends an instant alert to a partner app on the user's smartphone that in turn notifies a dispatch team of the need to send immediate emergency services assistance to the user's precise location using real time GPS tracking

Inventor **Jack Cover** is said to have come up with the idea for the TASER having read a newspaper article about a man who blundered into an electrified fence. The shocking experience left the man unable to move for a few minutes, but otherwise unharmed, which intrigued Cover. He set to work in his garage workshop and thus was born the TASER in wide use by law enforcement agencies today

In operation, the **TASER Pulse+** is capable of delivering neuromuscular incapacitation from a distance of five meters or less, causing involuntary muscle contraction during its 30-second cycle providing the user with an opportunity to move to safety

The TASER was first developed in the mid-1970s by American inventor and NASA researcher Jack Cover and is a modified acronym from the title of one of Cover's favorite childhood books, Tom Swift and His Electric Rifle, first published in 1911

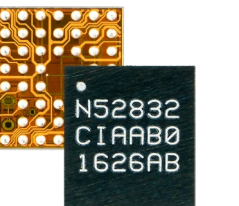

### Tech Check

The TASER Pulse+ employs Nordic's [nRF52832](#) Bluetooth LE multiprotocol SoC to provide low latency wireless connectivity between the TASER and a smartphone. The nRF52832 has been engineered to minimize power consumption with features such as the 2.4GHz radio's 5.5mA peak RX/TX currents and a fully-automatic power management system resulting in a battery life of more than one year from the device's two CR123 batteries

Industrial IoT

# Sensor helps industrial plant operators remotely analyze machinery health

Using Bluetooth 5 and National Instruments' Wireless Vibration Sensor, reliability engineers can monitor equipment for predictive maintenance purposes from anywhere

For industrial plant operators predictive maintenance is a must, it not only saves machine downtime, it also extends the life of essential equipment.

With industrial facilities sprawling over several kilometers, the ability to analyze the health of industrial assets remotely is important as it saves engineers many hours. Multiply this saving by hundreds or potentially thousands of critical assets, and the cost savings to a big company can run to millions of dollars. Engineers at Boeing's Everett facility, for example, work in the largest enclosed industrial space in the world, so checking the aircraft factory's equipment manually would be a daunting undertaking.

To this end, Austin, Texas-based National Instruments (NI), a leading developer of high performance automated test and measurement systems for engineering, has launched an innovative continuous monitoring solution employing low power wireless technology.

The [NI MON-10411 Wireless Vibration Sensor](#) helps automate the otherwise manual process of route-based data collection, allowing reliability engineers to focus on analyzing data and solving problems rather than regularly donning personal protective equipment to inspect machinery up close. With NI InsightCM software and the new wireless devices, plant maintenance teams can frequently check machine health and respond to alerts without ever needing to attend the plant in person.

"Unlike many alternatives on the market, the new NI wireless devices transmit diagnostic quality waveform data back to the InsightCM server so subject matter experts can immediately respond to alerts with a laptop rather than making a trip to the plant," says Jeff Kellam, Distinguished Engineer, NI.

The solution also allows plant owners to reduce the cost of connecting their assets to IT networks. "It takes us days to install continuous monitoring systems, but with wireless it's closer to hours so we can connect more equipment in less time and for less cost," says Chuck Requet, a Group Leader with the Louisville Gas & Electric utility. "More connected assets mean ... a shift in focus to data analysis rather than data collection. The NI wireless device data quality is as good as our wired continuous monitoring devices."

In operation, the Wireless Vibration Sensor can be mounted to any asset such as a large pump or motor, where it then monitors the health status of the asset using its internal MEMS triaxial accelerometer and temperature sensor.

The MON-10411 uses Bluetooth LE connectivity to transfer diagnostic quality waveform data to an NI gateway, then to the InsightCM software which is connected to a server.



## Challenging environments

To ensure precise delivery of key asset health data and alerts, this complex application relies on powerful hardware. Both the MON-10411 Wireless Vibration Sensor and the NI gateway use Nordic's [nRF52840](#) advanced multiprotocol SoC to provide the robust wireless link required for challenging industrial RF environments.

The nRF52840 SoC's new radio architecture features 95 dBm RX sensitivity (at 1 Mbps Bluetooth LE), with an on-chip power amplifier boosting maximum output power to 8 dBm for a total link budget of >103 dBm, and even greater when paired with an external power amplifier/low noise amplifier. According to NI, when combined with Bluetooth LE's robust channel selection algorithm, the SoC's link budget enables the device to transmit RF signals to the gateway over several hundred meters.

The company selected Bluetooth 5/Bluetooth LE over alternative wireless protocols due to a number of advantages, not least its raw data bandwidth capabilities. "We chose Bluetooth LE because it was fast, had surprisingly long range and was robust in industrial environments," explains Kellam. "Bluetooth LE has a very fast 2 Mbps [throughput]

## Need to Know

Checking the vibrations of an operating machine tells engineers much about its health. A change in the machine's vibration "signature" is the first sign of a problem. Advanced analysis can even pinpoint the source of the unusual vibration. Vibration anomalies occur months before failure giving engineers time to plan an overhaul of the machine



Experts can immediately respond to alerts with a laptop rather than making a time consuming trip to the plant

compared to most other [IIoT](#) protocols, and the protocol is efficient at streaming data. The faster we transfer [data], the more sensors we can support. Frequency hopping is also a big win for the [harsh RF] environments common for industrial customers because it provides robustness to fading. Bluetooth LE ... opens up wide scale deployments with only a modest infrastructure cost."

For NI, the nRF52840 SoC features proved decisive. "This was important because our platform includes several products. Even before release, the [Nordic] SDK, SoftDevice and datasheets enabled us to hit a substantial number of early milestones and confirm infield product validation for our entire system," says Kellam.

While the outstanding performance of the Nordic chip was a key factor in NI's decision, the company also values Nordic's reputation and experience. "To be successful we needed a mature supplier with strong low power wireless technology expertise who was willing to support our vision, and we found that in Nordic," says Kellam. "We've had stringent requirements that have pushed the nRF52840 far beyond a typical consumer reference design. Support questions ranged from Flash endurance to Bluetooth LE connection parameter tuning and RF front end enable/disable timing limits. The response times have been fast, and the [Nordic] engineers are some of the most knowledgeable Bluetooth LE experts in the world."

## Nordic People

# Application Engineer supports customers and nature

Hi, I'm Kaja Garbom Sørbotten and I'm an Application Engineer in Technical Support, based in Trondheim, Norway. In January I finished my Master of Science in Electronic Engineering at Norwegian University of Science and Technology (NTNU) and in February I began working at Nordic Semiconductor.



My main responsibilities include supporting customers by reviewing their hardware designs, working in the lab tuning antennas, performing RF measurement and fine tuning the radio matching network as preparation for certifications. In addition, I respond to a variety of other questions through [Nordic's DevZone](#) - our forum for communicating with customers. We try to provide timely, informative and valuable answers to all technical questions.

What drives me to do a good job is the gratitude of our customers when we help them succeed with their product designs.

It's therefore very important for me to be thorough when reviewing hardware designs to ensure customers don't need to undertake this step all over again. Hopefully this process leads to well functioning end products that pass all certifications.

I am thankful for the chance to challenge myself every day and work with such clever people. I find it incredibly exciting to learn from my colleagues. When challenging issues arise, we have the right people on hand to ask for advice. Working at Nordic is always very rewarding and educational.

Outside of work I have a number of different interests. In the summer I love going to Vinjerock, a great music festival at Eidsbugarden in Jotunheimen, Norway, where my friends and I go camping and of course listening to music with a lovely view. We always have the best time there. Generally, I'm happy spending quality time with my friends and family. I also enjoy traveling, playing volleyball and doing anything outdoors such as hiking or cross-country skiing.

Recently I also joined the social committee at Nordic, 'NoVe!'. The goal for the committee is to encourage Nordic employees to socialize outside

## Profile

**Name:** Kaja Garbom Sørbotten

**Job Title:** Application Engineer, Technical Support

**Joined Nordic:** February, 2019

**Based:** Trondheim, Norway

**Interests:** Hiking, cross-country skiing, traveling, volleyball

of the workplace. I really love this concept. So, I'm very much looking forward to planning and arranging more social events for my colleagues here at Nordic.

Another thing I'm very passionate about is wildlife conservation and 'strandrydding' (beach collection). Every day I try to pick up five items from the ground that don't belong in nature - it's a personal challenge called '5 for the whale'.

## Working at Nordic is always rewarding and educational

In Trondheim you should always take a rain jacket or umbrella when you go outside, but even after living in this city for six years I sometimes find it difficult to remember the important lesson that the weather can change instantly. One time it started raining on my way home from work and I'd accidentally left my rain jacket at home in the morning, so I found an alternative solution - wear a pink trash bag!

Looking ahead, I am aiming to continue learning, challenge myself, be a good colleague and fellow human, and give Nordic customers the best possible support for their developments and innovations.

# Tech Zone

An in-depth look at Nordic's wireless IoT solutions

## Internet of Things

### Precertified modem speeds cellular IoT product development

Cellular IoT products and applications will soon be able to be brought to market in a matter of days using the first publicly announced third party modem to be based on the Nordic LTE-M/NB-IoT nRF9160 SIP.

Called the Skywire Nano, the NimbeLink modem has achieved 'end device certification' for use on both LTE-M and NB-IoT cellular IoT networks worldwide. This means any product or application using the modem doesn't have to go through the carrier certification process.

The Skywire Nano Features the nRF9160's Arm Cortex-M33 processor with 1 MB of Flash and 256 KB of RAM; UART, SPI, and I2C serial interfaces; a soldered-down Verizon SIM; support for external SIM sockets; a simple firmware OTA update system; an

easy GSMA network back-off solution; AT command interface for UDP and TCP/IP socket dials, and GNSS support. According to NimbeLink, the modem will offer the smallest form factor and lowest power consumption of any cellular IoT modem available on the market.

NimbeLink says customers can also select their own antenna within some broad guidelines for use with their modem without affecting its precertified status. "This means if a customer isn't happy with the performance, they can use a different antenna or put the antenna in a better place within their product or application," says Kurt Larson, CTO of NimbeLink.

"Third-party modems make a lot of sense



when existing production volumes have yet to scale and in situations where a company wants to test market acceptance before investing further design resources," says Geir Langeland, Nordic Semiconductor Director of Sales & Marketing. "But above all else, cellular IoT modems further simplify the already simple design process Nordic works so hard to achieve in all its products."

NimbeLink says its Skywire Nano modem will be available during Q1 2020.

### Modules enable OEMs to use long range in IoT product designs

SG Wireless, a Hong Kong-based full-stack IoT solutions provider, has released two new modules based on Nordic's nRF52840 SoC, designed to provide a complete RF solution for use in a range of IoT applications including connected home, smart city infrastructure, industrial mesh networks, industrial smart lighting, and transport and logistics.

The SGW1010 and SGW1011 modules are supplied in a 10.2 by 15 by 2.1 mm form factor and are designed to reduce the engineering efforts and development costs associated with adding Bluetooth 5 to any product, thereby

accelerating time to market. The SGW1010 module provides an embedded PCB trace antenna, while the SGW1011 module offers a u.FL connector for an external antenna.

Enabled by the nRF52840 SoC's support for Bluetooth 5, the modules allow OEMs to utilize the Bluetooth 5 Long Range and advertising extension support features in IoT product designs. The integrated nRF52840 SoC provides full Bluetooth 5 support, including 2x on-air raw data bandwidth (2Mbps); 4x range; and 8x broadcasting ability with advertising extensions that increase the advertising packet payload size to 251 bytes.

"The SG Wireless certified Bluetooth LE modules are developed as accelerators to enable OEM finished products to be built with high value, long range and multiprotocol functions and the least possible engineering efforts," says Dr Ken Wong, CTO at SG Wireless.



### Satellite transmitter module DK

U.S.-based satellite and commercial IoT communications company, Globalstar, has released the STX3 Development Kit, enabling companies to rapidly develop and test solutions based on the company's STX3 Satellite Transmitter module used for sending data to Globalstar Satellite Network.

The inclusion of Nordic's nRF52832 SoC on the DK provides Bluetooth LE connectivity between the module software application and smartphones via an iOS or Android Globalstar app. From the app the user can configure the STX3 module, monitor the status of the application under development, as well as acquire data from or send data to the module. During field testing, the developer can connect the module to the STX3 Development Kit and issue commands to instruct the module to send data from its onboard sensors to the satellite network.



## Tech Briefing

### Inside the nRF52833

The latest member of Nordic's nRF52 Series is an ideal option for professional lighting and other industrial applications that require a proven multiprotocol solution

LEDs and wireless technology are coming together to power "Lighting as a Platform" (LaaP). Such systems not only allow control, configuration and monitoring of a lighting mesh network, but also make the smart lighting infrastructure the perfect platform for an array of wireless sensors checking such things as air quality, temperature and occupancy. (See WQ Issue 3, 2019, pg10.)

But LaaP demands much of the electronics. The wireless SoC requires mesh capability, decent range, multiprotocol support, and processing power to handle complex LaaP algorithms and more. To make things more challenging, the chip must be able to handle years inside a hot lighting fixture where temperatures can reach 100°C.

Nordic's recently launched nRF52833 SoC has been purpose-designed for professional lighting applications, and because the chip is equipped with a powerful microprocessor and large Flash and RAM capacity, it supports all the features of Bluetooth 5.1 Direction Finding and Bluetooth 5, including Long Range and high throughput. It also meets the demands of almost all smart-home, -industry, and -agriculture wireless applications.

The nRF52833 is now in volume production.

#### SoC architecture

Like the flagship nRF52 Series SoC, the nRF52840, the nRF52833 features a 64-MHz 32-bit Arm Cortex-M4 processor with floating point unit (FPU), DSP instruction set and cache. The hardware includes 512 KB Flash and 128 KB RAM. The SoC's 2.4 GHz multiprotocol radio features +8 dBm TX power (programmable from -20 dBm in +4 dBm steps) and -95 dBm sensitivity (Bluetooth LE at 1 Mbps) for a link budget of +103 dBm. Radio peak power consumption (DC/DC at 3 V) is 6.1 mA in TX mode (at 0 dBm) and 5.96 mA in RX (at 1 Mbps). The chip boasts an integrated balun with single-ended output. The output power together with Bluetooth 5 technology's Long Range feature ensures the nRF52833 is an ideal choice for smart-home applications demanding robust connections and complete building coverage.

The nRF52833 is the only SoC in the nRF52 Series range, apart from the high end nRF52840 that includes advanced features such as Full-Speed USB and High-Speed SPI. The SoC includes up to 42 GPIOs and a range of analog and digital interfaces NFC-A, ADC, UART/SPI/TWI, PWM, I2S and PDM, and features a 1.7 to 5.5 V supply voltage range allowing the nRF52833 SoC to be powered by coin-cells, rechargeable batteries, or the on-chip USB.

The SoC will be available in three different packages: a 7x7 mm aQFN73 with 42 GPIOs, a 5x5 mm QFN40 with 18 GPIOs and a 3.2x3.2 mm wLCSP with 42 GPIOs.

#### Software support

The nRF52833 is a multiprotocol wireless SoC and is supplied with the S113 or S140 SoftDevices, Nordic's Bluetooth RF protocol stacks. The S140 is a qualified Bluetooth 5.1 stack and includes support for 2 Mbps throughput, Bluetooth Long Range and improved

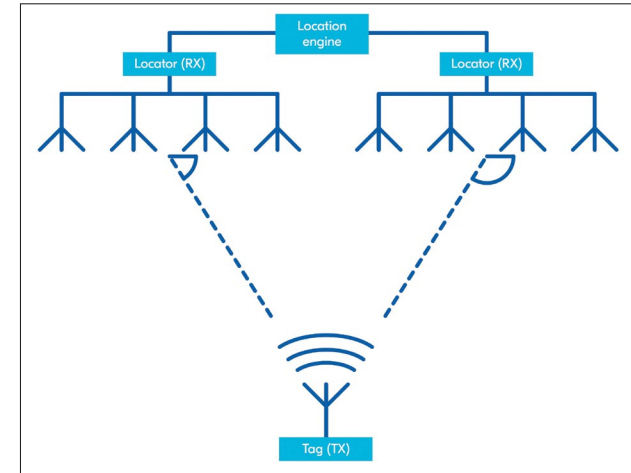

Bluetooth 5.1 Direction Finding supported by the nRF52833 SoC enables positioning applications that not only rely on received signal strength indication (RSSI) but also the signal direction. Illustrated here is an example of a real time location system (RTLS) where the principle of Angle-of-Arrival is used to determine tag location

coexistence through Channel Selection Algorithm #2. The SoC also features IEEE 802.15.4 support for protocols such as Thread and Zigbee.

The chip's dynamic multiprotocol capability is an advantage for applications where concurrent Bluetooth LE and Bluetooth mesh/Thread/Zigbee support enables provisioning, commissioning, and interaction with a lighting mesh network running either Bluetooth mesh or IEEE 802.15.4-based protocols from a smartphone using Bluetooth LE.

The nRF52833 joins the nRF52811 in the nRF52 Series by featuring a radio capable of all Bluetooth 5.1 Direction Finding features and its large memory can support both receiver and transmitter roles for Angle-of-Arrival (AoA) and Angle-of-Departure (AoD) applications. (See WQ Summer 2019, pg26.)

#### Development tools

Like all of Nordic's nRF52 Series SoCs the nRF52833 has been designed to make application development simple and accelerate time-to-market. The SoC is supported by the nRF5 SDK, nRF5 SDK for Mesh and nRF5 SDK for Thread & Zigbee. The software development kits (SDKs) provide the examples, libraries and drivers needed to get started with Bluetooth LE, Bluetooth mesh, and Thread or Zigbee development.

The nRF52833 Development Kit (DK) accompanies the SoC's introduction and is the ideal design tool to start nRF52833-based designs. The DK is a versatile single board development kit for Bluetooth LE, Bluetooth mesh, 802.15.4, Thread, Zigbee, and 2.4GHz proprietary applications running on the nRF52833 SoC. The DK is compatible with the Arduino Uno Rev3 standard, enabling the use of the compatible Nordic Power Profiler Kit and a wide range of third-party shields during development.



The recently launched nRF52833 has been purpose-designed for professional lighting, asset tracking and advanced wearable applications

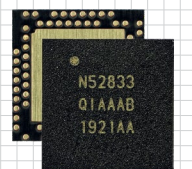

#### Tech Check

The nRF52833 SoC is the fifth addition to Nordic's nRF52 Series and is qualified for operation across an extended temperature range of -40 to 105°C. It supports Bluetooth 5.1, Bluetooth mesh, Thread, Zigbee and proprietary 2.4 GHz protocols



# Lifecycle protection for IoT devices

Arm's CryptoCell brings an embedded security platform to vulnerable connected products

In the last issue of *WQ*, we described the benefits of 'Trusted Execution Environments' (TEEs) such as TrustZone from Arm. (See *WQ Issue 3, 2019, pg25*) TrustZone operates by establishing a secure processor operational mode which enables security functions and cryptographic credentials to be hidden from the normal processor operating environment. A key benefit is that it prevents software vulnerabilities in one execution environment being exploited to gain access to another. But a truly secure IoT connected device requires more than just this isolated 'trusted platform module'; additional roots of trust (RoTs) and security mechanisms are needed. To meet this requirement, Arm complements TrustZone with CryptoCell.

CryptoCell is an embedded security platform for devices already using TrustZone, providing a greater level of security while boosting processor performance. The technology comprises a multilayered architecture combining hardware data path, RoT management and operation control with a layer of security firmware. In addition to boosting security, a key operational benefit is a reduction in switching between the TEE and normal processor modes which reduces power consumption and accelerates execution.

## How CryptoCell works

During an IoT device's lifecycle, multiple entities will be involved in the processes of manufacture, shipping, deployment and disposal. The objective of CryptoCell is to establish trust between these parties by providing the security services that protect the integrity, authenticity and confidentiality of various assets (for example, code and data) belonging to different stakeholders (for example, semiconductor vendors, OEMs and consumers). The tech associates a different security policy with each device's lifecycle stages.

Arm's latest product, CryptoCell-312, is partitioned into five domains: Control; data interface; symmetric cryptography; asymmetric cryptography, and security resources. The company explains that the partitioning helps maintain a modular approach, facilitating power, performance, area (PPA) trade-offs. CryptoCell addresses control and scheduling, data interfaces, cryptography and the various security resources which turns a cryptographic accelerator into a security solution. CryptoCell's control interface communicates directly with TrustZone (see figure).

The security resources domain is where CryptoCell's security elements are enabled, typically using cryptography and off-device tools. These security elements include: Lifecycle; RoT management; IP protection (code confidentiality); persistent and volatile data protection; secure debug, and feature enablement.

Key elements serve RoT; these elements use persistent on-chip storage accessible only by CryptoCell and are not modifiable or accessible by untrusted entities. RoT can be in the form of keys, used for various purposes and owned by different entities, or other information pertaining to the state of the device.

CryptoCell also supports an RoT ownership model which allows multiple owners and multiple sets of RoTs, which in turn enable different parties (for example, the semiconductor vendor, OEM and service provider) to own and monetize processes and assets without having to trust each other.

## A smart lock example

IoT connected smart locks have grown in popularity but some lesser models are proving vulnerable to malicious attack. For example, a hacker can employ a replay tactic by grabbing data over the air when a legitimate user unlocks the door and then replay that data to gain access later.

Authentication of the consumer's mobile phone prior to operating the lock is one way to counter the replay tactic. The process relies on a Cloud-based server and starts with the consumer buying a smart lock with a QR code incorporated into its packaging which provides access to a unique identifier and a smartphone hosted app. The app enables smartphone provisioning with an admin key pair and a manufacturer-signed digital certificate unique to the smart lock. The lock can then securely authenticate requests from the consumer's smartphone to activate after successful verification.

For this to work successfully, the smart lock requires several security mechanisms including: Secure boot validating the loaded software image; a firmware update mechanism to validate software updates; protection of the integrity of the Cloud service public key, and public keys belonging to authorized users. True random number generation (TRNG) is also included to issue random challenges to the device attempting to unlock, and asymmetric crypto support for verifying the signed response to the lock's challenge.

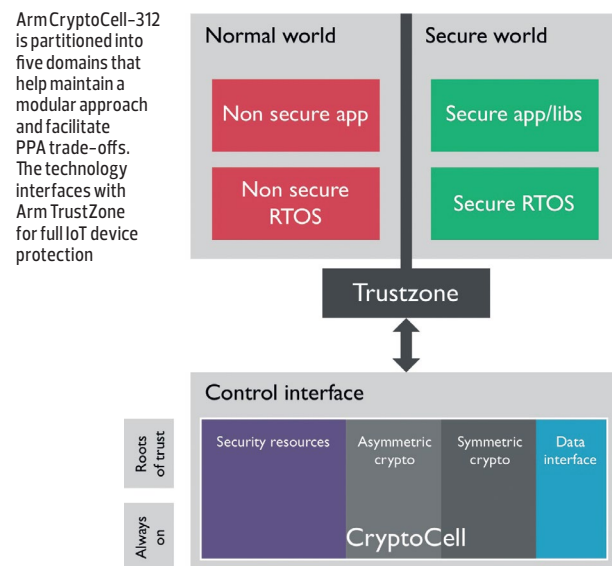

Truly securing an IoT device requires more than a Trusted Execution Environment

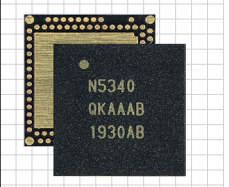

**Tech Check**  
 Nordic's nRF5340 incorporates Arm CryptoCell-312, Arm TrustZone technology and Secure Key Storage for the highest level of security. The nRF5340's combined security features enable advanced RoT and secure firmware updates while protecting the SoC from malicious attack



# Meet the nRF5340

Our new dual-core flagship SoC

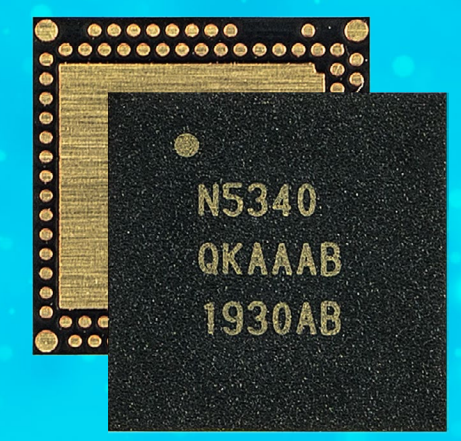

START YOUR DEVELOPMENT TODAY  
[nordicsemi.com/nrf5340pdk](http://nordicsemi.com/nrf5340pdk)



# Product Summary

Full product details at: [www.nordicsemi.com/Products](http://www.nordicsemi.com/Products)

	nRF9160	nRF5340	nRF52840	nRF52833	nRF52832	nRF52811	nRF52810	nRF51822	nRF51422	nRF51824
WIRELESS PROTOCOL	LTE-M	•								
	NB-IOT	•								
	GPS	•								
	BLUETOOTH LOW ENERGY		•	•	•	•	•	•	•	•
	BLUETOOTH 5.1 - DIRECTION FINDING		•		•		•			
	BLUETOOTH 5 - 2 Mbps		•	•	•	•	•	•		
	BLUETOOTH 5 - LONG RANGE		•	•	•	•	•			
	BLUETOOTH MESH		•	•	•	•	•			
	THREAD & ZIGBEE (802.15.4)		•	•	•	•	•			
	ANT		•	•	•	•	•	•	•	•
2.4 GHZ PROPRIETARY		•	•	•	•	•	•	•	•	
NFC		•	•	•	•	•	•	•	•	
SYSTEM-ON-CHIP		•	•	•	•	•	•	•	•	
SYSTEM-IN-PACKAGE	•									
CORE SYSTEM	CPU	64 MHz Arm Cortex-M33	128 MHz Arm Cortex-M33 64 MHz Arm Cortex-M33	64 MHz Arm Cortex-M4	64 MHz Arm Cortex-M4	64 MHz Arm Cortex-M4	64 MHz Arm Cortex-M4	64 MHz Arm Cortex-M4	16 MHz Arm Cortex-M0	16 MHz Arm Cortex-M0
	FPU	•	•	•	•	•				
	DSP INSTRUCTION SET	•	•	•	•	•	•	•		
	CACHE	•	•	•	•	•				
	MEMORY	1MB Flash, 256 kB RAM	1MB Flash, 512 kB RAM +256 kB Flash, 64 kB RAM	1MB Flash, 256 kB RAM	512 kB Flash, 128 kB RAM	512 kB or 256 kB Flash, 64 kB or 32 kB RAM	192 kB Flash, 24 kB RAM	192 kB Flash, 24 kB RAM	128 kB or 256 kB Flash, 32 kB or 16 kB RAM	128 kB or 256 kB Flash, 32 kB or 16 kB RAM
CLOCKS	64 MHz / 32 kHz	128 MHz / 64 MHz / 32 kHz	64 MHz / 32 kHz	64 MHz / 32 kHz	64 MHz / 32 kHz	64 MHz / 32 kHz	64 MHz / 32 kHz	16 MHz / 32 kHz	16 MHz / 32 kHz	16 MHz / 32 kHz
SECURITY	ARM TRUSTZONE	•	•	•	•	•	•	•	•	•
	ARM CRYPTOCELL	310	312	310						
	ROOT-OF-TRUST	•	•	•						
	SECURE KEY STORAGE	•	•	•						
	AES ENCRYPTION	•	•	•	•	•	•	•	•	•
RADIO	LTE-M/NB-IOT/GPS MODEM	•								
	CERTIFIED LTE BANDS	1-5, 8, 12-14, 17-20, 25-26, 28, 66								
	FREQUENCY	700-2200 MHz	2.4 GHz	2.4 GHz	2.4 GHz	2.4 GHz	2.4 GHz	2.4 GHz	2.4 GHz	2.4 GHz
	MAXIMUM TX POWER	23 dBm	3 dBm	8 dBm	8 dBm	4 dBm	4 dBm	4 dBm	4 dBm	4 dBm
	RX SENSITIVITY	-108 dBm (LTE-M), -114 dBm (NB-IoT)	-97.5 dBm (1Mbps)	-95 dBm (1Mbps)	-95 dBm (1Mbps)	-96 dBm (1Mbps)	-97 dBm (1Mbps)	-96 dBm (1Mbps)	-90 dBm (1Mbps)	-93 dBm (1Mbps)
ANTENNA INTERFACE	50 Ω single-ended	Single-ended	Single-ended	Single-ended	Single-ended	Single-ended	Single-ended	Differential	Differential	Differential
PERIPHERALS	HIGH SPEED SPI		•	•	•	•	•			
	TWI, SPI, UART	•	•	•	•	•	•	•	•	•
	QSPI		•	•	•	•	•			
	USB		•	•	•	•	•			
	PWM	•	•	•	•	•	•	•	•	•
	PDM	•	•	•	•	•	•	•	•	•
	I2S	•	•	•	•	•	•	•	•	•
	ADC/COMPARATOR	•	•	•	•	•	•	•	•	•
	TIMER/RTC	•	•	•	•	•	•	•	•	•
	TEMPERATURE SENSOR	•	•	•	•	•	•	•	•	•
APPLICATIONS	AGRICULTURE	•	•	•	•	•	•			
	ASSET TRACKING	•	•	•	•	•	•			
	AUTOMATION	•	•	•	•	•	•	•	•	•
	BEACON	•	•	•	•	•	•	•	•	•
	CONSUMER ELECTRONICS	•	•	•	•	•	•	•	•	•
	DIRECTION FINDING	•	•	•	•	•	•	•	•	•
	GAMING / VR + AR	•	•	•	•	•	•	•	•	•
	HEALTHCARE & MEDICAL	•	•	•	•	•	•	•	•	•
	INDUSTRIAL SYSTEMS	•	•	•	•	•	•	•	•	•
	MESH NETWORKS	•	•	•	•	•	•	•	•	•
	PC PERIPHERALS	•	•	•	•	•	•	•	•	•
	PROFESSIONAL LIGHTING	•	•	•	•	•	•	•	•	•
	SMART BUILDINGS	•	•	•	•	•	•	•	•	•
	SMART CITY	•	•	•	•	•	•	•	•	•
	SMART HOME	•	•	•	•	•	•	•	•	•
SMART METERING	•	•	•	•	•	•	•	•	•	
SPORTS & FITNESS	•	•	•	•	•	•	•	•	•	
TOYS	•	•	•	•	•	•	•	•	•	
WEARABLES	•	•	•	•	•	•	•	•	•	
CERTIFICATIONS	GCF, PTCRB, CE, FCC, Verizon ++	CE, FCC	CE, FCC	CE, FCC	CE, FCC	CE, FCC	CE, FCC	CE, FCC	CE, FCC	CE, FCC
OPERATING TEMPERATURE	-40 to 85 °C	-40 to 105 °C	-40 to 85 °C	-40 to 105 °C	-40 to 85 °C	-40 to 85 °C	-40 to 85 °C	-40 to 85 °C	-40 to 85 °C	-40 to 105 °C
SUPPLY VOLTAGE RANGE	3.0 to 5.5 V	1.7 to 5.5 V	1.7 to 5.5 V	1.7 to 5.5 V	1.7 to 3.6 V	1.7 to 3.6 V	1.7 to 3.6 V	1.8 to 3.6 V	1.8 to 3.6 V	1.8 to 3.6 V
DEVELOPMENT KITS	nRF9160 DK, Nordic Thingy:91	nRF5340 PDK	nRF52840 DK nRF52840 Dongle	nRF52833 DK	nRF52 DK Nordic Thingy:52	nRF52840 DK	nRF52 DK	nRF51DK, nRF51 Dongle	nRF51DK, nRF51 Dongle	nRF51DK, nRF51 Dongle
PACKAGES	10x16x1mm LGA	7x7 mm aQFN94 (48 GPIOs)	7x7 mm aQFN73 (48 GPIOs), 3.5x3.6 mm WLCSP94 (48 GPIOs)	7x7 mm aQFN73 (42 GPIOs), 5x5 mm QFN40 (18 GPIOs), 3.2x3.2 mm WLCSP (42 GPIOs)	6x6 mm QFN48 (32 GPIOs), 3.0x3.2 mm WLCSP50 (32 GPIOs)	6x6 mm QFN48 (32 GPIOs), 5x5 mm QFN32 (17 GPIOs), 2.48x2.46 mm WLCSP33 (15 GPIOs)	6x6 mm QFN48 (32 GPIOs), 5x5 mm QFN32 (16 GPIOs), 2.48x2.46 mm WLCSP33 (15 GPIOs)	6x6 mm QFN48, WLCSP48, Thin CSP	6x6 mm QFN48, WLCSP48	6x6 mm QFN48, WLCSP48

# Tech Profile

## nRF5340



**Description:** The nRF5340 is the world's first wireless SoC with two Arm Cortex-M33 processors. It is a comprehensive solution for the most complex IoT applications and features functionality such as High-Speed USB, multiprotocol support including Bluetooth 5.1 and up to 105 °C operating temperature.

**Radio:** Bluetooth LE, Bluetooth 5.1 Direction Finding, all Bluetooth 5 features, Bluetooth mesh, Thread and Zigbee, NFC, ANT, IEEE 802.15.4 and 2.4 GHz proprietary protocols are supported. The 0 dBm TX current is 3.2 mA, while the RX current is only 2.6 mA. The radio's RX sensitivity is -97.5 dBm, 2.5 dB better than the nRF52840 while using 40 per cent less current.

**Security:** The SoC offers trusted execution, root-of-trust and secure key storage security features through Arm TrustZone. Arm CryptoCell-312 provides hardware accelerated cryptography.

**Development Tools:** Software development is performed through the nRF Connect SDK. The SDK includes Zephyr RTOS, protocol stacks, application samples and hardware drivers, and has free SEGGER Embedded Studio IDE support. Hardware development is supported by the nRF5340 PDK (preview development kit). All the SoC's features and GPIOs are made available to the developer and the PDK is supplied with an on-board SEGGER J-Link debugger.

### Processors:

The nRF5340's Arm application processor is optimized for performance and can run at either 128 or 64 MHz. The highest performance (510 CoreMark) is achieved at the faster clock rate, while running at 64 MHz offers greater efficiency (76 CoreMark/mA). This processor features 1MB Flash, 512 KB RAM, a floating point unit (FPU), an 8 KB 2-way associative cache and DSP instruction capabilities. The fully-programmable Arm network processor is clocked at 64 MHz and is optimized for low power consumption and efficiency (101 CoreMark/mA). It features 256 KB Flash and 64 KB RAM. The processor runs the RF protocol software while the device's programmability enables the developer to select which elements of the application software also take advantage of the processor's high efficiency.

### Application Processor

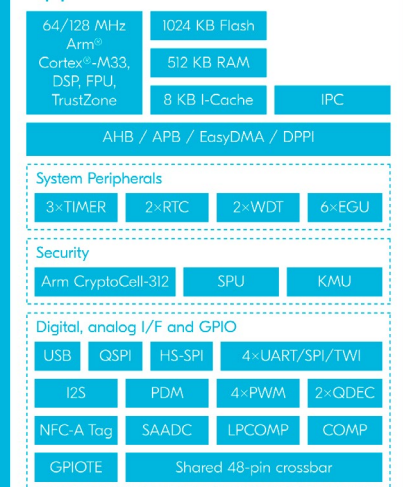

### Network Processor

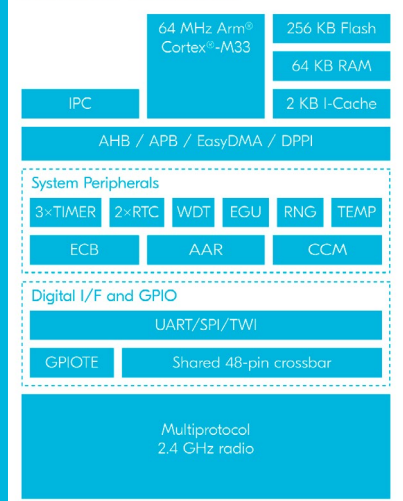

With dual Arm Cortex-M33 CPUs, the nRF5340 is ready for the most complex wireless applications