



XL- MaxSonar[®] - WR1[™] (MB7060) XL- MaxSonar[®] - WRA1[™] (MB7070) Weather Resistant (IP67) Sonar Range Finder with High Power Output, Noise Rejection, Auto Calibration & Long-Range Narrow Detection Zone

This sensor provides very short to long-range detection and ranging, in a compact, robust PVC housing, designed to meet IP67 water intrusion, and matches standard electrical 3/4" PCV pipe fittings. This sensor has a new high power output along with real-time auto calibration for changing conditions (temperature, voltage or acoustic or electrical noise) that ensure you receive the most reliable (in air) ranging data for every reading taken. The low power 3.3V – 5V operation detects objects from 0-cm to 765-cm (25.1 feet) and provides sonar range information from 25-cm out to 765-cm with 1-cm resolution. Objects from 0-cm to 25-cm range as 25-cm. The interface output formats included are pulse width output (MB7060), real-time analog voltage envelope (MB7070), analog voltage output, and serial digital output.

Features

- High acoustic power output
- Real-time auto calibration and noise rejection for every ranging cycle
- Precise narrow beam
- Continuously variable gain
- Object detection includes zero range objects
- 3.3V to 5V supply with very low average current draw
- Readings can occur up to every 100mS, (10-Hz rate)
- Free run operation can continually measure and output range information
- Triggered operation provides the range reading as desired
- All interfaces are active simultaneously
 - Serial, 0 to Vcc
 - 9600Baud, 81N
 - Analog, (Vcc/1024) / cm
 - Pulse Width (MB7060)
 - Real-time analog envelope (MB7070)
- Sensor operates at 42KHz

Benefits

- Acoustic and electrical noise resistance
- Reliable and stable range data
- Sensor dead zone virtually gone
- Low cost IP67 sensor
- Quality narrow beam characteristics
- Very low power ranger, excellent for multiple sensor or battery based systems
- Can be triggered externally or internally
- Sensor reports the range reading directly, frees up user processor
- Fast measurement cycle
- User can choose any of the sensor outputs
- No calibration requirement is perfect for when objects may be directly in front of the sensor during power up
- Easy hole mounting or mating with standard electrical fittings

Applications and Uses

- Tank level measurement
- Bin level measurement
- Proximity zone detection
- People detection
- Robot ranging sensor
- Autonomous navigation
- Environments with acoustic and electrical noise
- Multi-sensor arrays
- Distance measuring
- Long range object detection
- Wide beam sensitivity
- Users who prefer to process the analog voltage envelope (MB7070)
- Industrial sensor
- Physical drop-in upgrade for LV-MaxSonar-WR1 product, part numbers: MB7001

MB7060 & MB7070 Pin Out

- Pin 1** - Leave open (or high) for serial output on the Pin 5 output. When Pin 1 is held low, the Pin 5 output sends a pulse (instead of serial data), suitable for low noise chaining.
- Pin 2** - MB7060 (PW) This pin outputs a pulse width representation of range. To calculate distance, use the scale factor of 58uS per cm. MB7070 (AE) This pin outputs the analog voltage envelope of the acoustic wave form.
- Pin 3** - (AN) This pin outputs analog voltage with a scaling factor of (Vcc/1024) per cm. A supply of 5V yields ~4.9mV/cm., and 3.3V yields ~3.2mV/cm. Hardware limits the maximum reported range on this output to ~700 cm at 5V and ~600 cm at 3.3V. The output is buffered and corresponds to the most recent range data.
- Pin 4** - (RX) This pin is internally pulled high. The MB7060 & MB7070 will continually measure range and output if the pin is left unconnected or held high. If held low the MB7060 & MB7070 will stop ranging. Bring high 20uS or more for range reading.
- Pin 5** - (TX) When Pin 1 is open or held high, the Pin 5 output delivers asynchronous serial with an RS232 format, except voltages are 0-Vcc. The output is an ASCII capital "R", followed by three ASCII character digits representing the range in centimeters up to a maximum of 765, followed by a carriage return (ASCII 13). The baud rate is 9600, 8 bits, no parity, with one stop bit. Although the voltage of 0-Vcc is outside the RS232 standard, most RS232 devices have sufficient margin to read 0-Vcc serial data. If standard voltage level RS232 is desired, invert, and connect an RS232 converter such as a MAX232. When Pin 1 is held low, the Pin 5 output sends a single pulse, suitable for low noise chaining (no serial data).
- V+** Operates on 3.3V - 5V. The average (and peak) current draw for 3.3V operation is 2.1mA (50mA peak) and 5V operation is 3.4mA (100mA peak) respectively. Peak current is used during sonar pulse transmit.
- GND** Return for the DC power supply. GND (& V+) must be ripple and noise free for best operation.

MB7060 & MB7070 Circuit

The sensor functions using active components consisting of an LM324 and PIC16F690, together with a variety of other components. The schematic is shown to provide the user with detailed connection information.

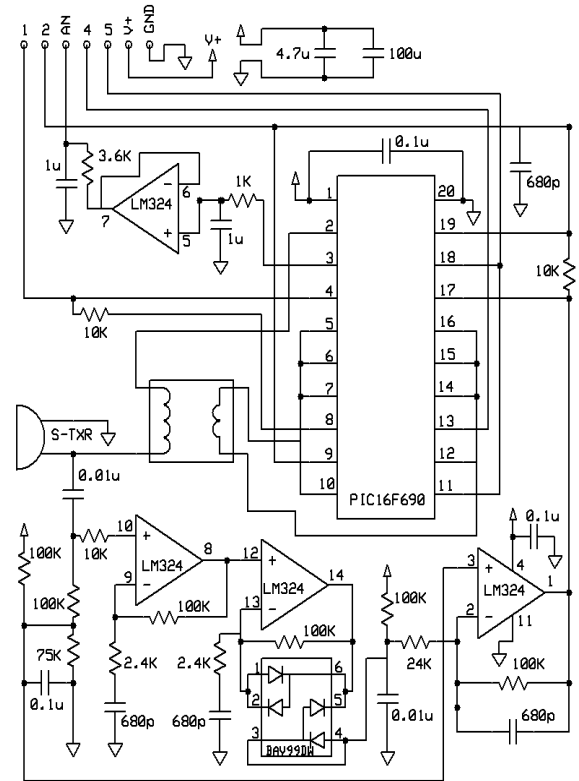

MB7060 & MB7070 Real-time Operation & Timing

175mS after power-up, the XL-MaxSonar® is ready to begin ranging. If Pin-4 is left open or held high (20uS or greater), the sensor will take a range reading. The XL-MaxSonar® checks the Pin-4 at the end of every cycle. Range data can be acquired once every 99mS. Each 99mS period starts by Pin-4 being high or open, after which the XL-MaxSonar® calibrates and calculates for 20.5mS, and after which, thirteen 42KHz waves are sent. Then for the MB7060, the pulse width (PW) Pin-2 is set high and when an object is detected the PW pin is pulled low, yet the PW pin can be held high for up to 44.4mS (i.e. 58uS * 765cm) if no target is detected. (The most accurate range data presented to the user is taken from the PW output of the MB7060 product.) For the MB7070 with analog envelop output, Pin-2 will show the real-time signal return information of the analog waveform. The remainder of the 99mS time (less 4.7mS) is spent adjusting the analog voltage to the correct level, (and allowing the high acoustic power to dissipate). During the last 4.7mS, the serial data is sent.

MB7060 & MB7070 Real-time Auto Calibration

Each time after the XL-MaxSonar® takes a range reading it calibrates itself. The sensor then uses this data to range objects. If the temperature, humidity, or applied voltage changes during sensor operation, the sensor will continue to function normally. The sensor does not apply compensation for the speed of sound change verses temperature to any range readings.

MB7060 & MB7070 Real-time Noise Rejection

While the XL-MaxSonar® is designed to operate in the presence of noise, best operation is obtained when noise strength is low and desired signal strength is high. Hence, the user is encouraged to mount the sensor in such a way that minimizes outside acoustic noise pickup. In addition, keep the DC power to the sensor free of noise. This will let the sensor deal with noise issues outside of the users direct control (in general, the sensor will still function well even if these things are ignored). Users are encouraged to test the sensor in their application to verify usability.

For every ranging cycle, individual filtering for that specific cycle is applied. In general, noise from regularly occurring periodic noise sources such as motors, fans, vibration, etc., will not falsely be detected as an object. This holds true even if the periodic noise increases or decreases (such as might occur in engine throttling or an increase/decrease of wind movement over the sensor). Even so, it is possible for sharp non-periodic noise sources to cause false target detection. In addition, *(because of dynamic range and signal to noise physics,) as the noise level increases, at first only small targets might be missed, but if noise increases to very high levels, it is likely that even large targets will be missed.

*HINT: In high noise environments, if needed, use 5V power to keep acoustic signal power high.

MB7060 & MB7070 Beam Characteristics

People detection requires high sensitivity, yet minimal side-lobes requires low sensitivity. The MB7060 and MB7070 balances the detection of people with minimal side-lobes. Sample results for measured beam patterns are shown below on a 30-inch grid. The detection pattern is shown for;

- (A) 0.25-inch diameter dowel,
- (B) 1-inch diameter dowel,
- (C) 3.25-inch diameter dowel,
- (D) 11-inch wide board moved left to right with the board parallel to the front sensor face and the sensor stationary.

This shows the sensor's range capability.

Note: The displayed beam width of (D) is a function of the specular nature of sonar and the shape of the board (i.e. flat mirror like) and should never be confused with actual sensor beam width.

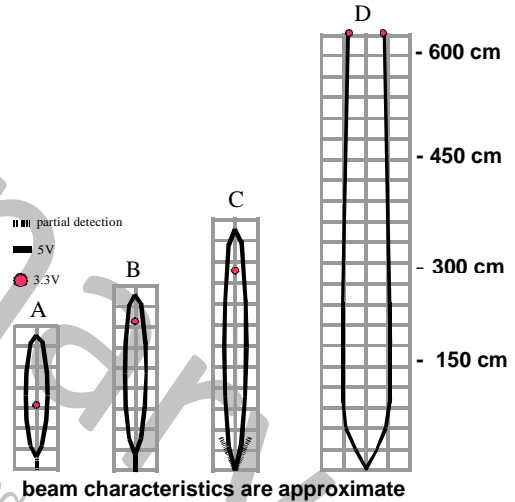

MB7060 & MB7070 Mechanical Dimensions

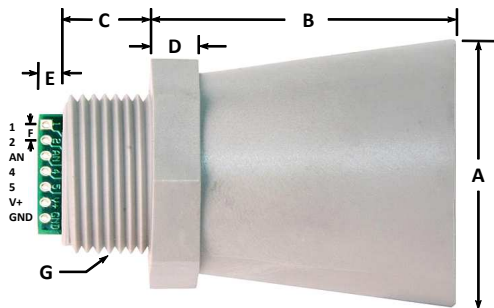

A	1.72" dia.	43.8 mm dia.
B	2.00"	50.7 mm
C	0.58"	14.4 mm
D	0.31"	7.9 mm
E	0.18"	4.6 mm
F	0.1"	2.54 mm
G	3/4" National Pipe Thread Straight	
H	1.032" dia.	26.2 mm dia.
I	1.37"	34.8 mm
weight, 1.76 oz., 50 grams		

values are nominal

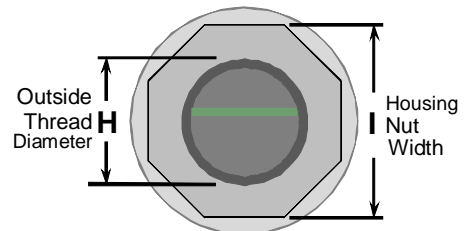

Typical Performance to Targets

Analog Envelope Output (Dowels, 5V)

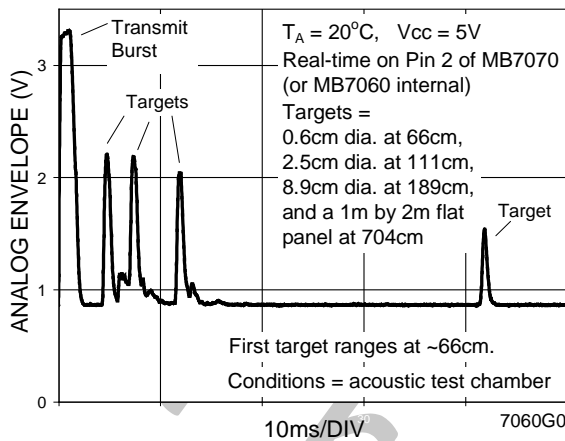

Analog Envelope Output (Dowels, 3.3V)

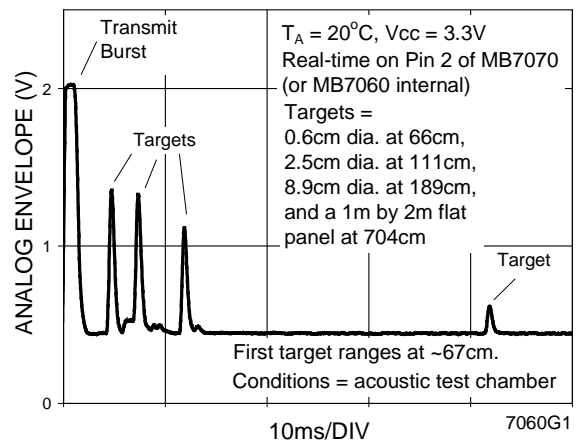

Typical Performance in Clutter

Analog Envelope Output (Clutter, 5V)

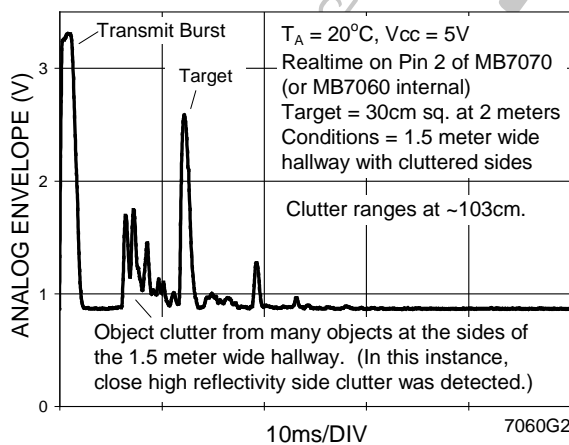

Analog Envelope Output (Clutter, 3.3V)

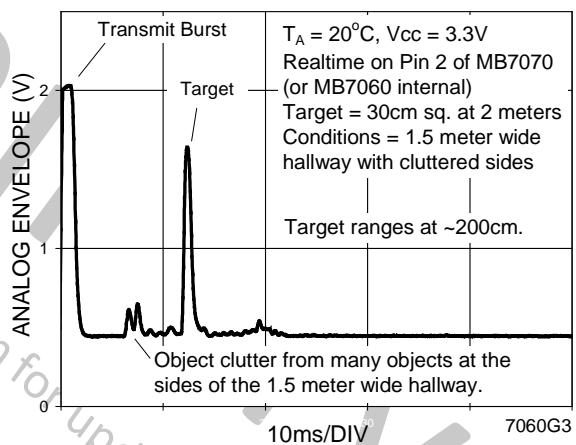

Typical Performance Over Temperature

This section will display graphs showing operation over temperature. Please check back at www.maxbotix.com for updated datasheets.

Typical Performance with Noise

This section will display graphs showing operation with noise present. Please check back at www.maxbotix.com for updated datasheets.

Product / specifications subject to change without notice. For more info visit www.maxbotix.com