

Pressure Management Control

Install, Setup, & Operation Manual

For VST Processors

Notice

Veeder-Root makes no warranty of any kind with regard to this publication, including, but not limited to, the implied warranties of merchantability and fitness for a particular purpose.

Veeder-Root shall not be liable for errors contained herein or for incidental or consequential damages in connection with the furnishing, performance, or use of this publication.

Veeder-Root reserves the right to change system options or features, or the information contained in this publication.

This publication contains proprietary information which is protected by copyright. All rights reserved. No part of this publication may be photocopied, modified or translated to another language without the prior written consent of Veeder-Root. Contact TLS Systems Technical Support for additional troubleshooting information at 800-323-1799.

DAMAGE CLAIMS / LOST EQUIPMENT

Thoroughly examine all components and units as soon as they are received. If any cartons are damaged or missing, write a complete and detailed description of the damage or shortage on the face of the freight bill. The carrier's agent must verify the inspection and sign the description. Refuse only the damaged product, not the entire shipment.

Veeder-Root must be notified of any damages and/or shortages within 30 days of receipt of the shipment, as stated in our Terms and Conditions.

VEEDER-ROOT'S PREFERRED CARRIER

1. Contact Veeder-Root Customer Service at 800-873-3313 with the specific part numbers and quantities that were missing or received damaged.
2. Fax signed Bill of Lading (BOL) to Veeder-Root Customer Service at 800-234-5350.
3. Veeder-Root will file the claim with the carrier and replace the damaged/missing product at no charge to the customer. Customer Service will work with production facility to have the replacement product shipped as soon as possible.

CUSTOMER'S PREFERRED CARRIER

1. It is the customer's responsibility to file a claim with their carrier.
2. Customer may submit a replacement purchase order. Customer is responsible for all charges and freight associated with replacement order. Customer Service will work with production facility to have the replacement product shipped as soon as possible.
3. If "lost" equipment is delivered at a later date and is not needed, Veeder-Root will allow a Return to Stock without a restocking fee.
4. Veeder-Root will NOT be responsible for any compensation when a customer chooses their own carrier.

RETURN SHIPPING

For the parts return procedure, please follow the appropriate instructions in the "General Returned Goods Policy" pages in the "Policies and Literature" section of the Veeder-Root **North American Environmental Products** price list. Veeder-Root will not accept any return product without a Return Goods Authorization (RGA) number clearly printed on the outside of the package.

FCC INFORMATION

This equipment complies with the requirements in Part 15 of the FCC rules for a Class A computing device. Operation of this equipment in a residential area may cause unacceptable interference to radio and TV reception requiring the operator to take whatever steps are necessary to correct the interference.

INSTALLATION IN THE STATE OF CALIFORNIA

Please refer to the California Air Resources Board Vapor Recover Certification Phase II EVR Executive Order web site (www.arb.ca.gov/vapor/eo-evrphasell.htm) for the latest manual revisions pertaining to VR 203 (VST Phase II EVR System).

©Veeder-Root 2012. All rights reserved.

Introduction

Site Requirements	1
Contractor Certification Requirements	1
Related Manuals	2
Safety Precautions	2

Installation

Installing TLS Console Modules - General Notes	3
Circuit Directory	4
Vapor Pressure Sensor	4
Smart Sensor Interface Module	4
NVMEM203 Board	5
Probe Interface Module	5
I/O Combination or 4-Relay Module	5
Multiport Card for Vapor Processor Communication	5
TLS Console with VST ECS Membrane Processor	5

Setup

Introduction	7
Smart Sensor Setup	7
Output Relay Setup - VST ECS Membrane Processor & VST Green Machine	8
PMC Setup	9

Operation

Alarms	10
Overview of TLS console Interface.....	10
Warning Posting	11
Alarm Posting	11
PMC Alarm Summary	12
PMC Status Report	13
Viewing PMC Reports Via RS-232 Connection	13
Connecting Laptop to Console	13
Connecting Laptop to Console	14
Sending Console Commands.....	17

Diagnostics

Automatic Control	22
Manual control	22
PMC Diagnostic Menu	22

Figures

Figure 1.	TLS console Interface Module Bays.....	3
Figure 2.	VST ECS Membrane Processor or VST Green Machine Connections to TLS Console.....	6
Figure 3.	Smart Sensor Setup.....	7
Figure 4.	Output Relay Setup for VST ECS Membrane Processor.....	8
Figure 5.	Output Relay Setup Printout Examples for TLS Console Controlled Processor.....	8
Figure 6.	PMC Setup.....	9
Figure 7.	TLS console alarm interface.....	10
Figure 8.	TLS console warning example.....	11
Figure 9.	TLS console alarm example.....	11
Figure 10.	PMC Status Report.....	13
Figure 11.	Connecting laptop to TLS console for serial communication.....	14
Figure 12.	Connection Description window.....	15
Figure 13.	Connect To window.....	15
Figure 14.	Console comm port settings printout example.....	16
Figure 15.	HyperTerminal main window.....	17
Figure 16.	Vapor Processor Status Report Details - Serial to PC Format.....	18
Figure 17.	Vapor Processor Runtime Diagnostic Report - Serial to PC Format.....	19
Figure 18.	Percent Hydrocarbon Diagnostic Report - Serial to PC Format.....	20
Figure 19.	Priority Alarm History Report - Serial to PC Format.....	20
Figure 20.	Non-Priority Alarm History Report - Serial to PC Format.....	21
Figure 21.	PMC Diagnostic Menus.....	22

Tables

Table 1.	Related Manuals.....	2
Table 2.	TLS-350 (PMC) Alarm Troubleshooting Summary.....	12
Table 3.	Serial Commands for PMC Diagnostic Reports.....	18

Introduction

This manual provides instructions to install, setup, and operate the components of Veeder-Root Pressure Management Control (PMC) equipment. The PMC feature is an option for the TLS console platform, and as such, many of the installation/setup/operation instructions for non-PMC specific tasks are covered in TLS-3XX supplied literature. Do not use this manual when PMC is installed with ISD. Use the ISD Setup & Operation Manual, 577021-800.

Site Requirements

Below are the requirements for all PMC installations:

- V-R TLS-350R/EMC w/BIR, TLS-350 Plus/EMC Enhanced, TLS-350/EMC and ProMax consoles with ECPU2 - install as per TLS-3XX Site Prep manual, setup following instructions in TLS-3XX System Setup Manual.
- A flash memory board (NVMEM203) for PMC software storage - installed on the ECPU2 board in place of the console's 1/2 Meg RAM board - install as per TLS-350 Series Board and Software Replacement Manual, no setup required.
- Smart Sensor Module and Vapor Pressure Sensor. Install and connect following instructions in the Vapor Pressure Sensor installation Guide.
- Multiport card connected to a hydrocarbon sensor module installed according to processor manufacturers specifications.
- A 4-Relay or I/O Combination Module to control the vapor processor motor and setup as instructed in this manual.
- An RS-232 Port will be available for use by contractor or government inspectors.

Contractor Certification Requirements

Veeder-Root requires the following minimum training certifications for contractors who will install and setup the equipment discussed in this manual:

Installer (Level 1) Certification: Contractors holding valid Installer Certification are approved to perform wiring and conduit routing; equipment mounting; probe, sensor and carbon canister vapor polisher installation; wireless equipment installation; tank and line preparation; and line leak detector installation.

ATG Technician (Level 2/3 or 4) Certification: Contractors holding valid ATG Technician Certifications are approved to perform installation checkout, startup, programming and operations training, system tests, troubleshooting and servicing for all Veeder-Root Series Tank Monitoring Systems, including Line Leak Detection. In addition, Contractors with the following sub-certification designations are approved to perform installation checkout, startup, programming, system tests, troubleshooting, service techniques and operations training on the designated system.

- Wireless 2
- Tall Tank

VR Vapor Products Certification: Contractors holding a certification with the following designations are approved to perform installation checkout, startup, programming, system tests, troubleshooting, service techniques and operations training on the designated system.

- ISD – In Station Diagnostics
- PMC – Pressure Management Control
- CCVP - Veeder-Root Vapor Polisher
- Wireless – ISD/PMC Wireless
- A current Veeder-Root Technician Certification is a prerequisite for the VR Vapor Products course.

Warranty Registrations may only be submitted by selected Distributors.

Related Manuals





The manuals in Table 1 below are shipped with the equipment on the V-R Tech Docs CD-ROM and will be needed to install specific equipment.

Table 1. Related Manuals



V-R Manual	Part Number
TLS-3XX Site Prep Manual	576013-879
Vapor Pressure Sensor For Vent Stacks Installation Guide (For Sensor P/N 861190-X0X)	577014-019
Pressure Sensor Installation Guide (For Sensor P/N 331946-001)	577013-797
TLS-3XX Series Consoles System Setup Manual	576013-623
TLS-3XX Series Consoles Operator's Manual	576013-610
Serial Comm Modules Installation Guide	577013-528
TLS-350 Series Board and Software Replacement Manual	576013-637

Safety Precautions

The following symbols may be used throughout this manual to alert you to important safety hazards.

 <p>ELECTRICITY High voltage exists in, and is supplied to, the device. A potential shock hazard exists.</p>	 <p>TURN POWER OFF Live power to a device creates a potential shock hazard. Turn Off power to the device and associated accessories when servicing the unit.</p>
 <p>READ ALL RELATED MANUALS Knowledge of all related procedures before you begin work is important. Read and understand all manuals thoroughly. If you do not understand a procedure, ask someone who does.</p>	 <p>WARNING Heed the adjacent instructions to avoid equipment damage or personal injury.</p>

⚠ WARNING

 	<p>The console contains high voltages which can be lethal. It is also connected to low power devices that must be kept intrinsically safe.</p> <p>Turn power Off at the circuit breaker. Do not connect the console AC power supply until all devices are installed.</p> <p>FAILURE TO COMPLY WITH THE FOLLOWING WARNINGS AND SAFETY PRECAUTIONS COULD CAUSE DAMAGE TO PROPERTY, ENVIRONMENT, RESULTING IN SERIOUS INJURY OR DEATH.</p>
---	--

Installation

This section discusses the installation and wiring of the hardware required to enable the TLS console to perform pressure management of the site's gasoline vapor processor equipment:

- Vapor Pressure Sensor
- Smart Sensor Interface Module
- NVMEM203 board
- Multiport Card
- 4-Relay or I/O Combination Module



All field wiring, its type, its length, etc., used for TLS console sensors must conform to the requirements outlined in the Veeder-Root TLS-3XX Site Prep manual (P/N 576013-879) and to additional field wiring requirements specified in related connected components, such as for Pressure Sensors.

Installing TLS Console Modules - General Notes

TLS consoles have three bays in which interface modules can be installed; Comm bay, Power bay and Intrinsically-Safe bay (ref. Figure 1). Probe Interface modules and Smart Sensor modules are installed in the Intrinsically-Safe bay and the Mod Bus module is installed in the Comm bay.

In all cases, the position of the modules, their respective connectors and the devices wired to the connectors must be recorded to prevent improper replacement during installation or service. A circuit directory for Power and I.S. bay Interface Modules is adhered to the back of the right-hand door for this purpose.



Switch off power to the TLS console before you install modules and connect sensor wiring.

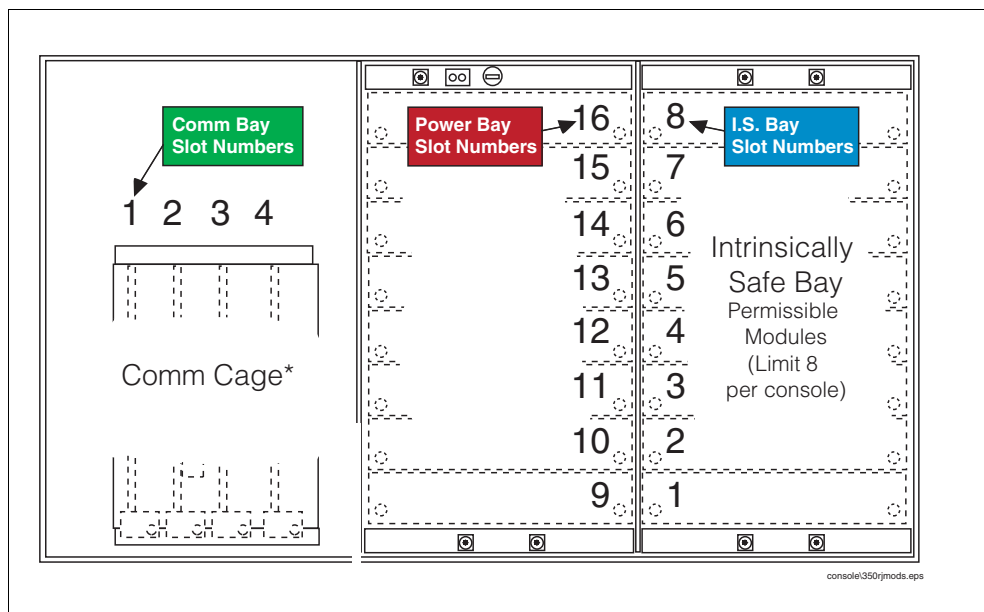

Figure 1. TLS console Interface Module Bays



CAUTION! During programming, module positions and the devices wired to each module are identified and stored in memory. If a connector is removed and reinstalled on a different module after programming, or if an entire module with its connector is removed and reinstalled in a different module slot, the TLS console will not identify correctly the data being received.

Module Position

1. Record on the circuit directory the type of module in each slot location.
2. If a system contains multiple modules of a single type (i.e., two Smart Sensor Modules), they may be swapped between their respective slot locations, **however, the connectors must remain with their original locations, not with the original modules.**

Connector Position

1. Identify all connectors according to their slot location using the self-adhesive numbering labels furnished with each module. Accurately record on the circuit directory the location of each device wired to the connector **as you attach wires** to the module.
2. Once a device has been wired to certain terminals on a connector and the system has been programmed, the wires from that device may not be relocated to other terminals without reprogramming the system.

Grounding Probe and Sensor Shields

Connect probe and sensor cable shields to ground at the console only. Do not ground both ends of the shield.

CIRCUIT DIRECTORY

A circuit directory is adhered to the inside of the right-hand door. It should be filled out by the installer as the module's connectors are being wired.

The following information should be recorded for each slot:

- Module Type: record what type of module has been installed in the slot, e.g., Smart Sensor Module.
- Position Record: record the physical location and/or type of device wired to each terminal of the module connector in the slot, e.g., VPS: FP1&2.

Vapor Pressure Sensor

Install one vapor pressure sensor as detailed in the applicable Pressure Sensor Installation Guide shown in Table 1.

Smart Sensor Interface Module

The Smart Sensor Interface Module 8 input or 7 input w/embedded pressure versions monitor the Vapor Pressure Sensor (VPS) inputs.



Switch off power to the TLS console while you install modules and connect sensor wiring.

Open the right door of the console and slide the necessary Smart Sensor modules into empty I.S. Bay slots. Connect the field wiring from the sensor following instructions in the Vapor Pressure Sensor manual. Setup the Smart Sensor module(s) following instructions in this manual.

NVMEM203 Board

Verify that a NVMEM203 board is installed in the TLS console (ref. Figure 2-7 in the V-R TLS-3XX Series Consoles Troubleshooting Manual P/N 576013-818, Rev Q or later). This board contains flash EEPROM and RAM needed to run PMC software. No setup is required.

Probe Interface Module

Verify that a Probe Interface Module(s) is installed (Intrinsically-Safe bay) and that a Mag probe is in each gasoline tank and is connected to the module(s). Program the Mag probes following instructions in the TLS-3XX System Setup manual.

I/O Combination or 4-Relay Module

Connect the vapor processor motor control relay to two relays on either the 4-Relay or I/O Combination module as shown in Figure 2.

Multiport Card for Vapor Processor Communication



A Multiport card is needed for RS-485 communication with the TLS console and is required with VST ECS membrane processor installations. Verify that a Multiport card is installed in slot 4 of the card cage in the communications bay of the TLS console (ref. Figure 2). When installing this card, refer to the V-R Serial Comm Modules Installation Guide (577013-528) for instructions. Connect this card to the vapor processor as shown in Figure 2. Program the card as instructed in this manual.

TLS Console with VST ECS Membrane Processor

Figure 2 shows the interconnection wiring between a TLS console and a VST ECS Membrane Processor.

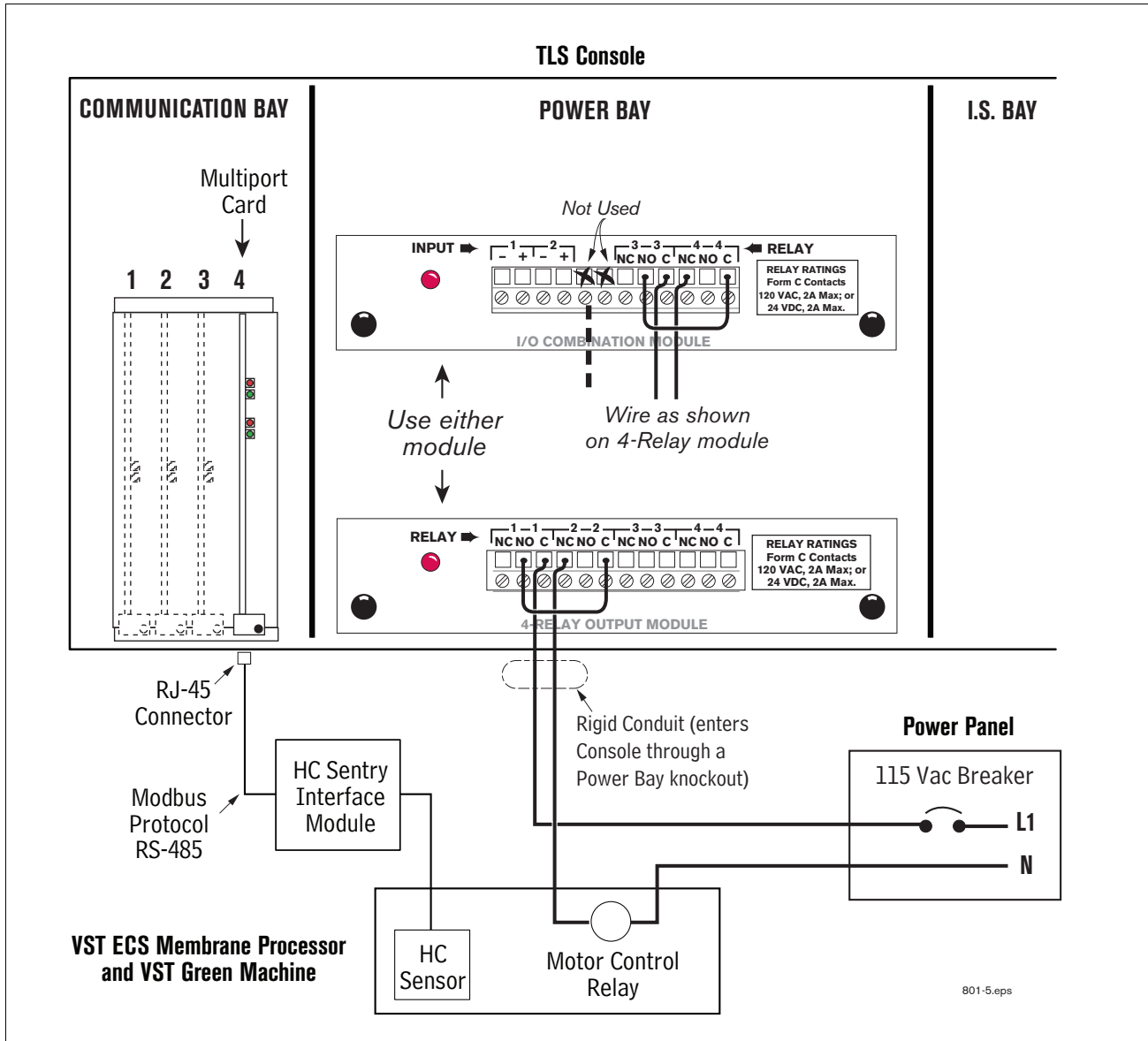

Figure 2. VST ECS Membrane Processor or VST Green Machine Connections to TLS Console

Setup

Introduction

This section describes how to perform PMC setup using the TLS console's front panel buttons and display. The procedures in this manual follow standard TLS console setup programming input, i.e., keypad/display interaction. If necessary, refer to Section 2 of the TLS-3XX System Setup manual (P/N 576013-623) to review entering data via the front panel keypads.

All PMC-related equipment must be installed in the site and connected to the TLS console prior to beginning the setups covered in this section. As with all TLS connections, you cannot change sensor wiring or module slots after programming or the console may not operate properly. Reference the section entitled "Connecting Probe/Sensor Wiring to Consoles" in the TLS-3XX Site Prep and Installation manual (P/N 576013-879) for rewiring precautions.

Smart Sensor Setup

The Smart Sensor Interface Module is installed in the Intrinsically-Safe bay of the TLS console. This module monitors the Vapor Pressure Sensor. Figure 3 diagrams the Smart Sensor setup procedure.

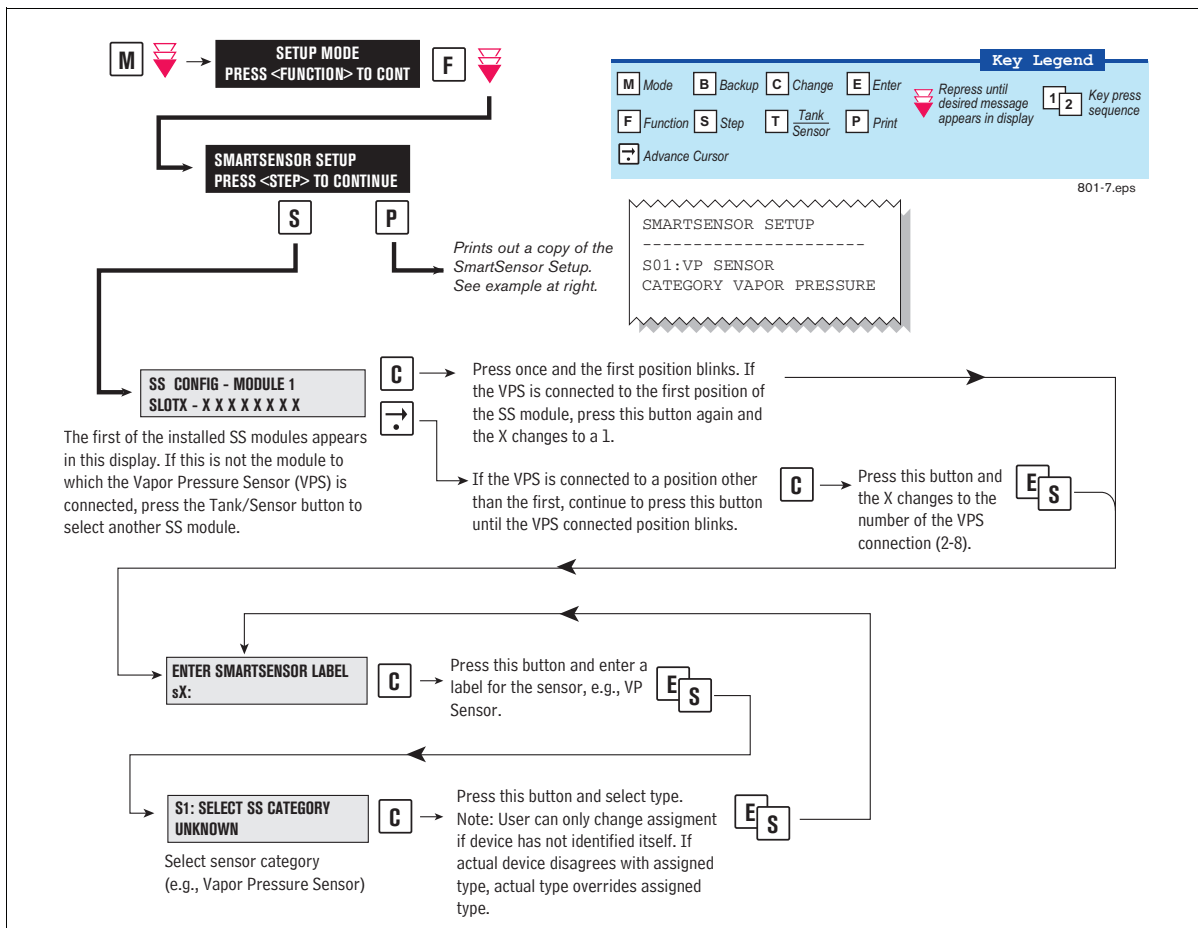

Figure 3. Smart Sensor Setup

Output Relay Setup - VST ECS Membrane Processor & VST Green Machine

The Output Relay setup programs an output relay so that the TLS console can switch a controlled vapor processor on and off as shown in Figure 4.

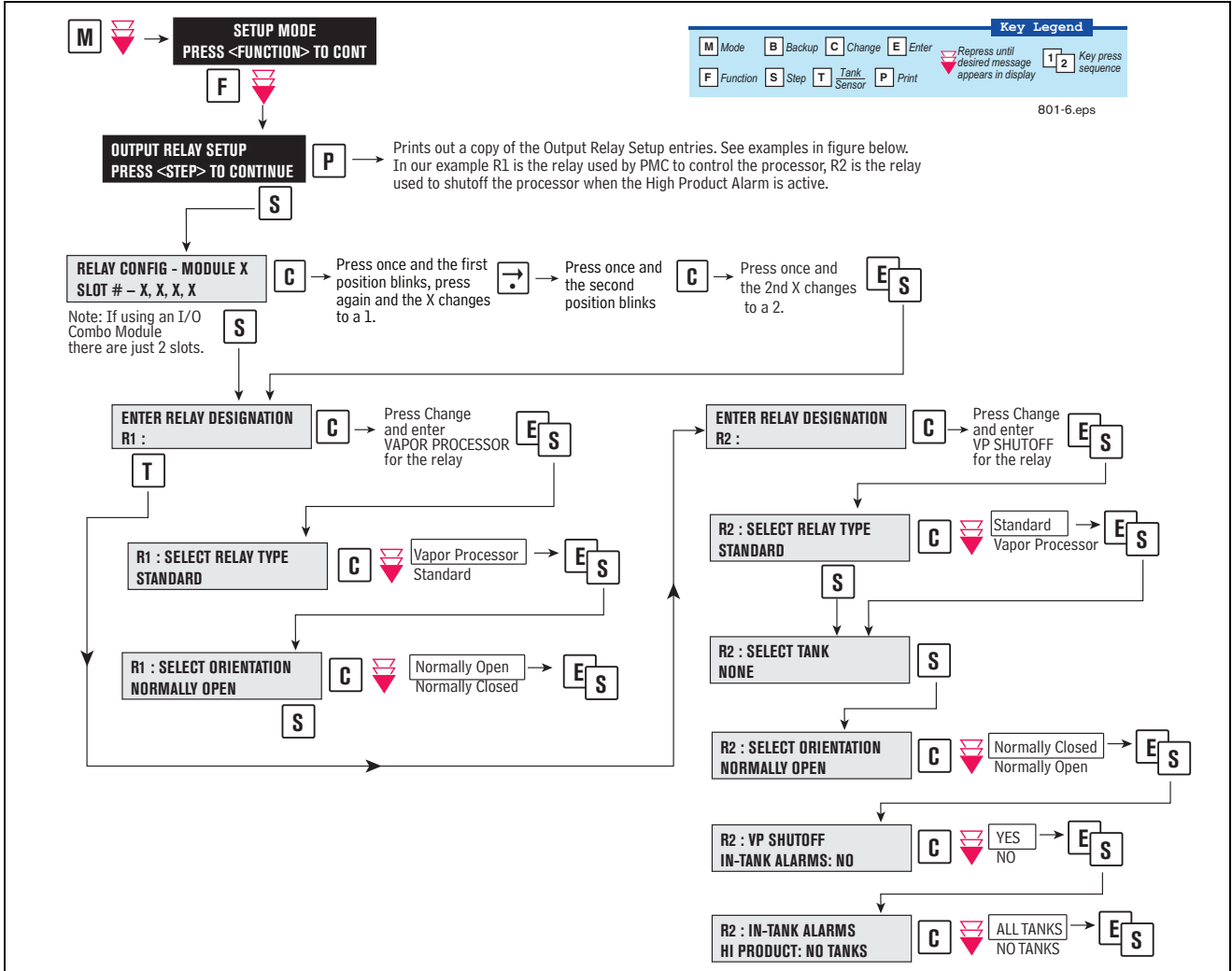

Figure 4. Output Relay Setup for VST ECS Membrane Processor

Figure 5 shows example setup printouts of the Output Relays setup.

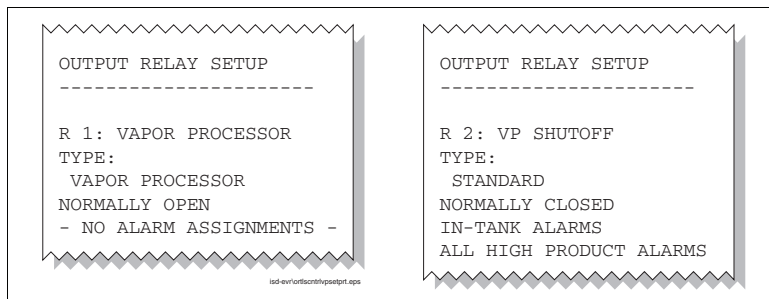

Figure 5. Output Relay Setup Printout Examples for TLS Console Controlled Processor

PMC Setup

Figure 6 diagrams the PMC setup programming.

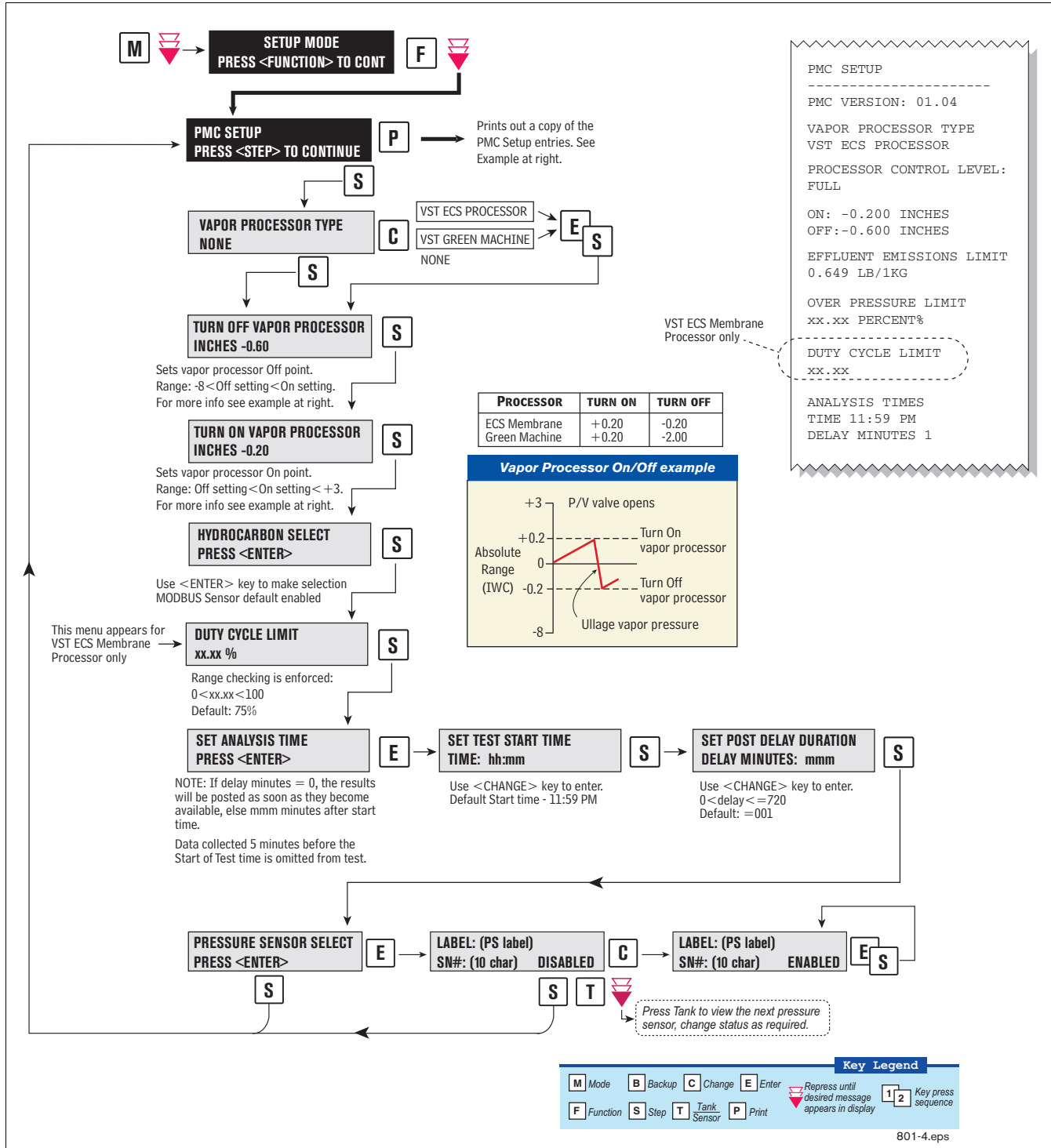

Figure 6. PMC Setup

Operation

Alarms

OVERVIEW OF TLS CONSOLE INTERFACE

The TLS console is continuously monitoring the vapor recovery system and PMC sensors for alarm conditions. During normal operation when the TLS console and monitored PMC equipment is functioning properly and no alarm conditions exist, the "ALL FUNCTIONS NORMAL" message will appear in the system status (bottom) line of the console display, and the green Power light will be On (see Figure 7).

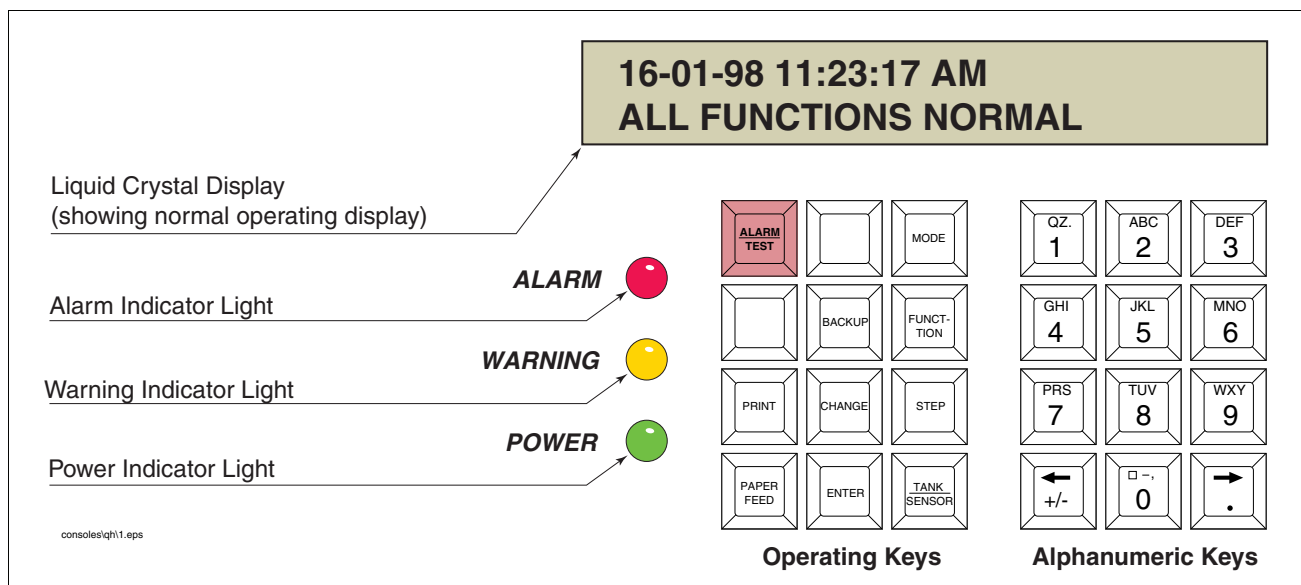

Figure 7. TLS console alarm interface

If an alarm condition occurs the system displays the condition type and its location. If more than one condition exists, the display will continuously cycle through the appropriate alarm messages. The system automatically prints an alarm report showing the alarm type, its location and the date and time the alarm condition occurred.

Warning and alarm posting causes the TLS console-based system to activate warning or failure indicator lights, an audible alarm, and an automatic strip paper printout documenting the warning or alarm.

WARNING POSTING

Displayed messages alert you to the type of warning. Printed messages show the type of warning and the time the warning was posted (see Figure 8). Warnings are logged into the Non-Priority Alarm History in the TLS.

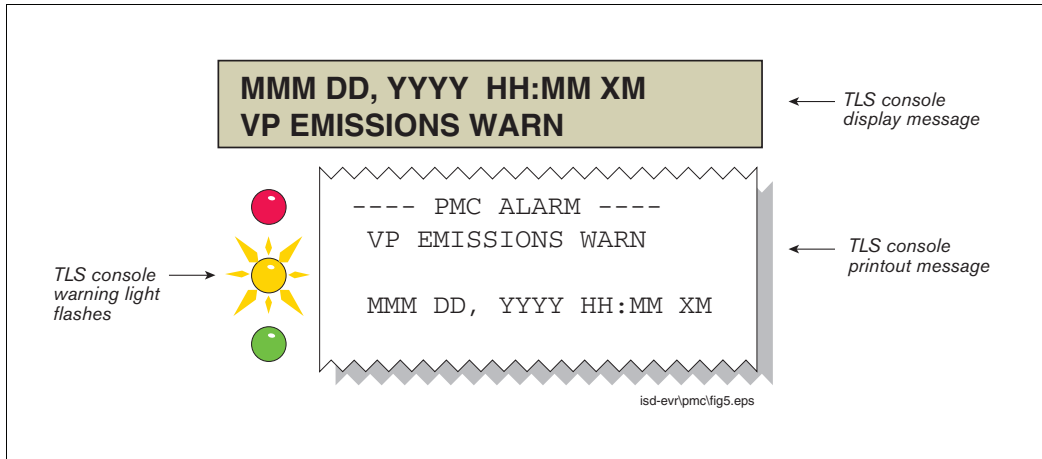

Figure 8. TLS console warning example

ALARM POSTING

Displayed Messages alert you to the type of alarm. Printed messages show the type of alarm and the time the alarm was posted. Alarm example in Figure 9. PMC Alarms are logged into the Priority Alarm History in the TLS.

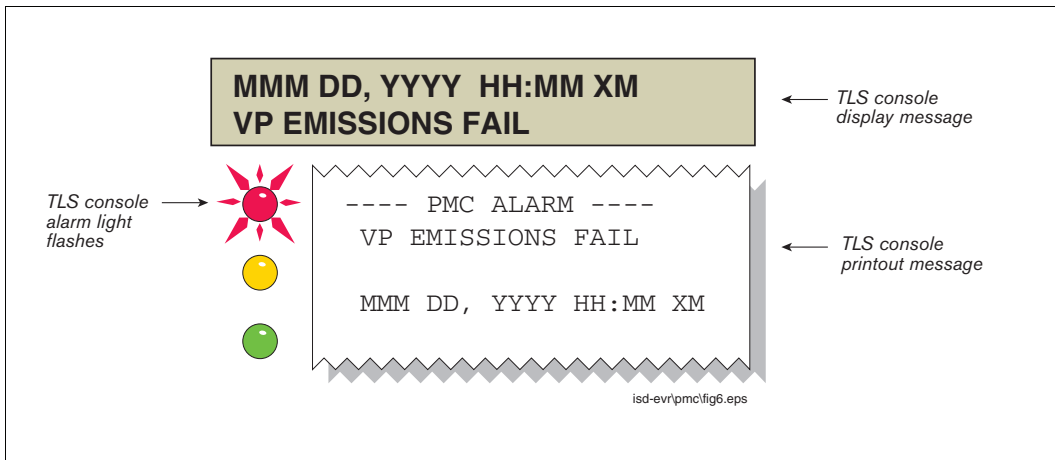

Figure 9. TLS console alarm example

PMC Alarm Summary

Table 2 contains a listing of the PMC generated alarms including their displayed message and cause. TLS Console PMC alarms may be interspersed amongst non-PMC alarms, please see TLS-350 Series manuals for more information.

Table 2. TLS-350 (PMC) Alarm Troubleshooting Summary

Displayed Message	Description	Light Indicator	Suggested Troubleshooting
VP EMISSION WARN	Mass emission exceeded the certified daily threshold	Yellow	<ul style="list-style-type: none"> • Troubleshooting Guide www.vsthose.com.
VP EMISSION FAIL	2nd Consecutive mass emission failure	Red	<ul style="list-style-type: none"> • Exhibit 8 • Exhibit 9
PMC SETUP FAIL	PMC is not configured or missing components.	Red	<ul style="list-style-type: none"> • Troubleshooting Guide www.vsthose.com • See ISD Troubleshooting Guide, P/N 577013-819 • Exhibit 8 • Exhibit 9
VP DUTY CYCLE WARN ¹	Duty cycle exceeds 18 hours per day Or 75% of 24 hours	Yellow	<ul style="list-style-type: none"> • Troubleshooting Guide www.vsthose.com.
VP DUTY CYCLE FAIL ¹	2nd Consecutive Duty Cycle Failure	Red	<ul style="list-style-type: none"> • TLS-350 PMC Setup Procedure • Exhibit 4 • Exhibit 9 • Exhibit 10
PMC SENSOR FAULT	Component used by PMC has failed or reported an error condition. See Troubleshooting section for complete description of sensors and associated conditions that can cause a sensor fault.	Red	Check for Smart Sensor Device Alarm or Fault.

¹VST ECS Membrane Processor Only

PMC Status Report

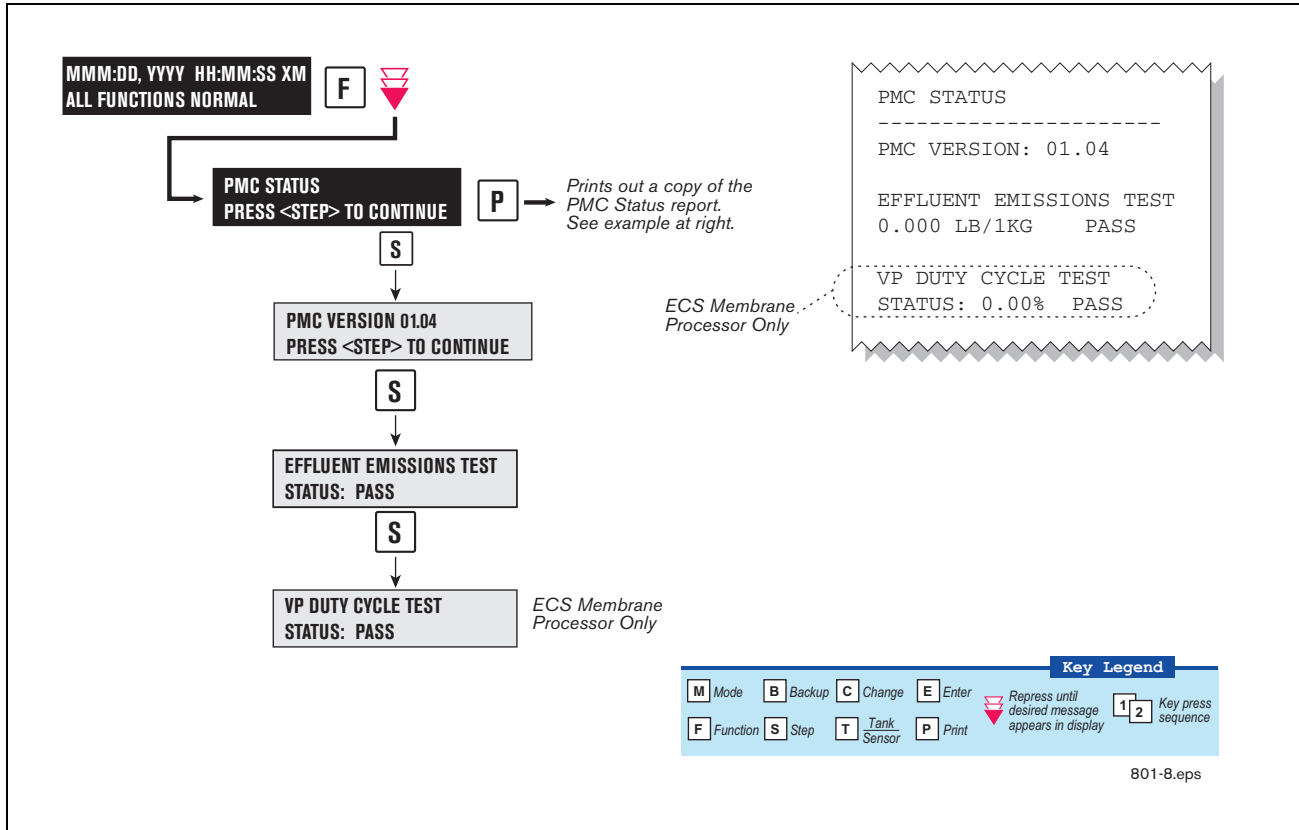

Figure 10. PMC Status Report

Viewing PMC Reports Via RS-232 Connection

CONNECTING LAPTOP TO CONSOLE

Connect your laptop to the TLS console's RS-232 or Multiport card using one of the methods shown in the examples in Figure 11 below.

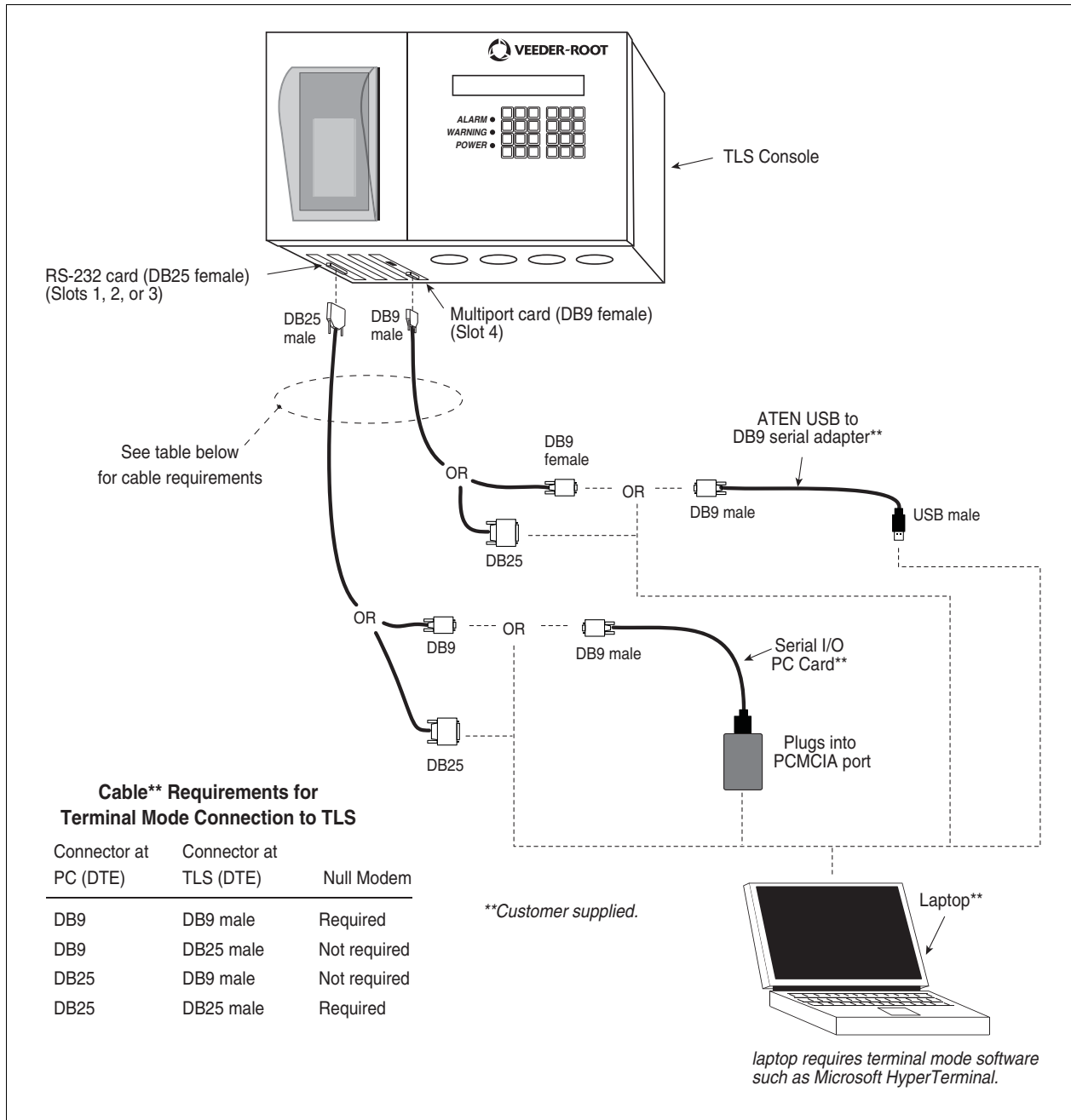

Figure 11. Connecting laptop to TLS console for serial communication

CONNECTING LAPTOP TO CONSOLE

1. Open your laptop's serial communication program, e.g., HyperTerminal. You can typically find HyperTerminal under: Start/Programs/Accessories/Communications.

2. After opening the terminal software program, ignore (cancel) any modem/dialing related request windows since you will be directly connecting to the console via serial communications. When the Connection Description window appears (Figure 12), enter a connection name, e.g., TLSDIRECT, and click the OK button.

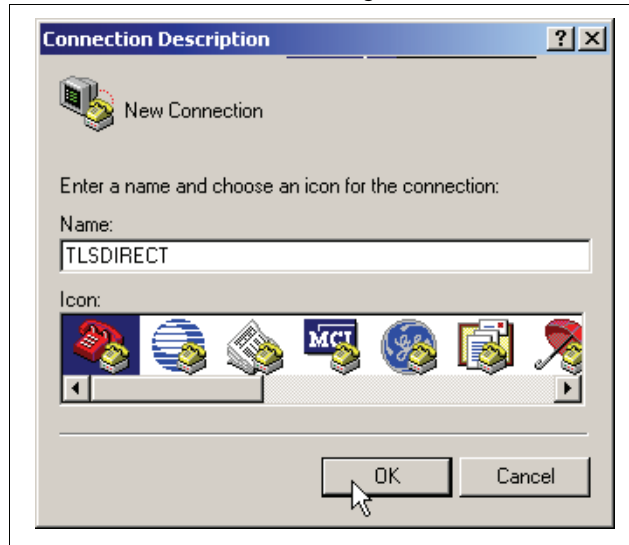

Figure 12. Connection Description window

3. After clicking the OK button, you may see a repeat of the modem/dialing windows, in which case ignore (cancel) them all.
4. When the Connect To window appears (Figure 13), depending on your connection method, select either COM1 (If RS-232 port on laptop), USB-Serial Controller (if using USB port on laptop), or Serial I/O PC Card (if using PCMCIA port on laptop) in the 'Connect using' drop down box, then click OK button.



Figure 13. Connect To window

5. Next you should see the 'Port Settings' window.



IMPORTANT! The settings of the laptop's com port must match those of the console's com port to which you are connected.

- a. Go to the console front panel press the MODE key until you see:

```
SETUP MODE
PRESS <FUNCTION> TO CONT
```

- b. Press the FUNCTION key until you see the message:

```
COMMUNICATIONS SETUP
PRESS <STEP> TO CONTINUE
```

- c. Press the STEP key until you see the message:

```
PORT SETTINGS
PRESS <ENTER>
```

- d. Press the PRINT key to printout the port settings for all communication modules installed in the console. Figure 14 shows an example port settings printout with the RS-232 module installed. Using the console port settings in the example below, your HyperTerminal 'Port Settings' window entries would be Bits per second - 2400, Data bits - 7, Parity - Odd, Stop Bits - 1. For the 'Flow Control' entry select None. Click OK.

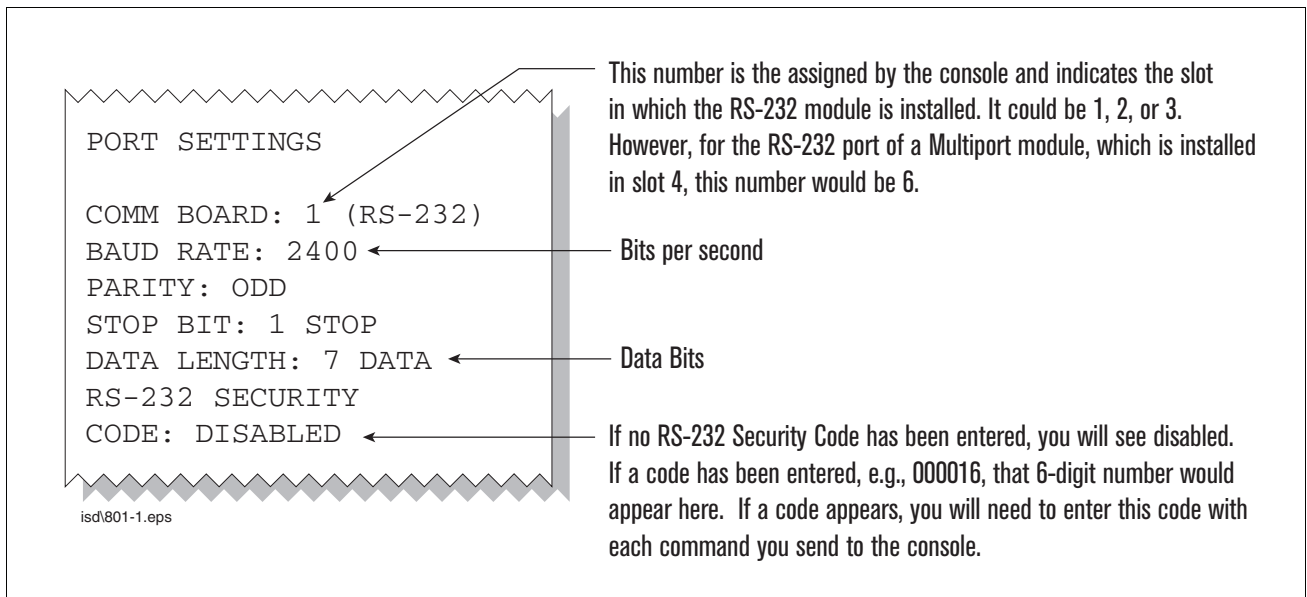

Figure 14. Console comm port settings printout example

In the example port settings printout above, the RS-232 Security Code is disabled. If the code was enabled you would see a 6-digit number which you will need to enter to access the console (refer to the 'Sending Console Commands' paragraph below for more information).

6. After entering your port settings, the program's main window appears (Figure 15).

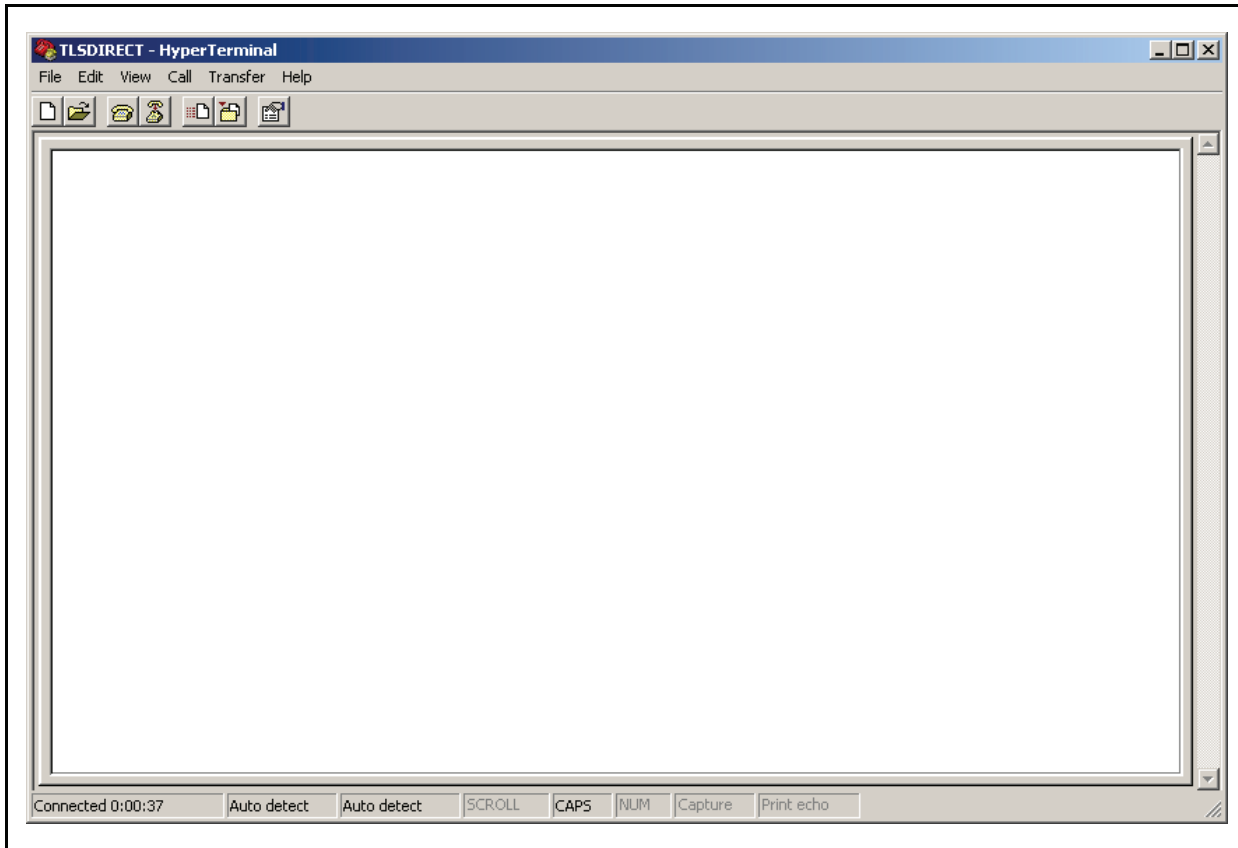

Figure 15. HyperTerminal main window

SENDING CONSOLE COMMANDS

Table 3 shows four important PMC console commands: IV8200, IV8000, IV8100 and I11100. The <SOH> shown in the table means that you must press and hold the **Ctrl** key while you press the **A** key.

For example, let's say you want to see the Vapor Processor Status Report.



Note: If you want to see the characters of the command as you type them in, click on File menu, then select Properties/Settings (tab)/ASCII Setup and click the check box for 'Echo typed characters locally', then click OK to close the window(s) and return to the main screen.

If the RS-232 Security Code is disabled - press and hold the Ctrl key while you press the A key, then type in IV8200. If the RS-232 Security Code is enabled (e.g., 000016) you must enter the security code before the command - press and hold the Ctrl key while you press the A key, then type in 000016IV8200.

You will see the typed command on the screen: ☺IV8200 followed by the response (report) from the console. The ☺ symbol indicates CtrlA and the ♥ symbol indicates the end of the response.

If the console recognizes the command the response displays as soon as the command is typed in.

If the console does not recognize the command you would see something like ☺IV8200☺9999FF1B♥ which indicates the console did not recognize the command.

All responses (Reports) can be printed or saved to a file. See the terminal program's help file for instructions.

Table 3. Serial Commands for PMC Diagnostic Reports

Report Type	Serial Command (PC to Console)*
Vapor Processor Status Report (See example Figure 16)	<SOH>IV8200
Vapor Processor Runtime Diagnostic Report (See example Figure 17)	<SOH>IV8000
Percent Hydrocarbon Diagnostic Report (See example Figure 18)	<SOH>IV8100
Priority Alarm History Report (See example Figure 19)	<SOH>I11100
Non-Priority Alarm History Report (See example Figure 20)	<SOH>I11200

*<SOH> = Control A. For more information on TLS console serial commands, refer to the V-R Serial Interface Manual.

```

<SOH>
  IV8200
  JUN 1, 2002 8:07 AM

  (SITE NAME)
  (SITE STREET)
  (CITY, STATE)
  (PHONE NUMBER)

  VAPOR PROCESSOR STATUS REPORT

  PMC VERSION: 01.04
  VAPOR PROCESSOR TYPE: VST ECS PROCESSOR

  PMC MONITORING TEST PASS/FAIL THRESHOLDS

  H2O                                PERIOD    BELOW    ABOVE
  VST ECS Membrane VAPOR PROCESSOR MASS EMISSION FAIL      1DAYS    ----    0.32 LBS/1KG
  Processor Only → VAPOR PROCESSOR DUTY CYCLE FAIL          1DAYS    ----    75.00 %

  VST ECS Membrane EFFLUENT EMISSIONS TEST : PASS      (0.15 LBS/1KG)
  Processor Only → VP DUTY CYCLE TEST           : PASS      (17.54%)
  VP INPUT STATUS   : NOTEST

  RUN TIME HOURS   : 4.2
  DAILY THROUGHPUT : 8421 GALS
  AVG HC PERCENT   : 8.85 %
  
```

Figure 16. Vapor Processor Status Report Details - Serial to PC Format

IV8000
AUG 30, 2007 11:52 AM

(SITE NAME)
(SITE STREET)
(CITY, STATE)
(PHONE NUMBER)

VAPOR PROCESSOR

DATE-TIME	ON	ELAPSED MINUTES	PRESSURE ON	INCHES H2O OFF	RUNTIME FAULT
3-08-07	8:52PM	5.53	0.209	-0.211	NO
3-08-07	8:58PM	0.98	0.303	-0.203	NO
3-09-07	5:03AM	26.60	0.221	-0.205	NO
3-09-07	1:15PM	17.92	0.278	-0.268	NO
3-10-07	3:01AM	7.70	0.200	-0.223	NO
3-10-07	4:30AM	4.02	0.202	-0.224	NO
3-10-07	7:54PM	23.62	0.306	-0.245	NO
3-11-07	11:24PM	6.55	0.256	-0.213	NO
3-12-07	11:31PM	21.23	0.228	-0.203	NO
3-13-07	3:44PM	23.95	0.926	-0.230	NO
3-15-07	1:35AM	30.00	0.202	0.154	YES
3-15-07	2:36AM	6.87	0.200	-0.205	NO
3-15-07	3:24AM	30.00	0.201	0.442	YES
3-16-07	3:10AM	4.33	0.202	-0.205	NO
3-16-07	1:28PM	20.78	0.234	-0.264	NO
3-16-07	2:38PM	1.30	0.220	-0.219	NO
3-17-07	12:44AM	6.52	0.206	-0.200	NO
3-17-07	2:00PM	27.47	0.254	-.210	NO

Figure 17. Vapor Processor Runtime Diagnostic Report - Serial to PC Format

```

IV800
SEP 21, 2010 8:52 AM
HYDROCARBON SENSOR DIAGNOSTIC
DATE/TIME      READING%
9-25-10 8:57 AM 1.174
9-25-10 8:57 AM 1.188
9-25-10 8:57 AM 1.168
9-25-10 8:57 AM 1.182
9-25-10 8:57 AM 1.182
9-25-10 8:57 AM 1.182
9-25-10 8:57 AM 1.174
9-25-10 8:57 AM 1.188
9-25-10 8:57 AM 1.182
9-25-10 8:57 AM 1.194
9-25-10 8:57 AM 1.188
9-25-10 8:57 AM 1.200
9-25-10 8:56 AM 1.188
    
```

Figure 18. Percent Hydrocarbon Diagnostic Report - Serial to PC Format

```

I11100
APR 17, 2008 12:30 AM

<Site Name>
<Site Address>
<Site Address>
<Site Address>

PRIORITY ALARM HISTORY
ID  CATEGORY  DESCRIPTION          ALARM TYPE          STATE   DATE      TIME
T 2  TANK      Premium 91          PROBE OUT           CLEAR   4-04-08  12:14PM
T 2  TANK      Premium 91          PROBE OUT           ALARM   4-04-08  12:14PM
T 2  TANK      Premium 91          LOW PRODUCT ALARM   CLEAR   4-04-08  12:04PM
T 2  TANK      Premium 91          PROBE OUT           CLEAR   4-04-08  12:04PM
T 1  TANK      Unlead 87          PROBE OUT           CLEAR   4-04-08  11:37AM
T 1  TANK      Unlead 87          PROBE OUT           ALARM   4-04-08  10:51AM
T 2  TANK      Premium 91          PROBE OUT           ALARM   4-04-08  10:42AM
T 2  TANK      Premium 91          LOW PRODUCT ALARM   ALARM   4-04-08  10:42AM
s 8  OTHER    PRES SEN 2 DISP 1-2 COMMUNICATION ALARM CLEAR   3-26-08  1:39PM
s 8  OTHER    PRES SEN 2 DISP 1-2 COMMUNICATION ALARM ALARM   3-26-08  1:37PM
      SYSTEM    BATTERY IS OFF      CLEAR   3-10-08  8:00AM
      SYSTEM    BATTERY IS OFF      ALARM   3-10-08  8:00AM
    
```

Figure 19. Priority Alarm History Report - Serial to PC Format

```

I11200
DEC 9, 2010 4:20 AM

<Site Name>
<Site Address>
<Site Address>
<Site Address>

NON-PRIORITY ALARM HISTORY
ID CATEGORY DESCRIPTION ALARM TYPE STATE DATE TIME
T 3 TANK DIESEL LOW TEMP WARNING CLEAR 12-08-10 3:00PM
T 3 TANK DIESEL LOW TEMP WARNING ALARM 12-08-10 3:00PM
T 3 TANK DIESEL HIGH PRODUCT ALARM CLEAR 12-08-10 3:00PM
T 3 TANK DIESEL HIGH PRODUCT ALARM ALARM 12-08-10 2:56PM
SYSTEM PRINTER ERROR CLEAR 11-17-10 10:51AM
SYSTEM PAPER OUT CLEAR 11-17-10 10:51AM
SYSTEM PAPER OUT ALARM 11-17-10 10:50AM
SYSTEM PRINTER ERROR ALARM 11-17-10 10:50AM
    
```

Figure 20. Non-Priority Alarm History Report - Serial to PC Format

Diagnostics

Automatic Control

Under Automatic control, vapor pressure readings are compared to user programmable thresholds to determine the appropriate Pressure Management Device (PMD) state. When the PMD is off and the TURN ON VAPOR PROCESSOR is exceeded, an internal relay is enabled and remains so until the pressure drops below the TURN OFF VAPOR PROCESSOR threshold. Automatic control is the default mode.

Manual control

If PMC mode is Manual, the diagnostic menu allows the PMD to be directly turned on/off through the relay. This feature is to support unit operational testing without waiting for the pressure to hit limits. The current UST ullage space vapor pressure will also be available through the diagnostic menu. The VC1 RS232 command allows for remote control of the PMD when the PMD control is manual. Note: If the PMD is on and the PMC mode is Automatic, changing the control mode to Manual mode will turn the PMD off.

When set to Manual mode, the system will revert to Automatic mode after 4 hours.

PMC Diagnostic Menu

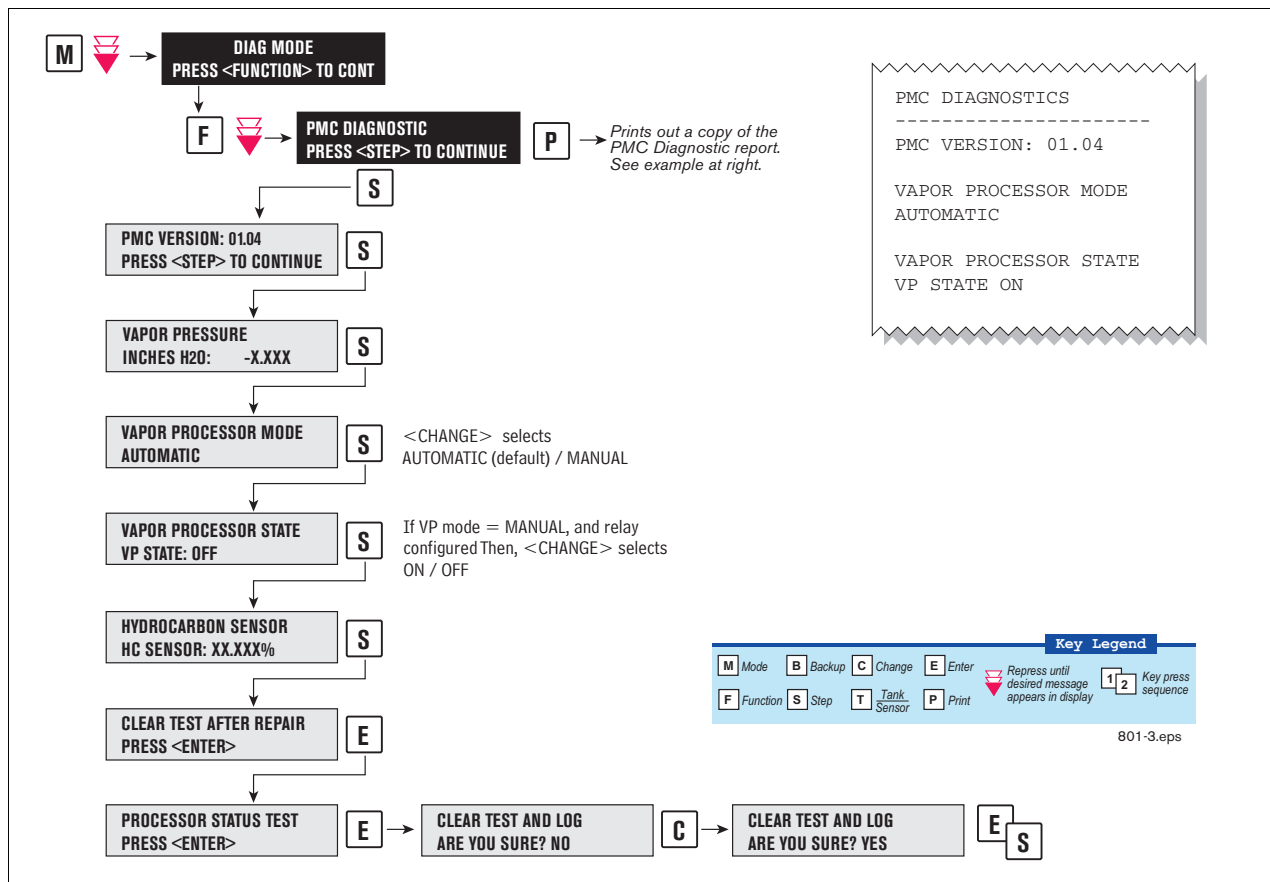

Figure 21. PMC Diagnostic Menus

