

Spectralink 6020 Wireless Telephone

User Guide

Copyright Notice

© 2007-2016 Spectralink Corporation All rights reserved. Spectralink™, the Spectralink logo and the names and marks associated with Spectralink's products are trademarks and/or service marks of Spectralink Corporation and are common law marks in the United States and various other countries. All other trademarks are property of their respective owners. No portion hereof may be reproduced or transmitted in any form or by any means, for any purpose other than the recipient's personal use, without the express written permission of Spectralink.

All rights reserved under the International and pan-American Copyright Conventions. No part of this manual, or the software described herein, may be reproduced or transmitted in any form or by any means, or translated into another language or format, in whole or in part, without the express written permission of Spectralink Corporation.

Do not remove (or allow any third party to remove) any product identification, copyright or other notices.

Notice

Spectralink Corporation has prepared this document for use by Spectralink personnel and customers. The drawings and specifications contained herein are the property of Spectralink and shall be neither reproduced in whole or in part without the prior written approval of Spectralink, nor be implied to grant any license to make, use, or sell equipment manufactured in accordance herewith.

Spectralink reserves the right to make changes in specifications and other information contained in this document without prior notice, and the reader should in all cases consult Spectralink to determine whether any such changes have been made.

NO REPRESENTATION OR OTHER AFFIRMATION OF FACT CONTAINED IN THIS DOCUMENT INCLUDING BUT NOT LIMITED TO STATEMENTS REGARDING CAPACITY, RESPONSE-TIME PERFORMANCE, SUITABILITY FOR USE, OR PERFORMANCE OF PRODUCTS DESCRIBED HEREIN SHALL BE DEEMED TO BE A WARRANTY BY SPECTRALINK FOR ANY PURPOSE, OR GIVE RISE TO ANY LIABILITY OF SPECTRALINK WHATSOEVER.

Warranty

The *Product Warranty and Software License and Warranty* and other support documents are available at <http://support.spectralink.com>.

Contact Information

US Location

+1 800-775-5330

Spectralink Corporation
2560 55th Street
Boulder, CO 80301
USA

info@spectralink.com

Denmark Location

+45 7560 2850

Spectralink Europe ApS
Bygholm Soepark 21 E Stuen
8700 Horsens
Denmark

infoemea@spectralink.com

UK Location

+44 (0) 20 3769 9800

Spectralink Europe UK
329 Bracknell, Doncastle Road
Bracknell, Berkshire, R612 8PE
United Kingdom

infoemea@spectralink.com

Contents

Product Support	7
Spectralink References	7
Conventions Used In This Document.....	7
<i>Icons</i>	7
<i>Typography</i>	9
Chapter 1: The Handset	10
Modes of Operation	10
Menu Navigation	10
Handset Displays	11
Shortcut Keys	11
Status Bar Indicators.....	12
Softkey Labels	13
Chapter 2: Getting Started.....	14
Basic Handset Operation Summary	14
Chapter 3: Advanced Features	18
Facility-Specific Features.....	18
Message Alert Feature.....	18
Data Entry and Editing	18
<i>Alphanumeric entries:</i>	19
The Config Menu.....	19
<i>Toggle Options</i>	20
<i>Profiles</i>	20
<i>Default Profile Settings</i>	20
<i>Changing Ring Settings</i>	21
Config Menu Options.....	22
Chapter 4: Accessories	23
Battery Packs	23
<i>Notes on Battery Packs</i>	23
<i>Charging Tips</i>	24
<i>Charging Status</i>	24
Charger Models.....	25
<i>Single Charger</i>	25
<i>Dual Charger</i>	26
<i>Quad Charger</i>	27

Carrying Options	28
<i>Headsets</i>	<i>28</i>
Chapter 5: Handset Administration	29
FAQs	29
<i>How does the handset power off and power on?</i>	<i>29</i>
<i>How do I place a call and terminate a call?</i>	<i>29</i>
<i>Can I change the ring?</i>	<i>29</i>
<i>How do I change the voice volume and the ringing volume?</i>	<i>29</i>
<i>What is the range of the wireless handset?</i>	<i>29</i>
<i>How do I charge the Battery Pack?</i>	<i>29</i>
<i>How long does the Battery Pack hold a charge?</i>	<i>30</i>
<i>What features (transfer, mute, etc.) are available and how are they activated?</i>	<i>30</i>
<i>Can I use the wireless handset at home?</i>	<i>30</i>
<i>How should I clean the handset?</i>	<i>30</i>
Appendix A: Specifications	31
Appendix B: Cleaning and Drying the Handset	32
Appendix C: Safety Information	34
Industry Canada Notice	34
Chargers and Battery Packs	35
Wireless Handsets	36
<i>Operational Warnings</i>	<i>36</i>
<i>Potentially Explosive Atmospheres</i>	<i>36</i>
Electromagnetic Interference and Compatibility	37
<i>Facilities</i>	<i>37</i>
<i>Pacemakers</i>	<i>37</i>
<i>Other Medical Devices</i>	<i>37</i>
FCC Statement	37
Use While Driving	38
<i>For Vehicles Equipped with an Airbag</i>	<i>38</i>
<i>Handset operation normal position</i>	<i>38</i>
Informations Concernant La Sécurité	39
Chargeurs et batteries	39
Téléphones sans fil	40
Avertissements concernant le fonctionnement	40
<i>Atmosphères potentiellement explosives</i>	<i>40</i>
Interférences électromagnétiques et compatibilité	41
<i>Établissements particuliers</i>	<i>41</i>

<i>Stimulateurs cardiaques</i>	41
<i>Autres appareils médicaux</i>	41
Utilisation au volant	42
<i>Pour les véhicules équipés d'un airbag</i>	42
Appendix D: Specific Absorption Rate (SAR) Information	43

Introduction

Your Spectralink 6020 Wireless Handset is a state-of-the-art communication device that utilizes radio wave technology to send and receive voice transmissions. It is designed to operate like a cell phone. However, the handset utilizes the private telephone system installed in your facility and will not operate outside the area covered by this system.

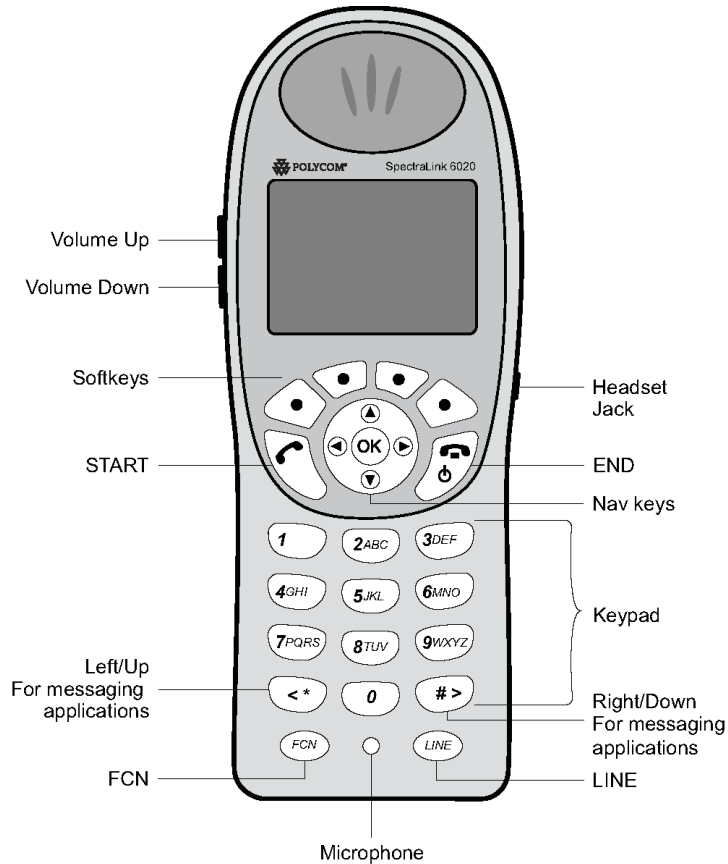

This guide is meant to provide general information about your handset. Contact your handset system administrator for additional information on how your handset functions within your telephone system. This guide includes information about:

- The Handset
- Getting Started
- Advanced Features
- Handset Accessories
- Handset Administration
- Safety Information

Product Support

Spectralink wants you to have a successful installation. If you have questions please contact the Customer Support Hotline at 1-800-775-5330.

The hotline is open Monday through Friday, 6 a.m. to 6 p.m. Mountain time.

For Technical Support: <mailto:technicalsupport@spectralink.com>

For Knowledge Base:

http://support.spectralink.com/SpectralinkService/support/us/support/voice/wifi/spectralink_8400_wireless.html

For Return Material Authorization: <mailto:nalarma@spectralink.com>

Spectralink References

All Spectralink documents are available at <http://support.spectralink.com>.

To go to a specific product page:

Use the top Documents and Downloads pane and select Voice as the Product Type and then select the product name from the drop down list and click Go.

To view all Voice Support page selections:

Use the second Documents and Downloads pane and click Voice.

Conventions Used In This Document

Icons

Icons indicate extra information about nearby text.



Warning

The *Warning* icon highlights an action you must perform (or avoid) to avoid exposing yourself or others to hazardous conditions.



Caution

The *Caution* icon highlights information you need to know to avoid a hazard that could potentially impact device performance, application functionality, successful feature configuration and/or affect handset or network performance.



Note

The Note icon highlights information of interest or important information that will help you be successful in accomplishing a procedure or understanding a concept.



Tip

The Tip icon highlights information that may be valuable or helpful for users to know, such as special techniques, shortcut methods, or information that will make user tasks easier to perform.



Web

The *Web Info* icon highlights supplementary information available online such as documents or downloads on support.spectralink.com or other locations.



Timesaver

A time-saving tip is typically used to mention or highlight a faster or alternative method for users who may already be familiar with the operation or method being discussed.



Admin Tip

This tip advises the administrator of a smarter, more productive or alternative method of performing an administrator-level task or procedure.



Power User

A Power User Tip is typically reserved for information directed specifically at high-level users who are familiar with the information or procedure being discussed and are looking for better or more efficient ways of performing the task. For example, this might highlight customization of a feature for a specific purpose.



Troubleshooting

This element can be used in any type of document and is typically used to highlight information to help you solve a relevant problem you may encounter, or to point to other relevant troubleshooting reference information.



Settings

The Settings icon highlights information to help you zero in on settings you need to choose for a specific behavior, to enable a specific feature, or access customization options.

Typography

A few typographic conventions, listed next, are used in this guide to distinguish types of in-text information.

<i>Convention</i>	<i>Description</i>
Bold	Highlights interface items such as menus, soft keys, file names, and directories. Also used to represent menu selections and text entry to the handset.
<i>Italics</i>	Used to emphasize text, to show example values or inputs, and to show titles of reference documents available from the Spectralink Support Web site and other reference sites.
<u>Underlined blue</u>	Used for URL links to external Web pages or documents. If you click on text in this style, you will be linked to an external document or Web page.
Bright orange text	Used for cross references to other sections within this document. If you click on text in this style, you will be taken to another part of this document.
Fixed-width-font	Used for code fragments and parameter names.

This guide also uses a few writing conventions to distinguish conditional information.

<i>Convention</i>	<i>Description</i>
<MACaddress>	Indicates that you must enter information specific to your installation, handset, or network. For example, when you see <MACaddress>, enter your handset's 12-digit MAC address. If you see <installed-directory>, enter the path to your installation directory.
>	Indicates that you need to select an item from a menu. For example, Settings > Basic indicates that you need to select Basic from the Settings menu.

Chapter 1: The Handset

Modes of Operation

Your handset has four modes of operation:

<i>Mode</i>	<i>Description</i>
Standby	The handset is not in a call or messaging.
Active	A call is coming in, a call is being dialed or the handset is in a call or messaging.
Config Menu	User preferences are being accessed in the Config Menu . In this mode the handset is on, but will not receive calls.
Message Alert	Custom text messaging applications may be programmed for your facility. This mode is activated through the FCN menu. See Advanced Features.

Menu Navigation

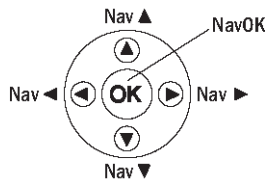

The navigation keys (Nav keys) just below the softkeys are used to navigate through menu options. These are referred to in this guide as **Nav ▲**, **Nav ▼**, **Nav ◀**, **Nav ▶**, and **NavOK**.

Handset Displays

The top row of the display provides status indicators for various handset conditions. It is referred to as the status bar.

The middle lines display information about the handset identity, user profile, calls in progress, menu options, and data from the telephone system.

The bottom row displays softkey labels.

Standby Mode Display

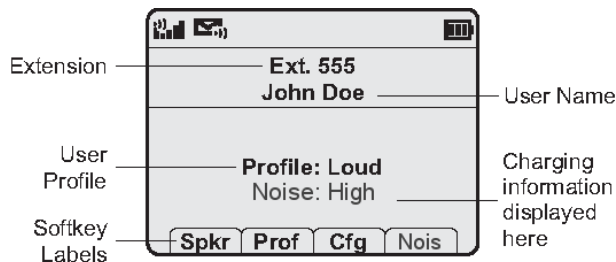





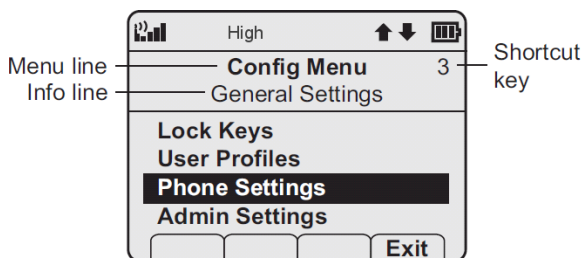

When the handset is in a call or in active mode, information from the telephone system in your facility displays. Information may include extension or telephone number of called or calling party, active line information, and softkeys that have been programmed by your system administrator.

Shortcut Keys

When a menu is displayed, a shortcut key may be displayed on the right edge of the menu line. Press the corresponding number on the keypad to activate the corresponding menu option.



Status Bar Indicators

Indicator	Function
	The signal-strength icon indicates the strength of the signal and can assist the user in determining if the handset is moving out of range.
	If voicemail is available the voicemail icon will appear when a new voicemail message is received.
	The battery icon indicates the amount of charge remaining in the Battery Pack. When only one level remains, the Battery Pack needs to be charged.
	The speakerphone icon displays when the speakerphone is active.
1.....	The line indicators are associated with handset line status and access.
	Up and down arrows are displayed when a menu has additional options above or below. Left or right arrows are displayed during editing when the cursor may be moved left or right.
Muted	The muted indicator displays after the Mute softkey has been pressed during a call. It indicates that the microphone is not transmitting sound. Press the Mute softkey again to unmute the microphone.
Normal High Severe	The muted position is shared with the noise mode currently set either by using the Nois softkey in the standby mode or through the Config menu. Select Normal for most office environments; High for moderate background noise; or Severe for extremely noisy conditions. If you use High or Severe modes in a quiet environment, the person on the other end of the line may find it difficult to hear your voice.
Locked	Locked indicates that the keypad is locked to prevent accidental activation. Press the Unlk softkey and then the # key to unlock it.
	The download icon indicates that the handset is downloading code. This icon only appears while the handset is running the over-the-air downloader. It appears to the right of the signal strength icon in the same location as the voicemail icon.
	The download failure icon indicates that the handset has failed to download code because the code is incompatible with the handset hardware. Contact your system administrator should this icon appear.

Softkey Labels

The bottom row of the handset displays labels associated with the four softkeys just below it. When a softkey is active, a label appears to describe its function. Pressing the softkey will activate the feature.

<i>Label</i>	<i>Description</i>	<i>Action</i>
Back	Go back	Returns to the previous menu display.
CAPS/caps	Change case	Toggles to allow a change in case when entering alphabetical text.
Cfg	Configure	Opens the Config Menu.
Clr	Clear	Deletes the entry.
Cncl	Cancel	Returns to the previous menu display without saving any data that might have been entered.
Del	Delete	Deletes the character to the left of the cursor.
Exit	Exit	Exits out of the menus.
Hold	Hold	Places a call on hold.
Mute	Mute	Toggles to mute or unmute the microphone.
No	Negative reply	Press to reply “No” to a displayed question.
Nois	Noise mode	Allows you to select the appropriate noise mode for the environment.
Play	Play	Plays the selected ring tone.
Prof	Profile	Opens the Profile menu.
Spkr	Speakerphone	Toggles speakerphone function.
Unlk	Unlock keys	Press Unlk, then the # key to unlock a locked keypad.
Yes	Positive reply	Press to reply “Yes” to a displayed question.

Chapter 2: Getting Started

Your Link 6020 Wireless Handset is designed for full mobility within the workplace and operates much like a cell phone. It also interfaces with the telephone system at your workplace and incorporates advanced telephony features. This section covers the basic functions available in every facility. For specific telephony system functions, see the Facility-Specific Features section or contact your system administrator.



The handset's Battery Pack must be fully charged before its first use. Place the handset into the charger for a minimum of two hours before using it. See the section Charger Models for full information. When you first receive your handset, you need to fully charge the Battery Pack in order to maximize the Battery Pack's storage capacity and lifespan. You may also need to familiarize yourself with turning the handset on and off and learn about the various audio options available to you. Additionally, your facility may have security standards that require you to enter your unique credentials, such as a domain name, user name, and password, so that the handset will correctly register with your system. This chapter covers all of these subjects.

Basic Handset Operation Summary

Remove the Battery Pack

Press down on the latch on the Battery Pack at the back of the handset and pull the Battery Pack towards you. The Battery Pack releases outward.

Replace the Battery Pack

Slide the lip of the Battery Pack into the bottom of the cavity. Push the top of the Battery Pack until it snaps into place. You should not have to force it into the handset.

Turn handset on

Press and hold the **END** key until two chirps sound.

Turn handset off

Press and hold the **END** key. One chirp will sound. If you are in a call, hang up first, then turn off the handset.

Unlock the keypad

Press the **Unlk** softkey, then #, to unlock the keypad.

Lock the keypad

Press the **Cfg** softkey, then **NavOK**. Navigate to **Phone Settings** in the **Config Menu** for **Keypad Autolock** settings.

Make an internal call

Press the **START** key, wait for a dial tone, then dial the extension.

Make an external call

Press the **START** key, wait for a dial tone, then dial the number just as you would from your desk handset.

Select a line

If multiple lines are available, your telephone system may require you to select a line before dialing a number. Press **LINE** and the number key corresponding to the desired line. You will hear a dial tone.

Dial a number

Once you hear a dial tone, press the number keys to dial the number.

Answer a call

The handset will ring or vibrate to alert you of an incoming call. Additionally, a line indicator on the display may flash and the display may show information about the call, such as the caller's name and extension.

To answer a call, press the **START** key and hold the earpiece to your ear. You may also activate the speakerphone by pressing the **Spkr** softkey or use a headset.

Answer a call on a second line

If you are on a call and hear subdued ringing, a call is coming in on a second line. The line number on the display may be flashing. To answer this call, put your first call on hold and press the **LINE** key, then the line number of the second call.

Answer with headset

Press any key (other than **END**) to answer a call when a headset is plugged in.

Silence while ringing

Press the **END** key to silence the ring.

Change the ring volume

Press the up/down volume buttons on the side of the handset during ringing. The default ring volumes are set in the User Profile menus.

Adjust the speaker volume

Press the up/down volume buttons on the side of the handset during the call.

Adjust the headset volume

Press the up/down volume buttons on the side of the handset during the call.

Place a call on hold

Press the **Hold** softkey.

Resume a held call

Press the **LINE** key followed by the line number key.

Mute the microphone

Press the **Mute** softkey.

End the call

Press the **END** key. Be sure to do this at the end of each call to return to the standby mode.

Change the profile

Press the **Prof** softkey and use the **Nav** keys to select a new profile while in standby mode. The selected profile is marked with an asterisk (*).

Display additional features

During a call or while off hook, press the **FCN** key to display the options programmed to additional features available in your facility. These might include transfer, conference, voicemail, etc.

Turn on the backlight

The backlight comes on when any key is pressed or when there is an incoming call and stays on for 10 seconds. It turns off after 10 seconds if another key is not pressed within that period.

Use message alerts

If programmed in your facility, message alerts may be activated by pressing the **FCN** key and then a menu option assigned by the system administrator.

The asterisk (< *) key is used for left and up navigation and the pound (# >) key is used for right and down navigation. Contact your system administrator for detailed information about message alert mode.

Set the noise mode

Press the **Nois** softkey and select the appropriate option for your environment. Select **Normal** for most office environments; **High** for moderate background noise; or **Severe** for extremely

noisy conditions. If you use High or Severe modes in a quiet environment, the person on the other end of the line may find it difficult to hear your voice. The noise mode can also be set in the Config Menu.

You can disable the noise mode soft key so that it does not display while the handset is in standby and only appears while the handset is ringing or in a call. The **Enable/Disable NM Softkey** option is on the Phone Settings menu. It is enabled by default.

Chapter 3: Advanced Features

Facility-Specific Features

Press the **FCN** key while off-hook or in a call to display the the menu options programmed for advanced telephony features such as transfer, conference, and voicemail.

Contact your system administrator for more information about custom features available in your facility.

Message Alert Feature

Custom applications may allow you to read and respond to text messages. The Message Alert application may be available through the **FCN** menu if programmed in your facility. While off-hook, press **FCN** to view the menu, then press one or more number keys to open the application. The handset is now in Message Alert mode.

The **Nav** keys are not enabled by text messaging applications. Instead, use < * to move left or up and # > to move right or down.

You may change **Message Alert** ring settings through the **Config Menu**. See the diagram on page 22 and the *Changing Ring Settings* section.

Data Entry and Editing

Enter numbers by pressing the buttons on the keypad. The blinking underscore identifies the current cursor position. When entering alphanumeric strings, the **CAPS/caps** softkey will appear and may be pressed to toggle the case. Enter letters by repeatedly pressing the corresponding key until the desired letter displays on the screen.

To edit during entry, delete the character to the left of the cursor by pressing the **Del** softkey. To replace an entry, delete it by pressing the **Clr** softkey and then enter the new data. To edit an existing entry, use **Nav◀** and **Nav▶** to move the cursor position, and then press the **Del** softkey to delete the character to the left. Insert new data by pressing the buttons on the keypad.

Alphanumeric entries:

Key	caps	CAPS
1	1	1
2	2 a b c	2 A B C
3	3 d e f	3 D E F
4	4 g h i	4 G H I
5	5 j k l	5 J K L
6	6 m n o	6 M N O
7	7 p q r s	7 P Q R S
8	8 t u v	8 T U V
9	9 w x y z	9 W X Y Z
0	0	0
*	* . - _ ! \$ % & ' () + , : ; / \ = @ ~	
#	<space>	

The Config Menu

When the handset is in standby mode, press the **Cfg** softkey to enter the **Config Menu**. The handset cannot make or receive calls while in the **Config Menu**. This menu allows you to set user preferences. Refer to the diagrams on pages 24-25.

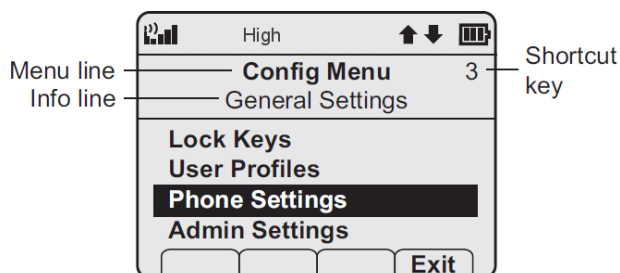

Scroll through menu options by using **Nav▲** and **Nav▼**. When an asterisk (*) appears to the left of an option, it indicates that the option is currently selected. Press the **Exit** softkey to return to standby mode. Use the **Back** softkey to return to the previous menu.

Toggle Options

Some menu options that have only two possibilities operate on a toggle basis. The current setting is shown on the second row of the display, called the info line. Highlight the option and press **NavOK** to toggle between the settings. For example, when **Ring in Headset** is the menu option, **Ring in Speaker** will show on the info line as the active setting.

If you select **Ring in Headset**, **Ring in Headset** will show on the info line as the active setting and the menu option will toggle to Ring in Speaker.

Profiles

Your handset ring behavior is established by five User Profiles: **Silent**, **Vibrate**, **Loud**, **Soft**, and **Custom**. The currently-active user profile is shown on the standby display. The ring behavior can easily be changed by pressing the **Prof** softkey and selecting a new profile from the list when the handset is in standby mode. The currently-active profile is marked with an asterisk (*).

Default Profile Settings

<i>Setting/Profile</i>	<i>Silent</i>	<i>Vibrate</i>	<i>Soft</i>	<i>Loud</i>	<i>Custom</i>
Ring Cadence	Off	Off	Handset	Handset	Handset
Ring Tone	Tone 1	Tone 1	Tone 1	Tone 1	Tone 1
Ring Volume	1	1	3	7	5
Vibrate Cadence	Off	Handset	Off	Off	Handset
Ring Delay	0	0	0	0	5
Noise Mode	Normal	Normal	Normal	Normal	Normal
Headset/Speaker	Speaker	Speaker	Speaker	Speaker	Speaker
Key Tones	Off	Off	On	On	On
Warning Tones	Off	Off	On	On	On

Contact your system administrator if you want to reset all user profiles back to these default settings.

Changing Ring Settings

To change the ring tone or any other ring setting for any profile, go to **User Profiles** and select the profile. Select **Ring Settings** and then select **Handset** for standard phone calls or one of the **Message Alerts** for text messages. Then select the ring option you want to adjust.

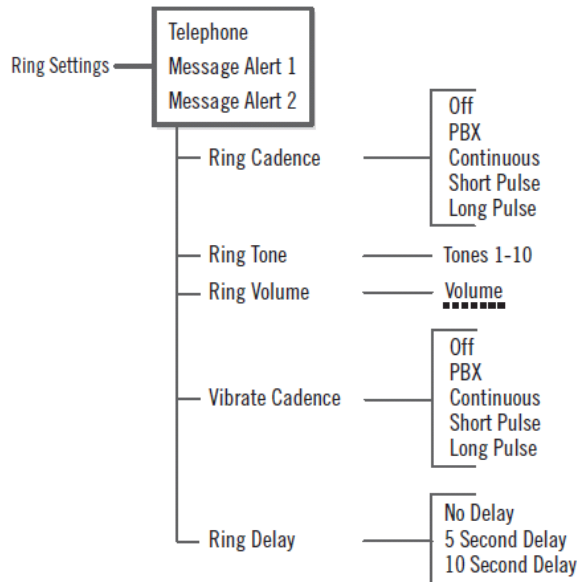

Config Menu Options

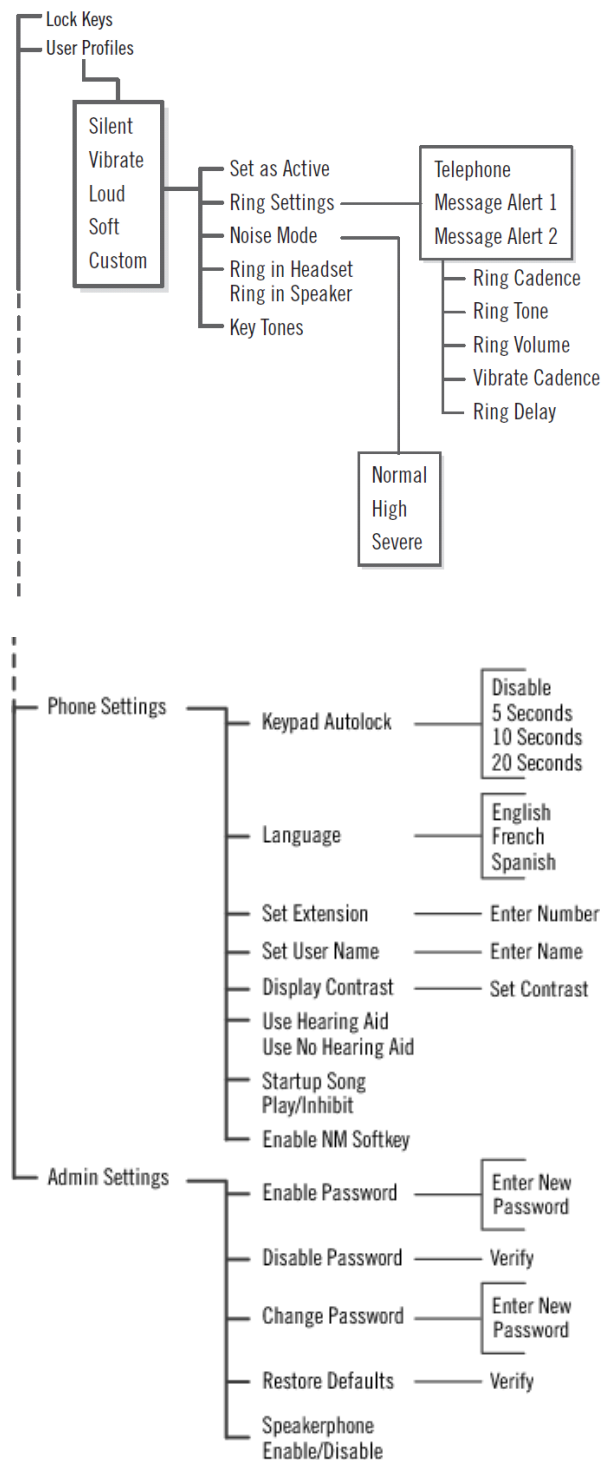

Chapter 4: Accessories

Accessories for the Spectralink 6020 Wireless Handset include three different charger models, three different Battery Pack models, headsets and several carrying options.

Battery Packs

The Battery Packs must be recharged periodically. Each type of Battery Pack requires a different amount of time to achieve a fully charged state from a fully depleted state. Three Battery Pack options are available.

Type	Talk Time	Standby Time	Charging Time
Standard	4 hours	80 hours	2 hours
Extended	6 hours	120 hours	3 hours
Ultra-Extended	8 hours	160 hours	4 hours

The Battery Pack icon on the status row indicates the charge amount remaining. Additionally the handset will sound warning tones and display the **Battery Low** message when there are fewer than two minutes of talk time remaining.

A melody will play when the handset is powered on for the first time after being fully charged, unless this feature has been disabled. Each Battery Pack type has a different melody.

See your system administrator if you have questions about the type of Battery Pack you have been issued.



The type of Battery Pack is printed on the label. Remove the Battery Pack and view the label to determine the type of Battery Pack you have been issued.

The Battery Pack can be changed while the call is still in progress. Do not press **END**. Quickly remove the discharged Battery Pack and replace with a charged Battery Pack, press **END** to turn the handset back on and then press **START** to resume the call.

Notes on Battery Packs

- Maximum Battery Pack performance is achieved after a few charge/discharge cycles.
- After a length of time Battery Packs will normally lose the ability to maintain a charge and to perform at maximum capacity and will need to be replaced. This is normal for all batteries.
- If your Battery Pack requires replacement, contact your system administrator.
- Any battery which exhibits swelling, cracking or other abnormality should be disposed of promptly and properly.

- DO NOT DISPOSE OF THE BATTERY PACK WITH YOUR DOMESTIC WASTE. TAKE USED BATTERY PACKS TO AN APPROPRIATE COLLECTION POINT FOR RECYCLING OR SEND THEM BACK TO YOUR SUPPLIER OR SERVICING AGENT.

Charging Tips

- Overnight charging is best done while the handset is turned off.
- If the handset does not charge, clean Battery Pack, charger and handset contacts.
- If multiple Battery Packs are supplied with your handset, Spectralink recommends that each be fully charged upon receipt to prolong battery life. Battery Packs will slowly lose charge if unused. To maintain battery potential, charge unused Battery Packs occasionally or alternate Battery Pack use.

Charging Status

The handset display and the LED on the Dual and Quad Chargers indicate whether or not charging is occurring or completed or if a Battery Pack failure has been detected.*



The Single Charger does not have an LED indicator.

<i>Handset/LED</i>	<i>Charging Status</i>
Charging... LED Solid On	The Battery Pack in the handset is charging.
	Note that in the Dual Charger, the handset's Battery Pack takes charging precedence, and when it is finished charging, the single Battery Pack in the rear slot will charge.
Charge Complete LED Off	The Battery Pack in the handset has finished charging. Battery Pack fully charged, empty slot, or unit is not powered.
Battery Failure LED Flash	Error. Battery Pack not able to be charged. Reinsert Battery Pack or replace Battery Pack.

Charger Models

Three charger models are available for the Spectralink 6020 Wireless Handset. The Single Charger will charge a single handset with an installed Battery Pack. The Dual Charger will charge the handset and a spare Battery Pack. The Quad Charger can charge up to four Battery Packs at a time.

The Single and Dual Chargers allow the handset to remain operative in speakerphone mode or with a headset while charging. Handsets may be charged while in standby mode, while in an active call or while turned off.

Place the Single or Dual Charger on a flat, horizontal surface. Plug the power supply into the charger and into an appropriate wall outlet. The Quad Charger may be mounted on a horizontal or vertical surface.

Single Charger



The Single Charger is designed to allow the handset to remain operational through speakerphone or headset use while the handset's Battery Pack is being charged. The handset may also be charged while it is in standby mode or turned off.

Place the handset in the Single Charger facing forward. While the handset is charging in standby mode, it will display its extension number and **Charging**.... An animated charge icon will indicate that charging is in progress. The handset is fully operational and will ring if called. When the handset is charging while turned off, only **Charging**... will display and no calls will be received. The dots will be racing during the charging cycle.

When the handset is fully charged, **Charge Complete** will display.

No charging information will display during an active call.

Dual Charger

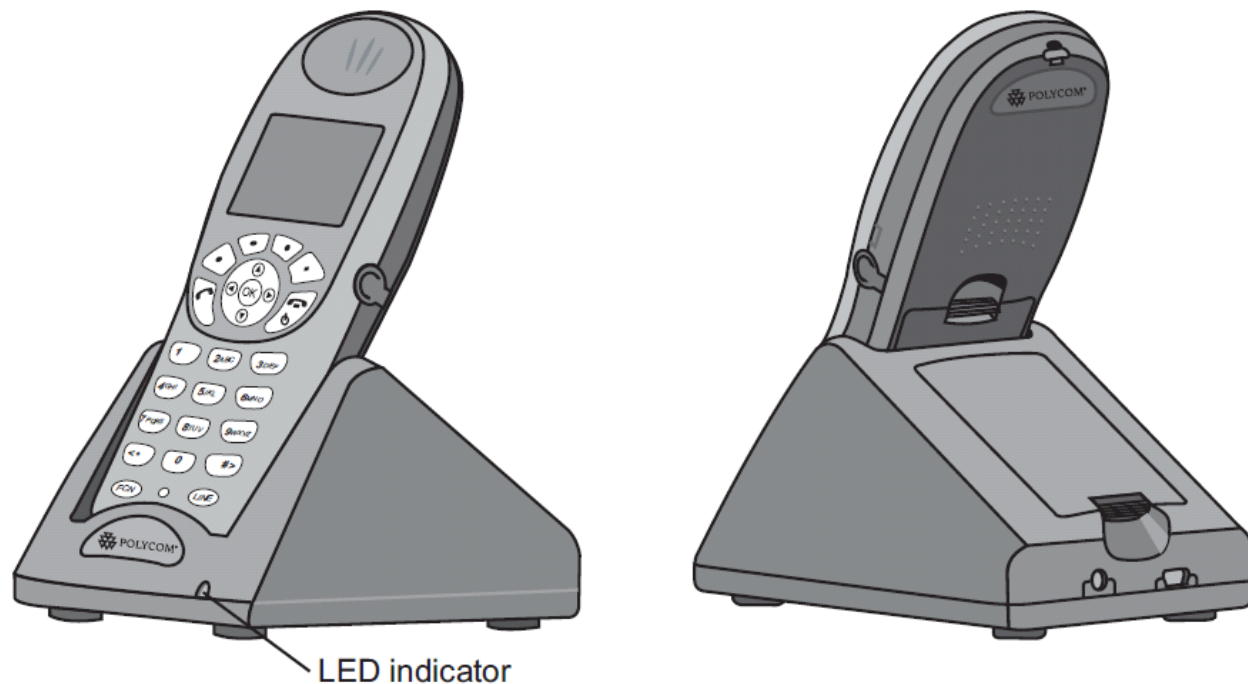

The Dual Charger is designed to charge the Battery Pack in the handset while it remains operational and also charge an additional Battery Pack in the rear charging bay. The handset has charging priority when both slots are occupied.

Place the handset in the front slot, facing forward. The Battery Pack alone snaps into the charging bay as shown in the illustration.

The LED indicates the status of the Battery Pack in the rear bay. The handset displays its charging status as described for the Single Charger.

When the handset is fully charged or is removed, the Battery Pack will begin charging.

Note that the time it takes for the Battery Pack to charge will be lengthened if its charging cycle is interrupted for a handset to charge.

Quad Charger

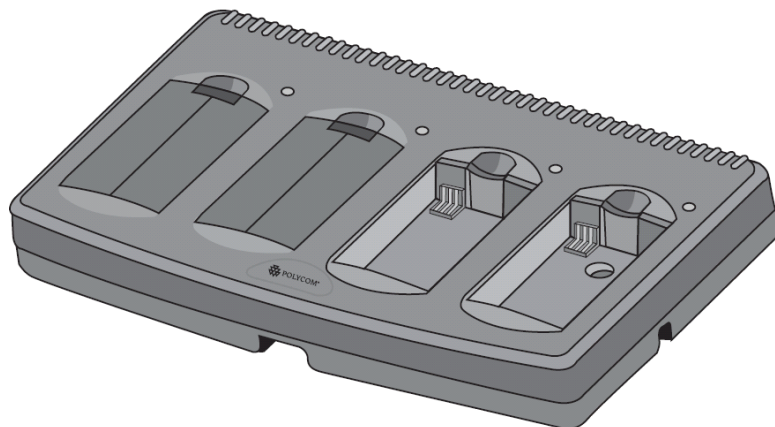

The Quad Charger is designed to simultaneously charge four Battery Packs. It may be mounted on a horizontal or vertical surface.

The Battery Pack snaps into the charging slot. The LED above the occupied bay indicates the charging status of the Battery Pack in the bay.



A flashing LED may indicate a Battery Pack failure. Verify the condition of the Battery Pack by the following procedure before replacing it. First check the Battery Pack in a different bay or substitute another charger and repeat the operation that caused the failure. If the same Battery Pack lights a steady LED when inserted in a different bay or charger, the first charger may be faulty. Contact your system administrator for service information.

Carrying Options

The following options are available for handset protection and easy handset carrying and removal.

Belt clip: Spring-loaded plastic belt clip that attaches to the back of the handset.

Swivel belt clip: Swivel-style belt clip that attaches to the back of the handset with full 360 degree swivel or eight-position ratchet options.

Swivel carrying case: Black leather case with keypad cover and swivel-style quick release belt clip.

Holster: Black holster with belt clip.

Cord lanyard: Nylon cord lanyard with quick disconnect.

Coiled lanyard: Plastic coiled lanyard with clothing clip.

Headsets

Spectralink offers optional headsets for use in noisy environments or if you need to have your hands free while talking on the handset.

To use the headset, simply plug it into the jack on the right side of the handset.

While using a headset, the handset will ring according to the user profile setting established in the **Headset/Speaker Ring** option. The external ring will ring according to the setting of the profile.

The headsets offered by Spectralink have been laboratory tested and work properly with the wireless handset. Spectralink does not recommend using other headsets.

Chapter 5: Handset Administration

FAQs

How does the handset power off and power on?

The **END** key is the power on/power off key. Press and hold it to turn the handset on. Turn the handset off from the standby mode by pressing and holding the **END** key. If you are in an active call, end the call by pressing the **END** key. This returns the handset to the standby mode, then press **END** again to turn the handset off.

How do I place a call and terminate a call?

To place a call, press the **START** key and then dial the number. End the call by pressing the **END** key. You can also use the speakerphone instead of the **START** key.

Can I change the ring?

The ring is fully adjustable and may be set differently for different profiles. For a complete explanation of how to change the ring, see the *Changing Ring Settings* section of this guide.

How do I change the voice volume and the ringing volume?

Whether using a headset, the speakerphone, or the internal speaker, the speaker volume for the current call may be raised or lowered by pressing the up and down volume buttons on the side of the handset.

The volume buttons may be pressed while the handset is ringing to raise or lower the ring volume, which also changes the ring volume setting in the current profile.

What is the range of the wireless handset?

As barriers affect radio transmission, there is no single answer for this question. Normally, you can expect the same range as with any other wireless device. However, if your facility has metal walls or other materials that inhibit radio waves, the range will be reduced.

How do I charge the Battery Pack?

The Battery Pack in the handset may be charged in a Single or Dual Charger without being removed from the handset by simply placing the handset into the charger. A spare Battery Pack may be charged in the rear bay of the Dual Charger or in a Quad Charger.

How long does the Battery Pack hold a charge?

There are three different Battery Pack models and each has a different charge capacity. The type of Battery Pack is printed on the label. Remove the Battery Pack and view the label to determine the type of Battery Pack you have been issued.

<i>Type</i>	<i>Talk Time</i>	<i>Standby Time</i>	<i>Charging Time</i>
Standard	4 hours	80 hours	2 hours
Extended	6 hours	120 hours	3 hours
Ultra-Extended	8 hours	160 hours	4 hours

What features (transfer, mute, etc.) are available and how are they activated?

Active call features such as Mute and Hold are available by pressing the softkey programmed to the feature. Additional features, such as Transfer and Conference, are locally programmed and usually activated by pressing the **FCN** key and then the softkey that corresponds to the programmed feature. Contact your handset system administrator for detailed information on how to access these features in your facility.

Can I use the wireless handset at home?

Access points installed in your facility transmit the radio waves emitted by your wireless handset to the telephone system in your facility which links the handsets to each other and to the rest of the world. The handset operates only within range of these access points and therefore will not work in your home.

How should I clean the handset?

Wiping the handset surface with a water-dampened cloth or paper towel will remove most films or residues. If the soiling is too stubborn for plain water, a mild detergent solution, Lysol or diluted bleach may be used. A spray cleaner may be used with care. Do not spray at an angle. Do not allow liquid cleaners to seep into keypad. Be sure to wipe away any detergent residue with a clean water-dampened cloth. Do not immerse in any fluid.

Appendix A: Specifications

Radio frequency	902–928 MHz
------------------------	-------------

Transmission type	Frequency Hopping Spread Spectrum (FHSS)
--------------------------	--

FCC certification	Part 15.247
--------------------------	-------------

Voice encoding	ADPCM (Proprietary)
-----------------------	---------------------

Transmit power	Up to 100 mW peak, < 10 mW average
-----------------------	------------------------------------

Display	Up to six lines of text plus one icon status row and one row for softkey labels.
----------------	--

Model dimensions	5.4" ´ 2.0" ´ 0.9" (14.0 ´ 5.1 ´ 2.3 cm)
-------------------------	---

Model weight	3.9 ounces (112.4 g) with) Standard Battery Pack 4.1 ounces (115.7 g) with Extended Battery Pack 4.5 ounces (128.8 g) with Ultra-Extended Battery Pack
---------------------	--

Standard Battery Pack capacity	4 hours talk time 80 hours standby
---------------------------------------	---------------------------------------

Extended Battery Pack capacity	6 hours talk time 120 hours standby
---------------------------------------	--

Ultra-Extended Battery Pack capacity	8 hours talk time 160 hours standby
---	--

Appendix B: Cleaning and Drying the Handset



The Spectralink 6020 Series Wireless Handsets have been tested for resistance to cleaning chemicals per IEC 60068-2-74 (1999). Exposure of the 6020 handsets to Lysol® or diluted bleach poses little risk of functional or cosmetic damage.

- Avoid dropping the handset or knocking it against hard surfaces. Carry the handset in a holster or carrying case to protect it.
- There are no serviceable parts in the handset or chargers. You should not open the handset case nor disassemble the chargers. Doing so will void your warranty.
- Turn off the handset and unplug the chargers before you clean them. Never immerse the handset or charger in liquid. Clean the exterior surfaces, including the charging contacts, with a cloth that has been slightly moistened with water. Take care not to exert undue pressure on charger electrical contacts while wiping.
- Spectralink recommends the use of a silicone cover to prolong the life of your handset, especially when it is dropped regularly or cleaned frequently with the disinfectants prescribed below.
- Wiping the handset surface with a water-dampened cloth or paper towel will remove most films or residues. If the soiling is too stubborn for plain water, a mild detergent solution, Lysol, isopropyl alcohol, or diluted bleach may be used.
- Pre-treated cloths and toiles, like those used for eyeglasses or cameras, may be used to clean the handset; however, avoid using those containing lanolin or aloe as these will leave a slippery residue.
- When cleaning with disinfectants, do not rub the keypad characters vigorously. Doing so will degrade the handset's keys and make them illegible.
- Do not directly spray or immerse the handset in a disinfectant or cleaning agent. Spray the disinfectant on a soft cloth or paper towel, then wipe the handset's surface to dry it.

- The following products should NOT be used on the Spectralink wireless handset:
 - Do not use cleaning products containing quaternary ammonium compounds,¹ such as CaviWipes™, CaviWipes™ XL, Cavicide® or Sani-Wipes®, Sani-Cloth, Super Sani-Cloth® and Sani-Cloth® Plus. Quaternary ammonium compounds have been laboratory tested and proven to damage the handset plastics.
 - Do not use furniture polishes, waxes, or plasticizer-based cleaners (ArmorAll®, etc.)
 - Do not use lanolin, aloe, glycerin, or other skin care products
 - Do not apply any solvent such as acetone, mineral spirits, etc.
- Should the headset connector become dirty, you may experience a scratchy or intermittent signal. To clean the connector, dip the non-padded end of either a wooden or paper handled cotton swab in isopropyl alcohol. Gently insert in the connector and twist, repeating several times. If available, blow compressed air into the connector to clear debris.
- Keep the headset jack covered when not in use.
- Using a carrying case may help protect the surfaces and help prevent liquids (rain, etc.) from entering into the interior of the handset. This product is not waterproof, and exposing the unit to liquids may result in permanent damage to the unit.
- If your wireless handset interior gets wet, do not try to accelerate drying with the use of an oven or a dryer as this will damage the wireless handset and void the warranty. Instead, do the following:
 - 1 Immediately power off the wireless handset.
 - 2 Remove Battery Pack from wireless handset.
 - 3 Shake excess liquid from the wireless handset.
 - 4 Place the wireless handset and Battery Pack in an area that is at room temperature and has good airflow.
 - 5 Let the wireless handset and Battery Pack dry for 72 hours before reconnecting the Battery Pack and/or powering on the wireless handset.

If the wireless handset does not work after following the steps listed above, contact your dealer for servicing information.

¹ Quaternary ammonium compounds are also known as C12-18-alkyl [(ethyl)phenyl] dimethyl, chlorides and Benzyl-C12-18-alkyldimethyl ammonium chlorides. Review the Materials Safety Data Sheet for your specific product to verify the chemical composition.

Appendix C: Safety Information



Each Spectralink family of products only works with other members of the same family. If you have any questions about product compatibility, contact your system administrator.

Spectralink 8000/6020 Series

The Spectralink 6020 Wireless Handset shares accessories with the Spectralink 8020/8030 Wireless Handset models. Use only the following Spectralink products with your Spectralink 6020 Wireless Handset as identified by the model number located on the label of the product.

Spectralink 6020 Wireless Handset	602X
Desktop Charger	PCS1850
Dual Charger	PCD1850
Quad Charger	PCQ1850
Standard Battery Pack	PBP0850
Extended Battery Pack	PBP1300
UltraExtended Battery Pack	PBP1850.

Industry Canada Notice

Under Industry Canada regulations, this radio transmitter may only operate using an antenna of a type and maximum (or lesser) gain approved for the transmitter by Industry Canada. To reduce potential radio interference to other users, the antenna type and its gain should not exceed the equivalent isotropically radiated power (EIRP) necessary for successful communication.

This device complies with Industry Canada license-exempt RSS standard(s). Operation is subject to the following two conditions: (1) this device may not cause interference, and (2) this device must accept any interference, including interference that may cause undesired operation of the device.

Chargers and Battery Packs

- Chargers operate in a 50° to 85° F (10° to 30° C) environment. Do not expose them to freezing temperatures or direct sunlight.
- Do not place anything in the charger other than the handset or single Battery Pack as appropriate to avoid bending the contacts. Bent contacts can keep the Battery Pack from charging.
- Only use Spectralink 8400 Series Battery Packs with Spectralink 8400 Series Chargers.
- Never use a non-Spectralink charging unit as it could damage the Battery Pack.
- Use only the original plug-in power adapter for the chargers.
- Contact your service representative for assistance if you have a faulty Battery Pack or a problem with your charger.
- Any battery that exhibits swelling, cracking or other abnormality should be disposed of promptly and properly.



Caution: Risk of explosion

Risk of explosion if battery is replaced by an incorrect type. Dispose of used batteries according to the instructions.

Attention: Risque d'explosion

Attention: Risque d'explosion si la batterie est remplacée par un type incorrect. Jeter les batteries usagées selon les instructions.



Do not immerse the Battery Pack in water or throw it into a fire.



Do not throw away the Battery Pack with your domestic waste. Take used Battery Packs to an appropriate collection point for recycling or send them back to your supplier or servicing agent.



All batteries can cause property damage and/or bodily injury, such as burns, if a conductive material such as jewelry, keys, or beaded chains touches exposed terminals. The conductive material may complete an electrical circuit (short circuit) and become quite hot. Exercise care in handling any charged battery, particularly when placing it inside a pocket, purse, or other container with metal objects.

Wireless Handsets

Please read the following text carefully for important safety information.



The earpiece may retain magnetic objects.



Changes or modifications to this equipment that are not approved by Spectralink may cause this equipment to fail to comply with part 15 of the FCC rules, voiding the user's authority to operate this equipment.



Spectralink products contain no user-serviceable parts inside. Refer servicing to qualified service personnel.



Spectralink recommends that standard acceptance procedures be followed prior to operating this equipment in proximity of life-support systems.

Operational Warnings

Certain operational environments are potentially hazardous. Please read the following text carefully to ensure that you understand the handset's operating conditions.

Potentially Explosive Atmospheres

Do not take your handset into any area with a potentially explosive atmosphere. Do not remove, install, or charge batteries in such areas. Sparks in a potentially explosive atmosphere can cause an explosion or fire resulting in bodily injury or even death.



Avoid areas with potentially explosive atmospheres include fueling areas such as lower decks on boats, fuel, or chemical transfer or storage facilities, areas where the air contains chemicals or particles such as grain, dust, or metal powders, and any other area where you would normally be advised to turn off your vehicle engine. Areas with potentially explosive atmospheres are often marked with signs, but not always.

Electromagnetic Interference and Compatibility

Nearly every electronic device is susceptible to electromagnetic interference (EMI) if inadequately shielded, designed, or otherwise configured for electromagnetic compatibility.

Facilities

To avoid electromagnetic interference and/or compatibility conflicts, turn off your handset in any facility where posted notices instruct you to do so. Hospitals or health care facilities may be using equipment that is sensitive to external radio frequency (RF) energy.

Pacemakers

The Health Industry Manufacturers Association recommends that you maintain a minimum separation of 6 inches (15 cm) between a handheld, wireless-radio product and a pacemaker. These recommendations are consistent with the independent research by, and recommendations of, Wireless Technology Research. Persons with pacemakers should:

- ALWAYS keep the handset more than 6 inches (15 cm) from their pacemaker when the handset is turned on
- Not carry the handset in a breast pocket
- Use the ear opposite the pacemaker to minimize the potential for interference
- Turn the handset off immediately if you have any reason to suspect that interference is taking place

Other Medical Devices

If you use any other personal medical device, consult the manufacturer of your device to determine if it is adequately shielded from external RF energy. Your physician may be able to assist you in obtaining this information.

FCC Statement

This device complies with part 15 of the FCC Rules. Operation is subject to the following two conditions: (1) This device may not cause harmful interference, and (2) this device must accept any interference received, including interference that may cause undesired operation.

Use While Driving

Campus installations and warehouse facilities that use vehicles such as forklifts or golf carts should abide by these guidelines when using wireless handsets:

- Give full attention to driving and to the road, aisle, or path
- Use hands-free operation, if available
- Pull off the road, aisle, or path and park before making or answering a call

For Vehicles Equipped with an Airbag

Do not place a portable device in the area over the airbag or in the airbag deployment area. An airbag inflates with great force. If you place the handset in the airbag deployment area, and the airbag inflates, the airbag may propel the handset at high speed and cause serious injury to occupants of the vehicle.

Handset operation normal position

To position the antenna properly, hold the handset as you would any other telephone, with the earpiece to your ear and speak into the microphone.

Informations Concernant La Sécurité

Chargeurs et batteries

- Il est normal que la batterie chauffe au cours du chargement.
- Les chargeurs fonctionnent dans un environnement où la température est comprise entre 10 ° et 30 °C (soit 50 ° à 85 °F). Ne les exposez pas directement au soleil, ni à des températures négatives.
- Ne placez dans le chargeur aucun objet autre que le combiné ou la batterie, selon les cas, pour éviter d'endommager les contacts. Si les contacts sont abîmés, la batterie ne pourra pas se charger correctement.
- Utilisez exclusivement des batteries Spectralink avec les chargeurs Spectralink.
- N'utilisez jamais de chargeurs autres que ceux de la gamme Spectralink car ils risqueraient d'endommager la batterie.
- Utilisez toujours l'adaptateur d'alimentation fourni avec les chargeurs.
- Si votre batterie est défectueuse ou en cas de problème avec votre chargeur, contactez le représentant du service à la clientèle pour obtenir une assistance.



Ne plongez pas la batterie dans l'eau et ne la jetez pas au feu.

Ne jetez pas la batterie avec vos ordures ménagères. Déposez les batteries usagées à un point de recyclage ou renvoyez-les à votre fournisseur ou agent de maintenance.



Caution

Toutes les batteries peuvent entraîner des dommages matériels et/ou des blessures corporelles, par exemple des brûlures, si un matériau conducteur comme un bijou, des clés ou des chaînes à perles entrent en contact avec les bornes exposées. Le matériau conducteur peut refermer un circuit électrique (court-circuit) et devenir assez chaud. Soyez vigilant lorsque vous manipulez une batterie chargée, en particulier si vous la placez à l'intérieur d'une poche, d'un porte-monnaie ou de tout autre réceptacle contenant des objets métalliques.

Téléphones sans fil



AVERTISSEMENT : Toute modification apportée à cet équipement qui n'a pas été expressément approuvée par Spectralink peut altérer la conformité de l'appareil à la section 15 des normes de la FCC, annulant alors votre droit d'utiliser cet appareil.



AVERTISSEMENT : Les produits de Spectralink ne contiennent aucune pièce réparable par l'utilisateur. Pour toute réparation, adressez-vous à un technicien qualifié.



Il est recommandé de suivre les procédures d'acceptation standard avant d'utiliser cet équipement à proximité d'équipements d'assistance respiratoire.



L'écouteur peut contenir des objets magnétiques.

Avertissements concernant le fonctionnement

Atmosphères potentiellement explosives

Mettez votre combiné hors tension avant d'entrer dans une zone présentant une atmosphère potentiellement explosive. Ne retirez pas, n'installez pas et ne chargez pas les piles dans ces zones. Dans une atmosphère potentiellement explosive, des étincelles peuvent provoquer une explosion ou un incendie, entraînant des blessures corporelles, voire la mort.



Les zones à atmosphère potentiellement explosive auxquelles il est fait référence ci-dessus comprennent les zones de ravitaillement en carburant, par exemple les ponts inférieurs de bateaux, les installations de transvasement ou d'entreposage de carburant ou de produits chimiques, les zones où l'air contient des produits chimiques ou des particules telles que des grains, des poussières ou des poudres métalliques et toute autre zone où il vous est généralement recommandé d'éteindre le moteur de votre véhicule. Les zones à atmosphère potentiellement explosive sont souvent, mais pas toujours, clairement signalées.

Interférences électromagnétiques et compatibilité



Quasiment tous les appareils électroniques sont sensibles aux interférences électromagnétiques (EMI) s'ils ne sont pas convenablement protégés, conçus ou configurés pour être compatibles avec ce type d'énergie.

Établissements particuliers

Pour éviter les interférences électromagnétiques et tout problème de compatibilité, mettez votre combiné hors tension dans tout établissement où des panneaux vous invitent expressément à l'éteindre. Les hôpitaux ou les centres de santé sont susceptibles d'utiliser des équipements sensibles à l'énergie externe des radio-fréquences.

Stimulateurs cardiaques

L'association des fabricants de matériel médical recommande que les équipements radio portables sans fil soient maintenus à une distance minimale de 15 centimètres des stimulateurs cardiaques. Ces recommandations sont conformes aux recherches et aux recommandations du cabinet indépendant Wireless Technology Research. Il est recommandé aux personnes portant un stimulateur cardiaque de :

- TOUJOURS maintenir le combiné, lorsqu'il est sous tension, à une distance minimale de 15 cm de leur stimulateur cardiaque ;
- ne pas porter le combiné dans une poche proche de leur cœur ;
- utiliser l'oreille du côté opposé à celui du stimulateur cardiaque pour minimiser les interférences potentielles ;
- mettre immédiatement hors tension le combiné s'ils soupçonnent le moindre problème d'interférences.

Autres appareils médicaux

Si vous utilisez un autre appareil médical, consultez son fabricant afin de déterminer s'il est suffisamment protégé contre l'énergie RF externe. Votre médecin peut vous aider à obtenir ces informations.

Utilisation au volant

Si vous conduisez des véhicules, par exemple des chariots élévateurs à fourche ou des voiturettes de golfe, sur votre campus ou au sein de vos entrepôts, vous devez respecter les lois et réglementations régissant l'usage des téléphones portables au volant :

- Vous devez être très attentif à la route, à l'allée ou au chemin où vous circulez.
- Utilisez la fonction mains libres, si celle-ci est disponible.
- Le cas échéant, arrêtez-vous et garez-vous sur le côté de la route, de l'allée ou du chemin avant d'effectuer un appel ou d'y répondre.

Pour les véhicules équipés d'un airbag

Ne posez pas un combiné portable sur un airbag ou dans sa zone de déploiement. Les airbags se gonflent avec puissance. Si un combiné est posé dans sa zone de déploiement et l'airbag se gonfle, le combiné risque d'être violemment projeté à l'intérieur du véhicule et de blesser gravement les occupants.

Appendix D: Specific Absorption Rate (SAR) Information

Your wireless handset is a low power radio transmitter and receiver. When it is on, it receives and sends out radio frequency (RF) signals. In August 1996, the Federal Communications Commission (FCC) adopted radio frequency (RF) exposure guidelines with safety levels for hand-held wireless handsets. Those guidelines are consistent with the safety standards previously set by both U.S. and international standards bodies:

- ANSI C95.1 (1992) American National Standards Institute
- NCRP - Report 86 (1986) National Council on Radiation Protection and Measurements
- ICNIRP (1996) International Commission on Non-Ionizing Radiation Protection
- DHWC - Safety Code 6 Department of Health and Welfare Canada

These standards were developed by independent scientific organizations through periodic and thorough evaluation of scientific studies. The standards include a substantial safety margin designed to assure the safety of all persons, regardless of age and health. The exposure standard for wireless mobile handsets employs a unit of measurement known as the Specific Absorption Rate, or SAR. The SAR limit set by the FCC is 1.6W/kg.



In the United States and Canada, the SAR limit for mobile handsets used by the public is 1.6 watts/kg (W/kg) averaged over one gram of tissue. The standard incorporates a substantial margin of safety to give additional protection for the public and to account for any variations in measurements.

The FCC conducts tests for SAR using standard operating positions specified by the FCC with the handset transmitting at its highest certified power level in all tested frequency bands. Although the SAR is determined at the highest certified power level, the actual SAR level of the handset while operating can be well below the maximum value. This is because the handset is designed to operate at multiple power levels so that it uses only the power required to reach the network. Before a handset model is available for sale to the public, the FCC must test and certify it to ensure that phones do not exceed the limit established by the government-adopted requirement for safe exposure. The tests are performed in positions and locations (at the ear and worn on the body) as required by the FCC for each model. While there may be differences between the SAR levels of various handsets and at various positions, they all meet the government requirement for safe exposure.

The FCC has granted an Equipment Authorization for this model handset with all reported SAR levels evaluated in compliance with the FCC RF emission guidelines.

SAR information on this model handset is on file with the FCC. You can find it under the Display Grant section at <http://www.fcc.gov/oet/ea> after searching on the FCC ID number found on the

handset label inside the battery compartment. Additional information on Specific Absorption Rates (SAR) can be found on the Cellular Telecommunications Industry Association (CTIA) Website at <http://www.ctia.org>.

6020 frequency: 902.4817 – 927.4826 MHz

6020-(head): 0.463 mW/g

6020-(body): 0.223 mW/g